



**HAL**  
open science

## Ammonia based CO<sub>2</sub> capture process using hollow fiber membrane contactors

Camel Makhloufi, Elsa Lasseguette, Jean Christophe Remigy, Bouchra Belaïssaoui, Denis Roizard, Eric Favre

► **To cite this version:**

Camel Makhloufi, Elsa Lasseguette, Jean Christophe Remigy, Bouchra Belaïssaoui, Denis Roizard, et al.. Ammonia based CO<sub>2</sub> capture process using hollow fiber membrane contactors. *Journal of Membrane Science*, 2014, 455, pp.236-246. 10.1016/j.memsci.2013.12.063 . hal-01278693

**HAL Id: hal-01278693**

**<https://hal.univ-lorraine.fr/hal-01278693>**

Submitted on 9 Nov 2018

**HAL** is a multi-disciplinary open access archive for the deposit and dissemination of scientific research documents, whether they are published or not. The documents may come from teaching and research institutions in France or abroad, or from public or private research centers.

L'archive ouverte pluridisciplinaire **HAL**, est destinée au dépôt et à la diffusion de documents scientifiques de niveau recherche, publiés ou non, émanant des établissements d'enseignement et de recherche français ou étrangers, des laboratoires publics ou privés.





## Open Archive Toulouse Archive Ouverte (OATAO)

OATAO is an open access repository that collects the work of Toulouse researchers and makes it freely available over the web where possible

This is an author's version published in: <http://oatao.univ-toulouse.fr/20258>

**Official URL:** <https://doi.org/10.1016/j.memsci.2013.12.063>

**To cite this version:**

Makhloufi, Camel and Tournadre-Lasseugnette, Elsa  and Remigy, Jean-Christophe  and Belaisaoui, Bouchra and Roizard, Denis and Favre, Eric *Ammonia based CO2 capture process using hollow fiber membrane contactors*. (2014) *Journal of Membrane Science*, 455. 236-246. ISSN 0376-7388

Any correspondence concerning this service should be sent to the repository administrator: [tech-oatao@listes-diff.inp-toulouse.fr](mailto:tech-oatao@listes-diff.inp-toulouse.fr)

# Ammonia based CO<sub>2</sub> capture process using hollow fiber membrane contactors

Camel Makhloufi<sup>a</sup>, Elsa Lasseuguette<sup>b,c</sup>, Jean Christophe Remigy<sup>b,c</sup>, Bouchra Belaissaoui<sup>a</sup>, Denis Roizard<sup>a</sup>, Eric Favre<sup>a,\*</sup>

<sup>a</sup> LRGP-CNRS Université de Lorraine 1, rue Grandville, 54001 Nancy, France

<sup>b</sup> Université de Toulouse, INPT, UPS, Laboratoire de Génie Chimique 4, Allée Emile Monso, 31030 Toulouse, France

<sup>c</sup> CNRS, Laboratoire de Génie Chimique, 31030 Toulouse, France

## ARTICLE INFO

### Keywords:

Membrane contactors

CO<sub>2</sub>

Absorption

Carbon capture

NH<sub>3</sub>

## ABSTRACT

Due to its low regeneration energy demands relative to MEA, ammonia is one of the most attractive solvents for post-combustion CO<sub>2</sub> capture processes. Nevertheless, additionally to a lower kinetic constant, a high ammonia slip takes place when the absorption process is performed in a packed column. In this study, the feasibility of an ammonia based CO<sub>2</sub> capture process using hollow fiber membrane contactors is investigated. CO<sub>2</sub> absorption experiments in ammonia have been performed with porous polypropylene membranes (Oxyphan) and with two different dense skin composite hollow fibers: tailor made (Teflon AF2400) and commercial (TPX). It is shown that microporous membranes do not offer stable performances, due to salt precipitation and pore blocking. Contrarily however, dense skin membranes show stable and attracting performances, whatever the operating conditions: reduced ammonia slip and intensified CO<sub>2</sub> mass transfer are obtained compared to packed column. The potentialities of dense skin membrane contactors, particularly based on fluorinated polymers, are discussed with regard to both increased CO<sub>2</sub> mass transfer performances and mitigation of ammonia volatilization compared to conventional gas/liquid contactors.

## 1. Introduction

Climate change, which is closely related to anthropogenic CO<sub>2</sub> emissions, is one of the main growing issues our society has to face. Particularly, electricity production, mostly performed using fossil fuels, is the largest stationary source. Beyond promoting renewable energies, large efforts have been carried out to reduce CO<sub>2</sub> emissions through improved power plant efficiencies. Nevertheless, developing technologies able to remove CO<sub>2</sub> is still required in order to achieve the recommended objectives. Coal being the most widespread resource available, post-combustion CO<sub>2</sub> capture from coal fired-plant flue gas is of higher interest, especially for retrofit purpose [1]. Up to now, the most mature technology for post-combustion capture consists in reacting CO<sub>2</sub> with a chemical solvent in a packed column. The reference solvent is an extremely reactive primary amine with fast reaction kinetics: monoethanolamine (MEA). Despite extensive research efforts, large scale deployment is not likely to happen. Indeed, energy penalty related to MEA based CO<sub>2</sub> capture process in packed column is prohibitive consequently to the high regeneration energy demand induced by this solvent (around 4 GJ per ton

of CO<sub>2</sub> removed) [2]. Besides, MEA is corrosive and is subjected to thermal and oxidative degradation by O<sub>2</sub> and SO<sub>2</sub>. As a result, volatile pollutants are produced and significant MEA losses take place (up to 6.5 kg MEA per ton CO<sub>2</sub>) [3]. Accordingly, an important solvent make up increasing the operational cost and a deep desulfurization of the flue gas (content less than 5 ppm) are compulsory [4].

For these reasons, numerous studies investigate new absorption solvents for post-combustion CO<sub>2</sub> capture and, over time, ammonia in aqueous solution has appeared as a serious candidate for that purpose [5]. Firstly, NH<sub>3</sub> could significantly reduce the energy regeneration demands and save up to 75% energy compared to MEA. In addition, NH<sub>3</sub> is cheaper than MEA (ratio 1/6 on the same mass basis) and its absorption capacity is 3 times higher. Finally, NH<sub>3</sub> is not corrosive and does not suffer from thermal or oxidative degradation. On the contrary, reusable products can be formed when reacting with NO<sub>x</sub> and SO<sub>x</sub> and a combined capture of these pollutants can be introduced. Nevertheless, ammonia shows two main drawbacks that lower its interest. First of all, ammonia absorption kinetics is less favorable than MEA, leading thus to larger absorber which increases the investment cost. Then, being highly volatile, high ammonia losses are generally observed when the absorption is performed in direct gas/liquid units such as packed columns. A washing section is therefore required to meet the ammonia emissions limits, thereby increasing again the

\* Corresponding author. Tel.: +33 383 17 53 90.

E-mail address: Eric.Favre@univ-lorraine.fr (E. Favre).

operating costs. Additionally, a solvent make-up must be considered. In that context, a gas/liquid contactor offering both improved CO<sub>2</sub> mass transfer performances and mitigating the ammonia slip compared to packed column could be of major interest.

Initially tested for CO<sub>2</sub> absorption by NaOH using microporous hollow fibers [6,7], membrane contactors are now considered as one of the most promising intensification strategies [8]. Generally speaking, hollow fiber membrane contactors could logically be of interest as gas/liquid units for the absorption of CO<sub>2</sub> in ammonia solution. Indeed, the very large interfacial area developed by membrane contactors (up to 6000 m<sup>2</sup>/m<sup>3</sup>) compared to packed columns (around 300 m<sup>2</sup>/m<sup>3</sup>) could potentially result in a significant improvement of the CO<sub>2</sub> absorption capacity compared to conventional absorption processes [9]. Furthermore, ammonia losses due its high volatility being certainly worsened by a direct contact between gas and liquid, the indirect gas/liquid contact allowed by membrane contactors could possibly lead, at first glance, to ammonia slip mitigation. To our knowledge, no study discussing the feasibility of a process using hollow fiber membrane contactors for CO<sub>2</sub> absorption in ammonia has been reported up to now.

A large number of studies dealing with CO<sub>2</sub> absorption by membrane contactors involve hydrophobic microporous hollow fibers for which impressive intensification factors have been reported [10,11]. Nevertheless, membrane wetting usually takes place after long term use decreasing thus the overall mass transfer coefficient [12]. While many studies have shown that the long term use of MEA for CO<sub>2</sub> absorption results in the membrane wetting for several membrane materials, no study discusses the use of microporous hollow fiber for CO<sub>2</sub> absorption in ammonia. In this work, the potential of microporous hollow fibers as gas/liquid contactor for an ammonia based CO<sub>2</sub> absorption process will be evaluated and discussed.

To avoid membrane wetting, the reference alternative consists in using composite hollow fibers membrane contactor where a thin dense layer added to a microporous support acts as a physical barrier facing the liquid phase [13,14]. In that case, wetting is suppressed while mass transport performances can be found comparable to those observed in microporous membrane contactors [15] in the peculiar case where the dense skin is properly

chosen. Composite hollow fiber membrane contactors as gas liquid contactors for ammonia based CO<sub>2</sub> capture process could be of interest compared to conventional CO<sub>2</sub> absorption in a packed column. Indeed, a chemically resistant composite fiber made of a thin dense layer ideally highly permeable to CO<sub>2</sub> but less permeable to NH<sub>3</sub> could potentially lead to a high CO<sub>2</sub> mass transfer intensification while drastically lowering ammonia slip.

In the following, the feasibility, advantages and drawbacks of both conventional microporous and composite hollow fibers for the absorption of CO<sub>2</sub> in ammonia will be discussed on the basis of experimental work performed using different lab scale modules.

Numerous publications have been already reported for membrane contactors fundamental studies and applications [16,17]. Generally speaking, the transfer of a single species is systematically studied, either in an absorption or in a stripping configuration (Fig. 1). The study detailed in this paper is however unique in that the simultaneous transfer of two different reacting compounds (CO<sub>2</sub> and NH<sub>3</sub>) in two opposite directions is considered (Fig. 1c). The system is further complicated by the role of water and the possibility to generate precipitating solids through the reaction between CO<sub>2</sub>, NH<sub>3</sub> and H<sub>2</sub>O. As a consequence, solid salt formation as well as ammonia causticity should absolutely be taken into account for fiber selection.

The objectives of the study are the following:

1. Evaluate the possibilities and limitations of membrane contactors based on microporous membranes for CO<sub>2</sub> absorption in ammonia.
2. Achieve dense materials screening tests, in order to identify the most appropriate dense skin polymer for CO<sub>2</sub> absorption in ammonia, with an emphasis on chemical resistance and precipitating salt complications.
3. Design dense skin composite hollow fiber membrane contactors based on the polymer proposed in step 2, and achieve absorption tests at laboratory scale, with an analysis of the effect of different operating conditions on process performances.
4. Determine the mass transfer characteristics of the different membrane contactors and perform a performances comparison with conventional packed columns.

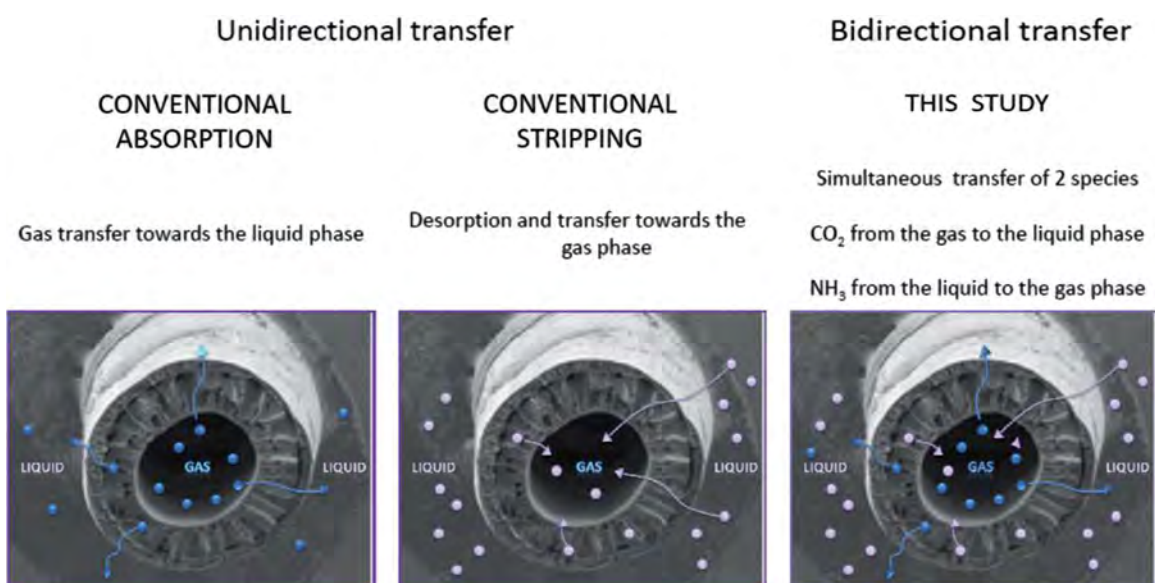

**Fig. 1.** Different types of situations investigated for gas-liquid membrane contactors applications. Studies almost systematically address a single solute absorption (a) or stripping (b) operation. In this study, the simultaneous CO<sub>2</sub> absorption and NH<sub>3</sub> stripping is considered (c).

## 2. Mass transfer in hollow fiber membrane contactors

Membrane contactors are a promising alternative to packed column, especially in absorption processes accompanied with a fast reaction where the interfacial area should be favored relatively to the reactor volume [18]. Nevertheless, the membrane induces a supplementary mass transfer resistance compared to direct gas/liquid contactors and the overall CO<sub>2</sub> mass transfer coefficient  $K_{CO_2}$  from the flue gas to the absorbing solution is generally lowered. The membrane resistance is particularly important in the case of composite materials where a dense layer, generally placed at the outer surface of a microporous support, is used as a physical separation between flue gases and absorbing medium. To compete with conventional CO<sub>2</sub> absorption processes using direct gas/liquid contactor, the microporous or composite fibers used should allow a high CO<sub>2</sub> mass transfer from the flue gas to the ammonia solution. At the same time, NH<sub>3</sub> transfer from the solution to the gas phase should be as low as possible.

To better understand the respective transport of CO<sub>2</sub> and NH<sub>3</sub> and design the most appropriate membrane contactor, a detailed analysis of the overall mass transfer coefficient for each type of system is needed.

### 2.1. Overall mass transfer coefficient $K_{CO_2}$ and $K_{NH_3}$

The CO<sub>2</sub> and NH<sub>3</sub> overall mass transfer coefficient respectively from the gas phase to the absorption liquid ( $K_{CO_2}$ ) and from the ammonia solution to the gas phase ( $K_{NH_3}$ ) can be described using the in resistance-in-series model (Fig. 2). The global resistance for each species corresponds to the sum of the resistances induced by the gas, membrane and liquid phase [19]. In the case where the flue gas is circulated in the fibers lumen, the overall mass transfer coefficients  $K_{CO_2}$  and  $K_{NH_3}$  can be linked to the individual mass

transfer coefficients using the following expressions [16,20,21]:

$$\frac{1}{K_{CO_2}} = \frac{d_o}{d_i} \frac{1}{k_g} + \frac{d_o}{d_{lm}} \frac{1}{k_{mCO_2}} + \frac{H_{CO_2}}{RT} \frac{1}{Ek_L} \quad (1)$$

$$\frac{1}{K_{NH_3}} = \frac{d_o}{d_i} \frac{1}{k_g} + \frac{d_o}{d_{lm}} \frac{1}{k_{mNH_3}} + \frac{H_{NH_3}}{RT} \frac{1}{k_L} \quad (2)$$

where  $d_o$ ,  $d_i$  and  $d_{lm}$  are respectively the outer, inner and logarithmic mean diameter of the composite fiber (expressed in  $m$ ).  $k_g$  and  $k_l$  are the individual gas and liquid mass transfer coefficient related to CO<sub>2</sub> and NH<sub>3</sub> ( $m\ s^{-1}$ ).  $k_{mCO_2}$  and  $k_{mNH_3}$  are the membrane mass transfer coefficients of CO<sub>2</sub> and NH<sub>3</sub> through the membrane ( $m\ s^{-1}$ ).  $E$  is the enhancement factor due to the chemical reaction of CO<sub>2</sub> with ammonia within the liquid phase.  $H_{CO_2}$  and  $H_{NH_3}$  are the Henry constant related to CO<sub>2</sub> and NH<sub>3</sub> ( $Pa\ m^3\ mol^{-1}$ ). NH<sub>3</sub> under its free form being in equilibrium within the solution with NH<sub>4</sub><sup>+</sup> ions,  $H_{NH_3}$  is considered as a function of the solution pH. This should reflect the evolution of the free ammonia species concentration as a function of the absorption reaction.

A high  $K_{CO_2}/K_{NH_3}$  ratio is expected, due to the chemical reaction enhancement term. Increasing  $K_{CO_2}$  to enhance the CO<sub>2</sub> mass transfer and simultaneously lowering  $K_{NH_3}$  to mitigate ammonia volatilization would be of major interest, but this requires one to carefully design the membrane mass transfer properties through optimizing the specific mass transfer resistance for each species. This possibility is discussed afterwards.

### 2.2. Membrane mass transfer coefficient $k_m$

#### 2.2.1. Microporous membrane mass transfer coefficient

The transport of a gaseous penetrant through a microporous membrane is defined by the microporous membrane mass transfer

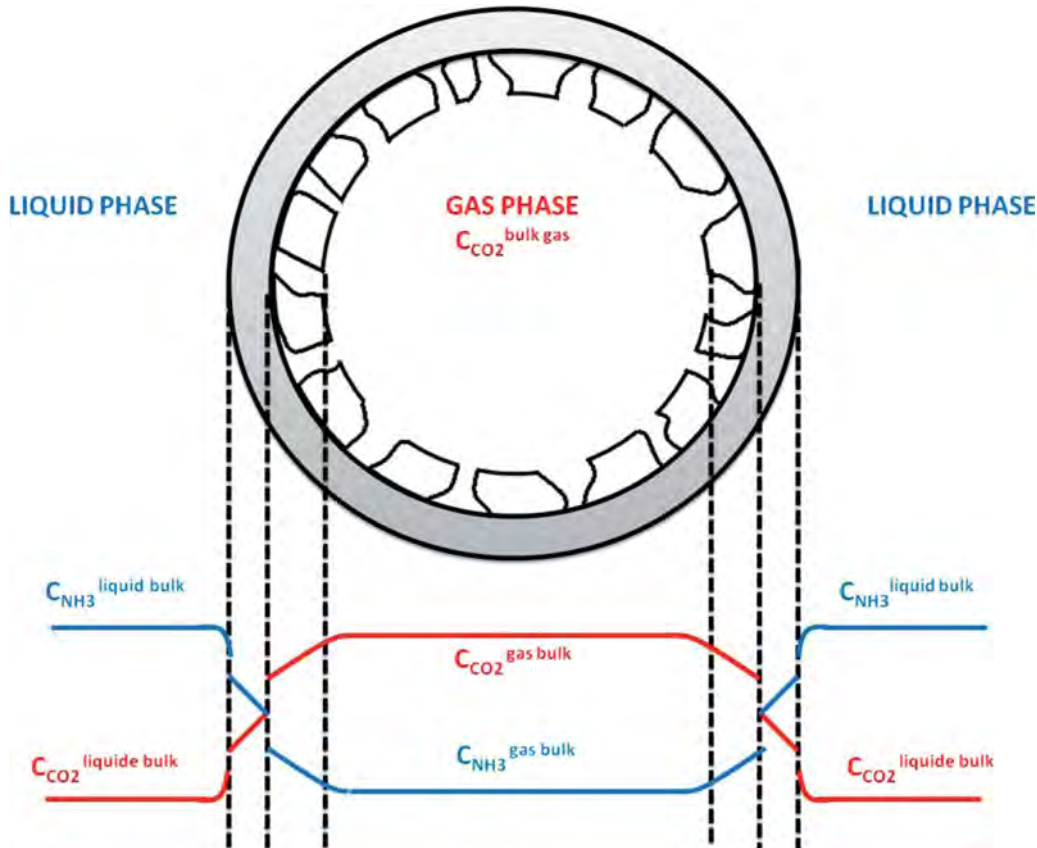

Fig. 2. CO<sub>2</sub> and NH<sub>3</sub> concentration profiles for ammonia based CO<sub>2</sub> capture process using hollow fibers membrane contactor.

coefficient  $k_{\text{micro}}$  given by the following relationship [16]:

$$k_{\text{micro}} = \frac{D_{\text{gas}} \epsilon}{\tau e_{\text{micro}}} \quad (3)$$

$k_{\text{micro}}$  is primarily a function of the material thickness ( $e_{\text{micro}}$ ) and structural properties, namely porosity  $\epsilon$ , tortuosity  $\tau$  and pore radius. In addition, it depends on the gas diffusivity within the pores ( $D_{\text{gas}}$ ) and particularly on the ratio between the mean pore radius  $r_p$  and the molecular mean free path which defines the penetrant mass transfer mechanism (mainly molecular diffusion or Knudsen). In order to maximize the gas diffusivity through the microporous structure during  $\text{CO}_2$  absorption operation, non-wetted mode is necessary (i.e. with the porous network filled with gas).

Reaching high  $\text{CO}_2$  mass transfer performances using a microporous membrane involves selecting a membrane as thin as possible and showing both a high porosity with large mean pore radius and low tortuosity. Nevertheless, these features necessarily maximize at the same time the ammonia slip from the liquid to the gas phase, because the  $\text{CO}_2$  and  $\text{NH}_3$  diffusion coefficients in gaseous phase are very close [19].

### 2.2.2. Composite membrane mass transfer coefficient and transport through the dense layer

In the case of a composite membrane (Fig. 2), the overall membrane resistance is the sum of the resistances due to the microporous support and the dense layer [15]:

$$\frac{1}{k_m} = \frac{1}{k_{\text{micro}}} + \frac{1}{k_{\text{dense}}} \quad (4)$$

$k_{\text{mdense}}$  can be determined precisely if the mass transport properties of the different species are known. Indeed, each species is transferred through the dense layer through a solution diffusion mechanism [22]. As a consequence, the process is fully determined by:

- A thermodynamic factor which corresponds to the solubility in the polymer  $S$  ( $\text{mol m}^{-3} \text{Pa}^{-1}$ )
- A kinetic factor which corresponds to the species diffusion coefficient in the dense polymer  $D$  ( $\text{m}^2 \text{s}^{-1}$ ).

These two contributions are gathered together in a term generally used to characterize the transport of a given species through a dense polymer: the permeability coefficient  $\mathcal{P}$  ( $\text{mol m m}^{-2} \text{s}^{-1} \text{Pa}^{-1}$ ). As a consequence, the dense layer mass transfer coefficient can be obtained through [15]

$$k_{\text{mdense}} = \frac{\mathcal{P}RT}{e_{\text{dense}}} \quad (5)$$

with  $e_{\text{dense}}$  the dense skin thickness (m) and  $\mathcal{P}$  the permeability coefficient related to  $\text{CO}_2$  or  $\text{NH}_3$  through the considered dense skin.

It should be stressed that, whereas microporous membranes only offer a limited number of degrees of freedom for differentiating  $\text{CO}_2$  and  $\text{NH}_3$  mass transfer, a meticulous selection of the dense skin could potentially allow maximizing  $\text{CO}_2$  mass transfer while lowering ammonia slip. This target requires designing a composite hollow fiber membrane contactor made of a chemically resistant dense layer showing both [23]:

- a  $\text{CO}_2$  permeability as high as possible,
- a  $\text{NH}_3$  permeability as low as possible,

The possibilities and limitations with respect to this selective mass transfer tuning property are some of the key targets of this study.

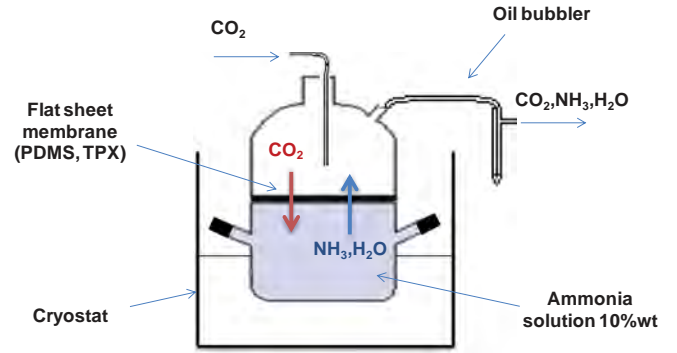

Fig. 3. Experimental setup used for dense polymeric materials screening tests.

## 3. Materials and methods

### 3.1. Polymeric films

TPX<sup>®</sup> flat sheets were purchased from Goodfellow Cambridge Limited<sup>®</sup>. PDMS was obtained from Perouse Plastique. All samples were used as received. Flat membranes of the copolymers poly(2,2-bis(trifluoromethyl)-4,5-difluoro-1,3-dioxole-co-tetrafluoroethylene) (Teflon AF2400<sup>®</sup>, Dupont) were prepared by solution casting from polymer pellets. Homogeneous Teflon AF2400<sup>®</sup> films were prepared by casting a 1 wt% solution, previously filtered to 0.45  $\mu\text{m}$ , onto glass dishes in Fluorinert FC-72 (3 M) fluids. After a slow and controlled evaporation of the solvent, the membranes were dried under vacuum at a temperature below the glass transition temperature until constant weight was reached.

### 3.2. Permeability measurements and chemical resistance assessment

Preliminary absorption experiments were performed using laboratory made flat sheet membranes. The experimental setup (Fig. 3) consists in two compartments separated by a flat sheet. A stagnant fresh ammonia solution of a given concentration is placed in the bottom part of the apparatus while pure  $\text{CO}_2$  flows in the upper part of the setup. The whole setup is disposed within a cryostat in order to precisely control the temperature. Each experiment was performed using a 10 wt% ammonia solution for a single value of the  $\text{CO}_2$  volumetric flow. A rubbery amorphous polymer (polydimethylsiloxane) as well as a glassy material (TPX) were tested in order to stress their ability to chemically withstand the harsh conditions met during the  $\text{CO}_2$  absorption process in ammonia. Their physical aspect as well as the amount of ammonium salt absorbed has to be taken into account in the material selection process.

Besides chemical resistance tests,  $\text{CO}_2$  and  $\text{NH}_3$  permeability measurements were performed using the Time Lag method [24]. The upstream and downstream pressure gauges are MKS Baratron, respectively, 870B 0–7 bar and 626B 0–26 mbar. The set up is thermostated and each experiment is performed at 294 K. The tests were repeated on a given membrane until at least 5 experiments showing results within an average error of 5% were obtained for the set of conditions tested. After permeation tests were performed using  $\text{CO}_2$  and  $\text{NH}_3$ , any alteration of the membrane performance was verified by performing reference time lag experiments. Any variation of the transport parameter higher than the average error led to a withdrawal of the polymer sample. Care was taken to neutralize all ammonia effluents in sulfuric acid solutions.

**Table 1**  
Characteristics of the three types of membrane contactors tested in this study.

	Oxyphan	Oxyphan-Teflon AF 2400	Oxyplus
Nature of the fiber	Microporous	Composite	Composite
Nature of the dense skin	–	Teflon AF2400	Poly(4-methyl-1-pentene)
Dense skin thickness ( $\mu\text{m}$ )	–	1.3	0.1
Microporous fiber material	Polypropylene	Polypropylene	Polypropylene
Microporous fiber outer diameter ( $\mu\text{m}$ )	380	380	380
Fiber inner diameter ( $\mu\text{m}$ )	280	280	200
Fiber number	54	54	54
Liquid flow conditions	Shell side	Shell side	Shell side

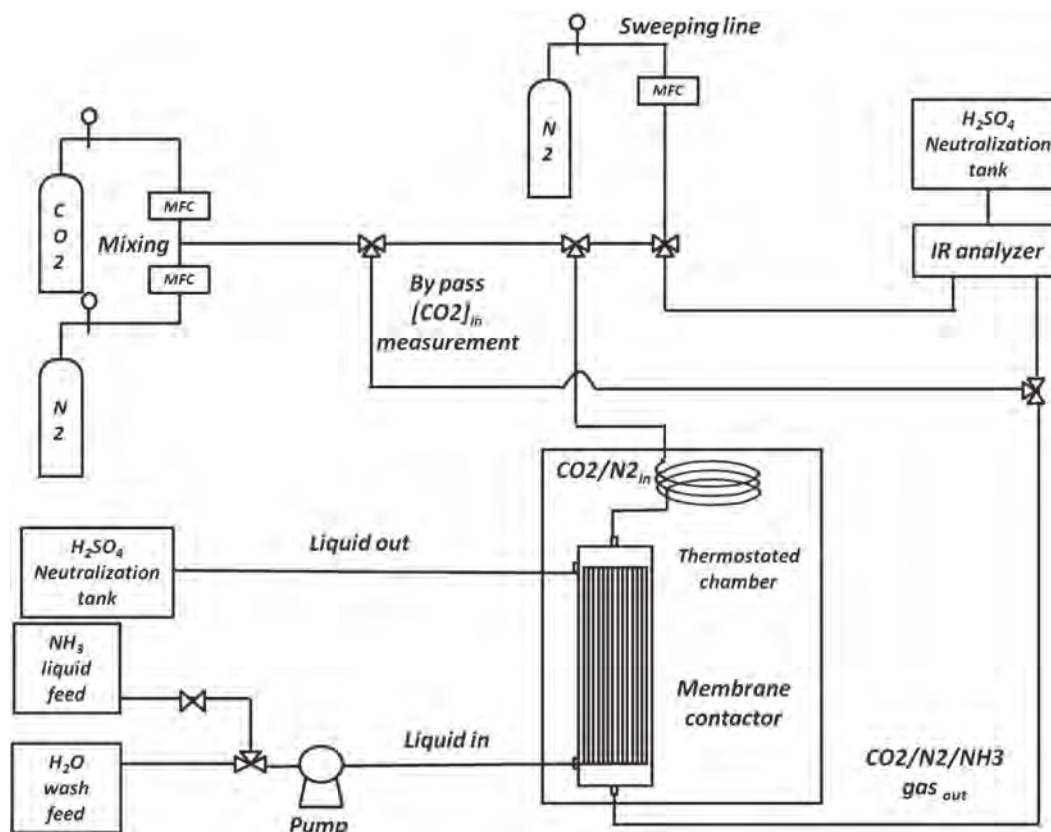

**Fig. 4.** Experimental setup used for gas/liquid absorption tests with hollow fiber membrane contactors.

### 3.3. Hollow fibers preparation

Two different types of hollow fiber membrane contactors were designed for this study: microporous membrane contactors and composite membrane contactors. The microporous membrane contactors are made of commercial polypropylene hollow fibers (Oxyphan). Additionally, two other contactors, made of dense skin composite hollow fibers, were prepared: one tailor made obtained by coating a Teflon AF2400 solution on the outer surface of an Oxyphan fiber used as microporous support [15], and a commercial hollow fiber (Oxyplus, Membrana) made of a thin layer of poly(4-methyl-1-pentene) coated on the external surface of a polypropylene microporous support. In each case, the fibers used have been gathered together in the form of a module of 54 fibers for gas/liquid absorption test. Fibers and module characteristics are summarized in Table 1.

### 3.4. Gas/liquid absorption setup

The experimental setup used for the absorption experiments is shown in Fig. 4. A gas mixture made of CO<sub>2</sub> and N<sub>2</sub> (15/85 vol) is

produced by means of 2 mass flow controllers (Bronckorst El-Flow Select) and flows through the fibers lumen at atmospheric pressure. Besides, a freshly prepared aqueous ammonia solution (1–3–5 wt%) is circulated counter-currently to the gas mixture in the membrane contactor shell side using a peristaltic pump (Watson and Marlow 314D). The membrane contactor is placed in a thermostated chamber and experiments are performed at 21 °C and 45 °C. A 20 m long stainless steel coil is placed in the enclosure upstream to the membrane contactor for a proper control of the gas temperature. Inlet and outlet gas concentrations (CO<sub>2</sub>, NH<sub>3</sub>) are measured on line using an infrared analyzer MGA3000 (Gruter and Marchand). All ammonia effluents, being gaseous or liquid, are neutralized in sulfuric acid solution. To ensure that the ammonia measured in the outlet gas results from ammonia evaporation only, a water wash of the shell side is performed between each experiment. Moreover, an additional nitrogen sweeping line allows one to remove all the ammonia gas remaining both in the fiber lumen and in the analyzer after each experiment. The same membrane conditioning was used for all membrane contactors (microporous and composite). More specifically, membrane contactors were vacuumed prior to each

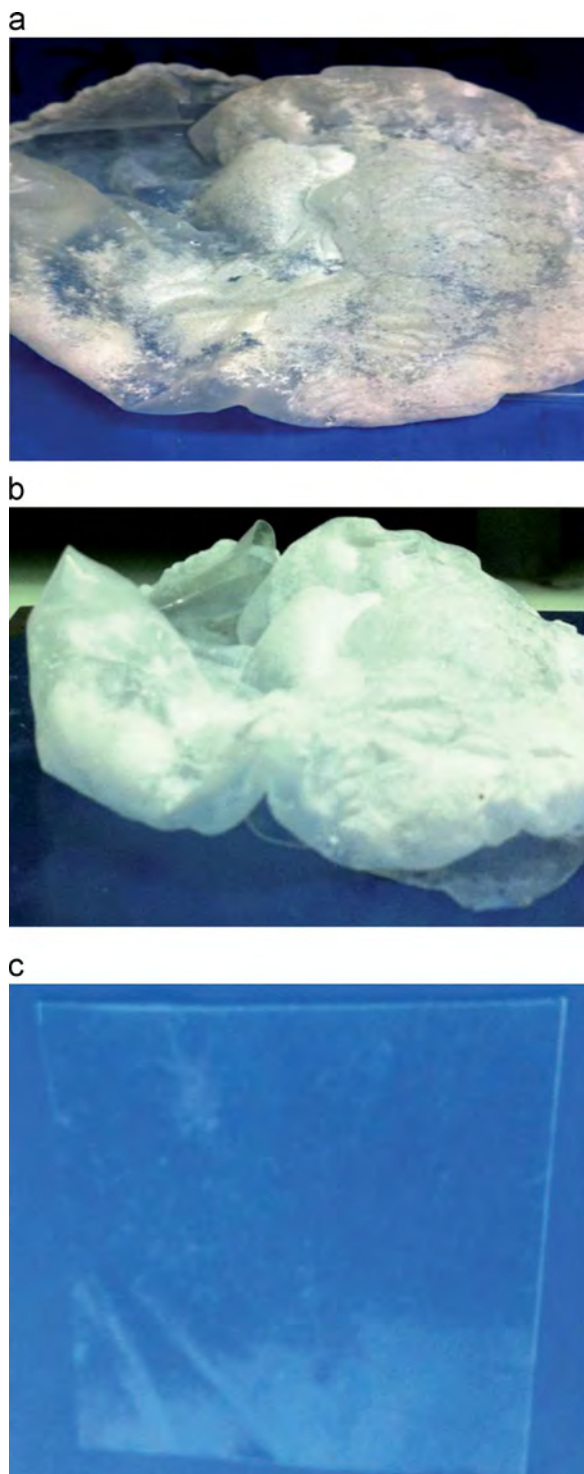

**Fig. 5.** Examples of flat membrane samples after exposure to ammonia and CO<sub>2</sub> in the set-up shown in Fig. 3. (a and b) Two different rubbery (PDMS) samples showing in situ salt precipitation and (c) TPX sample.

experiment in order to begin each test under similar experimental conditions. Care was taken to perform steady state experiments, checked through mass balance calculations. Each experiment performed on one type of membrane contactor was repeated several times on the same module; additionally, at least 2 membrane contactors of the same type were compared under similar operating conditions in order to ensure liable absorption performances.

**Table 2**

Pure CO<sub>2</sub> and NH<sub>3</sub> permeabilities of PDMS, TPX and Teflon AF2400 films obtained by time-lag experiments.

$\mathcal{P}$ (Barrer)	PDMS	TPX <sup>®</sup>	Teflon AF2400 <sup>®</sup>
$\mathcal{P}_{\text{CO}_2}$	2652 (0.7%)	99 (1.5%)	3127 (0.3%)
$\mathcal{P}_{\text{NH}_3}$	6552 (0.4%)	188 (2.9%)	1635 (0.6%)
$\alpha_{\text{CO}_2/\text{NH}_3}$	0.4	0.5	2

## 4. Results and discussion

### 4.1. Dense skin selection: preliminary screening tests

The main objective of these preliminary materials screening tests, performed with flat sheet membranes, is to evaluate the candidate polymers that withstand the harsh chemical conditions of the system and offer interesting CO<sub>2</sub> and NH<sub>3</sub> permeabilities. Among the different materials tested, totally different behaviors were observed during CO<sub>2</sub> absorption in ammonia performed, thanks to the set-up shown in Fig. 3. For instance, a large amount of solid ammonium salt is surprisingly observed when a rubbery PDMS matrix is used (Fig. 5a and b). As a consequence of the salt incorporation within this dense polymer, the membrane weight has increased by almost 400% in mass and the material is disfigured, unusable for further experiments. These results show that, with NH<sub>3</sub> and CO<sub>2</sub> fluxes occurring in the opposite directions, the chemical reaction may in some cases occur inside the polymeric structure. On the contrary, no degradation is observed when a TPX membrane is used (Fig. 5c), suggesting that a rigid glassy polymer might be more appropriate for an ammonia based CO<sub>2</sub> capture process.

Taking into accounts these chemical resistance considerations, CO<sub>2</sub> and NH<sub>3</sub> pure gas permeability measurements were performed in order to better evaluate the mass transfer through the dense layer. Time lag experiments were performed on the rubbery PDMS as well as on different glassy polymers. Particularly, TPX and Teflon AF2400 were chosen as appropriate dense skin materials. CO<sub>2</sub> and NH<sub>3</sub> pure gas permeabilities obtained performing time lag experiments for these three polymers are summarized in Table 2.

CO<sub>2</sub> permeability for PDMS, TPX and Teflon AF materials are in good agreement with the literature data [25–27]. PDMS is a solubility selective matrix favoring the transport of condensable penetrants. Being a smaller and more condensable molecule than CO<sub>2</sub>, NH<sub>3</sub> permeation is logically faster than CO<sub>2</sub> through the rubbery PDMS structure and a global selectivity  $\alpha_{\text{CO}_2/\text{NH}_3}$  lower than 1 is observed. NH<sub>3</sub> solubility in PDMS is high [24]. Its simultaneous solubilization with CO<sub>2</sub> inside the dynamic free volume network of the rubbery PDMS could potentially explain the in-situ ammonium salt precipitation observed [28]. Based on the results reported above, rubbery polymers reveal to be inappropriate and have been deliberately ruled out of the dense skin selection process.

TPX is a glassy semi-crystalline polyolefin with medium CO<sub>2</sub> permeability. Considering the size sieving properties of this polymer, NH<sub>3</sub> permeability is logically higher than CO<sub>2</sub> leading to  $\alpha_{\text{CO}_2/\text{NH}_3}$  lower than 1. On the contrary, a selectivity  $\alpha_{\text{CO}_2/\text{NH}_3}$  higher than 1 is surprisingly achieved for the super glassy Teflon AF2400. In this case, the CO<sub>2</sub> permeability is enhanced by its increased solubility in fluorinated polymers whereas NH<sub>3</sub> permeability is lower than expected by the usual correlation. This unexpected result has been previously assigned to a lower solubility ability of ammonia molecules in fluorinated structures [24]. Composite fibers made of a thin Teflon AF2400 layer have already shown CO<sub>2</sub> mass transfer coefficient comparable to those observed in microporous fibers [15]. The decreased ammonia permeability



towards Teflon AF2400 offers attractive characteristics to possibly mitigate the  $\text{NH}_3$  slip from the absorption solution. This possibility will be discussed afterwards.

More generally, the dense skin selection results reported in this section address unsolved issues on the occurrence of an external or internal salt precipitation process. A rigorous analysis of the different experimentally observed behaviors would require the complex framework of diffusion reaction coupling phenomena to be modeled [19,28]. Depending on the relative concentration ratios of  $\text{CO}_2$ ,  $\text{NH}_3$  and  $\text{H}_2\text{O}$  (which vary from one membrane to another depending on solubility) and local temperature (heat being released through the precipitation reaction), the conditions leading to salt precipitation can take place on the liquid side, inside the membrane or in the gaseous phase. We propose hereafter a tentative and qualitative data interpretation.

When a microporous materials is used, water,  $\text{CO}_2$  and  $\text{NH}_3$  fluxes will be high and no flux tuning effect can be expected from the membrane because of the absence of selectivity. Furthermore, capillary condensation effects are likely to occur in some pores. These characteristics probably favor the attainment of the salt solubility product within the membrane material, leading to in situ precipitation which has been observed with Oxyphan.

When a rubbery dense skin material such as PDMS is used, ammonia solubility is high, while water and  $\text{CO}_2$  solubilities remain larger than that in glassy polymers. These conditions may induce salt precipitation within the membrane material, such as that experimentally observed with the PDMS tests.

For glassy dense skin materials, ammonia concentration will be lower (due to the reverse selective behavior) and water and  $\text{CO}_2$  solubility is lower than in rubbery PDMS. Because no viscous flow takes place in the material (solution-diffusion process), the probability to locally attain the salt solubility product can be expected to be very low. Consequently, salt precipitation does not take place within the membrane, but may occur in the gas or liquid boundaries, where the three species probability contact is maximal.

It is obvious that these qualitative explanations remain hypothetical and should not be taken as generic. More specifically, the membrane thickness is also expected to play a role, because it will modify the fluxes and associated thermal effects.

In the following,  $\text{CO}_2$  absorption experiments performed on both microporous and composite hollow fiber membrane contactors under steady state conditions are presented and discussed.

#### 4.2. $\text{CO}_2$ absorption experiments in microporous hollow fiber membrane contactors

Generally cheaper than composite hollow fiber membrane contactors, microporous hollow fiber membranes are usually considered as the reference system for  $\text{CO}_2$  absorption operations [10,16]. Accordingly,  $\text{CO}_2$  absorption experiments were performed on polypropylene microporous hollow fibers in fresh ammonia solutions of different concentrations (1, 3, 5 wt%). Despite numerous attempts, the experiments performed have systematically revealed the impossibility to reach steady state conditions during the absorption operation. An example of results is shown in Fig. 6; it can be seen that no stable value of the  $\text{CO}_2$  removal efficiency can be achieved under the set of operating conditions. The  $\text{CO}_2$  transfer efficiency decreases indeed continuously from the very beginning of the absorption process. Visual observation confirmed that this behavior results from ammonium salt precipitation within the porous structure as well as on the lumen side of the microporous fibers. As a consequence,  $\text{CO}_2$  absorption performances turn out to be erratic and absolutely no reproducibility is observed. This phenomenon could be explained by a too high ammonia slip from the liquid phase to the gas phase where precipitation takes place in the humid environment. Microporous

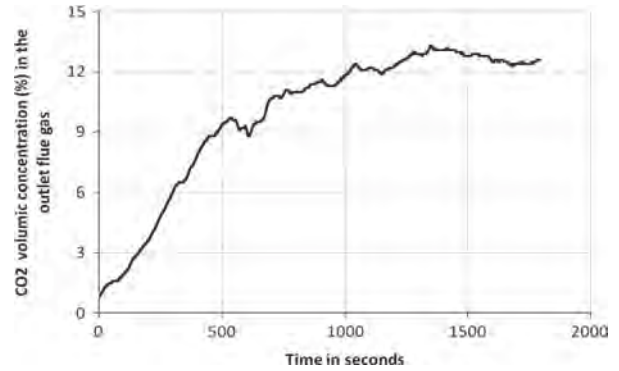

Fig. 6. Example of the evolution of  $\text{CO}_2$  outlet concentration in the gas phase for a microporous membrane contactor (Oxyphan) used for  $\text{CO}_2$  absorption in ammonia aqueous solution. The  $\text{CO}_2$  absorption performances decrease with time, due to salt precipitation.

hollow fibers being clearly inappropriate for this application, composite hollow fiber membrane contactors have been tested in a second step.

#### 4.3. $\text{CO}_2$ absorption experiments in composite hollow fiber membrane contactors

Another set of experiments was performed on commercially available contactors made of composite TPX coated PP fibers (Oxyplus) and tailor made fibers with a reverse selective dense skin of Teflon AF2400 (detailed in the materials and method section). Contrary to the results with microporous hollow fibers, all the  $\text{CO}_2$  absorption experiments achieved with these types of membranes led to perfectly reproducible steady state operation. Additionally, stability over time proved to be excellent, no performance loss being observed for any membrane contactor after more than 6 months of use. It can thus be concluded that both types of composite fibers are appropriate and resistant to the harsh operating conditions met during this process. The evaluation of the mass transfer and ammonia losses performances of the two composite fibers is detailed hereafter.

$\text{CO}_2$  mass transfer performances were evaluated according to a classical procedure detailed hereafter [6]. During the  $\text{CO}_2$  absorption process, the macroscopic  $\text{CO}_2$  mass transfer parameter for steady state conditions is the  $\text{CO}_2$  removal efficiency (or capture ratio)  $\eta$  defined by [15]:

$$\eta = \frac{Q_{\text{in}}[\text{CO}_2]_{\text{in}} - Q_{\text{out}}[\text{CO}_2]_{\text{out}}}{Q_{\text{in}}[\text{CO}_2]_{\text{in}}} \quad (6)$$

The removal efficiency which is experimentally obtained can be linked to the overall  $\text{CO}_2$  mass transfer coefficient performing a mass balance on the gas phase along the axial coordinate. In the case of  $\text{CO}_2$  absorption in membrane contactors, the following assumptions are generally proposed [6]:

- First order reaction (e.g. the  $\text{CO}_2$  and  $\text{NH}_3$  carbamate formation reaction takes place under large ammonia excess in the aqueous solution)
- Plug flow of the gas phase
- Constant gas velocity

For the sake of comparison, all absorption experiments with microporous and composite fibers were performed with the liquid phase circulating on the shell side of the membrane contactor. Indeed, the dense skin of the composite fiber is located on the outer surface of the microporous support facing the liquid absorbent. Accordingly, the following expression is used to determine

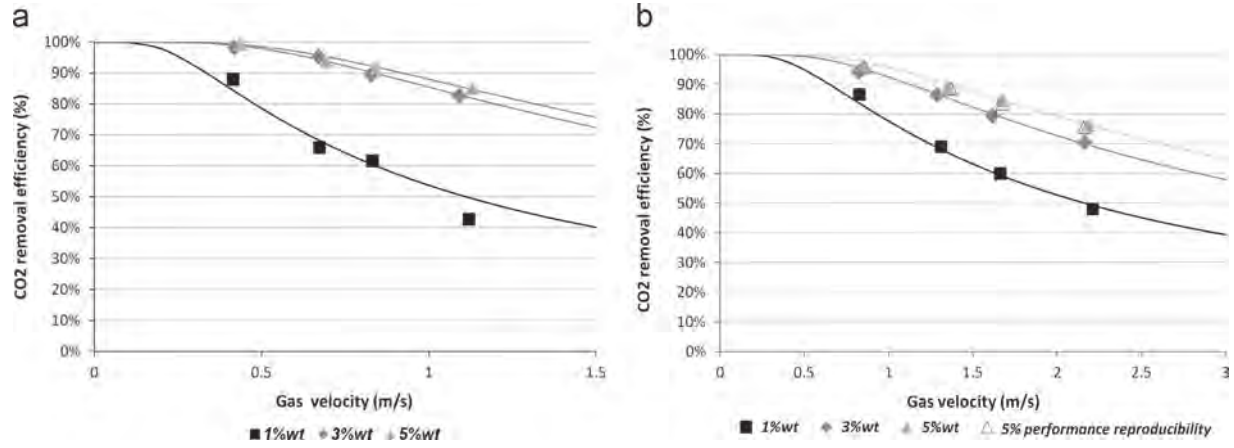

**Fig. 7.** CO<sub>2</sub> removal efficiency (capture ratio) evolution with gas phase velocity during CO<sub>2</sub> absorption experiments in ammonia at 21 °C under steady state conditions. Three different ammonia concentrations in solutions are shown. Symbols correspond to the experimental data. The lines correspond to model fit with  $K$  as adjustable parameter (Eq. (7)). (a) Composite fiber contactor Oxyphan-Teflon AF2400. (b) Composite fiber contactor Oxyplus (TPX dense skin).

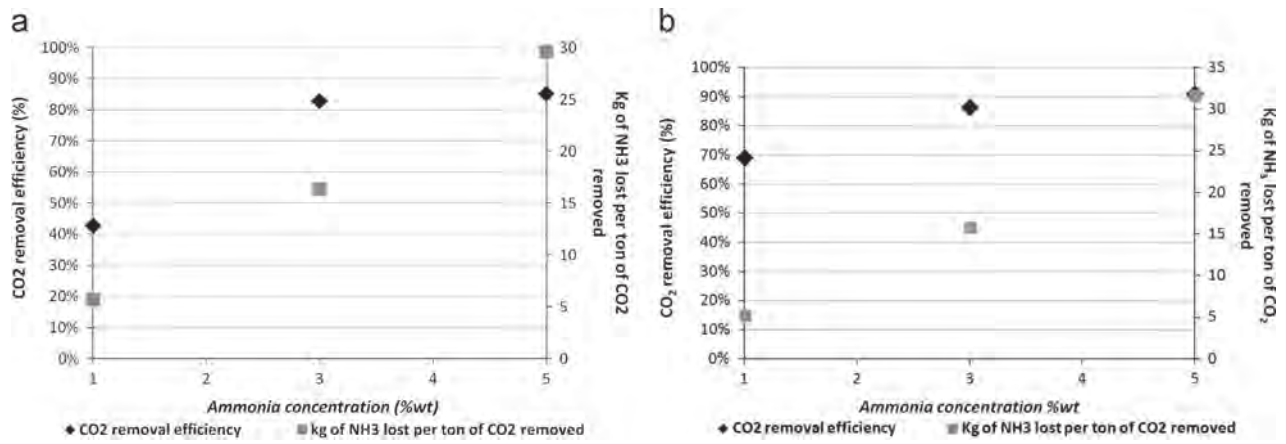

**Fig. 8.** Comparison of CO<sub>2</sub> removal efficiencies (left y axis) and ammonia slip (right y axis) for 3 different ammonia concentrations. (a) Composite fiber contactor Oxyphan-Teflon AF2400—gas velocity of 1.1 m s<sup>-1</sup>. (b) Composite fiber contactor Oxyplus (TPX dense skin)—gas velocity of 1.3 m s<sup>-1</sup>.

the mass transfer performance for a membrane contactor with a fiber length  $L$ :

$$K_{CO_2} \times a = -\frac{u_g}{L} \times \ln(1-\eta) \times \phi \times \left(1 - \frac{\delta}{r_o}\right)^2 \quad (7)$$

where  $u_g$  is the gas phase velocity (m s<sup>-1</sup>) and  $a$  is the membrane contactor interfacial area defined as the ratio of the total outer surface available with the contactor volume (m<sup>2</sup> m<sup>-3</sup>).  $\delta$  and  $r_o$  are respectively the overall membrane thickness and the fiber outer radius (m).  $\phi$  is the membrane contactor packing fraction.

Eq. (7) shows that the evolution of CO<sub>2</sub> capture ratio as a function of the gas phase velocity enables the overall mass transfer coefficient to be determined. Each experiment was performed for three different concentrations of fresh ammonia solutions (1, 3 and 5 wt%) at 21 °C.

As shown in Fig. 7a and b, the removal efficiency logically decreases with the gas velocity for both contactors, due to the decreasing contact time. For carbon capture application, a carbon capture ratio larger than 85% is classically recommended. Experimental results are fitted, thanks to Eq. (7), with the overall mass transfer coefficient  $K$  being taken as the only fitting variable. It can be seen that for all operating conditions, a good agreement between experiments and model is obtained, similar to previously reported studies [15,29]. An example of results reproducibility for two different Oxyplus membrane contactors is shown in Fig. 7b.

**Table 3**

TPX and TeflonAF2400 dense skin characteristics and corresponding CO<sub>2</sub> and NH<sub>3</sub> permeances for the two different composite fibers tested in this study.

Dense skin material	Membrane thickness (μm)	CO <sub>2</sub> permeance (GPU)	NH <sub>3</sub> permeance (GPU)
Teflon AF	1.3	2400	1300
TPX <sup>®</sup>	0.1–0.2	495–990	990–1880

CO<sub>2</sub> removal efficiency significantly depends on ammonia concentration in the liquid phase. The larger the amount of free ammonia species available in the solution, the higher the carbamate formation kinetics and finally the higher the CO<sub>2</sub> absorption rate [30–32]. Under the experimental conditions tested, a 1 wt% ammonia solution cannot reach the 85% CO<sub>2</sub> capture ratio target, whereas CO<sub>2</sub> capture ratio close to 90% is reached for higher concentrations. Particularly, switching from 3 to 5 wt% has only minor effects on CO<sub>2</sub> removal efficiency.

As stated in the introductory part, CO<sub>2</sub> mass transfer performances should however be balanced with ammonia slip, which is also strongly dependent on the ammonia concentration. Indeed, ammonia volatilization rate is logically linked to the amount of

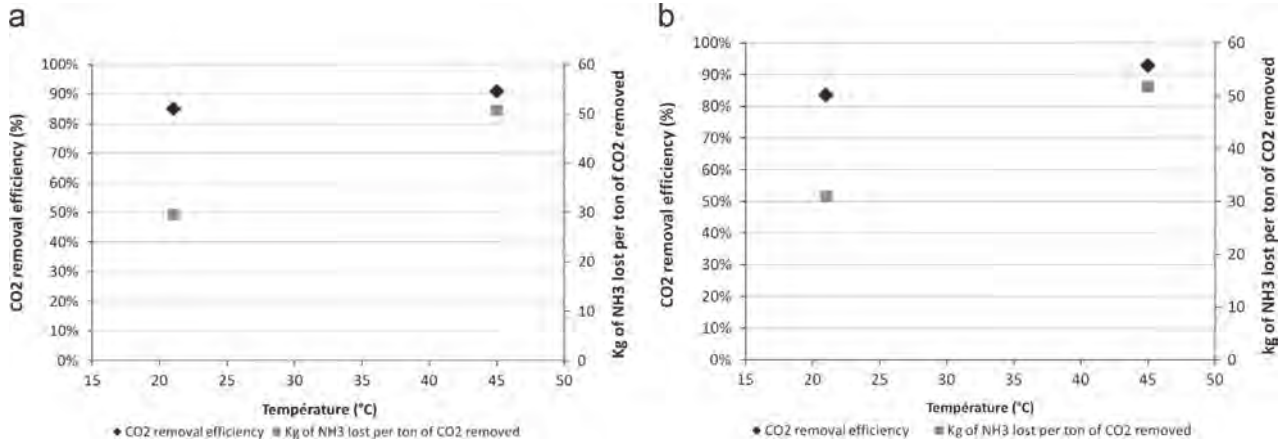

**Fig. 9.** Effect of temperature on CO<sub>2</sub> removal efficiency (left y axis) and ammonia slip (right y axis). Operating conditions: ammonia concentration 5 wt%, (a) Composite fiber contactor Oxyphan-Teflon AF2400—gas velocity of 1.1 m s<sup>-1</sup>. (b) Composite fiber contactor Oxyplus (TPX dense skin)—gas velocity of 1.7 m s<sup>-1</sup>.

**Table 4**  
Mass transfer ( $K_{CO_2}a$  ratio) and volume capacity ( $C_v$  ratio) intensification factors of the two composite fiber membrane contactors tested in this study, compared to a packed column for CO<sub>2</sub> absorption in ammonia [38]. A module packing fraction of 60%, typical of industrial conditions for membrane contactor applications, has been assumed for the calculations. Volume capacities have been determined for a CO<sub>2</sub> removal efficiency of 90%.

Intensification factors ( <i>I</i> )		NH <sub>3</sub> concentration		
		1 wt%	3 wt%	5 wt%
Mass transfer intensification factor: $\frac{(K_{CO_2}a)_{\text{contactor}}}{(K_{CO_2}a)_{\text{packed column}}}$	TPX dense skin module	14.4	9.3	7.1
	Teflon AF2400 dense skin module	13.5	12.3	8.6
Volume intensification factor: $\frac{C_v \text{ Contactor}}{C_v \text{ Packed column}}$	TPX dense skin module	9.3	6.0	4.0
	Teflon AF2400 dense skin module	8.3	7.8	4.9

free ammonia available and thus increases with the solution concentration [33]. Fig. 8a and b explicitly show the relationship between ammonia concentration, ammonia slip and CO<sub>2</sub> removal efficiency for a typical industrial absorber gas velocity (around 1 m s<sup>-1</sup>). Increasing ammonia concentration from 3 wt% to 5 wt% has a small impact on CO<sub>2</sub> capture but it leads to a strong increase of ammonia losses in the gas phase, respectively, from 15 to 30 kg NH<sub>3</sub> per ton of CO<sub>2</sub> removed. A 3 wt% ammonia solution thus appears as a good compromise between a high enough CO<sub>2</sub> removal efficiency and a minimal ammonia slip. It can also be noticed that the ammonia losses of the Oxyplus and Oxyphan-Teflon AF2400 membrane contactors are almost similar. This fact reflects the permeance characteristics of the two composite fibers, summarized in Table 3; even though membrane thickness and material intrinsic permeability strongly differ between the two membranes, the resulting ammonia effective permeance is finally almost similar. As a consequence, experimental ammonia losses for the two different composite fibers, which result from the combined driving force and mass transfer coefficient, are logically rather close.

The effect of temperature on CO<sub>2</sub> removal efficiency and ammonia losses has been studied with a 5% ammonia solution. Temperature has a positive effect on the carbon capture ratio which increased from 21 °C to 45 °C. A higher reaction kinetics effectively translates into a higher overall mass transfer coefficient.

The CO<sub>2</sub> mass transfer gain discussed above should however be balanced to the ammonia slip increase which is induced when temperature increases. As shown in Fig. 9a and b, the ammonia volatilization strongly increases between 21 °C and 45 °C for both contactors, from about 30 kg to 50 kg of NH<sub>3</sub> per ton of CO<sub>2</sub> removed.

In order to assess the potential of composite hollow fibers membrane contactors for CO<sub>2</sub> capture in ammonia, a comparison to conventional gas/liquid absorption processes (such as packed columns) is required and will be discussed hereafter.

#### 4.4. CO<sub>2</sub> mass transfer comparison for different gas/liquid absorption processes

Two options can be considered in order to evaluate the intensification factor of a gas liquid absorption system [12,14,34–36].

First, the CO<sub>2</sub> transfer time inverse  $K_{CO_2}a$  (s<sup>-1</sup>) which corresponds to the effective mass transfer performances of the process can be compared. The effective specific interfacial area ( $a$ ) of the module is known, and  $K$  can be determined through a curve fit of the experimental results, as shown before. The characteristic  $K_{CO_2}a$  value related to the two different membrane contactors employed have been compared to the packed column performances in order to assess the mass transfer intensification factor of membrane contactors.

In a second step, the CO<sub>2</sub> effective absorption capacities  $C_v$  were compared.  $C_v$  (mol m<sup>-3</sup> s<sup>-1</sup>) corresponds to the amount of CO<sub>2</sub> absorbed per unit time and unit contactor volume and is calculated as

$$C_v = \frac{\eta u_g (1 - (\delta/r_o))^2 \phi P_{CO_2}}{RTL} \quad (8)$$

with  $P_{CO_2}$  being the CO<sub>2</sub> partial pressure in the gas phase (Pa) and  $L$  the contactor length (m).

The results of the two approaches are summarized in Table 4. For packed columns, both  $K_{CO_2}a$  and CO<sub>2</sub> removal efficiencies are taken from [37] in which CO<sub>2</sub> absorption experiments were carried

**Table 5**

CO<sub>2</sub> volume absorption capacity for Oxyphan–TeflonAF2400 and Oxyplus: solvent performances comparison. Data for NH<sub>3</sub> and MEA have been obtained with identical membrane contactors (same module, fibers and capacity) and in both cases for fresh absorption solutions. Data for MEA (30 wt%) are taken from [12]. Data for NH<sub>3</sub> 3 wt% from this study. A module packing fraction of 60%, typical of industrial conditions for membrane contactor applications, has been assumed for the calculations. Volume capacities have been determined for a CO<sub>2</sub> removal efficiency of 90%.

Volume capacity ratio		
$\frac{(C_{v \text{ contactor}})_{\text{NH}_3 \text{ 3\% wt}}}{(C_{v \text{ contactor}})_{\text{MEA 30 wt\%}}}$	TPX dense skin module	1
	Teflon AF2400 dense skin module	1.3

out using fresh ammonia solutions. It can be noticed that both types of intensification calculations lead to similar trends. Considering similar concentrations, solvent loading and phase velocity conditions, intensification factors are in all cases significant and largely favorable to membrane contactors. The highest intensification factor is observed for 1 wt% ammonia solutions with a factor 15. Nevertheless, if target CO<sub>2</sub> removal efficiencies are taken into account, 3 wt% ammonia solution appears as the best compromise. The tailor made membrane contactor made of a Teflon AF2400 layer leads to better CO<sub>2</sub> mass transfer performances than those achieved using commercial Oxyplus contactors. All experiments were performed under similar operating conditions, the mass transfer coefficient in the liquid phase should be the same in both cases [20]. Consequently, the increased intensification factor observed with the Teflon AF2400 fiber results from the better intrinsic mass transfer performances (i.e. a larger membrane mass transfer coefficient). In fact, despite being thicker than the TPX dense layer of the Oxyplus contactor, the Teflon AF2400 dense skin shows a larger CO<sub>2</sub> permeance. The larger intensification factor can thus be attributed to the factor of 2.5 which exists between the CO<sub>2</sub> permeance of the Teflon AF2400 and the TPX dense skin (Table 3).

Regarding Table 4, it can be concluded that despite sharp CO<sub>2</sub> permeances differences, both types of contactors allow one to largely enhance the CO<sub>2</sub> mass transfer compared to a packed column. Finally the absorption performances offered by ammonia have been compared to those observed when MEA (30%wt) is used as a solvent for CO<sub>2</sub> capture (Table 5). The CO<sub>2</sub> volume absorption capacity values calculated for both solvent show that ammonia can offer similar absorption performances for concentration as low as 3%wt.

Generally speaking, studies reporting ammonia losses for conventional gas/liquid packed columns are scarce. A recent work by Yu et al. has shown that the absorption of CO<sub>2</sub> by ammonia in a packed column generates a loss of 58 kg NH<sub>3</sub> per ton of CO<sub>2</sub> for a 5 wt% lean solution with a loading of 0.31 [38]. For the experiments reported in this study, the absorption solutions are fresh, corresponding to maximal ammonia losses. Indeed, whatever the concentration considered (1, 3 or 5 wt%), the solution pH is higher than 11.5 and more than 99% of ammonia under its free form is available for desorption. Ammonia slip related to a fresh solution being necessarily higher than the one observed in a loaded solution, the lower losses obtained with membrane contactors in this study compared to the packed column data suggest that the ammonia losses mitigation due to the dense membrane layer is effective. This statement is confirmed through another comparison: in a recent work [39], ammonia slip in a packed column is reported to correspond to around 10 vol% of the outlet flue gas. A ten times smaller value has been experimentally obtained with the dense skin membrane contactors tested in this study.

## 5. Conclusion

This study intended to explore the potentialities and limitations of membrane contactors for post-combustion CO<sub>2</sub> capture by gas–liquid absorption in an aqueous ammonia solution. From an industrial point of view, process intensification and ammonia slip mitigation, which are effectively major issues for this technology, could possibly be tackled thanks to a tailor made membrane contactor. From a fundamental point of view, the simultaneous transfer of CO<sub>2</sub> from the gas to the liquid phase, and ammonia from the liquid to the gas phase, in a chemically reactive and harsh environment, correspond to a unique framework for membrane contactor operation.

The major conclusions of this exploratory study can be summarized as follows:

- i) Membrane contactors based on hydrophobic microporous fibers (i.e. the reference technology for industrial application) do not enable stable absorption performances, due to in situ salt precipitation. It is obvious that this conclusion is based on a limited number of tests and operating conditions, and it should not be considered as generic. Nevertheless, microporous structures probably lead to large ammonia and water stripping fluxes simultaneously to CO<sub>2</sub> absorption, thus promoting carbamate formation in or on the membrane.
- ii) Alternative membrane designs were tested, through the concept of dense skin composite fiber. Different polymeric materials were tested on a dedicated set-up in order to check the chemical compatibility and the structural and functional stability towards the CO<sub>2</sub>/NH<sub>3</sub>/H<sub>2</sub>O system. Rubbery materials showed a rapid detrimental evolution due to in situ salt precipitation. Selected super permeable glassy materials (TPX and Teflon AF2400) however showed stable performances over time. Consequently, two types of dense skin composite hollow fiber modules based on these two materials were designed and tested.
- iii) When operated for CO<sub>2</sub> absorption in aqueous ammonia, the dense skin composite membrane modules showed stable performances, with ammonia concentration and process temperature having a significant effect on mass transfer performances.
- iv) Despite significant differences (dense skin thickness, permeability), the two composite fibers (TPX and Teflon AF2400) showed closed performances for CO<sub>2</sub> and NH<sub>3</sub> mass transfer. The CO<sub>2</sub> permeance is indeed large enough in both cases to result in a low membrane mass transfer resistance. The ammonia losses are similar in accordance with the effective permeances.
- v) The experimental results confirm the high intensification potential of membrane contactors for ammonia absorption process compared to packed columns. Moreover, a significant reduction of ammonia slip is observed. These characteristics offer promising perspectives for industrial operation in terms of reduced installation size and higher flexibility in terms of process temperature. A classical strategy for ammonia process consists of operating under limited temperature conditions (chilled ammonia) in order to reduce ammonia losses; unfortunately, this translates into a slower absorption kinetics and consequently a larger unit size. The fact that membrane contactors offer the unique possibility to both increase interfacial area and limit ammonia slip, such as reported in this proof of concept study, offers promising perspectives.

## Acknowledgments

This research was funded by the Agence Nationale de la Recherche, France (ANR), through the Project Grant AMELIE.

## Nomenclature

$a$	interfacial area [ $\text{m}^{-1}$ ]
$d$	diameter [m]
$C_v$	absorption capacity (volume basis) [ $\text{mol m}^{-3} \text{s}^{-1}$ ]
$D$	diffusion coefficient [ $\text{m}^2 \text{s}^{-1}$ ]
$e$	membrane thickness [m]
$E$	enhancement factor [dimensionless]
$H$	Henry's constant [ $\text{Pa m}^3 \text{mol}^{-1}$ ]
$k_g$	local mass transfer coefficient in the gas phase [ $\text{m s}^{-1}$ ]
$k_l$	local mass transfer coefficient in the liquid phase [ $\text{m s}^{-1}$ ]
$k_m$	local mass transfer coefficient in the membrane [ $\text{m s}^{-1}$ ]
$K$	overall mass transfer coefficient [ $\text{m s}^{-1}$ ]
$L$	fiber length [m]
$P$	pressure [Pa]
$\mathcal{P}$	permeability [ $\text{m}^2 \text{s}^{-1} \text{Pa}^{-1}$ ]
$Q$	flowrate [ $\text{m}^3 \text{s}^{-1}$ ]
$r$	radius [m]
$R$	perfect gas constant [ $\text{J mol}^{-1} \text{K}^{-1}$ ]
$T$	temperature [K]
$u_g$	gas velocity [ $\text{m s}^{-1}$ ]
$z$	axial coordinate [m]
$[\text{CO}_2]$	$\text{CO}_2$ concentration [ $\text{mol m}^{-3}$ ]
$\alpha$	selectivity [dimensionless]
$\varepsilon$	porosity [dimensionless]
$\phi$	module packing fraction [dimensionless]
$\eta$	capture ratio [dimensionless]
$\tau$	tortuosity [dimensionless]

## References

- [1] B. Metz, Intergovernmental Panel on Climate Change Working Group III, IPCC Special Report on Carbon Dioxide Capture and Storage, Cambridge University Press for the Intergovernmental Panel on Climate Change, Cambridge, 2005.
- [2] R. Steeneveldt, B. Berger, T.A. Torp,  $\text{CO}_2$  capture and storage: closing the knowing-doing gap, *Chem. Eng. Res. Des.* 84 (9) (2006) 739–763.
- [3] J. Yang, X. Yu, J. Yan, S.-T. Tu, E. Dahlquist, Effects of  $\text{SO}_2$  on  $\text{CO}_2$  capture using a hollow fiber membrane contactor, *Appl. Energy* 112 (2013) 755–764.
- [4] E.S. Rubin, H. Mantripragada, A. Marks, P. Versteeg, J. Kitchin, The outlook for improved carbon capture technology, *Prog. Energy Combust. Sci.* 38 (5) (2012) 630–671.
- [5] A. Bandyopadhyay, Amine versus ammonia absorption of  $\text{CO}_2$  as a measure of reducing GHG emission: a critical analysis, *Clean Technol. Environ. Policy* 13 (2) (2011) 269–294.
- [6] Z. Qi, E.L. Cussler, Hollow fiber gas membranes, *AIChE J.* 31 (9) (1985) 1548–1553.
- [7] H.A. Rangwala, Absorption of carbon dioxide into aqueous solutions using hollow fiber membrane contactors, *J. Membr. Sci.* 112 (2) (1996) 229–240.
- [8] E. Drioli, M. Romano, Progress and new perspectives on integrated membrane operations for sustainable industrial growth, *Ind. Eng. Chem. Res.* 40 (5) (2001) 1277–1300.
- [9] P.H.M. Feron, A.E. Jansen,  $\text{CO}_2$  separation with polyolefin membrane contactors and dedicated absorption liquids: performances and prospects, *Sep. Purif. Technol.* 27 (3) (2002) 231–242.
- [10] J.-L. Li, B.-H. Chen, Review of  $\text{CO}_2$  absorption using chemical solvents in hollow fiber membrane contactors, *Sep. Purif. Technol.* 41 (2) (2005) 109–122.
- [11] D. deMontigny, P. Tontiwachwuthikul, A. Chakma, Comparing the absorption performance of packed columns and membrane contactors, *Ind. Eng. Chem. Res.* 44 (15) (2005) 5726–5732.
- [12] E. Chabanon, D. Roizard, E. Favre, Membrane contactors for postcombustion carbon dioxide capture: a comparative study of wetting resistance on long time scales, *Ind. Eng. Chem. Res.* 50 (13) (2011) 8237–8244.
- [13] K. Simons, K. Nijmeijer, M. Wessling, Gas–liquid membrane contactors for  $\text{CO}_2$  removal, *J. Membr. Sci.* 340 (1–2) (2009) 214–220.
- [14] E. Favre, H.F. Svendsen, Membrane contactors for intensified post-combustion carbon dioxide capture by gas–liquid absorption processes, *J. Membr. Sci.* 407–408 (2012) 1–7.
- [15] P.T. Nguyen, E. Lasseguette, Y. Medina-Gonzalez, J.C. Remigy, D. Roizard, E. Favre, A dense membrane contactor for intensified  $\text{CO}_2$  gas/liquid absorption in post-combustion capture, *J. Membr. Sci.* 377 (1–2) (2011) 261–272.
- [16] A. Gabelman, S.-T. Hwang, Hollow fiber membrane contactors, *J. Membr. Sci.* 159 (1–2) (1999) 61–106.
- [17] K.K. Sirkar, Membranes, phase interfaces, and separations: novel techniques and membranes—an overview, *Ind. Eng. Chem. Res.* 47 (15) (2008) 5250–5266.
- [18] K.R. Westerterp, W.P.M. van Swaaij, A.A.C.M. Beenackers, H. Kramers, *Chemical Reactor Design and Operation*, Wiley, New York, 1984.
- [19] E.L. Cussler, *Diffusion: Mass Transfer in Fluid Systems*, Cambridge University Press, Cambridge, 1997.
- [20] Z. Qi, E.L. Cussler, Microporous hollow fibers for gas absorption: I. Mass transfer in the liquid, *J. Membr. Sci.* 23 (3) (1985) 321–332.
- [21] Z. Qi, E.L. Cussler, Microporous hollow fibers for gas absorption: II. Mass transfer across the membrane, *J. Membr. Sci.*, 23, 333–345.
- [22] R. Baker, *Membrane Technology and Applications*, John Wiley & Sons, New York, 2004.
- [23] D.C. Nymeyer, B. Folkers, I. Breebaart, M.H.V. Mulder, M. Wessling, Selection of top layer materials for gas–liquid membrane contactors, *J. Appl. Polym. Sci.* 92 (1) (2004) 323–334.
- [24] C. Makhloufi, D. Roizard, E. Favre, Reverse selective  $\text{NH}_3/\text{CO}_2$  permeation in fluorinated polymers using membrane gas separation, *J. Membr. Sci.* 441 (2013) 63–72.
- [25] S.A. Stern, B.D. Bhide, Permeability of silicone polymers to ammonia and hydrogen sulfide, *J. Appl. Polym. Sci.* 38 (11) (1989) 2131–2147.
- [26] J.M. Mohr, D.R. Paul, Effect of casting solvent on the permeability of poly(4-methyl-1-pentene), *Polymer* 32 (7) (1991) 1236–1243.
- [27] I. Pinnau, L.G. Toy, Gas and vapor transport properties of amorphous perfluorinated copolymer membranes based on 2,2-bistrifluoromethyl-4,5-difluoro-1,3-dioxole/tetrafluoroethylene, *J. Membr. Sci.* 109 (1) (1996) 125–133.
- [28] E.L. Cussler, M.M. Breuer, Strongly coupled diffusion fluxes, *Nature* 235 (56) (1972) 74–75.
- [29] E. Chabanon, D. Roizard, E. Favre, Modeling strategies of membrane contactors for post-combustion carbon capture: a critical comparative study, *Chem. Eng. Sci.* 87 (2013) 393–407.
- [30] G. Puxty, R. Rowland, M. Attalla, Comparison of the rate of  $\text{CO}_2$  absorption into aqueous ammonia and monoethanolamine, *Chem. Eng. Sci.* 65 (2) (2010) 915–922.
- [31] B.R.W. Pinsent, L. Pearson, F.J.W. Roughton, The kinetics of combination of carbon dioxide with ammonia, *Trans. Faraday Soc.* 52 (1956) 1594–1598.
- [32] X. Wang, W. Conway, D. Fernandes, G. Lawrence, R. Burns, G. Puxty, M. Maeder, Kinetics of the reversible reaction of  $\text{CO}_{2(\text{aq})}$  with ammonia in aqueous solution, *J. Phys. Chem. A* 115 (24) (2011) 6405–6412.
- [33] J.T. Yeh, K.P. Resnik, K. Rygle, H.W. Pennline, Semi-batch absorption and regeneration studies for  $\text{CO}_2$  capture by aqueous ammonia, *Fuel Process. Technol.* 86 (14–15) (2005) 1533–1546.
- [34] O. Falk-Pedersen, H. Dannström, Separation of carbon dioxide from offshore gas turbine exhaust, *Energy Convers. Manage.* 38 (Supplement) (1997) S81–S86.
- [35] N. Nishikawa, M. Ishibashi, H. Ohta, N. Akutsu, H. Matsumoto, T. Kamata, H. Kitamura,  $\text{CO}_2$  removal by hollow-fiber gas–liquid contactor, *Energy Convers. Manage.* 36 (6) (1995) 415–418.
- [36] K.A. Hoff, O. Juliussen, O. Falk-Pedersen, H.F. Svendsen, Modeling and experimental study of carbon dioxide absorption in aqueous alkanolamine solutions using a membrane contactor, *Ind. Eng. Chem. Res.* 43 (16) (2004) 4908–4921.
- [37] Q. Zeng, Y. Guo, Z. Niu, W. Lin, Mass transfer coefficients for  $\text{CO}_2$  absorption into aqueous ammonia solution using a packed column, *Ind. Eng. Chem. Res.* 50 (17) (2011) 10168–10175.
- [38] H. Yu, S. Morgan, A. Allport, A. Cottrell, T. Do, J. McGregor, P. Feron, Results from trialling aqueous ammonia based post combustion capture in a pilot plant at Munmorah, *Energy Proc.* 4 (2011) 1294–1302.
- [39] Z. Niu, Y. Guo, Q. Zeng, W. Lin, Experimental studies and rate-based process simulations of  $\text{CO}_2$  absorption with aqueous ammonia solutions, *Ind. Eng. Chem. Res.* 51 (14) (2012) 5309–5319.