



**HAL**  
open science

# Polymer Electrolyte Fuel Cell Stack Modelling in VHDL-AMS Language with Temporal and EIS Experimental Validations

El-Hassane Aglzim, Amar Rouane, Daniela Chrenko, Djilali Kourtiche, Mustapha Nadi

► **To cite this version:**

El-Hassane Aglzim, Amar Rouane, Daniela Chrenko, Djilali Kourtiche, Mustapha Nadi. Polymer Electrolyte Fuel Cell Stack Modelling in VHDL-AMS Language with Temporal and EIS Experimental Validations. *Journal of Energy and Power Engineering*, 2014, 8, pp.343-349. 10.17265/1934-8975/2014.02.018 . hal-01397293

**HAL Id: hal-01397293**

<https://hal.univ-lorraine.fr/hal-01397293v1>

Submitted on 4 Mar 2022

**HAL** is a multi-disciplinary open access archive for the deposit and dissemination of scientific research documents, whether they are published or not. The documents may come from teaching and research institutions in France or abroad, or from public or private research centers.

L'archive ouverte pluridisciplinaire **HAL**, est destinée au dépôt et à la diffusion de documents scientifiques de niveau recherche, publiés ou non, émanant des établissements d'enseignement et de recherche français ou étrangers, des laboratoires publics ou privés.



Distributed under a Creative Commons Attribution - NonCommercial 4.0 International License

# Polymer Electrolyte Fuel Cell Stack Modelling in VHDL-AMS Language with Temporal and EIS Experimental Validations

El-Hassane Aglzim<sup>1</sup>, Amar Rouane<sup>2</sup>, Daniela Chrenko<sup>1</sup>, Djilali Kourtiche<sup>2</sup> and Mustapha Nadi<sup>2</sup>

1. Drive Laboratory, University of Burgundy, Nevers 58000, France

2. Jean Lamour institut, University of Lorraine, CNRS, Vandoeuvre les Nancy 54506, France

Received: January 18, 2013 / Accepted: April 08, 2013 / Published: February 28, 2014.

**Abstract:** This paper deals with two basic issues of fuel cell research: modelling and experimental validation. In particular, the EIS (electrochemical impedance spectroscopy) technique is applied to a PEMFC (proton exchange membrane fuel cell). Experiments have been performed using a low-cost test bench and instrumentation developed around a 1,200 W Ballard Nexa fuel cell system. An electrical and dynamic model in VHDL-AMS language for PEM fuel cell stack is described. The privileged approach in this paper is an electrical method. Few papers deal with the modelling of a fuel cell in VHDL-AMS language with an electric approach. The fuel cell is characterised cell wise in VHDL-AMS; AC and DC measurements show the good agreement between the simulation results of the model and those measured in experiments. The model is capable to predict accurate stack profiles. The model is validated using temporal and impedance spectroscopy method; the impedance spectroscopy is performed at low and high frequencies. The experimental and simulated Nyquist plots show that the frequency response of the fuel cell stack can be predicted by the proposed fuel cell stack model. At high frequencies, comparisons between experimental and model impedance results are performed and show some similarities between the two Nyquist. Error between the two approaches is below 1.5%.

**Key words:** PEM fuel cell, VHDL-AMS language, EIS method, modeling.

## 1. Introduction

Over the last 20 years, research and development efforts on fuel cells have increased because of the demand of developing an effective and no pollutant system, which can provide energy in transportation, portable and stationary sectors [1, 2].

The fuel cell is a reliable and sustainable tool to produce environmentally friendly energy for many applications. The PEM fuel cell is considered as the most promising technology for transportation and portable applications because of the low operating temperature and ease of assembly [3]. However, some problems are still to resolve and slow down its

development for civil applications. We will note the current price and the lifetime of the stack components.

A fuel cell is a device allowing direct conversion of free oxidation-reduction reaction chemical energy into electrical energy.

Fuel cell produces from hydrogen and oxygen electricity without any pollution. It is a multidisciplinary system involving a large number of scientific fields such as chemistry, electronics, power, thermal, fluidic, etc. [4]. This multidisciplinary makes the study of this system difficult and tiresome. The lack of control over all of these fields, and the high number of parameters influence the behaviour of the fuel cell. These behaviours are very different between the operation and rest. Our objective is firstly to exploit and characterize the fuel cell; secondly, based on its

---

**Corresponding author:** El-Hassane Aglzim, associate professor, research fields: fuel cells and hybrid/electric vehicles. E-mail: el-hassane.aglzim@u-bourgogne.fr.

characterization, to observe its operation status through the degradation state of the fuel cell by equipping an intelligent sensor. Many research groups have developed data-processing models of fuel cells in various environments and with various parameters for the study and the anticipation of its behaviour [5-7]. This type of model allows saving time in the design and better control this type of generator. There are a large number of models developed in different design and description languages as the VHDL-AMS, which makes it possible to model a complex and multidisciplinary system [8, 9]. In this paper, a dynamic model in VHDL-AMS of a Nexa fuel cell in load is presented. Modelling is made on the macroscopic level, only taking into account the electrical aspect and the experimental results. This aspect of study makes this work original. Colleagues from other disciplines are working on models where the chemical aspects, fluidic etc. are studied and proposed. This type of dynamic modelling enables us to understand the operation of the fuel cell in load and its dynamics without having to intervene on a real fuel cell. That reduces the testing costs and makes it possible to anticipate the modifications made on the system.

### 1.1 VHDL-AMS Language

In this paper, we modelled a fuel cell in VHDL-AMS language which is a derivation of the VHDL material description language (standard IEEE 1076-1993). It includes analogical extensions and mixed signals that are used to define the behaviour of the systems in analogical and mixed signals (IEEE 1076.1- 1999) [10]. The VHDL-AMS standard was created with the intention of enabling analogical and mixed signals system designers to create and use modules that encapsulate descriptions of high level behaviour, as well as structural descriptions of systems and components. At the same time, VHDL-AMS provides continuous and semantic event modelling. It is thus well adapted for analogical, digital and mixed circuits.

It is particularly well adapted for checking complex integrated circuits that combine analogical, mixed signals and radio frequencies as well as multidisciplinary systems such as fuel cells. VHDL-AMS is not a computer programming language, but a language of material description.

### 1.2 The 1.2 kW Nexa Fuel Cell

The fuel cell used during our experiments was the Nexa fuel cell from Ballard, with a rated power equal to 1.2 kW. This module does not require maintenance since it is entirely automated and highly integrated. It can provide a current to a maximum power of 46 A with a voltage equal to 26 V and a minimum current of 0.7 A for a no-load voltage of 48 V [11]. The stack is composed of 47 cells (Fig. 1), which provide individual voltages ranging between 0.6 V and 1 V according to the required power.

An embedded controller board ensures the safety of the fuel cell as well as the operator by controlling a certain number of parameters (hydrogen leak, abrupt falls in the tension, etc) via integrated sensors. The controller board also adjusts the parameters of the fuel cell for the optimization of energy efficiency. The fuel cell also includes an air compressor, a cooling system and other devices supporting its operation [12, 13].

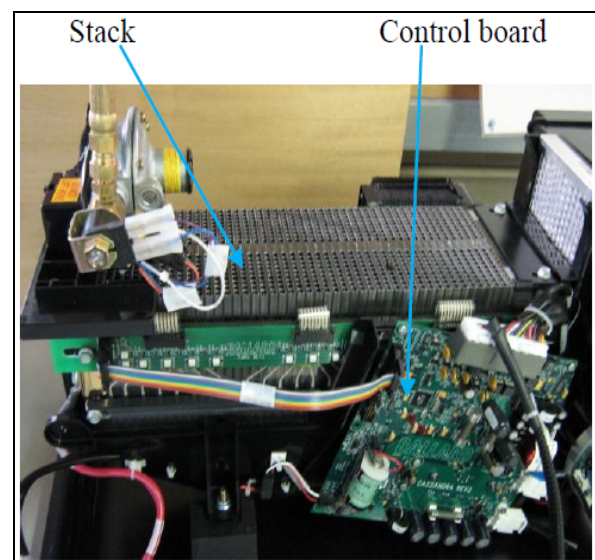

**Fig. 1** The Nexa fuel cell.

## 2. Macroscopic Study

In this study, the electrical side is given priority over the other fields involved in the operation of the fuel cell. The model uses the assembly of basic cells in connection with an electronic load. The dynamic model, unlike the static model [8], allows the operation of the fuel cell to be characterized while the fuel cell is in use. The fuel cell is a complete system, including gas cylinders, electronic load and other devices. It is modelled in a state of continuous operation. To model a dynamic system, we use experimental impedance measurements, carried out by the EIS method.

The measured impedance of the fuel cell predicts the various electrochemical losses and their evaluation using a Nyquist graph. For modelling, values of impedance can help to identify some parameters of the fuel cell (ohmic losses, activation losses, etc.) which are not accessible during stationary measurements at DC [14, 15]. An electrical equivalent circuit, valid for small signals, describes the different layers of the fuel cell. Conducting layers are characterized by their electric resistance. The model described in VHDL-AMS is an electric equivalent model extracted from experimental impedance measurements.

The Nyquist graphs produced by EIS (electrochemical impedance spectroscopy) allows each cell to be defined with an equivalent diagram reflecting the electrochemical process that take place inside the fuel cell. The first 45 cells are identical. Cells 46 and 47 are cells where the tension decreases due to the accumulation of water. An electrical resistance represents the load. The EIS method is modelled by a signal generator providing a sinusoidal signal equal to 20 mV and on a frequency band from 8 MHz to 12.4 kHz. This frequency band is identical to that used during the experimentation.

### 2.1 Schematic View of the Nexa Stack

For better legibility, the Nexa fuel cell is represented in the form of cells put in series (Figs. 2 and 3). The stack is not isolated from the remainder of the system.

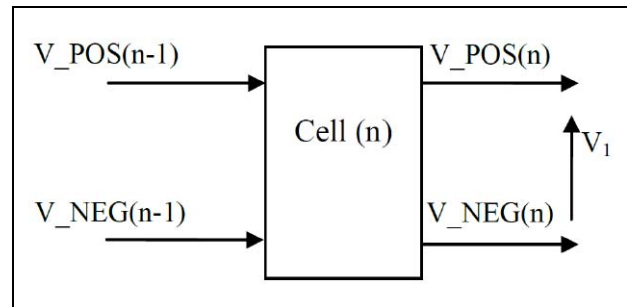

Fig. 2 Single cell of the fuel cell.

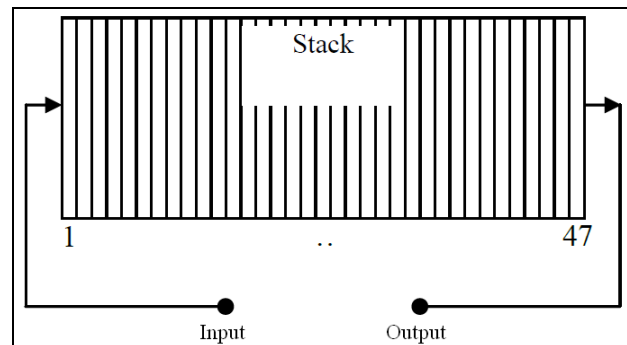

Fig. 3 Complete stack of the fuel cell.

Experimental measurements, as well as the model we studied, take into account the auxiliaries of the fuel cell (compressor, humidifier, electronic board, etc.).

The classification of the cells makes it possible to define the order and reveal the cells known as normal and those where the accumulation of water has an influence on the voltage delivered.

### 2.2 Electrical Model—Cell 1 to 45

The data on the electrical model of a cell is extracted from the experimental results. The experimentation allows the characteristics and the behaviour of the fuel cell to be defined while in action and at rest. The experimental electrical measurements performed on the fuel cell allow us to determine the voltage-current characteristic of the Nexa fuel cell. The impedance measurements show the electrochemical process taking place inside the fuel cell and allow us to create a diagram representing the behaviour of the cell in the best possible way. The cells 1 to 45 are not affected by water excess (Fig. 4), they show quasi-normal behaviour and their nominal voltage varies according to the required power. The dynamic cell voltage is

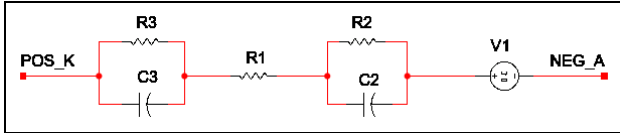

**Fig. 4** Electronic representation of cells 1 to 45 in VHDL-AMS.

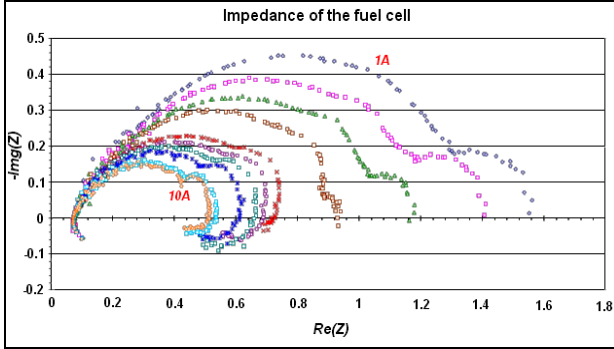

**Fig. 5** Nyquist graphs of the experimental tests.

presented by a continuous generator of tension VDC (V1), whose value is variable.

Fig. 5 represents the Nyquist graph of the impedance of the Nexa fuel cell obtained in the experiments [16-18]. Measurements were made in a current range from 1 A to 10 A and a frequency band of 8 MHz to 12.4 kHz. The shape of these curves shows the phenomenon of ohmic losses, and activation losses on the anode and cathode level. The cathodic activation losses are more important than that of the anode (variables according to the current). The ohmic losses are identical for all the current levels (0.073  $\Omega$ ).

The resistor  $R_2$ , in parallel with the capacitor  $C_2$ , represents the activation losses on the anode side. The resistor  $R_3$ , in parallel with the capacitor  $C_3$ , represents the activation losses on the cathode side. Resistor  $R_1$  represents the ohmic losses on the level of the membrane. The capacitors  $C_2$  and  $C_3$  are double-layer capacitors, representing to the surface of the electrolyte. The cell is represented by its nominal voltage, as well as the phenomenon of losses on anode, cathode and the membrane level. The cell voltage is the nominal voltage minus these three losses. The values of the electric components are extracted from experimental measurements carried out on the Nexa fuel cell by EIS. The band of current on which measurements were

made varied from 1 A to 10 A. The electronic load available (Agilent N3301A) supported a power of 600 W. A polynomial equation entered in the VHDL-AMS code modified the values of each component according to the value of the  $R_C$  load and indirectly the value of the required current. These polynomial equations were obtained from Polyfit command of Matlab. This technique enabled us to see the influence of the load on the fuel cell power and the behaviour of each cell individually.

Table 2 gives the experimental values of the components extracted from the experimental Nyquist graph. Table 1 shows the coefficients of the polynomial equation used to calculate the value of the components of the model according to the  $R_C$  load.

$$X = a_6 \cdot R_C^6 + a_5 \cdot R_C^5 + a_4 \cdot R_C^4 + a_3 \cdot R_C^3 + a_2 \cdot R_C^2 + a_1 \cdot R_C \quad (1)$$

$X$  represents the components  $V_1$ ,  $R_2$ ,  $R_3$ ,  $C_2$  and  $C_3$  and  $a_n$  is the coefficients of the polynomial equation.

Table 2 shows the results of  $R_2$ ,  $R_3$ ,  $C_2$ ,  $C_3$  and  $V_1$  calculated from the polynomial equation Eq. (1). We can show an error between the experimental values and those calculated that is under 1.5%, which gives us a good agreement between the simulation and the experiment.

### 2.3 Electrical Model—Cell 46 and 47

All the parameters of the electric models for cells 46 and 47 are identical to those of cells 1 to 45 (Fig. 6), except the cell voltage.

Indeed, in the case of the last two cells, the accumulation of humidity brings about an automatic purging that occurs periodically [19]. More power is required, the greater the purge time is short. This makes it possible to evacuate surplus of moisture through the gases  $H_2$  and  $O_2$ , accumulating on the level of the gas channels.

### 2.4 Electrical Model of the Complete Fuel Cell

The equivalent electric model of the complete fuel cell is the series of all the cells 1 to 45 and the last two where the accumulation of water decreases the voltage

**Table 1** Coefficient values of the polynomial equation.

$a_i$	$V_I$ (V)		$R_2$ ( $\Omega$ )		$C_2$ (F)		$R_3$ ( $\Omega$ )		$C_3$ (F)	
	$R_C < 8\Omega$	$R_C > 8\Omega$	$R_C < 8\Omega$	$R_C > 8\Omega$	$R_C < 8\Omega$	$R_C > 8\Omega$	$R_C < 8\Omega$	$R_C > 8\Omega$	$R_C < 8\Omega$	$R_C > 8\Omega$
$a_6$	$-11.97 \cdot 10^{-3}$	$-16.95 \cdot 10^{-6}$	$-86.73 \cdot 10^{-5}$	$-29.19 \cdot 10^{-8}$	$31.44 \cdot 10^{-5}$	$-17.29 \cdot 10^{-9}$	$-23.36 \cdot 10^{-4}$	$32.63 \cdot 10^{-9}$	$54.48 \cdot 10^{-4}$	$-51.76 \cdot 10^{-6}$
$a_5$	$31.13 \cdot 10^{-2}$	$12.86 \cdot 10^{-4}$	$23.47 \cdot 10^{-3}$	$22.48 \cdot 10^{-6}$	$-82.65 \cdot 10^{-4}$	$13.45 \cdot 10^{-7}$	$61.29 \cdot 10^{-3}$	$-22.18 \cdot 10^{-7}$	$-12.63 \cdot 10^{-2}$	$37.73 \cdot 10^{-4}$
$a_4$	-3.21	$-30.10 \cdot 10^{-3}$	$-25.06 \cdot 10^{-2}$	$-54.03 \cdot 10^{-5}$	$85.26 \cdot 10^{-3}$	$-32.74 \cdot 10^{-6}$	$-63.10 \cdot 10^{-2}$	$41.01 \cdot 10^{-6}$	1.085	$-82.11 \cdot 10^{-3}$
$a_3$	16.64	$22.86 \cdot 10^{-2}$	1.32	$43.04 \cdot 10^{-4}$	$-43.14 \cdot 10^{-2}$	$26.31 \cdot 10^{-5}$	3.18	$-16.94 \cdot 10^{-5}$	-4.11	$55.20 \cdot 10^{-2}$
$a_2$	-45.32	0	-3.43	0	1.06	0	-7.87	0	5.95	0
$a_1$	61.75	0	3.63	0	-1.03	0	7.65	0	-0.31	0

**Table 2** Measured and polynomial values of components  $V_I$ ,  $R_1$ ,  $R_2$ ,  $R_3$ ,  $C_2$  and  $C_3$ .

Current (A)	Load $R_C$ ( $\Omega$ )	Voltage (V)	$R_1$ ( $\Omega$ )		$R_2$ ( $\Omega$ )		$R_3$ ( $\Omega$ )		$C_2$ (F)		$C_3$ (F)	
			Meas	Poly	Meas	Poly	Meas	Poly	Meas	Poly	Meas	Poly
1	39.75	39.75	0.073	0.0728	1.227	1.21	0.250	0.242	0.065	0.065	3.146	3.156
2	19.50	39	0.073	0.0728	1.117	1.10	0.210	0.199	0.059	0.057	14.97	14.975
3	12.92	38.75	0.073	0.0728	0.957	0.942	0.130	0.128	0.059	0.048	20.35	20.361
4	9.45	37.80	0.073	0.0728	0.807	0.800	0.04	0.03	0.05	0.04	58.54	58.558
5	7.42	37.10	0.073	0.0728	0.517	0.502	0.136	0.125	0.038	0.032	0.97	0.975
6	6.10	36.60	0.073	0.0728	0.487	0.452	0.130	0.128	0.036	0.037	1.38	1.385
7	5.14	36	0.073	0.0728	0.447	0.435	0.130	0.128	0.032	0.036	1.27	1.276
8	4.46	35.65	0.073	0.0728	0.407	0.402	0.130	0.125	0.028	0.022	1.08	1.075
9	3.89	35	0.073	0.0728	0.367	0.356	0.09	0.07	0.029	0.022	1.34	1.346
10	3.43	34.30	0.073	0.0728	0.357	0.348	0.08	0.06	0.026	0.024	1.91	1.916

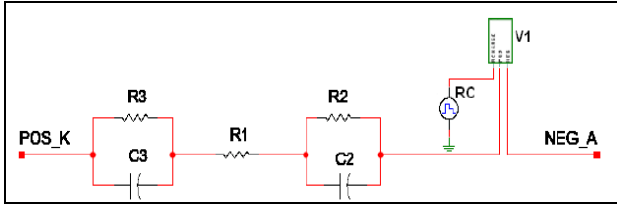

**Fig. 6** Electronic representation of cells 46 and 47 in VHDL-AMS.

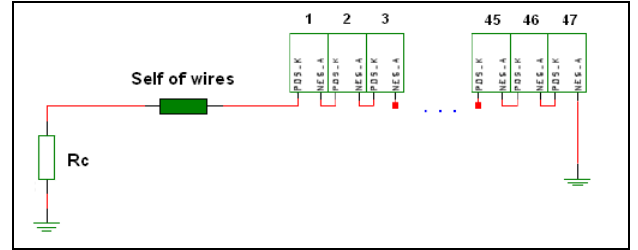

**Fig. 7** Electronic representation of the stack.

(Fig. 7). The whole stack is connected to a load represented by a resistance that varies automatically.

The EIS method is represented by a function generator sweeping the frequency band (8 MHz with 12.4 kHz) with an amplitude of 20 mV. The inductance of the different wires is taken into account for a better representation of the system.

### 3. Results and Discussion

A simulation in DC mode using the model developed in VHDL-AMS was performed. It enables us to observe the behaviour of the fuel cell with the variations of current level. DC mode is a temporal variation of the load to obtain a characteristic

tension-current without intervention of frequency. The simulated current is from 1 A to 10 A, which is the same range used in the experimentation. Fig. 8 shows the comparison between the simulated and experimental results, which shows a good agreement. The model answers well the change of power.

No boarding time or time-constant is observed during power variation. Each current is maintained over one min. We can note the influence of water on the voltage of the last two cells and on the total voltage of the complete stack. It appears for the current 3 A and 6 A corresponding each one to the interval 240-300 s and 440-600 s. This influence appears on the shape of the voltage curve that becomes decreasing.



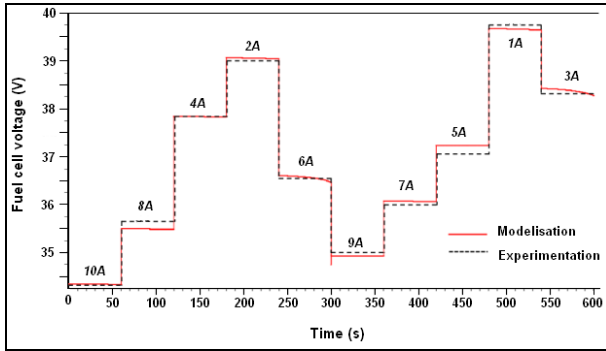

**Fig. 8 Results of the model in DC mode.**

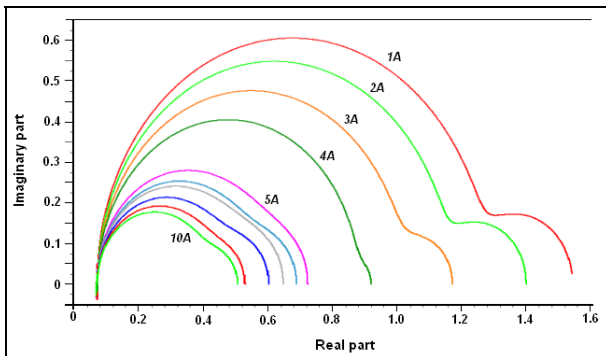

**Fig. 9 Results of the model in AC mode.**

The results in AC mode by using the EIS method enable us to obtain the Nyquist graphs of the complete stack on the band of current defined previously (Fig. 9). The activation losses (i.e., the resistance of polarization) are extremely high, because a temperature of 36 °C is relatively low temperature for the operation of a PEM fuel cell. The polarization resistance is the sum of the activation losses of the anode and the cathode. This resistance increases with the number of cells, which is the sum of each polarization resistance of the whole of the cells. Ohmic resistance does not vary; it is constant for the different currents. The polarization resistance decreases when current increases, it is 1.477  $\Omega$  for 1 A and 0.425  $\Omega$  for 10 A.

#### 4. Conclusions

A VHDL-AMS dynamic model of the Nexa fuel cell under load is introduced in this paper. A macroscopic model using the equivalent electric diagrams coded in VHDL-AMS is proposed and detailed. The results obtained in DC and AC mode show good agreement with the experiment. The model takes into account the

purge system. The current profile chosen for the DC mode shows accurate responses to the changes on current level.

The results in AC modes, represented by the Nyquist graphs, show the various electrochemical process occurring inside the fuel cell. The dynamic model allows us to understand the operation of the fuel cell without direct intervention in a real system.

This allows a time gain in the development of this type of system and a better comprehension of its operation. VHDL-AMS language allows characterization of these multidisciplinary systems. The supported model makes it possible to understand the dynamic operation of the Nexa fuel cell under load and at the electrical level. Modelling facilitates the design of a fuel cell, thus making the latter procedure more flexible.

#### References

- [1] S. Gottesfeld, T.A. Zawodzinski, *Advances in Electrochemical Science and Engineering*, Vol. 5, in: R.C. Alkire, H. Gerischer, D.M. Kolb, C.W. Tobias (Eds.), John Wiley and Sons, Inc., New York, 1997, p. 195.
- [2] N.R. Wagner, *Impedance Spectroscopy—Theory, Experiment, and Applications*, in: E. Barsoukov, J.R. Macdonald (Eds.), 2nd ed., John Wiley & Sons, Inc., Hoboken, New Jersey, 2005, p. 496.
- [3] R.A. Lemons, *Fuel cells for transportation*, *J. Power Sources* 29 (1990) 251-264.
- [4] R.O. Hayre, S.W. Cha, W. Colella, F.B. Prinz, *Fuel Cell Fundamentals*, Vol. 203, John Wiley and Sons, Inc., New Jersey, 2005, p. 212.
- [5] Y. Mugikura, K. Asano, *Analysis of polymer electrolyte fuel cell performance by electrode polarization model*, *Journal of Power Sources* 193 (1) (2009) 32-38.
- [6] T. Escobet, D. Feroldi, S. de Lira, V. Puig, J. Quevedo, J. Riera, et al., *Model-based fault diagnosis in PEM fuel cell systems*, *Journal of Power Sources* 192 (1) (2009) 216-223.
- [7] I. Verhaert, M. De Paepe, G. Mulder, *Thermodynamic model for an alkaline fuel cell*, *Journal of Power Sources* 193 (1) (2009) 233-240.
- [8] B. Blunier, A. Miraoui, *Modelling of fuel cell using multi domain VHDL-AMS language*, *Journal of Power Sources* 177 (2) (2008) 434-450.
- [9] Y. Herve, P. Desgreys, *Functional virtual prototyping design flow and vhd-AMS*, in: *Forum one Languages Design, FDL' 06*, 2006, pp. 69-76.

- [10] E. Christen, K. Bakalar, Vhdl-AMS—A hardware description language for analog and mixed-signal applications, *IEEE Transactions on Circuits and Systems II: Analog and Digital Signal Processing* 46 (10) (1999) 1263-1272.
- [11] H.H. Ottesen, Dynamic performance of the Nexa fuel cell power module, Ph.D. Thesis, University of Minnesota Rochester, Rochester, Minnesota, Jan. 2004.
- [12] P.M. Gomadam, J.W. Weidner, Analysis of electrochemical impedance spectroscopy in proton exchange membrane fuel cells, *Int. J. Energy Res.* 29 (2005) 1133-1151.
- [13] Nexa datasheet for 1.2 kW fuel cell, <http://www.ballard.com>.
- [14] J.P. Diard, N.R. Glandut, B.L. Gorrec, C. Montella, J. Electrochem, *Plowshare* 151 (2004) A2193-A2197.
- [15] W.H. Zhu, R.U. Payne, R.M. Nelms, B.J. Tatarchuk, In situ electrical characterization of PEM fuel cell at load, in: *Baits Annual Meeting*, Utah, Nov. 4-9, 2007.
- [16] E.H. Aglzim, A. Rouane, R. El-Moznine, An electronic measurement instrumentation of the impedance of a loaded fuel cell or battery, *Sensors Journal* 7 (10) (2007) 2363-2377.
- [17] W.H. Zhu, R.U. Payne, B. J. Tatarchuk, PEM stack test and analysis in a power system at operational load via ac impedance, *Journal of Power Sources* 168 (2007) 211-217.
- [18] C. Brunetto, G. Tina, G. Squadrito, A. Moschetto, PEMFC diagnostics and modelling by electrochemical impedance spectroscopy, in: *IEEE MELECON 2004*, Dubrovnik, Croatia, May 12-15, 2004.
- [19] D. Chrenko, M.C. P'era, D.I Hissel, M. Geweke, Macroscopic modeling of a PEFC system based on equivalent circuits of fuel and oxidant supply, *ASME Journal of Fuel Cell Science and Technology* 5 (2008) 011015-1-011015-5.