

Self-diffusion coefficients obtained from proton-decoupled carbon-13 spectra for analyzing a mixture of terpenes

Mehdi Yemloul, Vincent Castola, Sébastien Leclerc, Daniel Canet

► **To cite this version:**

Mehdi Yemloul, Vincent Castola, Sébastien Leclerc, Daniel Canet. Self-diffusion coefficients obtained from proton-decoupled carbon-13 spectra for analyzing a mixture of terpenes. *Magnetic Resonance in Chemistry*, Wiley, 2009, 47, pp.635 - 640. 10.1002/mrc.2442 . hal-01482094

HAL Id: hal-01482094

<https://hal.univ-lorraine.fr/hal-01482094>

Submitted on 3 Mar 2017

HAL is a multi-disciplinary open access archive for the deposit and dissemination of scientific research documents, whether they are published or not. The documents may come from teaching and research institutions in France or abroad, or from public or private research centers.

L'archive ouverte pluridisciplinaire **HAL**, est destinée au dépôt et à la diffusion de documents scientifiques de niveau recherche, publiés ou non, émanant des établissements d'enseignement et de recherche français ou étrangers, des laboratoires publics ou privés.

Self-diffusion coefficients obtained from proton-decoupled carbon-13 spectra for analyzing a mixture of terpenes

Mehdi Yemloul¹⁾, Vincent Castola²⁾, Sébastien Leclerc³⁾, Daniel Canet^{1)*}

- 1) Méthodologie RMN (CRM2 UMR 7036, Nancy-Université-CNRS), Faculté des Sciences et Techniques, B.P. 239, 54506 Vandoeuvre-lès-Nancy (cedex), France
- 2) Chimie et Biomasse (UMR 6134, Université de Corse Pascal Paoli-CNRS), Rte des Iles Sanguinaires, Vignola, 20000 Ajaccio, France
- 3) LEMTA (UMR 7056, Nancy-Université-CNRS), BP 160, 54504 Vandoeuvre-lès-Nancy (cedex), France

* Corresponding author: Daniel.Canet@rmn.uhp-nancy.fr

Abstract

Sensitivity permitting, natural abundance ^{13}C offers a much better spectral resolution than proton NMR. This is due to an important chemical shift range and to proton decoupling conditions which yield one peak per carbon with practically no overlap. However, PGSE experiments, which lead to the diffusion coefficient associated with each peak, have scarcely been employed. In this paper, we present and compare different ways to access this quantity and we have effectively verified that, without any precaution, diffusion coefficients cannot be properly determined from standard procedures. The cause of such a failure is decoupling during the gradient pulses. We have used a very simple remedy which proved to be very successful on a model mixture of three monoterpenes and which appears as being of general applicability.

Introduction:

During the last two decades, much effort has been directed toward the analysis of mixtures by the so-called PGSE (Pulsed Gradient Spin Echo) NMR technique¹. This technique is based on the measurement of the translational self-diffusion coefficient which is different from one molecule to the other (according to the size and/or the molecular weight), hence the possibility of separating the different species of a mixture. The experiment rests on the application of static field gradient pulses in each half of a spin echo experiment. The present standard sequence rather employs stimulated echoes² and bipolar gradient pulses³. A series of experiments is performed with incremented gradient amplitudes and processed so as to provide a two-dimensional DOSY⁴ diagram with chemical shifts along one dimension and diffusion coefficients along the other. These procedures are generally applied to proton NMR with the drawback of severe overlaps whenever the spectrum is crowded (as it is often the case for complex mixtures). The major problem is therefore the determination of the various diffusion coefficients involved in overlapping patterns. This implies Inverse Laplace Transform (ILT) which must be included in data processing. Several algorithms exist¹ but may fail in the case of strongly overlapping lines. A possible remedy is to increase the spectral resolution by using a third dimension which spreads out the various resonances so as to avoid unwanted overlaps. In this respect, various sequences belonging to the family dubbed IDOSY have been proposed⁵⁻⁸. Hadamard encoding has been invoked for shortening this type of experiment⁹ and, very recently, has also been used in DOSY-TOCSY experiment for reducing significantly the measuring time¹⁰. Another way of improving spectral resolution and thus avoiding problems related to overlapping patterns is to rely on proton-decoupled carbon-13 spectroscopy. However, having recourse to direct observation of carbon-13 is not so common¹¹⁻¹³ and, in that case, problems associated with proton decoupling have been mentioned¹⁴. In fact, most of the time¹⁵⁻¹⁸, the usual PGSE procedure is run at the level of

proton resonances and their polarization is transferred to carbon-13 via a refocused INEPT procedure and subsequently measured through the proton-decoupled carbon-13 spectrum. In that case, diffusion coefficients are effectively measured in a straightforward manner since, in proton-decoupled carbon-13 spectra, line overlapping is scarce. However, on the one hand, carbons non-bonded to protons are excluded and, on the other hand, polarization transfers are not the same for all carbons (because of different values of J couplings) thus rendering the procedure not quantitative. Evidently, the ideal procedure would be to measure the diffusion coefficient pertaining to all resonances in a proton-decoupled carbon-13 spectrum but, surprisingly, this methodology has not been often considered. In fact, due to the gyromagnetic ratio of carbon-13 which is four times smaller than the one of proton, gradients four times stronger are required. One other issue is that of decoupling. First, relatively strong irradiation at the proton frequency is expected to cause sample heating and therefore convection phenomena. The latter are known to obscure diffusion phenomena and, possibly, to prevent proper measurements of diffusion coefficients. As a matter of fact, we show in this communication that convection phenomena (if they exist) are not responsible for the encountered problems. In fact, problems related to decoupling have already been addressed^{12,13}. They are due to a frequency shift during gradient applications and, as a consequence, to a much less efficient decoupling. This will be detailed later.

It can be noticed that problems posed by homonuclear J coupling are of different nature (essentially echo modulation). In that case several remedies have been proposed^{19,20}.

Experimental:

All experiments reported in this paper have been performed at ambient temperature with a Bruker Avance DRX-600 spectrometer equipped with a cryogenic probe. The ¹³C 90° standard rf pulse has a duration of 15 μs. The duration of each sine-shaped gradient (g) pulse, δ/2, was 3ms. The maximum gradient strength is 50 G/cm. The gradient was incremented in

32 steps between 2% and 95% of this maximum value, each step corresponding to a separate experiment. The diffusion interval Δ was set at 600 ms; this unusual large value is allowed by the fact that ^{13}C longitudinal relaxation times (T_1) are generally relatively long (3-5 s). The time elapsed between two consecutive experiments is assumed to be five times the longest T_1 . The model mixture is made of three monoterpenes: limonene (17%), carvone (33%), terpinen-4-ol (50%). These three molecules differ slightly by their molecular weight and their diffusion coefficients are close to each other (table 1). This makes this mixture particularly well suited for testing the accuracy of the method and its separation capabilities. Values given in table 1 represent a mean obtained from the results displayed in figure 2 (those in figure 5 were not measured the same day and may present a slight systematic difference and cannot be mixed with data of figure 2). Uncertainties arise from 99% confidence intervals.

Results and Discussion:

We first run the experiment of figure 1b where decoupling is just applied during data acquisition. Contrary to our expectation, the result shown in figure 2 was very satisfactory. This was briefly mentioned about $^{31}\text{P}\{-^1\text{H}\}$ -PGE experiments (which yielded “excellent result, when inverse gated ^1H decoupling was used”)²¹.

We found, with small experimental uncertainties, three families of diffusion coefficients. This was checked by a diffusion experiment run classically at the level of proton resonances (not shown) where the three diffusion coefficients were indeed retrieved. The separation of the three components is achieved in a straightforward way and we have, of course, verified that the diffusion results are consistent with the chemical shifts of all peaks belonging to the three compounds²².

The next step was to go back to the sequence of figure 1a and to verify that it did not work. Indeed, it does not work for carbons bound to protons (figure 3a), but seems to work perfectly for carbons not bearing protons, as shown in figure 3d. As a consequence, in the present case,

convection phenomena have nothing to do with the failure of diffusion coefficient determination. The only difference between the experiment of figure 1a and the one of figure 1b is the period during which decoupling is applied. Of course, since convection is not concerned, the so-called diffusion interval Δ is not involved. On the other hand, continuous decoupling could be advantageous for sensitivity matters (nuclear Overhauser effect), especially for low concentration components. An experimental procedure maintaining the nOe enhancement is therefore desirable.

As mentioned above, the consequence of a gradient application is a strong shift of resonance frequencies, depending on the spatial location. This is of course true for proton resonances (due to the large proton gyromagnetic ratio). For example, for a gradient of 5G/cm and a sample height of 3cm, the spread in resonance frequencies is 64000 Hz. As a first consequence, decoupling will no longer be efficient for a large part of the sample and this becomes worse and worse when the gradient is incremented toward larger values. As a second consequence, if they could be observed, lines would be broadened by this incomplete decoupling leading to short effective T_2 's. It is well known that the process of defocusing-refocusing is hampered by short T_2 's and the decay due to diffusion is therefore corrupted. This is illustrated by figure 4 where two different decoupling schemes have been used. The decay obtained by Waltz-16, known to be efficient over a relatively small frequency range is much faster than the one using GARP. Nevertheless none of these decays can be considered for properly determining diffusion coefficients. The remedy employed by Furó¹³ consists in selecting a slice for which the modification of the B_0 field is not large, leading to a moderate defocusing, and thus to an efficient decoupling. However, in this case, one is dealing with dipolar couplings, and the use of decoupling during gradient pulses seems mandatory in order to avoid a large spread in resonance frequencies which could be incompatible with the effects of gradients. Sequence 1a could probably be used in this case but with a properly chosen

decoupling scheme. However, for practical reasons, it seems sufficient to apply decoupling only during gradient pulses. As far as liquid samples are concerned, because J-couplings are much smaller, the spread in resonance frequencies is negligible and the remedy is simply to switch off the decoupling, at least, during the gradient pulses (see sequences of figures 1b and 1c).

It can be mentioned that something which looks like sequence 1c has already been proposed for application to liquid crystals but with ambiguous explanations²³.

The efficiency of sequence 1c is nicely illustrated by the data displayed in figure 3c, where decoupling is switched off only during the application of gradients. This experiment provides the same diffusion coefficients as the one of figure 3b (sequence 1b), but, since proton irradiation is applied almost continuously, peak intensities are enhanced by the nuclear Overhauser effect (see figure 5 and figure 3d).

Conclusion:

We have compared here different procedures, employing self-diffusion coefficients for separating the carbon-13 NMR spectra of the different components belonging to a complex mixture. Two methods are available:

- One, which is straightforward and which can be used if sensitivity is sufficient, is fully quantitative, proton decoupling being applied only during data acquisition.
- The other leads to peak intensities enhanced by nOe, as proton decoupling is applied continuously except during the gradient periods (which are very short).

These methods, which can be cross-checked with analyses based on chemical shift values²², deserves to be developed for more complex mixtures with a DOSY type display of the results without the need to perform an Inverse Laplace Transform.

References

1. B. Antalek, *Conc. Magn. Reson.*, **2002**, 14, 225.
2. E. J. Tanner, *J. Chem. Phys.*, **1970**, 52, 2523.
3. R. M Cotts, M. J. R. Hoch, T. Sun, and J. T. Marker, *J. Magn. Reson.*, **1989**, 83, 252.
4. C. S. Johnson, Jr, *Prog. Nucl. Magn. Reson. Spectrosc.*, **1999**, 34, 203.
5. M. Nilsson, A. M. Gil, I. Delgadillo and G. A. Morris, *Anal. Chem.*, **2004**, 76, 5418.
6. M. J. Stchedroff, A. M. Kenwright, G. A. Morris, M. Nilsson and R. K. Harris, *Phys. Chem. Chem. Phys.*, **2004**, 6, 3221.
7. M. Nilsson, A. M. Gil, I. Delgadillo and G. A. Morris, *Chem. Commun.*, **2005**, 1737.
8. J. M. Newman and A. Jerschow, *Anal. Chem.*, **2007**, 79, 2957.
9. C. A. Steinbeck and B. F. Chmelka, *J. Am. Chem. Soc.*, **2005**, 127, 11624.
10. S. Viel and S. Caldarelli, *Chem. Commun.*, **2008**, 2013.
11. M. E. Moseley, P. Stilbs, *Chemica Scripta*, **1980**, 16, 114.
12. P. Stilbs, *Anal. Chem.*, **1981**, 53 (13), 2135.
13. S. V. Dvinskikh, R. Sitnikov, I Furó, *J. Magn. Reson.*, **2000**, 142, 102.
14. M. Zhou, V. Frydman, L. Frydman, *Macromolecules.*, **1997**, 30, 5416.
15. G. S. Kapur, M. Findeisn, S. Berger, *Fuel.*, **2000**, 79, 1347.
16. D. Wu, A. Chen, C. S. Johnson, *J Magn. Reson.*, **1996**, 123, 215.
17. D. Li, R. Hopson, W. Li, J. Liu, P. G. Williard, *Organic Letters.*, **2008**, 10, 909.
18. N. E. Schlörer, E. J. Cabrita and S. Berger, *Angew. Chem. Int. Ed.* **2002**, 41, 107.
19. P. Stilbs, M.E. Moseley, *Chemica Scripta*, **1980**, 15, 215.
20. M.J. Hubley, T.S. Moerland, *NMR in Biomedicine*, **1995**, 8, 113.
21. E. Martinez-Viviente, H. Regger, P. S. Pregosin, J. Lpez-Serrano, *Organometallics* **2002**, 21, 5841.
22. F. Tomi, J. Casanova, *Acta Hort.*, **2006**, 723, 185.
23. S. Kanekusa, H. Kimura, S. Kuroki, I. Ando, S. Fujishige, *Macromolecules.*, **2004**, 37, 453.

Structure			
Compound Name	TERPINEOL-4	CARVONE	LIMONENE
MW	154 g.mol ⁻¹	150 g.mol ⁻¹	136 g.mol ⁻¹
D	4.5 ± 0.08 10 ⁻¹⁰ m ² .s ⁻¹	5.09 ± 0.02 10 ⁻¹⁰ m ² .s ⁻¹	6.36 ± 0.20 10 ⁻¹⁰ m ² .s ⁻¹

Table1: The three compounds composing the model mixture investigated here. See figure 3 for the meaning of the star and of the arrow.

Figure captions

Figure 1. Sequences used in this work for measuring diffusion coefficients from proton-decoupled carbon-13 NMR spectra, decoupling is symbolized by filled rectangles:

- a) with continuous decoupling
- b) with decoupling only during data acquisition
- c) with decoupling switched off during gradient pulses

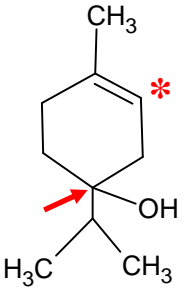
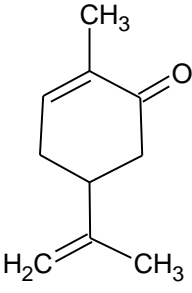
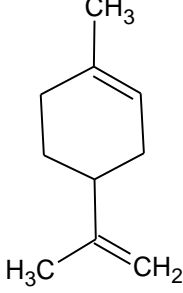
Figure 2. The sequence 1b) applied to the mixture of three terpenes. Two spectra, corresponding to low and high chemical shift ranges are displayed for the sake of clarity. The diffusion coefficient given at the top of each peak has been measured from the decay curve pertaining to that peak. Different colors are used for the three families of diffusion coefficients.

Figure 3.

a), b), c) Decays of the signal corresponding to the carbon-13 marked by a star in the molecule of Terpineol-4 (see table 1) obtained by the sequences of figures 1a, 1b, 1c, respectively. Notice the intensity increase in figure 3c with respect to figure 3b.

d) Decay of the signal corresponding to the carbon-13 marked by an arrow in the molecule of Terpineol-4 (see table 1) obtained by the sequence of figure 1a.

Dots: experimental data. Continuous curves: recalculated decays.

Figure 4. Decays of the signal corresponding to the carbon-13 marked by a star in the molecule of Terpineol-4 (see table 1) obtained by the sequence of figure 1a with two different

decoupling schemes. ●: Waltz-16. ◆: Garp. The continuous curve represents what should be the ideal decay.

Figure 5. Same as figure 2 but with the sequence 1c). n.m.: not measured.

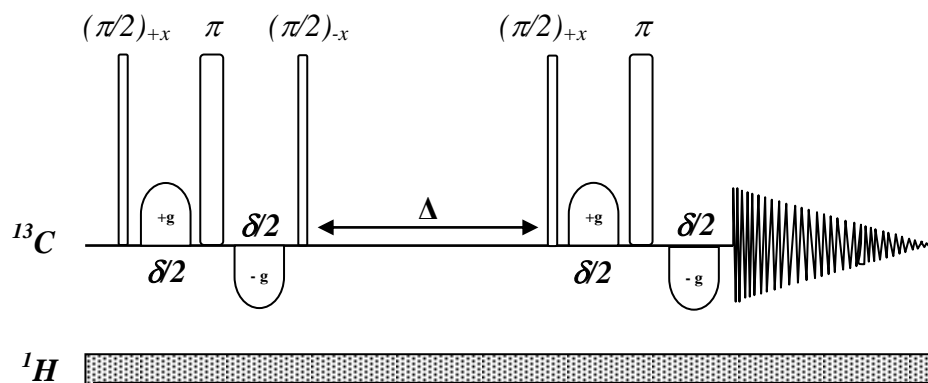

1.a

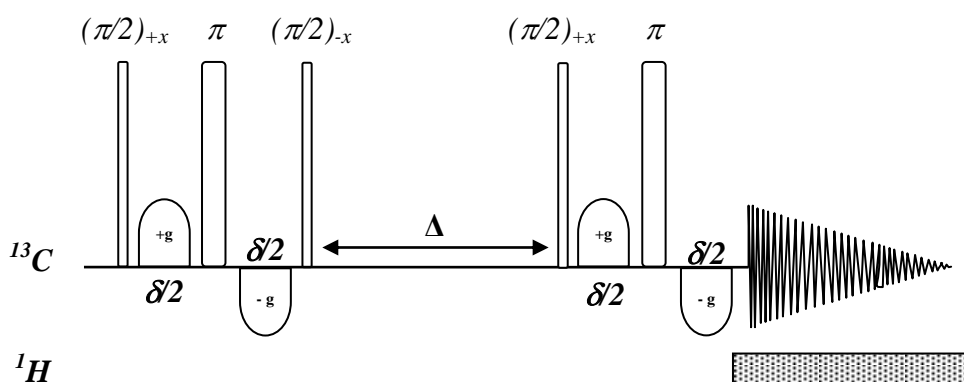

1.b

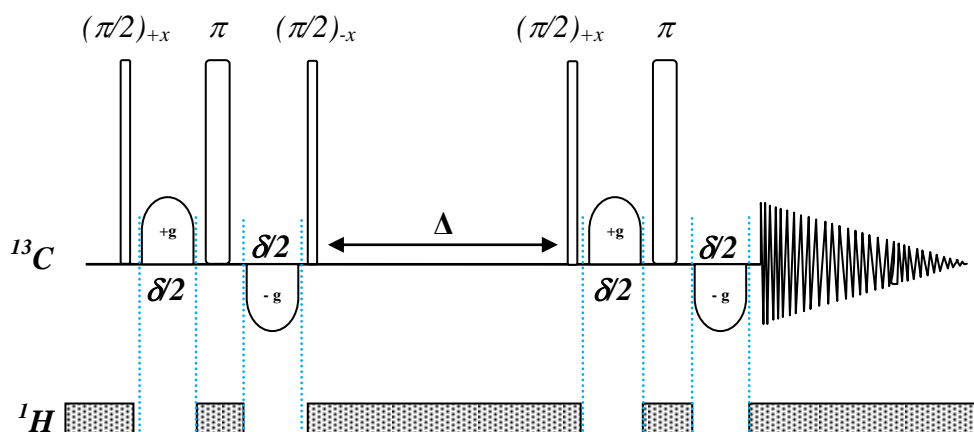

1.c

Figure 1

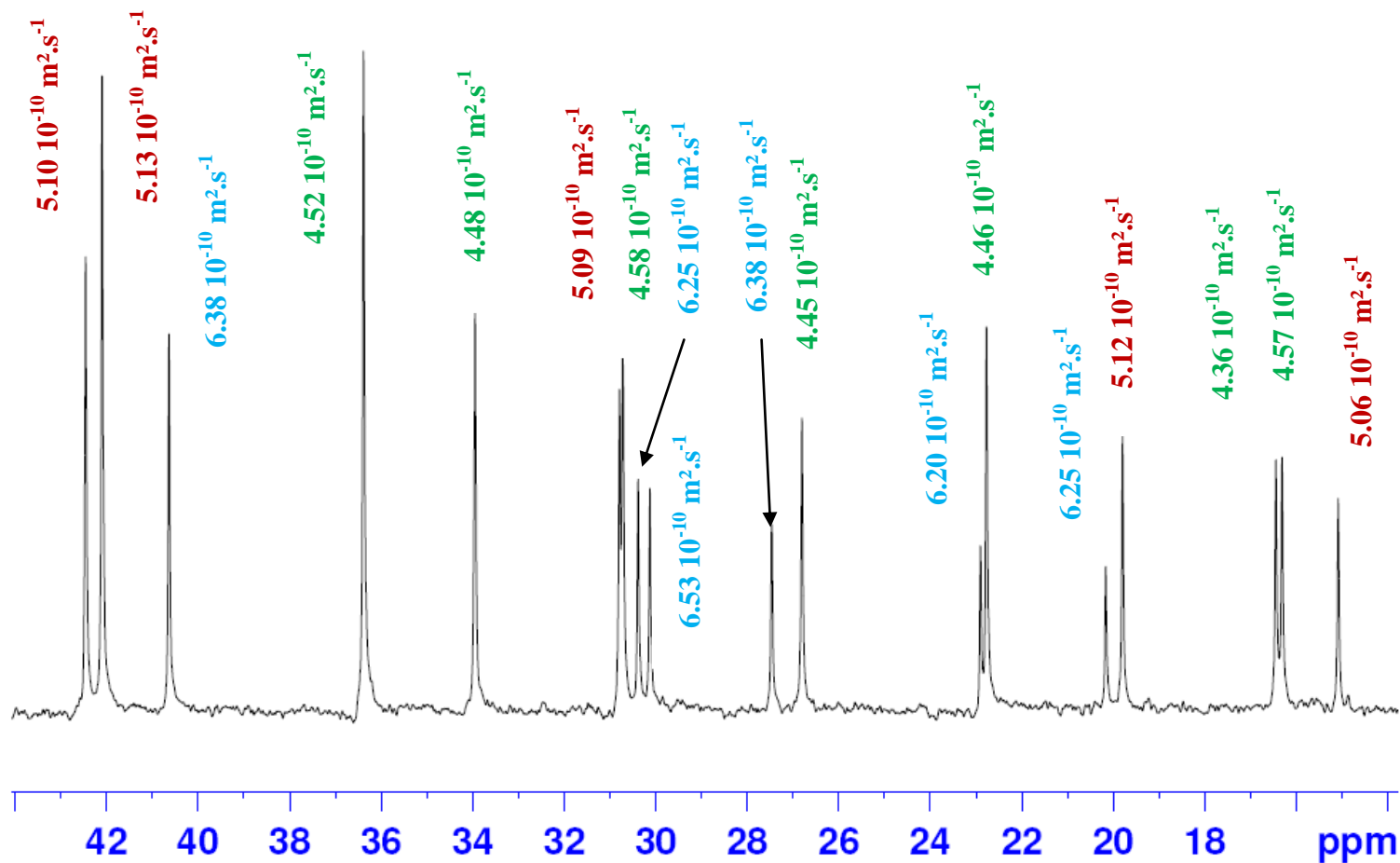
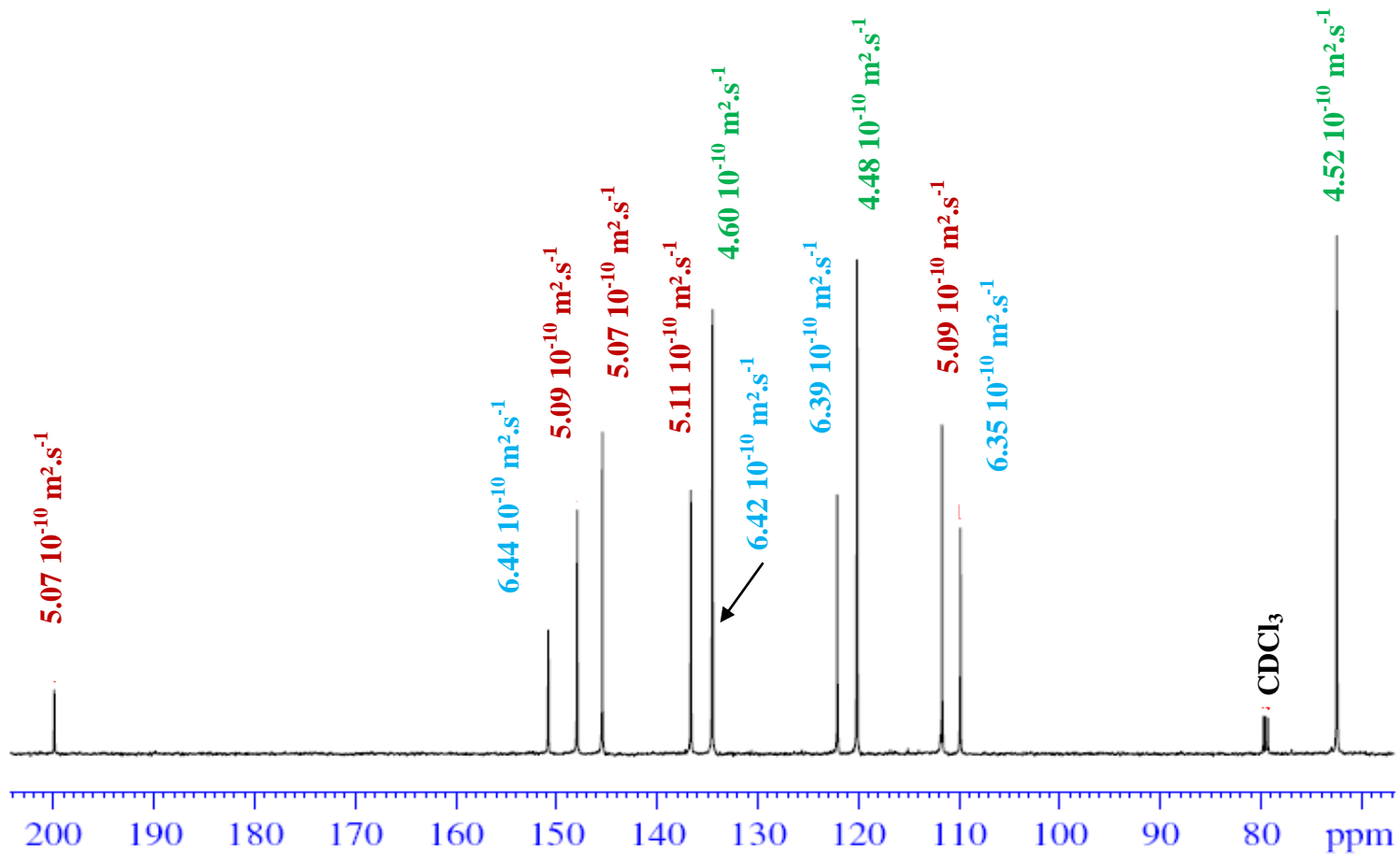

Figure 2

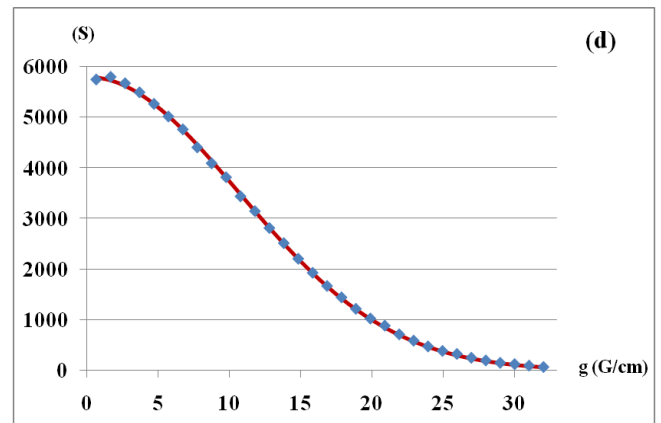
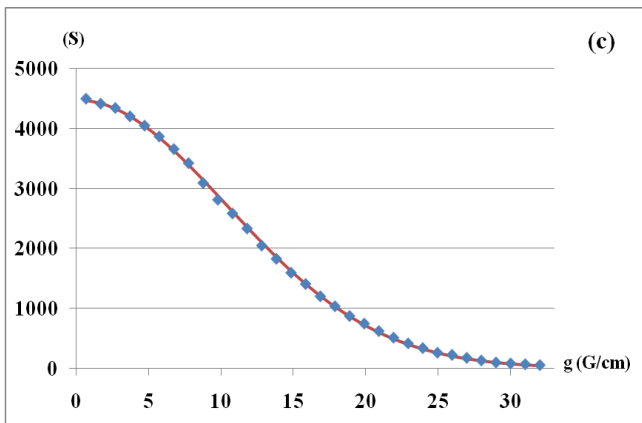
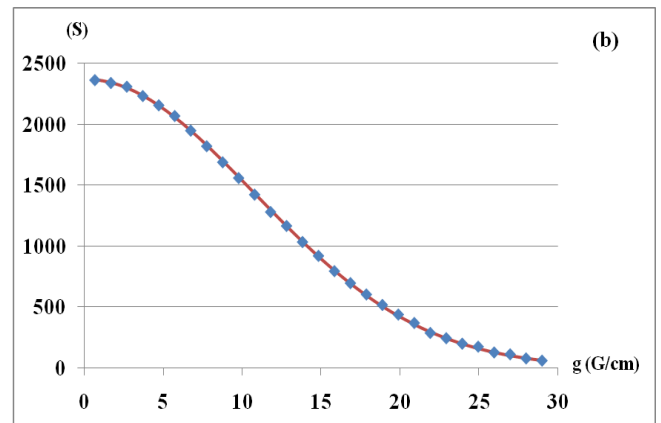
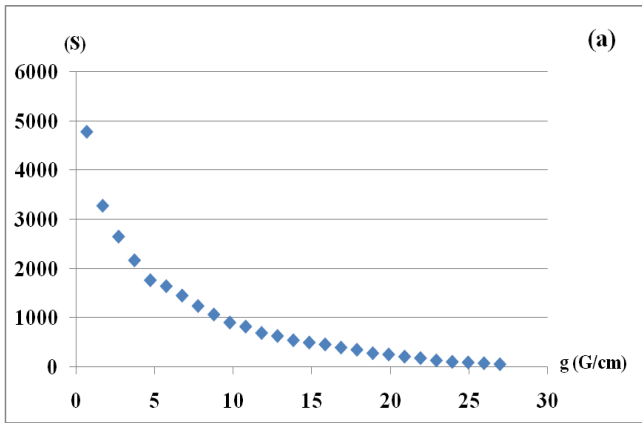

Figure 3

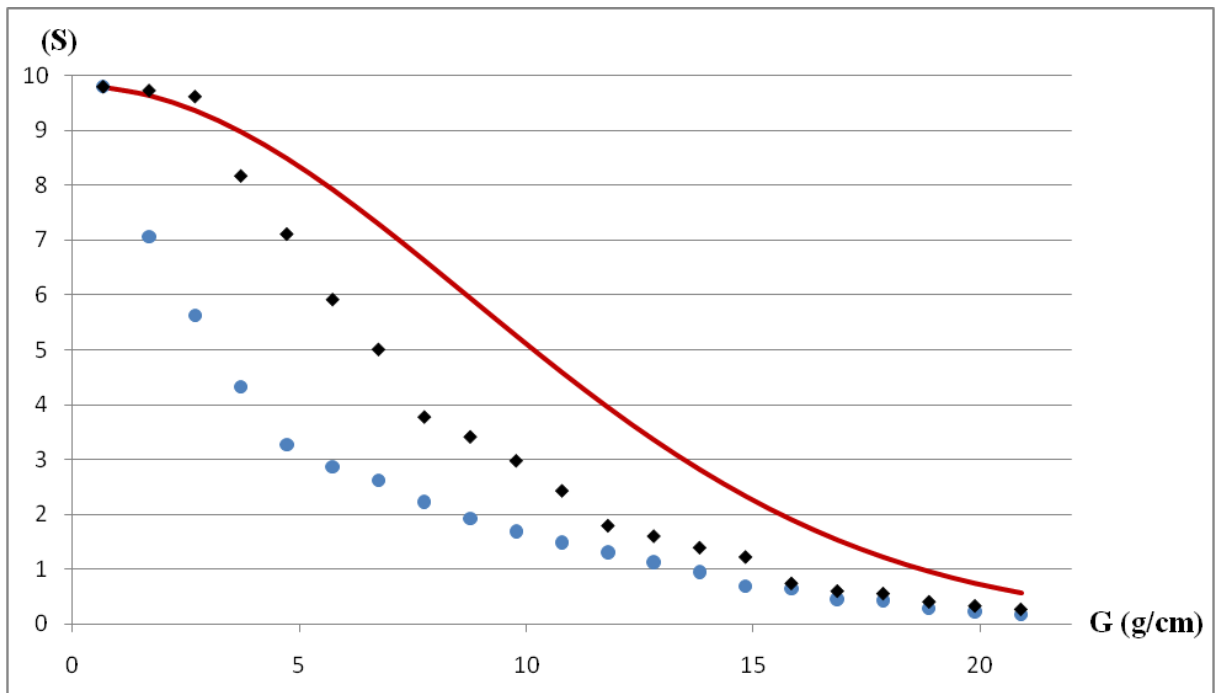

Figure 4

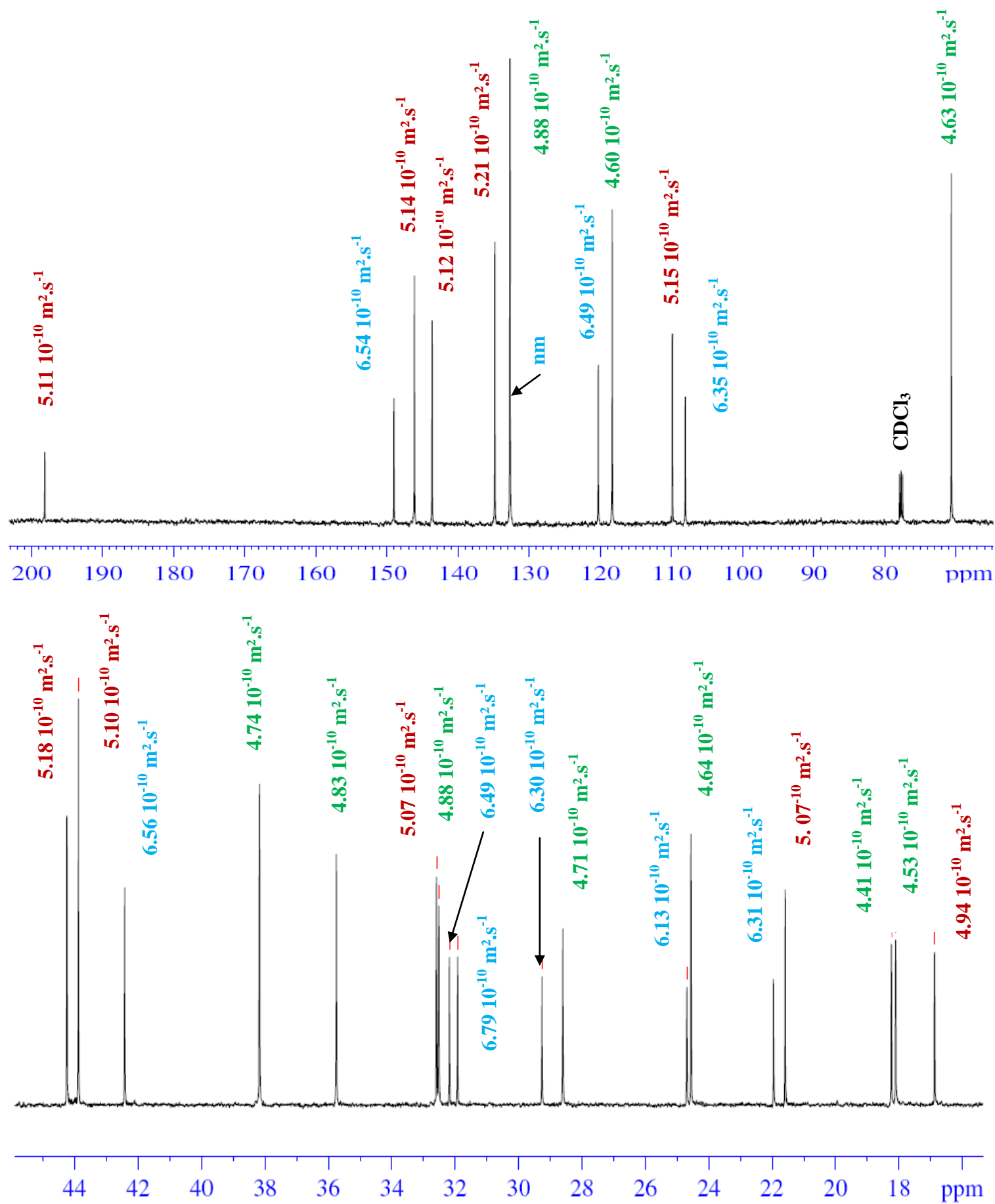

Figure 5