



**HAL**  
open science

## Contribution of shear deformation to grain refinement and densification of iron powder consolidated by high pressure torsion

Yajun Zhao, Roxane Massion, Thierry Grosdidier, Laszlo S. Toth

► **To cite this version:**

Yajun Zhao, Roxane Massion, Thierry Grosdidier, Laszlo S. Toth. Contribution of shear deformation to grain refinement and densification of iron powder consolidated by high pressure torsion. 6th International Conference on Nanomaterials by Severe Plastic Deformation, Jun 2014, Metz, France. 10.1088/1757-899X/63/1/012032 . hal-01518024

**HAL Id: hal-01518024**

**<https://hal.univ-lorraine.fr/hal-01518024>**

Submitted on 4 May 2017

**HAL** is a multi-disciplinary open access archive for the deposit and dissemination of scientific research documents, whether they are published or not. The documents may come from teaching and research institutions in France or abroad, or from public or private research centers.

L'archive ouverte pluridisciplinaire **HAL**, est destinée au dépôt et à la diffusion de documents scientifiques de niveau recherche, publiés ou non, émanant des établissements d'enseignement et de recherche français ou étrangers, des laboratoires publics ou privés.

## Contribution of shear deformation to grain refinement and densification of iron powder consolidated by high pressure torsion

This content has been downloaded from IOPscience. Please scroll down to see the full text.

2014 IOP Conf. Ser.: Mater. Sci. Eng. 63 012032

(<http://iopscience.iop.org/1757-899X/63/1/012032>)

View [the table of contents for this issue](#), or go to the [journal homepage](#) for more

Download details:

IP Address: 193.54.91.144

This content was downloaded on 04/05/2017 at 09:14

Please note that [terms and conditions apply](#).

You may also be interested in:

[Microstructure and mechanical properties of continuous equal channel angular pressed Titanium](#)

G S Dyakonov, C F Gu, L S Toth et al.

[High-Pressure Torsion of Ti: Synchrotron characterization of phase volume fraction and domain sizes](#)

Raúl E Bolmaro, Vitor L Sordi, Maurizio Ferrante et al.

[Microstructures and mechanical properties of pure tantalum processed by high-pressure torsion](#)

Y Huang, N Maury, N X Zhang et al.

[A study of plastic deformation behavior during high pressure torsion process by crystal plasticity finite element simulation](#)

P T Wei, C Lu, K Tieu et al.

[Fabrication of fine recrystallized grains and their mechanical property in HPT processed pure magnesium](#)

Mohit Joshi, Yuko Fukuta, Si Gao et al.

[Grain refinement and Lattice Imperfections in Commercial Aluminum Alloy Processed by Severe Plastic Deformation](#)

Saifeddine Charfeddine, Karim Zehani, Lotfi Besais et al.

[The significance of self-annealing in two-phase alloys processed by high-pressure torsion](#)

Nian Xian Zhang, Megumi Kawasaki, Yi Huang et al.

[Influence of deformation temperature on texture evolution in HPT deformed NiAl](#)

C Tränkner, R Chulist, W Skrotzki et al.

# Contribution of shear deformation to grain refinement and densification of iron powder consolidated by high pressure torsion

Y J ZHAO<sup>1\*</sup>, R Massion<sup>1,2</sup>, T Grosdidier<sup>1,2</sup>, L S Toth<sup>1,2</sup>

<sup>1</sup>Laboratoire d'Etude des Microstructures et de Mécanique des Matériaux (LEM3), Université de Lorraine, Ile du Saulcy, 57045 Metz, France

<sup>2</sup>Laboratory of Excellence on Design of Alloy Metals for low-mAss Structures (DAMAS), Université de Lorraine, Ile du Saulcy, 57045 Metz, France

\*E-mail: [yajun.zhao@univ-lorraine.fr](mailto:yajun.zhao@univ-lorraine.fr) (Y J ZHAO)

**Abstract.** High Pressure Torsion (HPT) experiments were performed for consolidation of water-atomized pure iron powder (99%) with initial particle sizes of 20-100  $\mu\text{m}$ . The experiments were carried out successfully at room temperature, achieving both low level of residual porosity and significant grain refinement, thanks to the intense shear strain and hydrostatic pressure applied in HPT. X-ray diffraction analysis was carried out on the consolidated samples which revealed no significant proportion of oxides. Considering the inherent heterogeneity of the imposed shear strain in HPT, different positions across the diameters of sample disks were selected for mechanical property and microstructure investigations. The effect of shear deformation on the microstructure and texture was investigated by metallography, scanning electron microscopy, electron backscattered diffraction (EBSD). The micro-hardness and porosity of the samples as a function of shear strain at constant hydrostatic pressure were also measured. The grain size distributions showed homogeneous microstructures with significant grain refinement due to shear deformation. The texture measurements revealed that a shear texture typical to the shear of bcc iron was obtained during HPT compaction of iron powder.

**Keywords:** *High Pressure Torsion, Shear Strain, Powder Consolidation, Grain Refinement, Texture evolution.*

## 1. Introduction

Through the assembly of individual particles or atoms, powder metallurgy (PM) is capable of producing bulk components with very small grain sizes and with special compositions that are not achievable with conventional metallurgical processes. It is also a suitable process to manufacture metals which are hard to deform or melt. In conventional PM, however, in order to obtain full density of the final product, a hot isostatic pressing or sintering stage is always necessary, where a residual porosity level of  $\sim 2\%$  can be achieved at high processing temperatures (higher than  $800^\circ\text{C}$  for iron) [1]. The sintering usually has to be done using inert atmosphere, which is an extra cost in conventional PM processes. At the same time, the high-temperature process inevitably causes grain growth or might even induces phase changes in the metal, which is considered as a bottle-neck of the conventional PM approach.

It is well known that severe plastic deformation (SPD) routes, such as high pressure torsion (HPT) and equal channel angular extrusion (ECAE), can lead to significant microstructure refinement of metals and alloys, by introducing heavy strain and thus high dislocation density to the material [2]. The grain refinement effect of SPD is expected to be viable also for powder materials, which makes the SPD processes promising for consolidation of metal powders. It has already been shown that SPD techniques which imposes severe shear deformation and high hydrostatic pressure to the samples is a very efficient process for consolidating powder [3-5]. Efforts have been done to achieve fully dense products through consolidation of metallic powders by SPD approaches e.g., ECAP [1,6] and HPT [7].



Compared to the conventional PM approach, the SPD technique is viable to be carried out and achieve fully dense products at room temperature [3], and thus to avoid grain growth. One of the widely used SPD technique for metallic powders consolidation is HPT. While reports have produced the knowledge with regard to microstructure and properties (density distribution [8], hardness [9], etc.) of different metallic powders consolidated through HPT, the mechanisms of grain refinement and the texture evolution, which are crucial for the property improvement [10], are rarely reported. In the present work, commercially pure iron powder (99% purity) was consolidated by HPT with various revolution numbers at constant hydrostatic pressure. We focus on the role of shear strain and the hydrostatic pressure on the compaction process, which could lead to a further understanding to the mechanism of powder densification and microstructure refinement during HPT. The evolution of the crystallographic texture of the consolidated samples is also discussed in the present work.

## 2. Experimental materials and procedures

Water atomized commercially pure (99% purity) iron powders with initial particle sizes 20-100  $\mu\text{m}$  in diameter were used in the present work (Fig. 1a). The microstructure observations showed that each single particle was composed of grains with an average size of  $\sim 20 \mu\text{m}$  in diameter (Fig. 1b).

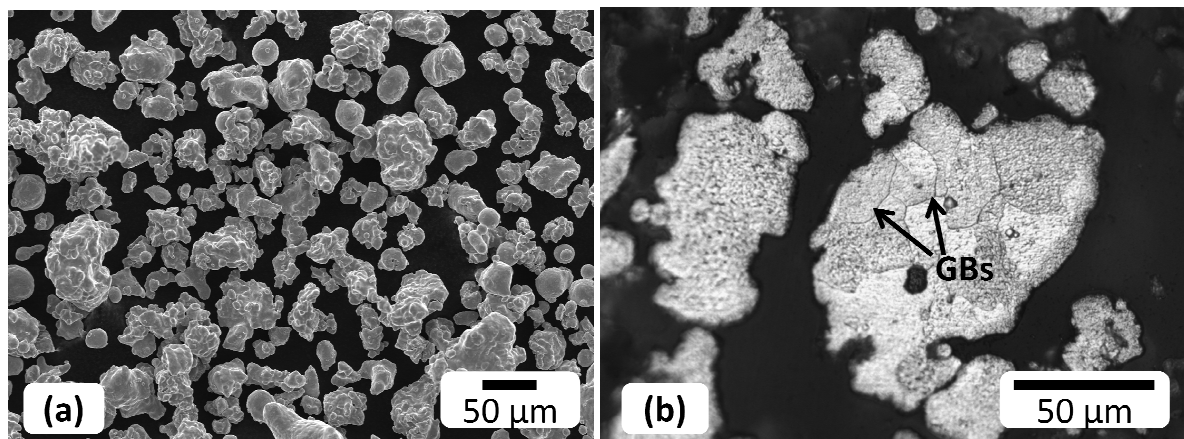

Fig. 1. Scanning electron microscopy images of the initial water atomized Fe powder showing particle sizes of 20-100  $\mu\text{m}$  (a) and grain sizes of  $\sim 20 \mu\text{m}$  (b). Some grain boundaries (GBs) are indicated in (b).

The powder was consolidated by high pressure torsion (HPT) into disk-shaped samples with dimensions of 20 mm in diameter and  $\sim 3 \text{ mm}$  in thickness at room temperature. The consolidation process and the dimensions of the high pressure torsion consolidated (HPTc) samples are illustrated schematically in Fig. 2. The compaction process was carried out in two steps: first simple axial compression of the initial powder, then HPT rotation. With the purpose of investigating the respective contributions of shear deformation and hydrostatic pressure to the consolidation process, HPT tests were carried out with different hydrostatic pressures and rotation angles, introducing different amount of shear strains into the HPTc samples. For comparison, the samples were examined also after the first stage of compaction, compacted only under axial pressure without imposing shear strain. The parameters applied in the HPT tests are summarized in Table 1.

Table 1. The parameters of the HPT consolidation process

Sample	Applied pressure (GPa)	Rotation angle (radian)	Rotation speed (degree/min)	Loading time (min)
1	1.5	$\pi/2$	72	1.25
2	1.1	$2\pi$	72	5
3	1.1	$4\pi$	72	10
4	1.1	-	-	10

Considering the inherent heterogeneity of the imposed shear strain in HPT, different positions across the diameters of the HPTc samples were selected for Vickers hardness measurements and microstructure observations. According to the definition of shear strain, the following formula was employed to calculate the shear strain at each selected position of the HPTc samples:

$$\gamma = 2\pi nr/h \quad (1)$$

Here  $r$  represents the radial distance from the center,  $h$  is the disk thickness and  $n$  is the number of revolutions. This formula is established under the assumption that the thickness of the disk remains constant during testing and that is independent of the rotation angle  $\theta = 2\pi n$ .

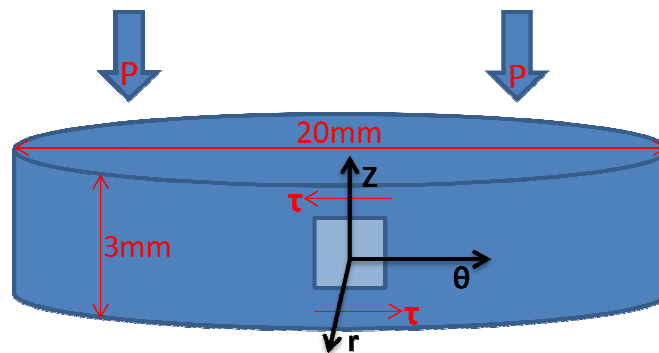

Fig. 2 Schematic illustration of the HPT consolidation process, the local reference system, and dimension of the HPTc samples, where  $\tau$  indicates the rotation direction.

X-ray diffraction (XRD) analyses of the initial powder as well as HPTc samples were performed using Co-K $\alpha$  radiation. The microstructure and texture were examined by means of electron backscattered diffraction (EBSD) technique using a field emission gun (FEG) scanning electron microscope (SEM). The specimens for EBSD were first mechanically ground on wet SiC paper up to 6  $\mu\text{m}$  roughness, which was followed by electro-polishing in a perchloric acid - alcohol solution. The Vickers hardness (HV) measurements were done by applying a load of 200 gr for 10 s on the bottom section of the disks. The porosity of the HPTc samples were measured using the Archimedes method in distilled water.

### 3. Results and discussions

#### 3.1 Porosity and Vickers hardness

The measured porosity of the HPTc samples are summarized in Table 2, which were obtained by means of the Archimedes drainage method carried out in distilled water at room temperature. In this section, the same serial numbers that shown in Table 1 are used to identify the samples. The results show a quite low level of residual porosity for all samples

consolidated by HPT, as low as the porosity of dense materials (1%-2%) produced by conventional powder metallurgy approach where the application of a high temperature sintering stage is necessary. For sample no. 3 even lower value was obtained (0.59 at 1.1 GPa pressure,  $4\pi$  rotation angle and 10 min loading). Comparing the porosity of sample no. 3 with sample no. 4 (at 1.1 GPa, 10 min loading, without HPT rotation), it is obvious that the porosity of the HPTc samples were reduced by the HPT imposed shear strain (at the same value of pressure and loading time). The evolution of the porosity indicates that there is a significant contribution of the shear deformation to the densification of the powders in the HPT consolidation process.

Table 2. Porosity of HPTc samples

Sample:	1	2	3	4
Rotation angle:	$\pi/2$	$2\pi$	$4\pi$	0
Porosity (%):	2.06	1.01	0.59	3.02

Fig. 3 shows the variation of the Vickers hardness (HV) across the diameter of the sample disks processed with different rotation numbers under a constant hydrostatic pressure of 1.1 GPa. It is apparent that there is a non-uniform distribution of the hardness within the cross-section of the HPTc samples with lower values in the center and increasing monotonically towards the periphery region. By increasing the rotation numbers there is a clear increase in the average values of HV both at the center and at the periphery of the samples. Considering the heterogeneity of the imposed shear strain calculated by formula (1), we can conclude that in the HPT consolidation process the shear deformation is extremely important in increasing the value of the Vickers hardness. This effect is most probably due to the increased dislocation density introduced by the additional shear strain.

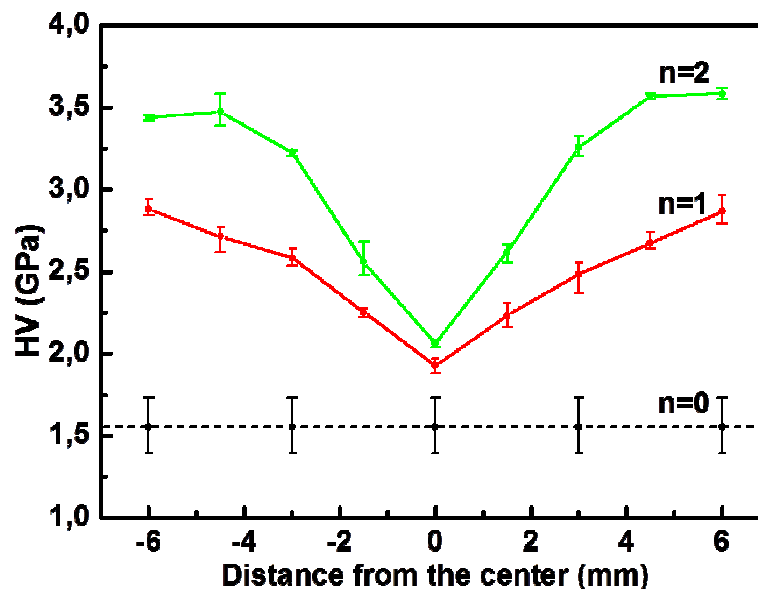

Fig. 3 Vickers hardness of the HPTc samples processed with different rotation numbers ( $n$ ). The hydrostatic pressure was 1.1 GPa for all samples.

### 3.2 Microstructure

The X-ray diffraction (XRD) patterns of the initial powder and the HPTc samples are shown in Fig. 4. The spectrum of the initial water atomized powder revealed the existence of only the  $\alpha$ -Fe phase, other constituents or contaminants like oxides were below detectable limits. After consolidation, the patterns of the HPTc samples can be indexed by the same reflection peaks as the initial powder. This result demonstrates that there are no unexpected new phases or contaminants which could have been introduced into the samples, which is the advantage of doing consolidation at room temperature.

The relative intensities of the main reflection peaks in an XRD measurement are indicative of the presence of textures in the samples. Namely, the ratios of the peak intensities of the (200), (211) and (220) peaks are close to the 2/3/1 ratios for a random distribution, respectively, which is the case for the initial powder and also for the consolidated sample without shear strain ( $n=0$ ). In contrast, these ratios change significantly for the HPTc samples which is the result of the texture introduced by the shear strain. Another difference between the initial state and the HPTc case is that the reflection peaks are much broader for the HPTc samples ( $n=1$  and  $n=2$ ). This broadening of the X-ray peaks are due to the presence of a large dislocation density and a reduction in the crystallite size.

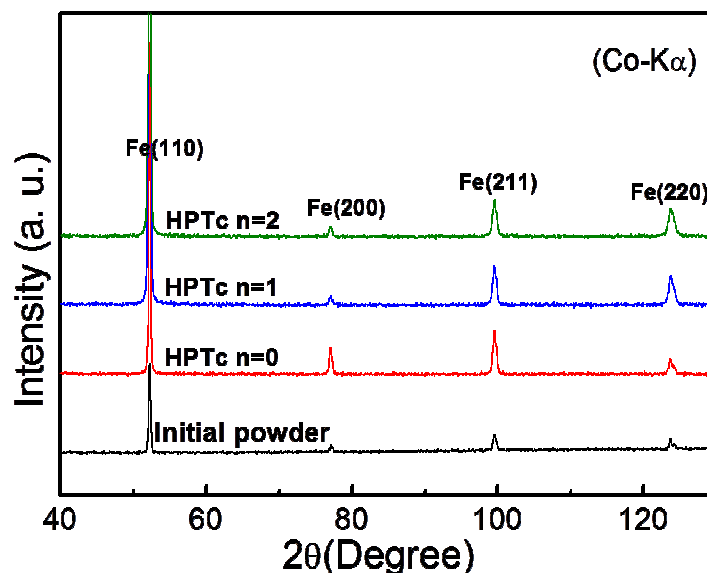

Fig. 4. X-ray diffraction patterns measured for the initial water atomized iron powder and for the HPTc samples.  $n$  is the revolution number applied in HPT tests.

The role of the shear deformation during the HPT consolidation process was assessed by comparing the microstructures of different positions selected across the diameter of the same sample disk. Under a constant hydrostatic pressure, the imposed shear strain of each selected position across the diameter could be calculated by formula (1). Fig. 5 shows the microstructures of positions selected from the central area and the periphery region of the HPTc sample no. 1 (at 1.5 GPa pressure,  $\pi/2$  rotation angle and 1.25 min loading time). At these positions, the imposed shear strain is  $\gamma=0$  and 4.25, respectively. It can be observed that the central area of the sample (Fig. 5a,  $\gamma=0$ ) displays equiaxed grains. The particle size and the grain size are equal to the sizes of the initial powder observed in Fig.1a and b, respectively. However, in the peripheral region (Fig. 5b,  $\gamma=4.25$ ), the grains are extremely refined due to the shear deformation. Note that the central region shows coarse particle boundaries, which are non existing in the peripheral area.

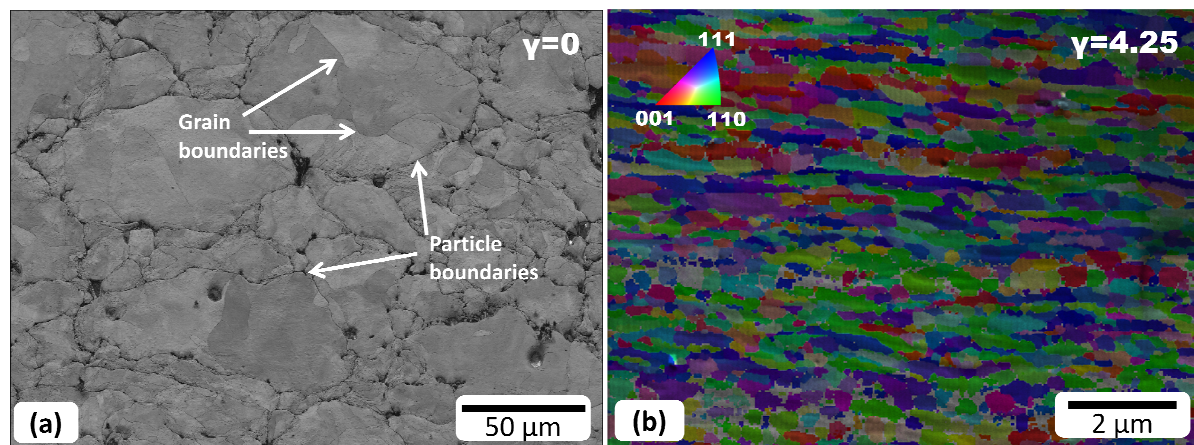

Fig. 5 Microstructures of an HPTc sample obtained by SEM and EBSD, in the central area where the shear strain is zero (a) and in the periphery region where  $\gamma=4.25$  (b). The latter map is an inverse pole figure map in which the radial axis direction within the crystal reference system is shown with a color code defined in the insert in (b).

The results obtained in the present investigation indicate that the shear deformation imposed on the samples has a dominant role in reducing the porosity and refining the microstructure of the samples in the HPT consolidation process. Lapovok et al. [1] examined the role of the shear strain in reducing the porosity in powder compaction processes through ECAP, where the shear deformation changes the spherical cavity geometry into an elliptical shape aligned with the shear plane, which is a geometrical effect that favors the closure of cavities under hydrostatic pressure [1].

The grain fragmentation process breaks the initial grains into small fragments which can fill the cavities more easily with the help of the applied hydrostatic pressure. As a result, a homogeneous microstructure with refined grains and low residual porosity can be achieved.

The grain size distributions of the selected areas shown in Fig. 5a and b are plotted in Fig. 6a and b, respectively, in area fractions. The distribution is bimodal in the central region having populations of small and large grains up to 44  $\mu\text{m}$  size. The average grain size is 20.18  $\mu\text{m}$  and 1.42  $\mu\text{m}$  in area weighted and number fraction calculation, respectively. However, at the periphery, the distribution is quite narrow with an average grain size of only 0.39  $\mu\text{m}$  in area weighted calculation (the same in number fraction calculation is 0.20  $\mu\text{m}$ ). The definition and formulas developed by Toth et al. in [11] were used for the average grain size calculations.



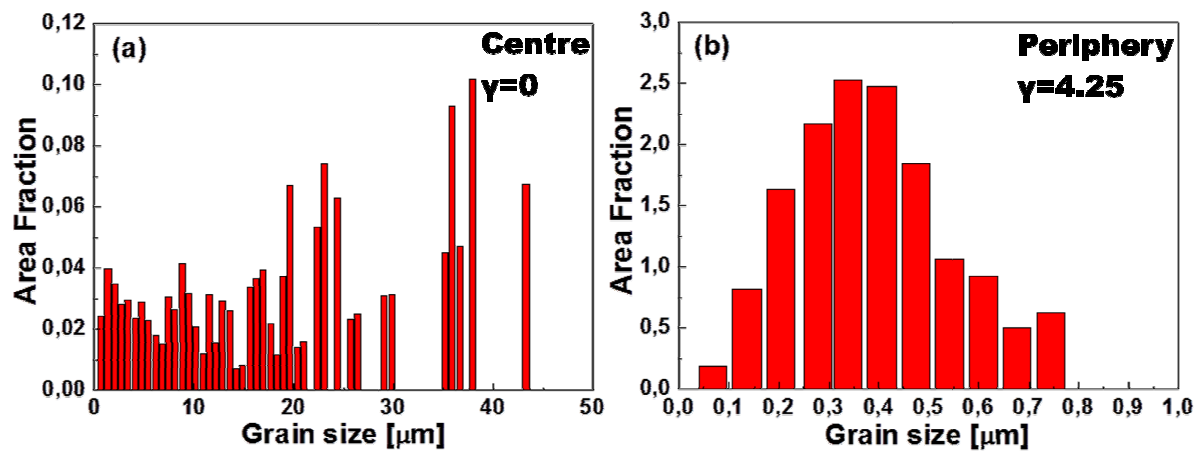

Fig. 6 Grain size distributions of the HPTc sample deformed by half rotation in HPT. (a): the central area where the shear strain is zero, (b): at the periphery region where  $\gamma=4.25$ .

### 3.3 Crystallographic texture

The inverse pole figure map for a selected position at the periphery with shear strain of  $\gamma=1.88$  is displayed in Fig. 7. The grain structure of the shear deformed area shows grains distinctly elongated in an inclined direction; the large axes of the grains are inclined at an angle of about  $22^\circ$  with respect to the shear direction. For the given value of the applied shear ( $\gamma=1.88$ ), nearly the same value can be obtained using the formula for shear [12]:

$$\beta = 0.5 \arctan (2/\gamma) = 23.4^\circ$$

This agreement indicates that the particles were deformed with the expected value of simple shear during the HPT consolidation process.

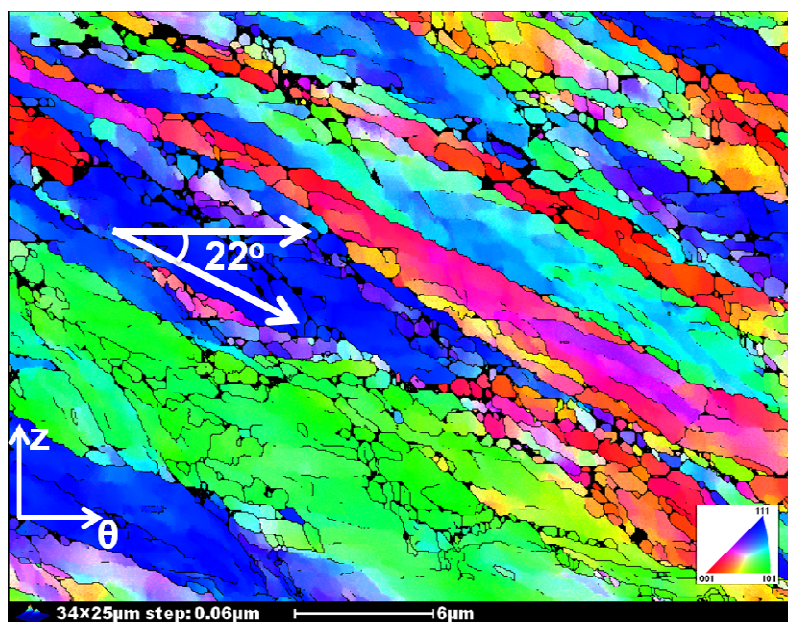

Fig. 7 Inverse pole figure map of an HPTc sample, deformed by a shear of  $\gamma=1.88$ .

In order to examine the crystallographic texture, the  $\{110\}$  pole figure obtained from Fig. 7 is presented in Fig. 8a. In comparison with the pole figure of ideal orientations (Fig. 8b), it shows clearly that the deformed material developed a typical torsion texture of b.c.c. metals. The texture is slightly rotated from its symmetry position in the anti-shear direction. This is typical for b.c.c. metals at relatively low shear strains [13].

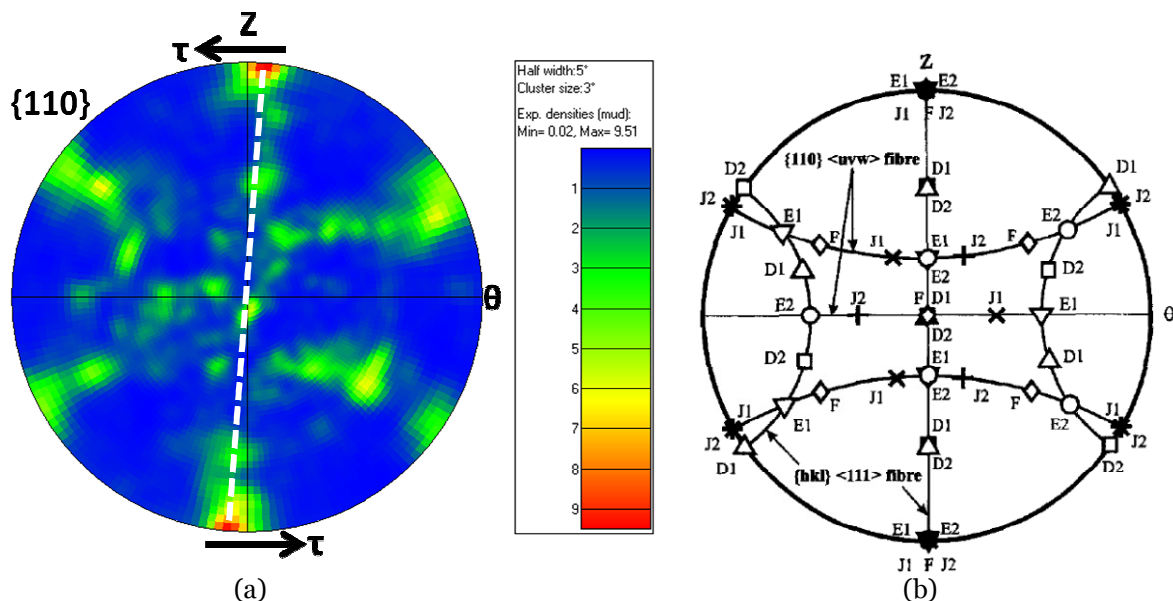

Fig. 8  $\{110\}$  pole figure shear deformed HPTc sample, with  $\gamma=1.88$  (a), where arrows indicate the sense of shear, and the ideal orientations of b.c.c. shear textures (b) (from Baczynski and Jonas [13]).

#### 4. Conclusions

High Pressure Torsion (HPT) was performed successfully for consolidating iron powder at room temperature. Low level of residual porosity and significant grain refinement was achieved. The Vickers hardness of the samples were increased monotonically with the imposed shear strain. The shear deformation was demonstrated to play a dominant role in reducing the porosity and refining the microstructure by changing both in shape and in dimension of the particles. In this process there is an effect of the grain fragmentation process as well. It has been demonstrated that the powder particles were deformed under simple shear and the consolidated samples developed typical torsion textures.

#### Acknowledgment

This work was supported by the French State through the program "Investment in the future" operated by the National Research Agency (ANR) and referenced by ANR-11-LABX-0008-01 (Labex DAMAS).

#### References

- [1] Lapovok R, Tomus D and Bettles C 2008 *Scr. Mater.* **58** 898–901
- [2] Segal VM 1995 *Mater. Sci. Eng. A* **197** 157
- [3] Valiev RZ, Islamgaliev RK, Alexandrov IV 2000 *Prog. Mater. Sci.* **45** 103–189
- [4] Valiev RZ, Langdon TG 2006 *Prog. Mater. Sci.* **51** 881–981

- [5] Shen H, Li Z, Gunther B, Korznikov AV, Valiev RZ 1995 *Nanostruct. Mater.* **6** 385-388
- [6] Xia K, Wu X 2005 *Scr. Mater.* **53** 1225-1229
- [7] Korznikov AV, Safarov IM, Laptionok V, Valiev RZ 1991 *Acta Metall.* **39** 3193-3197
- [8] Martin CL, Bouvard D, Shima S 2003 *J. Mech. Phys. Solids* **51** 667-693
- [9] Concustell A, Sort J, Woodcock TG, Gimazov A, et al. 2006 *Int. Metall.* **14** 871
- [10] Beyerlein IJ, Toth LS 2009 *Prog. Mater. Sci.* **54** 427-510
- [11] Toth LS, Biswas S, Gu ChF, Beausir B 2013 *Mater. Charact* **84** 67-71
- [12] Canova GR, Kocks U F, Jonas JJ 1984 *Acta Metall.* **32** 211-226
- [13] Baczynski J, Jonas JJ 1996 *Acta Meter.* **44** 4273-4288