



**HAL**  
open science

# Long term impacts of forest management on forest ecosystem: the case of “quart de reserve” in northeastern France

Camille Vauchelet

► **To cite this version:**

Camille Vauchelet. Long term impacts of forest management on forest ecosystem: the case of “quart de reserve” in northeastern France. Environmental Sciences. 2014. hal-01837055

**HAL Id: hal-01837055**

**<https://hal.univ-lorraine.fr/hal-01837055>**

Submitted on 12 Jul 2018

**HAL** is a multi-disciplinary open access archive for the deposit and dissemination of scientific research documents, whether they are published or not. The documents may come from teaching and research institutions in France or abroad, or from public or private research centers.

L'archive ouverte pluridisciplinaire **HAL**, est destinée au dépôt et à la diffusion de documents scientifiques de niveau recherche, publiés ou non, émanant des établissements d'enseignement et de recherche français ou étrangers, des laboratoires publics ou privés.



## AVERTISSEMENT

Ce document est le fruit d'un long travail approuvé par le jury de soutenance et mis à disposition de l'ensemble de la communauté universitaire élargie.

Il est soumis à la propriété intellectuelle de l'auteur. Ceci implique une obligation de citation et de référencement lors de l'utilisation de ce document.

D'autre part, toute contrefaçon, plagiat, reproduction illicite encourt une poursuite pénale.

Contact : [ddoc-memoires-contact@univ-lorraine.fr](mailto:ddoc-memoires-contact@univ-lorraine.fr)

## LIENS

Code de la Propriété Intellectuelle. articles L 122. 4

Code de la Propriété Intellectuelle. articles L 335.2- L 335.10

[http://www.cfcopies.com/V2/leg/leg\\_droi.php](http://www.cfcopies.com/V2/leg/leg_droi.php)

<http://www.culture.gouv.fr/culture/infos-pratiques/droits/protection.htm>

## **2nd-year international MSc**

Forestry, Agronomy and Ecosystem Management

Speciality: Forests and their ENvironment

### **LONG TERM IMPACTS OF FOREST MANAGEMENT ON FOREST ECOSYSTEM:**

**THE CASE OF “QUART DE RESERVE” IN NORTHEASTERN FRANCE**

**CAMILLE VAUCHELET**

Written dissertation defended at Nancy, 3 September



Supervisors: MONTPIED Pierre, Research engineer  
DUPOUEY Jean-Luc, Research director

*INRA Nancy – Lorraine University  
UMR 1137, “Forest Ecology and Ecophysiology”  
Rue d’Amance – 54 280 – Champenoux*

**2013 - 2014**

## AKNOWLEDGEMENTS

I should first like to thank very much my trainee supervisor, **Pierre Montpied**, for his availability and pedagogy throughout my internship. His knowledge in ecology, botanic (more particularly mosses) and data analysis allow me to improve my knowledge in forest ecology and to acquire a solid experience in research. More, his constant cheerfulness made my study a really good time!

I would also like to thank my co-supervisor, **Jean-Luc Dupouey**, for his pertinent advices and disciplined mind which helped me to step back on my study.

I am grateful to Patrick Behr and Remy Gaudaré for their assistance during the field trip, more particularly Patrick for his field experience and his practical advices.

I should like to thank Yves Lefèvre and Joseph Levillain for their knowledge and precious advices in pedology.

I am grateful to Christine Gehin, Séverine Bienaimé and Marie-Clo for their assistance and guidance in near and medium infrared spectroscopy.

I also thank mister Leyre for receiving us in ONF archives at Lunéville.

Obviously, I thank all the Forest Ecology and Eco physiology (EEF) team for his warm welcome and interns and doctoral students for their good company.

Finally, I thank very much my mother and my partner for their support and confidence in me.

## SUMMARY

LIST OF TABLES .....	3
LIST OF FIGURES .....	4
LIST OF ANNEXES .....	4
LIST OF ABBREVIATIONS .....	5
INTERNSHIP PRESENTATION .....	6
INTRODUCTION.....	7
LITTERATURE SYNTHESIS .....	7
Forest ecosystem modification by human actions: state of knowledge.....	7
Short term impacts of intensive forest biomass exportation.....	7
Long term impacts of past land use .....	8
Historical context of “Lorraine” communal forests .....	9
First results from a previous study .....	10
Hypotheses raised in the present study.....	10
MATERIAL AND METHODS .....	10
Study area .....	10
Sites selection by map analysis and field prospection.....	10
Sampling plan.....	11
Dendrometric protocol.....	12
Floristic protocol.....	12
Soil protocol .....	12
Humus and soil profile description .....	12
Soil sample.....	12
Soil analysis: Reflectance spectroscopy in near-IR and medium-IR (NIRS-MIRS)& chemical analysis .....	12
Statistical analysis.....	13
Stand analysis.....	13
Floristic analysis .....	13
Soil analysis .....	14
RESULTS.....	15
Studies aggregation and sites selection .....	15
Stand analysis .....	16
Flora analysis.....	16

Correspondence analysis.....	16
Probability test of apparition frequencies for each species.....	18
Ellenberg's and Julve's coefficients .....	18
Soil analysis.....	19
Soil properties .....	19
Bulk density.....	19
NIRS – MIRS analysis.....	19
DISCUSSION - CONCLUSION .....	20
BIBLIOGRAPHIC LIST.....	23
WEBSITES .....	26

## LIST OF TABLES

Table 1: Occurrence modalities of species according to treatment.....	13
Table 2: Wood categories percentages according to former treatment.....	16
Table 3: Quantiles logarithm values, number and ratio logarithm value for each specie.....	18
Table 4: Ellenberg's and Julve's coefficients according to former treatment.....	18
Table 5: P-value of MIRS and NIRS principal components according to studies.....	19

## LIST OF FIGURES

Figure 1: Organization chart.....	6
Figure 2: Scene harvest firewood during the 20th century (Husson, 1991).....	9
Figure 3: Soil carbon content in "coupes affouagères" based on the soil carbon content in the "quart de réserve" (line indicates equality).....	10
Figure 4: Old map (1770) and IGN map of Franconville communal forest.....	11
Figure 5: General plot schema.....	11
Figure 6: Factorial plane 1-2 from correspondence analysis of sites dispersion.....	15
Figure 7: Factorial plane 1-2 from correspondence analysis of sites dispersion according to studies.....	15
Figure 8: Factorial plane 1-2 from correspondence analysis with treatment effect.....	16
Figure 9: Factorial plane 1-2 from correspondence analysis of sites dispersion.....	17
Figure 10: Factorial plane 1-2 from correspondence analysis of species repartition.....	17
Figure 11: Mean values of bulk density between CA and QR.....	19
Figure 12: Principal component analysis for MIRS data.....	20

## LIST OF ANNEXES

Annex 1.....	27
Annex 2.....	28
Annex 3.....	29
Annex 4.....	30
Annex 5.....	32
Annex 6.....	33
Annex 7.....	34
Annex 8.....	35

## **LIST OF ABBREVIATIONS**

ADEME: French Environment and Energy Management Agency

BRGM: French Public institution for Earth Science applications

CA: Coupes affouagères

EEF: Forest Ecology and Eco-physiology

IGN: French National Institution for Geographic and Forest Information

INRA: French National Institute for Agronomic Research

MIRS: Medium Infrared Spectroscopy

NIRS: Near Infrared Spectroscopy

ONF: French National Office for Forests

PCA: Principal Component Analysis

Q: quantile

QR : Quart de réserve

SOM : Soil Organic Matter



## INTERNSHIP PRESENTATION

The French National Institute for Agronomic Research (INRA) produces scientific knowledge and works for economic and social innovation in the areas of food, agriculture and the environment. To face climate change, INRA must deal with major issues: prepare worldwide food availability and security by 2050, reduce greenhouse gas emissions from agriculture, and promote an alternative agricultural and forestry practices.

INRA centre from Nancy-Lorraine contains 16 research unities including EEF research unit (Forest Ecology and Eco-physiology) which develops research programs on interactions between environmental factors, ecosystem function, tree growth and on spatial-temporal species distribution.

My internship master is a project proposed by the phyto-ecology team from EEF (Figure 1). The work of this team is to improve the understanding of past and current dynamics of temperate forests. This involves time- and space-integrated studies of the changes of the environment that affect the health, fertility and biodiversity of forest stands.

My internship belongs to the main axis research “Impact of forest history on their current functioning”.

UMR 1137 INRA-UL EEF	
Jean-Marc GUEHL (Director), Daniel EPRON (Assistant director)	
Forest phyto-ecology	
Jean-Luc DUPOUEY (Research director)	
Researchers and research professors	
Bernard AMIAUD	Research professor
Nathalie BREDA	Research director
Sandrine CHAUCHARD	Research professor
Jean-Luc DUPOUEY	Research director
Catherine MASSONNET	Researcher
Stéphan PONTON	Researcher
Project manager	
Yves LEFEVRE	
Research engineers and research technicians	
Vincent BADEAU	Research engineer
Joseph LEVILLAIN	Research engineer
Patrick BEHR	Research technician
François GEREMIA	Research technician
Pierre MONTPIED	Research engineer
Christophe ROSE	Agent involved
Cyrielle VISINE	Technician agent
Phd students	
Yoran BORNOT	
Maxime BURST	

Figure 1: Organization chart

## INTRODUCTION

Nowadays, fossil energy depletion and global warming get our society on the way to renewable energy: one of these is forest biomass.

Biomass exportation presents a dilemma: it provides a solution for the two major energetic and climatic crises, but it involves land use changes (Landmann et al., 2009). These changes can affect forests ecosystems for the long term which evolve slowly.

This context has already been encountered in the past when forest was a vital energy source for local population (firewood) and economic activities (forges, salt works, naval construction...etc.).

A number of studies have already analysed short term biomass exportation effect, but very few focused on the long term effects in changes intensity of past forest management. The case of the “quart de reserve” in north-eastern France is a known situation about past forest management.

During the 18<sup>th</sup> and 19<sup>th</sup> century, most of the communal forests in the Lorraine region were divided into two parts. One called “coupes affouagères” (CA), was devoted to firewood production. The other one, called “quart de reserve” (QR) was not cut for firewood but kept as a wood reserve for unforeseen expenses and timber production (Rochel, 2013).

The “Quart de reserve” regulation is a documented historical situation by former management registers and available maps. Using this opportunity, we tested the hypothesis that: higher and more regular biomass removals in CA made long term differences (1740-2014) with QR in forest ecosystem properties.

This report is a follow-up to a similar study conducted in 2010 (Feiss, 2010) where 34 sites were surveyed on 3 substrates (marly, calcareous and acidic). It appeared that differences between CA and QR depended strongly on the type of substrate. Thus, we decided in our study to focus on marls only. On this substrate, differences in total organic matter content had been observed by Feiss (2010) but for 14 sites only.

## LITTERATURE SYNTHESIS

### **Forest ecosystem modification by human actions: state of knowledge**

During the last 4000-5000 years humans have been important agents affecting landscape composition and dynamics and biological diversity in Europe (Bengtsson et al., 2000). To maintain ecosystem functions in the present forests, it's necessary to understand short and long term forest ecosystem modifications generated by previous human management practices.

### **Short term impacts of intensive forest biomass exportation**

#### *Soil*

Several studies showed that some biomass compartments (branches, twigs and foliage) are richer in nutrients. So exportation of these compartments appears as a mineral exportation which can have impacts on soil fertility. More particularly on poor soils which can be acidified (Cacot et al., 2004; Huttel and Schaaf, 1995; Landmann et al., 2009, Ranger and

Bonnaud, 1984). Fertility is influenced by soil carbon content (C): organic matter improves soil properties and is a substrate for soil biota that perform decomposition and nutrient cycling (Thiffault et al., 2011). A meta analysis showed significant effects of whole-tree harvesting with a decrease of (-6%) for soil C and N (Johnson and Curtis, 2001). A more recent study reinforces this observation with a harvest-induced loss (-30% on average) for C stored in forest floor (Nave et al., 2010).

### *Vegetation*

A number of forest species are threatened because of the habitat quality reduction and fragmentation or even habitat loss as a result of forest management activities. The intensification of biomass exportation generally prevents the emergence of latter stages of forest natural cycle. These latter stages are composed by old trees micro-habitats and dead wood which favour a high richness of specialist taxa (Hartmann et al., 2010; Landmann et al., 2009; Stizia et al., 2012). Forest management can also have positive effects on primarily generalist species (easy dispersion, less sensitive to fragmentation and perturbation, light tolerant), more particularly vascular plants (Bengtsson et al., 2000; Fuller et al., 2013; Paillet et al., 2010). As regards slash maintaining, this one is generally favourable to floristic richness but not favourable to vascular plants which have a limited propagation capacity (Decocq et al., 2004; Landmann et al., 2009).

## ***Long term impacts of past land use***

### *Former land state*

In historical ecology, a lot of studies focused on the effects of past land use (ancient forest versus former agricultural land). For about two centuries, the French forest progress rapidly with nearly half of its surface was formerly agricultural lands. A distinction is visible in the current landscape: pre-existing forests at the minimum forest (ancient forests) are opposed to recent forests, installed subsequently (Dupouey et al., 2002 a). Ancient forest species were identified as associated to the interiors of ancient forests. Several studies have demonstrated a significant difference in the response of ancient forest plant species compared with other forest plant species for a variety of ecological characteristics (Ellenberg indicators, strategies, life form and phytosociology). Recent forest species are efficient colonists while ancient forest species possess a limited habitat range outside woods. This limitation could be explained by colonization difficulty (seed dispersal, production and inter specific competition) (Hermy et al., 1999; Peterken and Game, 1984; Sciama et al., 2009). Furthermore, former agricultural land is linked to long term changes of chemical and structural soil properties which have a key role in the forest structure and composition (Dupouey et al., 2002 b). Superficial horizons of former arable lands display lower organic carbon content and higher base saturation content. Former cultures are enriched in nitrogen caused by nitrogen cycle modifications, which generate the presence of nitrophilous species (Dupouey et al., 2004; Koerner et al., 1999).

### *Former forest practices*

Access to historical information is valued to understand historical trajectories and ecosystem processes. Numerous studies have illustrated the case of litter collecting (former practice) which has a strong impact on soil fertility, vegetation composition and tree growth (Burgi and Gimmi, 2007; Gimmi et al., 2010 Huffel, 1893). Experimental studies identified nutrient depletion and reduced acid neutralizing capacity as the most important effects of excessive biomass removal in forest soils (Glatzel, 1990; Glatzel, 1991) and detected long recovery times after abandonment of the practice (Glatzel et

al., 1999; Huttli and Schaaf, 1995). Gimmi et al. (2012) have shown using a biogeochemical model that after 310 years of litter raking soil carbon pools should be reduced by an average of 17 %.

More, a phyto-sociological study in Lorraine forests has identified clearly the influence of past silviculture and actual stand structure, between high forest and coppice with standards, on part of both the ligneous and herbaceous flora (Becker et al., 1979).

To our knowledge no study has been carried out on long term impacts of firewood extraction; historical context of past silviculture in Lorraine is well documented to consider the implementation of the following study.

### **Historical context of “Lorraine” communal forests**

Most of the communal forests in Lorraine are divided into compartments inherited from the former supervision of the State. During the 16<sup>th</sup> century, deforestation pressure had led royal order to require the imposition of a third woodland area being kept in reserve in 1561 and then a quarter in 1573. Is in 1669 thanks to the Colbert’s reformation that reserve quarter notion is generalized: local communities will have to save a forest quarter for extraordinary cuts while the remainder of the forest was exploited for firewood (Figure 2) (Husson, 1991; Rochel, 2013). At that time, Lorraine was not yet part of the France kingdom. However, in the 18th century, the Dukes of Lorraine adopted the measure of the reserve and applied it to the woodlands of the duchy (Dupouey et al., 2014). Former registers specify that the “quart de reserve” had to be located far from forest edges and villages, to avoid any pillaging (Degron, 1999 a). Spatial organisation of communal forests was often accompanied by a first forest surveying and mapping (*See Annex 1: “Survey maps” 1740 – 1790*). The forestry code reformation of 1827 has not changed the reserve quarter regulation but during the 19<sup>th</sup> century extraordinary cut permissions increased considerably (Degron, 1999 b). From 1880, QR was divided caused by repetition of extraordinary cut (*See Annex 1: Subdivision plan for the “quart de reserve”*). In the early 20th century, the coppice and coppice with standards, are accused of producing low-quality wood and be expensive in labour. High forest conversion has been established to ensure the demand of timber and the effective division between QR/CA disappeared. It’s in 1969 that QR obligations disappear by a public finance law.



**Figure 2 : Scene harvest firewood during the 20<sup>th</sup> century (Husson, 1991)**

### First results from a previous study

First study results (Feiss, 2010) showed slight effects of former management: the “Quart de réserve” contained more large wood and a lower floristic richness. Organic matter rate showed, only on marly substrates (14 sites), a significant gap between CA and QR with a loss of 14% in CA (Figure 3) (Dupouey, 2014). However, this observation was made on 14 pairs of plots only, a too small number to securely conclude at a true difference between CA and QR. The interest of my internship is to extend and to strengthen our belief that silviculture historical effects are in relationship with soil fertility.

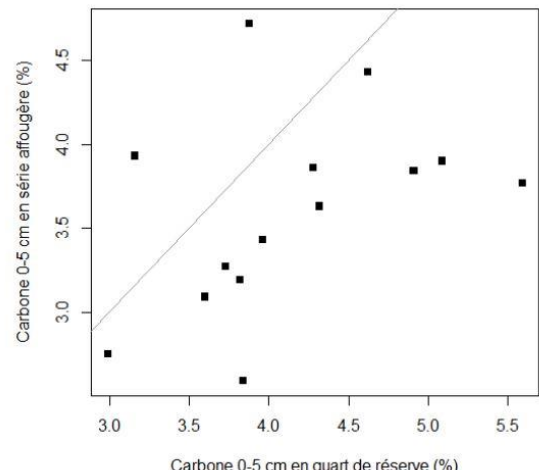

Figure 3: Soil carbon content in "coupes affouagères" based on the soil carbon content in the "quart de réserve" (line indicates equality).

### Hypotheses raised in the present study

As seen previously, short term impacts from high biomass exportation are well known: to cause a soil fertility loss and to foster species which are opportunistic in open and disturbed areas. Nowadays, reserve quarter regulation represents past ecological footprint from high biomass exportation period. Using the opportunity of this documented historical situation, we tested the following hypotheses:

**H1:** High wood extraction in “coupes affouagères” has resulted in loss of mineral (cations, acidity) and organic fertility (soil carbon and nitrogen content).

**H2:** Disturbances, more frequent in “coupes affouagères”, resulted in colonization by species of disturbed habitats (nitrophilous and heliophilous).

## MATERIAL AND METHODS

### Study area

The study was conducted in communal forests of the « Plateau Lorrain » in the “Meurthe et Moselle” department, France. The « Plateau Lorrain » is a large natural area relatively flat, clayey with a degraded oceanic climate with continental influence. Geologically, the “Plateau Lorrain” corresponds to Triassic and Liassic aureoles from the eastern part of the Parisian Basin. The typical substrate is marl from Keuper series. The vegetation consists of a temperate deciduous forest composed of oaks on clayey soils and beech forests on loamy and drained soils. The two main species are accompanied by noble hardwoods on rich soils (Brêthes, 1976; IGN, 2014).

### Sites selection by map analysis and field prospection

The “Plateau Lorrain” was chosen in our study for its dominant marl substrate and easy access to archives of QR old maps (Figure 4). The “Plateau Lorrain” from “Meurthe et Moselle” has 202 communes with forests. According to the availability of old maps, kept in the ONF archives, we were able to find 120 communes presenting at least one map with a QR representation.

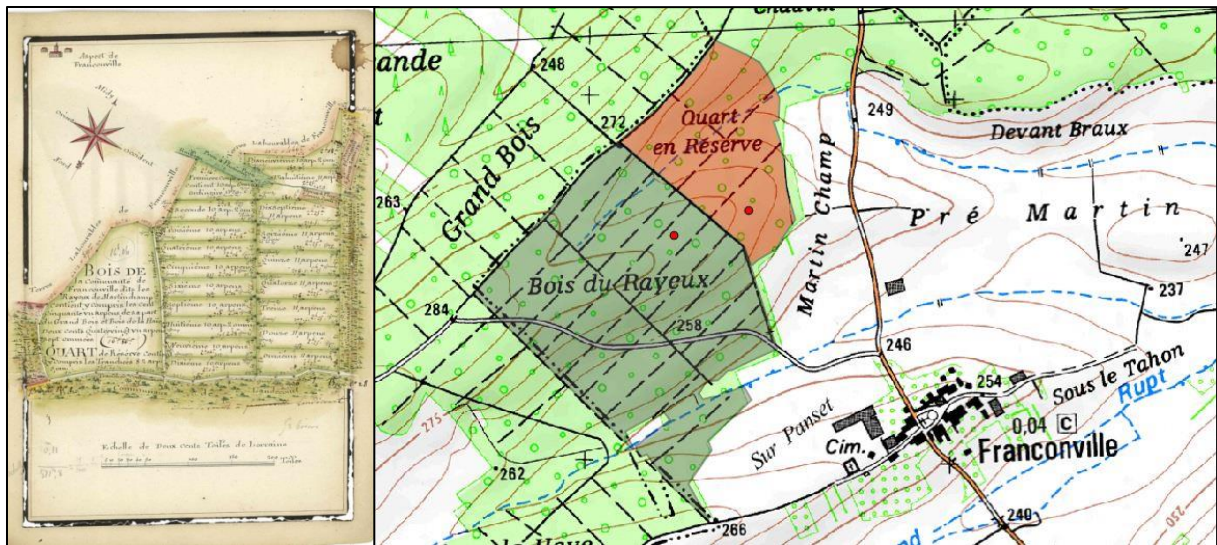

Figure 4: Old map (1770) and IGN map of Franconville communal forest.

The selection work by mapping analysis was achieved through the QGIS software and free access maps (Geoportail, BRGM). Communes for which it was been impossible to retrieve or to relocate the QR were excluded. To observe differences due to past practices forestry, a homogeneous condition is required between each treatment, according to following criteria: a same geological substrate, a similar topography and a homogeneous forest stand according to aerial photography (*See Annex 2: Criteria maps*).

This first phase allowed us to retain 36 potential sites for the field prospection. Then, during field trip potential sites were selected by several criteria: a homogenous stand with the same recent management and a same disturbance degree (roads, thinning...). Finally, we selected 20 sites (*See Annex 3: Study sites localisation*).

### Sampling plan

On each sampling site, a pair of plots was established, one in the “Quart de reserve” and one in the “Coupes affouagères”. The plots were established at a minimum distance of 50 m from the boundary between QR and CA. All apparent disturbances were avoided when locating the plot (recent cuttings, paths...).

In each plot, we installed, sampled and inventoried (*See Annex 4: Soil survey protocol*) :

- 2 concentric circles ( dendrometric protocol); one with a 9m radius (254 m<sup>2</sup>), in which were recorded all stems greater than 2.5 cm diameter and another one with a 17.8 m radius (1000 m<sup>2</sup>), where all stems greater than 22.5 cm diameter were recorded.
- A 400 m<sup>2</sup> square plot (floristic protocol).
- 9 topsoil samples (A horizon) with cylinders (281 cm<sup>3</sup>) at 9 points in the plot (8 at the corners of the 400m<sup>2</sup> plot and 1 at the centre).

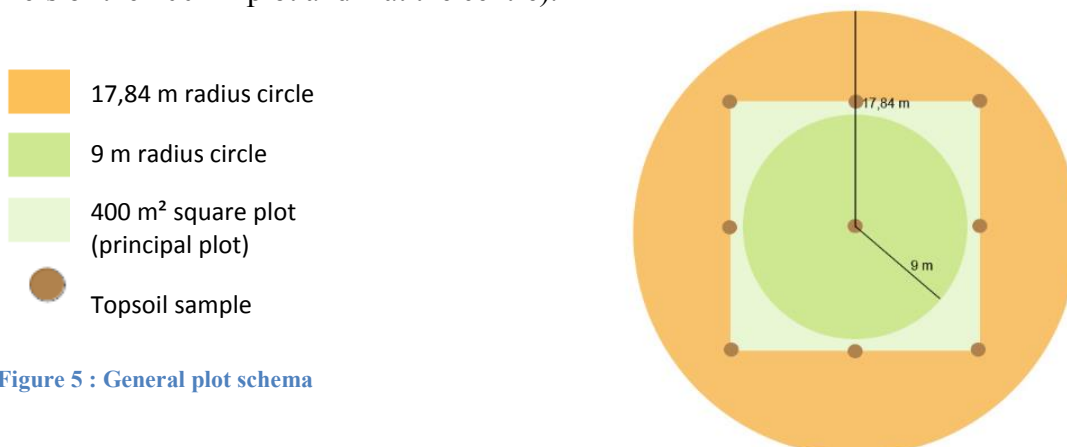

Figure 5 : General plot schema

## **Dendrometric protocol**

Stems more than 2.5 cm diameter were measured in the smallest circle and those of more than 22.5 cm were inventoried in the largest circle (Figure 5). For each tree was noted: species, circumference at 1.30 m (in cm), status (DO: dominant, codo: co-dominant, do: suppressed, us: understorey) and origin (S: seed or C: clump) (*See Annex 5: Dendrometric survey*)

## **Floristic protocol**

The floristic survey was conducted in the 400 m<sup>2</sup> plot (Figure 5); all species were identified and their cover-abundance was estimated using a Braun-Blanquet coefficient like scale (*See Annex 6: Floristic survey*). Species were separately noted in the following strata:

- the high tree stratum (AH) comprising dominant and co-dominant trees
- the low tree stratum (AB) comprising trees suppressed
- the shrub stratum (a) comprising species between 0, 3 and 7 m height
- the herbaceous stratum (h) comprising all vascular species below 0, 3 m height
- the moss stratum (m) for ground growing mosses

Data were directly collected in a data base by digital tablet data-entry.

## **Soil protocol**

### ***Humus and soil profile description***

In the centre plot, a soil pit of 0.60 m was described by horizon according to visual soil properties. In addition a soil auger observation was realized for deeper horizons. Further, the most representative humus of the plot was identified (*See Annex 7: Site description – Soil survey*).

### ***Soil sample***

For soil analysis, we sampled 9 soil surface cylinders (0 to 5 cm) in the plot. During this manipulation, cylinder must be vertically pushed after humus removal (in flat conditions for a complete filling). These samples will allow us to estimate soil carbon stocks (bulk density x high organic carbon) and to make near infrared and medium infrared reflectance spectroscopy analysis (*See Annex 8: Soil laboratory protocol*). From each soil pit, 2 soil textural samples (~500g) were collected for sieve analysis: one between 5 and 10 cm and another one between 40 and 50 cm.

### ***Soil analysis: Reflectance spectroscopy in near-IR and medium-IR (NIRS-MIRS) & chemical analysis***

Since first results have showed a significant difference for the soil carbon content between CA and QR, we were used a rapid and cheap method (NIRS-MIRS) which has proven its efficiency to discriminate among functional SOM fractions (Cecillon et al., 2010). Near and medium –infrared spectra depend on the number and type of chemical bonds in the material being analysed. The wide variety of these bonds gives rise to ‘fingerprints’ of soil samples (Ertlen et al., 2010). So our purpose was to compare the NIR & MIR spectra of soils from QR treatment with those of soils from CA treatment. For the physico-chemical analyses, soil samples will be sent to the Arras INRA centre and results should be received not before September 2014.

## Statistical analysis

In this study, all data (soil, floristic and dendrometric) are analysed to test whether differences exist between “coupes affouagères” and “quart de reserve” modalities.

For univariate analyses, a paired t test was used to compare means according to each treatment. Each sample observation is linked to a homologous observation of a second sample. For multivariate analyses, linear models were built: the explanatory variable is the historical management (QR vs CA) treated as fixed effect, covariates are site (random effect) and study (2010 vs 2014, fixed effect). For this model, we supposed that residues follow a normal distribution of same variance. Then, analyses of variance analyse the amount of variance that is contributed to a sample by different factors.

### *Stand analysis*

Circumference data allowed us to calculate relative total basal area according to each treatment, by wood categories (PB: small wood < 70 cm; BM: medium wood  $\geq$  70 cm to < 150 cm; GB: big wood  $\geq$  150 cm to < 212 cm and TGB: very big wood  $\geq$  212 cm) and by species. Comparisons between modalities (CA vs QR) are done on relative total basal area means by a paired t test.

### *Floristic analysis*

#### *Species richness*

Species richness indicates the species number present in a considered space. Species richness for all floristic species was compared for each treatment (CA/QR) with a paired student test.

#### *Correspondence analysis*

The contingency table of presence/absence for sites x species was analysed by correspondence analysis. This multivariate analysis allowed visualizing and summarizing the distribution of sites or species according to qualitative variables (site effect, treatment effect and study effect). To verify the significance of each effect, we fitted a linear model of the correspondence analysis according to different components and we tested effects previously mentioned in an analysis of variance.

#### *Probability test of relative frequencies for each species*

According to our knowledge, we do not know an exact test of frequencies comparison, like Fisher's exact test, which could be applied for structured data by pairs in each site. For each species, we applied a test on the ratio between relative frequencies in the two different treatments. Only species observed in at least 4 plots were studied. This test was based on 4 modalities to create a data set codification (Table 1):

Situation	Probability formula
Species absent in the site	$P(!CA \cap !QR) = (0,0)$
Species presents in CA, not in QR	$P(CA \cap !QR) = (1,0)$
Species presents in QR, not in CA	$P(!CA \cap QR) = (0,1)$
Species present in both CA and QR	$P(CA \cap QR) = (1,1)$

**Table 1: Occurrence modalities of species according to treatment.**



With the null hypothesis:  $\frac{P(CA \cap !QR) + P(CA \cap QR)}{P(!CA \cap QR) + P(CA \cap QR)} = 1$

Rejection of the null hypothesis indicates that one of two treatments is favourable for one species. In this test the set of observations (data set codification) can be assumed to be from an independent and identically distributed population. An empirical distribution can be drawn by constructing 9999 resamples of the observed dataset, each of which is obtained by random sampling with replacement from the original dataset (bootstrap technique). Then, we applied a confidence interval (Min, Q2.5, Q50, Q97.5, Max) on this data set. Finally, we eliminated species which were only present in one treatment (Q50 = 0 | Inf) and species which accepted the null hypothesis (Q2.5 <= 1 & Q97.5 >= 1).

#### *Ellenberg and Julve coefficients*

Ellenberg and Julve indicator values express the ecological behaviour of species along a scale of 9 levels. Indicator values represent environmental factors. In our study we have tested the following indicator values: Light, Temperature, Continental, Edaphic humidity, pH, Nitrogen, Nutrients, Texture and Organic matter (<http://philippe.julve.pagesperso-orange.fr/>). Means indicator value by sample, for environment factors previously mentioned were compared between CA and QR by a paired t test.

#### ***Soil analysis***

##### *Soil properties*

To compare soil depth mean, oxidation depth apparition mean and bulk density mean between CA and QR, we have realised a set of paired t-test on these different soil properties.

##### *NIRS-MIRS analysis*

Infrared absorption spectra are composed by absorption band intensities at different frequencies. Absorption band intensities are very different to analyse it a standard normal distribution was applied. Then, the first derivative of spectra data was calculated. For data quality:

- Each sample has been analysed by 3 machine acquisition repetitions (to reduce the machine shift effect) then a mean by repetition was calculated.
- CO<sub>2</sub> effect was deleted in removing absorption band corresponding to this compound (MIRS: 1615 to 1640 and NIRS: 3945 to 3986).
- Site effect has been removed; we have centred data by site mean.

NIRS and MIRS data were analysed with a principal component analysis (PCA) to summarize similarities between plots and liaisons between variables. Then, the former management (QR vs CA) was tested with an analysis of variance for each principal component. Finally, significant principal component were used to visualize site distribution according to treatment effect.

All statistical analyses were conducted with R software on the Rstudio interface (<http://www.rstudio.com/>).

## RESULTS

### Studies aggregation and sites selection

A correspondence analysis of 20 sites (for species seen in at least 2 plots) from our study and 34 sites from the 2010 study presents sites dispersion by geological substrate (Figure 6). We can see that marly plots (green sites) gather, they are therefore chosen for the analysis selection. This selection associates 14 sites from the 2010 study including 12 marly sites and 2 from other substrates.

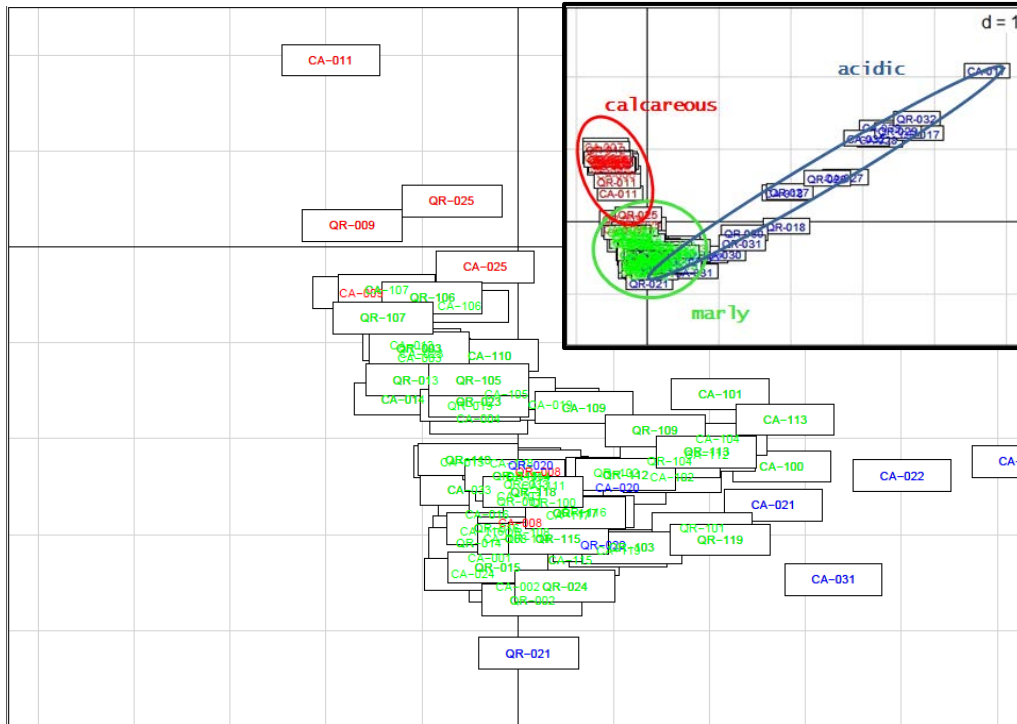

Figure 6: Factorial plane 1-2 from correspondence analysis of sites dispersion. All sites dispersion for top right graphic. Zoom of marly sites dispersion for general graphic. (Legend; red=calcareous, green=marly and blue=acidic).

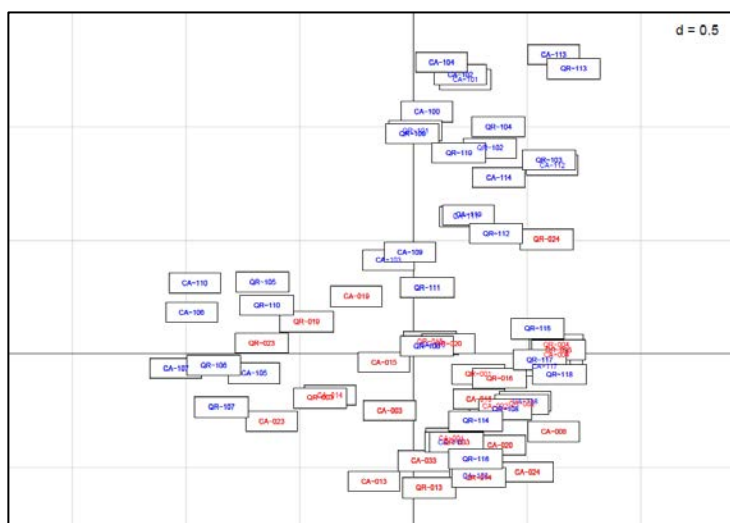

Figure 7: Factorial plane 1-2 from correspondence analysis of sites dispersion according to studies (Legend; red= 2010 study, blue = 2014 study).

However, the correspondence analysis from the selection (34 sites) shows a separation between the previous and the present studies, along the second axis (Figure 7).

This separation is probably caused by:

- Sites selection: the previous study chosen open habitats where the flora expresses more while the present study chosen more closed habitats.

- An observation bias for *Carex* identification (the present study contains especially *Carex umbrosa* and *Carex pilulifera* while the

previous study contains *Carex remota*) and oak seedlings identification (*Quercus petraea* / *Quercus robur*).

- The observation period: species were observed during mid-April to late June for the previous study and only during May for our study.

### Stand analysis

Comparisons of mean values of the total basal area shows no significant effect from former treatment (51.5 m<sup>2</sup>/ha for CA and 50.3 m<sup>2</sup>/ha for QR). This is also the case for basal area percentage of wood diameter categories (Table 2). For species composition (*Carpinus betulus*, *Quercus petraea*, *Quercus robur*, *Fagus sylvatica*, others), we do not observe any significant effect from treatment on the basal area.

Paired t-test according to former treatment ( mean values in percentage)			
Wood Category	CA %	QR %	p-value
Total basal area	50.6	49.4	0.56
PB (small wood)	15.2	13.7	0.48
BM ( medium wood)	32	32.6	0.85
GB (big wood)	38.2	31.1	0.26
TGB (very big wood)	21.8	28.9	0.28

Table 2 : Wood categories percentages according to former treatment.

Trees species richness does not show any significant difference between “coupes affouagères” and “quart de réserve”. More, a variance analysis on treatment effect does not show any preferences from species for a treatment. We have observed 2 to 6 species per plot with a median value of 3 species.

### Flora analysis

For all species of all strata from 34 sites, we have observed 137 taxa with 121 taxa for QR treatment and 118 taxa for CA treatment. And by plots, we have sampled 9 to 50 taxa with a median value of 28.5 taxa. Species richness does not show a significant result comparing the two treatments.

### Correspondence analysis

A correspondence analysis of the 68 plots (for species observed in at least 5 plots) shows a significant effect from former management (CA or QR) on the herbaceous composition (80 taxa), and only on this stratum (Figure 8). A model of analyse of variance, taken into account site effect then treatment effect, on the axis 1 of the correspondence analysis allow us to conclude that this axis is defined by a strong site effect with a p-value < 10<sup>-11</sup> and a smaller treatment effect with a p-value < 0.05.

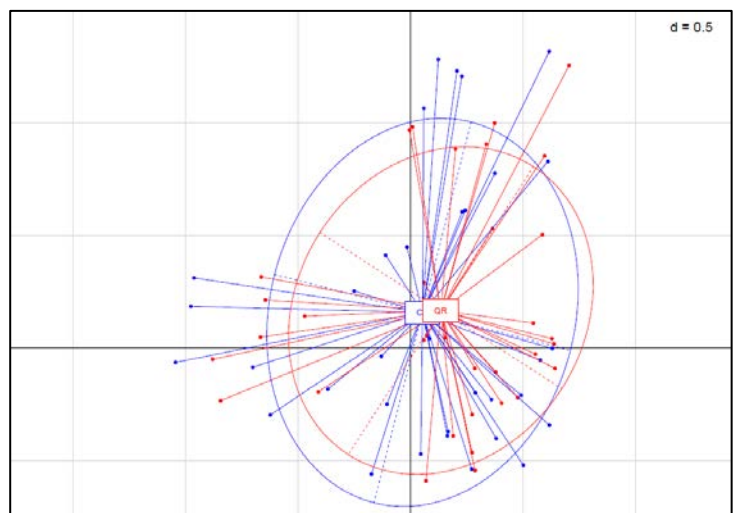

Figure 8: Factorial plane 1-2 from correspondence analysis with treatment effect (red = QR, blue = CA).

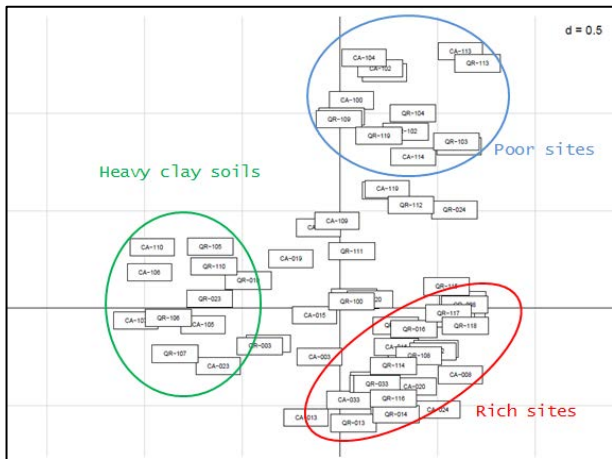

Figure 9: Factorial plane 1-2 from correspondence analysis of sites dispersion.

The axis 1 from correspondence analysis represents 11.5% of the total inertia of the dataset. And the axis 2 represents 9.2% of the total inertia of the dataset.

Sites positions according to these axes are probably due to ecological gradients (Figure 9).

The axis 2 distinguishes sites by studies and is also probably due to a pH gradient: the upper part of the axis contains acidic environment (thick silt) while the lower part contains calcareous environment (Woëvre).

The axis 1 is probably due to soil types with the green lot which represents heavy clay soils (Pélosols-RP2008 or Epistagnic Regosols-WRB2006 / Planosols-WRB2006).

For species dispersion (Figure 10), the axis 1 formation is mainly represented by the left part of the axis with: *Phyteuma spicatum* (PHYspi), *Brachypodium sylvaticum* (BRAsyl), *Carex flacca* (CARfla), *Cardamine pratensis* (CARpra), *Ranunculus auricomus* (RANaur), *Viburnum opulus* (VIBopu), *Ligustrum vulgare* (LIGvul) and *Primula elatior* (PRlela). While the right part of the axis is less marked with: *Galeopsis tetrahit* (GALTet), *Corylus avellana* (CORave), *Melica uniflora* (MELuni), *Milium effusum* (MILEff), *Quercus petraea* (QUEpet) and *Prunus avium* (PRUavi). Species are especially differentiated by the site effect (axis 1 with a p-value  $< 10^{-10}$  and axis 2 with a p-value  $< 10^{-4}$ ) and a little by the treatment effect (axis 1 with a p-value  $< 0.05$  and axis 2 with a p-value  $< 0.10$ ) with “coupes affouagères” which would be represented by the left part of the axis 1 and the “quart de réserve” by the other.

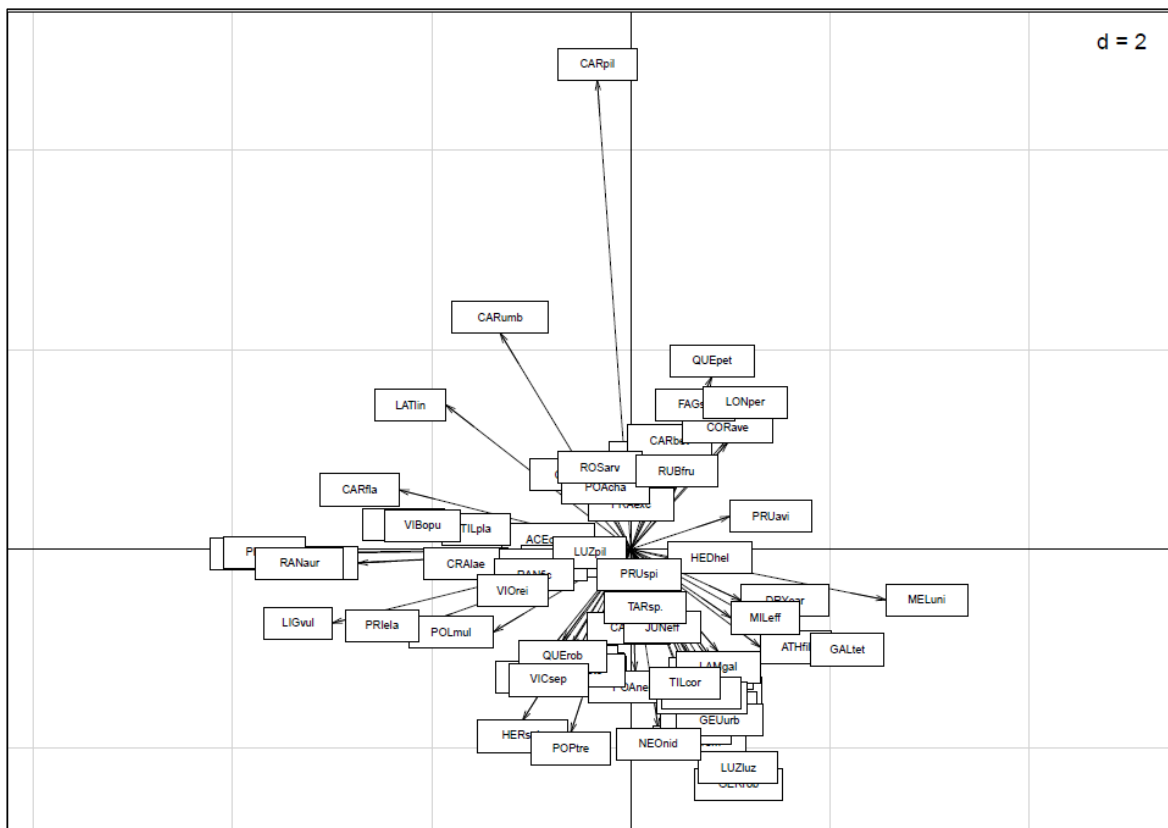

Figure 10: Factorial plane 1-2 from correspondence analysis of species repartition.

Furthermore, an intra-site correspondence analysis (**wca** R function) has been realized in order to mitigate site effects but this one does not show any significant difference between CA and QR.

### *Probability test of relative frequencies for each species*

The test of relative frequencies in the two different treatments shows us that 4 species display a significant difference between CA and QR: *Ajuga reptans* and *Rosa arvensis* for the “quart de reserve” and *Carex flacca* and *Viburnum opulus* for “coupes affouagères” (Table 3).

Specie	Min	Q2.5	Q50	Q97.5	Max	Number	Ratio
<i>CARfla</i>	- Inf	-1.79	-0.69	-0.18	0	10	0.5
<i>VIBopu</i>	- Inf	-1.28	-0.56	-0.09	0.4	15	0.6
<i>ROSarv</i>	-0.1	0.04	0.26	0.54	0.85	27	1.3
<i>AJUrep</i>	0	0.51	1.39	Inf	Inf	8	4

Table 3: Quantiles logarithm values, number and ratio logarithm value for each specie.

### *Ellenberg’s and Julve’s coefficients*

In our study, means coefficients for each species were calculated with indicator values and former treatments were compared through a paired t-test (with a table of presence/absence).

Paired t-test according to former treatment			
Ellenberg’s coefficients	Mean CA	Mean QR	p-value
<i>Light</i>	4.84	4.80	0.51
<i>Temperature</i>	5.29	5.26	0.22
<i>Continental</i>	3.14	3.11	0.33
<i>Edaphic humidity</i>	5.21	5.26	0.32
<i>pH</i>	NaN	NaN	0.38
<i>Nitrogen</i>	NaN	4.97	0.48
Julve’s coefficients	Mean CA	Mean QR	p-value
<i>Light</i>	5.50	5.43	0.27
<i>Temperature</i>	5.12	5.11	0.68
<i>Continental</i>	4.77	4.74	0.30
<i>Atmospheric humidity</i>	5.96	6.00	0.36
<i>Edaphic humidity</i>	5.27	5.29	0.72
<i>pH</i>	5.11	5.05	0.32
<i>Nutrients</i>	5.10	5.07	0.50
<i>Texture</i>	3.14	3.17	0.65
<i>Organic matter</i>	3.98	4.00	0.65

Table 4: Ellenberg’s and Julve’s coefficients according to former treatment.

Not any difference was observed between « coupes affouagères » and « quart de réserve » (Table 4).

## Soil analysis

### *Soil properties*

A set of paired student test were realized on different criteria between QR and CA:

- Soil depth is homogenous with a median value of 100 cm.
- Oxidation depth apparition is homogenous with a median value of 21 cm.

### *Bulk density*

A paired student test on bulk density mean values from our study (20 sites) for the surface horizon (9 cylinders x 0-5 cm) indicates no significant effect of treatment (Figure 11). These bulk density values will serve to calculate organic matter stocks once we have received carbon content results.

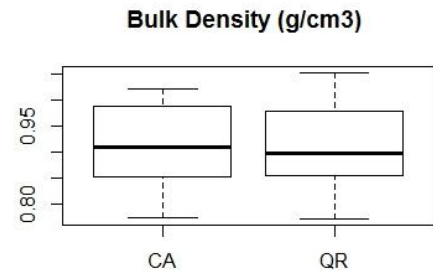

Figure 11: Mean values of bulk density between CA and QR.

### *NIRS – MIRS analysis*

The analysis of variance of principal component analysis for each principal component shows us 16 principal components significantly different between the CA treatment and the QR treatment (Table 5).

2014 Study				2010 Study			
MIRS		NIRS		MIRS		NIRS	
Principal component	p-value	Principal component	p-value	Principal component	p-value	Principal component	p-value
Axis 8	< 0.001	Axis 2	< 0.01	Axis 3	< 0.05	Axis 3	<0.001
Axis 12	< 10 <sup>-7</sup>	Axis 4	< 0.001	Axis 5	< 0.05	Axis 4	<0.05
		Axis 5	< 0.05	Axis 6	< 0.05	Axis 6	<0.05
		Axis 7	< 0.01	Axis 8	< 10 <sup>-15</sup>	Axis 7	< 10 <sup>-4</sup>
		Axis 9	< 0.05				
		Axis 10	< 0.001				

Table 5 : P-value of MIRS and NIRS principal components according to studies.

Factorial planes from the MIRS principal component analysis show us a clear separation between CA and QR (Figure 12).

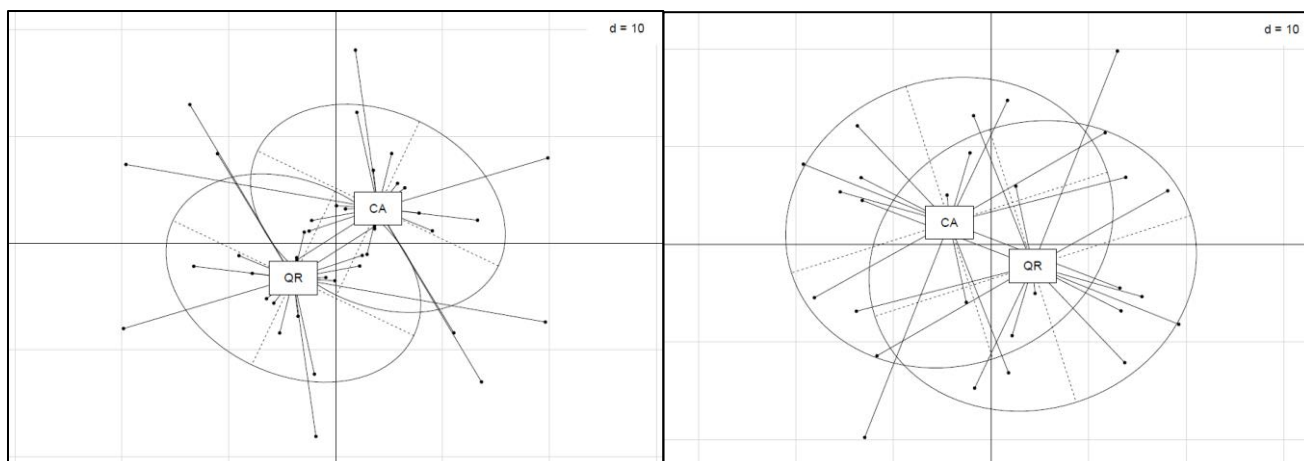

Figure 12: Left figure, factorial plane 8-12 of principal component analysis from 20 sites of 2014 study. Right figure, factorial plane 6-8 of principal component analysis from 14 sites of 2010 study.

## DISCUSSION - CONCLUSION

Second study results are consistent with those of the first study. Indeed, we observe relatively less pronounced effects of the former forest management. There is a difference in soil composition between the two treatments which according to the first study is due to loss of organic matter in “coupes affouagères”. The “coupes affouagères” tends to have preferential plant species to disturbed and open environments while the “quart de reserve” tends to have plant species associated to more closed and stable environments. Stands tend to have slightly more very large wood in “quart de reserve” compared to “coupes affouagères”.

### Difference of soils organic matter

Authors from the first study have observed a decline in the organic matter content, with an average loss of 14% in “coupes affouagères” compared to the “quart de reserve” (Dupouey et al., 2014). By increasing the sampling of 14 pairs to 34 pairs on marl substrate, we want to consolidate this result here. Classical chemical analysis of soils which we collected (absorbent complex, pH, organic matter, phosphorous) could not be performed that after the end of our training period (by INRA Arras). However, to get some results quickly, we used an innovative technique in the domain: the analysis by infrared spectroscopy. We compared spectra, of medium and near-infrared, from soils subjected to regular biomass export (coupes affouagères) with those of considered as undisturbed soils (quart de réserve).

Principal component analysis of derived of standardized NIR-MIR spectra clearly distinguishes the type of treatment between the two floors. We observe this phenomenon on several principal components. This means that for the portions of the spectra corresponding to these principal components, some chemical components or different proportions of these components in the soil organic matter differ between “coupes affouagères” and the “quart de reserve”. These preliminary results are encouraging and indicate that MIR and NIR spectroscopy has real potential to discriminate the state of soil organic matter according to silvicultural past.

However, at this stage it is not interpretable. To choose pertinent principal components in both studies, our perspectives are to estimate the prediction error: several resampling techniques are possible. Firstly, the sample must be subdivided in two parts: one to build the model and another one to evaluate model performances. The cross-validation will allow us to directly estimate the error with a prediction model while the bootstrap will allow us to reduce the variance of the estimator increasing replications. Results obtained by standard analyses methods (INRA Arras), are needed to calibrate and validate the NIR and MIR absorption data. This second step may allow us to identify the chemical compounds responsible for soil discrimination observed. For example perhaps is it related to a simple difference of total organic matter content?

In this first phase, the results are consistent with our hypothesis: silvicultural treatments induced differential evolution of organic fertility. This is probably due to the fact that biomass exports were much more frequent and intense in “coupes affouagères” compared to the “quart de réserve”. Forest ecosystems are therefore able in the long term in our context (about 150 years) to lose some of their fertility under intensive export of biomass. Carbon stocks in forest soils are slow to change, but their quantity is limited and highly dependent on natural flows of chemical elements and organic matter (ADEME, 2014). Our results confirm that an increase in demand for wood energy should be accompanied by recommendations for preserving mineral and organic forest soil fertility.

### **Colonization of plant species of disturbed habitats**

The extension of the sampling on marly area allows us to see a significant difference of plant communities between “coupes affouagères” and “quarts de réserve”. The correspondence analysis of the herbaceous strata shows a first axis of inertia defined by a classical gradient of soil acidity and that explains the site effect highly significant on this axis. When this effect is designated cofactor, we see a trend of the silvicultural past effect: “coupes affouagères” include species from disturbed habitats which prefer high nitrogen content and hydrophilic soils, while the “quart de réserve” has species from stable environments associated to slightly acidic soils.

A probability test of relative frequencies of each species according to former forest management has showed that:

- The “coupes affouagères” favour the presence of *Carex flacca* and *Viburnum opulus*; these species are heliophilous and neutroclines. These are species that we find in disturbed environments such as edges, roads and logging (Rameau, 1989).
- The “quart de réserve” favours the presence of *Ajuga reptans* and *Rosa arvensis*; we do not explain these results since these specie prefer nitrogen-rich environments (Rameau, 1989).

Contrary to what might be expected, species richness is not higher in “coupes affouagères”.

Our second hypothesis is partially validated, repeated cuts in “coupes affouagères” bring about a colonization of forest species subjected to disturbance. Our results confirm what was observed previously by Saur (1951): the old cuts contain herbaceous species in hydrophilic nature. However, we must consider that from the mid-18th century, all communal forests were converted from coppice-with-standard to high forest. Becker (1979) observed a number of species preferentially associated to stands under conversion (*Phyteuma spicatum*, *Cardamine pratensis*, *Ranunculus auricomus*) that they tend to prefer “coupes affouagères” in our flora analyses.



## **Preservation of very large wood in the reserve**

The role of the “quart de réserve” was to keep a timber capital susceptible to be exploited for extraordinary cuts. Today, we see a historical memory with a trend to have more very large wood (circumference  $\geq 212$  cm) in the “quart de réserve” compared to “coupes affouagères”. Comparisons of total basal area by diameter classes or by species show no significant differences between “coupes affouagères” and “quart de réserve”; this is due to criteria selection of our sites. The choice of uniform stands between the two treatments was part of these criteria. In addition, the conversion to high forest of former “coupes affouagères” favoured the presence of large timber and homogenized stand structure on all forests areas.

## **Limitations of the study**

All the results presented above show low impacts on forest ecosystem due to extraction of firewood in “coupes affouagères”. The main limitation of our study of historical ecology is the information source of the old silvicultural treatment. Indeed it has been difficult to find the localisation plans of communal forests in the 18th and 19th centuries to develop our study. But we have no certainty about the rates and frequencies of sampling biomass under both management methods.

According to several studies in historical biogeography, regulation of the “quart de réserve” was not fully respected:

- From 1840 to 1880, the number of authorisations of deemed extraordinary cuts increased significantly in “quarts de réserve”, going from 4 to 20 per year (Degron, 1999).
- A recent study looked at the records of timber hammerings (115 cups) of Lorraine communal forests. First results show that the population of the reserve is rich in large wood but permitted exploitations not leave more than a poor density of high forests (Rochel, 2013).

More, real duration of these silvicultural practices is not known for studied forests.

Regarding floristic surveys, they have often been made in poor habitats in our study. This does not favour the appearance of a difference in species richness between “coupes affouagères” and the “quart de réserve”. Furthermore, aggregation of data flora between the previous study and the present study clearly shows an observation bias. Several inter-calibration exercises on the quality of observation during floristic surveys indicate differences there are sometimes important between surveys of observers. These differences are mainly due to: inaccuracies allocation to a stratum, problems of determination for herbaceous species and mosses, the number of observers and the survey duration (Camaret et al., 2004).

We could talk about a final classical limit: a number of samples too low (68), increasing repetitions we can more easily highlight the differences between former silvicultural managements. But their extent would remain low.

## **Prospects**

These first results are not sufficient to conclude that “coupes affouagères” have only a minimal impact on the organic soil fertility and vegetation. To confirm that there has maybe a net loss of organic matter in the first centimetres of the soil, we have several perspectives. First, the spectra calibration will be an essential step to know compounds and their amounts, which differ according to the treatment effect. Second, chemical analyses of new collected soils will test whether the observed trend in the previous study confirms.

Samples have also been made at different depths: one between 5 and 10cm and a second between 40 and 50 cm. The preparation and analysis of these samples will test the site homogeneity according to soil texture. The sample of 40-50 cm will test the homogeneity of the substrate. In particular, it can be tested if thickness limes is even, or if bias appear between the two treatments.

For more results, a future study could be conducted in similar environments on the impact of salt mine in Lorraine on the forest ecosystem. With the increasing development of salt mines during the Middle-Age, forests have been affected by a strong need for wood energy to extract salt (Degron, 1995). The study would compare the wood previously destined to saline work, widely over-exploited during the 18<sup>th</sup> century with those spared from these samples.

Finally, it would be interesting to organize a project that would combine researchers and historians. This project would allow us to acquire detailed information on the amount of wood really realized by the former treatment information, through long and meticulous work of historians, of research and analysis of timber hammering records of communal forests. Then, forest researchers could sample and analyse forests for which samples and dates of former silvicultural treatments were known.

## **BIBLIOGRAPHIC LIST**

ADEME, 2014, Carbone organique des sols : L'énergie de l'agro-écologie, une solution pour le climat, *Collectivités territoriales et monde agricole : connaître et agir*, ADEME, 30 p.

BECKER, M, 1979, Influence du traitement sylvicole sur la flore forestière : cas de la futaie et du taillis-sous-futaie. *Vegetatio*. Vol.40, no.3, p. 155-161.

BENGTSSON, J, NILSSON, SG, FRANCO, A and MENOZZI, P, 2000, Biodiversity, disturbances, ecosystem function and management of European forests. 2000. P. 39–50.

BERTHES, Alain, 1976, CATALOGUE DES STATIONS FORESTIERES DU PLATEAU LORRAIN. *ONF & INRA*. 1976.

BÜRGI, M and GIMMI, U, 2007, Three objectives of historical ecology: the case of litter collecting in Central European forests. *Landscape Ecology*.2007. Vol. 22, no. S1, p. 77–87.

CACOT, E, CHARNET, F, RANGER, J and VIEBAN, S, 2004, Impact du prélèvement des rémanents en forêt. *Fiches information forêt, Afocel*. 2004. No. 1, Fiche no. 686, 6 p.

CAMARET, S, BOURJOT, L, DOBREMÉZ J.-F (coordinateurs), 2004, Suivi de la composition floristique des placettes du réseau (1994/95-2000) et élaboration d'un programme d'assurance qualité intensif. *Office National des Forêts, Direction Technique*, 86 p.

CECILLON, L. and BRUN, J.-J., 2007, Near-infrared spectroscopy (NIRS): a practical tool for the assessment of soil carbon and nitrogen budget. *COST action 639: greenhouse –gas budget of soils under changing climate and land use*. p. 103-110.

DECOCQ, G, AUBERT, M, DUPONT, F, ALARD, D, SAGUEZ, R, WATTEZ-FRANGER, A, FOUCAULT, B, DELELIS-DUSOLLIER, A and BARDAT, J, 2004, Plant diversity in a

managed temperate deciduous forest: understorey response to two silvicultural systems. *Journal of Applied Ecology* .2004. Vol. 41, no. 6, p. 1065–1079.

DEGRON, R., 1999 a. Les conversions forestières de Lorraine : bilan, contrastes, rythmes et ruptures. Thèse, Université Nancy II, p.450.

DEGRON, R., 1999 b. Continuités et ruptures dans la gestion des bois communaux au XIXe siècle. Quelques exemples lorrains. *Revue Forestière Française*. 1998. Vol. LI 3.

DEGRON, R., 1995. Historique de la forêt de Romersberg : une forêt de Lorraine sous l’emprise des salines. *Revue Forestière Française*. 1995. Vol. XLVII.

DUPOUEY, JL, BESOAIN, R, CHAUCHARD, S, FEISS, T, LAIGLE, I, MONTPIED, P, ROCHEL, X, 2014, Identifier les facteurs historiques de vulnérabilité dans la relation sylviculture-biodiversité. *Projet FORGECO, programme ANR Systerra*. 54 p.

DUPOUEY, JL, DAMBRINE, E, DARDIGNAC, C and GEORGES-LEROY, M, 2004, *La mémoire des forêts : “Forêt, archéologie et environnement.”*. 2004. 294 p.

DUPOUEY, JL, SCIAMA, D, KOERNER, W, DAMBRINE, E, RAMEAU, JC, 2002 a, La végétation des forêts anciennes. *Revue Forestière Française*. 2002. Vol. LIV. No. 6. p. 521-532

DUPOUEY, JL, DAMBRINE, E, LAFFITE, JD and MOARES, C, 2002 b, Irreversible impact of past land use on forest soils and biodiversity. *Ecology*. 2002. Vol. 83, no. 11, p. 2978–2984.

ERTLEN, D, SCHWARTZ, D, TRAUTMANN, M, WEBSTER, R, BRUNET, D, 2010, Discriminating between organic matter in soil from grass and forest by near-infrared spectroscopy. *European Journal of Soil Science*. 2010. Vol.61, p.207-216.

FEISS, T, 2010, Impact du type de traitement sylvicole ancien sur l’état actuel des forêts : le cas du quart en réserve. *Master Dissertation*. 39 p.

FULLER, Robert J., 2013, FORUM: Searching for biodiversity gains through woodfuel and forest management. *Journal of Applied Ecology*.2013. Vol. 50, no. 6, p. 1295–1300.

GIMMI, U, POULTER, B, WOLF, A, PORTNER, H, WEBER, P and BÜRGI, M, 2012, Soil carbon pools in Swiss forests show legacy effects from historic forest litter raking. *Landscape Ecology* .2012. Vol. 28, no. 5, p. 835–846.

GIMMI, U, WOHLGEMUTH, T, RIGLING, A, HOFFMANN, C W. and BÜRGI, M, 2010, Land-use and climate change effects in forest compositional trajectories in a dry Central-Alpine valley. *Annals of Forest Science* .2010. Vol. 67, no. 7, p. 701–701.

GLATZEL, G, 1990, The nitrogen status of Austrian forest ecosystems as influenced by atmospheric deposition, biomass harvesting and lateral organomass exchange. *Plant and Soil* .1990. Vol. 128, no. 1, p. 67–74.

GLATZEL, G, 1991, The impact of historic land use and modern forestry on nutrient relations of Central European forest ecosystems. *Fertilizer Research* .1991. Vol. 27, no. 1, p. 1–8.

GLATZEL, G. 1999. Historic forest use and its possible implication to recently accelerated tree growth in Central Europe. 1999. P. 65–74.

HARTMANN, H., DAOUST, G., BIGUÉ, B. and MESSIER, C. 2010. Negative or positive effects of plantation and intensive forestry on biodiversity : A matter of scale and perspective. *The forestry chronicle*, Vol. 86., N°3, p.354-364.

HERMY, M., HONNAY, O., FIRBANK, L., GRASHOF-BOKDAM, C. and LAWESSON, J E. 1999. An ecological comparison between ancient and other forest plant species of Europe, and the implications for forest conservation. *Biological Conservation*. 1999. Vol. 91, p. 9–22.

HUFFEL, G. 1893. Influence de l'enlèvement de la couverture du sol sur la végétation. *Revue des eaux et forêts*, Tome 32, 2° Série, Vol.7, p.7-9.

HÜTTL, RF. and SCHAAF, W. 1995. Nutrient supply of forest soils in relation to management and site history. *Plant and Soil* , No. 1988, p. 31–41.

HUSSON, JP. 1991. Les hommes et la forêt en Lorraine. Editions Bonneton, p. 318

INSTITUT NATIONAL DE L'INFORMATION GÉOGRAPHIQUE ET FORESTIÈRE. 2014. SER C 30 : Plaines et dépressions argileuses du Nord-Est.

JOHNSON, D W. and CURTIS, P S. 2001. Effects of forest management on soil C and N storage: meta analysis. *Forest Ecology and Management*, Vol. 140, no. 2-3, p. 227–238.

KOERNER, W., BENOIT, M., DAMBRIN, E., DUPOUEY, JL. 1999. Influence des anciennes pratiques agricoles sur la végétation et les sols des forêts reboisées dans le massif vosgien. *Revue Forestière Française*, N°2, p.231-238

LANDMANN, G, GOSSELIN, F, BONHEME, I, 2009, BIO 2 : Biomasse et biodiversité forestière. Augmentation de l'utilisation de la biomasse forestière : implications pour la biodiversité et les ressources naturelles. *Rapport GIP ECOFOR et Ministère de l'Ecologie, de l'Energie, du Développement Durable et de la Mer*.211 p.

NAVE, L E., VANCE, E D., SWANSTON, C W. and CURTIS, P S.. 2010. Harvest impacts on soil carbon storage in temperate forests. *Forest Ecology and Management*, Vol. 259, no. 5, p. 857–866.

PAILLET, Y., BERGÈS, L., HJÄLTÉN, J., ODOR, P., AVON, C., BERNHARDT-RÖMMERMANN, M., BIJLSMA, RJ., DE BRUYN, L., FUHR, M., GRANDIN, U., KANKA, R., LUNDIN, L., LUQUE, S., MAGURA, T., MATESANZ, S., MÉSZÁROS, I., SEBASTIÀ, MT., SCHMIDT, W., STANDOVÁR, T., TÓTHMÉRÉSZ, B., UOTILA, A., VALLADARES, F., VELLAK, K. and VIRTANEN, R. 2010. Biodiversity differences between managed and unmanaged forests: meta-analysis of species richness in Europe. *Conservation biology : the journal of the Society for Conservation Biology* ,Vol. 24, no. 1, p. 101–112.

PETERKEN, GF. and GAME, M. 1984. Historical factors affecting the number and distribution of vascular plant species in the woodlands of central Lincolnshire. *The Journal of Ecology*, Vol. 72, N°1, p. 155-182.

RAMEAU, JC, MANSION, D, DUME, G, 1989, Flore forestière française : guide écologique illustré, Tome 1 : Plaines et collines. *Institut pour le Développement Forestier*. 1785 p.

RANGER, J, BONNAUD, P, 1984, Effets prévisibles de l'intensification de la production et des récoltes sur la fertilité des sols de forêt. Le cycle biologique en forêt. *Revue Forestière Française*. 1984. Vol. XXXVI, No. 2, p.93-112.

ROCHEL, X. 2013. Aménagement, mises en réserve et exploitations dans les bois communaux de Lorraine au XVIIIe siècle. *La forêt et ses marges. Autour de la biogéographie historique: outils, résultats, enjeux*. 2013. Vol. 3.

SAUR, H, 1951, Une méthode locale de conversion des Taillis-sous-Futaie en Futaie, *Académie nationale de Metz*. P.51-66.

SCIAMA, D., AUGUSTO, L., DUPOUEY, JL., GONZALEZ, M. and MOARES DOMÍNGUEZ, C. 2009. Floristic and ecological differences between recent and ancient forests growing on non-acidic soils. *Forest Ecology and Management*, Vol. 258, no. 5, p. 600–608.

SITZIA, T., TRENTANOVI, G., DAINESE, M., GOBBO, G., LINGUA, E. and SOMMACAL, M., 2012, Stand structure and plant species diversity in managed and abandoned silver fir mature woodlands. *Forest Ecology and Management*, Vol. 270, p. 232–238.

THIFFAULT, E., HANNAM, K D., PARÉ, D., TITUS, B D., HAZLETT, P W., MAYNARD, D G. and BRAIS, S. 2011. Effects of forest biomass harvesting on soil productivity in boreal and temperate forests — A review. *Environmental Reviews*, Vol. 19, no. NA, p. 278–309.

## **WEBSITES**

<http://www.geoportail.gouv.fr/>

<http://infoterre.brgm.fr/>

<http://philippe.julve.pagesperso-orange.fr/>

<http://www.qgis.org/>

<http://www.rstudio.com/>

**ANNEX 1:** Topographic map of Franconville’s forest (1770) and subdivision map of the “quart de réserve” of the Franconville forest (1886).

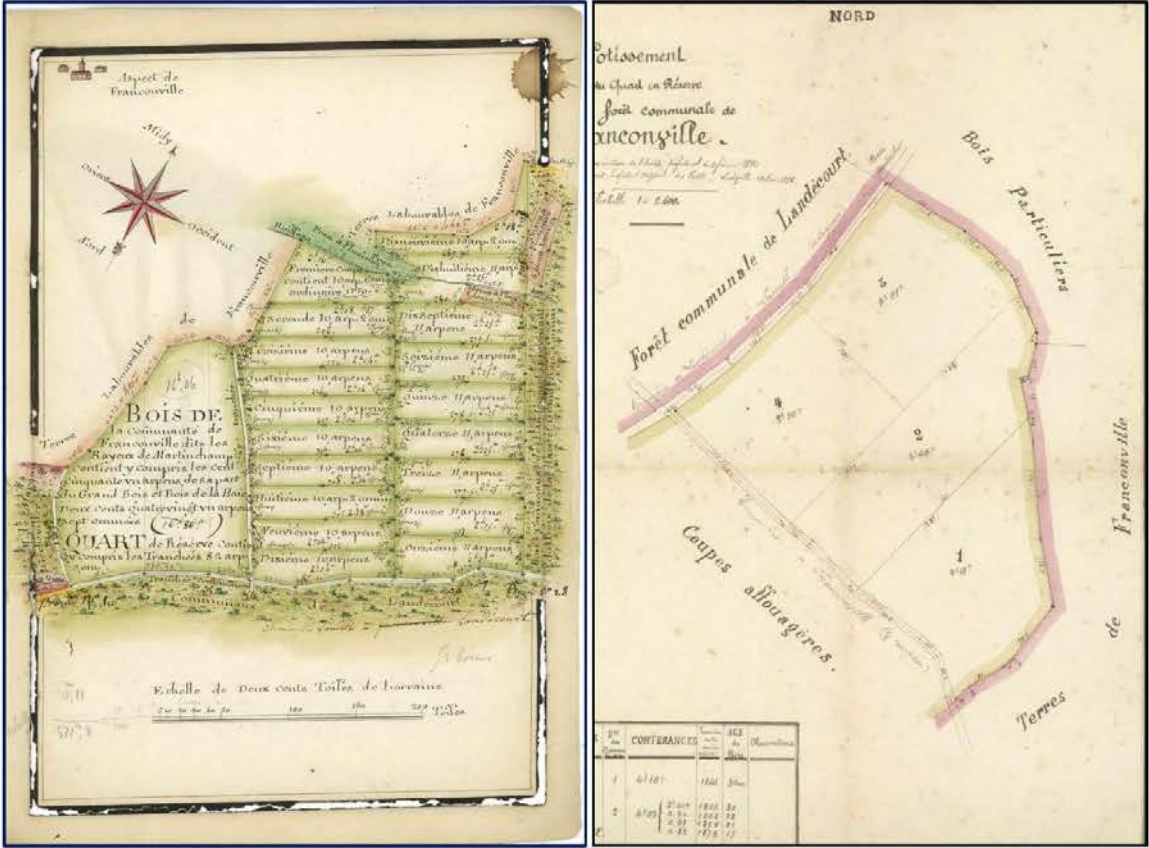

ANNEX 2: IGN map, Ordnance map, Geologic map and aerial photography – Franconville’s forest.

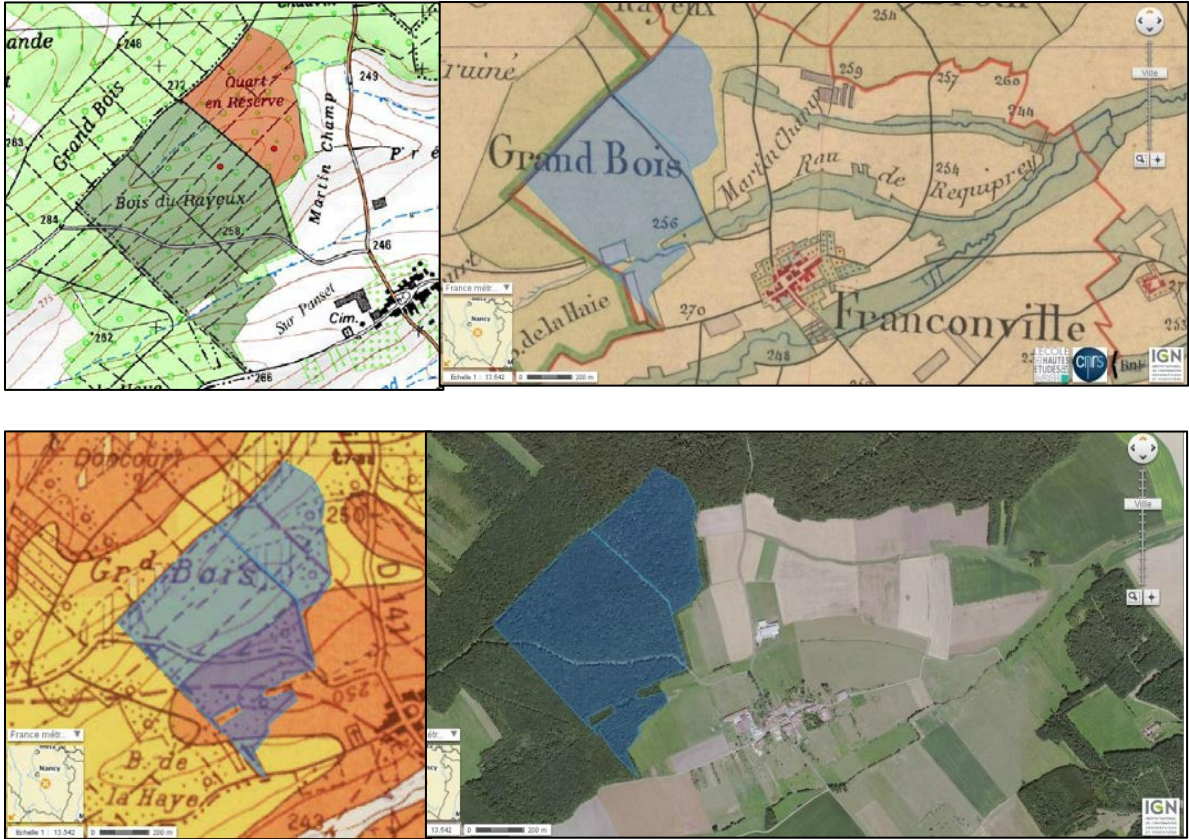

**ANNEX 3: Study localisation and sampled site position – QGIS**

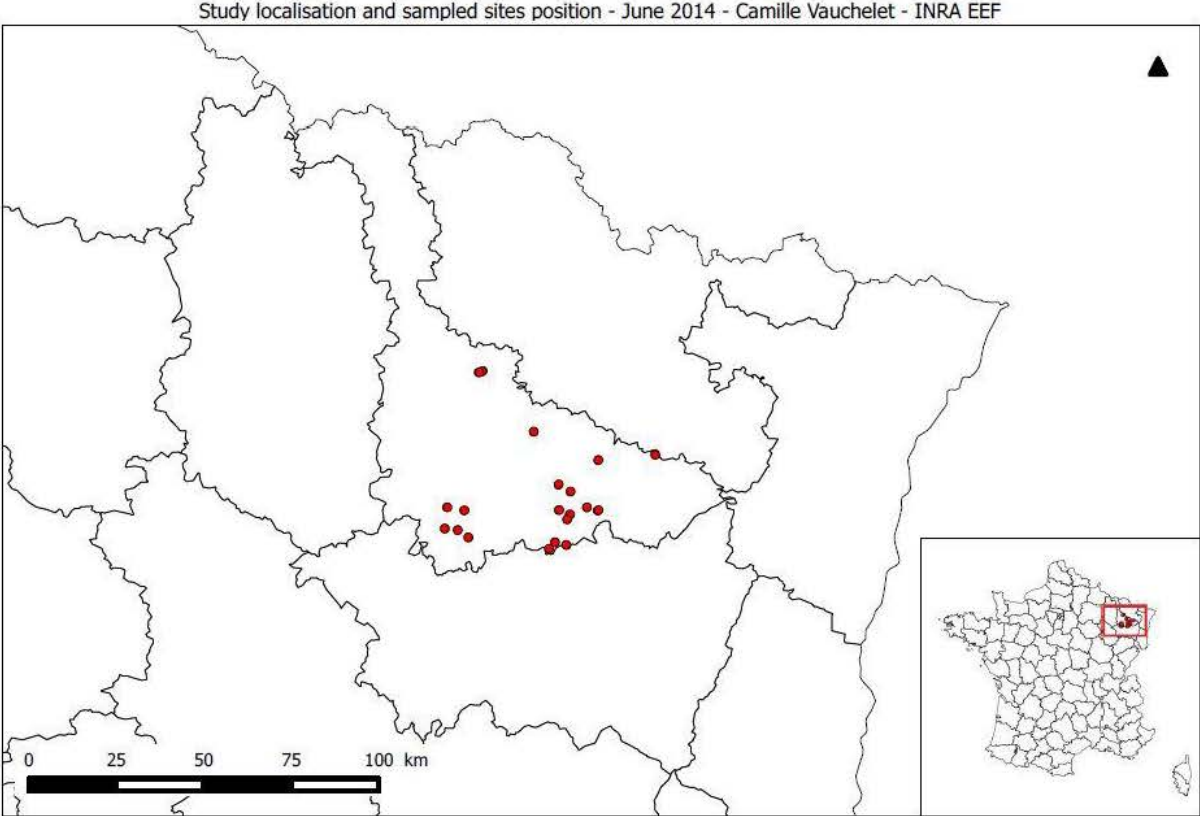



## ANNEX 4: Field survey protocol

EQUIPMENT			
Basic			
IGN maps		20 L water storage	
Compass		Trash bags	
GPS		First aid kit	
Topofil		Reserve battery	
Altimeter		Backpacks	
Clinometer		Umbrella	
Soil			
Soil survey sheet		Hammer	
Field board		HCL vial	
Pen and rubber		Dagger / knife	
Spade		Pruning shear	
Shovel		Sampling bag	
Pick		Marker pen and paper	
American shovel		id papers	
Soil auger		Munsell code	
2 cylinders		Wash bottle	
Small wooden board		Yard meter	
Plastic sheeting			
Vegetation			
Dendrometric survey sheet		Retractable decameter (25m)	
Florist survey sheet		Fluo marker (limit plot)	
Pen and rubber		2-3 tapes measure	
Botanical books		Chalks	
Scraper		Haglof DME 201 rangefinder 20 m , +/- 10 cm	
Wooden strakes		Rod bamboo	
Paper bags		Plastic bags	
Magnifying glass			

Sampling plan:

- 17,84 m radius circle
- 400 m<sup>2</sup> square plot (principal plot)
- 9 m radius circle
- Topsoil sample
- Pit and auger observation

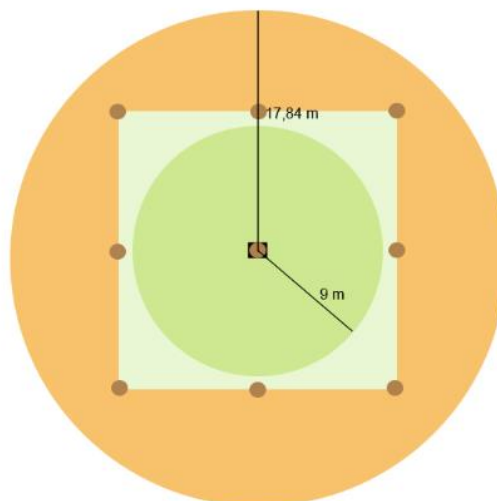

### Soil and humus description:

In the principal plot, a pit profile of 0, 60 m is described with information horizon referring to soil properties. In complement a soil auger observation is realized for depth horizons:

- Horizon : Name or number
- Depth horizon : top to floor in cm
- Transition : net or progressive / linear or sinuous (n,p / l,s)
- Color : horizon color with Munsell code (wet)
- Texture : Silt (L) , clay (A) and sand (S)
- Structure : lumpy, particulate, polyhedral or compact ( grum, part, poly or comp)
- HCL test (**0** : absent, **1** : reaction)
- Rooting : abundance in %  
Rooting type ( **VT** : very thin <0,2 cm, **T** : thin 0,2-0,5 cm, **M** : medium 0,5-2 cm, **L** : large > 2 cm )
- Coarse elements : abundance in %  
Coarse elements type (**G** : gravel 0,2-2 cm , **SS** : small stones 2-6 cm, **S** : stones 6-20 cm, **BS** : block of stone > 20cm )
- Hydromorphy : abundance in %  
Hydromorphy type(**Deco** : decoloration, **Ox** :oxidation stains, **Conc** : concretion stains)

The more representative humus of the plot is described:

- Oln : organic layer with new litter ( very little transformation)
- Olt : organic layer with transition litter ( loose material)
- Olv : organic layer with old litter ( bleached, softened and stuck)
- OF: fragmented organic layer ( fragments and organic matter particle)
- OH : organic layer with humification processes
- Earthworms castings ( **0** : nothing, **1** : low, **2** : medium, **3** : high)

### Soil sample:

For soil analysis, we sampled 9 soil surface cylinders (0 to 5 cm) in the plot. During this manipulation, cylinder must be vertically pushed after humus removal (in flat conditions for a complete filling). From each soil pit, 2 soil textural samples (~500g) were collected for sieve and organic matter analysis: one between 5 and 10 cm and another one between 40 and 50 cm.

### Dendrometric protocol:

Stems more than 2.5 cm diameter were measured in the smallest circle and those of more than 22.5 cm were inventoried in the largest circle (Figure 3). For each tree was noted: species, circumference at 1.30 m (in cm), status (DO: dominant, codo: co-dominant, do: suppressed, us: understorey) and origin (S: seed or C: clump)

### Florisitic protocol:

The floristic survey was conducted in the 400 m<sup>2</sup> plot; all species were identified and their cover-abundance was estimated using a Braun-Blanquet coefficient like scale. Species were separately noted in the following strata:

- the high tree stratum (AH) comprising dominant trees
- the low tree stratum (AB) comprising trees suppressed
- the shrub stratum (a) comprising ligneous species between 0, 3 and 7 m height
- the herbaceous stratum (h) comprising all vascular species below 0, 3 m height
- the moss stratum (m) for ground growing mosses



# ANNEX 6: Floristic survey

Master FAGE -Long term impacts of forest management on the ecosystem - Camille Vauchele - 2014																
FLORISTIC SURVEY																
Observer :											Date :		Plot id :			
Starting time :											Over time :					
Stratum cover (%) : AH =			AB=		a=		h=		m=							
Trees							Herbaceous									
Species	AH	AB	a	h	m	Species	AH	AB	a	h	m	AH	AB	a	h	m
Abies alba Mill.						Dryopteris filix-mas (L.) Schott										
Acer campestre L.						Euphorbia amygdaloides L. subsp. amygdaloides										
Acer pseudoplatanus L.						Fragaria vesca L.										
Betula pendula Roth						Galeopsis tetrahit L.										
Carpinus betulus L.						Galium aparine L.										
Fagus sylvatica L.						Galium odoratum (L.) Scop.										
Fraxinus excelsior L.						Geranium robertianum L.										
Picea abies (L.) H.Karst. subsp. abies						Geum urbanum L.										
Pinus sylvestris L.						Glechoma hederacea L.										
Populus tremula L.						Hedera helix L.										
Prunus avium (L.) L. [1755]						Hypericum hirsutum L.										
Prunus spinosa L.						Lamium galeobdolon (L.) L. subsp. galeobdolon										
Quercus petraea Liebl. subsp. petraea						Ligustrum vulgare L.										
Quercus robur L. subsp. robur						Lonicera periclymenum L.										
Robinia pseudoacacia L.						Lonicera xylosteum L.										
Salix caprea L.						Luzula luzuloides (Lam.) Dandy & Wilmott var. luzuloides										
Sorbus torminalis (L.) Crantz						Luzula pilosa (L.) Willd.										
Tilia cordata Mill.						Luzula sylvatica (Huds.) Gaudin subsp. sylvatica										
Tilia platyphyllos Scop. subsp. platyphyllos						Melica uniflora Retz.										
Shrubs							Mercurialis perennis L.									
Clematis vitalba L.						Milium effusum L.										
Cornus mas L.						Molinia caerulea (L.) Moench										
Cornus sanguinea L.						Neottia nidus-avis (L.) Rich.										
Corylus avellana L.						Oxalis acetosella L.										
Crataegus laevigata (Poir.) DC.						Paris quadrifolia L.										
Crataegus monogyna Jacq.						Phyteuma spicatum L.										
Cytisus scoparius (L.) Link						Poa chaixii Vill.										
Euonymus europaeus L.						Poa nemoralis L.										
Frangula dodonei Ard. subsp. dodonei						Polygonatum multiflorum (L.) All.										
Ribes uva-crispa L.						Potentilla sterilis (L.) Garcke										
Rosa arvensis Huds.						Primula elatior (L.) Hill										
Rosa canina L.						Pteridium aquilinum (L.) Kuhn										
Rubus fruticosus L.						Ranunculus auricomus L.										
Rubus idaeus L.						Rumex sanguineus L.										
Sambucus nigra L.						Scrophularia nodosa L.										
Sambucus racemosa L.						Stachys sylvatica L.										
Viburnum lantana L.						Stellaria holostea L.										
Viburnum opulus L.						Teucrium scorodonia L.										
Herbaceous							Urtica dioica L.									
Ajuga reptans L.						Vicia sepium L.										
Anemone nemorosa L.						Viola reichenbachiana Jord. ex Boreau										
Arum maculatum L.						Mosses										
Athyrium filix-femina (L.) Roth						Atrichum undulatum (Hedw.) P.Beauv.										
Brachypodium sylvaticum (Huds.) P.Beauv.						Dicranella heteromalla (Hedw.) Schimp.										
Cardamine pratensis L.						Dicranum scoparium Hedw.										
Carex brizoides L.						Eurhynchium striatum (Schreb. ex Hedw.) Schimp.										
Carex flacca Schreb. subsp. flacca						Fissidens taxifolius Hedw.										
Carex pilulifera L.						Hypnum cupressiforme Hedw.										
Carex remota L.						Mnium hornum Hedw.										
Carex sylvatica Huds.						Plagiommium affine (Blandow ex Funck) T.J.Kop.										
Carex umbrosa Host subsp. umbrosa						Plagiommium undulatum (Hedw.) T.J.Kop.										
Circaea lutetiana L.						Polytrichastrum formosum (Hedw.) G.L.Sm.										
Convallaria majalis L.						Rhytidiadelphus loreus (Hedw.) Warnst.										
Dactylis glomerata L. subsp. glomerata						Rhytidiadelphus triquetrus (Hedw.) Warnst.										
Deschampsia cespitosa (L.) P.Beauv.						Scleropodium purum (Hedw.) Limpr.										
Dryopteris carthusiana (Vill.) H.P.Fuchs						Thuidium tamariscinum (Hedw.) Schimp.										
Dryopteris dilatata (Hoffm.) A.Gray																
Off-list flora																



## ANNEX 8: Soil laboratory protocol

### BULK DENSITY

In laboratory, the sample is sieved (2mm) and the fine fraction is dried and weighted. For coarse and root elements, volume is calculated by water displacement based on Archimedes principle.

The density of the sample is the ratio of the mass of dry sieved soil at the exact volume of the cylinders taken less the volume of coarse elements and roots. Its bulk density is expressed in g/cm<sup>3</sup>.

### NIRS-MIRS (Near Infrared and medium infrared reflectance spectroscopy)

In laboratory, soil samples are dry-sieved (2 mm), ground (using a soil crusher with rotary rings during 1 minute) to obtain a homogeneous powder and stored in polypropylene boxes. The day before analysis, powders are oven-dried at 60°C during the night to homogenize moisture and kept in a desiccator before analysis.

From 1 g to 25 g of soil is required for NIR-MIR analysis, depending on the NIR-MIR analyser. Spectra consist of absorbance (absorbance =  $\log [1 / \text{reflectance}]$ ) values from 1000 to 2500 nm (Cécillon et al., 2010). All our soil samples were analysed by Fourier transform infrared spectroscopy (FTIR) with a diffuse reflection (Figure 1) (Spectrometer: BRUKER / Spectroscopy software: OPUS). Each spectrum is the average of 16 scans with a spectral resolution of 4 cm<sup>-1</sup>.

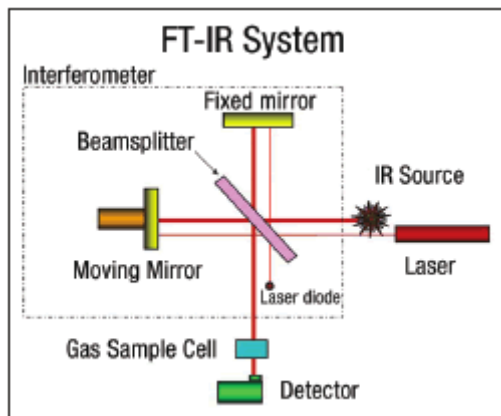

Source: **FTIR Analytical Systems: Part II—Experimental Design**  
by Steven Vaughan, Ph.D. and William “Kip” Vaughan  
January/February 2009

Figure: Schematic optical diagram of an FTIR spectrometer

## **ABSTRACT**

Nowadays, fossil energy depletion and global warming get our society on the way to renewable energetic strategies: one of these is forest biomass. In north-eastern France, most of the communal forests were divided into two parts during the 18<sup>th</sup> and 19<sup>th</sup> century. One called “coupes affouagères” (CA), was devoted to firewood production. The other one, called “quart de réserve” (QR) was kept as a wood reserve. Using this opportunity, we tested the hypothesis that: higher and more regular biomass removals in CA made long term differences (1740-2014) with QR in forest ecosystem properties. To observe differences, we studied stand structure, vegetal communities and soil organic matter. Results show relatively less pronounced effects of the former silvicultural treatment. There is a difference in soil fertility between the two treatments with a loss of organic matter in CA. We observe a trend in “coupes affouagères” to be colonizing by plant species of disturbed habitats. And stand structure tends to have slightly more very large wood in the QR. To conclude, an increase in demand for wood energy should be accompanied by recommendations for preserving mineral and organic forest soil fertility.

## **Impacts à long terme de la gestion forestière sur l'écosystème forestier : le cas du “Quart de réserve” dans le Nord-Est de la France**

### **RESUME**

De nos jours, l'épuisement des énergies fossiles et le réchauffement climatique ont amené notre société à utiliser des énergies renouvelables : l'une d'entre elle est la biomasse forestière. Dans le Nord-Est de la France, la plupart des forêts communales ont été divisées en deux parties pendant le 18<sup>ème</sup> et le 19<sup>ème</sup> siècle. L'une d'elle nommée « coupes affouagères »(CA), été dévolue à la production de bois de chauffage. La seconde, appelée « quart de réserve »(QR) été maintenue en tant que réserve de bois. Face à cette opportunité, nous avons testé l'hypothèse suivante : des prélèvements réguliers et intenses de biomasse dans les coupes affouagères ont provoqué sur le long terme (1740-2014) des différences avec le quart de réserve pour certaines propriétés de l'écosystème forestier. Pour observer ces différences, nous avons étudié la structure du peuplement, les communautés végétales et la matière organique du sol. L'ensemble des résultats montrent des effets peu prononcés selon l'ancien traitement sylvicole. Il existe une différence dans la composition du sol entre les deux traitements. Nous observons une tendance dans les anciennes coupes à être colonisées par des espèces de milieux perturbés. Et les peuplements forestiers ont tendance à avoir légèrement plus de très gros bois dans leur quart de réserve. Pour conclure, la demande croissante en bois énergie devrait être accompagnée de recommandations pour préserver la fertilité minérale et organique des sols.