



**HAL**  
open science

## Aerogel production by supercritical drying of organogels: experimental study and modelling investigation of drying kinetics

Mouna Lazrag, Cecile Lemaitre, Christophe Castel, Ahmed Hannachi, Danielle Barth

### ► To cite this version:

Mouna Lazrag, Cecile Lemaitre, Christophe Castel, Ahmed Hannachi, Danielle Barth. Aerogel production by supercritical drying of organogels: experimental study and modelling investigation of drying kinetics. *Journal of Supercritical Fluids*, 2018, 140, pp.394 - 405. 10.1016/j.supflu.2018.07.016 . hal-01896852

**HAL Id: hal-01896852**

**<https://hal.univ-lorraine.fr/hal-01896852>**

Submitted on 16 Oct 2018

**HAL** is a multi-disciplinary open access archive for the deposit and dissemination of scientific research documents, whether they are published or not. The documents may come from teaching and research institutions in France or abroad, or from public or private research centers.

L'archive ouverte pluridisciplinaire **HAL**, est destinée au dépôt et à la diffusion de documents scientifiques de niveau recherche, publiés ou non, émanant des établissements d'enseignement et de recherche français ou étrangers, des laboratoires publics ou privés.

1 **Aerogel production by supercritical drying of organogels: experimental study and**  
2 **modelling investigation of drying kinetics**

3 Mouna LAZRAG<sup>1, 2</sup>, Cécile LEMAITRE<sup>1</sup>, Christophe CASTEL<sup>1</sup>, Ahmed HANNACHI<sup>2</sup>,  
4 Danielle BARTH<sup>1\*</sup>

5  
6 <sup>1</sup>Laboratoire Réactions et Génie des Procédés, Université de Lorraine, CNRS, LRGP  
7 F-54000 Nancy, France

8 <sup>2</sup>Laboratoire Génie des Procédés et Systèmes Industriels (LR11ES54),  
9 Ecole Nationale d'Ingénieurs de Gabés, Université de Gabés, Avenue Omar Ibn El Khattab,  
10 Zrig Eddakhlania, 6072, Tunisia

11  
12 \*Corresponding author e-mail: [danielle.barth@univ-lorraine.fr](mailto:danielle.barth@univ-lorraine.fr)  
13 Tel: 33 (0)3 72 74 37 91  
14

15 **Abstract**

16 A supercritical process to dry organogels, in order to produce aerogels is studied. The  
17 organogel is firstly produced by synthesizing an amino-acid-type organogelator of fibrillary  
18 structure, which is able to trap a solvent, here tetralin. The extraction of tetralin from the  
19 organogel using supercritical CO<sub>2</sub> is then investigated both through experiments and  
20 simulations. Two approaches are developed in order to understand the tetralin mass transfer  
21 mechanisms. In the first approach, the organogel is regarded as an impenetrable material and  
22 the mass transfer within it is assumed to be only diffusive. In the second approach, the  
23 organogel is considered as a penetrable porous material so that CO<sub>2</sub> can flow across it. The  
24 tetralin transfer is thus governed both by diffusion and convection. Both approaches are  
25 implemented in Computational fluid dynamics (CFD) software ANSYS Fluent. The drying  
26 kinetics obtained by the second approach is found to agree better with the experimental  
27 results.

28 **Keys words:** Organogel, supercritical drying, aerogel, diffusion –convection, CFD

29 **1. Introduction**

30 **1.1. Processes used to dry gels**

31 The drying of a gel containing a solvent is operated by extracting the interstitial solvent. This  
32 process allows to produce a dry material with a highly porous structure and so a low thermal  
33 conductivity. **Because of the risk of degrading the product solid structure, this operation is**  
34 **delicate.** Different drying processes have been developed and used for inorganic gels such as  
35 silica gels: freeze drying, evaporative drying and supercritical drying (**Fig. 1**)[1]. Freeze

36 drying applied to nanostructured silica gels leads to cryogels that are usually cracked and  
 37 show obvious damages in the pore structure [2]. Evaporative drying is performed at  
 38 atmospheric pressure and the obtained material is generally called xerogel [3]. Supercritical  
 39 drying was developed in the 1930's by Kistler [4]. Above the critical point, the sharp  
 40 distinction between liquid and gas phases disappears, inhibiting surface tension effects which  
 41 are held responsible for the gel degradation. This technique has proved to be far more  
 42 efficient and to produce monolithic aerogel materials [1].

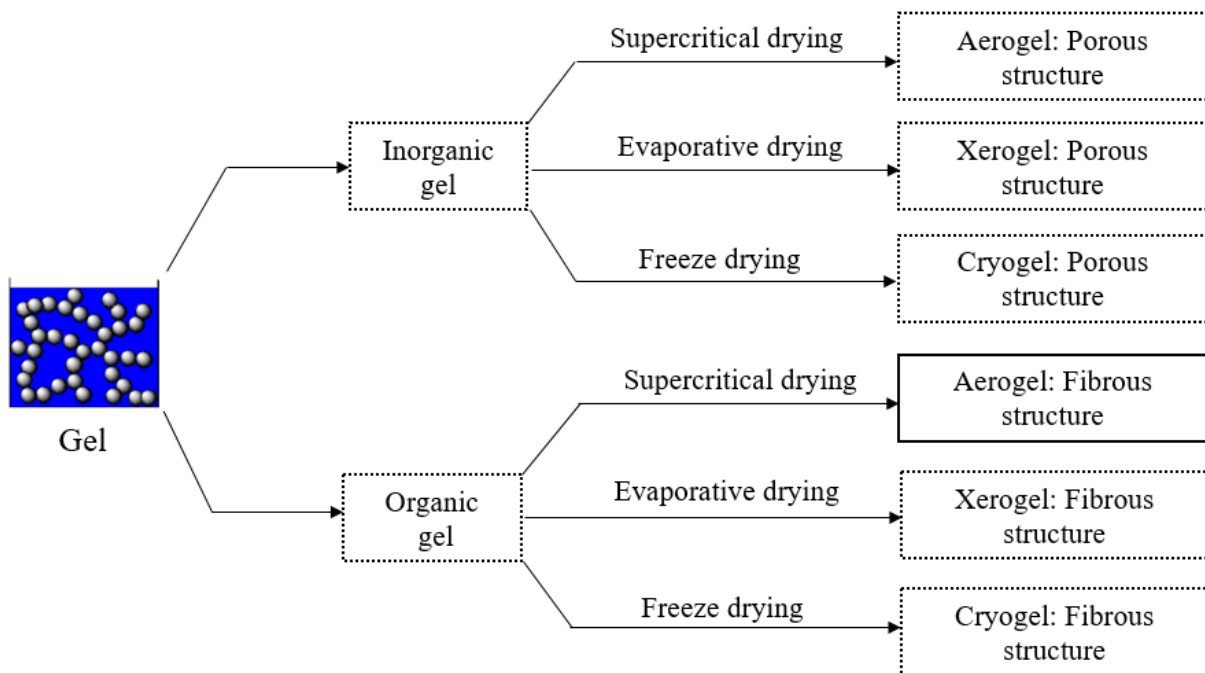

43

44

**Fig. 1.** Methods of gel drying and their outcome [1].

45

### 1.2. Structure of the resulting aerogels, xerogels and cryogels

46 Aerogels are derived from the supercritical drying of two main categories of gels (**Fig. 1**):  
 47 inorganic gels such as silica aerogels and organic gels, such as the organogels studied in this  
 48 paper. SEM (scanning electron microscopy) images of xerogels, cryogels and aerogels  
 49 obtained by the evaporative drying, freeze drying and the supercritical drying techniques  
 50 respectively were studied in previous works [3,5–8]. The structural patterns are very ramified  
 51 which allows a low bulk density and a large porous volume in the materials. All aerogels are  
 52 less dense than xerogels and cryogels. Indeed, aerogel samples display the least shrinkage  
 53 compared to cryogels and xerogels. Among these materials, aerogels are generally the most  
 54 porous media and possess the largest surface area [3,7]. Xerogels, cryogels and aerogels  
 55 produced from silica gels have similar cloudy and diffuse structures, with very small

56 interconnected units [3,5] . The pores have similar nanometric sizes (generally 1-100 nm)  
57 [9,10]. On the contrary, the materials obtained from organogels display highly entangled  
58 fibrillar structures, presenting a discontinuous skeleton of fibers with random distribution  
59 [6,7]. The aerogel fibers are less thick than the fibers of the materials obtained from the same  
60 organic gels but with other drying techniques [7]. Organic aerogels are less fragile than  
61 inorganic aerogels [11,12]. It was shown that they can be converted into carbon aerogels  
62 through pyrolysis [13].

63 The first organic aerogels of natural origin and their derivatives were produced by Kistler  
64 [4,14]. Resorcinol/formaldehyde (RF) and melamine/formaldehyde (MF) are two of the most  
65 common precursor mixtures to form the organic polymer network [15,16]. Organic aerogels  
66 are also prepared from cellulose, the most abundant polymer in nature [7,17]. The pore  
67 volume fraction of nanofibers at the cell wall of cellulose aerogels has an important influence  
68 on the mechanical properties [7]. However, cellulose aerogels display an impact strength  
69 much larger than that of RF aerogels and thousand times larger than for inorganic aerogels  
70 [17].

71 The aerogels studied here are obtained from organogels, which can be prepared with different  
72 types of solvents. For aerogels produced from toluene and tetralin organogels, with a weight  
73 percentage of gelator between 0.5 and 1 mass % introduced in the solvent, the fiber diameters  
74 are nanometric in both cases.

### 75 1.3. Properties and applications of aerogels produced by supercritical drying

76 Silica aerogels, the most common and extensively studied aerogels, show outstanding  
77 properties such as high porosity (80–99.8%), high specific surface area (500–1200m<sup>2</sup>/g), very  
78 low conductivity ( $<0.02\text{W}\cdot\text{m}^{-1}\text{K}^{-1}$ ) [18], low density ( $\sim 0.003\text{ g/cm}^3$ ), low index of refraction  
79 ( $\sim 1.05$ ) and ultralow dielectric constant ( $k = 1.0\text{--}2.0$ ) [19]. Owing to these properties, the  
80 aerogels open numerous application perspectives such as acoustic and thermal insulation and  
81 to a lesser extent, catalysis, electric devices, filtration and collection devices [20]. The  
82 industrial production of aerogels is mainly limited to silica-based systems, carbon, and some  
83 small amounts of organic aerogels [21].

### 84 1.4. Organogels used to produce aerogels

85 Organogels are physical organic gels made of a three-dimensional network of gelator  
86 molecules, which trap the solvent and prevent its flow. Weak bonds ensure the cohesion of

87 this supramolecular network. The gelator molecules, also called organogelators, have a low  
88 molecular weight ( $<3000 \text{ g}\cdot\text{mol}^{-1}$ ) and can be amino acid derivatives such as phenylalanine, as  
89 in the present study. The bonds responsible for the gelation phenomenon in this case are  $\pi$ - $\pi$   
90 stacking interactions, hydrogen bonding and van der Waals interactions [6, 22-24]. The  
91 organogelators show gelation capacity in various solvents such as aromatic solvents (toluene,  
92 benzene, tetralin...), alcohols, and ketones. The organogel studied in this paper are produced  
93 with tetralin as a solvent.

#### 94 1.5. Some lessons from previous supercritical gel drying practices

95 The gel supercritical drying to produce aerogel is based on two crucial steps, the solvent  
96 removal from the organogel by supercritical  $\text{CO}_2$  extraction and the separation of the solvent-  
97  $\text{CO}_2$  mixture. Extraction of the liquid solvent by preserving the gel texture and in particular its  
98 original porous network is an important issue in aerogel production. In experimental studies,  
99 this step needs to be conducted without creating a liquid-vapor interface, since the resulting  
100 capillary forces in the pores cause shrinkage and cracking of the gel samples due to internal  
101 stress [25]. According to Novak and Knez [26], the quality and the shape of this kind of  
102 aerogels, [monolithic cylindrical silica gels formed with methanol](#), were governed by diffusion  
103 of methanol solvent in the  $\text{CO}_2$  phase. Furthermore, cracking of samples resulted from rapid  
104 drying while transparent crack-free aerogels were obtained for slow drying. Non-transparent  
105 areas were observed inside the silica aerogel with intermediate drying times [26].

106 In order to understand the phenomena occurring within the gels during supercritical drying,  
107 the most important parameter to follow is the solvent transport into the porous medium. In the  
108 earliest studies, researchers considered that mass transfer was purely governed by diffusion  
109 phenomena. For this reason, they focused on the [experimental](#) determination of the effective  
110 solvent- $\text{CO}_2$  diffusion coefficient through gel structure. In the work of Wawrzyniak [27], this  
111 parameter was determined for ethanol- $\text{CO}_2$  at different temperatures and pressures, by  
112 combining the diffusional resistances in the fluid phase and structural gel parameters, porosity  
113 and tortuosity [27]. The effective methanol- $\text{CO}_2$  diffusion coefficients through cylindrical gels  
114 at two different temperatures were also determined experimentally by Novak and Knez [26].  
115 A recent experimental research showed the reliability of NMR (Nuclear Magnetic Resonance)  
116 technique in-situ to estimate this parameters at ambient temperature for different methanol-  
117  $\text{CO}_2$  and ethanol- $\text{CO}_2$  mixtures within silica gels as a function of the solvent concentration  
118 and pressure [28]. Sanz-Moral *et al.* [29] studied experimentally the supercritical  $\text{CO}_2$  aerogel  
119 drying by image analysis of video captures. Cylindrical silica alcogels produced with

120 methanol were followed in a high pressure view cell. The mass transfer mechanisms were  
121 investigated through analysis of the aerogels transparency evolution during drying. In the  
122 early stages of drying, the mass transfer inside the gel was found to be dominated by  
123 convection, the drying rate evolution directly depending on the CO<sub>2</sub> flow rate. On the  
124 contrary, diffusion governed the transfer of methanol through the alcogel in the later stages  
125 [29].

126 Quiño *et al.* [30] used Raman Spectroscopy to determine the composition of the CO<sub>2</sub>/ethanol  
127 mixture inside gels during supercritical drying, as a function of time and position. From the  
128 obtained CO<sub>2</sub> and ethanol concentration fields, the authors concluded that the ethanol is  
129 permanently removed from the structure of the gel while CO<sub>2</sub> travels into and out of the  
130 sample at the beginning and at the end of the drying operation, respectively. The diffusion  
131 coefficient has been determined as function of CO<sub>2</sub> concentration by fitting the experimental  
132 data with the analytical model of Crank [31].

### 133 1.6. State of the art on modelling and simulations of gel supercritical drying

134 In order to model and optimize the supercritical drying process, a good understanding of the  
135 phenomena that occur in the complex system of solvent and carbon dioxide is necessary.  
136 Process optimization leads to an overall cost reduction and modelling is the key to estimate  
137 the drying time and to contribute to the process development. *With this respect, different*  
138 *studies can be found* in the literature. The systems studied are generally silica gel and an  
139 alcohol. A mechanistic model was proposed by Mukhopadhyay *et al.* on supercritical drying  
140 of silica aerogel by focusing on mass transfer modeling of CO<sub>2</sub> and ethanol to and from the  
141 gel [32]. It was based on the assumption that the pores are parallel arrangements of cylinders.  
142 The pore structure was considered open on one or both ends, with direct contact with  
143 supercritical CO<sub>2</sub> (SCCO<sub>2</sub>) at the open end. The diffusive CO<sub>2</sub> flux and the convective mass  
144 ethanol flux to and out of the open end of the pores were calculated. The effective diffusion  
145 coefficient is introduced as a function of molecular and Knudsen diffusion. The C++ language  
146 was used to solve classical mass balance equations of the 1D model. It was concluded that the  
147 supercritical extraction of ethanol occurred by spillage due to the supercritical CO<sub>2</sub> dissolution  
148 in the pore liquid rather than by the convective evaporation. The drying time was found  
149 theoretically to depend strongly on different parameters such as flow velocity of SCCO<sub>2</sub>, gel  
150 thickness, temperature, and pressure. Only the effect of the gel thickness was validated  
151 experimentally.

152 Orlovic *et al.*[33] studied the case of alumina/silica gels containing 1-butanol solvent. They  
153 simulated the transfer of the solvent in the gel by pure diffusion. An effective diffusivity was  
154 determined with four different models. The two first models were shrinking core models in  
155 which a unique effective diffusivity was taken for the whole porous medium. One used  
156 Knudsen diffusivity while the other used tortuosity and porosity in the calculation of the  
157 diffusivity. The two last models were based on particular pore arrangements. Parallel pore  
158 arrangement modeled the simultaneous drying of all pores. Pores in series modelled the  
159 successive drying of the pores from the largest to the smallest. A different effective  
160 diffusivity was used for each pore size by considering Knudsen diffusion for the micropores.  
161 Better fitting of experimental data was obtained for the two last models.

162 In the theoretical approach of Griffin *et al.*[34], gels of annular geometry and blown around  
163 by SCCO<sub>2</sub> were modeled with 2D axisymmetric COMSOL model. The mass transfer model  
164 considered pure diffusion within the gel. Only molecular diffusion was taken into account and  
165 Knudsen diffusion terms were not considered. The gel structure, porosity and tortuosity were  
166 assumed not to affect diffusion. The model included a diffusion coefficient dependent on the  
167 solvent composition. The results were compared with experimental data obtained from a pilot  
168 unit that ensured a continuous measurement of the solvent (ethanol) extraction for different  
169 gel thickness and CO<sub>2</sub> mass flow rate. A good agreement was found between theoretical and  
170 experimental results. It was also concluded from experiments that the ethanol extraction  
171 process is due to sole diffusion phenomena, a significant effect on drying time of both gel  
172 thickness and CO<sub>2</sub> mass flow rate was shown.

173 In the study of Ozbakir *et al.* [35] the mass transfer within the cylindrical gel and in the  
174 flowing SCCO<sub>2</sub> was modelled. The mass transfer inside the gel was assumed to be diffusive.  
175 Mass transfer occurred by convection from the gel surface to the flowing SCCO<sub>2</sub> stream. The  
176 effective diffusion coefficient for the porous gel was estimated proportional to both the CO<sub>2</sub>-  
177 ethanol diffusion coefficient and gel porosity and inversely proportional to the gel tortuosity.  
178 The binary diffusion coefficient was considered a function of the CO<sub>2</sub> mole fraction. To  
179 describe mass transfer along the tubular extraction vessel, a convective mass term was taken  
180 into account. Experiments were carried out with a SCCO<sub>2</sub> continuous flow surrounding a  
181 cylindrical silica gel in a tubular extraction vessel allowing to measure the mass of ethanol  
182 removed as a function of time. The gel experimental extraction profiles were compared to the  
183 model predictions. A good agreement was reached using mass transfer coefficients fitted from  
184 the experiments that varied from an experiment to other. The effect of the CO<sub>2</sub> flow rate on

185 drying kinetic was studied both experimentally and theoretically. It was concluded that the  
186 increase of CO<sub>2</sub> flow rate led to a decrease of effluent concentration at a specific time.  
187 However, the effect on the rate of extraction of ethanol was not significant. The simulations  
188 were used to investigate the effect of the effective diffusion coefficient and gel thickness. It  
189 was found that the drying time of the silica gel decreased with increasing effective diffusion  
190 coefficient and decreasing gel thickness. For instance, the solvent concentration was divided  
191 by two after 10 min for a diffusion coefficient of  $5 \cdot 10^{-9} \text{ m}^2/\text{s}$  and after 120 min for a diffusion  
192 coefficient ten times lower ( $0.5 \cdot 10^{-9} \text{ m}^2/\text{s}$ ). Also, the drying time increased from 50 min to 300  
193 min when the diameter was increased from 0.5 cm to 2 cm.

194 Supercritical solvent extraction process was also simulated using CFD (Computational Fluid  
195 Dynamics) techniques. Lebedev *et al.* [36] performed simulations to describe the supercritical  
196 drying process of silica gels. They developed a mathematical model describing the flow in the  
197 reactor of a supercritical alcohol-CO<sub>2</sub> mixture, assumed a compressible viscous fluid. In their  
198 approach, heat and mass transfer were also accounted for. ANSYS-Fluent software was used  
199 for simulations. Two flow domains were considered in the system: the volume of the porous  
200 body (gel) and the free volume of the reactor. In the porous medium, mass transfer was  
201 described by Fick diffusion equation accounting for molecular diffusion only. The CO<sub>2</sub>-  
202 alcohol mixture inside the reactor was described by Peng-Robinson equation of state. The  
203 experimental study of the supercritical drying kinetics was performed with ten cylindrical  
204 monolithic gels. The developed model represented adequately the experiments. The influence  
205 of flow rate and gel thickness on kinetic curves was investigated showing a significant effect.

206 In almost all the previous researches, the dried gels were silica gels. Very few papers treated  
207 the case of organic gels. Garcia-Gonzalez *et al.* [37] have studied the supercritical drying of  
208 gels from different precursors (inorganic silica gel and organic starch gels) in order to show  
209 the precursor effect on the kinetics profile. The solvent (ethanol) removal process was  
210 followed experimentally. The solvent extraction was studied experimentally by measuring its  
211 amount in the CO<sub>2</sub> gaseous stream, using an alcoholmeter device. It was concluded that the  
212 gel supercritical drying is governed by a mass transfer mechanism based on a combination of  
213 both convection and diffusion inside the gel. In the first drying step (0-60% of recovery rate),  
214 convective mass transfer was shown to play a significant role while the last drying step is  
215 controlled by diffusion. The experimental drying profiles were compared to theoretical  
216 profiles calculated considering only Fickian diffusion-based model without convective  
217 transport. This model failed to predict correctly the experimental data. The effective diffusion



218 coefficient was determined by using the curve fitting Matlab tool. The obtained values were  
219 slightly higher than those found in the previous literature for the silica aerogel ( $10^{-8}$  m<sup>2</sup>/s).  
220 The effective diffusion coefficient of organic starch aerogel were almost ten times lower than  
221 that found for the monolithic silica aerogel ( $10^{-9}$  m<sup>2</sup>/s). This last value is the only value  
222 found in the literature for organic gels. The drying profiles of inorganic silica gel and organic  
223 starch gels were compared to investigate the effect of precursor nature of the gel. It was found  
224 that both drying profiles followed a similar two-step drying rate behavior. However, the  
225 drying rate was lower in the case of organic gel. The authors attributed this to the difference  
226 between the gels textural properties which could affect the diffusion process. Moreover, they  
227 assumed that the interaction of ethanol with the starch components of the organic gel might  
228 hinder and delay the solvent extraction. The effect of morphology in the drying process was  
229 also studied by comparing the experimental drying profiles of cylindrical monoliths and  
230 microspheres gels having the same target densities. It was observed that these profiles were  
231 similar in the first drying step (0-60% of recovery rate) then the drying process of  
232 microspheres was faster than for the cylindrical monoliths. This was explained by the  
233 threshold point at which the drying process became more affected by the diffusion  
234 phenomena. The minimum diffusion path length was shown to have a significant effect on the  
235 drying process by comparing organic gels profiles with different geometrical shapes (cube  
236 and cylinder) and sizes.

237 So far, most [models reported in the](#) literature describe the supercritical drying of [inorganic](#)  
238 [silica](#) gels ([Table 1](#)). The present study focuses on the supercritical drying of organic gels,  
239 derived from a low molecular weight molecule, which have been received little attention. The  
240 structure and properties of aerogels derived from organogels are very different from those  
241 derived from silica gels. Furthermore, the solvents used to produce silica gel were often  
242 alcohols like ethanol, methanol and isopropanol. The solvent chosen here is tetralin, which is  
243 aromatic and not volatile. At the best of our knowledge, it was never used in the past to  
244 produce gels. A new theoretical approach is developed in this paper in order to model the  
245 supercritical drying of organogels accounting for diffusion as well as convective mass  
246 transfer. In fact, two different approaches are assumed and compared, depending on the  
247 penetrable or impenetrable nature of the organogel.

249 **Table 1.** Models describing supercritical drying of gels in literature and in the present paper

Gel nature	Mass transport in sample	Diffusivity determination in sample	Mass transport in surrounding fluid in autoclave	Software & geometry	Reference
Inorganic	-Simulation of one pore, -Diffusion only - Boundary condition: convection at the end of the pore	-Effective diffusivity function of molecular and Knudsen diffusion - Molecular diffusivity in CO <sub>2</sub> dependent on solvent concentration	Not considered	- C++ - 1D model	[32]
Inorganic	-Diffusion only -Boundary condition: constant concentration at the sample surface	Effective diffusivity: 4 different models dependent on molecular diffusivity in CO <sub>2</sub> , porosity and tortuosity and Knudsen diffusivity	Not considered	- Fortran - 1D model	[33]
Inorganic	Diffusion only	Molecular diffusivity in CO <sub>2</sub> dependent on solvent concentration	Convection-diffusion	-COMSOL -2D axisymmetric simplified model	[34]
Inorganic	Diffusion only	- Effective diffusivity calculated as function of molecular diffusivity and tortuosity and porosity - Molecular diffusivity in CO <sub>2</sub>	Convection-diffusion	- Matlab -2D axisymmetric model	[35]

		dependent on solvent concentration			
Inorganic	Diffusion only	Molecular diffusivity in CO <sub>2</sub> dependent on solvent concentration	Convection-diffusion	- Ansys-Fluent -3D geometry	[36]
Inorganic/ organic	-Diffusion only -Boundary condition: zero concentration at the sample surface	Fitted effective diffusivity	Not considered	- Matlab -Analytical 1D model	[37]
Organic	Diffusion Only	Effective Diffusivity Calculated by a correlation from litterature	Convection-diffusion	- Ansys-Fluent -3D model	Present paper Approach 1
Organic	Convection-Diffusion	Calculated Molecular diffusivity in CO <sub>2</sub> by an equation from litterature	Convection-diffusion	- Ansys-Fluent -3D model	Present paper Approach 2

## 2. Experimental drying of cylindrical organogels

In this section, a drying experiment of organogels is described and kinetic results are presented.

### 2.1. Organogel preparation

The process to obtain organogel is based on two main steps. The first step is the synthesis of low molecular weight organogelator molecules derived from amino acids (Phenylalanine Phe) which was described by Brosse *et al.*[22]. It consists of an esterification of the Z group (benzyloxycarbonyl) protected amino acid, called Z-Phe-OMe, followed by a hydrazide synthesis (Z-Phe-NH-NH<sub>2</sub>) by reacting the ester with hydrazine hydrate. Then, the final compound, the organogelator (Z-Phe-NH-Napht) is obtained by condensation of naphthalic anhydride with the hydrazide. The second step consists in the gel formation by dissolving and stirring a desired amount of the organogelator into a desired amount of organic solvent (here tetralin) in a round bottomed flask connected to a reflux condenser at T=80°C. The hot solution is then transferred into a cylindrical mold and cooled down to T= 4°C [6]. Four cylindrical organogel samples with 30 mm diameter and 6.7 mm, 10.5 mm, 10.5 mm and 12.9 mm height respectively were prepared following this experimental protocol.

### 2.2. Experimental setup for organogel drying

The organogels drying is carried out in a home-made supercritical laboratory equipment represented in **Fig.2**. This unit is mainly composed of a high pressure cylindrical extractor or autoclave<sup>9</sup> of 250 ml volume where the organogel is dried. Gaseous CO<sub>2</sub> (50-60 bar) supplied by a CO<sub>2</sub> bottle<sup>1</sup> is liquefied by cooling in a cold exchanger<sup>2</sup> at 4°C. A pump<sup>4</sup> manufactured by LEWA (EK1) pushes the liquid CO<sub>2</sub> into the back pressure regulator<sup>6</sup>. The pressure of the CO<sub>2</sub> leaving the pressure regulator is 180 bar. Then, it is heated in a hot exchanger<sup>7</sup> up to 45°C. Under these conditions (45°C and 180 bar), the CO<sub>2</sub> flow is under supercritical state. The autoclave containing the gel is fed with the supercritical CO<sub>2</sub>. The organogel sample is placed on a bed of glass beads (**Fig. 3**). The CO<sub>2</sub> entering from the bottom of the autoclave first flows through this bed before it is blown around the sample. The cumulative mass and the flow rate of CO<sub>2</sub> are measured using a Micromotion<sup>8</sup> Coriolis mass flowmeter placed upstream from the autoclave with  $\pm 1$  g accuracy. The pressure inside the autoclave is controlled by a pressure gauge (PI1). The supercritical CO<sub>2</sub> allows organogel drying by extracting the tetralin from its porous structure. The CO<sub>2</sub>-tetralin mixture leaving the autoclave is then separated in a cascade of three successive separators<sup>10</sup> operating at 50 bar, 30

282 bar and atmospheric pressure respectively and at 20°C. Further details about the drying  
 283 process and the separation are provided in [38].

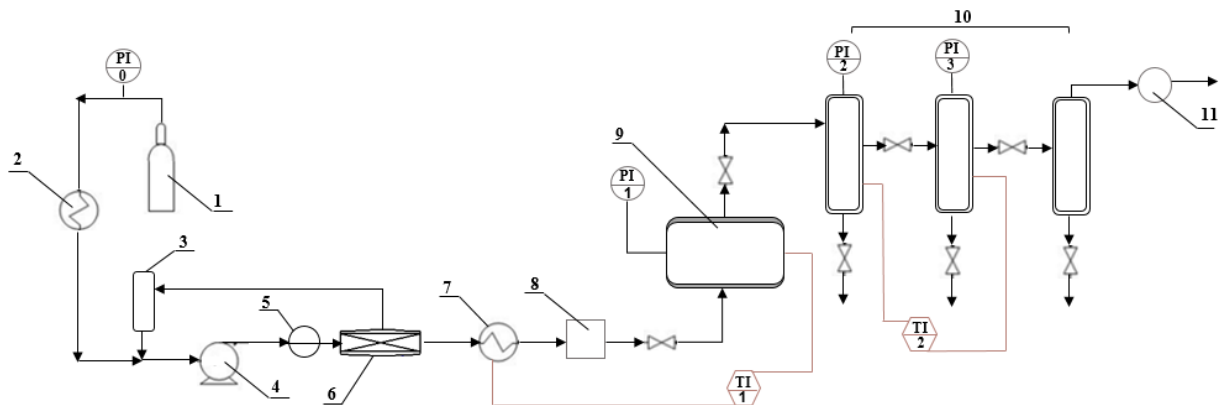

284  
 285 **Fig.2.** Scheme of the supercritical drying set-up: 1-CO<sub>2</sub> bottle; 2-cold exchanger; 3-CO<sub>2</sub> tank  
 286 4-pump; 5- Damper, 6-back pressure regulator; 7-hot exchanger; 8-Coriolis mass flowmeter;  
 287 9-autoclave; 10- three cyclone separators; 11- Flowmeter,  
 288 PI-pressure gauge, TI-thermostatic bath.  
 289

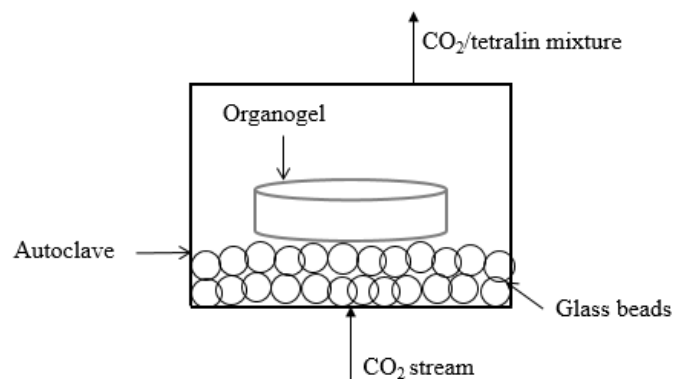

290  
 291 **Fig. 3.** Organogel sample placed in the autoclave

### 292 2.3. Drying procedure

293 The organogel drying procedure in order to obtain the aerogel follows several steps, during  
 294 which the temperature and pressure in the autoclave evolve with time, as described in **Fig. 4**  
 295 and detailed hereafter:

- 296 - Step 1: autoclave filling with CO<sub>2</sub> for 15 min
- 297 - Step 2: pressurization of the autoclave for 20 min up to 180 bars
- 298 - Step 3: autoclave heating for 20 min up to 45 °C
- 299 - Step 4: supercritical extraction by transport of tetralin from the gel to the CO<sub>2</sub> stream

300 - Step 5 and 6 : depressurization and decrease of temperature to the ambient conditions  
301 during 30 min

302 At the end of these steps, the autoclave is opened and the aerogel is recovered.

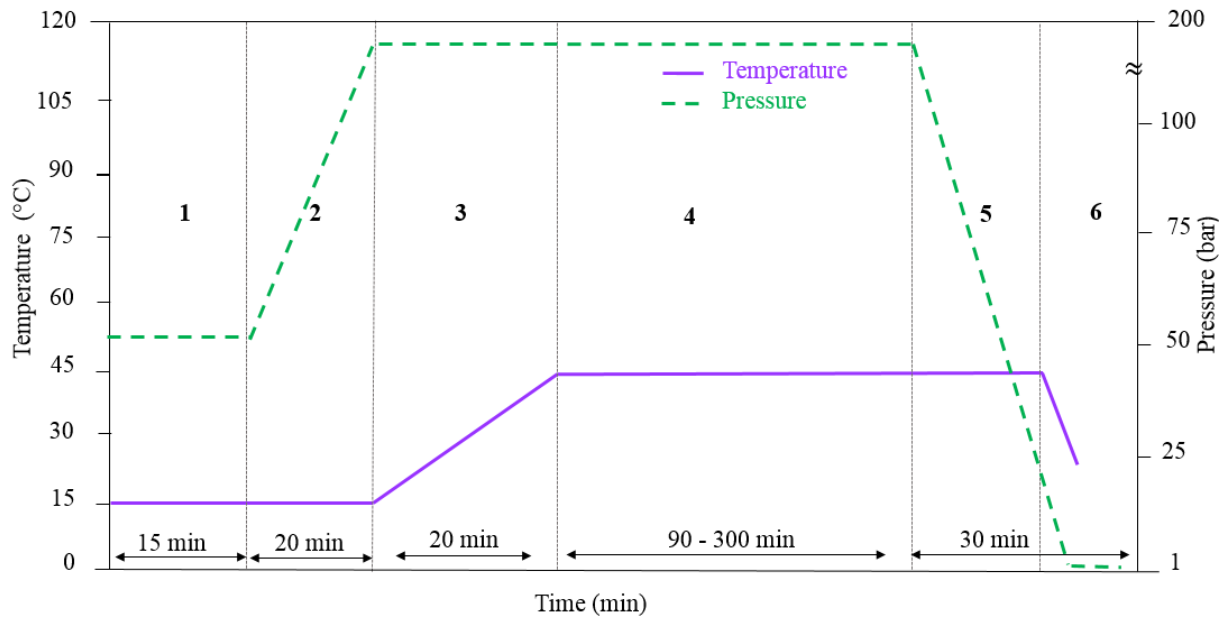

303

304 **Fig. 4.**Steps of drying in the autoclave: temperature and pressure enforced in time.

305 The step of supercritical extraction is the crucial and the longest step. During this step, the  
306 liquid phase is collected every 15 min from the bottom of the separators and then weighed  
307 ( $\pm 0.1mg$ ). The weight values are summed up and the total quantity of tetralin recovered from  
308 the autoclave during the supercritical extraction is determined. The CO<sub>2</sub> flow rate slightly  
309 varies along the extraction process. However, instantaneous flow rate measurements, showed  
310 that the variations did not exceed 10 %. The pressures in the separators are regulated  
311 manually by depressurisation valves and also recorded at each collecting step. At the end of  
312 supercritical extraction, the mean CO<sub>2</sub> flow rate is calculated as the arithmetic average of the  
313 measured flow rates.

314 The sample thickness and the CO<sub>2</sub> flow rate differed for every experiment. This is why it was  
315 not possible to perform replication tests.

#### 316 2.4.Drying experiments results

317 The four cylindrical samples with different size described in section 2.1 are dried according to  
318 this experimental protocol. The experimental data and results, gel thickness, organogelator  
319 weight fraction, tetralin mass in the gel, mean CO<sub>2</sub> flow rate, drying time, initial tetralin

320 concentration, and tetralin **degree of recovery**, are reported in **Table 2**. The initial tetralin  
 321 concentration is calculated as the ratio of the tetralin mass in the gel to the pore volume of the  
 322 sample, multiplied by the tetralin molar mass. The experimental tetralin **degree of recovery** is  
 323 the ratio of the total quantity of tetralin recovered from the autoclave to the initial total  
 324 quantity of tetralin in the gel. The final recovery is satisfactory, around 90% but is not  
 325 complete (**Table 2**). A thermodynamic modeling of CO<sub>2</sub>/tetralin separation has been carried  
 326 out and the tetralin **degree of recovery** has been computed in a former work [39] .

327 The computed recovery (theoretical tetralin recovery) were in agreement with the  
 328 experimental values (experimental tetralin recovery). **The discrepancies may be attributed to**  
 329 **experimental errors and to variations of CO<sub>2</sub> flow rate and pressures during experiments. In**  
 330 **the thermodynamic model, on the contrary, the flow rate and the pressures are assumed**  
 331 **constant all along the experiments.**

332 The unrecovered amount is due to thermodynamic reasons: about 10% of the tetralin stays in  
 333 the gas phase and leaves the separators with the CO<sub>2</sub> through the upper gas exits, as explained  
 334 by Lazrag *et al.*[39].

335 **Table 2.** Experimental data and results of the four organogel samples

<b>Sample</b>	<b>Exp.1</b>	<b>Exp.2</b>	<b>Exp.3</b>	<b>Exp.4</b>
Gel thickness (mm)	6.7	10.5	10.5	12.9
<b>Organogelator weight fraction (%)</b>	<b>1</b>	<b>1</b>	<b>1</b>	<b>0.5</b>
Tetralin mass in the gel (g)	4.500	7.086	7.075	8.735
Initial tetralin concentration (mol.L <sup>-1</sup> )	7.409	7.445	7.443	7.470
CO <sub>2</sub> mean flow rate (g/h)	729	733	820	540
Drying time (min.)	150	240	240	240
Experimental tetralin <b>degree of recovery (%)</b>	81	<b>91</b>	<b>88</b>	87
Theoretical tetralin <b>degree of recovery (%)</b>	89.0	85.9	85.9	92.3
Mean tetralin molar fraction (%)	0.09	0.07	0.07	0.13

336  
 337 To compare the experimental results with the numerical calculations presented later, the  
 338 instantaneous recovery rate is considered relatively to the recovered value at long times,

$$\text{NTRR} = \frac{\text{tetralin cumulative quantity recovered at a time } t}{\text{tetralin total quantity recovered from the autoclave}} \quad (1)$$

339 and is called the normalized tetralin recovery rate (**NTRR**). In **Fig. 5**, the experimental **NTRR**  
 340 is presented as a function of time.

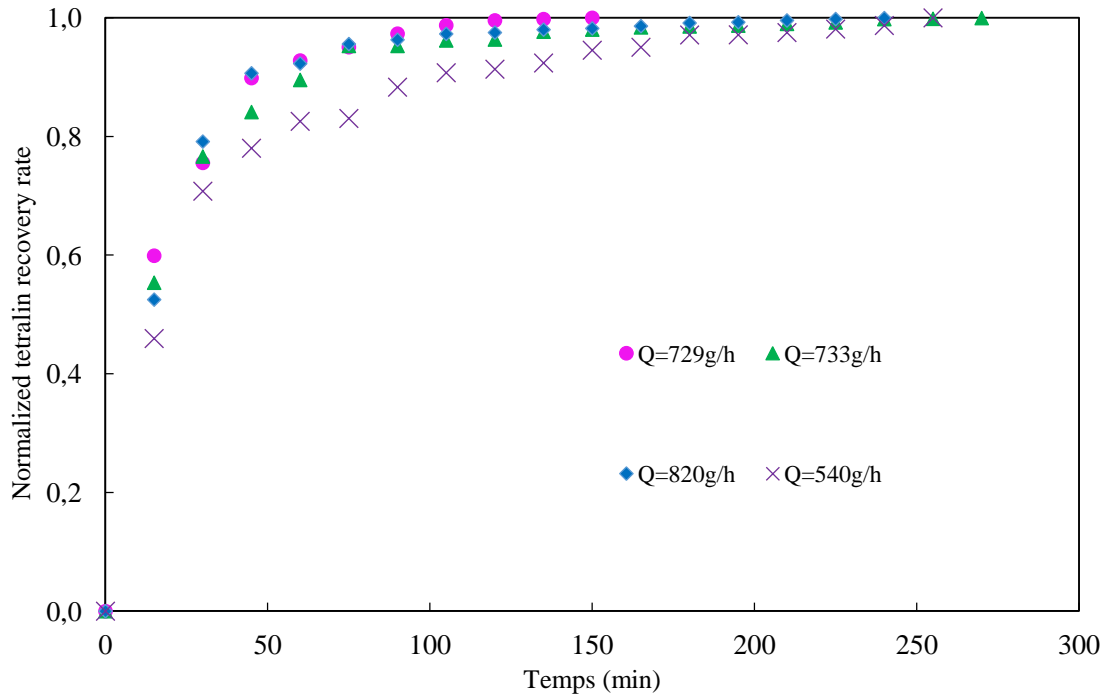

341

342

**Fig. 5.** Experimental supercritical drying kinetics of the four organogel samples

343

As stressed before, the normalized tetralin recovery rate considers the total cumulative solvent quantity and not the initial quantity of the solvent in the gel as the reference, thus leading to 100% recovery rates for all four experiments. The experimental drying time differs from one experiment to another and ranges between 150 and 240 min. In section 3, a theoretical study is conducted to model the drying kinetics. Two different models are developed depending on the mass transfer mode inside the gel volume, whether governed by diffusion-convection transport or only by Fickian diffusion.

348

### 350 3. Mathematical models and simulation results

351

#### 3.1. Thermodynamics Data

352

As explained in section 1, supercritical monophasic conditions are enforced in order to obtain a well-dried and non-cracked aerogel. In all studied experiments (Table 1), the tetralin concentration does not exceed 1% (mol). In Fig. 6, the equilibrium diagram of the CO<sub>2</sub>-tetralin binary mixture is presented at two temperatures (40°C and 71°C), between which lies the actual autoclave temperature of the drying process (45°C). The experimental bubbles and dew points were taken from the literature and were summarized in a previous work [23]. The theoretical curves were determined from a thermodynamic model detailed in the same paper. This diagram shows that the selected experimental conditions, 45°C and 180 bar with a tetralin molar fraction inferior to 0.01 (CO<sub>2</sub> molar fraction > 0.99) produce a supercritical

360



361 binary mixture. At these low tetralin concentrations, there is no risk of the appearance of a  
362 liquid-vapor equilibrium. As a result, there is no evaporation phenomenon, the resulting  
363 mixture is monophasic.  
364

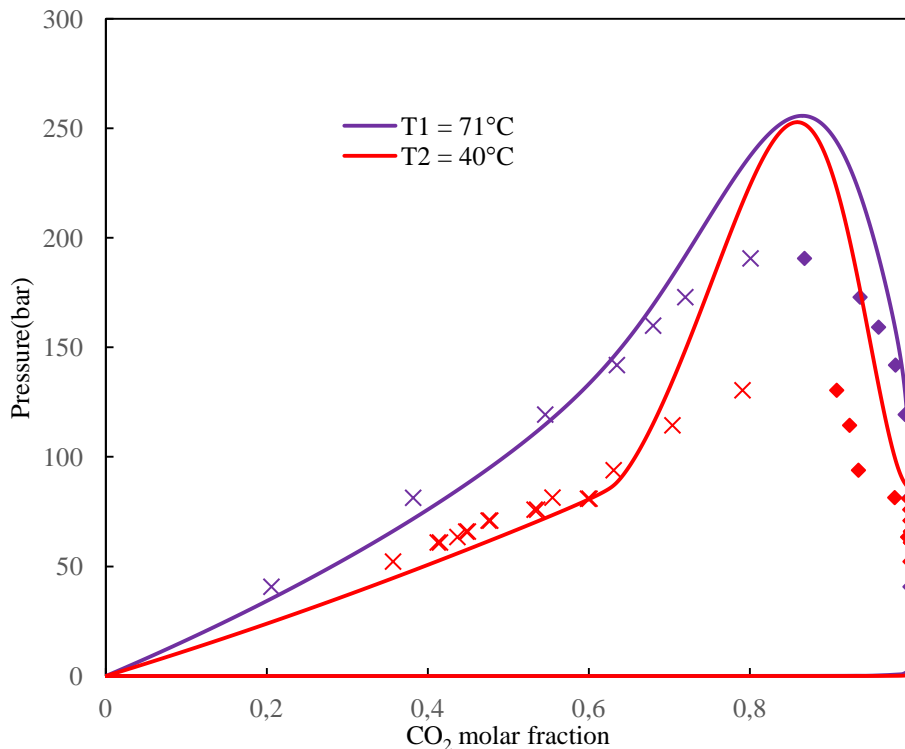

365  
366 **Fig. 6:** × experimental bubble points, ♦: experimental dew points.  
367 Solid line: predicted curves with the PPR model [23] for the system CO<sub>2</sub>-tetralin  
368 at two temperatures : 40°C and 71°C

### 369 3.2. Mathematical models

371 In this modeling study, the system is the organogel sample and the autoclave. The  
372 mathematical models are developed to describe the flow hydrodynamics of the supercritical  
373 fluid (SCCO<sub>2</sub>) in the autoclave and the mass transfer of tetralin during the organogel drying  
374 process. This model is based on equations of continuum mechanics. The system is divided  
375 into three zones: the upper autoclave volume surrounding the sample, the gel volume, and the  
376 inferior autoclave volume containing the glass beads.

377 The produced aerogels samples possess a very high porosity (void fraction) with an average  
378 value of 0.97, determined from SEM images [40]. For this reason, an important issue is  
379 discussed here, which is to investigate whether the gel sample is penetrable to the CO<sub>2</sub> flow or

380 not. Two approaches are therefore considered here. In the first approach, the organogel is  
381 assumed to be an impenetrable solid. In the second one, the organogel is regarded as  
382 penetrable. Both approaches are implemented in Computational fluid dynamics (CFD)  
383 software ANSYS Fluent.

### 384 3.2.1. Model equations

#### 385 3.2.1.1. Approach 1: Organogel sample as an impenetrable solid ( Pure 386 diffusion transfer inside the gel)

387 In this approach, the organogel is considered as an impenetrable solid meaning that the  
388 surrounding fluid cannot pass through it. The considered assumptions are as follows:

- 389 - The flow of the supercritical CO<sub>2</sub> in the free volume is considered laminar ( $Re < 60$ )  
390 and is described by Navier–Stokes equations. Due to the low velocities involved, the  
391 Mach number is inferior to 0.3 and the flow may be considered incompressible.
- 392 - The inferior volume of glass beads is described as a homogeneous porous medium and  
393 the CO<sub>2</sub> flow is governed by Darcy law.
- 394 - Tetralin mass transfer in the porous medium of the gel volume is described by Fick's  
395 diffusion equation without convective transport. An effective diffusion coefficient is  
396 considered, taking into account the porous structure of the gel.
- 397 - The system is assumed to be isothermal and isobaric, since it is the case in the  
398 experiments, which leads to a constant fluid density.

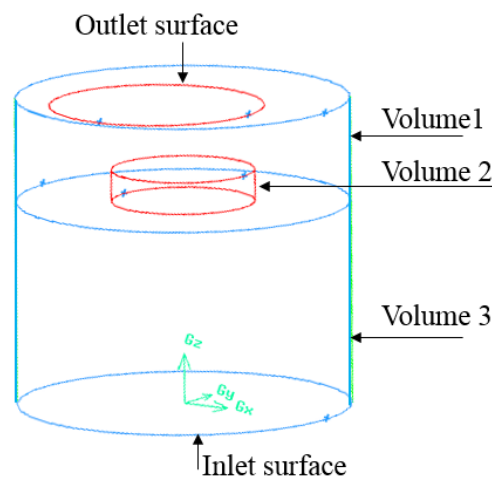

399  
400 **Fig. 7.** Sketch of the modeled flow and transport domain. Volume 1: free volume above the  
401 sample. Volume 2: organogel sample. Volume 3: Glass beads supporting the sample.

402 The equations describing the tetralin mass transfer and the hydrodynamics of CO<sub>2</sub> flow in the  
403 different autoclave sub-domains (Fig. 7), deriving from these assumptions are as follows:

404 • Model equations in Volume 1, the free upper volume of the autoclave

$$\left\{ \begin{array}{l} \mathit{div}(\mathbf{v}) = 0 \\ \rho \left( \frac{\partial \mathbf{v}}{\partial t} + \mathbf{v} \cdot \nabla \mathbf{v} \right) = -\nabla p + \mu \nabla^2 \mathbf{v} + \rho \mathbf{g} \\ \frac{\partial(\phi)}{\partial t} = \nabla \cdot (D_{AB} \nabla \phi) - \nabla \cdot (\mathbf{v}\phi) \\ \rho = \rho_{CO_2} \end{array} \right. \quad (2)$$

405 • Model equation in Volume 2, the organogel sample

$$406 \quad \frac{\partial \phi}{\partial t} = \nabla \cdot (D_{eff} \Delta \phi) \quad (3)$$

407 • Model equations in Volume 3, the bottom zone of the autoclave containing glass beads

$$408 \quad \left\{ \begin{array}{l} \mathit{div}(\mathbf{v}) = 0 \\ \nabla p = -\frac{\mu \mathbf{v}}{\alpha_b} \\ \frac{\partial(\phi)}{\partial t} = \nabla \cdot (D_{AB} \nabla \phi) - \nabla \cdot (\mathbf{v}\phi) \end{array} \right.$$

409 (4)

410 where  $\mathbf{v}$  is the CO<sub>2</sub> velocity,  $\rho_{CO_2}$  is the CO<sub>2</sub> density,  $p$  is the pressure in the autoclave,  $\mathbf{g}$  is  
411 the gravity constant,  $\phi$  is the mass fraction of tetralin and  $\mu$  is the CO<sub>2</sub> dynamic viscosity.

412 The fluid velocity at the walls is zero, i.e. no-slip boundary conditions. Tetralin flux at the  
413 walls is also set to zero. There is no tetralin in the CO<sub>2</sub> flow entering the autoclave.

414 At initial time, the CO<sub>2</sub> fluid around the gel is free of tetralin. The sample contains only  
415 tetralin with a uniform molar concentration as described in **Table 2**.

416 The permeability  $\alpha$  of the glass beads bed is estimated with Kozeny-Carman equation [41]:

$$417 \quad \alpha_b = \frac{d_b \varepsilon_b^3}{36 K_0 \tau^2 (1 - \varepsilon_b^2)} \quad (5)$$

418 where  $d_b$  is the glass beads diameter here equal to 10 mm,  $\varepsilon_b$  is the porosity of random  
419 stacking of monodisperse spheres,  $K_0 \tau^2$  is the Kozeny coefficient that is equal to 4.17,  $K_0$  is  
420 the form factor which is equal to 2 for a spherical packing yielding  $\tau^2 = 2.085$ , where  $\tau$  is the  
421 tortuosity of the glass beads bed [42–44].

422 The molecular diffusion coefficient  $D_{AB}$  is the diffusion coefficient of tetralin (A) in  
423 supercritical CO<sub>2</sub> (B). In the literature [45], this coefficient was determined at temperature and  
424 pressure conditions different from supercritical drying conditions in this process. It is equal to

424  $1.741 \times 10^{-3} \text{ cm}^2/\text{s}$  at 573 K and 8.97 MPa, and  $2.221 \times 10^{-3} \text{ cm}^2/\text{s}$  at 648 K and 8.97 MPa. The  
 425 hydrodynamic theory of Stokes-Einstein was used by Medina [46] to calculate the diffusivity  
 426 in supercritical fluids and gave acceptable agreements with experiments. This model assumes  
 427 the diffusion of large molecules of solute through a continuum of smaller molecules of  
 428 solvent which seems relevant here considering that the  $\text{CO}_2$  molecules (the solvent) are  
 429 smaller than the solute molecules (tetralin). For this reason, this model is adopted here to  
 430 estimate the diffusion coefficient  $D_{AB}$ :

$$\left\{ \begin{array}{l} D_{AB} = \frac{k T}{6\pi r_H \mu_B} \\ r_H = 3.18 \times 10^{-10} (R_A^{vdW})^{1/3} \\ R_A^{vdW} = \frac{V_{wA}}{15.17 \times 10^{-6}} \end{array} \right. \quad (6)$$

431 Where T is the temperature, k is the Boltzmann constant,  $\mu_B$  is the viscosity of the solvent,  
 432 here  $\text{CO}_2$ ,  $r_H$  is the hydrodynamic radius of solute A,  $R_A^{vdW}$  is the van der Waals volume  
 433 parameter and  $V_{wA}$  is the van der Waals volume of solute A (tetralin).

434 The organogel sample is considered as homogenous solid within which tetralin diffuses. The  
 435 free mean path of the tetralin molecules is increased since they must circumvent the gel fibers,  
 436 which contributes to slow down their motion and is taken into account in the effective  
 437 coefficient  $D_{eff}$ .

438 Several models have been established for a long time in order to predict the diffusion of  
 439 solutes in liquid fluids and supercritical fluids [46]. The determination of the diffusion  
 440 coefficient of a solute in a solid matrix such as solid polymers and gels was also addressed in  
 441 the literature in order to understand these complex systems from the point of view of mass  
 442 transfer. Different mathematical models describing the retardation of solute diffusion within  
 443 gels have been developed which were based on different theoretical approaches. A very good  
 444 overview of these different theories is given in the literature review of Amsden [47] and  
 445 Masaro *et al.* [48]. In the present paper, we are concerned by the theoretical approach of  
 446 obstruction that focuses on gels of fibrillar structure. The presence of impenetrable fibers  
 447 leads to an increase in the path length for diffusive transport. The fibers, in models based on  
 448 this theory, are assumed to be at rest and randomly embedded. In this theoretical approach,  
 449 the greatest importance is given to the structural description of the system. For this reason, the  
 450 decrease of the diffusion coefficient is correlated with the solute size and the volume fraction  
 451 of the fibers [29]. Among these models, the one proposed by Ogston [49,50] is selected to

452 predict the effective diffusivity  $D_{eff}$ , diffusion coefficient of the solvent in the supercritical  
 453 fluid through the matrix of the gel. It allows to predict the ratio  $D_{eff}/D_{AB}$  from the structural  
 454 data on the solute and the gel matrix for the fibrous medium. The Ogston model is usually  
 455 adopted for fibrous matrix and for random distribution of fibers inside the gel [49,50]. This  
 456 model describes the repartition of spaces inside a fiber suspension which structure can be  
 457 compared to that of organogels. The assumptions of this model were the following: the fibers  
 458 were considered rectilinear and the solute was considered rigid and spherical. The Ogston  
 459 model is a phenomenological approach where the solute diffusion is the result of random  
 460 successive movements. This model is chosen in this study to predict the ratio  $D_{eff}/D_{AB}$  and  
 461 the free mean path is taken as the average distance between the organogel fibers. It is  
 462 expressed in equation (7) as a function of the fiber radius ( $r_f$ ), the solute hydrodynamic radius  
 463 ( $r_H$ ) and the fiber volume fraction ( $\Phi_p$ ), which is equal to  $1 - \varepsilon$ , with  $\varepsilon$  the gel porosity.

$$\frac{D_{eff}}{D_{AB}} = \exp \left[ -\frac{r_H + r_f}{r_f} \sqrt{\Phi_p} \right] \quad (7)$$

464 The calculated effective diffusion coefficient is equal to  $4.8 \times 10^{-9} \text{ m}^2/\text{s}$  (Table 2). This value is  
 465 close to that found by fitting in the work of Garcia-Gonzalez [37] for organic aerogels which  
 466 equals to  $1 \times 10^{-9} \text{ m}^2/\text{s}$ .

### 3.2.1.2. Approach 2: Organogel sample as a penetrable solid (diffusion- convection transfer inside the gel)

469 In this approach, the organogel sample is assumed to be a penetrable solid allowing the  $\text{CO}_2$  to  
 470 flow through its pores. In this approach the free volume surrounding the gel and the glass  
 471 beads volume are treated the same manner as in the 1<sup>st</sup> approach. But the organogel sample is  
 472 treated as a volume of porous medium. The convective transport is added to molecular  
 473 diffusion in this medium. The  $\text{CO}_2$  flow is governed by Darcy law. In this approach, equation  
 474 (2) is kept for Volume 1 and equation (4) for Volume 3. But in Volume 2, the organogel  
 475 sample, equation (3) is replaced by

$$\begin{cases} \text{div}(\mathbf{v}) = 0 \\ \nabla p = -\frac{\mu \mathbf{v}}{\alpha_b} \\ \frac{\partial(\phi)}{\partial t} = \nabla \cdot (D_{AB} \nabla \phi) - \nabla(\mathbf{v}\phi) \end{cases} \quad (8)$$

478 The permeability  $\alpha$  of the fibers bed is calculated using the expression proposed by Davies  
 479 [51] :

$$\alpha = \frac{d_f^2}{64 (1 - \varepsilon)^{3/2} (1 + 56(1 - \varepsilon)^3)} \quad (9)$$

480 where  $d_f$  is the fibers diameter and  $\varepsilon$  is the organogel porosity, which are measured through  
 481 SEM images. The values of the different parameters used in these models are reported in  
 482 **Table 3**. Since the tetralin molar fractions are very low (below 0.13%), the considered density  
 483 and viscosity are those of pure CO<sub>2</sub>. Furthermore, the diffusivities were assumed to be  
 484 independent of tetralin concentration.

485 **Table 3.** Parameter values used in the simulations

Parameter	Value	Reference
$\rho$ (CO <sub>2</sub> ) (kg.m <sup>-3</sup> )	772.86	[52]
$\mu$ (CO <sub>2</sub> ) (Pa.s)	6.95×10 <sup>-5</sup>	[53]
$V_{wA}$ (cm <sup>3</sup> /s)	80.98	[54]
$r_H$ (Å)	5.49	-
$D_{AB}$ (m <sup>2</sup> /s)	6 ×10 <sup>-9</sup>	-
$d_f$ (nm)	207	[40]
$D_{eff}$ (m <sup>2</sup> /s)	4.8×10 <sup>-9</sup>	-
$\varepsilon_b$ (m <sup>2</sup> )	0.39	[55]
$\alpha_b$ (m <sup>2</sup> )	10 <sup>-7</sup>	-
$\varepsilon$	0.97	[40]
$\alpha$ (m <sup>2</sup> )	1.29×10 <sup>-13</sup>	-

486

### 3.2.2. Simulation methods

487

#### 3.2.2.1. Numerical schemes

488

489 In ANSYS-Fluent, the convective terms are discretized using the second order upwind  
 490 approach. The interpolation model is maintained for the pressure term. In order to solve the  
 491 transport equation of tetralin, the first order upwind scheme is selected.

#### 3.2.2.2. Computational mesh

492

493 The software Gambit is used to create the computational domain and the mesh shown in **Fig.**  
 494 **8**. The mesh is three-dimensional (3D). The domain is divided into three volumes:

- 495 • Volume 1, the upper free volume surrounding the sample is discretized with  
496 tetrahedral elements
- 497 • Volume 2, the organogel sample is meshed with tetrahedral elements.
- 498 • Volume 3, the lower autoclave volume that contains glass beads is discretized with  
499 hexahedral elements.

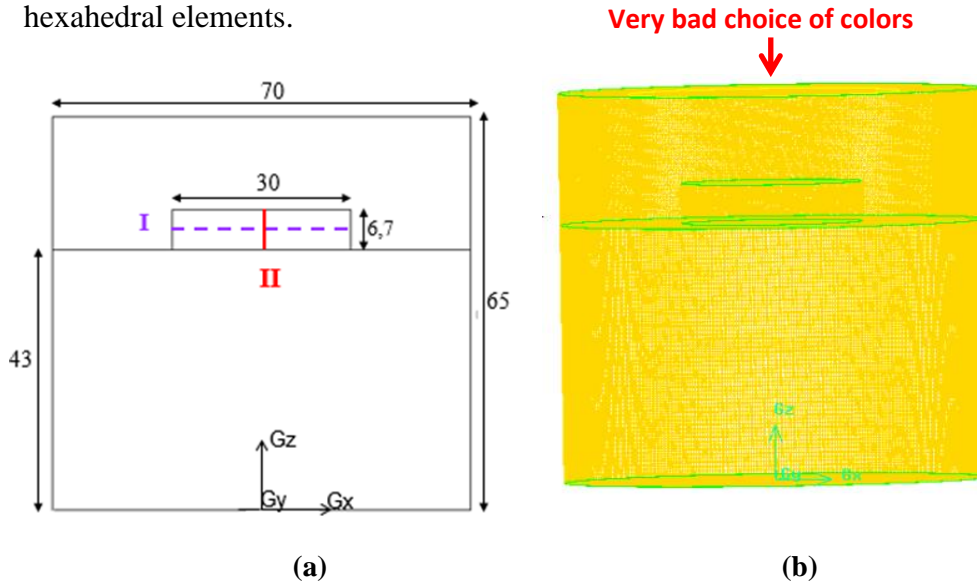

500 **Fig. 8.** (a) System dimensions (mm) and segments I and II used for plotting  
501 concentration profiles, (b) Mesh

### 502 3.2.2.3. Boundary conditions

504 The CO<sub>2</sub> velocity is imposed at the autoclave inlet and no-slip conditions are applied at the  
505 solid walls.

### 506 3.2.2.4. Mesh independence test

507 The first experiment corresponding to sample 1, of 6.7mm thickness, is chosen as a reference  
508 to build the mathematical models. The other experiments (sample 2, 3, and 4) will be  
509 compared to theory in a second step. In order to perform mesh independence tests, two  
510 meshes are created, a coarse and a refined mesh composed of 3.3 million and 6.5 million cells  
511 respectively. In **Fig.9**, tetralin mass fraction profiles in volume 2, the organogel sample, are  
512 compared for both meshes with the first approach. These profiles are plotted along two  
513 segments, I and II, indicated in **Fig. 8 (a)** and at four different times  $t=100s$ ,  $t=500s$ ,  $t=1500s$   
514 and  $t=3000s$ . As shown in **Fig.9 (a)** and **Fig.9 (b)**, the profiles for both tested meshes, coarse  
515 and refined are completely superimposed. This result proves that both meshes are sufficiently  
516 refined to ensure a mesh independent solution. The coarser mesh (3.3 million cells) is thus

517 retained for the calculations in order to reduce the computational efforts. It is noted that the  
 518 axial profiles are not symmetrical (**Fig.9** (b)) with respect to the plane  $z = e / 2$  (with  $e$  the  
 519 gel thickness) and that this asymmetry is accentuated over time. The reason is that the  
 520 convective flux leaving the gel is different on the 3 gel boundaries.

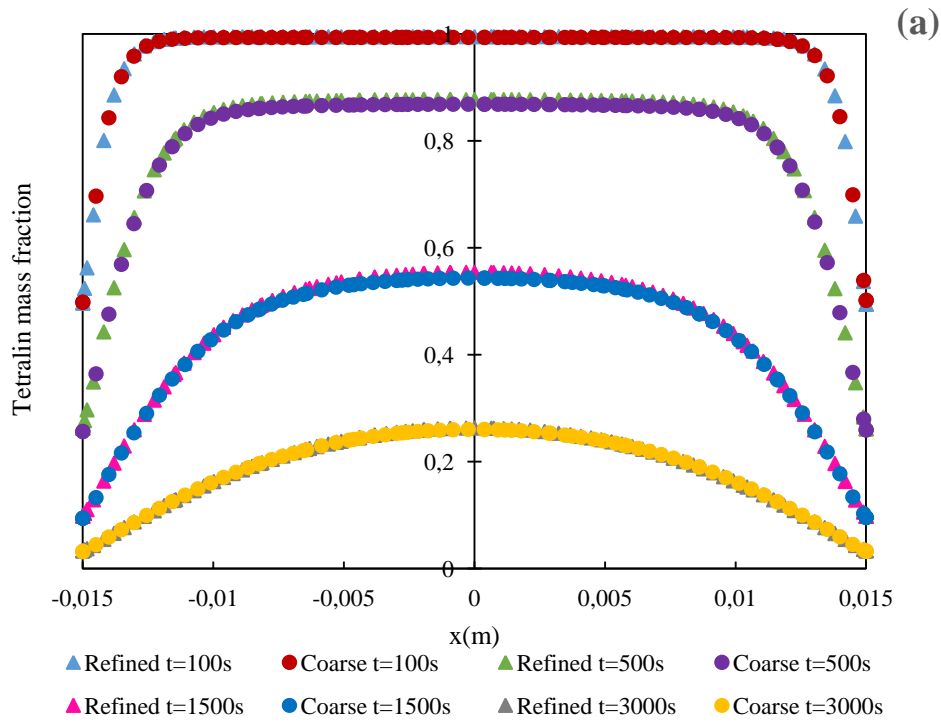

521

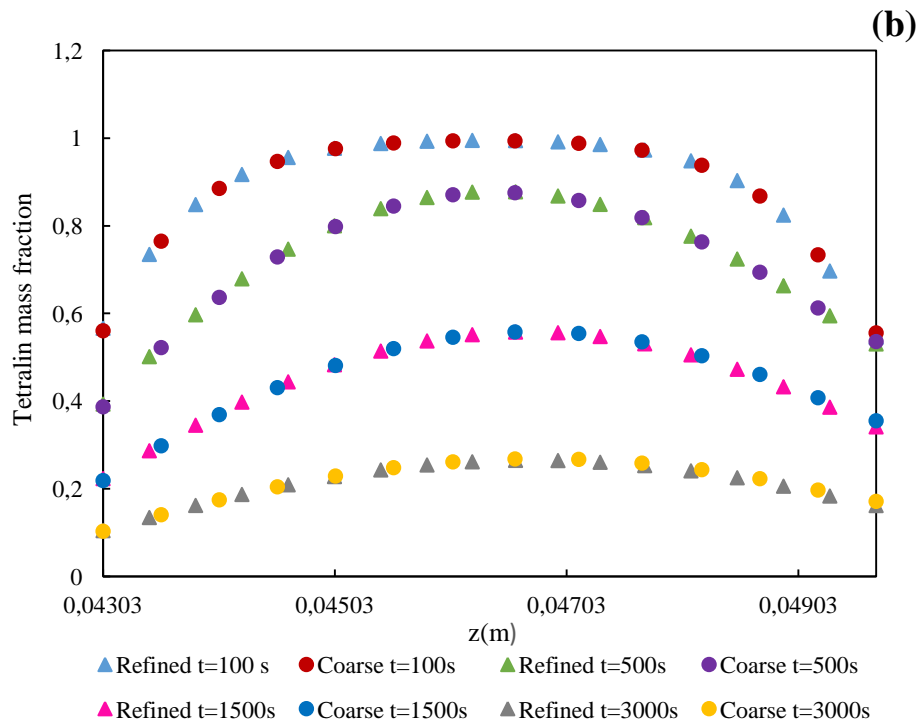

522



523 **Fig.9.** Mesh independence tests: Comparison of the tetralin mass fraction profiles in the  
524 organogel sample, obtained with the first approach for two meshes (coarse and refined).

525 (a) In the radial direction of the gel, along segment I

526 (b) in the axial direction of the gel, along segment II.

527 Segments I and II are defined in **Fig. 8.**

### 528 3.3.Supercritical drying simulation results

#### 529 3.3.1. Comparison of the models results

530 The calculations provide the tetralin mass fraction  $\phi$  inside the organogel sample as a function  
531 of time. The theoretical tetralin recovery rate (*TRR*) extracted from the pores at the drying  
532 conditions mentioned in section 2 is also predicted using the following equation

$$TRR = 1 - \frac{\iiint \rho_t \times \phi}{\text{Initial Mass of tetralin in the sample}} \quad (10)$$

533 where  $\rho_t$  is the total density and  $\phi$  is the tetralin mass fraction

534 Both simulations are carried out with a time step  $\Delta t = 50$  s which is equal approximately to a  
535 thousandth of the characteristic diffusion time computed from approach 1.

$$t_{car} = R^2/D_{eff} = 46\,875\text{ s} \quad (11)$$

536 The theoretical tetralin recovery rate is computed with the two approaches described in  
537 sections 3.1.1. In **Fig. 10**, the models results are compared to the experimental extraction  
538 profiles given in **Fig. 5**. A large amount of tetralin is collected in the initial period of the  
539 experiment. An extraction rate (amount of tetralin extracted per unit time) of 75% is reached  
540 between 25 and 30 min for all experiments, **Fig. 10(a-d)**. The extraction rate decreases with  
541 drying progress. The two theoretical drying kinetics are close but the kinetics predicted by  
542 approach 2 is closer to the experiment. The discrepancies between theory and experiment are  
543 quantified by the least square method and are equal to and 9.4% and 5.6% for approaches 1  
544 and 2 respectively, in the case of the first experiment, **Fig. 10(a)**. For the other experiments 2,  
545 3, and 4, the discrepancies between approach 2 and the experiments are equal to 16%, 19.6%  
546 and 16.6% respectively. While, the discrepancies between approach 1 and the experiments are  
547 equal to 31.1%, 34.8% and 30.1% respectively. So, the second approach can be considered  
548 the closest approach to the experimental reality. The gel appears to behave as a penetrable  
549 porous medium. The fibers are not an obstacle against the penetration of fluid. Accordingly,  
550 the fibrous matrix of the gel can be assimilated to a sieve in which the solute can diffuse  
551 freely.

552 In this fibrous organogel, it is possible that penetration velocity is not sufficient which can  
553 explain the difficulty to discriminate the drying kinetics given by both approaches. But  
554 approach 2, which considers the organogel as a penetrable solid allows to represent in a  
555 satisfactory manner all the carried out experiments. The deviations, not exceeding 20%, can  
556 be explained by the following facts:

- 557 - The CO<sub>2</sub> flow rate was not perfectly stable during the experiments while an average  
558 constant flow rate was used in the simulations.
- 559 - In the theoretical approach, the organogel is considered as a penetrable porous  
560 medium. The porosity and permeability values of each organogel sample were  
561 unknown and estimated mean values were used for all calculations and simulations.
- 562 - In the literature, experimental data corresponding to the molecular diffusion  
563 coefficient of tetralin in CO<sub>2</sub> could not be found for the actual operating conditions.  
564 The Stokes-Einstein equation used for supercritical fluids was selected to predict the  
565 binary diffusivity.

566 A parametric study on the operating conditions of the supercritical drying, like CO<sub>2</sub> flow  
567 rate and organogel thickness, is necessary to show the sensitivity of the drying kinetic  
568 with these parameters and may also allow to differentiate the approaches.

569

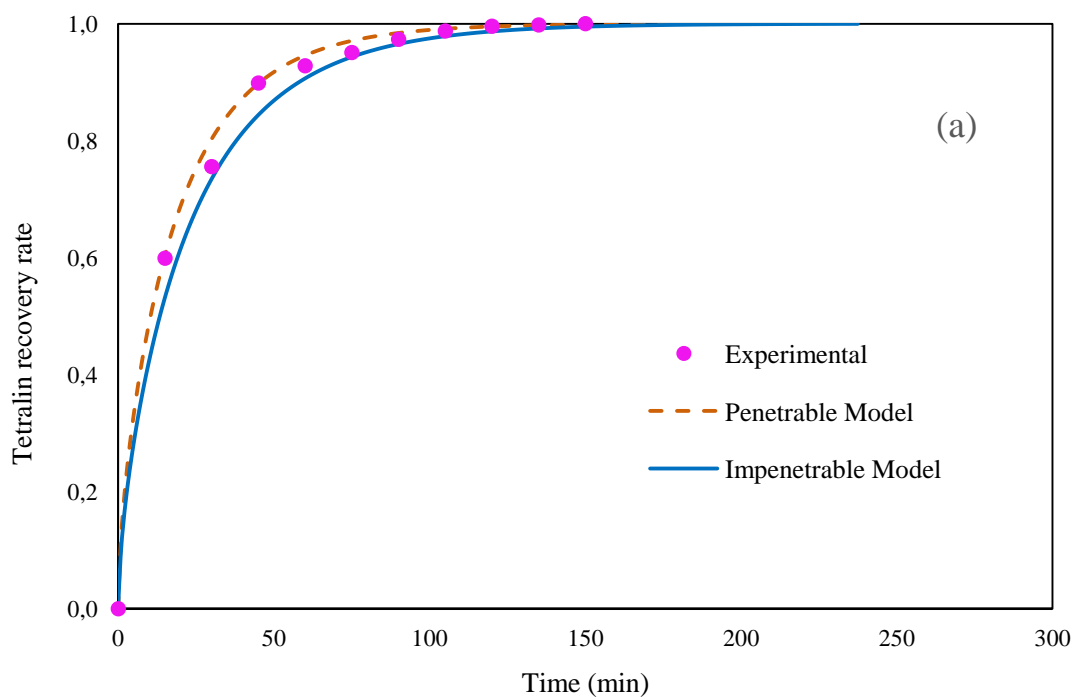

570

571

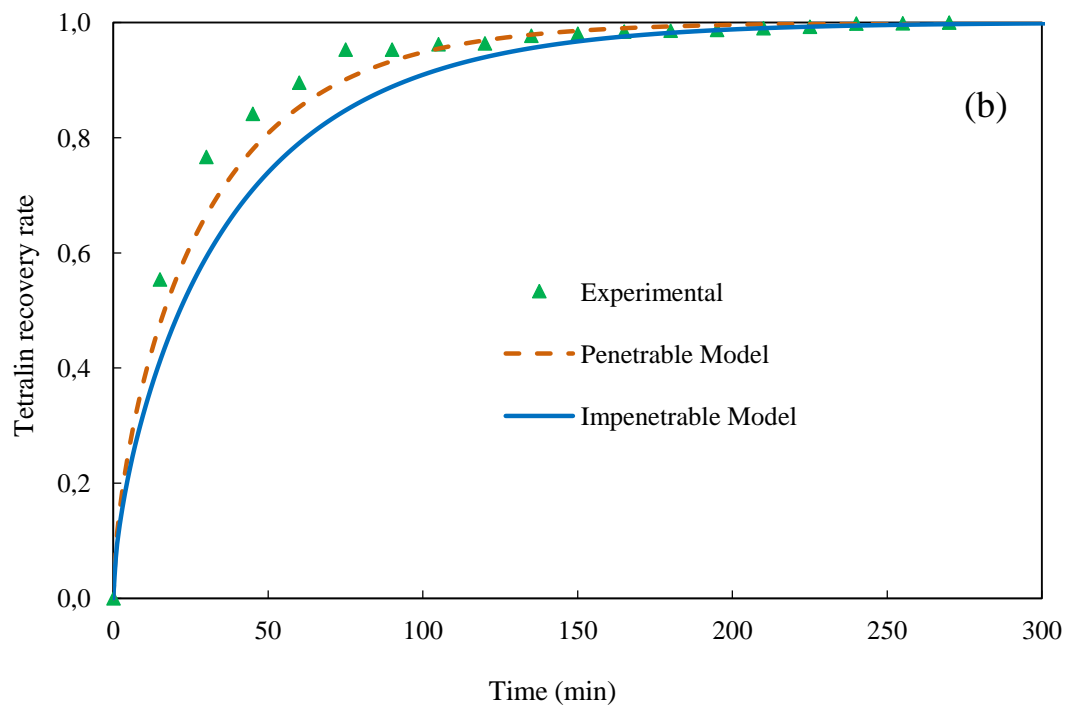

572

573

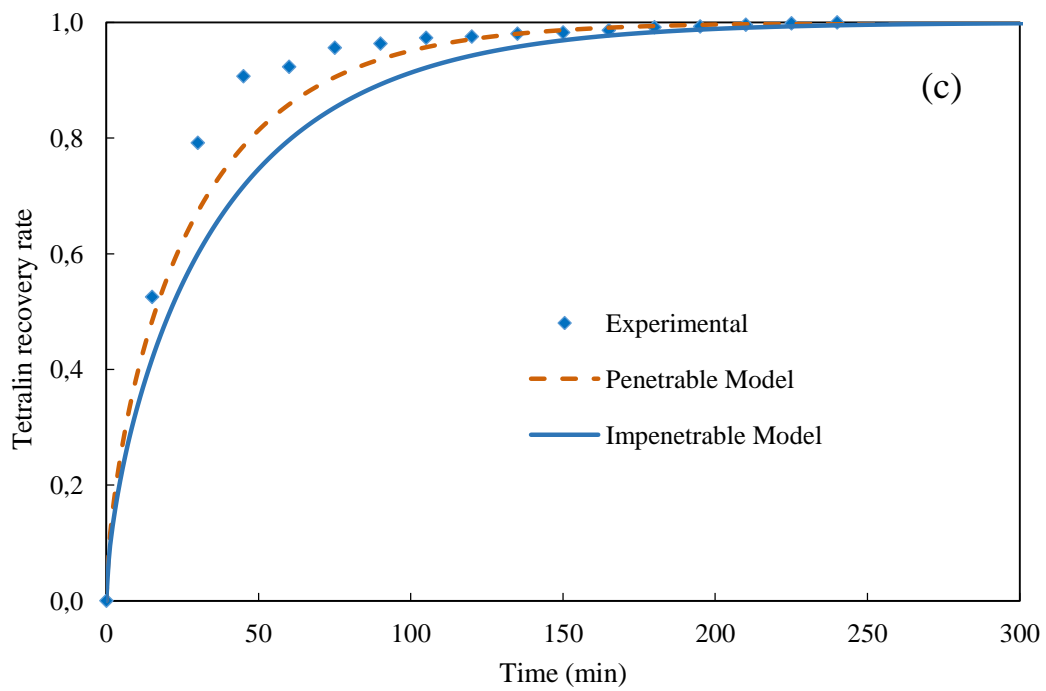

574

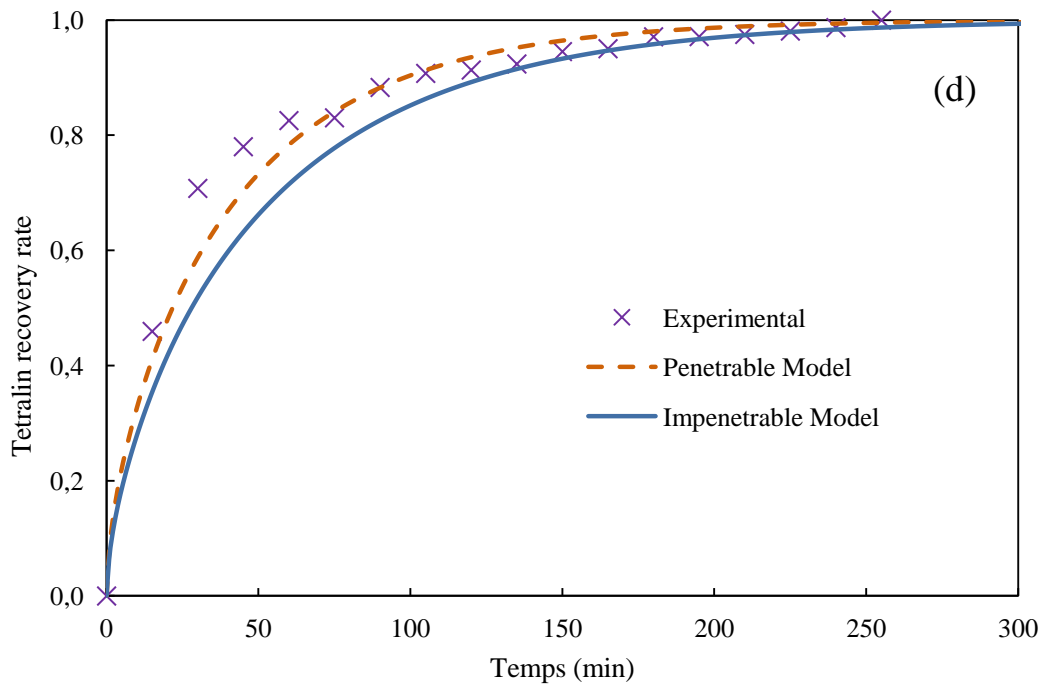

575

576 **Fig. 10.** Comparison of experimental drying kinetics to model results at 180 bar and 45°C  
 577 (approach 1: impenetrable solid, approach 2: penetrable solid)

578 (a) Experiment 1: Q=729g/h and e=6.7mm. (b) Experiment 2: Q=733g/h and e=10.5mm.

579 (c) Experiment 3:Q=820g/h and e=10.5mm. (d) Experiment 4:Q=540g/h and e=12.9mm

580

581 3.3.2. Concentration distribution of tetralin in the autoclave

582 **Fig. 11** shows the drying evolution over time. Mass fraction contours of tetralin are plotted at  
 583 different times with the second approach (penetrable gel). Areas with the highest tetralin  
 584 concentration are marked with red color, lowest with blue color. These contours show that the  
 585 tetralin concentration in the fluid surrounding the gel is close to zero  $C_{\infty} \approx 0$ . This indicates  
 586 that the tetralin extracted from the gel leaves immediately the autoclave with the fluid CO<sub>2</sub>  
 587 exiting from the extractor. A maximal concentration zone is observed in the gel center. The  
 588 organogel sample is dried progressively from the sides to the center. Over time, the zone of  
 589 high concentration is reduced and the tetralin concentration decreases in the whole gel. This  
 590 evolution is similar to that observed by Lebedev *et al.* [36] during silica gel drying. It is clear  
 591 also that the removal of the tetralin from the gel volume mainly takes place during the first 50  
 592 min of the process.

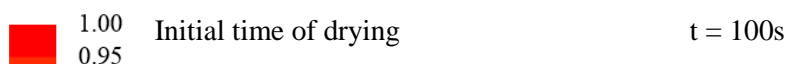

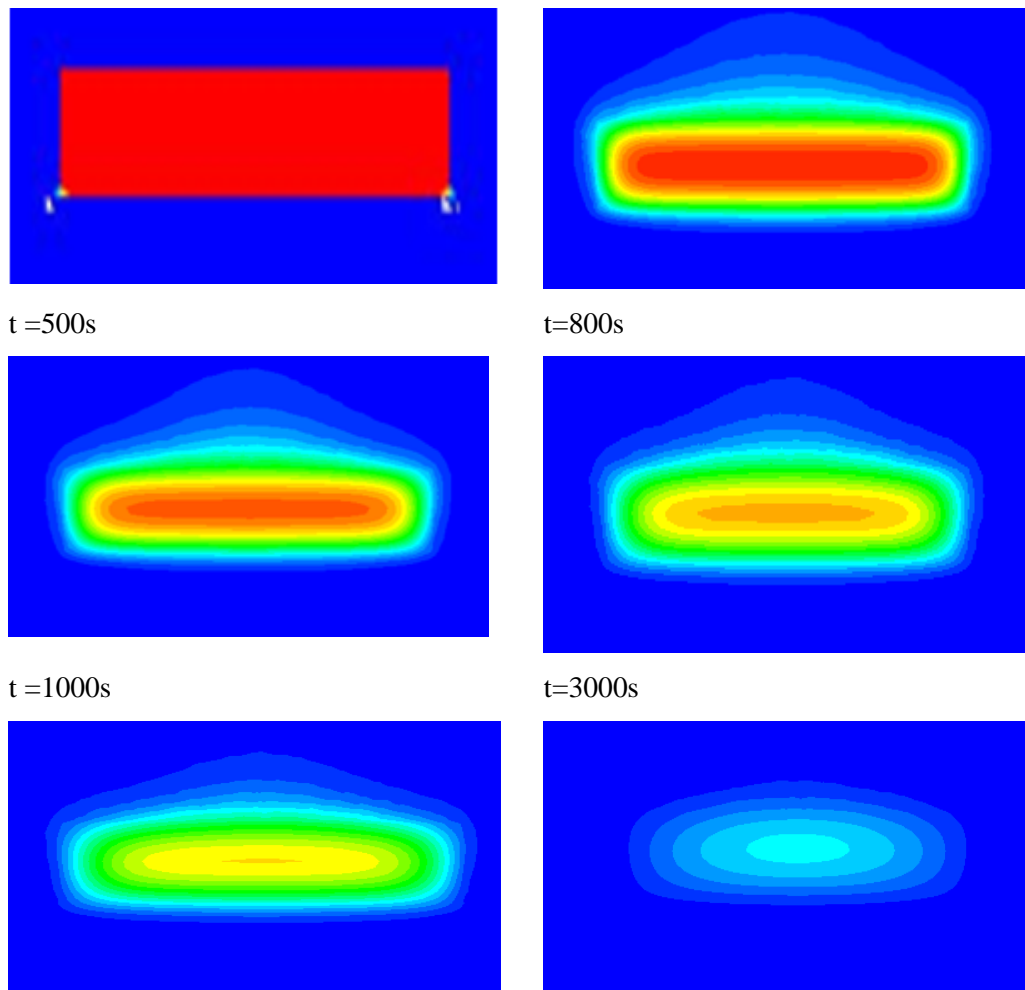

593 **Fig. 11.**Contours of tetralin mass fraction at the central section vertical to the autoclave at different  
 594 time, zoomed around the sample (experiment 1).

### 595 3.3.3. Parametric study

596 A parametric study is also performed to determine the sensitivity of the drying kinetic to  
 597 variables such as SCCO<sub>2</sub> flow rate and gel thickness [using the second approach](#).

598 The effect of SCCO<sub>2</sub> flow rate on the drying kinetics of a 6.7mm-height, 30mm-diameter  
 599 organogel sample at 45°C and 180 bar is examined using a wide range of CO<sub>2</sub> flow rate  
 600 between 100g/h and 1700 g/h, that includes the experimental flow rates. The tetralin mass  
 601 fraction in the organogel as a function of time is converted into recovery rate of removed from  
 602 the pores with drying time (Eq 10). **Fig.12** indicates how the tetralin recovery rate evolves  
 603 with time for various flow **rates**. An increasing flow rate of SCCO<sub>2</sub> leads to a decrease of the  
 604 effluent concentration and consequently to a decrease of the drying time. The different  
 605 simulations demonstrate that a significant effect is observed on drying for flow rates in the  
 606 range 100g/h and 1700g/h. A similar conclusion was also reached by a similar study by

607 Lebedev *et al.*[36] which was recently published. These results should be confirmed with  
608 experiments to conclude that for industrial scale, it is necessary to run at a high CO<sub>2</sub> flow rate  
609 in order to minimize drying time. But also, an optimal CO<sub>2</sub> flow rate should be evaluated  
610 because a very high CO<sub>2</sub> flow rate can lead to cracking of the organogel sample as it is  
611 observed experimentally.

612

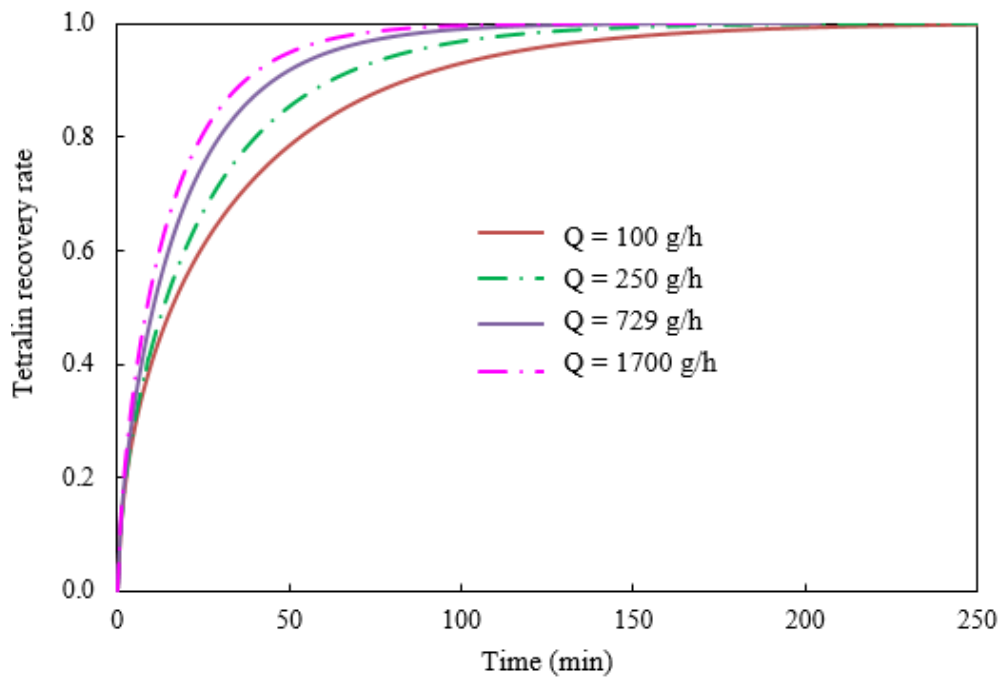

613

614 **Fig.12.** Variation of tetralin recovery rate as a function of time at varying SCCO<sub>2</sub> mass flow  
615 rate at 180 bar and 45°C, with a 30 mm sample diameter and a 6.7 mm sample height.

616

617 Organogel thickness is one of the most important parameters influencing drying time. Effect  
618 of gel thickness on drying kinetic is evaluated by performing simulations for organogel  
619 samples with 30mm diameter and with heights of 6.7 mm, 10.5 mm and 12.9 mm. The drying  
620 conditions are 45°C and 180 bar with a SCCO<sub>2</sub> flow rate of 729g/h. The simulations results  
621 are plotted in **Fig. 13**. As expected and as is concluded in a similar study [35] thicker  
622 organogel samples need longer drying times. The CO<sub>2</sub> which penetrates into the gel follows a  
623 longer path as the gel sample thickness increases. The drying time increases from 135 to 210  
624 min as the height increases from 6.7mm to 12.9 mm. Both the SCCO<sub>2</sub> flow rate and the gel  
625 thickness have important effects on the drying kinetics.

626

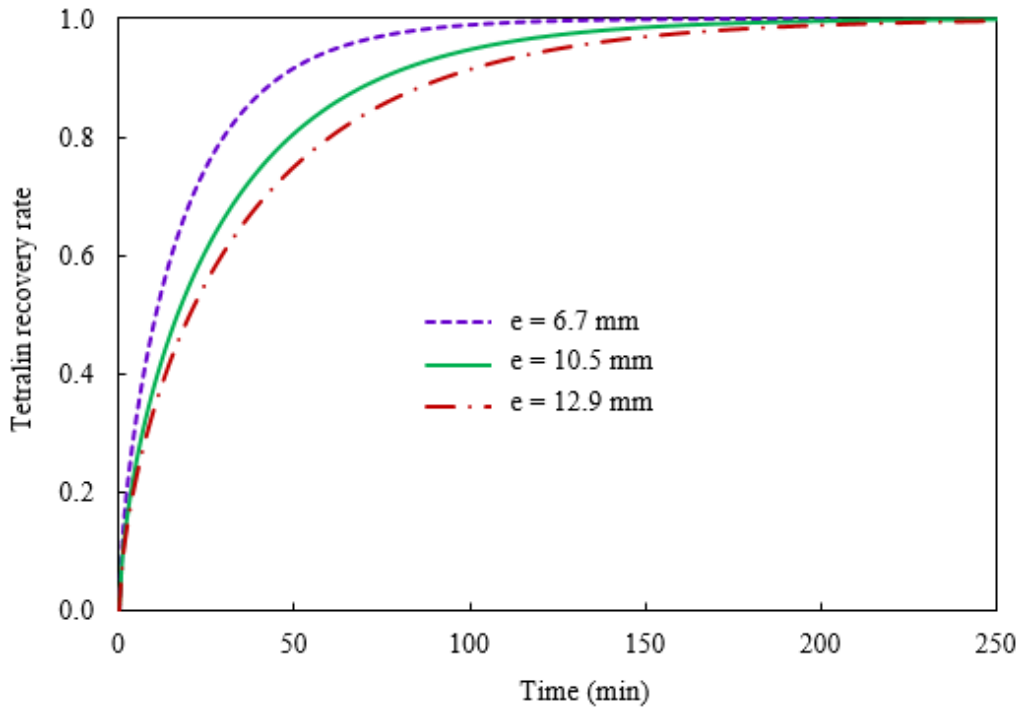

627

628 **Fig. 13.** Variation of tetralin recovery rate as a function of time at varying organogel thickness  
 629 (6.9mm, 10.5mm and 12.9mm) at 180 bar and 45°C and SC-CO<sub>2</sub> flow rate of 729 g/h

630

631 **4. Conclusion**

632 In order to investigate the supercritical drying process of organogel for aerogels production,  
 633 both experimental and theoretical studies have been carried out. The experiments have been  
 634 performed in a supercritical [pilot unit](#). Different samples of 30 mm diameter and 6.7mm to  
 635 12.9 mm thickness were dried with a supercritical CO<sub>2</sub> stream in an autoclave at 45°C and  
 636 180 bar. Based on the previsions of continuum mechanics, two mathematical models have  
 637 been established to describe the hydrodynamics of the CO<sub>2</sub> flow and mass transfer of solvent  
 638 during drying process. In a first approach, the organogel was considered as an impenetrable  
 639 sample. Mass transfer in the gel was described by Fick diffusion, with an effective diffusivity  
 640 to account for the gel porosity. In a second approach, the organogel was regarded as  
 641 penetrable by the CO<sub>2</sub> flow. In this case, convective transport occurred together with  
 642 diffusion. For both models, the molecular diffusion coefficient, the diffusivities, gel and glass  
 643 beads permeabilities were estimated from literature correlations. The numerical results,  
 644 tetralin recovery rate as function of time, of both models were compared to experimental data.  
 645 The second model, in which the gel was considered as penetrable, yielded results closer to  
 646 experiments with relative discrepancies below 20%. This showed that the approach

647 considering the organogel as a penetrable sample better represents the experimental reality.  
648 Using the second approach, many simulations were performed in order to study the effect of  
649 CO<sub>2</sub> flow rate and gel thickness, showing a significant effect of both parameters. Likewise, a  
650 parametric study with simulations on structural parameters like fibers diameters and solvent  
651 hydrodynamic radius would be interesting. It could allow to discriminate the two approaches  
652 and investigate the sensitivity of drying kinetics to these parameters.

### 653 **Acknowledgements**

654 This work was partially supported by the Institut Carnot ICEEL.

### 655 **References**

- 656 [1] A. Bisson, A. Rigacci, D. Lecomte, E. Rodier, P. Achard, Drying of Silica Gels to Obtain  
657 Aerogels: Phenomenology and Basic Techniques, *Dry. Technol.* 21 (2003) 593–628.
- 658 [2] G.W. Scherer, Freezing gels, *J. Non-Cryst. Solids.* 155 (1993) 1–25.
- 659 [3] L. Durães, M. Ochoa, N. Rocha, R. Patrício, N. Duarte, V. Redondo, A. Portugal, Effect  
660 of the Drying Conditions on the Microstructure of Silica Based Xerogels and Aerogels, *J.*  
661 *Nanosci. Nanotechnol.* 12 (2012) 6828–6834.
- 662 [4] S.S. Kistler, Coherent Expanded-Aerogels, *J. Phys. Chem.* 36 (1932) 52–64.
- 663 [5] L.F. Su, L. Miao, S. Tanemura, G. Xu, Low-cost and fast synthesis of nanoporous silica  
664 cryogels for thermal insulation applications, *Sci. Technol. Adv. Mater.* 13 (2012).
- 665 [6] B. Jamart-Grégoire, S. Son, F. Allix, V. Felix, D. Barth, Y. Jannot, G. Pickaert, A.  
666 Degiovanni, Monolithic organic aerogels derived from single amino-acid based  
667 supramolecular gels: physical and thermal properties, *RSC Adv.* 6 (2016) 102198–  
668 102205.
- 669 [7] K. Ganesan, A. Dennstedt, A. Barowski, L. Ratke, Design of aerogels, cryogels and  
670 xerogels of cellulose with hierarchical porous structures, *Mater. Des.* 92 (2016) 345–355.
- 671 [8] S. Reichelt, J. Becher, J. Weisser, A. Prager, U. Decker, S. Möller, A. Berg, M.  
672 Schnabelrauch, Biocompatible polysaccharide-based cryogels., *Mater. Sci. Eng. C Mater.*  
673 *Biol. Appl.* 35 (2014) 164–170.
- 674 [9] F. Shi, L. Wang, J. Liu, Synthesis and characterization of silica aerogels by a novel fast  
675 ambient pressure drying process, *Mater. Lett.* 60 (2006) 3718–3722.
- 676 [10] Y. Masmoudi, A. Rigacci, P. Achard, F. Cauneau, Supercritical CO<sub>2</sub> drying of silica  
677 aerogels synthesized in 2-propanol, in: 7th Ital. Conf. Supercrit. Fluids Their Appl. 9th  
678 Meet. Supercrit. Fluids, 2004: p. 12.
- 679 [11] B.M. Novak, D. Auerbach, C. Verrier, Low-Density, Mutually Interpenetrating  
680 Organic-Inorganic Composite Materials via Supercritical Drying Techniques, *Chem.*  
681 *Mater.* 6 (1994) 282–286.
- 682 [12] R. Saliger, V. Bock, R. Petricevic, T. Tillotson, S. Geis, J. Fricke, Carbon aerogels  
683 from dilute catalysis of resorcinol with formaldehyde, *J. Non-Cryst. Solids.* 221 (1997)  
684 144–150.
- 685 [13] H. Tamon, H. Ishizaka, SAXS Study on Gelation Process in Preparation of  
686 Resorcinol-Formaldehyde Aerogel, *J. Colloid Interface Sci.* 206 (1998) 577–582.
- 687 [14] S.S. Kistler, Coherent Expanded Aerogels and Jellies, *Nature.* 127 (1931) 741.
- 688 [15] V. Bock, A. Emmerling, J. Fricke, Influence of monomer and catalyst concentration  
689 on RF and carbon aerogel structure, *J. Non-Cryst. Solids.* 225 (1998) 69–73.
- 690 [16] M.H. Nguyen, L.H. Dao, Effects of processing variable on melamine–formaldehyde  
691 aerogel formation, *J. Non-Cryst. Solids.* 225 (1998) 51–57.



- 692 [17] C. Tan, B.M. Fung, J.K. Newman, C. Vu, Organic Aerogels with Very High Impact  
693 Strength, *Adv. Mater.* 13 (2001) 644–646.
- 694 [18] M. Stolarski, J. Walendziewski, M. Steininger, Barbara Pniak, Synthesis and  
695 characteristic of silica aerogels, *Appl. Catal. Gen.* 177 (1999) 139–148.
- 696 [19] A. Soleimani Dorcheh, M.H. Abbasi, Silica aerogel; synthesis, properties and  
697 characterization, *J. Mater. Process. Technol.* 199 (2008) 10–26.
- 698 [20] L.W. Hrubesh, Aerogel applications, *J. Non-Cryst. Solids.* 225 (1998) 335–342.
- 699 [21] I. Smirnova, P. Gurikov, Aerogels in Chemical Engineering: Strategies Toward Tailor-  
700 Made Aerogels, *Annu. Rev. Chem. Biomol. Eng.* 8 (2017) 307–334.
- 701 [22] N. Brosse, D. Barth, B. Jamart-Grégoire, A family of strong low-molecular-weight  
702 organogelators based on aminoacid derivatives, *Tetrahedron Lett.* 45 (2004) 9521–9524.
- 703 [23] Q.N. Pham, N. Brosse, C. Frochot, D. Dumas, A. Hocquet, B. Jamart-Grégoire,  
704 Influence of the gelator structure and solvent on the organisation and chirality of self-  
705 assembling fibrillar networks, *New J. Chem.* 32 (2008) 1131–1139.
- 706 [24] M. Yemloul, E. Steiner, A. Robert, S. Bouguet-Bonnet, F. Allix, B. Jamart-Grégoire,  
707 D. Canet, Solvent Dynamical Behavior in an Organogel Phase As Studied by NMR  
708 Relaxation and Diffusion Experiments, *J. Phys. Chem. B.* 115 (2011) 2511–2517.
- 709 [25] M.J. van Bommel, A.B. de Haan, Drying of silica aerogel with supercritical carbon  
710 dioxide, *J. Non-Cryst. Solids.* 186 (1995) 78–82.
- 711 [26] Z. Novak, Ž. Knez, Diffusion of methanol–liquid CO<sub>2</sub> and methanol–supercritical  
712 CO<sub>2</sub> in silica aerogels, *J. Non-Cryst. Solids.* 221 (1997) 163–169.
- 713 [27] P. Wawrzyniak, Diffusion of ethanol-carbon dioxide in silica gel, *J. Non Cryst. Solids.*  
714 225 (1998) 86–90.
- 715 [28] W. Behr, V.C. Behr, G. Reichenauer, Self diffusion coefficients of organic solvents  
716 and their binary mixtures with CO<sub>2</sub> in silica alcogels at pressures up to 6MPa derived by  
717 NMR pulsed gradient spin echo, *J. Supercrit. Fluids.* 106 (2015) 50–56.
- 718 [29] L.M. Sanz-Moral, M. Rueda, R. Mato, Á. Martín, View cell investigation of silica  
719 aerogels during supercritical drying: Analysis of size variation and mass transfer  
720 mechanisms, *J. Supercrit. Fluids.* 92 (2014) 24–30.
- 721 [30] J. Quiño, M. Ruehl, T. Klima, F. Ruiz, S. Will, A. Braeuer, Supercritical drying of  
722 aerogel: In situ analysis of concentration profiles inside the gel and derivation of the  
723 effective binary diffusion coefficient using Raman spectroscopy, *J. Supercrit. Fluids.* 108  
724 (2016) 1–12.
- 725 [31] J. Crank, *The mathematics of diffusion*, 2d ed, Clarendon Press, Oxford, [Eng], 1975.
- 726 [32] M. Mukhopadhyay, B.S. Rao, Modeling of supercritical drying of ethanol-soaked  
727 silica aerogels with carbon dioxide, *J. Chem. Technol. Biotechnol.* 83 (2008) 1101–1109.
- 728 [33] A.M. Orlović, S. Petrović, D.U. Skala, Mathematical modeling and simulation of gel  
729 drying with supercritical carbon dioxide, *J. Serbian Chem. Soc.* 70 (2005) 125–136.
- 730 [34] J.S. Griffin, D.H. Mills, M. Cleary, R. Nelson, V.P. Manno, M. Hodes, Continuous  
731 extraction rate measurements during supercritical CO<sub>2</sub> drying of silica alcogel, *J.*  
732 *Supercrit. Fluids.* 94 (2014) 38–47.
- 733 [35] Y. Özbakır, C. Erkey, Experimental and theoretical investigation of supercritical  
734 drying of silica alcogels, *J. Supercrit. Fluids.* 98 (2015) 153–166.
- 735 [36] A.E. Lebedev, A.M. Katalevich, N.V. Menshutina, Modeling and scale-up of  
736 supercritical fluid processes. Part I: Supercritical drying, *J. Supercrit. Fluids.* 106 (2015)  
737 122–132.
- 738 [37] C.A. García-González, M.C. Camino-Rey, M. Alnaief, C. Zetzl, I. Smirnova,  
739 Supercritical drying of aerogels using CO<sub>2</sub>: Effect of extraction time on the end material  
740 textural properties, *J. Supercrit. Fluids.* 66 (2012) 297–306.

- 741 [38] M. Lazrag, D.L. Mejia-Mendez, C. Lemaitre, P.H.E. Stafford, R. Hreiz, R. Privat, A.  
742 Hannachi, D. Barth, Thermodynamic and hydrodynamic study of a gas-liquid flow in a  
743 cyclone separator downstream supercritical drying, *J. Supercrit. Fluids.* 118 (2016) 27–38.
- 744 [39] M. Lazrag, E. Steiner, C. Lemaitre, F. Mutelet, R. Privat, S. Rode, A. Hannachi, D.  
745 Barth, Experimental and thermodynamic comparison of the separation of CO<sub>2</sub>/toluene  
746 and CO<sub>2</sub>/tetralin mixtures in the process of organogel supercritical drying for aerogels  
747 production, *J. Sol-Gel Sci. Technol.* 84 (2017) 453–465.
- 748 [40] F. Allix, Etude Physico-Chimique d'Organogels et d' Aérögels de Faible Poids  
749 Moléculaire Dérivés d'Acides Aminés, INPL-Nancy, 2011.
- 750 [41] J. Bear, Dynamics of Fluids in Porous Media, Courier Corporation, New York, 1972.
- 751 [42] R.P. Dias, C.S. Fernandes, M. Mota, J.A. Teixeira, A. Yelshin, Permeability and  
752 effective thermal conductivity of bisized porous media, *Int. J. Heat Mass Transf.* 50  
753 (2007) 1295–1301.
- 754 [43] R.P. Dias, C.S. Fernandes, J.A. Teixeira, M. Mota, A. Yelshin, Permeability analysis  
755 in bisized porous media: Wall effect between particles of different size, *J. Hydrol.* 349  
756 (2008) 470–474.
- 757 [44] M. Mota, J.A. Teixeira, W.R. Bowen, A. Yelshin, Binary spherical particle mixed  
758 beds : porosity and permeability relationship measurement, (2001).
- 759 [45] L. Zhou, C. Erkey, A. Akgerman, Catalytic oxidation of toluene and tetralin in  
760 supercritical Carbon Dioxide, *AIChE J.* 41 (1995) 2122–2130.
- 761 [46] I. Medina, Determination of diffusion coefficients for supercritical fluids, *J.*  
762 *Chromatogr. A.* 1250 (2012) 124–140.
- 763 [47] B. Amsden, Solute diffusion in hydrogels: an examination of the retardation effect,  
764 *Polym. Gels Netw.* 6 (1998) 13–43.
- 765 [48] L. Masaro, X.X. Zhu, Physical models of diffusion for polymer solutions, gels and  
766 solids, *Prog. Polym. Sci.* 24 (1999) 731–775.
- 767 [49] A.G. Ogston, B.N. Preston, J.D. Wells, On the Transport of Compact Particles  
768 Through Solutions of Chain-Polymers, *Proc. R. Soc. Math. Phys. Eng. Sci.* 333 (1973)  
769 297–316.
- 770 [50] A.G. Ogston, The spaces in a uniform random suspension of fibres, *Trans. Faraday*  
771 *Soc.* 54 (1958) 1754.
- 772 [51] R.M. Davies, G. Taylor, The Mechanics of Large Bubbles Rising through Extended  
773 Liquids and through Liquids in Tubes, *Proc. R. Soc. Lond. Math. Phys. Eng. Sci.* 200  
774 (1950) 375–390.
- 775 [52] K.M. de Reuck, B. Armstrong, International thermodynamic tables of the fluid state:  
776 carbon dioxide, Pergamon Press, Oxford; New York, 1976.
- 777 [53] A. Fenghour, W.A. Wakeham, V. Vesovic, The Viscosity of Carbon Dioxide, *J. Phys.*  
778 *Chem. Ref. Data.* 27 (1998) 31–44.
- 779 [54] A. Bondi, van der Waals volumes and radii, *J. Phys. Chem.* 68 (1964) 441–451.
- 780 [55] H. Rumpf, A.R. Gupte, The influence of porosity and grain size distribution on the  
781 permeability equation of porous flow, *Chem. Ing. Tech.* 43 (1975) 367–375.
- 782