



HAL
open science

Study and modeling of fluctuating dissolved oxygen concentration impact on *Corynebacterium glutamicum* growth in a scale-down bioreactor

Abdoul Karim Kaboré, Stéphane Delaunay, Fabrice Blanchard, Emmanuel Guedon, Michel Fick, Eric Olmos

► To cite this version:

Abdoul Karim Kaboré, Stéphane Delaunay, Fabrice Blanchard, Emmanuel Guedon, Michel Fick, et al.. Study and modeling of fluctuating dissolved oxygen concentration impact on *Corynebacterium glutamicum* growth in a scale-down bioreactor. *Process Biochemistry*, 2018, 10.1016/j.procbio.2018.10.016 . hal-01924081

HAL Id: hal-01924081

<https://hal.univ-lorraine.fr/hal-01924081>

Submitted on 21 Oct 2021

HAL is a multi-disciplinary open access archive for the deposit and dissemination of scientific research documents, whether they are published or not. The documents may come from teaching and research institutions in France or abroad, or from public or private research centers.

L'archive ouverte pluridisciplinaire **HAL**, est destinée au dépôt et à la diffusion de documents scientifiques de niveau recherche, publiés ou non, émanant des établissements d'enseignement et de recherche français ou étrangers, des laboratoires publics ou privés.



Distributed under a Creative Commons Attribution - NonCommercial 4.0 International License

Study and modeling of fluctuating dissolved oxygen
concentration impact on *Corynebacterium glutamicum*
growth in a scale-down bioreactor.

Abdoul Karim Kaboré^{a,b}, Stéphane Delaunay^{a,b}, Fabrice Blanchard^{a,b}, Emmanuel
Guedon^{a,b}, Michel Fick^{a,b}, Eric Olmos^{a,b,*}

^aCNRS, Laboratoire Réactions et Génie des Procédés, UMR 7274, 2 avenue de la forêt de Haye,
TSA 40602, Vandœuvre-lès-Nancy, F-54518, France

^bUniversité de Lorraine, LRGP, UMR 7274, 2 avenue de la forêt de Haye, TSA 40602,
Vandœuvre-lès-Nancy, F-54518, France

*Corresponding author : eric.olmos@univ-lorraine.fr

Abstract

In this study, the impact of dissolved oxygen concentrations oscillations on *Corynebacterium glutamicum* 2262 Δ ldhA growth was studied experimentally and modeled. Aiming at this, a dedicated two-compartment scale down set-up composed of two interconnected aerobic/anaerobic stirred tank bioreactors was used. The mean residence time of bacteria in each compartment was modified by adapting circulation rates and culture volumes in each bioreactor and the resulting temporal ratio of aeration was calculated. The five growth kinetics were then modeled using an original kinetic model coupling Monod growth modeling and the Residence Time Distributions. Our study showed that the microbial growth rate and macroscopic yields were clearly linked to the temporal ratio of aeration, allowing the definition of simple but robust law for process scale-up purpose. It was also revealed that the model proposed precisely agreed with the experimental growth data, whatever the fractions of aeration time imposed experimentally.

Keywords

Scale-down, kinetic model, *Corynebacterium glutamicum*

1. Introduction

Whereas the first step of process development generally consists in the research of value-added products production at the laboratory scale by selecting productive microbial strains for instance, scale-up of bioreactor is the second paramount step to allow the large-scale synthesis of the targeted molecule. However, using a constant power dissipation per unit of volume as criterion for bioreactor scale-up entails an increase of mixing times at larger scales [1], that potentially promotes concentration heterogeneities. Therefore, prediction, at lab-scale, of possible impact of concentration gradients on microbial performance is of great interest before scale-up and was the subject of major publications these last years [2, 3, 4, 5, 6]. The concentration gradients observed may concern dissolved oxygen concentrations [7, 8, 9], pH [10] or nutrients such as carbon source [11]. Among the previous parameters identified, dissolved oxygen is one of the most critical, due to heterogeneity of the oxygen injection, to spatial variation of hydrostatic pressure and thus of oxygen transfer capacities and to high oxygen consumption rates when high biomass concentrations are encountered [12]. To investigate the physiological effects of chronic exposure of microorganisms to the heterogeneous distribution of micro-environmental conditions, scale-down models were then introduced as rational and practical approaches to simulate the dynamic micro-environment (also called 'lifelines') experienced by the cells at large scale by using small-scale set-ups. In most studies, fluctuating environments are controlled by combining two or three small-scale bioreactors [2].

In this study, the behaviour of *Corynebacterium glutamicum* subjected to fluctuations of dissolved oxygen concentrations, is studied using a scale-down approach.

24 *Corynebacterium glutamicum* is a gram-positive bacterium isolated in 1950s, used for
25 the production of millions tons of amino acid per year including, glutamate, lysine,
26 valine and alanine [13, 14]. Currently, the interest for *C. glutamicum* as an efficient
27 organic acids producer under deprived oxygen conditions is increasing [15, 16]. To
28 meet the demand of bio-based products, optimized large-scale bioreactors are re-
29 quired, thus leading to the occurrence of possible spatial concentration gradients.
30 Until now, only few scale-down approaches have been carried out with *C. glutam-*
31 *icum*. Schilling et al. [17] investigated the performance of L-lysine production by *C.*
32 *glutamicum* under substrate gradients while glucose and oxygen oscillations impact
33 on *C. glutamicum* metabolism have been analyzed recently in a Continuous Stirred
34 Tank (CST) bioreactor connected to Plug Flow (PF) bioreactor [18, 19, 20] or con-
35 nected to another CST [21]. In all these works, the robustness of *C. glutamicum*
36 towards fluctuations of carbon source or oxygen concentrations was noticed. How-
37 ever, although no modification at transcriptomic, proteomic and metabolomics levels
38 was noticed [18], oscillations induced a modification in the carbon fluxes resulting
39 in an accumulation of side-products such as lactate [19, 20, 21]. These negative ef-
40 fects were increased when *C. glutamicum* was cultivated in a complex medium. In
41 this culture conditions, in a three-compartment scale-down reactor, a significative
42 decrease in the product yield, a stop of growth and an accumulation of lactate and
43 acetate were observed [20]. Otherwise, Buchholz et al. [22] focused on *C. glutamicum*
44 metabolic and transcriptional response when exposed to carbon dioxide gradients in
45 a three stirred tank compartment set-up. They reported that the dissolved [CO₂]
46 gradients expected at industry-relevant residence times, of about 3.6 min, did not

47 hamper the process performances in comparison to lab-scale reference. However,
48 transcriptional analysis have revealed up to 66 differentially expressed genes already
49 after a 3.6 min dissolved $[\text{CO}_2]$ gradient exposure ; the genes expression was also
50 related to gradient intensity and residence time of the cells. More recently, advanced
51 CFD simulations using Euler-Lagrangian approaches were performed to determine
52 the substrate concentrations encountered by cells in industrial scale bioreactors by
53 Haringa et al. [23, 24, 25]. These approaches allow the design of adapted and repre-
54 sentative scale-down set-ups. In our previous work, the variation of DOC imposed be-
55 tween fully-aerobic growth and oxygen-limited production phases was shown to play
56 an important role in the succinic acid production process [26]. Therefore, it seems
57 of great importance to also determine this impact when the bacteria are exposed
58 to chronic gradients, as encountered in large-scale bioreactors. The present work is
59 thus dedicated to the study of *C. glutamicum* response when this microorganism is
60 subjected to DOC oscillations, by using a CSTR-CSTR scale-down set-up. Whereas
61 one CSTR operate in anaerobiosis, the second one operates in fully-aerobiosis. As
62 presented by Limberg et al. [21], CST are characterized by a high back-mixing, offer-
63 ing high level of flexibility for the adjustment of mean residence time and the control
64 of DOC, temperature and pH in both compartments. However, as the Residence
65 Time Distribution (RTD) of CSTR are strongly spread around the mean residence
66 time, with a standard deviation equal to the mean residence time τ , it is necessary
67 to consider the impact of RTDs on the real DOC fluctuations imposed to the cells.
68 To manage this, our study proposes an approach that takes into account the DOC
69 fluctuations along bacteria lifelines and their impact on microbial growth, in the

70 CSTR-CSTR loop. The results of this model are then compared to the experimental
71 measurements.

72 **2. Material and methods**

73 *2.1. Bacterial strain, culture media and inoculum preparation*

74 Batch cultures of a mutant strain of *C. glutamicum* 2262, deleted for lactate dehy-
75 drogenase gene (Δ ldhA) were performed in a modified MCGC mineral salt medium
76 in which citrate was replaced by deferoxamine. This mutant strain is built using
77 the minimal genetic modification to redirect the carbon flux towards the succinate
78 production as presented in a previous paper [27]. Final concentrations of nutrients
79 and medium preparation details are provided in a previous study [26]. The mutant
80 strain was constructed via a two-step homologous recombination procedure using the
81 vector pK19mobsacB Δ ldh 34. This plasmid was constructed using the suicide vector
82 pK19mobsacB as previously described [28]. The culture medium was supplemented
83 with glucose as carbon and energy source at the desired concentration. Inoculum
84 culture is obtained from glycerol stocks used in different preculture steps in mineral
85 salts medium and described in the study of Kaboré et al. [26].

86 *2.2. Experimental set-up and culture conditions*

87 To impose oscillating dissolved oxygen concentration (DOC) to cultures of *C.*
88 *glutamicum* 2262 Δ ldhA, a scale-down bioreactor system was used. This system
89 consisted of two interconnected stirred tank bioreactors (Tryton, Pierre Guerin Tech-
90 nologies, France). One bioreactor was maintained at a constant DOC of 50 % of air
91 saturation (Bio_{O_2}) while the second was set at $\text{DOC} = 0$ % of air saturation (Bio_{N_2})

102 to mimic transition from aerobic to anaerobic environments (Figure 1). The culture
103 broth continuously looped between both vessels at given recirculation flow rates Q
104 through a low gas permeability tubing (Exacanal, 5 mm internal diameter, 2.5 m long
105 and volume $V_{tube} = 50$ mL) using two peristaltic pumps (Masterflex, Cole-Parmer,
106 Barrington IL, USA). Depending on liquid volume, each bioreactor was equipped
107 with two or three four-bladed Rushton turbines (diameter $D = 0.06$ m). DOC was
108 measured in both bioreactors using sterilizable polarographic probes (Mettler-toledo,
109 ISM technology, Switzerland). In the aerobic Bio_{O_2} bioreactor, DOC was maintained
110 constant by sparging air or pure oxygen through a ten-orifice diffuser and by adjust-
111 ing gas flow rate. Anaerobic conditions were ensured in Bio_{N_2} bioreactor by sparging
112 pure nitrogen through a porous diffuser. Liquid volumes V_1 and V_2 and residence
113 times $\tau_1 = V_1/Q$ and $\tau_2 = V_2/Q$ in aerobic and anaerobic bioreactors respectively
114 were set-up according to Table 1. Agitation rates were set to constant values of
900 rpm and 500 rpm respectively for Bio_{O_2} and Bio_{N_2} . pH was measured using
sterilizable glass electrode (Mettler-toledo, ISM technology, InPro3253, Switzerland)
and regulated in the two compartments at a set-point of 7.6 by automatic addition
of a 10 N KOH solution or 2 N HCl with a peristaltic pump connected to an on/off
pH controller. The foam formation was controlled by manual addition of drops of
pure polypropylene glycol (ppg) in both vessels with respect to final concentration
less than 1.2 mL ppg L^{-1} of broth. The temperature of cultures was maintained at
33°C by automatic cool and hot water circulation in the jacket of the bioreactors.
Biomass concentrations, glucose and organic acids concentrations were measured fol-
lowing the protocols detailed in the work of Kaboré et al. [27]. The precision of

115 biomass concentration determination was 5 % and the one of glucose and organic
 116 acid concentrations was 3 %. Three different control cultures were first performed
 117 at constant DOC. The first one, Bio_{ref1} , consisted of a culture performed using a
 118 single aerobic bioreactor and thus without medium circulation ; this experiment was
 119 identified as reference for biomass growth maximization. To assess the impact of two-
 120 compartment experimental set-up on microbial response, a second reference culture
 121 Bio_{ref2} consisting of two identical aerobic CSTRs connected by the continuous recir-
 122 culation was studied (Table 1). For the third reference culture Bio_{ref3} , two CSTRs
 123 operating in anaerobic conditions were interconnected and were considered as refer-
 124 ence cultures of *C. glutamicum* 2262 $\Delta ldhA$ regarding organic acids production. In
 125 addition to these three reference cultures, six culture conditions imposing fluctuating
 126 oxygenation conditions were defined. These experiments could be described by their
 127 mean aeration ratios and residence times :

$$\alpha \simeq \frac{\tau_1 + V_{tube}/Q}{\tau_1 + \tau_2 + 2V_{tube}/Q} \quad (1)$$

128 Lastly, to quantify the culture performance in terms of growth, uptake and pro-
 129 duction, maximal specific growth rate μ_{max} and maximal yield of biomass on glucose
 130 $Y_{max}^{X/S}$ were determined using method of Kaboré et al. [27].

131 3. Results

132 3.1. Control cultures at constant dissolved oxygen concentration

133 Kinetics of growth, consumption of glucose, production of organic acids for the
 134 anaerobic culture, pH and DOC profiles are shown in Figure 2 for the three reference

135 cultures detailed in Table 1. Biomass concentration increased exponentially until
136 exhaustion of glucose with maximal biomass concentrations of 18.2 and 19.8 g_{CDW}
137 L^{-1} , respectively obtained in one aerobic and two aerobic interconnected bioreactors
138 (Figure 2A 2B). Only minor amounts of organic acids were detected in the aerobic
139 control cultures including pyruvate, acetate with maximal concentrations of 0.4 g
140 L^{-1} approximately and succinate with a maximal concentration of 1 g L^{-1} . For the
141 anaerobic reference culture Bio_{Ref3} , a negligible growth with maximal biomass con-
142 centration of 0.7 $g_{CDW} L^{-1}$ was measured after 50 h of culture (Figure 2C). Whereas
143 for the aerobic cultures the initial amount of glucose was completely exhausted, only
144 29 mM (4.3 g L^{-1}) were consumed for the anaerobic culture (Figure 2D). In these
145 anaerobic conditions, the glucose consumed was mainly converted into organic acids.
146 After 50 h of culture also, the maximal concentrations of pyruvate, acetate and suc-
147 cinate were respectively 4.6 mM (0.4 g L^{-1}), 10.9 mM (0.7 g L^{-1}) and 14.6 mM (1.7
148 g L^{-1}) (Figure 2D). These concentrations were similar to the one measured in aero-
149 bic conditions but with 30 times less of biomass. The linearity of the organic acids
150 production kinetics seemed to indicate that this production was mainly related to
151 biomass concentration and not to specific growth rate. From the results obtained, it
152 could be concluded that (i) similar results were obtained in the two-compartment and
153 single compartment aerobic bioreactors, (ii) in fully-anaerobic cultures, no growth
154 but organic acids production was observed, (iii) in fully-aerobic culture conditions,
155 exponential growth but no significant organic acids production could be measured.

156 *3.2. Modeling of oxygen fluctuations imposed to C. glutamicum*

157 For the experiments with aeration ratios $0 < \alpha < 1$ (experiments 1 to 6 in Table 1),
158 fluctuations of DOC were imposed by continuously circulating cells from the aerobic
159 bioreactor operating at a DOC of 50 % of air saturation to the anaerobic bioreactor
160 (DOC = 0 % and N₂ sparging). Regarding bioreactors geometry, agitation and cir-
161 culation conditions, it could be assumed as a first approximation that the two mixing
162 vessels used were similar to homogeneous Continuous Stirred-Tank Reactor (CSTR)
163 vessels while connection tubes could be assumed to real plug-flow bioreactors. Using
164 a constant power number in the turbulent regime for the impeller ($N_{p0}=4$) and the
165 model proposed by Nienow [1], the mixing times in both vessels were also estimated
166 between 1 and 2 s. Thus, these values were two orders of magnitude lower than the
167 mean residence time (Table 1). Lastly, the characteristic time of oxygen consump-
168 tion from 50 to 0 % of air saturation was previously estimated at 25 s [27], which is
169 one order of magnitude higher than the mixing time. This confirms the validity of
170 bioreactor homogeneity for the set-up proposed.

171 Usually, the mean residence time is used in scale-down studies to characterize
172 the set-up and the period of dissolved oxygen (or other substrates) oscillations of
173 concentration . However, mixed bioreactors also perform a mixing of the microbial
174 populations through the residence time distributions (RTD) imposed. While in the
175 case of PF bioreactors, it could be supposed that RTD only consists in a delay
176 function, in the case of CSTR, for a mean residence time τ , the RTD $E(t)$ takes the
177 well-known following form:

$$E(t) = \frac{1}{\tau} \exp(-t/\tau) \quad (2)$$

178 Supposing that the bacteria perfectly followed the liquid flow, the succession of
179 DOC oscillations encountered was thus specific to each bacterium and related to the
180 RTD distributions in each CSTR, which indeed represented the probability for a given
181 entity to spend a time t in the bioreactor. It is thus necessary to first validate the
182 robustness of the set-up by quantifying the dispersion of the aeration ratio α around
183 its mean value given by equation (1). Aiming at this, the oscillations encountered
184 by a statistically representative population of 1,000 microbial sub-populations were
185 modeled using a dedicated Matlab script. From the oscillations profiles obtained, it
186 was then possible to calculate the dynamic fraction of time spent in aerobic conditions
187 $\beta(j,M)$ for each sub-population j after M circulations or turns inside the set-up.
188 Regarding the residence time in each connection pipe, it was considered that the
189 pipe connecting aerobic compartment to anaerobic one promoted aerobic culture
190 conditions while the other one applied anaerobic environment. Thus, the dynamic
191 ratio $\beta(j, M)$ was determined using the following expression:

$$\beta(j, M) = \frac{\sum_{i=1}^M [t_1(i, j)] + (MV_{tube})/Q}{\sum_{i=1}^M [t_1(i, j) + t_2(i, j)] + (2MV_{tube})/Q} j \in 1 \dots 1,000 \quad (3)$$

192 With $t_1(i, j)$ and $t_2(i, j)$ the times spent by each individual bacteria group j in
193 aerobic and anaerobic conditions. The values of $t_1(i, j)$ and $t_2(i, j)$ were randomly
194 determined in the distribution functions provided by equation 2 and by using the
195 dedicated function of the Statistics and Machine Learning toolbox of Matlab2018
196 software. The value of M was chosen to match the simulation time to the experi-
197 mental culture duration. The variation of β obtained for $\alpha = 0.33$ (experiment 4)
198 and $\alpha = 0.67$ (experiment 5) are given in Figure 3A-B. It can be noticed that, as ex-

199 pected each dynamic profile of aerobic fractions progressively converged to the mean
200 value α (equation 1) but also that some of the bacteria may exhibit sensibly higher
201 or lower values of aeration fraction, especially during the first hours of culture.
202 As a complementary result, the equivalent RTD of the scale-down set-up was deter-
203 mined using closed-loop equivalent model, simulated using the Simulink package of
204 Matlab software. Details of the model the model are given in Supplementary 1. At
205 time $t = 0$, a Dirac pulse of numerical tracer was injected at the inlet of compart-
206 ment 1 while its concentration was recored at the outlet of compartment 2. Each
207 CSTR compartment was modeled using a first-order model in Laplace space while
208 pipes were described by a pure delay model. Volume-averaged tracer concentration
209 $\langle c \rangle$ was also calculated. Simulation results are reported in Figure 4. Simulations 3-5
210 and 4-6, which only consisted in a permutation of compartments 1 and 2 provided
211 the same RTD distributions as compartment order has no impact on the result-
212 ing RTD. These distributions show that the number-averaged value of aeration rate
213 progressively reach the equilibrium value with a time varying from 600 s to 2000 s
214 approximately, depending on the operating conditions applied. However, it should
215 be kept in mind that, once this mean value reached, some discrepancies may still
216 exist from one sous-group to another, as indicated by results of Figure 3.

217 3.3. Cultures under oscillating DOC conditions

218 To study the impact of dissolved oxygen gradients encountered by cells in large-
219 scale bioreactors, *C. glutamicum* 2262 $\Delta ldhA$ was continuously circulated between
220 the aerobic and anaerobic compartments of the scale-down set-up. The impact of
221 DOC oscillations on microbial growth kinetics and glucose consumption were de-

222 pictured in Figure 5. When the cells were cultivated in fully aerobic conditions (ref-
223 erence culture), the maximal biomass concentration reached a value of 19 g_{CDW}
224 L^{-1} (Figure 5A). For a mean aeration fraction $\alpha = 0.67$, no significant difference
225 was observed between experiments 5 and 6 and the maximal biomass accumulated
226 was 16.3 $g_{CDW} L^{-1}$. Compared to the reference culture, circulation between aerobic
227 and anaerobic environment with this mean aeration fraction resulted in a biomass
228 concentration decrease of approximately 14 %. Similar growth were also obtained
229 comparing mean aeration fractions of $\alpha = 0.33$ (experiments 3 and 4) but, compara-
230 tively to reference culture, a decrease of 31 % in maximal biomass concentration was
231 noticed. Thus, experiments 3 to 6 seemed to indicate that, in the range of culture
232 conditions studied, increasing the residence time while maintaining mean aeration
233 fraction had no sensible influence on bacterial growth. For lowest mean aeration frac-
234 tions of $\alpha = 0.25$ and 0.2, an important decrease of maximal biomass concentration
235 was observed with a 37 % and 51 % decrease in comparison with reference culture,
236 respectively. Lastly, when *C. glutamicum* 2262 $\Delta ldhA$ was cultured in two anaer-
237 obic bioreactors ($\alpha = 0$), no sensible growth was observed, resulting in a loss of 96
238 % of the maximal biomass concentration compared to the reference culture (Figure
239 5A). Moreover, Figure 6 showed that μ_{max} increased linearly with the mean aeration
240 fraction α and varied between 0.02 h^{-1} and 0.6 h^{-1} for $\alpha = 0$ and $\alpha = 1$, respec-
241 tively. This would indicate that the apparent specific growth rate of the bacteria was
242 strongly related to mean fraction of aeration and would thus also impact the time
243 necessary to reach the maximal biomass concentration $t(X_{max})$. Indeed, the report
244 of the quantity $1/t(X_{max})$ also indicated a linear relationship between both variables

245 (Figure 6). It could be thus suggested that the aerobic oxidative metabolism of the
246 bacteria could sequentially operate, without lag phase but with a loss of productivity,
247 as indicated by the decrease of the maximal biomass concentration (Figure 5). This
248 may indicate an apparent and number-averaged metabolism able to rapidly switch
249 from aerobic to anaerobic culture conditions ; this will be further discussed in the
250 paragraph dedicated to kinetics modeling (paragraph 3.5).

251 Influence of DOC oscillations on the organic acids production by *C. glutamicum*
252 2262 $\Delta ldhA$ was also investigated. No significant concentrations of organic acids
253 were measured for aeration fraction strictly higher than 0. This could probably be
254 explained by the fact that the rapid transition from aerobic to anaerobic culture
255 conditions do not promote organic acids production, as demonstrated in a preceding
256 paper [26] but also that, faced to low glucose concentrations, *C. glutamicum* 2262
257 $\Delta ldhA$ may use organic acids as carbon source for its growth [27]. Concerning glu-
258 cose consumption and according to Figure 5B, the fastest glucose consumption was
259 obtained for the reference culture ($\alpha = Bio_{Ref1}$ and Bio_{Ref2}) with a total glucose ex-
260 haustion, which was observed within 10 hours. For the lower mean aeration ratios,
261 glucose was also totally consumed later than for the reference cultures. Indeed, in
262 the absence of aeration ($\alpha = 0$), 90 % of glucose remained in the culture (Figure
263 5B). According to substrate flux distribution, when cultivated under one aerobic or
264 two interconnected aerobic bioreactors, the carbon was thus mainly converted into
265 biomass with maximal biomass on glucose yield $Y_{X/S}$ of $0.5 \text{ g}_{CDW} \text{ g}_{glucose}^{-1}$ (Figure
266 7). This yield progressively decreased when the mean fraction of aeration also de-
267 creased. Thus, in comparison with the fully aerobic reference culture, maximal yield

268 showed a 56 % decrease in the scale-down experiment with mean aeration fraction of
 269 0.2. Indeed, this yield dropped to $0.07 \text{ g}_{CDW} \text{ g}_{glucose}^{-1}$ for the fully anaerobic culture.
 270 It could be also noted that maximal biomass concentration and maximal specific
 271 glucose consumption rate exhibited similar linear trends while, similarly to maximal
 272 specific growth rate, maximal biomass to glucose yield was not linearly linked to the
 273 mean fraction of aeration. This would thus further suggest the hypothesis of 'on/off'
 274 oxidative metabolism of *C. glutamicum* during their culture in the scale-down set-up.

275 3.4. Growth kinetic modeling using a RTD-Monod model

276 To get further insight in the microbial physiological response, it was proposed
 277 to couple the results of RTD modeling with a Monod growth kinetic model. First,
 278 Monod law was applied to model the growth of each simulated bacteria i , character-
 279 ized by their concentration X_i :

$$\frac{dX_i}{dt} = \mu_{max} \frac{[Gluc]}{[Gluc] + K_s} X_i - k_d X_i, \quad i \in \{1 \dots 1,000\} \quad (4)$$

280 A cell death rate was added in the growth kinetics to model the decrease of
 281 biomass concentration observed experimentally (Figure 5A) and the shape of growth
 282 kinetics for each mean fraction of aeration ; death kinetics of group i was thus
 283 modeled using a first-order kinetic equation $k_d X_i$. The total biomass concentration
 284 was then directly obtained by summing the concentration of each group i : $X =$
 285 $\sum_i^N X_i$. For glucose consumption, a constant biomass to glucose yield was supposed:

$$\frac{d[Gluc]}{dt} = -\frac{\mu X}{Y_{X/S}} \quad (5)$$

286 The kinetic modeling was thus based on these hypotheses.

- 287 1. Only $N=1000$ groups of bacteria were tracked inside the two bioreactors to
288 decrease calculation time. Each group thus represented an initial biomass con-
289 centration of $X_0/N \text{ g}_{CDW} \text{ L}^{-1}$.
- 290 2. Kinetic parameters, namely maximal specific growth rate μ_{max} , biomass on
291 substrate yield $Y_{X/S}$, death rate k_d and half-velocity constant K_s were main-
292 tained constant whatever the culture modeled. Whereas μ_{max} , $Y_{X/S}$ and k_d
293 were determined using kinetic data of the fully aerobic reference culture, K_s
294 was given by Seletzky [29]. The values of the kinetic parameters were given in
295 Table 2.
- 296 3. In the aerobic bioreactor, bacteria grew and consumed glucose, whatever the
297 DOC oscillations imposed before (no history effect) and following equations 4
298 and 5 . It was also assumed that transition from anaerobic to aerobic metabolism
299 was immediate.
- 300 4. In the anaerobic bioreactor, bacteria neither grew nor produced organic acids
301 nor consumed glucose and only the death rate was applied on biomass con-
302 centration. In fact, at every run, the bacteria switched promptly from aerated
303 to non-aerated zones, whereas a suitable induction of anaerobic metabolism
304 requires a progressive transition from aerobic to anaerobic [26]. Growth and
305 glucose consumption were thus supposed immediately stopped when the mi-
306 croorganisms entered the anaerobic bioreactor.

307 The results obtained by the RTD-kinetic model were given in Figure 8. It can be
308 noted that the results were in very good agreement with the experimental mea-

309 surement of biomass concentrations. In particular, the coupled RTD-growth kinetic
310 model was able to satisfactorily predict the decrease of maximal biomass concentra-
311 tion X_{max} and the increase of the time necessary to reach X_{max} when the mean
312 fraction of aeration was increased. This result confirmed the fact that, if a 'on/off'
313 metabolism was supposed for the oxidative metabolism of each bacterium, the global
314 physiological response of the whole microbial population was matching the experi-
315 mental observations. As noticed before, the operating mode of culture chosen in the
316 present paper was batch for the culture medium despite the fed-batch mode is now
317 preferred at the industrial scale. The main consequence of this choice was an earlier
318 depletion of glucose and thus of microbial growth. However, as the focus was mainly
319 put on the impact of DOC oscillations during the growth phase, this had no impact
320 on the results of the model. Furthermore the earlier death after glucose depletion
321 was taken into account in the model through the death rate k_d .

322 4. Discussion

323 This study provided new insights into growth responses of *C. glutamicum* 2262
324 $\Delta ldhA$ when subjected to quantified oscillating DOC. The comparison of reference
325 fully aerobic cultures either performed in a single aerobic compartment or two inter-
326 connected aerobic bioreactors revealed unchanged growth and metabolic responses
327 (Figure 2A-D). However, subjecting *C. glutamicum* 2262 $\Delta ldhA$ to various mean
328 aeration fractions α by continuously circulating bacterial cells between an aerobic
329 and an anaerobic bioreactor had various impacts on cell growth and organic acids
330 production. For instance, for experiments 5 and 6 ($\alpha = 0.67$), DOC oscillations with

331 residence times in the anaerobic bioreactor of 138 s and 551 s respectively (Table
332 1 and Figure 3) resulted only in a small decrease (14 %) of maximal biomass con-
333 centration and glucose uptake rate despite the bacteria were oxygenated only 67 %
334 of total culture time. Scale-down experiments using stirred tank bioreactor (STR)
335 and plug flow reactor (PFR) for the culture of *C. glutamicum* ATCC 13032 under
336 DOC oscillations with residence times in anaerobic vessel of 45 and 87 s with total
337 oxygenation ratio of 82 %, have also reported unchanged growth yields [30]. In our
338 case, the time spent in anaerobic bioreactor was sensibly higher, which could explain
339 the decrease observed. It is also interesting to notice that biomass concentration
340 decrease was also observed in scale-down systems, with anaerobic residence times of
341 the same order of magnitude, but for other microorganisms such as *Saccharomyces*
342 *cerevisiae* [31]. When the anaerobic residence time was increased to 551 s while
343 aerobic residence time was 138 s (condition $\alpha = 0.2$ in Table 1) or anaerobic resi-
344 dence of 616 s associated to aerobic residence time of 206 s (condition $\alpha = 0.25$ in
345 Table 1), detrimental consequences on microbial growth and glucose consumption
346 were observed (Figure 5). In two-compartment scale-down experiment, comparing
347 plug-flow and stirred tank characteristics, Limberg et al. [21] observed a 25 % de-
348 crease in growth rate and noted an interesting similarity between that decrease and
349 the two-compartment volume proportion. Like in our study, the reduction was ex-
350 plained by growth stop in the oxygen-deprived compartment. By simulating DOC
351 oscillations effects on *B. subtilis*, using a scale-down approach, Amanullah et al. [32]
352 reported a similar decrease in maximal biomass concentration and specific growth
353 rate when the circulation time was increased at a constant ratio of volume aerobic

354 reactor/volume anaerobic reactor. Decreasing the mean aeration ratio resulted in
355 lengthening the culture time. Similarly to our results, Oosterhuis et al. [33] reported
356 detrimental influence of oscillating DOC, not only on gluconic acid productivity but
357 also on the rate of growth of *Gluconobacter oxydans*. In our scale-down study, minor
358 quantities of organic acids were obtained when *C. glutamicum* was subjected to DOC
359 fluctuations. Indeed, in *C. glutamicum*, it is well known that the lack of oxygen and
360 nitrate as external electron acceptors in such conditions resulted in cell growth stop
361 but still in fermentation of carbohydrates into organic acids [15, 34, 35]. When *C.*
362 *glutamicum* 2262 $\Delta ldhA$ was cultured in two interconnected anaerobic bioreactors
363 ($\alpha = 0$), the concentration of organic acids was maximal although growth was al-
364 most undetectable. For the other experiments ($\alpha > 0$), organic acids were produced
365 and re-consumed as a second substrate as already reported in previous work [27] in
366 shaking flasks. Metabolization of produced organic acids have also been reported
367 in STR - PFR scale down of *C. glutamicum* ; the majority of glucose entering the
368 PFR was indeed transformed into lactate in the PFR and which was further quickly
369 metabolized once the bacteria were in the aerated STR again [30] . Through the dif-
370 ferent scale-down experiments, our results showed that decreasing the volume ratio
371 resulted in a negative impact on growth performance while fermentation products
372 accumulation were slightly enhanced but still anecdotic. Recent scale-down stud-
373 ies involving different strains of *C. glutamicum* performed in a two compartment
374 STR-PFR system, revealed no loss of process performance with DOC oscillation
375 frequencies in the minute range. Indeed, analysis of proteome, metabolome, tran-
376 scriptome indicated that no change was noted in the response to DOC oscillations.

377 Therefore, they emphasized the robustness of *C. glutamicum* in comparison to other
378 industrial microorganisms [18, 30]. This conclusion was verified in our study when
379 experiments were performed with mean aeration fractions between 0.67 and 1. For
380 these conditions, the physiological response of *C. glutamicum* was not significantly
381 different from those of fully-aerobic reference culture (Figure 5). However, when
382 mean aeration fraction were below 0.33, maximal substrate uptake rate decreased
383 from $1.3 \text{ g g}_{CDW}^{-1} \text{ h}^{-1}$ to $0.2 \text{ g g}_{CDW}^{-1} \text{ h}^{-1}$ (Figure 7) associated to bacterial growth
384 performance loss and overflow of side product increase. However, although *C. glu-*
385 *tamicum* showed robustness, Lemoine et al. [19] showed in two and three scale-down
386 that mimic substrate and oxygen gradients, alterations in extra and intra-cellular
387 metabolite concentrations. For example, lysine product yield was seen to be reduced
388 in scale-down cultivation compared to cultivations at homogeneous conditions. To
389 deepen the understanding on *C. glutamicum* performance in scale down tailoring the
390 industrial conditions, Lemoine et al. [20] applied their three-compartment system
391 with complex medium based on several carbon sources and observed drastic reduc-
392 tion of growth and volumetric product yield of a cadaverine with accumulation of
393 many short chain fatty acids. Finally, *C. glutamicum* has been demonstrated to be
394 able to switch with 100 s from aerobic respiration to fermentative pathways [36, 37]
395 ; these times were similar to the ones studied in the present work and thus confirm
396 the agreement of our results with literature data. Lastly, our study proposed an
397 original coupled RTD-growth model that considered independently 1000 microbial
398 groups based on their respective residence time in each vessel. A very good agree-
399 ment was obtained between our experimental data and model simulations results. In

400 particular, this suggested that the growth of *C. glutamicum* 2262 Δ *ldhA* observed in
401 our scale-down set-up could be modeled by considering kinetic parameters (maximal
402 specific growth rate, biomass on glucose yield) that were independent of the mean
403 aeration fraction. Thus, these parameters could be determined in aerobic culture
404 conditions and their use extended to scale-down experiments. To our knowledge,
405 growth kinetics modeling in scale-down systems, considering the RTD of the systems
406 is, to date, original in literature.

407 **5. Conclusion**

408 Using a two CSTR scale-down set-up, the impact of mean aeration fraction on
409 *C. glutamicum* 2262 Δ *ldhA* growth and organic acids production was experimentally
410 studied and modeled using a RTD-kinetic model. Our results showed that, in the
411 range of culture conditions studied, *C. glutamicum* 2262 Δ *ldhA* was strongly related
412 to the value of mean aeration fraction but that the organic acids production was non-
413 significant due to microbial reuptake. The model results were in excellent agreement
414 without kinetic parameter fitting. Indeed, it could be shown that fully aerobic kinetic
415 data could be directly transposed to oscillating DOC culture conditions.

416 **6. Acknowledgments**

417 The authors would like to thank the french ICEEL Carnot Institute for its finan-
418 cial support.

419 **Nomenclature**

Variables

DOC	Dissolved Oxygen Concentration	(% air sat.)
k_d	Death rate	(s ⁻¹)
M	Number of circulations	()
N	Agitation rate	(s ⁻¹)
Np_0	Power number	()
Q	Circulation flow rate	(m ³ s ⁻¹)
P	Power dissipation	(W)
Re	Reynolds number	()
V_1	Volume of aerobic bioreactor	(m ³)
V_2	Volume of anaerobic bioreactor	(m ³)
V_{tube}	Volume connection tube	(m ³)
420 vvm	Volume of gas per volume of liquid and per minute	(L L ⁻¹ h ⁻¹)
X_f	Fitted biomass concentration	(g _{CDW} L ⁻¹)
X	Biomass concentration	(g _{CDW} L ⁻¹)

Greek letters

α	Aeration ratio	()
β	Dynamic fraction of aeration	()
η	Dynamic viscosity	(Pa s)
ρ	Density	(kg m ⁻³)
μ	Specific growth rate	(h ⁻¹)
τ_1	Mean residence time in compartment 1	(s)
τ_2	Mean residence time 22 compartment 2	(s)

422 **References**

- 423 [1] A. Nienow, On impeller circulation and mixing effectiveness in the turbulent
424 flow regime, *Chemical Engineering Science* 52 (1997) 2557–2565.
- 425 [2] A. R. Lara, E. Galindo, O. T. Ramírez, L. A. Palomares, Living with hetero-
426 geneities in bioreactors, *Molecular Biotechnology* 34 (2006) 355–381.
- 427 [3] A. Sweere, K. C. A. Luyben, N. Kossen, Regime analysis and scale-down: tools
428 to investigate the performance of bioreactors, *Enzyme and Microbial Technology*
429 9 (1987) 386–398.
- 430 [4] P. K. Namdev, N. Irwin, B. Thompson, M. R. Gray, Effect of oxygen fluctuations
431 on recombinant *Escherichia coli* fermentation, *Biotechnology and Bioengineer-
432 ing* 41 (1993) 666–670.
- 433 [5] F. Bylund, F. Guillard, S.-O. Enfors, C. Trägårdh, G. Larsson, Scale down of
434 recombinant protein production: a comparative study of scaling performance,
435 *Bioprocess and Biosystems Engineering* 20 (1999) 377–389.
- 436 [6] C. J. Hewitt, N.-V. Caron, B. Axelsson, C. M. McFarlane, A. W. Nienow,
437 et al., Studies related to the scale-up of high-cell-density *Escherichia coli* fed-
438 batch fermentations using multiparameter flow cytometry: Effect of a changing
439 microenvironment with respect to glucose and dissolved oxygen concentration,
440 *Biotechnology and Bioengineering* 70 (2000) 381–390.
- 441 [7] N. Oosterhuis, N. Kossen, Dissolved oxygen concentration profiles in a

- 442 production-scale bioreactor, *Biotechnology and Bioengineering* 26 (1984) 546–
443 550.
- 444 [8] E. A. Sandoval-Basurto, G. Gosset, F. Bolívar, O. T. Ramírez, Culture of *Es-*
445 *cherichia coli* under dissolved oxygen gradients simulated in a two-compartment
446 scale-down system: Metabolic response and production of recombinant protein,
447 *Biotechnology and Bioengineering* 89 (2005) 453–463.
- 448 [9] A. R. Lara, L. Leal, N. Flores, G. Gosset, F. Bolívar, O. T. Ramírez, Tran-
449 scriptional and metabolic response of recombinant *Escherichia coli* to spatial
450 dissolved oxygen tension gradients simulated in a scale-down system, *Biotech-*
451 *nology and Bioengineering* 93 (2006) 372–385.
- 452 [10] C. Langheinrich, A. W. Nienow, et al., Control of pH in large-scale, free suspen-
453 sion animal cell bioreactors: alkali addition and pH excursions, *Biotechnology*
454 *and Bioengineering* 66 (1999) 171–179.
- 455 [11] F. Bylund, E. Collet, S.-O. Enfors, G. Larsson, Substrate gradient formation in
456 the large-scale bioreactor lowers cell yield and increases by-product formation,
457 *Bioprocess Engineering* 18 (1998) 171–180.
- 458 [12] J. Bryant, The characterization of mixing in fermenters, *Advances in Biochem-*
459 *ical Engineering* 5 (1977) 101–123.
- 460 [13] L. Eggeling, H. Sahm, L-glutamate and l-lysine: traditional products with
461 impetuous developments, *Applied Microbiology and Biotechnology* 52 (1999)
462 146–153.

- 463 [14] T. Hermann, Industrial production of amino acids by coryneform bacteria,
464 Journal of Biotechnology 104 (2003) 155–172.
- 465 [15] M. Inui, S. Murakami, S. Okino, H. Kawaguchi, A. A. Vertès, H. Yukawa,
466 Metabolic analysis of *Corynebacterium glutamicum* during lactate and succi-
467 nate productions under oxygen deprivation conditions, Journal of Molecular
468 Microbiology and Biotechnology 7 (2004) 182–196.
- 469 [16] B. Litsanov, M. Brocker, M. Bott, Toward homosuccinate fermentation:
470 metabolic engineering of *Corynebacterium glutamicum* for anaerobic production
471 of succinate from glucose and formate, Applied and Environmental Microbiology
472 78 (2012) 3325–3337.
- 473 [17] B. Schilling, W. Pfefferle, B. Bachmann, W. Leuchtenberger, W.-D. Deckwer, A
474 special reactor design for investigations of mixing time effects in a scaled-down
475 industrial l-lysine fed-batch fermentation process, Biotechnology and bioengi-
476 neering 64 (1999) 599–606.
- 477 [18] F. Käß, I. Hariskos, A. Michel, H.-J. Brandt, R. Spann, S. Junne, W. Wiechert,
478 P. Neubauer, M. Oldiges, Assessment of robustness against dissolved oxy-
479 gen/substrate oscillations for *Corynebacterium glutamicum* dm1933 in two-
480 compartment bioreactor, Bioprocess and Biosystems Engineering 37 (2014)
481 1151–1162.
- 482 [19] A. Lemoine, N. Maya Martinez-Iturralde, R. Spann, P. Neubauer, S. Junne, Re-
483 sponse of *Corynebacterium glutamicum* exposed to oscillating cultivation condi-

- 484 tions in a two-and a novel three-compartment scale-down bioreactor, *Biotech-*
485 *nology and Bioengineering* 112 (2015) 1220–1231.
- 486 [20] A. Lemoine, M. H. Limberg, S. Kästner, M. Oldiges, P. Neubauer, S. Junne,
487 Performance loss of *Corynebacterium glutamicum* cultivations under scale-down
488 conditions using complex media, *Engineering in Life Sciences* 16 (2016) 620–632.
- 489 [21] M. H. Limberg, V. Pooth, W. Wiechert, M. Oldiges, Plug flow versus stirred
490 tank reactor flow characteristics in two-compartment scale-down bioreactor:
491 Setup-specific influence on the metabolic phenotype and bioprocess performance
492 of *corynebacterium glutamicum*, *Engineering in Life Sciences* 16 (2016) 610–619.
- 493 [22] J. Buchholz, M. Graf, A. Freund, T. Busche, J. Kalinowski, B. Blombach,
494 R. Takors, $\text{CO}_2/\text{HCO}_3^-$ perturbations of simulated large scale gradients in a
495 scale-down device cause fast transcriptional responses in *Corynebacterium glu-*
496 *tamicum*, *Applied Microbiology and Biotechnology* 98 (2014) 8563–8572.
- 497 [23] C. Haringa, W. Tang, A. T. Deshmukh, J. Xia, M. Reuss, J. J. Heijnen, R. F.
498 Mudde, H. J. Noorman, Euler-lagrange computational fluid dynamics for (bio)
499 reactor scale down: an analysis of organism lifelines, *Engineering in life sciences*
500 16 (2016) 652–663.
- 501 [24] C. Haringa, A. T. Deshmukh, R. F. Mudde, H. J. Noorman, Euler-lagrange
502 analysis towards representative down-scaling of a 22 m³ aerobic *s. cerevisiae*
503 fermentation, *Chemical Engineering Science* 170 (2017) 653–669.
- 504 [25] C. Haringa, H. J. Noorman, R. F. Mudde, Lagrangian modeling of

- 505 hydrodynamic–kinetic interactions in (bio) chemical reactors: practical imple-
506 mentation and setup guidelines, *Chemical Engineering Science* 157 (2017) 159–
507 168.
- 508 [26] A.-K. Kaboré, E. Olmos, M. Fick, F. Blanchard, E. Guedon, S. Delaunay,
509 Aerobiosis–anaerobiosis transition has a significant impact on organic acid pro-
510 duction by *Corynebacterium glutamicum*, *Process Biochemistry* 52 (2017) 10–21.
- 511 [27] A. K. Kaboré, E. Olmos, F. Blanchard, M. Fick, S. Delaunay, E. Guedon, Impact
512 of gas–liquid mass transfer on organic acids production by *Corynebacterium*
513 *glutamicum* in unbaffled shake flasks, *Biochemical Engineering Journal* 101
514 (2015) 237–247.
- 515 [28] A. Schäfer, A. Tauch, W. Jäger, J. Kalinowski, G. Thierbach, A. Pühler, Small
516 mobilizable multi-purpose cloning vectors derived from the *Escherichia coli*
517 plasmids pk18 and pk19: selection of defined deletions in the chromosome of
518 *Corynebacterium glutamicum*, *Gene* 145 (1994) 69–73.
- 519 [29] J. M. Seletzky, U. Noak, J. Fricke, E. Welk, W. Eberhard, C. Knocke, J. Büchs,
520 Scale-up from shake flasks to fermenters in batch and continuous mode with
521 *Corynebacterium glutamicum* on lactic acid based on oxygen transfer and ph,
522 *Biotechnology and Bioengineering* 98 (2007) 800–811.
- 523 [30] F. Käß, S. Junne, P. Neubauer, W. Wiechert, M. Oldiges, Process inhom-
524 geneity leads to rapid side product turnover in cultivation of *Corynebacterium*
525 *glutamicum*, *Microbial Cell Factories* 13 (2014b) 6.

- 526 [31] S. George, G. Larsson, S.-O. Enfors, A scale-down two-compartment reactor
527 with controlled substrate oscillations: metabolic response of *Saccharomyces cere-*
528 *visiae*, *Bioprocess and Biosystems Engineering* 9 (1993) 249–257.
- 529 [32] A. Amanullah, B. C. Buckland, A. W. Nienow, *Mixing in the fermentation and*
530 *cell culture industries*, Wiley Online Library, 2004.
- 531 [33] N. Oosterhuis, N. Kossen, A. Olivier, E. Schenk, Scale-down and optimization
532 studies of the gluconic acid fermentation by *Gluconobacter oxydans*, *Biotech-*
533 *nology and Bioengineering* 27 (1985) 711–720.
- 534 [34] H. B. T. Khuat, A. K. Kabore, E. Olmos, M. Fick, J. Boudrant, J.-L. Goergen,
535 S. Delaunay, E. Guedon, Lactate production as representative of the fermen-
536 tation potential of *Corynebacterium glutamicum* 2262 in a one-step process,
537 *Bioscience, Biotechnology and Biochemistry* 78 (2014) 343–349.
- 538 [35] H. Dominguez, C. Nezondet, N. Lindley, M. Coccagn, Modified carbon flux dur-
539 ing oxygen limited growth of *Corynebacterium glutamicum* and the consequences
540 for amino acid overproduction, *Biotechnology Letters* 15 (1993) 449–454.
- 541 [36] S. Okino, M. Inui, H. Yukawa, Production of organic acids by *Corynebacterium*
542 *glutamicum* under oxygen deprivation, *Applied Microbiology and Biotechnology*
543 68 (2005) 475–480.
- 544 [37] S. Yamamoto, M. Sakai, M. Inui, H. Yukawa, Diversity of metabolic shift in
545 response to oxygen deprivation in *Corynebacterium glutamicum* and its close
546 relatives, *Applied Microbiology and Biotechnology* 90 (2011) 1051–1061.

547 **Table legends**

548 **Table 1.** Scale-down culture conditions.

549 **Table 2.** Values of the optimized parameters for kinetic modeling.

Table 1

Table 1: Scale-down culture conditions.

Experiment	α	Compartment 1				Compartment 2			
		Q (mL/s)	V_1 (L)	τ_1 (s)	DOC ¹ (% air sat.)	V_2 (L)	τ_2 (s)	DOC ² (% air sat)	
reference Bio _{ref1}	1 ⁽⁴⁾	n/a	1.5	n/a	50	n/a	n/a	n/a	
reference Bio _{ref2}	1 ⁽³⁾	7.3	1.5	205	50	1.5	205	50	
reference Bio _{ref3}	0	7.3	1.5	205	0 ⁽¹⁾	1.5	205	0	
1	0.2	7.3	1	137	50	4	548	0	
2	0.25	7.3	1.5	205	50	4.5	616	0	
3	0.33	7.3	1	137	50	2	274	0	
4	0.33	1.8	1	556	50	2	1111	0	
5	0.67	7.3	2	274	50	1	137	0	
6	0.67	1.8	2	1111	50	1	556	0	

(1) In this case, once the oxygen probe was calibrated, the culture was started without air/oxygen sparging nor nitrogen sparging whereas the Bio_{N₂} compartment was sparged continuously with nitrogen.

(2) Nitrogen was sparged continuously to warrant anaerobic conditions.

(3) Corresponded to two aerobic bioreactors interconnected.

(4) Corresponded to a single anaerobic bioreactor.

Table 2

Table 2: Values of the optimized parameters for kinetic modeling

Parameter	μ_{max} (h^{-1})	$Y_{X/S}$ (g g_{CDW}^{-1})	K_s (g L^{-1})	k_d (h^{-1})
Value	0.55*	0.4*	0.0045**	0.0005*

(*) Parameters determined using the fully aerobic reference culture Bio_{Ref1} .

(**) Value given by [29].

553 **Figure legends**

554 **Figure 1.** Experimental set-up.

555

556 **Figure 2.** Reference culture kinetics of *C. glutamicum* 2262 $\Delta ldhA$ under con-
557 stant dissolved oxygen concentration. Temporal profiles of biomass concentration
558 and glucose concentrations in a single bioreactor with constant dissolved oxygen
559 concentration of 50 % of air saturation (A) and in two interconnected stirred tank
560 bioreactors with constant dissolved oxygen concentration of 50 % of air saturation
561 (B). Temporal profiles of biomass concentration and glucose concentration (C) and
562 organic acids concentration (D) in two interconnected stirred anaerobic bioreactors.
563 The different symbols represent: glucose (\square), biomass (\bullet), succinate ($*$), acetate (\blacktriangleleft),
564 pyruvate (\blacklozenge).

565

566 **Figure 3.** Variation of the dynamic fraction of aeration β for 10,000 bacteria in
567 function of time for mean aeration fractions $\alpha=0.33$ (A) and $\alpha=0.67$ (B).

568

569 **Figure 4.** Modeled Residence Time Distribution in the scale-down set-up normal-
570 ized by volume-averaged tracer concentration $\langle c \rangle$. Operating conditions as given by
571 Table 1 were experiment 1, (\cdots), experiment 2 ($\cdot - \cdot - \cdot$), experiment 3 and 5 ($- - -$),
572 experiments 4 and 6 ($-$).

573

574 **Figure 5.** Influence of dissolved oxygen oscillation on *C. glutamicum* 2262 $\Delta ldhA$
575 growth and substrate consumption during a scale-down cultures. (A). Growth kinet-

576 ics; (B). Glucose uptake profiles. The mean aerobic fractions α are: 0 (\times), 0.2 (*),
577 0.25 (\blacktriangleright), 0.33 - experiment 3 (\blacklozenge), 0.33 - experiment 4 (\diamond), 0.67 - experiment 5 (\blacksquare),
578 0.67 - experiment (\square) 0.67, 1a (\bullet), 1b (\circ).

579

580 **Figure 6.** Relationship between mean fraction of aeration α , $1/t(X_{max})$ (\square) and
581 maximal specific growth rate μ_{max} (Δ).

582

583 **Figure 7.** Relationship between mean fraction of aeration α , maximal biomass
584 concentration X_{max} (\square), maximal specific glucose consumption rate (\circ) and maxi-
585 mal biomass on glucose yield $Y_{X/S}$ (Δ).

586

587 **Figure 8.** Comparison of experimental and modeled growth kinetics and impact
588 of DOC oscillations. Dots are experimental values while continuous lines are mod-
589 eled kinetics. Mean aerobic fractions α are 0.2 (\square , - $\bullet\bullet$ -), 0.25 (\diamond , - - -), 0.33 -
590 experiment 3 (Δ , - \bullet -), 0.67 - experiment 5 (*, $\bullet\bullet\bullet$), 1 (+, -).

591 **Figures**

592 **Figure 1**

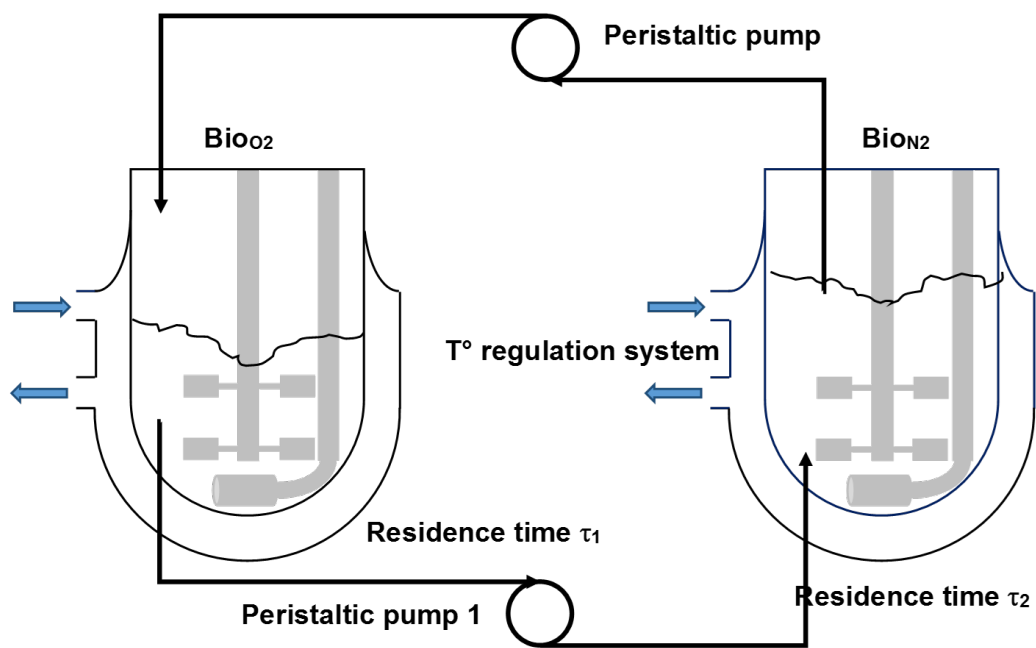

Figure 1: Experimental set-up

593

Figure 2

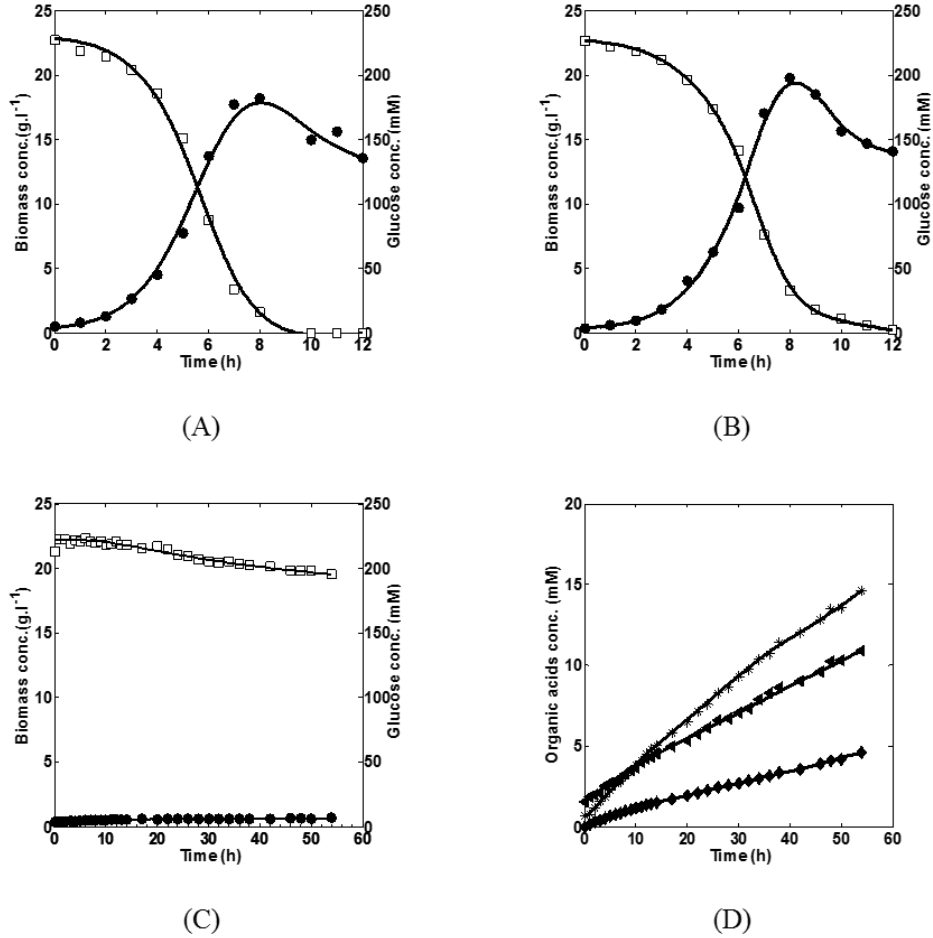

Figure 2: Reference culture kinetics of *C. glutamicum* 2262 ΔldhA under constant dissolved oxygen concentration. Temporal profiles of biomass concentration and glucose concentrations in a single bioreactor with constant dissolved oxygen concentration of 50 % of air saturation (A) and in two interconnected stirred tank bioreactors with constant dissolved oxygen concentration of 50 % of air saturation (B). Temporal profiles of biomass concentration and glucose concentration (C) and organic acids concentration (D) in two interconnected stirred anaerobic bioreactors. The different symbols represent: glucose (□), biomass (●), succinate (*), acetate (◄), pyruvate (◆).

Figure 3

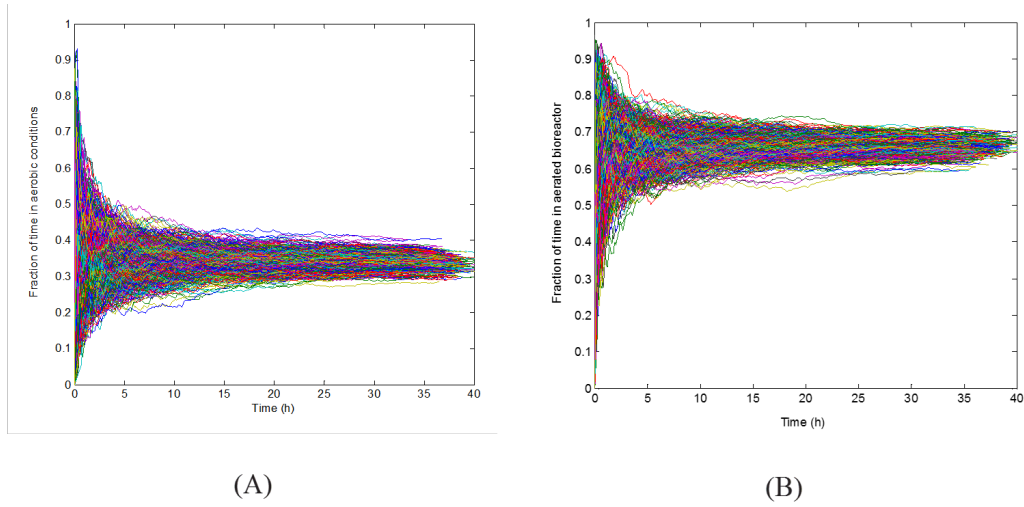

Figure 3: Variation of the dynamic fraction of aeration β for 10,000 bacteria in function of time for mean aeration fractions $\alpha=0.33$ (A) and $\alpha=0.67$ (B).

Figure 4

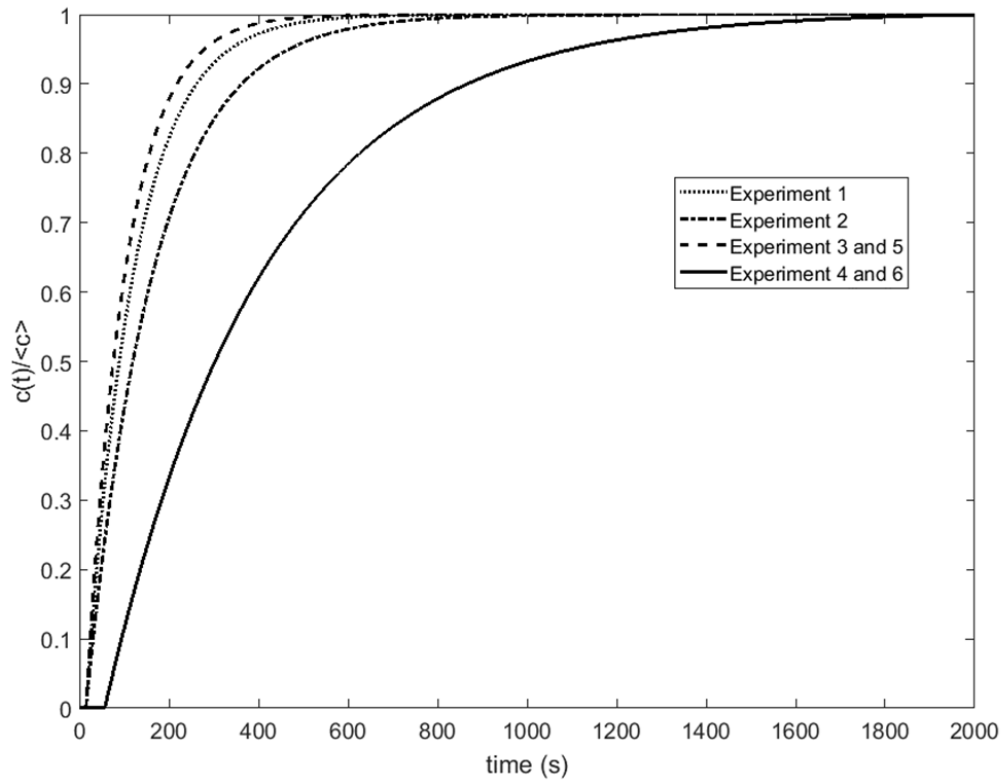

Figure 4: Modeled Residence Time Distribution in the scale-down set-up normalized by volume-averaged tracer concentration $\langle c \rangle$. Operating conditions as given by Table 1 were experiment 1, (\cdots), experiment 2 ($\cdot-\cdot-\cdot$), experiment 3 and 5 ($- - -$), experiments 4 and 6 ($-$).

Figure 5

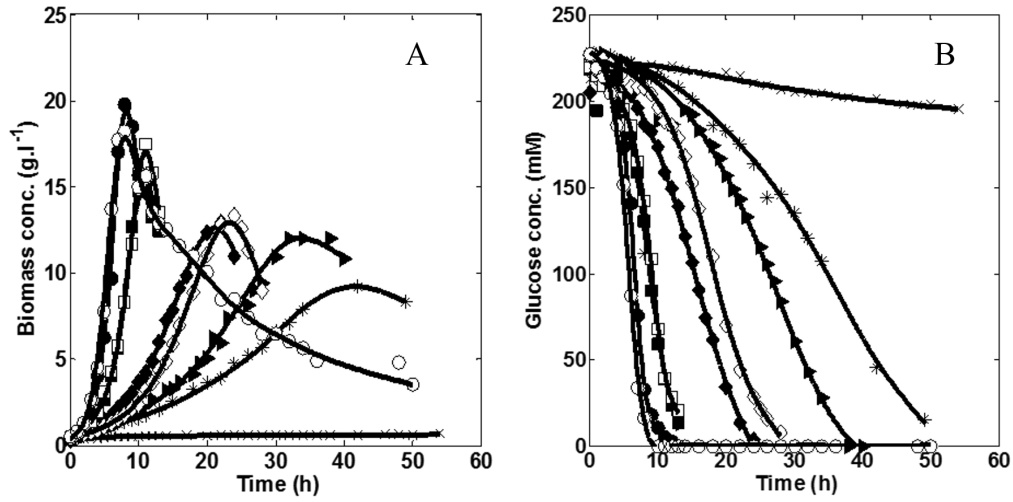

Figure 5: Influence of dissolved oxygen oscillation on *C. glutamicum* 2262 $\Delta ldhA$ growth and substrate consumption during a scale-down cultures. (A). Growth kinetics; (B). Glucose uptake profiles. The mean aerobic fractions α are: 0 (\times), 0.2 ($*$), 0.25 (\blacktriangleright), 0.33 - experiment 3 (\blacklozenge), 0.33 - experiment 4 (\diamond), 0.67 - experiment 5 (\blacksquare), 0.67 - experiment (\square) 0.67, 1a (\bullet), 1b (\circ).

Figure 6

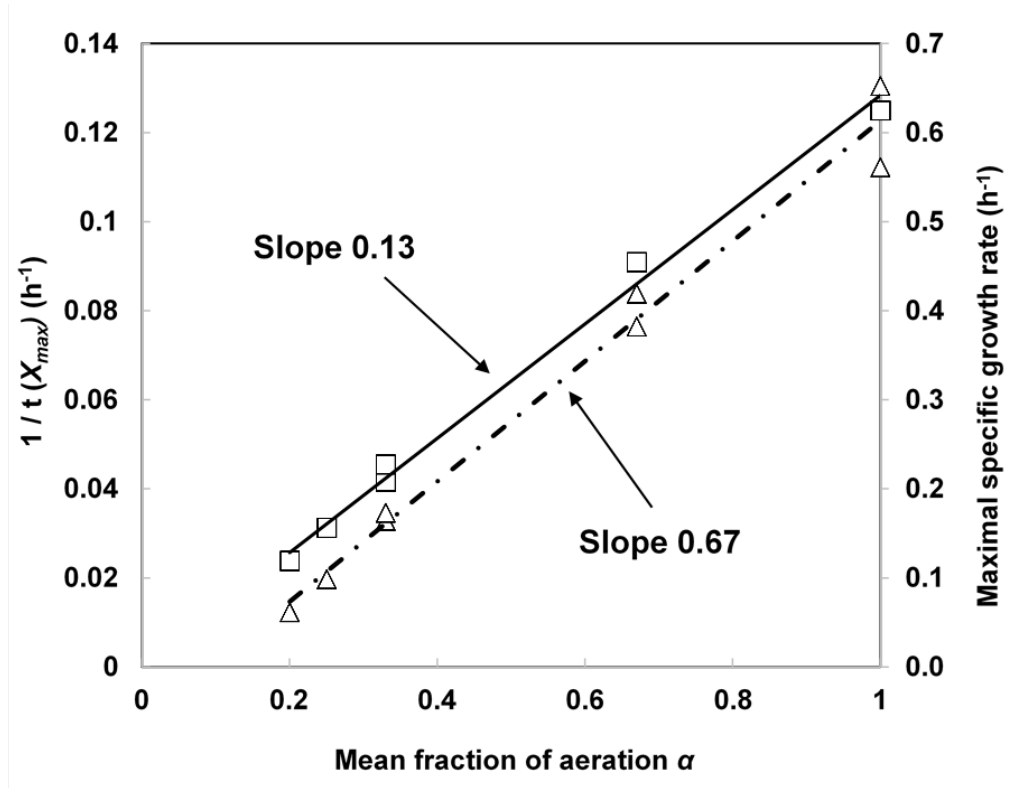

Figure 6: Relationship between mean fraction of aeration α , $1/t(X_{max})$ (□) and maximal specific growth rate μ_{max} (Δ).

Figure 7

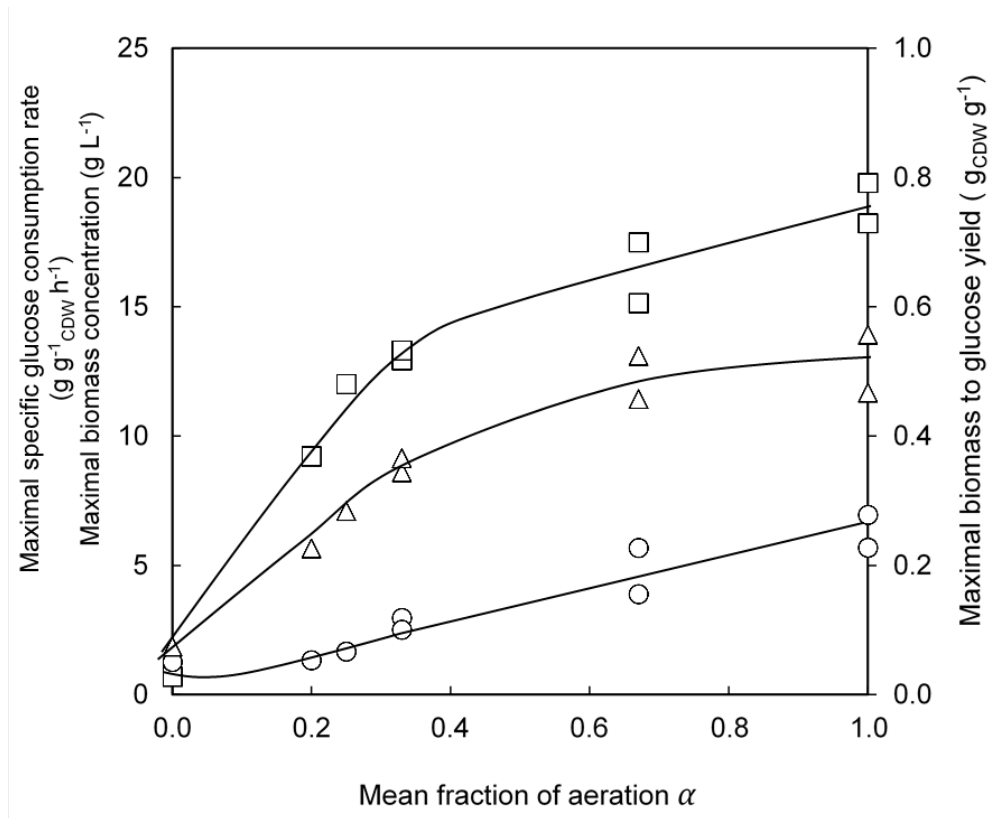

Figure 7: Relationship between mean fraction of aeration α , maximal biomass concentration X_{max} (\square), maximal specific glucose consumption rate (\circ) and maximal biomass on glucose yield $Y_{X/S}$ (Δ).

Figure 8

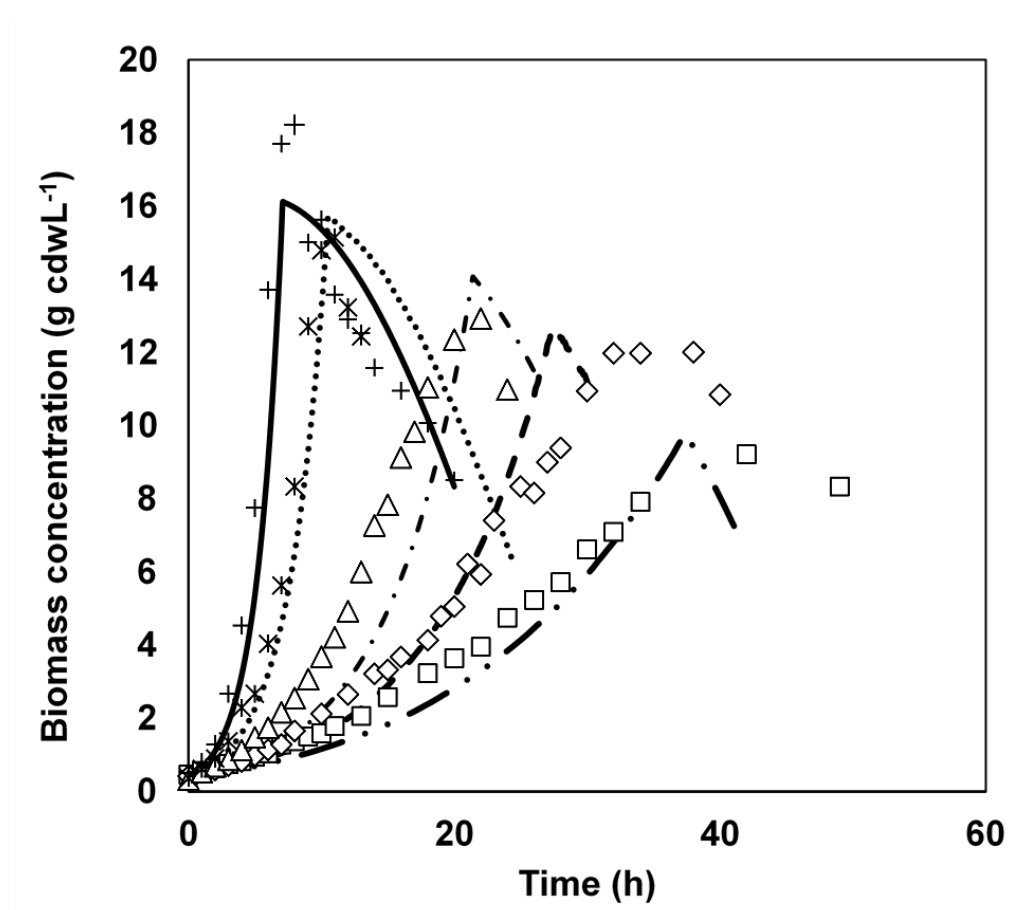

Figure 8: Comparison of experimental and modeled growth kinetics and impact of DOC oscillations. Dots are experimental values while continuous lines are modeled kinetics. Mean aerobic fractions α are 0.2 (\square , $-\bullet-$), 0.25 (\diamond , $- - -$), 0.33 - experiment 3 (Δ , $-\bullet-$), 0.67 - experiment 5 ($*$, $\bullet\bullet\bullet$), 1 ($+$, $-$).

608 **Supplementary figure**

609 The Simulink model defined for each culture condition was reported on Figure 9.

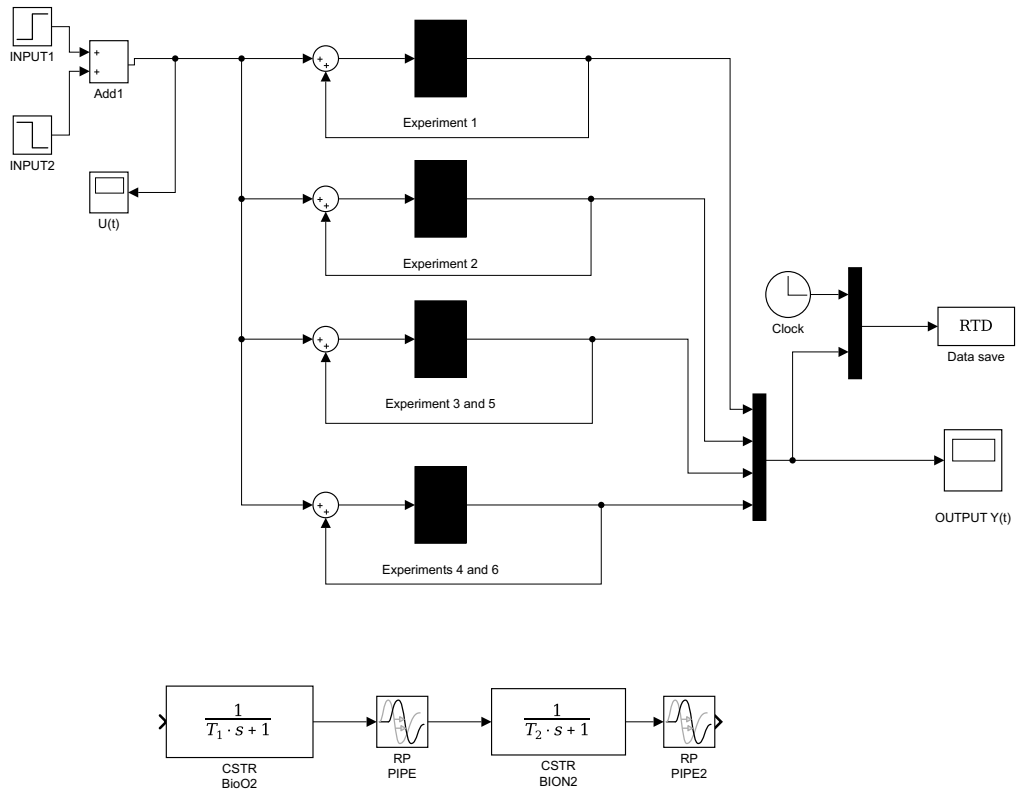
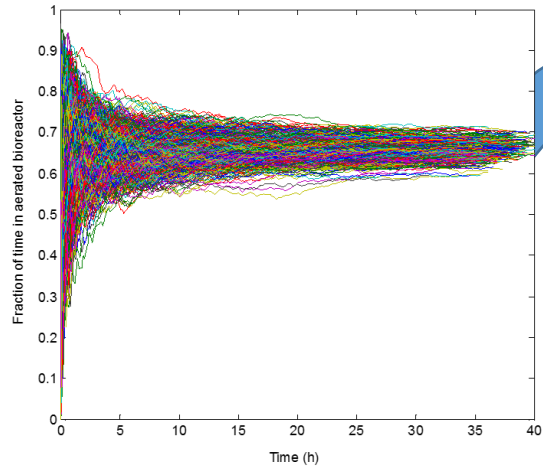
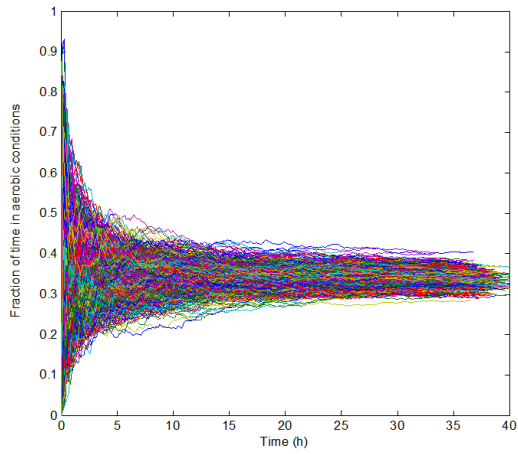

Figure 9: Modeling of scale-down set-up using Simulink software.

610



Modelling of lagrangian tracking of the bacteria

+

Experimental study of *C. glutamicum* growth in a two-compartment scale-down bioreactor, imposing fluctuating dO_2 .

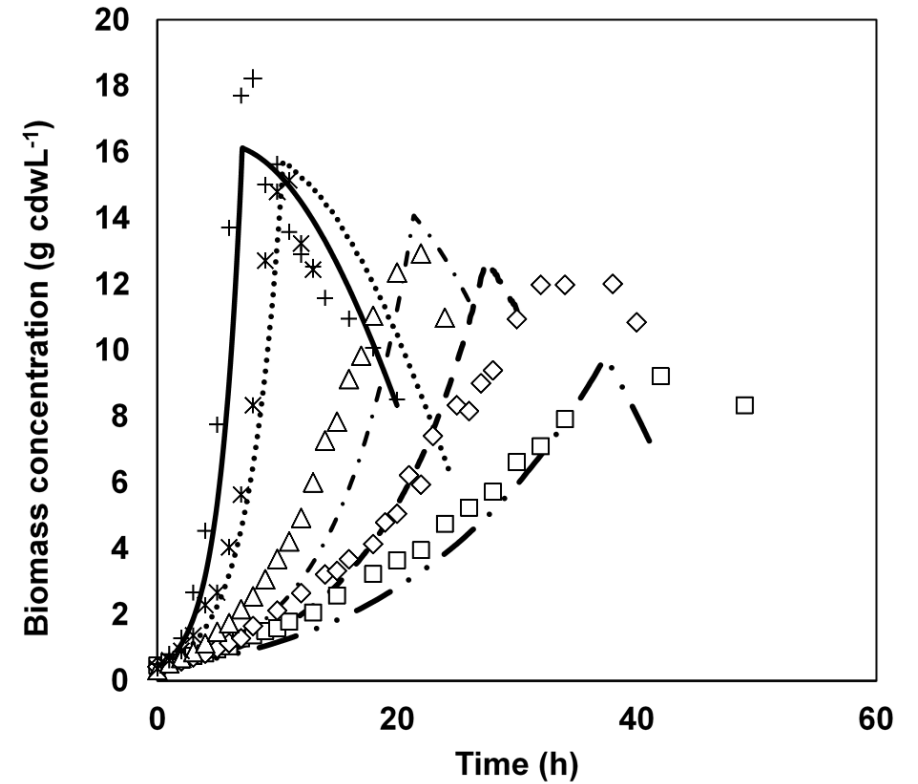
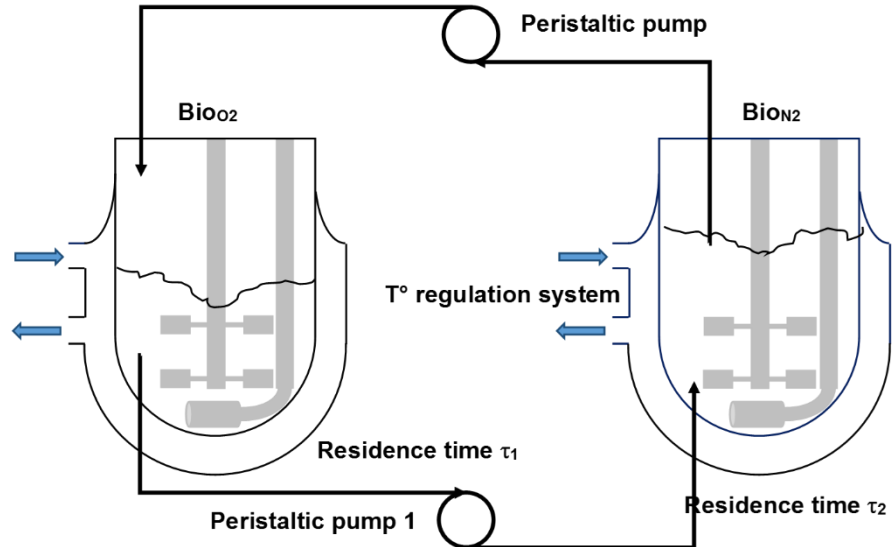

Kinetic modelling of growth curves under various mean aeration fractions.