



HAL
open science

Micro- and macro-scale water retention properties of granular soils: contribution of the X-Ray CT-based voxel percolation method

Erika Shiota, Toshifumi Mukunoki, Laurent Oxarango, Anne-Julie Tinet, Fabrice Golfier

► To cite this version:

Erika Shiota, Toshifumi Mukunoki, Laurent Oxarango, Anne-Julie Tinet, Fabrice Golfier. Micro- and macro-scale water retention properties of granular soils: contribution of the X-Ray CT-based voxel percolation method. *Soil Research*, 2019, 10.1071/sr18179 . hal-02012512

HAL Id: hal-02012512

<https://hal.univ-lorraine.fr/hal-02012512>

Submitted on 13 Feb 2019

HAL is a multi-disciplinary open access archive for the deposit and dissemination of scientific research documents, whether they are published or not. The documents may come from teaching and research institutions in France or abroad, or from public or private research centers.

L'archive ouverte pluridisciplinaire **HAL**, est destinée au dépôt et à la diffusion de documents scientifiques de niveau recherche, publiés ou non, émanant des établissements d'enseignement et de recherche français ou étrangers, des laboratoires publics ou privés.

1 **Micro- and macro-scale water retention properties of granular soils: contribution**
2 **of the X-Ray CT-based voxel percolation method**

3 *Erika Shiota^{A,E}, Toshifumi Mukunoki^B, Laurent Oxarango^C, Anne-Julie Tinet^D and Fabrice*
4 *Golfier^D*

5 ^AGraduate school of Science and Technology, Kumamoto University, Japan.

6 ^BX-Earth Center, Faculty of Advanced Science and Technology, Kumamoto University, Japan.

7 ^CUniversité Grenoble Alpes, CNRS, IRD, Grenoble-INP, IGE, F-38000 Grenoble, France.

8 ^DUniversité de Lorraine, CNRS, CREGU, GeoRessources, F-54000 Nancy, France.

9 ^ECorresponding author. Email: 171d9401@st.kumamoto-u.ac.jp

10 Water retention in granular soils is a key mechanism for understanding transport processes in the vadose
11 zone for various applications from agronomy to hydrological and environmental sciences. The
12 macroscopic pattern of water entrapment is mainly driven by the pore-scale morphology and capillary and
13 gravity forces. In the present study, the drainage water retention curve (WRC) was measured for three
14 different granular materials using a miniaturised hanging column apparatus. The samples were scanned
15 using X-ray micro-computed tomography during the experiment. A segmentation procedure was applied
16 to identify air, water and solid phases in 3D at the pore-scale. A representative elementary volume
17 analysis based on volume and surface properties validated the experimental setup size. A morphological
18 approach, the voxel percolation method (VPM) was used to model the drainage experiment under the
19 assumption of capillary-dominated quasi-static flow. At the macro-scale, the VPM showed a good
20 capability to predict the WRC when compared with direct experimental measurements. An in-depth
21 comparison with image data also revealed a satisfactory agreement concerning both the average
22 volumetric distributions and the pore-scale local topology. Image voxelisation and the quasi-static
23 assumption of VPM are likely to explain minor discrepancies observed at low suctions and for coarser
24 materials.

25 **Additional keywords:** hanging column experiment, marker-controlled watershed, representative element
26 volume, voxel percolation method.

27 **Introduction**

28 Water distribution and transfer in the vadose zone plays a major role in a wide range of
29 applications including agronomy for plant growth response to water availability (Couvreur et al.
30 2014), hydrology with water budget and infiltration or runoff assessment (Ciocca et al. 2014),
31 environmental sciences for contaminant transport (Šimůnek and van Genuchten 2016) and,
32 more recently, soil mechanics for soil bearing capacity (Imhoff et al. 2016). These vadose zone
33 processes are found to be mainly driven by the water retention curve (WRC), which is a
34 fundamental property of soils relating the average capillary pressure (or suction) with the
35 volumetric water content (θ). The WRC could be seen as a macroscale effective property
36 averaging the complexity of water and air distribution inside the pore space and the wettability
37 of the medium (including surface tension and contact angle effects). Although criticised for
38 filtering an important part of the local-scale information (McClure et al. 2018), the WRC still
39 constitutes the basis of the majority of continuum models describing water equilibrium and flow
40 in the vadose zone.

41 Conventionally, the hanging column test (HCT) is conducted to evaluate the water retentivity
42 of sandy soil. It consists of applying successive suction steps and measuring the change in
43 sample mass due to the water drainage (or imbibition) at hydrostatic equilibrium. However, it is
44 limited by the range of suction pressure that can be applied. Pressure cell or pressure plate
45 methods can be an alternative for measurement at low water content but the accuracy of air
46 pressure regulation is usually inappropriate for coarse materials. Moreover, the HCT requires
47 very careful handling to guarantee appropriate reproducibility.

48 In order to overcome these issues, several methods have been proposed to indirectly estimate
49 the WRC. Mercury intrusion porosimetry (MIP) provides an estimation of soil pore (or throat)

50 size distribution (PSD). A straightforward use of Laplace's law is then commonly used to derive
51 the WRC. Hence, pore structure of soil is generally modelled as a bundle of parallel pipes with
52 sizes corresponding to the PSD. Such an approach thus fails to take into account the complex
53 pore structure of the medium (e.g. tortuosity and constriction effect). To overcome these
54 limitations, numerical derivations of the percolation theory have been proposed by Xu et al.
55 (1997) and Bird and Dexter (1997) in order to include, an estimation of the pore network
56 complexity while deriving the WRC from MIP. However, the mathematical background of the
57 percolation theory limits these approaches to 2D configurations.

58 In parallel, for more than a decade, the micro-focused X-ray computed tomography (μ CT)
59 scanner has proven to be a powerful tool to study soils at a micrometric resolution (see the
60 recent reviews of Cnudde and Boone 2013; Wildenschild and Sheppard 2013). Therefore, this
61 non-invasive imaging technique is able to extract the complete pore structure of sandy soils.
62 Moreover, μ CT provides detailed information about the phase distribution and topology within
63 pores that give insight not only on the fluid saturation values, but also on local properties such
64 as phase connectivity, contact angle or interfacial curvatures (Al-Raoush and Willson 2005;
65 Armstrong et al. 2012; Andrew et al. 2014; Armstrong et al. 2016; Manahiloh and Meehan
66 2017). Hamamoto et al. (2016) derived the mean pore diameter and pore coordination number
67 by percolation thresholds and pore network connectivity from μ CT observation on repacked
68 columns of sand and glass beads representing different size fractions and particle shapes at
69 different compaction levels. Recently, Manahiloh and Meehan (2017) measured the WRC and
70 values of interfacial contact angle on an unsaturated glass beads sample in a suction-controlled
71 setup directly imaged with μ CT.

72 These recent advances in μ CT imaging, combined with theoretical or computational models,
73 bridge the gap between pore-scale observations and macro-scale properties. Column-scale
74 values of capillary pressure were back-calculated by Armstrong et al. (2012) from local
75 measurement of interface curvatures during drainage and imbibition processes and comparison

76 with direct measurement has shown good agreement. Berg et al. (2016) carried out Navier–
77 Stokes flow simulations on synchrotron-based μ CT pore-scale images of an imbibition
78 experiment in sandstone rock to determine relative permeability curves.

79 However, numerical computations of core scale parameters like retention curve or saturated
80 and unsaturated hydraulic conductivity require to achieve a representative elementary volume
81 (REV) of the soil sample, which is itself dependent on the targeted property (Blunt et al. 2013;
82 Raeini et al. 2014). Georgiadis et al. (2013) suggested that the two-phase REV for a sintered
83 glass-bead porous medium is one to two orders of magnitude larger than the porosity-based
84 REV and not reachable by μ CT imaging at the required resolution. A similar conclusion was
85 drawn by Yuan et al. (2016) from pore network simulations on granular materials. In contrast,
86 REV calculations by Costanza-Robinson et al. (2011) on different unsaturated homogeneous
87 porous media with varying degrees of heterogeneity in moisture distributions claim that
88 moisture saturation-based and air–water interfacial area-based REV_s are overly restrictive and
89 requiring a porosity REV to be achieved can be sufficient. Nonetheless, two-phase flow
90 simulations at the pore scale are still numerically costly and concerns remain regarding the
91 capability to image soil samples at the REV size and directly compute the core-scale properties
92 of these 3D digitalised porous media. In this framework, morphological approaches represent a
93 promising alternative to exploit large volumes of 3D μ CT images but at the cost of highly
94 simplified physical description (Hilpert and Miller 2001; Vogel et al. 2005; Mukunoki et al.
95 2016). Berg et al. (2016) showed that the morphological approach produced a good prediction
96 of the relative permeability curve of sandstone rock for drainage steady-state experiment but it
97 failed for imbibition conditions. Recently, Mukunoki et al. (2016) introduced an original
98 method called the voxel percolation method (VPM), which enables an a priori estimate of the
99 retention curve based on the solid–pore binary image obtained from μ CT. The WRC predicted
100 by VPM compared fairly with experimental WRC, provided that the computation was carried
101 out in a sufficiently large image sample.

102 These recent works suggest that in-depth assessment of morphological approach capabilities
103 is required to gain confidence in outcomes of numerical models applied to soil drainage.
104 Notably, it remains unclear whether these approaches are limited to predicting WRC or whether
105 lower-scale information can be properly captured in spite of their simplified mechanistic
106 description. The present work aimed to address these issues to ultimately obtain a better
107 understanding for the water retention property of granular materials.

108 To achieve this goal, three different materials were selected and their pore structure and water
109 distribution were visualised by μ CT during HCT retention curve characterisation. The VPM
110 model (Mukunoki et al. 2016) was considered as representative example of morphological
111 approach. In the first part of this paper, the drainage WRC determination using a mini HCT
112 apparatus is described. In the second part, a REV analysis is performed to establish the
113 confidence associated with the properties of interest (porosity, water content and surface or
114 interface specific areas) and the representativeness of samples with respect to saturation state. In
115 the third part, the water-filled pore size distribution (WPSD) is analysed with respect to the
116 suction state. Finally, the VPM is applied to estimate the WRC from the initial state binary
117 image. This numerical model is then compared with experimental data both at the macro and
118 pore scale.

119 **Materials and methods**

120 *Experimental method*

121 In order to evaluate the applicability of the method to different granular media, three different
122 granular materials were selected. Toyoura sand is a clean silica sand commonly found in Japan.
123 It has a uniform fine grain distribution of median diameter 160 μ m. Keisa5 sand is a silica sand
124 from Japan with a uniform grain distribution of median diameter 500 μ m, larger than Toyoura
125 sand. Toyoura and Keisa5 sands also contain iron material. The third material is glass beads
126 (CGB) manufactured by Potters-Ballotini, which were crushed in order to create an artificial

127 material with very angular particles with a median diameter of 650 μm . Characteristics of the
128 three materials are presented in Table 1.

129 A miniaturised HCT apparatus was designed to measure the WRC of the different materials.
130 The miniaturisation allows imaging of the whole sample with a maximum resolution of 6 μm
131 with the X-ray micro-CT scanner. The sample of 15 mm-diameter was set up in a cylindrical
132 cell, above a glass filter (20–30 μm pore diameter) (Fig. 1b). The sand was poured in the water-
133 filled cell to avoid air entrapment. The sample was compacted reaching the dry densities shown
134 in Table 1. Suction (i.e. negative water head) was imposed by modifying the relative position of
135 the top of the sample and the free water level in the syringe (Fig. 1a) in a range between 0 and
136 60 cm. It was measured based on a graduated ruler with an accuracy of 1 mm. It should be noted
137 that selected suctions, aside from the initially saturated conditions, were significantly larger than
138 the sample height. The distribution of suction steps for each sample was selected after the
139 preliminary experiments in order to match the suction values that could be simulated with the
140 VPM. The top of the sample was selected as reference to ensure a total saturation for a suction
141 of 0 cm. The volume of drained water in the syringe was measured with a precision of 0.02 mL.
142 For each suction step, the equilibrium was guaranteed by a waiting time of at least 24 h. The
143 experiment is performed under temperature-controlled conditions ($20 \pm 1^\circ\text{C}$).

144 For each suction step, once the equilibrium is reached, the sample was thermally insulated
145 using polystyrene and hydraulically isolated by closing the outlet valve. The sample was then
146 fitted in the μCT scanner (Toshiba TOSCANER 32300 FPD) to perform the image acquisition
147 with image size of 1024×1024 voxels (Fig. 1c). A selected height of 890 slices was imaged
148 around the centre of the sample. The resolution used was of 10 μm for crushed glass beads and
149 Keisa5 sand, and 6 μm for Toyoura sand. Details on the μCT scan conditions are shown in
150 Table 2.

151

152 *Image treatment and analysis*

153 All image treatment steps were performed on the open-source software Fiji (Abramoff et al.
154 2004; Schneider et al. 2012) or using custom-made programs. 3D grey-scale images were
155 reconstructed from each set of 2D slices obtained using μ CT. The grey value of each voxel
156 depends on the material parameters such as density and atomic number, therefore allowing
157 differentiation of the various materials present in the sample such as silica grains, water and air.
158 However, when using the μ CT scanner, artefacts may occur as well as image noise that
159 influence the segmentation process (Wildenschild and Sheppard 2013). As a consequence,
160 filtering of the images is necessary before the segmentation process. In the present study,
161 filtering was carried out using a 3D median filter with a $3 \times 3 \times 3$ voxel window, followed by a
162 3D Gaussian blur with a standard deviation of 1 in order to remove noise and facilitate edge
163 detection (Tamura 2002; Wildenschild and Sheppard 2013).

164 Numerous segmentation approaches exist to distinguish different phase in an imaged porous
165 medium (Wildenschild and Sheppard 2013; Berg et al. 2018). Recent works on multiphase
166 porous medium have used region-growing segmentation (Hashemi et al. 2014; Schlüter et al.
167 2014; Mukunoki et al. 2016). In the present work, a custom-made marker-controlled watershed
168 software (Soille 2002; Mukunoki et al. 2016) was used. This segmentation technique has
169 already shown a good capability to separate three phases in unsaturated sand samples while
170 recovering volume fractions matching gravimetric measurements (Mukunoki et al. 2016).
171 Marker-controlled watershed is based on seeds for each phase and iteratively simulates their
172 growth so as to fill the image (Fig. 2). The resulting discrete image was analysed considering
173 three phases: water, air and solid (Fig. 2). In Toyoura and Keisa5 sands, the solid phase
174 consisted of the sum of silica and iron grains. The sum of water and air phases is referred to as
175 the pore phase. Segmented images were checked to validate the method based on visual
176 inspection of 2D images with superposition of pre- and post-treated data once every 50 images,
177 especially regarding separation between the pore and solid phases.

178 For the subsequent studies, the final image was cropped for image treatment (700 × 700 ×
179 700 voxels) and numerical simulation (600 × 600 × 600 voxels). This cropping allows removal
180 of the cylindrical cell borders, which simplifies the numerical treatment as well as providing
181 improved computing performances.

182 Morphological characteristics were computed in order to validate the image processing
183 through comparison of image data and experimental results, but also to quantitatively study the
184 evolution of unsaturated properties depending on the saturation level and material properties.
185 Global characteristics under consideration include volume averaged properties (porosity (ϵ), θ ,
186 specific surface and specific air–water interface) and statistical description of local geometrical
187 properties (WPSD and air-filled particle size distribution (APSD)) which allows a more detailed
188 description of the sample structure.

189 The ϵ and θ were straightforwardly calculated from the segmented images as the ratio
190 between the number of corresponding voxels (respectively pore and water voxels) to the total
191 number of voxels in the sample. Interfacial areas are evaluated through the discrete cutting lines
192 method proposed as a 3D extension of Cauchy–Crofton theory (Santalo 2004; Legland et al.
193 2011; Lehmann and Legland 2012). This method is less sensitive to the staircase effect than a
194 direct counting of interface voxels and has much lower computational cost than methods based
195 on surface meshes. The specific surface (S_s in m^{-1}) was computed as the ratio between the area
196 of pore–solid interfaces and the total volume of the sample. In a similar manner, the specific
197 water–air surface (S_{wa} in m^{-1}) was computed using the area of water–air interfaces.

198 Pore size distributions (PSD) were calculated using the 3D granulometric method (GM)
199 developed by Mukunoki et al. (2016). This method considers pores as spheres of various radii.
200 For each radius, the occupation rate of spheres having three points of contact with the solid
201 phase is computed. PSD is derived from this occupation rate and the diameters of the spheres. In
202 a classical manner, GM is used to estimate the total PSD (TPSD) of the porous medium. In this
203 study, it was also applied to the water phase only to estimate the WPSD.

204 A major concern with regards to studies at the pore structure scale is the representativeness of
205 the selected medium in relation to a larger scale, relevant to the applications. To consider this
206 issue and allow upscaling, the evaluation of the REV is necessary. In order to estimate a
207 representative property of the medium, the study should involve a volume large enough to
208 capture the average trends at the upper scale. All the macroscale models used to describe soils
209 (and more generally porous media) can be used confidently only if a REV can be defined for the
210 studied process. Various methods have been proposed to estimate the size of the REV using a
211 reconstructed 3D image of the pore structure. Of these, the stochastic REV (Zhang et al. 2000)
212 was selected in the present work. This method offers the advantage to provide a distribution of
213 the studied property for each region of interest (ROI) volume. The average value of the
214 distribution generally converges towards the representative value, whereas the discrepancy of
215 the distribution, computed as the relative standard deviation (RSD), provides a metric of the
216 representativeness of the studied ROI size. In the present study, distributions were computed as
217 a set of 20 ROI distributed stochastically in the total volume. This ensured that the discrepancy
218 between the total volume property and the distributions means was lower than 1%. The ROI
219 size was limited to $350 \times 350 \times 350$ voxels to limit overlapping ROIs.

220 As emphasised in the Introduction, REV is not an intrinsic property of the medium. Its size
221 generally varies depending on the studied property. Therefore, REV should be determined for
222 each studied property of the medium. In the current work, calculation of the REV was carried
223 out for each global characteristic (porosity, water content, specific surface and air–water
224 interface).

225 *Numerical modelling*

226 The numerical derivation of the drainage WRC is achieved using the VPM model (Mukunoki
227 et al. 2016). It is based on two steps. The first, using the same algorithm as the 3D GM, consists
228 of labelling each pore, considered as a sphere element, with the sphere geometrical
229 characteristics. Once this cluster labelling process is carried out, a percolation step can be

230 performed for different values of the capillary pressure. The Young–Laplace law is used to
231 associate a pore diameter to this capillary pressure with the water surface tension at 20°C
232 (0.07288 N m^{-1}) and a contact angle for the air–water–quartz system of $44^\circ \pm 5^\circ$ (based on data
233 from Ethington 1990; and Mukunoki et al. 2016). During each percolation step, fluid is allowed
234 to penetrate, from the entry face into pores labelled with spheres of diameters higher or equal to
235 the chosen value as long as the injected fluid phase remains connected. Fluid-filled voxels may
236 then be marked so as to allow calculation of the injected fluid content. If this calculation is
237 performed decreasing the size of the sphere diameters, the drainage WRC is derived.
238 Conversely, if the calculation is carried out with increasing spheres, the imbibition WRC is
239 derived. It should be noted that the capillary pressure points that can be computed with VPM are
240 strongly dependent on the image resolution since diameter values can only be multiples of the
241 voxel size.

242 In the present work, VPM simulations were performed based on the initial state (saturated
243 conditions) image for each sand. The confidence interval associated to each VP simulation was
244 based on the range of contact angle variation (between 39° and 49°), with a larger contact angle
245 leading to a smaller air entry pressure of the WRC. As for μCT image analysis, PSD
246 calculations were performed on VPM simulations for comparison purposes. Note that only the
247 total and APSD were directly computed here. The WPSD was obtained as the difference
248 between TPSD and the APSD.

249 **Results and discussion**

250 *Macro-scale results: the WRC*

251 The experimental WRC (based on water outflow measurement) for the three materials is
252 presented in Fig. 3 along with the image-based WRC (based on voxel counting), and the WRC
253 predicted by the VPM. All WRC are typical of sandy materials with low air entry pressures,
254 which decrease with increasing mean grain sizes. A strong decrease of θ was then observed at
255 intermediate suctions leading to small residual water content (< 0.05). The variability of the

256 VPM data with contact angle decreased with suction and, thus, with the increase of water
257 content.

258 Experimental and image-based WRC show very similar global behaviour, those values are
259 mostly included within the range provided using VPM. Some differences should, however, be
260 noted. Since the capillary pressure is not recalculated from the image, water content between
261 imaged WRC and experimental WRC may be compared at each drainage step. Whilst the
262 comparison for Toyoura sand is rather good, it is less satisfactory for Keisa5 and CGB. Indeed,
263 variation in water content of around 0.05 was observed for Keisa5 Step 2 to 4 and CGB Step 3
264 and 4. We believe that the sub-sampling procedure could explain this bias due to preferential
265 pathways for air intrusion along the walls of the experimental sample, especially for the coarse
266 materials.

267 The VPM data tend to deviate from experimental data at low water content. Indeed, under
268 such conditions, air invades the smaller pores, making the VPM much more sensitive to the
269 image resolution and potentially leading to a larger calculation error.

270 *Evaluation of the REV on averaged characteristics*

271 In this section, we investigate the changes in the REV size achieved when the RSD is below
272 5%. Since there is no consensus for the best value of RSD to describe the REV, the value was
273 arbitrarily chosen. Besides, the ROI size was limited to 350 voxels (i.e. half of the total
274 subsample size in each direction). The evolution of RSD with ROI size for each sample at each
275 step considering ε (initial step of volume REV), θ (step 1 to 4 of volume REV), specific surface
276 S_s (initial step of surface REV) and S_{wa} (Steps 1 to 4 of surface REV) are shown in Fig. 4.
277 Total values of each studied characteristic as well as computed REV and RSD for the maximal
278 ROI size are summarised in Table 3.

279 The computed S_s ranging from 6661 m^{-1} for CGB up to 16817 m^{-1} for Toyoura sand
280 appears to scale properly with the median grain diameters and the median pore size for each

281 material. Contrasted behaviours were observed for each material concerning S_{wa} . Except the
282 null value at Step 1, reflecting the full saturation, Toyoura sand exhibited a constant S_{wa} of
283 $\sim 2300 \text{ m}^{-1}$ for Steps 2 to 4, while θ is continuously decreasing. This reflects a transition from a
284 small number of large water clusters to a large number of small clusters. For Keisa5 sand, the
285 same effect appeared to promote a maximum S_{wa} value at the intermediate water content of
286 Step 3 (14.4%). The very low water content at Step 4 (4.6%), leading to the reduction of the
287 number of water clusters, probably explains this noticeable decrease of S_{wa} . Finally, CGB
288 exhibited very low S_{wa} from Step 1 to 3, which is in agreement with its high water contents. At
289 Step 4, S_{wa} reached a value of 731 m^{-1} , which is consistent with the results obtained for
290 Keisa5 sand due to the similar mean grain size for both materials.

291 RSD evolutions with ROI size for volume (Fig. 4a, c, e) and surface (Fig. 4b, d, f) properties
292 yield very similar trends with the notable exception of samples close to water saturation. In
293 these cases, the air–water specific interface is limited due to the small amount of air. Therefore,
294 the likeliness to have some air phase in a given ROI is small, leading to a very large RSD for
295 S_{wa} (over 100%).

296 In saturated conditions (initial step) or at high water saturation, both REV values are
297 reasonably low for all materials (i.e. below 4 times the grain size, Table 3). This value, however,
298 increases with the progress of the drainage process to the point that neither volume REV nor
299 surface REV with RSD lower than 5% is achieved at Step 4, with the exception of CGB surface
300 REV. However, in the latter case, the water content is much larger than for Keisa5 at Step 4 and
301 Toyoura at Step 4 (13.5% against 4.6% and 7.1% respectively). The REV size globally evolves
302 in a similar way as the correlation length of the object of interest (i.e. the water clusters). As the
303 water clusters become increasingly fragmented when θ decreases, the inter-cluster characteristic
304 length increases and hence the REV increase. Note, however, that at high water content, the
305 estimate of this correlation length may be biased because of the cut off effect of the
306 experimental sample size (Georgiadis et al. 2013).

307 Considering the value of RSD for ROIs of 350 voxels generally below 15% (Table 3) and the
308 decreasing trend observed in Fig. 4, it is reasonable to consider that the ROI of size 600 x 600 x
309 600 and 700 x 700 x 700 voxels used for characterisation purposes present satisfactory
310 representativeness for the three materials. These ROI sizes are 3–7 times larger than the porosity
311 REV size, which was considered large enough to study multiphase properties by Costanza-
312 Robinson et al. (2011). In the present study, RSD values measured for the porosity REV were
313 generally larger than 30% for all the computed properties and thus appear inadequate for a
314 confident interpretation of experimental and numerical results. However, it must be kept in
315 mind that defining a REV for multiphase property presents an intrinsic difficulty due to the
316 increasing size of the connected phase with increasing sample size, as suggested by Georgiadis
317 et al. (2013) and Yuan et al. (2016).

318 *Pore (TPSD) and water-filled (WPSD) pore size distributions*

319 The PSD values were calculated at the different steps for each material from the segmented
320 images as well as from VPM simulations and the comparison is shown in Fig. 5.

321 Under initial conditions, the WPSD corresponds to the TPSD. Moreover, since all VPM
322 simulations were performed on the initial images, TPSD from image data and VPM data were
323 strictly identical. All materials show a unimodal distribution with increasing dispersion around
324 the mode from Toyoura to Keisa5 and to CGB. More specifically, Toyoura PSD shows a mode
325 of 66 μm pore diameter (110 μm for Keisa5 and 170 μm for CGB) with pores ranging from 5 to
326 150 μm (5–250 μm for Keisa5 and 30–350 μm for CGB).

327 For Toyoura sand (Fig. 5a, b), the WPSD exhibited very similar behaviours between image-
328 based and VPM-based WPSD. The successive suction steps led to a shifting of the right part of
329 the WPSD since the largest pores were the first filled with air. The absence of a significant
330 tailing effect confirms the good uniformity of the Toyoura sand and is consistent with its narrow
331 distribution around the mean pore size. The VPM-based WPSD, however, exhibited a slightly

332 stiffer shape, close to the Young–Laplace diameter used to define the air percolation at a given
333 suction step.

334 For Keisa5 sand (Fig. 5c, d) and CGB (Fig. 5e, f) the tailing effect became increasingly
335 marked on image-based WPSD with increasing air intrusion. At Step 3 of Keisa5 sand, some
336 larger pores remained filled with water, even though smaller size pores began to be desaturated.
337 A similar observation was made on Step 4 of CGB for the imaged-based WPSD (Fig. 5 e, f).
338 The pore heterogeneity features of both materials were probably driving this effect; some large
339 pores were isolated from the air flow by smaller size pores which played the role of throats or
340 constrictions. Therefore, those large pores may only get filled by air when the capillary pressure
341 is sufficient to invade these throats. The VPM only partially captured this behaviour, as can be
342 observed for CGB at \square of 0.233. A significant number of large pores remained filled with
343 water.

344 All in all, keeping in mind that the water contents are not strictly equal between the steps of
345 VPM simulations and direct imaging, the VPM appears to satisfactorily describe the distribution
346 of water within the pore system. However, being based on a straightforward use of the Young–
347 Laplace diameter to impose a chosen suction, it tended to impose an overestimated cutoff of the
348 WPSD close to this diameter. The resulting curves were thus steeper than those directly
349 obtained from the μ CT image. For material presenting a spread PSD, VPM simulations could
350 partially describe the complexity of pore connectivity and the associated entrapment of water in
351 large pores. However, dynamical processes, such as by-passing entrapment, preferential flow
352 effects or unstable flow patterns, remain beyond the capability of the model and could explain
353 some of the discrepancy between simulation and imaging (Berg et al. 2016).

354 *Local phase distribution comparison*

355 In order to go a step further in the analysis of the capability and limitation of the VPM, a
356 straightforward comparison of the 3D phase fields (air, water and solid) obtained from direct

357 imaging (I) and VPM simulations was performed. Considering similar water content conditions,
358 the two datasets were compared voxel by voxel for Toyoura Steps 3 and 4, Keisa5 Steps 2–4
359 and CGB Step 4. 3D matching images were computed by defining nine different classes of
360 voxels, each one consisting of the matching of the phases (air, water and solid) between the two
361 sets of images (I and VPM).

362 Fig. 6 details the proportion of each matching set expressed as the volume fractions of
363 matching and mismatching voxels with respect to the total volume. The solid phase was mostly
364 well matched, but some variation still remained between the segmented image and the VPM
365 simulation ranging from 4.5% for Keisa5 Step 2 and 3 up to 8.5% for Keisa5 Step 4. Indeed, the
366 VPM simulation was performed using the initial step binary image. Since the experiment was
367 performed outside the μ CT, the sample needed to be repositioned in the μ CT for each image
368 acquisition. Even though this repositioning was performed very carefully, considering the high
369 resolution of the acquisition, even a very small modification of the initial location (e.g. tilting,
370 rotation and modification of the structure) leads to some errors in the solid phase reconstruction.
371 Moreover, it is well known that even if identical μ CT acquisition is used, changes in the CT-
372 values could occur, resulting in a variability of the segmentation procedure. Such uncertainties
373 promote the observed mismatches in the localisation of the solid phase.

374 With regards to the fluid phases, the dependency of matching success rate with the phase
375 saturation is shown in Fig. 7 to ease the interpretation of Fig. 6. Note that all the comparison
376 results are summed up in Fig. 7, independently of the material or of the saturation step. It may
377 be observed that as the saturation of a given phase increased, the success rate also increased
378 until reaching a plateau of 80% success rate from a saturation of around 50%. The remaining
379 20% could be caused by the grim resolution limit (Saxena et al. 2017) or the potential issue for
380 segmentation (Leu et al. 2014). This maximum value of success rate was, for a large part, due to
381 pore–solid mismatches, as discussed previously, but air–water mismatched voxels still
382 remained. Such voxels represent between 4% and 9%, the latter value being for CGB Step 4,

383 where the discrepancy in water content between segmented image and VP simulation was the
384 largest.

385 The local distribution of matching and mismatching voxels in the 2D middle horizontal slice
386 of the 600 x 600 x 600 subsample is illustrated in Fig. 8. A focus on 3D air voxels distribution is
387 presented in 3D in Fig. 9.

388 The images of Toyoura sand at Steps 3 and 4 and Keisa5 sand at Step 4 (Fig. 8, 9a, b, e)
389 correspond to low water contents (0.11, 0.07 and 0.05 respectively). The agreement for the air
390 phase, which is dominant, appears very satisfactory, as suggested previously by Fig. 7 but a
391 reasonable agreement could also be noticed concerning the water phase. It was observed that the
392 errors were rather homogeneously distributed through the volumes. Some of these errors may be
393 attributed to the same causes than the pore–solid errors. VPM simulations appear to promote
394 water films along solids and water bridges between two or more solids. Such geometrical
395 anomalies may be attributed to imaging-induced roughness or voxelisation. Indeed, VPM
396 considers a spherical shape for the air-filled pores, therefore voxels at the surface of the solids
397 not matching the spheres or at junction between two spheres are not filled with air. It should
398 also be noted that most of the pores anomalously filled with air by the VPM present a large size,
399 whereas the small size pores filled with air in the segmented image remain occupied by water in
400 the VPM simulation. This local observation supports the interpretation of the WPSD that strict
401 application of the Young–Laplace theory prevents the invasion of pores smaller than the
402 capillary diameter in VPM simulations. In practice, several phenomena occurring during the
403 drainage experiment are likely to break this assumption. For instance, fluid flow is by essence
404 associated with local pressure non-uniformity in both the water and gas phases during a
405 drainage step. It is thus possible to locally reach capillary pressure higher than the imposed
406 suction, thus allowing small pore invasion. Aside from these fundamental considerations, Fig.
407 9a, b puts forward a good uniformity of the satisfactory air–phase matching all along the sample
408 height.

409 For mid-wet conditions (Keisa5 Step 3 and CGB Step 4), it was first observed that the water
410 and air phases were rather heterogeneously distributed within the medium. This supports the
411 hypothesis of preferential flow occurring during the experiment. Moreover, the air phase
412 overestimation by VPM simulation was mostly attributed to mismatches with water phase
413 locations, possibly due to the snap-off or bypassing mechanisms.

414 Finally, the 3D image for Keisa5 Step 2, in almost saturated conditions, showed the largest
415 discrepancy with the μ CT image (Fig. 8c and more drastically in 3D in Fig. 9c). The segmented
416 image data exhibited non-connected air phase within the subsample. This indicates that the
417 subsampling misses a large part of the air-phase intrusion. This is likely to be the main
418 explanation for significantly lower experimental water content than imaged water content. The
419 discrepancy between the segmented image and VPM air distribution may be imputed to
420 boundary effect. Indeed, in VPM simulations, air is injected homogeneously over the whole
421 entry surface (Fig. 9c), but in the experiment, the air distribution around the sub-sample image
422 was dependent on the flow surrounding the selected ROI. It should also be noted that a rather
423 low suction was applied to this sample (17.8 cm). The dominant effect of capillary forces
424 considered in the VPM model may be questioned: gravity and viscosity effects could turn
425 dominant and enhance air phase fingering.

426 **Conclusion**

427 In the present study, WRC were derived for three different granular materials. The samples
428 were monitored using μ CT at various steps of the drainage process during HCTs. A marker-
429 controlled watershed method was applied to segment the different phases of each sample. Based
430 on this segmentation, a morphological approach (VPM) was applied to simulate air intrusion on
431 a subsample. Then experimental, imaged and simulated results were compared from the global
432 (WRC and PSD) to the local scale (2D and 3D images of the two-fluid phases), including a
433 REV analysis. The following results were obtained:

434 The segmentation method showed good adequacy with the core-scale experimental
435 measurements; however, there was limitation caused by the sub-sampling and the non-
436 consideration of preferential pathways for air intrusion along the walls of the test cell,
437 especially for the coarser materials. The REV analysis supports the choice of subsample
438 size ($600 \times 600 \times 600$ and $700 \times 700 \times 700$ voxels) for the characterisation study of the
439 three materials. Such ROI sizes are 3–7 times larger than the porosity REV size and are very
440 likely to be of the same order of magnitude as the water content and surface REV, even if
441 we have to be cautious with the definition of the REV in multiphase conditions due to the
442 relative water cluster size compared with the core dimensions.

443 Through the above validation of image processing, this study proposes an original
444 comparison of local phase field at the pore scale between direct imaging and VPM. Even
445 though it is based on a simplified quasi-static approach. While considering the phase
446 presenting the higher saturation (i.e. water at the beginning of the drainage or air at the end),
447 the VPM provided a satisfactory agreement for the Toyoura sand sample. The agreement
448 with direct imaging results tended to decrease for materials with larger PSD (Keisa5 sand
449 and CGB). The assumption of capillary driven quasi-static drainage also promoted an over-
450 estimation of the cut-off effect close to the Young–Laplace pore diameter. Hence, the VPM
451 model demonstrates a good capacity to reproduce air intrusion for the studied materials at
452 the macro-scale.

453 **Conflicts of interest**

454 The authors declare no conflicts of interest.

455 **Acknowledgements**

456 This study is part of the PROTINUS project funded by the European Union's Horizon 2020 research and
457 innovation program under grant agreement No 645717. It was supported by the International Research
458 Organisation for Advanced Science Technology (IROAST) and Priority Organisation for Innovation and

459 Excellence (POIE) of Kumamoto University. This work also benefited of a Grant in-Aid for Scientific
460 Research (C) of JSPS Fellows Grant Number: 26420483 and 17J11642. The authors appreciate Toru
461 Yoshinaga, who is technical staff in Kumamoto University, for his support in developing experiments and
462 scanning CT imagery, and Christophe Morlot (Université de Lorraine, CNRS, GeoRessources) for his
463 advice on image treatment.

464 **References**

465 Abramoff MD, Magelhaes PJ, Ram SJ (2004) Image pProcessing with ImageJ. *Biophotonics*
466 *International* 11(7), 36–42.

467 Al-Raoush RI, Willson CS (2005) A pore-scale investigation of a multiphase porous media system.
468 *Journal of Contaminant Hydrology* 77(1–2), 67–89. doi:10.1016/j.jconhyd.2004.12.001

469 Andrew M, Bijeljic B, Blunt MJ (2014) Pore-scale contact angle measurements at reservoir conditions
470 using X-ray microtomography. *Advances in Water Resources* 68, 24–31.
471 doi:10.1016/j.advwatres.2014.02.014

472 Armstrong RT, Porter ML, Wildenschild D (2012) Linking pore-scale interfacial curvature to column-
473 scale capillary pressure. *Advances in Water Resources* 46, 55–62.
474 doi:10.1016/j.advwatres.2012.05.009

475 Armstrong RT, McClure JE, Berrill MA, Rucker M, Schlüter S, Berg S (2016) Beyond Darcy's law: tThe
476 role of phase topology and ganglion dynamics for two-fluid flow. *Physical Review. E* 94(4), 043113.
477 doi:10.1103/PhysRevE.94.043113

- 478 Berg S, Rücker M, Ott H, Georgiadis A, van der Linde H, Enzmann F, Kersten M, Armstrong RT, de
479 With S, Becker J, Wiegmann A (2016) Connected pathway relative permeability from pore-scale
480 imaging of imbibition. *Advances in Water Resources* 90, 24–35. doi:10.1016/j.advwatres.2016.01.010
- 481 Berg S, Sexana N, Shaik M, Phadhan C (2018) Generation of ground truth images to validate micro-CT
482 image-processing pipelines. *The Leading Edge* 37(6), 412–420. doi:10.1190/tle37060412.1
- 483 Bird NRA, Dexter AR (1997) Simulation of soil water retention using random fractal networks. *European*
484 *Journal of Soil Science* 48(4), 633–641. doi:10.1111/j.1365-2389.1997.tb00563.x
- 485 Blunt JM, Bijeljic B, Dong H, Gharbi O, Iglauer S, Mostaghimi P, Paluszny A, Pentland Cet al. (2013)
486 Pore-scale imaging and modeling. *Advances in Water Resources* 51, 197–216.
487 doi:10.1016/j.advwatres.2012.03.003
- 488 Ciocca F, Lunati I, Parlange MB (2014) Effects of the water retention curve on evaporation from arid
489 soils. *Geophysical Research Letters* 41, 3110–3116. doi:10.1002/2014GL059827
- 490 Cnudde V, Boone MN (2013) High-resolution X-ray computed tomography in geosciences: aA review of
491 the current technology and applications. *Earth-Science Reviews* 123, 1–17.
492 doi:10.1016/j.earscirev.2013.04.003
- 493 Costanza-Robinson MS, Estabrook BD, Fouhey DF (2011) Representative elementary volume estimation
494 for porosity, moisture saturation, and air-water interfacial areas in unsaturated porous media: dData
495 quality implications. *Water Resources Research* 47(7), W07513. doi:10.1029/2010WR009655

- 496 Couvreur V, Vanderborght J, Draye X, Javaux M (2014) Dynamic aspects of soil water availability for
497 isohydric plants: Ffocus on root hydraulic resistances. *Water Resources Research* 50, 8891–8906.
498 doi:10.1002/2014WR015608
- 499 Ethington EF (1990) Interfacial contact angle measurements of water, mercury, and 20 organic liquids on
500 quartz, calcite, biotite, and Ca-montmorillonite substrates (No. 90–409). US Geological Survey.
- 501 Georgiadis A, Berg S, Makurat A, Maitland G, Ott H (2013) Pore-scale micro-computed-tomography
502 imaging: nonwetting-phase cluster-size distribution during drainage and imbibition. *Physical Review*.
503 E 88(3), 033002. doi:10.1103/PhysRevE.88.033002
- 504 Hamamoto S, Moldrup P, Kawamoto K, Sakaki T, Nishimura T, Komatsu Tet al. (2016) Pore network
505 structure linked by X-ray CT to particle characteristics and transport parameters. *Soil and Foundation*
506 56(4), 676–690. doi:10.1016/j.sandf.2016.07.008
- 507 Hashemi MA, Khaddour G, Francois B, Massart JT, Salager Set al. (2014) A tomographic imagery
508 segmentation methodology for three-phase geomaterials based on simultaneous region growing. *Acta*
509 *Geotechnica* 9, 831–846. doi:10.1007/s11440-013-0289-5
- 510 Hilpert M, Miller CT (2001) Pore-morphology-based simulation of drainage in totally wetting porous
511 media. *Advances in Water Resources* 24, 243–255. doi:10.1016/S0309-1708(00)00056-7
- 512 Imhoff S, Pires da Silva A, Ghiberto PJ, Tormena CA, Pilatti MA, Libardi PL (2016) Physical Qquality
513 Indicators and Mmechanical Bbehavior of Aagricultural Ssoils of Argentina. *PLoS One* 11(4),
514 e0153827. doi:10.1371/journal.pone.0153827

- 515 Legland D, Kieu K, Devaux MF (2011) Computation of Minkowski measures on 2D and 3D binary
516 images. *Image Analysis & Stereology* 26(2), 83–92. doi:10.5566/ias.v26.p83-92
- 517 Lehmann G, Legland D (2012) Efficient N-Ddimensional surface estimation using Crofton formula and
518 run-length encoding. *The Insight Journal*. Kitware INC. Available at: <http://hdl.handle.net/10380/3342>
519 [verified 20 December 2018].
- 520 Leu L, Berg S, Enzmann F, Armstrong TR, Kersten Met al. (2014) Fast X-ray mMicro- –Tomography of
521 mMultiphase Fflow in Berea sSandstone: aA sensitivity sStudy on limage Pprocessing. *Transport in*
522 *Porous Media* 105(2), 451–469. doi:10.1007/s11242-014-0378-4
- 523 Manahiloh KN, Meehan CL (2017) Determining the sSoil Wwater Ccharacteristic Ccurve and linterfacial
524 Ccontact Aangle from Mmicrostructural Aanalysis of X-rRay CT limages. *Journal of Geotechnical and*
525 *Geoenvironmental Engineering* 143(8), 04017034. doi:10.1061/(ASCE)GT.1943-5606.0001677
- 526 McClure JE, Armstrong RT, Berrill MA, Schlüter S, Berg S, Gray WG, Miller CT (2018) A geometric
527 state function for two-fluid flow in porous media. *Physical Review Fluids* 3, 084306.
528 doi:10.1103/PhysRevFluids.3.084306
- 529 Mukunoki T, Miyata Y, Mikami K, Shiota E (2016) X-ray CT analysis of pore structure in sand. *Solid*
530 *Earth* 7(3), 929–942. doi:10.5194/se-7-929-2016
- 531 Raeini AQ, Blunt MJ, Bijeljic B (2014) Direct simulations of two-phase flow on micro-CT images of
532 porous media and upscaling of pore-scale forces. *Advances in Water Resources* 74, 116–126.
533 doi:10.1016/j.advwatres.2014.08.012
- 534 Santalo LA (2004) ‘Integral geometry and geometric probability.’ (Cambridge university press)

- 535 Saxena N, Hofmann R, Alpark OF, Dietderich J, Hunter S, Day-Stirrat JRet al. (2017) Effect of image
536 segmentation & voxel size on micro-CT computed effective transport & elastic properties. *Marine and*
537 *Petroleum Geology* 86, 972–990. doi:10.1016/j.marpetgeo.2017.07.004
- 538 Schlüter S, Sheppard A, Brown K, Whildenschild D (2014) Image processing of multiphase images
539 obtained via X-ray microtomography: aA review. *Water Resources Research* 50(4), 3615–3639.
540 doi:10.1002/2014WR015256
- 541 Schneider CA, Rasband WS, Eliceiri KW (2012) NIH Image to ImageJ: 25 years of image analysis.
542 *Nature Methods* 9, 671–675. doi:10.1038/nmeth.2089
- 543 Šimůnek J, van Genuchten MT (2016) Contaminant tTransport in the Uunsaturated Zzone: Ttheory and
544 Mmodeling. In ‘The Hhandbook of Ggroundwater Eengineering’. 3rd edn. (Eds J Cushman, D
545 Tartakovsky) pp. 221–254. (CRC Press:Third Edition. Boca Raton, FL: CRC Press).
- 546 Soille P (2002) ‘Morphological image analysis: Pprinciples and Aapplications.’ (Springer-Verlag: Berlin
547 Heidelberg. New York)
- 548 Tamura T (2002) ‘Kkonpyuta gazoushori [Computer image processing]’ (Ohmsha. Japan) (in Japanese)
- 549 Vogel HJ, Tolke J, Schulz VP, Krafczyk M, Roth Ket al. (2005) Comparison of a lLattice--Boltzmann
550 mModel, a Ffull-mMorphology mModel, and a Ppore Nnetwork Mmodel for determining capillary
551 pressure – saturation relationships. *Vadose Zone Journal* 4, 380–388. doi:10.2136/vzj2004.0114
- 552 Wildenschild D, Sheppard AP (2013) X-ray imaging and analysis techniques for quantifying pore-scale
553 structure and processes in subsurface porous medium systems. *Advances in Water Resources* 51, 217–
554 246. doi:10.1016/j.advwatres.2012.07.018

- 555 Xu K, Daian JF, Quenard D (1997) Multiscale structures to describe porous media part I: theoretical
556 background and invasion by fluids. *Transport in Porous Media* 26(1), 51–73.
557 doi:10.1023/A:1006557915438
- 558 Yuan C, Chareyre B, Darve F (2016) Pore-scale simulations of drainage in granular materials: finite size
559 effects and the representative elementary volume. *Advances in Water Resources* 95, 109–124.
560 doi:10.1016/j.advwatres.2015.11.018
- 561 Zhang D, Zhang R, Chen S, Soll WE (2000) Pore scale study of flow in porous media: scale dependency,
562 REV and statistical REV. *Geophysical Research Letters* 27, 1195–1198. doi:10.1029/1999GL011101
563

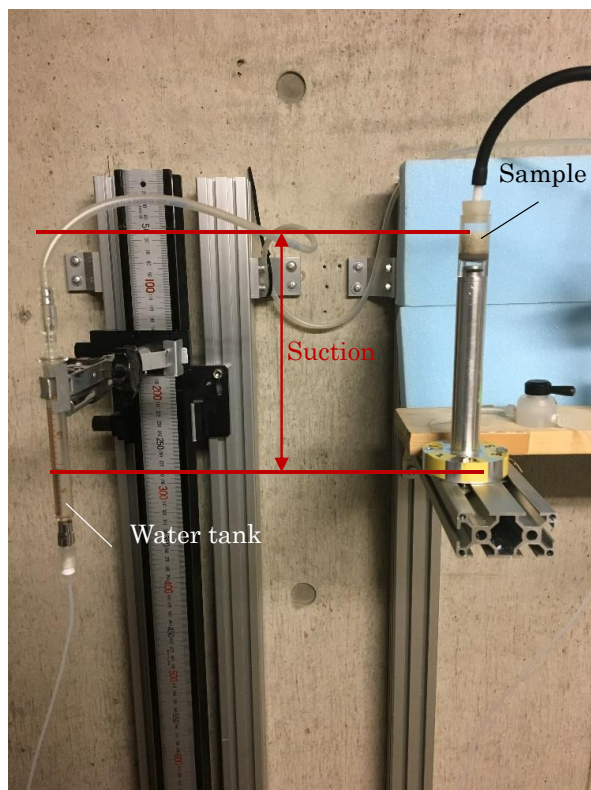

a)

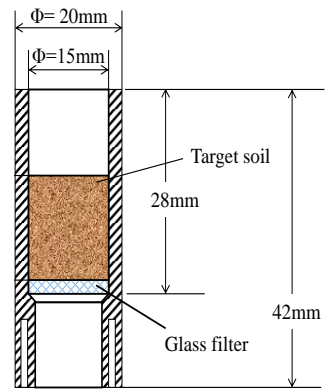

b)

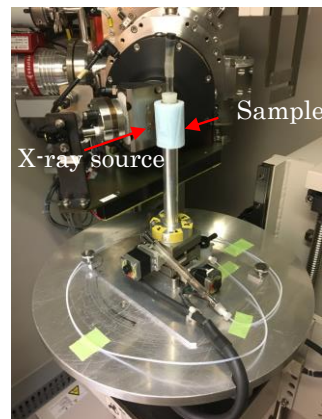

c)

564

565 **Fig. 1.** Experimental set-up. (a) hanging column test experiment, (b) schematic of the cell and (c) set-up
566 for micro-focused X-ray computed tomography (μ CT) scanning.

567

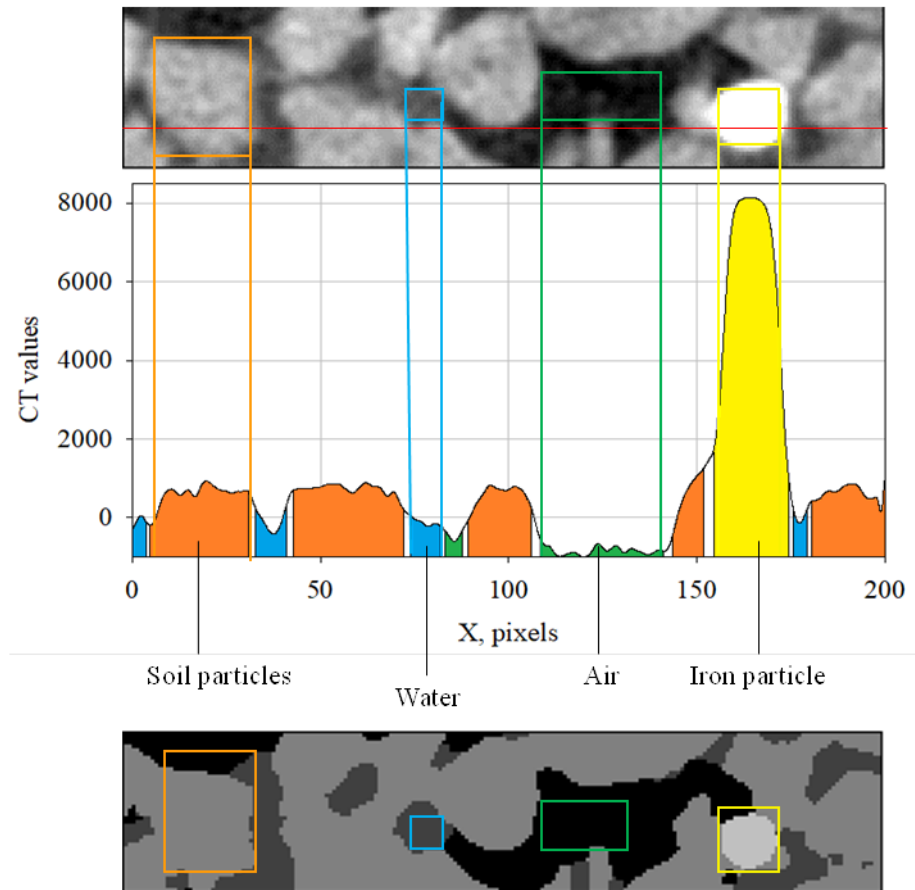

568

569 **Fig. 2.** Marker-controlled watershed method. Top: computed tomography (CT)-image pre-processing of
570 the Toyoura sand. Four phases are observed. Middle: CT values at a cut-line along with identification of
571 the different phases after markers are identified. White zones indicate unknown areas that will be filled by
572 region growth. Bottom: CT-image post-processing of the Toyoura sand.

573

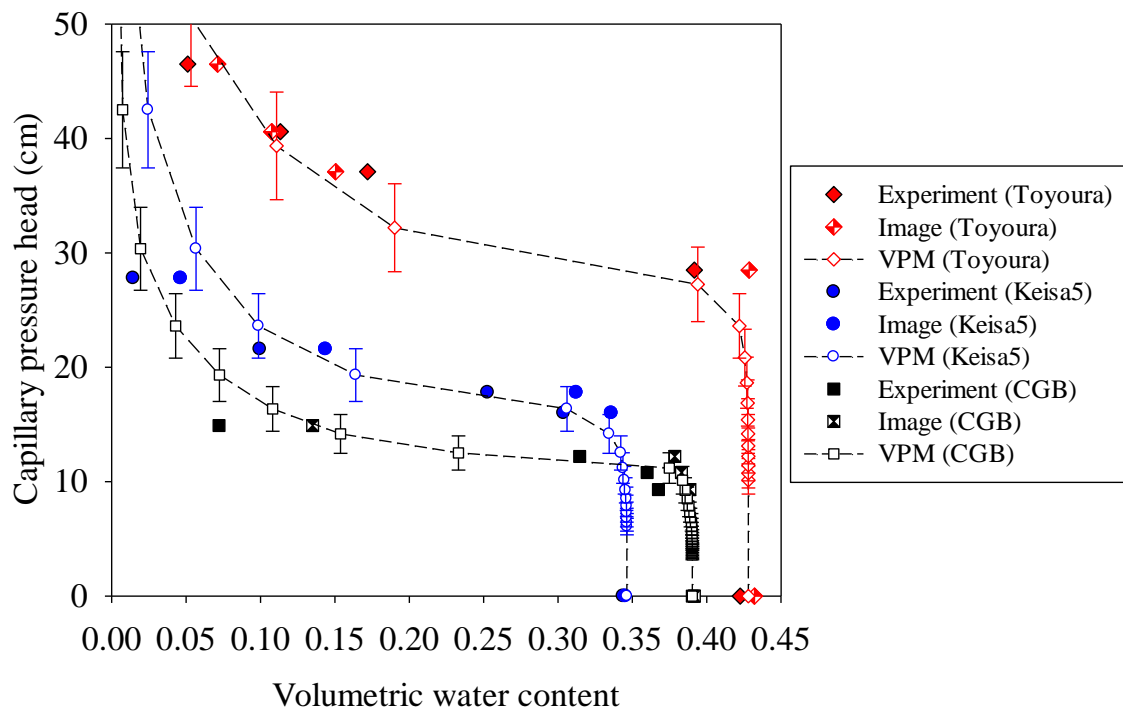

574

575 **Fig. 3.** Water retention curve (WRC) for each sand (Toyoura, Keisa5 and glass beads (CGB)) using
576 experimental data, image data and voxel percolation method (VPM) modelling results. The image data
577 means calculating the volumetric water content from the segmented CT image data.

578

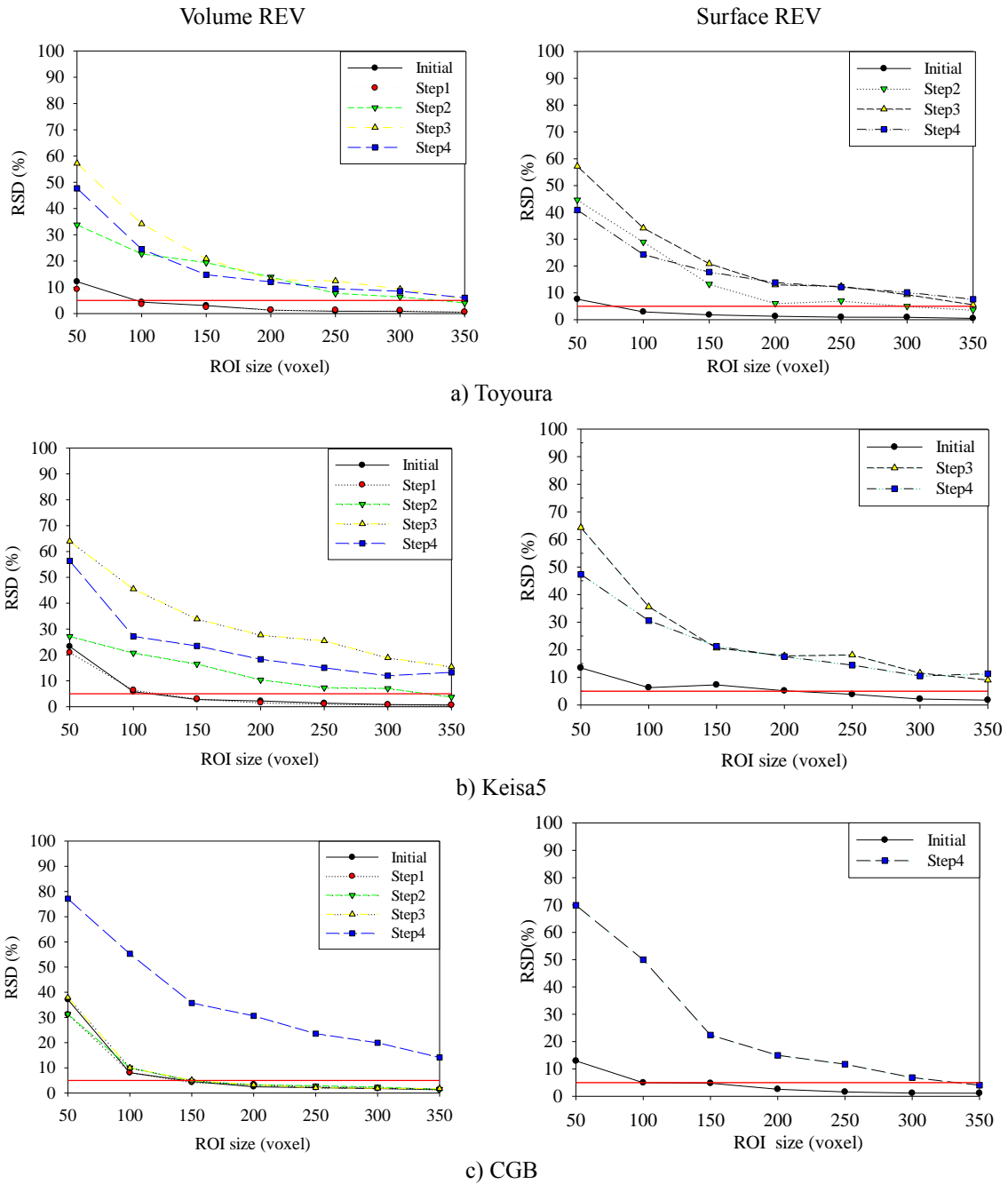

580 **Fig. 4.** Representative elementary volume (REV) calculation for each drainage step for (a, b) Toyoura
 581 sand, (c, d) Keisa5 sand and (e, f) glass beads (CGB). Evolution of relative standard deviation with ROI
 582 size (edge length in voxels). REV was considered achieved at relative standard deviation (RSD) < 5%
 583 (red line). (a, c, e) REV for water content. (b, d, e) Right side: REV for air–water specific interface. Only
 584 data below 100% are presented. One-voxel size is equal to 0.006 mm for Toyoura sand and 0.01 mm for
 585 Keisa5 sand and CGB.

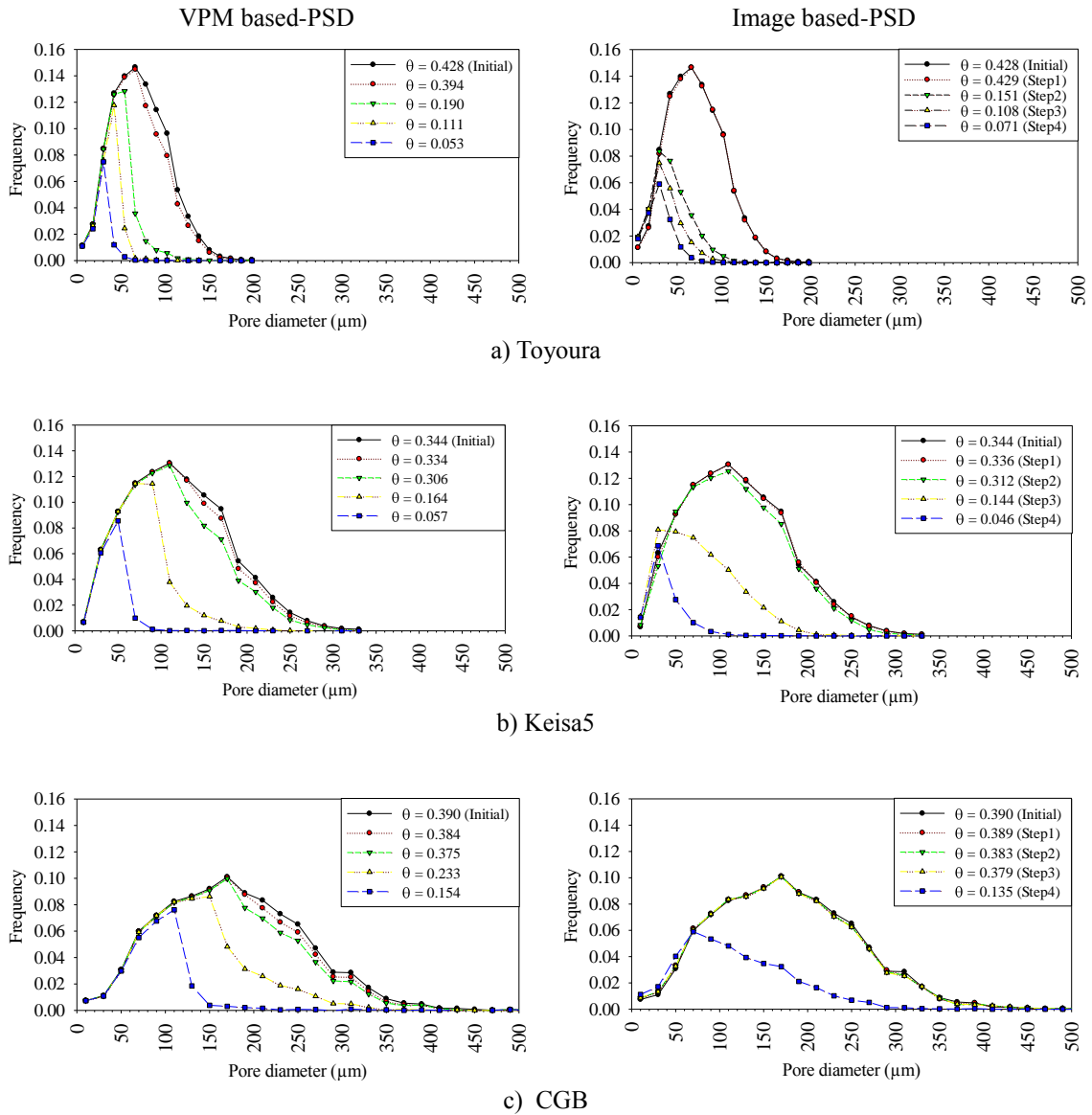

588 **Fig. 5.** Water-filled pore size distribution for all drainage steps for (a, b) Toyoura sand, (c, d) Keisa5
 589 sand and (e, f) glass beads (CGB). Volumetric water content (θ) of (a, c, e) was calculated from the
 590 segmented computed tomography image and θ of (b, d, f) was obtained from the experiment. The initial
 591 step corresponds to fully saturated conditions.
 592

593

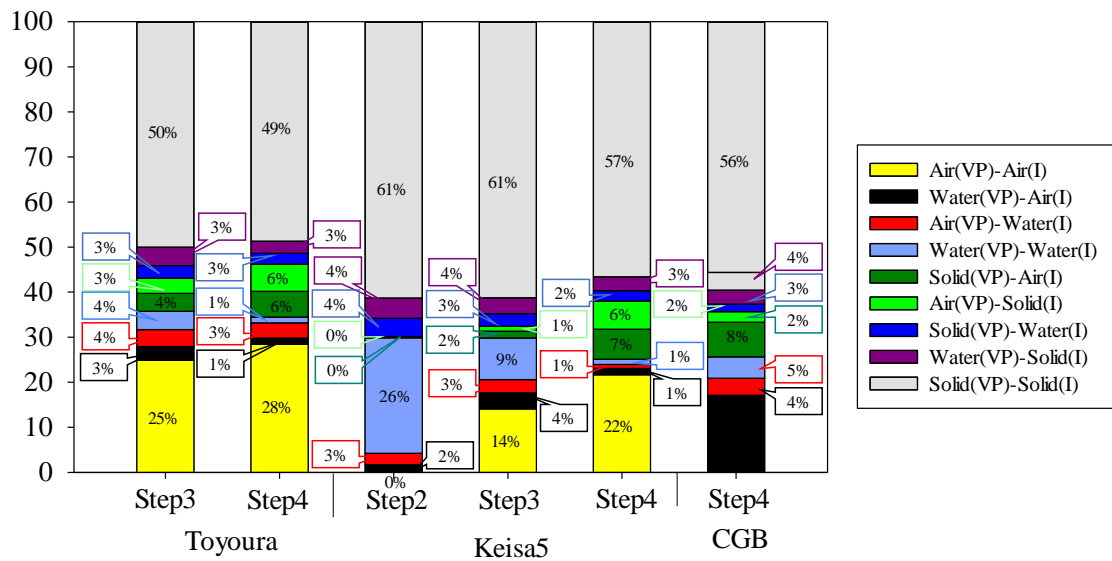

594

595 **Fig. 6.** Matching phase volume against total volume between segmented image (iron phase is included

596 in the solid phase) and voxel percolation method (VPM) simulation.

597

598

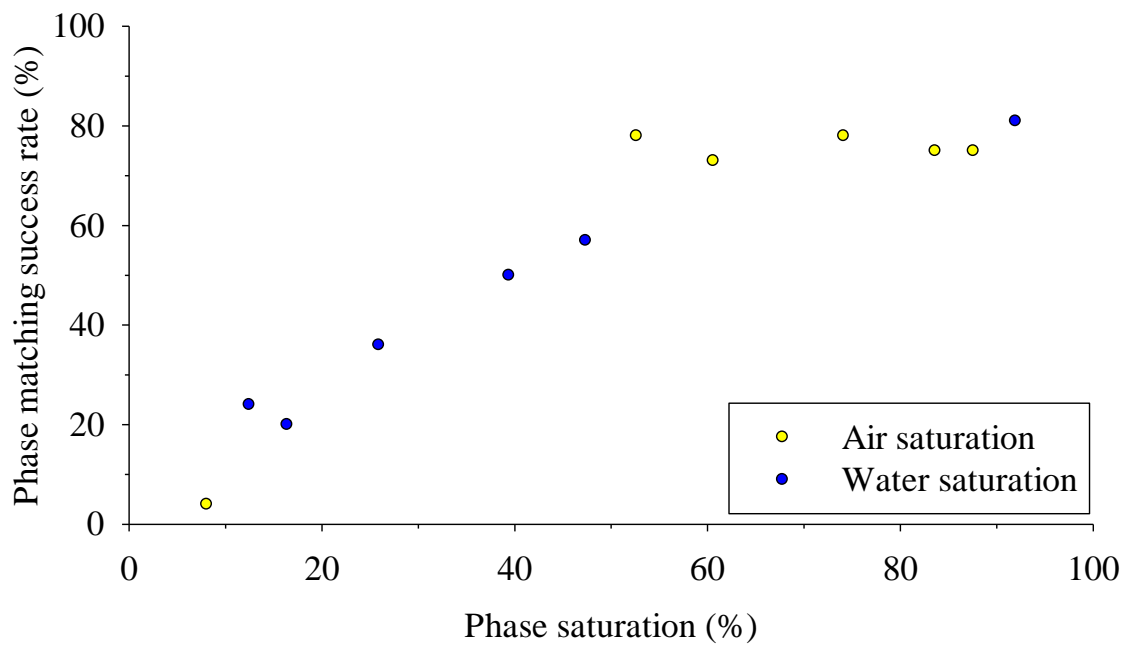

599

600 **Fig. 7.** Matching success rate between segmented image data and voxel percolation method simulation
601 for water and air phases against phase saturation (phase content over porosity).

602

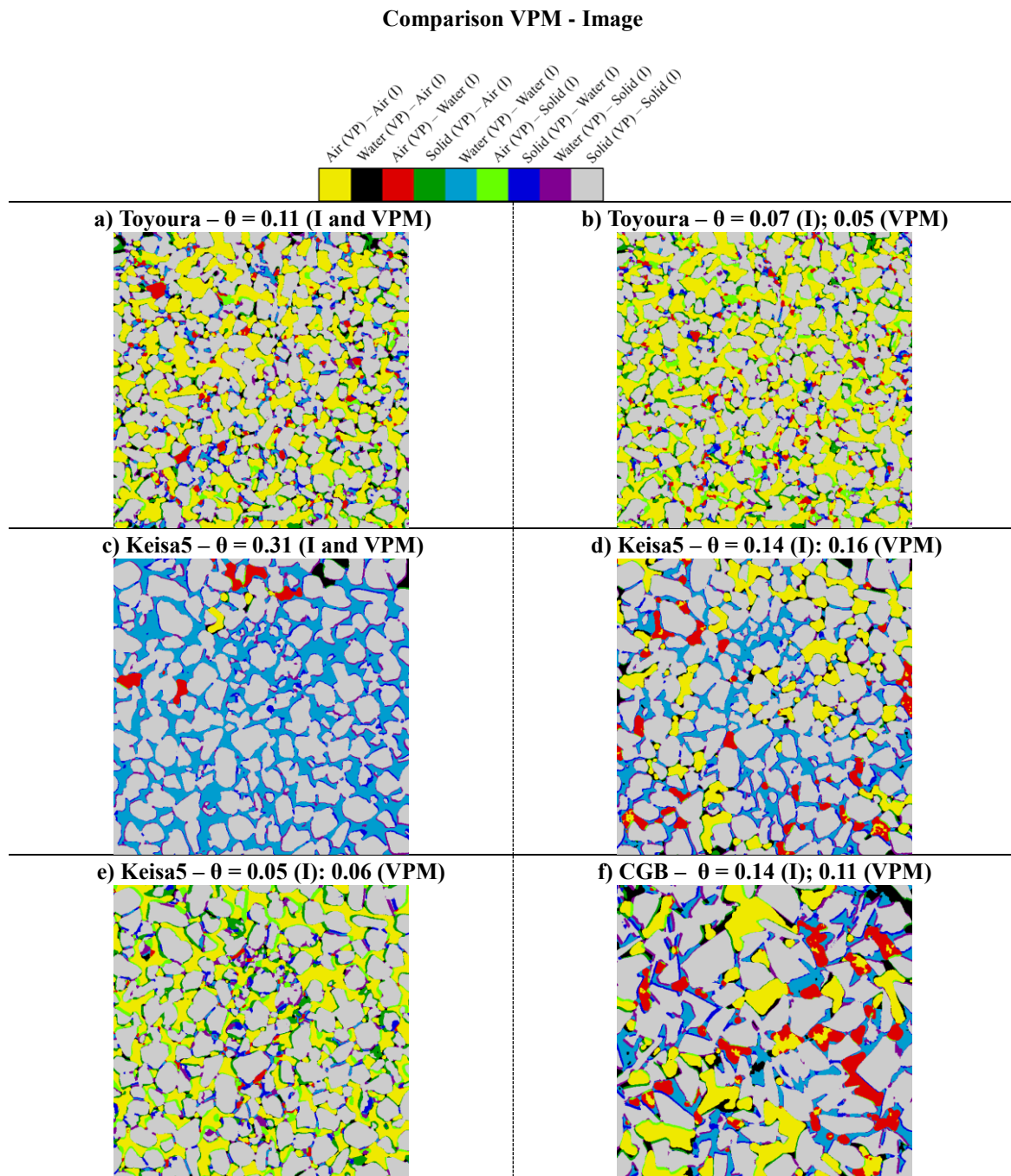

605 **Fig. 8.** Local comparison between the three-phase segmented image data (I, direct image) and voxel
606 percolation method (VPM) computed results for the 2D middle horizontal slice. (a, b) Toyoura sand at
607 Steps 3 and 4; (c, d, e) Keisa5 sand at Steps 2, 3 and 4; (f) CGB at Step 4. The colourbar associates each
608 colour with the pore labelling of the VPM results (VPM) and the segmented image results (I).

609

a) Toyoura – Step 3

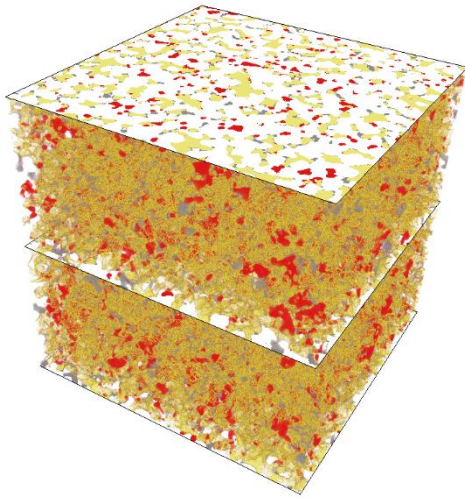

b) Toyoura – Step 4

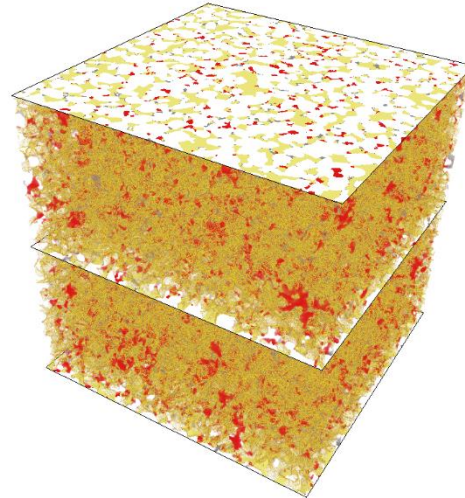

c) Keisa5 – Step 2

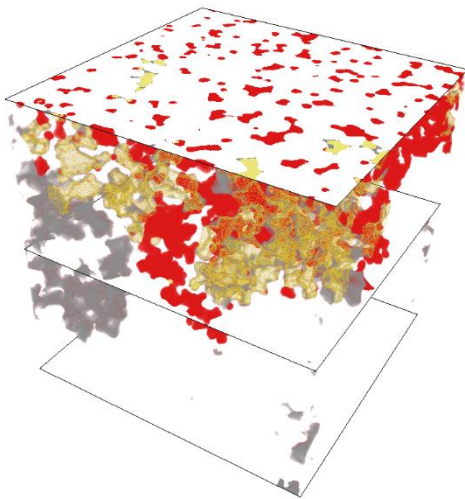

d) Keisa5 – Step 3

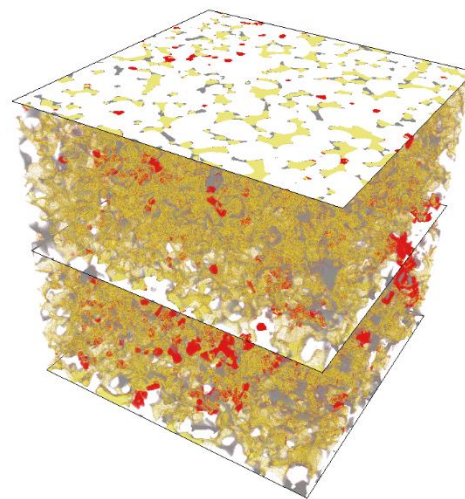

e) Keisa5 – Step 4

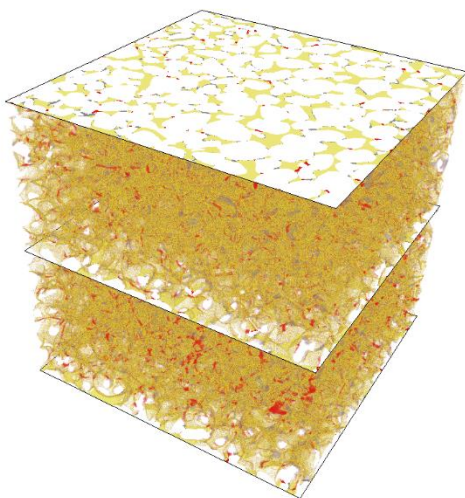

f) CGB – Step 4

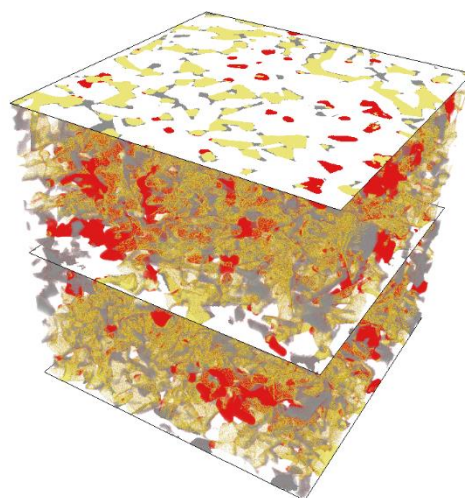

610

611 **Fig. 9.** Local comparison between the three-phase segmented image data and voxel percolation method
612 (VPM) computed results in 3D for *(a, b)* Toyoura sand at Steps 3 and 4; *(c, d, e)* Keisa5 sand at Steps 2, 3
613 and 4; *(f)* CGB at Step 4. Air flows from top to bottom. Air (VPM) vs. Air (I) in yellow, Air (VPM) vs.
614 Water (I) in red and Water (VPM) vs. Air (I) in grey, others in white.
615
616

617 **Table 1. Material properties in Toyoura sand, Keisa5 and CGB**

| | Toyouura | Keisa5 | CGB |
|---|----------|--------|------|
| Median grain diameter (μm) | 160 | 500 | 650 |
| Uniformity coefficient | 1.5 | 1.5 | 1.5 |
| Dry density (kg L^{-1}) | 1.51 | 1.72 | 1.53 |
| Initial porosity | 0.43 | 0.34 | 0.39 |
| Grain density (kg L^{-1}) | 2.64 | 2.63 | 2.51 |
| Sample Volume (mm^3) | 27.3 | 23.5 | 26.4 |

618

619

620 **Table 2. Micro-focused X-ray computed tomography (μ CT) scanning conditions for**
621 **each material**

| | Toyoura | CGB and Keisa5 |
|---|----------------------------------|---------------------------------|
| Voltage (kV) | 60 | 60 |
| Current (μ A) | 200 | 200 |
| Number of view angles | 1200 | 1200 |
| Projection average | 3 | 3 |
| Focus-to-centre distance (mm) | 14.0 | 24.7 |
| Voxel dimension (μ m) | $6 \times 6 \times 6$ | $10 \times 10 \times 10$ |
| Scan duration (min) | 45 | 45 |
| Volume of sample imaged (mm^3) | $6.144 \times 6.144 \times 5.34$ | $10.24 \times 10.24 \times 8.9$ |

622

623

624 **Table 3. Global characteristics values, computed representative elementary volume**
 625 **(REV) (“-“ means REV can’t calculate because specific interface is near 0 value. NA**
 626 **indicates when REV is not achieved at region of interest (ROI) edge length of 350 voxels),**
 627 **and relative standard deviation (RSD) at ROI edge length of 350.**

628 S_s , Specific surface (m^{-1} , initial step); S_{wa} , air–water specific interface (m^{-1} , Step 1 to Step 4).

| Values for total sample | | Initial | Step 1 | Step 2 | Step 3 | Step 4 |
|---|---------|---------|--------|--------|--------|--------|
| Water content | Toyoura | 43.2% | 42.9% | 15.1% | 10.7% | 7.1% |
| | Keisa5 | 34.5% | 34.4% | 31.2% | 14.4% | 4.6% |
| | CGB | 39.1% | 38.9% | 38.3% | 37.9% | 13.5% |
| Specific interface S_s or S_{wa} | Toyoura | 16817 | 0 | 2333 | 2336 | 2241 |
| | Keisa5 | 8019 | 1.8 | 170 | 927 | 735 |
| | CGB | 6661 | 67 | 73 | 65 | 731 |
| REV in voxels at RSD = 5% | | Initial | Step 1 | Step 2 | Step 3 | Step 4 |
| Water content | Toyoura | 97 | 97 | 330 | NA | NA |
| | Keisa5 | 115 | 123 | 282 | NA | NA |
| | CGB | 187 | 142 | 161 | 183 | NA |
| Specific interface S_s or S_{wa} | Toyoura | 74 | – | 333 | NA | NA |
| | Keisa5 | 169 | – | NA | NA | NA |
| | CGB | 114 | NA | NA | NA | 346 |
| RSD at ROI = 350 voxels | | Initial | Step 1 | Step 2 | Step 3 | Step 4 |
| Water content | Toyoura | 0.5% | 0.9% | 4.0% | 5.4% | 9.4% |
| | Keisa5 | 0.7% | 0.7% | 4% | 16% | 15% |
| | CGB | 1.6% | 1.3% | 1.8% | 1.3% | 10.7% |
| Specific interface S_s or S_{wa} | Toyoura | 0.7% | – | 4.1% | 5.7% | 8.8% |
| | Keisa5 | 2.4% | – | 135% | 9.2% | 8.4% |
| | CGB | 1.1% | 113% | 185% | 131% | 4.8% |

629

630