



HAL
open science

Isomer-sensitive characterization of low temperature oxidation reaction products by coupling a jet-stirred reactor to an electron/ion coincidence spectrometer: case of n-pentane

Jérémy Bourgalais, Zied Goud, Olivier Herbinet, Gustavo Adolfo Garcia, Philippe Arnoux, Zhandong Wang, Luc Sy Tran, Guillaume Vanhove, Majdi Hochlaf, Laurent Nahon, et al.

► To cite this version:

Jérémy Bourgalais, Zied Goud, Olivier Herbinet, Gustavo Adolfo Garcia, Philippe Arnoux, et al.. Isomer-sensitive characterization of low temperature oxidation reaction products by coupling a jet-stirred reactor to an electron/ion coincidence spectrometer: case of n-pentane. *Physical Chemistry Chemical Physics*, 2020, 22, pp.1222-1241. 10.1039/C9CP04992D . hal-02403856

HAL Id: hal-02403856

<https://hal.univ-lorraine.fr/hal-02403856v1>

Submitted on 2 Jul 2020

HAL is a multi-disciplinary open access archive for the deposit and dissemination of scientific research documents, whether they are published or not. The documents may come from teaching and research institutions in France or abroad, or from public or private research centers.

L'archive ouverte pluridisciplinaire **HAL**, est destinée au dépôt et à la diffusion de documents scientifiques de niveau recherche, publiés ou non, émanant des établissements d'enseignement et de recherche français ou étrangers, des laboratoires publics ou privés.

1 **Isomer-sensitive characterization of low temperature oxidation reaction**
2 **products by coupling a jet-stirred reactor to an electron/ion coincidence**
3 **spectrometer: case of *n*-pentane**

4
5 Jérémy Bourgalais¹, Zied Gouid², Olivier Herbinet³, Gustavo A. Garcia⁴, Philippe Arnoux²,
6 Zhandong Wang⁵, Luc-Sy Tran⁶, Guillaume Vanhove⁶, Majdi Hochlaf², Laurent Nahon⁴,
7 Frédérique Battin-Leclerc³

8
9 ¹LATMOS/IPSL, UVSQ Université Paris-Saclay, Sorbonne Université, CNRS, Guyancourt,
10 France

11 ²Université Paris-Est, Laboratoire Modélisation et Simulation Multi Echelle, MSME UMR 8208
12 CNRS, 5 bd Descartes, 77454 Marne-la-Vallée, France.

13 ³Université de Lorraine, Laboratoire Réactions et Génie des Procédés, UPR 3349, Nancy F-54000,
14 France

15 ⁴Synchrotron SOLEIL, L'Orme des Merisiers, Saint-Aubin-BP 48, 91192 Gif-sur-Yvette Cedex,
16 France

17 ⁵National Synchrotron Radiation Laboratory, University of Science and Technology of China,
18 Hefei, Anhui 230029, People's Republic of China

19 ⁶Physicochimie des Processus de Combustion et de l'Atmosphère (PC2A), UMR 8522 CNRS,
20 Université de Lille, F-59000 Lille, France

21
22
23
24 Physical Chemistry Chemical Physics
25
26
27
28

29 *Corresponding author: Frédérique Battin-Leclerc

30 e-mail: Frederique.battin-leclerc@univ-lorraine.fr

31 ORCID: 0000-0001-8265-7492

32 Phone: +33 (0)3 72 74 38 19

33
34
35
36
37
38
39
40
41
42
43
44
45
46
47
48
49
50
51
52
53
54
55
56

Abstract

Through the use of tunable vacuum ultraviolet light generated by the DESIRS VUV synchrotron beamline, a jet-stirred reactor was coupled for the first time to an advanced photoionization mass spectrometer based upon a double imaging PhotoElectron PhotoIon COincidence (i^2 PEPICO) scheme. This new coupling was used to investigate the low-temperature oxidation of *n*-pentane, a prototype molecule for gasoline or Diesel fuels. Experiments were performed under quasi-atmospheric pressure (1.1 bar) with a residence time of 3 s for two equivalence ratios (1/3 and 0.5) with a fuel initial mole fraction of 0.01. The measured time-of-flight mass spectra are in good agreement with those previously obtained with other photoionization mass spectrometers and, like those previous ones, display several m/z peaks for which the related species assignment is ambiguous. This paper shows how the analysis of the coincident mass-tagged Threshold PhotoElectron Spectra (TPES) together with first principle computations, consisting of the determination of the adiabatic ionization energies and the spectra of some products, may assist products identification. The results mostly confirm those previously obtained by photoionization mass spectrometry and gas chromatography, but also allow a more accurate estimation of the 1-pentene/2-pentene mole fraction ratio. Our data also indicate a higher formation of acetone and methyl ethyl ketone than what is predicted by current models, as well as the presence of products that were not previously taken into account, such as methoxyacetylene, methyl vinyl ketone or furanone. The formation of three, four and five membered ring cyclic ethers is confirmed along with linear ketones: 2- and 3-pentanone. A significant general trend in indicating higher amounts of ketones than gas chromatography is noted. Finally, TPES of alkenylhydroperoxides are also provided for the first time and constrains on the isomers identification are provided.

1. Introduction

In a critical energy and environment context, urgent actions need to be undertaken to reduce the emissions of harmful pollutants and to improve the energy efficiency of combustion processes. However, both require a comprehensive understanding of the combustion physico-chemical mechanisms explaining the reactivity behavior as a function of the temperature regime and of the fuel's molecular structure.[1] Detailed kinetic models based on elementary reactions help to address the influence of fuel-replacement and additives on the combustion reactions identifying

64 chemical pathways that form hazardous pollutants. However, despite a long period of research on
65 conventional petroleum-based fuels and more recently on alternative fuels, understanding detailed
66 combustion processes is still a large and vivid field of investigation. *In situ* diagnostics for real
67 combustion gas-phase environments (*e.g.*, motor engines, gas turbines) are challenging due to the
68 extreme physical parameters (pressure and temperature) and the rich chemistry leading to a wide
69 range of products (hundreds of species involved in thousands of reactions).[2] Thus, fundamental
70 investigations of combustion reactions are carried out in dedicated laboratory environments (*e.g.*,
71 jet-stirred or tubular reactors, laminar premixed low-pressure flames, shock tubes, rapid
72 compression machines)[3–9] under controlled conditions akin to practical systems. Then, reaction
73 mechanisms are built from this fundamental knowledge obtained over a large range of conditions
74 [10,11] and transferred to actual applied combustion processes.[12]

75 Most of the time laboratory diagnostics rely on Gas Chromatography (GC) often coupled
76 with Mass Spectrometry (MS) to provide an efficient structure-based identification of many stable
77 species for gas-phase chemistry analysis.[13,14] However, GC time resolution does not allow the
78 detection of elusive intermediates present in trace amounts with short lifetimes, in mixtures
79 containing up to several dozens of compounds. Short-lived reaction intermediates play key roles
80 in various gas-phase environments, determining reaction rates and the branching ratios between
81 different product channels, whose identification and quantification are mandatory to improve our
82 understanding of the relevant chemical processes.[15,16] Laser-based non-invasive methods are
83 sensitive and selective diagnostics allowing to detect and quantify reactive intermediates such as
84 free radicals.[17–20] However, most promising techniques are based on PhotoIonization Mass
85 Spectrometry (PIMS), through the use of synchrotron-generated tunable Vacuum UltraViolet
86 (VUV) light, providing a diagnostic to perform sensitive, multiplex *in situ* chemical analysis for
87 laboratory combustion environments.[5,6,16,21–23] However, synchrotron VUV PhotoIonization
88 Mass Spectrometry (SVUV-PIMS) allows only in few favorable cases isomer separation and
89 measurement of product branching ratios, including reactive intermediates through the
90 measurement of the photoion intensities as a function of photon energy to obtain the so-called
91 PhotoIonization Efficiency (PIE) curve of each molecule. [6,16,24–26]

92 Despite the efficiency of SVUV-PIMS, much more detail on the electronic and molecular
93 structures of the compounds can be obtained from photoelectron spectroscopy measuring the
94 kinetic energy (KE) of the electron ejected upon photoionization.[27,28] For a given species, the

95 photoelectron intensity is monitored as a function of electron binding energy yielding its
96 PhotoElectron Spectrum (PES), which by integration leads to the PIE curve. Note that the opposite,
97 differentiating the PIE to obtain the PES, is in practice not possible due to the experimental noise
98 amplification. PES offer a better sensitivity and selectivity as each electronic/vibronic state of the
99 ion appears as a distinct peak rather than changes of the slope in PIE spectra. However, PES
100 analysis in a complex environment, such as in combustion studies, results in the sum of all the
101 individual photoelectron spectra, making quantitative analysis difficult. PhotoElectron PhotoIon
102 COincidence (PEPICO) technique extracts both electrons and ions from the ionization events and
103 correlates them, in order to make use of the additional and complementary information from
104 coincident mass spectrometry and photoelectron spectroscopy.[29–34] In the context of
105 combustion processes, PES on mass-selected compounds is extremely useful as it adds to the mass
106 analysis provided by the PIMS method a full electronic/vibrational fingerprint, specific of a given
107 isomer, much richer than the single ionization energy information. Franck-Condon analysis can
108 also provide the ro-vibronic temperature of a given compound. This analytical method has been
109 only recently applied to combustion studies such as flames but its application is fast spreading and
110 has already succeeded in detecting reactive intermediates and final products.[35–41]

111 In this work we performed for the first time a PEPICO spectroscopy analysis during the
112 oxidation in a Jet-Stirred Reactor (JSR) of *n*-pentane, the simplest alkane presenting a low-
113 temperature reactivity really representative of that of heavier fuels present in gasolines and Diesel
114 fuels. For this reason, the oxidation of this C₅ saturated hydrocarbon has been thoroughly
115 experimentally investigated with reliable detailed kinetic modeling.[42–44] It is therefore a very
116 suitable example to address the capability of the PEPICO technique as an efficient probe for
117 complex combustion environments. The assignment of the experimental spectra is carried out
118 using either PES available in the literature or theoretical spectra as generated using first principle
119 approaches. It should be noted that the ionic products were considered in their electronic ground
120 states, i.e. we omitted the population of their electronic excited states.

121
122
123
124
125

126 2. Methods

127 2.1 Experimental procedure

128 Experiments were carried out at the undulator-based DESIRS VUV beamline [45] of
129 synchrotron SOLEIL using the SAPHIRS end-station [46], equipped with the double-imaging
130 photoelectron/photoion (i^2 PEPICO) spectrometer DELICIOUS III [33], to which the JSR
131 oxidation system was adapted. The SAPHIRS experimental setup was already described in the
132 past and only the specificities related to this work are therefore presented here. **Figure 1** displays
133 a scheme of the experimental setup adapted from Krüger et al. [36]

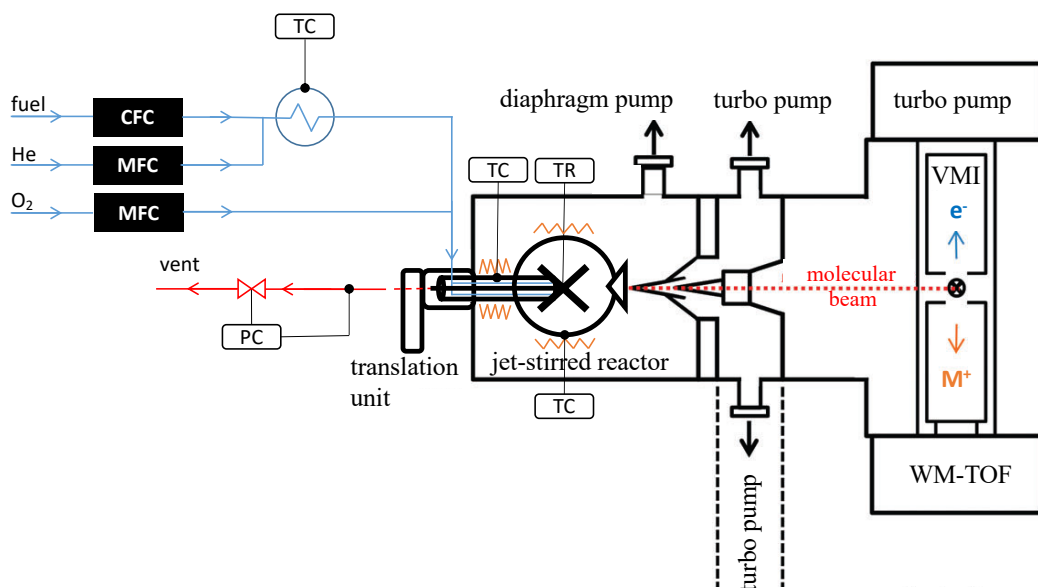

134
135 **Figure 1.** Schematic setup coupling the JSR to the SAPHIRS end-station. The synchrotron
136 radiation is perpendicular to the plane of the figure. CFC is the CoriFlow Controller, MFC are
137 the Mass Flow Controllers, TR is a Temperature Reading, TC are Temperature Controllers and
138 finally PC is a Pressure Controller.

139
140 The JSR set-up consists in a quartz sphere (volume $\approx 60 \text{ cm}^3$) connected to annular quartz
141 tubes (an outer tube inside an inner tube) mounted into a CF flange carrying all the diluted reactant
142 gas mixture, which was itself mounted into a 3-axes manipulator. After flowing in the outer tube,
143 the reactant enters the sphere through an injection cross located at the JSR center providing four
144 turbulent jets ensuring the mixing of the gas phase. Contrary to our usual JSR experiments [47],
145 the main gas flow leaves the reactor via a small hole in the injection cross, which is connected to
146 the inner tube. The JSR and the outer tube were heated with Thermocoax wires and temperatures

147 were varied from 580 to 675 K. The annular preheating zone is used to progressively increase the
 148 gas temperature up to the reactor temperature before entering the JSR (the residence time in this
 149 annular zone is only a few percent of that in the JSR). The preheating is important to avoid the
 150 non-homogeneity of the temperature in the gas phase [48]. Temperature measurements at different
 151 positions into the gas phase show that the temperature difference is smaller than 5K. The
 152 temperature was controlled using K-type thermocouples. An additional K-type thermocouple,
 153 located in the inner tube and only in contact with the burnt gases, was used to monitor the reaction
 154 temperature inside the reactor. Experiments were performed at constant temperature and pressure
 155 under steady state conditions and under quasi-atmospheric pressure (1.1 bar) with a residence time
 156 of 3 s for two equivalence ratios (1/3 and 0.5) with a fuel initial mole fraction of 0.01 and a dilution
 157 with He as a buffer gas. Calibrated mass and Coriolis flow controllers were used to control gas
 158 and liquid flow rates and the liquid fuel was mixed homogeneously into the gas flow using He as
 159 a carrier gas through a controlled evaporation mixing system (CEM, Bronkhorst). The fuel was
 160 provided by Sigma-Aldrich (anhydrous, purity $\geq 99\%$), the carrier gas and oxygen by Air Liquide
 161 (purities of 99.99% and 99.999%, respectively). Typical JSR conditions established from mixtures
 162 of fuel, oxygen and diluent He are summarized in **Table 1**.

163

C ₅ H ₁₂ (nmlm)	O ₂ (nmlm)	He (nmlm)	total flow (nmlm)	He dilution
6.1	145.9	456.0	607.9	75 mol% of He

164 **Table 1.** Typical JSR conditions for a $\phi = 1/3$ pentane-oxygen mixture at 1.1 bar, a
 165 residence time of 3 s, and a reaction temperature of 585 K; all flow rates are expressed in nmlm
 166 (normal milliliter per minute at 273.15 K and 1 bar).

167

168 The gas sample inside the reactor was probed through a quartz nozzle with a 100 μm hole
 169 and expanded into a differential pumping chamber (10^{-4} mbar), freezing the composition of the
 170 reactor. Then, the molecular beam traversed two consecutive copper skimmers of 1 and 2 mm
 171 diameter, expanding further (10^{-6} mbar) towards the ionization chamber where it intersects the
 172 ionizing focused VUV beam of DESIRS. Prior to entering the ionization chamber, the light
 173 supplied by DESIRS passed through a monochromator, equipped for this experiment with a 200
 174 grooves/mm grating, leading to a flux of ca. 10^{13} ph/s with a spectral resolution of ca. 20 meV at

175 10 eV. A gas filter located upstream the monochromator and filled with Kr effectively removed
176 high harmonics from the undulator ensuring a spectral purity across the 8-12 eV range used during
177 the experiments.[49] The photon flux was recorded as a function of the photon energy with a
178 dedicated photodiode (AXUV from Optodiode) and used to correct the spectra. The absolute
179 energy scale was calibrated against the 5s and 5s' Kr absorption lines seen in the experimental
180 total ion yields, leading to an absolute accuracy in the energy scale of the order of 4 meV.[50]

181 The molecular beam crossed the VUV synchrotron radiation at the center of the i²PEPICO
182 spectrometer DELICIOUS III [33]. The coincident electrons and ions resulting from the ionization
183 process are accelerated in opposite directions, analyzed respectively by a Velocity Map Imaging
184 (VMI) spectrometer and a modified Wiley-McLaren time-of-flight imaging spectrometer, and
185 detected in a multi-start/multi-stop coincidence scheme. The coincidence scheme allows the
186 photoelectron images to be tagged by the ion mass and velocity vector. In this work, apart from
187 the mass tagging, only photoelectrons correlated to ions having a net velocity along the molecular
188 beam axis are considered. This removes the background associated to the thermalized gas inside
189 the ionization chamber, and also improves KE and mass resolutions. The resulting mass-filtered
190 ion imaging-filtered photoelectron images are further treated to yield the photoelectron spectra by
191 Abel inversion.[51] The Threshold PES (TPES) are obtained according to the method outlined by
192 Pouilly et al. [52] and Briant et al. [53] where at each photon energy, only electrons along the
193 constant ionic state lines up to a certain eKE_{\max} value are counted. Here, a value of $eKE_{\max}=100$
194 meV has been used, which leads to an electron resolution of around 20 meV, comparable to the
195 photon energy resolution. The total energy resolution of the TPES is then ~ 30 meV. The TPES
196 shows the resonant transitions from the neutral ground state towards vibronic states of the cation,
197 and act as the vibronic fingerprint of the ionic species.[40]

198 In the following paragraphs, the experimental PE spectra have been used to identify
199 important combustion intermediates including isomers. Literature and calculated reference PE
200 spectra for each mass channel were summed and weighted with appropriate factors to fit the
201 measured PES in the appropriate photon energy range. The fit of the signal for a given mass
202 channel results in an isomeric branching ratio. Relative mole fractions of each isomer could then
203 be estimated by weighting the branching ratios using their respective absolute photoionization
204 cross sections from the literature when available. Note that this estimated relative mole fraction
205 derivation from published absolute photoionization cross sections relies on the assumption that we

206 can neglect autoionization processes and that the Franck-Condon approximation holds, so that we
207 can consider the TPES overall shape being representative of a fixed-photon energy PES.

208

209 **2.2 Theoretical PES calculations**

210 Species detected below m/z 70 in this work have been identified using their photoelectron
211 spectra and/or adiabatic Ionization Energies (IEs) found in the literature when available. In the
212 course of a previous study [22] of the low temperature combustion of *n*-pentane the adiabatic
213 ionization energies for several products common to this work have already been calculated using
214 Gaussian at CBS-QB3 level of theory including zero-point energy corrections [54]. This method
215 was assumed to be accurate to better than 50 meV when computing IEs. In the present work, we
216 aim not only at improving the accuracy, but also at providing full simulated photoelectron
217 spectrum for better selectivity when comparing with experimental results.

218 For $m/z > 70$, state-of-the-art *ab initio* methodology has been used to characterize specific
219 isomers, that lie close in energy making the experimental characterization challenging, for each
220 mass channel detected in the molecular beam. This combination between VUV synchrotron based
221 experiments and high level theoretical calculation has already been used for the study of the
222 electronic structure of nucleobases, including for instance the determination of the structures and
223 the energetics of gas phase cytosine tautomers [55], which are found in biological entities such as
224 DNA and RNA.

225 The electronic computations consisted on the determination of the equilibrium structures
226 of neutral and ionic species using the PBE0 density functional [56] as implemented in
227 GAUSSIAN09 [57], where the atoms are described using the augmented correlation-consistent
228 aug-cc-pVDZ basis set.[58,59] These full geometry optimizations were done in C_1 point group.
229 The minimal nature of these stationary points is checked after harmonic frequency computations
230 (all frequencies are positive). Zero point vibrational energies (ZPVE) were determined at the
231 anharmonic level as implemented in GAUSSIAN. Afterwards, we generated the PES using the
232 approach implemented in GAUSSIAN 09. Briefly, we performed Franck Condon (FC) analysis
233 and simulated the vibrationally resolved electronic spectra by means of the Time-Independent
234 Adiabatic Hessian Franck-Condon (TI-AH|FC) model.[60–63] The stick spectrum has been
235 convolved with a 20 meV bandwidth Gaussian profile.

236 For the determination of the IEs, the geometry optimizations are followed by single point
237 computations on the optimized structures using the explicitly correlated coupled cluster with
238 single, double and perturbative triple excitations ((R)CCSD(T)-F12) [64–67] together with the
239 aug-cc-pVTZ basis set in conjunction with the corresponding resolutions of the identity and
240 density fitting functions [68] as generated by MOLPRO.[69] Previous benchmarking by
241 comparison to experimental results showed that the composite scheme PBE0/aug-cc-
242 pVDZ(opt)//(R)CCSD(T)-F12/aug-cc-pVTZ(SP) allows accurate derivation of ionization energies
243 of medium-sized molecular systems (to within ± 0.01 eV).[55,70–74]

244 Afterwards, the computed spectra were shifted in energy so that the first peak fits with
245 adiabatic ionization energy as computed at the PBE0/aug-cc-pVDZ(opt)//(R)CCSD(T)-F12/aug-
246 cc-pVTZ(SP) level. All the simulated vibrationally resolved electronic spectra in this work are
247 given in the Supplementary Material.

248

249 3. Results

250 **Figure 2** shows typical Time-Of-Flight Mass Spectra (TOF-MS) obtained during the
251 oxidation of *n*-pentane at a reactor temperature of 585 K. To show the full range of obtained
252 spectrometric data, **Figure 2a** plots the TOF-MS as a function of *m/z* and photon energy at an
253 equivalence ratio (ϕ) of 0.5. **Figure 2b** shows the related TOF-MS recorded at a 10.5 eV fixed
254 photon energy for two different fuels, $\phi = 1/3$ and 0.5.

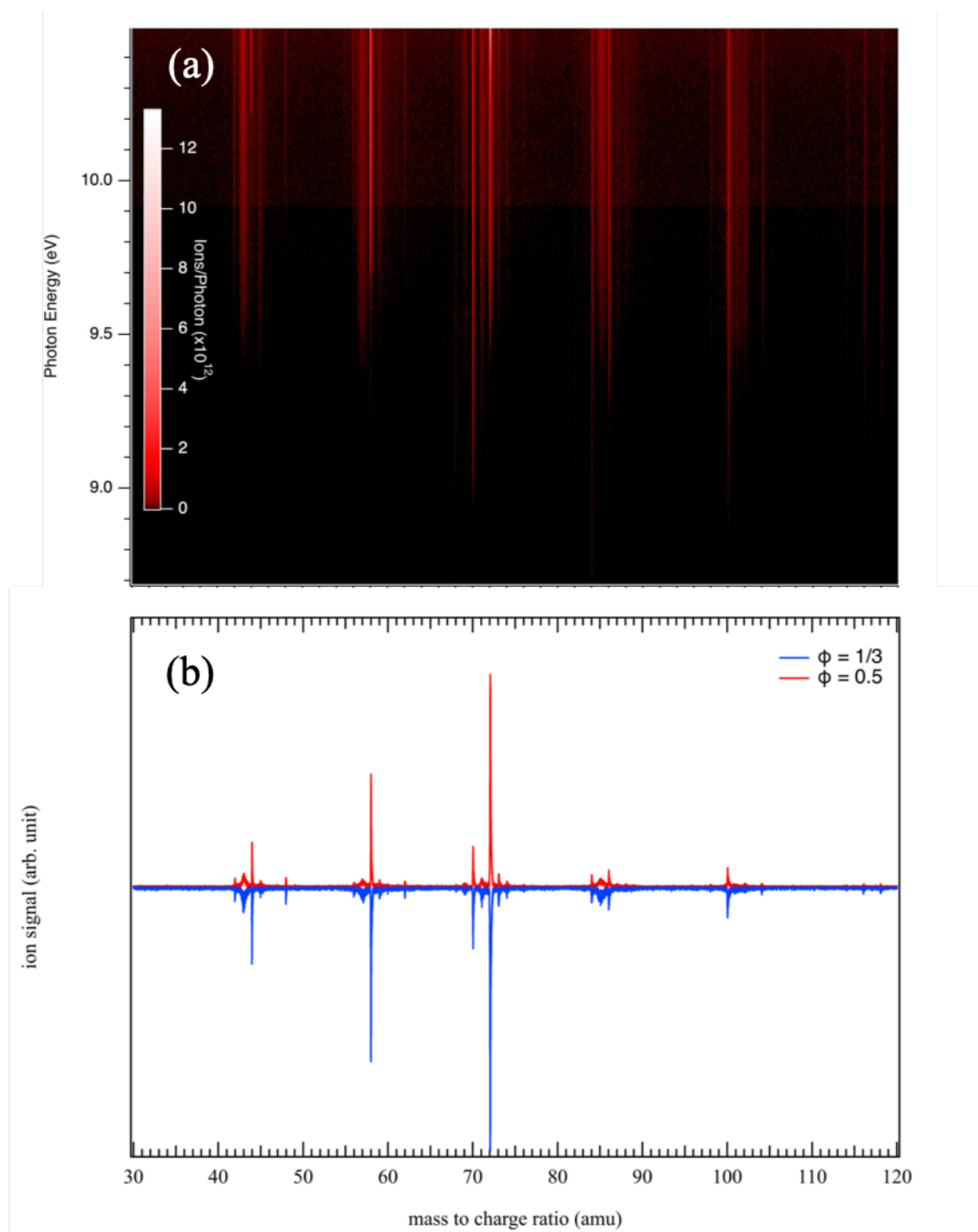

255
 256
 257
 258
 259
 260

Figure 2. Typical ion signal (a) as a function of m/z and of photon energy (a $\gamma=3$ non-linear colormap, where $\text{intensity}=\text{counts}^{(1/\gamma)}$, has been applied to enhance contrast), and (b) at a fixed energy of 10.5 eV for the $\phi = 1/3$ (blue) and $\phi = 0.5$ (red) conditions during the low temperature combustion of *n*-pentane ($T = 585$ K).

261 In the following text, two types of experimental data are presented: (i) at a fixed photon
262 energy and (ii) in the scanning mode where the photon energy is scanned in 7 meV steps and the
263 mass-selected photoelectron spectra and mass spectra are recorded as a function of photon energy.
264 The comparison of both $\phi = 1/3$ and $\phi = 0.5$ conditions shows nearly identical TOF-MS and only
265 small variations on the relative intensities of the TOF peaks are observed. The analysis of this work
266 is focused on relatively heavy molecules (> 40 amu) for which experimental or calculated
267 reference PES have been used to identify important combustion intermediates.

268 Literature presents a couple of experiments [42,44] about *n*-pentane oxidation carried out
269 in JSR under conditions close to those used in this work:

- 270 • Fuel inlet mole fraction 0.01
- 271 • Equivalence ratios of 0.5, 1 and 2
- 272 • Temperatures: 500-1100 K
- 273 • Residence time: 2 s
- 274 • Pressure: 106.7 kPa
- 275 • Four diagnostics (GC with MS for identification and flame ionization detection for
276 quantification, SVUV-PIMS, Single Photoionisation-TOF-MS (SPI-MS), Cavity Ring
277 Down Spectroscopy (cw-CRDS))

278 Using these different techniques, many species were quantified in these two studies such
279 as acetaldehyde ethylene, propene and cyclic ethers by GC, formaldehyde and H₂O₂ by cw-CDRS,
280 C₁-C₄ hydroperoxides by SVUV-PIMS and SPI-MS, ketene by SPI-MS. The quantification in
281 SVUV-PIMS and SPIMS analyses was performed using an approximate absolute ionization cross
282 section, estimated by group additivity as proposed by Bobeldijk et al. [75], as there is no data
283 available in the literature for each species and isomers could not be separated for several mass
284 channels. In the following, the simulated mole fractions and production mechanisms are obtained,
285 in the above-described conditions ($\phi = 0.5$), using the model of Bugler et al. [44], which can very
286 well reproduce the JSR results of both studies.

287 As shown in the comparison displayed in **Figure 3**, the typical mass spectra obtained in
288 this work are consistent with previous studies from the literature about *n*-pentane oxidation at low
289 temperature obtained by SPI-MS [42]: all the *m/z* species measured by SPI-MS between 50 and
290 90 are also in our TOF-MS.

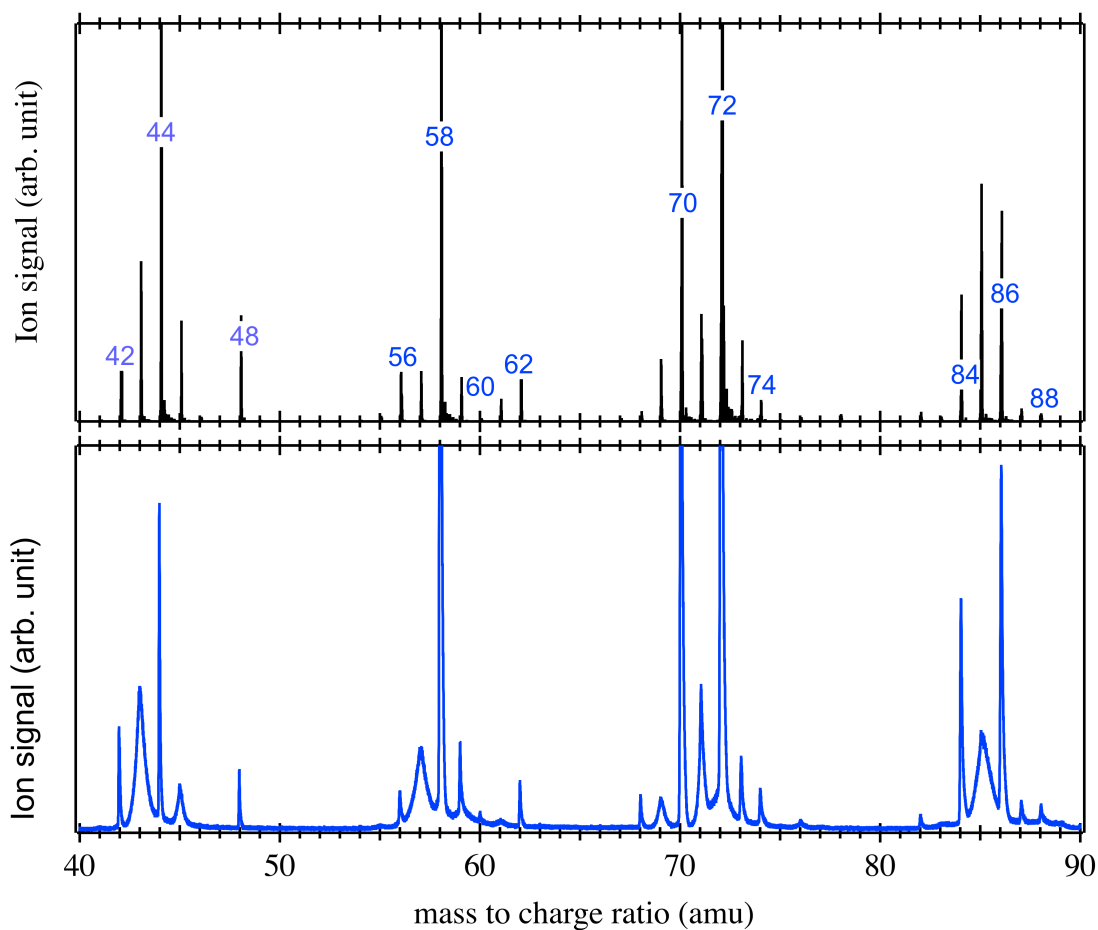

291
 292 **Figure 3.** Comparison between (upper panel) the mass spectra obtained by SPI-MS [42] during
 293 *n*-pentane oxidation at 600 K at $\phi = 0.5$, and (lower panel) the results obtained in this work at
 294 10.5 eV photon energy and 585 K at a similar fuel to air equivalence ratio - Peaks at *m/z* 58, 70
 295 and 72 have been cut off in intensity for the sake of clarity.

296
 297 Among the measured signal observed on the mass spectra, discrimination has been made
 298 between fragments and parent ions. This was easily achieved since daughter species nearly always
 299 show no structure on the corresponding TPESs because they come from unbound states of the
 300 parent ion. Additionally, the fragments exhibit broader peak shapes in the TOF-MS, due to the
 301 kinetic energy release upon fragmentation, as shown in the mass spectrum of the lower panel in
 302 the **Figure 3**. Therefore, *m/z* 43, 45, 57, 71 and 85 are considered as fragments even if the presence
 303 of an additional parent species for a given mass channel could not be ruled out. The origin of those
 304 fragments along with the analysis of the heaviest intense peaks above *m/z* 90 (such as *m/z* 100 and

305 118 present in both spectra but not shown in **Figure 3**) will be the focus of a future article and will
 306 not be considered in this work.

307 The identification of the important species detected in the mass spectra in **Figure 3** was
 308 attempted using their ionization energies, as summarized in **Table 2**. However, for most of the
 309 species, several identifications are possible. Therefore, the TPES corresponding to each m/z of
 310 interest should be examined more closely. The TPES related to all the m/z labeled in blue in **Figure**
 311 **3** are presented and discussed hereafter in the text. These were measured during the JSR oxidation
 312 of *n*-pentane at a reaction temperature of 585 K with an equivalence ratio of $\phi = 1/3$ and 0.5.

313 ^aprevious theoretical calculations from the literature.[22]

314 ^bcalculated value in this work.

315 *NIST database (<http://webbook.nist.gov/>).

m/z	formula	Name	IE (eV)
28	C ₂ H ₄	ethylene	10.51*
	CO	carbon monoxide	14.01*
30	CH ₂ O	formaldehyde	10.88*
32	CH ₄ O	methanol	10.84*
	O ₂	oxygen (reactant)	12.07*
42	C₃H₆	propene	9.73*
	C₂H₂O	ketene	9.62*
44	C ₃ H ₈	propane	10.94*
	C₂H₄O	acetaldehyde	10.23*
		ethylene oxide	10.56
	CO ₂	carbon dioxide	13.777*
48	CH₄O₂	methyl hydroperoxide	9.84^a
56	C₂HOCH₃	methoxyacetylene	9.48*
	C₂H₃CHO	acrolein	10.11*
58	(CH₃)₂CO	acetone	9.7*
	CH₃CH₂CHO	propanal	9.96*
60	C ₂ H ₄ O ₂	acetic acid	10.69*
62	C ₂ H ₆ O ₂	ethyl hydroperoxide	9.61 ^a
70	C ₅ H ₁₀	1-pentene	9.49*
	C ₅ H ₁₀	2-pentene (Z)	9.01*
	C ₅ H ₁₀	2-pentene (E)	9.04*
	C₄H₆O	methyl-vinyl-ketone	9.65*
72	C ₅ H ₁₂	<i>n</i> -pentane (reactant)	10.28*
	C₄H₈O	methyl-ethyl-ketone	9.60^b
74	C ₃ H ₆ O ₂	allyl hydroperoxide	9.55 ^a
		propanoic acid	10.44*
84	C ₄ H ₄ O ₂	2-furanone	10.86 ^b
		3-furanone	9.30 ^b
86	C ₅ H ₁₀ O	tetrahydropyran	9.62 ^b
		2-methyltetrahydrofuran	9.33^b

		cis 2,4-dimethyloxetane	9.40^b
		trans 2,4-dimethyloxetane	9.38^b
		2-ethyloxetane	9.45^b
		cis 2-ethyl-3-methyloxirane	9.48^b
		trans 2-ethyl-3-methyloxirane	9.98^b
		2-propyloxirane	10.11^b
		pentanal	9.98^b
		pentenol	7.48^b
		2-pentanone	9.52^b
		3-pentanone	9.439^b
88	C₄H₈O₂	But-1-enyl-3-hydroperoxide	9.33^b
		But-2-enyl-1-hydroperoxide	9.52^b

316 **Table 2.** Possible identifications of species detected in SVUV-PIMS analysis using their IE. IEs
 317 are from the NIST database (<http://webbook.nist.gov/>) when available or were calculated using
 318 Gaussian (CBS-QB3 level of theory) in previous work.[22] Adiabatic IEs were calculated in this
 319 work at the PBE0/aug-cc-pVDZ(opt)//(R)CCSD(T)-F12/aug-cc-pVTZ(SP) level of theory. The
 320 identification of the compounds in bold are discussed further in the paper.
 321

322 *Channel m/z 42*

323 **Figure 4** displays the measured TPES for m/z 42. The observed features in **Figure 4** agree
 324 well with the literature spectra of ketene (C₂H₂O) [76] and propene (C₃H₆) [77]. The first peak
 325 corresponds to the IE of ketene at 9.62 eV and the second one at 9.73 eV to propene along with
 326 contributions corresponding to the population of the vibrational levels of the ketene cation upon
 327 ionization of the corresponding neutral. The other peaks at higher energy arise from a vibrational
 328 progression of both propene and ketene. The literature spectra were summed and weighted with
 329 appropriate factors to fit the measured PES in the appropriate photon energy range. The fit of the
 330 data results in an observed ketene:propene signal branching ratio of 1:0.5 with fit errors below
 331 10%. Relative mole fractions could then be estimated by weighting the branching ratio using the
 332 absolute photoionization cross sections at 10.5 eV from Yang et al. [78] for ketene (24.8 Mb) and
 333 Person et al. [79] for propene (10.9 Mb). The weighting leads to a ketene:propene mole fraction
 334 (MF) ratio of 0.9:1 suggesting that propene is present in higher amounts than ketene. These results
 335 are in very good agreement with previous GC [44] and SPI-MS [42] measurements for which mole
 336 fractions of 10 ppm for ketene and of 15 ppm for propene at 580 K were determined leading to a
 337 MF ratio of ketene:propene 0.6:1. Ketene was already detected in flames [41] and JSR experiments
 338 [42] during oxidation of alkenes and alkanes, respectively. According to Bugler et al. kinetic model
 339 [44], in a JSR at low temperatures, ketene is predicted to be formed mainly by successive
 340 decomposition from the second most abundant ketohydroperoxide (the 3,1-C₅ ketohydroperoxide)

341 via the $C_2H_5COCH_2$ radical according to model computations. Ketohydroperoxides are the heart
342 of the low-temperature oxidation mechanism [21] their production by two successive oxygen
343 additions is favored as ϕ decreases. Propene is a significant product above 800 K, which can be
344 formed by β -scission decomposition of 2-pentyl radical.
345

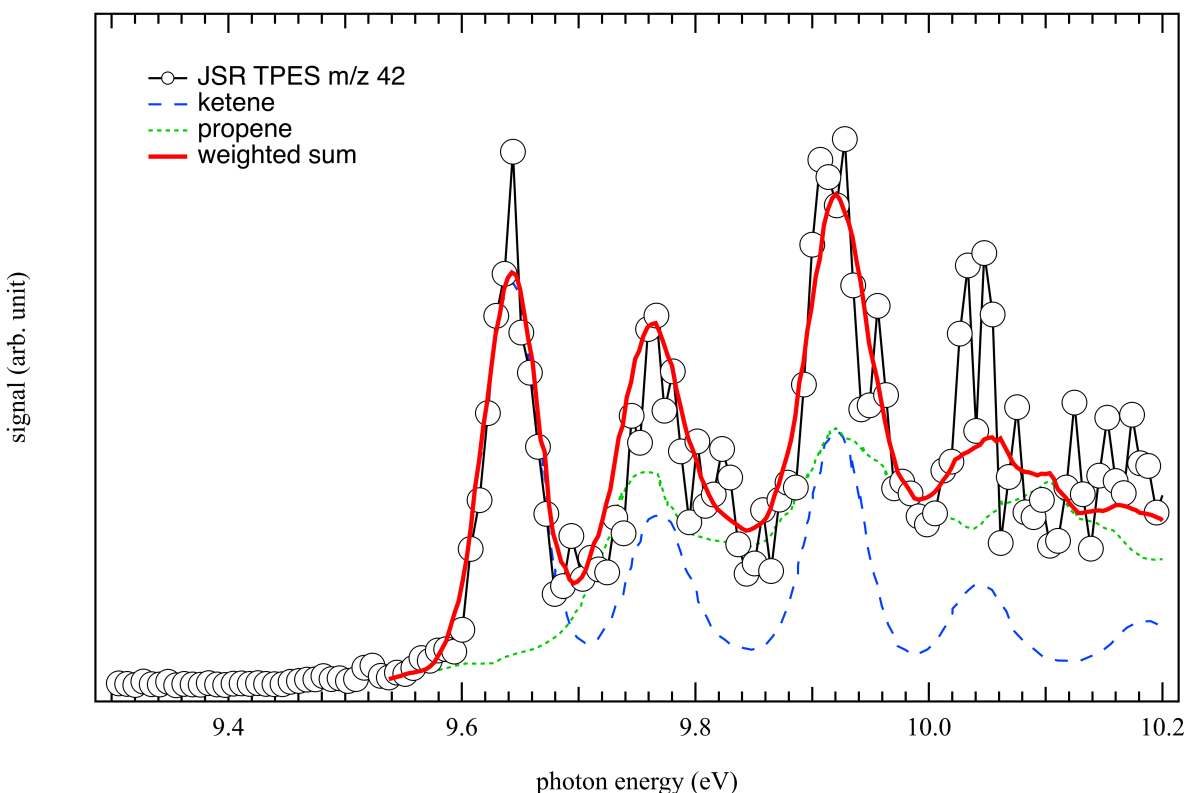

346
347 **Figure 4.** Comparison of the TPES at m/z 42 (open circles) measured during the JSR oxidation
348 of n -pentane at a reaction temperature of 585 K with an equivalence ratio of $\phi = 0.5$ with the
349 weighted sum of reference spectra using the PES of ketene (dashed red line) from Niu et al. [76]
350 and propene (dot green line) from Bieri et al. [77] The best fit is obtained for a ketene:propene
351 signal branching ratio of 1:0.5.

352
353 **Channel m/z 44**

354 As it is readily assigned to CH_3CHO (acetaldehyde) through its published PES [80], the
355 TPES of m/z 44 is discussed first. For other m/z , several species assignments can be proposed.
356 The experimental TPES of m/z 44 is shown in **Figure 5**, and. Another possible isomer could be
357 ethylene oxide C_2H_4O based on its ionization energy (IE: 10.56 eV). However, there is nothing

358 evident at this photon energy to suggest its presence, and the reported reference PES [81] for this
359 species in the literature does not match the bands seen in **Figure 5**. Propane (C_3H_8) is another
360 possibility with an IE of 10.94 eV [82], but the reported TPES does not much the bump seen
361 around 11 eV in our TPES and GC experiments show that propane can only be formed at much
362 higher temperatures. Therefore, we did not see propane in TPES obtained at 585K and the unsigned
363 bands peaking at 10.9 eV and 11.3 eV cannot be matched to other isomeric structures and might
364 arise from dissociative ionization of heavier species. Note that carbon dioxide cannot be detected
365 in this photon energy range since its ionization energy is much higher at 13.77 eV. Acetaldehyde
366 (IE: 10.229 eV) [83] is a toxic pollutant and a major intermediate during alkane low-temperature
367 oxidation arising mainly from the decomposition of the major ketohydroperoxide (the 2,4- C_5
368 ketohydroperoxide) according to model computations. The mole fraction of acetaldehyde at 580
369 K ($\phi = 0.5$) measured by GC [44] is 600 ppm, while that of ethylene oxide is 15 ppm supporting
370 the lack of signal around its predicted IE.
371

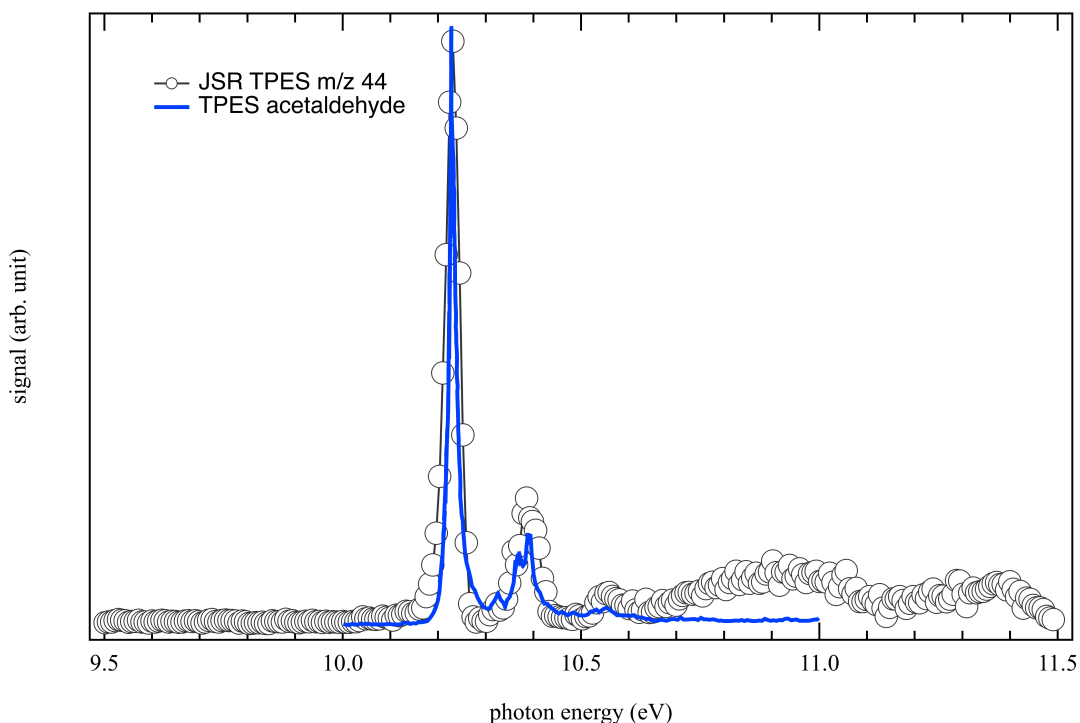

372
373 **Figure 5.** Comparison between the TPES at m/z 44 (open circles) measured during the JSR
374 oxidation of n -pentane at a reaction temperature of 585 K with an equivalence ratio of $\phi = 1/3$
375 and the TPES of acetaldehyde (blue line) from Yench et al. [84].

376
377
378
379
380
381
382
383
384
385

Channel m/z 48

The TPES correlated to 48 amu is displayed in **Figure 6**. It shows a threshold around 9.8 eV, which is in good agreement with previous experimental and theoretical ionization energy of methyl hydroperoxide CH_3OOH (IE: 9.84 eV) in the literature.[42] However no theoretical or experimental PES are available in the literature. Methyl hydroperoxide (mole fraction of 150 ppm at 585 K, $\phi = 0.5$) was found along with H_2O_2 , the most abundant peroxide in SVUV-PIMS experiments during the oxidation of *n*-pentane.[42] Note that the sharp signal drop around 11 eV is due to ion fragmentation as in **Figure 9**.

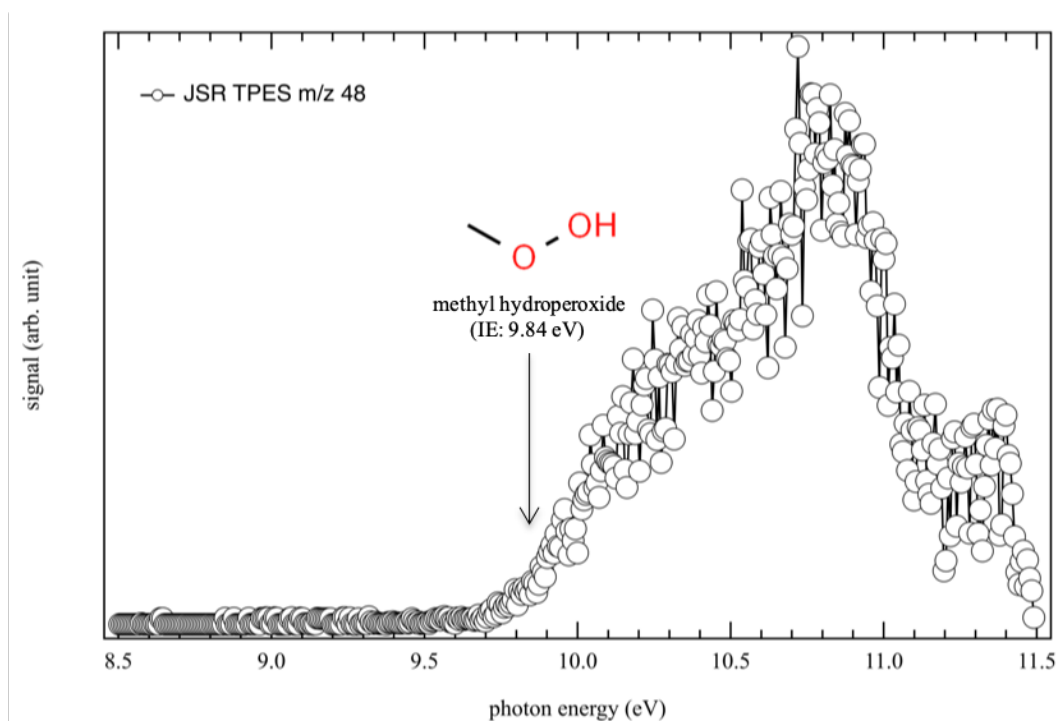

386
387 **Figure 6.** Measured TPES at m/z 48 (open circles) during the JSR oxidation of *n*-pentane at a
388 reaction temperature of 585 K with an equivalence ratio of $\phi = 1/3$.

389
390

Channel m/z 56

391 **Figure 7** shows the experimental TPES at m/z 56 measured in JSR which could come from
392 potential contributions from several species such as C_4H_8 (but-2-ene, iso-butene, but-1-ene) and
393 $\text{C}_3\text{H}_4\text{O}$ isomers (acrolein ($\text{C}_2\text{H}_3\text{CHO}$), methylketene, methoxyacetylene (C_2HOCH_3)) isomers.
394 However, methylketene (IE: 8.95 eV) [85], but-2-ene (IE: *trans* 9.10 & *cis* 9.11 eV) and iso-butene

395 (IE: 9.22 eV) (<http://webbook.nist.gov/>) could be easily ruled out based on their lower ionization
396 energies and compared to the threshold observed around 9.4 eV in **Figure 7**. The best fit obtained
397 from the available PESs of acrolein, methoxyacetylene, and but-1-ene is shown in **Figure 7**. This
398 fit is for an observed acrolein:methoxyacetylene:but-1-ene signal branching ratio of 1:0.04:0.08
399 and allows us to infer that the measured spectrum is dominated by acrolein (IE: 10.11 eV) [84].
400 The unsaturated C₃ aldehyde, acrolein is a very toxic compound and also a typical intermediate
401 found during the oxidation of organic fuels at low temperature.[86] Acrolein was measured in
402 relatively high amounts during *n*-pentane oxidation experiments (around 180 ppm at 580 K and
403 $\phi=0.5$) [44]. Acrolein, the formation of which is satisfactorily predicted by the model (140 ppm),
404 can be obtained through fast decomposition of allyl hydroperoxide, obtained by the combination
405 of the abundant allyl and HOO radicals. However, the best fit does not reproduce satisfactorily the
406 low photon energy part of the spectrum. Despite the fact that the weighting factor error on acrolein
407 is around 3%, the weighting factor errors on methoxyacetylene and but-1-ene are 40% and 10%
408 respectively due to a low signal to noise ratio. Thus, it is not possible to address or rule out their
409 respective contribution in this work but if so, they are formed as minor species. Methoxyacetylene
410 (IE: 9.48 eV) [87] is not considered in the *n*-pentane oxidation model of Bugler et al. [44] and
411 under the present conditions, butenes were also measured in low amount by GC [44] (7 ppm).
412 However, but-1-ene (IE: 9.55 eV) [88] is a significant product above 800 K because it can be
413 formed by C-C β -scission decomposition of the 3-pentyl radical.

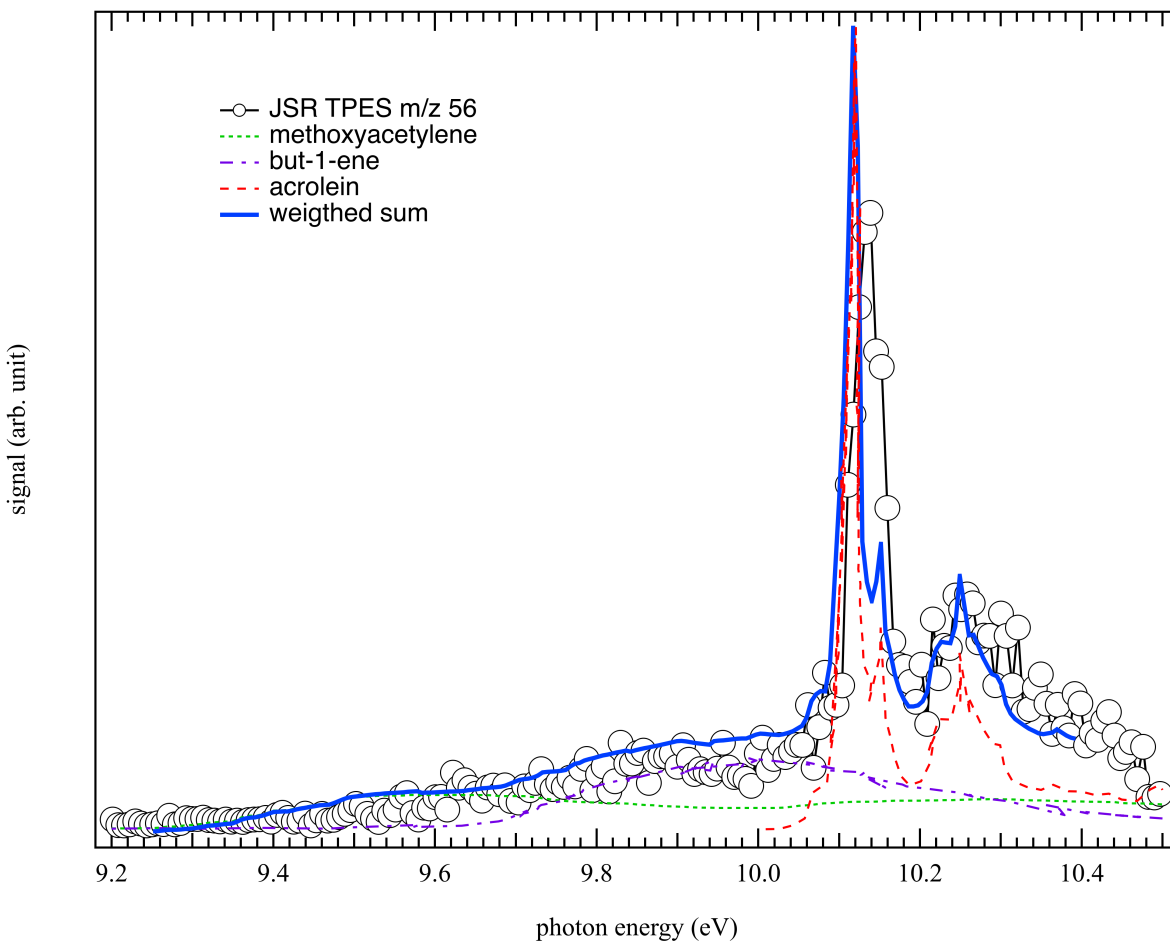

414
 415 **Figure 7.** Comparison between the TPES at m/z 56 (open circles) measured during the JSR
 416 oxidation of n -pentane at a reaction temperature of 585 K with an equivalence ratio of $\phi = 0.5$
 417 and the weighted sum of reference spectra using the TPES of acrolein (dashed red line) from
 418 Yenchu et al. [84], and the PES of methoxyacetylene (dot green line) [87], and but-1-ene (dot-
 419 dashed line) [88]. The best fit is obtained for a acrolein:methoxyacetylene:but-1-ene signal
 420 branching ratio of 1:0.04:0.08.

421
 422 **Channel m/z 58**

423 **Figure 8** shows the TPES of m/z 58, the second highest peak in the TOF-MS spectra of
 424 **Figure 3**, as measured in JSR. It appears to be nicely reproduced by a mixture of reference spectra
 425 of acetone [89] and propanal [90]: the first two peaks correspond to acetone (IE: 9.7 eV) [91] while
 426 the third one to a contribution from both acetone and propanal (IE: 9.96 eV) [78]. Other potential
 427 isomers at this mass channel such as methyloxirane would lead to a threshold at 10.22 eV for

428 which almost no signal is observed. [92] The fit to the data returns an observed acetone:propanal
429 signal branching ratio of 1:0.1 corresponding to a acetone:propanal 1:0.12 mole fraction ratio using
430 the absolute photoionization cross sections at 10.5 eV from Wang et al. [93] for propanal (9.51
431 Mb) and from Cool et al. [94] for acetone (11.20 Mb). This result is at odds with the GC
432 measurements at 600K [44], where acetone was found in amounts 100 times lower than propanal
433 (mole fraction = 120 ppm at 580 K, $\phi = 0.5$). This unfavorable ratio is, to a lower extent, confirmed
434 by the model, which predicts twice more propanal (3.6×10^{-4}) than acetone (1.7×10^{-4}).
435

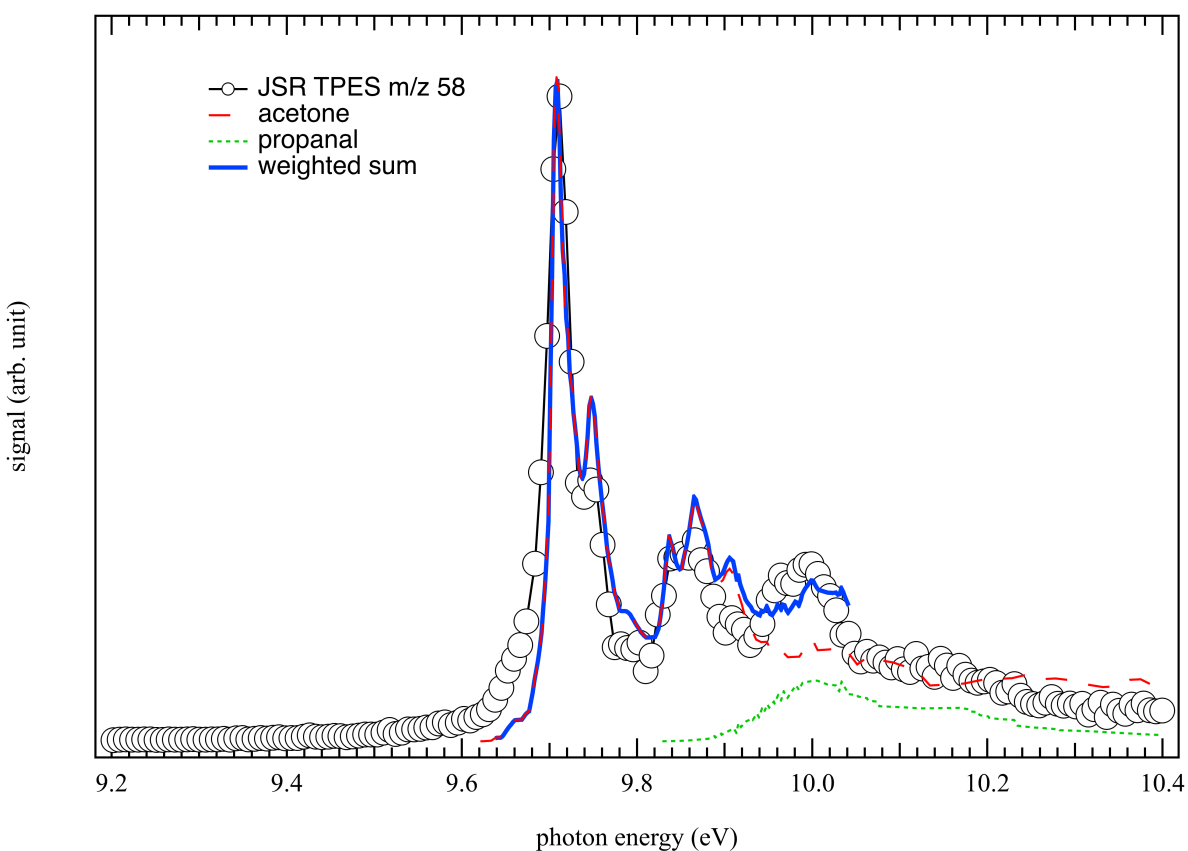

436
437 **Figure 8.** Comparison between the measured TPES at m/z 58 (open circles) measured during the
438 JSR oxidation of *n*-pentane at a reaction temperature of 585 K with an equivalence ratio of $\phi =$
439 0.5 and the weighted sum of reference spectra using the PES of acetone (dashed red line) from
440 Dannacher & Stadelmann [89] and propanal (dot green line) from Rennie et al. [90] The best fit
441 is obtained for an acetone:propanal branching ratio of 1:0.1.
442

443 To check if the signal at m/z 58 is not due to the use of acetone as cleaning solvent in the
444 experiments, **Figure S1** displays its variation of the ion signal at m/z 58 as function of the
445 temperature, showing well a product profile, negligible below 540 K and increasing with
446 temperature. Propanal, the mole fraction of which is correctly enough predicted, is formed through
447 the decomposition of the 3-pentylhydroperoxide. Acetone can be easily formed by H-abstractions
448 by CH_3COCH_2 , the radical arising, together with acetaldehyde, from the decomposition of the
449 major ketohydroperoxide (the 2,4- C_5 ketohydroperoxide). However, the predicted formation of
450 acetone is very low in the n -pentane oxidation model of Bugler et al. [44]. This is because many
451 important possible H-abstractions by this radical to give acetone are not considered in the model.
452 This is especially the case of the H-abstractions with the fuel or with aldehydes.

453

454 ***Channel m/z 60 and m/z 62***

455 **Figure 9** displays the experimental TPES of m/z 60, which is in very good agreement with
456 the experimental PES of acetic acid (CH_3COOH) from von Niessen et al. [95], although with a
457 better resolution here. The formation of acetic acid (IE: 10.65 eV) and other organic acids in low-
458 temperature oxidation of n -alkanes are explained with the Korcek mechanism, pathways based on
459 the ketohydroperoxide decomposition via a cyclic peroxide isomer.[96] Acetic acid has been
460 detected by SVUV-PIMS [42] and quantified by GC measurements [44] as the major acid
461 produced during low temperature oxidation of n -pentane, with a mole fraction of 40 ppm at 600 K
462 and $\phi = 0.5$. **Figure 9** also shows the presence of a compound at m/z 62 during JSR experiments,
463 which has been identified as ethylhydroperoxide ($\text{C}_2\text{H}_5\text{OOH}$) based on its calculated IE (9.61 eV)
464 and quantified (mole fraction of 50 ppm at 580 K, $\phi = 0.5$) in a previous n -pentane oxidation study.
465 [42] Along with methylhydroperoxide attributed to the signal at m/z 48, they are the two major
466 alkylhydroperoxides mainly produced through HOO radicals combining with alkyl peroxy radicals
467 in low-temperature lean fuel environment. Note that the slow rise observed is probably due to some
468 geometry change between the neutral and the cation leading to poor FC factors, so that the
469 adiabatic and vertical IEs are very different. Such a situation makes the PES more sensitive to hot
470 band contribution, probably explaining the methyl and ethylhydroperoxide signals below their
471 respective IE.

472

473

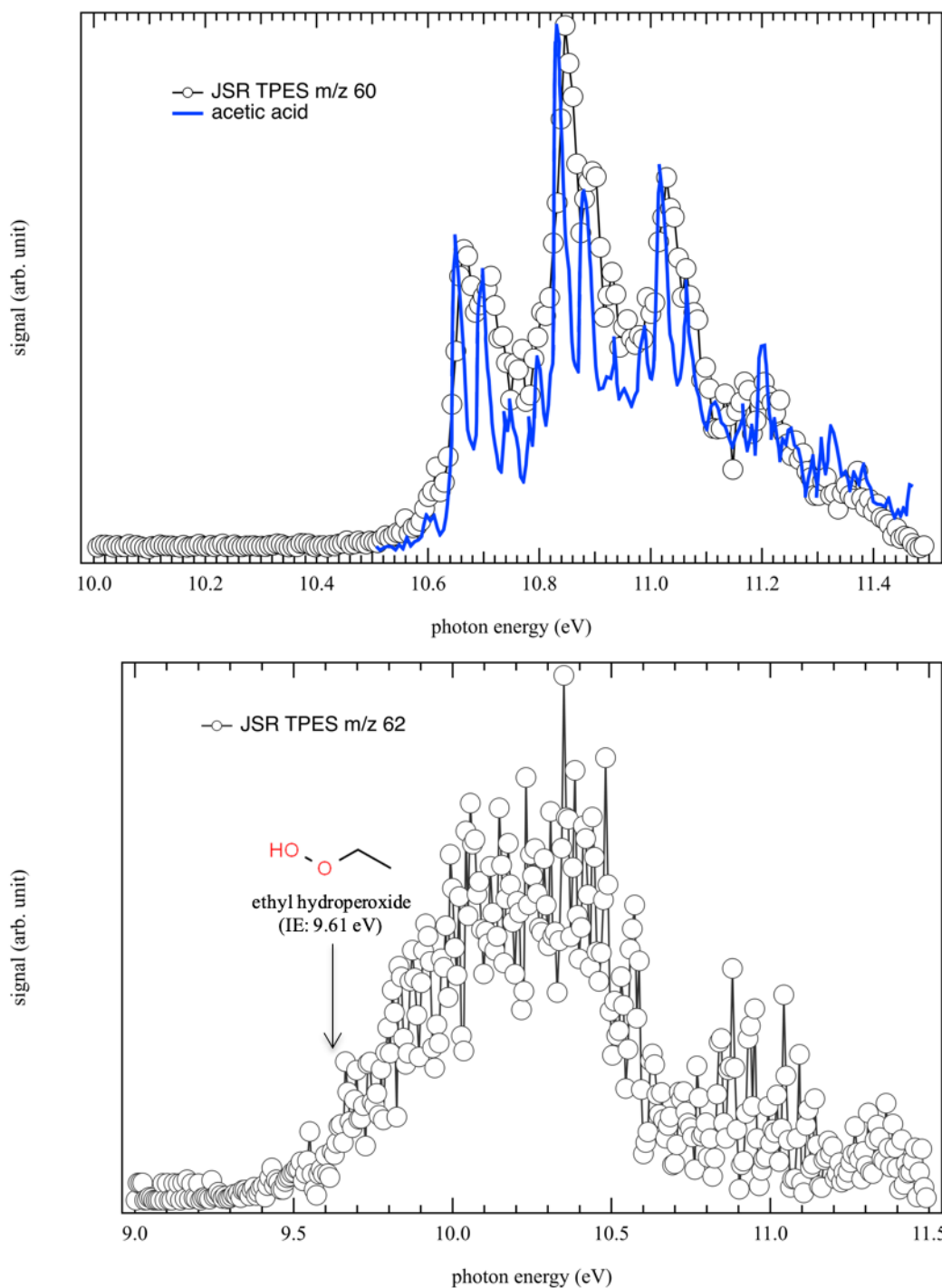

474
 475 **Figure 9.** (Upper panel) comparison between the measured TPES at m/z 60 (open circles)
 476 measured during the JSR oxidation of *n*-pentane at a reaction temperature of 585 K with an
 477 equivalence ratio of $\phi = 1/3$ and the integrated TPES of acetic acid (blue line) from von Niessen
 478 et al..[95] (Lower panel) Measured TPES at m/z 62 (open circles) measured during the JSR
 479 oxidation of *n*-pentane at a reaction temperature of 585 K with an equivalence ratio of $\phi = 1/3$.

480
481
482
483
484
485
486
487
488
489
490
491
492
493
494
495
496
497
498
499
500
501
502
503
504
505
506
507
508
509
510

Channel m/z 70

As the molecular mass increases, more and more potential candidates and isomers have to be considered and *a priori* choices based on chemical knowledge need to be made. This is the case of the m/z 70 corresponding photoelectron spectra displayed in **Figure 10**. At m/z 70 based on *n*-pentane molecular structure, linear isomers such as 1-pentene (IE: 9.5 eV) and 2-pentene (IE: 9.04 eV) are most likely to be formed compared to branched structures, such as 2-methyl-1-butene (IE: 9.1 eV), 2-methyl-2-butene (IE: 8.69 eV) and 3-methyl-1-butene (IE: 9.5 eV).[40]. Indeed, 2-methyl-2-butene can already be ruled out due to its low IE with respect to our TPES signal rise. The PES 3-methyl-1-butene [40] is very similar to that of 1-pentene, and the PES of 2-methyl-1-butene has been recently calculated taking into account possible rotamers [40] but its vibronic structure, although close to that of 2-pentene, does not match the present TPES. Based on the molecular structure argument enounced before, and the fact that 2-methyl-2-butene can be excluded, we have not considered neither 3-methyl-1-butene nor 2-methyl-1-butene in the fitting procedure. In addition, oxygenated species such as methyl vinyl ketone C₄H₆O (IE: 9.65 eV) could also contribute significantly to the signal measured at m/z 70.[97] The shape of the measured TPES of m/z 70 displayed in **Figure 10** is very well reproduced from the weighted contributions of three different isomers (2-pentene, 1-pentene and methyl vinyl ketone) with an observed 2-pentene:1-pentene:methyl vinyl ketone signal branching ratio of 1:0.3:0.6. The quality of the fit further validates the choice of removing the branched isomers. Under the GC conditions [44], 1-pentene was detected in peak mole fractions sometimes over ten times those of 2-pentene due to potential co-elution with the reactant. However, simulations indicate a 2.6 times higher mole fraction of 2-pentene (170 ppm) compared to that of 1-pentene (65 ppm). According to Bugler et al. model [44], pentenes are mainly formed from HOO elimination from the three pentylperoxy radicals derived from the three (one primary and two secondary) pentyl radicals. 2-pentene arises only from the more abundant secondary pentyl radicals, while 1-pentene arises from both one primary and one secondary pentyl radicals. The mole fraction (580 K, $\phi = 0.5$) of methyl vinyl ketone (17 ppm) was found to be about a third of that of pentenes [44] through GC measurements, which is in agreement with the present results assuming similar absolute ionization cross-sections for the three isomers. Methyl vinyl ketone is not considered in the model. [44]

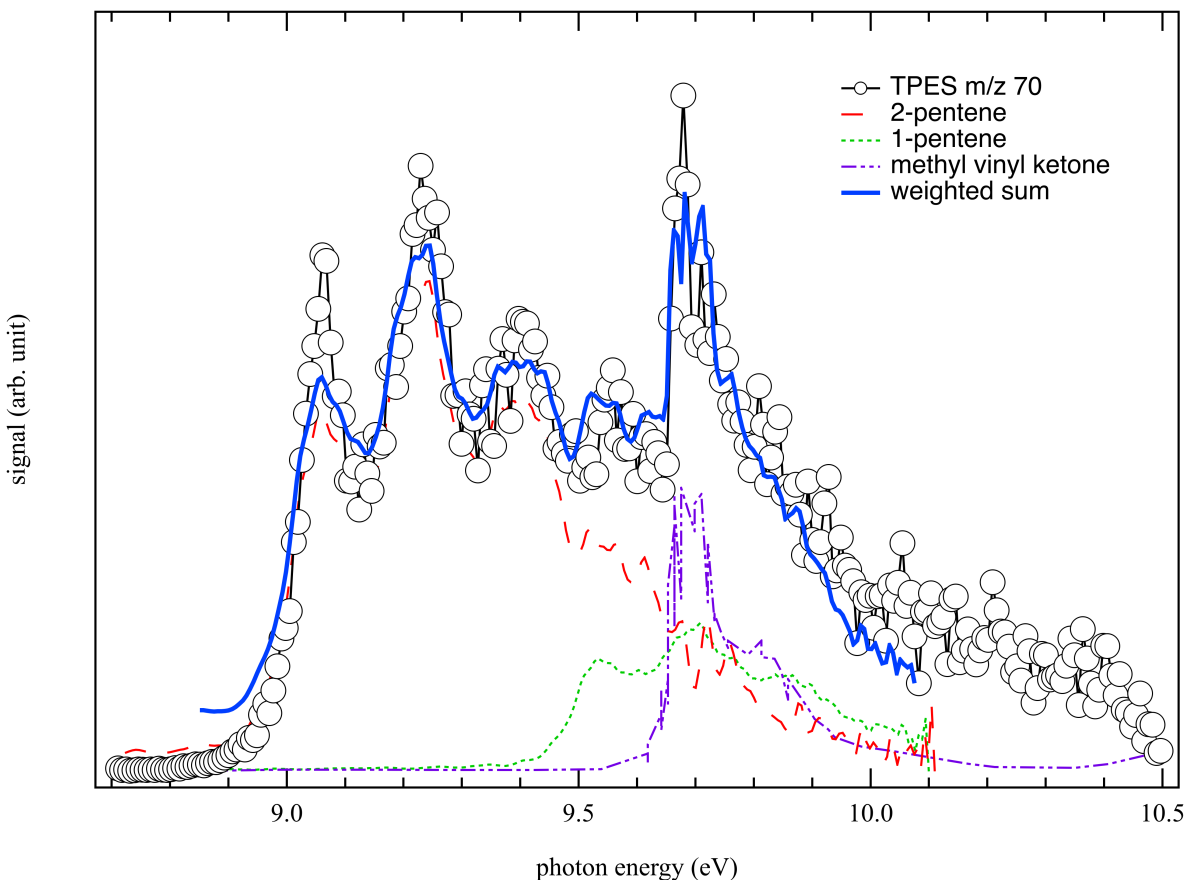

511
 512 **Figure 10.** Comparison of the measured TPES at m/z 70 (open circles) obtained in the JSR
 513 during *n*-pentane oxidation at a reaction temperature of 585 K with an equivalence ratio of $\phi =$
 514 0.5 to the weighted sum of reference spectra using the PES of 2-pentene (dashed red line) and 1-
 515 pentene (dot green line) from Pieper et al. [40] and methyl vinyl ketone (purple dot-dashed line)
 516 from Tam et al. [98] The best fit is obtained for a 2-pentene:1-pentene:methyl vinyl ketone
 517 branching ratio of 1:0.3:0.6.

518
 519 **Channel m/z 72**

520 **Figure 11** displays the experimental TPES of m/z 72, which is in very good agreement
 521 with the experimental PES of Methyl Ethyl Ketone (MEK) from Pieper et al. [40], although with
 522 a better resolution here. We observe a double structure around 9.6 eV, as verified by the simulated
 523 TPES of MEK (IE: 9.6 eV) also displayed in **Figure 11**. Numerous additional potential isomasses
 524 at this mass channel were ruled out such as iso-butanol, tetrahydrofuran, 2-methoxypropene, ethyl
 525 vinyl ether, 3-buten-1-ol, 3-buten-2-ol and *iso*-butanal. For instance, 2-methoxypropene (IE: 8.64

526 eV) and ethyl vinyl ether (IE: 8.98 eV) are ruled out based on their respective ionization energies,
527 which sit below the rise of the TPES signal. The other isomasses: *n*-butanal, iso-butanol,
528 tetrahydrofuran, 3-buten-1-ol, 3-buten-2-ol and iso-butanal are dismissed on the basis of their PES,
529 which do not match the experimental TPES (cf. **Figure S2**).[40] This result is in agreement based
530 on *n*-pentane molecular structure, where contributions from branched structures such as *iso*-
531 butanol (IE: 9.24 eV), 3-buten-1-ol (IE: 9.56 eV), 3-buten-2-ol (IE: 9.53 eV) and iso-butanal (IE:
532 9.83 eV) are expected to be small. The mole fraction of Methyl Ethyl Ketone (MEK) was measured
533 equal to 90 ppm at 580 K ($\phi=0.5$) in previous GC experiments [44], with that of butanal being 5
534 times lower (18 ppm under the same conditions). The much lower concentration of the butanal
535 isomer is consistent with the lack of signal in the present results assuming comparable
536 photoionization cross sections. MEK (predicted mole fraction = 3 ppm) is modeled as being
537 formed by H-abstractions from the $C_2H_5COCH_2$ radical obtained from the decomposition of the
538 second most abundant ketohydroperoxide (the 3,1- C_5 ketohydroperoxide); here also only many H-
539 abstractions with $C_2H_5COCH_2$ radical are missing in the model [44] involving a probable
540 significant underprediction. It should be noted that the peak at 9.54 eV, which is also clearly seen
541 in the experimental PES measured by Pieper et al. [40], is not seen in the calculations using a
542 vibrational temperature of 0K so it must likely come from a hot band because the high temperature
543 at which this compound is formed.

544

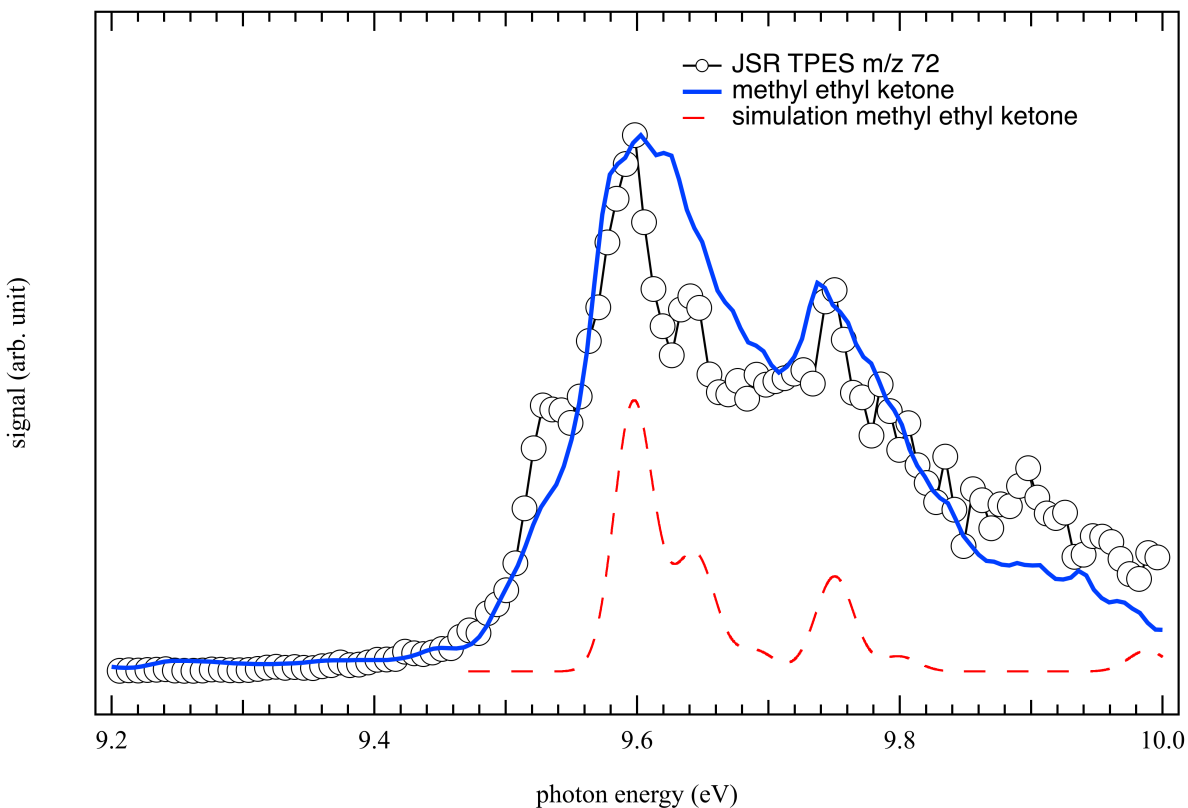

545
 546 **Figure 11.** Comparison of the measured TPES at m/z 72 (open circles) obtained in the JSR
 547 during n -pentane oxidation at a reaction temperature of 585 K with an equivalence ratio of $\phi =$
 548 0.5 to the reference spectrum of MEK (solid blue line) from Pieper et al. [40] and the envelope
 549 from convolution of the FC factors for the MEK (long dashed red line) as computed in this work
 550 at the PBE0/aug-cc-pVDZ level and shifted to fit with the adiabatic ionization energy determined
 551 at the PBE0/aug-cc-pVDZ(opt)//(R)CCSD(T)-F12/aug-cc-pVTZ(SP) level. Note that for the
 552 sake of clarity, the signal above 10.1 eV is not shown since it is saturated by the n -pentane signal
 553 (IE: 10.28 eV).

554
 555 **Channel m/z 74**

556 The TPES shown in **Figure 12** (m/z 74 corresponding to a minor peak in **Figure 3**) could
 557 correspond to allyl hydroperoxide (IE: 9.55 eV), the lightest alkenyl hydroperoxide, and propanoic
 558 acid (IE: 10.44 eV). The organic acid was measured in significant amounts during the oxidation
 559 of several alkanes at low temperatures in the past.[47] Regarding allyl-OOH, it was already
 560 detected in SVUV-PIMS and SPI-MS experiments (mole fraction of 7 ppm at 580 K ($\phi =$

561 0.5)).[42,44] Allyl hydroperoxide (predicted mole fraction = 2 ppm) is mainly formed by
562 combination of allyl and HOO radicals.

563

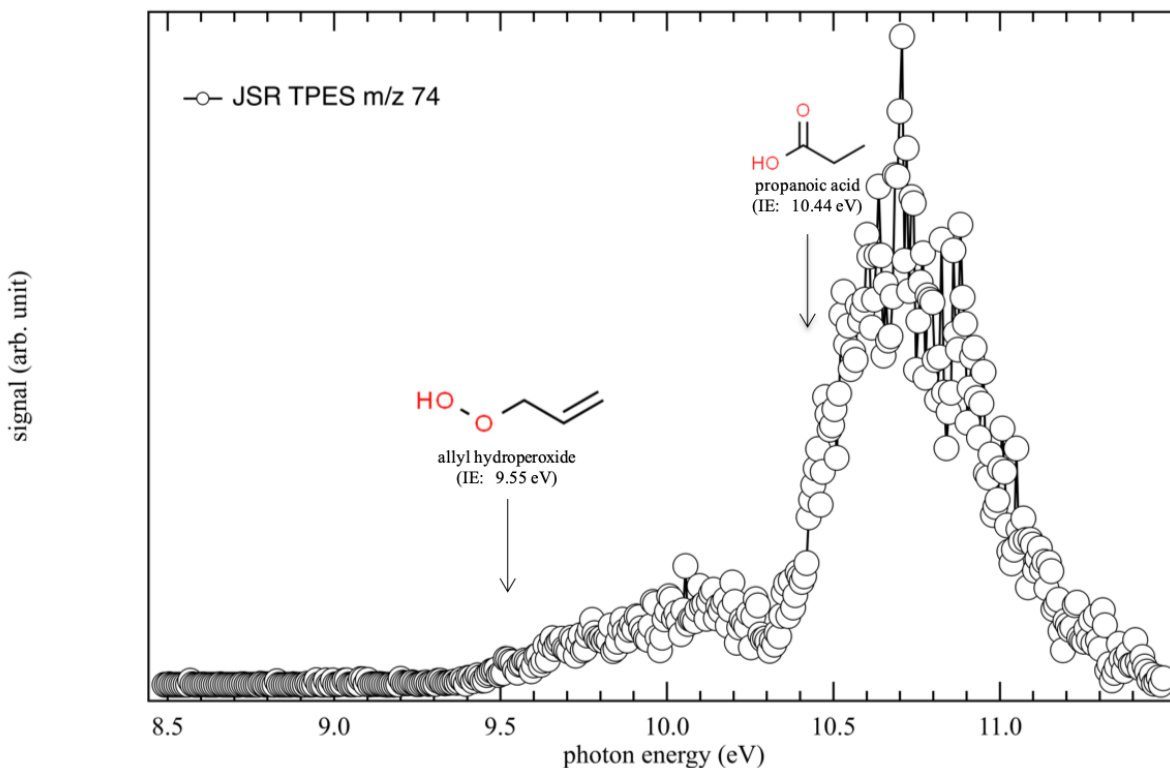

564

565 **Figure 12.** Measured TPES at m/z 74 (open circles) obtained in the JSR during *n*-pentane
566 oxidation at a reaction temperature of 585 K with an equivalence ratio of $\phi = 1/3$.

567

568 **Channel m/z 84**

569 **Figure 13** shows the measured TPES at m/z 84 (open circles) obtained in the JSR during
570 *n*-pentane oxidation. GC-MS experiments [44] led to suggest pentenones for this m/z but with a
571 slightly higher start of detection, from 590 K instead of the 585K used to record the TPES. This
572 would be consistent with previous measurements in SVUV-PIMS during *n*-heptane oxidation at
573 low temperature suggesting the possible formation of products derived from cyclic ethers such as
574 furanones (C₄H₄O₂) [22] with the potential formation of at least two products contributing to this
575 mass channel such as 3-furanone (IE: 9.30 eV) and 2-furanone (IE: 10.86 eV). Based on the good
576 overlap between the measured TPES and the envelope from convolution of the FC factors for the
577 3-furanone, we are able to pinpoint the formation of 3-furanone and rule out the other furanone

578 isomer for which the TPES in **Figure 13** shows no measurable intensity at its ionization energy.
579 Contribution from hydrocarbons at this mass such 1-hexene (C_6H_{12}) could also be ruled out based
580 on the shape of its PES, since there is a second, intense electronic band starting above 10.2 eV [99]
581 which we don't see in our TPES. Furanones are not considered in the model, but are expected to
582 derive from dihydrofurans by H-abstraction followed by a combination with HO_2 radicals and the
583 decomposition of the obtained hydroperoxides. 2,3-dihydrofuran is considered in the model, but it
584 is predicted to be formed in very negligible amounts.

585

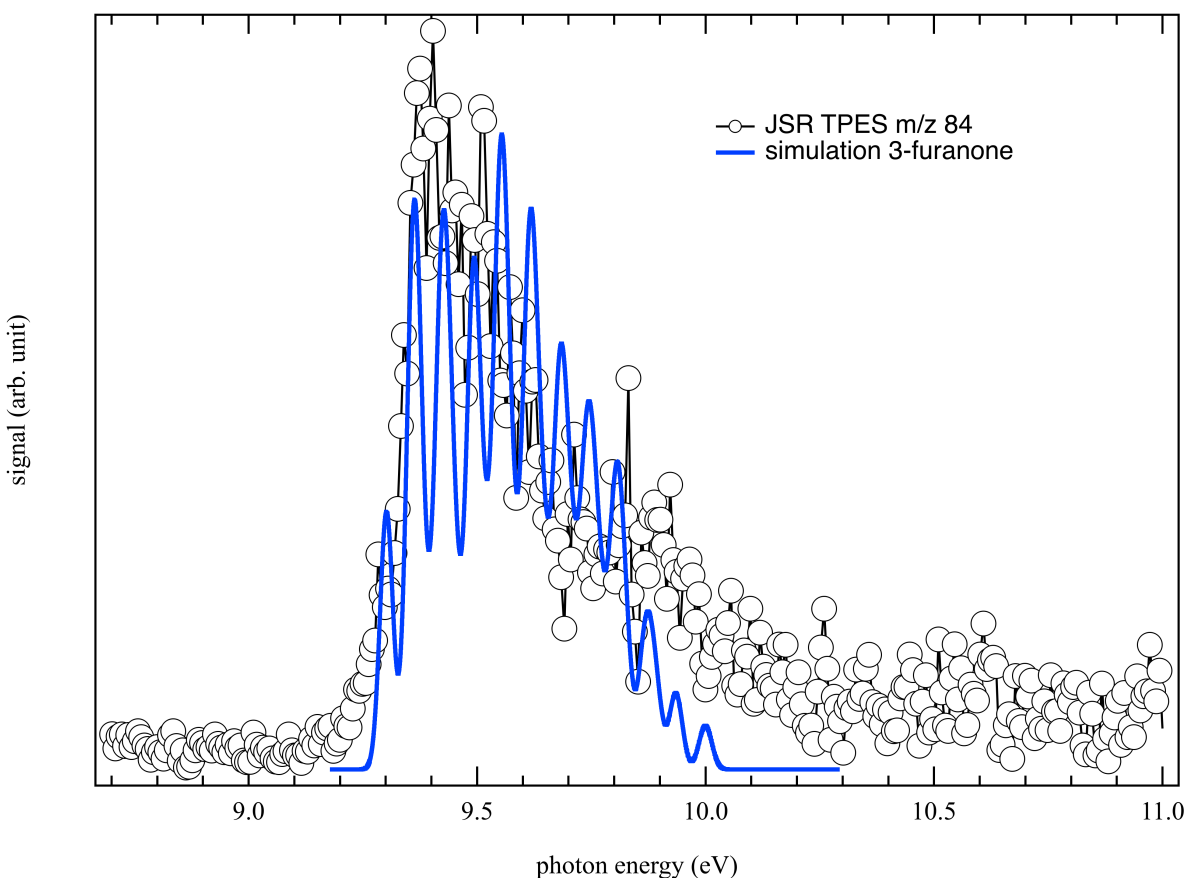

586

587 **Figure 13.** Measured TPES at m/z 84 (open circles) obtained in the JSR during *n*-pentane
588 oxidation at a reaction temperature of 585 K with an equivalence ratio of $\phi = 1/3$ and the
589 envelope from convolution of the FC factors for the 3-furanone (blue line) as computed at the
590 PBE0/aug-cc-pVDZ level and shifted to fit with the adiabatic ionization energy determined at the
591 PBE0/aug-cc-pVDZ(opt)/(R)CCSD(T)-F12/aug-cc-pVTZ(SP) level.

592

593 *Channel m/z 86*

594 **Figure 14** displays the TPES obtained for the intense m/z 86 peak and the simulated TPES
595 of 2-methyltetrahydrofuran (IE: 9.33 eV), 2-pentanone (IE: 9.52 eV), 3-pentanone (IE: 9.439 eV),
596 cis 2-ethyl-3-methyloxirane (IE: 9.48 eV), trans 2,4-dimethyloxetane (IE: 9.38 eV) and 2-
597 ethyloxetane (IE: 9.45 eV) to fit the TPES. The best fit is obtained for a 2-methyltetrahydrofuran:2-
598 pentanone:3-pentanone:cis 2-ethyl-3-methyloxirane:trans 2,4-dimethyloxetane:2-ethyloxetane
599 observed signal branching ratio of 0.69:0.82:1:0.82:0.56:0.39. Numerous additional potential
600 isomers at this mass channel were ruled out based on previous studies in GC-MS [44]. All the
601 C₅H₁₀O isomers for m/z 86 with an amount below 10 ppm have not been considered in the fitting
602 procedure: trans 2-ethyl-3-methyloxirane, pentanal, pentenol and 2-propyloxirane and
603 tetrahydropyrans (see **Table S1**). The cis conformation of 2,4-dimethyloxetane was not considered
604 since the IE with the trans conformation is close (trans: 9.38 eV and cis: 9.40 eV) and the
605 experimental resolution does not allow to differentiate their respective contributions. To obtain the
606 relative contribution of the 6 other isomers for m/z 86, calculated TPES of 2-
607 methyltetrahydrofuran, 2-pentanone, 3-pentanone, cis 2-ethyl-3-methyloxirane, trans 2,4-
608 dimethyloxetane and 2-ethyloxetane were considered in the evaluation. The fitting procedure sums
609 and weights with 6 appropriate factors the calculated TPES of the 6 isomers in the appropriate
610 photon energy range. The best fit displayed in **Figure 14** reproduces satisfactorily the overall
611 structure of the measured TPES of m/z 86 from the weighted contributions of the different isomers.
612 **Table S1** reports the comparison between the amount detected by GC-MS [42], the predicted value
613 using the model of Bugler et al. [44] and the observed signal branching ratio for isomers at m/z
614 86.

615 However, the evaluation faces some challenges here since the calculated TPES of the
616 isomers overlap in a narrow energy region. Thus, with the noise level for the signal at this mass
617 channel, the relative contribution of the different isomers must be interpreted with care, and the
618 uncertainty in the observed signal branching ratio is associated with the experimental TPES fit. As
619 shown in **Figure S3**, the procedure is more sensitive to non-overlapping and structured PES, such
620 as trans 2,4-dimethyloxetane (isolated on the low energy part) or 2-methyltetrahydrofuran (double
621 band structure). Overall, the systematic errors on the branching ratios range from a few percent for
622 the abovementioned isomers, to a few tens of percent that sometimes exceed the fitted value itself.

623 The evaluation shows the formation of several linear and cyclic isomers. Cyclic ethers are
624 involved in the low temperature gas phase oxidation of different types of fuels, emitted in exhaust
625 gases of engines from an incomplete combustion. They derived from an oxygen addition on an
626 alkyl radical (deriving from the reactant) to form a peroxy radical ROO followed by several
627 isomerization steps to yield a hydroperoxy alkyl radical QOOH, which could decompose to form
628 three, four, five and six membered ring cyclic ethers. Usually, the five membered ring cyclic ethers
629 (tetrahydrofurans and oxolanes) are expected to be the most abundant during low-temperature
630 oxidation of linear *n*-alkanes due to a lower ring strain energy involved in the transition state during
631 the isomerization in comparison to that of the other cyclic transition states.[100] The presence of
632 2-methyltetrahydrofuran (2-MeTHF) in this work along with the 88.4 ppm mole fraction measured
633 in previous GC experiments at 580 K ($\phi = 0.5$) [44] supports this statement. However, the
634 evaluation in this work does not conclude on the dominance of 2-MeTHF due to lack of
635 information on photoabsorption cross sections in the literature. The formation of four membered
636 ring cyclic ethers (oxetanes) is usually observed but these species are present in much smaller
637 amounts than five membered ring ones. The evaluation revealed the formation of 2,4-
638 dimethyloxetane and 2-ethyloxetane. Both species were detected as major species during previous
639 GC experiments [44] with a mole fraction equal to 16.3 and 19.6 ppm at 580 K ($\phi = 0.5$)
640 respectively. Cis 2-ethyl-3-methyloxirane is also detected which is consistent with the 22.4 ppm
641 mole fraction measured in previous GC experiments [44] at 580 K ($\phi = 0.5$) even if three membered
642 ring cyclic ethers are not easily detected due to a difficult isomerization with a high extra internal
643 energy transition state. Finally, the evaluation addressed the contribution of two linear ketone
644 isomers: 2- and 3-pentanone which was found as the second major species after 2-MeTHF in
645 previous GC experiments during low temperature *n*-pentane oxidation [44] with a mole fraction
646 equal to 54 ppm at 580 K ($\phi = 0.5$). Those species are formed from H-abstraction reactions from
647 alkyl radicals with a carbonyl group leading to the formation of ketones such as acetone or
648 pentanone. According to Bugler et al model [44], 2- and 3-pentanone arise, respectively, from 2-
649 and 3-pentylperoxy radicals by reaction with methyl-/ethyl-peroxy radicals producing these
650 ketones, methanol/ethanol and O₂.

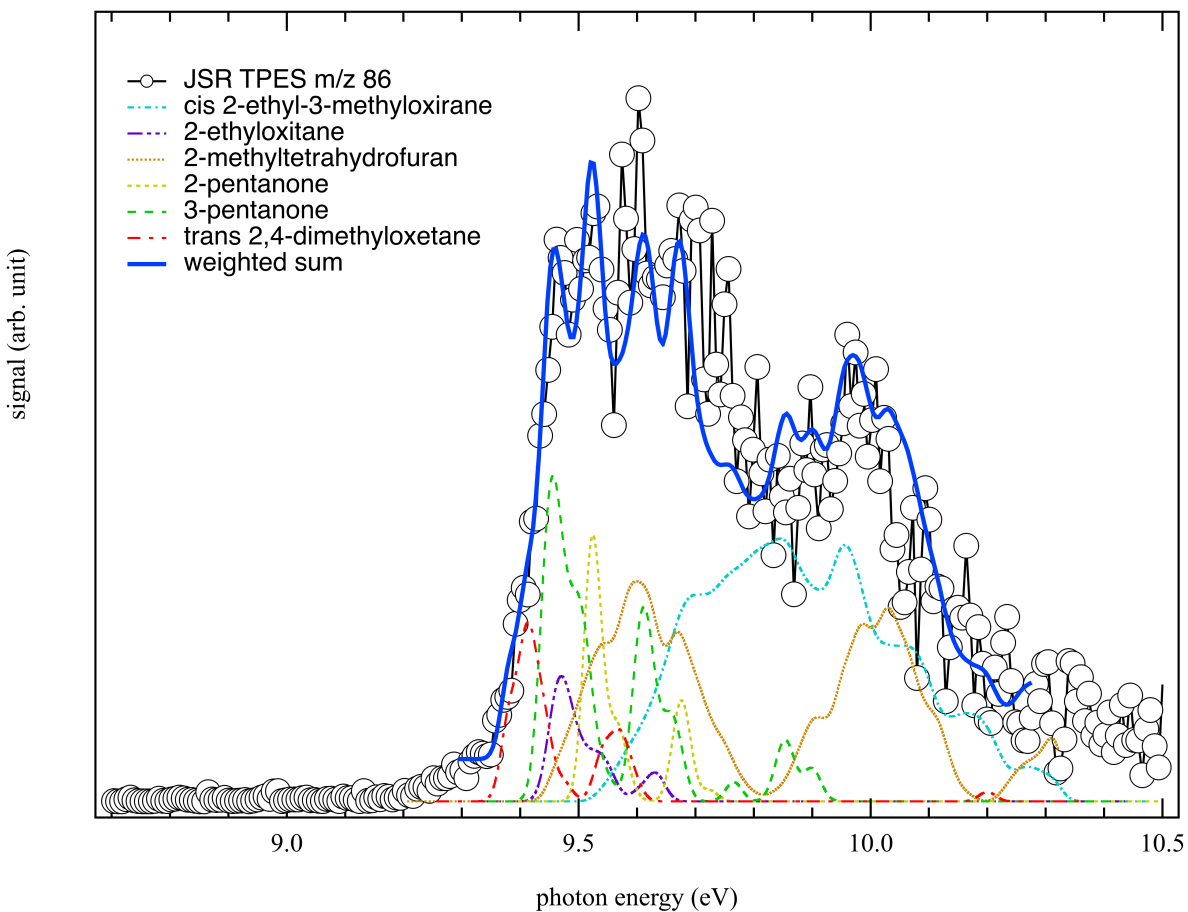

651
 652 **Figure 14.** Comparison of the measured TPES at m/z 86 (open circles) obtained in the JSR
 653 during n -pentane oxidation at a reaction temperature of 585 K with an equivalence ratio of $\phi =$
 654 0.5 to the weighted sum of the envelopes from convolution of the FC factors for the 2-
 655 methyltetrahydrofuran (orange small dotted line), 2-pentanone (yellow long dotted line), 3-
 656 pentanone (green short dashed line), cis 2-ethyl-3-methyloxirane (cyan dot-dashed line), trans
 657 2,4-dimethyloxetane (red long and short dashed line) and 2-ethyloxetane (purple long line
 658 followed by two short dashes) as computed at the PBE0/aug-cc-pVDZ level and shifted to fit
 659 with the adiabatic ionization energy determined at the PBE0/aug-cc-pVDZ(opt)/(R)CCSD(T)-
 660 F12/aug-cc-pVTZ(SP) level. The best fit is obtained for a 2-methyltetrahydrofuran:2-
 661 pentanone:3-pentanone:cis 2-ethyl-3-methyloxirane:trans 2,4-dimethyloxetane:2-ethyloxetane
 662 observed signal branching ratio of 0.69:0.82:1:0.82:0.56:0.39.

663
 664
 665 **Channel m/z 88**

666 **Figure 15** displays the TPES at m/z 88 obtained in the JSR during *n*-pentane oxidation and
667 the envelope from convolution of the FC factors for the but-1-enyl-3-hydroperoxide. During
668 previous alkane oxidation experiments using TOF-MS combined with tunable synchrotron
669 photoionization and during GC analysis (0.02 ppm at 580 K) [42,44] the formation of C₄
670 alkenylhydroperoxides was suggested along with butanoic acid but without further information on
671 the identification of the isomer of C₄ alkenylhydroperoxides. In this work, FC analysis allow us to
672 observe a good overlap between the measured TPES at m/z 88 and the envelope from convolution
673 of the FC factors for the but-1-enyl-3-hydroperoxide (IE: 9.33 eV). The convolution of the
674 simulated vibrationally resolved electronic spectrum of the other isomer but-2-enyl-1-
675 hydroperoxide (IE: 9.52 eV) and displays in the **Figure 15** allows us to rule out its contribution in
676 the measured signal at mass channel 88. The formation of butanoic acid is also ruled out since no
677 signal was observed at its ionization energy, 10.3 eV. It should be noted that the large difference
678 in shape between the TPES and the simulations is explained by the fact that when high masses are
679 reached, there are more internal modes, especially low frequencies, that may be populated prior to
680 photon ionization contributing to the spectra as hot bands. Also several conformers may be formed
681 and may contribute. These effects are not taken into account in the simulated spectra.
682

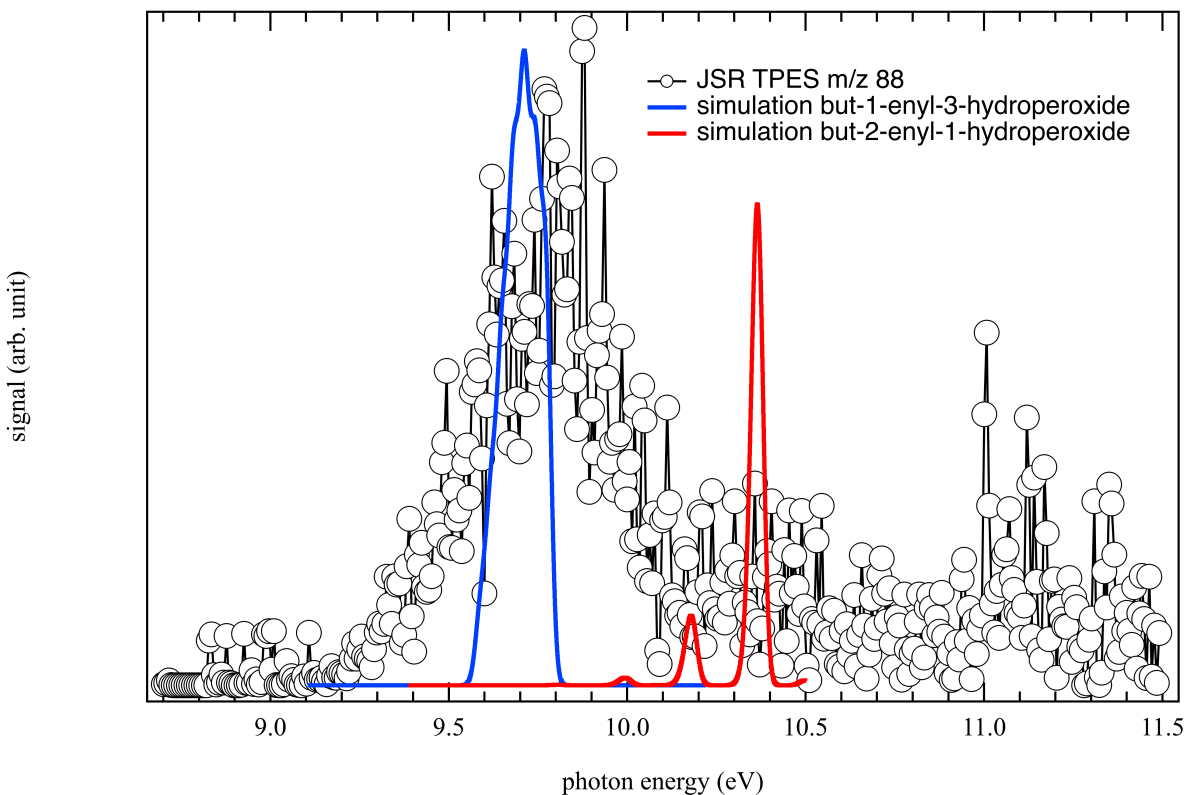

683
 684 **Figure 15.** Measured TPES at m/z 88 (open circles) obtained in the JSR during *n*-pentane
 685 oxidation at a reaction temperature of 585 K with an equivalence ratio of $\phi = 1/3$ and the
 686 envelope from convolution of the FC factors for the but-1-enyl-3-hydroperoxide (blue line) and
 687 the but-2-enyl-1-hydroperoxide (red line) at as computed at the PBE0/aug-cc-pVDZ level and
 688 shifted to fit with the adiabatic ionization energy determined at the PBE0/aug-cc-
 689 pVDZ(opt)//(R)CCSD(T)-F12/aug-cc-pVTZ(SP) level.

690
 691 **4. Summary and conclusions**

692 The oxidation of *n*-pentane has been studied in a JSR, for the first time using the i^2 PEPICO
 693 spectroscopy technique for the analysis of combustion intermediates. The i^2 PEPICO approach
 694 reveals the fingerprint TPES of each species, allowing specific information about the chemical
 695 composition at a given mass channel to be unraveled. Especially in combustion environments such
 696 as in a JSR, this technique is advantageous to decipher the contribution of several isomers with
 697 close ionization energies and when the slopes of the PIE are featureless. When coupled to FC
 698 calculations, this method allows the determination of the vibrational temperature of the
 699 environment by comparing the intensity ratio between the peaks involved into the transitions.

700 To analyze the JSR spectra, reference PES of species in the literature were used along with
701 calculated PES for several compounds of $m/z = 72, 84, 86$ and 88 reported for the first time and
702 obtained via Franck-Condon simulations on the basis of high-level quantum chemistry
703 calculations. These simulated PES have a critical role in the detection of products since the
704 experimental literature is often very limited, especially for reactive intermediates, and will also
705 enrich the data base of vibronic footprints, which will be of interest to the increasing number of
706 groups using mass-selected PES for analytical purposes.

707 As demonstrated already in flame environments, the i^2 PEPICO technique supports isomer
708 identification up to relatively heavy masses (50 - 100 amu) and is an efficient diagnostic tool for
709 complex chemical gas-phase combustion analysis. Interestingly, an unexplained significant
710 general trend seems to appear: the i^2 PEPICO mass spectrometry is more sensitive to ketones than
711 gas chromatography. This could imply needed revision in the current models largely validated on
712 these later data.

713 For large masses, the isomeric sensitivity could be enhanced if a more complete database
714 were available for all the possible isomers that would include for instance high resolution TPES.
715 For JSR experiments, this technique complements nicely gas chromatography for the separation
716 of stable compounds with the same m/z . Its major advantage compared to GC is that it can also be
717 applied to the detection short-lived species, such as hydroperoxides which play a major role in
718 chemistry of the low-temperature oxidation of hydrocarbons. The analysis of diones and
719 ketohydroperoxides detected at $m/z 100$ & 118 in this work along with the investigation of their
720 fragmentation processes is planned in the near future. We show also that i^2 PEPICO data coupled
721 to FC simulations and ab initio determination of the adiabatic ionization energies represent a
722 powerful method which complements the GC data analysis for the heavy species.

723 Generally, the spreading use of the PEPICO technique should be consider as a powerful
724 complementary diagnostic method aimed at improving the use of alternatives fossil fuels such as
725 those derived from biogenic sources. In this prospect, further experiments should be focused on
726 the reactions of oxygenated and N-bearing species found in biomass-derived nitrogenated-fuels in
727 order to further improve reaction mechanisms developed for a new generation of cleaner and
728 efficient fuels. Note that the GC analysis with highly-oxygenated and N-bearing species is often
729 more challenging that than with species obtained during the hydrocarbon oxidation (species
730 containing C, H, and one or two oxygen atoms).

731

732 **Acknowledgement**

733 We are grateful to the whole SOLEIL staff for smoothly running the facility under project
734 20180021. We warmly thank J.-F. Gil for his technical help around the SAPHIRS experiment. J.B.
735 thanks the ERC Starting Grant PRIMCHEM, grant agreement n°636829 for financial support.
736 M.H. acknowledge the use of the computing center MésoLUM of the LUMAT research federation
737 (FR LUMAT 2764).

738

739 **Supplementary material**

740 The Supplementary Material provides the results from the temperature dependence of the
741 ion signal at m/z 58, the sensitivity analysis for the procedure fitting of m/z 86, the comparison
742 between mole fractions in the literature and the observed signal branching ratio for isomers at m/z
743 86 and the comparison of the PES for the isomers at m/z 56 and 72 with the experimental TPES
744 measured in this work. The simulated vibrationally resolved electronic spectra are also provided
745 in the Supplementary Material.

746

747 **References**

- 748 [1] K. Kohse-Höinghaus, Combustion Chemistry Diagnostics for Cleaner Processes, Chem. -
749 A Eur. J. 22 (2016) 13390–13401. doi:10.1002/chem.201602676.
- 750 [2] C.K. Westbrook, M. Mehl, W.J. Pitz, G. Kukkadapu, S. Wagnon, K. Zhang, Multi-fuel
751 surrogate chemical kinetic mechanisms for real world applications, Phys. Chem. Chem.
752 Phys. 20 (2018) 10588–10606. doi:10.1039/C7CP07901J.
- 753 [3] P. Dagaut, S.M. Sarathy, M.J. Thomson, A chemical kinetic study of n-butanol oxidation
754 at elevated pressure in a jet stirred reactor, Proc. Combust. Inst. 32 (2009) 229–237.
755 doi:10.1016/J.PROCI.2008.05.005.
- 756 [4] M.H. Hakka, P.-A. Glaude, O. Herbinet, F. Battin-Leclerc, Experimental study of the
757 oxidation of large surrogates for diesel and biodiesel fuels, Combust. Flame. 156 (2009)
758 2129–2144. doi:10.1016/J.COMBUSTFLAME.2009.06.003.
- 759 [5] N. Hansen, T.A. Cool, P.R. Westmoreland, K. Kohse-Höinghaus, Recent contributions of
760 flame-sampling molecular-beam mass spectrometry to a fundamental understanding of
761 combustion chemistry, Prog. Energy Combust. Sci. 35 (2009) 168–191.
762 doi:10.1016/J.PECS.2008.10.001.
- 763 [6] Y. Li, F. Qi, Recent Applications of Synchrotron VUV Photoionization Mass
764 Spectrometry: Insight into Combustion Chemistry, Acc. Chem. Res. 43 (2010) 68–78.
765 doi:10.1021/ar900130b.
- 766 [7] H. Hashemi, J.M. Christensen, L.B. Harding, S.J. Klippenstein, P. Glarborg, High-
767 pressure oxidation of propane, Proc. Combust. Inst. 37 (2019) 461–468.
768 doi:10.1016/j.proci.2018.07.009.

- 769 [8] D.F. Davidson, Z. Hong, G.L. Pilla, A. Farooq, R.D. Cook, R.K. Hanson, Multi-species
770 time-history measurements during n-heptane oxidation behind reflected shock
771 waves. *Combustion and flame* (2010) 157(10), 1899-1905.
- 772 [9] S.S. Goldsborough, S. Hochgreb, G. Vanhove, M.S. Wooldridge, H.J. Curran, C.-J. Sung,
773 Advances in rapid compression machine studies of low- and intermediate-temperature
774 autoignition phenomena, *Prog. Energy Combust. Sci.* 63 (2017) 1–78.
775 doi:10.1016/j.pecs.2017.05.002.
- 776 [10] E. Ranzi, A. Frassoldati, A. Stagni, M. Pelucchi, A. Cuoci, T. Faravelli, Reduced kinetic
777 schemes of complex reaction systems: Fossil and biomass-derived transportation fuels,
778 *Int. J. Chem. Kinet.* 46 (2014) 512–542. doi:10.1002/kin.20867.
- 779 [11] S.M. Sarathy, P. Oßwald, N. Hansen, K. Kohse-Höinghaus, Alcohol combustion
780 chemistry, *Prog. Energy Combust. Sci.* 44 (2014) 40–102.
781 doi:10.1016/J.PECS.2014.04.003.
- 782 [12] B. Duboc, G. Ribert, P. Domingo, Description of kerosene/air combustion with Hybrid
783 Transported-Tabulated Chemistry. *Fuel* (2018) 233, 146-158.
- 784 [13] M. Djokic, H.-H. Carstensen, K.M. Van Geem, G.B. Marin, The thermal decomposition
785 of 2,5-dimethylfuran, *Proc. Combust. Inst.* 34 (2013) 251–258.
786 doi:10.1016/J.PROCI.2012.05.066.
- 787 [14] O. Herbinet, S. Bax, P.-A. Glaude, V. Carré, F. Battin-Leclerc, Mass spectra of cyclic
788 ethers formed in the low-temperature oxidation of a series of n-alkanes, *Fuel.* 90 (2011)
789 528–535. doi:10.1016/j.fuel.2010.09.047.
- 790 [15] N. Lamoureux, X. Mercier, C. Western, J.F. Pauwels, P. Desgroux, NCN quantitative
791 measurement in a laminar low pressure flame, *Proc. Combust. Inst.* 32 (2009) 937–944.
792 doi:10.1016/J.PROCI.2008.06.043.
- 793 [16] C.A. Taatjes, N. Hansen, A. McIlroy, J.A. Miller, J.P. Senosiain, S.J. Klippenstein, F. Qi,
794 L. Sheng, Y. Zhang, T.A. Cool, J. Wang, P.R. Westmoreland, M.E. Law, T. Kasper, K.
795 Kohse-Höinghaus, Enols are common intermediates in hydrocarbon oxidation., *Science.*
796 308 (2005) 1887–9. doi:10.1126/science.1112532.
- 797 [17] M.B. Sajid, E. Es-sebbar, T. Javed, C. Fittschen, A. Farooq, Measurement of the Rate of
798 Hydrogen Peroxide Thermal Decomposition in a Shock Tube Using Quantum Cascade
799 Laser Absorption Near 7.7 μm , *Int. J. Chem. Kinet.* 46 (2014) 275–284.
800 doi:10.1002/kin.20827.
- 801 [18] K. Kohse-Höinghaus, R.S. Barlow, M. Aldén, J. Wolfrum, Combustion at the focus: laser
802 diagnostics and control, *Proc. Combust. Inst.* 30 (2005) 89–123.
803 doi:10.1016/J.PROCI.2004.08.274.
- 804 [19] R.K. Hanson, Applications of quantitative laser sensors to kinetics, propulsion and
805 practical energy systems, *Proc. Combust. Inst.* 33 (2011) 1–40.
806 doi:10.1016/J.PROCI.2010.09.007.
- 807 [20] J.H. Northern, A.W.J. Thompson, M.L. Hamilton, P. Ewart, Multi-species detection using
808 multi-mode absorption spectroscopy (MUMAS), *Appl. Phys. B.* 111 (2013) 627–635.
809 doi:10.1007/s00340-013-5382-9.
- 810 [21] Z. Wang, O. Herbinet, N. Hansen, F. Battin-Leclerc, Exploring hydroperoxides in
811 combustion: History, recent advances and perspectives, *Prog. Energy Combust. Sci.* 73
812 (2019) 132–181. doi:10.1016/J.PECS.2019.02.003.
- 813 [22] O. Herbinet, F. Battin-Leclerc, S. Bax, H. Le Gall, P.-A. Glaude, R. Fournet, Z. Zhou, L.
814 Deng, H. Guo, M. Xie, F. Qi, Detailed product analysis during the low temperature

- 815 oxidation of n-butane, *Phys. Chem. Chem. Phys.* 13 (2011) 296–308.
816 doi:10.1039/C0CP00539H.
- 817 [23] F. Battin-Leclerc, O. Herbinet, P.-A. Glaude, R. Fournet, Z. Zhou, L. Deng, H. Guo, M.
818 Xie, F. Qi, New experimental evidences about the formation and consumption of
819 ketohydroperoxides, *Proc. Combust. Inst.* 33 (2011) 325–331.
820 doi:10.1016/j.proci.2010.05.001.
- 821 [24] D.L. Osborn, P. Zou, H. Johnsen, C.C. Hayden, C.A. Taatjes, V.D. Knyazev, S.W. North,
822 D.S. Peterka, M. Ahmed, S.R. Leone, The multiplexed chemical kinetic photoionization
823 mass spectrometer: A new approach to isomer-resolved chemical kinetics, *Rev. Sci.*
824 *Instrum.* 79 (2008) 104103. doi:10.1063/1.3000004.
- 825 [25] C.A. Taatjes, N. Hansen, D.L. Osborn, K. Kohse-Höinghaus, T.A. Cool, P.R.
826 Westmoreland, “Imaging” combustion chemistry via multiplexed synchrotron-
827 photoionization mass spectrometry, *Phys. Chem. Chem. Phys.* 10 (2008) 20–34.
828 doi:10.1039/B713460F.
- 829 [26] F. Qi, Combustion chemistry probed by synchrotron VUV photoionization mass
830 spectrometry, *Proc. Combust. Inst.* 34 (2013) 33–63. doi:10.1016/j.proci.2012.09.002.
- 831 [27] J. Eland, *Photoelectron spectroscopy: an introduction to ultraviolet photoelectron*
832 *spectroscopy in the gas phase*, Elsevier (2013).
- 833 [28] T. Baer, P.M. Guyon, *An historical introduction to threshold photoionization. High-*
834 *Resolution Laser Photoionization and Photoelectron Studies*, John Wiley Sons Chichester
835 (1995) 1-20.
- 836 [29] A. Bodi, P. Hemberger, D.L. Osborn, B. Sztáray, Mass-Resolved Isomer-Selective
837 Chemical Analysis with Imaging Photoelectron Photoion Coincidence Spectroscopy, *J.*
838 *Phys. Chem. Lett.* 4 (2013) 2948–2952. doi:10.1021/jz401500c.
- 839 [30] D.L. Osborn, C.C. Hayden, P. Hemberger, A. Bodi, K. Voronova, B. Sztáray, Breaking
840 through the false coincidence barrier in electron–ion coincidence experiments, *J. Chem.*
841 *Phys.* 145 (2016) 164202. doi:10.1063/1.4965428.
- 842 [31] A. Bodi, M. Johnson, T. Gerber, Z. Gengeliczki, B. Sztáray, T. Baer, Imaging
843 photoelectron photoion coincidence spectroscopy with velocity focusing electron optics,
844 *Rev. Sci. Instrum.* 80 (2009) 034101. doi:10.1063/1.3082016.
- 845 [32] G.A. Garcia, H. Soldi-Lose, L. Nahon, A versatile electron-ion coincidence spectrometer
846 for photoelectron momentum imaging and threshold spectroscopy on mass selected ions
847 using synchrotron radiation, *Rev. Sci. Instrum.* 80 (2009) 023102. doi:10.1063/1.3079331.
- 848 [33] G.A. Garcia, B.K. Cunha de Miranda, M. Tia, S. Daly, L. Nahon, DELICIOUS III: A
849 multipurpose double imaging particle coincidence spectrometer for gas phase vacuum
850 ultraviolet photodynamics studies, *Rev. Sci. Instrum.* 84 (2013) 053112.
851 doi:10.1063/1.4807751.
- 852 [34] T. Baer, R.P. Tuckett, Advances in threshold photoelectron spectroscopy (TPES) and
853 threshold photoelectron photoion coincidence (TPEPICO), *Phys. Chem. Chem. Phys.* 19
854 (2017) 9698–9723. doi:10.1039/C7CP00144D.
- 855 [35] D. Felsmann, K. Moshhammer, J. Krüger, A. Lackner, A. Brockhinke, T. Kasper, T.
856 Bierkandt, E. Akyildiz, N. Hansen, A. Lucassen, P. Oßwald, M. Köhler, G.A. Garcia, L.
857 Nahon, P. Hemberger, A. Bodi, T. Gerber, K. Kohse-Höinghaus, Electron ionization,
858 photoionization and photoelectron/photoion coincidence spectroscopy in mass-
859 spectrometric investigations of a low-pressure ethylene/oxygen flame, *Proc. Combust.*
860 *Inst.* 35 (2015) 779–786. doi:10.1016/J.PROCI.2014.05.151.

- 861 [36] J. Krüger, G.A. Garcia, D. Felsmann, K. Moshhammer, A. Lackner, A. Brockhinke, L.
862 Nahon, K. Kohse-Höinghaus, Photoelectron–photoion coincidence spectroscopy for
863 multiplexed detection of intermediate species in a flame, *Phys. Chem. Chem. Phys.* 16
864 (2014) 22791–22804. doi:10.1039/C4CP02857K.
- 865 [37] P. Oßwald, P. Hemberger, T. Bierkandt, E. Akyildiz, M. Köhler, A. Bodi, T. Gerber, T.
866 Kasper, *In situ* flame chemistry tracing by imaging photoelectron photoion coincidence
867 spectroscopy, *Rev. Sci. Instrum.* 85 (2014) 025101. doi:10.1063/1.4861175.
- 868 [38] D. Krüger, P. Oßwald, M. Köhler, P. Hemberger, T. Bierkandt, T. Kasper, The fate of the
869 OH radical in molecular beam sampling experiments, *Proc. Combust. Inst.* 37 (2019)
870 1563–1570. doi:10.1016/J.PROCI.2018.05.041.
- 871 [39] T. Bierkandt, P. Hemberger, P. Oßwald, D. Krüger, M. Köhler, T. Kasper, Flame structure
872 of laminar premixed anisole flames investigated by photoionization mass spectrometry
873 and photoelectron spectroscopy, *Proc. Combust. Inst.* 37 (2019) 1579–1587.
874 doi:10.1016/J.PROCI.2018.07.037.
- 875 [40] J. Pieper, S. Schmitt, C. Hemken, E. Davies, J. Wullenkord, A. Brockhinke, J. Krüger,
876 G.A. Garcia, L. Nahon, A. Lucassen, W. Eisfeld, K. Kohse-Höinghaus, Isomer
877 Identification in Flames with Double-Imaging Photoelectron/Photoion Coincidence
878 Spectroscopy (i²PEPICO) using Measured and Calculated Reference Photoelectron
879 Spectra, *Zeitschrift Für Phys. Chemie.* 232 (2018) 153–187. doi:10.1515/zpch-2017-1009.
- 880 [41] D. Felsmann, A. Lucassen, J. Krüger, C. Hemken, L.-S. Tran, J. Pieper, G.A. Garcia, A.
881 Brockhinke, L. Nahon, K. Kohse-Höinghaus, Progress in Fixed-Photon-Energy Time-
882 Efficient Double Imaging Photoelectron/Photoion Coincidence Measurements in
883 Quantitative Flame Analysis, *Zeitschrift Für Phys. Chemie.* 230 (2016). doi:10.1515/zpch-
884 2016-0760.
- 885 [42] A. Rodriguez, O. Herbinet, Z. Wang, F. Qi, C. Fittschen, P.R. Westmoreland, F. Battin-
886 Leclerc, Measuring hydroperoxide chain-branching agents during n-pentane low-
887 temperature oxidation, *Proc. Combust. Inst.* 36 (2017) 333–342.
888 doi:10.1016/J.PROCI.2016.05.044.
- 889 [43] J. Bugler, K.P. Somers, E.J. Silke, H.J. Curran, Revisiting the Kinetics and
890 Thermodynamics of the Low-Temperature Oxidation Pathways of Alkanes: A Case Study
891 of the Three Pentane Isomers, *J. Phys. Chem. A.* 119 (2015) 7510–7527.
892 doi:10.1021/acs.jpca.5b00837.
- 893 [44] J. Bugler, A. Rodriguez, O. Herbinet, F. Battin-Leclerc, C. Togbé, G. Dayma, P. Dagaut,
894 H.J. Curran, An experimental and modelling study of n-pentane oxidation in two jet-
895 stirred reactors: The importance of pressure-dependent kinetics and new reaction
896 pathways, *Proc. Combust. Inst.* 36 (2017) 441–448. doi:10.1016/J.PROCI.2016.05.048.
- 897 [45] L. Nahon, N. de Oliveira, G.A. Garcia, J.-F. Gil, B. Pilette, O. Marcouillé, B. Lagarde, F.
898 Polack, IUCr, DESIRS: a state-of-the-art VUV beamline featuring high resolution and
899 variable polarization for spectroscopy and dichroism at SOLEIL, *J. Synchrotron Radiat.*
900 19 (2012) 508–520. doi:10.1107/S0909049512010588.
- 901 [46] X. Tang, G.A. Garcia, J.-F. Gil, L. Nahon, Vacuum upgrade and enhanced performances
902 of the double imaging electron/ion coincidence end-station at the vacuum ultraviolet
903 beamline DESIRS, *Rev. Sci. Instrum.* 86 (2015) 123108. doi:10.1063/1.4937624.
- 904 [47] O. Herbinet, F. Battin-Leclerc, Progress in Understanding Low-Temperature Organic
905 Compound Oxidation Using a Jet-Stirred Reactor, *Int. J. Chem. Kinet.* 46 (2014) 619–639.
906 doi:10.1002/kin.20871.

- 907 [48] P. Azay, G.-M. Côme, Temperature Gradients in a Continuous Flow Stirred Tank Reactor,
908 *Ind. Eng. Chem. Process Des. Dev.* 18 (1979) 754–756. doi:10.1021/i260072a030.
- 909 [49] B. Mercier, M. Compin, C. Prevost, G. Bellec, R. Thissen, O. Dutuit, L. Nahon,
910 Experimental and theoretical study of a differentially pumped absorption gas cell used as a
911 low energy-pass filter in the vacuum ultraviolet photon energy range, *J. Vac. Sci. Technol.*
912 *A Vacuum, Surfaces, Film.* 18 (2000) 2533. doi:10.1116/1.1288196.
- 913 [50] K. Yoshino, Y. Tanaka, Absorption spectrum of krypton in the vacuum uv region, *J. Opt.*
914 *Soc. Am.* 69 (1979) 159. doi:10.1364/JOSA.69.000159.
- 915 [51] G.A. Garcia, L. Nahon, I. Powis, Two-dimensional charged particle image inversion using
916 a polar basis function expansion, *Rev. Sci. Instrum.* 75 (2004) 4989–4996.
917 doi:10.1063/1.1807578.
- 918 [52] J.C. Pouilly, J.P. Schermann, N. Nieuwjaer, F. Lecomte, G. Grégoire, C. Desfrancois, G.A.
919 Garcia, L. Nahon, D. Nandi, L. Poisson, M. Hochlaf, Photoionization of 2-pyridone and 2-
920 hydroxypyridine, *Phys. Chem. Chem. Phys.* 12 (2010) 3566. doi:10.1039/b923630a.
- 921 [53] M. Briant, L. Poisson, M. Hochlaf, P. de Pujo, M.-A. Gaveau, B. Soep, Ar₂ Photoelectron
922 Spectroscopy Mediated by Autoionizing States, *Phys. Rev. Lett.* 109 (2012) 193401.
923 doi:10.1103/PhysRevLett.109.193401.
- 924 [54] J.A. Montgomery, M.J. Frisch, J.W. Ochterski, G.A. Petersson, A complete basis set
925 model chemistry. VI. Use of density functional geometries and frequencies, *J. Chem.*
926 *Phys.* 110 (1999) 2822–2827. doi:10.1063/1.477924.
- 927 [55] Z. Chen, K.-C. Lau, G.A. Garcia, L. Nahon, D.K. Božanić, L. Poisson, M.M. Al-Mogren,
928 M. Schwell, J.S. Francisco, A. Bellili, M. Hochlaf, Identifying Cytosine-Specific Isomers
929 via High-Accuracy Single Photon Ionization, *J. Am. Chem. Soc.* 138 (2016) 16596–
930 16599. doi:10.1021/jacs.6b10413.
- 931 [56] C. Adamo, V. Barone, Toward reliable density functional methods without adjustable
932 parameters: The PBE0 model, *J. Chem. Phys.* 110 (1999) 6158–6170.
933 doi:10.1063/1.478522.
- 934 [57] M. Frisch, G. Trucks, H. Schlegel, G. Scuseria, M. Robb, J. Cheeseman, G. Scalmani, V.
935 Barone, B. Mennucci, G. Petersson, H. Nakatsuji, X. Li, M. Caricato, A. Marenich, J.
936 Bloino, B.G. Janesko, R. Gomperts, B. Mennucci, H.P. Hratchian, J. V. Ortiz, A.F.
937 Izmaylov, J.L. Sonnenberg, D. Williams-Young, F. Ding, F. Lipparini, F. Egidi, J. Goings,
938 B. Peng, A. Petrone, T. Henderson, D. Ranasinghe, V.G. Zakrzewski, J. Gao, N. Rega, G.
939 Zheng, W. Liang, M. Hada, M. Ehara, K. Toyota, R. Fukuda, J. Hasegawa, M. Ishida, T.
940 Nakajima, Y. Honda, O. Kitao, H. Nakai, T. Vreven, K. Throssell, J.A. Montgomery Jr.,
941 J.E. Peralta, F. Ogliaro, M. Bearpark, J.J. Heyd, E. Brothers, K.N. Kudin, V.N.
942 Staroverov, T. Keith, R. Kobayashi, J. Normand, K. Raghavachari, A. Rendell, J.C.
943 Burant, S.S. Iyengar, J. Tomasi, M. Cossi, J.M. Millam, M. Klene, C. Adamo, R. Cammi,
944 J.W. Ochterski, R.L. Martin, K. Morokuma, O. Farkas, J.B. Foresman, D.J. Fox, Gaussian
945 09, Revision A.02, Gaussian, Inc., Wallingford CT. 200 (2009) 28.
- 946 [58] T.H. Dunning, Gaussian basis sets for use in correlated molecular calculations. I. The
947 atoms boron through neon and hydrogen, *J. Chem. Phys.* 90 (1989) 1007–1023.
948 doi:10.1063/1.456153.
- 949 [59] R.A. Kendall, T.H. Dunning, R.J. Harrison, Electron affinities of the first-row atoms
950 revisited. Systematic basis sets and wave functions, *J. Chem. Phys.* 96 (1992) 6796–6806.
951 doi:10.1063/1.462569.
- 952 [60] J. Bloino, M. Biczysko, F. Santoro, V. Barone, General Approach to Compute

- 953 Vibrationally Resolved One-Photon Electronic Spectra, *J. Chem. Theory Comput.* 6
954 (2010) 1256–1274. doi:10.1021/ct9006772.
- 955 [61] V. Barone, J. Bloino, M. Biczysko, F. Santoro, Fully Integrated Approach to Compute
956 Vibrationally Resolved Optical Spectra: From Small Molecules to Macrosystems, *J.*
957 *Chem. Theory Comput.* 5 (2009) 540–554. doi:10.1021/ct8004744.
- 958 [62] J. Bloino, M. Biczysko, O. Crescenzi, V. Barone, Integrated computational approach to
959 vibrationally resolved electronic spectra: Anisole as a test case, *J. Chem. Phys.* 128 (2008)
960 244105. doi:10.1063/1.2943140.
- 961 [63] J. Bloino, A. Baiardi, M. Biczysko, Aiming at an accurate prediction of vibrational and
962 electronic spectra for medium-to-large molecules: An overview, *Int. J. Quantum Chem.*
963 116 (2016) 1543–1574. doi:10.1002/qua.25188.
- 964 [64] T.B. Adler, H.-J. Werner, Local explicitly correlated coupled-cluster methods: Efficient
965 removal of the basis set incompleteness and domain errors, *J. Chem. Phys.* 130 (2009)
966 241101. doi:10.1063/1.3160675.
- 967 [65] T.B. Adler, G. Knizia, H.-J. Werner, A simple and efficient CCSD(T)-F12 approximation,
968 *J. Chem. Phys.* 127 (2007) 221106. doi:10.1063/1.2817618.
- 969 [66] G. Knizia, T.B. Adler, H.-J. Werner, Simplified CCSD(T)-F12 methods: Theory and
970 benchmarks, *J. Chem. Phys.* 130 (2009) 054104. doi:10.1063/1.3054300.
- 971 [67] T.B. Adler, H.-J. Werner, F.R. Manby, Local explicitly correlated second-order
972 perturbation theory for the accurate treatment of large molecules, *J. Chem. Phys.* 130
973 (2009) 054106. doi:10.1063/1.3040174.
- 974 [68] K.E. Yousaf, K.A. Peterson, Optimized auxiliary basis sets for explicitly correlated
975 methods, *J. Chem. Phys.* 129 (2008) 184108. doi:10.1063/1.3009271.
- 976 [69] H.-J. Werner, P.J. Knowles, G. Knizia, F.R. Manby, M. Schütz, Molpro: a general-
977 purpose quantum chemistry program package, *Wiley Interdiscip. Rev. Comput. Mol. Sci.*
978 2 (2012) 242–253. doi:10.1002/wcms.82.
- 979 [70] Y. Pan, K.-C. Lau, L. Poisson, G.A. Garcia, L. Nahon, M. Hochlaf, Slow Photoelectron
980 Spectroscopy of 3-Hydroxyisoquinoline, *J. Phys. Chem. A.* 117 (2013) 8095–8102.
981 doi:10.1021/jp311615u.
- 982 [71] Y. Pan, K.-C. Lau, M.M. Al-Mogren, A. Mahjoub, M. Hochlaf, Theoretical studies of 2-
983 quinolinol: Geometries, vibrational frequencies, isomerization, tautomerism, and excited
984 states, *Chem. Phys. Lett.* 613 (2014) 29–33. doi:10.1016/J.CPLETT.2014.08.033.
- 985 [72] M. Hochlaf, Advances in spectroscopy and dynamics of small and medium sized
986 molecules and clusters, *Phys. Chem. Chem. Phys.* 19 (2017) 21236–21261.
987 doi:10.1039/C7CP01980G.
- 988 [73] Y. Majdi, M. Hochlaf, Y. Pan, K.-C. Lau, L. Poisson, G.A. Garcia, L. Nahon, M.M. Al-
989 Mogren, M. Schwell, Theoretical and Experimental Photoelectron Spectroscopy
990 Characterization of the Ground State of Thymine Cation, *J. Phys. Chem. A.* 119 (2015)
991 5951–5958. doi:10.1021/jp510716c.
- 992 [74] H.Y. Zhao, K.-C. Lau, G.A. Garcia, L. Nahon, S. Carniato, L. Poisson, M. Schwell, M.M.
993 Al-Mogren, M. Hochlaf, Unveiling the complex vibronic structure of the canonical
994 adenine cation, *Phys. Chem. Chem. Phys.* 20 (2018) 20756–20765.
995 doi:10.1039/C8CP02930J.
- 996 [75] M. Bobeldijk, W.J. Van der Zande, P.G. Kistemaker, Simple models for the calculation of
997 photoionization and electron impact ionization cross sections of polyatomic
998 molecules, *Chemical physics*, 179(2) (1994) 125-130. doi:10.1016/0301-0104(93)E0376-7

- 999 [76] B. Niu, Y. Bai, D.A. Shirley, High resolution He I α photoelectron spectroscopy of H₂CCO
1000 and D₂CCO using supersonic molecular beams, Chem. Phys. Lett. 201 (1993) 217–222.
1001 doi:10.1016/0009-2614(93)85059-W.
- 1002 [77] G. Bieri, F. Burger, E. Heilbronner, J.P. Maier, Valence Ionization Energies of
1003 Hydrocarbons, Helv. Chim. Acta. 60 (1977) 2213–2233. doi:10.1002/hlca.19770600714.
- 1004 [78] B. Yang, J. Wang, T.A. Cool, N. Hansen, S. Skeen, D.L. Osborn, Absolute
1005 photoionization cross-sections of some combustion intermediates, Int. J. Mass Spectrom.
1006 309 (2012) 118–128. doi:10.1016/j.ijms.2011.09.006.
- 1007 [79] J.C. Person, P.P. Nicole, Isotope Effects in the Photoionization Yields and the Absorption
1008 Cross Sections for Acetylene, Propyne, and Propene, J. Chem. Phys. 53 (1970) 1767–
1009 1774. doi:10.1063/1.1674254.
- 1010 [80] D. Chadwick, A. Katrib, Photoelectron spectra of acetaldehyde and acetyl halides, J.
1011 Electron Spectros. Relat. Phenomena. 3 (1974) 39–52. doi:10.1016/0368-2048(74)80073-
1012 3.
- 1013 [81] K. Johnson, I. Powis, C.J. Danby, A photoelectron—photoion coincidence study of
1014 acetaldehyde and ethylene oxide molecular ions, Chem. Phys. 70 (1982) 329–343.
1015 doi:10.1016/0301-0104(82)88103-2.
- 1016 [82] W.R. Stevens, A. Bodi, T. Baer, Dissociation Dynamics of Energy Selected, Propane, and
1017 *i*-C₃H₇X⁺ Ions by iPEPICO: Accurate Heats of Formation of *i*-C₃H₇⁺, *i*-C₃H₇Cl, *i*-C₃H₇Br,
1018 and *i*-C₃H₇I, J. Phys. Chem. A. 114 (2010) 11285–11291. doi:10.1021/jp104200h.
- 1019 [83] D.J. Knowles, A.J.C. Nicholson, Ionization energies of formic and acetic acid monomers,
1020 J. Chem. Phys. 60 (1974) 1180–1181. doi:10.1063/1.1681132.
- 1021 [84] A.J. Yench, M.R.F. Siggel-King, G.C. King, A.E.R. Malins, M. Eypper, Threshold
1022 photoelectron spectroscopy of acetaldehyde and acrolein, J. Electron Spectros. Relat.
1023 Phenomena. 187 (2013) 65–71. doi:10.1016/J.ELSPEC.2013.04.005.
- 1024 [85] H. Bock, T. Hirabayashi, S. Mohmand, Gasphasen-Reaktionen, 21. Thermische
1025 Erzeugung von Alkyl- und Halogenketenen, Chem. Ber. 114 (1981) 2595–2608.
1026 doi:10.1002/cber.19811140722.
- 1027 [86] E. Ranzi, C. Cavallotti, A. Cuoci, A. Frassoldati, M. Pelucchi, T. Faravelli, New reaction
1028 classes in the kinetic modeling of low temperature oxidation of n-alkanes, Combust.
1029 Flame. 162 (2015) 1679–1691. doi:10.1016/J.COMBUSTFLAME.2014.11.030.
- 1030 [87] A.A. Bredikhin, Photoelectron spectra of alkoxyacetylenes: σ , α -interactions with
1031 simultaneous participation of both oxygen unshared pairs, Bull. Acad. Sci. USSR Div.
1032 Chem. Sci. 40 (1991) 1583–1587. doi:10.1007/BF01172255.
- 1033 [88] C.E. van Der Meij, J. Van Eck, A. Niehaus, The decomposition of C₄H₈⁺ complexes at
1034 controlled internal energies, Chem. Phys. 130 (1989) 325–334. doi:10.1016/0301-
1035 0104(89)87061-2.
- 1036 [89] J. Dannacher, J.-P. Stadelmann, Behavior of excited C₃H₆O⁺ cations: a He-I α
1037 photoelectron-photoion coincidence study of propanal, Int. J. Mass Spectrom. 208 (2001)
1038 147–157. doi:10.1016/S1387-3806(01)00387-6.
- 1039 [90] Emma E. Rennie, Anne-Marie Boulanger, P.M. Mayer, D.M. Holland, D.A. Shaw, L.
1040 Cooper, L.G. Shpinkova, A Photoelectron and TPEPICO Investigation of the Acetone
1041 Radical Cation, (2006). doi:10.1021/JP0616866.
- 1042 [91] Z. Zhou, M. Xie, Z. Wang, F. Qi, Determination of absolute photoionization cross-
1043 sections of aromatics and aromatic derivatives, Rapid Commun. Mass Spectrom. 23
1044 (2009) 3994–4002. doi:10.1002/rcm.4339.

- 1045 [92] K. Watanabe, T. Nakayama, J. Mottl, Ionization potentials of some molecules, *J. Quant.*
1046 *Spectrosc. Radiat. Transf.* 2 (1962) 369–382. doi:10.1016/0022-4073(62)90023-7.
- 1047 [93] J. Wang, B. Yang, T.A. Cool, N. Hansen, T. Kasper, Near-threshold absolute
1048 photoionization cross-sections of some reaction intermediates in combustion, *Int. J. Mass*
1049 *Spectrom.* 269 (2008) 210–220. doi:10.1016/J.IJMS.2007.10.013.
- 1050 [94] T.A. Cool, J. Wang, K. Nakajima, C.A. Taatjes, A. McIlroy, Photoionization cross
1051 sections for reaction intermediates in hydrocarbon combustion, *Int. J. Mass Spectrom.* 247
1052 (2005) 18–27. doi:10.1016/J.IJMS.2005.08.018.
- 1053 [95] W. von Niessen, G. Bieri, L. Åsbrink, 30.4-nm He (II) photoelectron spectra of organic
1054 molecules: Part III. Oxo-compounds (C, H, O), *J. Electron Spectros. Relat. Phenomena.*
1055 21 (1980) 175–191. doi:10.1016/0368-2048(80)85046-8.
- 1056 [96] A. Jalan, I.M. Alecu, R. Meana-Pañeda, J. Aguilera-Iparraguirre, K.R. Yang, S.S.
1057 Merchant, D.G. Truhlar, W.H. Green, New Pathways for Formation of Acids and
1058 Carbonyl Products in Low-Temperature Oxidation: The Korcek Decomposition of γ -
1059 Ketohydroperoxides, *J. Am. Chem. Soc.* 135 (2013) 11100–11114.
1060 doi:10.1021/ja4034439.
- 1061 [97] J.-P. Morizur, J. Mercier, M. Sarraf, 2-substituted-2,3-dihydro-4H-pyrans: Competition
1062 between ‘retro Diels-Alder’ fragmentation and substituent loss, *Org. Mass Spectrom.* 17
1063 (1982) 327–330. doi:10.1002/oms.1210170708.
- 1064 [98] W.-C. Tam, D. Yee, C.E. Brion, Photoelectron spectra of some aldehydes and ketones, *J.*
1065 *Electron Spectros. Relat. Phenomena.* 4 (1974) 77–80. doi:10.1016/0368-2048(74)80045-
1066 9.
- 1067 [99] K. Seki, H. Inokuchi, The Ultraviolet Photoelectron Spectroscopy of Aliphatic
1068 Hydrocarbons and Tetramethylsilane in the Solid State, *Bull. Chem. Soc. Jpn.* 56 (1983)
1069 2212–2219. doi:10.1246/bcsj.56.2212.
- 1070 [100] F. Buda, R. Bounaceur, V. Warth, P.A. Glaude, R. Fournet, F. Battin-Leclerc, Progress
1071 toward a unified detailed kinetic model for the autoignition of alkanes from C₄ to C₁₀
1072 between 600 and 1200 K, *Combust. Flame.* 142 (2005) 170–186.
1073 doi:10.1016/J.COMBUSTFLAME.2005.03.005.

1074
1075
1076
1077
1078
1079
1080
1081
1082
1083
1084
1085
1086

Graphical Abstract

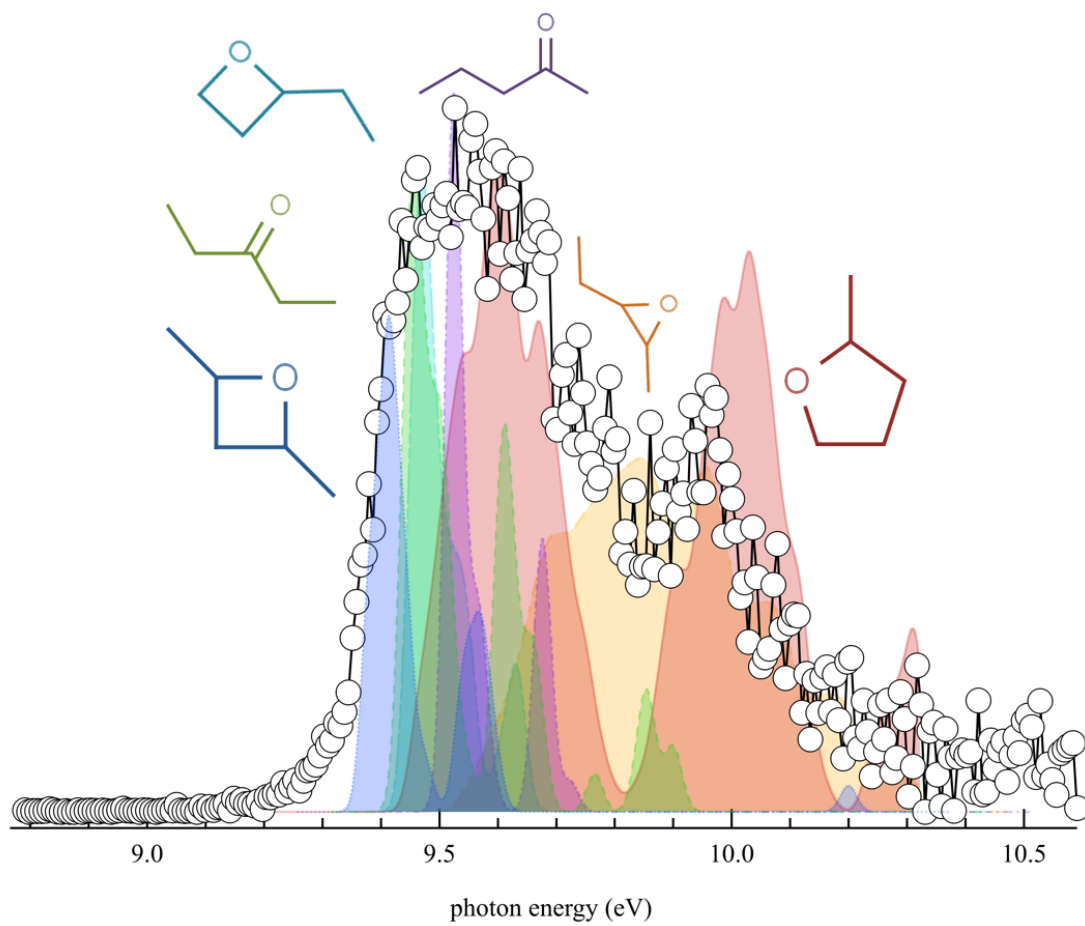

1087