



HAL
open science

Analytical expression of mechanical fields for Gurson type porous models

Cédric Sartori, Sébastien Mercier, Alain Molinari

► **To cite this version:**

Cédric Sartori, Sébastien Mercier, Alain Molinari. Analytical expression of mechanical fields for Gurson type porous models. *International Journal of Solids and Structures*, 2019, 163, pp.25-39. 10.1016/j.ijsolstr.2018.11.034 . hal-03229005

HAL Id: hal-03229005

<https://hal.univ-lorraine.fr/hal-03229005v1>

Submitted on 22 Oct 2021

HAL is a multi-disciplinary open access archive for the deposit and dissemination of scientific research documents, whether they are published or not. The documents may come from teaching and research institutions in France or abroad, or from public or private research centers.

L'archive ouverte pluridisciplinaire **HAL**, est destinée au dépôt et à la diffusion de documents scientifiques de niveau recherche, publiés ou non, émanant des établissements d'enseignement et de recherche français ou étrangers, des laboratoires publics ou privés.



Distributed under a Creative Commons Attribution - NonCommercial 4.0 International License

ANALYTICAL EXPRESSION OF MECHANICAL FIELDS FOR GURSON TYPE POROUS MODELS.

C. Sartori^{1*}, S. Mercier¹, A. Molinari¹

¹ *Université de Lorraine, CNRS, Arts et Métiers ParisTech, LEM3, F-57000 Metz, France*

Abstract:

In this work, analytical expressions of mechanical fields are provided for strain hardening thermo-viscoplastic porous materials containing spheroidal voids subjected to homogeneous strain rate loading. Explicit relationships are provided for the macroscopic stress, the plastic multiplier, the effective equivalent plastic strain in the matrix when the constitutive behavior of the porous medium is of Gurson type model. Axisymmetric and non-axisymmetric loadings are considered. The behavior of the porous material is governed by the model developed by Gologanu et al. (Gologanu, M., Leblond, J.-B., Perrin, G., Devaux, J., 1997, *CISM Courses and lectures*, **377**, 61-130). The particular case of the Gurson model (Gurson, A. L., 1977, *ASME Journal of Engineering Materials and Technology* **99**, 2-15) is also investigated since it is widely adopted in the literature for analytical modeling or finite elements calculations. Various matrix behaviors are considered. The matrix is first considered as rigid perfectly plastic. Interestingly, the approach is also valid for nonlinear viscoplastic material with work hardening and temperature dependency. Extensions are also considered when the matrix material is orthotropic. Finally, the numerical implementation is discussed and it is shown that by adopting the proposed approach, the efficiency of the radial return algorithm can be improved.

*Corresponding author. Tel: +33 3 72 74 80 21
E mail address: cedric.sartori@univ-lorraine.fr

Key words: Porous plasticity models, spheroidal voids, viscoplastic material, porous material, anisotropy.

1. Introduction

The description of plasticity problems generates non linear equations which are usually solved by iterative procedures, Simo and Hughes (1998). In the present work, we address the case of porous ductile materials, whose behavior is described by a Gurson type approach. Porous plasticity has received a large attention in the literature. Different strategies have been proposed to model this type of materials.

Some of the works are based on non linear homogenization techniques to characterize the macroscopic behavior of porous medium, see Duva (1986), Ponte Castañeda (1991), Michel and Suquet (1992), Song and Ponte-Castaneda (2017). In these works, the key point is to define a stress or strain rate potential for the considered microstructures. When the potential is known, then, the conjugates variables (strain rate or stress tensor) are immediately obtained. As mentioned in Danas and Ponte Castañeda (2009), for linear viscous matrix, the predictions of the variational approach of Ponte Castañeda (1991) provides exact results in case of spherical loading. This type of approach has received lots of attention in the literature as many additional references can be found in the literature. We will not develop further the interest of adopting such formalism since our contribution is not dedicated to this type of approach.

Some works are based on limit analysis. Since the seminal paper of Gurson (1977), numerous forms of yield surfaces have been proposed relating the effective and spherical parts of the stress tensor to the porosity. For Gurson type models, when the matrix is assumed to be viscoplastic or when strain hardening, temperature softening or anisotropy are introduced, the model is complemented by evolution equations for internal variables. The extension of

Gurson type models from perfectly plastic to viscoplastic and hardening materials has been widely discussed in the literature (Cocks (1989), Duva (1986), Michel and Suquet (1992)). Such effort was continued in the recent years, see Reboul and Vadillo (2018) for viscoplastic material or Morin et al. (2017) for kinematic and isotropic hardening. The shape of the void is also an important parameter that should be accounted for to accurately analyze the fracture mechanism of ductile porous materials, Gologanu et al. (1993, 1994, 1997), Gărăjeu et al. (2000). Next, we will focus on this type of models to explore the possibility to have analytical expressions for the mechanical fields.

Unfortunately, as the number of internal variables is increased, the opportunity to derive analytical expressions for the mechanical fields is reduced and the recourse to numerical approach is necessary. The derivation of efficient strategies to numerically implement porous models has led to a large effort over the last decades. One may refer for instance to Aravas (1987), Mühlich et al. (2003), Vadillo et al. (2008), Enakoutsa et al. (2009) to have an overview of available strategies to implement porous constitutive models in finite element software.

In the present work, specific porous plasticity models are adopted: Gurson (1977), Gologanu et al. (1997). By construction, their mathematical expressions are similar. For the Gurson model, the effective stress is linked to the mean stress and the porosity. For a perfectly plastic material, the limit analysis provides analytical expressions for the macroscopic stress, Gologanu et al. (1997), Gologanu (1997), Leblond (2003), Monchiet et al. (2007), Monchiet and Kondo (2013), Balan and Cazacu (2013). Exact solutions were also developed in the literature for a hollow cylinder or a sphere under hydrostatic loading in a viscoplastic matrix, Michel and Suquet (1992), Leblond et al. (1994), Leblond and Roy (2000).

We propose a versatile method for obtaining analytical expressions of the macroscopic stress for axisymmetric loading. The approach applies for a large variety of matrix behaviors, from perfect plasticity to strain hardening thermo-viscoplasticity. Matrix anisotropy can be also considered for some specific cases. However, it should be noted that all expressions obtained are estimates that should be evaluated. For a perfectly plastic matrix, the estimates of the yield surfaces are consistently obtained from the limit analysis, Gurson (1977), Gologanu et al. (1993, 1994, 1997). However, a direct extension of these results to viscoplasticity or to strain-hardening plasticity is problematic. Leblond et al. (1994) have clearly explained the difficulties to get consistent estimates for porous materials with non-linear matrix. Analytical expressions of mechanical fields obtained in this paper may help to validate such extensions.

The paper is organized as follows. The method is introduced in Section 2 and applied to the model of Gologanu et al. (1993, 1994, 1997). For this first example, a rigid perfectly plastic response and a viscoplastic behavior are considered for the matrix. Extension to materials presenting strain hardening and/or temperature dependency is also addressed. In Section 3, various particular cases are investigated: Gurson (1977) model with spherical voids, Gologanu et al. (1997) model for spheroidal and cylindrical voids. Section 4 extends the method to non-axisymmetric loadings and the possibility of considering anisotropic matrix responses is discussed. Finally, it is shown that the proposed analytical expressions can be adopted to reduce the number of non-linear equations to be solved in a finite element code. This is a noteworthy point when dealing with large scale finite element calculations.

2. General formulation of the problem

2.1 Introduction

A porous material is considered with porosity f . The distribution of void centers is isotropic. The matrix material is rigid thermo-viscoplastic and has an orthotropic response. Elasticity is disregarded from Section 2 to Section 4. A representative volume element (RVE) is defined having the same porosity f . A Cartesian coordinate system is associated to a reference frame $(\underline{e}_x; \underline{e}_y; \underline{e}_z)$ (see Fig. 1), corresponding to the principal directions of the macroscopic loading and the principal directions of orthotropy. The RVE is subjected to homogeneous strain rate loading at the external boundary:

$$\underline{v} = \underline{\underline{D}} \cdot \underline{x} \quad \text{with} \quad \underline{\underline{D}} = \begin{bmatrix} D_{XX} & 0 & 0 \\ 0 & D_{YY} & 0 \\ 0 & 0 & D_{ZZ} \end{bmatrix} \quad (1)$$

Let us denote $\underline{\underline{\Sigma}}$ the macroscopic stress prevailing at the external boundary of the RVE.

Assuming that the voids are spheroidal with principal directions $(\underline{e}_x; \underline{e}_y; \underline{e}_z)$, we have:

$$\underline{\underline{\Sigma}} = \begin{bmatrix} \Sigma_{XX} & 0 & 0 \\ 0 & \Sigma_{YY} & 0 \\ 0 & 0 & \Sigma_{ZZ} \end{bmatrix} \quad (2)$$

In the present work, we focus on Gurson type of models. So the macroscopic yield surface can be written as:

$$\Phi(\Sigma_{XX}, \Sigma_{YY}, \Sigma_{ZZ}, \tilde{\sigma}_0, f) = 0 \quad (3)$$

where $\tilde{\sigma}_0$ is a measure of the effective flow stress existing in the matrix during the loading.

As already stated, the matrix is thermo-viscoplastic and the general expression for the flow stress takes the form:

$$\tilde{\sigma}_0 = F_0(d_{eq}, \varepsilon_{eq}, T) \quad (4)$$

d_{eq} denotes the effective equivalent plastic strain rate (assumed uniform in the matrix), $\varepsilon_{eq} = \int d_{eq} dt$ is the accumulated plastic strain and T is the temperature. The matrix material obeys the J_2 flow law except otherwise specified.

The porous material is assumed to be plastically loaded. The macroscopic plastic strain rate tensor is given by:

$$\underline{\underline{D}} = \Lambda \frac{\partial \Phi}{\partial \underline{\underline{\Sigma}}} \quad (5)$$

Λ is the plastic multiplier defined by the Kuhn-Tucker complementary condition ($\Lambda \geq 0$, $\Phi \leq 0$ and $\Lambda \Phi = 0$). Note that $\underline{\underline{D}}$ represents the plastic strain rate tensor since the material is rigid (elasticity neglected in Sections 2-4).

The evolution of the effective equivalent plastic strain rate in the matrix is defined assuming that the macroscopic work of deformation per unit volume is equal to the plastic work in the matrix:

$$\underline{\underline{\Sigma}} : \underline{\underline{D}} = (1 - f) \tilde{\sigma}_0 d_{eq} \quad (6)$$

The goal of the present work is to provide a set of analytical expressions for the macro-stress components, the effective plastic strain rate in the matrix and the plastic multiplier. The matrix behavior is thermo-viscoplastic (see Eq. (4)). Note that analytical expressions for a perfectly rigid matrix are given in the literature, see for instance Gologanu et al. (1997), Gologanu (1997), Leblond (2003). The following set of equations has to be solved:

$$\begin{cases} \Phi = 0 \\ \exists \Lambda > 0, \underline{\underline{D}} = \Lambda \frac{\partial \Phi}{\partial \underline{\underline{\Sigma}}} \\ \Sigma_{XX} D_{XX} + \Sigma_{YY} D_{YY} + \Sigma_{ZZ} D_{ZZ} = (1 - f) \tilde{\sigma}_0 d_{eq} \end{cases} \quad (7)$$

Next, a specific representative volume element and an associated flow surface Φ are considered. In this contribution, we will consider the Gologanu et al. model (1997) (referred to as GLPD in the following), the Gurson model (1977) and we provide some indication for more general models valid for ellipsoid voids. The proposed method is general so that extension to some other porous models of the literature might be considered.

2.2 Analytical expressions for mechanical fields based on the model of Gologanu et al. (1997)

2.2.1 Stress state evaluation

In this section, the porous medium contains spheroidal voids of identical shape. The semi axes of the spheroids are aligned with the loading axis. As proposed by Gologanu et al. (1997), the representative volume element (RVE) is made of two confocal axisymmetric spheroids (see Figure 1 for a RVE with prolate void). The lengths a_1 (along \underline{e}_z) and b_1 (along \underline{e}_x and \underline{e}_y) are the semi axes of the void. a_2 (along \underline{e}_z) and b_2 (along \underline{e}_x and \underline{e}_y) represent the semi axes of the outer surface of the RVE. Note that Gologanu et al. (1997) have considered porous medium with prolate and oblate spheroids. They have also shown that the spherical void case is a limit case of both prolate and oblate configurations. Since spheroids are confocal, the focal distance c is constant $c = \sqrt{a_1^2 - b_1^2} = \sqrt{a_2^2 - b_2^2}$. The void volume fraction in the RVE is $f = \frac{a_1 b_1^2}{a_2 b_2^2}$, chosen identical to the porosity of the porous material.

The strain rate tensor (for axisymmetric loading) is given by Eq. (1) with $D_{XX} = D_{YY}$. As a consequence, the macroscopic stress is also diagonal, as in Eq. (2) with $\Sigma_{XX} = \Sigma_{YY}$.

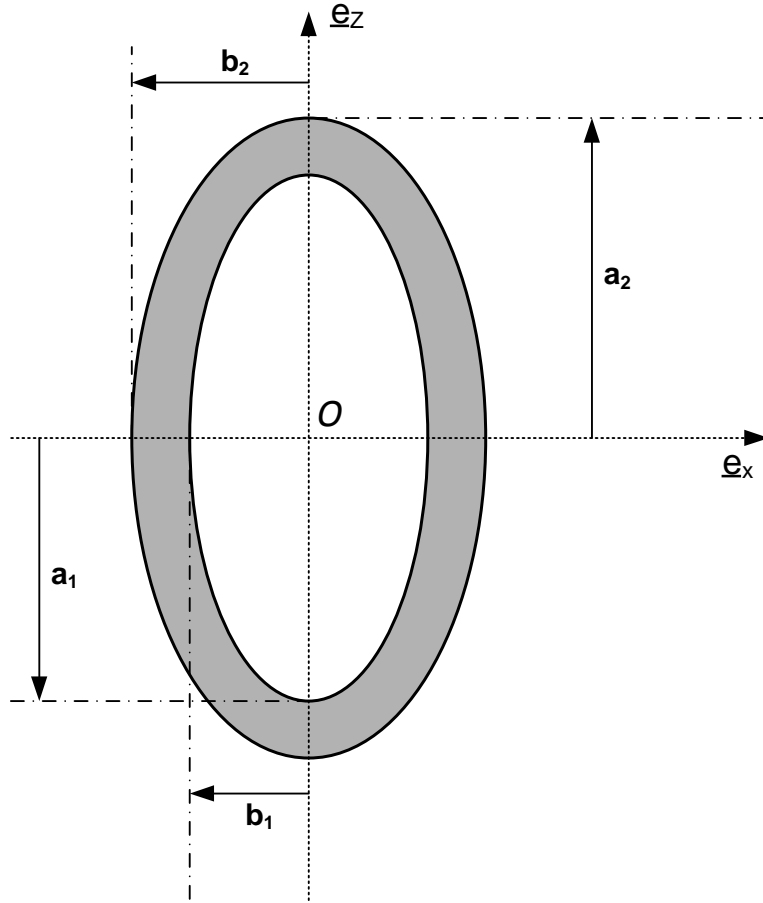

FIG. 1 – RVE configuration: A prolate void with semi axes a_1 and b_1 is embedded into a confocal prolate spheroid with semi axes a_2 and b_2 . The symmetry axis is $(O; \underline{e}_z)$.

Under loading conditions ($\Lambda > 0$), the plastic multiplier can be eliminated and the set of equations (7) can be replaced by the following one:

$$\begin{cases} \Phi = 0 \\ \frac{\partial \Phi}{\partial \Sigma_{XX}} D_{ZZ} - \frac{\partial \Phi}{\partial \Sigma_{ZZ}} D_{XX} = 0 \\ 2\Sigma_{XX} D_{XX} + \Sigma_{ZZ} D_{ZZ} = (1 - f) \tilde{\sigma}_0 d_{eq} \\ \Lambda > 0 \end{cases} \quad (8)$$

Based on limit analysis, Gologanu et al. (1997) were able to propose a yield surface for the porous medium under axisymmetric loading:

$$\Phi = \frac{c}{\tilde{\sigma}_0^2} (\Sigma_{ZZ} - \Sigma_{XX} + \eta \Sigma_h)^2 + 2(g+1)(g+f) \cosh\left(k \frac{\Sigma_h}{\tilde{\sigma}_0}\right) - (g+1)^2 - (g+f)^2 = 0 \quad (9)$$

with:

$$\Sigma_h = 2\alpha_2 \Sigma_{XX} + (1 - 2\alpha_2) \Sigma_{ZZ} \quad (10)$$

α_2 is the shape parameter of the outer surface of the RVE. Expressions for parameters (C, η, g, k) are detailed in Gologanu et al. (1997) for a rigid perfectly plastic matrix material and provided in Appendix A for prolate and oblate voids.

These parameters are only depending on the shape of the void.

From the yield surface (9), the derivatives $\frac{\partial \Phi}{\partial \Sigma_{XX}}$ and $\frac{\partial \Phi}{\partial \Sigma_{ZZ}}$ can be evaluated. Note that the expression $\frac{\partial \Phi}{\partial \Sigma_{XX}}$ is obtained from Equation (9) where a factor $\frac{1}{2}$ has been introduced because of axisymmetric loading, as explained in Gologanu et al. (1997):

$$\begin{cases} \frac{\partial \Phi}{\partial \Sigma_{XX}} = \frac{2C}{\tilde{\sigma}_0^2} (\Sigma_{ZZ} - \Sigma_{XX} + \eta \Sigma_h) \left(-\frac{1}{2} + \eta \alpha_2\right) + 2(g+1)(g+f) k \frac{\alpha_2}{\tilde{\sigma}_0} \sinh\left(k \frac{\Sigma_h}{\tilde{\sigma}_0}\right) \\ \frac{\partial \Phi}{\partial \Sigma_{ZZ}} = \frac{2C}{\tilde{\sigma}_0^2} (\Sigma_{ZZ} - \Sigma_{XX} + \eta \Sigma_h) (1 + \eta(1 - 2\alpha_2)) + 2(g+1)(g+f) k \frac{(1-2\alpha_2)}{\tilde{\sigma}_0} \sinh\left(k \frac{\Sigma_h}{\tilde{\sigma}_0}\right) \end{cases} \quad (11)$$

In the present work the deviatoric stress is defined as:

$$\Sigma_D = \Sigma_{ZZ} - \Sigma_{XX} \quad (12)$$

With Eqs. (9), (10), (11) and $tr(\underline{\underline{D}}) = 2D_{XX} + D_{ZZ}$, the set of Equations (8) becomes:

$$\begin{cases} \frac{c}{\tilde{\sigma}_0^2} (\Sigma_D + \eta \Sigma_h)^2 + 2(g+1)(g+f) \cosh\left(k \frac{\Sigma_h}{\tilde{\sigma}_0}\right) - (g+1)^2 - (g+f)^2 = 0 \\ \frac{2c}{\tilde{\sigma}_0^2} (\Sigma_D + \eta \Sigma_h) \Pi_1 + 2\Pi_2 (g+1)(g+f) \frac{k}{\tilde{\sigma}_0} \sinh\left(k \frac{\Sigma_h}{\tilde{\sigma}_0}\right) = 0 \\ \Sigma_h \text{tr}\left(\underline{D}\right) + 2\Sigma_D \Pi_2 = (1-f) \tilde{\sigma}_0 d_{eq} \\ \Lambda > 0 \end{cases} \quad (13)$$

where:

$$\begin{cases} \Pi_1 = (-1 + 2\eta\alpha_2) \frac{D_{ZZ}}{2} + (-1 - \eta + 2\eta\alpha_2) D_{XX} \\ \Pi_2 = \alpha_2 D_{ZZ} - (1 - 2\alpha_2) D_{XX} \end{cases} \quad (14)$$

Next, the condition $\Pi_1 \neq 0$ is assumed. The case $\Pi_1 = 0$ is investigated in Appendix B. From equation (13-2), we have:

$$\Sigma_D + \eta \Sigma_h = -\frac{\Pi_2}{\Pi_1} (g+1)(g+f) \frac{k\tilde{\sigma}_0}{c} \sinh\left(k \frac{\Sigma_h}{\tilde{\sigma}_0}\right) \quad (15)$$

Introducing Eq. (15) into Eq. (13-1) gives:

$$\left(-\frac{\Pi_2}{\Pi_1}\right)^2 (g+1)^2 (g+f)^2 \frac{k^2}{c} \left(\sinh\left(k \frac{\Sigma_h}{\tilde{\sigma}_0}\right)\right)^2 + 2(g+1)(g+f) \cosh\left(k \frac{\Sigma_h}{\tilde{\sigma}_0}\right) - (g+1)^2 - (g+f)^2 = 0 \quad (16)$$

With the definition:

$$X = \cosh\left(k \frac{\Sigma_h}{\tilde{\sigma}_0}\right), \quad (17)$$

Eq. (16) becomes:

$$\frac{\Pi_2^2 k^2}{\Pi_1^2 c} (g+1)^2 (g+f)^2 [X^2 - 1] + 2(g+1)(g+f)X - (g+1)^2 - (g+f)^2 = 0 \quad (18)$$

This quadratic equation in X has a single positive solution which is:

$$X = \frac{-\delta_2 + \sqrt{\delta_2^2 - 4\delta_1\delta_3}}{2\delta_1} = -\frac{2\delta_3}{\delta_2 + \sqrt{\delta_2^2 - 4\delta_1\delta_3}} \quad (19)$$

where:

$$\begin{cases} \delta_1 = \frac{\Pi_2^2 k^2}{\Pi_1^2 c} (g+1)^2 (g+f)^2 \\ \delta_2 = 2(g+1)(g+f) \\ \delta_3 = -(g+1)^2 - (g+f)^2 - \frac{\Pi_2^2 k^2}{\Pi_1^2 c} (g+1)^2 (g+f)^2 \end{cases} \quad (20)$$

Note that Eq. (19) is also valid for the particular case $\Pi_2 = 0$.

Based on the analytical expression of X (Eq. (19)), the stress parameter Σ_h can be written from Eq. (17) as:

$$\Sigma_h = \tilde{\sigma}_0 \beta_1 \quad (21)$$

with:

$$\beta_1 = \pm \frac{1}{k} \ln(X + \sqrt{X^2 - 1}) \quad (22)$$

It should be noticed that the result (21) was already obtained by Gologanu et al. (1997), during the derivation of the yield surface but the matrix material was assumed perfectly plastic. In this work, the relationship (21) is obtained adopting a different way, which may also be used for different yield surfaces of the literature.

At this stage, the term $\tilde{\sigma}_0$ is still unknown and the sign of Σ_h has to be determined. From equation (15), Σ_D is found:

$$\Sigma_D = \tilde{\sigma}_0 \beta_2 \quad (23)$$

where:

$$\beta_2 = -\eta\beta_1 - \frac{\Pi_2 k}{\Pi_1 C} (g + 1)(g + f) \sinh(k\beta_1) \quad (24)$$

From the equivalence between the macroscopic and microscopic plastic dissipations (Eq. 6):

$$\tilde{\sigma}_0 \beta_1 \text{tr}(\underline{D}) + 2\tilde{\sigma}_0 \beta_2 \Pi_2 = (1 - f) \tilde{\sigma}_0 d_{eq}, \quad (25)$$

an analytical form for the effective equivalent plastic strain rate in the matrix is found:

$$d_{eq} = \frac{\beta_1 \text{tr}(\underline{D}) + 2\beta_2 \Pi_2}{1 - f} \quad (26)$$

It appears that d_{eq} is only related to the macroscopic strain rate and to the geometrical configuration (shape of the RVE and porosity). Note that d_{eq} is independent of the description of the matrix behavior. This feature is due to the fact that the parameters $(\alpha_2, C, \eta, g, k)$ of the model have no material dependency since they have been derived for the specific case of a rigid perfectly plastic matrix. The effective equivalent plastic strain rate can be linked to material properties when the parameters of the model present such dependency, as for instance in Flandi and Leblond (2005a, 2005b). It should be mentioned that to the author best knowledge, the analytical expression of the effective equivalent plastic strain rate in the matrix was never obtained previously. This is an interesting outcome of the present work. Such explicit expression could be useful to validate the extension of the Gurson type model to thermoviscoplastic materials based on the dissipation balance Eq. (6).

The effective equivalent plastic strain rate d_{eq} is by definition positive. It is shown in Appendix C that $d_{eq} > 0$ implies $\beta_1 \Pi_1 < 0$. Therefore, from Eq. (22) we have:

$$\beta_1 = -\frac{1}{k} \ln(X + \sqrt{X^2 - 1}) \text{sgn}(\Pi_1) \quad (27)$$

By introducing Eq. (15) into Eq. (11), a simplified expression for the stress derivative of the yield function Φ is found. After some mathematical developments (see Appendix D), using definitions (5) and (14), a closed form expression for the plastic multiplier is found:

$$\Lambda = -\frac{\Pi_1}{(g+1)(g+f)k\tilde{\sigma}_0\sinh(k\beta_1)} \quad (28)$$

It is noteworthy to mention that as the sign of β_1 has been selected to ensure the positivity of d_{eq} , this selection process leads also to the fact that Λ is positive (see Appendix C).

To summarize equations, the closed form expressions for the macrostress, plastic multiplier and effective equivalent plastic strain rate in the matrix are:

$$\left\{ \begin{array}{l} \Sigma_{XX} = \tilde{\sigma}_0(\beta_1 + (2\alpha_2 - 1)\beta_2) \\ \Sigma_{ZZ} = \tilde{\sigma}_0(\beta_1 + 2\alpha_2\beta_2) \\ \Lambda = -\frac{\Pi_1}{(g+1)(g+f)k\tilde{\sigma}_0\sinh(k\beta_1)} \\ d_{eq} = \frac{\beta_1 \text{tr}(\underline{D}) + 2\beta_2\Pi_2}{1-f} \end{array} \right. \quad (29)$$

As a consequence, the stress state and the plastic multiplier are function of the matrix flow stress $\tilde{\sigma}_0$, the strain rate tensor, the porosity and geometrical configuration of the RVE while the effective plastic strain rate in the matrix is solely dependent upon the strain rate tensor, the porosity and the geometrical configuration of the RVE.

Note that the first three equations of set (29) are identical to the parametrization proposed earlier by Gologanu (1997). Next, some particular constitutive relationships for the matrix are considered to evaluate $\tilde{\sigma}_0$.

2.2.2 Evaluation of the matrix flow stress and internal parameters

The matrix material is assumed viscoplastic with a flow stress which is, in the first step, solely dependent upon the effective plastic strain rate: $\tilde{\sigma}_0 = \sigma_0 \mathcal{F}(d_{eq})$. The resistance stress σ_0 is a material parameter. With Eq. (26) we have:

$$\tilde{\sigma}_0 = \sigma_0 \mathcal{F}\left(\frac{\beta_1 \text{tr}(\underline{D}) + 2\beta_2 \Pi_2}{1-f}\right) \quad (30)$$

Consequently, the stress components, the plastic multiplier (set of equations (29)) are analytically derived. With this method, recourse to the Newton-Raphson procedure, often adopted in the literature, is no more necessary to evaluate the stress state. The present approach enables to provide an explicit expression for the effective stress in the matrix, see Eq. (30). To the author's best knowledge, such a close form expression for viscoplastic material was not found in the literature. Those quantities d_{eq} and $\tilde{\sigma}_0$ were introduced by Gurson (1977) in a heuristic manner to preserve the balance between macroscopic and microscopic plastic work. Eqs (26) and (30) provide the closed form expressions of d_{eq} and $\tilde{\sigma}_0$ which are only linked to the macroscopic strain rate, the RVE configuration and for $\tilde{\sigma}_0$ to the constitutive behavior of the matrix.

Note that this formulation is presently used by the authors to define the dynamic flow surface of porous materials subjected to dynamic loadings (see Sartori et al. (2015, 2016)). Based on the above closed form expressions, the overall stress components are defined in a straightforward manner. The computation cost is almost vanishing for these types of applications.

Now we address the case where the matrix flow stress exhibits also strain rate hardening and temperature dependence as described in Eq. (4). Consider that at time t , all mechanical fields

are known. The porous material is subjected to a constant strain rate during the time period dt . As a consequence, when elasticity is disregarded, the porosity evolution is provided by $\dot{f} = (1 - f)tr \underline{\underline{D}}$, leading to:

$$f(t + dt) = 1 + (f(t) - 1)exp\left(-tr\left(\underline{\underline{D}}\right)dt\right) \quad (31)$$

From Eq. (26), the cumulative plastic strain is updated:

$$\varepsilon_{eq}(t + dt) = \varepsilon_{eq}(t) + d_{eq}dt \quad (32)$$

Note that for both Eqs (31) and (32), the strain rate tensor and d_{eq} are assumed constant during the time increment dt .

With no temperature dependence, the yield stress is updated $\tilde{\sigma}_0(d_{eq}, \varepsilon_{eq}(t + dt))$, and the two stress components are: $\Sigma_h = \tilde{\sigma}_0\beta_1$ and $\Sigma_D = \tilde{\sigma}_0\beta_2$.

In the case of temperature dependency, the temperature increment dT is, assuming adiabatic conditions, given by:

$$\rho cdT = \beta\tilde{\sigma}_0d_{eq}dt \quad (33)$$

Finally, it is important to notice that the above method can be applied to any yield surface of the following form:

$$\frac{A}{\tilde{\sigma}_0^2}(\Sigma_{eq})^2 + Bcosh\left(\frac{F(\underline{\underline{\Sigma}})}{\tilde{\sigma}_0}\right) + C = 0 \quad (34)$$

Σ_{eq} is the equivalent macroscopic stress, $F(\underline{\underline{\Sigma}})$ is a linear function of $\underline{\underline{\Sigma}}$ and (A, B, C) are parameters depending only on the strain rate components and the geometry of the RVE.

The proposed approach is applied in the following section to the Gurson model. Specific configurations for voids (spherical, cylindrical, spheroidal) are also discussed.

3. Particular cases

In this section, the previous methodology is applied to some classical models of the literature. The Gurson model (spherical or cylindrical voids) with viscoplastic matrix is analyzed. Note that the method can also easily provide closed form expressions of mechanical fields for microcracked materials, by using the GLPD model with the appropriate set of parameters. In Section 2, the porous material is subjected to axisymmetric loading, since the GLPD model is valid for such loading conditions. Nevertheless, it has been mentioned that the Gurson model with spherical void has an explicit expression for general loadings. Some indications is provided in Appendix E to prove the fact that the proposed method is also valid for general loadings in the case of Gurson model. In addition, the section 5 dedicated to numerical implementation considers such general loading conditions.

3.1 Gurson model

The Gurson model with spherical void is a particular case of the Gologanu et al. (1997) model with: $C = 1$, $\alpha_2 = \frac{1}{3}$, $\eta = 0$, $g = 0$, $k = \frac{3}{2}$. Then, we have $\Pi_1 = -\frac{1}{2}tr(\underline{D})$, $\Pi_2 = \frac{1}{3}(D_{ZZ} -$

$$D_{XX}) \text{ and } X = \frac{-2 + \sqrt{4 - 9\frac{\pi_2^2}{\pi_1^2}\left(-1 - f^2 - \frac{9\pi_2^2}{4\pi_1^2}f^2\right)}}{\frac{9\pi_2^2}{2\pi_1^2}f}$$

In case of viscoplastic matrix (power law model $\tilde{\sigma}_0 = \sigma_0 d_{eq}^m$), the set of Eq. (29) defining the macrostress, plastic multiplier and effective strain rate in the matrix simplifies (see Appendix E for more details):

$$\begin{cases} d_{eq} = \frac{\frac{2}{3} \ln(\frac{1}{f}) |tr(\underline{D})|}{1-f} \\ \tilde{\sigma}_0 = \sigma_0 \left(\frac{\frac{2}{3} \ln(\frac{1}{f}) |tr(\underline{D})|}{1-f} \right)^m \\ \Sigma_{XX}^{Gu} = \Sigma_{ZZ}^{Gu} = \frac{2}{3} \tilde{\sigma}_0 \ln\left(\frac{1}{f}\right) sgn\left(tr\left(\underline{D}\right)\right) \\ \Lambda = \frac{|tr(\underline{D})|}{3\tilde{\sigma}_0(1-f^2)} \end{cases} \quad (35)$$

The estimate of the mean stress obtained by the Gurson model, complimented with Eq. (8) to account for matrix viscoplasticity is therefore:

$$\Sigma_m^{Gu} = \frac{2}{3} \sigma_0 \left(\frac{|tr(\underline{D})|}{1-f} \right)^m \left(\ln \frac{1}{f} \right)^{m+1} sgn\left(tr\left(\underline{D}\right)\right) \quad (36)$$

Note that this result was already mentioned in the literature, see for instance Czarnota et al. (2006). To obtain this result, Czarnota et al. (2006) have adopted the definition of the effective stress in the matrix proposed by Duva (1986).

It is then interesting to compare the expression Σ_m^{Gu} with the exact solution proposed for instance by Michel and Suquet (1992) or Leblond et al. (1994) for viscoplastic porous material (power law expression for the flow stress):

$$\Sigma_m^{Ex} = \frac{2}{3} \frac{\sigma_0}{m} \left(\frac{1}{f^m} - 1 \right) \left(\left| \frac{2}{3} tr\left(\underline{D}\right) \right| \right)^m sgn\left(tr\left(\underline{D}\right)\right) \quad (37)$$

Note that from the work of Ponte Castañeda (1991) and Danas and Ponte Castañeda (2009), an estimate for the mean stress is defined based on the variational bound approach (VAR):

$$\Sigma_m^{VAR} = \frac{2}{3} \frac{\sigma_0(1-f)}{(\sqrt{f})^{1+m}} \left(\left| \frac{2}{3} tr\left(\underline{D}\right) \right| \right)^m sgn\left(tr\left(\underline{D}\right)\right)$$

Danas and Ponte Castañeda (2009) have mentioned that Σ_m^{VAR} deviates from the exact solution at low porosity and for low value of m , while it is exact for linear porous medium ($m=1$). Since the VAR approach differs in its mathematical formalism from a Gurson type of approach, the present development cannot be used yet.

By defining the ratio:

$$R^{sph} = \frac{\Sigma_m^{Ex}}{\Sigma_m^{Gu}} = \frac{1}{m} \left(\frac{1}{f^m} - 1 \right) \left(\frac{2}{3} \right)^m \frac{(1-f)^m}{\left(\ln\left(\frac{1}{f}\right) \right)^{m+1}}, \quad (38)$$

as expected, analytical expression (36) coincide with Eq. (37) only for $m = 0$, i.e. $R^{sph} = 1$. Indeed, $\lim_{m \rightarrow 0} \left[\frac{2}{3} \frac{\sigma_o}{m} \left(\frac{1}{f^m} - 1 \right) \right] = \frac{2}{3} \sigma_o \ln \frac{1}{f}$. The extension of the Gurson model to viscoplastic matrix based on Eq. (6) is known to provide only estimate, see Duva (1986), Michel and Suquet (1992), Leblond et al. (1994). Figure 2 displays the evolution of the ratio R^{sph} for three different values of the porosity while the strain rate sensitivity m is ranging from 0 to 1 (from perfectly plastic to linear viscous material).

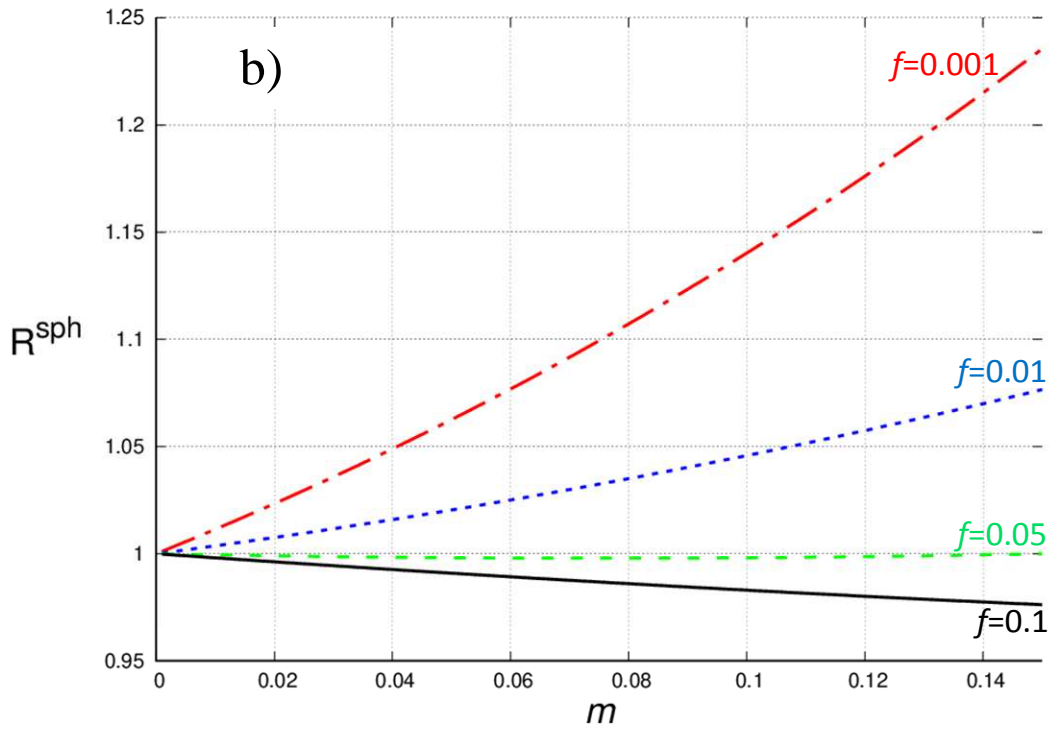
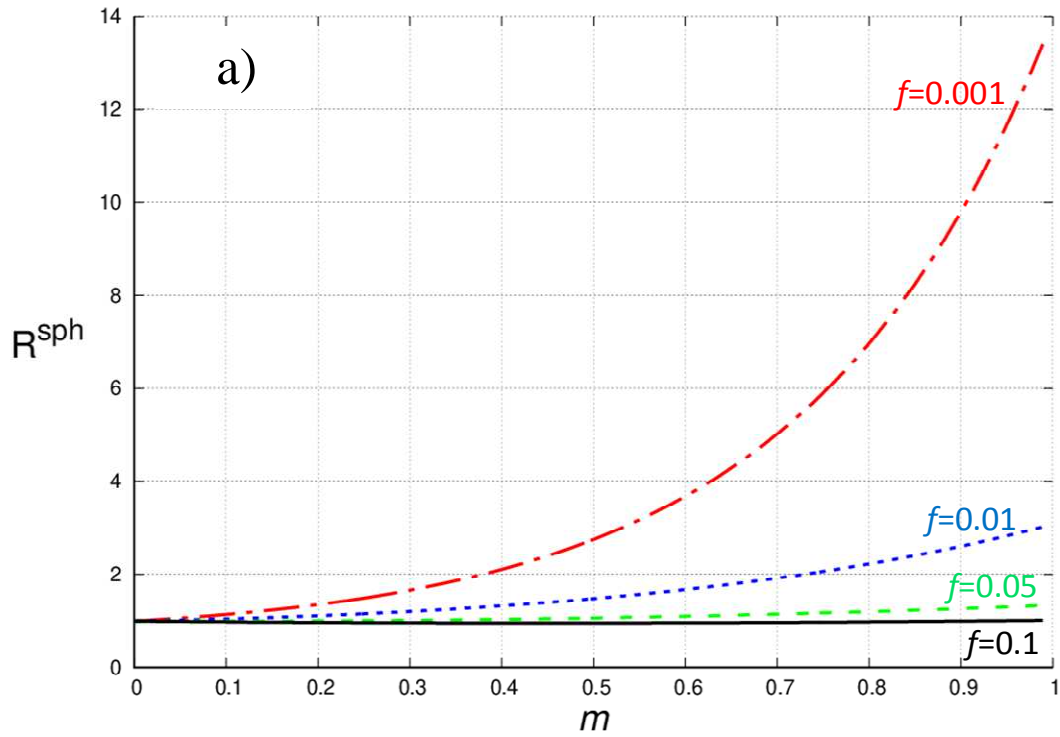

FIG. 2 – Evolution of the ratio R^{sph} in terms of m for four values of the porosity f . a) m is ranging from 0 to 1.0. b) m is ranging from 0 to 0.1. The matrix material is viscoplastic (power law flow stress). The voids are spherical.

As observed on figure 2, the two expressions are quite equivalent for low value of m and for large porosity ($f=0.05$ and $f=0.1$). One observes that as the porosity decreases, the prediction based on the viscoplastic Gurson model deviates from the exact solution, this trend is amplified as the strain rate sensitivity m increases. For a porosity $f = 10^{-3}$ and $m = 1$, the ratio R^{sph} is larger than ten. For low values of the strain rate sensitivity m ($m < 0.05$), the approximate expression Σ_m^{Gu} gives quite accurate predictions when compared to the exact expression Σ_m^{Ex} (6% difference is observed for $m = 0.05$ and $f = 10^{-3}$).

Note that for axisymmetric loading and a power law type for the matrix behavior, an approximate solution exists for the spherical or cylindrical voids, see the formalism proposed by Leblond et al. (1994). The proposition can be extended for spheroidal voids and still a power law matrix. The components of the macroscopic stress are obtained:

$$\begin{cases} \Sigma_{XX}^{Est} = \frac{k_0}{2} \left\{ \left(D_m - \frac{1}{3} \eta B \right) \left(\frac{2}{3} - \frac{2}{3} \eta (2\alpha_2 - 1) \right) \bar{F}^2 \Psi_1 + 2B\bar{H}^2 (2\alpha_2 - 1) \Psi_2 \right\} \\ \Sigma_{ZZ}^{Est} = \frac{k_0}{2} \left\{ \left(D_m - \frac{1}{3} \eta B \right) \left(\frac{2}{3} - \frac{4}{3} \eta \alpha_2 \right) \bar{F}^2 \Psi_1 + 4B\bar{H}^2 \alpha_2 \Psi_2 \right\} \end{cases} \quad (39)$$

Where the superscript *Est* indicates that Eqs (39) are only estimates. These expressions (39) are valid for spheroidal void shape (oblate or prolate with semi axes aligned with the principal direction of the strain rate tensor). Indeed, \bar{F} , \bar{G} , \bar{H} and B are parameters linked to the shape of the void and the components of the strain rate tensor (see Gologanu et al. (1997) for more information). Ψ_1 and Ψ_2 are integral terms defined as follows:

$$\begin{cases} \Psi_1 = \int_1^{\bar{f}} \left[\left(\bar{F} D_m - \frac{1}{3} \eta \bar{F} B \right)^2 z^2 + \bar{H}^2 B^2 \right]^{\frac{m-1}{2}} dz \\ \Psi_2 = \int_1^{\bar{f}} \left[\left(\bar{F} D_m - \frac{1}{3} \eta \bar{F} B \right)^2 z^2 + \bar{H}^2 B^2 \right]^{\frac{m-1}{2}} \frac{dz}{z^2} \end{cases} \quad (40)$$

For spherical void: $\bar{F} = \sqrt{3}$, $B = \frac{2}{3}(D_{ZZ} - D_{XX})$, $\eta = 0$, $\bar{H}^2 = 1$ and $\alpha_2 = \frac{1}{3}$. Note that under spherical loading ($D_{XX} = D_{YY} = D_{ZZ}$), one has $B = 0$. In this particular case, Eqs. (39, 40) give the formulation provided by Leblond and Roy (2000) and the closed form expression (36) is retrieved. For a perfectly plastic matrix ($m = 0$), the two integrals of system (40) reduce to the integrals proposed by Gologanu et al. (1997).

Next, we compare the predictions of the macroscopic stress components based on the Gurson model Eq. (35) to the predictions of Eq. (39). For that purpose, we investigate the variations of the following ratios:

$$\begin{cases} R_X = \frac{\Sigma_{XX}^{Est}}{\Sigma_{XX}^{Gu}} \\ R_Z = \frac{\Sigma_{ZZ}^{Est}}{\Sigma_{ZZ}^{Gu}} \end{cases}, \quad (41)$$

for two loading conditions: loading 1 ($D_{XX} = 1 \text{ s}^{-1}$, $D_{ZZ} = 0 \text{ s}^{-1}$) and loading 2 ($D_{XX} = 1 \text{ s}^{-1}$, $D_{ZZ} = 0,5 \text{ s}^{-1}$).

The evolutions of ratios R_X and R_Z are displayed in terms of the strain rate sensitivity m for three porosities. A porous viscous material containing spherical voids (resp. prolate voids with an aspect ratio of 5) is analyzed in Figs (3-4) (resp. in Fig. (5)).

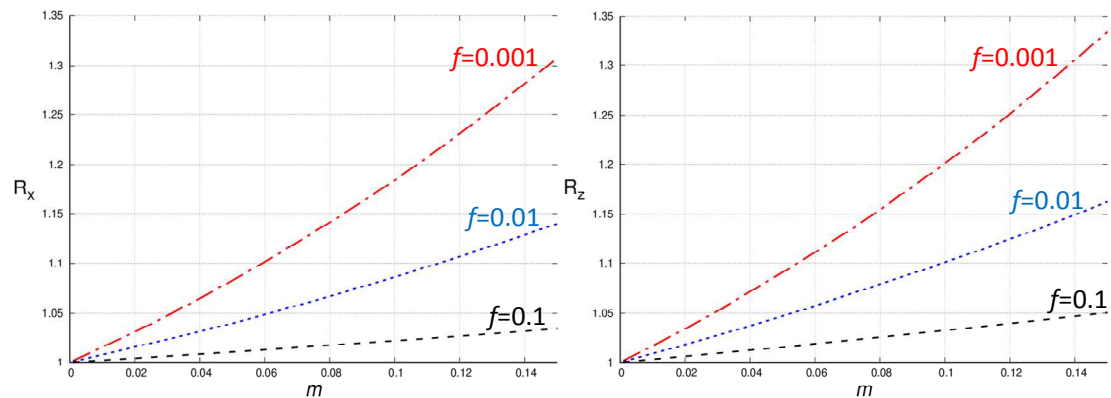

FIG. 3 – R_X and R_Z in terms of m for 3 values of the porosity f . Loading 1 is considered. m is ranging from 0 to 0.15. a) R_X evolution. b) R_Z evolution. The voids are spherical.

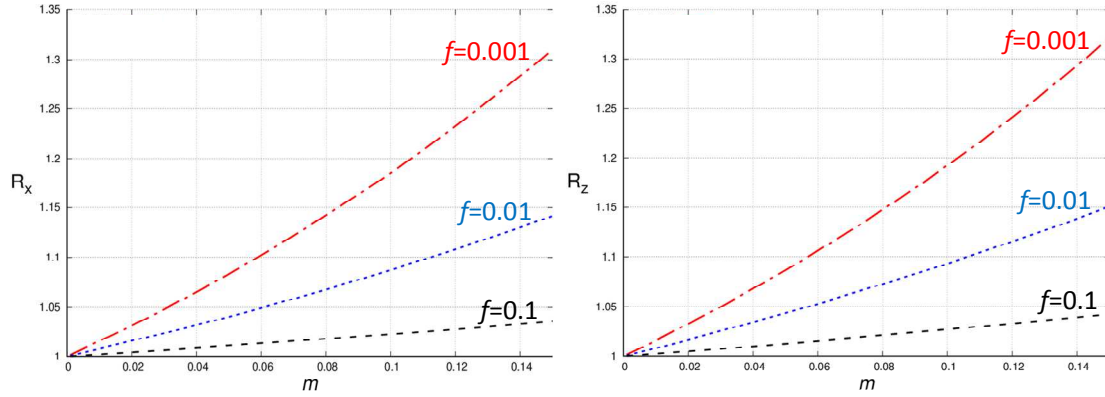

FIG. 4 – R_X and R_Z in terms of m for 3 values of the porosity f . Loading 2 is considered. m is ranging from 0 to 0.15. a) R_X evolution. b) R_Z evolution. Voids are spherical.

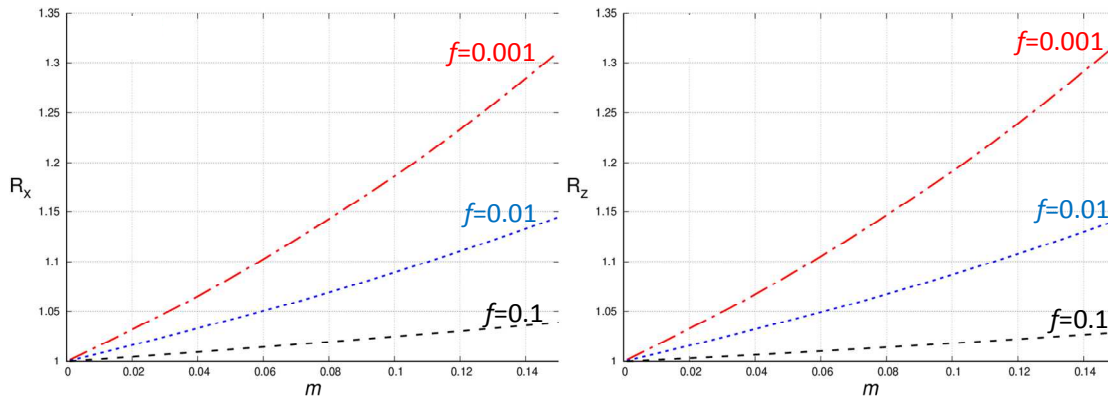

FIG. 5 – R_X and R_Z in terms of m for 3 values of the porosity f . Loading 2 is considered. m is ranging from 0 to 0.15. a) R_X evolution. b) R_Z evolution. Voids are prolate with aspect ratio

$$\frac{a_1}{b_1} = 5.$$

Similar trends, as in Fig. (2) are observed in Figs (3-5). Indeed, there is a good agreement for low values of m and for high porosity. Discrepancies are larger for high values of m and for

low porosity. For a porosity of $f = 10^{-3}$ and for $m=0.15$ a difference of 30% is found between the two approaches. Note that Finite Element validations based on unit cell calculations should be of interest to evaluate the accuracy of the estimates provided by Eq. (39).

3.2 Cylindrical void in a viscoplastic matrix

By adopting the following values: $\alpha_2 = 1$, $\alpha_2 = \frac{1}{2}$, $\eta = 0$, $g = 0$, $k = \sqrt{3}$, in Eq. (9), the Gurson model with cylindrical void is obtained. In this particular case we have the following analytical expressions (see Appendix E for more details):

$$\begin{cases} \Sigma_{XX} = \frac{1}{\sqrt{3}} \tilde{\sigma}_0 \ln\left(\frac{1}{f}\right) \text{sgn}(D_{XX}) \\ \Sigma_{ZZ} = \frac{1}{\sqrt{3}} \tilde{\sigma}_0 \ln\left(\frac{1}{f}\right) \text{sgn}(D_{XX}) \\ d_{eq} = \frac{2}{\sqrt{3}} \frac{\ln\left(\frac{1}{f}\right) |D_{XX}|}{1-f} \\ \Lambda = \frac{4|D_{XX}|}{\sqrt{3}\tilde{\sigma}_0(1-f^2)} \end{cases} \quad (42)$$

For a porous material under axisymmetric plane strain loading with cylindrical voids and a viscoplastic matrix (powerlaw description $\tilde{\sigma}_0 = \sigma_0 d_{eq}^m$), Leblond et al (1994), Leblond and Roy (2000) proposed an exact solution for the spherical part of the macroscopic stress:

$$\Sigma_m^{Ex-Cyl} = \frac{1}{\sqrt{3}} \frac{\sigma_0}{m} \left(\frac{1}{f^m} - 1 \right) \left(\frac{\text{tr}(\underline{D})}{\sqrt{3}} \right)^m \quad (43)$$

From Eq. (42), it is shown that for a Gurson type model under plane strain conditions and axisymmetric loading ($D_{XX} = D_{YY}$), the macroscopic stress tensor is spherical. This result was already mentioned in Gurson (1977). In addition, the spherical part of the macroscopic

stress predicted by the Gurson model with cylindrical voids is different from the exact results given in Eq. (43):

$$\Sigma_m^{Gu-Cyl} = \frac{\sigma_o}{\sqrt{3}} \left(\frac{2tr(\underline{D})}{\sqrt{3}(1-f)} \right)^m \left(\ln \frac{1}{f} \right)^{m+1} \quad (44)$$

To check the accuracy of Eq. (44), the following ratio is considered:

$$R^{Cyl} = \frac{\Sigma_m^{Ex-Cyl}}{\Sigma_m^{Gu-Cyl}} = \frac{1}{m} \left(\frac{1}{f^m} - 1 \right) \left(\frac{1-f}{2} \right)^m \frac{1}{\left(\ln \left(\frac{1}{f} \right) \right)^{m+1}} \quad (45)$$

It is seen that R^{Cyl} is linked to R^{sph} by $R^{Cyl} = \left(\frac{3}{4} \right)^m R^{sph}$. As a consequence, for a perfectly plastic matrix ($m = 0$), the two expressions are equal and $R^{Cyl} = 1$. Figure 6 presents the dependence of the ratio R^{Cyl} with respect to m when the strain rate sensitivity m is varied in the range $[0;1]$. The conclusion of Fig. 2 is still valid.

Note also that the VAR approach of Ponte Castañeda (1991) provides also an estimate for cylindrical voids, see Danas and Ponte Castañeda (2009):

$$\Sigma_m^{VAR} = \frac{2}{3} \frac{\sigma_o(1-f)}{(\sqrt{f})^{1+m}} \left(\frac{\sqrt{3}}{2} \right)^{1+m} \left(\left| \frac{2}{3} tr(\underline{D}) \right| \right)^m sgn \left(tr(\underline{D}) \right) \quad (46)$$

As for sphere, the exact solution (43) is retrieved only in the case of linear viscous material with $m=1$.

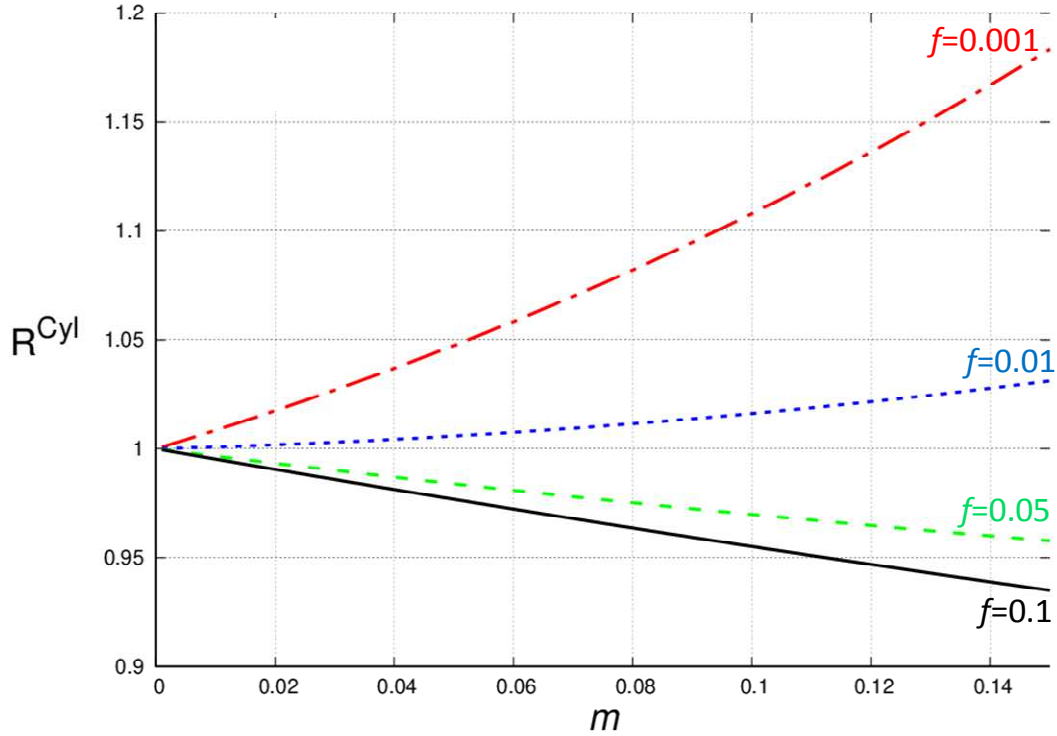

FIG. 6 – Variation of R^{Cyl} with respect to the strain rate sensitivity exponent m . Four porosity levels are considered. The matrix material is viscoplastic, with a power law flow stress. The voids have a cylindrical shape.

4. Extension of the method to non-axisymmetric problem and anisotropic matrix

4.1 Formulation for non-axisymmetric loadings

In this section, we extend the previous method to non-axisymmetric loadings. Our goal is still to provide explicit expressions for the macroscopic stress tensor defined by Eq. (2). The proposed derivation is valid for porous material with a matrix having an isotropic behavior and containing spherical voids or spheroidal voids with axes aligned with the principal direction of the loading. Thus, the loading is still in the form given by Eq. (1).

As shown previously, the proposed methodology can be applied to a variety of porous plasticity models (Gurson (1977) or Gologanu et al. (1997)). As a consequence, we consider a yield surface of the form:

$$\Phi = \frac{A}{\tilde{\sigma}_0^2} ((\Sigma_{XX} - \Sigma_{YY})^2 + (\Sigma_{XX} - \Sigma_{ZZ})^2 + (\Sigma_{YY} - \Sigma_{ZZ})^2) + B \cosh\left(\frac{F(\underline{\Sigma})}{\tilde{\sigma}_0}\right) + C = 0 \quad (47)$$

where coefficients A , B and C depend on the void geometry, the porosity and material parameters. $F(\underline{\Sigma})$ is a linear function of the components of the macroscopic stress: $F(\underline{\Sigma}) = \theta_1 \Sigma_{XX} + \theta_2 \Sigma_{YY} + \theta_3 \Sigma_{ZZ}$. For the Gurson model, $\theta_i = 1/2$.

Adopting the same scheme previously developed (details are provided in Appendix F), the components of the macroscopic stress tensor can be written in a generic way:

$$\begin{cases} \Sigma_{XX} = \tilde{\sigma}_0 \psi_X \\ \Sigma_{YY} = \tilde{\sigma}_0 \psi_Y \\ \Sigma_{ZZ} = \tilde{\sigma}_0 \psi_Z \end{cases} \quad (48)$$

where ψ_X , ψ_Y and ψ_Z are analytical expressions, see Appendix F. With recourse of the equivalence between the macroscopic and microscopic plastic dissipations:

$$\tilde{\sigma}_0 \psi_X D_{XX} + \tilde{\sigma}_0 \psi_Y D_{YY} + \tilde{\sigma}_0 \psi_Z D_{ZZ} = (1 - f) \tilde{\sigma}_0 d_{eq}, \quad (49)$$

a closed form expression for the effective equivalent strain rate in the matrix is found:

$$d_{eq} = \frac{\psi_X D_{XX} + \psi_Y D_{YY} + \psi_Z D_{ZZ}}{(1-f)} \quad (50)$$

For the viscoplastic power law $\tilde{\sigma}_0 = \sigma_0 d_{eq}^m$, the effective flow stress of the matrix follows from Eq. (50):

$$\tilde{\sigma}_0 = \sigma_0 \left(\frac{\psi_X D_{XX} + \psi_Y D_{YY} + \psi_Z D_{ZZ}}{1-f} \right)^m \quad (51)$$

Finally, when the loading is 3D, an explicit expression for the overall stress tensor is still provided by the proposed methodology (see Eq. (48) and Eq. (51)).

Note that the expression for the plastic multiplier can be obtained combining Eqs. (48), (51), (F2) and (F4).

4.2 Matrix anisotropy

The role of matrix anisotropy (we restrict our attention to orthotropy) has been investigated widely in the literature in the field of porous plasticity (Benzerga and Besson (2001), Cazacu et al. (2003), Monchiet et al. (2008), ...). There is a large recent literature in that field and our goal is not to consider all proposed models. This section aims at proving that owing to the versatility of the methodology, the overall stress tensor can also be derived analytically in terms of the overall strain rate. In fact, the present derivations are currently proposed when the directions of the loading coincide with the orthotropy axes. Next, we will exemplify the strategy based on the work of Benzerga and Besson (2001) who consider a porous medium, containing spherical voids and a rigid perfectly plastic matrix obeying Hill's quadratic yield criterion. Note that the derivation can be extended in a straightforward manner for a porous material containing spheroidal voids (Monchiet et al. (2008)) where the orthotropy directions, the semi axes of the spheroids and the loading directions are aligned. More general cases (general loading with ellipsoids) need to be further investigated. Nevertheless, some comments are provided at the end of this section.

Hill (1948) has proposed the following yield criterion:

$$F(\underline{\underline{\sigma}}) = \frac{3}{2} \underline{\underline{\sigma}} : \underline{\underline{H}} : \underline{\underline{\sigma}} - \sigma_0^2 \leq 0 \quad (52)$$

where σ_0 is a material constant, $\underline{\underline{H}}$ is an orthotropic fourth-order symmetric tensor and $\underline{\underline{\sigma}}$ the stress field in the matrix. In the orthotropy axes, the Hill-equivalent stress can be expressed as:

$$(\Sigma_{eq})^2 = F(\Sigma_{XX} - \Sigma_{YY})^2 + G(\Sigma_{XX} - \Sigma_{ZZ})^2 + H(\Sigma_{ZZ} - \Sigma_{YY})^2 + 2L\Sigma_{YZ}^2 + 2M\Sigma_{XZ}^2 + 2N\Sigma_{YX}^2 \quad (53)$$

where F, G, H, L, M and N are Hill's parameters linked to the Lankford's coefficients (see for instance Hill (1948), Cazacu et al. (2003) for more information). In our problem, based on the previous restrictions (orthotropy and loading directions are aligned) $\Sigma_{XY} = \Sigma_{XZ} = \Sigma_{YZ} = 0$.

The yield function proposed by Benzerga and Besson (2001) or Monchiet et al. (2008) can be written in a generic form:

$$\Phi = \frac{A}{\tilde{\sigma}_0^2} (F(\Sigma_{XX} - \Sigma_{YY})^2 + G(\Sigma_{XX} - \Sigma_{ZZ})^2 + H(\Sigma_{YY} - \Sigma_{ZZ})^2) + B \cosh\left(\frac{F(\underline{\underline{\Sigma}})}{\tilde{\sigma}_0}\right) + C = 0 \quad (54)$$

As in the previous section, Δ_1 and Δ_2 are introduced so that the Hill equivalent stress becomes:

$$\Sigma_{eq}^2 = F\Delta_1^2 + G\Delta_2^2 + H(\Delta_1 - \Delta_2)^2 \quad (55)$$

The relationship (54) is able to mimic the yield surface for spherical and spheroidal voids in orthotropic matrix. It should be reminded that the principal axes of spheroids are assumed to be aligned with the orthotropy directions.

From Eqs (54-55), calculating $\frac{\partial \phi}{\partial \underline{\underline{\Sigma}}}$ and using the flow rule Eq. (5), one obtains:

$$\begin{cases} F\Delta_1 + G\Delta_2 = \frac{\tilde{\sigma}_0^2}{2\tilde{A}} \left[\frac{D_{XX}}{\Lambda} - \frac{B}{\tilde{\sigma}_0} \sinh\left(\frac{F(\underline{\underline{\Sigma}})}{\tilde{\sigma}_0}\right) \frac{\partial F(\underline{\underline{\Sigma}})}{\partial \Sigma_{XX}} \right] \\ -(F+H)\Delta_1 + H\Delta_2 = \frac{\tilde{\sigma}_0^2}{2\tilde{A}} \left[\frac{D_{YY}}{\Lambda} - \frac{B}{\tilde{\sigma}_0} \sinh\left(\frac{F(\underline{\underline{\Sigma}})}{\tilde{\sigma}_0}\right) \frac{\partial F(\underline{\underline{\Sigma}})}{\partial \Sigma_{YY}} \right] \\ H\Delta_1 - (G+H)\Delta_2 = \frac{\tilde{\sigma}_0^2}{2\tilde{A}} \left[\frac{D_{ZZ}}{\Lambda} - \frac{B}{\tilde{\sigma}_0} \sinh\left(\frac{F(\underline{\underline{\Sigma}})}{\tilde{\sigma}_0}\right) \frac{\partial F(\underline{\underline{\Sigma}})}{\partial \Sigma_{ZZ}} \right] \end{cases} \quad (56)$$

As in the previous section, at least one of the strain rate components has non-zero value, so by elimination of Λ , we obtain a set of two linear equations for the unknowns Δ_1 and Δ_2 :

$$\begin{cases} \Delta_1(FD_{YY} + (F+H)D_{XX}) + \Delta_2(GD_{YY} - HD_{XX}) = -\frac{\tilde{\sigma}_0 B}{2\tilde{A}} \sinh\left(\frac{F(\underline{\underline{\Sigma}})}{\tilde{\sigma}_0}\right) \left\{ \frac{\partial F(\underline{\underline{\Sigma}})}{\partial \Sigma_{XX}} D_{YY} - \frac{\partial F(\underline{\underline{\Sigma}})}{\partial \Sigma_{YY}} D_{XX} \right\} \\ \Delta_1(FD_{ZZ} - HD_{XX}) + \Delta_2(GD_{ZZ} + (G+H)D_{XX}) = -\frac{\tilde{\sigma}_0 B}{2\tilde{A}} \sinh\left(\frac{F(\underline{\underline{\Sigma}})}{\tilde{\sigma}_0}\right) \left\{ \frac{\partial F(\underline{\underline{\Sigma}})}{\partial \Sigma_{XX}} D_{ZZ} - \frac{\partial F(\underline{\underline{\Sigma}})}{\partial \Sigma_{ZZ}} D_{XX} \right\} \end{cases} \quad (57)$$

Eqs. (57) can be written as:

$$\mathcal{M} \begin{bmatrix} \Delta_1 \\ \Delta_2 \end{bmatrix} = -\frac{\tilde{\sigma}_0 B}{2\tilde{A}} \sinh\left(\frac{F(\underline{\underline{\Sigma}})}{\tilde{\sigma}_0}\right) \begin{bmatrix} \mathcal{L}_1 \\ \mathcal{L}_2 \end{bmatrix} \quad (58)$$

$$\text{with } \mathcal{M} = \begin{bmatrix} FD_{YY} + (F+H)D_{XX} & GD_{YY} - HD_{XX} \\ FD_{ZZ} - HD_{XX} & GD_{ZZ} + (G+H)D_{XX} \end{bmatrix}.$$

and:

$$\det(\mathcal{M}) = D_{XX}(D_{XX} + D_{YY} + D_{ZZ})(FG + FH + GH) \quad (59)$$

Due to the definition of the Lankford coefficient, based on the Hill yield surface (Hill (1948)), one has: $\frac{H}{G} = r_0$ and $\frac{H}{F} = r_{90}$. It implies that $FG + FH + GH = FG(1 + r_0 + r_{90})$ which is different from zero. The case $tr(\underline{\underline{D}}) = 0$ can be analyzed as in the previous section. As a consequence, for loading conditions given by Eq. (1), analytical expressions for Δ_1 and Δ_2 exist since $det(\mathcal{M}) \neq 0$. At this point, the same procedure as previously developed in part 4.1 (and detailed in Appendix F) enables to determine the macroscopic stress. Expressions are not given here but can be easily obtained and analytical forms for the stress state can be derived when matrix anisotropy is considered.

Interestingly, in the case of non-axisymmetric void, Madou et al. (2012) propose a yield surface quite similar to Eq. (56) (at least from a structure point of view). When the loading (the strain rate tensor) is diagonal and aligned with the main axes of the ellipsoid, the expression of the mechanical fields (stress state, effective strain rate in the matrix, plastic multiplier) can be obtained with the proposed method in this section in a straightforward manner. For general loading, the work is still in progress.

Another point to address is the fact that ψ_x, ψ_y, ψ_z (see Eq. (48)) are related to the macroscopic strain rate, the porosity and the shape of the RVE (for the GLPD model). Elasticity being neglected, $\underline{\underline{D}}^p = \underline{\underline{D}}$, so that the porosity is updated owing to Eq (31). The evolution of the RVE shape can be also evaluated based on the kinematic boundary conditions or with the introduction of a shape parameter S (see Gologanu et al. (1997) or Flandi et al. (2006)). In any case, the evolution laws for the RVE shape are only related to the macroscopic plastic strain rate. So, with the present method the update of the RVE geometry is straightforward and can be done in an implicit manner.

5. Analytical results and numerical computation for porous material

To analyze damage evolution in ductile materials, finite element calculations are widely adopted. For an elastic-(thermo-visco) plastic matrix, specific algorithms are needed to implement the porous constitutive behavior in the finite element software. Considering a Gurson model, Aravas (1987) proposed a return mapping algorithm and detailed all the necessary steps, from the elastic predictor to the plastic corrector. Later, some extensions were needed to account for more complex mechanical behavior of the matrix material. For instance, among other contributions, one can refer to the work of Mühlich et al. (2003) for kinematic hardening or the work of Vadillo et al. (2008) for proposing an efficient scheme for thermo-viscoplasticity.

The goal of this part is to describe how the analytical expressions obtained in the previous sections may be used to reduce the number of non-linear equations which are needed to update the mechanical quantities.

Assume that at time t all the quantities of the problem are known. The material is subjected to a total strain increment $\underline{\Delta \underline{E}}$ during the time step Δt . In the present case, $\underline{\Delta \underline{E}}$ can be general (not only restricted to axisymmetric loading). The purpose is to update all quantities at time $t + \Delta t$.

Following the work of Aravas (1987), the Gurson yield surface is written in terms of hydrostatic p and deviatoric q stresses:

$$\Phi = \frac{q^2}{\bar{\sigma}_0^2} + 2q_1 f \cosh\left(\frac{3q_2 p}{2\bar{\sigma}_0}\right) - 1 - q_1 f^2 = 0 \quad (60)$$

where q_1 and q_2 are coefficients introduced by Tveergard and Needleman (1984). The mean stress p and the effective stress q are defined below:

$$\begin{cases} p = -\frac{1}{3} \text{tr}(\underline{\underline{\Sigma}}) \\ q = \left(\frac{3}{2} \underline{\underline{\Sigma}}^D : \underline{\underline{\Sigma}}^D\right)^{\frac{1}{2}} \end{cases} \quad (61)$$

$\underline{\underline{\Sigma}}^D$ is the deviatoric stress tensor.

Adopting the formulation proposed by Aravas (1987), introducing $\Delta\varepsilon_p = -\Delta\Lambda \left(\frac{\partial\Phi}{\partial p}\right)$ and $\Delta\varepsilon_q = \Delta\Lambda \left(\frac{\partial\Phi}{\partial q}\right)$, eliminating $\Delta\Lambda$, a second equation is obtained:

$$2 \frac{q}{\bar{\sigma}_0^2} \Delta\varepsilon_p + \frac{3q_1 q_2 f}{\bar{\sigma}_0} \sinh\left(\frac{3q_2 p}{2\bar{\sigma}_0}\right) \Delta\varepsilon_q = 0 \quad (62)$$

Adopting a predictor-corrector algorithm, it is shown that the hydrostatic and deviatoric stresses p and q at time $t + \Delta t$ are only related to the plastic strain increments $\Delta\varepsilon_q$ and $\Delta\varepsilon_p$:

$$p(t + \Delta t) = p^{trial} + K\Delta\varepsilon_p \text{ and } q(t + \Delta t) = q^{trial} - 3G\Delta\varepsilon_q \quad (63)$$

where p^{trial} and q^{trial} are the elastic predictors. They are related to quantities p and q at time t and to the total strain increment $\underline{\underline{\Delta E}}$, see Aravas (1987) or Vadillo et al (2008) for more information. So the trial stresses are known quantities. K and G are the bulk and shear elastic modulus respectively.

From Eq. (62), one has: $\frac{q}{\bar{\sigma}_0} = -\frac{\Delta\varepsilon_q}{\Delta\varepsilon_p} \frac{3q_1 q_2 f}{2} \sinh\left(\frac{3q_2 p}{2\bar{\sigma}_0}\right)$. By substitution in Eq. (60), a quadratic expression in hyperbolic sine is obtained:

$$\left(\frac{\Delta\varepsilon_q}{\Delta\varepsilon_p}\right)^2 \frac{9}{4} (q_1 q_2 f)^2 \left(\sinh\left(\frac{3q_2 p}{2\tilde{\sigma}_0}\right)\right)^2 + 2q_1 f \cosh\left(\frac{3q_2 p}{2\tilde{\sigma}_0}\right) - 1 - q_1 f^2 = 0 \quad (64)$$

Similarly to Section 2, with the change of variable $X = \cosh\left(\frac{3q_2 p}{2\tilde{\sigma}_0}\right)$ and using Eq. (64), the hydrostatic stress p is given by:

$$p = \pm \frac{2\tilde{\sigma}_0}{3q_2} \ln(X + \sqrt{X^2 - 1}) = \tilde{\sigma}_0 \beta_1 \quad (65)$$

Note that X is a function of $\Delta\varepsilon_q$, $\Delta\varepsilon_p$ and the porosity f . From Eq. (31), the update of the porosity is:

$$f(t + \Delta t) = 1 - (1 - f(t)) \exp\left((- \Delta\varepsilon_p)\right) \quad (66)$$

In the following, the porosity $f(t + \Delta t)$ will be denoted by f . From Eq. (62), the deviatoric stress q can be written as: $q = \tilde{\sigma}_0 \beta_2$. At this stage, the hydrostatic p and deviatoric q stresses are given by:

$$\begin{cases} p = \tilde{\sigma}_0 \beta_1(\Delta\varepsilon_q, \Delta\varepsilon_p) = \tilde{\sigma}_0 \beta_1 \\ q = \tilde{\sigma}_0 \beta_2(\Delta\varepsilon_q, \Delta\varepsilon_p) = \tilde{\sigma}_0 \beta_2 \end{cases} \quad (67)$$

From the equivalence between the macroscopic and microscopic plastic dissipation, Eq. (6), an analytical link between the plastic strain increment within the matrix $\Delta\varepsilon^p$ and the overall plastic strain increments, $\Delta\varepsilon_q$ and $\Delta\varepsilon_p$ is proposed:

$$\Delta\varepsilon^p = \frac{\beta_2 \Delta\varepsilon_q - \beta_1 \Delta\varepsilon_p}{1-f} \quad (68)$$

Next, the matrix flow stress $\tilde{\sigma}_0$ has to be defined. In this example, we consider the case of a viscoplastic matrix (adopting for instance a power law for the flow stress description $\tilde{\sigma}_0 =$

$\sigma_0 d_{eq}^m$). A more general flow law could have been adopted, as presented in Section 2.2.2. The relationship (68) provides:

$$\tilde{\sigma}_0 = \sigma_0 \left(\frac{\beta_2 \Delta \varepsilon_q - \beta_1 \Delta \varepsilon_p}{(1-f)\Delta t} \right)^m \quad (69)$$

Combining Eqs. (62), (67) and (69), the two main unknowns $\Delta \varepsilon_q$ and $\Delta \varepsilon_p$ are obtained as solutions of the two relationships:

$$\begin{cases} \sigma_0 \left(\frac{\beta_2 \Delta \varepsilon_q - \beta_1 \Delta \varepsilon_p}{(1-f)\Delta t} \right)^m \beta_1(\Delta \varepsilon_q, \Delta \varepsilon_p) = p^{trial} + K \Delta \varepsilon_p \\ \sigma_0 \left(\frac{\beta_2 \Delta \varepsilon_q - \beta_1 \Delta \varepsilon_p}{(1-f)\Delta t} \right)^m \beta_2(\Delta \varepsilon_q, \Delta \varepsilon_p) = q^{trial} - 3G \Delta \varepsilon_q \end{cases} \quad (70)$$

The system can be solved using a Newton Raphson technique. The interesting point of the proposed method lies in the fact that the derivative of the two relationships with respect to $\Delta \varepsilon_q$ and $\Delta \varepsilon_p$ have analytical expressions. Therefore, the efficiency of the calculation can be accelerated. In addition, when $\Delta \varepsilon_q$ and $\Delta \varepsilon_p$ are known, the porosity, the accumulated plastic strain in the matrix, the effective equivalent plastic strain rate in the matrix, and the stress measures p and q are obtained simultaneously with no additional effort, in a fully implicit scheme. Note that with our proposition, only two nonlinear equations are needed to update all variables when the matrix is viscous. From the literature, it is usually shown that three equations are needed.

Enakoutsa and Leblond (2009) have discussed the integration of the Gologanu et al. (1997) model. These authors proposed to update the porosity based on Eq. (66) but with the increment $\Delta \varepsilon_p(t)$ calculated at time t and not at $t + \Delta t$. The numerical scheme is therefore not fully implicit. In that case, it can easily be shown from Eqs. (64-65) that, for the Gurson

(1977) model, the parameter $\beta_1(\Delta\varepsilon_q, \Delta\varepsilon_p)$ is depending on a single variable: $\beta_1(\Delta\varepsilon_q/\Delta\varepsilon_p)$. Similarly, we have $\beta_2(\Delta\varepsilon_q/\Delta\varepsilon_p)$.

Based on the explicit expression of the porosity f , the set of Eq. (70) becomes for the perfectly plastic case:

$$\begin{cases} \sigma_0\beta_1(\Delta\varepsilon_q/\Delta\varepsilon_p) - (p^{trial} + K\Delta\varepsilon_p) = 0 \\ \sigma_0\beta_2(\Delta\varepsilon_q/\Delta\varepsilon_p) - (q^{trial} - 3G\Delta\varepsilon_q) = 0 \end{cases} \quad (71)$$

The combination of the two equations leads to:

$$\frac{\sigma_0\beta_2(\Delta\varepsilon_q/\Delta\varepsilon_p) - q^{trial}}{\sigma_0\beta_1(\Delta\varepsilon_q/\Delta\varepsilon_p) - p^{trial}} + \frac{3G}{K} \frac{\Delta\varepsilon_q}{\Delta\varepsilon_p} = 0 \quad (72)$$

One obtains a unique nonlinear equation for the unknown $\Delta\varepsilon_q/\Delta\varepsilon_p$. With this solution and Eq. (71), the two plastic strain increments $\Delta\varepsilon_q$ and $\Delta\varepsilon_p$ are found.

It is seen here that the numerical implementation of the Gurson model, can greatly benefit from the analytical expressions derived in the present paper. Mainly, the major novelty is the closed form expression of the effective strain rate in the matrix. We will not develop further this numerical implementation part but it could be extended to the GLPD model when considering diagonal loading. It should be emphasized that the parameters of the model are related to the shape of the RVE. As a consequence, the semi axes of the RVE (see Fig.1.) need to be updated. Various propositions exist in the literature (see Gologanu et al. (1997), Flandi et al. (2005a)) for the definition of a shape parameter S . It can be shown that the shape parameter is only related to the macroscopic plastic strain rate. As a consequence, as for the porosity (Eq. 66), the semi axes are only related to $\Delta\varepsilon_q$ and $\Delta\varepsilon_p$. Finally, even if the final

system can be quite complex, only a set of two equations similar to set (70) is obtained (not presented here for sake of brevity).

The numerical implementation of more complex models like the one of Madou et al. (2012), accounting for ellipsoidal voids, could be treated also when the strain rate tensor is diagonal.

6. Conclusion

Analytical expressions for mechanical fields (macroscopic stress, effective equivalent plastic strain rate in the matrix, plastic multiplier) are derived when the porous material is described by the Gologanu et al. (1997) or Gurson (1977) yield surfaces. The present work provides the first explicit link between the effective equivalent plastic strain rate in the matrix and the macroscopic loading and the geometry of the RVE. Note that this effective equivalent plastic strain rate was introduced in a heuristic way by Gurson (1977) to extend his model valid for perfectly plastic material to complex constitutive law. This heuristic extension is widely used in the literature for porous models based on limit analysis but also for porous models derived from the macroscopic potential. This method is valid for thermo-viscoplastic material with strain rate hardening and is not restricted to perfectly plastic material.

When the approach is applied to rigid perfectly plastic matrix material, results of the literature are retrieved concerning the macroscopic stress and the plastic multiplier. It is also demonstrated that the method is able to provide analytical expressions of mechanics fields for non-axisymmetric loading and for orthotropic matrix material when the loading directions and the orthotropy axes are aligned.

The main novelty of the proposed work is that analytical expressions are also obtained when the matrix behavior is viscoplastic. Nevertheless, it is important to mention that those expressions correspond only to estimates that have to be validated. Comparisons between exact results of the literature and analytical results derived from the Gurson (1977) and Gologanu et al. (1997) models are discussed for particular void shapes (spherical and cylindrical voids). It is shown that significant differences exist when the strain rate sensitivity m is large and the porosity f is low.

Finally, the issue of the numerical implementation of porous plasticity models in a finite element code was addressed. It appears that, with the proposed approach, the efficiency of the integration scheme can be greatly enhanced by reducing the number of non-linear equations to be iteratively solved.

Appendix A: Gologanu et al. (1997) model

Gologanu et al. (1997) have proposed the following yield surface for porous materials with prolate and oblate voids:

$$\frac{c}{\sigma_0^2} (\Sigma_{ZZ} - \Sigma_{XX} + \eta \Sigma_h)^2 + 2(g+1)(g+f) \cosh\left(\kappa \frac{\Sigma_h}{\sigma_0}\right) - (g+1)^2 - (g+f)^2 = 0 \quad (\text{A1})$$

with

$$\begin{cases} \Sigma_h = 2\alpha_2 \Sigma_{XX} + (1 - 2\alpha_2) \Sigma_{ZZ} \\ \eta = -\frac{\kappa Q(g+1)(g+f) \sinh(\kappa H)}{(g+1)^2 + (g+f)^2 + (g+1)(g+f)[\kappa H \sinh(\kappa H) - 2 \cosh(\kappa H)]} \\ C = -\frac{\kappa(g+1)(g+f) \sinh(\kappa H)}{(Q + \eta H)\eta} \\ \kappa = \frac{3}{\bar{F}} \\ H = 2(\alpha_1^S - \alpha_2^S) \\ Q = (1 - f) \end{cases} \quad (\text{A2})$$

σ_0 is the yield stress of the matrix material. α_2 is defined as follows:

$$\alpha_2 = \frac{a_2 b_2^2}{2c^3} R(\lambda_2) \quad (\text{A3})$$

where a_2 and b_2 are the semi-axes of the outer surface of the RVE (see Fig. 1). a_1 and b_1 are the semi-axes of the voids (see Fig. 1). $c = \sqrt{a_1^2 - b_1^2} = \sqrt{a_2^2 - b_2^2}$ is the focal distance. $R(\lambda_2)$ enters into the definition of the velocity field proposed by Gologanu et al. (1993,1994) whose expression is different in the prolate and oblate cases, see below.

For **oblate void**, Gologanu et al. (1997) have proposed the following expressions for parameters \bar{F} , g , α_1^S and α_2^S :

$$\left\{ \begin{array}{l} \bar{F} = 2 + \frac{2(g_f - g_1) + \frac{6}{5} \left(g_f^{\frac{5}{2}} - g_1^{\frac{5}{2}} \right) \left(\frac{4}{3} - g_f^{\frac{5}{2}} - g_1^{\frac{5}{2}} \right)}{\ln\left(\frac{g_f}{g_1}\right)} \\ g = \frac{e_2^3}{\sqrt{1-e_2^2}} \\ \alpha_1^S = \frac{-e_1(1-e_1^2) + \sqrt{1-e_1^2} \sin^{-1} e_1}{2e_1^3} \\ \alpha_2^S = \frac{(1+e_2^2)(3+e_2^4)}{3-6e_2^2+4e_2^4} \\ R(\lambda_2) = \frac{-\sinh(\lambda_2)}{(\cosh(\lambda_2))^2} - \arctan(\sinh(\lambda_2)) + \frac{\pi}{2} \end{array} \right. \quad (\text{A4})$$

with $g_f = \frac{g}{g+f}$, $g_1 = \frac{g}{g+1}$, $\lambda_1 = \operatorname{arctanh}\left(\frac{a_1}{b_1}\right)$, $\lambda_2 = \operatorname{arctanh}\left(\frac{a_2}{b_2}\right)$, $e_1 = \frac{1}{\cosh(\lambda_1)}$ and $e_2 = \frac{1}{\cosh(\lambda_2)}$ are respectively the eccentricities of the inner and outer boundary of the RVE.

For **prolate voids**, the expressions for \bar{F} , g , α_1^S and α_2^S are (Gologanu et al. (1997)):

$$\left\{ \begin{array}{l} \bar{F} = \frac{3}{\sqrt{3}} + \frac{3}{\ln(f)} \left[(\sqrt{3} - 2) \ln\left(\frac{e_1}{e_2}\right) + \frac{1}{\sqrt{3}} \ln\left(\frac{3+e_2^2+2\sqrt{3+e_2^4}}{3+e_1^2+2\sqrt{3+e_1^4}}\right) + \ln\left(\frac{\sqrt{3}+\sqrt{3+e_1^4}}{\sqrt{3}+\sqrt{3+e_2^4}}\right) \right] \\ g = 0 \\ \alpha_1^S = \frac{e_1 - (1-e_1^2) \tanh^{-1} e_1}{2e_1^3} \\ \alpha_2^S = \frac{1+e_2^2}{3+e_2^4} \\ R(\lambda_2) = \frac{\cosh(\lambda_2)}{(\sinh(\lambda_2))^2} - \frac{1}{2} \ln \left[\frac{\cosh(\lambda_2)+1}{\cosh(\lambda_2)-1} \right] \end{array} \right. \quad (\text{A5})$$

with $\lambda_1 = \operatorname{arctanh}\left(\frac{b_1}{a_1}\right)$, $\lambda_2 = \operatorname{arctanh}\left(\frac{b_2}{a_2}\right)$.

Appendix B: Particular case $\Pi_1 = 0$

The particular case $\Pi_1 = 0$ of Section 2 is investigated. With this condition, system (13) becomes:

$$\begin{cases} \frac{c}{\tilde{\sigma}_0^2} (\Sigma_D + \eta \Sigma_h)^2 + 2(g+1)(g+f) \cosh\left(k \frac{\Sigma_h}{\tilde{\sigma}_0}\right) - (g+1)^2 - (g+f)^2 = 0 \\ 2\Pi_2(g+1)(g+f) \frac{k}{\tilde{\sigma}_0} \sinh\left(k \frac{\Sigma_h}{\tilde{\sigma}_0}\right) = 0 \\ \Sigma_h \text{tr}\left(\underline{\underline{D}}\right) + 2\Sigma_D \Pi_2 = (1-f)\tilde{\sigma}_0 d_{eq} \\ \Lambda > 0 \end{cases} \quad (\text{B1})$$

The second relation of set (B1) implies that (a) $\Pi_2 = 0$ or (b) $k \frac{\Sigma_h}{\tilde{\sigma}_0} = 0$.

Sub case (a): $\Pi_2 = 0$

From the definition (14) of Π_1 and Π_2 , it follows that $D_{XX} = D_{ZZ} = 0$. This trivial solution is of no interest since plastic loading is assumed.

Sub case (b): $\Sigma_h = 0$

From the definition of the yield function Eq. (B1-1), one easily gets:

$$\Sigma_D = \pm \frac{\tilde{\sigma}_0}{\sqrt{c}} (1-f) \quad (\text{B2})$$

The sign of Σ_D is defined so as to ensure the positivity of the plastic dissipation.

$$2\Sigma_D \Pi_2 = (1-f)\tilde{\sigma}_0 d_{eq} \quad (\text{B3})$$

This implies that Σ_D and Π_2 must have the same sign. Thus:

$$\Sigma_D = \tilde{\sigma}_0 \frac{1-f}{\sqrt{c}} \text{sgn}(\Pi_2) \quad (\text{B4})$$

From relationship (B3), the effective equivalent plastic strain rate in the matrix is found:

$$d_{eq} = \frac{2|\Pi_2|}{\sqrt{c}} \quad (\text{B5})$$

So, we finally have:

$$\begin{cases} d_{eq} = \frac{2|\Pi_2|}{\sqrt{c}} \\ \Sigma_{XX} = (2\alpha_2 - 1) \frac{1-f}{\sqrt{c}} \tilde{\sigma}_0 \text{sgn}(\Pi_2) \\ \Sigma_{ZZ} = 2\alpha_2 \frac{1-f}{\sqrt{c}} \tilde{\sigma}_0 \text{sgn}(\Pi_2) \\ \Lambda = \left| \frac{\Pi_2}{(1-f)\sqrt{c}\tilde{\sigma}_0} \right| \end{cases} \quad (\text{B6})$$

Appendix C: Link between the sign of the plastic multiplier, the effective equivalent plastic strain rate in the matrix and β_1

The sign of β_1 has to be selected in Eq. (22) to ensure the positivity of the plastic multiplier Λ .

To check this feature, the definition (28) of the plastic multiplier is used:

$$\Lambda = -\frac{\Pi_1}{(g+1)(g+f)k\bar{\sigma}_0 \sinh(k\beta_1)} \quad (\text{C1})$$

Since hyperbolic sine is an odd function, we have $\text{sgn}(k\sinh(k\beta_1)) = \text{sgn}(\beta_1)$. From Eq.

(C1), one gets:

$$\text{sgn}(\Lambda) = -\text{sgn}(\Pi_1\beta_1) \quad (\text{C2})$$

On the other side, the effective equivalent plastic strain rate is given by:

$$d_{eq} = \frac{\beta_1 \text{tr}(\underline{\underline{D}}) + 2\beta_2 \Pi_2}{1-f} \quad (\text{C3})$$

With use of Eq. (24) one gets:

$$d_{eq} = \frac{1}{1-f} \left[\beta_1 \left(\text{tr}(\underline{\underline{D}}) - 2\eta \Pi_2 \right) - 2\Pi_2 \frac{\Pi_2 k}{\Pi_1 c} (g+1)(g+f) \sinh(k\beta_1) \right] \quad (\text{C4})$$

Since,

$$\Pi_1 = -\frac{\text{tr}(\underline{\underline{D}}) - 2\eta \Pi_2}{2}, \quad (\text{C5})$$

the effective equivalent plastic strain rate in the matrix has the following form:

$$d_{eq} = -\beta_1 \Pi_1 \mathcal{B}^+ \quad (\text{C6})$$

with $\mathcal{B}^+ = \frac{2}{1-f} \left[1 + \frac{\Pi_2^2 k^2}{\Pi_1^2 c} (g+1)(g+f) \frac{\sinh(k\beta_1)}{k\beta_1} \right]$. It is clear that \mathcal{B}^+ is always positive. As a consequence, from Eqs. (C2-C6), the positivity of the two terms d_{eq} and Λ is satisfied when the product $\beta_1 \Pi_1$ is negative. In other words, β_1 and Π_1 must have opposite sign.

Note that the case $\beta_1 = 0$ (i.e. $\Sigma_h = 0$ from Eq. (21)), corresponds to the sub case (b) of Appendix B.

Appendix D: Analytical expression of the plastic multiplier Λ for the Gologanu et al. (1997) model

The porous material is under plastic loading so at least one of the diagonal components of $\underline{\underline{D}}$ is non-zero. Let us consider that $D_{XX} \neq 0$. The plastic multiplier is given by:

$$\Lambda = D_{XX} \left(\frac{\partial \Phi}{\partial \Sigma_{XX}} \right)^{-1} \quad (\text{D1})$$

From Eq. (11), it follows:

$$\Lambda = \frac{D_{XX}}{\bar{\sigma}_0} \left(2C(\eta\beta_1 + \beta_2) \left(-\frac{1}{2} + \eta\alpha_2 \right) + 2(g+1)(g+f)k\alpha_2 \sinh(k\beta_1) \right)^{-1} \quad (\text{D2})$$

The term $\beta_2 + \eta\beta_1$ can be replaced in (D2) with use of Eq. (24). Therefore, one obtains:

$$\Lambda(g+1)(g+f)k \sinh(k\beta_1) = \frac{D_{XX}}{\bar{\sigma}_0} \left(\frac{\Pi_2}{\Pi_1} (1 - 2\eta\alpha_2) + 2\alpha_2 \right)^{-1} \quad (\text{D3})$$

With definitions (14) of Π_1 and Π_2 , the analytical expression of Λ is found

$$\Lambda = - \frac{\Pi_1}{(g+1)(g+f)k\bar{\sigma}_0 \sinh(k\beta_1)} \quad (\text{D4})$$

Note that the definition is valid also when $D_{XX} = 0$. In that case, for axisymmetric loading,

D_{ZZ} is non-zero. By using $\Lambda = D_{ZZ} \left(\frac{\partial \Phi}{\partial \Sigma_{ZZ}} \right)^{-1}$ and relationships (11) and (24), one obtains:

$$\Lambda(g+1)(g+f)k \sinh(k\beta_1) = \frac{D_{ZZ}}{\bar{\sigma}_0} \left(-2 \frac{\Pi_2}{\Pi_1} (1 + \eta(1 - 2\alpha_2)) + 2(1 - 2\alpha_2) \right)^{-1} \quad (\text{D5})$$

Eq. (D3) for Λ is retrieved by introducing into Eq. (D5) the expressions of Π_1 and Π_2 given in Eq. (14).

Appendix E: Particular case

Gurson model:

The GLPD model coincides with the Gurson model when spheroids are spherical. By adopting the following parameters: $C = 1$, $\alpha_2 = \frac{1}{3}$, $\eta = 0$, $g = 0$, $k = \frac{3}{2}$, expression of Section 2.2.1 can be used. We also have $\Pi_1 = -\frac{1}{2}tr(\underline{\underline{D}})$, $\Pi_2 = \frac{1}{3}(D_{ZZ} - D_{XX})$ and $X =$

$$\frac{-2 + \sqrt{4 - 9\frac{\pi_2^2}{\pi_1^2}\left(-1 - f^2 - \frac{9\pi_2^2}{4\pi_1^2}f^2\right)}}{\frac{9\pi_2^2}{2\pi_1^2}f}$$

For this set of parameters, the macroscopic stress, the effective equivalent plastic strain rate in the matrix and plastic multiplier have the following expressions:

$$\begin{cases} \Sigma_{XX} = \tilde{\sigma}_0 \left(\beta_1 - \frac{1}{3}\beta_2 \right) \\ \Sigma_{ZZ} = \tilde{\sigma}_0 \left(\beta_1 + \frac{2}{3}\beta_2 \right) \\ d_{eq} = \frac{\beta_1 tr(\underline{\underline{D}}) + 2\beta_2 \Pi_2}{1-f} \\ \Lambda = -\frac{\Pi_1}{f^{\frac{3}{2}} \tilde{\sigma}_0 \sinh\left(\frac{3}{2}\beta_1\right)} \end{cases} \quad (\text{E1})$$

From Eqs. (24) and (27), the two coefficients β_1 and β_2 are:

$$\begin{cases} \beta_1 = \frac{2}{3} \ln(X + \sqrt{X^2 - 1}) \operatorname{sgn}\left(tr(\underline{\underline{D}})\right) \\ \beta_2 = -\frac{3}{2} \frac{\Pi_2}{\Pi_1} f \sinh\left(\frac{3}{2}\beta_1\right) \end{cases} \quad (\text{E2})$$

With a perfectly plastic matrix, Leblond (2003), Monchiet et al. (2013), Gologanu (1997), Balan and Cazacu (2013), Dormieux and Kondo (2013) have proposed a parametrization of

the components of the macroscopic stress derived from the Gurson yield surface (spherical void). Eq. (E1) is similar to their parametrization.

For a viscoplastic matrix with a power law dependence $\tilde{\sigma}_0 = \sigma_0 d_{eq}^m$, the effective flow stress in the matrix is:

$$\tilde{\sigma}_0 = \sigma_0 \left(\frac{1}{1-f} \right)^m \left(\beta_1 \text{tr} \left(\underline{\underline{D}} \right) + 2\beta_2 \Pi_2 \right)^m \quad (\text{E3})$$

For spherical loading ($\Pi_2 = 0$ or equivalently $D_{ZZ} = D_{XX}$ and $X = \frac{1+f^2}{2f}$), the set of equation (E1) becomes:

$$\begin{cases} \Sigma_{XX} = \Sigma_{ZZ} = \frac{2}{3} \tilde{\sigma}_0 \ln \left(\frac{1}{f} \right) \text{sgn} \left(\text{tr} \left(\underline{\underline{D}} \right) \right) \\ d_{eq} = \frac{\frac{2}{3} \ln \left(\frac{1}{f} \right) |\text{tr} \left(\underline{\underline{D}} \right)|}{1-f} \\ \Lambda = \frac{|\text{tr} \left(\underline{\underline{D}} \right)|}{3\tilde{\sigma}_0(1-f^2)} \end{cases} \quad (\text{E4})$$

With $\tilde{\sigma}_0$ given by Eq. (E3)

Cylindrical void in a viscoplastic matrix:

A viscoplastic material containing cylindrical void is considered here. The GLPD model contains also the Gurson model with cylinder. For that purpose, the following set of parameters has to be adopted : $C = 1$, $\alpha_2 = \frac{1}{2}$, $\eta = 0$, $g = 0$, $k = \sqrt{3}$. In this case, Π_1 and Π_2 are linked to the macroscopic strain rate by $\Pi_1 = -\frac{1}{2} \text{tr} \left(\underline{\underline{D}} \right)$ and $\Pi_2 = \frac{1}{2} D_{ZZ}$. Then, the solution X (Eq. (19)) of Eq. (18) becomes:

$$X = \frac{-1 + \sqrt{1 + 3 \left(\frac{D_{ZZ}}{\text{tr}(\underline{D})} \right)^2 \left(1 + f^2 + 3f^2 \left(\frac{D_{ZZ}}{\text{tr}(\underline{D})} \right)^2 \right)}}{3 \left(\frac{D_{ZZ}}{\text{tr}(\underline{D})} \right)^2 f} \quad (\text{E5})$$

Analytical expressions for Σ_{XX} , Σ_{ZZ} , d_{eq} , Λ and $\tilde{\sigma}_0$ are :

$$\begin{cases} \Sigma_{XX} = \tilde{\sigma}_0 \beta_1 \\ \Sigma_{ZZ} = \tilde{\sigma}_0 (\beta_1 + \beta_2) \\ d_{eq} = \frac{\beta_1 \text{tr}(\underline{D}) + 2\beta_2 \Pi_2}{1-f} \\ \Lambda = -\frac{\Pi_1}{\sqrt{3} f \tilde{\sigma}_0 \sinh(\sqrt{3}\beta_1)} \\ \tilde{\sigma}_0 = \sigma_0 \left(\frac{1}{1-f} \right)^m \left(\beta_1 \text{tr}(\underline{D}) + 2\beta_2 \Pi_2 \right)^m \end{cases} \quad (\text{E6})$$

Note that Eqs (E6) are valid for a viscoplastic matrix having a powerlaw flow stress.

In addition

$$\begin{cases} \beta_1 = \frac{1}{\sqrt{3}} \ln(X + \sqrt{X^2 - 1}) \text{sgn} \left(\text{tr}(\underline{D}) \right) \\ \beta_2 = \frac{D_{ZZ} \sqrt{3}}{\text{tr}(\underline{D})} f \sinh(\sqrt{3}\beta_1) \end{cases} \quad (\text{E7})$$

Under axisymmetric ($D_{XX} = D_{YY}$) plane strain loading ($D_{ZZ} = 0$ or $\Pi_2 = 0$) one has ,

$X = \frac{1+f^2}{2f}$, $\beta_2 = 0$ and $\beta_1 = \frac{1}{\sqrt{3}} \ln \left(\frac{1}{f} \right) \text{sgn}(D_{XX})$. Finally, from Eq. (E5), we have:

$$\begin{cases} \Sigma_{XX} = \frac{1}{\sqrt{3}} \tilde{\sigma}_0 \ln \left(\frac{1}{f} \right) \text{sgn}(D_{XX}) \\ \Sigma_{ZZ} = \frac{1}{\sqrt{3}} \tilde{\sigma}_0 \ln \left(\frac{1}{f} \right) \text{sgn}(D_{XX}) \\ d_{eq} = \frac{2}{\sqrt{3}} \frac{\ln \left(\frac{1}{f} \right) |D_{XX}|}{1-f} \\ \Lambda = \frac{4|D_{XX}|}{\sqrt{3} \tilde{\sigma}_0 (1-f^2)} \\ \tilde{\sigma}_0 = \sigma_0 \left[\frac{2}{\sqrt{3}} \frac{\ln \left(\frac{1}{f} \right) |D_{XX}|}{1-f} \right]^m \end{cases} \quad (\text{E8})$$

Gurson with general loadings conditions:

A porous medium (spherical void) subjected to general loading conditions is considered. The constitutive law is described by the Gurson model. Based on Eq. (60) and Eq. (61), we have the following expression for the yield surface:

$$\frac{q^2}{\tilde{\sigma}_0^2} + 2q_1 f \cosh\left(\frac{3q_2 p}{2\tilde{\sigma}_0}\right) - 1 - q_1 f^2 = 0 \quad (\text{E9})$$

with:

$$\begin{cases} p = -\frac{1}{3} \text{tr}(\underline{\underline{\Sigma}}) \\ q = \left(\frac{3}{2} \underline{\underline{\Sigma}}^D : \underline{\underline{\Sigma}}^D\right)^{\frac{1}{2}} \end{cases}, \quad (\text{E10})$$

where $\underline{\underline{\Sigma}}^D$ is the deviatoric stress tensor. From Aravas (1987), the mean and effective strain rate can be obtained for the flow surface:

$$\begin{cases} \dot{\epsilon}_p = -\Lambda \left(\frac{\partial \Phi}{\partial p}\right) \\ \dot{\epsilon}_q = \Lambda \left(\frac{\partial \Phi}{\partial q}\right) \end{cases} \quad (\text{E11})$$

Combining Eq. (E9) and (E11), one obtains:

$$q = -\frac{3q_1 q_2 f}{2} \tilde{\sigma}_0 \left(\frac{\dot{\epsilon}_q}{\dot{\epsilon}_p}\right) \sinh\left(\frac{3q_2 p}{2\tilde{\sigma}_0}\right) \quad (\text{E12})$$

Using the scheme developed in the paper (see Section 2), and by defining:

$$X = \cosh\left(\frac{3q_2 p}{2\tilde{\sigma}_0}\right) \quad (\text{E13})$$

Eq. (E9) provides a quadratic equation in X:

$$\left(\frac{3q_1 q_2 f}{2}\right)^2 \left(\frac{\dot{\epsilon}_q}{\dot{\epsilon}_p}\right)^2 (X^2 - 1) + 2q_1 f X - 1 - q_1 f^2 = 0 \quad (\text{E14})$$

From Eq. (E13) we obtain:

$$p = \pm \frac{2\tilde{\sigma}_0}{3q_2} \ln(X + \sqrt{X^2 - 1}) \quad (\text{E15})$$

where X is the positive solution of Eq. (14).

The analytical expression of q is obtained from Eq. (E12):

$$q = -\frac{3q_1q_2f}{2} \tilde{\sigma}_0 \left(\frac{\dot{\epsilon}_q}{\dot{\epsilon}_p} \right) \operatorname{sgn}(p) \sqrt{X^2 - 1} \quad (\mathbf{E16})$$

Note that q is always positive. As previously in this paper, the sign of p is determined from the positivity of the equivalent strain rate in the matrix.

Appendix F: Extension to non-axisymmetric loadings

In this Appendix, we extend the strategy proposed for axisymmetric loading in Section 2.2.1. The extension deals with strain rate loading given by Eq. (1) where the three diagonal components are different. We also assume that the porous model of Gurson type has the following form

$$\Phi = \frac{A}{\bar{\sigma}_0^2} ((\Sigma_{XX} - \Sigma_{YY})^2 + (\Sigma_{XX} - \Sigma_{ZZ})^2 + (\Sigma_{YY} - \Sigma_{ZZ})^2) + B \cosh\left(\frac{F(\underline{\Sigma})}{\bar{\sigma}_0}\right) + C = 0 \quad (\mathbf{F1})$$

where coefficients A , B and C may depend on the void geometry, the porosity and material parameters. $F(\underline{\Sigma})$ is a linear function of the components of the macroscopic stress: $F(\underline{\Sigma}) = \theta_1 \Sigma_{XX} + \theta_2 \Sigma_{YY} + \theta_3 \Sigma_{ZZ}$. Eq. (F1) is representative for the Gurson model with $\theta_i = 1/2$ and of the GLPD model when the semi axes of the spheroids are aligned with the principal loading direction.

By adopting the following definition, $\Delta_1 = \Sigma_{XX} - \Sigma_{YY}$ and $\Delta_2 = \Sigma_{XX} - \Sigma_{ZZ}$, Eq. (F1) becomes:

$$\Phi = \frac{A}{\bar{\sigma}_0^2} (\Delta_1^2 + \Delta_2^2 + (\Delta_2 - \Delta_1)^2) + B \cosh\left(\frac{F(\underline{\Sigma})}{\bar{\sigma}_0}\right) + C = 0 \quad (\mathbf{F2})$$

The derivatives of the yield function Φ with respect to the stress components are evaluated:

$$\begin{cases} \frac{\partial \Phi}{\partial \Sigma_{XX}} = \frac{2A}{\bar{\sigma}_0^2} (\Delta_1 + \Delta_2) + \frac{B}{\bar{\sigma}_0} \sinh\left(\frac{F(\underline{\Sigma})}{\bar{\sigma}_0}\right) \frac{\partial F(\underline{\Sigma})}{\partial \Sigma_{XX}} \\ \frac{\partial \Phi}{\partial \Sigma_{YY}} = -\frac{2A}{\bar{\sigma}_0^2} (\Delta_1 - \Delta_2) + \frac{B}{\bar{\sigma}_0} \sinh\left(\frac{F(\underline{\Sigma})}{\bar{\sigma}_0}\right) \frac{\partial F(\underline{\Sigma})}{\partial \Sigma_{YY}} \\ \frac{\partial \Phi}{\partial \Sigma_{ZZ}} = -\frac{2A}{\bar{\sigma}_0^2} (\Delta_2 - \Delta_1) + \frac{B}{\bar{\sigma}_0} \sinh\left(\frac{F(\underline{\Sigma})}{\bar{\sigma}_0}\right) \frac{\partial F(\underline{\Sigma})}{\partial \Sigma_{ZZ}} \end{cases} \quad (\mathbf{F3})$$

where terms $\frac{\partial F(\underline{\Sigma})}{\partial \Sigma_{ij}}$ are constant. Under plastic loading, the plastic multiplier is positive $\Lambda > 0$ and at least one of the three plastic strain rates D_{XX}, D_{YY}, D_{ZZ} is non-zero. Without loss of generality, we assume that $D_{XX} \neq 0$. Combining Eq. (5) and Eq. (F3), a new set of relations is obtained for the main unknown variables Δ_1 , Δ_2 and Λ :

$$\begin{cases} \Delta_1 + \Delta_2 = \frac{\tilde{\sigma}_0^2}{2A} \left[\frac{D_{XX}}{\Lambda} - \frac{B}{\tilde{\sigma}_0} \sinh \left(\frac{F(\underline{\Sigma})}{\tilde{\sigma}_0} \right) \frac{\partial F(\underline{\Sigma})}{\partial \Sigma_{XX}} \right] \\ -2\Delta_1 + \Delta_2 = \frac{\tilde{\sigma}_0^2}{2A} \left[\frac{D_{YY}}{\Lambda} - \frac{B}{\tilde{\sigma}_0} \sinh \left(\frac{F(\underline{\Sigma})}{\tilde{\sigma}_0} \right) \frac{\partial F(\underline{\Sigma})}{\partial \Sigma_{YY}} \right] \\ \Delta_1 - 2\Delta_2 = \frac{\tilde{\sigma}_0^2}{2A} \left[\frac{D_{ZZ}}{\Lambda} - \frac{B}{\tilde{\sigma}_0} \sinh \left(\frac{F(\underline{\Sigma})}{\tilde{\sigma}_0} \right) \frac{\partial F(\underline{\Sigma})}{\partial \Sigma_{ZZ}} \right] \end{cases} \quad (\text{F4})$$

The elimination of Λ in Eqs (F4) leads to a linear system for Δ_1 , Δ_2 :

$$\begin{cases} \Delta_1(D_{YY} + 2D_{XX}) + \Delta_2(D_{YY} - D_{XX}) = -\frac{\tilde{\sigma}_0 B}{2\tilde{A}} \sinh \left(\frac{F(\underline{\Sigma})}{\tilde{\sigma}_0} \right) \mathcal{L}_1 \\ \Delta_1(D_{ZZ} - D_{XX}) + \Delta_2(D_{ZZ} + 2D_{XX}) = -\frac{\tilde{\sigma}_0 B}{2\tilde{A}} \sinh \left(\frac{F(\underline{\Sigma})}{\tilde{\sigma}_0} \right) \mathcal{L}_2 \end{cases} \quad (\text{F5})$$

where $\mathcal{L}_1 = \frac{\partial F(\underline{\Sigma})}{\partial \Sigma_{XX}} D_{YY} - \frac{\partial F(\underline{\Sigma})}{\partial \Sigma_{YY}} D_{XX}$ and $\mathcal{L}_2 = \frac{\partial F(\underline{\Sigma})}{\partial \Sigma_{XX}} D_{ZZ} - \frac{\partial F(\underline{\Sigma})}{\partial \Sigma_{ZZ}} D_{XX}$

It is important to notice that the functions \mathcal{L}_1 and \mathcal{L}_2 are linear combination of the macroscopic strain rate \underline{D} since $F(\underline{\Sigma})$ is linear with respect to the components of the macroscopic stress. So the expressions of Δ_1 and Δ_2 are found:

$$\begin{bmatrix} \Delta_1 \\ \Delta_2 \end{bmatrix} = -\frac{\tilde{\sigma}_0 B}{2A} \sinh \left(\frac{F(\underline{\Sigma})}{\tilde{\sigma}_0} \right) \underline{\underline{\mathcal{M}}}^{-1} \cdot \begin{bmatrix} \mathcal{L}_1 \\ \mathcal{L}_2 \end{bmatrix} \quad (\text{F6})$$

with $\underline{\underline{\mathcal{M}}} = \begin{bmatrix} D_{YY} + 2D_{XX} & D_{YY} - D_{XX} \\ D_{ZZ} - D_{XX} & D_{ZZ} + 2D_{XX} \end{bmatrix}$. The solution exists when the determinant $det(\mathcal{M}) = 3 D_{XX}(D_{XX} + D_{YY} + D_{ZZ})$ is non-zero. Please note that when $D_{XX} + D_{YY} + D_{ZZ} = 0$, the values of Δ_1 and Δ_2 can also be found in a more direct manner. Indeed, in that case, from Eq. (F4), it appears that $F(\underline{\underline{\Sigma}}) = 0$ and from the first two relations of set (F3), closed form expression for Δ_1 and Δ_2 are obtained. In that particular case, where the mean strain rate is vanishing, the porosity is not evolving and the effective stress for the porous medium is $\Sigma_{eq} = -\frac{\tilde{\sigma}_0}{\sqrt{A}}(B + C)$.

Assuming that the condition $det(\mathcal{M}) \neq 0$ is met, the variables Δ_1 and Δ_2 are shown to be scaled by the effective yield stress $\tilde{\sigma}_0$ of the matrix.

$$\begin{cases} \Delta_1 = -\frac{\tilde{\sigma}_0 B}{2A} \sinh\left(\frac{F(\underline{\underline{\Sigma}})}{\tilde{\sigma}_0}\right) \hat{\mathcal{L}}_1 \\ \Delta_2 = -\frac{\tilde{\sigma}_0 B}{2A} \sinh\left(\frac{F(\underline{\underline{\Sigma}})}{\tilde{\sigma}_0}\right) \hat{\mathcal{L}}_2 \end{cases} \quad (\text{F7})$$

with $\underline{\underline{\hat{\mathcal{L}}}} = \underline{\underline{\mathcal{M}}}^{-1} \cdot \underline{\underline{\mathcal{L}}}$.

Based on expression (F7), the yield function (F2) is written as:

$$\frac{B^2}{4A} \sinh\left(\frac{F(\underline{\underline{\Sigma}})}{\tilde{\sigma}_0}\right) \left(\hat{\mathcal{L}}_1^2 + \hat{\mathcal{L}}_2^2 + (\hat{\mathcal{L}}_2 - \hat{\mathcal{L}}_1)^2\right) + B \cosh\left(\frac{F(\underline{\underline{\Sigma}})}{\tilde{\sigma}_0}\right) + C = 0 \quad (\text{F8})$$

Similarly to Section 2.2.1, the variable X is defined as $X = \cosh\left(\frac{F(\underline{\underline{\Sigma}})}{\tilde{\sigma}_0}\right)$.

As a consequence, Equation (F8) becomes a quadratic expression in X :

$$\frac{B^2}{4A} (X^2 - 1) \left(\hat{\mathcal{L}}_1^2 + \hat{\mathcal{L}}_2^2 + (\hat{\mathcal{L}}_2 - \hat{\mathcal{L}}_1)^2\right) + BX + C = 0 \quad (\text{F9})$$

A positive solution X exists (at least for the Gurson (1977) model or the Gologanu et al. (1997) model). A direct consequence is that the scalar term $F(\underline{\underline{\Sigma}})$ is still proportional to the

yield stress in the matrix, as already mentioned in Section 2.2.1 for axisymmetric loading conditions:

$$F(\underline{\underline{\Sigma}}) = \pm \tilde{\sigma}_0 \ln(X + \sqrt{X^2 - 1}) \quad (\text{F10})$$

As $F(\underline{\underline{\Sigma}})$ is a linear function of the stress tensor, the components of the macroscopic stress can be written in a generic way by combining Eq. (F10) with Eq. (F9):

$$\begin{cases} \Sigma_{XX} = \tilde{\sigma}_0 \psi_X \\ \Sigma_{YY} = \tilde{\sigma}_0 \psi_Y \\ \Sigma_{ZZ} = \tilde{\sigma}_0 \psi_Z \end{cases} \quad (\text{F11})$$

where ψ_X, ψ_Y and ψ_Z are analytical expressions. Please note that the sign in Eq. (F10) is fixed from the equivalence between the macroscopic and microscopic plastic dissipations.

References:

Aravas, N., 1987. On the numerical integration of a class of pressure-dependent plasticity models. *International Journal for Numerical Methods in Engineering*, 24, 1395-1416.

Balan, T., Cazacu, O., 2013. Elastic-plastic ductile damage model based on strain-rate plastic potential. *Mechanics Research Communications* 54, 21-26.

Benzerga, A.A., Besson, J., 2001. Plastic potentials for anisotropic porous solids. *European Journal of Mechanics A/Solids* 20, 397-434.

Cazacu, O., Barlat, F., 2003. Application of the theory of representation to describe yielding of anisotropic aluminium alloys. *International Journal of Engineering Science* 41, 1367-1385.

Cocks, A.C.F., 1989. Inelastic deformation of porous materials. *Journal of the Mechanics and Physics of Materials* 37, 693-715.

Czarnota, C., Mercier, S., Molinari, A., 2006. Modelling of nucleation and void growth in dynamic pressure loading, application to spall test on tantalum. *International Journal of Fracture* 141, 177-194.

Danas, K., Ponte Castañeda, P., 2009. A finite-strain model for anisotropic viscoplastic porous media: I – Theory. *European Journal of Mechanics A/Solids* 28, 387-401.

Duva, J. M., 1986. A constitutive description of nonlinear materials containing voids. *Mechanics of Materials* 5, 137-144.

Dormieux, L., Kondo, D., 2013. Non linear homogenization approach of strength of nanoporous materials with interface effects. *International Journal of Engineering Science* 71, 102-110.

Enakoutsa, K., Leblond, J.-B., 2009. Numerical implantation and assessment of the GLPD micromorphic model of ductile rupture. *European Journal of Mechanics A/Solids* 28, 445-460.

Flandi, L., Leblond, J.-B., 2005a. A new model for porous nonlinear viscous solids incorporating void shape effects - I: Theory. *European Journal of Mechanics A/Solids* 24, 537-551.

Flandi, L., Leblond, J.-B., 2005b. A new model for porous nonlinear viscous solids incorporating void shape effects - II: Numerical validation. *European Journal of Mechanics A/Solids* 24, 552-571.

Gărăjeu, M., Michel, J.C., Suquet, P., 2000. A micromechanical approach of damage in viscoplastic materials by evolution in size shape and distribution of voids. *Computer methods in applied mechanics and engineering* 183, 223-246.

Gologanu, M., Leblond, J.-B., Devaux, J., 1993. Approximate models for ductile metals containing non-spherical voids - Case of axisymmetric prolate ellipsoidal cavities. *Journal of the Mechanics and Physics of Solids* 41, 1723-1754.

Gologanu, M., Leblond, J.-B., Devaux, J., 1994. Approximate models for ductile metals containing non-spherical voids - Case of axisymmetric oblate ellipsoidal cavities. *Journal of Engineering materials and technology* 116, 290-297.

Gologanu, M., Leblond, J.-B., Perrin, G., Devaux, J., 1997. Recent extensions of Gurson's model for porous ductile metals. *Continuum Micromechanics, International Centre for Mechanical Sciences Courses and lectures n°377*, P. Suquet, ed., Springer-Verlag, 61-130.

Gologanu, M., 1997. Etude de quelques problèmes de rupture ductile des métaux. Ph. D., Université de Paris VI, Paris, France.

Gurson, A. L., 1977. Continuum theory of ductile rupture by void nucleation and growth: Part I - yield criteria and flow rules for porous ductile media. *Journal of Engineering Materials and Technology* 99, 2-15.

Hill, R., 1948. A theory of yielding and plastic flow of anisotropic solids. *Proceedings of the Royal Society London A* 193, 281-297.

Leblond, J.-B., Perrin, G., Suquet, P., 1994. Exact results and approximate models for porous viscoplastic solids. *International Journal of plasticity* 10, 213-235.

Leblond, J-B., Roy, G., 2000. A model for dynamic ductile behavior applicable for arbitrary triaxialities. *Compte Rendus Académie des Sciences Paris*, t. 328, Série II b, 381-386.

Leblond, J-B., 2003. *Mécanique de la rupture fragile et ductile. Etudes en mécanique des matériaux et des structures*, Hermes Science Publications.

Michel, J.C., Suquet, P., 1992. The constitutive law of nonlinear viscous and porous materials. *Journal of the Mechanics and Physics of Materials*, 40, 783-812.

Madou, K., Leblond, J.-B., 2012. A Gurson-type criterion for porous ductile solids containing arbitrary ellipsoidal voids – I: Limit-analysis of some representative cell. *Journal of the Mechanics and Physics of Solids* 60, 1020-1036.

Monchiet, V., Charkaluk, E., Kondo, D., 2007. An improvement of Gurson-type models of porous materials by using Eshelby-like trial velocity fields. *Comptes Rendus Mécanique* 335, 32-41.

Monchiet, V., Cazacu, O., Charkaluk, E., Kondo, D., 2008. Macroscopic yield criteria for plastic anisotropic materials containing spheroidal voids. *International Journal of Plasticity* 24, 1158-1189.

Monchiet, V., Kondo, D., 2013. Combined void size and shape effects on the macroscopic criterion of ductile nanoporous materials. *International Journal of Plasticity* 43, 20-40.

Morin L., Michel J.C., Leblond J.B., 2017. A Gurson-type layer model for ductile porous solids with isotropic and kinematic hardening, *International Journal of Solids and Structures*, 118-119, 167-178

Mühlich, U., Brocks, W., 2003. On the numerical integration of a class of pressure-dependent plasticity models including kinematic hardening. *Computational mechanics* 31, 479-488.

Ponte Castañeda, P., 1991. The effective mechanical properties of nonlinear isotropic composites. *Journal of the Mechanics and Physics of solids* 39, 45-71.

Reboul J., Vadillo G., 2018. Homogenized Gurson-type behavior equations for strain rate sensitive material. *Acta Mechanica*, on line.

Sartori, C., Mercier, S., Jacques, N., Molinari, A., 2015. Constitutive behavior of porous ductile materials accounting for micro-inertia and void shape. *Mechanics of Materials* 80, Part B, 324-339

Sartori, C., Mercier, S., Jacques, N., Molinari, A., 2016. On the dynamic behavior of porous ductile solids containing spheroidal voids. *International Journal of solids and structures* 97-98, 150-167.

Simo, J.-C., Hugues, T.-J.-R., 1998. *Computational inelasticity*. Springer-Verlag New York.

Song, D., Ponte Castañeda, P., 2017. A finite-strain homogeneization model for viscoplastic porous single crystals: I – theory. *Journal of the Mechanics and Physics of Solids* 107, 560-579.

Tvergaard, V., Needleman, A., 1984. Analysis of cup-cone fracture in a round tensile bar. *Acta Metallurgica* 32, 157-169.

Vadillo, G., Zaera, R., Fernández-Sáez, J., 2008. Consistent integration of the constitutive equations of Gurson materials under adiabatic conditions. *Computer Methods in Applied Mechanics and Engineering* 197, 1280-1295.