



HAL
open science

Competitive distribution system planning model integration of dg, interruptible load and voltage regulator devices

Siyamak Porkar Koumleh, A. Abbaspour-Tehrani-Fard, Philippe Poure,
Shahrokh Saadate

► **To cite this version:**

Siyamak Porkar Koumleh, A. Abbaspour-Tehrani-Fard, Philippe Poure, Shahrokh Saadate. Competitive distribution system planning model integration of dg, interruptible load and voltage regulator devices. Iranian Journal of Science and Technology, Transaction B: Engineering, 2010, 34 (B6), pp.619-635. hal-03568491

HAL Id: hal-03568491

<https://hal.univ-lorraine.fr/hal-03568491>

Submitted on 23 Feb 2022

HAL is a multi-disciplinary open access archive for the deposit and dissemination of scientific research documents, whether they are published or not. The documents may come from teaching and research institutions in France or abroad, or from public or private research centers.

L'archive ouverte pluridisciplinaire **HAL**, est destinée au dépôt et à la diffusion de documents scientifiques de niveau recherche, publiés ou non, émanant des établissements d'enseignement et de recherche français ou étrangers, des laboratoires publics ou privés.

Competitive Distribution System Planning Model Integration of DG, Interruptible Load and Voltage Regulator Devices

S. Porkar^{1,2} A. Abbaspour-Tehrani-fard¹ P. Poure³ S. Saadate²

¹ Department of Electrical Engineering, Sharif University of Technology, Tehran, Iran

² Groupe de Recherches en Electrotechnique et Electronique de Nancy, GREEN-UHP, UMR 7037, Université Henri Poincaré de Nancy I, BP 239, 54506 Vandoeuvre les Nancy cedex France

³ Laboratoire d'Instrumentation Electronique de Nancy, LIEN, EA 3440, Université Henri Poincaré de Nancy I, BP 239, 54506 Vandoeuvre les Nancy cedex France

Email : s_porkar@yahoo.com

Abstract— Distribution systems management is becoming an increasingly complicated issue due to the introduction of new technologies, new energy trading strategies and new deregulated environment. In the new deregulated energy market and considering the incentives coming from the technical and economical fields, it is reasonable to consider Distributed Generation (DG) as a viable option to solve the lacking electric power supply problem. This paper presents a mathematical distribution system planning model considering three planning options to system expansion and to meet the load growth requirements with a reasonable price as well as the system power quality problems. DG is introduced as an attractive planning option with competition of voltage regulator devices and Interruptible load. In mathematical model, the object function includes investment costs, which are evaluated as annualized total cost, plus total running cost as well as cost of curtailed loads and losses. This model identifies the optimal type, size and location of the planning options. This paper is also studied fluctuation of load and electricity market price versus time period and the effect of DG placement on system improvement. To solve the proposed mathematical planning model a new software package interfacing MATLAB and GAMS is developed. This package is enabling to solve large extent distribution system planning program visually and very fast. The proposed methodology is tested in the case of the well-known IEEE 30-bus test system.

Keywords— Deregulation, Distributed Generation (DG), Distribution Company (DISCO), GAMS-MATLAB interface, Interruptible Load (IL), Optimization.

I. INTRODUCTION

Electrical energy sector over the past two decades has been affected by two important factors. The first factor is the advancement in generation technologies which has been evolving on a continuous basis, and newer and different energy transformation resources have been introduced to achieve high standards of energy provision. The second factor is the trend to liberate the energy sector from a monopolistic operating regime to a deregulated one, and to establish competitive markets for electricity.

The deregulation of the power industry and setting up of open markets for electricity in many countries, from the erstwhile vertically integrated systems has led to a clear separation between generation, transmission and distribution activities. All of these activities have undergone significant transformation processes in the restructured environment in order to find the operational range which is more secure, reliable and economic [1]-[3].

Changes in electric system logistics and high growth of load densities make it now more essential than ever to create alternative solutions to system planning. More efficient distribution system planning models have to be developed taking into consideration the new available planning options. Distributed generation (DG) is one of these new planning options [4]-[6] which should be investigated in combination with the traditional distribution system planning options.

Traditionally, a Distribution System Company (DISCO) purchased energy other electrical identities such as Transmission Companies (TRANSCOs) connected to DISCO distribution system, at a high

voltage level, and then transfers this energy to final customers. Nevertheless, the restructuring process of the energy sector has stimulated the introduction of new agents and products, and the unbundling of traditional DISCO into technical and commercial tasks, including the provision of ancillary services [5].

The distribution system planning problem consists of determining the type, capacity, and siting of installation of new distribution equipment, taking capacity restrictions on feeders, voltage drop, and demand forecasts into account [4], [7]. In this paper it is assumed that the planner has three planning alternatives to system expansion: utilization of DG, installation voltage regulator devices such as Synchronous Condenser (SC) and load shedding. This paper considers all of possible combination of these planning alternatives which is depended to planner decision, system limitation and investment budget. Mathematical programming method has been used to obtain the optimum solution.

In order to solve this planning program a new software package has been developed by interfacing MATLAB (user friendly tool for using its visualization capabilities and easy data transfer suitable for distribution system planners) and GAMS (especial tool for solving various types of mathematical optimization problems). The proposed distribution system planning framework and models are executed on the well-known IEEE 30-bus test system.

II. MATHEMATICAL PROGRAMMING

The methods which are used to solve the expansion planning problem can be divided into two categories: heuristic methods, including specialist systems and evolutionary algorithms and mathematical programming methods [4]. The most widely used of mathematical programming methods include linear programming (LP) [8], nonlinear programming (NLP) [9], mixed-integer linear or nonlinear programming (MILP or MINLP) [10]-[12], and Dynamic Non-Linear Programming (DNLP) [13], [14].

In this method, it is possible to minimize total system cost consist of fixed (investment) and variable (operating and maintenance) costs representing the main restrictions explicitly such as power flow equations, equipment capacities, voltage drop, and budget. These methods guarantee to find optimum solution. Also it is possible to use the computers resources which are currently available in order to solve mathematical programming. These two advantages make this approach very attractive.

Since 1980, much effort has been directed toward solving the distribution system planning problem using the heuristic algorithms [4]. Heuristic methods provide an alternative to mathematical programming. They attracted attention because they can work in a straightforward approach with nonlinear constraints and objective function. In this approach, it is also easy to introduce aspects, such as losses, reliability, and uncertainties. However, there is no guarantee that an optimum solution can be found. Branch-exchange algorithms [15], algorithms based on evolutionary computation [16], [17], specialist systems [18], ant colony [19], [20], genetic algorithm [21], [22], simulated annealing [22], and tabu search [23] are notable heuristic methods that have been used to solve optimization problem.

A. General Market Structure

In this subsection, a general description of the DISCO acquisition market model is presented. In Fig. 1 the DISCO acquisition market is shown in dashed line as part of a more general market structure. This structure encompasses pool markets and financial bilateral contracts. Definitions of market agents are as follows:

- **DISCO:** Distribution Company is entity that own and operate the distribution networks. Its main function is to operate, maintain and develop the network from a technical viewpoint. It operates the facilities and buys energy, either through financial bilateral contracts or in the Pool.
- **Wholesale Market:** In the restructured electricity market environment, the wholesale market is an organized process based on the principle of competition. In other words, the wholesale market provides energy at a given (or estimated) price. This is the typical case in Pool or financial bilateral contracts market structures.

- DG O/I: Distributed generation units inside the DISCO control area which are managed or owned by the DISCO or independently from the DISCO.
- It is to be noted that when a DISCO invests directly in DGs, that value is a direct benefit to the distribution system in its territory. When a DISCO tries to encourage customers or developers to own and operate DGs, the value is to the both owner and DISCO.
- SC: voltage regulator devices such as Synchronous Condenser (SC) units inside the DISCO control area.
- Loads: Customers served by the DISCO, which have flexible contracts with load curtailment (interruptible load) and demand side management oriented options.

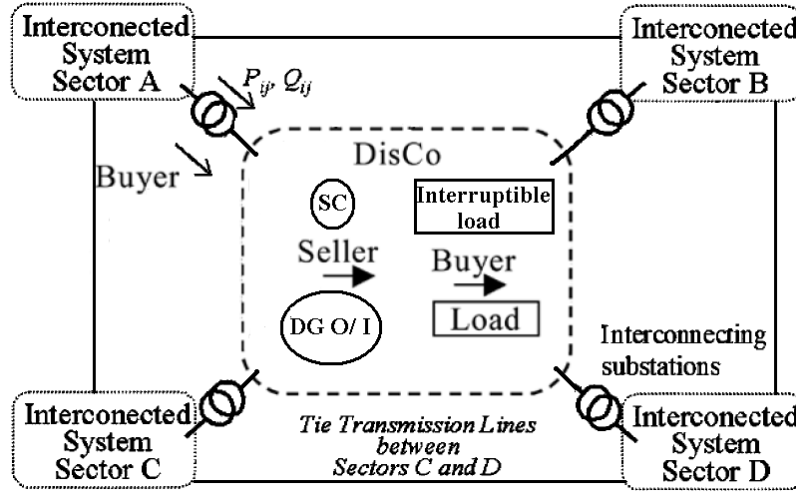

Fig. 1: General market structure.

B. Mathematical formulation

The main objective of the DG or SC allocation problem is to minimize installation costs and energy losses. This paper formulates an objective function that considers the effects of each planning option to find the best solution to meet the load growth and improve system security and power quality. So, the problem may be stated as an optimization problem as follows:

Minimize an objective function representing the annualized fixed costs correspondent to the investment and the variable costs associated to the maintenance and operation of DG and SC, cost of load curtailment and cost of purchasing power from interconnected system such as TRANSCOs connected to DISCO distribution system, respectively, expressed by the following equation:

$$\begin{aligned}
 \text{Min } obj(\$/h) = & \left(\frac{\sum_{i=1}^B C_{Inv_{DG}^i} \cdot P_{DG i}^{\max}}{A * 8760} + \sum_{i=1}^B C_{O\&M_{DG}^i} \cdot P_{DG i} \right. \\
 & + \frac{\sum_{i=1}^B C_{Inv_{SC}^i} \cdot Q_{SC i}^{\max}}{A * 8760} + \sum_{i=1}^B C_{O\&M_{SC}^i} \cdot Q_{SC i} \\
 & + \sum_{i=1}^L P_i^{cur} * C_{pen} \\
 & \left. + \sum_{i=1}^G C_{p i} \cdot P_{G i} \right) \quad \forall t
 \end{aligned} \tag{1}$$

It is to be noted that the system power losses appears in term of the total power purchased from the TRANSCOs and DGs. To annualize this investment, we have used the following equation [1], [2]:

$$A = \left[\frac{(1+d)^T - 1}{d(1+d)^T} \right] \quad (2)$$

Subject to the following constraints [24], [25]:

1) Energy balance constraint at all of the system nodes:

$$\sum_{j \neq i} P_{ij} = P_{G_i} + P_{DG_i} - P_i^d + P_i^{cur} \quad (3)$$

$$\sum_{j \neq i} Q_{ij} = Q_{G_i} + Q_{SC_i} + Q_{DG_i} - Q_i^d + Q_i^{cur}$$

2) Distribution system devices limits:

i) Active power generation:

$$0 \leq P_{G_i} \leq P_{G_i}^{\max} \quad (4)$$

ii) Reactive power generation:

$$Q_{G_i}^{\min} \leq Q_{G_i} \leq Q_{G_i}^{\max} \quad (5)$$

iii) Distribution feeder load flow:

$$\left| S_{ij} \right| \leq S_{ij}^{\max} \quad (6)$$

iv) DG capacity:

$$0 \leq P_{DG_i} \leq P_{DG_i}^{\max} \quad \forall i = 1, \dots, B \quad (7)$$

v) SC capacity:

$$0 \leq Q_{SC_i} \leq Q_{SC_i}^{\max} \quad \forall i = 1, \dots, B \quad (8)$$

3) Bus voltage limit:

$$V_i^{\min} \leq V_i \leq V_i^{\max} \quad (9)$$

4) Investment resource constraint:

$$\sum_{i=1}^B C_{Inv_{DG_i}} \cdot P_{DG_i}^{\max} + \sum_{i=1}^B C_{Inv_{SC_i}} \cdot Q_{SC_i}^{\max} \leq BCL \quad (10)$$

C. Simulation tool

However, software packages such as MATLAB have optimization tools they are useful for small-scale nonlinear models (and to some extent for large linear models). The lack the ability to perform automatic derivatives makes them impractical for large scale nonlinear optimization. In sharp contrast, modeling languages such as General Algebraic Modeling System (GAMS) [26] have such a capability for many years, and have been used in many practical large scale nonlinear applications. However, GAMS has some capabilities for data manipulation and visualization, specialized software tools like MATLAB are much better at these tasks for large extent data.

The targets in this paper are the following:

- To consider all of the possible planning options and constraints together in a multi-objective optimization model to approach more realistic results;
- To solve optimization problem as fast as possible even in practical distribution systems that have a large number of variations and parameters;
- To develop a user-friendly software package to be used in applicable cases by distribution system planners.

However GAMS and MATLAB interfacing has been presented in the other works such as [27], [28], they are not sufficient for this purpose because of their weakness in:

- Choice of distribution planning alternatives such as DG, voltage regulators, capacitors bank, SC, load shedding, ...
- Choice of the problem constraints and possibilities to change their limits according to system conditions;
- Capability of entering electricity market price and load fluctuations as a matrix or input file in excel format;

- Change of GAMS solver depending on the change in type of planning alternatives (i.e. the DG type can be defined as a positive variable or a positive integer multiple a fixed scalar, because of its discrete nature. So, the type of model should be changed from DNLP to MINLP).

So it was necessary for our work to develop a new software package by interfacing these softwares specially for distribution system planning to achieve the above mentioned purposes. Although power system and system constraints equations (2)-(10) are always the same, the object function is depended on the planner decision. In this paper DG is introduced as an attractive planning option with competition of voltage regulator devices and Interruptible load.

The aim of this link is two-fold. Firstly, it is intended to provide MATLAB users with a sophisticated nonlinear optimization capability. Secondly, the visualization tools of MATLAB are made available to a GAMS modeler in a easy and extendable manner so that optimization results can be viewed using any of the wide variety of plots and imaging capabilities that exist in MATLAB (See Fig.2).

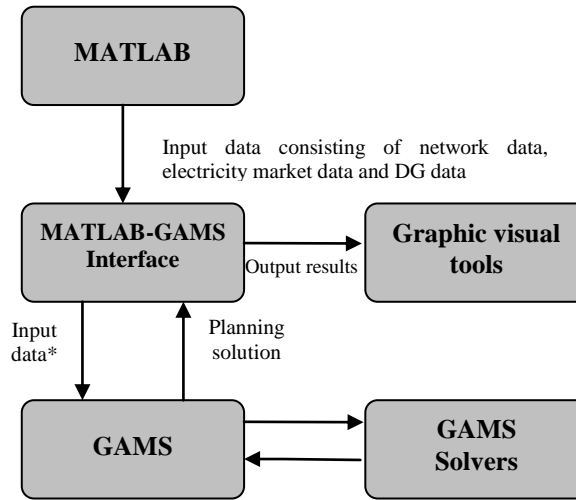

* In format of adjustable with GAMS

Fig. 2: MATLAB-GAMS interface.

III. APPLICATION

Considering three planning options (DG and SC installation and load shedding) there are eight possible cases. The choice of each of these cases is depended to the planner decision. These cases are:

- Case I: Without DG or SC installation and load shedding
- Case II: load shedding
- Case III: SC installation
- Case IV: DG installation
- Case V: SC installation and load shedding
- Case VI: DG installation and load shedding
- Case VII: DG and SC installation
- Case VIII: DG and SC installation and load shedding

These cases with the proposed mathematical model have been tested on the modified IEEE 30-Bus system [25], [29] based on a real distribution system (Midwestern US). It consists of two subsystems; 132 kV sub-transmission system (buses No. 1-8 and 28) which has 132/33 kV step-down transformers and 11 kV or 33 kV distribution system (the other buses) [29]. The system parameters as reported in [30] are modified according to following (see Fig. 3):

The voltage of the buses No. 1-4 is equal to 132KV and the voltage of the other ones is assumed to be equal to 33KV. The synchronous condenser of bus No. 8 has been considered to be out of service.

So, there are two TRANSCOs connected at buses 1 and 2 and also three SCs at buses 5, 11 and 13. Wide varieties of DG technologies with varying operating characteristics are available in the market. Combine Heat and Power (CHP) units, due to their heat recovery system can deliver power at much cheaper price than the central generation. The technologies such as fuel cells are characterized by their high cost while technologies such as wind turbine and gas turbines lie somewhere in the middle. In this paper the fixed and variable cost of DG is assumed to be 0.5 M\$/MW and 40 \$/MWh [9], [24], [25]. The candidate individual and total DG capacity for installation at each bus is assumed to be 1MW and 4MW, respectively. The upper bound of SC in each bus is assumed to be 4MVA. According to budget constraint the maximum total candidate DG and SC capacities are assumed to be equal to 20 MW. The discount rate is taken as 10%. The penalty of load curtailment is assumed to be equal to 500 \$/MW [31].

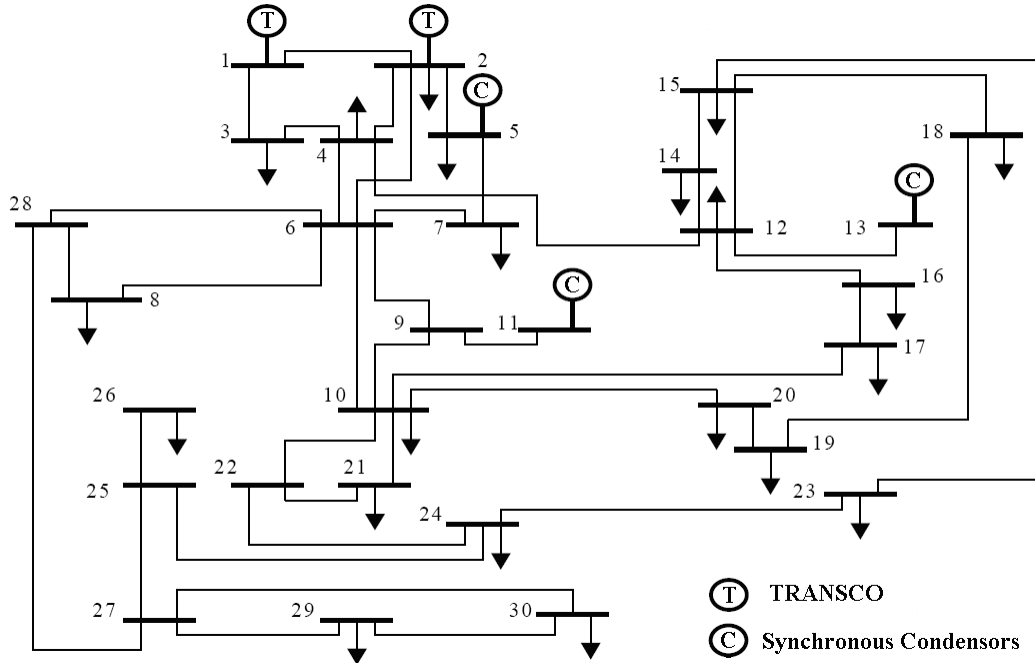

Fig. 3: Modified IEEE 30-Bus system under study.

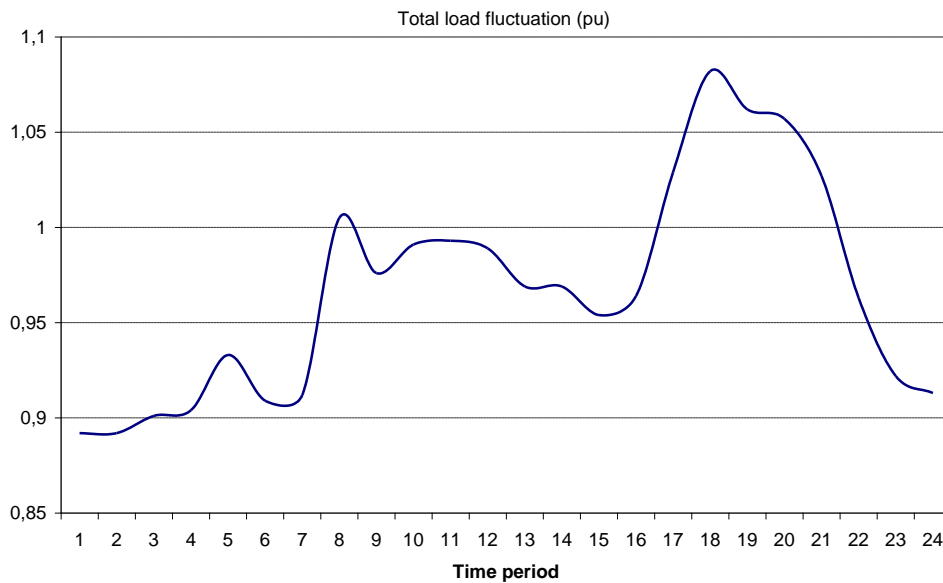

Fig. 4: Total load fluctuation versus time period

To study fluctuation of load and electricity market price versus time period (uncertainty on fuel price and load) electricity market price and system load is considered to be variable. The shape of the daily, seasonal, and annual load curves is important characteristic for operation and expansion

of generation systems to meet the system load. Utilities record the chronological hourly loads on a continuous basis. Many of sample hours in total planning period have similar data. So it is possible to summarize input data by using an average data model to simplify simulation. In this paper, the sample time is chosen equal to 24. Fig. 4 shows a total load fluctuation versus 24-time period. Electricity base market price is variable by 24-period according to Fig. 5.

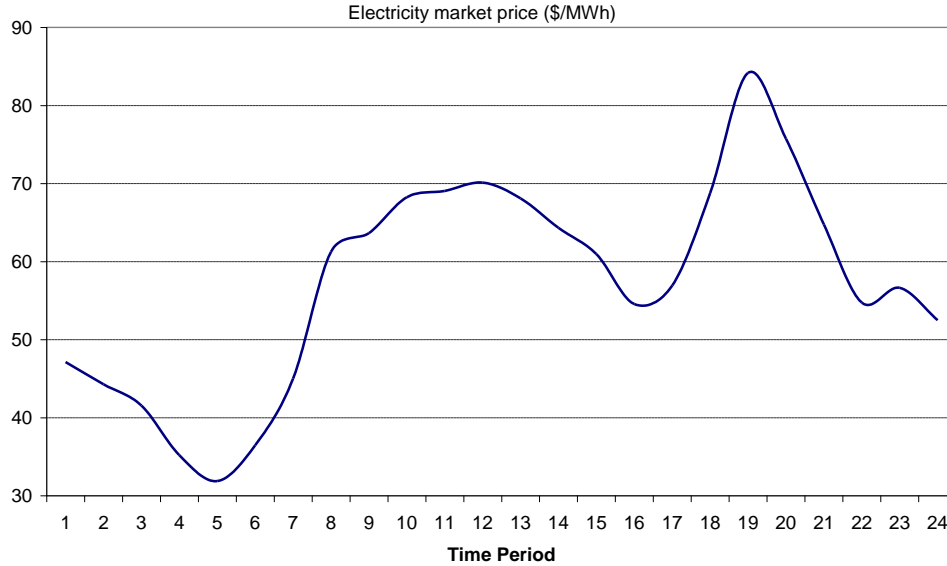

Fig. 5: Electricity market price.

IV. ANALYSIS AND RESULTS

Case I:

In this case there is not any planning option. This case exactly studies system condition and problems after load growing. The results of simulation indicate that in some time period the load flow equations don't converge. To converge these equations the lower constraint of bus voltage (0.96 pu) is removed. In this condition voltage profile of nine buses in some time period violate their lower limits which confirm the necessity of system upgrading.

Fig. 6 indicates the voltage profile of sensitive buses versus the time period. These buses are sorted as 30, 8, 26, 29, 28, 7, 6, 25 and 27 according to their profile voltage from lowest to highest. It is to be noted that in this condition protection devices may disconnect these buses.

Case II:

Rolling blackouts, also referred to as load shedding, are a last resort measure used by an electricity utility company in order to avoid a total blackout of the power system which may occur to above mentioned problem (case I). Table 1 indicates the percentage of curtailed load at each time period and in each bus. It also summarized total active and reactive curtailed load versus time period. The optimum curtailed load is shown in the hatched area of Fig. 7 and Fig. 8.

Table 1: Optimum curtailed load at each time period and in each bus in case II.

Bus #	Time Period														sum	
	8	9	10	11	12	13	14	15	16	17	18	19	20	21		22
Curtailed load at bus # 8 (%)	11.3	1.7	6.7	7.4	6.1	-	-	-	-	19.1	34.8	28.8	27.4	18.5	-	85.8
Curtailed load at bus #26 (%)	-	-	-	-	-	-	-	-	-	-	13.2	8.1	8.1	-	-	
Curtailed load at bus #30 (%)	22.4	16.5	20.0	20.0	19.0	14.6	14.6	7.9	12.7	27.5	35.7	32.7	32.1	27.5	11.8	
Total active load shedding (MW)	5.8	2.2	4.1	4.3	3.8	1.5	1.5	0.8	1.3	8.9	15.9	13.2	12.6	8.7	1.2	85.8
Total reactive load shedding (MVar)	3.8	0.8	2.4	2.6	2.2	0.3	0.3	0.1	0.2	6.4	12.3	10.1	9.5	6.2	0.2	57.4

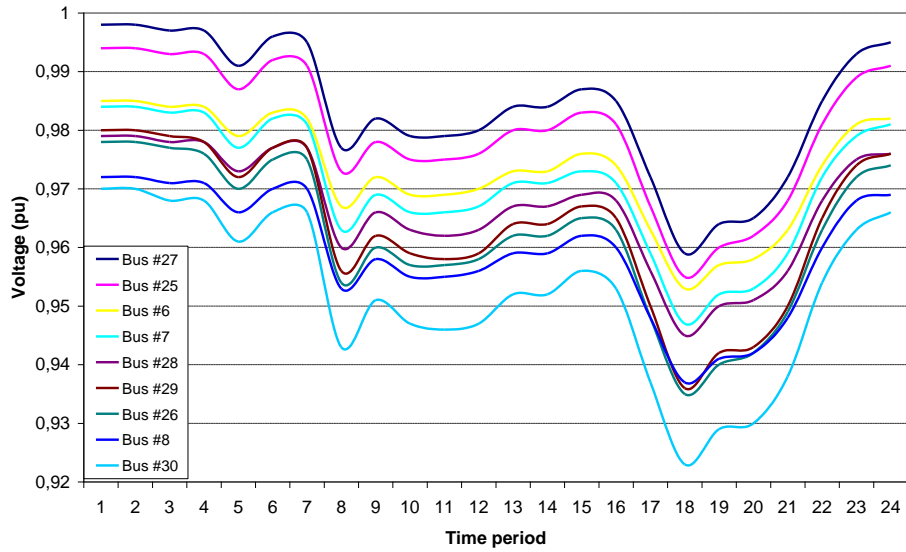

Fig. 6: Voltage profile versus time period at sensitive buses in case I.

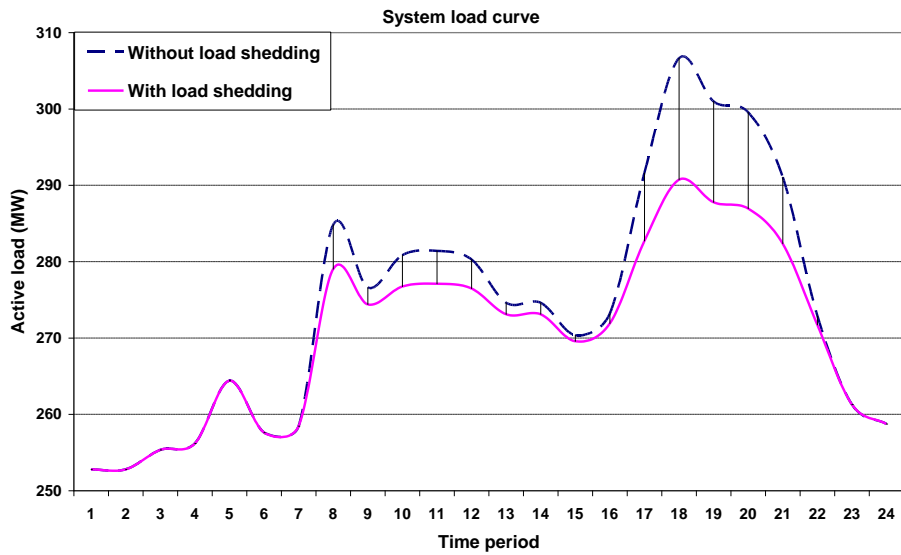

Fig. 7: Total system active load before and after load shedding in case II.

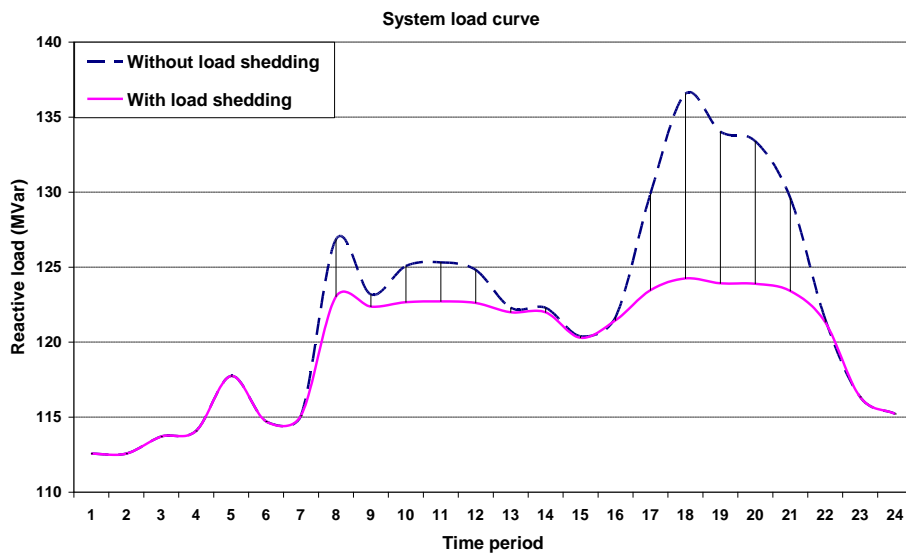

Fig. 8: Total system reactive load before and after load shedding in case II.

Case III:

Based on system weak point on its voltage profile which is mentioned on case I, one option is the usage of voltage regulator devices. The results of simulations illustrate that in this case, voltage profile of buses 7 and 8 violate their lower bound to converge the load flow equations (Fig. 9). The optimum capacity and location of SC installation will be shown in the next figures.

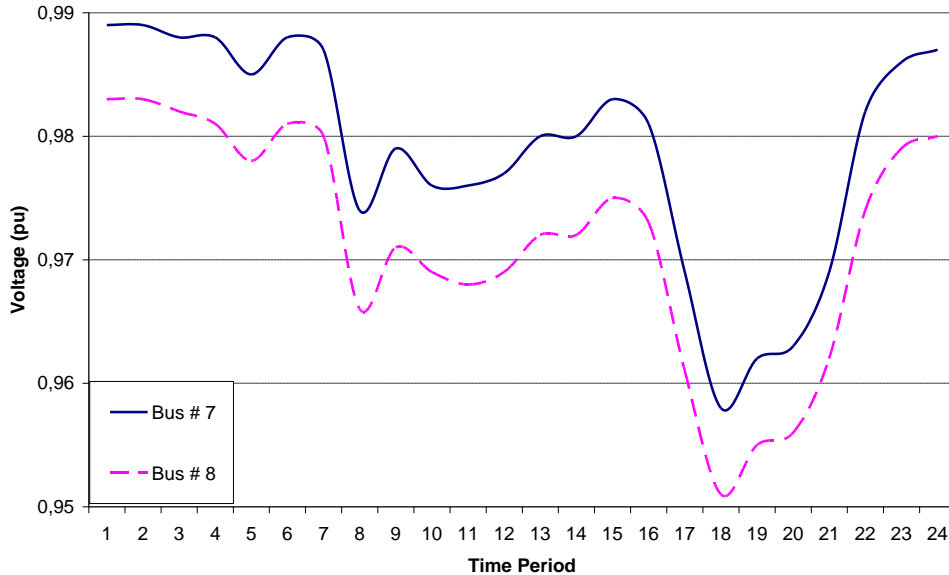

Fig. 9: Voltage profile versus time period at sensitive buses in case III.

Case IV:

In this case the effect of DG installation on system improvement is studied. In this case voltage profiles of six buses are violated. Fig. 10 illustrates these voltage profiles. The optimal size and site of DG installation will be shown in the next figures.

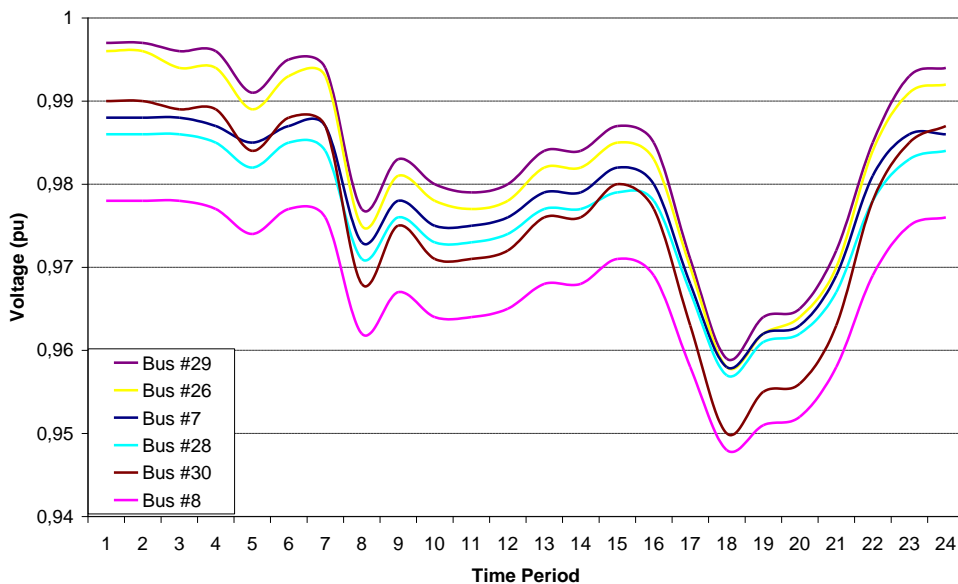

Fig. 10: Voltage profile versus time period at sensitive buses in case IV.

Case V:

To overcome the problem which is mentioned in case III in this case the combination of SC installation and load shedding is considered. Fig. 11 and 12 show the optimum active and reactive load curtailment in each time period, respectively. Percentage and amount of total curtailed load is shown in Table 2.

Table 2: Optimum curtailed load at each time period and bus in case V.

Bus #	Time Period			sum
	18	19	20	
Curtailed load at bus # 8 (%)	11.1	4.1	2.2	
Total active load shedding (MW)	3.6	1.3	0.7	5.6
Total reactive load shedding (MVar)	3.6	1.3	0.7	5.6

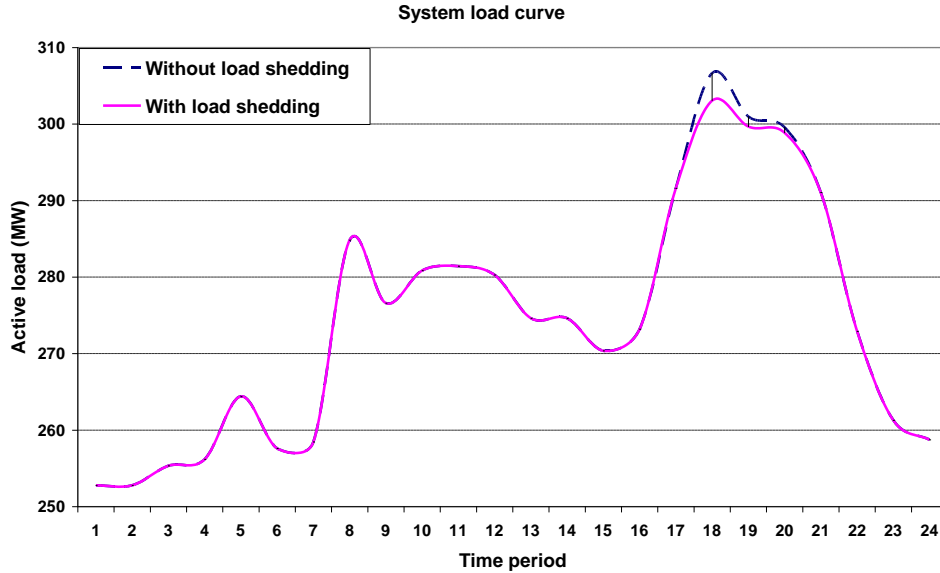

Fig. 11: Total system active load before and after load shedding in case V.

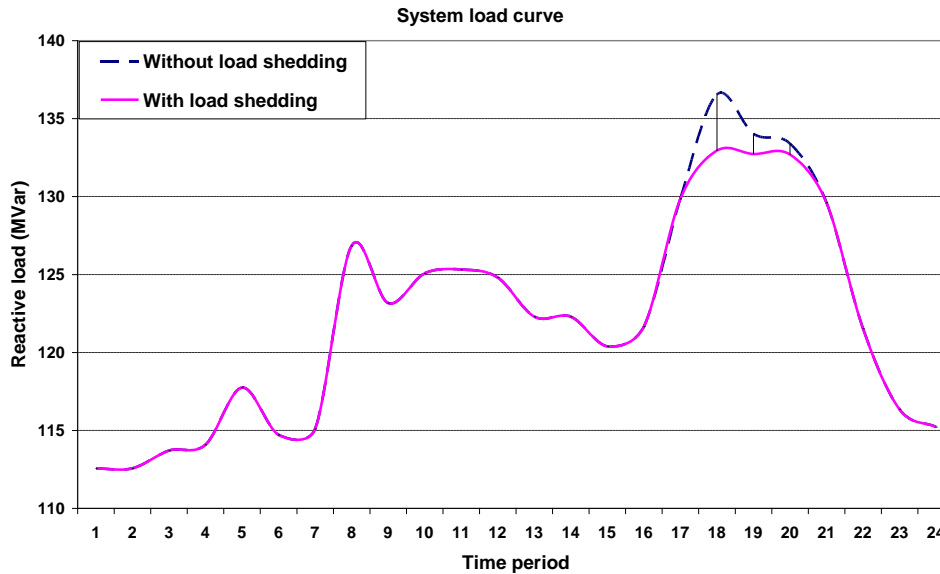

Fig. 12: Total system reactive load before and after load shedding in case V

Case VI:

In this case the best solution considering DG installation and load shedding is studied. Time, location and amount of curtailed load are shown in Table 3, Fig. 13 and 14. Hatched area illustrates Energy Not Supplied or ENS.

Table 3: Optimum curtailed load at each time period and bus in case VI.

Bus #	Time Period					Sum
	17	18	19	20	21	
Curtailed load at bus # 8 (%)	2.9	21.2	14.4	12.6	2.3	
Total active load shedding (MW)	0.9	6.9	4.6	4	0.7	17.1
Total reactive load shedding (MVar)	0.9	6.9	4.6	4	0.7	17.1

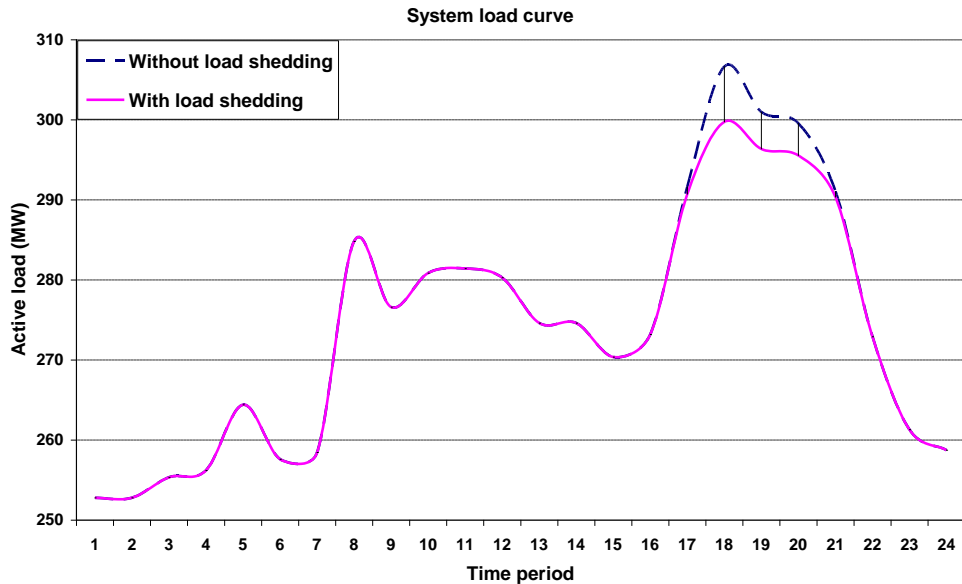

Fig. 13: Total system active load before and after load shedding in case VI.

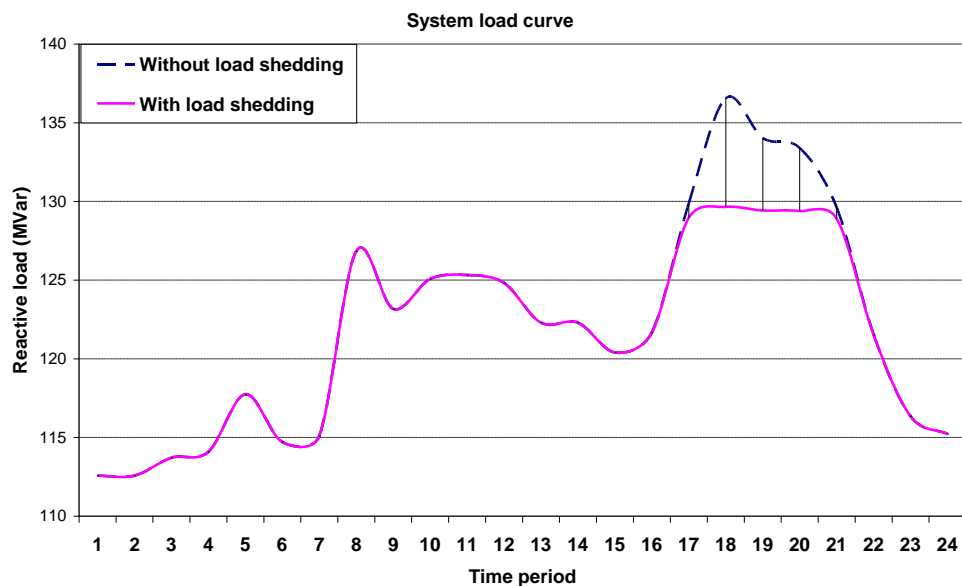

Fig. 14: Total system reactive load before and after load shedding in case VI.

Cases VII & VIII:

The results of cases VII and VIII are similar. Because in case VIII by considering DG and SC installation, load shedding is not necessary. Optimum size and site of DG in cases II, VI, VII and VIII is shown in Fig. 15. Fig. 16 illustrates optimum location and capacity of SC in cases III, V, VII and VIII. The results illustrate that the size and capacity of DG or SC is depended to planning options. It is to be noted that in this paper the size of DG, in contrast of SC, is considered to be multiple of 1MW.

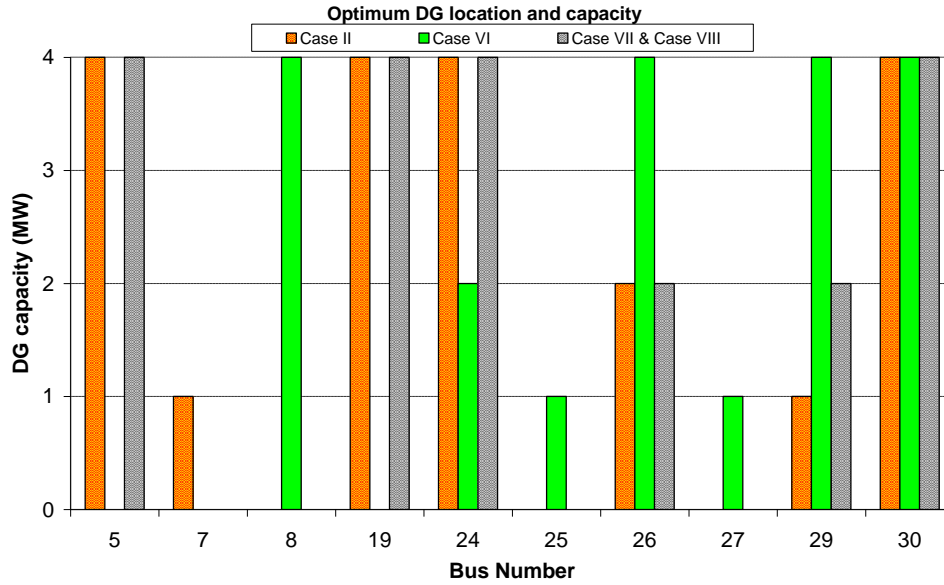

Fig. 15: Optimum location and size of DG in case II, VI, VII&VII.

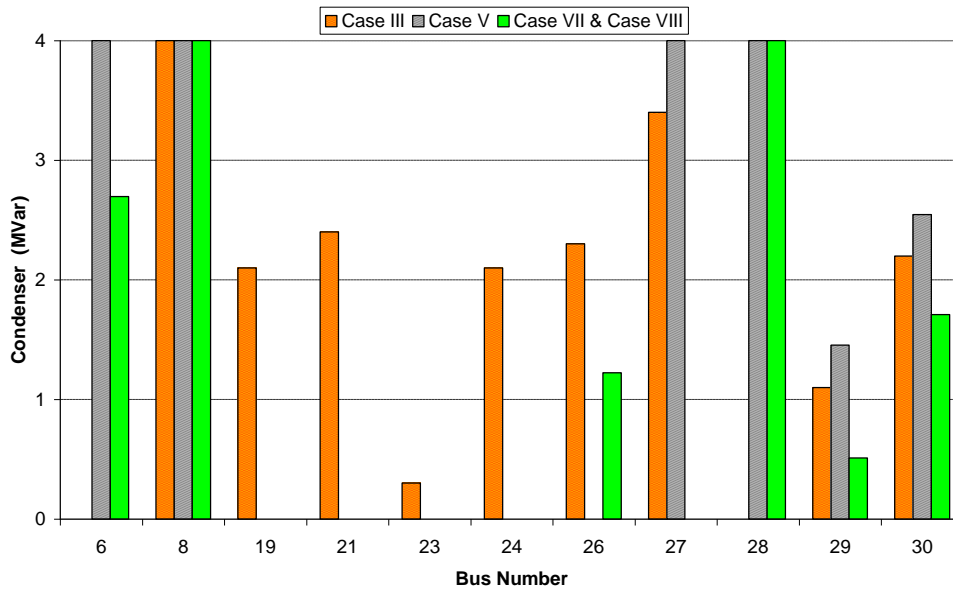

Fig. 16: Optimum location and size of SC in case III, V, VII&VII.

Fig. 17 compares total system losses versus time period from up to down in cases I, III, IV, VII and VIII, respectively. Cases II, V and VI are not considered in this comparison because the load shedding effects directly on total losses. It is shown that however, SC installation has negligible effect on total system losses reduction DG installation has significant effect on total system losses.

Table 4 summarizes the best solution of each case. As it is clear in this table the optimum case between these cases is case IV or DG installation. As before mentioned the addition of this case is the voltage violation in some buses at some time periods. If the protection devices permit these violations this case will be the best. Otherwise, the best solution will be case VII or VIII. In the other word by installing almost 14 MVar this problem will be eliminate.

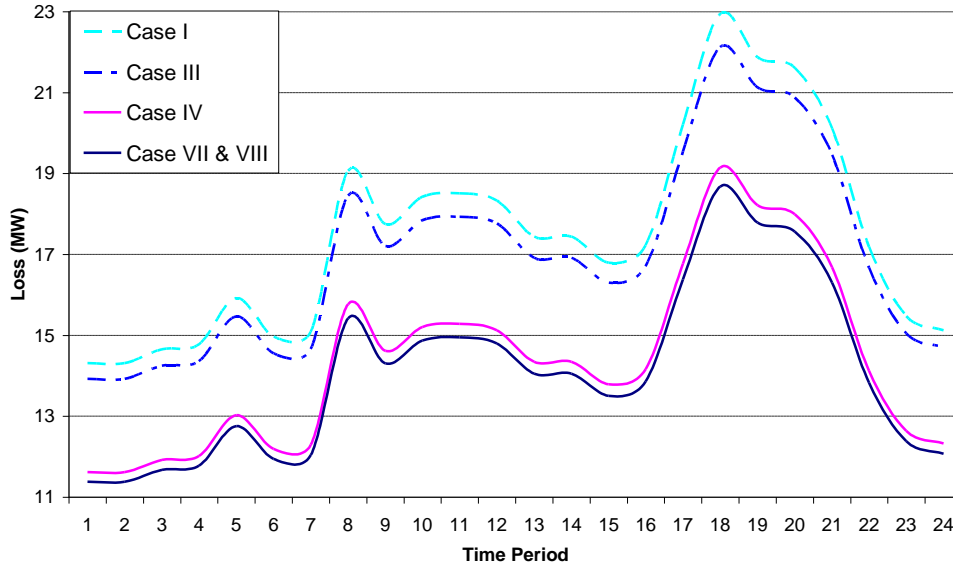

Fig. 17: Total system losses versus time period in cases I, III, IV, VII&VII

Table 4: Optimum solution in each case.

	Case I	Case II	Case III	Case IV	Case V	Case VI	Case VII & VIII
Total system cost in 24-period time (M\$)	0.406	0.471	0.405	0.393	0.413	0.409	0.394
Total purchased power from TRANSCOs # 1,2 (MVA)	6996.6	6893.5	6983.9	6442.4	6978.4	6427.6	6434.9
Total installed DG (MW)	-	-	-	20	-	20	20
Total installed condenser (MVA _r)	-	-	20	-	20	-	14.138
Total active load shedding (MW)	-	85.8	-	-	5.6	17.1	-
Total reactive load shedding (MW)	-	57.4	-	-	5.6	17.1	-
Total loss in 24-time period (MW)	419.5	402.475	406.712	345.21	406.85	347.515	337.765

V. CONCLUSIONS

In this paper DG is introduced to participate in electricity market as an attractive planning option with competition of voltage regulator devices and Interruptible load to solve the electric power supply problem and meet the load growth requirement with a reasonable price as well as improve power quality. In this paper, some effects of DG on the distribution system such as voltage profile improvement and losses reduction and effect of planning condition on the optimal DG sitting and sizing are discussed. It is also shown that DG will play an increasing role in the electrical power system of the future, not only for the cost savings but also for the additional power quality. Cost is one of the most essential factors that influence many decisions taken in the distribution system planning. In general, cost can be defined as anything that must be sacrificed to gain some desired results. This paper proposes a mathematical planning model and a new software package to solve it. The best solution considering the planner policy and its facilities including kind, capacity and location of usage of these alternatives are obtained. It was shown that, although DGs may never supply the total distribution loads, these can be a powerful option. However, penetration of DG at a particular location is influenced by technical as well as economic factors.

REFERENCES

1. G. Rothwell and T. Gomez, Electricity Economics: Regulation and Deregulation, John Wiley and Sons, 2003

2. D. Kirschen and G. Strbac, *Fundamental of Power System Economics*, John Wiley and Sons, 2004.
3. M. Shahidehpour, H. Yamin, and Z. Li, *Market Operation in Electric Power System: Forecasting, Scheduling and Risk Management*, John Wiley and Sons, 2002.
4. S. Haffner, L. F. A. Pereira, L. A. Pereira, and L. S. Barreto, "Multistage Model for Distribution Expansion Planning With Distributed Generation—Part I: Problem Formulation", *IEEE Trans. Power Del.*, Vol. 23, No. 2, pp. 915-923, April 2008.
5. R. Palma-Behnke, J. L. Cerda A., L. S. Vargas, and A. Jofré, "A Distribution Company Energy Acquisition Market Model With Integration of Distributed Generation and Load Curtailment Options", *IEEE Trans. Power Syst.*, Vol. 20, No. 4, Nov. 2005, pp. 1718-1727.
6. A. Keane, and M. O'Malley, "Optimal Allocation of Embedded Generation on Distribution Networks", *IEEE Trans. Power Syst.*, Vol. 20, No. 3, August 2005, pp. 1640-1646.
7. H. L. Willis, *Power Distribution Planning Reference Book*, 2nd ed New York: Marcel Dekker, 2004, p. 1217.
8. M. A. Farrag, M. M. El-Metwally, and M. S. El-Bages, "A new model for distribution system planning", *Elect. Power Energy Syst.*, vol. 21, pp. 523-531, 1999.
9. W. El-Khattam, Y. G. Hegazy, and M. M. A. Salama, "An integrated distributed generation optimization model for distribution system planning," *IEEE Trans. Power Syst.*, vol. 20, no. 2, pp. 1158-1165, May 2005.
10. M. Vaziri, K. Tomsovic, and A. Bose, "A direct graph formulation of the multistage distribution expansion problem," *IEEE Trans. Power Del.*, vol. 19, no. 3, pp. 1335-1341, Jul. 2004.
11. M. Vaziri, K. Tomsovic, and A. Bose, "Numerical analyses of a direct graph formulation of the multistage distribution expansion problem," *IEEE Trans. Power Del.*, vol. 19, no. 3, pp. 1348-1354, Jul. 2004.
12. P. C. Paiva, H. M. Khodr, J. A. Domínguez-Navarro, J. M. Yusta, and A. J. Urduñeta, "Integral planning of primary-secondary distribution systems using mixed integer linear programming," *IEEE Trans. Power Syst.*, vol. 20, no. 2, pp. 1134-1143, May 2005.
13. N. G. Boulaxis and M. P. Papadopoulos, "Optimal feeder routing in distribution system planning using dynamic programming technique and GIS facilities," *IEEE Trans. Power Del.*, vol. 17, no. 1, pp. 242-247, Jan. 2002.
14. E. Díaz-Dorado and J. C. Pidre, "Optimal planning of unbalanced networks using dynamic programming optimization," *IEEE Trans. Power Syst.*, vol. 19, no. 4, pp. 2077-2085, Nov. 2004.
15. E. Míguez, J. Cidrás, E. Díaz-Dorado, and J. L. García-Dornelas, "An improved branch-exchange algorithm for large-scale distribution network planning," *IEEE Trans. Power Syst.*, vol. 17, no. 4, pp. 931-936, Nov. 2002.
16. I. J. Ramírez-Rosado and J. L. Bernal-Augustín, "Reliability and costs optimization for distribution networks expansion using an evolutionary algorithm," *IEEE Trans. Power Syst.*, vol. 16, no. 1, pp. 111-118, Feb. 2001.
17. E. Díaz-Dorado, J. Cidrás, and E. Míguez, "Application of evolutionary algorithms for the planning of urban distribution networks of medium voltage," *IEEE Trans. Power Syst.*, vol. 17, no. 3, pp. 1151-1159, Aug. 2002.
18. R. Ranjan, B. Venkatesh, and D. Das, "A new algorithm for power distribution system planning," *Elect. Power Syst. Res.*, vol. 62, no. 1, pp. 55-65, 2002.
19. T. Niknam, "A new approach based on ant colony optimization for daily Volt/Var control in distribution networks considering distributed generators", *Energy Conversion and Management*, Vol. 49, No. 12, Dec. 2008, pp. 3417-3424.
20. S. Abachezadeh, M. Abedi, S. H. Hosseini, S. Najafi, A. Vahidnia, "A Framework for Optimal Planning in Large Distribution Networks", *IEEE Trans. Power Syst.* Accepted for future publication, 2009.
21. G. P. Harrison, A. Piccolo, P. Siano, A. Robin Wallace, "Hybrid GA and OPF evaluation of network capacity for distributed generation connections", *Elsevier, Electric Power Systems Research*, Volume 78, Issue 3, March 2008, Pages 392-398

22. V. Parada, J. A. Ferland, M. Arias, and K. Daniels, "Optimization of electrical distribution feeders using simulated annealing," IEEE Trans. Power Del., vol. 19, no. 3, pp. 1135–1141, Jul. 2004.
23. A. Augugliaro, L. Dusonchet, and E. R. Sanseverino, "An evolutionary parallel tabu search approach for distribution systems reinforcement planning," Adv. Eng. Inform., no. 16, pp. 205–215, 2002.
24. S. Porkar, A. Abbaspour-Tehrani-fard, S. Saadate, "An Approach to Distribution System Planning by Implementing Distributed Generation in a Deregulated Electricity Market", Power Engineering, 2007 Large Engineering Systems Conference on 10-12 Oct. 2007 Page(s):90 - 95
25. S. Porkar, P. Poure, A. Abbaspour-Tehrani-fard, S. Saadate, "Distributed Generation Planning for Losses, Voltage Profile, Line Congestion and Total System Cost Improvement", International Review of Electrical Engineering (IREE), Vol 4, No. 3, pp. 434-440, June 2009.
26. A. Brooke, D. Kendrick, and A. Meeraus, GAMS -A User's Guide. The Scientific Press, 1988.
27. M. C. Ferris, "MATLAB and GAMS: Interfacing optimization and visualization software", Mathematical Programming Technical Report 98-19, Computer Sciences Department, University of Wisconsin, Madison, Wisconsin, 1998.
28. F. Milano, "A Graphical and Open Source Matlab-GAMS Interface for Electricity Market Models", 9th Spanish Portuguese Congress on Electrical Engineering, 30 June - 2 July 2005, Marbella, Spain.
29. M. Shahidepour and Y. Wang, "Communication and Control of Electric Power Systems," John Wiley and Sons, June 2003.
30. A. Y. Abdelaziz, H. E. A. Talaat, A. I. Nosseir and Ammar A. Hajjar, "An adaptive protection scheme for optimal coordination of overcurrent relays", Electric Power Systems Research, Vol. 61, No. 1, pp 1-9, Feb. 2002.
31. J. H. Teng, C. N. Lu, "Optimum Fault Current Limiter Placement", International Conference on Intelligent Systems Applications to Power Systems, Nov. 2007.

NOMENCLATURE

A	Annualized factor
B	Number of system buses for DG or SC connection
BCL	DISCO Budget Capacity Limit (\$)
$C_{Inv_{dg}^i}$	DG investment cost at bus i (\$/MW)
$C_{Inv_{sc}^i}$	SC investment cost at bus i (\$/MVA _r)
C_{pen}^{cur}	Penalty of load shedding (\$/MW)
C_{P_i}	Active power price of TRANSCO number i (\$/MWh)
$C_{O\&M_{dg}^i}$	DG operating and maintenance cost at bus i (\$/MWh)
$C_{O\&M_{sc}^i}$	SC operating and maintenance cost at bus i (\$/MWh)
d	Discount rate
G	Number of interconnected system to the distribution system
L	Number of system load buses
Obj	Object function
P_{DG_i}	Active power generated by DG at bus i (MW)
$P_{DG_i}^{max}$	Maximum DG capacity at bus i (MW)
P_{G_i}	Active power dispatched from TRANSCO number i (MW)
$P_{G_i}^{max}$	Maximum active power limit of TRANSCO number i (MW)
P_{ij}	Power flow transfer from bus i to bus j (MW)
P_i^d	Total active power demand at bus i (MW)
P_i^{cur}	Total active curtailed load at bus i (MW)

$P_{DG i}$	Reactive power generated by DG at bus i (MVar)
Q_i^d	Total reactive power demand at bus i (MVar)
Q_i^{cur}	Total reactive curtailed load at bus i (MVar)
Q_{ij}	Reactive Power flow transfer from bus i to bus j (MVar)
$Q_{SC i}$	SC generated reactive power at bus i (MW)
$Q_{SC i}^{\max}$	Maximum SC capacity at bus i (MW)
$Q_{G i}$	Reactive power dispatched from TRANSCO number i (MVar)
$Q_{G i}^{\max}$	Maximum reactive power limit of TRANSCO number i (MVar)
$Q_{G i}^{\min}$	Minimum reactive power limit of TRANSCO number i (MVar)
S_{ij}	Apparent power flow through line connected between buses i and j (MVA)
S_{ij}^{\max}	Maximum permissible line power flow capacity
T	Planning horizon time (year)
V_i	Bus voltage at bus i (V)
V_i^{\max}	Maximum permissible voltage at bus i (V)
V_i^{\min}	Minimum permissible voltage at bus i (V)