

**ICE-IAMOT 2022 Special days on European projects: Round table,
Parallel workshops, Demonstrators in living lab mode, Posters & talks**

“Open innovation, technologies & communities as enablers of socio-economical transition”

Wednesday 22nd June & Thursday 23rd June

Chairs:

Day 1 – **Dr. Laurent DUPONT**, Université de Lorraine, France

Day 2 – **Dr. Fabio Cruz, Dr. Ferney Osorio**, Université de Lorraine, France



2022 IEEE 28th ICE/ITMC & 31st IAMOT JOINT CONFERENCE

**Technology, Engineering and Innovation Management Communities
as Enablers for Social Ecological Transitions**



Copyright information

2022 IEEE 28th International Conference on Engineering, Technology and Innovation (ICE/ITMC) & 31st International Association For Management of Technology (IAMOT) Joint Conference ©

All rights reserved. Copyright ©2022 by IEEE.

Copyright and Reprint Permission:

Abstracting is permitted with credit to the source. Libraries are permitted to photocopy beyond the limit of U.S. copyright law for private use of patrons those articles in this volume that carry a code at the bottom of the first page, provided the per-copy fee indicated in the code is paid through Copyright Clearance Center, 222 Rosewood Drive, Danvers, MA 01923.

For reprint or republication permission, email to IEEE Copyrights Manager at pubs-permissions@ieee.org.



2022 IEEE 28th ICE/ITMC & 31st IAMOT JOINT CONFERENCE

**Technology, Engineering and Innovation Management Communities
as Enablers for Social Ecological Transitions**



Two special days – seven EU projects



GA n°: 870148



GA n°: 869952



GA n°: 870037



GA n°: 869984



GA n°: 873010



“Open innovation, technologies & communities as enablers of socio-economical transition”

Seven European projects share their thoughts and results at 2022 IEEE 28th ICE/ITMC & 31st IAMOT Joint Conference

- Round table,
- Workshops,
- Demonstrator in living lab mode
- Posters & talks

2022 IEEE 28th ICE/ITMC & 31st IAMOT JOINT CONFERENCE

**Technology, Engineering and Innovation Management Communities
as Enablers for Social Ecological Transitions**



Wednesday 22nd June

Round table & Workshops & Demonstrator



1. Responsible Research and Innovation: new methodological approaches and practical insights



2. Emerging Trends and Innovations in Project Management



3. Co-creation laboratories for mitigation and adaptation to climate change –



INEDIT
open INnovation Ecosystems
for Do It Together process

4. Open Innovation for collaborative production engineering (IA)
TOPIC ID: DT-FOF-05-2019



TRANSFORMING COLLABORATIVE
PRODUCT CREATION











2022 IEEE 28th ICE/ITMC & 31st IAMOT JOINT CONFERENCE

Technology, Engineering and Innovation Management Communities
as Enablers for Social Ecological Transitions



Overview

Wednesday 22 nd June [Venues: Centre Prouvé & Octroi Nancy]			Thursday 23 rd June [Venue: Octroi Nancy]		
9:00 – 10:30	<p>Round table Open innovation, technologies & communities as enablers of socio-economical transition :</p> <p>Short presentation of the projects, results and perspectives + focus:</p> <ul style="list-style-type: none"> Definitions of (open) communities and open innovation Engagement strategy to transform European Industry in line with Responsible Research and Innovation and Circular Economy <p>Centre Prouvé Auditorium 300 + stream</p> 			<p>9:30 – 12:00</p> <p>When West meets East - ICE-IAMOT</p> <p>Open workshop - Expo Green Techs – Posters, short talks & networking (open to all)</p> 	<p>9:00-13:00 WS INEDIT (only for project members)</p> 
10:30 – 11:00	Coffee break				
11:00 – 12:30	<p>Short session - Sister projects shared workshop (open to all): “Co-designing Open innovation, technologies & communities to enable socio-economical transition” – practices and actions from Centre Prouvé Auditorium 300 + stream</p> 	<p>11:00-12:30 WS DigiTeRRI (open to all)</p> 	<p>11:00-12:30 WS Climate labs (only for CL members)</p> 	<p>11:30 – Hélène Boulanger, President of Université de Lorraine</p> <p>Venue: Petite Halle – Octroi Nancy</p>	
12:30 – 14:00	Lunch break + travel of participants to Octroi Nancy		Food truck (not include in fees)		
14:00 – 18:00	<p>Demonstrator in Living lab mode + networking (open to all citizens & local industry): “Innovative Design Factory in the city”</p> <ul style="list-style-type: none"> DIT process: from Co-creation to open manufacturing Open_Next pilots & booth iProduce software & booth DIY4U booth <p>Venue: Petite Halle – Octroi Nancy</p> 	<p>13:30 – 16:30 WS HyValue (open to all) Centre Prouvé Auditorium 300 + stream</p> 	<p>13:30-18:00 WS Climate labs (only for CL members)</p> 	<p>14:00-18:00 WS Climate labs (only for CL members)</p> 	
18:00 – 19:45	Free time				
19:45	<p>Gala Diner & surprises Place Stanislas - City Hall</p>		<p>Climate labs welcoming cocktail</p>		

"Open innovation, technologies & communities as enablers of socio-economical transition"

Chair: **Dr. Laurent DUPONT**, Université de Lorraine, France

- Context:
 - Climate change! Limits and challenges of our current societal model – An introduction. Mauricio Camargo - Université de Lorraine
 - New trends in the EU context and the Society: What responsibility of Science and Innovation in societal transitions? Introduction to RRI by DigiTeRRI - Marianne Hoerlesberger - Austrian Institute of Technology
 - Transforming European industry with DIY and open manufacturing facilities - Mehera Hassan – Technische Universität Berlin
- Short presentation of five European projects (DIY4U, iProduce, INEDIT, Open!_Next, Climate Labs), results and perspectives + focus:
 - Definitions of (open) communities and open innovation
 - Engagement strategy to transform European Industry in line with Responsible Research and Innovation and Circular Economy



2022 IEEE 28th ICE/ITMC & 31st IAMOT JOINT CONFERENCE

**Technology, Engineering and Innovation Management Communities
as Enablers for Social Ecological Transitions**



EU projects Round table

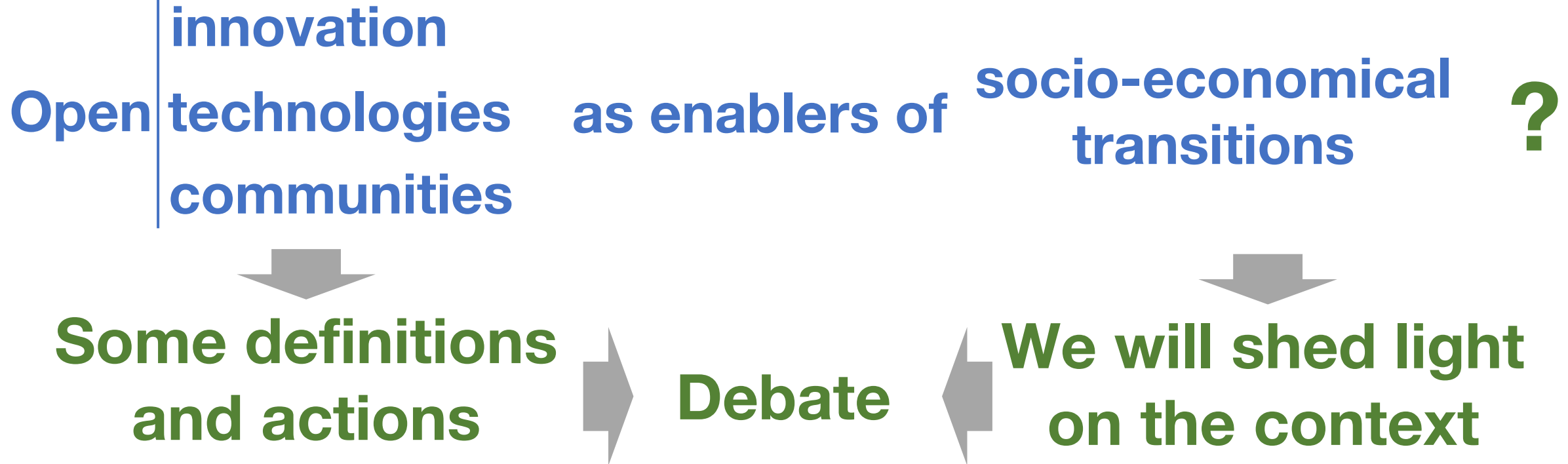

2022 **IEEE 28th ICE/ITMC & 31st IAMOT JOINT CONFERENCE**

Technology, Engineering and Innovation Management Communities
as Enablers for Social Ecological Transitions



EU projects Round table – International Panel



Laurent Dupont
(France)



Benjamin Poussard
(France)



Waldo Soto
(Chile)



Mehera Hassan
(Germany)



Manuel Sánchez
(Spain)



Marianne Hörlesberger
(Austria)



Chandana Ratnayake
(Norway)



Robert Mies
(Germany)



Mauricio Camargo
(France & Colombie)



2022 **IEEE 28th ICE/ITMC & 31st IAMOT JOINT CONFERENCE**

**Technology, Engineering and Innovation Management Communities
as Enablers for Social Ecological Transitions**



EU projects Round table

Open innovation technologies communities as enablers of socio-economical transitions ?



We will shed light on the context



2022 IEEE 28th ICE/ITMC & 31st IAMOT JOINT CONFERENCE

Technology, Engineering and Innovation Management Communities as Enablers for Social Ecological Transitions



EU projects Round table – International Panel



Marianne Hörlesberger joined AIT **Austrian** Institute of Technology GmbH 2001. She studied at the University of Vienna and holds a PhD in Mathematics. She started with methodologies for informetrics, scientometrics, and bibliometrics for identification of emerging technologies and the network of agents behind those topics. Nowadays, she further develops and applies foresight methodologies and approaches for responsible research and innovation in a broader context of innovation systems and has been responsible for such approaches in several EU projects.

Mauricio Camargo (France & Colombie) is full professor on Management of Technology and Innovation at the Ecole Nationale en Génie des Systèmes Industriels of Nancy (The Industrial Engineering School of the University of Lorraine - France), and researcher at the ERPI Laboratory (Research team on Innovative processes). BSc. On Chemical Engineering Universidad Nacional de Colombia.



Mehera Hassan (Germany): Mehera Hassan is a Research Associate and Doctoral Candidate at the Technische Universität Berlin. Passionate about mainstreaming open-source collaborative product creation and the future of production systems. Mehera is an Independent Expert Evaluator for the European Commission and she brings along 7+ years of international experience in the manufacturing industry. She is the co-project manager for OPENNEXT <https://opennext.eu/>.

Climate change!

Limits and challenges of our current societal model

An introduction



2022 **IEEE 28th ICE/ITMC & 31st IAMOT JOINT CONFERENCE**

**Technology, Engineering and Innovation Management Communities
as Enablers for Social Ecological Transitions**



What kind of innovation for ecological transicion ?



ERPI Equipe de Recherche sur les Processus Innovatifs

<http://erpi.univ-lorraine.fr>

Prof. Mauricio CAMARGO

Mauricio.Camargo@univ-Lorraine.fr

Nancy, june 22 2022

Can we continue to live under the same economic model?

Global warming still there

Global warming relative to 1850-1900 (°C)

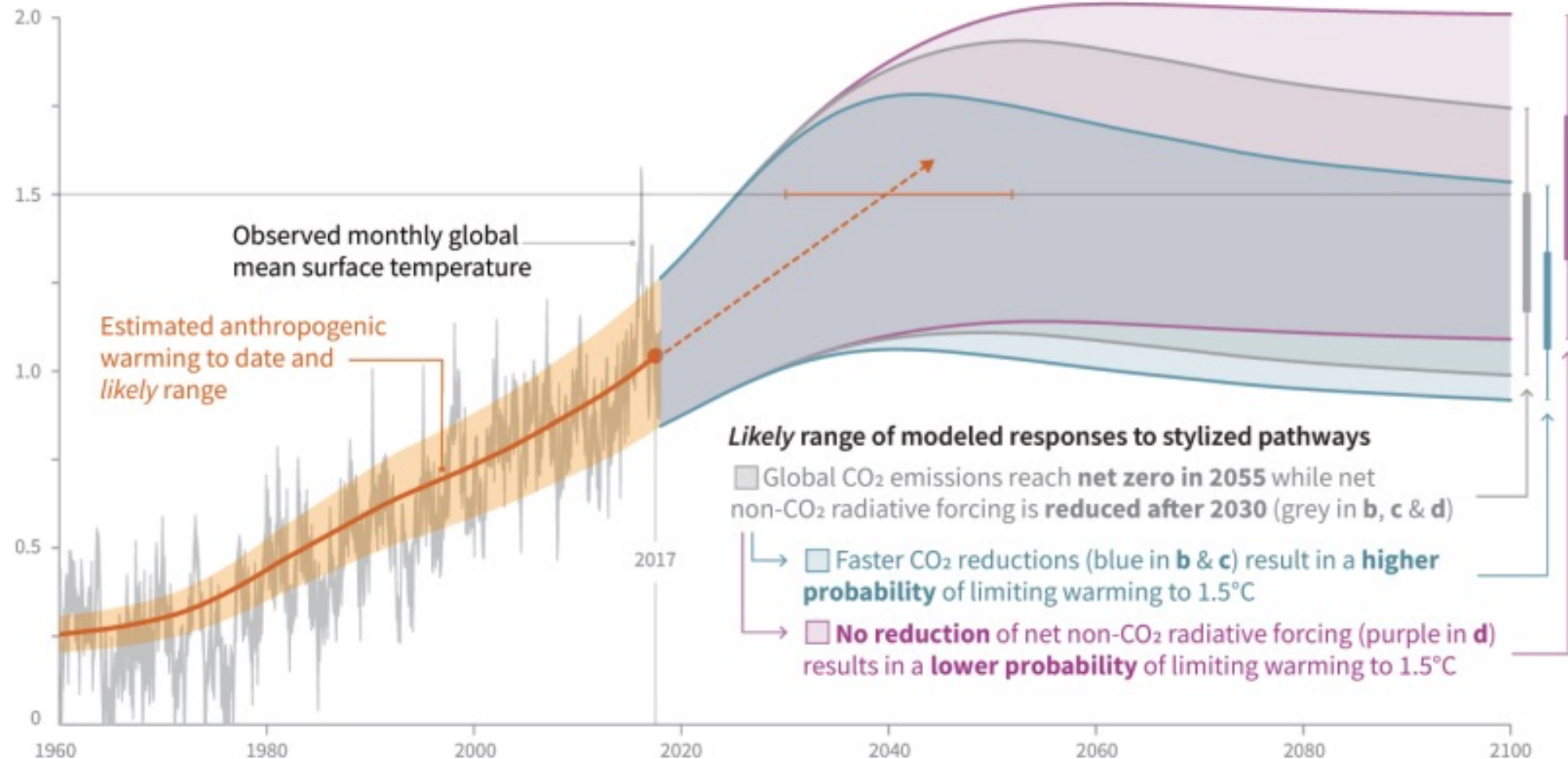

Augmentation de la température mondiale

b) Stylized net global CO₂ emission pathways

Billion tonnes CO₂ per year (GtCO₂/yr)

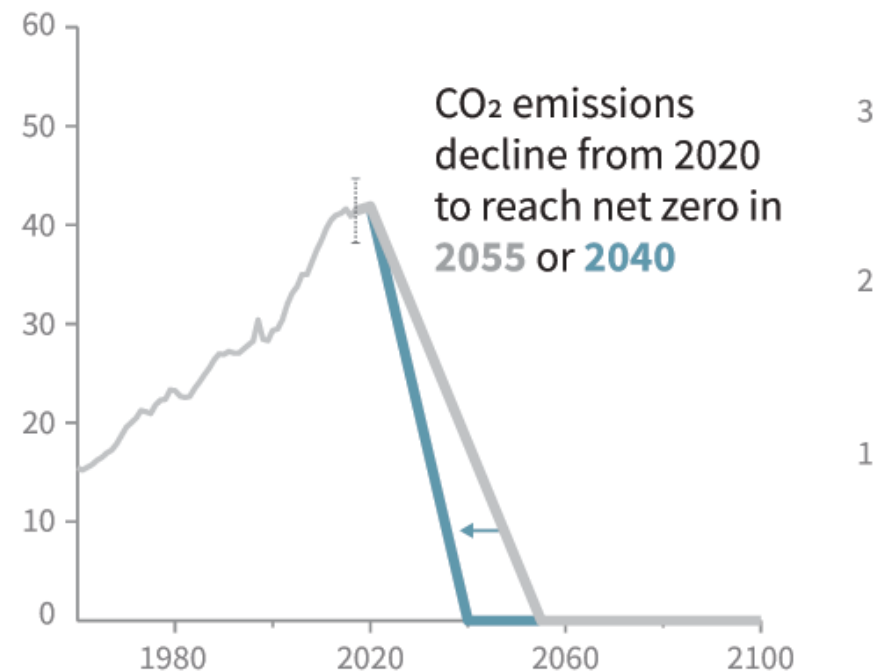

Faster immediate CO₂ emission reductions limit cumulative CO₂ emissions shown in panel (c).

c) Cumulative net CO₂ emissions

Billion tonnes CO₂ (GtCO₂)

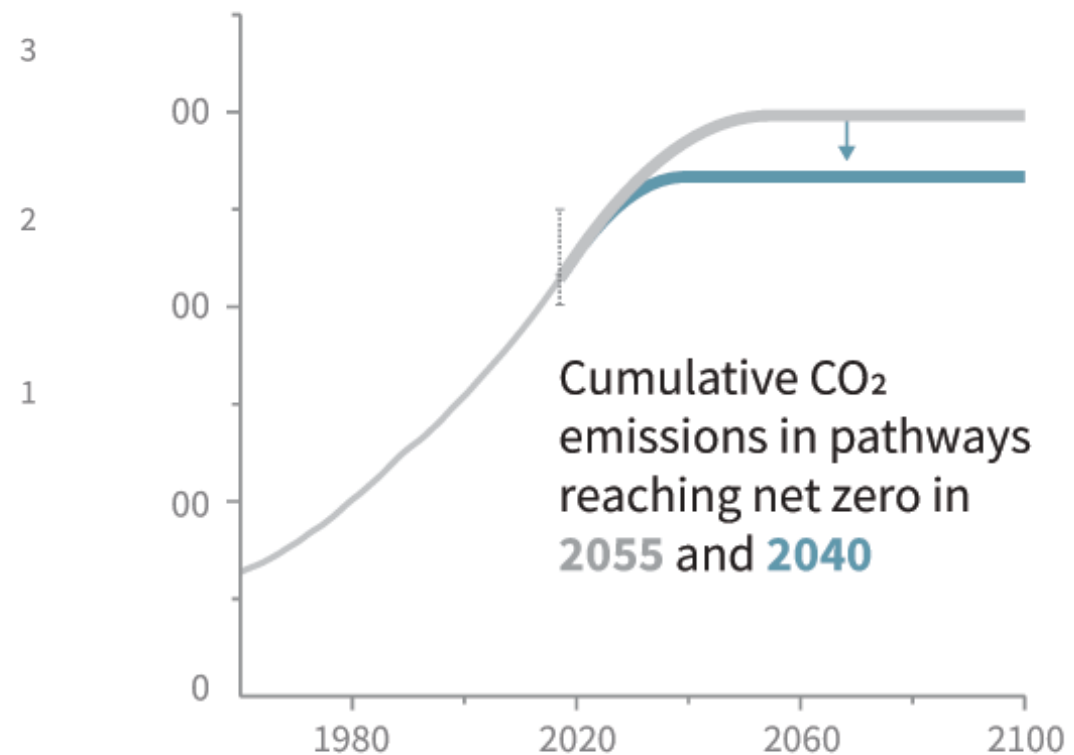

Primary energy consumed by type of source

World consumption Exajoules

BP World Energy Statistical Report 2020

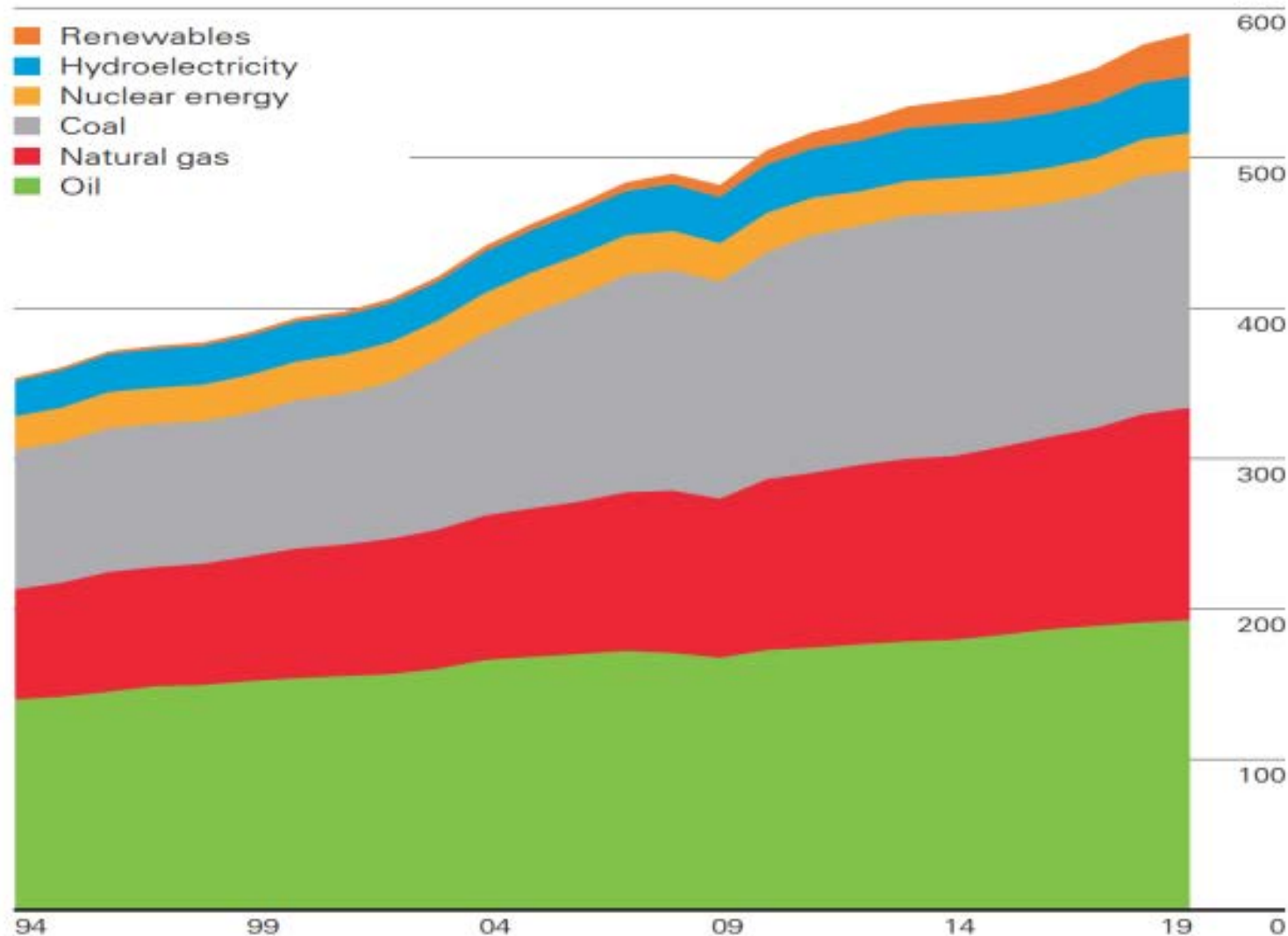

Energy consumption is increasing at a slower rate. But it is not decreasing.

Hydrocarbons continue to account for over 80% of consumption

Despite growth, renewable energy is still in the minority (5%)

The Doughnut of social and planetary boundaries

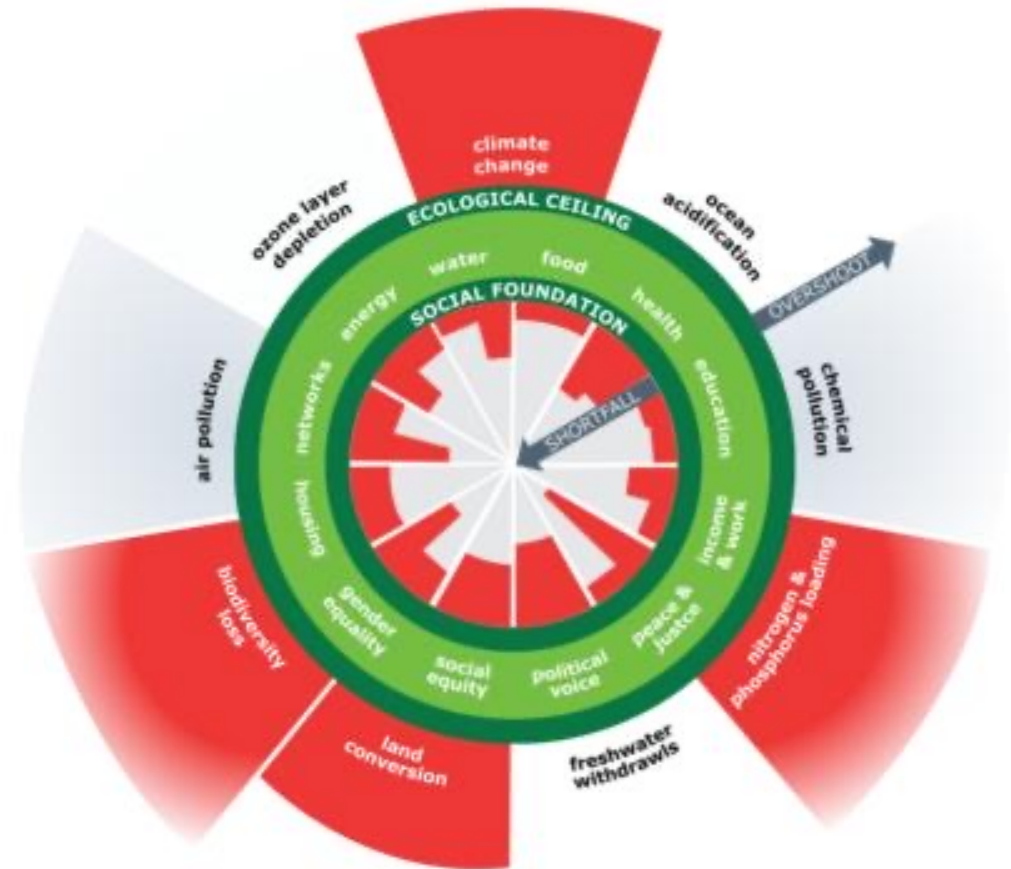

<https://www.kateraworth.com/doughnut/>

Urgent need for a new model !!

Our role from the university

At our level, how can we act?

Enhancing our exchanges (with, for) society

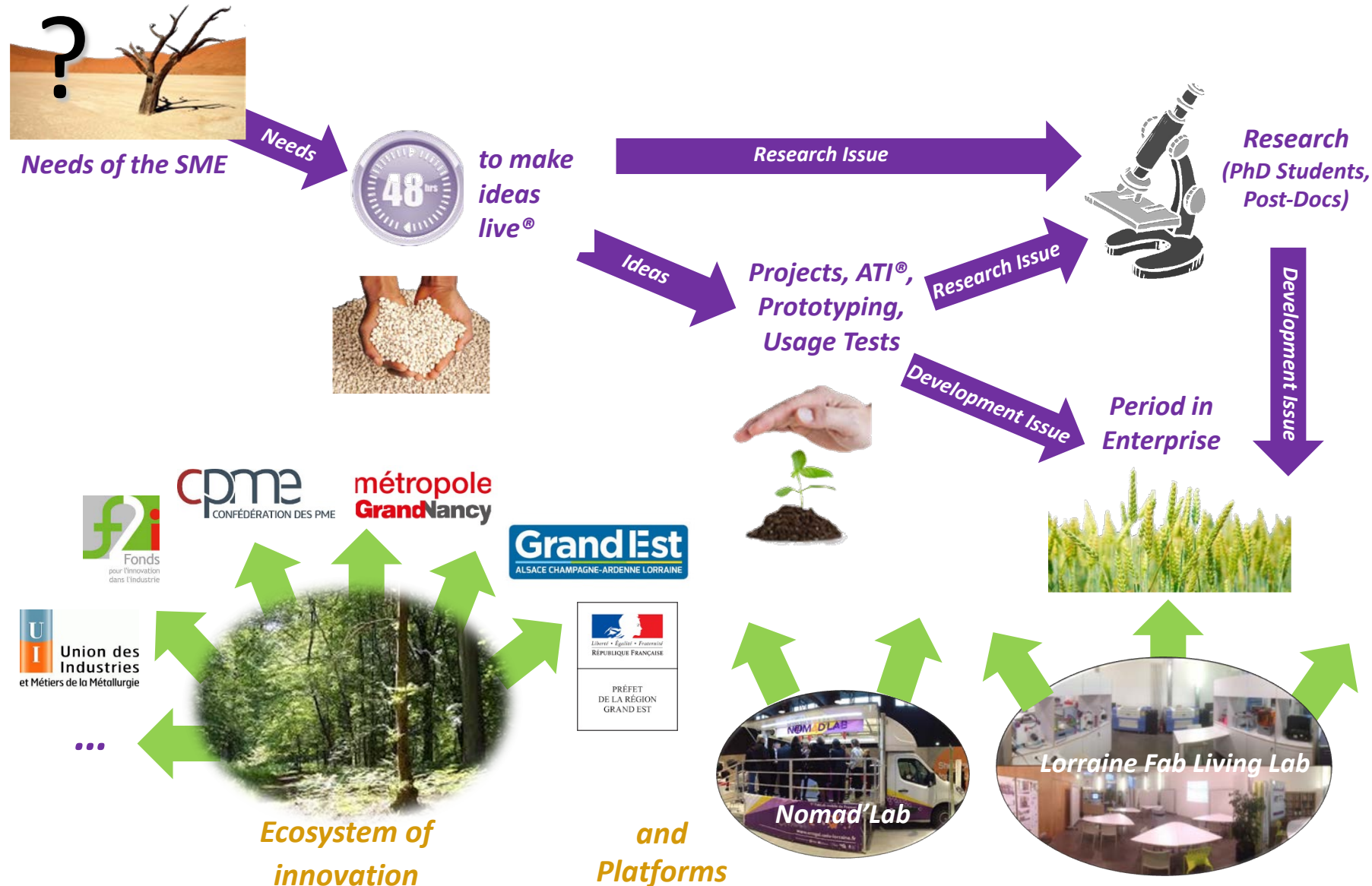

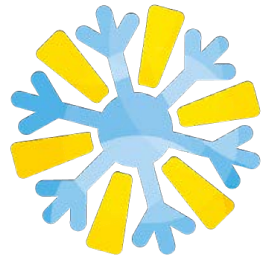

Climate
Labs

Climate Labs: Building capacity through co-creation of climate change labs



Climate
Labs



Co-funded by the
Erasmus+ Programme
of the European Union

New trends in the EU context and the Society: What responsibility of Science and Innovation in societal transitions? Introduction to RRI by DigiTeRRI



2022 **IEEE 28th ICE/ITMC & 31st IAMOT JOINT CONFERENCE**

**Technology, Engineering and Innovation Management Communities
as Enablers for Social Ecological Transitions**





Marianne Hörlesberger, AIT Austrian Institute of Technology
ICE-IAMOT 2022, Nancy

DigiTeRRI – Responsible Research and Innovation Approach for Transitioning the Traditional Industry Regions into Digitalised Industry Territories

Identity: H2020 SwafS project (CSA), 12 partners, 5 European countries

Life-time: Jan. 2020 – Dec. 2022

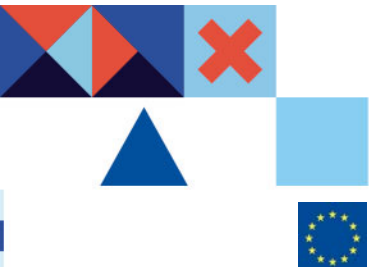
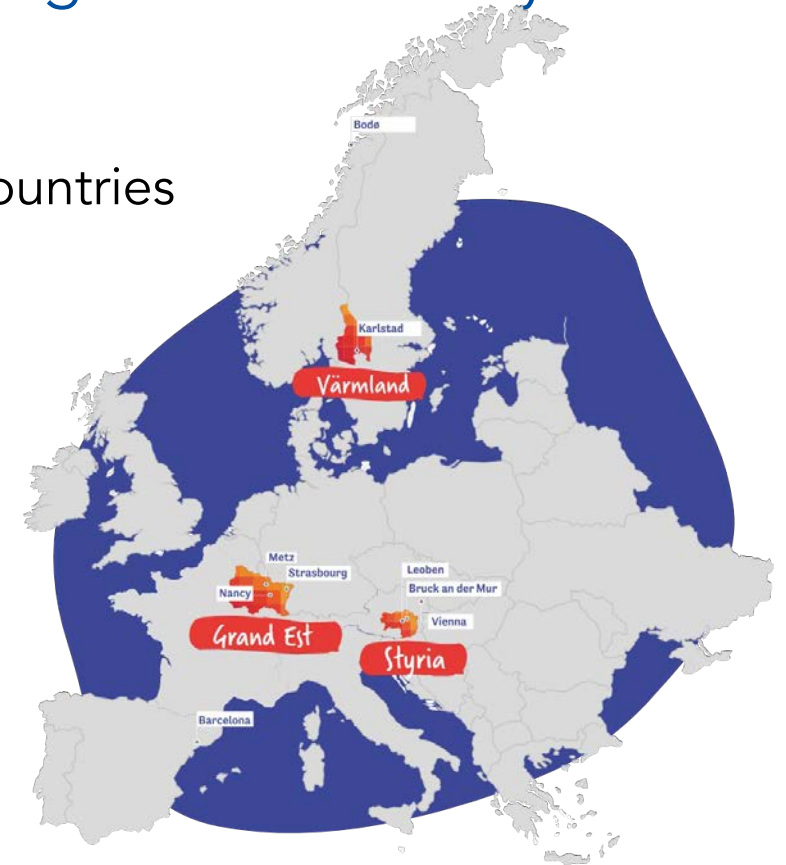

ICE-IAMOT 2022, Nancy, 2022, June 22

This project has received funding from the European Union's Horizon 2020 research and innovation programme under grant agreement n° 873010

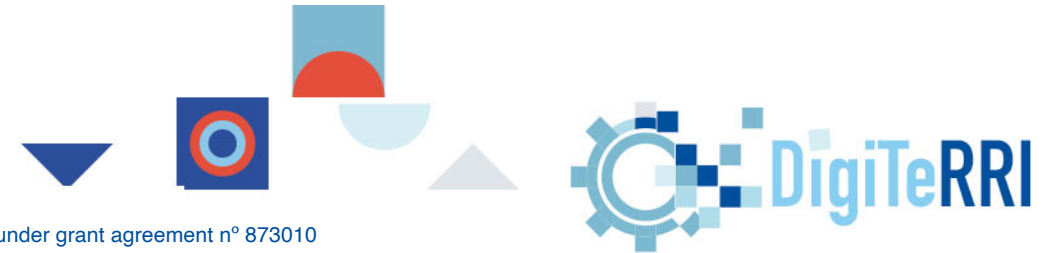

Objective

- DigiTeRRI elaborates a **framework and develops a roadmap**
- for a transition of traditional industry regions into digitalized industrial innovation ecosystems
- by using **Responsible Research and Innovation (RRI) approach.**

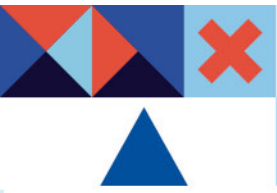

ICE-IAMOT 2022, Nancy, 2022, June 22



This project has received funding from the European Union's Horizon 2020 research and innovation programme under grant agreement n° 873010

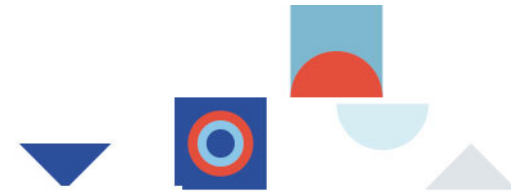

Responsible Research and Innovation (RRI)

Responsible Research and Innovation (RRI) approach

- would like to **bridge the gap between the scientific community and society at large** and
- **tackle the grand societal challenges**
- foresees that researchers and innovators actively design and align their work with **responsibility for society and environment**.

RRI approach anticipates and assesses potential implications and societal expectations.

- *Under H2020 EU Programme the RRI approach was implemented in so called SwafS projects (Science with and for Society).*
- *In Horizon Europe (current programme) RRI requirements are integrated into technology development calls such as ICT, AI, Nano, etc.*
- Owen, R., Stilgoe, J., Macnaghten, P., Gorman, M., Fisher, E., & Guston, D. (2012). A Framework for Responsible Innovation. In Responsible Innovation (pp. 27–50). John Wiley & Sons, Ltd. <https://doi.org/10.1002/9781118551424.ch2>.
- Renè von Schomberg. (2020). Raising the Sail of Innovation. Philosophical Explorations on Responsible Innovation. <https://renevonschomberg.wordpress.com/2022/01/13/raising-the-sail-of-innovation-philosophical-explorations-on-responsible-innovation/>
- Linden Farrer - RRI Policy officer in EC



MH



ICE-IAMOT 2022, Nancy, 2022, June 22



This project has received funding from the European Union's Horizon 2020 research and innovation programme under grant agreement n° 873010



The DigiTeRRI RRI Approach

Stakeholders of the innovation ecosystem in each region develop **TOGETHER** their future!

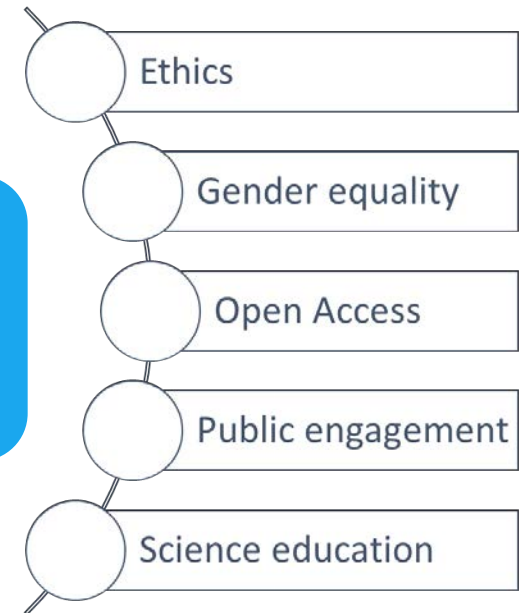
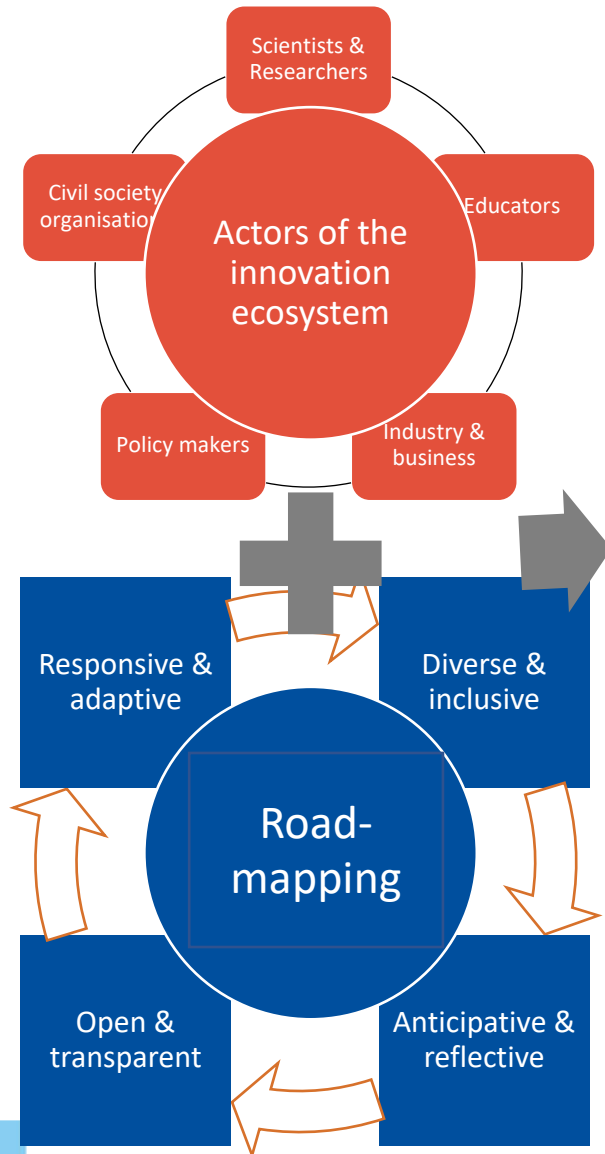

ICE-IAMOT 2022, Nancy, 2022, June 22



This project has received funding from the European Union's Horizon 2020 research and innovation programme under grant agreement n° 873010



DigiTeRRI Process

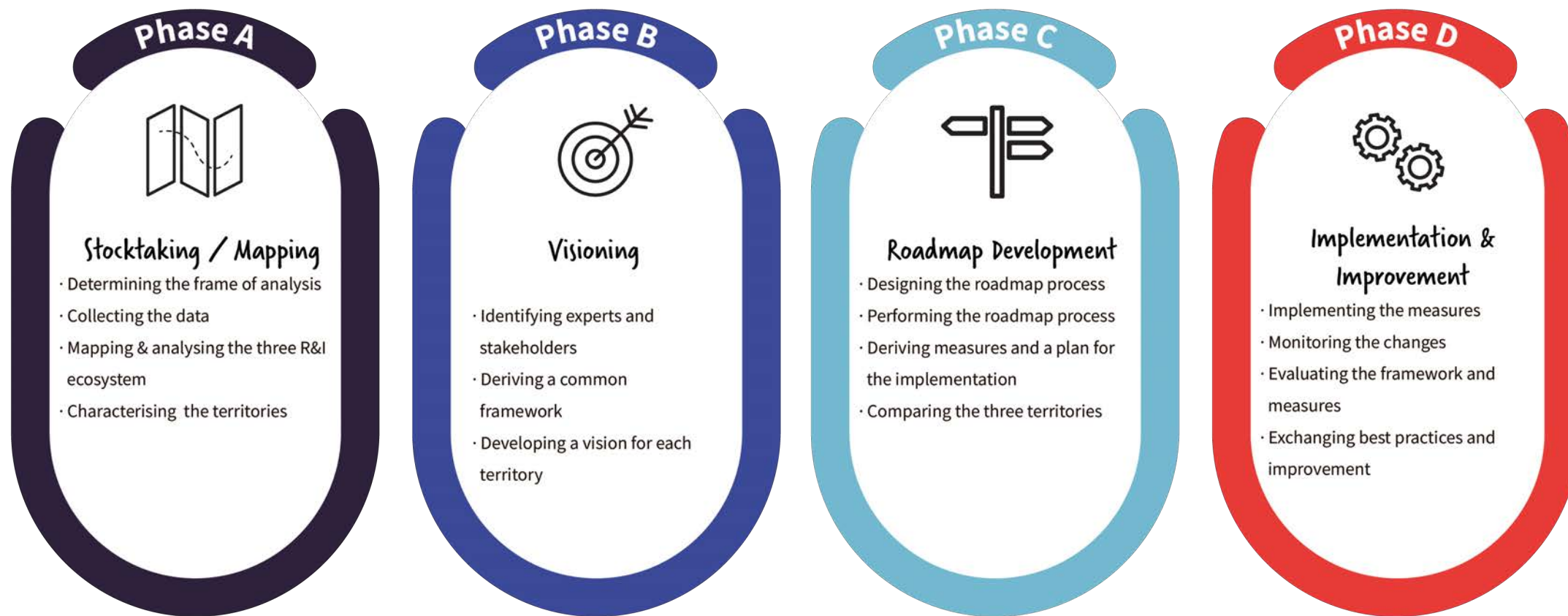

Road-mapping procedure

ICE-IAMOT 2022, Nancy, 2022, June 22

This project has received funding from the European Union's Horizon 2020 research and innovation programme under grant agreement n° 873010



The DigiTeRRI roadmap domains and addressed actors / stakeholders

- 7 fields of actions,
 - developed based on Bumann & Peter*, however, translated to regions+
- 4H actors of the innovation ecosystem

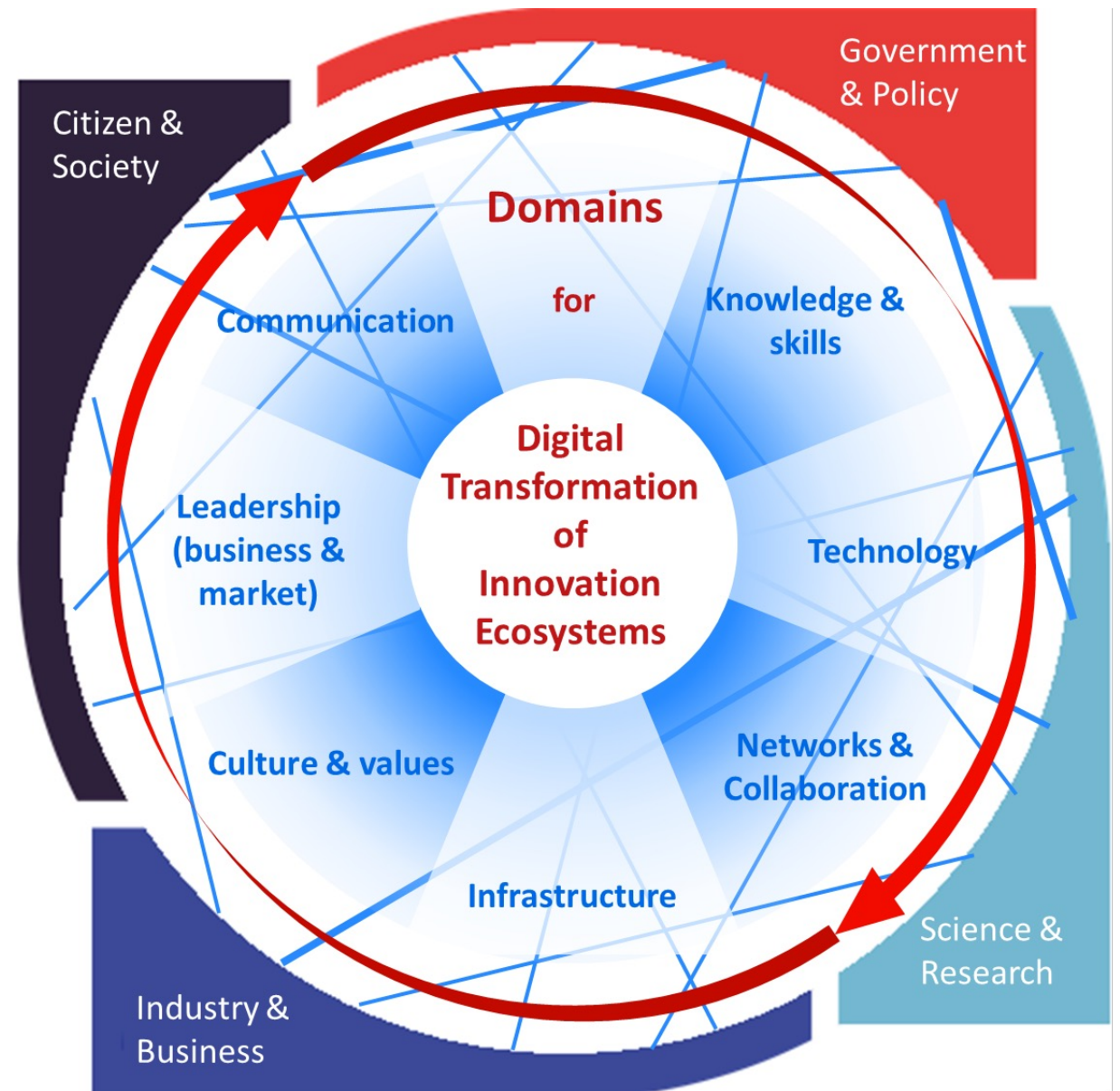

*) Bumann, Jimmy; Peter, Marc. (2019). Action Fields of Digital Transformation - A Review and Comparative Analysis of Digital Transformation Maturity Models and Frameworks.

ICE-IAMOT 2022, Nancy, 2022, June 22

This project has received funding from the European Union's Horizon 2020 research and innovation programme under grant agreement n° 873010



Mapping & Stocktaking

Attainment of RRI

Achievement of maturity (Example: Styria)

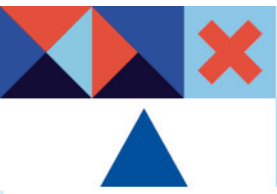
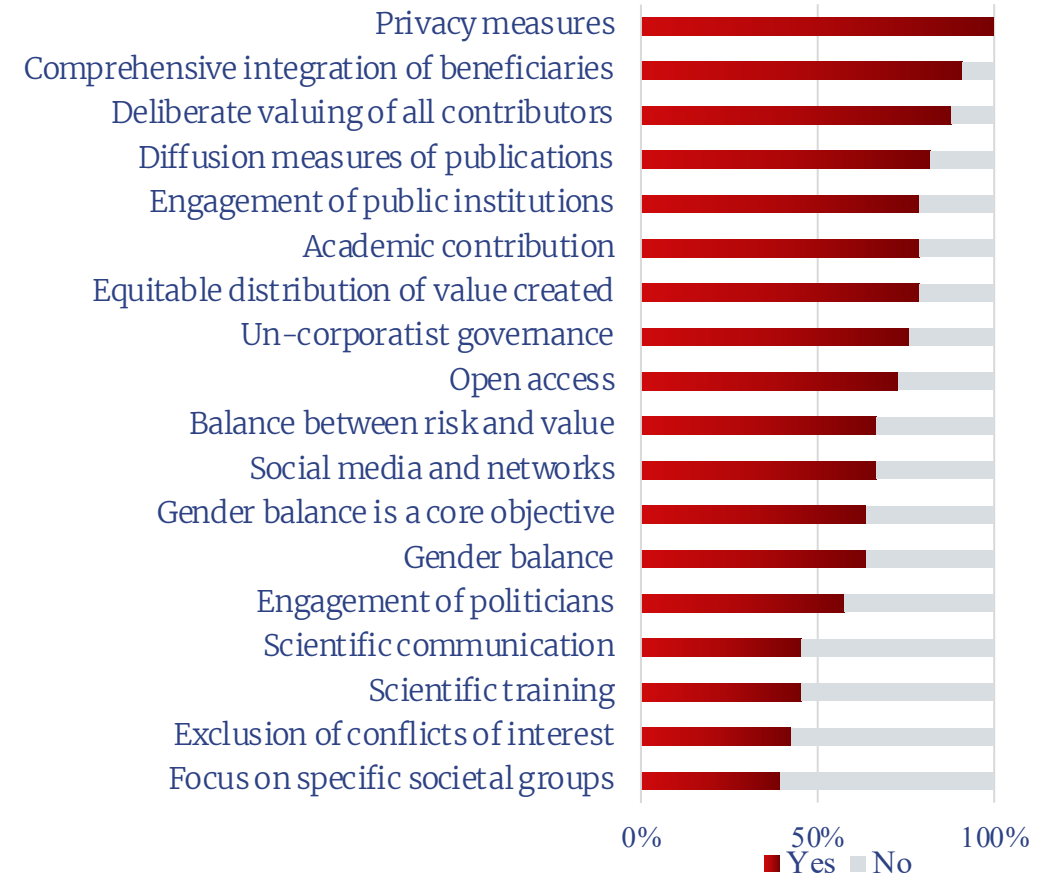
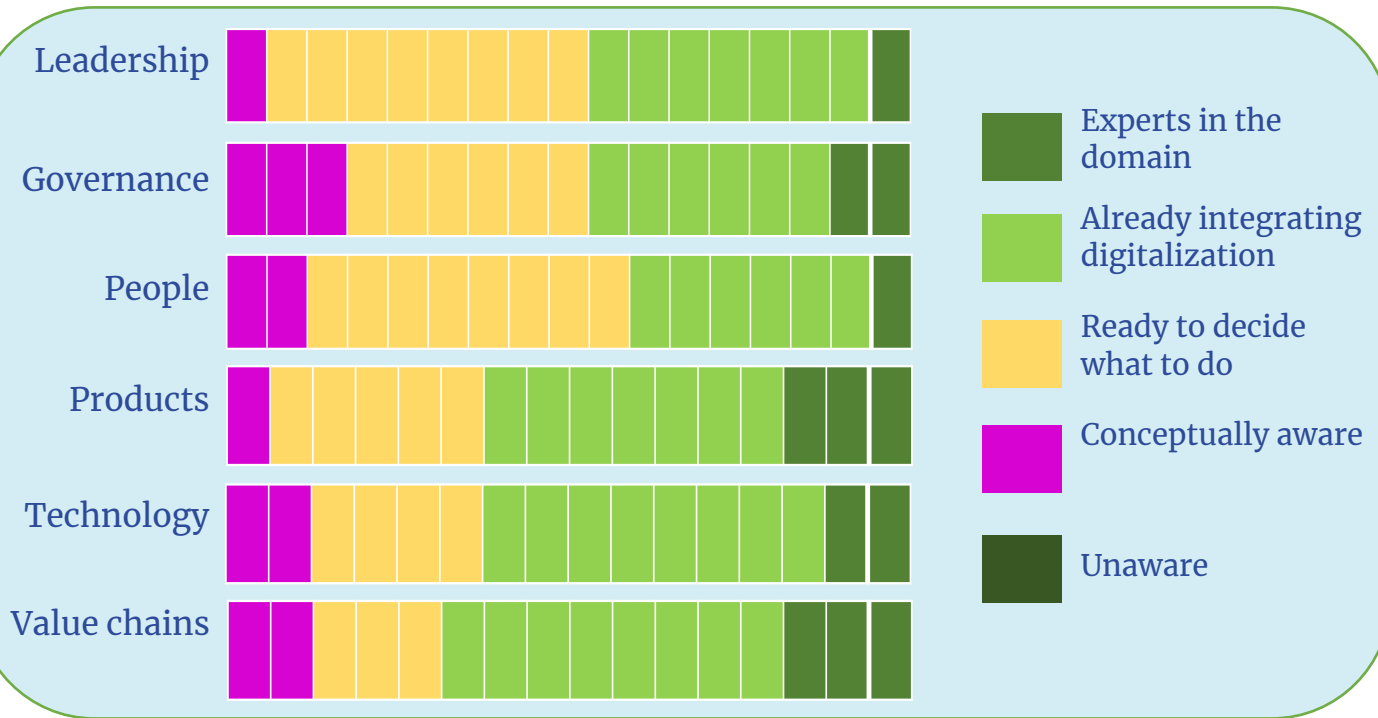

ICE-IAMOT 2022, Nancy, 2022, June 22



This project has received funding from the European Union's Horizon 2020 research and innovation programme under grant agreement n° 873010

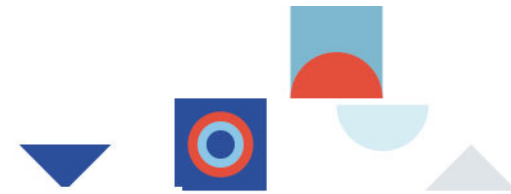

A large, abstract graphic on the left side of the slide, composed of various geometric shapes like squares, circles, and triangles in shades of blue, white, and red. Some shapes contain patterns like crosses or checkers. A blue arrow points to the right from the top of this graphic.

Visioning



Vision Statements



A vertical decorative bar on the left side of the slide, composed of various geometric shapes and patterns in shades of blue, red, and white, including squares, circles, and abstract patterns.A blue arrow pointing to the right, located in the upper right quadrant of the slide.

Roadmap development itself
Goals, objectives, gaps, actions

5 goals for Grand Est

Enable all talents in the Grand Est to seize opportunities provided by the digital sector

Digital technology allows a great number of people to make use of it, regardless of their level of education, socio-professional category, gender, or nationality. The actions to be carried out will vastly help people to be aware that they can consider digital technology as an accessible tool for professional and personal development.

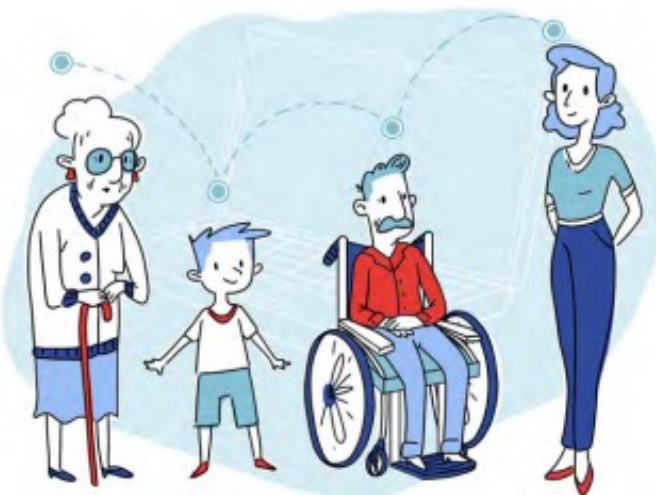

Developing new forms of collaboration

We believe that digital technology cannot be seen solely in terms of technology. This vision may result in a form of compartmentalisation between professions, uses and generations. Our ambition is to overcome "silos" to facilitate meetings and create links between different communities to create added value.



Increasing social responsibility as part of a digital transformation process

Assist public decision-makers and project support organisations in taking RRI into account in the strategic decision-making phases.



Creating the conditions for the development of 'responsible' digital services and products

It has become a necessity to make sense of science and innovation to ensure a more sustainable and responsible world for society. The stakeholders involved in the development of new digital services are at the forefront of efforts this process. Our objective is to provide this audience with adequate tools and methods.



Giving as many people as possible the opportunity to discover digital technologies

New digital technologies can seem unclear and distant for some people, leading to fears and misconceptions. We intend to transform these fears into hopes to allow vocations, ambitions, and new projects to emerge. A willingness to open the innovation ecosystem to the public.

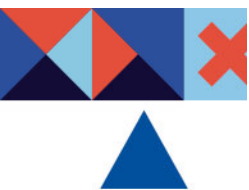
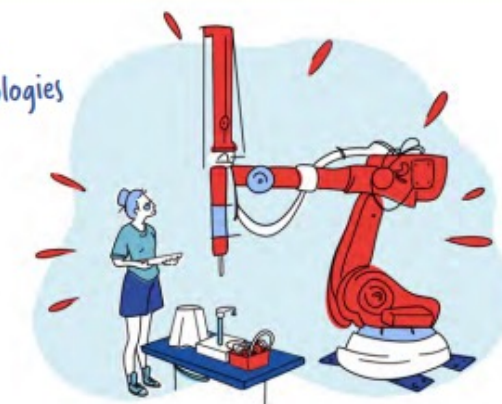

Objectives

– 21 in Värmland, 5 for Grand Est, and 12 for Styria

Objective 1	
Title of objective	Excellent competences for digital processes, platforms and tools to connect the population
Description of objective	The whole innovation ecosystem and all citizens there are confronted with digitalisation of the everyday life, with job requirements for digital processes, with digital processes in education, in science. Therefore, the overall level of knowledge and skill has to be increased and offered in a barrierfree platform
Gaps	The development of technologies for digitalisation is very fast. For coming along with this trend skills and knowledge acquirement is necessary continuously.
Addressed roadmap domains	Knowledge & skills, network & collaboration, infrastructure, culture and values, communication
Stakeholders affected	Science & research, education, industry & business, public administration, civil society.
Necessary activities	<ul style="list-style-type: none"> • Interaction and cooperation, joint education programmes will bridge the primery, secondary, tertiary, and academic segments, but also offer new trainings for lifelong learning. • Digi@school: developing a comprehensive programme for digital skills for pubils, for all groups in the society.
Timeline	Mid term, continuous action.
Initiated by whom	Montanuniversitaet Leoben, Industry & Business with Centre for Applied Technology



12 actions in each territory - each described as in the example here

Action No 1: Apply the competence wheel (compare methodology)

October 2021

Digitally - (Teams/Zoom)

A well proven methodology called Competence Wheel will be used to identify the competence gap as well as the future needs from the industry and the possibilities that are coming with new technology.

<https://www.compare.se/uploads/2020/02/Kompetenshjulet.pdf>

Who is responsible for that the performance of that action (name, organisation, contact mail)	Per Myhrén, Paper Province and Mikael Holmgren, Compare
Name Target group(s) within quadruple helix according to groups in D3.1 the action will address	Industry and business
If stakeholders are involved give the name and type of their organisation	No
Action belongs to which objects/goal in the territorial roadmap	Knowledge and Skills / high level data management courses
Name the group of measure to which the action contributes	Competence mapping, gaps identification, future needs
Timeline for action preparation (when should the action be performed beginning of preparation)	Preparation Q3 2021 and performed during October 1st – 31st.
Describe the impact of action – which gap will be closed according to the territorial roadmap	Low data management capabilities and capacities on high level data science management currently.
Does that action support other goals?	No
Does that action support the realisation of other measures?	Investigate companies' needs for data science. Investigate companies' and public sector's needs for open data
Which RRI dimension/key/process are addressed?	Anticipative initiative, Science Education
Is that a cross territorial action?	No
Is it a single action or multiple actions	Single



ICE-IAMOT 2022, Nancy, 2022, June 22



This project has received funding from the European Union's Horizon 2020 research and innovation |

Implementation & Evaluation

ongoing
9 action in each territory already
implemented

DigiTeRRI final conference



20th and 21st of October 2022
In Vienna!

Subscribe to our newsletter to receive the latest information about the event.

Subscription page is coming soon!

Subscribe here:
<https://digiterri.eu/>

ICE-IAMOT 2022, Nancy, 2022, June 22

This project has received funding from the European Union's Horizon 2020 research and innovation programme under grant agreement n° 873010



Marianne Hörlesberger, AIT

marianne.hoerlesberger@ait.ac.at

Transforming European industry with DIY and open manufacturing facilities – Factories of the Future?



2022 **IEEE 28th ICE/ITMC & 31st IAMOT JOINT CONFERENCE**

**Technology, Engineering and Innovation Management Communities
as Enablers for Social Ecological Transitions**



<https://ec.europa.eu/info/funding-tenders/opportunities/portal/screen/opportunities/topic-details/dt-fof-05-2019>

The transfer to industrial companies of the Do It Yourself (DIY), fablabs, micro-factories and makers approaches can pioneer ways towards engineering solutions throughout the whole value chain. These innovative methods can lead to new processes, machines and products with new functionalities and shorter time to market.

Industry is not yet widely using such innovative approaches to engage consumers and respond to societal needs, also taking into account the individual preferences of women and men. Collaborative production liaising companies, especially SMEs, with these new approaches can however create Open Innovation networks that can unroll a wide range of entirely new business opportunities for the benefit of consumers.

The purpose of this call is to transform European industry through the integration of digitisation and other enabling technologies and achieve global industrial leadership. Success will be seen in global industrial leadership, notably in manufacturing, and in opportunities for re-industrialisation.



2022 IEEE 28th ICE/ITMC & 31st IAMOT JOINT CONFERENCE

Technology, Engineering and Innovation Management Communities
as Enablers for Social Ecological Transitions





Transforming European industry
with DIY and open manufacturing
facilities



Horizon 2020 – Factories of the
Future ↴

Mehera Hassan
Technische Universität Berlin
2022 IEEE 28th ICE/ITMC & 31st IAMOT joint conference
Nancy 22/06/2022

22/06/2022

2022 IEEE 28th ICE/ITMC & 31st IAMOT Joint Conference



Creating the European Manufacturing of the Future!



EU – Horizon 2020 – Funding programme ↴



Facts:

- Timeline 2014 – 2020
- 80 billion Euros
- Public Private Partnership (PPP)



Factories of the Future

- 1.15 billion Euros
- up to 43 call topics
- F0F-05-2019 – Open innovation for collaborative production engineering

FoF-05-2019-Open innovation for collaborative production engineering ↴

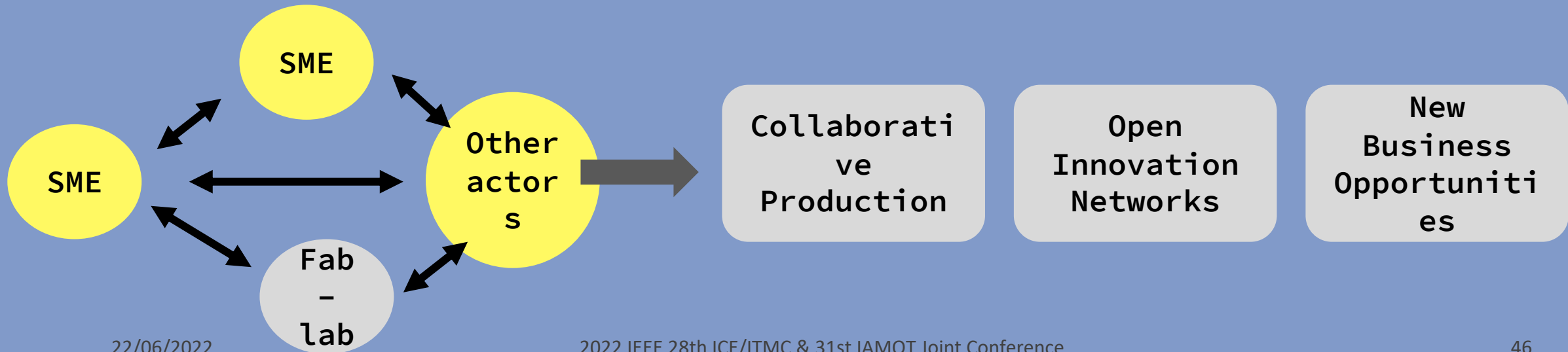

FOF-05-2019:

Scope – Consumer goods with customer-driven production

- 1 Designing and engineering from different actors
- 2 Creative and agile analysis methods
- 3 Ways to share and analyse user data for collaborative engineering in production networks
- 4 Open-source data exchange & definition of standards
- 5 Manufacturing Demonstrators Facilities (MDFs)



FOF-05-2019: Expected Impacts

- 1 Europe-wide open innovation manufacturing networks
- 2 Customer-driven production
- 3 Increased customisation
- 4 Improved co-design & co-development capabilities
- 5 Lower development cost



FOF-05-2019

Four sister Projects!



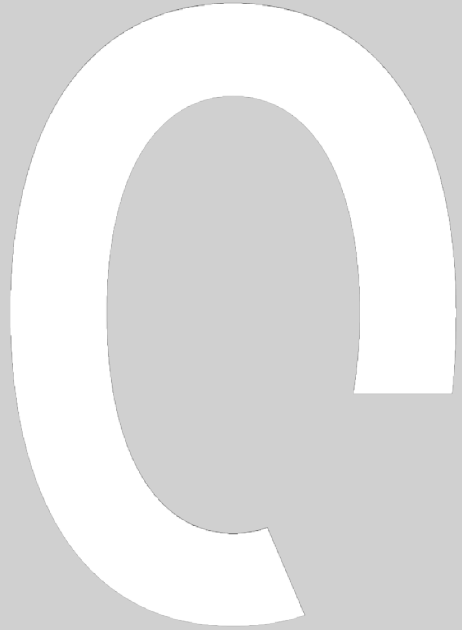

**Thank you
for your attention**

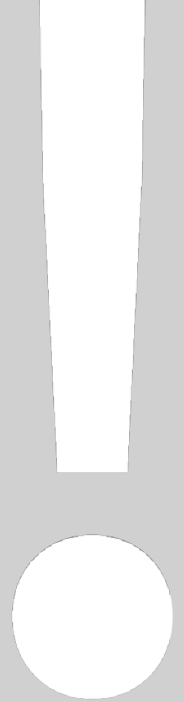

EU projects Round table

innovation
Open technologies communities as enablers of socio-economical transitions ?

Some definitions and actions







2022 IEEE 28th ICE/ITMC & 31st IAMOT JOINT CONFERENCE

Technology, Engineering and Innovation Management Communities
as Enablers for Social Ecological Transitions



EU projects Round table – International Panel

				
Demonstrator(s)	2 MDFs (Fablabs) + Digital platform; 2 rounds of OIPs with 6 SMEs	4 OMDF (Innovation Hub supported by a SME & a Big company; 3D printing with wood ; 3D printing & moulding with recycled plastic ; smartification) + Digital platform for Co-creation (website + Apps + ERP + SDO	6 (5) CMDF + 19 Use cases (co-creation ventures) + several open innovation missions. Digital platform for co-creation	6 pilot + 12 demonstrator SME cases (OS hardware projects with makerspaces providing facilitation support for co-creation); one co-creation and one metadatabase for linked open hardware
Sectors	FMCG	Furniture	Furniture, Mobility, Microelectronic, Medical equipment...	Consumer electronic, eco-friendly mobility, build-to-order furniture
Level of development	From TRL4 to TRL6	From TRL4 to TRL6	From TRL4 to TRL6	From TRL4 to TRL6
European Countries	7	8	8	8
Consortium	1 Large industry, 7 RTOs, 6 SMEs	4 SMEs, 2 RTD centers, 6 High Educ., 2 large companies	7 SMEs, 1 large company, 1 University, 3 RTO, 4 Fablabs, 2 regional entities, 1 cluster	6 SMEs, 4 Makerspaces, 2 ICT providers, 6 research partners

EU projects Round table – International Panel



Robert Mies (Germany) is an industrial engineer by training with a specialisation on mechanical engineering. He works since 2016 as research associate at the Chair of Quality Science at the TU Berlin, doing research on the topic of open design and open source hardware development from an engineering design/industrial engineering perspective, currently in: OPENNEXT as project manager <https://opennext.eu/> and Open.Make as project member <https://openmake.de/>.

Manuel Sánchez (Spain) works in the Research and Development area of AIDIMME (www.aidimme.es), the Metal-processing, wood, furniture and packaging technology institute. He is currently coordinating the iPRODUCE project. His background includes Additive Manufacturing, Computer Aided Design, Clean Technologies and cluster development.

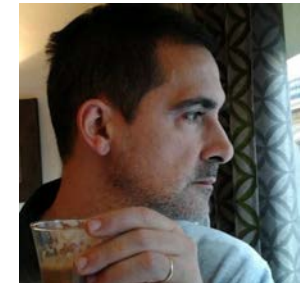

Chandana Ratnayake is a chief Scientist in SINTEF, **Norway** and the main coordinator contact of the DIY4U Project. Got a PhD in Process Technology, specialising in Powder & Particulate Technology (Norwegian University of Science and Technology -NTNU) with a long-term experience and expertise on Powders and Bulk Material Technology- storage, transport, processing, and characterisation of particulate materials. Also works as a Professor II (Adjunct Professor) in the University of South-Eastern Norway (USN).



OPENNEXT

ICE-IAMOT 2022 ↴

The Future is open
and community-based!

Robert Mies

Technische Universität Berlin (TUB), Institute for Machine
Tools and Factory Management, Chair of Quality Science
Nancy, 22 Jun. 2022

22/06/2022

2022 IEEE 28th ICE/ITMC & 31st IAMOT Joint Conference

OPEN!
NEXT

Project details ↴

- Three years (09/2019 – 08/2022)
- 19 partners from seven countries (DE, DK, NL, GB, FR, ES, AT)
- Budget 6.4 M€ / EU contribution 5.9 M€

OPEN! NEXT

Seven research partners



Six facilitation partners



Six small medium enterprises (SMEs)



Concept ↴

OPENNEXT focuses on encouraging and supporting SMEs to: unleash the potential of open source hardware (OSH) through engagement on collaborative open design of products and services together with fab labs /makerspaces

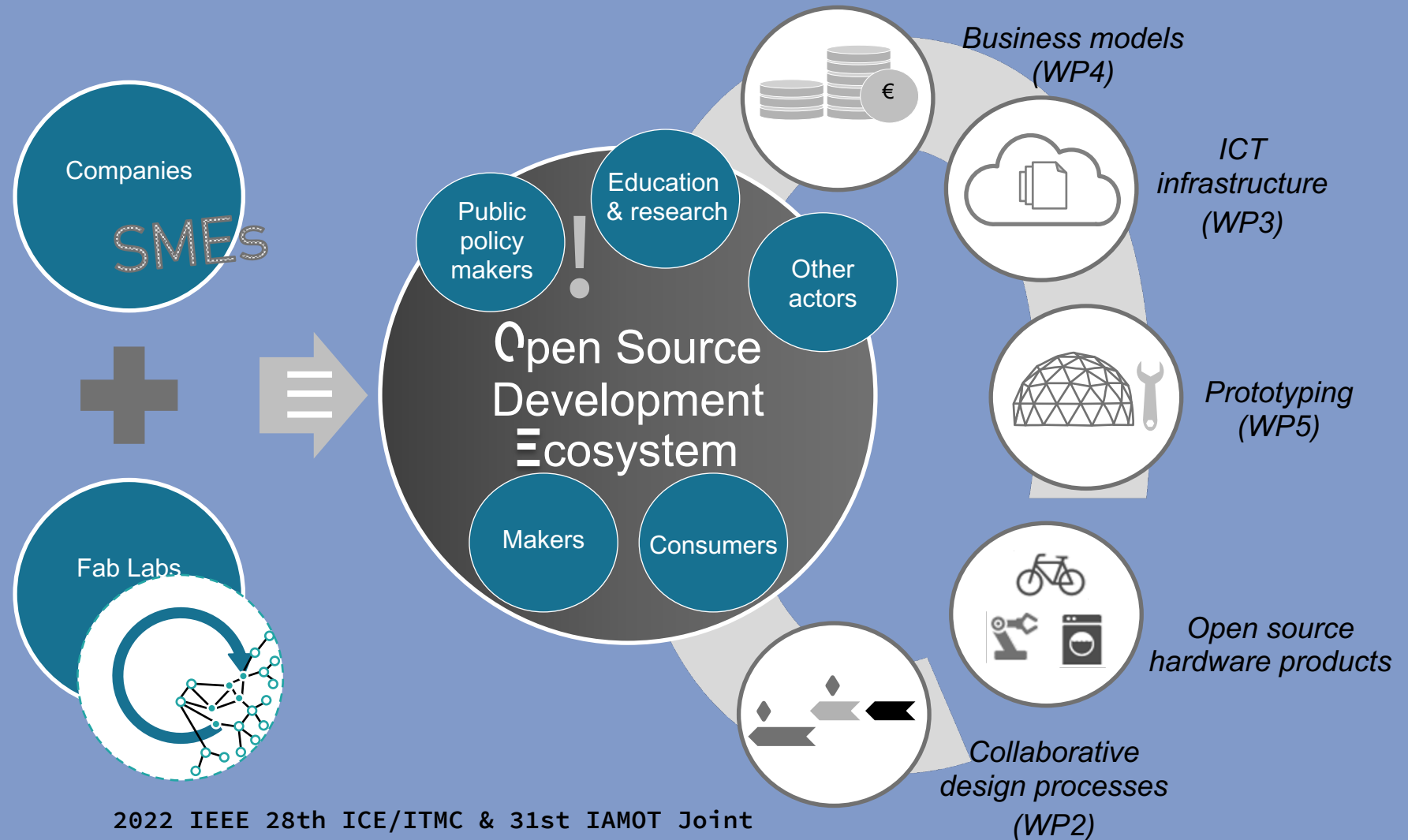

Target Companies ↴

1.

Established
Small Medium
Enterprises

2.

Startups
focused on
Open Source
Hardware

&

/

activist

COMPANIES

- Social entrepreneurship
- The common good economy
- NGOs
- *Make Sense* network
- Many others

Article by Lars Zimmermann - Mifactory
URL: <https://mifactori.de/activist-companies/>

Timeline ↴



- Research and development phase
- Pilot phase
- Demonstrator phase

INDUSTRIES IN FOCUS

- Consumer electronics
- Built-to-order furniture
- Eco-friendly mobility

Sept '19

Sept '20

Jun '21

Jan '22

Jun '22

Nov '22

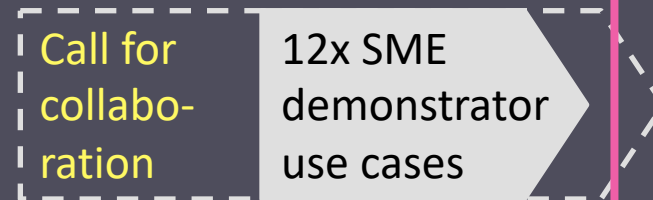
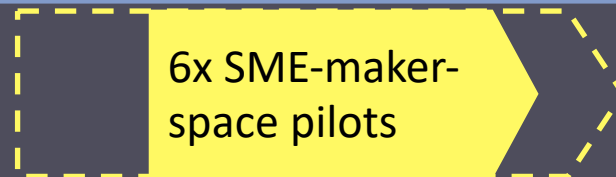

Community partners:

maker

#Copenhagen
22/06/2022

**PROTO
TYPES**

#Berlin

HAPPYLAB

#Vienna





waag
technology & society

#Amsterdam

2022 IEEE 28th ICE/ITMC & 31st IAMOT Joint Conference

We are here

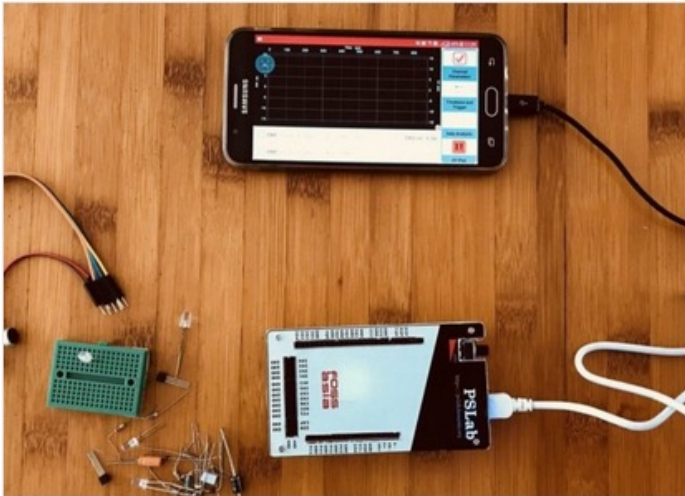
OPENNEXT Projects Hub ↴

		
<p>+stykkaxmaker/lastdesk-opensour... Workstations haven't changed radically for the p...</p>	<p>+opennext/pocket-science-lab The Open Source PSLab board is a small USB po...</p>	<p>@xyz-cargo-add-ons/xyz-cargo-ad... Functional modules that can be added to a cargo...</p>
<p>👁 142 👤 7 📈 6 ➔</p>	<p>👁 125 👤 7 📈 4 ➔</p>	<p>👁 849 👤 69 📈 25 ➔</p>

Join our pilots and partnering demonstrator projects
on <https://projects.opennext.eu>

22/06/2022

2022 IEEE 28th ICE/ITMC & 31st IAMOT Joint Conference



OPEN!
NEXT

Co-creating prototypes ↴



22/06/2022

2022 IEEE 28th ICE/ITMC & 31st IAMOT Joint Conference

Expected Impacts

- Increase SMEs innovation capacity, particularly their capacity to develop user-centric solutions
- Reduction of 15% in SMEs time-to-market and 20% in their development costs
- Building an open-innovation network for matchmaking between SMEs and fab labs in Europe

Identify OSH-based business models

Derive strategic guidance

Facilitation offering by Fab Labs

Enable design reuse

Create seamless ICT tools that advance OSH development

Enhance the collaborative capacity of SMEs and communities for OSH development

Develop a blueprint for an Open Lab Alliance that connects OSD Labs and SMEs

Gather 15% of all fab labs/makerspaces in EEA



Join us IRL in 2022

- Wed., 29 Jun. at TU Berlin from 1 to 5.30 p.m.
 - Public event to showcase OPENNEXT demonstrators and learnings
 - See TU Berlin press release:
<https://www.tu.berlin/en/about/profile/press-releases-news/juni/opennext/>
- Fri., 21 Oct. at Grenoble INP, all day
 - 2nd international workshop on Open Design and Open Source Hardware Development
 - Information to be shared soon under the following link:
<https://opennext.eu/events/>

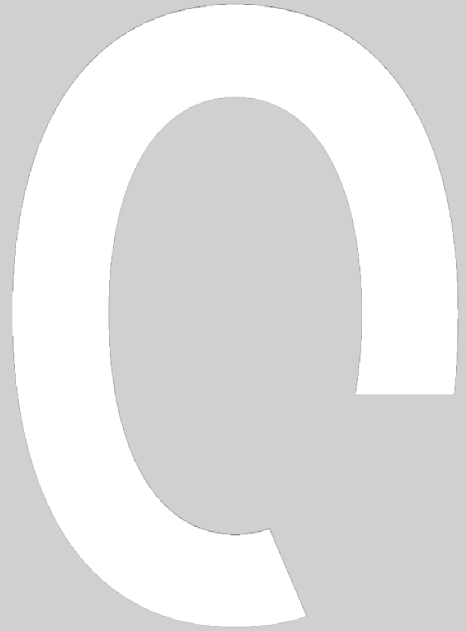

**Thank you
for your attention**

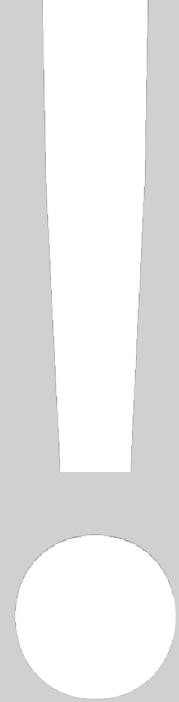

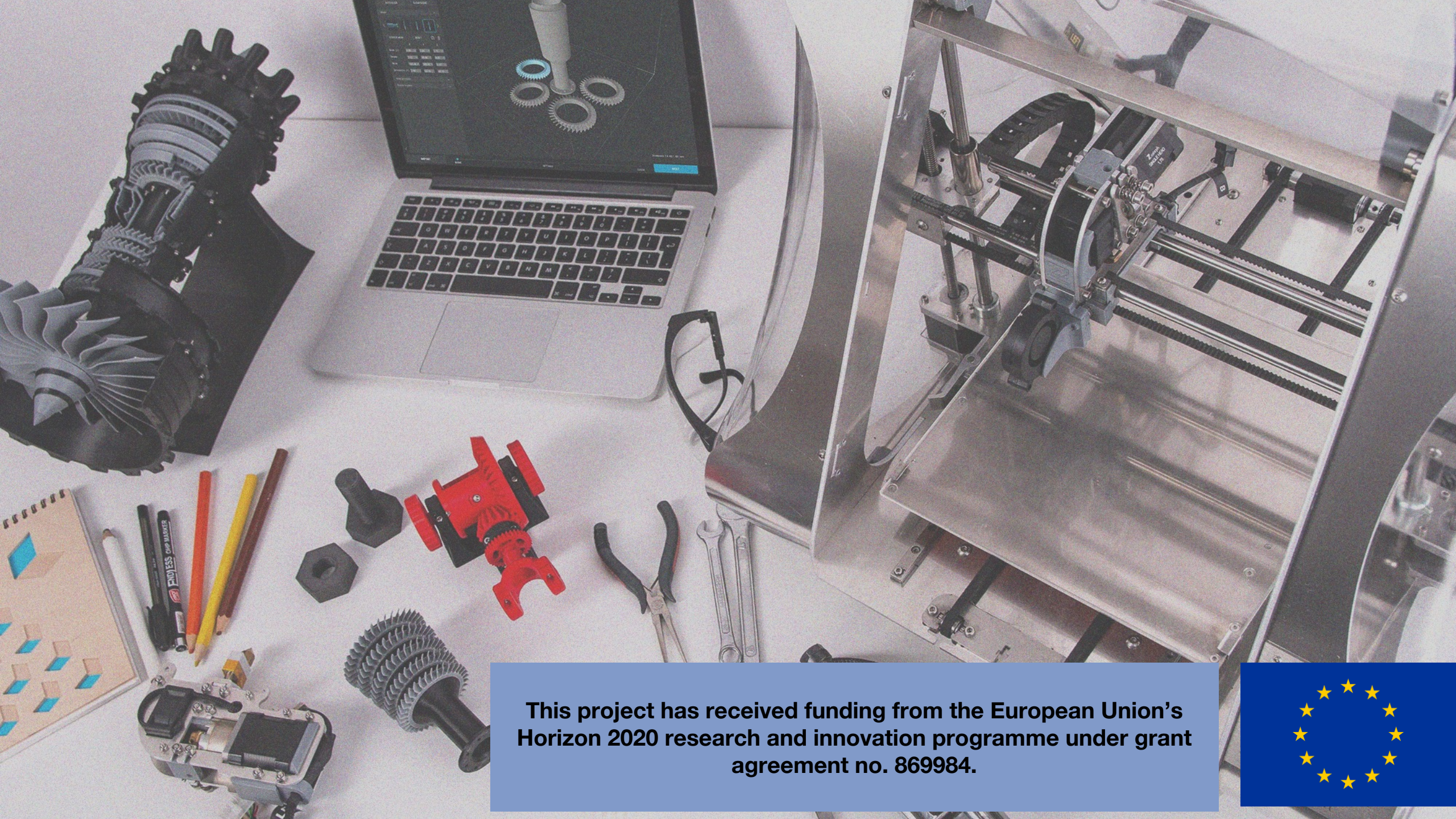

This project has received funding from the European Union's Horizon 2020 research and innovation programme under grant agreement no. 869984.





A Social Manufacturing Framework.

AIDIMME/ Manuel Sánchez

June 2021



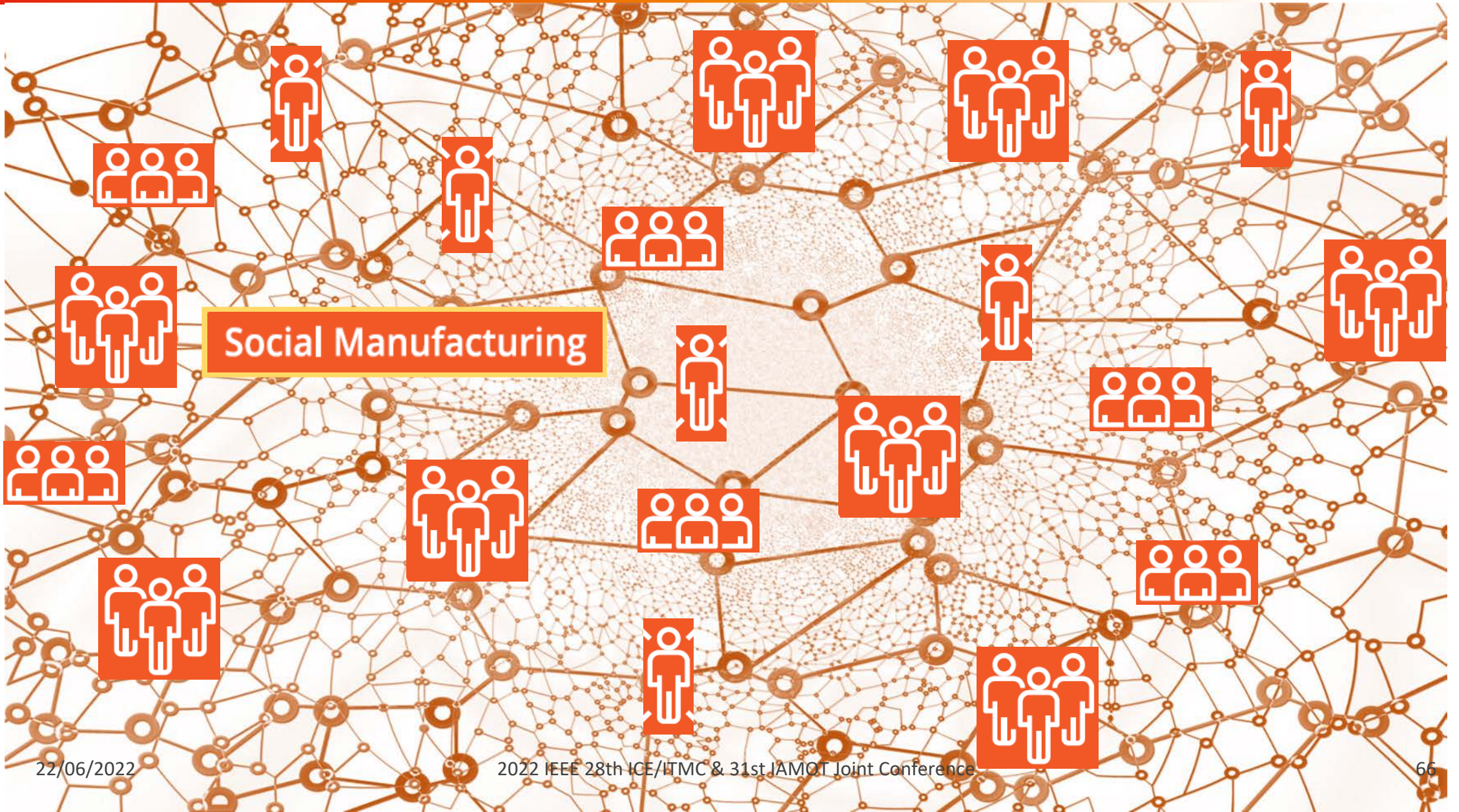



SOCIAL MANUFACTURING FRAMEWORK

iPRODUCE aims to introduce and define a **social manufacturing framework (SMF)** to support **open innovation** and **co-creation activities** for the design, engineering and production of **consumer goods**.



LOCAL & EUROPEAN ENGAGEMENT

The SMF aims to **engage** at the local and European level manufacturing **enterprises** (SMEs and/or mid-caps); **makers** communities (fab labs, makerspaces and start-up communities); and **consumers**.



INCREASED COLLABORATION

The SMF proposes **increased collaboration** between manufacturing companies and makers so that new ideas and perspectives are leveraged to meet **consumers' needs** and existing ideas, designs and prototypes can be better explored for commercialisation and mass production.



COLLABORATIVE MANUFACTURING DEMONSTRATION FACILITIES

The SMF aims to **connect** micro-manufacturing and other existing **facilities** at the local level, organising them into **collaborative Manufacturing Demonstration Facilities (cMDFs)**





cMDFs are local communities (ecosystems)

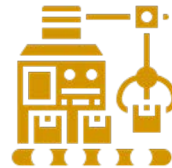

with the base **infrastructure** and facilities



for user engagement, co-creation, prototyping, validation and training



to support collaborative **production**



This slide has been designed using resources from [Flaticon.com](https://www.flaticon.com/)

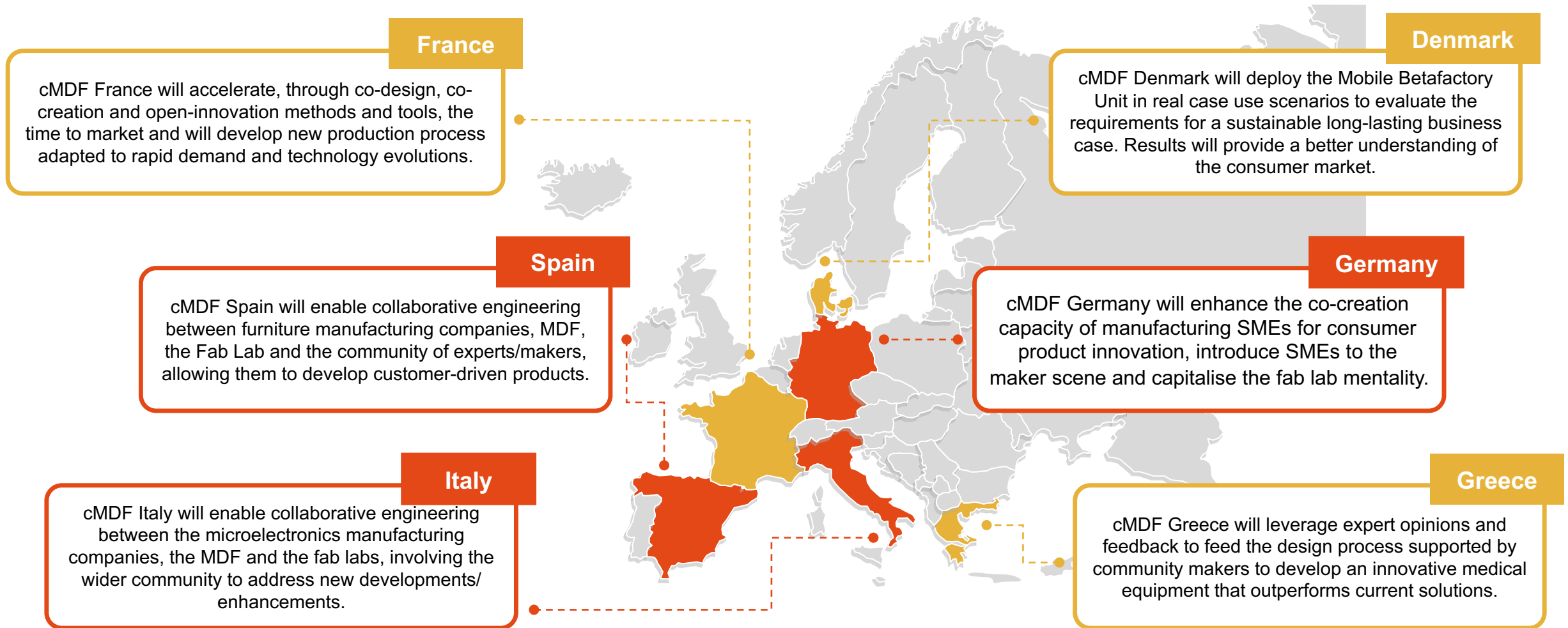

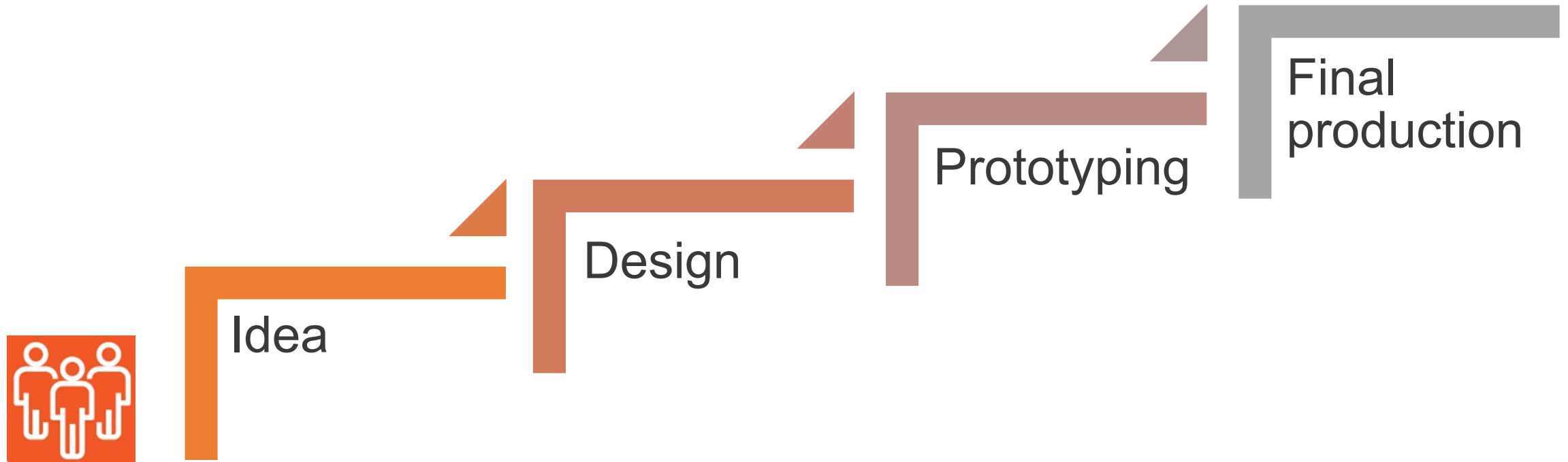



Hopefully, even easier with iPRODUCE

(Which, additionally, expands the local scope of the cMDF)

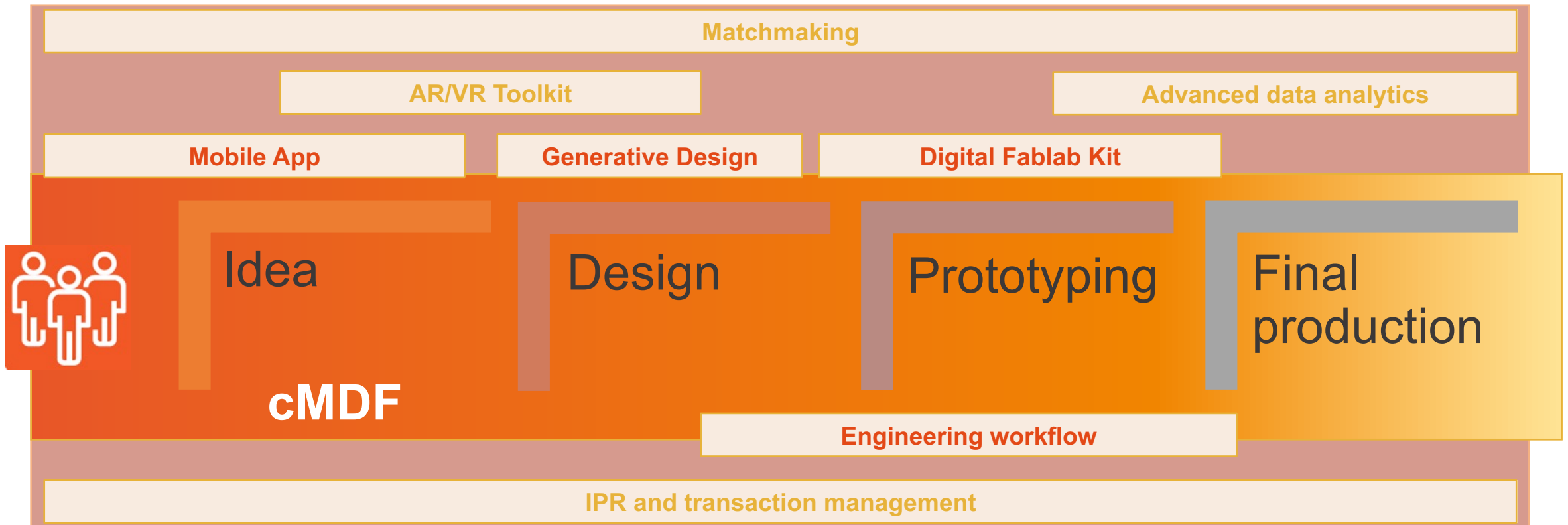

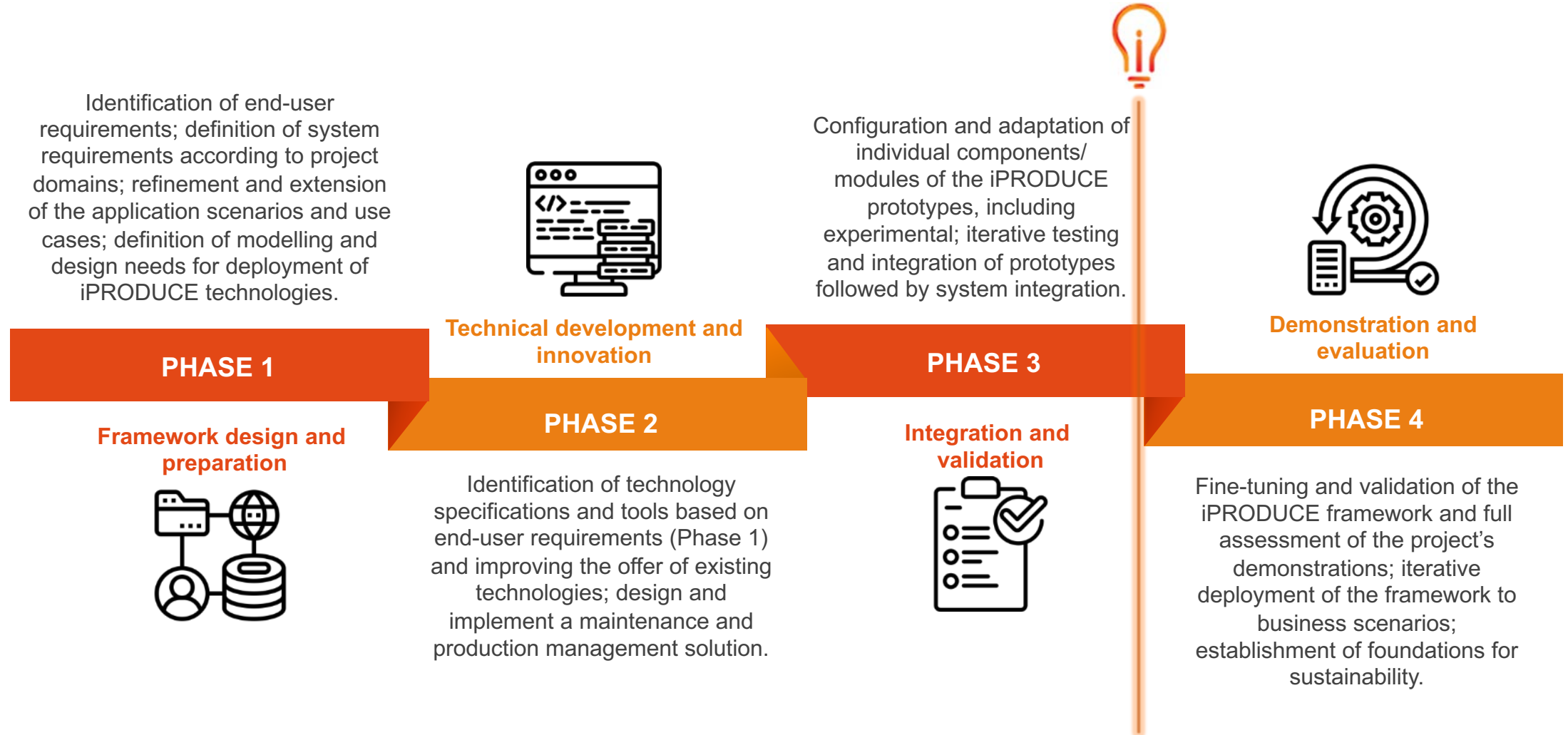

Get in touch :)



<https://iproduce-project.eu/>



https://twitter.com/iPRODUCE_EU



<https://www.linkedin.com/company/iproduce-project>



https://www.youtube.com/channel/UCECO_LmEXaP4ZhiGd-jMHKq

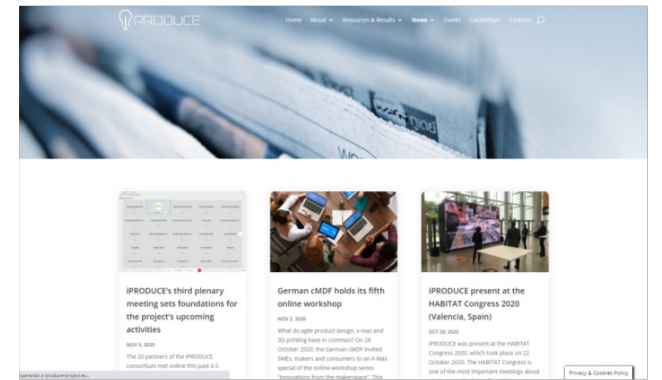
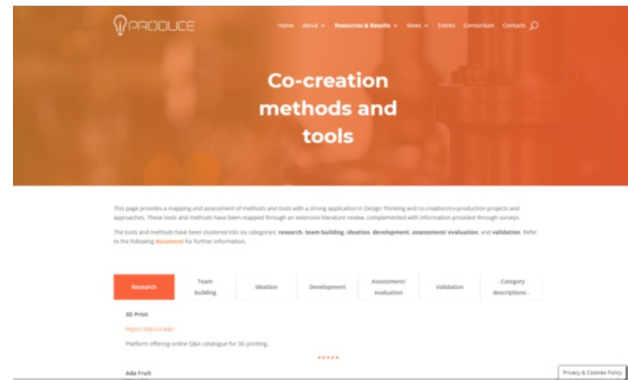



Thank you.

Manuel Sánchez de la Asunción
AIDIMME

msanchez@aidimme.es



Acknowledgements

- [geotatah](#)
- [turkkub](#)
- [Eucalypt](#)
- [Nikita Golubev](#)
- [Becris](#)
- [Smashicons](#)
- [Pause08](#)





Open Innovation Digital Platform & Fablabs for Collaborative Design & Production of Personalised Fast Moving Consumer Goods

– DIY4U



Chandana Ratnayake
SINTEF, Norway- The Coordinator DIY4U

2022 IEEE
28TH ICE/ITMC & 31ST IAMOT
JOINT CONFERENCE



This project has received funding from the European Union's Horizon 2020 innovation programme under grant agreement number: 870148



SINTEF

DIY4U – Design & production of personalised powdered & liquid FMCG (Fast Moving Consumer Goods)



42 Months (11/2019 to 04/2023)



Overall: ~6,8 MEUR



14 Partners (7 Industries, 7 R&D Partners), 8 Countries



<http://www.diy4u.eu>



Factories of the Future
Public Private Partnership



This project has received funding from the European Union's Horizon 2020 innovation programme under grant agreement number: 870148

Partners..

1. SINTEF AS (Norway)
2. Procter & Gamble Company (UK)
3. Centre for Process Innovation Limited (UK)
4. VTT (Finland)
5. Technology Centre of Metal-mechanical & Transport (Spain)
6. IRIS Technology Group (Spain)
7. Digital Catapult Centre (UK)
8. Cap Digital (France)
9. CODY (Norway)
10. RDIUP (France)
11. Stelar Security Technology Law Research UG (Germany)
12. Effective Decisions (Romania)
13. Dynamic & Security Computations (Spain)
14. WIZ Development (Romania)

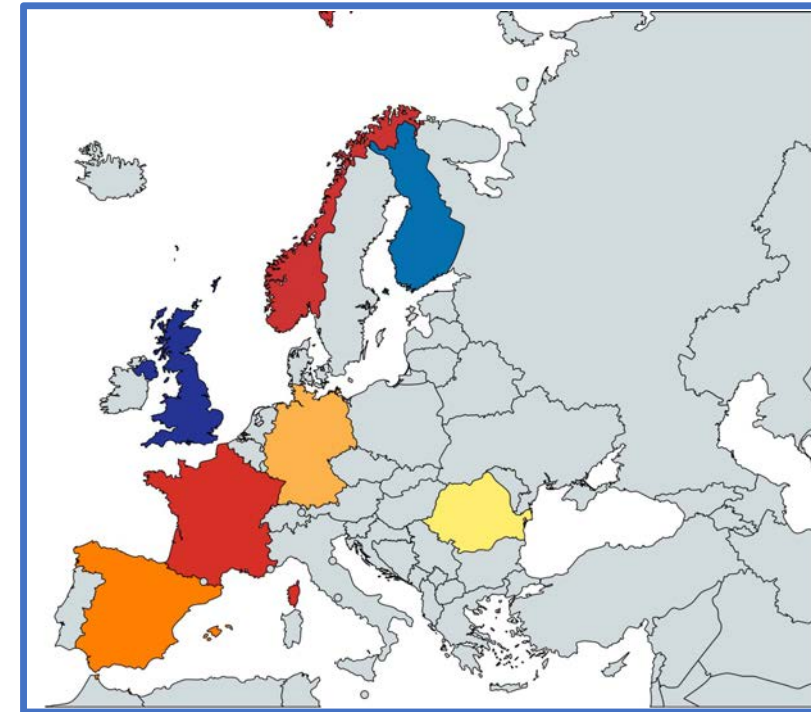

Motivation & Concept



- Fast-Moving Consumer Goods (FMCG)
 - Key business sector in EU
 - Cost-based processes, thus mass production
 - Personalised/customised production → 'known challenge'
 - Lack of adequate infrastructures → hamper consumers & new actors to participate in design & production

Co-creation through Manufacturing Eco-systems → Customer-driven, Holistic & collaborative production, co-creation through open innovation



FABLABs for digital manufacturing

- FABLAB (Fabrication Laboratory)- Digitally enabled, small scale, flexible manufacturing demonstration unit - 'mini-factories'

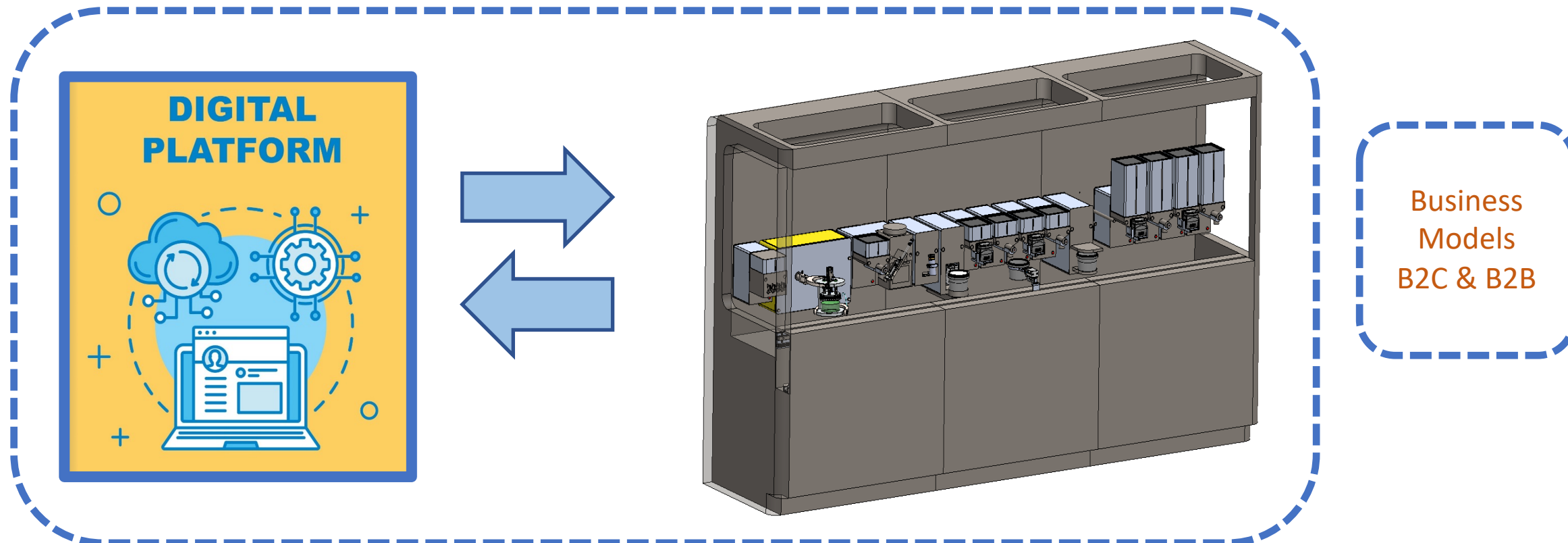

DIY4U- Concept & Approach

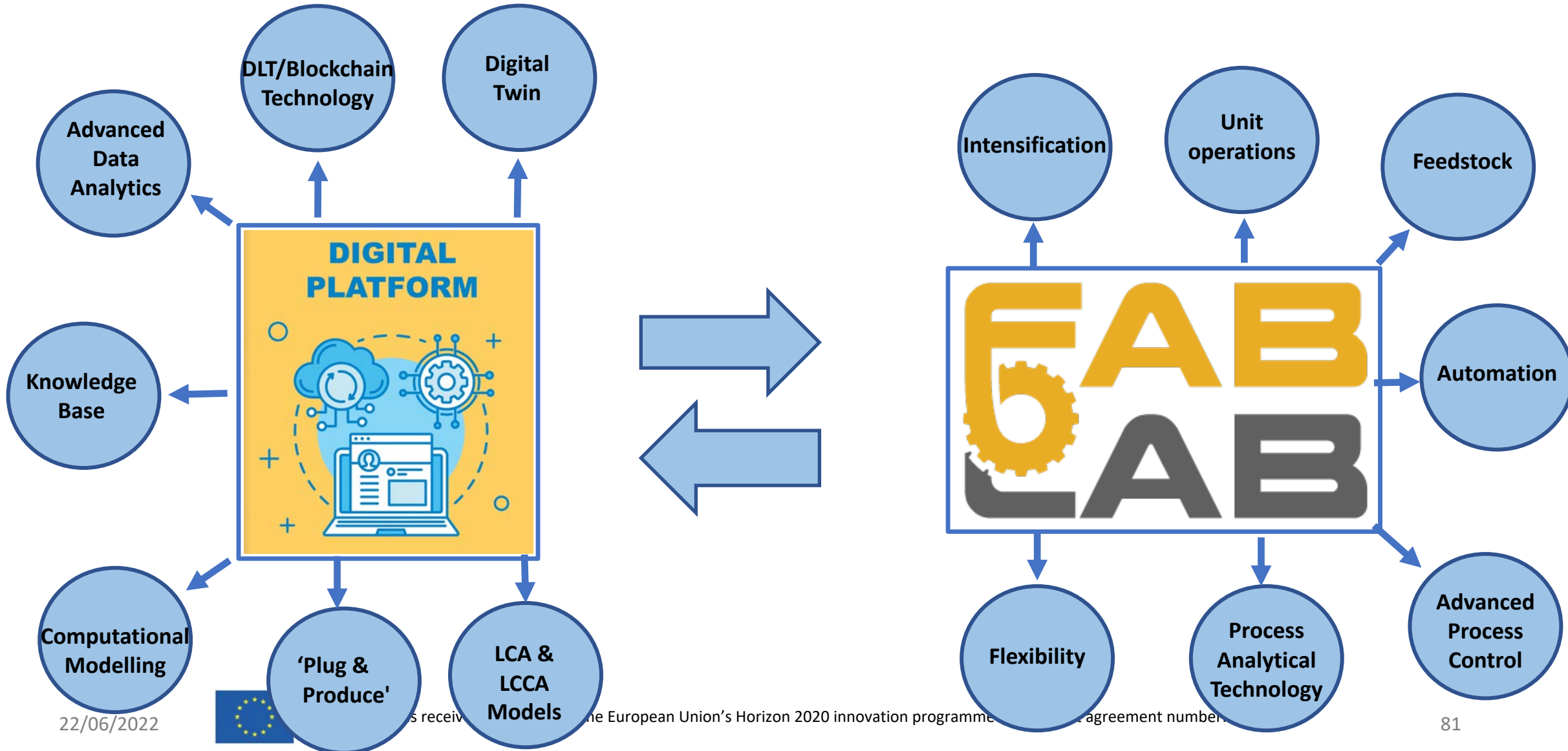

Project Structure

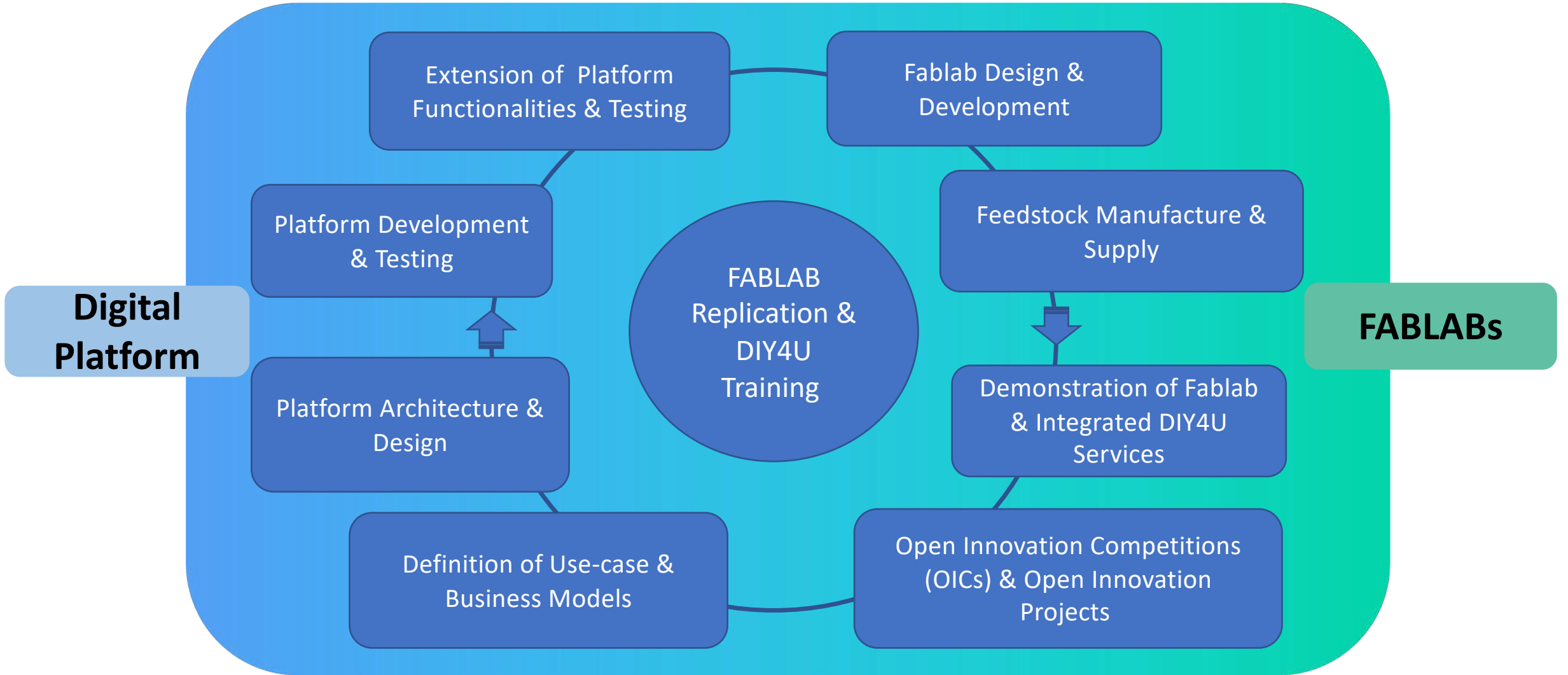

Post – Project scenario

Food, Pharmaceuticals, Detergent, Cosmetics, Paint.....

Business - to - Consumer (B2C)



Allergy



Dietary



Stain



Supplements



Ingredients



Fragrance



Geography



Color



Industrial R&D (Chemical, Metallurgical, High Performance Materials, Batteries, Fuel Cells etc.)

Business – to - Business (B2B)



'Rapid Prototyping' & Testing of New Formulations



Thank you for your attention!

PROPRIETARY RIGHTS STATEMENT

The information in this presentation reflects the views only of the author, and the Commission cannot be held responsible for any use which may be made of the information contained therein.



EU projects Round table – International Panel



Benjamin Poussard (France) is a Research Engineer at the Arts et Métiers Institute of Technology, in the Présence & Innovation team based in Laval, France where he leads the technology transfer team. Benjamin has a 10-year experience in Research and Development in the field of 3D interactive technologies (XR) and teaches AR to master's degree students. He is the coordinator of the H2020 project "INEDIT" funded by the European Commission.

Waldo Soto (Chile) is the co-founder of the global change platform "2811" and the Climate Action Academy, a program recognized by the EU Climate-KIC to teach skills and knowledge in climate action. Chilean social entrepreneur and Ashoka foundation consultant.



2022 **IEEE 28th ICE/ITMC & 31st IAMOT JOINT CONFERENCE**

**Technology, Engineering and Innovation Management Communities
as Enablers for Social Ecological Transitions**



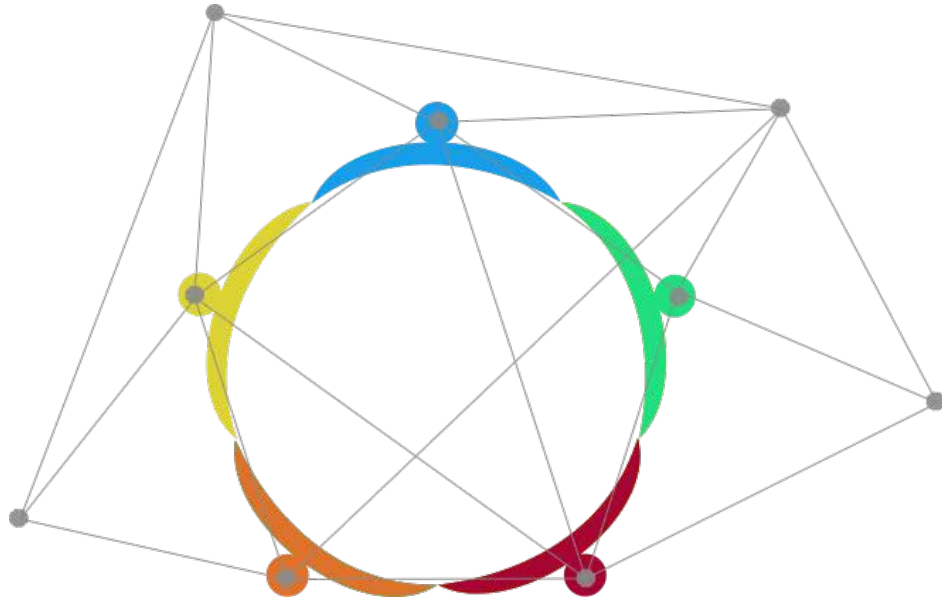

INEDIT

open INnovation Ecosystems
for Do It Together process



ICE IAMOT Conference - 22/06/2022



Introduction to INEDIT concepts



Benjamin Poussard - ENSAM - Coordinator

“DO IT TOGETHER” CONCEPT?

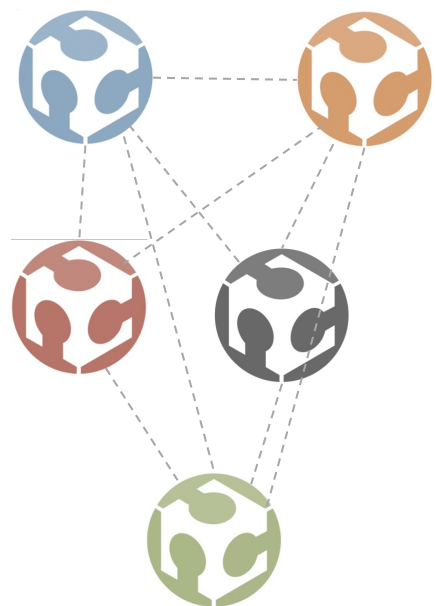

International network

Do It Yourself



“Do It Together”

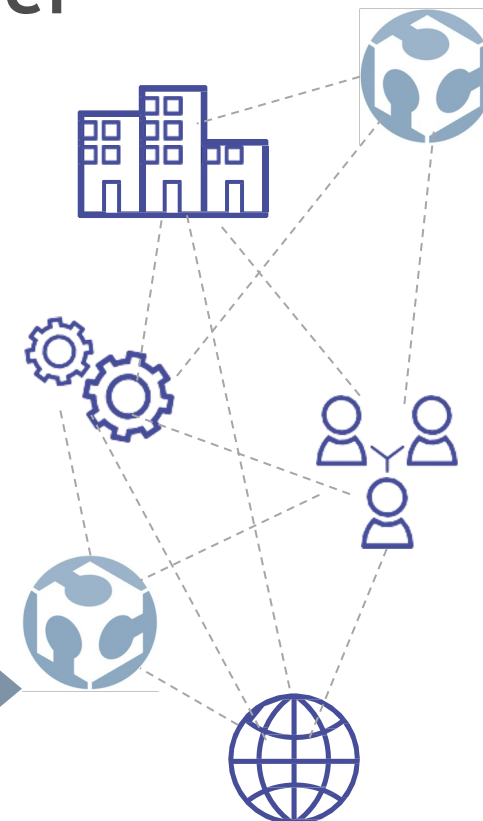
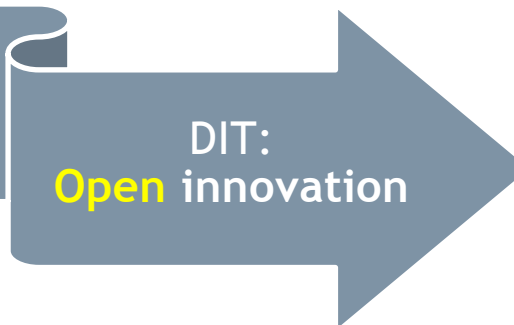



New approaches to capitalise on the knowledge and ideas of design and engineering coming from different and even new actors;



Development of knowledge, technologies and tools to share and analyse relevant data and demands from users as well as to fully enable collaborative engineering in the production network, allowing all actors to propose innovative solutions;

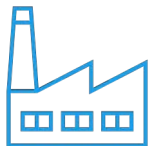

Development of new Manufacturing Demonstration Facilities (MDFs), where companies will test new technologies in cooperation with fablabs and makers in order to develop real industrial products and where training is offered.



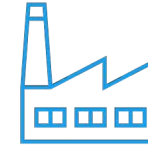

Engage consumers in product creation and respond to societal needs

Establish Open-Innovation networks

Create business models for the engineering of customised solutions

Improve the co-design and co-development capabilities

Increase of product variety and personalisation



Introducing the consortium

2

RTD centers

6

High Education

2

Large Companies

4

SMEs

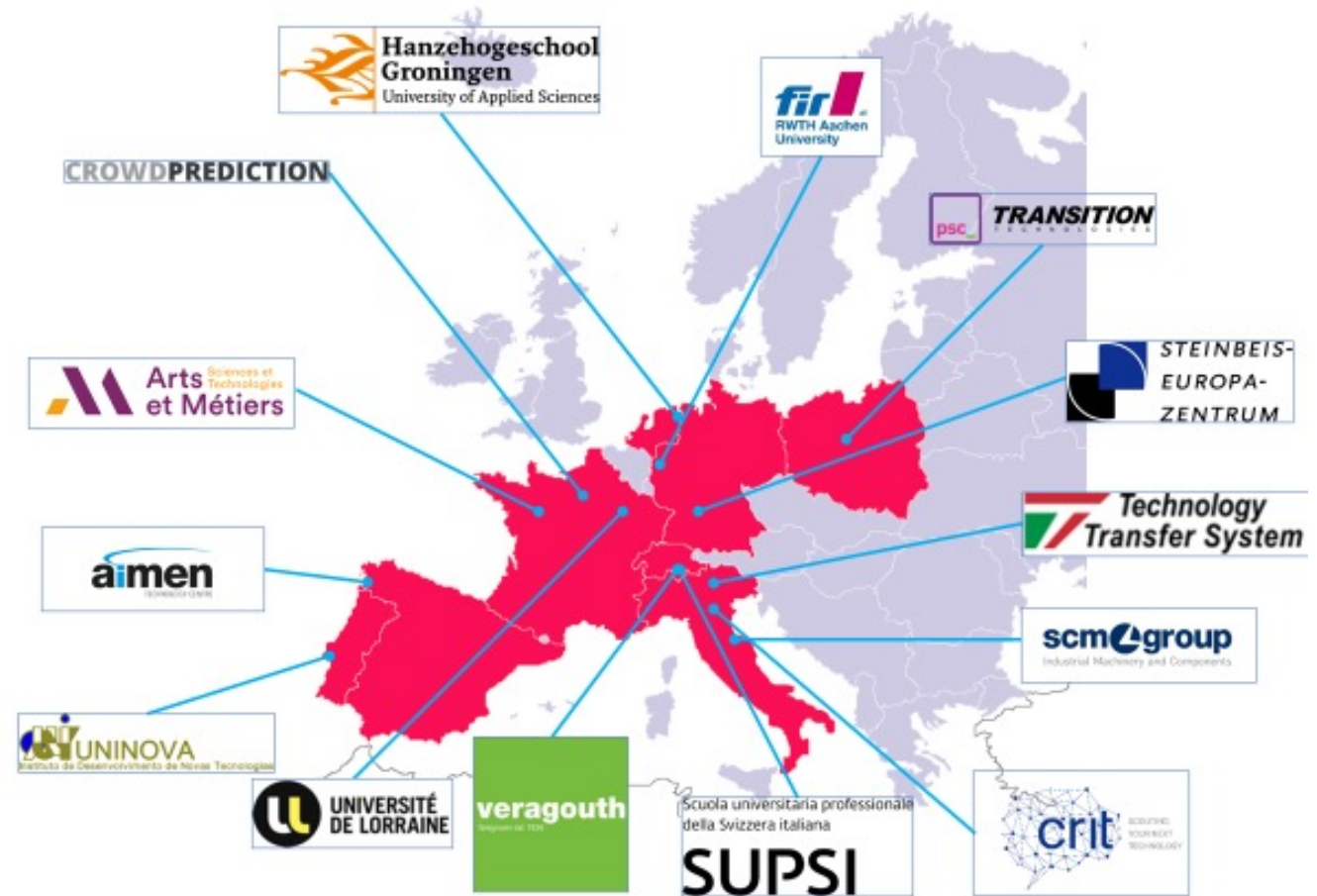

open INnovation Ecosystems for Do It Together process



Where did we start from ?

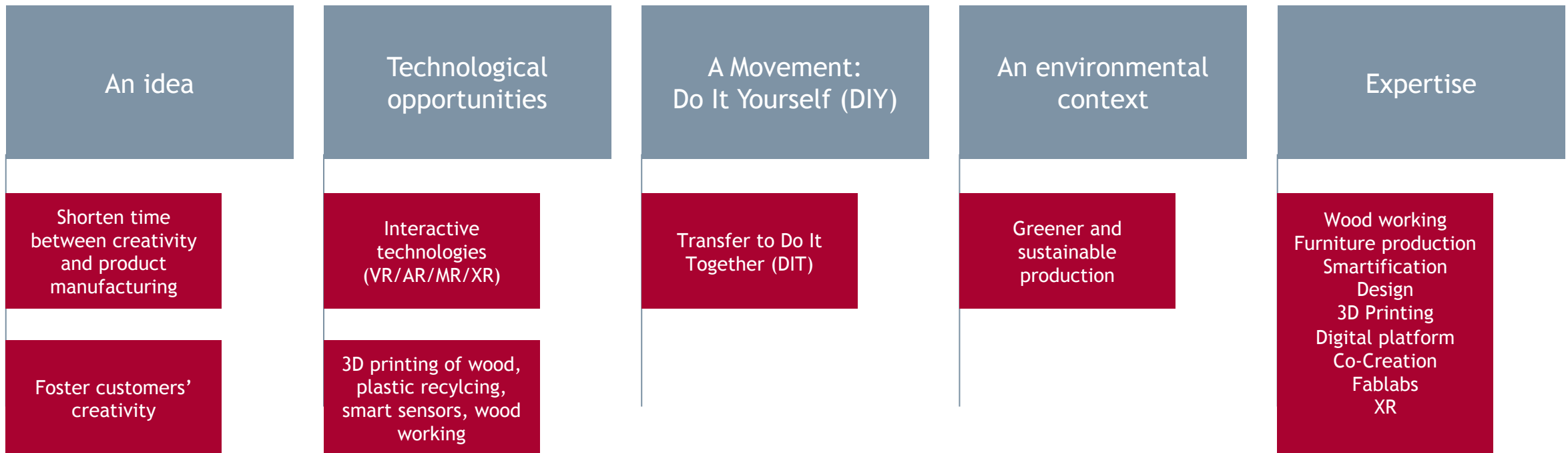

INEDIT demonstrates the potential innovation of **Social Manufacturing Models**
creating an Open Innovation European **Do It Together** ecosystem
for sustainable furniture co-creation

Design Global, Produce Local

High Level Objectives

- HL01** To unleash creativity of consumers and designers towards co-creation of new pieces of furniture addressing the needs of the single user in an industrial context.
- HL02** To democratize the access to production resources in the furniture sector.
- HL03** To support SME operating in the furniture sector in finding new business opportunities.
- HL04** To create a framework of solutions for creation, engineering, and distributed production of customer-driven pieces of furniture.
- HL05** To define design and manufacturing strategies focusing on lowering ecological impact and addressing societal challenges.
- HL06** To create an ecosystem of all stakeholders within Europe.

Our concept

"INEDIT creates an open innovation European DIT ecosystem for sustainable furniture co-creation. It channels the creativity of consumers, shapes it through designers' professional skills, and makes it viable by leveraging on the expertise of production specialists in order to deliver sustainable, smart and personalized new products in a shorter time to market"

→ Prove technical feasibility for the co-creation phase

→ Prove technical feasibility for the open manufacturing phase

→ Prove the business model validity for such a process

A DIT PLATFORM TO FOSTER CREATIVITY AND MAKE CUSTOM FURNITURE
EVALUATION THROUGH DEMONSTRATORS

open INnovation Ecosystems for Do It Together process

94



**Design a Framework of a replicable DIT
Open Manufacturing Demonstration Facility**

open INnovation Ecosystems for Do It Together process

95

Our approach

By building

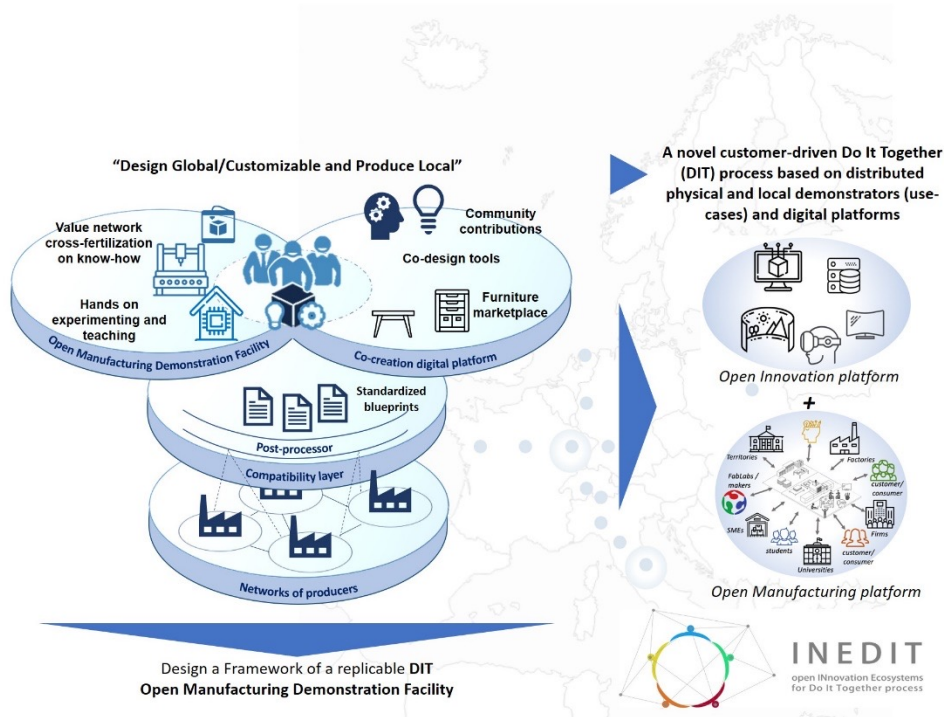

We will get

INEDIT - EU based Open Innovation Ecosystem Towards a more circular economy

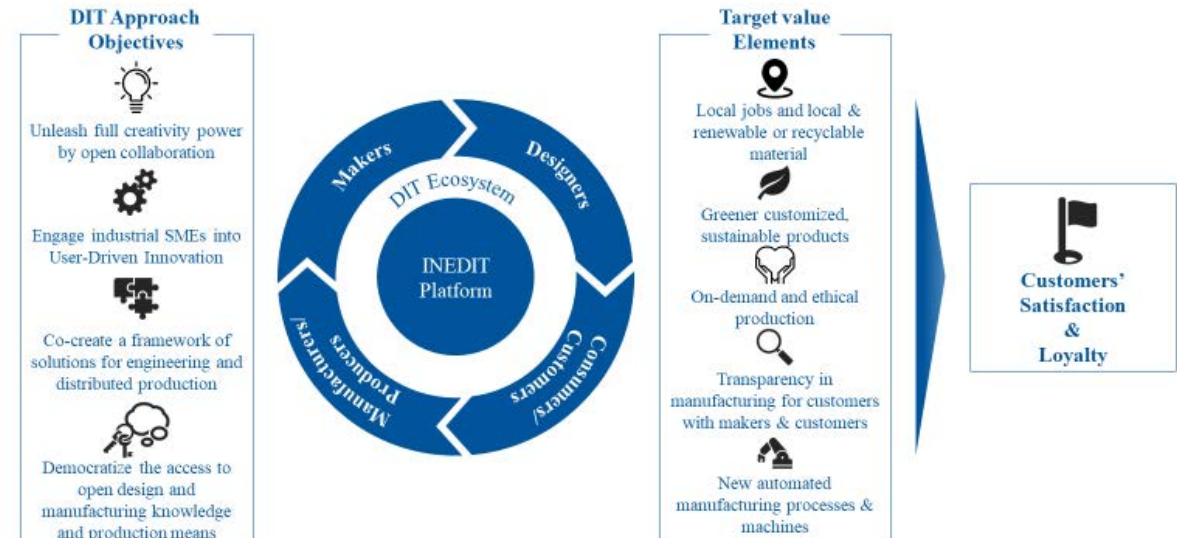

open INnovation Ecosystems for Do It Together process

96

INEDIT - EU based Open Innovation Ecosystem Towards a more circular economy

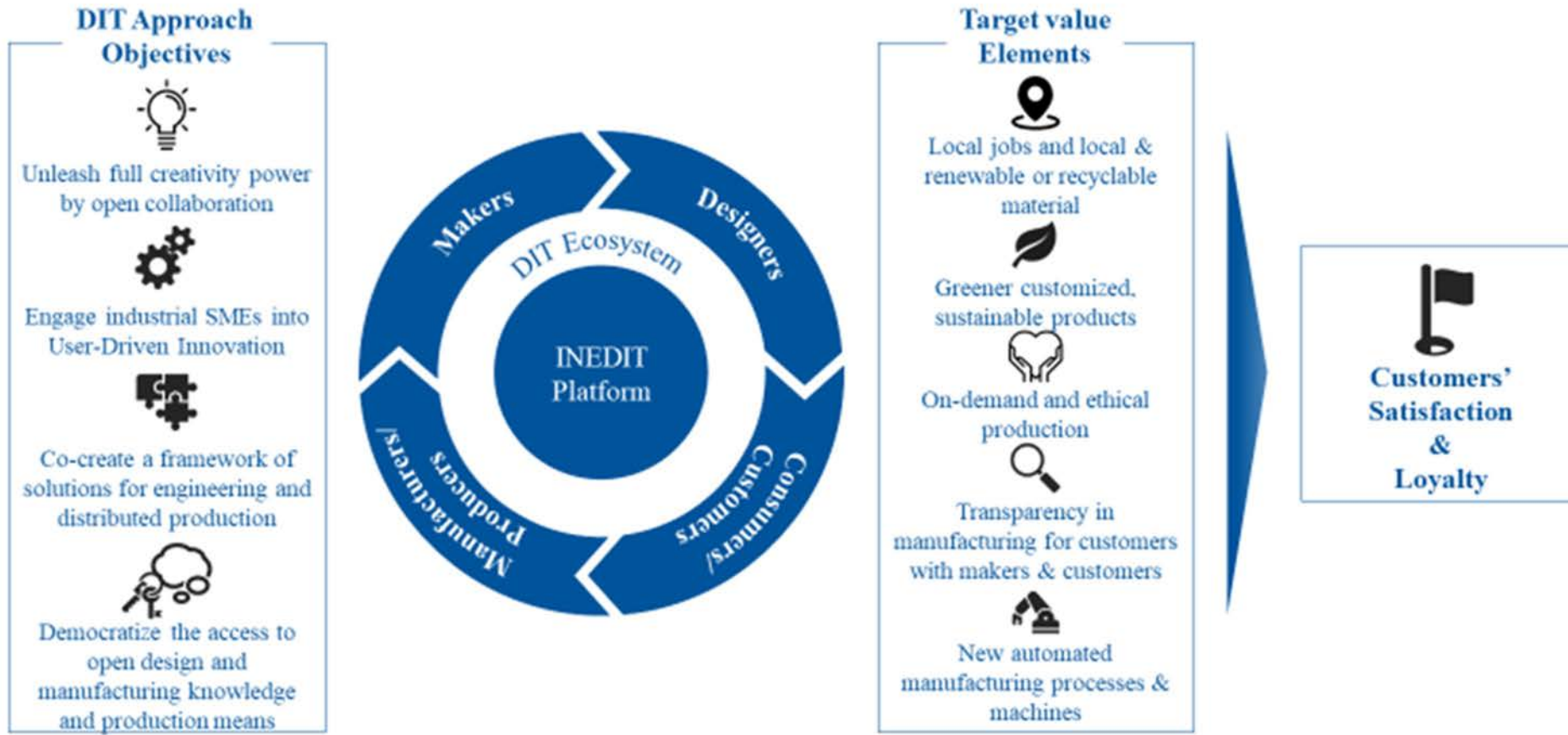

open INnovation Ecosystems for Do It Together process



SIMPLIFIED REPRESENTATION OF THE TWO MAIN PROCESSES OF DIT APPROACH

the co-creation and the open-manufacturing processes

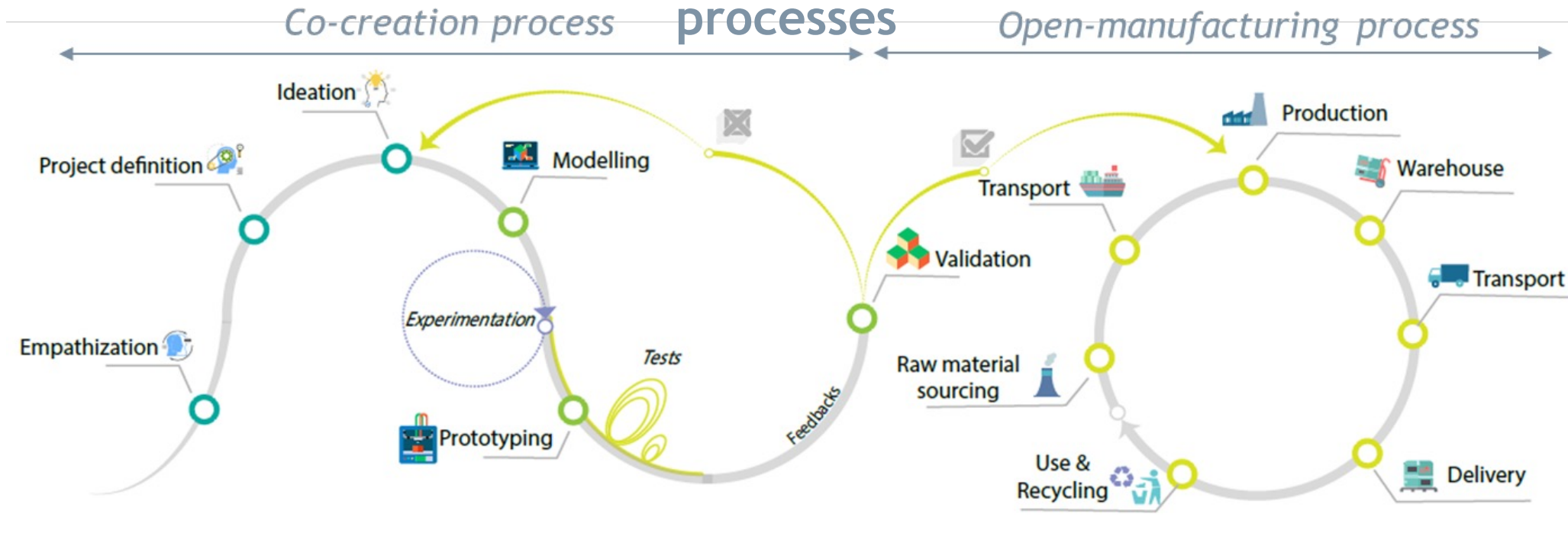

MARCHE Brunelle, KASMI Fedoua, MAYER Frédérique *et al.*, « Implementing Do-It-Together: The Cross-fertilization of Do-It-Yourself and Open Manufacturing », *Journal of Innovation Economics & Management*, 2022/0 (Prepublication), DOI : 10.3917/jie.pr1.0122. URL : <https://www.cairn.info/revue-journal-of-innovation-economics-2022-0-page-1.htm>

**Different steps / time / places to involve stakeholders
& a multi-scale process cognitive / product / Ecosystem**

open INnovation Ecosystems for Do It Together process

DIT: A USER EXPERIENCE SUPPORTED BY A LOCAL NETWORK



open INNOVATION Ecosystems for Do It Together process

100



Specifications of the «Do It Together» approach:

User-centered **Open Innovation Platform**

Replicable **Open Manufacturing Demonstration Facility**

“Do It Together” **Business Models**





THANK YOU FOR
YOUR ATTENTION !



 www.inedit-project.eu

 info@inedit-project.eu

 facebook.com/inedit-project

 linkedin.com/in/inedit-project

 [@INEDIT6](https://twitter.com/INEDIT6)

This project has received funding from the European Union's Horizon 2020 research and innovation programme under Grant Agreement No. 869952



EU projects Round table – International Panel

From technological innovation to social innovation

Waldo Soto (Chile) is the co-founder of the global change platform "2811" and the Climate Action Academy, a program recognized by the EU Climate-KIC to teach skills and knowledge in climate action. Chilean social entrepreneur and Ashoka foundation consultant.



2022 **IEEE 28th ICE/ITMC & 31st IAMOT JOINT CONFERENCE**

Technology, Engineering and Innovation Management Communities
as Enablers for Social Ecological Transitions





Climate
Labs

Climate-Labs Project: Strengthening applied research and innovation capacities in Latin-America through co-creation labs for mitigation and adaptation to Climate Change.

Waldo Soto - Ashoka & 2811

June 22, 2022

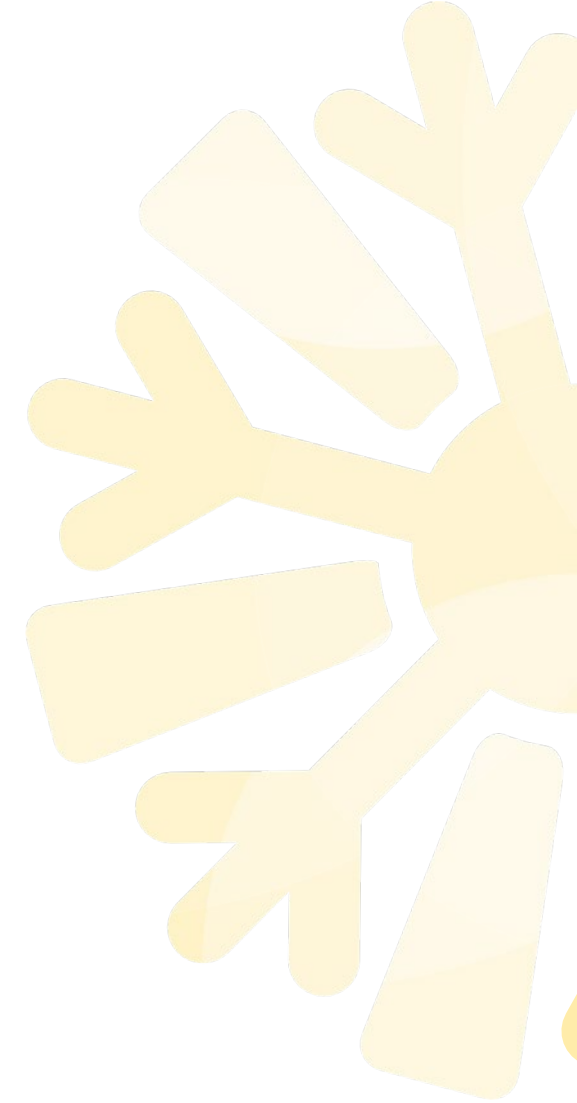

Carbon Neutral Project: The project has offset carbon emissions due to international travel.



Climate
Labs



Co-funded by the
Erasmus+ Programme
of the European Union

COAL CONSUMPTION AFFECTING CLIMATE.

The furnaces of the world are now burning about 2,000,000,000 tons of coal a year. When this is burned, uniting with oxygen, it adds about 7,000,000,000 tons of carbon dioxide to the atmosphere yearly. This tends to make the air a more effective blanket for the earth and to raise its temperature. The effect may be considerable in a few centuries.

August 14, 1912, a newspaper called the Rodney and Otamatea Times,

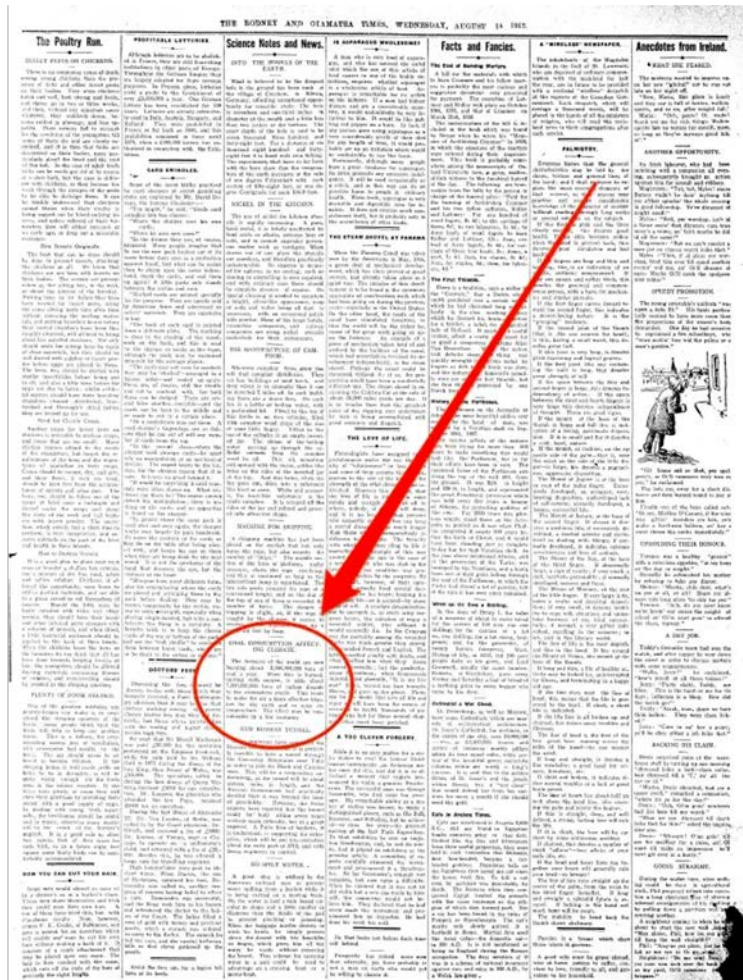

New Zealand, Aug 14, 1912. National Library of New Zealand



Carbon Neutral Project: The project has offset carbon emissions due to international travel.



Climate Labs



Co-funded by the Erasmus+ Programme of the European Union

World Scientists' Warning of a Climate Emergency

WILLIAM J. RIPPLE, CHRISTOPHER WOLF, THOMAS M. NEWSOME, PHOEBE BARNARD, WILLIAM R. MOOMAW,
AND 11,258 SCIENTIST SIGNATORIES FROM 153 COUNTRIES (LIST IN SUPPLEMENTAL FILE S1)

From Publications to Public Actions: The Role of Universities in Facilitating Academic Advocacy and Activism in the Climate and Ecological Emergency

Charlie J. Gardner^{1*}, Aaron Thierry², William Rowlandson³ and Julia K. Steinberger⁴

¹ Durrell Institute of Conservation and Ecology, University of Kent, Canterbury, United Kingdom, ² Cardiff School of Social Sciences, Cardiff University, Cardiff, United Kingdom, ³ Division of Arts and Humanities, University of Kent, Canterbury, United Kingdom, ⁴ Faculté de Géosciences et de l'environnement, Université de Lausanne, Lausanne, Switzerland

Re-framing the threat of global warming: an empirical causal loop diagram of climate change, food insecurity and societal collapse

C. E. Richards¹  • R. C. Lupton^{1,2}  • J. M. Allwood¹ 



Carbon Neutral Project: The project has offset carbon emissions due to international travel.



Climate
Labs



Co-funded by the
Erasmus+ Programme
of the European Union

Project partners



2011





Carbon Neutral Project: The project has offset carbon emissions due to international travel.



Climate
Labs



Co-funded by the
Erasmus+ Programme
of the European Union



Carbon Neutral Project: The project has offset carbon emissions due to international travel.



Climate
Labs



Co-funded by the
Erasmus+ Programme
of the European Union

ClimateLabs: Co-creation process

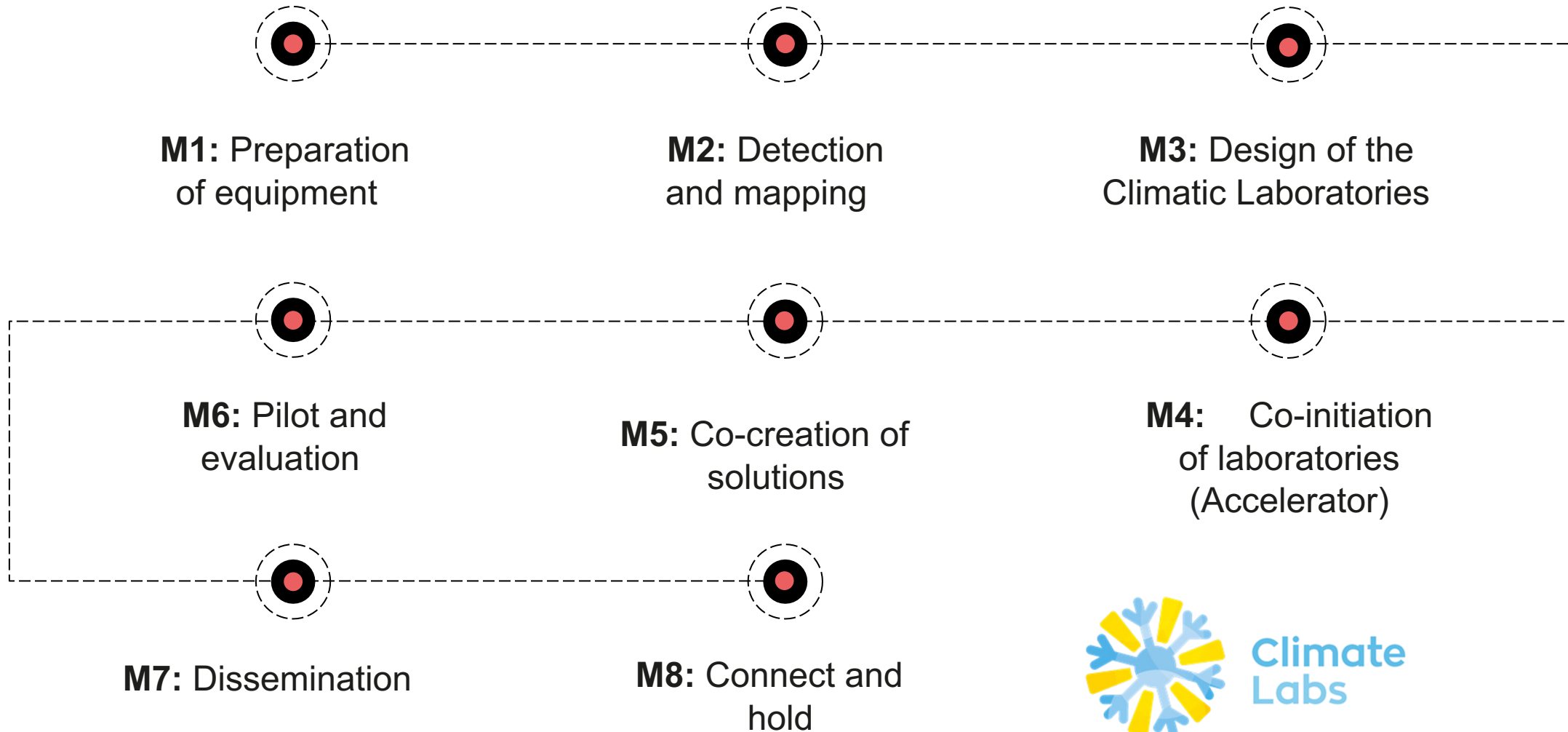

Remember!

Pilots presentation

- Climate change education curricular development
- Participatory assessment of ecosystem services
- Ecosystemic and social analysis of public spaces as strategies for mitigation and adaptation to Climate Change
- Generate adaptations of the coffee value chain through sustainable practices that strengthen local economy resilience.
- Climate education project at the school level



Climate
Labs

Climate-Labs Project: Strengthening applied research and innovation capacities in Latin-America through co-creation labs for mitigation and adaptation to Climate Change.

June 22, 2022

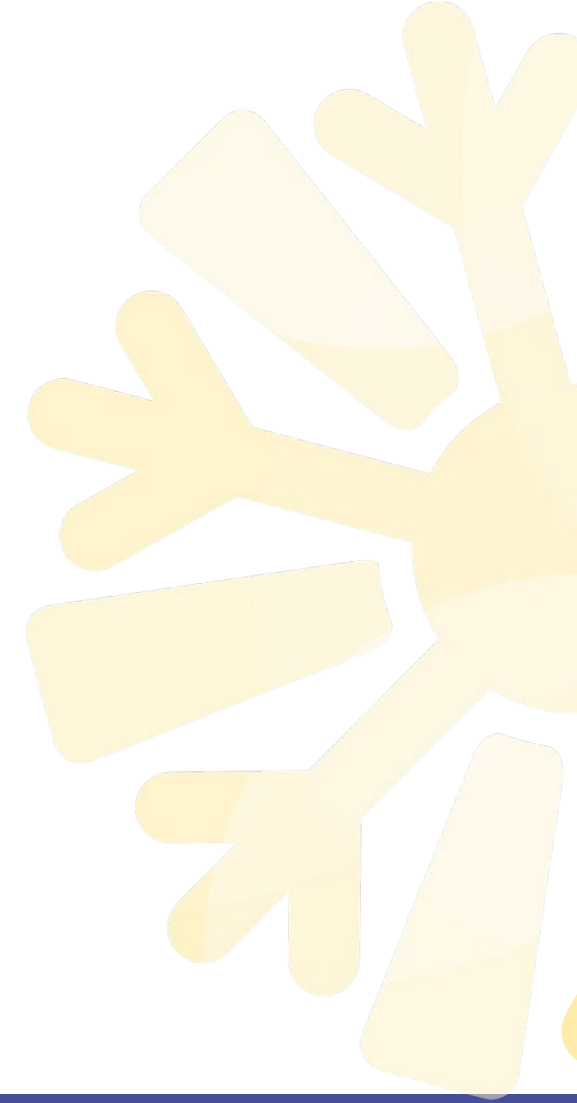

Carbon Neutral Project: The project has offset carbon emissions due to international travel.



Climate
Labs



Co-funded by the
Erasmus+ Programme
of the European Union

EU projects Round table

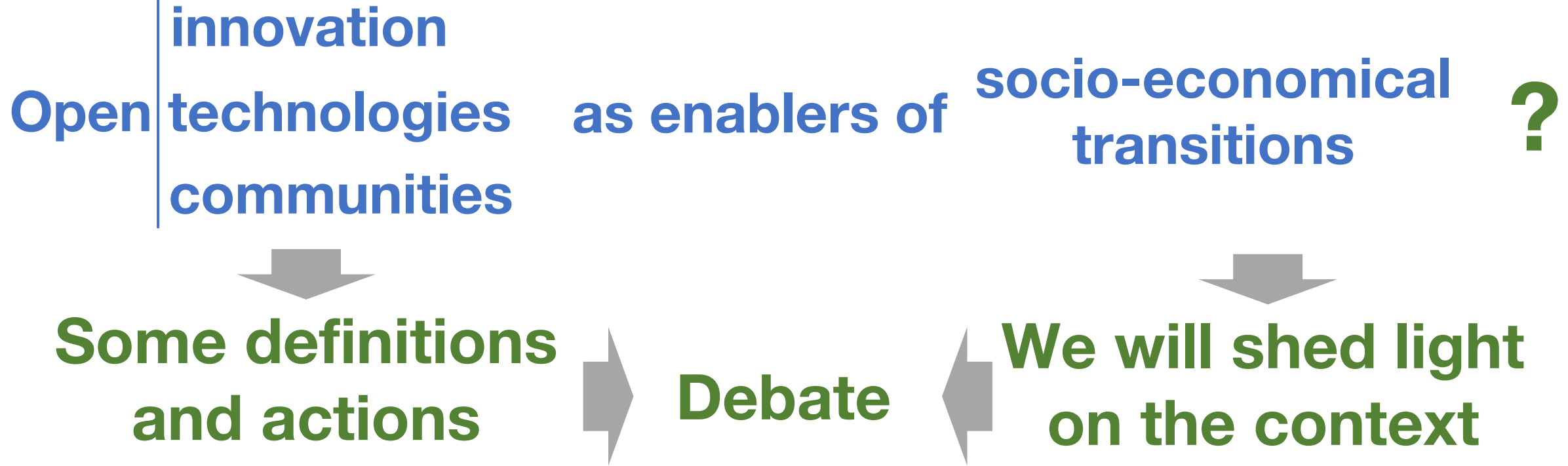

2022 **IEEE 28th ICE/ITMC & 31st IAMOT JOINT CONFERENCE**

Technology, Engineering and Innovation Management Communities
as Enablers for Social Ecological Transitions



Wednesday 22nd June parallel Workshops & Sessions

11:00–12:30 & 13:30–16:30 – Centre Prouvé



2022 IEEE 28th ICE/ITMC & 31st IAMOT JOINT CONFERENCE

**Technology, Engineering and Innovation Management Communities
as Enablers for Social Ecological Transitions**





Responsible Research and Innovation: new methodological approaches and practical insights

Wednesday 22nd June

9:00-10:30:

Round table: cross reflexion about four European projects relating to digitalization, open manufacturing, transformation of European industry through the integration of digitisation and other enabling technologies

- Presentation about DigiTerri: Marianne Hörlesberger
- Debate

11:00 – 12:30 second workshop: responsible digitalization: the example of the DigiTeRRI project

Presentations (10’):

- RRI definition – Mario+Nhiem
- Implementation of Responsible Digitalization: the necessary adaptation to the context (Manfred)
- Territorial strategy for Responsible Digitalization implementation: the methodologies (roadmapping and vision definition) and the roadmap presentation of three european territories (Nhiem/Jens)
- Practices and actions to stimulate Responsible Digitalization in Styria (Brigitte)
- Practices and actions to stimulate Responsible Digitalization in Värmland (Eamonn/Malin)
- Practices and actions to stimulate Responsible Digitalization in Grand Est (JJ Bernardini)



Workshop: *Wed. 22nd June 11:00 – 12:30 – Auditorium*

From concept (morning) to open demonstrator (afternoon)



INEDIT
open INnovation Ecosystems
for Do It Together process

**Co-designing Open innovation, technologies
& communities to enable socio-economical transition:
practices and actions**

Transforming industry and territories developing of new
Manufacturing Demonstration Facilities (MDFs):

DIY4U, iProduce, INEDIT, Open_Next



Emerging Trends and Innovations in Project Management

Wednesday 22nd June 13:30 – 16:30 – Auditorium

Chairs: Robert Bierwolf, IEEE TEMS & *Prof. Davy Monticolo (ICE-IAMOT team)*

- 13:30 Robert Bierwolf - Towards PM2030 – Research through Project Management
- 13:45 Anna Schidek - Agilization in MedTech
- 14:00 Phillip Hansen - Fuzzy Expert System for Estimation
- 14:15 Markus Schmidtner - PM Context Modeling
- 14:30 Holger Timinger - Weighting of project management process parameters

- 14:40 coffee Break

- 15:00 1 Hour HyValue Presentation (20 Min incl. 5 min discussion each)
- 15:00 Markus Schmidtner - Interorganizational Project Management in the automotive Industry
- 15:20 Alexander Ziegler- From Cooperation to Collaboration: Sociological Insights into Digital Collaboration Platforms in the Automotive Value Chain
- 15:40 Kirsten Hentschl & Andreas Trautheim-Hofmann - Digital Transformation of Project Schedule Management and Synchronization (PSMS) in Collaboration Networks
- 16:00 Open Discussion
- 16:15 End of Workshop

Contact: Markus.Schmidtner@haw-landshut.de

From concept to open demonstrator - Living Lab approach at L'Octroi Nancy -



Wed. 22 June
Morning

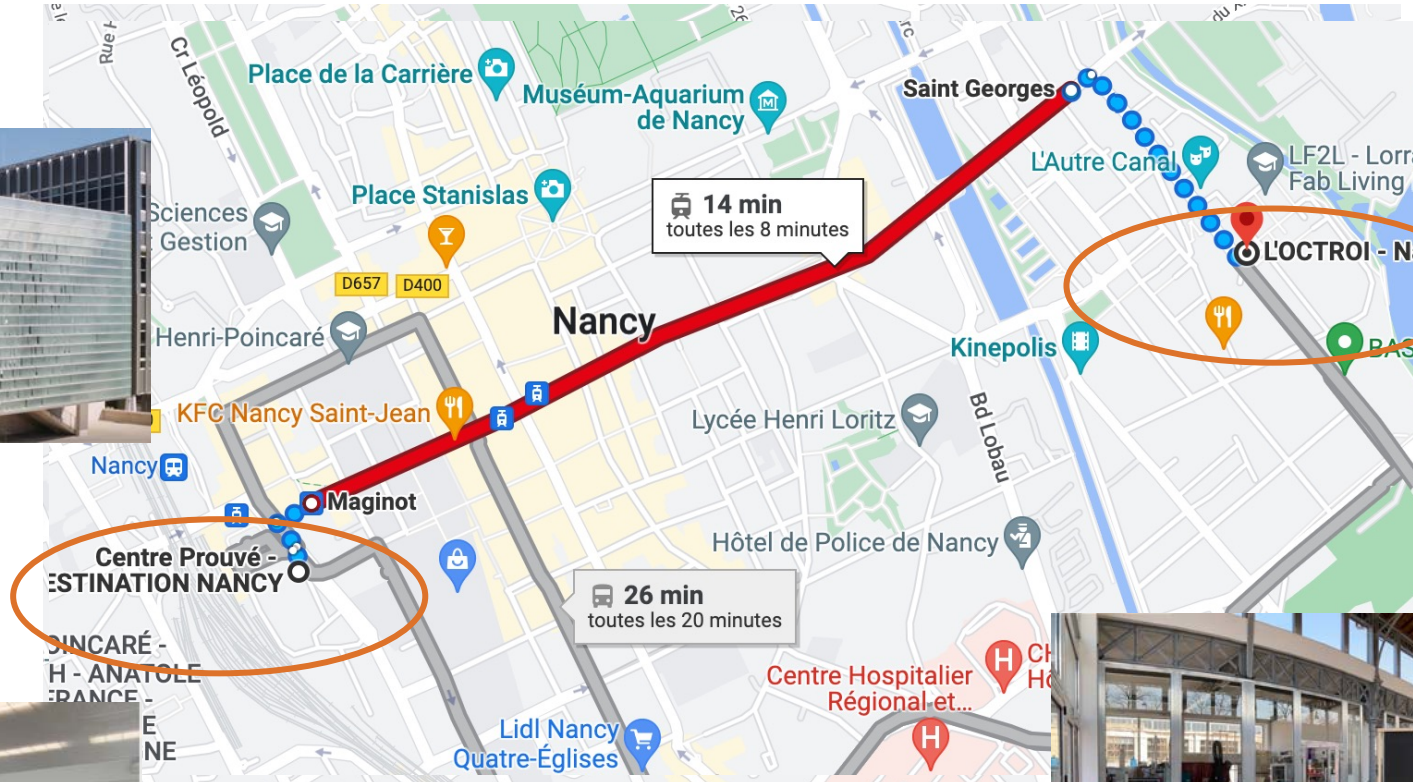

Wed. 22 June
afternoon

L'OCTROI
Nancy





Wed. 22nd June 14:00 – 18:00 – Octroi Nancy

Innovative Design Factory in the City at L'OCTROI Nancy

Scientific manager: Dr. Laurent Dupont
Technical manager: Benjamin Ennesser-Serville



Immersive environment



Hang Printer (in progress)

OPEN!
NEXT





Wed. 22nd June 14:00 – 18:00 – Octroi Nancy

Innovative Design Factory in the City at L'OCTROI



Demonstrator (TRL4 to TRL6) in Living Lab mode, involving and making links between EU sister projects, to work on the European industry transformation through the integration of digitisation and other enabling technologies and achieve global industrial leadership

- > Experiment The Do It Together process, DesignTogether Apps and Open Manufacturing Demonstrator Facilities*
- > Open-Source Hardware exhibition and associated business model*
- > Involve researchers, practitioners, industrialists, SMEs in a space supporting creative communities (L'Octroi Nancy – the Creative and Citizen Third-Place of the City of Nancy)*
- > Strengthen the transfer to industrial companies of the Do It Yourself (DIY), fablabs, micro-factories and makers approaches*
- > etc.*

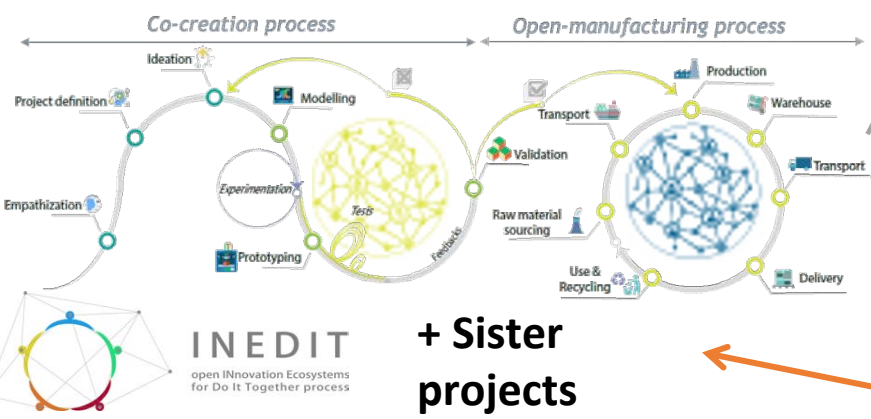

INEDIT
open Innovation Ecosystems
for Do It Together process

+ Sister projects

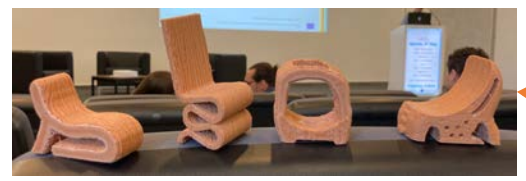

Mock-up of the 3D printer robot + production

- Technologies
- Short talks
- Booths

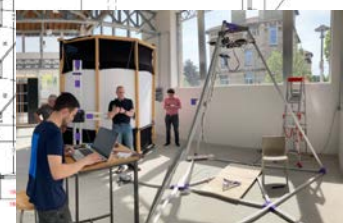
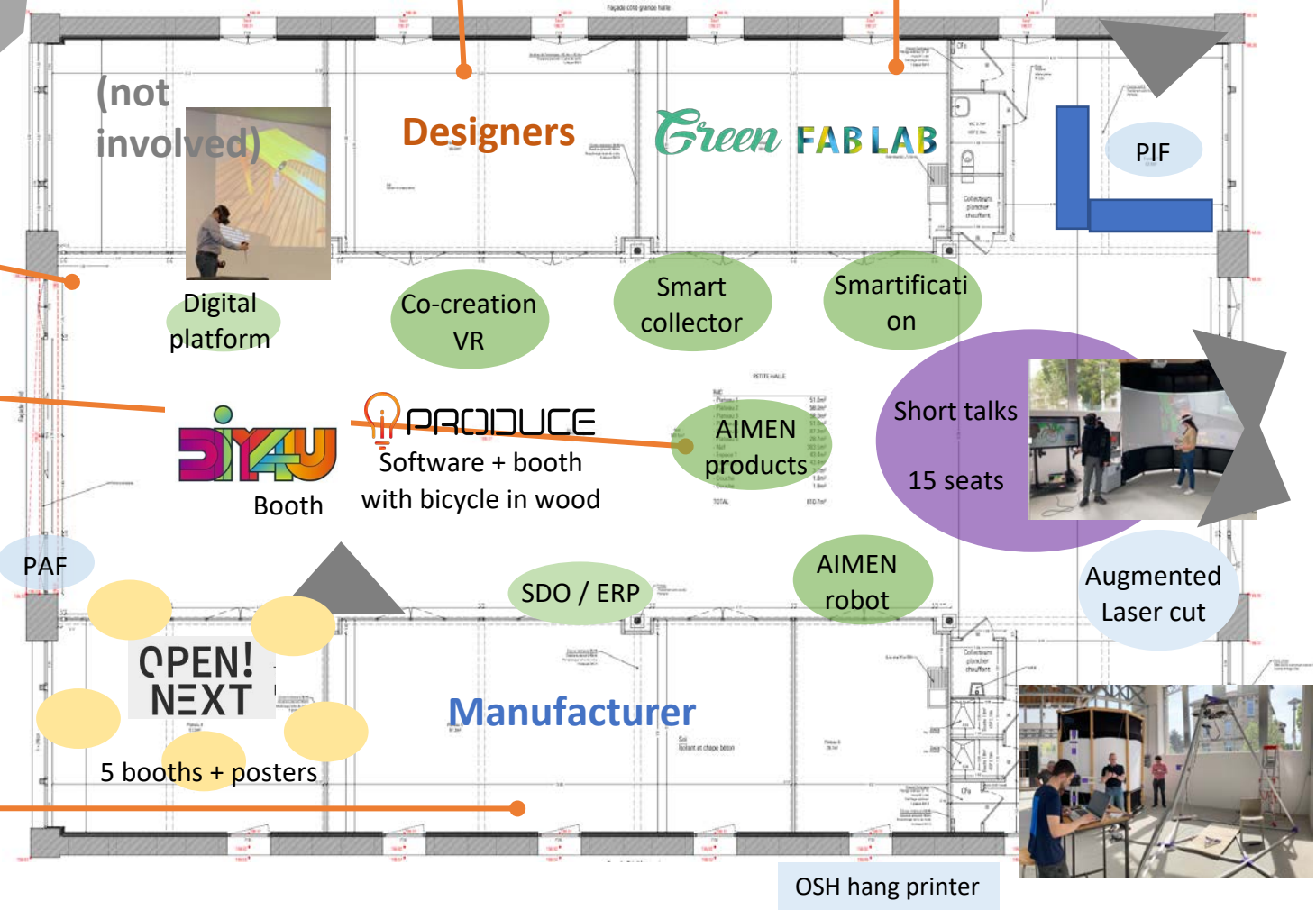

Green FAB LAB

Open and creative ecosystem supported by



GA 869952

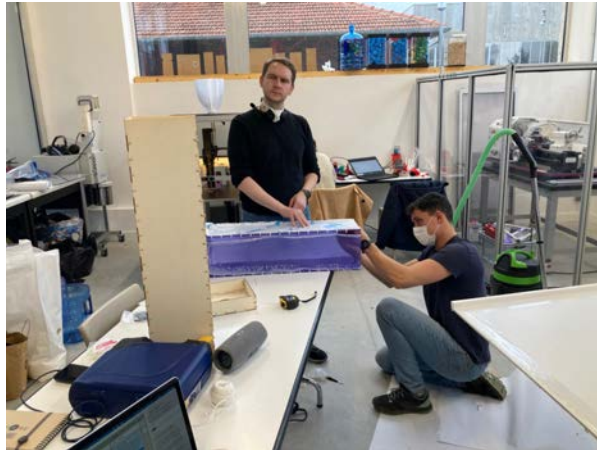

22/06/2022

2022 IEEE 28th ICE/ITMC & 31st IAMOT Joint Conference

122

Wed. 22nd June 14:00 – 18:00 – Octroi Nancy

Innovative Design Factory in the City at L'OCTROI





Wed. 22nd June 9:00 – 12:30

Zoom on INEDIT

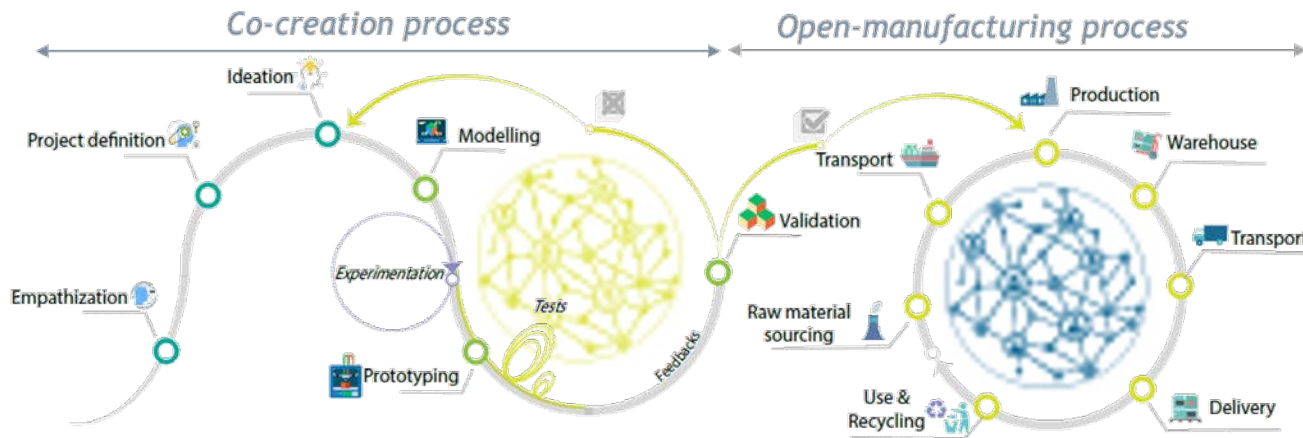
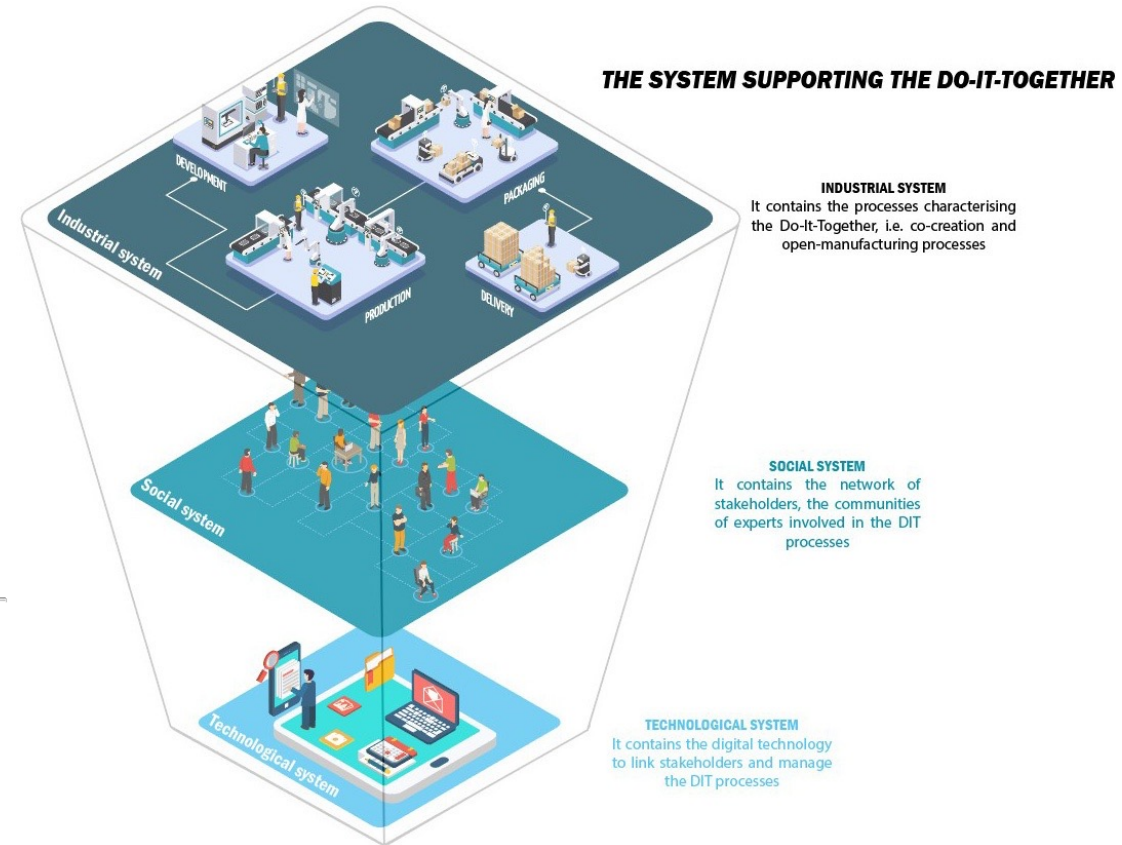

MARCHE Brunelle, KASMI Fedoua, MAYER Frédérique, DUPONT Laurent, « Implementing Do-It-Together: The Cross-fertilization of Do-It-Yourself and Open Manufacturing », *Journal of Innovation Economics & Management*, 2022/0 (Prepublication), DOI : 10.3917/jie.pr.1.0122. URL : <https://www.cairn.info/revue-journal-of-innovation-economics-2022-0-page-1122.htm>



Wed. 22nd June 14:00 – 18:00 - Zoom on INEDIT



Living Lab demonstrator at l'Octroi Nancy: INEDIT User path

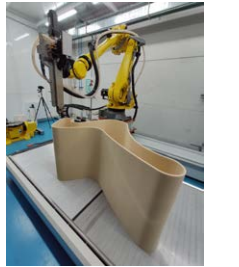



Zoom on INEDIT



DESIGN TOGETHER PLATFORM & SCANVIEW APP

01. JOIN THE PLATFORM **02. SCAN YOUR ROOM**

INVOLVEMENT IN THE DEMONSTRATION FUNCTIONS

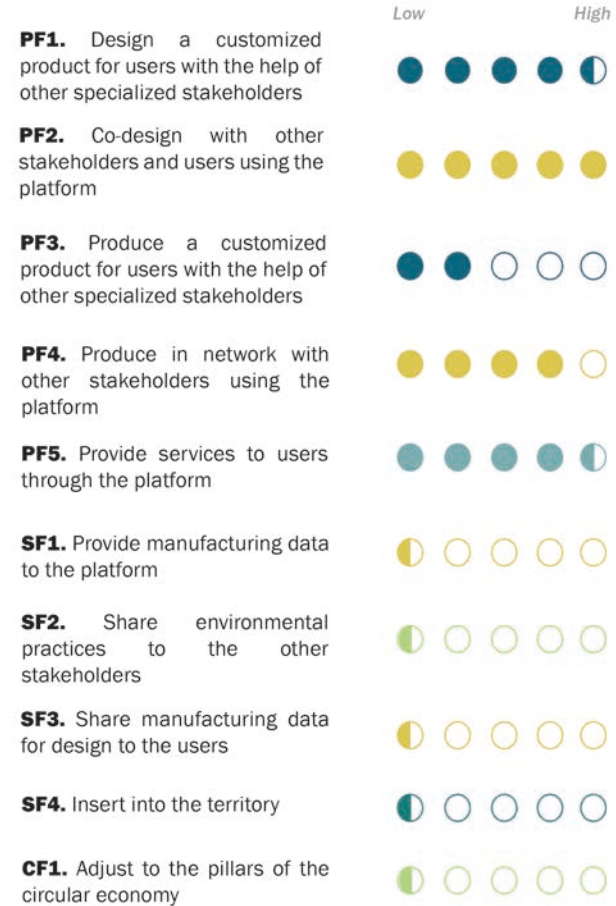

This project has received funding from the European Union's H2020 research and innovation programme under Grant Agreement N 869862.



Zoom on INEDIT

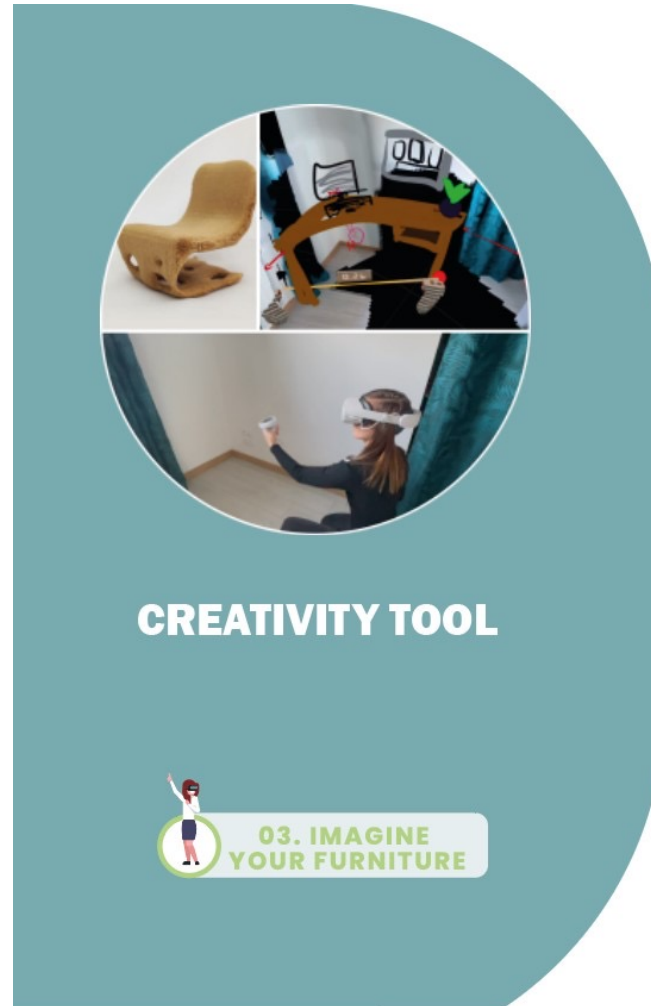

INVOLVEMENT IN THE DEMONSTRATION FUNCTIONS

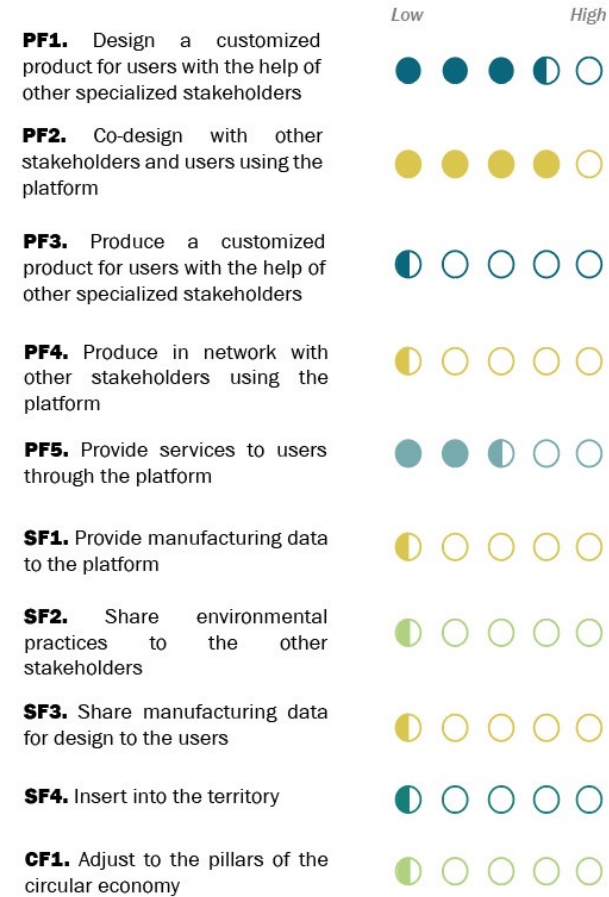

This project has received funding from the European Union's H2020 research and innovation programme under Grant Agreement N 869952.





Zoom on INEDIT



IMMERSIVE DESIGN TOOL

03. IMAGINE YOUR FURNITURE

INVOLVEMENT IN THE DEMONSTRATION FUNCTIONS

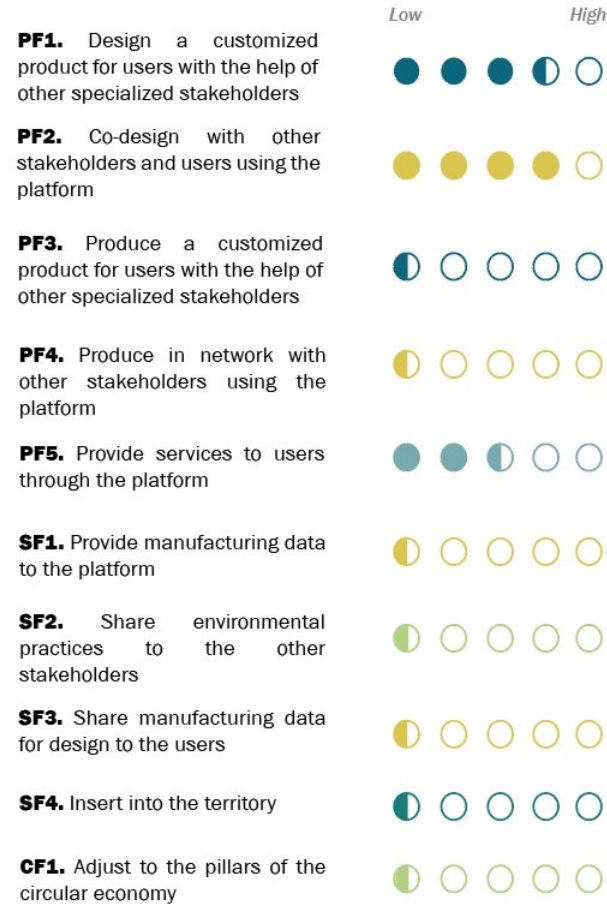

This project has received funding from the European Union's H2020 research and innovation programme under Grant Agreement N 889952.





Zoom on INEDIT





MANUFACTURING OF WOOD FURNITURE & INNOVATION HUB

04. GET FEEDBACKS 07. PRODUCE LOCALLY

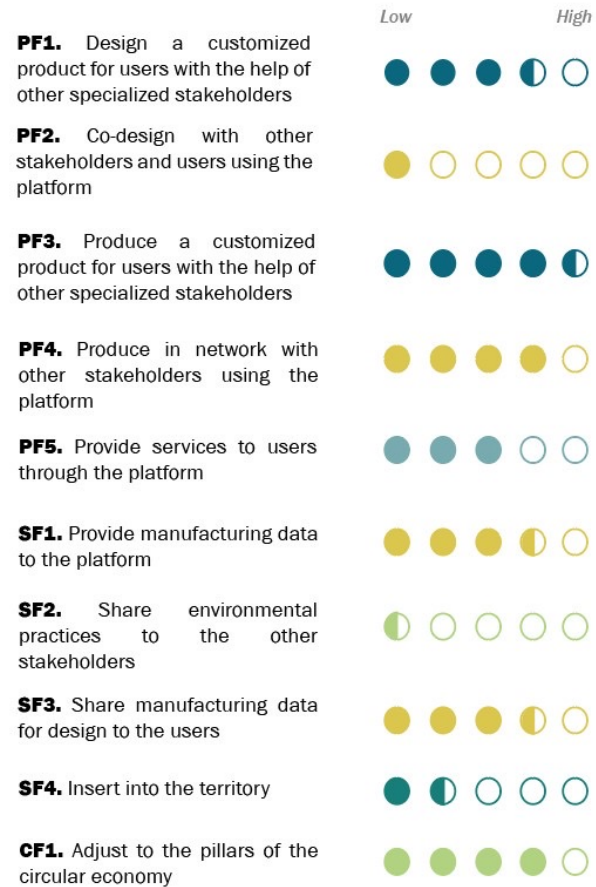

INVOLVEMENT IN THE DEMONSTRATION FUNCTIONS



This project has received funding from the European Union's H2020 research and innovation programme under Grant Agreement N 869952.



Zoom on INEDIT



INEDIT
open INnovation Ecosystems
for Do It Together process



3D PRINTING OF WOOD



05. TRY IT OUT



07. PRODUCE LOCALLY

INVOLVEMENT IN THE DEMONSTRATION FUNCTIONS

Low High

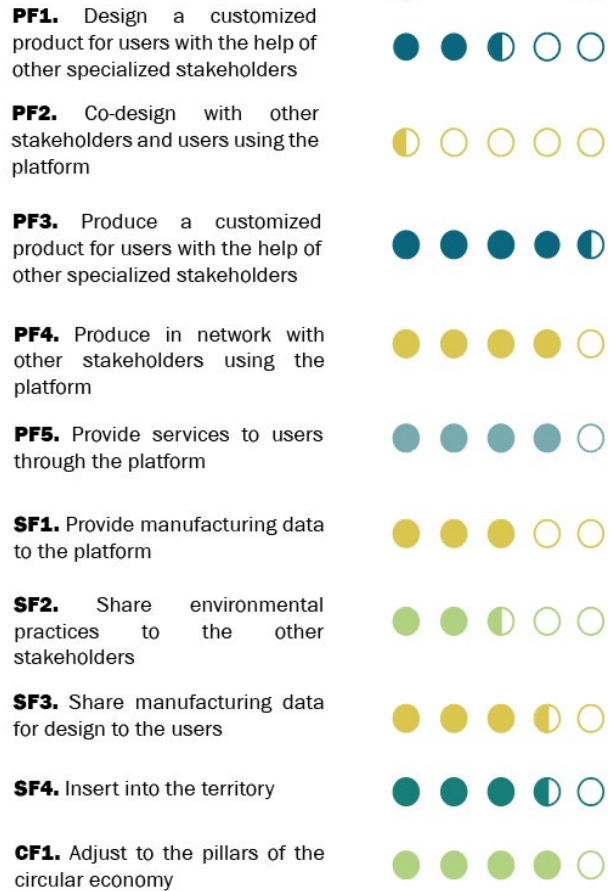

This project has received funding from the European Union's H2020 research and innovation programme under Grant Agreement N 869952.





Zoom on INEDIT



DISTRIBUTED RECYCLING OF PLASTIC

Smart Collector, 3D Printing & Manual Injection Moulding

05. TRY IT OUT **07. PRODUCE LOCALLY**

INVOLVEMENT IN THE DEMONSTRATION FUNCTIONS

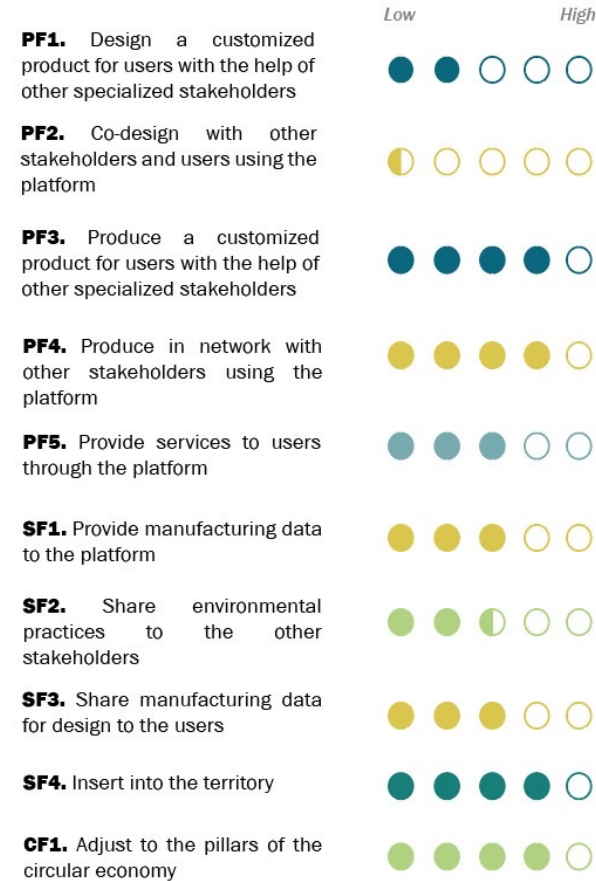

This project has received funding from the European Union's H2020 research and innovation programme under Grant Agreement N 869952.





Zoom on INEDIT

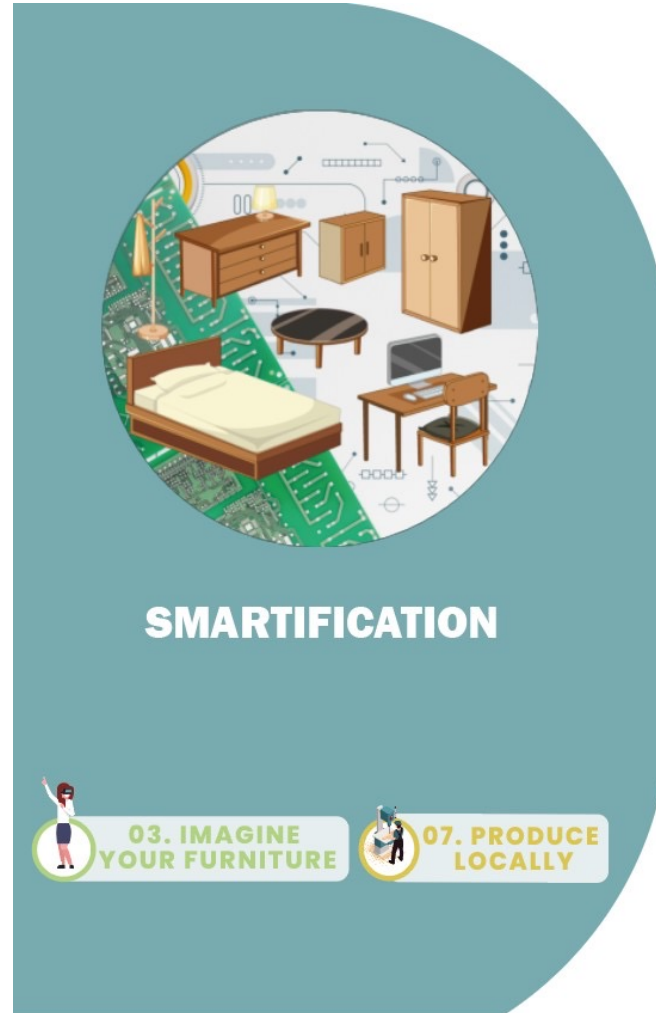

INVOLVEMENT IN THE DEMONSTRATION FUNCTIONS

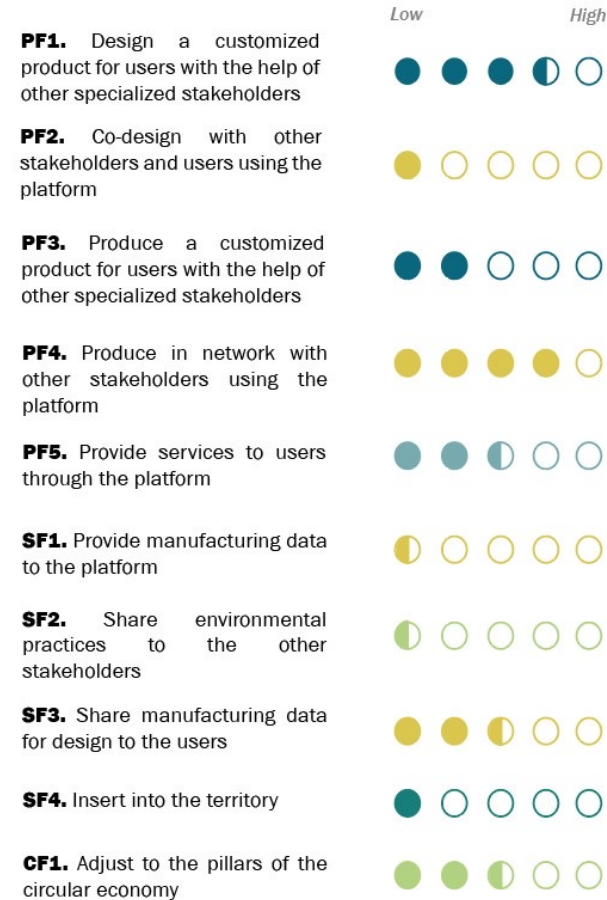

This project has received funding from the European Union's Horizon 2020 research and innovation programme under Grant Agreement N 869952.





Zoom on INEDIT



MANUFACTURER REGISTERING, SDO & ERP

06. ORDER IT

INVOLVEMENT IN THE DEMONSTRATION FUNCTIONS

	Low	High
PF1. Design a customized product for users with the help of other specialized stakeholders	●	○ ○ ○ ○ ○
PF2. Co-design with other stakeholders and users using the platform	●	○ ○ ○ ○ ○
PF3. Produce a customized product for users with the help of other specialized stakeholders	●	○ ○ ○ ○ ○
PF4. Produce in network with other stakeholders using the platform	● ●	○ ○ ○ ○ ○
PF5. Provide services to users through the platform	●	○ ○ ○ ○ ○
SF1. Provide manufacturing data to the platform	● ● ● ●	○
SF2. Share environmental practices to the other stakeholders	● ● ●	○ ○ ○ ○ ○
SF3. Share manufacturing data for design to the users	● ● ● ● ●	○
SF4. Insert into the territory	●	○ ○ ○ ○ ○
CF1. Adjust to the pillars of the circular economy	●	○ ○ ○ ○ ○



This project has received funding from the European Union's H2020 research and innovation programme under Grant Agreement N 869952.





Wed. 22nd June 9:00 – 12:30

Zoom on Open_Next



**OPEN!
NEXT**

TRANSFORMING COLLABORATIVE
PRODUCT CREATION

The future is open and community-based.

Today's industrial product creation is expensive, risky and unsustainable. But it doesn't have to be.

Presently, SMEs and maker communities across Europe are coming together to fundamentally change the way we create, produce, and distribute products.

We're establishing new collaborations between companies and consumers, focusing on eco-friendly mobility, consumer electronics and built-to-order furniture.

OPENNEXT seeks to empower both companies and consumers to co-design and co-manufacture products based on new mindsets, new business models, and new collaborative software solutions.



Wed. 22nd June 14:00 – 18:00 – Octroi Nancy

Zoom on Open_Next demo

at L'OCTROI Nancy



<https://docs.google.com/document/d/1DBji-4X6NISdBuwaebIVssaBcLIOawSi61votCWYl7I/edit?usp=sharing>

OPEN! NEXT

TRANSFORMING COLLABORATIVE
PRODUCT CREATION

5 Open Next partners

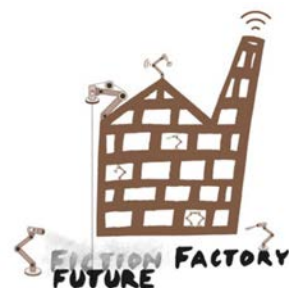

SpreeBerlin

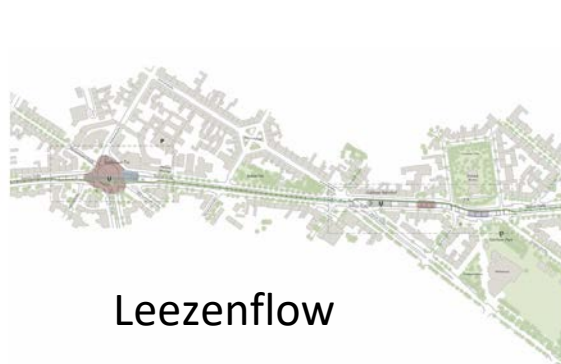

Leezenflow



Prototypes for Eur<ope
e.V. / Pocket Science Lab
/ Anavi Info uHat



Wed. 22nd June 14:00 – 18:00 – Octroi Nancy

Zoom on Open_Next demo

at L'OCTROI Nancy



OPEN! NEXT

TRANSFORMING COLLABORATIVE
PRODUCT CREATION





Wed. 22nd June 9:00 – 12:30

Zoom on iProduce



The iPRODUCE project aims to boost collaborative production by mobilising manufacturers, makers and consumers towards open innovation and the co-creation of consumer goods.



The project takes well-proven concepts and approaches (from makerspaces, fab labs and DIY manufacturing) and will upscale them through innovative digital tools and services that integrate a Social Manufacturing Framework (SMF).

These will be integrated and validated in well-connected multi-stakeholder ecosystems under the umbrella concept of collaborative Manufacturing Demonstration Facilities (cMDF).



Wed. 22nd June 14:00 – 18:00 – Octroi Nancy

Zoom on iProduce demo

at L'OCTROI Nancy

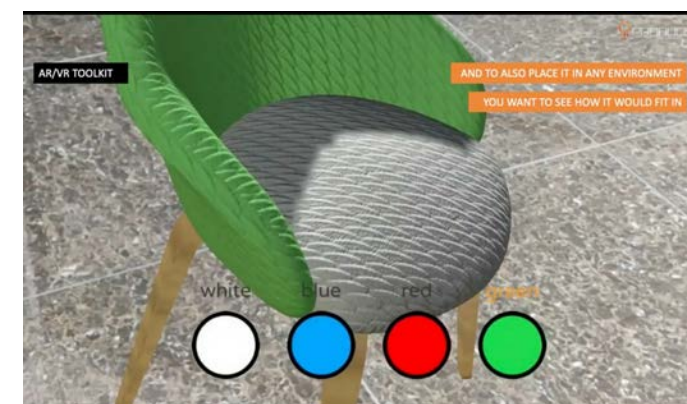
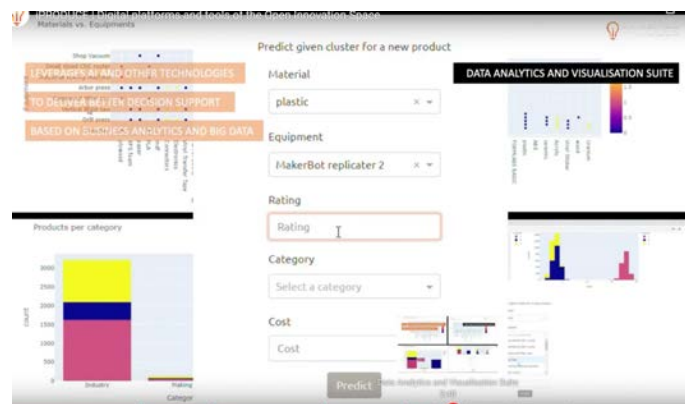
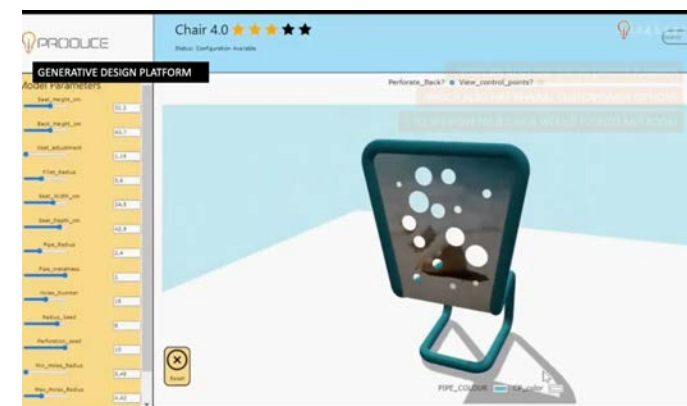



Wed. 22nd June 14:00 – 18:00 – Octroi Nancy



Zoom on iProduce local demo

at L'OCTROI Nancy



22/06/2022



2022 IEEE 28th ICE/ITMC & 31st IAMOT Joint Conference



140



Wed. 22nd June 9:00 – 12:00

Zoom on DIY4U



DIY4U focuses on digitalizing and transforming European industries and services involved in the formulation, production and supply of particulate and liquid based Fast-Moving Consumer Goods (FMCG), enhancing the innovation capacity and competitiveness through decentralized customer-centric production approaches, by promoting the adoption of Open Innovation (OI) digital platform for collaborative production engineering and Fablabs (digitally enabled small-scale manufacturing machines/factories).



Wed. 22nd June 14:00 – 18:00 – Octroi Nancy



Zoom on DIY4U demo

at L'OCTROI 



DIY4U brings together a leading global Fast-Moving Consumer Goods (FMCG) Company, expert Small-to-Medium Enterprises (SMEs) from across Europe and supporting Industry Innovation and Research & Technology Organisations (RTOs). Together, we will build an open innovation digital platform integrated into 2 small-scale automated manufacturing machines (Fablabs), for you to create and make customised FMCG.

This project will develop new digital services and end-to-end solutions to enable real-time design (either locally or remotely via web-based portals) and delivery of your customised FMCG product. The project is supported by external industry stakeholders, who also want to use our technologies and services

Our Offering

The Open Innovation digital platform will be a highly visible and transparent means of bringing together supply-chain stakeholders and consumers, enabling you to seamlessly collaborate on the efficient creation of new powder and/or liquid FMCG. Integrated digital tools will be used in conjunction with product and process information from ingredient suppliers and equipment manufacturers, to digitally design new, high performance customised products, which can then be made on the automated Fablabs.

Special Issue coming issue (open access)

“Do-It-Together” and innovation – [link to the call](#)

Guest Editor(s): Laurent Dupont¹, Fedoua Kasmi¹, Joshua M. Pearce², Roland J. Ortt³

1. Université de Lorraine, ERPI, F-54000 Nancy, France
2. Department of Materials Science and Engineering and Department of Electrical & Computer Engineering, Michigan Technological University
3. Department of Values, Technology & Innovation (VTI), Section Economics of Technology and Innovation (ETI), Delft University of Technology



2022 **IEEE 28th ICE/ITMC & 31st IAMOT JOINT CONFERENCE**

**Technology, Engineering and Innovation Management Communities
as Enablers for Social Ecological Transitions**

7 original papers – 6 already available:

1. **Marche, B., Kasmi, F., Mayer, F. & Dupont, L.** (2022). Implementing Do-It-Together: The Cross-fertilization of Do-It-Yourself and Open Manufacturing. *Journal of Innovation Economics & Management*, <https://doi.org/10.3917/jie.pr1.0122>
2. **Pallot, M. Fleury, S. Poussard, B. Richir S. et al.** (2022) What are the Challenges and Enabling Technologies to Implement the Do-It-Together Approach Enhanced by Social Media, its Benefits and Drawbacks? *Journal of Innovation Economics & Management* <https://doi.org/10.3917/jie.pr1.0132>
3. **Leiting, T., Külschbach, A. Stich, V. & Jana, F.** - *Development of Sustainable Business Models for Co-Creation Ecosystems* <https://doi.org/10.3917/jie.pr1.0129>
4. **Franz, J. & Pearce, J.** (2022). Making the Tools to Do-It-Together: Open-source Compression Screw Manufacturing Case Study. *Journal of Innovation Economics & Management*, <https://www.cairn.info/revue-journal-of-innovation-economics-2022-0-page-l123.htm>
5. **Garnier, & Capdevilla** (2022) Making, hacking, coding. FabLabs as intermediary platforms for modes of social manufacturing. *Journal of Innovation Economics & Management* <https://www.cairn.info/revue-journal-of-innovation-economics-2022-0-page-l128.html>
6. **M. Hassan, R. Mies, et al.** (2022) Key enablers towards mature company-community collaboration in open-source hardware *Journal of Innovation Economics & Management* <https://doi.org/10.3917/jie.pr1.0135>
7. **Thomas L., Samuel K.** - *Leveraging Open-Source Hardware Value with External Stakeholders: The case of Barcelona*, *Journal of Innovation Economics & Management*

Open Special Issue coming issue

3 Book recensions

1. Joshua M. Pearce. (2020) Create, share and save money using open-source projects, McGraw-Hill Education, 176 p. by **Boujut J-F. (INP Grenoble, G-Scope)**
2. Sylvain Fleury, Simon Richir (2022), Immersive Technologies to Accelerate Innovation: How Virtual and Augmented Reality Enables the Co-Creation of Concepts, Smart Innovation, London, ISTE, 192 p. by **Benjamin POUSSARD (ENSAM)**
3. Mariana Mazzucato (2021), Mission Economy: A Moonshot Guide to Changing Capitalism, Allen Lane, 272 p. by **Camargo M. (Université de Lorraine, ERPI)**

Thursday 23rd June - 9:00 – 12:00 – Octroi Nancy Posters & short talks & Demonstrators

Chairs: Dr. Fabio Cruz, Dr. Ferney Osorio, Université de Lorraine, France



1. Co-creation laboratories for mitigation and adaptation to climate change



2. Demonstrators from the Université de Lorraine and industrial partners



2022 IEEE 28th ICE/ITMC & 31st IAMOT JOINT CONFERENCE

**Technology, Engineering and Innovation Management Communities
as Enablers for Social Ecological Transitions**





Strengthening applied research and innovation capacities in Latin-America through co-creation labs for mitigation and adaptation to Climate Change (2020-2023)

Country	University	Thematic Focus
Brazil	Pontifícia Universidade Católica de Paraná	Urban Flood and Heat Island Management
	Pontifícia Universidade Católica do Rio Grande do Sul	Social Innovation and Community Development
	Universidade Católica de Pernambuco	Urban Sustainable Development & Community Resilience
Colombia	Universidad Minuto de Dios	Coffee Production and Watersheds
	Universidad de Caldas	Food Production and Urban Agriculture
	Universidad de Manizales	Sustainable Water Governance
	Universidad del Quindío	Climate Variability and Pollinators
Mexico	Universidad Tecnológica de Pereira	Women's and Children's Resilience and Climate Change
	Instituto Tecnológico y Estudios Superiores de Monterrey	Waste Management and Circular Economy
	Universidad de Guadalajara	Sustainable Food Production





VR technology Demonstration

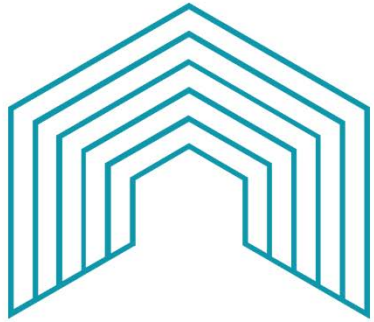

N-HUM-INNO



Humans at the Heart of the Challenges of the Digital Worlds

<https://n-hum-inno.eu/>

Contact: mauricio.camargo@univ-Lorraine.fr



AR technology Demonstration

Indico Project - <https://factuel.univ-lorraine.fr/node/20733>

Contacts: alex.Gabriel@univ-Lorraine.fr,
alaa.hassan@univ-lorraine.fr

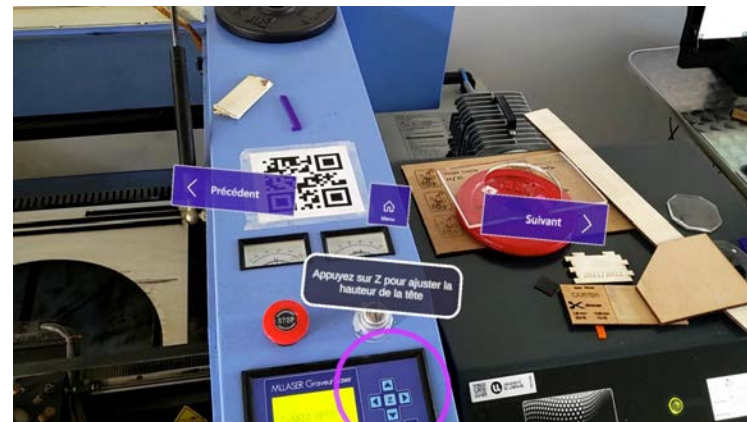
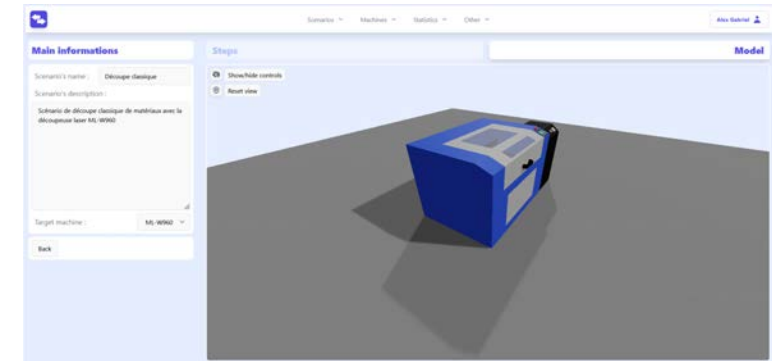

The chairs of these two EU project days thank

all the ERPI team, in particular: Benjamin Ennesser-Serville, Fedoua Kasmi, Alex Gabriel, Catalina Suescun Gonzalez, Giovanny Arbelaez, Brunelle Marche, Frédérique Mayer, Hakim Boudaoud, Vincent Boly, Davy Monticolo, Aurélia Geinsen, Aurianne Rainot, Cristian Caceres, Alexandre Astachenko, Romain Schafer, Anaëlle Hily, Julien Michaux, Diana Daza, Juan Pablo Ortega, Sebastián Cantillo, Beatriz Ferreira, Sara Lucía Umana, Marcos Felipe Medina, Albert Jean Paul Castro, Oussama Zaghar, Ashley Santoro-Duarte, and obviously Laure Morel & Mauricio Camargo

INEDIT project, in particular: Carlos Gonzalez, Alberto Botana, Ramon Angosto Artigues, Leopoldine, Hajar Rikaoui, Rahmi Turhan, Benjamin Poussard, Sylvain Fleury, Alexandre Nollet, Noémie Chappe, Simon Richir, Thomas Massé, Regina Schrank, Stephanie Harfensteller, Ivo Zeller, Steve Bageritz, Riccardo Canavesi, Siro Dell'Ambrogio, Andrea Valdata, Jorge Calado, Wojciech Swierczyk, Slawomir Opalka

Open_Next project, in particular: Mehera Hassan, Sara Reichert, Robert Mies, Christian Josef Thams, Mario Behling, Miriam Gradel, Martin Duchêne, Maxime Gravet, Jakob Lucca Kukula, Tuyet Oehme, Daniel Wessolek

iProduce project, in particular: Manuel Sánchez de la Asunción, Jérémy Keller, Elie Abou Absin

DIY4U project, in particular: Chandana Ratnayake

L'Octroi Nancy, in particular: Stéphanie Breton, Lucas Renaud and the Board of directors

GSI Media for the beautiful videos of the demonstrator



The chairs of these two EU project days thank

Climate labs project, in particular: [UCaldas] Camilo Vallejo, Daniel Vanegas, Sandra Montoya, Jose Gallego, Julio Vargas ; [UQ] Diana Marcela Duarte, Lina Marcela León, Ángela Jimena Chicaiza, Deibi Octavio Riascos ; [UManizales] Irma Soto Vallejo, Carlos Humberto González Escobar ; [UTP] Wilson Arenas Valencia, Erika Milena Echeverri, Carlos Mauricio Zuluaga ; [Uniminuto] Clara Andrea Montenegro B, Yenny Lorena Rincon, Sebastian Saenz, Tomas Duran, Wilson Espitia ; [PUCRS] Lucas Bonacina Roldan, Clécio Falcão Araújo, Luzia Menegotto Frick de Moura, Edimara Mezzomo Luciano, Altair Rosa, André Luiz Braga Turbay, Harry Alberto Bollmann, Luciene Pimentel da Silva ; [Unicap] Cynthia Suassuna, João Elton de Jesus, Fabio Pedrosa, Breno Carvalho, Valdenice Raimundo ; [Ashoka] Waldo Soto Bruna, Malu Landaberea, Remy Rupp, Brenda Berenice Villegas Valenzuela ; [UDG] Angélica Isabel García Navarro, Ray Freddy Lara Pacheco, Ildelfonso Enciso Padilla ; [TEC] Misael Sebastian Gradilla Hernandez, Diego Diaz Vazquez, Carolina Senés Guerrero, Patricia Cuevas Servin, Monica Gonzalez Frias ; [UPV] Carola Calabuig Tormo, Álvaro Fernández-Baldor Martínez ; [Unige] Christiano Lepratti, Ayla Schiappacasse, Giovanni Galli ; [ULorraine] Ferney Osorio, Mauricio Camargo ; [Uniminuto] Wilson Espitia

HyValue project, in particular: Markus Schmidtner, Robert Bierwolf, Anna Schidek, Phillip Hansen, Holger Timinger, Alexander Ziegler, Kirsten Hentschl & Andreas Trautheim-Hofmann

DigiTeRRI project, in particular: Marianne Hörlesberger, Manfred Paier, Jens Ørding Hansen, Lucia Gonzalez Aguilar, Malin Stegmann McCallion, Alexis Steiner, Jean Jacques Bernardini



2022 IEEE 28th International Conference on Engineering, Technology and Innovation (ICE/ITMC) & 31st International Association For Management of Technology (IAMOT) Joint Conference ©

Supporting Institutions



Local Organizers



Sponsors



EU projects

