



HAL
open science

Planification technico-économique de la production décentralisée raccordée aux réseaux de distribution

Siyamak Porkar Koumleh

► **To cite this version:**

Siyamak Porkar Koumleh. Planification technico-économique de la production décentralisée raccordée aux réseaux de distribution. Autre. Université Henri Poincaré - Nancy 1, 2011. Français. NNT : 2011NAN10021 . tel-01747098

HAL Id: tel-01747098

<https://hal.univ-lorraine.fr/tel-01747098>

Submitted on 29 Mar 2018

HAL is a multi-disciplinary open access archive for the deposit and dissemination of scientific research documents, whether they are published or not. The documents may come from teaching and research institutions in France or abroad, or from public or private research centers.

L'archive ouverte pluridisciplinaire **HAL**, est destinée au dépôt et à la diffusion de documents scientifiques de niveau recherche, publiés ou non, émanant des établissements d'enseignement et de recherche français ou étrangers, des laboratoires publics ou privés.



AVERTISSEMENT

Ce document est le fruit d'un long travail approuvé par le jury de soutenance et mis à disposition de l'ensemble de la communauté universitaire élargie.

Il est soumis à la propriété intellectuelle de l'auteur. Ceci implique une obligation de citation et de référencement lors de l'utilisation de ce document.

D'autre part, toute contrefaçon, plagiat, reproduction illicite encourt une poursuite pénale.

Contact : ddoc-theses-contact@univ-lorraine.fr

LIENS

Code de la Propriété Intellectuelle. articles L 122. 4

Code de la Propriété Intellectuelle. articles L 335.2- L 335.10

http://www.cfcopies.com/V2/leg/leg_droi.php

<http://www.culture.gouv.fr/culture/infos-pratiques/droits/protection.htm>



Faculté des Sciences et Technologies, Secteur MIAE
Ecole Doctorale: Informatique- Automatique-
Electrotechnique- Electrique- Mathématique (IAEM)
Département de Formation Doctorale (DFD):
Electrotechnique - Electronique

Sharif University of Technology
Dept. of Electrical Engineering

Thèse (Co-tutelle)

Présentée pour l'obtention du titre de **Docteur de l'université Henri Poincaré, Nancy-1** en Génie Electrique

Planification technico-économique de la production décentralisée raccordée aux réseaux de distribution

ET

Ph. D. Thesis of Sharif University of Technology (SUT), Tehran

Distribution System Planning Implementing Distributed Generation

Soutenue le 10 janvier 2011

Par **Siyamak PORKAR KOUMLEH**

Membres du jury :

Rapporteurs
(partie Française):

J.M. KAUFFMANN

Professeur émérite, FEMTO, Université de Franche comté, Besançon

N. HADJSAID

Professeur, G2Elab, INPG, Grenoble

Examineurs
(partie Française):

P. POURE

Maître de conférences, LIEN, UHP-Nancy 1

S. SAADATE

Professeur, GREEN, UHP-Nancy 1

Examineurs
(partie Iranienne):

A. ABBASPOUR

Assistant Professor, SUT, Téhéran

A.M. RANJBAR

Professor, SUT, Téhéran

M. VAKILIAN

Professor, SUT, Téhéran

G. GHAREHPETIAN

Professor, Amirkabir University of Technology, Téhéran

Résumé

Planification technico-économique de la production décentralisée raccordée aux réseaux de distribution

I. Introduction

La plupart des pays en voie de développement connaît une croissance importante de la demande en énergie. Cette croissance, liée à celle de la population et à l'amélioration du niveau de vie, est estimée à une moyenne annuelle d'environ 3,8% pour les trois prochaines décennies.

Pour satisfaire cette expansion des besoins énergétiques, de nombreux investissements associés à une politique énergétique adéquate sont nécessaires, tant pour la construction de nouvelles unités de production que pour l'amélioration et l'extension des réseaux de transport et de distribution actuels. La question de fond est de savoir comment ce développement indispensable devrait s'effectuer.

Dans les conditions économiques actuelles, les aides publics ne cessent de décroître, aggravant ainsi les difficultés à mobiliser les financements indispensables pour construire des systèmes énergétiques cohérents.

La Commission mondiale sur l'environnement et le développement définit le développement durable comme étant "le développement qui satisfait aux besoins du présent sans compromettre la capacité des générations futures à satisfaire leurs besoins". Ainsi, la recherche d'une voie de développement durable impose trois conditions à remplir simultanément:

- L'amélioration de la qualité de vie,

- Le maintien d'un accès permanent aux ressources naturelles, qu'elles soient renouvelables ou non-renouvelables,
- La réduction des émissions de déchets ou de polluants de manière à éviter tous dégâts environnementaux persistants.

Il y a donc lieu d'envisager une décentralisation de la production d'électricité basée sur les ressources en énergies renouvelables, l'augmentation de la production n'étant pas sans conséquence sur l'environnement. Cependant, les bases d'une telle stratégie énergétique doivent être économiquement efficaces, socialement équitables, environnementalement viables et contribuer à la réduction des disparités.

Examinons le cas d'un pays comme le Brésil où l'introduction à partir des sources renouvelables et l'amélioration de l'efficacité énergétique a contribué de manière significative à la réduction des Gaz à Effet de Serre (GES). Le programme de conservation de l'énergie électrique (PROCEL) a permis d'éviter en 1997 la production de 1,2 million de tonnes de GES (en équivalent-dioxyde de carbone), limitant ainsi les émissions du secteur électrique à 17 millions de tonnes d'équivalent-dioxyde de carbone. Son expansion, couplée à un accroissement des centrales thermiques prévu pour les deux prochaines décennies, laisse envisager une baisse des émissions de GES du secteur électrique de 32% entre 1990 et 2020.

Le protocole de Kyoto crée le Mécanisme de Développement Propre (MDP). Le MDP va permettre aux *Pays En (voie de) Développement* (PED), soit d'initier eux-mêmes des projets réduisant les émissions de GES, soit en partenariat avec des pays industrialisés et en retour vendre à ces derniers les réductions d'émissions certifiées. Si le MDP est bien implanté dans le secteur énergétique, il contribuera à renverser ou freiner la tendance d'utilisation accrue des énergies fossiles. Il faut préciser que le succès de ce mécanisme dépendra de la capacité des gouvernements des PED à établir des critères permettant de juger de la durabilité des projets, des bénéfices du transfert technologique et des réductions de la pollution.

I.1. Dérégulation du marché de l'énergie

Traditionnellement, le secteur de l'électricité est détenu par un seul opérateur historique, qui gère à la fois la production de l'énergie, son transport et sa distribution vers ses clients. C'était une situation dite de «monopole», où les clients, hormis quelques gros

consommateurs industriels ou ceux raccordés à de rares distributeurs indépendants, n'ont pas eu le choix de leur fournisseur.

La dérégulation des marchés de l'énergie électrique, qui a commencé depuis la fin du XXIème siècle, a créé des changements profonds dans le secteur de l'électricité. La séparation entre la production, le transport et la distribution donne une nouvelle occasion aux entreprises de se restructurer afin d'affronter la concurrence nouvelle. Cette libéralisation se traduit pour les consommateurs par la possibilité de choisir un fournisseur autre que le fournisseur historique.

Pendant des décennies, les caractéristiques technico-économiques du secteur électrique ont été favorables à l'apparition de puissants monopoles "verticalement intégrés". La principale raison provenait des coûts très élevés de la construction et de l'entretien des infrastructures de production, de transport et de distribution de l'électricité. Ce coût financier impliquait indirectement la notion de monopole du réseau.

Le rythme du développement du monde économique est souvent deux ou trois fois plus rapide que celui du système énergétique. En effet, le système électrique a été confronté ces dernières années à une opposition croissante à l'implantation de nouveaux équipements de transport, de nouvelles centrales de production et à une pression sur les coûts.

L'évolution du réseau était basée sur l'économie, la sécurité du système et la qualité de fourniture de l'énergie. La libéralisation de la production d'électricité offre des opportunités à de nouveaux acteurs qui pourraient bénéficier du nouveau cadre de la politique énergétique. Le consommateur bénéficie d'économie financière. Les entreprises de services énergétiques (y compris les producteurs et les distributeurs d'électricité) y voient un moyen de développer leurs marchés dans de nouveaux créneaux qui s'inscrivent bien dans le processus de libéralisation du marché d'énergie et qui bénéficient d'un soutien politique. Finalement, la collectivité y trouve un triple avantage environnemental, de préservation des stocks d'énergie fossile et d'émergence de nouveaux emplois.

D'ailleurs, depuis ces dernières décennies, un ensemble de raisons diverses telles que :

- l'obligation de réduire l'émission de GES (protocole de Kyoto en 1997)
- la menace de l'épuisement de l'énergie fossile
- le souci de l'indépendance énergétique
- le développement durable

- le développement de nouvelles technologies de petites productions et de moyens de stockage
- l'ouverture à la concurrence du marché de l'énergie

ont encouragé les producteurs à développer la production décentralisée ou Génération d'Énergie Dispersée (GED), en particulier sur la base des énergies nouvelles et renouvelables et des solutions à haut rendement énergétique.

I.2. Génération d'Énergie Dispersée (GED)

Dans un contexte de dérégulation, une arrivée massive de GED (comme les éoliennes, la biomasse, les micro-turbines, les piles à combustibles, les panneaux solaires, ...) au niveau de la Haute Tension de niveau A (HTA, principalement 20/33 kV) et de la Basse Tension (BT, principalement 400/230V) était à prévoir.

De nombreux avantages, techniques et économiques, justifient le développement de ce type de production, parmi lesquels nous relevons les suivants:

- La production d'énergie plus près des consommateurs d'où une baisse des coûts de transport et de distribution, ainsi que la réduction des pertes dans les lignes.
- La substitution de l'énergie conventionnelle «polluante» par des énergies nouvelles plus «propres» et silencieuses.
- Un intérêt économique très important pour les exploitants de GED grâce aux subventions accordées.
- En matière de planification, face à une augmentation de la charge, l'insertion de GED sur le réseau de distribution permet d'éviter la construction de nouvelles lignes HTB.
- La plus grande facilité de trouver des sites pour installer de petits générateurs.
- Le temps d'installation relativement court de GED.
- Pour l'alimentation de sites isolés, il peut être plus rentable d'alimenter un réseau de distribution local avec des GED plutôt que de le relier à un poste HTB/HTA lointain.

- La cogénération, une des formes de GED la plus répandue, améliore le rendement énergétique.

Les enjeux financiers, la politique énergétique des pays et les orientations stratégiques des distributeurs influencent fortement le développement des réseaux. Dans la grande majorité des pays électriquement développés, la distribution d'électricité est concédée à un distributeur désigné par l'état ou la collectivité locale responsable. Ce distributeur a alors un monopole sur un territoire délimité. Cette situation permet le développement d'un réseau de distribution optimal pour la collectivité desservie.

Dans ce contexte, les choix de dimensionnement du réseau par le distributeur tiennent donc compte de facteurs socio-économiques importants comme :

- éviter les préjudices graves causés soit par une discontinuité de service (par exemple une perte de production) soit par une qualité insuffisante,
- éviter d'avoir un coût d'installation, de maintenance et de fonctionnement trop élevé.

Les gestionnaires du réseau, souhaitent, dans la mesure du possible, d'une part avoir le plus d'énergie fournie par des GEDs, et veulent d'autre part limiter, dans les situations critiques, leur influence négative sur le réseau. Cet impératif demande une très bonne connaissance et une bonne identification des GEDs dans le réseau. On devra donc disposer des informations précises sur la technologie utilisée, le point de raccordement, le régime de fonctionnement, l'emplacement, la taille et le prix de revient de la production d'électricité.

Généralement, pour la planification (gestion) de GED dans les réseaux de distribution, le dimensionnement de chaque élément du réseau doit donc être défini de manière à ce qu'il puisse répondre aux contraintes immédiates mais aussi futures, d'où l'importance d'une optimisation basée sur un calcul ou optimisation technico-économique à long ou moyen terme tenant compte du bouclage implicite (réseau de qualité, prix de revient, choix énergétiques de la clientèle). L'optimisation a conduit au développement de réseaux dits «forts» c'est-à-dire capables d'évolutions importantes en termes de capacité d'accueil de nouvelles charges.

L'insertion de GED dans les réseaux de distribution fait que ces réseaux deviennent pratiquement des réseaux dits "actifs". Aujourd'hui, du fait de l'insertion de GED, les flux de puissance et les tensions seront gouvernés non seulement par les charges mais aussi par

les sources et par ailleurs, la caractéristique d'intermittence de GED pourrait avoir une influence néfaste sur la qualité de l'énergie fournie aux clients. Les influences les plus significatives de GED sur le réseau de distribution sont étudiées dans cette thèse. En particulier, l'impact de GED sur le plan de tension dans les réseaux de distribution doit donc être traité de manière prioritaire afin de permettre l'insertion de GED (au niveau HTA et BTA) à des taux de pénétration élevés tout en respectant les contraintes légales sur la tension. A cet égard, les autres moyens de régulation du plan de tension, comme les bancs de condensateurs, les compensateurs synchrones, éventuellement les D-FACTS ou l'injection du réactif par les producteurs, ou encore les transformateurs réglables sous charge peuvent être tous considérés comme des concurrents de GED. Les lignes et les transformateurs du réseau peuvent se trouver en surcharge avec la croissance de la demande. L'insertion de GED dans les réseaux de distribution peut apporter une solution à l'accroissement de la demande énergétique. Elle permet, en outre, comme nous l'avons mentionné ci-dessus, de réduire les pertes du système, d'améliorer la qualité de service et la fiabilité du système.

Ensuite, cette thèse traitera des points suivants:

- Brève description des réseaux de distribution,
- Présentation d'une méthodologie systématique d'optimisation de la planification des réseaux de distribution incluant la GED,
- Etude des effets des paramètres des réseaux sur l'insertion de GED,
- Etude systématique des impacts de GED sur le réseau.

II. Optimisation de la planification des réseaux de distribution

Les algorithmes d'optimisation utilisés pour résoudre les problèmes de planification visent très souvent des problèmes spécifiques. Nous avons donc décidé de développer notre propre algorithme dédié à la coordination des moyens d'ajustement et de la planification de GED dans les réseaux de distribution.

La définition du problème d'optimisation de dimension n peut s'écrire de manière générale sous la forme suivante :

$$\begin{cases} \text{Min } F(x) & x = \{x_1, x_2, \dots, x_n\} \in R^n \\ g_i(x) = 0 & i = \{1, 2, \dots, p\} \\ h_j(x) \leq 0 & j = \{1, 2, \dots, q\} \end{cases}$$

Avec :

$F(x)$ la fonction à minimiser; elle est couramment appelée fonction «objective»,

x le vecteur de n variables qui représente les paramètres du problème à optimiser,

$g_i(x)$ les contraintes d'égalité (exemple : calcul de répartition),

$h_j(x)$ les contraintes d'inégalité (tensions maximales, puissances transmissibles maximales).

La résolution de ce problème consiste alors à explorer l'espace de recherche afin de déterminer le point de cet espace (optimum noté x_{optim}) qui minimise la valeur de la fonction objective tout en respectant les contraintes d'égalité et d'inégalité.

II.1. Méthodes d'optimisation appliquées à la planification des réseaux de distribution

Les méthodes utilisées pour résoudre le problème de planification peuvent être divisées en deux catégories: les méthodes de programmation mathématique (méthodes déterministes) et les méthodes non déterministes (ou stochastiques), notamment celles utilisant des algorithmes évolutifs. Les méthodes déterministes sont efficaces lorsque l'on a une idée de l'optimum global (en effet, celle-ci converge vers l'optimum le plus proche du point de départ). Les cas plus complexes (nombreux optima locaux, fonctions non dérivables, etc.) sont souvent traités par des méthodes non déterministes. Celles-ci peuvent cependant mener à des temps de calcul plus importants.

La programmation mathématique d'un problème technico-économique consiste à chercher, parmi tous les points x vérifiant certaines conditions celui qui rend maximal (ou minimal, suivant le cas) un certain critère $f(x)$, qui sera interprété comme un gain dans le premier cas (et comme un coût dans le second). Quand la variable x est de dimension finie, et que ses composantes (x_1, \dots, x_n) ne peuvent prendre que des valeurs entières, on parle de programmation en nombres entiers; quand elle est continue, c'est-à-dire quand x décrit R_n ou un autre espace vectoriel, on parle de programmation linéaire, convexe ou non convexe suivant les propriétés des fonctions f , g et h . Enfin, la variable x peut se présenter comme une fonction d'autres variables plus primitives, notamment le temps; on emploie alors la programmation dynamique. La programmation mathématique peut donc se définir comme l'analyse numérique des problèmes d'optimisation et de contrôle. Elle a eu une grande importance historique, car à une époque où les moyens de calcul étaient loin d'être ce qu'ils

sont devenus maintenant, seules des méthodes numériques très performantes pouvaient faire le lien entre la théorie et la pratique, c'est-à-dire démontrer aux utilisateurs la pertinence des modèles adoptés par les chercheurs, et alimenter ces derniers en problèmes concrets.

Les techniques pour résoudre les problèmes mathématiques dépendent de la nature de la fonction objective et de l'ensemble des contraintes. Les sous-domaines majeurs suivants existent :

- la programmation linéaire¹ étudie les cas où la frontière de l'ensemble des contraintes et les fonctions objectives sont linéaires. C'est une méthode souvent employée pour établir les programmes des raffineries pétrolières, mais aussi pour déterminer la composition la plus rentable d'un mélange salé, sous contraintes, à partir des prix de marché du moment.
- la programmation linéaire en nombres entiers mixtes² étudie les programmes linéaires dans lesquels certaines ou toutes les variables sont contraintes à prendre des valeurs entières. Ces problèmes peuvent être résolus par différentes méthodes: séparation et évaluation, plans sécants,....
- la programmation quadratique³ permet à la fonction objective d'avoir des termes quadratiques, tout en conservant une description de l'ensemble des contraintes à partir d'égalités/inégalités linéaires.
- la programmation non-linéaire⁴ étudie le cas général dans lequel l'objectif ou les contraintes (ou les deux) contiennent des parties non-linéaires.

Dans cette approche, il est possible de représenter les principales restrictions de manière explicite (lois de Kirchhoff, les capacités du matériel, chute de tension, budget) et de minimiser les coûts fixes et variables découlant de l'installation et du remplacement des équipements. Lorsque la programmation en nombres entiers mixtes est utilisée, des considérations pratiques limitent souvent le nombre de solutions. Ceci, combiné avec les possibilités à la fois de garantir l'optimalité et l'utilisation des ressources informatiques actuellement disponibles, rend l'approche très attractive.

¹ Linear Programming (LP)

² Mixed-Integer Programming (MIP)

³ Quadratic programming (QP)

⁴ Non-Linear Programming (NLP)

Depuis 1980, beaucoup d'efforts ont été dirigés vers la résolution des problèmes de la planification dans les réseaux de distribution par l'utilisation d'algorithmes non déterministes qui venaient offrir une alternative à la programmation mathématique. Les méthodes non déterministes ont suscité un fort intérêt car elles permettent de travailler de façon simple et claire avec des contraintes non-linéaires et minimiser (ou maximiser) la fonction objective. Cependant, il n'y a aucune certitude qu'une solution optimale puisse être trouvée. Toutefois, dans cette approche, il est également facile d'introduire des aspects tels que les pertes, la fiabilité et les incertitudes.

Les méthodes non déterministes font appel à des tirages de nombres aléatoires ; ainsi, l'exécution successive de ces tirages conduit à des résultats différents pour un même problème d'optimisation. Elles présentent l'avantage de ne pas dépendre du point de départ et de ne pas s'arrêter sur des optima locaux, si les réglages sont corrects. Cependant, elles demandent un nombre important d'évaluations avant d'arriver à la solution du problème. Les méthodes les plus employées sont:

- *Le recuit simulé*⁵: on effectue des déplacements aléatoires à partir d'un point de départ; ces déplacements sont évalués, puis acceptés ou non. Dans son origine, le recuit simulé alterne des cycles de refroidissement lent et de réchauffage (recuit) qui tendent à minimiser l'énergie du matériau. A chaque configuration du système est associée une fonction à minimiser, l'énergie dans ce cas. On part d'une configuration aléatoire (ou choisie astucieusement en fonction du problème). Au départ de l'itération, on fixe un paramètre, la température, en relation avec la gamme des énergies accessibles au système. On itère alors le processus par tirage au sort et on modifie la configuration actuelle qui aboutit à un changement de l'énergie du système. Si l'énergie diminue, on valide le changement. Si l'énergie augmente, on modifie la température selon une loi de probabilité exponentielle. L'itération se poursuit tant que l'énergie du système diminue. On arrête lorsque la diminution de température devient inefficace.
- *la recherche Tabou*⁶: on ajoute une mémoire rudimentaire à un algorithme de recherche et on essaye de copier la réflexion qu'aurait un opérateur qui parcourt lui-même l'espace des solutions. Ce dernier, malgré son objectif de descente s'autorise

⁵ Simulated Annealing (SA)

⁶ Tabu Search (TS)

une fois le premier minimum local trouvé, à chercher d'autres directions de recherche qui dégradent la fonction objective. Il se souvient des derniers chemins qu'il a empruntés et s'interdit de les réutiliser avant un certain nombre d'itérations (liste tabou).

- *les algorithmes génétiques*⁷ : ils sont basés sur la théorie de l'évolution de Darwin et consistent à faire évoluer une population de dispositifs à l'aide de différents opérateurs (sélection, croisements, mutations). Ils sont particulièrement bien adaptés aux problèmes d'optimisation comportant des paramètres et des objectifs multiples.
- *la programmation dynamique*⁸ : elle utilise la propriété qu'une solution optimale se compose nécessairement de sous-solutions optimales (attention : le contraire n'est pas vrai en général) pour décomposer le problème en évitant l'explosion combinatoire. Elle n'est utilisable que lorsque la fonction objective est croissante et monotone.

II.2. Méthodes de placement optimal des moyens de réglage et d'optimisation multiobjectif

Le choix de la fonction objective est primordial dans un processus d'optimisation. En effet, on peut obtenir des performances très différentes par rapport à des choix qui peuvent paraître sans grande conséquence a priori.

Ce choix est particulièrement important lors de la planification des réseaux de distribution, car le caractère distinctif des objectifs d'optimisation, qui peuvent s'opposer l'un à l'autre (par exemple, le coût de l'investissement contre celui du délestage), a un impact considérable sur la recherche de la configuration optimale. En effet, dans notre cas, nous sommes face à un problème d'optimisation multiobjectif.

Dans une problématique de réduction du coût de réglage, une réflexion a été menée sur le choix et la localisation des moyens de réglage. Ce choix doit être optimal pour permettre de minimiser les coûts totaux de la planification des réseaux de distribution dans le cadre du marché spot.

Dans cette thèse, la méthode d'agrégation, qui est l'une des plus anciennes en matière

⁷ Genetic Algorithm (GA)

⁸ Dynamic Programming (DP)

de programmation mathématique est utilisée pour résoudre le problème d'optimisation multiobjectif défini comme suit:

$$\text{Min } y = F(x) = \{f_1(x), f_2(x), f_3(x), \dots, f_k(x)\}$$

$$\text{Avec } e(x) = \{e_1(x), e_2(x), e_3(x), \dots, e_k(x)\} \leq 0 \\ x \in X$$

où:

- $F(x)$ est la fonction multiobjective formée de k fonctions objectives $f_j(x)$, $j=1$ à k ;
- $e(x)$ la ou les équations (au nombre de h) qui se réfèrent à des conditions d'égalité (exemple : calcul de répartition);

La résolution de ce problème est différente du problème d'optimisation présenté précédemment. Le résultat doit, en fait, être un ensemble de solutions qui minimise simultanément les k fonctions objectives. Cette introduction montre le degré de difficulté de la résolution d'un problème multiobjectif.

III. Nouvelle méthode de simulation

Depuis les années 1980, le développement rapide des algorithmes et des codes informatiques a rendu possible la résolution de problèmes de grande taille par une approche de programmation mathématique.

Le code numérique General Algebraic Modeling System (GAMS) a été le premier qui a utilisé le langage de modélisation algébrique (Algebraic Modeling language ou AML). Dans cette approche, les modèles sont décrits en formulations algébriques concises, lisibles à la fois par les humains et les machines. GAMS se compose d'un compilateur de langage propriétaire et d'une série de solveurs intégrés, à haute performance. Il est spécifiquement conçu pour ce type de problème, c'est-à-dire de grande taille et complexe, et permet la création et la maintenance des modèles pour une grande variété d'applications et de disciplines.

Les différentes techniques de résolution des problèmes mathématiques précédemment citées, LP, NLP, MIP, MINLP, QP et DP sont applicables aux modèles utilisés dans GAMS. En plus, grâce à la souplesse de ses solveurs, tout changement dans la fonction objective est facile à introduire. A titre d'exemple, si l'on souhaite rajouter une variable entière dans le problème non-linéaire, il est simplement nécessaire de changer le solveur en un autre

qui est capable de résoudre le problème entier mixte. Par conséquent, la fonction objective peut être facilement changée selon les décideurs ou planificateur et des options de planification disponibles, sans nécessité de modification du modèle initial.

Cependant, d'autres logiciels comme MATLAB proposent des outils d'optimisation mais qui ne sont performants que pour des modèles non linéaires à petite échelle. À l'opposé, le GAMS est capable de résoudre des problèmes d'optimisation mathématique de grande échelle mais il présente quelques faiblesses pour la manipulation de données et la visualisation des résultats, alors que MATLAB est bien mieux adapté à ces tâches. Ces constatations sont à l'origine de l'idée d'utiliser ces deux codes ensemble dans ce travail.

III.1. Progiciel développé dans ce travail

Les objectifs dans cette thèse sont les suivants :

- Considérer toutes les options de planification possibles et l'ensemble des contraintes dans un modèle d'optimisation multiobjective pour s'approcher des résultats les plus réalistes possibles;
- Résoudre le problème d'optimisation aussi rapidement que possible même pour des systèmes de distribution réels avec un grand nombre de variables et de paramètres;
- Développer un progiciel facile à utiliser et à employer par des planificateurs de systèmes de distribution.

L'utilisation simultanée de GAMS et MATLAB qui a fait l'objet de nombreux travaux de recherche ne peut convenir pour notre recherche car elle présente des restrictions majeures suivantes concernant :

- Le choix de la planification des réseaux de distribution au niveau de GED, régulateurs de tension, banc de condensateurs, compensateur synchrone, délestage, ...
- Le choix des contraintes du problème et les possibilités de changer les limites selon les conditions du système;
- Les possibilités d'entrer les fluctuations du prix de l'électricité et celles de la charge sous forme d'une matrice ou d'un fichier attaché en format EXCEL;
- Le changement du solveur de GAMS selon le changement de variable x . Par exemple, le type de GED peut être défini comme une variable positive ou un nombre entier positif multiple d'un scalaire, en raison de sa nature discrète. En

conséquence, le type de modèle devrait être changé de DNLP à MINLP.

Il nous a donc été nécessaire de développer un nouveau progiciel reliant ces deux logiciels, permettant ainsi la planification des systèmes de distribution afin d'atteindre les objectifs fixés en se libérant des restrictions mentionnées ci-dessus.

Le schéma de la figure 1 présente cette démarche. Nous allons ensuite utiliser le code développé dans notre laboratoire dans le cadre de cette thèse pour l'étude de quelques cas réels afin de valider son efficacité.

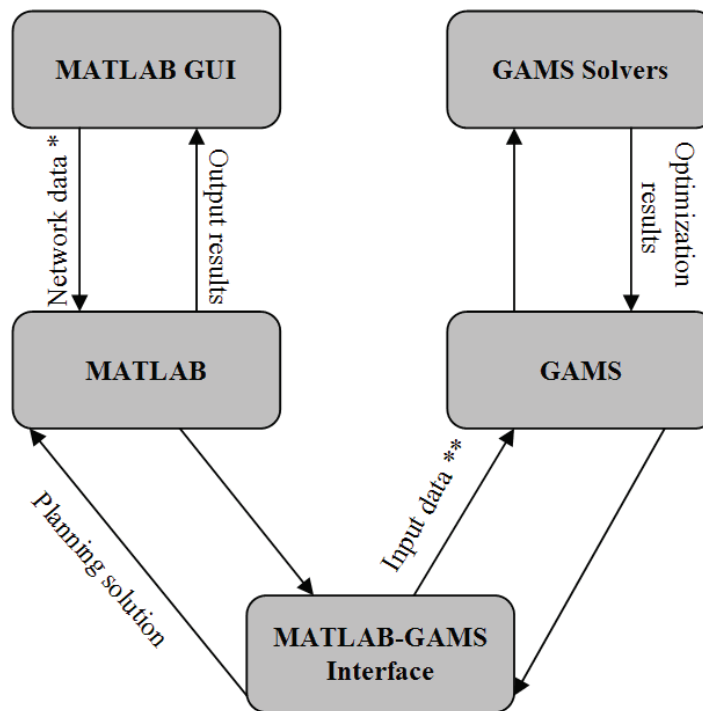

* Input data : network, electricity market and DG data

** In format of adjustable with GAMS

Fig. 1: MATLAB-GAMS interface

III.2. Étude de cas

Les modèles mathématiques développés ont été examinés pour un système IEEE 30-Bus modifié et extrait d'un système de distribution réel (celui de Midwestern US, Fig.2). Il se compose de deux sous-systèmes; le système de transmission de 132 kV (les nœuds numéro 1-8 et 28) munis des transformateurs 132/33 kV et le système de distribution de 11 ou 33 kV (les autres nœuds). La tension des nœuds numérotés 1 à 4 est égale à 132kV et on suppose que la tension des autres nœuds est égale à 33kV. Le système modifié est présenté sur la Fig. 3.

Deux Transmission Companies ("T" comme TRANSCOs) sont connectées aux nœuds 1 et 2 et quatre Compensateurs Synchrones ("C" pour CS) sont reliés aux nœuds 5, 8, 11 et 13.

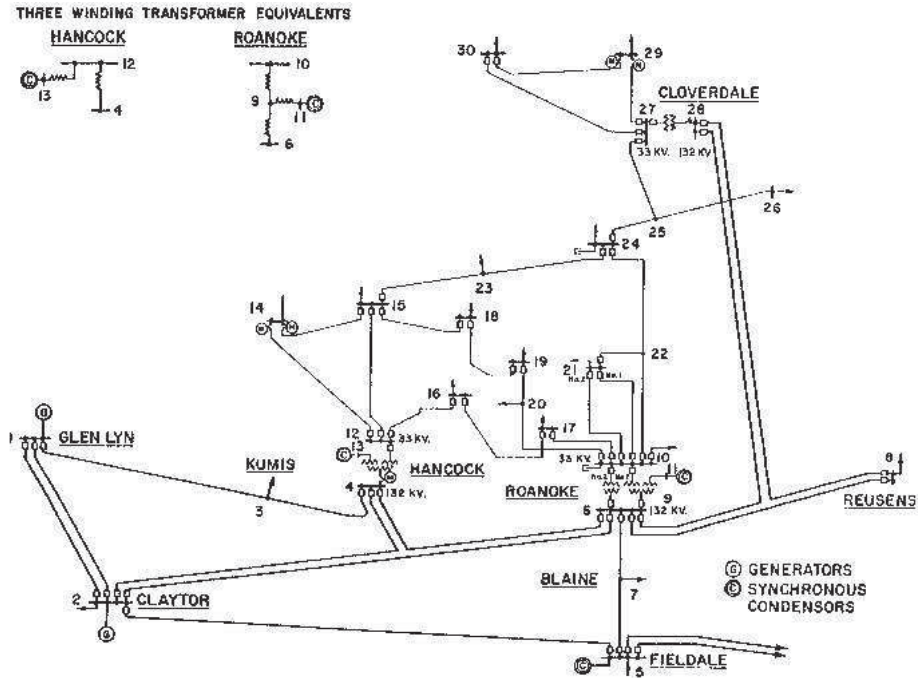

Fig. 2 : Partie du système de distribution du Midwestern US.

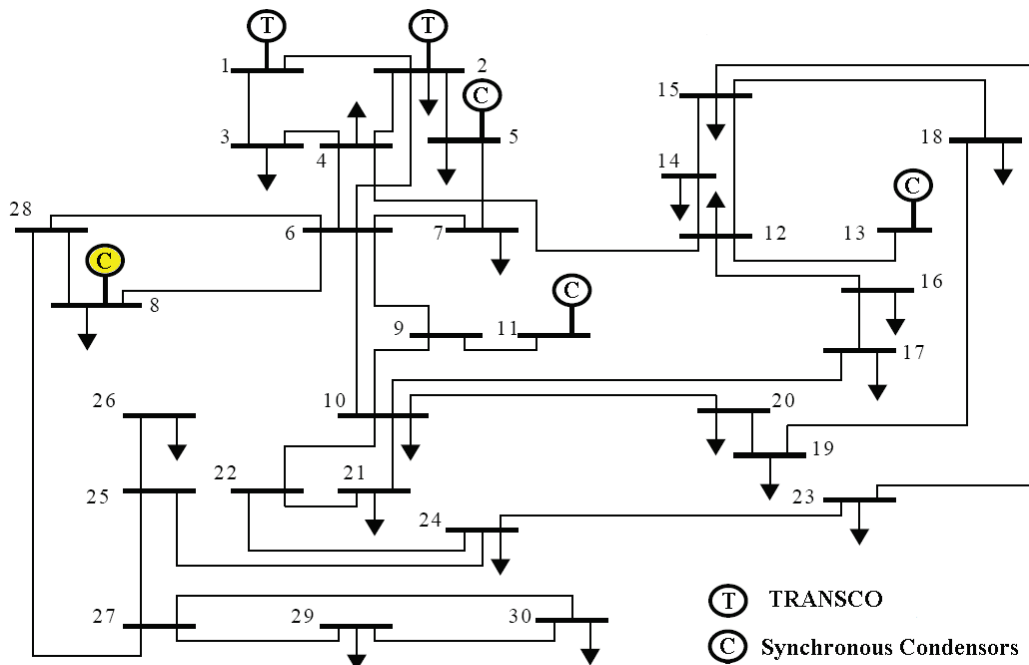

Fig. 3 : Système modifié d'IEEE 30-Bus étudié.

Afin d'illustrer l'effet des différentes conditions de fonctionnement du réseau sur la recherche de l'optimum, trois cas différents sont étudiés:

Cas 1 - La tension aux différents nœuds et les puissances transmises par les différentes lignes restent dans leurs limites autorisées. On suppose que cela soit le cas même lors de la croissance de charge sur la période d'étude (5 ans dans notre cas). Le but de l'étude est de chercher la taille et l'emplacement optimal des GED afin de minimiser le coût total du système, incluant également celui des pertes dans les lignes et du délestage.

Cas 2 - La tension à certain(s) nœud(s) sort de la limite autorisée. Pour réaliser concrètement ce cas, il est supposé qu'il n'y a pas de CS raccordé au bus 8 (le CS 40MVar du bus 8 est hors service). Dans cette situation, la tension du système à certains nœuds n'est pas dans ses limites admissibles. Par conséquent, sans l'insertion de GED et/ou de CS, il est nécessaire de réduire certaines charges pour éviter une chute de tension généralisée dans le système. Ainsi, dans ce cas, l'objectif est de trouver la meilleure combinaison de l'utilisation de GED et/ou de CS pour restabiliser la tension du système, tout en minimisant le coût total, comme pour le cas précédent.

Cas 3 - La tension à certain (s) nœud (s) et les puissances transmises par certaine (s) ligne (s) sortent de leurs limites autorisées. Afin de se trouver dans ce cas, en plus du CS du bus 8 mis hors service, on baisse volontairement les capacités en puissance transmissibles de certaines lignes (Voir tableau 4.4 du manuscrit anglais). Le but de l'étude est, en plus des objectifs du cas 2, d'éviter l'apparition de toute congestion dans les lignes du réseau, au regard de la baisse de capacité de transmission de certains d'entre elles.

III.3. Planification du système de distribution pour le long ou moyen terme

Le concept développé dans ce travail consiste à exploiter la GED comme une option dans la planification des systèmes de distribution appelés à se développer dans le futur. Pour cela, trois approches sont développées, chacune avec son modèle mathématique approprié et son propre cahier des charges. Elles seront détaillées dans les sections suivantes. Les trois cas d'étude précédents sont examinés par la première et troisième, alors que la seconde approche est uniquement examinée pour le second cas.

L'insertion de GED dans des emplacements stratégiques peut nous faire éviter l'achat et l'installation de tout nouvel équipement, comme des lignes et des transformateurs, pour les réseaux de transmission ou distribution (T&D), jusqu'à la prochaine évaluation des besoins. Elle contribue également à l'amélioration de la congestion dans les lignes des réseaux de distribution. La GED peut également servir pour satisfaire aux besoins locaux

en charge ou surcharge et, de ce fait, réduire les pertes, le coût du T&D et augmenter la qualité de service

III.3.1. Première approche

Il s'agit d'utiliser la GED comme un outil attrayant pour résoudre le problème de planification de système de distribution confronté à une croissance de charge dans certains territoires de DISCO⁹. Le nouveau modèle proposé pour la planification du système de distribution étudie la rentabilité de mise en œuvre de la GED. Il en résulte des décisions stratégiques d'investissement dans la GED qui sont principalement basées sur les structures de ces dispositifs et le prix de l'électricité.

Dans une optimisation multiobjective, des fonctions objectives et un ensemble de contraintes sont définies. Les objectifs d'optimisation sont de réduire simultanément les coûts de:

- L'expansion du réseau (dans cette étude, l'installation de GED ($C_{In\ DG}$) et leur coût d'opération et de maintenance ($C_{O\&M\ DG}$)),
- L'énergie achetée au TRANSCOs connectés au réseau de distribution (C_E),
- Les pertes d'Énergie (C_{loss}).

Ainsi, la fonction objective peut s'exprimer comme suit :

$$\text{Minimize} \quad obj(\$ / h) = C_{In\ DG} + C_{O\&M\ DG} + C_E + C_{loss}$$

Avec:

$$C_{In\ DG} = \frac{\sum_{i=1}^B C_{Inv\ i} \cdot P_{DG\ i}^{\max}}{A_{Depr} * 8760}$$

$$A_{Depr} = \left[\frac{(1+d)^T - 1}{d(1+d)^T} \right]$$

$$C_{O\&M\ DG} = \sum_{i=1}^B C_{O\&M\ i} \cdot P_{DG\ i}$$

⁹ Distribution Company

$$C_E = \sum_{i=1}^G C_{p_i} \cdot P_{G_i} + \sum_{i=1}^G C_{Q_i} \cdot Q_{G_i}$$

$$C_{loss} = loss * C_{p_i}$$

Le processus de planification devra inclure la réalisation de quelques tâches et tenir compte d'un certain nombre de contraintes, dont les plus importantes sont listées ci-dessous :

- 1) Répartition du flux de puissance (load flow) dans toutes les lignes du réseau,
- 2) Limites des différents éléments du réseau de distribution :
 - 2-i) Puissance active disponible par TRANSCOs
 - 2-ii) Puissance réactive disponible par TRANSCOs
 - 2-iii) Capacité de transmission des lignes
 - 2-iv) Capacité de production de GED
 - 2-v) Capacité des CSs (S'ils existent comme une solution alternative en planification)
 - 2-vi) Délestage (S'il est envisageable comme une solution alternative en planification)
- 3) Limite en tension des nœuds
- 4) Limites en investissement.

Le modèle d'optimisation mathématique proposé utilise les variables de décision binaires qui fournissent la solution optimale sans les arrondir. Ce modèle prévoit deux scénarios selon les conditions spécifiques de chacun, comme illustré à la figure 4.

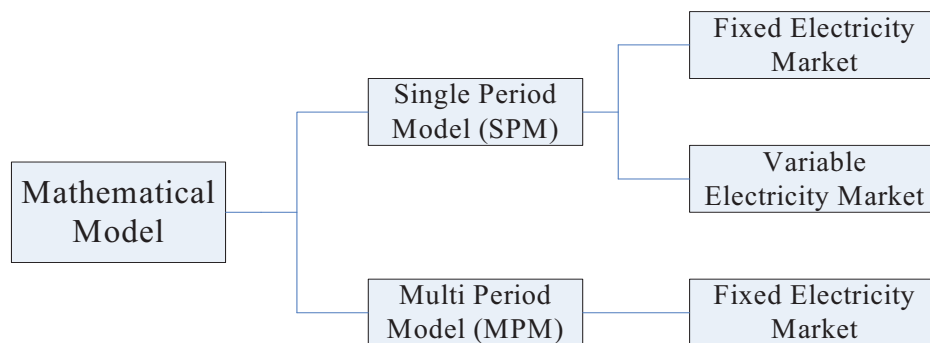

Fig. 4: Scénarios proposés selon les différentes conditions du système

Dans le premier scénario appelé "Single-Period Models (SPMs)" nous ne tenons compte de l'accroissement de la demande qu'à la fin de la période envisagée, sans les années intermédiaires. Deux cas sont envisagés, selon que le prix de l'électricité est fixe ou variable. Le second scénario "The Multi-Period Model (MPM)" peut être considéré comme un enchaînement en série de plusieurs SPM et dans ce cas on pourra y inclure un accroissement annuel de la demande, jusqu'à la fin de la période de calcul. Dans ce cas, les équations de flux de puissance et les contraintes traditionnelles du système seront répétées à chaque itération et pour chaque niveau de charge. L'équation de la fonction objective doit alors être modifiée pour le modèle multi-périodes comme suit :

$$\text{Minimize} \quad \text{obj}(\$ / h) = \sum_{t=1}^T \text{obj}(t)$$

Avec:

T La période de planification (5 ans dans notre étude).

Le modèle d'optimisation proposé minimise le coût total du système incluant celui de l'investissement, d'opération et de maintenance de GED, de l'achat de l'électricité auprès des TRANSCOs et des pertes dans le système. En outre et en même temps, il s'agit de garantir le profil de tension du système et d'éviter toute congestion dans les lignes de transmission.

Les résultats des simulations fournissent la taille et le (meilleur) site pour insérer la GED, la puissance à acheter aux TRANSCOs et propose un nouveau prix de l'électricité à l'issue de cette optimisation. Ces résultats ont été obtenus pour les trois cas d'étude présentés précédemment et ils illustrent également les avantages électriques et économiques de GED. Selon les cas et les scénarios étudiés, les résultats sont différents. Néanmoins, dans tous les cas étudiés, les résultats prouvent que l'installation de la GED augmente la durée de vie des lignes en réduisant leurs pertes. La GED rend le système de distribution existant capable de répondre à une croissance de charge sans ajouter de nouvelles lignes, transformateurs...etc. Le maintien du plan de tension et la réduction des flux de puissances dans les lignes sont d'autres avantages de l'insertion de GED dans les réseaux de distribution. Concernant le volet économique, l'introduction de GED a permis de minimiser le coût total du système et de baisser le prix de l'électricité, en particulier aux moments où celui-ci est élevé sur le marché.

III.3.2. Deuxième approche

Dans cette approche, on suppose disposer en plus de GED (première approche) de deux autres options (CS ou délestage), pour satisfaire à la croissance de charge. Il sera donc créé une sorte de compétition entre ces trois options, lesquelles donneront naissance à huit possibilités. Le choix de chacune de ces solutions dépend de la décision du planificateur. Ces cas sont :

- Possibilité I : Sans installation de GED ou CS ni délestage
- Possibilité II : Délestage
- Possibilité III : Installation de CS
- Possibilité IV : Installation de GED
- Possibilité V : Installation de CS et délestage
- Possibilité VI : Installation de GED et délestage
- Possibilité VII : Installations de GED et CS
- Possibilité VIII : Installations de GED et CS et délestage.

La formulation mathématique considérée dans cette approche est décrite par :

$$\text{Minimize} \quad \text{obj}(\$ / h) = C_{In DG} + C_{O\&M DG} + C_{In SC} + C_{O\&M SC} + C_{LS} + C_E$$

Avec:

$C_{In SC}$ Coût d'investissement de CS,

$C_{O\&M SC}$ Coût d'opération et de maintenance de CS,

C_{LS} Coût du délestage,

Pour étudier la fluctuation de la charge et celle du prix de l'électricité en fonction du temps (l'incertitude sur le prix du combustible), on considère que le prix de l'électricité et la charge du système sont des variables. La forme des courbes de la charge quotidienne, saisonnière et annuelle est une caractéristique importante pour l'opération présente et l'expansion future du système de génération. D'une manière générale, la variation des données est assez lente dans le temps. Il est donc possible de les moyenniser sur des périodes d'échantillonnage de plusieurs heures afin de simplifier les simulations. Ces huit possibilités ont été examinées sur le système IEEE 30-bus modifié présenté auparavant. Seul le second cas a été étudié.

Une fois encore, les simulations confirment les (mêmes) avantages de l'insertion de GED dans les systèmes de distribution. En outre, comparée à l'emploi des compensateurs synchrones et/ou d'une stratégie de délestage, la GED se révèle comme une solution plus efficace électriquement et économiquement.

La GED jouera un rôle croissant dans les systèmes de distribution de demain, non seulement pour les économies qu'elle permet de réaliser, mais aussi parce qu'elle offre une option de source d'énergie assez facilement implantable, pour satisfaire des besoins non prévus, en tout point du système.

III.3.3. Troisième approche

Cette approche présente une nouvelle méthodologie pour l'optimisation du placement et de la taille mais également du temps de retour à l'investissement de différents types de GED en considérant la fluctuation du prix de l'électricité. Cette optimisation est réalisée en deux étapes :

- Etape 1 : Minimisation des coûts totaux de planification des réseaux de distribution dans le cadre du marché spot pour trouver le site et la taille optimaux des différents types de GED en fonction de la durée de retour à l'investissement,
- Etape 2 : Maximisation de la fonction du bénéfice total du système¹⁰ (TSB) permettant de trouver le meilleur retour à l'investissement en fonction de la durée de vie de la GED.

Dans la première étape, la fonction "coût" (*cost function*) est considérée comme la somme du coût de l'amortissement de l'investissement sur différentes durées de retour à l'investissement, de l'opération et de maintenance, de délestage et des pertes dans le système. Notons que le temps de retour à l'investissement détermine à lui seul le prix de l'électricité produite par la GED. A l'étape deux, la fonction bénéfice (*TSB function*) est définie par la différence entre le coût total du système sans et avec GED, calculée sur la durée de vie de GED.

Plusieurs technologies de GED disponibles sur le marché, avec leurs coûts marginaux, sont envisagées dans cette approche. Pour chaque technologie de GED, la taille et l'emplacement optimaux pour différents temps de retour à l'investissement sont d'abord

¹⁰ Total System Benefit (TSB)

recherchés (étape 1). Ensuite, la maximisation du TSB permet de trouver, pour chaque technologie GED, le temps de retour à l'investissement (étape 2). Le bouclage avec l'étape 1 conduit à la solution optimale pour chaque technologie, à savoir la taille, l'emplacement et finalement le temps de retour à l'investissement correspondant.

Cette méthode à deux étapes permet de réaliser les objectifs d'optimisation surtout dans un contexte de marché dérégulé. Dans la suite, les formulations mathématiques de la minimisation du coût et de la maximisation du bénéfice sont détaillées.

III.3.3.1. Formulation Mathématique de la minimisation de la fonction du coût

Comme nous l'avons précisé auparavant, dans la première étape, la fonction "coût" inclut celui du développement du réseau (l'insertion de GED et/ou de CS (C_{DG} , C_{SC})), de l'énergie achetée (C_E), des pertes (C_{Loss}) et du délestage (C_{LS}).

Par conséquent, la fonction objective est exprimée comme suit :

$$\text{Min } C = \min [C_{DG}, C_{SC}, C_E, C_{Loss}, C_{LS}]$$

La formulation mathématique de la minimisation du coût total, utilisant l'approche dite "aggregating approach" de la planification du système est décrite par l'équation :

$$\text{Minimize} \quad \text{cost}(\$/h) = C_{In\ DG} + C_{O\&M\ DG} + C_{In\ SC} + C_{O\&M\ SC} + C_E + C_{loss} + C_{LS}$$

où les différents éléments sont calculés par heure.

III.3.3.2. Formulation Mathématique de la Maximisation du TSB

Le temps de retour à l'investissement est le temps au bout duquel le montant de cet investissement est compensé par les économies financières résultant directement des économies d'énergie procurées par cet investissement. Dans le cadre de cette étude, la méthode consiste à calculer, pour une même demande d'énergie, l'économie annuelle réalisée, en frais de combustibles, par la substitution (totale ou partielle) par la GED, puis en tenant compte du surcoût de l'investissement, le temps de retour d'investissement sera déduit.

La sortie de la première étape fournit l'emplacement et la taille optimaux de la GED (capacité installée) pour plusieurs temps de retour à l'investissement. En fonctionnement, la production réelle de la GED dépend des conditions de fonctionnement et du prix de l'énergie, particulièrement dans les réseaux de distribution subissant la dérégulation du marché de l'électricité. Ainsi, le prix de l'électricité produite par la GED, qui dépend du

temps de retour à l'investissement ($C_{E_{DG}}$), est un facteur important pour déterminer la puissance produite par la GED au nœud i en fonction du temps ($P_{DG_i}(t)$). Par conséquent, l'achat de la puissance des TRANSCOs, les pertes totales du système et le coût de délestage changeront avec la durée de vie de GED.

Dans la seconde étape, la fonction TSB définie comme la différence entre les coûts totaux du système avant et après l'installation de la GED, sera maximisée afin de trouver le temps optimal de retour et le prix de l'électricité produite par la GED. Cette fonction objective est donnée par :

$$\text{Maximize} \quad TSB(\$) = C_{DG_Save} + A * \sum_{t=1}^{8760} (C_{E_Save}(t) + C_{loss_Save}(t) + C_{ENS_Save}(t))$$

Avec:

$$A = \frac{1 - (1 + d)^{-T}}{d}$$

$$C_{E_Save}(t) = C_{E_B}(t) - C_{E_A}(t)$$

$$C_{loss_Save}(t) = C_{loss_B}(t) - C_{loss_A}(t)$$

$$C_{ENS_Save}(t) = C_{ENS_B}(t) - C_{ENS_A}(t)$$

$$C_{DG_Save}(t) = DG \text{ Re venue} - DG \text{ Expenses}$$

Avec:

T Durée de vie prévue pour la GED (ans)

$$DG \text{ Re venue} = A * \sum_{t=1}^{8760} \sum_{i=1}^B C_{E_{DG}} * P_{DG_i}(t)$$

$$DG \text{ Expenses} = \sum_{i=1}^B C_{Inv_{DG_i}} * P_{DG_i}^{\max} + A * \sum_{t=1}^{8760} \sum_{i=1}^B C_{O\&M_{DG}} * P_{DG_i}(t)$$

Avec :

$$C_{E_{DG}} = \left(\frac{\sum_{i=1}^B C_{Inv_{DG_i}} * P_{DG_i}^{\max}}{A_{PB} * 8760} + \sum_{i=1}^B C_{O\&M_{DG_i}} * P_{DG_i}^{\max} \right) / \sum_{i=1}^B P_{DG_i}^{\max}$$

Pour déterminer le temps optimal de retour, il est très important de connaître la durée de vie de la GED (T). La durée de vie de la GED dépend principalement de la technologie utilisée, de la qualité de sa fabrication et de ses conditions d'opération.

Dans cette étape, l'emplacement et la taille de GED, calculés lors de l'étape précédente, ainsi que des données du système sans GED, sont considérés comme des variables d'entrée.

Aujourd'hui, on dispose sur le marché d'un large éventail de technologies de GED, avec des caractéristiques de fonctionnement différentes. Les unités de cogénération (CHP), en raison de leur système de récupération de chaleur, peuvent produire l'énergie à un prix plus bas que celle achetée auprès des TRANSCO's. D'autres technologies, telles que les piles à combustible, sont caractérisées par leur prix relativement élevé tandis que l'éolienne et la turbine à gaz sont réputés avoir un prix plus intéressant. Dans cette partie, cinq technologies de GED sont étudiées afin de laisser du choix aux acteurs économiques et aux planificateurs des réseaux de distribution. Cependant, en pratique d'autres éléments interviennent dans le choix technologique de GED dans un site donné, les considérations écologiques comme les conditions environnementales favorables ou pas au fonctionnement de ces systèmes de production. C'est la raison pour laquelle, dans cette étude, nous nous sommes retenus de comparer entre elles ces cinq technologies car la décision finale d'un choix technologique dépend d'autres paramètres.

Finalement cette approche permet de créer un modèle pour la prévision du prix de l'électricité et de celui qui sera proposé aux usagers. En incorporant le TSB, cette troisième approche réalise un modèle éco-électrique.

V. Conclusion

L'objectif du planificateur des réseaux de distribution est de s'assurer que l'accroissement de la charge est pris techniquement et économiquement en compte par l'expansion optimale du réseau de distribution. Le but principal de cette thèse est de créer une nouvelle méthodologie pour la planification des réseaux de distribution afin de gérer efficacement les changements induits par la dérégulation du marché de l'électricité.

La dérégulation des marchés de l'énergie électrique a eu une influence considérable sur les aspects techniques de la planification. Dans ce contexte, le coût est l'un des facteurs essentiels qui pèse sur de nombreuses décisions prises dans le cadre de la planification du réseau de distribution. Après la privatisation de la production d'électricité, de nouvelles options sont offertes et doivent être considérées par les planificateurs des réseaux de

distribution, en particulier, l'intégration d'une nouvelle catégorie de production d'énergie, la génération d'énergie dispersée (GED). Cependant, il faut rappeler que le développement de ce type de production n'est pas directement imputable au phénomène de la libéralisation du marché de l'énergie électrique. Ce dernier constitue plus un contexte politique et économique favorable. L'insertion à grande échelle de GED dans les années à venir semble énergétiquement et économiquement intéressante. En effet, de nombreux potentiels existent et un grand nombre de pays tentera sûrement de promouvoir au mieux ces modes de production "locaux".

Par conséquent, la GED influence et change les méthodes traditionnelles de planification. Dans cette thèse, la GED est appelée à participer au marché de l'électricité comme une option attractive en concurrence avec d'autres dispositifs de réglage de tension. Elle permet également de satisfaire les besoins en croissance de charge à un prix raisonnable tout en améliorant la disponibilité énergétique du système.

La planification optimale de l'expansion des réseaux peut être réalisée en utilisant l'une des trois approches suivantes pour lesquelles nous avons développé le modèle mathématique approprié.

Dans la première approche, la GED est considérée comme une solution unique offerte au planificateur confronté à une augmentation de la demande dans certains territoires de DISCO. Cette approche fournit des éléments de décisions d'investissement de GED qui sont principalement basés sur des structures et des prix du marché de l'électricité. Le modèle proposé est validé tant comme "*Single-Period Model*" (SPM) que "*Multi-Period Model*" (MPM). Dans ce modèle, les coûts totaux du réseau doivent être minimisés tout en garantissant le plan de tension et une fluidité dans la transmission de puissance dans les lignes. Les résultats de la simulation de ce modèle sont donc la taille et l'emplacement de la GED, la puissance achetée auprès des TRANSCOs et le prix de l'électricité.

Dans la deuxième approche, la GED est concurrencée par d'autres dispositifs de réglage de tension (comme les Compensateurs Synchrones (CS)) et/ou du délestage pour préserver le plan de tension et satisfaire à la croissance de charge des réseaux de distribution à coût minimal. Dans cette partie, pour étudier la fluctuation des charges et des prix de l'électricité en fonction du temps (l'incertitude sur la charge et le prix de carburant), on considère que le prix de l'électricité et la charge du réseau sont des variables.

Le but de la troisième approche est d'obtenir l'emplacement et la taille de la GED mais

également le temps de retour à l'investissement qui, en même temps, minimisent le coût total et maximisent le bénéfice du système (TSB). Elle propose une nouvelle méthodologie à deux étapes pour la planification du réseau de distribution. Il en résulte également un modèle de prévision du prix de l'électricité et celui du marché. Les différentes technologies de la GED offrent au planificateur l'occasion de choisir la meilleure solution en termes de capacité énergétique et d'emplacement de la GED.

Pour mettre en application ces trois approches, un nouveau progiciel d'interface entre deux logiciels (MATLAB et GAMS) a été développé dans le cadre de ce travail. Ce nouveau progiciel est un outil capable de résoudre les problèmes complexes de la planification dans des réseaux de grande échelle et de visualiser les résultats en utilisant une interface graphique¹¹ (interface GUI de Matlab). GUI permet de choisir le modèle d'optimisation, de changer les paramètres du modèle, d'introduire les données du réseau et d'afficher les résultats à l'attention du planificateur. L'utilisation de ce progiciel ne demande pas de connaissance spécifique des langages de programmation de Matlab et/ou de GAMS. Son autre avantage est sa rapidité de résolution, surtout appréciable dans le cas des grands réseaux.

Le réseau IEEE 30-Bus modifié a été choisi comme réseau test. Afin d'illustrer l'effet des conditions de fonctionnement du réseau de distribution sur les décisions prises par le planificateur, trois cas ont été considérés, puis étudiés. Les résultats des simulations illustrent des avantages électriques et économiques de la GED. On montre que la GED présente effectivement une option intéressante pour, d'une part, préserver le plan de tension et d'autre part, répondre à un accroissement de la demande dans des réseaux de distribution tout en améliorant la qualité de service. Selon les cas et les approches, les résultats sont différents. Mais, dans tous les cas l'insertion de la GED augmente la durée de vie des lignes et des autres équipements en réduisant leurs pertes, en rendant plus fluide la circulation de puissance dans les lignes. Ainsi, elle rend possible l'utilisation des installations existantes sans aucun rajout d'équipement. L'impact économique de la GED a été mesuré sur le cout total et le bénéfice réalisé par le DISCO.

¹¹ Graphic User Interface (GUI)

Publications et communication

Publications:

- [1] S. Porkar, P. Poure, A. Abbaspour-Tehrani-fard, S. Saadate , "A Novel Optimal Distribution System Planning Framework Implementing Distributed Generation in a Deregulated Electricity Market", Elsevier Electric Power Systems Research (EPSR), Vol 80, No. 7, pp. 828-837, July 2010.
- [2] S. Porkar, A. Abbaspour-Tehrani-fard, P. Poure, S. Saadate, "A multistage model for distribution expansion planning with distributed generation in a deregulated electricity market", Iranian Journal of Science and Technology Transaction B: Engineering, 2010, No. 34, Vol. 3, 275-287.
- [3] S. Porkar, P. Poure, A. Abbaspour-Tehrani-fard, S. Saadate, "Distributed Generation Planning for Losses, Voltage Profile, Line Congestion and Total System Cost Improvement", International Review of Electrical Engineering (IREE), Vol 4, No. 3, pp. 434-440, June 2009.
- [4] S. Porkar, P. Poure, A. Abbaspour-Tehrani-fard, S. Saadate, "Optimal Allocation of Distributed Generation Using a Two-Stage Multi-objective Mixed-Integer-Nonlinear Programming", European Transactions on Electrical Power (ETEP), in press.
- [5] S. Porkar, A. Abbaspour-Tehrani-fard, P. Poure, S. Saadate, "Distribution System Planning Integration of Distributed Generation and Load Curtailment Options in a Competitive Electricity Market", Journal of Electrical Engineering, Springer Publication, in press.
- [6] S. Porkar, A. Abbaspour-Tehrani-fard, P. Poure, S. Saadate, "Two-Stage Distribution System Planning by Implementing DG in a Deregulated Electricity Market", IEEE Power Delivery , in press.

Communication:

- [1] S. Porkar, A. Abbaspour-Tehrani-fard, S. Saadate, "An Approach to Distribution System Planning by Implementing Distributed Generation in a Deregulated Electricity Market", Power Engineering, IEEE Large Engineering Systems Conference on 10-12 Oct. 2007, pp. 90 – 95, Montreal, Québec.
- [2] S. Porkar, P. Poure, S. Saadate, A. Abbaspour-Tehrani-fard, "A Novel Soft-Switching Seven-Level Converter Topology with Self-Voltage Balancing Ability", IEEE AFRICON 2009. 23 - 26 September 2009, Nairobi, Kenya (CD-ROM).
- [3] S. Porkar, M. Fotuhi-Firuzabad, A. Abbaspour-Tehrani, B. Porkar "An Approach to Determine Spinning Reserve Requirements in a Deregulated Electricity Market", 2006 IEEE Power System Conference and Exposition IEEE-PSCE/2006, October 29-November 1, 2006, pp. 1341-1344, Atlanta, Georgia, USA.

ABSTRACT

In the recent years, there is a worldwide wave of considerable changes in power industries, including the operation of distribution networks. Deregulation, open market, alternative and local energy sources, new energy conversion technologies and other future development of electrical power systems must pursue different goals. Also growth in the demand and change in load patterns may create major bottlenecks in the delivery of electric energy. This would cause distribution system stress.

Furthermore, in competitive electricity markets, operators determine the electricity price for specific intervals during a day, taking into account various economical and operational factors. Traditionally, a Distribution System Company (DISCO) purchased energy other electrical identities such as Transmission Companies (TRANSCOs) connected to DISCO distribution system, at a high voltage level, and then transfers this energy to final customers. Nevertheless, the restructuring process of the energy sector has stimulated the introduction of new agents and products, and the unbundling of traditional DISCO into technical and commercial tasks, including the provision of ancillary services.

In this condition, DISCOs should provide a least-cost plan and should not damage the environment. The DISCOs planner attempts to find the best strategy from a large number of possible alternatives. Thus, the complexity of the problems related to distribution systems planning is mainly caused by multiple objectives. It is predicted that Distributed Generation (DG) will play an increasing role in the electrical power system of the future, not only for the cost savings but also for the additional power quality.

Careful coordination and placement of DGs is mandatory. Improper placement can reduce DGs benefits and even jeopardize the system operation and condition. This thesis discusses the effects of DG implementation under different distribution system conditions and states not only to decrease system costs and losses but also to improve power quality, system voltage and line congestion.

This thesis introduces three methodologies included mathematical model to obtain the optimal DG capacity sizing and sitting investments with capability to solve large distribution system planning problem.

The first proposed optimization model allows minimizing total system planning costs

for DG investment, DG operation and maintenance, purchase of power by the DISCOs from TRANSCOs and system power losses. The proposed model provides not only the DG size and site but also the new market price as well. Three different cases depending on system conditions and three different scenarios depending on different planning alternatives and electrical market structures have been considered. This model is valid as both single-period model and multi-period model.

In the second framework, it is presented a mathematical distribution system planning model considering three planning options to system expansion and to meet the load growth requirements with a reasonable price as well as the system power quality problems. DG is introduced as an attractive planning option with competition of voltage regulator devices such as Synchronous Condenser (SC) and Interruptible load. In mathematical model, the object function includes investment costs, which are evaluated as annualized total cost, plus total running cost as well as cost of curtailed loads and losses. This model identifies the optimal type, size and location of the planning options. This methodology is also studied fluctuation of load and electricity market price versus time period and the effect of DG placement on system improvement.

In the third framework, it is presented a new two-stage methodology (integrated electric-market investment model) for optimal placement, size and investment payback time of DG in competition with voltage regulator devices such as SC. In first stage, the object is the minimization of the total costs to find the optimal sizing and siting versus investment payback times. In the second stage, the goal consists in the maximization of the Total System Benefit (TSB) to find the optimal payback time. A total costs object function is proposed as an approach to identify optimal DG placement and sizing and candidate payback time. In this framework, the object function includes investment costs, which are evaluated as annualized total cost, plus total running cost as well as cost of Energy Not Supply (ENS) and losses. To provide some scenarios of variety of DGs available in the market, several DG types with different cost characteristics are considered. For each DG type, an optimal placement, size and investment payback time is identified. With so much to consider, it is often difficult for the planners to determine which technology is the best suited one to meet their specific energy needs. In this framework, it is compared five types of DG technologies to give choices for decision makers in a given case study and under different system conditions. This framework creates an electric market price forecasting

model to predict the electricity market price. TSB is incorporated with the proposed optimization model (first or second framework) to provide a modified integrated electric-market investment model.

These frameworks have allowed validating the economical and electrical benefits of introducing DG by solving the distribution system planning problem and by improving power quality of distribution system. DG installation increases the feeders' lifetime by reducing their loading and adds the benefit of using the existing distribution system for further load growth without the need for feeders upgrading. More, by investing in DG, the DISCO can minimize its total planning cost and reduce its customers' bills.

To solve the proposed mathematical planning model a new software package interfacing MATLAB and GAMS is developed. This package is enabling to solve large extent distribution system planning program visually and very fast. The proposed methodology is tested in the modified IEEE 30-bus test system. Different system conditions are considered to study their effect on planning decisions. It is also studied the effect of DG placement on system conditions improvement.

LIST OF ABBREVIATIONS

ACO	Ant Colony Optimization
CGT	Combustion Gas Turbine
CHP	Combine Heat and Power
CS	Classifier Systems
DG	Distributed Generation
DISCO	Distribution Company
DP	Dynamic Programming
EA	Evolutionary Algorithms
EAC	Equivalent Annual Cost
ENS	Energy Not Supply
EP	Evolutionary Programming
ES	Evolution Strategies
FC	Fuel Cell
FV	Future Value
GA	Genetic Algorithms
GAMS	General Algebraic Modeling System
GENCO	Generation Company
GP	Genetic Programming
GUI	Graphic User Interface
IC	Internal Combustion
IL	Interruptible Load
IPP	dependent Power Producer
IRP	Integrated Resource Planning
ISO	dependent System Operator
LDP	Load Distance Product
LMP	Locational Marginal Price
LP	Linear programming
LTC	Load Tap Changing
MADM	Multi-Attribute Decision-Making
MCMDM	Multi-Criteria Decision-Making
MFD	Minimum Feasible Distance

MODM	Multi-Objective Decision-Making
MIP	Mixed-Integer-Programming
MILP	Mixed-Integer-Linear-Programming
MINLP	Mixed-Integer-Non-Linear Programming
MPM	Multi-Period Model
MRR	Minimum Revenue Requirement
MT	Microturbine
NLP	Non-Linear-Programming
O&M	Operation and Maintenance
OPF	Optimal Power Flow
PHV	Photovoltaic systems
PV	Present Value
QMIP	Quadratic Mixed Integer Programming
RESCO	Retailer Company
SC	Synchronous Condenser
SPM	Single-Period Model
T&D	Transmission and Distribution
TRANSCO	Transmission Company
TSB	Total System Benefit
VEGA	Vector Evaluation Genetic Algorithm
WT	Wind turbine

LIST OF NOMENCLATURE

B	Total number of system buses for DG and/or SC connection
C_{E_A}	Cost of total purchased power from TRANSCOs after DG installation (\$/h)
C_{E_B}	Cost of total purchased power from TRANSCOs before DG installation(\$/h)
$C_{E\ DG}$	DG electricity price (\$/MWh)
$C_{Inv_{DG}^i}$	DG investment cost at bus i (\$/MW)
$C_{Inv_{SC}^i}$	SC investment cost at bus i (\$/MVAh)
C_{loss_A}	Cost of total system losses after DG installation (\$/h)
C_{loss_B}	Cost of total system losses before DG installation (\$/h)
C_{P_i}	Active power price of TRANSCO number i (\$/MWh)
C_{pen}^{cur}	Penalty of load shedding (\$/MW)
$C_{O\&M_{DG}^i}$	DG operation and maintenance cost at bus i (\$/MWh)
$C_{O\&M_{SC}^i}$	SC operation and maintenance cost at bus i (\$/MVAh)
C_{LS_A}	Cost of total curtailed load after DG installation (\$/h)
C_{LS_B}	Cost of total curtailed load before DG installation (\$/h)
C_{Q_i}	Reactive power price of TRANSCO number i (\$/MVAh)
d	Discount rate
DIB	DG Investors' Bid (MW)
G	Total number of interconnected systems (TRANSCOs)
IRC	Investment Resource Constraint (\$)
l	DG unit number index
$N_{DG,l}^{Max}$	Maximum number of candidate DG units at each bus
$P_{DG\ i}$	Active power generated by DG at bus i (MW)
$P_{DG\ i}^{max}$	Maximum DG capacity at bus i (MW)
$P_{G\ i}$	Active power dispatched from TRANSCO number i (MW)
$P_{G\ i}^{max}$	Maximum active power dispatched from TRANSCO number i (MW)
P_i^{cur}	Total active curtailed load at bus i (MW)
P_i^d	Total active power demand at bus i (MW)
P_i^{IL}	Total interruptible active load at bus i (MW)

P_{ij}	Power flow transfer from bus i to bus j (MW)
pf_i^{IL}	IL power factor at bus i
$Q_{G i}$	Reactive power dispatched from TRANSCO number i (MVar)
$Q_{G i}^{\max}$	Maximum reactive power dispatched from TRANSCO number i (MVar)
$Q_{G i}^{\min}$	Minimum reactive power dispatched from TRANSCO number i (MVar)
Q_i^{cur}	Total reactive curtailed load at bus i (MVar)
Q_i^d	Total reactive power demand at bus i (MVar)
Q_i^{IL}	Total interruptible reactive load at bus i (MVar)
$Q_{SC i}$	Reactive power generated or absorbed by SC at bus i (MVar)
$Q_{SC i}^{\max}$	Maximum SC capacity at bus i (MVar)
S	Total number of exciting SC in the distribution system
S_{ij}	Apparent power flow through line connected between buses i and j (MVA)
S_{ij}^{\max}	Maximum permissible line power flow capacity
T	The predicted DG life time (year)
T_h	Horizon planning period (year)
T_{PB}	DG Investment payback time (year)
T_{SC}	The predicted SC life time (year)
V_i	Bus voltage at bus i (V)
V_i^{\max}	Maximum permissible voltage at bus i (V)
V_i^{\min}	Minimum permissible voltage at bus i (V)
Y_{ij}	Feeder segment admittance connecting bus i and bus j
θ_{ij}	Angle of admittance connecting bus i and bus j
δ_i	Angle of bus voltage at bus i
σ_{DGil}	Binary decision variable of DG unit l at bus i

Contents

- CHAPTER 1 1**
- INTRODUCTION 1**
- 1.1 Changes in the Power System.....2**
- 1.2 Models of Competition.....4**
 - 1.2.1 Model 1: Vertically Integrated Monopoly5
 - 1.3.2 Model 2: Single Buyer6
 - 1.3.3 Model 3: Wholesale competition7
 - 1.3.4 Model 4: Retail competition.....9
- 1.3 Power Delivery System Planning 11**
- 1.4 Research Motivation and Objectives12**
- 1.5 Outline of the Thesis14**
- CHAPTER 2 16**
- CHANGES IN DISTRIBUTION SYSTEM PLANNING 16**
- 2.1 Distribution Systems in General17**
 - 2.1.1 Primary Distribution17
 - 2.1.2 Secondary Distribution20
- 2.2 Essence of System Planning Problem20**
 - 2.2.1 Planning Philosophies21
 - 2.2.2 Planning horizon22
- 2.3 Traditional Distribution System Planning23**
 - 2.3.1 Traditional Distribution Planning Factors24
 - 2.3.2 Traditional Distribution Planning Model25
- 2.4 Deregulation Effect on Distribution System planning27**
- 2.5 Generation in Distribution Networks28**
- 2.6 Changes in Distribution System Planning.....30**
 - 2.6.1 Process of Distribution Planning.....31
 - 2.6.2 Factors Affecting on DG Planning31
 - 2.6.3 Novel Distribution Planning Model34
- 2.7 Conclusions36**
- CHAPTER 3 38**
- REVIEW OF LITERATURE 38**

3.1 Review of Traditional Distribution System Planning.....	38
3.2 Review of DISCO Planning in Deregulation.....	41
3.3 Review of Multi-objective programming	43
3.3.1 Solution Methods	45
3.3.1.1 Aggregating Functions	46
3.3.1.2 Lexicographic Ordering	47
3.3.1.3 Sub-Population Approaches	47
3.3.1.4 Pareto-Based Approaches	47
3.4 Optimization Methods Applied to Distribution Planning.....	48
3.4.1 Review of Mathematical Distribution Planning.....	50
3.5.1.1 Review of Single-Period Models (SPMs)	52
3.5.1.2 Review of Multi-Period Models (MPMs).....	54
3.5.2 Review of Heuristic Methods.....	56
3.5.2.1 Branch Exchange Methods	56
3.5.2.2 Simulated Annealing.....	57
3.5.2.3 Tabu Search.....	59
3.5.2.4 Dynamic Programming (DP)	60
3.5.2.5 Evolutionary Algorithms.....	62
CHAPTER 4	67
DG IMPLEMENTED DISTRIBUTION PLANNING IN AN ELECTRICITY MARKET	67
4.1 Objectives of the Network Reinforcement	68
4.2 The Proposed Novel Integrated distribution system planning Model	69
4.2.1 Cost-Modeling	69
4.2.1.1 Investment (Fixed) Cost.....	71
4.2.1.2 Variable (Running) Cost.....	72
4.2.2 Mathematical Planning Problem Constraints	74
4.3 New Simulation Software Package	77
4.4 Modeling Network Elements.....	80
4.5 Case study	81
4.5.1 Network Conditions (Case Studies)	81
4.5.2 Load Characteristics.....	82
4.5.3 Fluctuation in Demand.....	84
4.5.4 Load and Electricity Market Price Curves	85
4.6 DG Planning Model.....	86
4.6.1 Analyses and Results of Case 1.....	89
4.6.2 Analyses and Results of Case 2.....	94
4.6.3 Analyses and Results of Case 3.....	95
4.7 Comparative Market Model.....	97
4.7.1 Analysis and Results of Attitude I.....	98
4.7.2 Analysis and Results of Attitude II.....	99
4.7.3 Analysis and Results of Attitude III	100
4.7.4 Analysis and Results of Attitude IV	101
4.7.5 Analysis and Results of Attitude V	102
4.7.6 Analysis and Results of Attitude VI	103

4.7.7 Analysis and Results of Attitudes VII & VIII	105
4.8 Conclusion.....	106
CHAPTER 5	108
DG PLANNING AND PRICING IN AN ELECTRICITY MARKET.....	108
5.1 Mathematical Formulation.....	109
5.1.1 Cost function minimization.....	109
5.1.2 Total System Benefit (TSB) maximization	110
5.2 Simulation results and discussion	111
5.3.1 Case 1.....	112
5.3.2 Case 2.....	114
5.3.3 Case 3.....	116
5.3 Conclusion.....	117
CHAPTER 6	119
CONCLUSIONS	119
6.1 Future Work Recommendations	124
APPENDIX A.....	125
DISTRIBUTED GENERATION	125
A.1 Introduction	125
A.2 DG Technologies and Status.....	126
A.3 DG Applications.....	129
A.4 Benefits of DG.....	132
A.4.1 Customer Benefits.....	132
A.4.2 Supplier Benefits.....	133
A.4.3 National Benefits.....	134
A.5 Issues of DG	134
A.5.1 DG Electrical Interconnection.....	134
A.5.2 Islanding Issues	134
A.5.3 Protection Issues.....	135
A.5.4 Commercial and Planning Issues	136
A.6 Impacts of DG on Power Quality	137
A.6.1 Voltage Impact.....	138
A.6.2 Losses.....	139
A.7 Cost of DG Technologies	139
A.8 Market.....	140

APPENDIX B.....	142
ECONOMIC AND FINANCIAL ASPECTS	142
B.1 Effect of Time on the Value of Money	144
B.2 Discounting of Future Cash Flows	144
B.3 Annuity Depreciation and Equivalent Cash Flows	146
B.4 Procedure for Economic Studies.....	149
B.5 Conclusion	150
APPENDIX C.....	151
MODIFIED IEEE 30-BUS SYSTEM.....	151
REFERENCE	154

Contents of Figures

Figure 1.1: Two different monopoly sub-models of electricity market.	6
Figure 1.2: Purchasing agency model of electricity market. (a) integrated version; (b) disaggregated version.	7
Figure 1.3: Wholesale competition model of electricity market.	8
Figure 1.4: Retail competition model of electricity market.	10
Figure 2.1: Typical power system structure with different voltage levels.	18
Figure 2.2: Primary network. Sectionalizing devices on feeders not shown.	19
Figure 2.3: System planning philosophies.	22
Figure 2.4: Distribution system planning decisions.	26
Figure 2.5: Distribution system planning constraints.	27
Figure 2.6: New distribution planning decisions.	35
Figure 2.7: New distribution planning constraints.	36
Figure 3.1: Concept of Pareto optimality.	45
Figure 3.2: Dynamic Programming graph for network reinforcement problem.	61
Figure 3.3: An example of Single Point crossover.	63
Figure 4.1: Hierarchy of objectives for distribution planning.	69
Figure 4.2: Distribution system planning structure.	70
Figure 4.3: MATLAB-GAMS interface.	79
Figure 4.4: Maximum demands and average maximum demands, coincident and non-coincident.	84
Figure 4.5: Electricity market price.	86
Figure 4.6: Total load fluctuation versus time period.	86
Figure 4.7: Different scenarios used to evaluate proposed DG planning model.	88
Figure 4.8: Distribution system buses voltage profiles without (hatched) and with (black) DG installation.	90
Figure 4.9: Electricity market price before (solid line) and after (dash line) DG installation.	91
Figure 4.10: Total system losses at each year.	92
Figure 4.11: Distribution system buses voltage profiles at each year.	92
Figure 4.12: Electricity market price after DG installation at each year.	93
Figure 4.13: Optimum location and sizing of DG for the three different scenarios.	93
Figure 4.14: Optimum location and sizing of DG for scenarios A and C.	94
Figure 4.15: System voltage profiles without DG and with DG at the horizon year.	95
Figure 4.16: Optimum location and sizing of DGs for scenarios A and C.	96
Figure 4.17: Voltage profiles without DG and with DG.	96
Figure 4.18: Line power flow without DG and with DG.	97
Figure 4.19: Voltage profile versus time period at sensitive buses in attitude I.	98
Figure 4.20: Total system active load before and after load shedding in attitude II.	99
Figure 4.21: Total system reactive load before and after load shedding in attitude II.	100
Figure 4.22: Optimum location and size of SC in attitudes III, V, VII&VII.	100
Figure 4.23: Voltage profile versus time period at sensitive buses in attitude III.	101
Figure 4.24: Optimum location and size of DG in attitudes II, VI, VII&VII.	101
Figure 4.25: Voltage profile versus time period at sensitive buses in attitude IV.	102
Figure 4.26: Total system active load before and after load shedding in attitude V.	103
Figure 4.27: Total system reactive load before and after load shedding in attitude V.	103
Figure 4.28: Total system active load before and after load shedding in attitude VI.	104
Figure 4.29: Total system reactive load before and after load shedding in attitude VI.	104
Figure 4.30: Total system losses versus time period in attitudes I, III, IV, VII&VII.	105
Figure 5.1: TSB according to different payback time (T_{PB}) and different wind turbine life time (T). ...	113
Figure B.1: The present worth factor ($P/F, r, N$) as function of rate r and number of years N	146

Figure B.2: The capital recovery factor ($A/P, r; N$) as function of rate r and number of years N	148
Figure C.1: Portion of the Midwestern US distribution system.	151
Figure C.2: Modified IEEE 30-Bus system under study.	152

Contents of Tables

Table 2.1: Typical short and long-term planning periods for power system planning.	23
Table 4.1: Distribution feeders' design capacity limits constraints.	82
Table 4.2: Optimum solutions for the three scenarios in Case 1.	89
Table 4.3: Optimum solution for the different scenarios in case 2.	94
Table 4.4: Optimum solution for different scenario in case 3.	95
Table 4.5: Optimum curtailed load at each time period and in each bus in attitude II.	99
Table 4.6: Optimum curtailed load at each time period and bus in attitude V.	102
Table 4.7: Optimum curtailed load at each time period and bus in attitude VI.	104
Table 4.8: Optimum solution in each attitude.	106
Table 5.1: Different DG technology cost.	112
Table 5.2: Optimal solution for different DG technology in Case 1.	113
Table 5.3: Optimal payback time and its related total TSB for different DG technology in case 1.	114
Table 5.4: Optimal solution for different DG technology in Case 2.	115
Table 5.5: Optimal payback time and its related total TSB for different DG technology in Case 2.	115
Table 5.6: Optimal solution for different DG technology in Case 3.	116
Table 5.7: Optimal payback time and its related total TSB for different DG technology in Case 3.	117
Table A.1: Summary of DG technologies.	140
Table C.1: Base load data of modified IEEE 30-Bus System.	152
Table C.2: Active and reactive power limit of modified IEEE 30-Bus System.	153
Table C.3: Network Data.	153

Chapter 1

Introduction

Electrical energy sector over the past two decades has been affected by two important factors. The first factor is the advancement in generation technologies which has been evolving on a continuous basis, and newer and different energy transformation resources have been introduced to achieve high standards of energy provision. The second factor is the trend to liberate the energy sector from a monopolistic operating regime to a deregulated one, and to establish competitive markets for electricity.

The deregulation of the power industry and setting up of open markets for electricity in many countries, from the erstwhile vertically integrated systems has led to a clear separation between generation, transmission and distribution activities. All of these activities have undergone significant transformation processes in the restructured environment in order to find the operational range which is more secure, reliable and economic [1]-[5].

Changes in electric system logistics and high growth of load densities make it now more essential than ever to create alternative solutions to system planning. More efficient distribution system planning models have to be developed taking into consideration the new available planning options. Distributed generation (DG) is one of these new planning options [6]-[8] which should be investigated in combination with the traditional

distribution system planning options.

1.1 Changes in the Power System

The operation of the electric power industry world-wide has been changing from a vertically integrated mode to competitive market models. In the traditional system, electric energy was generated and transmitted in bulk, then distributed in a ready-to-use form to customers. The electric utility had a monopoly franchise of the electric system and was granted the rights to provide and sell electricity to customers in their territories with regulated operations and prices [9]. The electricity tariff was set by a regulatory process, rather than by market forces, whereby rates were established to recover the cost of producing and delivering the power to consumers as well as to recover the capital costs [3].

Two fundamental trends in society are important drivers in the long-term development of the electrical power system:

- **Economic efficiency:** The first trend is the demand for cost efficiency, which has triggered a wave of deregulation and liberalization initiatives in various industries that used to be operated under regulation (e.g. aviation, railway, telecommunication, gas, and electricity).
- **Environmental responsibility:** The second trend is the increased public awareness of the environmental consequences caused by the increasing use of energy in the world. This aspect, in compliance with the Kyoto Protocol [118], drives the search for new and cleaner technologies to generate electricity.

The two above mentioned trends contribute to change the conditions under which the participants in the electrical power system operate. The objective behind power system liberalization is to increase the competition, and thereby also the economic efficiency in the operation of the electrical power system. One important consequence of the liberalization is that the traditional regulated utilities shift their focus from cost minimization to profit maximization in the segments of their operation where competition is introduced. The increased environmental concern is mainly reflected in regulations whose aim is to curb polluting emissions from power generation.

Tradable certificates for renewable power generation and limits, quotas, and taxes on emissions from power plants are examples of such environmental regulations. While the

drive towards competitive markets in general induces fewer regulations in the system, the drive towards less environmental impact tends to introduce more regulations.

The term *deregulation* in the context of the electric power industry refers to a new industry structure of companies producing unbundled electrical services. It also means a clear separation between generation, transmission and distribution activities [10], and creating a competition structure amongst generation companies either through auction markets or through bilateral/multi-lateral mechanisms. The transmission sector is still considered a monopoly that must be regulated so as to ensure open and non-discriminatory access for all market participants.

The combination of full market opening, unbundling of transmission activities, regulated access to the network and liberalization of electricity trade is known as “retail competition”. Under retail competition, transaction among generators, end users and a number of possible intermediaries, such as retailers, power exchanges and brokers take place freely (within the “physical” constraints imposed by the network). Thus, on the demand side, end users are free to choose their supplier and to negotiate their contracts; on the supply side, generator can sell their electricity to any other market players.

Before we delve into the analysis of electricity markets, it is useful to introduce the types of companies and organizations that play a role in these markets. The development of electricity markets have progressed in different directions across the countries / regions around the world. Therefore, some of entities that may be present in one market may not necessarily exist by the same name or function in another market. Moreover, one entity can also play more than one role in the market. In the following, the most common entities participating in electricity markets are briefly described [4], [5], [9].

- *Generation companies (GENCO)*

Generation companies participate in the electricity market by producing and selling electrical energy either to the pool or directly to the customers through bilateral contracts. Their main aim is to maximize their own profit while participating in the market.

- *Transmission companies (TRANSCO)*

Transmission companies are entities that own and operate the high voltage transmission networks. TRANSCO assets are usually under the control of the Independent System Operator (ISO) and they operate in close cooperation with each other with the objective to

provide non-discriminatory connections to all market participants.

- *Distribution companies (DISCO)*

Distribution companies are entities that own and operate the distribution networks. Their main function is to operate, maintain and develop the network from a technical viewpoint. In a fully deregulated environment, the sale of energy to retail consumers is decoupled from the DISCO's operational responsibilities and is a separate business where different *retailers* can compete in. The DISCO may or may not be a retailer.

- *Independent System Operator (ISO)*

The ISO is truly an *independent* entity in the deregulated electricity market environment having no interest in the commercial aspects of energy transactions, but is involved in maintaining the instantaneous demand-supply balance of the system and ensures that the energy delivery process is secure. Providing a non-discriminatory open access to all bulk system users is one of its functions. In other words, its main responsibility is to operate the system at high levels of security and reliability.

- *Retailers*

Retailers are entities that buy energy from the wholesale electricity market and sell it to customers. However, they need not necessarily own any generation or network asset. A retailer can simultaneously serve customers that are connected to different DISCOs using their respective network facilities.

- *Customers*

Wholesale customers are entities that purchase electrical energy either from the GENCOs through bilateral contracts or from the market by participating in the market clearing process. On the other hand, end-use customers are entities (*usually connected at distribution voltage levels*) that purchase their electrical energy from the DISCO/retailer and usually do not participate in the market.

1.2 Models of Competition

The shift towards liberalized and competitive power markets has led to a major change in how electrical power systems are being planned and operated. Electrical power systems are large-scale, integrated, and complex engineering systems which need a certain level of

centralized coordination to function. Besides, electric power has a set of special features which makes it different from most other commodities that are traded in competitive markets. The list of special features includes instant and continuous generation and consumption, non-storability, high variability in demand over day and season, and non-traceability (i.e. a unit of consumed electricity can not be traced back to the actual producer). At the same time electricity is an essential good for society, and we know that blackouts with huge detrimental effects can occur if the system is not maintained under control. Furthermore, generation and transmission of electricity are highly capital intensive businesses. Large up-front investments can easily deter new participants from entering the market, and thereby prevent efficient competition. It is therefore obvious that special attention is essential in the process of liberalizing and restructuring the electrical power system. There is currently no real consensus among researchers and industry practitioners about what is the ideal organization of a liberalized market for electricity.

The optimal solution will necessarily depend on the physical character of the power system in question, and different market designs are implemented in various parts of the world. The purpose of this section is not to give an extensive presentation of all the aspects of the different market designs. However, we want to give an overview of the main participants that are typically involved in the planning of a restructured power system, and how the participants interact and are regulated.

Hunt and Shuttleworth have proposed four models to chart the evolution of the electricity supply industry from a regulated monopoly to full competition [11].

1.2.1 Model 1: Vertically Integrated Monopoly

The first model, which is shown in Figure 1.1, corresponds to the traditional monopoly utility [12]. Sub-model (a) corresponds to the case where the utility integrates the generation, transmission and distribution of electricity. In sub-model (b), generation and transmission are handled by one utility, which sells the energy to local monopoly distribution companies. This model does not preclude bilateral energy trades between utilities operating in different geographical areas. As illustrated in this figure, these trades take place at the wholesale level.

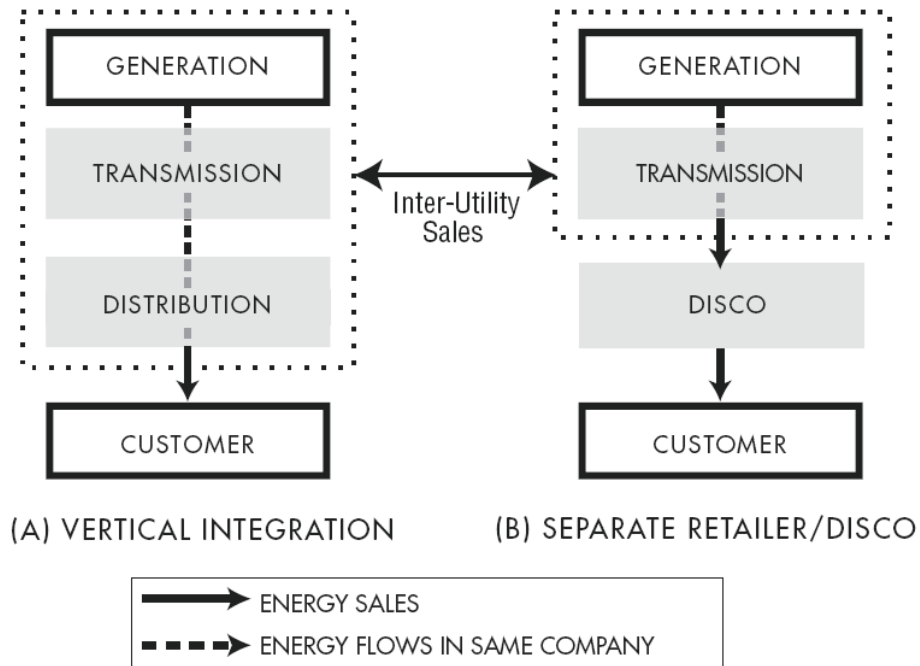

Figure 1.1: Two different monopoly sub-models of electricity market.

1.3.2 Model 2: Single Buyer

Figure 1.2(a) shows a possible first step toward the introduction of competition in the electricity supply industry [12]. The integrated utility no longer owns all the generation capacity. Independent Power Producers (IPPs) are connected to the network and sell their output to the utility that acts as a purchasing agent. Figure 1.2(b) shows a further evolution of this model where the utility no longer owns any generation capacity and purchases all its energy from the IPPs [12]. The distribution and retail activities are also disaggregated. DISCOs then purchase the energy consumed by their customers from the wholesale purchasing agency. The rates set by the purchasing agency must be regulated because it has monopoly power over the DISCOs and monopoly power toward the IPPs.

This model therefore does not discover a cost-reflective price in the same way that a free market does. However, it has the advantage of introducing some competition between generators without the expense of setting up a competitive market as in the more complex models that we describe next.

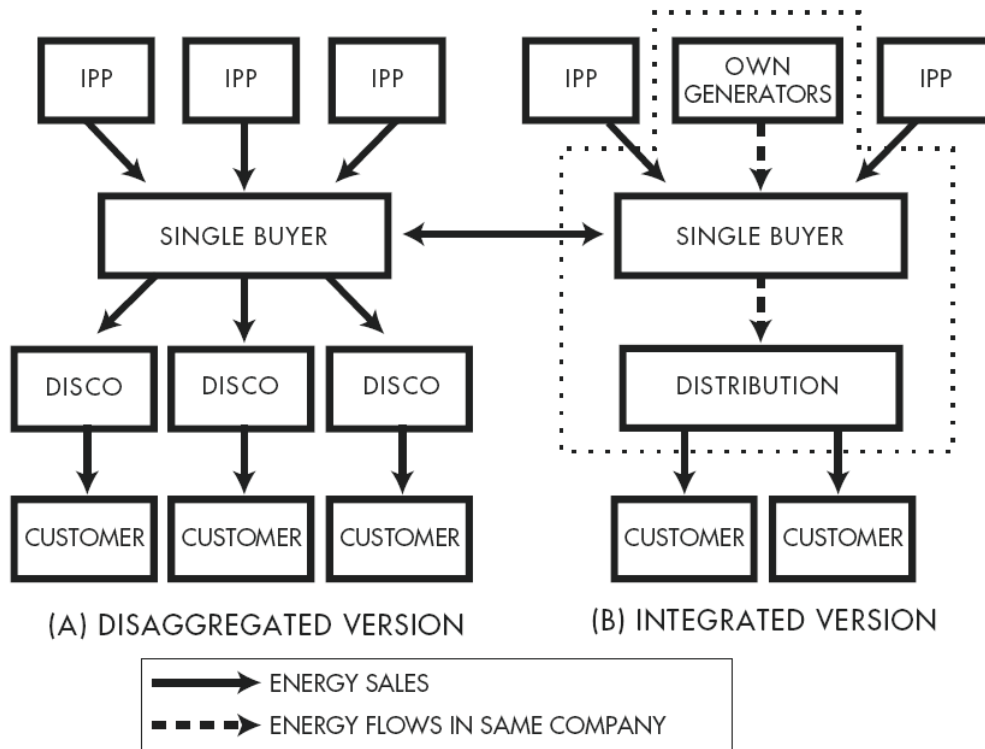

Figure 1.2: Purchasing agency model of electricity market. (a) integrated version; (b) disaggregated version.

1.3.3 Model 3: Wholesale competition

In the restructured electricity market environment, the wholesale market is an organized process based on the principle of competition. All generators compete amongst each other to sell power to the market, or directly to customers and retailers if retail competition is allowed (see Figure 1.3) [12]. In this model, no central organization is responsible for the provision of electrical energy. Instead, DISCOs purchase the electrical energy consumed by their customers directly from generating companies. These transactions take place in a wholesale electricity market. The largest consumers are often allowed to purchase electrical energy directly on the wholesale market.

The wholesale electricity market operation is coordinated by two entities, the market operator and the ISO. In most systems in North America, the market operator is also the ISO. Functions of the wholesale market operator include electric energy auctions and settlement of energy transactions in different operational time frames, such as forward, day-ahead, real-time, *etc.* In contrast, the ISO oversees that the system is secure in real-time, and therefore it is responsible for procuring and managing the ancillary services to enhance the system reliability. So, at the wholesale level, the only functions that remain

centralized are the operation of the spot market, and the operation of the transmission network. At the retail level, the system remains centralized because each DISCO not only operates the distribution network in its area but also purchases electrical energy on behalf of the consumers located in its service territory.

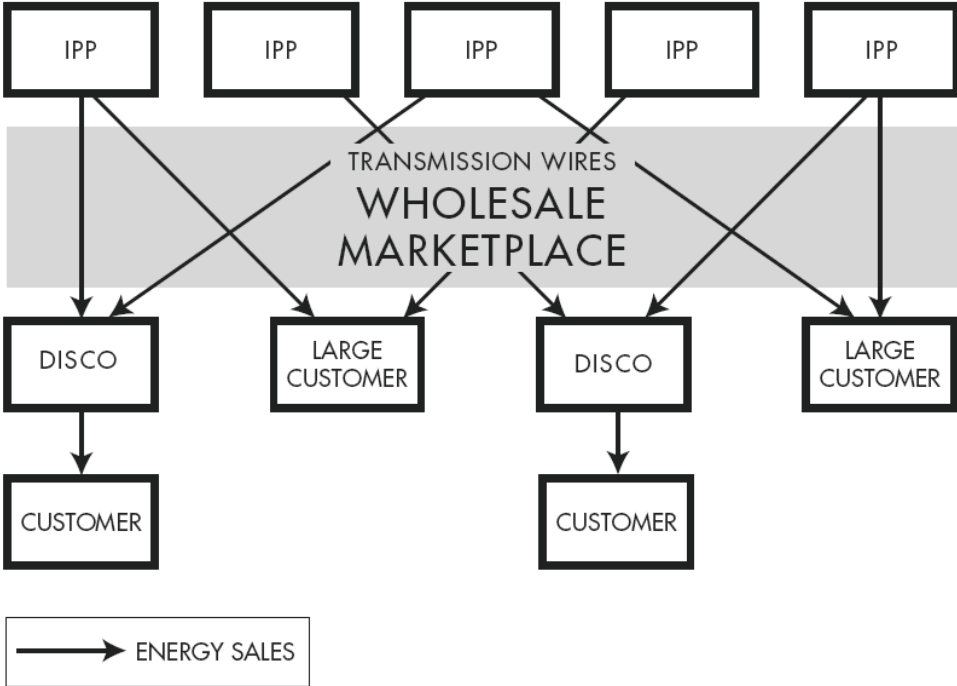

Figure 1.3: Wholesale competition model of electricity market.

This model creates considerably more competition for the generating companies because the wholesale price is determined by the interplay of supply and demand. On the other hand, the retail price of electrical energy must remain regulated because small consumers cannot choose a competing supplier if they feel that the price is too high. This leaves the distribution companies exposed to sudden large increases in the wholesale price of energy.

In the literature, the organization and structure of the wholesale electricity market has been discussed with the help of two basic models, the pool model and the bilateral contract model, which are briefly discussed below.

a) Pool Model

In this model, participation in the pool is usually mandatory for all participants and the market operator functions as the central coordinator. The GENCOs submit their offers to the pool in order to supply energy to the grid and not directed to specific customers. These

offers are arranged in increasing order of their prices to form an aggregate supply curve. The buyers, on the other hand, can also submit their bids to the pool where they are ranked and arranged as a demand function (inverse slope, in decreasing order of prices). The pool matches the sale offers and purchase bids and clears the market for sellers and buyers. Two main approaches have been reported for market clearing in a pool- the first is the *uniform price auction* and the second is the *locational marginal price (LMP)* auction, both of which seeks to maximize the social welfare.

b) Bilateral Contract Model

Bilateral contract based market models are negotiated agreements for delivery and receipt of power between two parties. These contracts set the terms and conditions of agreements independent of the ISO or the market operator. In this model the ISO and the TRANSCO are only involved after the settlement process to verify that sufficient transmission capacity exists to complete the transactions between the parties and to ensure system security. The bilateral contract model is very flexible because the trading parties involved in the contracts specify their own desired contract terms. In practice, most of the bilateral markets function as hybrid ones where a pool / power exchange exists along side but participation in the pool is not obligatory and customers can negotiate bilateral agreements directly with suppliers or choose to buy/sell power at the pool.

1.3.4 Model 4: Retail competition

Figure 1.4 illustrates the ultimate form of competitive electricity market in which all consumers can choose their supplier [12]. Because of the transaction costs, only the largest consumers choose to purchase energy directly on the wholesale market. Most small and medium consumers purchase it from retailers, who in turn buy it in the wholesale market. In this model, the “wires” activities of the distribution companies are normally separated from their retail activities because they no longer have a local monopoly for the supply of electrical energy in the area covered by their network. In this model, the only remaining monopoly functions are thus the provision and operation of the transmission and distribution networks.

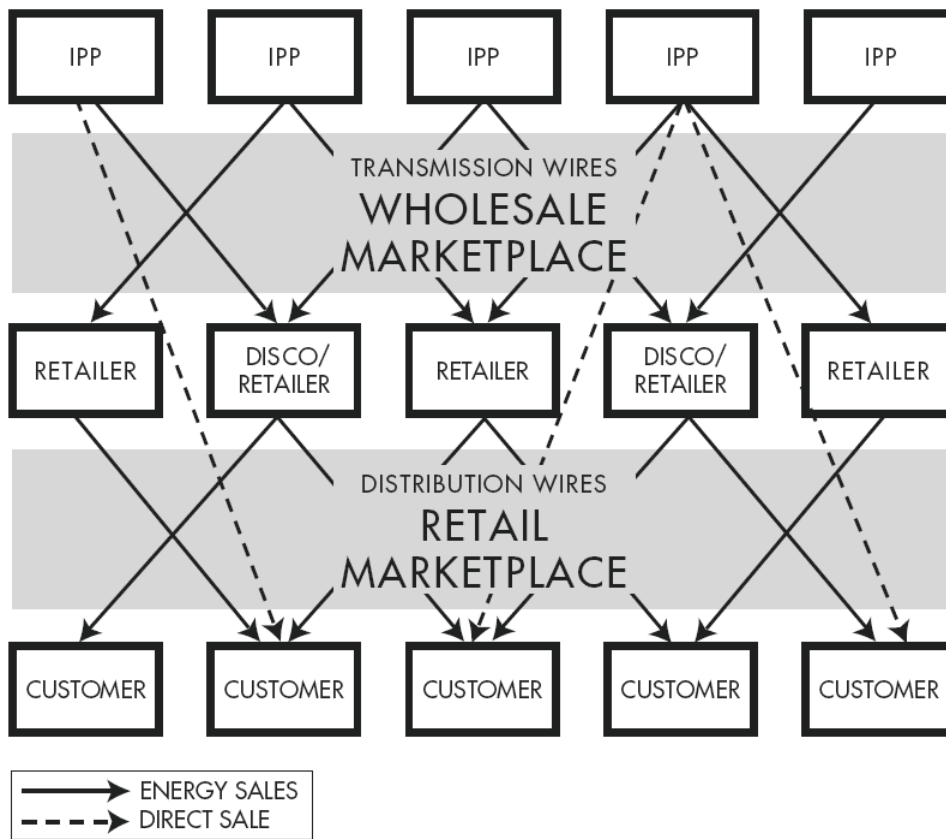

Figure 1.4: Retail competition model of electricity market.

The provision of retail electricity markets allow all customers, particularly those at the low-voltage levels and who have not participated in the wholesale market, to be able to choose their electricity providers [2]. In such markets, the distribution network operations are two-fold. The first task is to ensure provision for distribution network facilities to the customers, and the second task is to ensure the provision for retail energy to customers by any retailer, including those without network facilities.

As explained in [4], electricity retailers are in business to bridge the gap between the wholesale market and small consumers. The challenge for them is that, they have to buy energy at variable price in the wholesale market and sell it at a fixed price at the retail level. In order to reduce their exposure to the risk associated with the unpredictability of spot market prices, the retailer therefore tries to forecast as accurately as possible the demand of its customers. It then purchases energy on the spot market to match this forecast. A retailer therefore, has a strong incentive to understand the consumption patterns of its customers.

In many instances the retailer also plays the dual role of being the DISCO, with the

responsibility of network operational aspects. With technical developments in DG and their penetration in the distribution network, the DISCO's role has therefore, further evolved. The tariff of electrical energy charged from the end-use customers usually comprises two cost components- that of the retail energy and the network access. In Spain, for instance, the retail access tariffs for end-use customers are calculated from the retail tariffs charged to regulated customers minus the market price of energy [2]. The implementation of retail markets world-wide, especially in countries or states that have decided to introduce a total competition for end-use customers, have taken different approaches with respect to regulations and operations.

Implementing this model, however, requires considerable amounts of metering, communication and data processing. The cost of the transmission and distribution networks is still charged to all their users. This is done on a regulated basis because these networks remain monopolies.

The unbundling in the electric system structure invites the possibility of having power generation anywhere in the electric system. Moreover, the rapid load growth of electric energy consumption adds a further burden on the electric planners and increases planning complexity. Traditional investments are not quite feasible under a deregulated environment, where the fluctuations of market prices make investments more risky and difficult to produce a stable economical investment decision [13]-[16]. These changes and alterations in the electric system structure, operation, and economics have to be incorporated in the distribution system planning process. Therefore, new distribution system planning models have to be developed; otherwise misleading optimal planning decisions are obtained.

1.3 Power Delivery System Planning

The aim of the distribution system planning is to assure that the growing load demand can be fulfilled technically and economically by optimal distribution system expansion. It works on the retail not the wholesale system level, and has close physical proximity to retail customers [17].

The distribution system planning process is carried out for various reasons; each one has its own objective function. The traditional distribution system planning strategies are based on an established rule base experience. The load growth value is forecasted till it reaches a predetermined threshold by the local distribution utility. Then it new investment, has to be

installed in the network, which requires sizing and siting decisions. This new capacity is obtained by considering the installation of new substations and expanding existing substations and their associated new feeders or both of them [18]-[20] and/or reconfiguring the existing distribution system. The options for this rule base strategy are limited and valid only if the economic status is not varying rapidly. However, if the economic variations are tremendous, this rule base strategy has to be drastically developed and modified to accommodate the new system changes and rapid economy fluctuations. Therefore, the new distribution system planning problem has to be formulated and introduced to obtain the win-win case for all players [13], [14], [21] by introducing non-traditional capacity investment options. DG is one of the new attractive capacity options for local distribution company planning, which puts to use the economical and operational benefits of DGs.

DG provides small-scale power generation at/or close to customer sites using different technologies. It can be considered as a new take on an old concept that plays an immense role in alleviating the pressure on an already overloaded electric power system. DG reduces: the system's capital cost by deferring the construction of new distribution facilities [22], the system's power flow thus improving the system's voltage profile [23], [24], [120], and the system loss [23], [25], [26], [121], [198]. DG also relieves the heavily loaded feeders, extends the equipment's lifetime [23], and minimizes the unserved customers' power (load curtailment) [13]. On the other hand, installing DG in the distribution system will increase the complexity of the distribution system planning problem. Hence, a new look at the system's objective function is required.

1.4 Research Motivation and Objectives

As discussed earlier, the latest sub-sector to be affected by deregulation has been the distribution system with introduction of retail competition and penetration of DG sources. Various issues have arisen from this, such as the role of the DG in short-term system planning with regard to reduction of feeder losses, active purchased power, *etc.* There are also issues regarding the role the DISCOs can play in the long-term and their impact on serving the distribution system's growth and investment requirements. These issues need to be examined in greater detail so as to utilize and plan for the DG capacities optimally. Furthermore, there is a growing need for participation of customers in system planning

aspects to help the system in several ways.

This research is concerned with implementing DG as an appealing tool combined with the traditional distribution system planning options to solve the distribution system planning problem to meet the electric load growth in its power distribution system territories. Implementing DG planning makes the most use of DGs' economical and operational benefits in the new structured electric power system. The proposed distribution system planning model investigates the cost-effectiveness of implementing DG in solving the distribution system planning problem. This framework obtains DG investment decisions which are mainly based on electricity market structures and prices.

The role of the DISCO has therefore evolved into a very important and critical one for a sound and efficient operation of the whole power system taking into consideration the presence of new DG units. The issues of planning of DISCOs therefore need to be studied and examined in detail.

The main objectives of the thesis are outlined as follows:

1. In order to analyze the gamut of issues involved, there is a need to develop a comprehensive modeling framework pertaining to DISCOs that incorporate the complete distribution system power flow conditions. The modelling framework should take into account the DISCO's optimization objectives and operating constraints arising from both the distribution system and the retail electricity market. Thereafter, there is a need to examine and validate such a model for fairly large and ill-conditioned distribution systems for their solvability and to examine their computational aspects.
2. To consider all of the possible constraints and objects together in a multi-objective optimization model to approach more realistic results is necessary.
3. To solve optimization problem as fast as possible even in practical distribution systems that have a large number of variations and parameters a user-friendly software package should be used in applicable cases by distribution system planners.
4. It is also important to note that an individual DISCO is only a part of a large integrated power system. The wholesale market price in the system will have an effect on the system demand, and consequently, on the individual DISCO's

demand. Therefore, such inter-relationship between the external electricity market price and the local DISCO demand is an issue of importance, and the DISCO's operations can be affected by such interactions. There is a need to examine this issue within the short-term operations framework developed.

5. In addition to the above, it is also important to examine the impact of DG on system voltage and distribution system feeders' congestion improvement. The effect of DG comparing voltage regulator devices on DISCO losses and the contribution of DGs and customer load curtailment and their appropriate pricing mechanisms.

The distribution system planning options taken into consideration within this research are: purchasing the required additional power from existing TRANSCOs, load curtailment, and to meet the load growth locally by installation active and/or reactive power generation in the system. The aim of the proposed work is to minimize the planning investment cost by obtaining the optimal DG sizing, siting, and timing combined with other traditional distribution system planning options. The cost minimization includes: capital and running costs of new installed facilities, running cost of the existing facilities, cost of purchasing power from other electric identities, and payments towards electric system power losses.

This work deals with planning situations by introducing DG in a full service utility's structure. The proposed distribution system planning frameworks and models are executed on the IEEE 30-Bus system. Different scenarios (planning alternatives, electric market structures, and price fluctuations) are discussed to evaluate and validate the proposed distribution system planning frameworks and optimization models and illustrate the importance of accuracy input data.

1.5 Outline of the Thesis

This thesis is structured as six chapters. Following this introductory chapter which discusses on general introduction to the aspects which lead to the proposed research, work objectives, the problem definition, and thesis organization, changes in distribution system planning is studied in **Chapter 2**. This chapter assigns the distribution system as an important part of the electric power system, one of the most complicated systems created by the mankind. It also states the essence of power system planning problem, the effect of DG and deregulation on traditional distribution system planning and change in distribution

system planning.

A literature review is presented in **Chapter 3** where research publications pertaining to planning aspects of distribution systems are discussed based on planning model and solving method.

In **Chapter 4**, two proposed frameworks and integrated DG optimization models for distribution system planning are explained and formulated. The results of frameworks and models implementations on modified IEEE 30-Bus system under several alternative planning scenarios are discussed.

In **Chapter 5**, a new two-stage methodology to optimize total system cost and obtain the optimal location and size of DG and to provide an integrated electric-market investment model. This framework creates an electric market price forecasting model to predict electricity market price.

Chapter 6 draws the conclusions from the research work carried out in the thesis, summarizes the main conclusions, and outlines some scope for future work in this area.

Chapter 2

Changes in Distribution System Planning

This chapter presents a comprehensive survey of traditional distribution system planning aspects; changes made to the electric power system under the new structure; main planning objectives; the stages of the planning process; and the proposed DG implementation as an alternative to solve distribution system planning problems. In Section 2.1, an introduction of distribution system in general is discussed. In Section 2.2, essence of system planning problem are introduced. Traditional distribution factors, objectives, models, decisions, and constraints are illustrated in detail in Section 2.3. Section 2.4 provides the effect of deregulation on the appearance, and implementation of DG. In Section 2.5, the effects of DG on distribution system planning are proposed. In addition, DG implementation and factors affecting DG planning, the proposed modification to the traditional distribution system planning models and constraints due to introducing DG as a planning option are illustrated in Section 2.6. Finally, Section 2.7 concludes this chapter by emphasizing the viability of the DG implementation as a key element in the distribution system planning.

2.1 Distribution Systems in General

Distribution system is an important part of the electric power system and one of the most complicated systems created by the mankind. It is declared that the complexity of the stated task of distribution planning is caused by multiple objectives, large number of variables, and uncertainty of initial information and dynamic nature of the problem.

Distribution systems can be defined as electrical interconnections joining the bulk electric power system to end-use customers requiring energy services at voltage levels below that of transmission and sub-transmission systems. At the generating station, the voltage level of the generated power is boosted up by a step-up transformer to match the voltage level of the transmission system. After a long distance transmission of this power, and near to the customer end, step-down transformers transform the bulk power to lower voltage levels. The power is transferred further over the sub-transmission system network to reach the local substations close to the demand centre. At the distribution substation, the power is transformed to a lower voltage level for distribution on a primary distribution feeder [10], [27]-[29]. Figure 2.1 shows the typical configuration of a power system with different voltage levels. Distribution circuits generally consist of two parts:

2.1.1 Primary Distribution

The primary distribution operating at a relatively high voltage that carries the electric supply to the area here it is to be used. The primary distribution feeder can be configured as radial, loop or as primary network systems.

Radial systems

The radial distribution system is the most frequently and widely used configuration since it is the simplest and the least expensive system to build. In this configuration, there is only one path for the power flow from the substation to the end-user. So the operation and expansion of such distribution systems are simple [29]. However, radial feeder configurations suffer from low reliability because any fault occurring immediately after the substation will cause a power interruption on the downstream feeder. The service reliability can be improved on this feeder by installing automatic re-closing devices at the substation or at various locations on the feeder. These devices work to reduce the duration of interruptions by re-energizing the feeder if the fault is temporary. Sectionalizing fuses are also installed on branches of radial feeders to isolate the affected portions of a feeder and

allow the unaffected ones to remain in service.

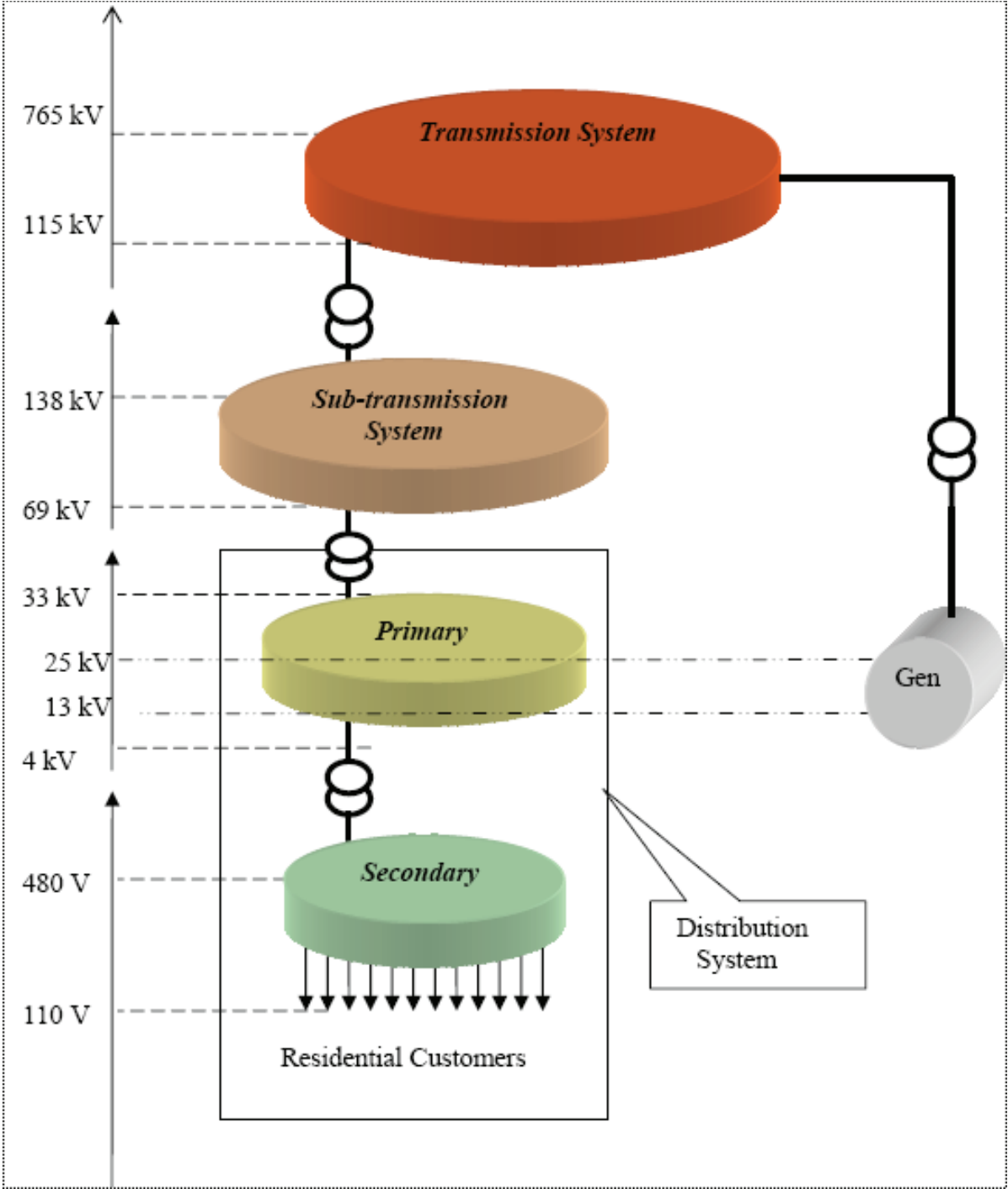

Figure 2.1: Typical power system structure with different voltage levels.

Loop Systems

Another means of restricting the duration of interruption employs feeders designed as loops, which essentially provide a two-way primary feed for critical consumers. Here, should the supply from one direction fail, the entire load of the feeder may be carried from

the other end, but sufficient spare capacity must be provided in the feeder. This type of system may be operated with the loop normally open or with the loop normally closed.

Primary network systems

Where higher reliability is desired than from radial or loop circuits (such as commercial and industrial complexes where the units may not be spaced close together), the radial primary circuits are tied together into a network. The network is supplied from a number of transformers or substations supplied (TRANSCOs) in turn by sub-transmission and transmission lines. Circuit breakers between the transformers and grid act as network protectors to protect the network from faults on the incoming high voltage lines (See Figure 2.2) [New01]. The high cost of operating such a system in providing for load growth and the high potential hazard involved with the enormous fault currents handled by the circuit breakers have led to their replacement by low voltage secondary ‘spot’ networks, though some primary networks may still be in operation.

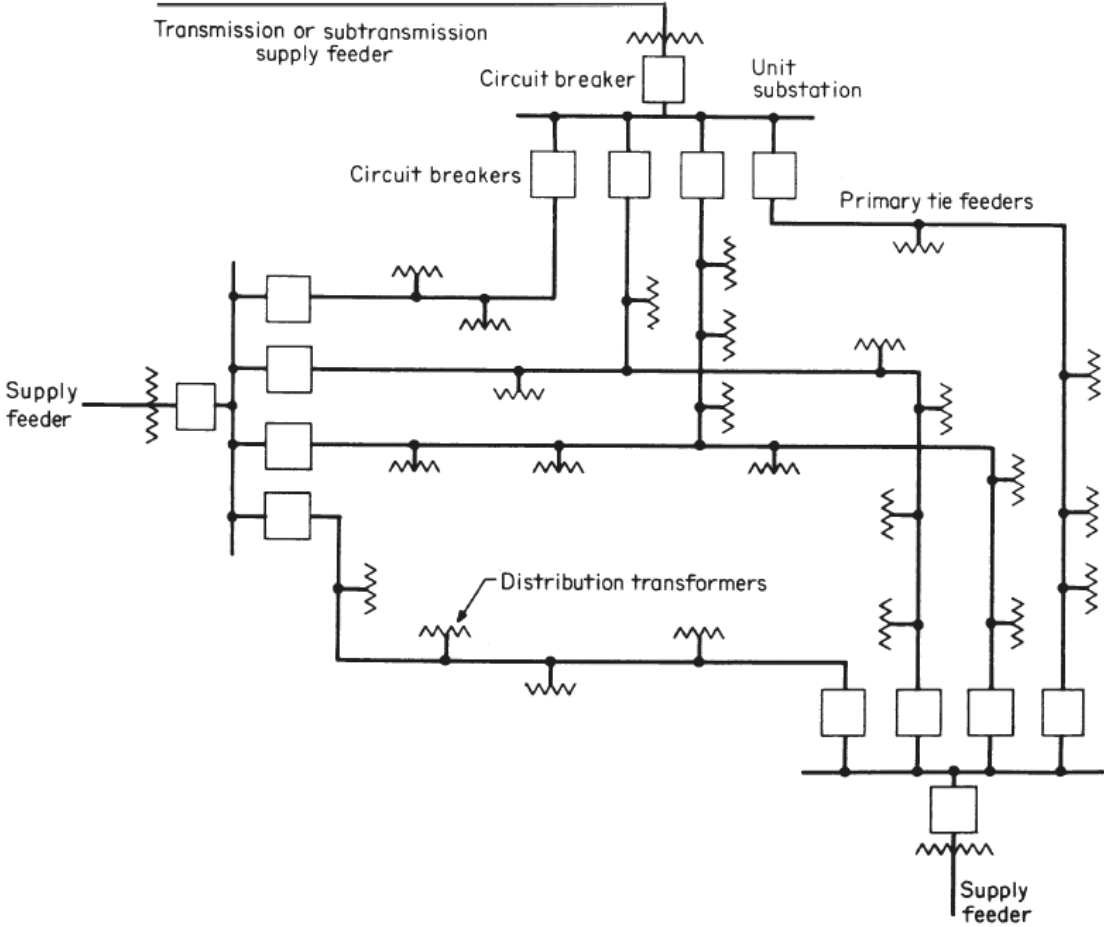

Figure 2.2: Primary network. Sectionalizing devices on feeders not shown.

2.1.2 Secondary Distribution

The secondary distribution receives the supply from the primary through transformers that reduce its voltage to values low enough to deliver the product safely to consumers. It operates at relatively low voltages and, like primary systems, involves considerations of service reliability and voltage regulation. Four general types of the secondary system, which each of these types has its application, are summarized as [New01]:

1. An individual transformer for each consumer; i.e., a single service from each transformer.
2. A common secondary main associated with one transformer from which a group of consumers is supplied.
3. A continuous secondary main associated with two or more transformers, connected to the same primary feeder, from which a group of consumers is supplied. This is sometimes known as banking of transformer.
4. A continuous secondary main or grid fed by a number of transformers, connected to two or more primary feeders, from which a large group of consumers is supplied. This is known as a *low-voltage* or *secondary* network.

2.2 Essence of System Planning Problem

The electric power systems are among the most complex systems created by the mankind. These include hundreds of thousands components: generators, transformers, transmission lines, control and protection equipment, etc. Construction of power systems and their operation and maintenance require billiards of dollars. The functions are interdependent: the processes going on in one of the system's components influence functioning of the other elements.

System conditions are continuously varying in time because of new customers and power system objects appear, prices grow and legislation changes. Additionally, constantly changing weather conditions, e.g. temperature and wind speed, influence significantly operation of the system. The costly objects and elements have a finite life of several decades. This motivates the need to estimate the conditions, which may arise in a rather distant future. Clearly, these conditions cannot be predicted exactly. Thus, the planning mistakes leading to the wrong decisions cannot be corrected fast and may result in substantial financial losses.

In planning of electric power systems a number of goals must be achieved and correspondingly a number of objectives, which often are conflicting, must be optimized. The planning goals include minimization of power losses and required investments, enhancement of reliability, personal safety and power quality, and consideration of environmental factors. If there are a number of objectives and it is impossible to define their relative importance or to express the corresponding attributes in monetary terms, the planner has to deal with multi-criteria optimization tasks. Significance of electric power for the national economies, high investment costs and considerable possible losses in case of planning mistakes encourage the development of well-motivated methods for robust and flexible planning of power systems.

Strong interdependence of the power system elements imposes the need to consider the system as a whole. However, the optimization of large power system is the task of remarkable complexity. One of the most powerful means to reduce the complexity of the problem is decomposition, i.e. the task is divided into several simpler sub-problems. Thus, traditionally transmission, sub-transmission and distribution systems can be treated independently (e.g. [30]). Furthermore, the local distribution networks can also be handled separately, taking into consideration relatively weak connection between them. It should be noted that decomposition of the initial complicated problem into several sub-problems is not free of charge. The decisions of each sub-problem should be consistent moreover often there is a need to solve each sub-problem for several outcomes of other sub-problems [31]. The main basis for any planning process is described flowing:

2.2.1 Planning Philosophies

In general, under the traditional monopoly regulated electric utility structure, the utility is obliged to serve its territory customers' loads with certain standards within a regulated price structure. Figure 2.3 illustrate system planning philosophies.

As it is shown in this figure planning philosophies are used as follows [10]:

1. In the supply-side planning process, the electric utility will get a higher profit after paying for its expenses by minimizing their costs, The main planning goal is to minimize the long-term lifetime (>30 years) cost for its expensive equipment (supply-side resources: generation and Transmission and Distribution (T&D)) irrespective of the customers' costs and their electricity usages effectiveness profile.

Therefore, the cost of delivered power to customers is reduced while keeping the electrical standards.

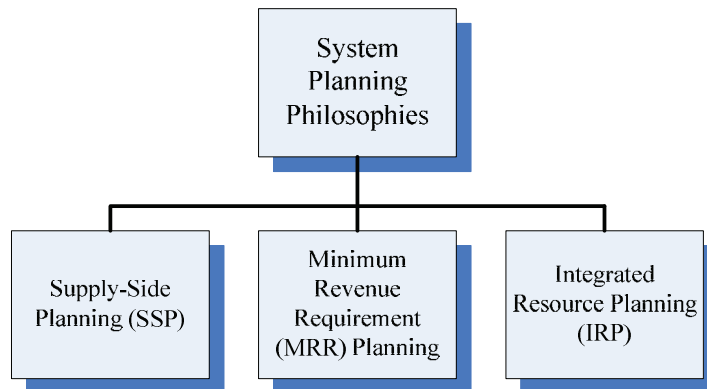

Figure 2.3: System planning philosophies.

2. Another prospective of the supply-side planning strategy used is the Minimum Revenue Requirement (MRR) planning strategy. Its goal is to minimize the revenue requirements, which is the rate base to collect from customers, to keep customer charges as low as possible. Also, it aims to keep sufficient revenue for the utility expenses and provide profit for their owners (shareholders) with a regulatory-approved profit margin. Therefore, the decision-making planning process has to take into consideration the Operation and Maintenance (O&M), fuel costs, and the loans and debt payments using the economic and financial analysis.
3. Later in the 80s supply-side planning started to include some customer costs and profits as an Integrated Resource Planning (IRP). IRP has the same goals to obtain the least-cost use of electric power by trying to calculate the actual energy needed from the supply-side after enhancing the customer-side usage. Hence, it concentrates on reducing the overall cost by satisfying customer end-users. In the early 90s, IRP was developed by considering T&D marginal benefit /cost (which is location dependable) as a planning selection criteria.

2.2.2 Planning horizon

The decision for the planning duration is restricted by the "Lead Time" at minimum. The lead time is the duration taken to arrange and order materials, get hold of permits and budgets, survey and study, manufacture and build, install and test, and put into service the best obtained planning alternative electrical facilities. Due to uncertainty in future

circumstances, the planner may commit only to the planning alternatives, which have to be realized in the nearest future. However, the consequences of these alternatives must be estimated on a long-term basis. Thus, the planning process may be divided into two major time stages: short and long term. The purpose of short-term planning is to make certain that the system can continue to serve customer load while meeting all standards and criteria. The duration of the short-term period depends on the lead time for the particular level of power system. Then again, the purpose of the long-term plan is to assure that all short-term decisions have lasting value and contribute to a robust solution for network reinforcement. A typical lead time depends on the electrical facilities types, projects and system levels shown in Table 2.1 [10]. This lead time identifies the planning horizon year: either a short- or long-term planning process.

Table 2.1: Typical short and long-term planning periods for power system planning.

System level	Lead Time (Year)	
	Short-term	Long-term
Large generation (>150 MVA)	10	30
Small generation (<50 MVA)	7	20
Transmission	8	25
Sub-transmission	6	20
Distribution substations	6	20
Feeder system	6	20
Primary tree-phase feeders	4	12
Laterals and small feeder segments	1	4
Service transformers and secondary	0.5	2

2.3 Traditional Distribution System Planning

Despite the possible simplifications the problem of distribution network planning remains an extremely complicated optimization and decision-making problem due to, conflicting objectives, large number of variables, dynamic nature, uncertainties, etc. To ensure substation capacity adequacy and satisfaction of feeder thermal capacity, distribution utilities' planners forecast, their territories' load growth for several future years. Therefore they can dictate when there is a mandatory need of system expansion and installation investments due to capacity limit violation at some peak loading situations as a planning criterion. Once a new capacity investment is required, a cost function which includes fixed and running costs for all feasible planning alternatives of important issues such as meeting the required capacity, power quality, loss reduction and reliability is created after converting them to a present worth cost value or converting fixed price to annual payments based on rated-of-return. The analysis is carried out using different

mathematical formulations to obtain the most optimum decision. The choice of a certain planning option is based on the best solution that meets the electric load growth needs with the least-cost and is constrained by the required system performance. It is to be noted that the planning concepts mentioned in Section 2.2, philosophies, and horizon year definition are applicable on the distribution system planning problem.

2.3.1 Traditional Distribution Planning Factors

The factors that affect distribution planning decision-making accuracy can be divided into two categories, direct factors which the planner can control and indirect factors with no distribution planner control. Direct factors are: sub-transmission systems' expansion, equipment sizing and siting, operating voltage level, and permissible voltage drop. Indirect factors are: duration and frequency of outages, cost of equipments and labor, fuel market price fluctuations, economic variations, and changes in the government regulations. The most important factors which have a direct impact are discussed below:

- **Planning duration:** Short-term planning is usually associated with a schedule of reinforcement and changes required for the electric system to meet the planning goals. Its plan range is 0-5 years and is mainly concerned with solving the expected demand growth problem. On the other hand, long term planning is allied to install and build new facilities to meet the required demand growth and at the same time ensure the lowest overall cost, during the new installed facilities' lifetime. Its plan range is 10-25 years and mainly concentrates on satisfying the short-term needs and obtains the most lasting value over the equipments' lifetime [10].
- **Load forecasting:** It is affected by: population growth, load density and use, historical data, city and community plans and alternative energy sources.
- **Substations expansion:** There are several factors affecting the decision for expansion of existing substations such as: load forecast, land availability, physical size and barriers, gateway feeder limitation, transmission voltage level and capacity, system power losses, existing substation capacity and configuration, and tie-capacity [27].
- **Installing new substations:** This decision is affected by at vast number of factors. The most important is substations' locations which are affected by many aspects besides those mentioned in case of substations' expansion such as: the distance

between the existing sub-transmission lines and the load center to be served, existing substations' locations, land availability, and used regulations. The substation siting is based on examination of several candidate areas and ranking them into three categories: unsuitable, keep for further evaluation, and candidate feasible site [27].

- **Planning alternatives:** The availability of various planning alternatives can greatly affect the planning process such as: inter-tie power, expanding new substations, building new substations associated with their feeders, system restructuring, feeders' upgrading and/or adding extra new feeders.
- **Feeder size, type, and route:** The freedom of selecting different feeder is restricted by: the feeder's configuration that minimizes its power loss, feeder's tension for keeping acceptable voltage limits along its terminals, feeders' thermal capacity and short circuit levels, allowable number of feeders, and utility feeders' available stock.

2.3.2 Traditional Distribution Planning Model

The distribution system planning problem has numerous variables in mathematical model and is constrained by different limitations. Various distribution system planning mathematical models and strategies are introduced to minimize the total cost of different alternatives. Normally the distribution system planning problem includes several planning decisions which are discussed below, shown in Figure 2.4:

- Optimal new substation location and capacity, which is usually investigated when a high load level is required to be supplied in a new area near to the main utility grid or a load density increase in an existing area. The later case is considered to be more difficult due to several restrictions in substation location choice.
- Optimal substation expansion capacity, which is implemented if the load growth can be supplied within existing substation territories under condition that the candidate substation has land availability and no feeder limitations exist.
- Optimal feeders' routing, upgrade, and new addition, which is required in combination with new substation and/or existing substation expansion, or alone

if the substation has sufficient capacity to serve the load. The limitations are the violation of the permissible voltage drop or feeders' thermal capacity.

- Optimal individual feeder design is introduced for new feeders' construction size and installation to satisfy certain operational system constraints.
- Optimal load allocation required for load transfer between substations and load shedding.

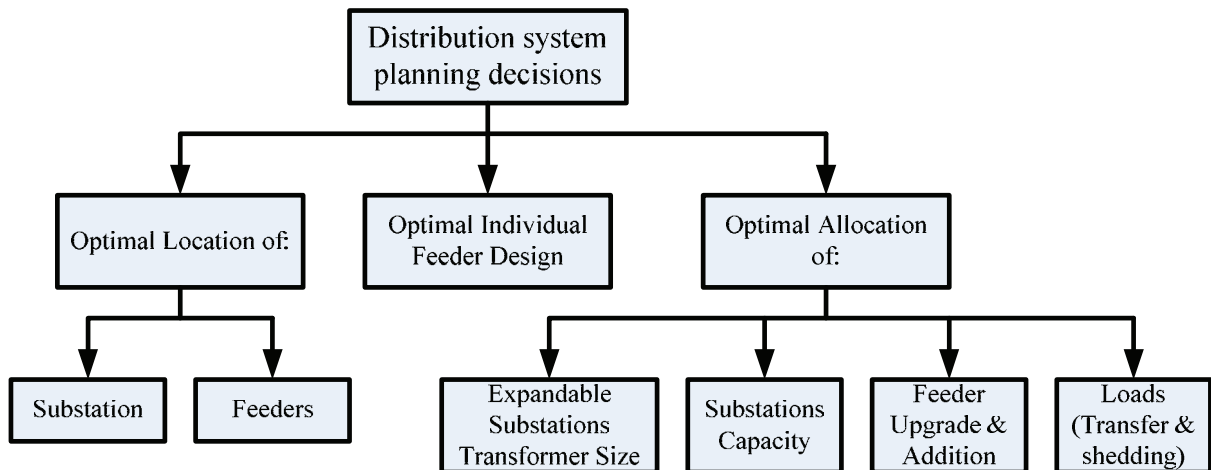

Figure 2.4: Distribution system planning decisions.

These decisions are carried out under the constraints shown in Figure 2.5:

- System capacity constraints such as: substation and its transformers capacity and feeders' thermal capacity constraints,
- System operating constraints as: power balance and flow, voltage drop, and feeders' radial configuration constraints,
- Feeder variable cost.

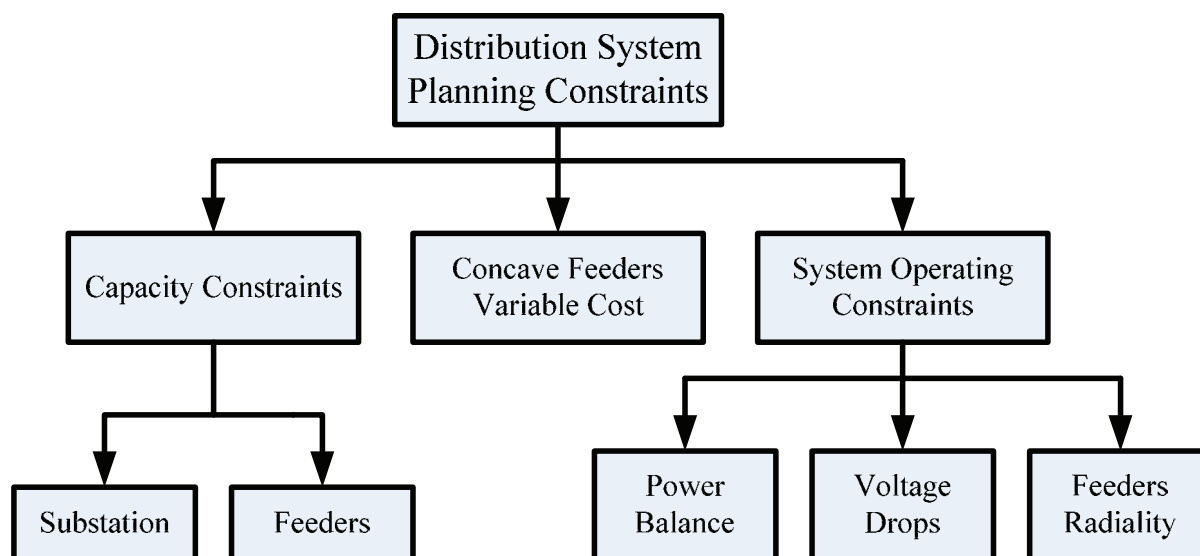

Figure 2.5: Distribution system planning constraints.

2.4 Deregulation Effect on Distribution System planning

The main objectives of the deregulation are to improve efficiency of the electric power industry and to reduce electricity prices. So, the planning of electric power systems in the competitive market environment has taken new trends. The traditional planning problems in distribution systems pertaining to the vertically integrated power system structure continue to be important issues in the context of deregulation, as well. However, further new issues have arisen because of the emergence of new entities within the distribution system domain such as generation sources and interties, which make it a very complex arrangement both from the technical and the economic perspectives.

As discussed before, under deregulation each electric identity is separately owned, operated, and is responsible for its own financial results [32]. GENCOs independently perform generation planning and aim at maximum profit planning instead of least-cost planning [32]. The grid operator is responsible for T&D planning evaluation depending on the system operation, requirements, and structure. At the distribution level, according to competition models, (discussed in Section 1.2) there are different new distribution structures [9].

In fully regulated distribution system, competition and open access (for any qualified electric power buyers and sellers) is restricted by law or regulation to the transmission power level only. The regulated TRANSCOs own and operate transmission facilities. The regulated local distribution companies shop around to purchase power at wholesale with

lowest price, deliver this power through the open transmission system to their substations, and sell it to their looked up retail customers. In this case the distribution system is closed to other users and market players [9].

In Fully deregulated distribution system, competition and open access is available for both transmission (as wholesale electricity) and distribution levels (as retail electricity). In this situation, local distribution companies are transformed into wire companies DISCOs and Retailer Companies (RESCOs). Within this structure, there is open access to RESCOs competition. Therefore, customers have the choice to buy power from several retail sellers or generate and move their power from one site to another. DISCOs are regulated companies, which guarantee fair access for every player and are responsible for distribution system ownership and management. They are not allowed to sell energy but only deliver the power to power retailers in addition to its associated services. However, wire companies have to purchase energy from the wholesale market through customer bidding to cover their losses and operate their own facilities. DISCOs are performing distribution system extension planning, with the aim of reducing their power losses and operating the distribution system efficiently. DISCOs provide services such as meter reading and outage restoration [33]. RESCOs are considered to be the DISCOs customers, as they pay for distribution system access and usage. RESCOs aim to sell power to the customer and seek maximizing their profits [33]. They can either be bulk power buyers from the wholesale market and sell power to customers in retail prices on a retail market division of large energy producers (generator-retail seller) [10]. DISCOs remain responsible for the technical aspects of the power quality and the technical state of the network. Usually it is also responsible for the new network connections and installation of meters. Under full deregulation, customers can choose any electric power provider to supply their demands, irrespective of their distances from load centers to reduce their bills [32].

2.5 Generation in Distribution Networks

Due to the fact that the deregulation trend has changed electric per generation worldwide and still cannot solve the electricity problem alone, the development of new generation technologies can change the ways of producing power. Hence, customers can

generate their own power on-site, which is similar to electric utilities using DGs in their planning plans.

The current trend in penetration of generating sources located within the distribution system (*termed as DG*) is a very promising option in the context of deregulation. The DG units have a significant impact on the operation of distribution systems. For example, radial distribution feeders are normally regulated using on-load tap changing transformers at substations or switched capacitors on feeders. With the installation of DG units there will be an impact on the system voltage profile. This impact can be positive such as voltage support in some cases, but can also be negative such as over-voltage or an under-voltage, depending on relative DG size and their location, distribution line and load characteristics, and method of voltage regulation.

There could be several types of small scale local generation sources such as wind power plants, small hydro power plants, small fuel cells or local combined heat and power plants connected to the network. For decades it has been recognized [34] that introduction of DG into distribution systems will significantly complicate distribution planning and operating practices and require substantially greater data collection and analysis efforts. Normally, small power plants are connected to the distribution network at relatively low voltage level. Therefore, in distribution network calculations it is important to consider presence of the DG in the network area and its influence at least to the losses, investments to the network and reliability of supply [35]. The existence of DG technologies in the electric system can fit into the planning philosophies discussed in Subsection 2.3.1 as follows [10]:

I) Utility-owned DGs: The distribution system structure affects the DG planning process as follows:

a. Regulated systems: As in the case of regulation, the planning philosophy will remain the same, whether it uses supply-side or IRP strategies with some concentration on customer satisfaction. With the employment of DGs, local distribution companies aim at obtaining the minimum cost or revenue requirements for the planning process, by deferring T&D expansion to accommodate load peak demand growth, or use for reliability purposes. However, a budget-constraint has to be included in the planning process to estimate the maximum allowable investment on the capital cost with a priority list. In this case local distribution companies can benefit from considering DGs as a viable option for the planning process [10].

b. Deregulated systems: In fully regulated structure, DISCOs have much less interest in implementing DGs. However, in this case, DG applications are a source of interest for RESCOs. They can use DGs to avoid the electric system's transportation costs and reduce the high fee connection zones. Therefore, their main goal is to maximize their short-term profit not to minimize long-term costs as the utility does [10]. Self-generation large industrial sites and commercial applications with DG implementation are new players in the deregulated environment. In this case the planning process will use only the actual needs of those customers. However, DG maintenance and operation problems will not encourage small consumers to own them which open the DG market to the RESCOs.

II) Customer-owned DGs: They can easily suite the IRP as a customer-side resource, where the focus is on the co-generation application of DG waste heat. Therefore, they reduce the actual power required from the supply-side resources.

2.6 Changes in Distribution System Planning

Taking into account the processes of deregulation going on in many countries and rapid development in power generation technologies, there may be a need to reconsider or to extend the traditional approach to the planning of electricity distribution networks. So, in recent years, distribution network planning has become a subject of interest both for researchers and power utilities. There are several reasons for this. First of all there is the need from the industry to have such tools. The conditions for which the network was planned are changing: open market introduces new challenges and new technologies provide new possibilities for reinforcement, etc. All these changes encourage the efforts to improve the performance of the network and, therefore, the efficiency of the planning process. On the other hand increasing computation capacities and introduction of new powerful methods for the optimization problems decision provide a possibility to develop new tools for the network planning. Clearly there is a need to examine the very important role that DG will play in the DISCO planning in the coming years.

2.6.1 Process of Distribution Planning

A starting point of reinforcement planning is the existing network under the influence of external factors. Once it has been identified that network performance during the planning period is in any way inadequate, it is time to start the planning process.

Reinforcement actions may include addition, upgrade or elimination of the network elements. Each problem may have several possible solutions. For example, monitoring calculations indicate that in five years voltage level will be too low at some parts of the network. Possible reinforcement actions may include for example building of new lines, selecting between overhead line and cable, providing alternative network configurations, installation of capacitors, change of transformers, enlargement of conductor cross-section or transition to the alternative voltage level. Moreover, appearance and development of new technologies, such as DG, may suggest alternative or additional options, which should also be considered in the planning process.

The planning process consists of several steps including identification of possible alternatives, their evaluation according to selected performance criteria and selection of the most suitable alternatives, which form the development strategy. For instance, in [36] the planning process is segmented into the following five stages:

- Stage 1 Identify the problem: Explicitly define the range of application and its limits.
- Stage 2 Determine the goals: What goals are to be achieved? What is to be minimized?
- Stage 3 Identify the alternatives: What options are available?
- Stage 4 Evaluate the alternatives: Evaluate all the options on a sound basis.
- Stage 5 Select the best alternatives: Select the options that best satisfy the goals with respect to the problem.

2.6.2 Factors Affecting on DG Planning

Implementing DG in the distribution system has many benefits, but at the same time it faces many restrictions and limitations. DG increases the system planning problem complexity. Some factors affecting DG planning decision-making are discussed below:

- **DG costs:** DG cost is technology dependable. Photovoltaic (PHV) and Wind Turbine (WT) have very high fixed (capital) costs with very low running (O&M) costs. Natural gas engines, natural gas turbines, and Microturbines (MTs) have low fixed costs and high running costs. Fuel Cell (FC) has very high fixed costs and high running costs. Most DG technologies fixed and running costs are higher than those of equivalent amounts of output power from a centralized power plant in normal operation. However, including all planning aspects might give DGs an advantage as an option for planning in specific circumstances and applications.

- **DG modularity:** Although the DG modular form is considered to be an advantage, determining modular size is not an easy task and has to be investigated. Many factors affect DG modular size choice such as: the interaction between these modulars; if there are new installations of the same modular size; or plans of expansion to already existing different DG modular sizes. Another factor affecting DG modular size is the required reliability and the number of extra modulars to be used for power redundancy in case of failure. The smaller the modular size, the higher number of modulars required and higher reliability obtained.

- **DG size:** There are no clear restrictions for selecting the total size and number of candidate units in one location and/or over one feeder during the planning process. However, some dimensions can be taken as a guideline for primary DG's size selection as follows:

- DG total capacity range 10-20% of the total feeder demand is sufficient to improve the system voltage profile and reduce the power loss [21]. Moreover, increasing DG size can be used to reduce the substation loading [37]. DG size must be greater than double the required islanded load for the sake of reliability.
- DG size can affect the system protection, therefore protection devices and relay settings have to be readjusted and/or upgraded [38].

- **DG grid interconnection:** DG requirements, agreements and logistics with the utility operator have to be discussed before starting the planning process. Two further points are of consideration: whether DGs can face islanding and be able to handle the load requirements; whether DGs are able to feed power and sell it back to the main grid.

- **DG environmental aspects:** Some areas have environmental restrictions regarding DG

emissions, noise, or visual obstacles. In such situations, the DG technology choice has to be acceptable in the selected installation areas or hybrid DG technologies can be used to reduce these effects. In addition, the availability of government subsidies for renewable and low emission DGs, encourage consideration of DGs as an alternative in the planning process.

- **DG applications:** The by-products of each DG technology can affect the choice of DG in the planning process. A typical example would be the use of the DG waste heat for Combine Heat and Power (CHP) applications (suitable for paper industry, large commercial and residential buildings) [21]. Furthermore, the dispatchability of the application required to be served in the planning process can affect the choice of the DG technology type.

- **Installation area:** The location of the area which requires DG installation can also affect DG planning. Certain DG technologies require minimum specifications such as wind speed for WT, sunlight for PHV, natural gas availability for MT, Combustion Gas Turbine (CGT). For rural areas, the DG option would be considered more advantageous as an option in the planning process [39]. DG has no geographical limitations; hence, the only limitations are related to electrical requirements [37]. If the DG is customer-owned then the utility has no control on its location.

- **DG technical aspects:** Some DG technologies have ramp time which can not follow sudden load change affecting the choice of DG technology. Other DG technologies can withstand overloading with 10% for 2 hours which would not be suitable for some electric systems [10]. Furthermore, some requirements for DG operation are essential as discussed in Appendix A and can affect the DG planning decision.

- **Fossil fuel costs:** An accurate fuel cost forecast is required to be used as an input for DG planning processes in order to estimate the DG technology type to be used.

- **DG schedules and operation cycles:** This is considered to be one of the main obstructions facing the mathematical planning model design, since the time of introducing DGs in the system must be known. If DG is utility-owned, then its operating cycle is well known as it is controlled by the utility. On the other hand, relatively large and medium customer-owned DG operating cycle are not known unless there is a unit commitment agreement between the electric utility and the customer, which is unlikely to happen. However, small customer-owned DG operating cycles are considered as completely

unpredictable components from the point of view of the electric utility. The utility has no control on their operation. Comprehensive studies are carried out to estimate the customer-owned DG power contribution to the distribution system [40]-[42]. This customer-owned DG random operation changes the distribution system planning problem from a deterministic problem to a non-deterministic one in the planning process.

2.6.3 Novel Distribution Planning Model

Deregulation will give a new focus to the traditional network planning. DISCOs are business focused on making profit. Thus, in the majority of cases the company is tending to maximize utilization of existing assets and avoid redundant investments. On the other hand, a particular attention is paid on minimization of operation and maintenance costs.

DG planning benefits can be classified into three categories: DG location, economical, and operational benefits as discussed in Appendix A. The objective of the new proposed distribution planning is to assure meeting the load growth optimally while satisfying the overall system performance by expanding, adding new facilities and/or adding DGs in the distribution system. This satisfaction is constrained by technical design and economical design aspects with the least-cost as possible.

The introduction of DG as an alternative for the traditional distribution system planning problem has increased the number of variables involved in its mathematical model formulation. In addition to the traditional distribution planning problem decisions shown in Figure 2.4, new decisions have to be taken into consideration as shown in Figure 2.5 such as:

- Optimal investment for DG installation (DG location and size) to meet the load growth locally.
- Optimal value of load curtailment to reduce the demand-side requirement to meet the supply-side facilities at peak hours without new facility investments.

The above mentioned planning decisions are carried out under several new constraints in addition to those shown in Figure 2.6.

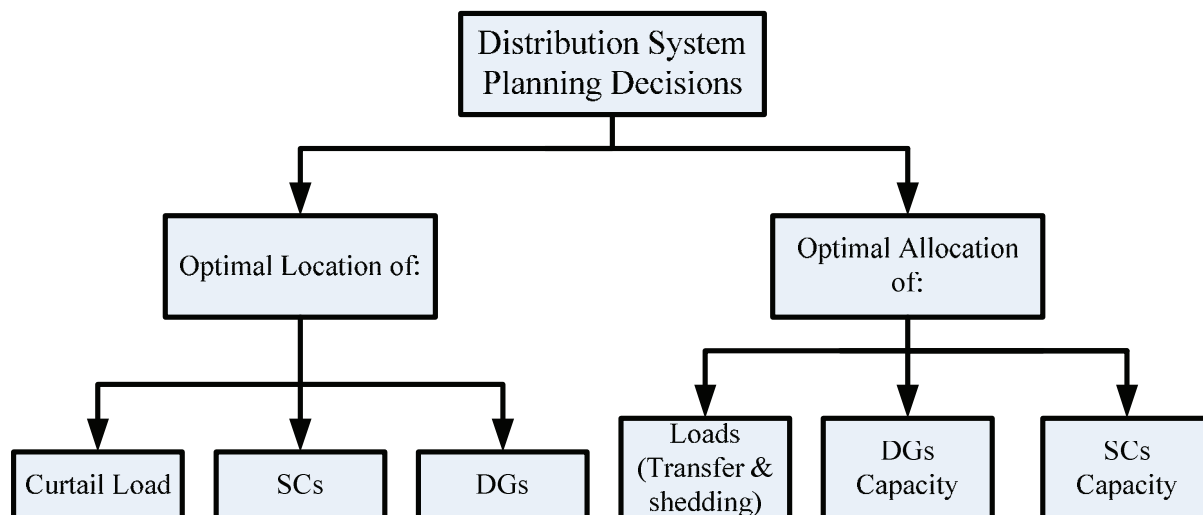

Figure 2.6: New distribution planning decisions.

The constraints for the new planning model with the DG option are shown in Figure 2.7.

The new added constraints are:

- System capacity constraints such as: total DG and SC modular capacity constraints,
- System economical constraint such as: distribution utility available budget constraints,
- System uncertainty constraints such as: DG operating time and cycles, customer-owned DG contribution, and electricity and gas market price fluctuation constraints,
- System operating constraints such as: DG ramp time, and anti-islanding constraints.

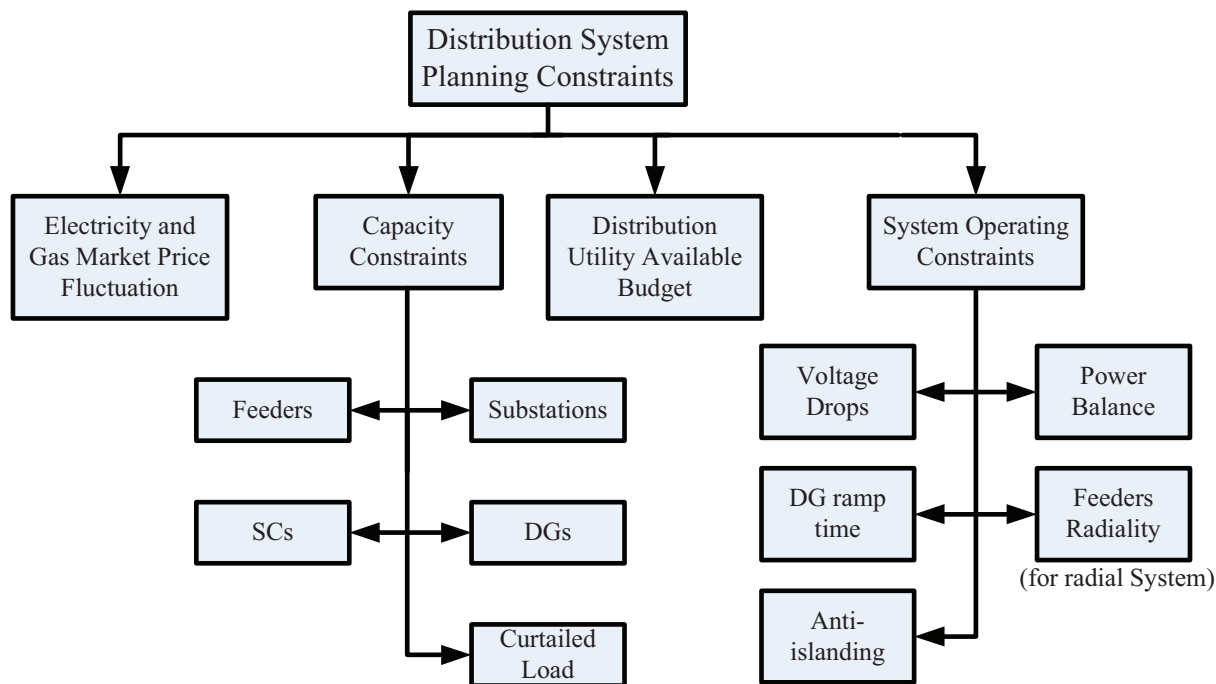

Figure 2.7: New distribution planning constraints.

2.7 Conclusions

- Distribution network is an important part of electric power system, which is one of the most complicated systems created by the mankind.
- Planning of the development of distribution networks pursues a number of conflicting objectives: minimization of power losses, capital investments, operation and maintenance costs and Energy Not Supplied (ENS) due to interruptions in the network.
- The complexity of the stated task is caused by multiple objectives, large number of variables, and uncertainty of initial information and dynamic nature of the problem.
- Traditional distribution system planning is facing a vast number of challenges of different natures which have to be considered in the planning process.
- (Delete) Planning is a multi-stage process. Primary calculations and analysis, and actually the decision-making traditionally are made by different group of persons.
- New tendencies and conditions in organization of electric power supply, deregulation, open market and appearance of local generation such as DG, inspire the search for the new methods.

- Development of new technologies provides the extended opportunities for improvement of network operation, but simultaneously complicates the planning process.
- DG as a source of active power in the distribution system will play a noticeable role in the distribution system's design and planning. DG technologies, benefits, concepts, and its valuable effect on the electricity market, give it valid credibility to be used as a candidate option to solve the distribution system planning problem.
- Incorporation of DG can defer bulk investments, minimize the system upgrading cost and provide the required power with high quality.

Chapter 3

Review of Literature

The problem of expansion planning to a distribution system consists of determining the capacity, siting, and timing of installation of new distribution equipment, taking capacity restrictions on feeders, voltage drop, and demand forecasts into account [10], [19], [43], [44]. In this chapter an attempt has been made to discuss and review some of the published literature pertaining to various aspects of distribution system planning in traditional and deregulated structures. In Section 3.1, review of traditional distribution system planning is discussed. Section 3.2 provides review of distribution planning in deregulated structure. In Section 3.3, multi-objective programming and its solution methods are studied. Review of optimization methods applied to distribution planning is illustrated in Section 3.4.

3.1 Review of Traditional Distribution System Planning

Initially, a number of authors solved a simplified form of this problem, using a static planning model with a fixed time horizon [45]–[48]. Their work resulted in a formalization of the problem in a single stage, in which the resources are introduced at one single time

step over the planning horizon. In general, a short-term planning horizon has been used so that those investments are selected which correspond to the network's immediate needs, since the uncertainty in forecasts tends to increase as the time horizon increases.

Subsequently, the problem was adapted to deal with a long-term time horizon [49]–[53]. This approach resulted in a multistage formulation of the problem in which resources needed for the planning horizon can be distributed according to the requirements determined at each stage. Network operators can thereby accommodate the gradually increasing demand at minimum cost, using a long-term planning horizon. The investments needed for the initial steps are effectively executed while the investments for later stages are re-evaluated in the future with the use of updated forecasts. The planning horizon is therefore dynamically advanced, with the initial stage always coinciding with the time of execution (month or year).

The general formulation and solution methods for distribution load flow are proposed in [54] for loss reduction and load balancing based on radial network reconfiguration. Two approximate power flow methods are developed in order to determine the best radial configuration. A load flow technique for solving radial distribution networks by using a unique lateral, node and branch numbering scheme is presented in [55]. The method solved a recursive relation of voltage magnitude without any trigonometric functions while loads are represented as constant power.

In [56], the load flow equations are written in terms of new variables instead of the conventional state variables (complex bus voltages). This leads to a set of $3N$ equations, of which $2N$ equations relate to power injections and are linear, while the remaining N equations relate to bus voltages and are quadratic. Then, the Newton-Raphson method is used to solve these equations. The formulation of the radial distribution load flow problem as a conic program is presented in [57]. The main advantages of the conic programming formulation are that its conditioned systems are easily handled and distribution power flow equations are included in radial system optimization problems.

In [58] the reactive power optimization problem with time-varying loads in a distribution system is investigated. The objective is to determine the hourly settings of capacitor banks and transformer taps for the next day. A combination of heuristic and algorithmic approach is proposed that simplifies the mathematical model of the daily setting values of reactive power/voltage control devices, solves the temporal optimization

of each control devices by heuristic rules, and then converts the optimization model with time-varying load into one as conventional optimization model with constant load.

A fuzzy-logic based algorithm to determine the optimal capacitor allocation in radial distribution feeders is developed in [59]. The effect of varying some parameters in the membership functions to obtain better results is discussed. Also, the effect of selection of parameters that should be used in the fuzzy modeling is investigated.

A two-stage, heuristic method, for determining a minimum loss configuration, based on real power loss sensitivities with respect to the impedances of the candidate branches is presented in [60]. In the first stage, the method uses this sensitivity information while the second stage uses branch exchange procedure to improve the solution.

In [61] the authors propose an Ant Colony Optimization (ACO) method for solving distribution reconfiguration problem for loss minimization. The ACO algorithm is implemented in a novel hypercube framework on a 33-bus test system and the results obtained show that the ACO algorithm provided the most optimum solution found thus far by any other method proposed in the literature for the 33-bus test system considered.

In [62], a joint optimization algorithm of combining network reconfiguration and capacitor control is proposed for loss reduction in distribution systems. To achieve high performance and high efficiency an improved adaptive genetic algorithm optimizes the capacitor switching and a simplified branch exchange algorithm determines the optimal network structure for each iteration of capacitor optimization algorithm.

A method to optimally locate resources in a meshed network for maximizing the potential benefits is outlined in [63]. The algorithm computes the required amount of resources at selected nodes to achieve the desired optimization objectives such as the minimization of losses, or loading on selected lines.

A method for selection of optimal set of conductors is presented in [64]. Several financial and engineering factors are considered in the proposed procedure. The intent is to arrive at a least-cost solution, considering both capital and operating costs. A framework for solving the capacitor placement problem on a radial distribution system using a Genetic Algorithm has been presented in [65]. The objective is to minimize the peak power losses and the energy losses in the distribution system considering the capacitor cost. A sensitivity analysis based method is used to select the candidate locations for the capacitors.

3.2 Review of DISCO Planning in Deregulation

The change in power flow patterns in distribution systems because of the presence of DG units, calls for detailed analysis and development of tools that can compute their contributions on increase/reduction of feeder losses and feeder loadability. To this effect an approach to quantification of the distribution network capacity deferral value of DGs is presented in [66]. It is reported that the most important benefits from deferral are obtained when DGs are installed at the end of long feeders and near load pockets.

A method for distribution access via uniform pricing for remuneration of distribution networks is presented in [67]. Hourly uniform marginal prices are derived, *i.e.*, tariffs for use of network, from maximization of a social welfare. These prices are efficient indicators (signals) to the DISCO and consumers regarding optimal operation of the grid and use of energy at peak and valley hours, respectively. A linear Optimal Power Flow (OPF) model is used to determine the prices.

A new circuit-based loss allocation technique, based on the decomposition of the branch currents, specifically developed for radial distribution systems with DGs is presented in [68]. The technique is simple and effective and is only based on the information provided by the network data and by the power flow solution.

A distributed slack bus model has been developed in [69] using the concept of participation factors, applicable to unbalanced systems. The participation factors were incorporated in three-phase power flow equations which were solved using a Newton-Raphson algorithm. Such a model can be used for DG placement studies, network reconfiguration, economic analysis for fair pricing and aggregate substations loading.

A multi-objective model to evaluate the impact of energy storage specific costs on net present value of energy storage installations in distribution substations is presented in [70]. Specific cost effects on economic performance of energy storage technologies are evaluated for an HV/MV substation. For each technology, sets of optimal economic operation strategies and capacities of the storage devices are determined.

Tracing of real and imaginary components of the feeder current is used in [71] to allocate the losses in distribution networks with DG. First losses are calculated considering no DGs in the distribution network, and allocated to the consumers. Thereafter, the variations in losses because of DG are allocated to them. The allocation is made to each

user of the network based on its impact on a branch basis.

The performance of distribution systems including DG is analyzed in [42] by considering the deterministic and stochastic natures of power systems. Monte Carlo simulation is employed taking into consideration the system operation constraints. The uncertainties in their siting, expected penetration level and states (on/off) of the DG units constitute the random parameters. The algorithm incorporates these parameters within traditional power flow equations.

An approach to analyzing the technical impact and assessing the voltage rise that would be caused by high DG penetration was presented in [72]. It was concluded that considerable penetration of DGs may be accommodated without modification of network voltage control systems.

A multi-period energy acquisition model for a DISCO with DG and Interruptible Load (IL) options has been presented in [73]. A bi-level optimization formulation is developed wherein the upper sub-problem maximizes the DISCO's revenue, while the lower sub-problem addresses the ISO's market clearing by minimizing generation costs and compensation costs for IL. The model takes into consideration inter-temporal effects such as ramping.

In [74] a quantification of benefits from customer-owned back-up generators to DISCOs is carried out. An integration scheme for DGs in a pool-based market structure is proposed in [75] that encompasses both energy and capacity payment procedures. The problem of dispatch and control of DGs is formulated in [76] as a multi-agent system-based scheme, specifically for the purpose of voltage support.

In [77], it has been brought out that DG owners create significant benefits to the utility by loss reduction and capacity deferral. However, they are still charged a connection tariff instead of being financially compensated for the benefit they provide. In [77], mathematical models, somewhat approximation, have been developed to quantify these benefits.

In [78], the effect of implementing intentional islanding on electricity market prices is examined. It has been clearly identified that DISCO prices are affected during such a system condition.

Optimal location of DGs in distribution networks is an important issue in order to derive

maximum benefits from them. In [79], analytical methods are proposed to determine the optimal location of DGs in radial and networked distribution systems to minimize the power losses.

In [80], a comprehensive optimization model is developed that also incorporates the planner's experience to achieve optimal sizing and siting of DG. Binary decision variables are employed in the model to determine exact planning decisions. A present worth analysis of different scenarios is carried out to estimate the feasibility of introducing DG as a key element in solving the planning problem. In the same context, a heuristic cost-benefit analysis based approach was proposed in [81] to obtain the optimal DG sizing and sitting that meets peak demand forecast. The model aims to minimize the DISCO's investment and operating costs as well as payments toward loss compensation.

In [82] a method for optimal planning of radial distribution networks is presented based on a combination of steepest descent and simulated annealing approaches. The optimal network of available routes is determined that results in the minimal total annual cost. The minimum capital cost solution obtained from the steepest descent approach is used as the initial solution for the optimization procedure that is further improved by simulated annealing to obtain the minimum total cost solution. The method takes into account the capital recovery, energy loss and undelivered energy costs.

A DG investment planning model is presented in [83] using various reliability indices in order to determine the optimal DG locations and sizes. It was concluded that although the DG addition may be the most expensive alternative, using the reliability techniques and the capital deferral credit obtained from DISCO, the DG option could become a cost-effective solution.

A Benders decomposition solution is used in [84] to determine optimal DG siting on network buses. The model considers stochastic nature of generator outputs, with power flows represented using linear models. A locational marginal pricing approach for the siting and sizing of DG units is proposed in [85].

3.3 Review of Multi-objective programming

Multi-Criteria Decision-Making (MCDM) was developed in recent decades as a response to the problems faced by decision-makers when confronting complex

environmental issues [108], [109]. Generally, MCDM can be divided into two categories [110]: Multi-attribute decision-making (MADM) and multi-objective decision-making (MODM; also known as multi-objective programming).

Multi-objective programming can further be divided into three parts based on information property: including non-preference, preference and interactive type. MADM can be divided into the outranking method and value or utility function based methods [111]. Some differences exist between these two methods: MADM is “attribute” in criteria definition while MODM is “objective”; the MADM is “passive” that it cannot treat constraints explicitly in a decision model while MODM is “active”. The key difference is that MADM can cope with qualitative and quantitative data while MODM can only deal with quantitative data.

Even though some real-world problems can be reduced to a matter of a single objective very often it is hard to define all the aspects in terms of a single objective. Defining multiple objectives often gives a better idea of the task. Multi-objective optimization has been available for about two decades, and its application in real-world problems is continuously increasing. In contrast to the plethora of techniques available for single-objective optimization, relatively few techniques have been developed for multi-objective optimization.

In single-objective optimization, the search space is often well defined. As soon as there are several possibly contradicting objectives to be optimized simultaneously, there is no longer a single optimal solution but rather a whole set of possible solutions of equivalent quality. When we try to optimize several objectives at the same time the search space also becomes partially ordered. To obtain the optimal solution, there will be a set of optimal trade-offs between the conflicting objectives [112]-[116]. However, Multi-objective programming encounters difficulties in dealing with both qualitative and quantitative objectives in a decision problem.

Generally, the multi-objective problem can be expressed as follows [117]:

$$\begin{aligned}
 \text{Min } y = F(x) &= \{f_1(x), f_2(x), f_3(x), \dots, f_k(x)\} & (3-1) \\
 e(x) &= \{e_1(x), e_2(x), e_3(x), \dots, e_k(x)\} \leq 0 \\
 \text{s.t } x &\in X \\
 y &\in Y
 \end{aligned}$$

where $f_i(x)$ denotes the i -th objective functions, $e(x)$ are the sets of constraints, and x represents the sets of decision variables. The objective functions are separated into qualitative and quantitative categories: $f_1(x), \dots, f_k(x)$ have quantitative properties.

As shown in Figure 3.1, a solution could be best, worst and also indifferent to other solutions (neither dominating nor dominated) with respect to the objective values. Best solution means a solution not worst in any of the objectives and at least better in one objective than the other. An optimal solution is the solution that is not dominated by any other solution in the search space. Such an optimal solution is called a Pareto-optimal and the entire set of such optimal trade-offs solutions is called a Pareto- optimal set.

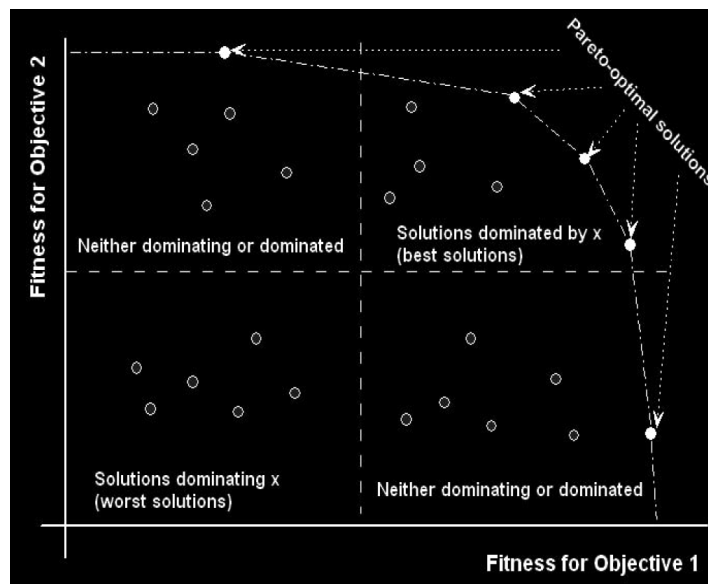

Figure 3.1: Concept of Pareto optimality.

As evident, in a real world situation a decision making (trade-off) process is required to obtain the optimal solution. Even though there are several ways to approach a multi-objective optimization problem, most work is concentrated on the approximation of the Pareto set.

3.3.1 Solution Methods

A wide variety of methods to solve multi-objective algorithm have been proposed in the literature [122]-[124]. We can roughly divide them into the following types:

- Aggregating approaches
- Lexicographic ordering
- Sub-Population approaches

- Pareto-based approaches

We will briefly discuss each of them in the following subsections.

3.3.1.1 Aggregating Functions

Perhaps the most straightforward approach to handling multiple objectives with any technique is to combine all the objectives into a single one using either an addition, multiplication or any other combination of arithmetical operations. These techniques are normally known as “aggregating functions” because they combine (or “aggregate”) all the objectives of the problem into a single one. In fact, aggregating approaches are the oldest mathematical programming methods for multi-objective optimization, since they can be derived from the Kuhn-Tucker conditions for non-dominated solutions [125], [126].

An example of this approach is a linear sum of weights of the form:

$$\begin{aligned}
 \text{Min } F(x) &= w_1 \cdot f_1(x) + w_2 \cdot f_2(x) + w_3 \cdot f_3(x) + \dots + w_k \cdot f_k(x) \\
 \text{s.t. } e(x) &= \{e_1(x), e_2(x), e_3(x), \dots, e_k(x)\} \leq 0 \\
 &x \in X
 \end{aligned} \tag{3-2}$$

where $w_i \geq 0$ are the weighting coefficients representing the relative importance of the k objective functions of our problem. It is usually assumed that the sum of the weighting coefficients is equal to one.

Aggregating functions may be linear or nonlinear (e.g., the aggregating functions adopted by game theory [127], [128], goal programming [129], [130], goal attainment [131], [132] and the min-max algorithm [133], [134]). Both types of aggregating functions have been used with relative success.

In [135] an algorithm has been adopted three types of aggregating functions:

- (1) A conventional linear aggregating function (where weights are fixed during the run),
- (2) A dynamic aggregating function (where weights are gradually modified during the run),
- (3) The bang-bang weighted aggregation approach (where weights are abruptly modified during the run) [136].

This approach has the peculiarity of being able to generate nonconvex portions of the Pareto front, which is something that traditional linear aggregating functions cannot do

[137].

3.3.1.2 Lexicographic Ordering

In this method, the user is asked to rank the objectives in order of importance. The optimum solution is then obtained by minimizing the objective functions separately, starting with the most important one and proceeding according to the assigned order of importance of the objectives [138]. Lexicographic ordering tends to be useful only when few objective functions are used (two or three), and it may be sensitive to the ordering of the objectives [113].

3.3.1.3 Sub-Population Approaches

These approaches involve the use of several subpopulations as single-objective optimizers. Then, the subpopulations somehow exchange information or recombine among themselves aiming to produce trade-offs among the different solutions previously generated for the objectives that were separately optimized.

In these techniques, the population is used to diversify the search, but the concept of Pareto dominance is not directly incorporated into the selection process. At each generation, a number of sub-populations are generated by performing proportional selection according to each objective function in turn. Thus, for a problem with k objectives, k sub-populations of size M/k each are generated (assuming a total population size of M). These sub-populations are then shuffled together to obtain a new population of size M [139]. Despite the limitations of these approaches, their simplicity has attracted several researchers and we should expect to see more work on population-based approaches in the next few years.

3.3.1.4 Pareto-Based Approaches

Tackling as basis the main drawback of above mentioned approaches, [140] discussed a way of tackling multi-objective problems. It consists of a selection scheme based on the concept of Pareto optimality. [140] not only suggested what would become the standard multi-objective optimisation for several years, but also indicated that stochastic noise would make such algorithms useless unless some special mechanism was adopted to block convergence.

Pareto-based approaches can be historically studied as covering two generations. The first generation is characterized by the use of fitness sharing and niching combined with

Pareto ranking (as defined by [140] or adopting a slight variation).

Pareto optimality is an important concept in economics with broad applications in game theory, engineering and the social sciences. The term is named after Vilfredo Pareto, an Italian economist who used the concept in his studies of economic efficiency and income distribution. Informally, Pareto efficient situations are those in which any change to make any person better off is impossible without making someone else worse off.

Given a set of alternative allocations of, say, goods or income for a set of individuals, a change from one allocation to another that can make at least one individual better off without making any other individual worse off is called a Pareto improvement. An allocation is defined as Pareto efficient or Pareto optimal when no further Pareto improvements can be made. Such an allocation is often called a strong Pareto optimum by way of setting it apart from mere "weak Pareto optima" as defined below.

3.4 Optimization Methods Applied to Distribution Planning

The methods used to solve the expansion planning problem can be divided into two categories: methods of mathematical programming and heuristic methods, including specialist systems and evolutionary algorithms [125]. Among the methods of mathematical programming, the most widely used include Linear programming (LP) [145], Non-Linear-Programming (NLP) with non-linear constraints [18], [80], [144], and Mixed-Integer-Programming (MLP) consist of Mixed-Integer-Linear-Programming (MILP) with linear or linearization of the constraints or Mixed-Integer-Non-Linear Programming (MINLP) with non-linear and integer decision variables constraints [46], [47], [141]–[143].

In this approach, it is possible to represent the main restrictions explicitly (Kirchhoff's laws, equipment capacities, voltage drop, and budget) and to minimize fixed and variable costs arising from installation and substitution of equipment. Where mixed integer programming is used, practical considerations frequently limit the number of solutions and make the associated combinatorial problems computationally tractable [146]. This, together with the possibilities both of guaranteeing optimality and of using the computers resources currently available, makes the approach very attractive.

Since 1980, much effort has been directed toward solving the problem of planning distribution by the use of heuristic algorithms, which came to provide an alternative to

mathematical programming. Heuristic methods gained attention because they can work in a straightforward fashion with nonlinear constraints and objective function; although there is no guarantee that an optimum solution can be found. However, in this approach, it is also easy to introduce aspects, such as losses, reliability, and uncertainties.

Notable among heuristic methods are the branch-exchange algorithms [48], [53], [147], [148] and algorithms based on evolutionary computation [149]–[152]. Other heuristic methods that have been used for the problem include specialist systems [153], [154], the ant colony [155], simulated annealing [156], dynamic programming [157], [158] and tabu search [99], [159].

The first computer-aided distribution network planning tools were presented in the seventies [34]. Different optimization techniques were first applied only to simplified models. During the last two decades a lot of research efforts have been made to include more details in the models.

Linearization of objective function was applied by several researchers [86]–[89]. In [89] the problem is formulated as a transportation problem and LP is applied as an optimization tool. In [86] and [87] the authors apply MILP to a linearized model. However, besides resulting in less accurate solution, disadvantages of this simplification are that it has restricted application and is not suitable for network reinforcement problems. As a result, most of the present network planning models utilizes nonlinear cost functions [90]–[94], therefore applying either more complex optimization techniques, namely NLP methods [94] or different kinds of heuristic algorithms [91]–[93].

In some models first applied to the network planning, the problem was decomposed into two subsystems: substations subsystem and feeders' subsystem [34]. In these models it is assumed, that the problem of optimal substation allocation and sizing to be solved, based on which the optimal feeder routing can be provided. This approximation was avoided in later models.

The importance of time consideration is obvious in planning tasks. However, dynamic problem formulation results in dramatic increase of computational efforts. Until recently, most of the models considered the study period as a single stage, providing so called “horizon year” planning [87], [89], [94]. To expand the study period over several time-stages a number of either dynamic models [95]–[98] or pseudo-dynamic models [53], [88], [91], [99] were introduced. In [95]–[97] DP is applied as an optimization tool, while in

[86], [100] MIP, which in the last reference is combined with Bender's decomposition. Some kind of heuristic algorithm is utilized in most of pseudo-dynamic models. State-of-the-art is that timing issue is present in most of the recent studies, e.g. [97], [101]-[103].

In the nineties the necessity was recognized to deal with multi-criteria nature of the problem [104]. This fact together with exceptional complexity of the model requires new optimization tools. Furthermore, it changes the whole philosophy of network planning applied so far: instead of search for a single optimum the search in multi-objective domain should be provided resulting in a set of competitive solutions, and none of which is optimal [105]-[107].

It is to be noted that the discussed planning decisions and their constraints are implemented under two main planning categories: Normal condition planning (which concentrates on meeting the peak load demand at normal system operation) and Emergency planning (which focuses on formulating contingency aspects due to substation and/or feeder failure).

This section is to provide a broad survey on the bases of different distribution system planning techniques. A detailed survey of the normal distribution planning conditions using optimization models and heuristic approaches are evaluated below. This chapter does not aim at a detailed description of the whole variety of models and algorithms that have been applied to the problem. Nevertheless, the main techniques for distribution planning and their advantages and limitations are presented and discussed.

3.4.1 Review of Mathematical Distribution Planning

Numerical optimization may be considered the traditional approach for optimization. Depending on problem formulation, it can involve either use of algorithms tailored to discrete or continuous analysis. Regardless, numerical optimization applies computed numerical formula and procedure to search for the optimal solution.

General matrix formulation of mixed-integer model can be represented as follows:

$$\begin{aligned}
 &\min \quad c_1x + c_2y \\
 &\text{Subject to:} \\
 &A_1x + A_2y \geq b \\
 &A_3y \geq d
 \end{aligned} \tag{3-3}$$

where x is the vector of continuous variables containing power flows, power supplies and voltage drops and, y is the vector of integer decision variables. Cost coefficients c_1 and c_2 reflect fixed and variable costs associated with both integer and continuous variables. Matrices A_1 , A_2 , A_3 as well as right hand side constraints vectors b , d depend on constraints of the problem and can be derived from the problem formulation. The weak point of this formulation is that linearization of quadratic terms is required.

The task in form of Eq. (3-3) for multi-stage distribution network planning was presented in [86], [99], [100], where mixed-integer programming was used as an optimization tool. Furthermore, in order to spare computer time and to speed up calculations Bender's decomposition was applied to the mixed-integer model in [100]. To separate continuous and integer variables, Eq. (3-3) can be rewritten as:

$$\min\{c_2 y + \min[c_1 x, \text{subject to : } A_1 x \geq b - A_2 y], \text{subject to : } A_3 y \geq d\} \quad (3-4)$$

with subsequent formulation of dual problem to the inner problem:

$$\begin{aligned} \max \quad & u(b - A_2 y) \\ \text{Subject to:} \quad & \\ & u A_1 \leq c_1, \quad u \geq 0 \end{aligned} \quad (3-5)$$

As a result, the Master problem, the outer problem, contains only integer variables and the inner problem has to deal only with continuous variables. Decomposition approach simplifies the optimization task. However, as any simplification, it has disadvantages from the point of view of accuracy of the calculation. Another weak point of decomposition approach is the complexity dealing with multiple criteria.

The main advantage of numerical optimization approaches is the convergence, at least in theory, to the optimal solution and not just to a "good" solution. However, methods based on this type of optimization can, in practice, hardly be applied to real dimension cases. This is due to extreme mathematical and computational complexity introduced by the discrete and non-linear nature of the problems to be considered.

Extensive work has been done using these mathematical models under two categories Single-Period Model (SPM) and Multi-Period Model (MPM).

3.5.1.1 Review of Single-Period Models (SPMs)

In these static kinds of models the load growth forecast is calculated as one step at the horizon year therefore, the design is for an optimal system with a certain load density expected after one pre-specified time duration [160]. Several researches have been carried out within this category [19].

a. **Individual feeders' models:** These models are optimized to provide the substation and feeder service area and size as follows:

In [161], the configuration and size of each feeder is optimized using trade-off between feeders' capital (feeder length) and operating costs (power losses). A uniform load density with a constant power factor is assumed.

In [160], the model adds details in the cost trade-off function with some assumptions and obtains the feeders' layout. A MINLP model with non-linear constraints is optimized. It does not guarantee a global optimum unless voltages are constant.

b. **System feeders routing models:** The aim of these models is to minimize the cost of obtaining the best way of connecting a given set of load nodes to a given set of supply nodes (substations) by feeders to meet the load demand. The model is a binary MIP with the form shown in Eq. (3-6):

$$\begin{aligned} & \text{Minimize} && \sum c_f \cdot \sigma + \sum c_r \cdot S \\ & \text{S.T.} : && A \cdot S = D; \quad 0 \leq S \leq S^{Max} \cdot \sigma \quad \sigma \in [0,1] \end{aligned} \quad (3-6)$$

Where c_f is the feeder connection fixed charge; c_r is the running cost per unit power flow, σ is the individual feeder connection binary decision variable vector, S is the power flow quantity, A is the flow matrix, D is the demand /supply vector, and S^{max} is the feeder connection capacity. Under this category, several works are discussed below:

In [162], the MIP model (branch-and-bound technique) is implemented on the fixed cost transportation and model. The model is used to obtain optimal design of sub-transmission and low voltage system cable selection, number in each route and layout. The flow direction is represented by two routes for each path. Drawbacks of this model are: using a piecewise linearization power loss function and not including voltage drop and radial design constraints.

In [163], the shortest path algorithm and LP transportation framework are used to solve

the optimal substations service boundaries, locations and sizes by selecting feeder connections. Different possible feeder routes are assumed for connecting each source-node to each demand-node. The Minimum Feasible Distance (MFD) is evaluated by assigning weighting factor for each route, which represent obstacle facing the feeder route. The Load Distance Product (LDP) objective function is optimized by minimizing the overall system transportation cost. Drawbacks of this model are: using LDP is inaccurate; demands are supplied directly from the sources; the physical system and power losses are ignored; fixed costs, minimum substation loading and voltage drop constraints are not included.

In [164], the deficiencies discussed in [163] are solved by using the transshipment model to represent the physical system. The system with its aggregated loads is treated as a graph with nodes and arcs representing possible feeders routing. The model minimizes the feeders' segments running cost which is subject to substation capacity, feeders' thermal capacity and demand power balance constraints. Drawbacks of this model are: the feeders' fixed costs and voltage drop constraints are not included and linearization of the feeder running cost.

c. **Substation-feeder models:** This category is used to solve the optimization problem of substation and feeder installation, the feeder power flow, and substation loading. The mathematical formulation is based on (3.4) and adding the substation installation decision and its running cost in Eq. (3-7):

$$\begin{aligned}
 & \text{Minimize} && \sum c_f \cdot \sigma + \sum c_{f\,ss} \cdot \sigma_{Sub} + \sum c_r \cdot S + \sum c_{r\,ss} \cdot S_{Sub} \\
 S.T.: & && AS = D; && 0 \leq S \leq U \cdot \sigma && \sigma \in [0,1] \\
 & && S_{Sub} = FL \cdot S; && S_{Sub} \leq CR \cdot \sigma_{Sub} && \sigma_{Sub} \in [0,1]
 \end{aligned} \tag{3-7}$$

Where $c_{f\,ss}$ is the substation fixed cost; $C_{r\,ss}$ is the substation running cost; σ_{Sub} is the substation binary decision variable; S_{Sub} is the total individual substation power; FL is the substation flow matrix; and CR is the capacity choice matrix.

Under this category, several works are discussed below:

In [165], a fixed-cost transshipment model is used by implementing branch-and-bound technique, as in [162], to obtain the optimal substation location. The model acquires the lower bound cost by two algorithms as follows: Minimum increment cost bound and Shortest Path Model. Drawbacks of this model are: feeders' fixed and substations running cost and power losses calculations and voltage drop constraints are not included.

In [166], the system is decomposed into small sub-problems each one is solved separately. The model provides: the optimal substation location and size, load transfer among substations, and feeder routing and sizing. A MIP present-worth cost function is solved in two steps using: simplex method to obtain an LP solution, It branch-and-bound method to get the integer solution. A planner decision can be used to reduce the number of intellectual variables. Drawbacks of this model are: the running cost linearization and lacking consideration of voltage constraints.

In [18], the substation siting and sizing and feeder routing problems are solved. The model is nonlinear Quadratic Mixed Integer Programming (QMIP) due to the present-worth feeders' running cost. The solution is carried out in two steps: using simplex method treating all variables as continuous variables; these continuous values of binary decision variables are rounded to one with 0.5 thresholds. Drawbacks of this model are the inaccuracy of rounding decision variable values and lacking consideration of voltage constraints.

3.5.1.2 Review of Multi-Period Models (MPMs)

In these dynamic models, the investment plan for yearly required electric facilities' installations are obtained. The series solution of SPM for each planning time period will not provide the overall optimal system solution, as each step is not affected by the overall required planning decision. However, the MPMs provide intermediate step decisions correlated with time in order not to repeat installation at the same location.

The model is based on binary decision variables and present-worth values similar to Eq. (3-7) but with time summation, as shown in Eq. (3-8):

$$\begin{aligned}
 & \text{Minimize } \sum_t \left(\sum c_{f_t} \cdot \sigma_t + \sum c_{f_{SS_t}} \cdot \sigma_{Sub_t} + \sum c_{r_t} \cdot S_t + \sum c_{r_{SS_t}} \cdot S_{Sub_t} \right) \\
 S.T.: & \quad A_t \cdot S_t = D_t; \quad 0 \leq S_t \leq U_t \cdot \sigma_t \quad \sigma_t \in [0,1]; \forall t \in [1, \dots, T] \\
 & \quad S_{Sub_t} = FL_t \cdot S_t; \quad S_{Sub_t} \leq CR_t \cdot \sigma_{Sub_t} \quad \sigma_{Sub_t} \in [0,1]; \forall t \in [1, \dots, T] \\
 & \quad K_t \cdot \sigma_t \leq 1, \quad K_t \cdot \sigma_{Sub_t} \leq 1, \quad G_t \sigma_t + F_t \cdot \sigma_{Sub_t} = 0; \quad \forall t \in [1, \dots, T]
 \end{aligned} \tag{3-8}$$

Where: G_t , F_t , and K_t are the logic matrices to correlate time-dynamic installation to ensure one installation per site, and T is the horizon planning year.

Under this category, several works are discussed below:

In [46], two-phase planning of substations and primary feeders is discussed. First, it branch-and-bound algorithm of a fixed-charge-transshipment framework is used to

estimate the static optimal planning investment at the horizon year. Second, successive single year expansions are carried out. For each study period, new input such as load growth and new demand locations are introduced to the model. Each intermediate year optimized installation is used as input for the following planning period till the model reaches the horizon year. Drawbacks of this model are: load growth linear curves require more investigation, feeder loss cost linearization, lacking consideration of voltage constraints and the overall planning decision is not guaranteed to be optimal due to lacking correlation to the future decisions.

Improvement has occurred by adding more details to this model with power balance, power capacity, voltage drop, and radial configuration constraints by [50]. It uses the same present, value two-phase approach based on pseudo-dynamic methodology to obtain the substations and feeders: sizing, timing, and location problem. The feeder's conductor size is taken into consideration in the model discrete values with a linearized power loss cost.

In [167], an improvement to [164] is carried out by modeling MIP fixed-charge cost function solved by branch-and-bound, to obtain optimal feeder routing. The model adds potential feeder fixed cost, which includes actual fixed feeder segment, present-worth construction and maintenance costs. Existing feeders' fixed costs are set to zeros, where binary decision variables indicate not adding or adding a new feeder.

In [47], explicit time dependant fixed, variable, and cost of losses variables are implemented with voltage drop and power flow constraints. The model is formulated as a binary MIP model solved using branch-and-bound technique. Fixed costs are included only once during the planning process while variable costs are calculated throughout the equipment's life. Drawbacks of this model are the piece-wise linearization power losses function kind the inaccuracy of the system partitioning.

In [168] and [169], an improvement occurred to [166] to obtain distribution substations and feeders expansion. The MIP model represents present value and adding power balance, power capacity, voltage drop, and radial configuration constraints. The drawback of this model is using a feeder power loss cost as a linear function.

The researches which have been done in distribution system planning in regulated structure are targeted in three main trends:

1. The first trend provides a general discussion about DG planning without offering

any mathematical framework such as:

- a. The DG impact on the distribution system planning decisions [21], [33], [170],
 - b. The proposed guidelines for distribution system planning which include DG as a candidate option [171],
 - c. The recommended frameworks to be implemented when introducing DG for distribution system planning problem [13], [14], [172]-[174].
2. The second trend attempts to solve the DG planning problem only using genetic algorithm. This approach mainly focuses on decisions related to DG planning alone not with comparison with other traditional distribution system planning alternatives [175].
 3. The third trend implements a heuristic mathematical approach. In [176], a network capacity expansion algorithm is presented to meet the load growth. The number, size, and location of DG units are optimally obtained through combining other facility to defer T&D expansive (new and upgrading feeders and new and expandable substations) using a successive elimination algorithm based on system capacity reserve to evaluate the effectiveness of each expansion option. The algorithm starts by an overbuilt system including all candidate expansion alternatives for sub-transmission systems; and then eliminates the least cost-effective alternative facility. The Process is repeated till a stage when any further elimination will violate system operation and constraints. The constraints include: system capacity and reliability, investment budget, and DG penetration constraints.

According to the above survey on implementing DG in the distribution planning process up-to-now, there is no work done using mathematical optimization modeling.

3.5.2 Review of Heuristic Methods

3.5.2.1 Branch Exchange Methods

A large class of methods, which are widely, applied both to the transmission and distribution network planning can be related to the class of heuristic methods. The major part of them is based on the implicit enumeration. Mathematically, the general problem formulation can be represented by Eq. (3-3), where the task is to define a vector of state variables x , and one of the decision variables y minimizing the objective function.

The idea behind the algorithms is that decision and state variables can be separated. Then for every network configuration defined by decision variables the state variables can be calculated. A search algorithm is applied to find the optimal configuration.

According to the literature [92] these heuristic approaches can be classified according to the search space exploration method: constructive and destructive (greedy search) or branch exchange approaches. The common principle used can be described as follows: starting from some reasonable initial plan, the current configuration is replaced with one of its neighbors, which is obtained by applying an elementary modification to the current configuration.

The different kinds of algorithms preferring branch exchange approach to other heuristic techniques are probably the most prevalent for distribution network planning [53]. The search starts from some feasible configuration (radial) and by opening and closing branches (one at the time), it accepts configurations if the objective function is improved and rejects otherwise.

As it was stated, besides siting and sizing in network planning problem we have to cope also with the problem of timing which is much more challenging. A number of heuristic approaches suggest different combination of forward/backward procedures. The problem is decomposed into several single-year sub-problems and each sub-problem is solved independently which gives pseudo-dynamic solutions [53], [91]. In [53] the advantages of multi-year heuristic optimization approach in comparison with single-year planning approach are shown.

The main advantage of heuristic algorithms is that a good solution can be found for the real-size (large) network with comparably small computational effort. But the global optimum cannot be guaranteed, especially for time-variant tasks due to their pseudo-dynamic nature.

3.5.2.2 Simulated Annealing

Some researchers relate to the Heuristic Methods the optimization technique known as Simulated Annealing. It is based on the analogy between the simulation of annealing in solids and the problem of solving large combinatorial optimization problems. The objective function is referred to as the energy function. The system to be optimized starts at a high temperature and is cooled down until the system freezes and reaches the global

optimum.

The algorithm can be illustrated by the following three steps:

Step 1 Generation of candidate solutions by perturbation of current solution according to probabilistic distribution function;

Step 2 Acceptance test of solutions. A new solution is accepted as current when its cost is lower than that of the current solution. If cost is higher, a new solution is accepted with a probability of acceptance:

$$P_r(\Delta F) = 1 / \left(1 + e^{\frac{\Delta F}{t}} \right) \quad (3-9)$$

where ΔF is the increment of cost of the new solution compared to the current solution and t is the temperature level.

Step 3 Iterative procedure. The last accepted candidate solution becomes the initial solution for the next iteration. The temperature of the next iteration is reduced according to the cooling schedule:

$$t_k = r^{(k-1)} t_0 \quad (3-10)$$

in which t_k is the temperature at the k^{th} iteration, t_0 is the initial temperature and r is the temperature reduction rate ($0 < r < 1$).

The iterative process is terminated when there is no significant improvement in the solution or the maximum allowable number of iterations is reached.

Application of Simulated Annealing approach to distribution network planning is presented in [177] and [178]. Another application of Simulated Annealing to combinatorial planning problem is illustrated in [179], [180], where the optimal capacitor placement problem is addressed.

A basic characteristic of Simulated Annealing is that the quality of the final solution does not depend on the initial configuration. It can be shown mathematically that the algorithm converges asymptotically to the global optimal solution with probability one. Although this may turn out to be computational expensive, it is a valuable feature of the approach. Normally, in practice, a faster solution could be obtained with faster cooling schemes, which may yield optimal solution. Another important feature of Simulated

Annealing as well as another heuristic approaches is that there are no special requirements of the model; the problem can be modeled as non-linear, non-differential and constrained.

3.5.2.3 Tabu Search

The basic concept of Tabu Search as described in [105] is a meta-heuristic superimposed on another heuristic. The overall approach is to avoid entrapment in cycles by forbidding or penalizing moves which take the solution, in the next iteration, to points in the solution space previously visited (hence “tabu”). The method is still actively researched, and is continuing to evolve and improve.

The Tabu method was partly motivated by the observation that human behavior appears to operate with a random element that leads to inconsistent behavior given similar circumstances. Thus, the resulting tendency to deviate from a charted course might be regretted as a source of error but can also prove to be a source of gain. The Tabu method operates in this way with the exception that new courses are not chosen randomly. Instead the Tabu search proceeds according to the supposition that there is no point in accepting a new (poor) solution unless it is to avoid a path already investigated. This insures new regions of a problem’s solution space will be investigated in with the goal of avoiding local minima and ultimately finding the desired solution.

The Tabu search begins by marching to local minima. To avoid retracing the steps used, the method records recent moves in one or more Tabu lists. The original intent of the list was not to prevent a previous move from being repeated, but rather to insure it was not reversed. The Tabu lists are historical in nature and form the Tabu search memory. The role of the memory can change as the algorithm proceeds. At initialization the goal is to make a coarse examination of the solution space, known as “diversification”, but as candidate locations are identified the search is more focused to produce local optimal solutions in a process of “intensification”. In many cases the differences between the various implementations of the Tabu method have to do with the size, variability, and adaptability of the Tabu memory to a particular problem domain.

The following steps can illustrate the basic algorithm:

Step 1 Initialization:

- Select an initial solution $x_{now} \in X$
- Initialize the best with the initial solution $x_{better} = x_{new}$

- Initialize the tabu list H with now x_{now}

Step 2 Search:

- Determine a neighborhood of $x_{now} \in N(x_{now})$;
- Select a subset Candidates $_ N(x_{now}) \subset N(x_{now})$;
- Evaluate each solution $x_{new} \in \text{Candidates}_ N(x_{now})$ and choose the best according to the objective function $F(H, x_{new})$;
- Store the best solution $x_{now} = x_{new}$;
- If x_{now} is better than x_{better} , then assign $x_{better} = x_{new}$
- Update the history of the search H with x_{now}

Step 3 Termination of the process.

- Stop the process if the termination criterion is verified, otherwise return to the Step 2.

Application of Tabu Search to distribution network optimization is presented in [99], [181].

3.5.2.4 Dynamic Programming (DP)

The methods based on dynamic programming seem to be very attractive since they naturally allow for representing the dynamic nature of the development process. Another advantage of the method is that there is no need for linearization of the objective function used in the optimization process. This also means that the objective function can contain present values of costs, which reduces the influence of the investments made far in the future. Thus, the decisions made for the nearest future will be correct, but the decisions for the distant future can be corrected when more accurate forecasts are available.

The only challenge, which makes DP not applicable to the real-size network planning problem, is the so-called “curse of dimensionality”; the method demands very big computational effort for large dimension problems. On the other hand, when talking about network planning, in many cases it means reinforcement of existing network. These are the types of tasks where dynamic programming could be applied efficiently.

The planning task could be represented as a graph where the nodes represent particular states of the network and the branches represent certain investments made to reinforce the network (realized actions) when moving from one state to another. Each column depicts a

certain time stage and each horizontal line one possible action (Figure 3.2). For a particular task some of the graph branches can be absent corresponding to the logical (or others) constraints. On the other hand, some investments can be made simultaneously, in which case the graphical problem representation would not be so obvious.

The idea behind DP is that the decision at the t^{th} stage is obtained from the decision made at stage $(t-1)$ minimizing the transfer cost of moving from the starting point to this stage, which mathematically can be expressed as follows:

$$F(t, e) = \min_{\{G(t,e)\}} [g(0, e(0)) + g(1, e(1)) + \dots + g(t, e(t))] \quad (3-11)$$

where $\{G(t,e)\}$ is the set of acceptable strategies during the time t and until state e is reached and, $g(t, e(t))$ is the component of the objective function at t^{th} stage for the state $e(t)$.

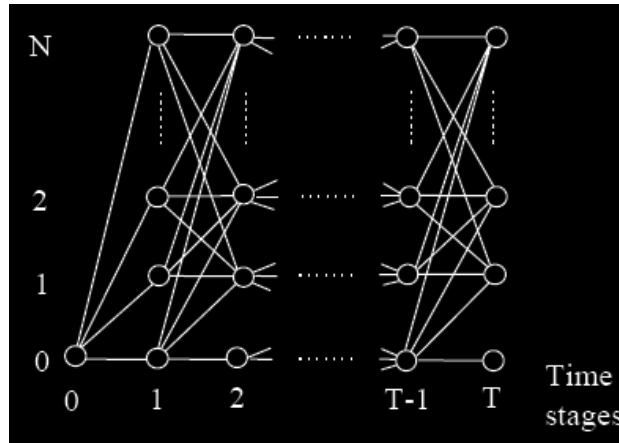

Figure 3.2: Dynamic Programming graph for network reinforcement problem

Furthermore, it can be shown [96], [182] that Eq. (3-11) can be reduced to the following recursive equation of DP:

$$F(t, e) = g(t, e) + \min_{\{e(t-1) \subseteq e\}} F(t-1, e(t-1)) \quad (3-12)$$

where $\{e(t-1) \subseteq e\}$ stands for the set of states $e(t-1)$ from which the transition to state e is feasible.

Then the optimization process can be accomplished by decision of some set of equations according to Eq. (3-12) minimizing the objective function for the period from the initial to the final stage.

In order to overcome the difficulties connected with high dimensions, there are attempts

to reduce computational capacities needed for realization of the dynamic programming method. For instance, the modified method of dynamic programming called the Optimal Initial States method [96], [97], [182] which actually is a heuristic time-variant optimization algorithm based on dynamic programming. The idea behind this algorithm is that as dynamic optimization proceeds at each stage, only some states could lead to the optimal solution.

Only these states, called Optimal Initial States, should be kept for further consideration. It gives the great savings in computer time and memory. It is proven that Optimal Initial States for the particular task of power system planning could be found by applying technical economic characteristics of the power object which are regular.

A number of researchers have applied DP to the distribution network reinforcement problem [95]-[97] attracted by its advantageous features. However, the problem of the “green-field” network planning (planning of a new network) is likely to be addressed by some other optimization techniques.

3.5.2.5 Evolutionary Algorithms

The complexity introduced by planning concepts such as uncertainties, multiple objectives, etc., associated with the combinatorial complexity of the problem, lead to the perception of the limitation of the traditional methods referred to in the previous points.

The technique known as Evolutionary Algorithms (EA) includes several algorithms, which share the same conceptual base of simulating the evolution of individual structures by processes of selection, mutation and recombination. These processes depend on the perceived performance of each one of these structures in a certain environment.

Interest in EA-related research [183] as well as in EA application in Power Systems [98], [106], [149], [150], [184], [185] increased rapidly in recent years. The main advantages of these methodologies can be summarized as follows:

- search is performed starting from several points and is based on probabilistic transition rules; consequently, there is less chance for convergence to a local optimum
- EA do not require “well behaved” objective functions, discontinuities can be tolerated
- EA are very good for multi-criteria optimization.

These features have caused increased interest in EA application as an optimization tool to the tasks (non-differentiable, discrete, and non-convergent) where it is difficult to apply any other optimization method.

The weak point of these algorithms is that if the numbers of variables increases, the speed of converge reduced rapidly and they can't find optimum solution. Different variants of EA exist, the most popular of which are the following:

- Genetic Algorithms (GA)
- Evolution Strategies (ES)
- Evolutionary Programming (EP)
- Genetic Programming (GP)
- Classifier Systems (CS).

In application to Power Systems, the most attention among EA has been received by GA [98], [149], [150], [184], [185].

Genetic Algorithms (GA)

The standard GA operates on a population of binary strings, referred to as “chromosomes”, which consist of bit-genes, referred to as “individuals”. Each individual represents a solution coding all the decision parameters. A population of individuals is replaced during each generation cycle. Individuals for reproduction are selected according to their “fitness”, which reflects the quality of the particular solution, thus biased towards the best. Then the recombination of selected strings takes place through crossover according to some high probability. An example of Single Point crossover is shown in Figure 3.3.

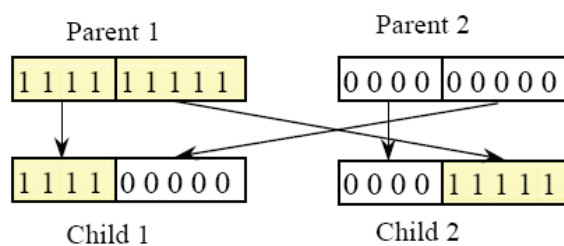

Figure 3.3: An example of Single Point crossover

The resulting offspring may undergo mutation according to some mutation probability, which usually is very low. Utilization of this operator ensures that the probability of searching a particular subspace of the problem space is never zero, thereby tending to

inhibit the possibility of ending the search at a local, rather than global optimum.

The technique for encoding the solution to the problem on strings also may vary from problem to problem and within GA. The following general guidelines are given in [105]:

- A coding should be selected so that short, low-order schemata* are relevant to the underlying problem and relatively unrelated to schemata over other fixed positions.
- The smallest alphabet that permits a natural expression of the problem should be selected.

Most optimization tasks require consideration of constraints. There are the following two ways to represent constraints for optimization by GA:

- The most effective way is to embed constraints in the coding
- Alternative way is to apply penalty function method.

Evolutionary Programming (EP)

EP starts from the assumption, that evolution optimizes behavior (phenotype level) and not the encoding genetics. EP, therefore, has no restriction on problem representation (coding is not essential). This is a beneficial feature of EP in comparison with GA. Mutation is the only source of variations in the algorithm. EP typically does not use recombination or other genetic operators.

The basic EP method starts from some initial population of trial solutions created randomly. Then the algorithm proceeds with the following two steps until a termination criterion holds:

- Off-springs are created from parent solutions by duplicating them. In basic EP mutation is implemented as adding normally distributed random variables with zero mean and dynamically adjusted variance to the components of all new trial solutions. Mutation variance is derived from the parent's fitness score.
- Each offspring solution is estimated according to its fitness. Some form of tournament between individuals leads to selection of a new population of a pre-specified size.

Genetic Programming (GP) [186]

GP is a variant of GA with a different problem representation. The main difference

* In low order schemata the number of fixed string positions is small.

from GA is that Genetic Programming operates by computer programs, which are candidate solutions, instead of strings that encode possible solutions. Similarly, each program is evaluated in terms of fitness by running it on a number of test problems and averaging the result. Usual Genetic Operators are used except Mutation, which usually is not applied.

Evolution Strategies (ES)

ES are similar to GA with some notable differences [186]. The real-valued vector of the objective variables is processed instead of binary strings. Mutation is the dominating operator. It adds normally distributed random variables with zero mean and dynamically adjusted standard deviation to all components of each solution in the population. An additional feature of some ES is the self-adaptation of mutation variances and covariances. ES method is very similar to EP, although independently developed.

Classifier Systems (CS)

CS are rule-based machine-learning systems capable of learning by examples [186]. It takes a set of inputs and produces a set of outputs, which indicate some classification of the inputs. There is functional similarity of CS to neural networks.

Heuristics and Algorithms overcome some mathematical optimization problems associated with real life distribution system planning. Some of these problems obtain unfeasible solutions when using binary decision variables or obtaining local optimal solutions when relaxing some constraints due to the system's physical large size. The aim is to provide the planner with a computationally manageable mathematical model formulation. However, some trials have been done, at the expense of getting optimal solutions, to simplify the problem from a dynamic to a static situation: [46] uses two-phase solution; [47] divides the original system into some sub-problems; [50] uses the pseudo-dynamic method. Based on this approach some significant works are illustrated:

In [48], "Branch-Exchange Algorithm" is implemented to solve a large scale single-period distribution system planning problem. The model is formulated as MIP with both fixed and variable parts. The model is constrained by demand and supply balance, radial configuration, equipments capacity, and voltage drop constraints. The solution algorithm is divided into four steps to get the most sensitive exchange from the simplex tableau. The drawback of this model is that it provides an approximate optimal solution only.

In [51], the approach used in [48] is extended from a single to a multi-period algorithm. This work proposes a use of three steps as follow: Forward Path implemented as normal branch-exchange method for each time period; Backward Path used to ensure that the model got the best solution fur the time-period under study; and Backward/Forward Path used to proceed for the next time-period.

An improvement is done to [51] in [52] to avoid local optimum obtained from the single-stage model. The model performs Multi-stage algorithm by processing several series of branch-exchange and does not address any time-dynamic.

In [20], the substations and primary feeders' sizing, location and timing planning are obtained by using an NLP model with non-discrete variables to reduce a large number of binary decision variables. The model uses an explicit time factor and is constrained by voltage drop, equipments capacity, and power conservation constraints. The heuristic approach divides the overall planning problem into two stages: clustering and forecasting stage provides the load growth location and magnitude; and planning stage where the distribution system planning problem is divided into two phases. In phase-1, the planning problem is solved using all feasible candidate location and feeder routes as a single-period approach to meet the demand growth at the horizon year. The decision to add or not to add a new facility is done through the facility power's continuous variables. If the potential substation power or potential feeder power flow is greater than zero, then this facility is chosen. In phase-2, the optimal yearly expansion plan is obtained by using the required equipments at the horizon year obtained from solving phase-1. The solution is based on the pseudo-dynamic methodology in [46] and [50].

The same mathematical model and solving approach improved in [187] by including the present worth of substation energy losses. The model determines the substation service area and the required exciting substations' expansion and new substations' installation size in term of candidate number of transformers. However, the model did not consider the physical system's configuration.

In [188], the optimal conductor number and cross-section area selection of the multi-section branching feeder model with non-uniform load distribution is discussed. The model is formulated as integer programming uses a heuristic index to obtain the near optimal solution. The model has voltage drop, power balance, and radial configuration constraints.

Chapter 4

DG Implemented Distribution Planning in an Electricity Market

This chapter presents new frameworks for distribution system planning. Section 4.1 introduces hierarchy of objectives for distribution network planning. The proposed integrated distribution system planning model is presented and discussed in Section 4.2. In Section 4.3, novel software package interfacing MATLAB and GAMS is developed to solve mathematical planning problem. This package is capable to solve large extent distribution system planning program visually and very fast. In Section 4.4, system elements modeling are presented. Case study, load characteristics and cost data is illustrated in Section 4.5. In Section 4.6, a new framework included mathematical model is introduced to obtain the optimal DG capacity sizing and sitting investments with capability to simulate large distribution system planning. Section 4.7 presents a mathematical distribution system planning model considering three planning options to system expansion and to meet the load growth requirements with a reasonable price with respect to system constraints. DG is introduced as a planning option in competition with voltage regulator devices and IL. In this section, it is also studied fluctuation of load and electricity market price vs. time period and the effect of DG placement on system improvement. Section 4.8 concludes this chapter.

4.1 Objectives of the Network Reinforcement

Objectives of the network reinforcement may vary considerably from one utility to another and from one plan to another within the utility. However, it is possible to formulate the common objectives for the planning task generally in terms of planning attributes, which have to be minimized.

The approximate hierarchy of objectives for distribution network planning is presented in Figure 4.1. More or differently formulated objectives can be added, i.e. voltage quality or environmental impact.

Shaded rectangles in Figure 4.1 contain the attributes, which are suggested for application in planning method presented in this dissertation. The relative goodness of each alternative can be measured in terms of chosen set of attributes. In order to estimate the attributes the corresponding model is needed. Modeling is an approximate reflection of the reality. The good model must essentially consider the most important features of the real system and neglect excessive details. The mission of the model is to gather numerous data about the problem under a single framework, and to process this data in such a way that the planning objectives can be expressed numerically in terms of attributes. As a result, there are the following three general attributes to be minimized:

- Attribute 1 Power Losses: Cost of power losses is calculated for the whole planning period. Different loading conditions may be modeled by duration of every mode,
- Attribute 2 Expansion Costs: Investment and O&M costs are combined into the single attribute,
- Attribute 3 Reliability: Cost of ENS is used depending on the information available.

During the whole planning period the network must satisfy a number of security and configuration constraints. Furthermore, there is an option to apply a number of logical constraints on the order and compatibility of reinforcement actions realization. The objectives, which are the subject of optimization, are open-ended. No matter how good the plan is, the planner is always challenged to do better. By contrast, the operational constraints must only be met, not exceeded [10].

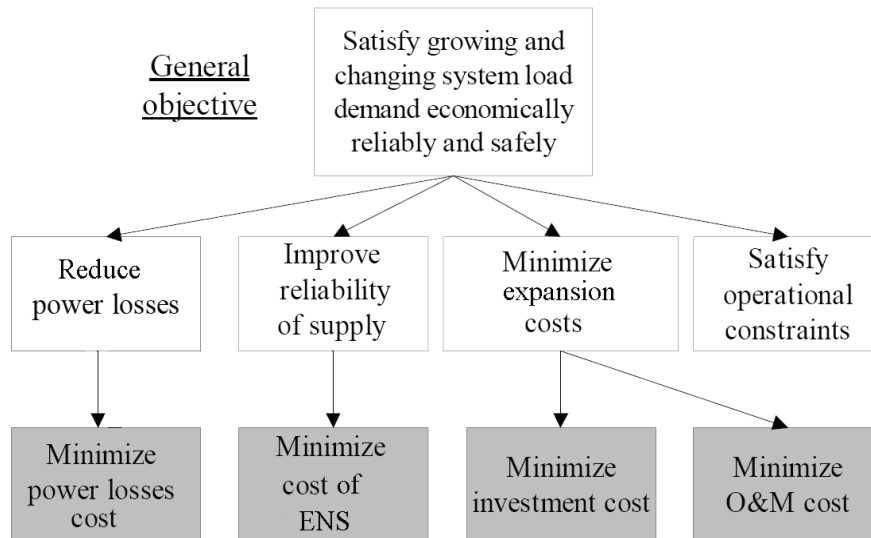

Figure 4.1: Hierarchy of objectives for distribution planning.

There may be additional goals specific for particular project. For example, reinforcement of the existing stations primarily in order to improve personal safety standards or replace oil-paper cables or green energy mainly for environmental reasons.

Part of the objectives may be formulated as attributes and taken into account during optimization, but some are considered as constraints. In any case, the objectives combine engineering and economics. The solution, satisfying all the objectives must be both technically feasible and economically efficient.

4.2 The Proposed Novel Integrated distribution system planning Model

This section presents a detailed mathematical model formulation for distribution system planning problem. In proposed models in this chapter, the local DISCO is considered to be the sole owner and operator of the distribution system that supplies electricity to its customers. In addition, the existing substations have to be utilized as much as possible to get the whole benefit from their sunk capital costs. The model follows the, traditional distribution system planning problem formulation trend and adds the necessary terms and constraints to incorporate the DG planning option as discussed in the following subsections.

4.2.1 Cost-Modeling

Each distribution system's equipment cost is split into two main parts: investment (fixed) cost and variable (running) cost. Figure 4.2 shows the main factors and

relationships influencing investments in proposed distribution system planning structure. The signs on the arrows indicate the signs of the feedbacks for the relations between the variables.

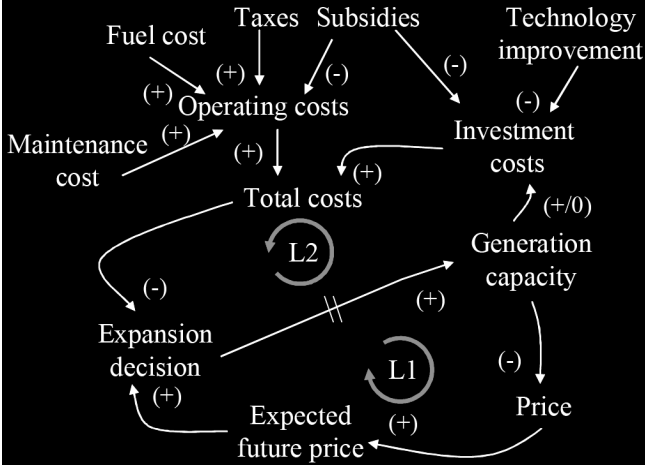

Figure 4.2: Distribution system planning structure.

There are two feedback loops in Figure 4.2, and the expansion decision can be considered as the control variable for both loops. The first feedback loop (L1) states that when generation capacity is increased the electricity price is likely to fall. This lowers expectations of future prices, which in turn reduces the likelihood of future expansion decisions. L1 is therefore a balancing loop that limits the investments in new generation. The second feedback loop (L2) is caused by the connection between current installed capacity and investment costs. The sign and magnitude of this relationship varies for different generation technologies. For renewable technologies like hydropower and wind power we assume that locations with the best energy resources, or the highest expected capacity factor, are utilized first. The investment cost is therefore a function of remaining reserves, which in turn are directly linked to installed capacity. Hence, there is a positive link between installed capacity and investment costs, so that L2 becomes a balancing loop for these technologies. On the other hand, fossil-fuelled power plants do not have the same clear link between generation capacity and investment cost, since there is usually no constraint on the amount of fuel supplied to these plants. The capacity factor for thermal power plants is a function of the dispatch of the power plant. The change in dispatch due to new installed generation capacity is dependent on the overall power system characteristics. We are treating the capacity factors for thermal technologies as constants in the investment part of the model. As a result, there is no link between installed capacity and investment cost for these technologies in the model. However, by including more details in the

modeling of the power system operation, we could include the relation between installed capacity, the expected capacity factor and thereby the unit investment cost for thermal technologies.

Fixed cost is spent during construction and installation and does not depend on intended loading variation to be served after operation. It consists of construction, installation, equipment, land, permits, site developing and preparation, taxes, insurance, labor, and testing costs. Variable (running) cost exists as the system goes in service and depends mainly on the loading required. It is the cost of fuel, electric system losses, inspection, O&M, taxes, and insurance [10]. Each planning options' equipment cost is represented as follows:

4.2.1.1 Investment (Fixed) Cost

In finance, the Equivalent Annual Cost (EAC) is the cost per year of owning and operating an asset over its entire lifespan. EAC is often used as a decision making tool in capital budgeting when comparing investment projects of unequal lifespan. For example, different types of DGs, reactive power compensation (such as capacitor banks, SC), transformers, feeders and other network equipment which maybe required to distribution system upgrade have different invest costs and expected lifetimes. It would be improper to simply compare planning alternatives. So, these models provide possibility of comparing, purchasing power from different TRANSCOs, installation any distribution planning options as well as penalty of environment pollution and load curtailment. Containing of each combination of these parameters is according to planners' decision.

a. DG units cost:

The total DGs fixed cost is the sum of each individual DG unit connected at the same bus. The annualized DG units cost is mathematically defined in Eq. 4-1.

$$C_{In\ DG} = \frac{\sum_{i=1}^B C_{Inv_{DG}i} \cdot P_{DG\ i}^{max}}{A_{PB} * 8760} \quad (4-1)$$

where:

$$A_{PB} = \left[\frac{1 - (1 + d)^{-T_{PB}}}{d} \right] \quad (4-2)$$

The existence of DG units and their capacity at it certain bus is identified by their

maximum capacity as integer variables.

b. SC units cost:

The total SCs fixed cost is the sum of each individual SC unit connected at the same bus. The annualized SC units cost is mathematically defined in Eq. 4-3.

$$C_{In\ SC} = \frac{\sum_{i=1}^B C_{Inv\ SC\ i} \cdot Q_{SC\ i}^{\max}}{A_{SC} * 8760} \quad (4-3)$$

where:

$$A_{SC} = \left[\frac{1 - (1 + d)^{-T_{SC}}}{d} \right] \quad (4-4)$$

4.2.1.2 Variable (Running) Cost

In traditional distribution system planning the system variable cost is based only on the system power losses and O&M costs. However, under deregulation, the proposed model introduces the incorporation of new terms such as the cost of purchasing the required extra power from several alternatives and/or cost of generating power from DG units. The market power price is chosen based on the type of electricity market used in the given local distribution company region. The DG generated power price is chosen based on: the type of DG technology used, the market fuel price, and the cost associated with DG maintenance. The different variable costs proposed by the integrated model are described in detail as follows:

a. Purchased power cost from TRANSCOs:

The amount of power required to be purchased from the interconnected system to the distribution system such as TRANSCOs to meet its load growth has to be incorporated in the optimization model. This amount of power is associated from TRANSCO connected to the distribution system. The total hourly value of the cost of purchasing power is:

$$C_E = \sum_{i=1}^G C_{P\ i} \cdot P_{G\ i} + \sum_{i=1}^G C_{Q\ i} \cdot Q_{G\ i} + \sum_{i=1}^S C_{Q\ i} \cdot Q_{SC\ i} \quad (4-5)$$

b. DG generating and O&M costs:

The amount of power required to be generated by DG units and exported to the local distribution system meet their load growth has to be considered in the optimization model.

This amount of power is coupled with the number and size of DG units optimally chosen by the model. The hourly value of the cost of generating power:

$$C_{O\&M\ DG} = \sum_{i=1}^B C_{O\&M_{DG}i} \cdot P_{DG\ i} \quad (4-6)$$

Because of used variable DG investment and operation costs, it is possible to evaluate different DG technologies in distribution system.

c. SC O&M costs:

The hourly value of the cost of generating or absorbing reactive power of SC is:

$$C_{O\&M\ SC} = \sum_{i=1}^B C_{O\&M_{SC}i} \cdot Q_{SC\ i} \quad (4-7)$$

It is to be noted that different type of voltage regulator system can be evaluated in this model.

d. Curtailed load costs:

Load shedding, also referred to as rolling blackout, is an intentionally-engineered electrical power outage. Load shedding is a last resort measure used by an electricity utility company in order to avoid a total blackout of the power system. It is usually in response to a situation where the demand for electricity exceeds the power supply capability of the network.

The need for load shedding stems from two general causes, usually unforeseen:

1. Lack of sufficient power supply.
2. Lack of sufficient transmission or distribution load-carrying ability.

These conditions may come about from:

1. Load growth faster than the construction of new facilities can be accomplished.
2. Abnormally high unforeseen demands that are created by unusual seasonal changes or by some special events that causes a significant loss in diversity of consumers' loads.
3. Failure or overload in some element or elements of the supply facilities; e.g., transmission line failure, substation transformer failure, etc., for a prolonged period.

Load shedding may be localized to a specific part of the electricity network or may be

more widespread and affect entire countries and continents. The penalty of load shedding calculates as:

$$C_{LS} = \sum_{i=1}^L P_i^{cur} * C_{pen}^{cur} \quad (4-8)$$

e. Feeder power losses:

The total feeder segments (connecting buses i and j) cost of power losses over the system buses is given by Eq. (4-9).

$$C_{loss} = loss * C_{P_i} \quad (4-9)$$

Where:

$$loss = \sum_i \sum_j P_{ij} = \sum_i \sum_j (V_i^2 Y_{ij} \cos(\theta_{ij}) - V_i V_j Y_{ij} \cos(\delta_j - \delta_i + \theta_{ij})) \quad (4-10)$$

4.2.2 Mathematical Planning Problem Constraints

There are yet other requirements which the design of distribution systems must meet, other than those of meeting the consumer’s and community’s needs and desires. The additional requirements, in the main, have arisen from the changing national economic and energy situations.

Collected under the general subject of operating requirements are the installation and arrangement of facilities to achieve a better quality of service, but also a more efficient distribution system and a more economical overall electric system from the generating plant to the consumer’s premises.

The optimization model has to be solved based on pre-specified constraints to ensure satisfaction of the minimum electric system operation requirements, and avoid equipment overloading. In addition to the traditional system constraints, new constraints and several modifications to existing traditional constraints are introduced by the proposed integrated model as follows:

1. Total power-flow conservation constraint:

Energy conservation law is implemented to ensure the fulfillment of the load power demand. At any load center bus, the net power received from all incoming local DISCO feeders after subtracting the feeder losses and all outgoing power to other and the power

supplied by DG and/or SC (if exist) should be equal to the total supplied demand (total load subtract curtailed load) at this bus. The proposed models modify this constraint by including the DG and SC power into its power balance equality. The mathematical formulations are expressed in Eq. 4-11 and Eq. 4-12.

$$\sum_{j \neq i} P_{ij} = P_{G_i} + P_{DG_i} - P_i^d + P_i^{cur} \quad (4-11)$$

$$\sum_{j \neq i} Q_{ij} = Q_{G_i} + Q_{SC_i} - Q_i^d + Q_i^{cur} \quad (4-12)$$

2. Equipment power capacity constraints:

a. Distribution substation's capacity constraints:

The summation of total power dispatched from each substation's transformer to the distribution system must be within the substation's capacity limit (upper limit). The lower capacity limit is set to zero to force the substation only to deliver power to the distribution system and not to receive and pump power back to the transmission grid. The constraints are formulated as shown in Eq. 4-13 and Eq. 4-14.

$$0 \leq P_{G_i} \leq P_{G_i}^{\max} \quad (4-13)$$

$$Q_{G_i}^{\min} \leq Q_{G_i} \leq Q_{G_i}^{\max} \quad (4-14)$$

b. Distribution feeders' design capacity limits constraint:

Primary distribution feeder has an upper design capacity limit for the total power that can be carried by each feeder during peak loads. In mathematical terms, this constraint is expressed in Eq. 4-15.

$$\left| S_{ij} \right| \leq S_{ij}^{\max} \quad (4-15)$$

3. Voltage drop constraints:

The selection and maintenance of proper voltage, materials and equipment of ample capacity, and the maintenance of frequency within very rigid limits all contribute to the quality of electric service rendered the consumer. Equally, if not more, important, however, are service continuity and environmental considerations, which also play a large part in the high standard of quality, established by the power suppliers.

Voltage drop constraints improve the quality of the electric service by maintenance of

voltage profile in proper limits at each load center bus. The local DISCO's regulatory authority provides the maximum allowable voltage drop at load centers [27], [50]. The proposed integrated model introduces new addition to the voltage constraints. The equation of the voltage constraint, given in Eq. 4-16, states that the voltage at any loads center bus must not exceed the system nominal voltage.

$$V_i^{\min} \leq V_i \leq V_i^{\max} \quad (4-16)$$

Such a constraint is not essential in the traditional planning problem as the feeder's power flow is radial. However, due to DG implementing, the bus's voltage might exceed its nominal value if feeder's power flow reverse due to DG injected power to the system.

4. DG operation constraint:

The proposed models require the following constraint, the, summation of all DG units generated power at a load center bus must be within the total modular DG capacities at that, bus to alleviate DG overloading during peak demands.

For a SPM, the DG power capacity constraint is shown in Eq. 4-17 to get the overall total DG size at the horizon year.

$$0 \leq P_{DG_i} \leq P_{DG_i}^{\max} \quad \forall i = 1, \dots, B \quad (4-17)$$

For a MPM, the yearly number of DG unit installations requires more details. Therefore, the individual DG power capacity constraint is shown in Eq. 4-18

$$\sum_{l=1}^{N_{DG_i}^{\max}} P_{DG_i,l} \leq P_{DG_i}^{\max} \cdot \sigma_{DG_i} \quad \forall i = 1, \dots, B; \forall l = 1, \dots, N_{DG_i}^{\max} \quad (4-18)$$

5. SC operation constraint:

The SC power capacity constraint is shown in Eq. 4-19 to get the overall total SC size at the horizon year.

$$0 \leq Q_{SC_i} \leq Q_{SC_i}^{\max} \quad \forall i = 1, \dots, B \quad (4-19)$$

6. Curtailed load limit:

IL is load that can be curtailed at the supplier's discretion. Total active and reactive curtailed load at bus i are in accordance with a contractual agreement as follows:

$$0 \leq P_i^{cur} \leq P_i^{LL} \leq P_i^d \quad \forall i=1, \dots, B \quad (4-20)$$

$$0 \leq Q_i^{cur} \leq Q_i^{LL} \leq Q_i^d \quad \forall i=1, \dots, B \quad (4-21)$$

It is to be noted that there is a relation between active and reactive curtailed load. So, the Eq. 4-21 can be defined as:

$$Q_i^{cur} = P_i^{cur} \cdot \tan(\text{pf}_i^{LL}) = P_i^{cur} \cdot \tan\left(\frac{Q_i^{LL}}{P_i^{LL}}\right) \quad (4-22)$$

7. Investment resources constraint:

The proposed models introduce the new investment resources constraint to the distribution system planning. The local distribution company has to often carry out, investment planning decision-making while considering its financial constraints. This constraint, which is given in Eq. 4-23, imposes a limit on how much capacity the local distribution company can invest in.

$$\sum_{i=1}^B C_{Inv_{DG}^i} \cdot P_{DG i}^{\max} + \sum_{i=1}^B C_{Inv_{SC}^i} \cdot Q_{SC i}^{\max} \leq IRC \quad (4-23)$$

It is to be noted that when a DISCO invests directly in DGs, that value is a direct benefit to the distribution system in its territory. When a DISCO tries to encourage customers or developers to own and operate DGs (especially in fully deregulated distribution system), the value is to the both owner (i.e. RESCOs) and DISCO. In the recent case, Eq. 4-23 should be changed. In this situation, the maximum DG installed capacity in DISCO territory is limited by available DG investors' bids. This constraint is shown in Eq. 4-24:

$$\sum_{i=1}^B P_{DG i}^{\max} \leq DIB \quad (4-24)$$

4.3 New Simulation Software Package

The years since the 1950s have seen the rapid development of algorithms and computer codes to analyze and solve large mathematical programming problems. One important part of this growth was the development in the early 1980's of modeling systems, one of the earlier of which was the General Algebraic Modeling System (GAMS) [189].

GAMS is a high-level modeling system for mathematical optimization problems. It consists of a proprietary language compiler and a variety of integrated high-performance

solvers. GAMS is specifically designed for large and complex problems, and allows creating and maintaining models for a wide variety of applications and disciplines [189]. GAMS is able to formulate models in many different types of problem classes, such as LP, NLP, MILP, MINLP and DP. It makes this framework as a problem-independent framework. Because changing in the objective function, by adding or deleting an item or variable, only the change of solver maybe necessary. For example, by adding an integer variable in NLP problem, it is necessary to change solver to another one that is capable to solve MINLP. Therefore, the objective function can be change easily according to decision makers and available planning options without worry of whole framework changing.

However, software tools such as MATLAB have optimization tools they are useful for small-scale nonlinear models (and to some extent for large linear models). The lack of the ability to perform automatic derivatives makes them impractical for large scale nonlinear optimization. In sharp contrast, modeling languages such as GAMS have capability to solve mathematical optimization problem for many years, and have been used in many practical large scale nonlinear applications. However, GAMS has some capabilities for data manipulation and visualization, specialized software tools like MATLAB are much better at these tasks for large extent data.

This thesis aims to satisfy following aspects:

- To consider all of the possible planning options and constraints together in a multi-objective optimization model to approach more realistic results;
- To solve optimization problem as fast as possible even in practical distribution systems that have a large number of variations and parameters;
- To develop a user-friendly software package to be used in applicable cases by distribution system planners.

However GAMS and MATLAB interfacing has been presented in the other works such as [190], [191], they are not sufficient for this purpose because of their weakness in:

- Choice of distribution planning alternatives such as DG, voltage regulators, capacitors bank, SC, load shedding, etc;
- Choice of the problem constraints and possibilities to change their limits according to system conditions;
- Capability of entering electricity market price and load fluctuations as a matrix or input file in excel format;

- Change of GAMS solver depending on the change in type of planning alternatives (i.e. the DG type can be defined as a positive variable or a positive integer multiple one scalar, because of its discrete nature. So, the type of model should be changed from DNLP to MINLP).

So it was necessary for our work to develop a new software package by interfacing these softwares especially for distribution system planning to achieve the above mentioned purposes.

The new developed bridge between GAMS and MATLAB allows using simultaneously sophisticated nonlinear optimization tools provided by GAMS with the user-friendly visualization tools provided by MATLAB (see Figure 4.3). The aim of this link is two-fold. Firstly, it is intended to provide MATLAB users with a sophisticated nonlinear optimization capability. Secondly, the visualization tools of MATLAB are made available to a GAMS modeler in one easy and extendable manner so that optimization results can be viewed using any of the wide variety of plots and imaging capabilities that exist in MATLAB.

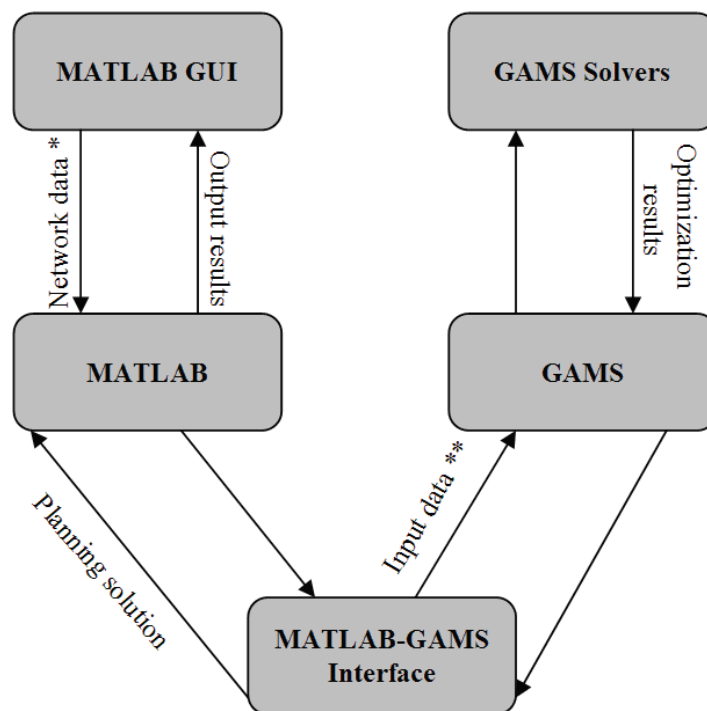

* Input data : network, electricity market and DG data
 ** In format of adjustable with GAMS

Figure 4.3: MATLAB-GAMS interface.

The resulting software package is a powerful tool able to set up large scale power

system, to solve complex planning problems and finally to visualize results by means of a user-friendly Graphic User Interface (GUI). This GUI allows the user selecting the optimization model, setting model parameters, entering network data and displaying GAMS results. Therefore, using this package, the user does not require knowing anything about MATLAB and/or GAMS programming language. The other advantage of this package is solving complex problems such as large systems very fast.

4.4 Modeling Network Elements

In proposed distribution system planning software the same basic circuit model provides the basis for all performance simulators of the distribution system, including load flow and economic analysis. It contains representation of lines, loads, and equipment along with connectivity information. The most basic decision in building a circuit model for distribution planning relates to how much detail is used. For the purposes of planning study usually single-phase circuit model is an adequate answer.

The transformers, regulators, capacitors, line drop compensators and other elements of the distribution system can be modeled in varying levels of details from simplistic to greatly detailed [10]. Generally, distribution planning requires less detail in the modeling of equipment behavior and control than distribution engineering. The key aspects are technical – capacity and basic electric behavior, and financial – costs.

The relatively short length of distribution lines enables simple modeling. It is usually sufficiently accurate to ignore the capacitance of a distribution circuit and represent it by an impedance.

Transformers can be represented by shunt and series impedances. The smaller distribution transformers have a larger series resistance than reactance, while the larger power transformers have negligible resistance compared to reactance. Tap-changing devices can be approximated for planning purposes as step-less devices which maintain voltage at a control bus at a constant level regardless of upstream voltage level.

Synchronous Condenser (SC) and Capacitors can be modeled as an impedance or a source of reactive power generation. TRANSCOs and DGs can be modeled as a source of power generation.

Static model of the electrical loads normally falls into one of the following three

categories: constant current, constant power or constant impedance. It's used constant power model for loads in this study.

4.5 Case study

The proposed mathematical models have been tested on the modified IEEE 30-Bus system [192] based on a real distribution system (Midwestern US, see Figure C.1) [193]. It consists of two subsystems; 132 kV sub-transmission system (buses No. 1-8 and 28) which has 132/33 kV step-down transformers and 11 kV or 33 kV distribution system (the other buses) [194]. The system parameters as reported in Appendix C are modified according to following (see Figure C.2):

- The voltage of the buses No. 1-4 is equal to 132KV and the voltage of the other ones is assumed to be equal to 33KV.

There are two TRANSCOs connected at buses 1 and 2 and also four SCs at buses 5, 8, 11 and 13. The system has been modeled with all of its detailed parameters. It is assumed that the DISCO faces a load growth with a total value of 310 MVA (283.4MW + 126.2 MVar) with a rate of 28% (5% in each year) increase in the 5 years planning period.

The investment cost of DG, according to used technology, ranges from 0.35-4 M\$/MW [195], [196]. This cost is considered to be relatively high with respect to other alternatives such as SC (0.01 M\$/MVar) [13], [14]:

The candidate individual DG capacity and maximum number of allowed DG installed units for each bus of the case study are assumed to be equal to 1MVA and 4, respectively. The discount rate is assumed as 10%.

4.5.1 Network Conditions (Case Studies)

In order to illustrate the effect of network conditions on distribution system planning three different network constraints as discussed below:

Case 1: In this case the above mentioned modified IEEE 30-bus system is assumed as case study. In this system, there are not any congestion areas or voltage problem even by load growth in the horizon year, therefore this system can work without needing to add any other generation devices. In this situation the goal is to determine the best placement and size of the different DG technologies in order to only decrease the total system losses and

costs, if it is possible.

Case 2: In this case it is assumed that in bus No. 8 there is not any SC. In the other word, it is assumed that 40MVar condenser of bus No. 8 is out of service for always. In this situation the voltage of the system in some buses is not in its permissible limits.

Therefore without DG and/or SC installation, it is necessary to curtail some loads to avoid voltage collapse in the system. So, in this case the goal is to find the best combination of utilization of DG and/or SC to improve system voltage as well as decrease the total system costs, losses and ENS.

Case 3: In some cases, placing DG units in strategic locations can help delay the purchase of new transmission or distribution systems and equipment such as lines and substations. In this case, the effect of DG on resolving of distribution feeders' congestion and deferring T&D investment is discussed. In such situation, it can serve the local load and effectively reduce the load as well as loss.

It may be driven by competition to provide the best customer service for the most competitive price. Since T&D costs are borne directly by the DISCO, and the quality of delivery directly impacts customer perceptions of service, many DISCOs are continuing to plan carefully for T&D improvements, and some are considering DG alternatives.

In this case, in addition of ignoring SC in bus 8, the permissible margins values of lines capacity are also reduced (S_{ij}^{\max}) to study the impact of DG to prevent system line congestion as well as avoid system voltage collapse (see Table 4.1).

Table 4.1: Distribution feeders' design capacity limits constraints.

Line (from-to)	Capacity limit (MVA)
1-2 (two lines), 1-3, 3-4, 2-5	80
4-6	70
2-6	55
2-4, 6-7, 4-12, 6-8	40
6-9, 9-10, 5-7	25
6-10, 12-15, 10-21, 27-28, 6-28, 12-16, 10-17, 10-22	20
The others	5

4.5.2 Load Characteristics

In the planning of an electrical distribution system, as in any other enterprise, it is necessary to know three basic things:

1. The quantity of the product or service desired (per unit of time);
2. The quality of the product or service desired;
3. The location of the market and the individual consumers.

Logically, then, it would be well to begin with the basic building blocks, the individual consumers, and then determine efficient means of supplying their wants, individually and collectively.

Maximum Demand: The actual load in use by a consumer creates a demand for electric energy that varies from hour to hour over a period of time but reaches its greatest value at some point. This may be called the consumer's instantaneous maximum demand.

Load Factor: The load factor is a characteristic related to the demand factor, expressing the ratio of the average load or demand for a period of time (say a day) to the maximum demand (say 60 min) during that period. This provides a means of estimating particular consumers' maximum demand if both their consumption and a typical load factor for their kind of load are known.

Diversity: Consumer load diversity describes the variation in the time of use, or of maximum use, of two or more connected loads. Load diversity is the difference between the sum of the maximum demands of two or more individual consumers' loads and the maximum demand of the combined loads (also called the maximum diversified demand or maximum coincident demand). For example, one consumer's maximum demand may occur in the morning, while another's may occur in the afternoon, and still another's in the early morning hours, as shown in Figure 4.4. The coincidence factor is the ratio of the maximum coincident total demand of a group of consumers to the sum of the maximum demands of each of the consumers.

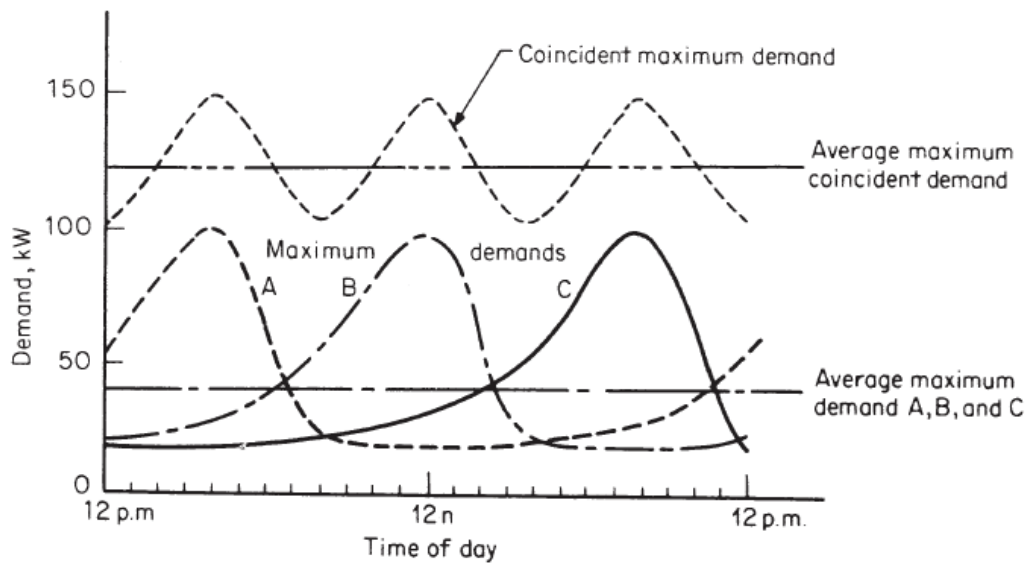

Figure 4.4: Maximum demands and average maximum demands, coincident and non-coincident.

4.5.3 Fluctuation in Demand

There are three main factors that greatly influence the magnitude of maximum demand and the time of its occurrence. The most frequent is the weather as it affects light intensity during daylight hours and temperatures throughout the day and year. The sharpest factor and perhaps that of least duration is special events which result in a temporary slowdown of activities or a greatly increased usage of lighting, radio, and TV and associated increases in water pumping, cooking, and other loads. The largest factor is changes in business conditions accompanied by significant changes in industrial demands and consumption; while much less significant, fluctuations in both residential and commercial consumer demands also follow such changes in business conditions.

The nature, magnitude, and time of these fluctuations are generally unpredictable. Some estimate of them can be gleaned, however, from past experiences, which may vary widely in different areas of the country. Provision for these fluctuations should be taken into account in the planning of distribution systems.

Good engineering requires that probable future growth of loads be considered in planning. This is usually provided by spare capacity in the present design of the several elements, or by provisions for possible future additions or alterations, or both of these. Load growth is rarely uniform throughout an area, so that growths in various parts of a system will be different from each other and from that of the system as a whole.

Data from past performances, such as total system loads, substation loads, and feeder loads, can be used as a basis for estimating such growth. The variations from year to year, or from month to month, can furnish a trend for such growth; separate trends can be developed for different parts or areas. Where such data are nonexistent or patently unreliable, estimates can include a fixed percentage growth above the values on which planning is made.

To obtain some idea of what may occur in the future, it may be well to look back a generation or two. Earlier, consumers' appliances could be contained in a relatively short table. To attempt to list all the electrically operated devices, appliances, and gadgets presently to be found in homes and commercial establishments would be an almost endless task. To attempt to foretell what may develop in the future would be an exercise in futility.

4.5.4 Load and Electricity Market Price Curves

To study fluctuation of load and electricity market price versus time period (uncertainty on fuel price and load) electricity market price and system load is considered to be variable. The shape of the daily, seasonal, and annual load curves is important characteristic for operation and expansion of generation systems to meet the system load. Utilities record the chronological hourly loads on a continuous basis. In this thesis, electricity market price and total load fluctuation vs. time are considered to be according to Figure 4.5, and Figure 4.6, respectively. It is to be noted that these data are extracted of France power exchange [197].

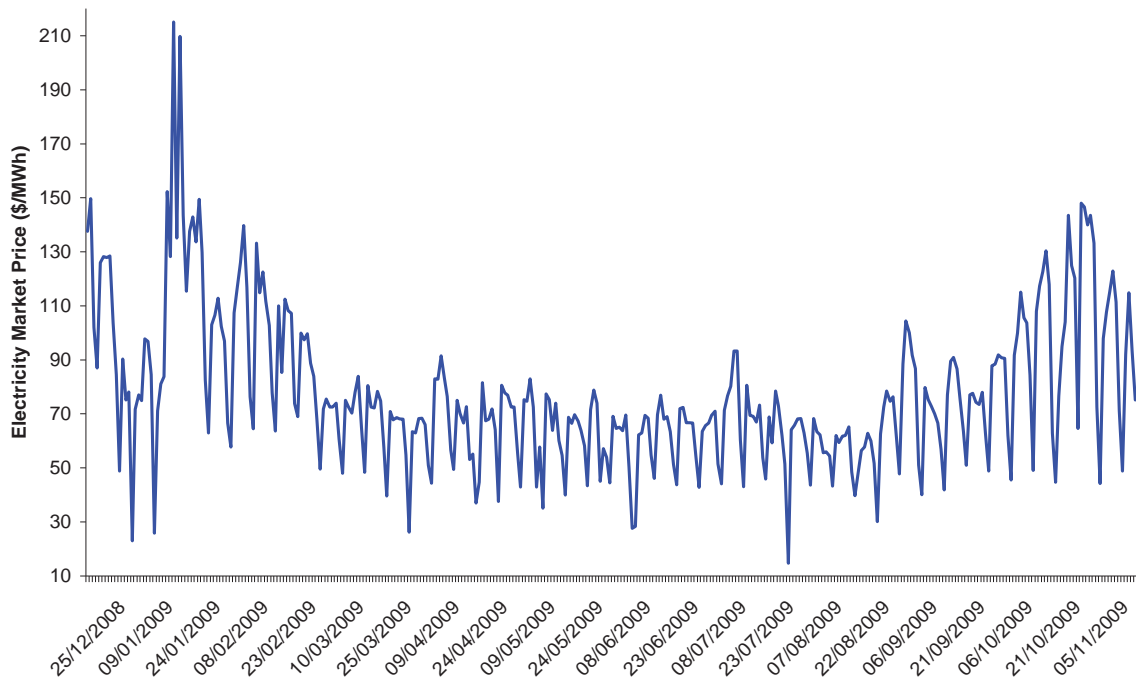

Figure 4.5: Electricity market price.

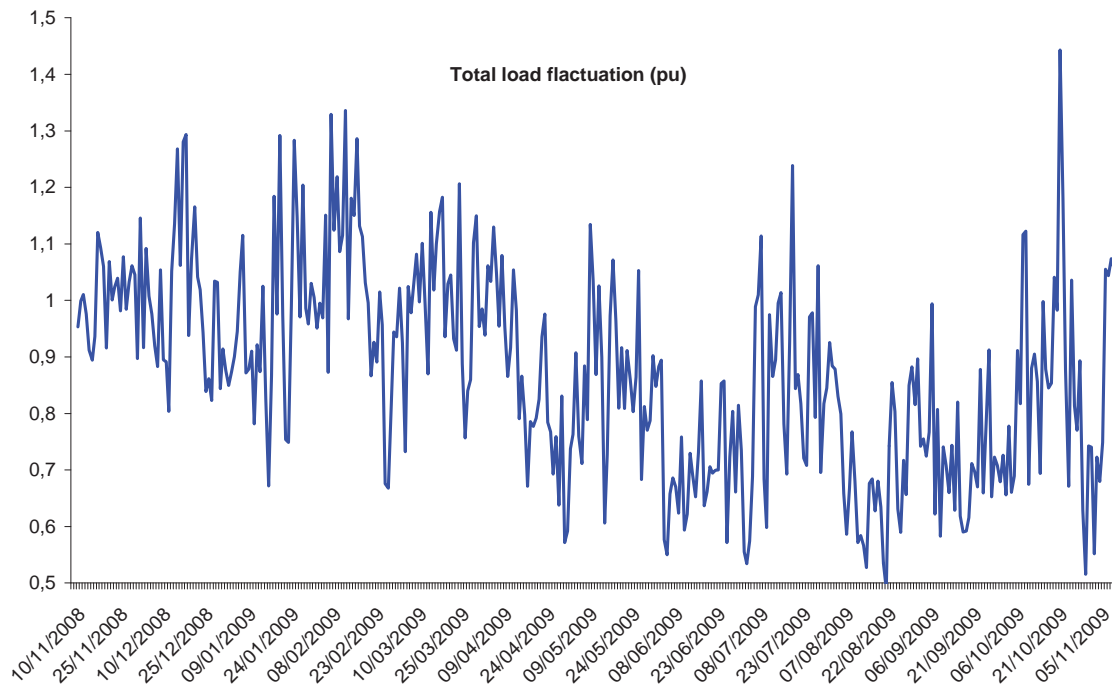

Figure 4.6: Total load fluctuation versus time period.

4.6 DG Planning Model

The mathematical formulation considered in this section is described by Eq. 4-25:

$$\text{Minimize} \quad obj(\$ / h) = C_{In\ DG} + C_{O\&M\ DG} + C_E + C_{loss} \quad (4-25)$$

This cost function aims to minimize the sum of:

- The investment $C_{In\ DG}$ (Eq. (4.1)) and operating cost $C_{O\&M\ DG}$ (Eq. (4.6)) of candidate local DGs.
- The cost C_E of purchasing the required additional power from TRANSCOs (Eq. (4.5));
- The cost C_{loss} of losses compensation services (Eq. (4.9)).

The proposed model adopted the use of the CGT set since sitting of this kind of DG has less environmental restrictions, and this technology is also known to be environmentally friendly and produces the least pollution compared to other fossil fuel DGs [7]. The investment cost of this kind of DG is assumed to be 0.5 M\$/MW [199]. The generated electricity and maintenance price is assumed to be 50 \$/MWh [15], [199].

The proposed model is executed in two categories as described below:

- SPM: This model is static models, which assume that the load demand would not change during the horizon year. They do not take into account the load growth factor and there is no need to relate installations of substations and feeders in one year to the next.
- MPM: Although, this model may be solved as a series of SPM thus treating each incremental period as an expansion situation, the resulting solution will not be an overall optimum as current solutions are not influenced by future decisions during the optimization process. Moreover, extending SPM by the single time-subscripting of time-dynamic variables and parameters is not adequate. In MPM, explicit modeling of correlated time-dynamic decisions is formulated.

In this subsection, based on the optimal SPM investment decisions, the model is executed as a MPM to provide the year-to-year installation requirements along with the demand growth. The proposed optimization model uses integer variables that provide the optimal decisions without any need for rounding the solution.

For MPM the power flow equations and the traditional system constraints will be repeated for each load level, in any iteration. Therefore, the Eq. (4.25) should be modified

for MPM. The objective function of MPM becomes:

$$\text{Minimize} \quad \text{obj}(\$ / h) = \sum_{t=1}^{T_h} \text{obj}(t) \quad (4-26)$$

Three comprehensive scenarios based on two above mentioned categories (SPM or MPM) and market structures (fixed or variable power electricity) are discussed as following (also see Figure 4.7):

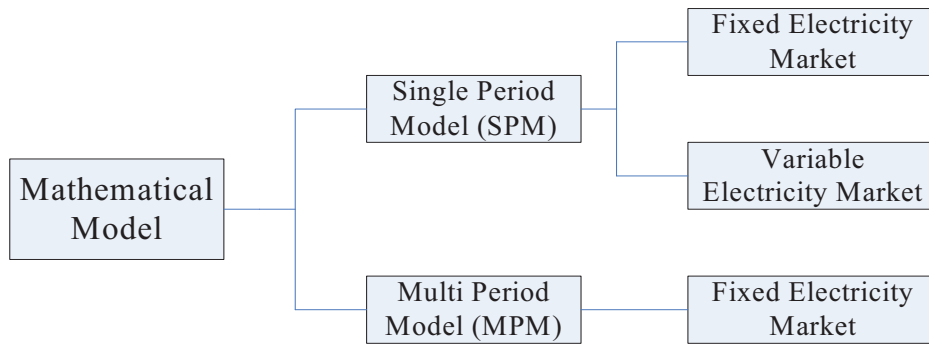

Figure 4.7: Different scenarios used to evaluate proposed DG planning model.

Scenario A: SPM with fixed electricity market. In this scenario, it is assumed that the price of electricity is fixed all over the period of the study. This scenario is applicable in bilateral contract based market models. In this study, the electricity base market price of fixed electricity market structure is assumed to be 70 \$/MWh for purchasing power by the DISCO from the main grid or TRANSCOs [7], [199].

Scenario B: SPM with variable electricity market. In this scenario, it is assumed that the price of electricity is variable according to Figure 4.5. This scenario is more applicable in pool market models.

Scenario C: MPM with fixed electricity market. In the scenarios A and B, SPM has been used as planning option. In this scenario, MPM has been used. The proposed model is executed each intermediate year between the base and the horizon year. It is also assumed that the power electricity market price is fixed all over each year of the study period. MPM with variable electricity market has a lot of time samples ($5 \times 8760 = 43800$) which makes optimization planning problem too complicated. So, in this study this scenario is not considered.

In this section, for each of the three cases depending on network constraints discussed in Section 4.5.1, three above mentioned scenarios are carried out. It is to be noted that DG investment payback time is assumed to be equal to horizon planning period (5 years). It is

also assumed that the maximum and minimum permissible voltages at any bus are 1.05 pu and 0.96 pu, respectively.

4.6.1 Analyses and Results of Case 1

The results of simulation illustrate that to supply load growth, additional 68.3 MW are required at the horizon year, without DG installation. This additional active power should be purchased from TRANSCO connected to bus number 1. In this situation, total system loss is 18.031 MW.

The optimal total purchased power and DG required units (locations, sizes, generated power and operation costs) have been achieved. The results are summarized in Table 4.2 which comprises results without and with DG installation according to *IRC*, for the three scenarios A, B and C.

Table 4.2: Optimum solutions for the three scenarios in Case 1.

	With DG installation according to IRC		
	Scenario A	Scenario B	Scenario C
DG Investment Cost (M\$)	10	7	10
Total Expansion Cost (\$/MWh)	15.057	15.057	15.057
Additional substation purchased (MW)	45.6 @ Bus#1	52.3 @ Bus#1	45.6 @ Bus#1
Total loss (MW)	14.936	15.777	See Figure 4.10
DG Capacity (MW) & Location	4 @ Bus# 5, 19, 30 3 @ Bus# 24 2 @ Bus# 7, 26 1 @ Bus# 29	4 @ Bus# 5, 30 3 @ Bus# 19 2 @ Bus# 26 1 @ Bus# 24	4 @ Bus# 5, 19, 30 3 @ Bus# 7, 24 2 @ Bus# 26
Losses Cost (\$/h)	1045.52	-	1045.66
Electricity Market Price (\$/MWh)	69.658	See Figure 4.9	See Figure 4.12

Scenario A:

In scenario A, DG installation has caused a reduction in the power flow in the primary feeders which results in reducing the total loss from 18.031 MW to 14.936 MW (see Table 4.2, column Scenario A), that caused decreasing by 16% and therefore increasing lines lifetime. It adds the opportunity to use the existing DISCO's network for future load growth without the need for feeders upgrading.

By both purchasing 45.6MW additional power from TRANSCOs and 20MW DG installation (see Table 4.2, column Scenario A) better planning decisions are obtained. The results show that by installing seven groups of DGs (see Table 4.2), electricity market price is reduced of 0.342 \$/MWh or of 0.15 M\$/MW in five years. More, DG has electrical operational benefits, as depicted in Figure 4.8 where distribution system buses voltage

profiles are drawn without and with DG installation. As it is shown in this figure, DGs' installation has improved system voltage profiles.

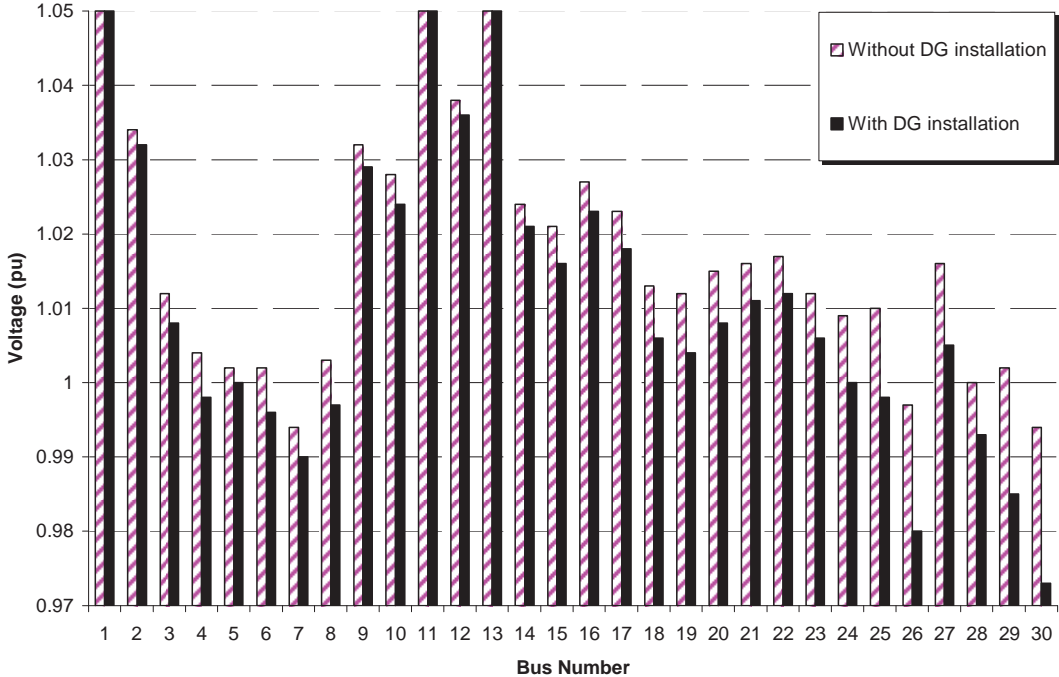

Figure 4.8: Distribution system buses voltage profiles without (hatched) and with (black) DG installation.

Scenario B:

In scenario B, it is assumed that electricity market price varies according to Figure 4.5. It is to be noted that electricity market prices can be entered as software package input by a data input file. In this scenario, however the budget is enough to install 20 MW DG (as scenario A), the optimum solution for scenario B is achieved by only installing 14 MW DG. Installing this amount of DG decreases total system loss by 15 %.

Figure 4.9 illustrates the influence of installing these DGs (optimum capacity and location mentioned in Table 4.2) on the electricity price for a sample day. As it is shown in this figure, DG installation increases electricity market price when electricity price is low and decreases it when market price is high. However, DG installation is increased electricity market price in much more hours of this sample day; it can decrease the total system costs. For example, installation of 14 MW DG with size and capacity specified in the Table 4.2 decreases the total system cost by 252 \$ in this sample day.

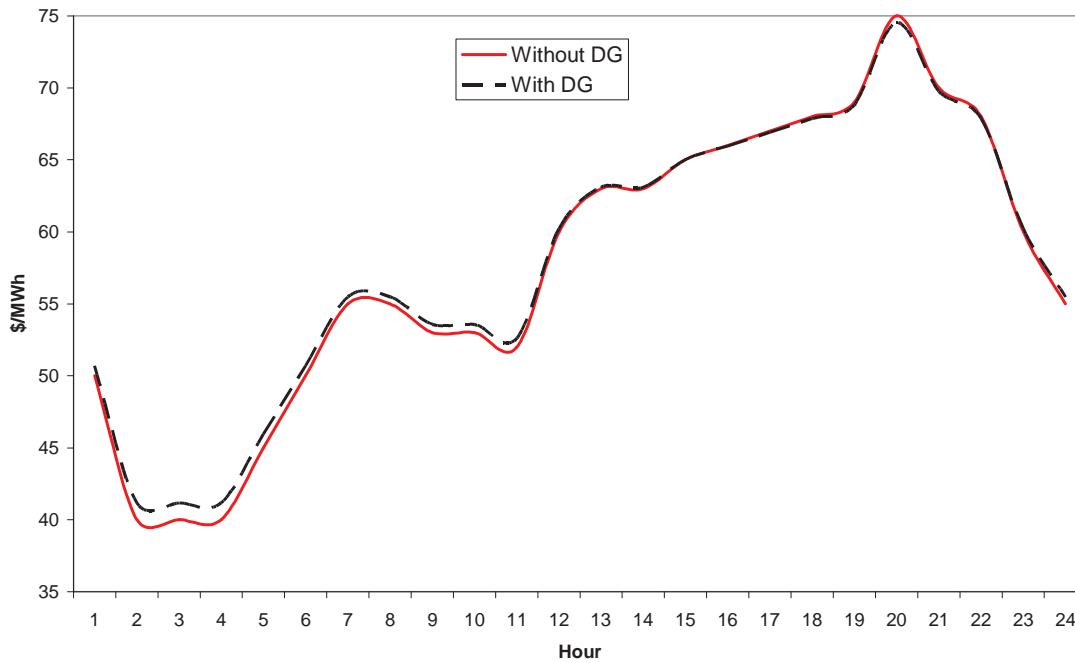

Figure 4.9: Electricity market price before (solid line) and after (dash line) DG installation.

Scenario C:

The results of this scenario are shown in Table 4.2. Total system losses and system buses voltage profiles are shown in Figure 4.10 (case 1) and Figure 4.11, respectively. DG installation has decreased total system losses in horizon year as shown in Figure 4.10. As it is shown in Figure 4.11, DG installation in this distribution system improved system voltage profile. In this scenario, the existing distribution system feeder design capacity limits aren't violated. The effects of DG installation on electricity market prices are illustrated in Figure 4.12 (case 1).

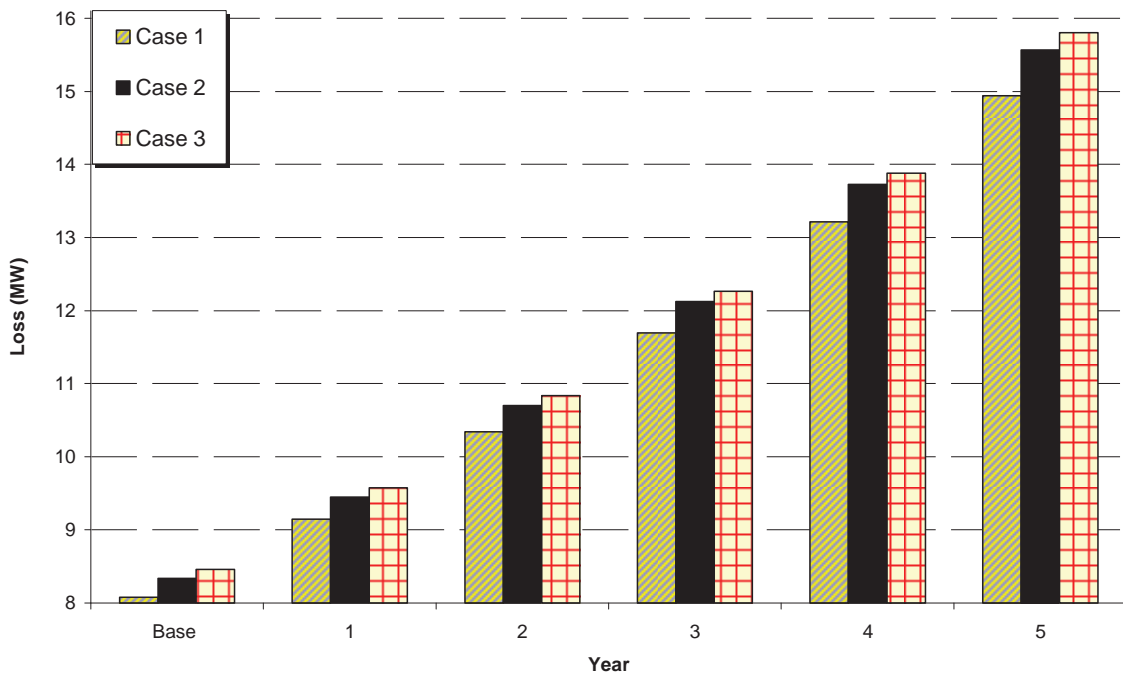

Figure 4.10: Total system losses at each year.

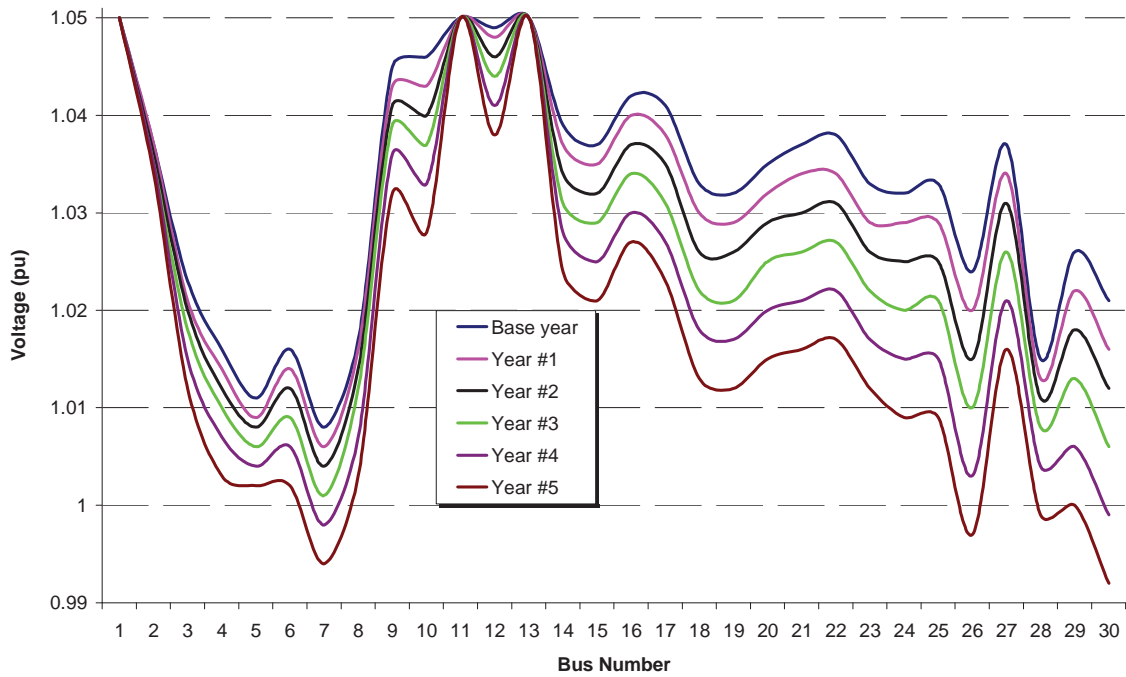

Figure 4.11: Distribution system buses voltage profiles at each year.

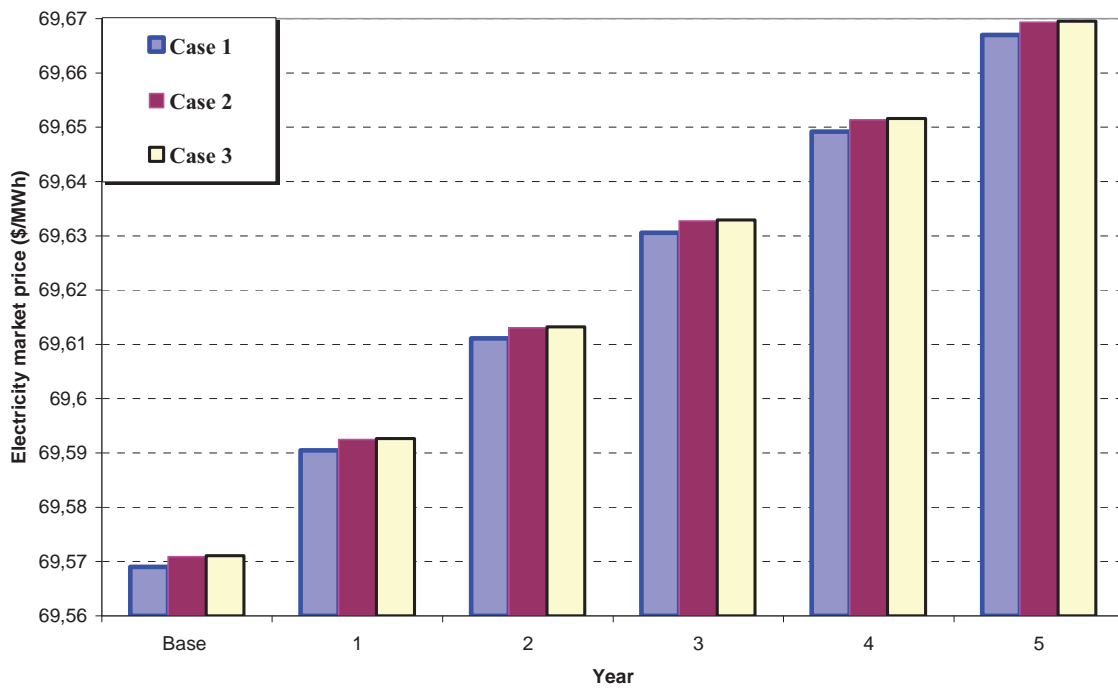

Figure 4.12: Electricity market price after DG installation at each year.

Figure 4.13 compares optimum location and capacity of DG in the three studied scenarios. As it shown in this figure, the results may be different according to the different planning categories and electrical market structures.

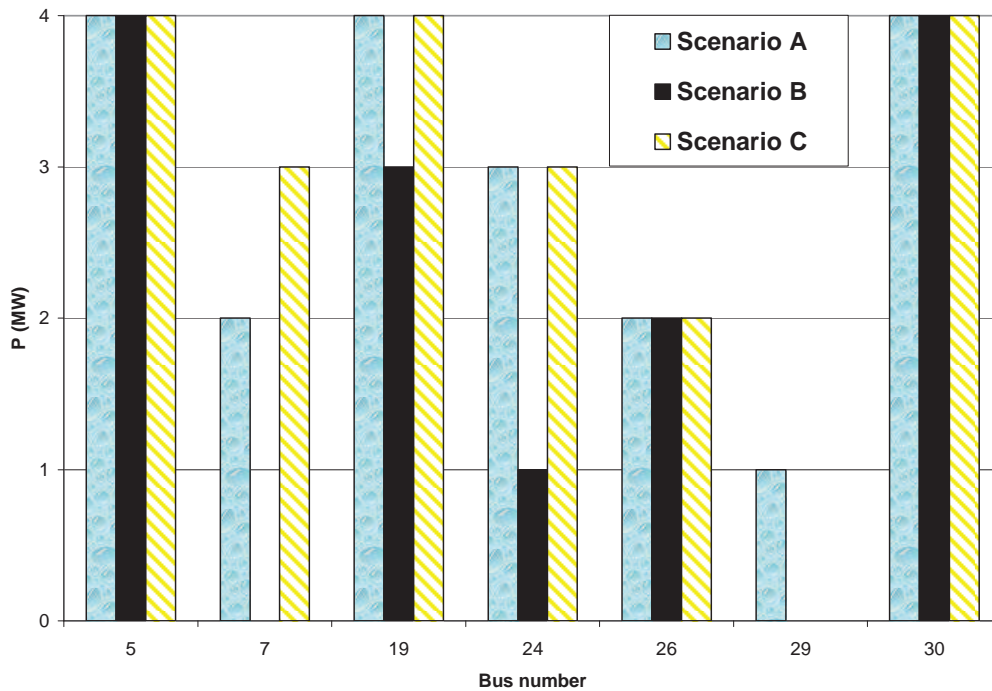

Figure 4.13: Optimum location and sizing of DG for the three different scenarios.

4.6.2 Analyses and Results of Case 2

Table 4.3 summarizes the results for the three scenarios. It is to be noted that the results of scenarios A and B are similar, except for losses costs which is depended on market prices. Consequently, in the next figures, results of scenario B are not shown.

Table 4.3: Optimum solution for the different scenarios in case 2.

	With DG installation according to IRC		
	Scenario A	Scenario B	Scenario C
DG Investment Cost (M\$)	10	10	10
Total Expansion Cost (\$/MWh)	15.057	15.057	15.057
Additional substation purchased (MW)	47.7 @ Bus#1	47.7 @ Bus#1	47.7 @ Bus#1
Total loss (MW)	15.564	15.564	Figure 4.10
DG Capacity (MW) & Location	4 @ Bus# 5, 19, 24, 30 2 @ Bus# 26 1 @ Bus# 7, 29	4 @ Bus# 5, 19, 24, 30 2 @ Bus# 26 1 @ Bus# 7, 29	4 @ Bus# 5, 19, 30 3 @ Bus# 24 2 @ Bus# 7, 26 1 @ Bus# 29
Losses Cost (\$/h)	1089.48	-	1089.55
Electricity Market Price (\$/MWh)	69.669	-	Figure 4.12

Figure 4.14 shows the best capacity and location of the DGs to obtain minimum system upgrading costs as well as system voltage improvement for scenarios A and C.

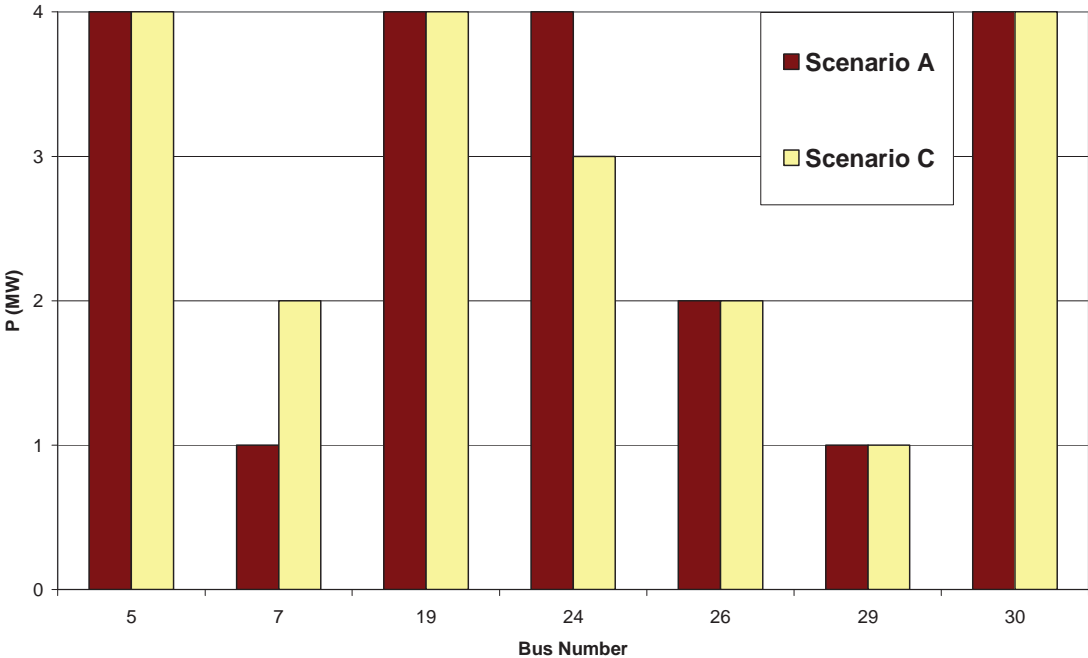

Figure 4.14: Optimum location and sizing of DG for scenarios A and C.

In this case, DGs should not only decrease total system losses and cost but also prevent voltage violation. Distribution system voltages profiles before and after DG installation has been determined and shown in Figure 4.15. Before DG installation, voltages are violated at

buses numbers 8, 26, 29 and 30 at the horizon year. After DG installation, the system voltage profiles satisfy the constraints.

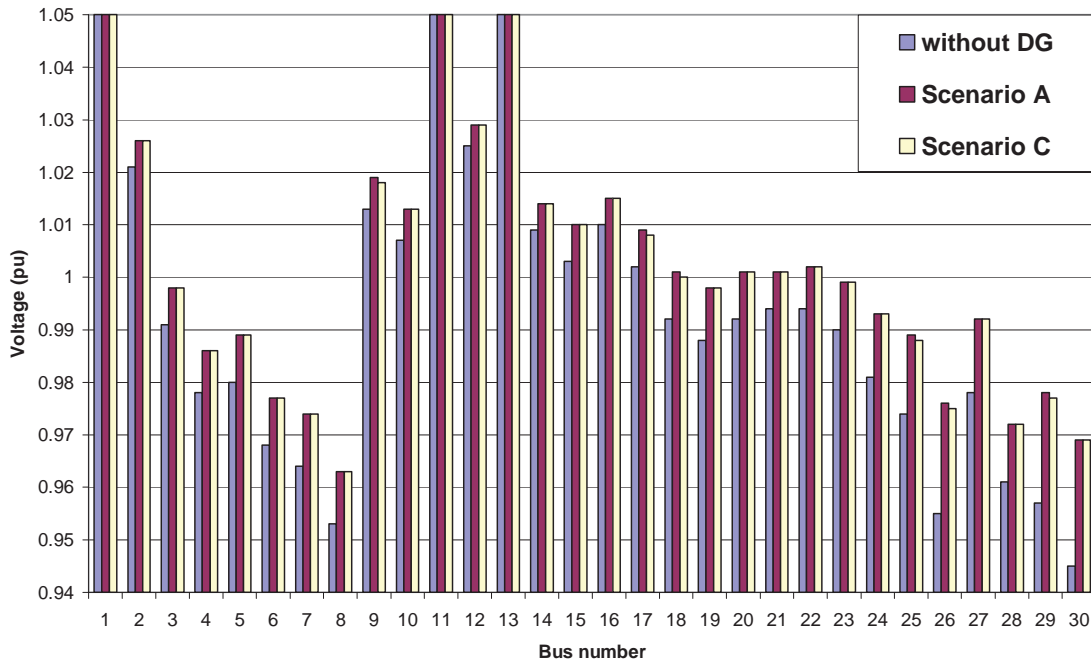

Figure 4.15: System voltage profiles without DG and with DG at the horizon year.

4.6.3 Analyses and Results of Case 3

Table 4.4 summarizes the results for the three scenarios in the case 3. Results for scenarios A and B are similar.

Table 4.4: Optimum solution for different scenario in case 3.

	With DG installation according to IRC		
	Scenario A	Scenario B	Scenario C
DG Investment Cost (M\$)	10	10	10
Total Expansion Cost (\$/MWh)	15.057	15.057	15.799
Additional substation purchased (MW)	47.9 @ Bus#1	47.9 @ Bus#1	47.9 @ Bus#1
Total loss (MW)	15.779	15.779	Figure 4.10
DG Capacity (MW) & Location	4 @ Bus# 15, 30 3 @ Bus# 18, 19, 23 2 @ Bus# 14 1 @ Bus# 26	4 @ Bus# 15, 30 3 @ Bus#18,19,23 2 @ Bus# 14 1 @ Bus# 26	4 @ Bus# 30 3 @ Bus# 15, 18, 19, 23 2 @ Bus# 14 1 @ Bus# 24, 26
Losses Cost (\$/h)	1104.53	-	1105.93
Electricity Market Price (\$/MWh)	69.669	-	Figure 4.12

The simulation results have determined the best size and location of DGs to minimize system upgrading and losses cost as well as improve system voltage and decrease line power flow to its permissible limits (see Figure 4.16).

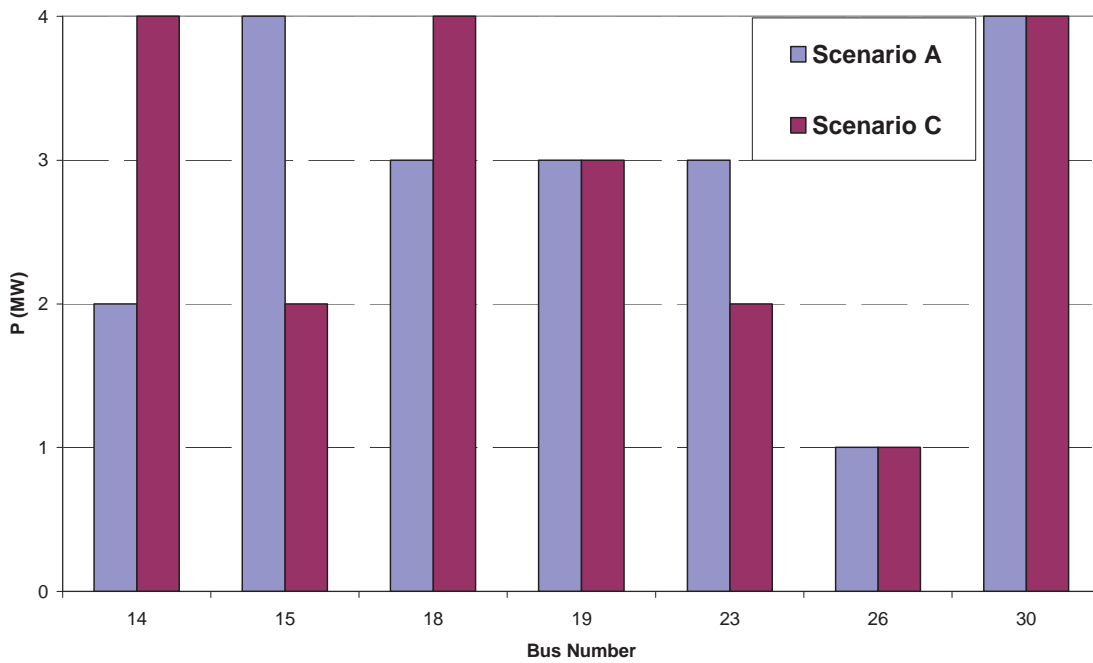

Figure 4.16: Optimum location and sizing of DGs for scenarios A and C.

Figure 4.17 shows the voltage profiles before and after DG installation with capacity and location specified for scenarios A and C.

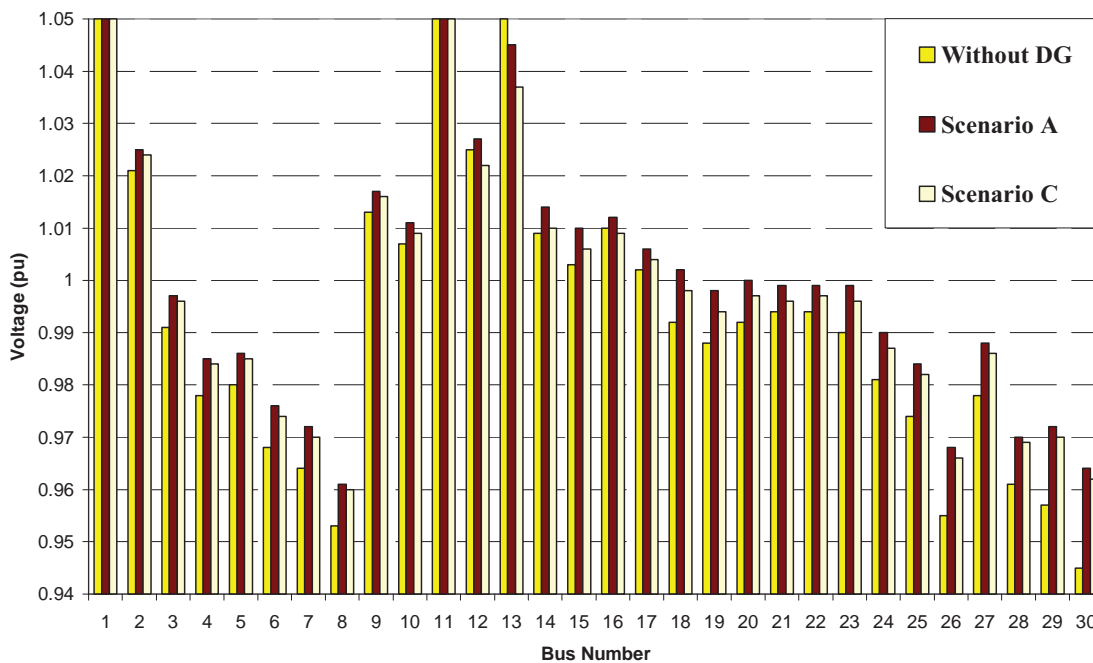

Figure 4.17: Voltage profiles without DG and with DG.

Figure 4.18 describes the effect of DG sizing and sitting on distribution system lines power flow for scenarios A and C.

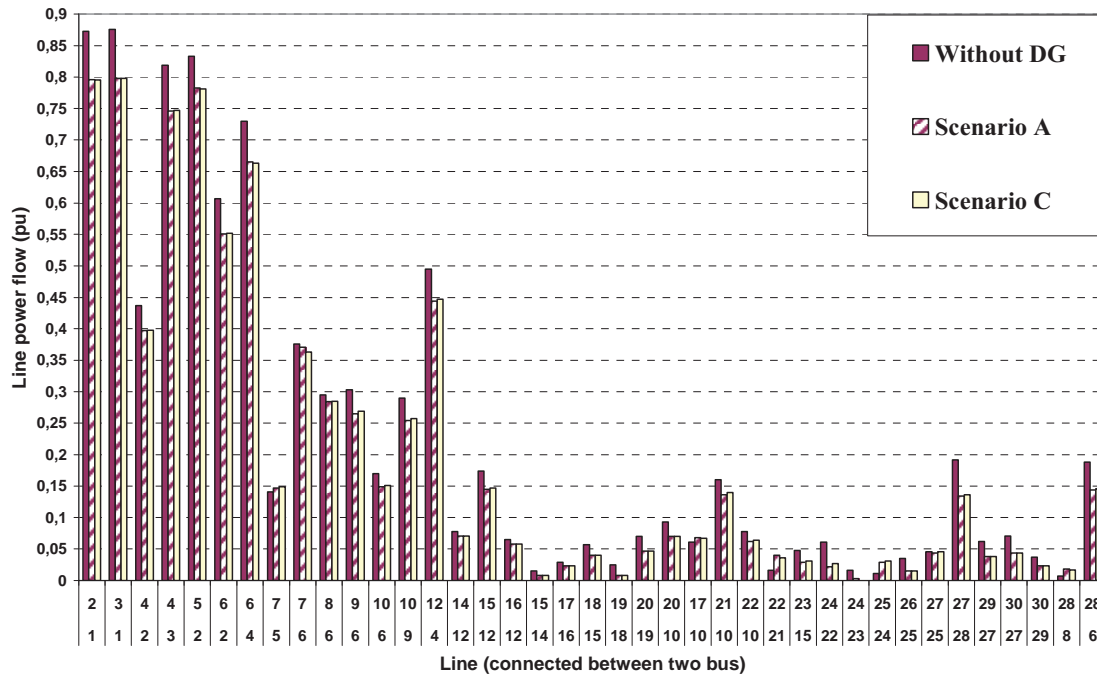

Figure 4.18: Line power flow without DG and with DG.

4.7 Comparative Market Model

Considering three planning options (DG and SC installation and load shedding) there are eight possible attitudes. The choice of each of these attitudes is depended to the planner decision. These attitudes are:

- Attitude I: Without DG or SC installation and load shedding,
- Attitude II: Load shedding,
- Attitude III: SC installation,
- Attitude IV: DG installation,
- Attitude V: SC installation and load shedding,
- Attitude VI: DG installation and load shedding,
- Attitude VII: DG and SC installation,
- Attitude VIII: DG and SC installation and load shedding.

The mathematical formulation considered in this model is described by Eq. (4.25):

$$\text{Minimize} \quad \text{obj}(\$/h) = C_{In\ DG} + C_{O\&M\ DG} + C_{In\ SC} + C_{O\&M\ SC} + C_{LS} + C_E \quad (4.25)$$

The test system is described in case 2 (Section 4.5.1). Wide varieties of DG technologies with varying operating characteristics are available in the market. CHP units, due to their

heat recovery system can deliver power at much cheaper price than the central generation. The technologies such as fuel cells are characterized by their high cost while technologies such as wind turbine and gas turbines lie somewhere in the middle. In this section the fixed and variable cost of DG is assumed to be 0.5 M\$/MW and 40 \$/MWh [79], [195]. The penalty of load curtailment is assumed to be equal to 500 \$/MW [200]. In this framework, electricity market price and load are variable as shown in Figure 4.5 and Figure 4.6 (Section 4.5.4), respectively. Because of large number of data, in the figures of this section only a sample day is shown.

4.7.1 Analysis and Results of Attitude I

In this attitude there is not any planning option. This attitude exactly studies system condition and problems after load growing. The results of simulation indicate that in some time period the load flow equations don't converge. To converge these equations the lower constraint of bus voltage (0.96 pu) is removed. In this condition voltage profile of nine buses in some time period (during peak hours) violates their lower limits which confirm the necessity of system upgrading. Figure 4.19 indicates the voltage profile of sensitive buses versus the time period in a sample day. These buses are sorted as 30, 8, 26, 29, 28, 7, 6, 25 and 27 according to their profile voltage from lowest to highest. It is to be noted that in this condition protection devices may disconnect these buses or voltage collapse happen.

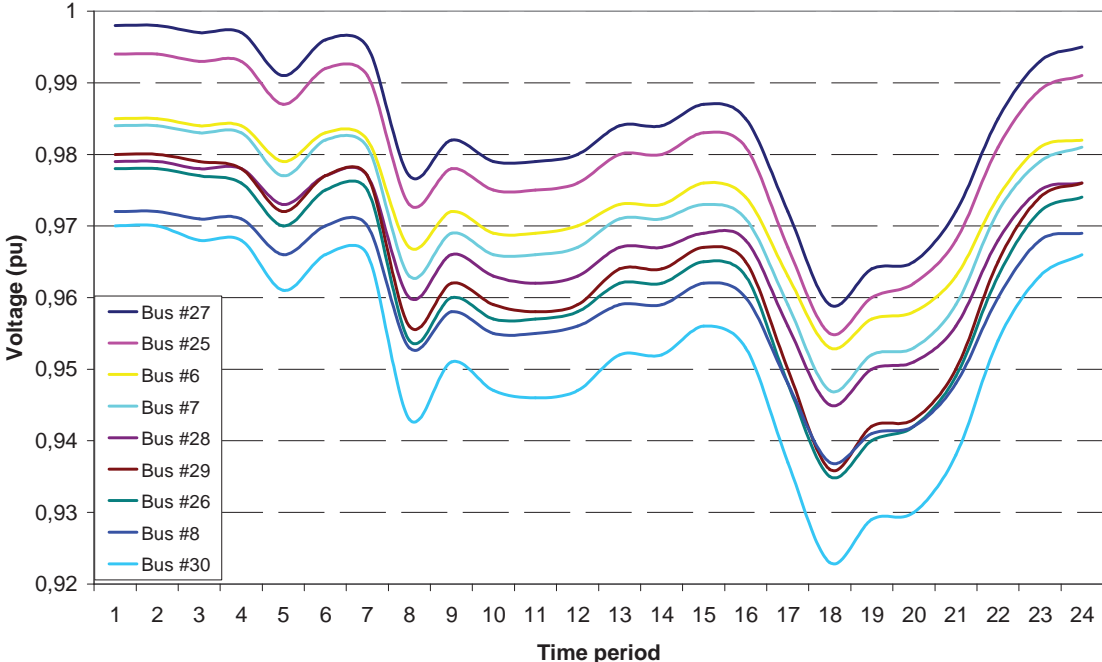

Figure 4.19: Voltage profile versus time period at sensitive buses in attitude I.

4.7.2 Analysis and Results of Attitude II

Load shedding is a last resort measure used by an electricity utility company in order to avoid a total blackout of the power system which may occur to above mentioned problem (attitude I). Table 4.5 indicates the percentage of curtailed load at each time period and in each bus. It also summarized total active and reactive curtailed load versus time period.

Table 4.5: Optimum curtailed load at each time period and in each bus in attitude II.

Bus #	Time Period															sum
	8	9	10	11	12	13	14	15	16	17	18	19	20	21	22	
Curtailed load at bus # 8 (%)	11.3	1.7	6.7	7.4	6.1	-	-	-	-	19.1	34.8	28.8	27.4	18.5	-	
Curtailed load at bus #26 (%)	-	-	-	-	-	-	-	-	-	-	13.2	8.1	8.1	-	-	
Curtailed load at bus #30 (%)	22.4	16.5	20.0	20.0	19.0	14.6	14.6	7.9	12.7	27.5	35.7	32.7	32.1	27.5	11.8	
Total active load shedding (MW)	5.8	2.2	4.1	4.3	3.8	1.5	1.5	0.8	1.3	8.9	15.9	13.2	12.6	8.7	1.2	85.8
Total reactive load shedding (MVar)	3.8	0.8	2.4	2.6	2.2	0.3	0.3	0.1	0.2	6.4	12.3	10.1	9.5	6.2	0.2	57.4

The optimum curtailed load for a sample day is shown in the hatched area of Figure 4.20 and Figure 4.21.

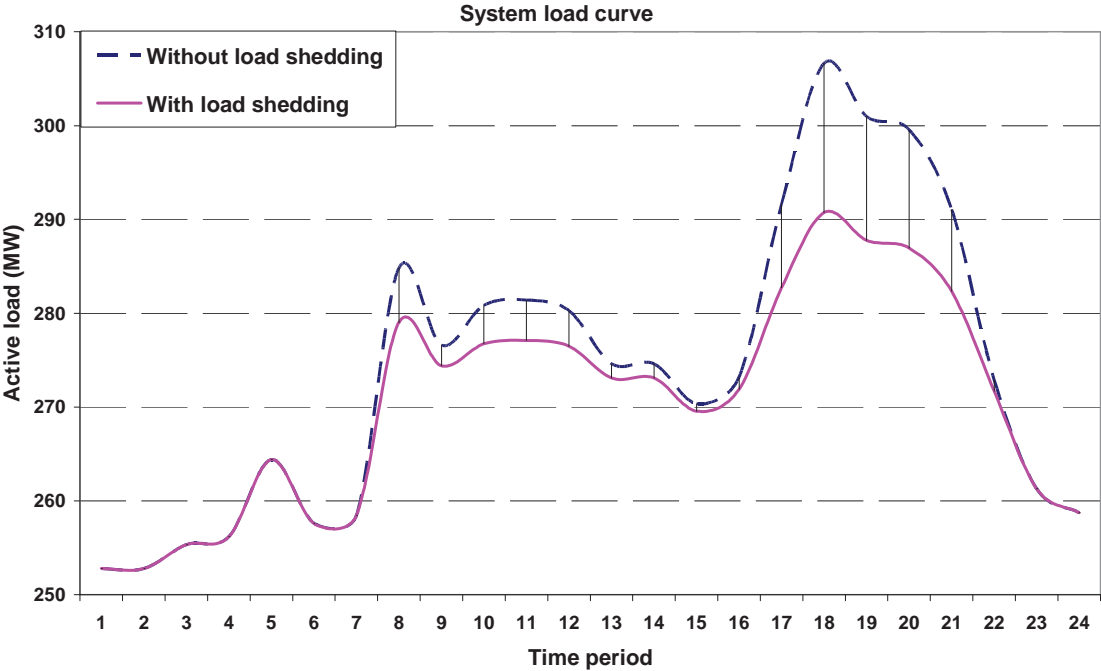

Figure 4.20: Total system active load before and after load shedding in attitude II.

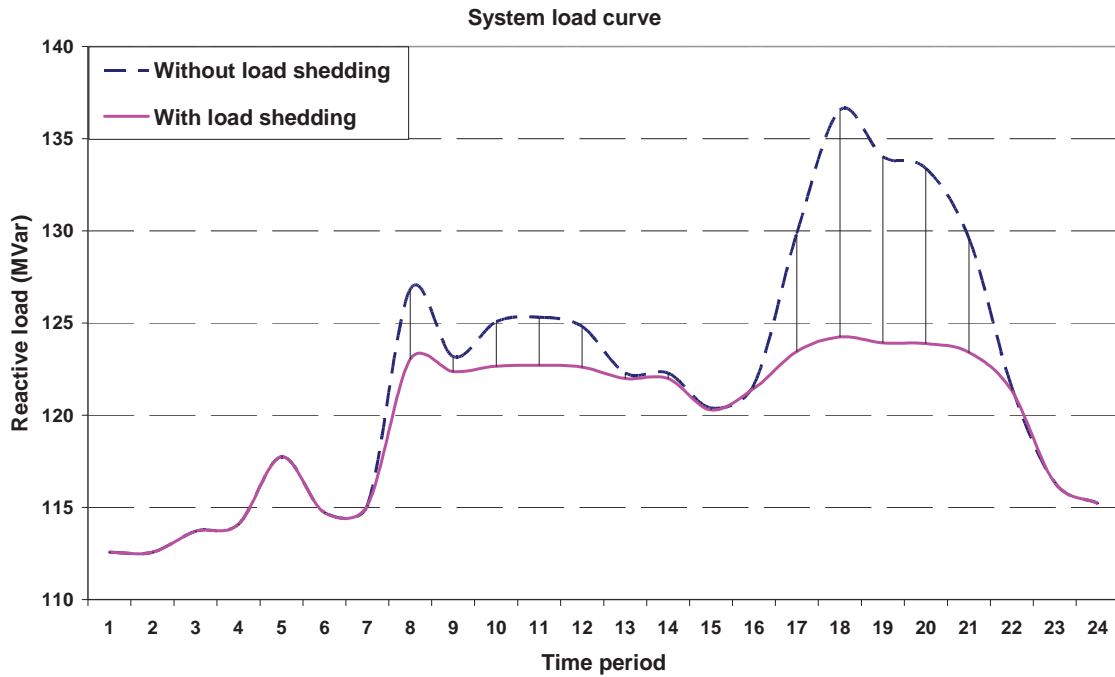

Figure 4.21: Total system reactive load before and after load shedding in attitude II.

4.7.3 Analysis and Results of Attitude III

Based on system weak point on its voltage profile which is mentioned on attitude I, one option is the usage of voltage regulator devices. Optimum capacity and location of SC are shown in Figure 4.22.

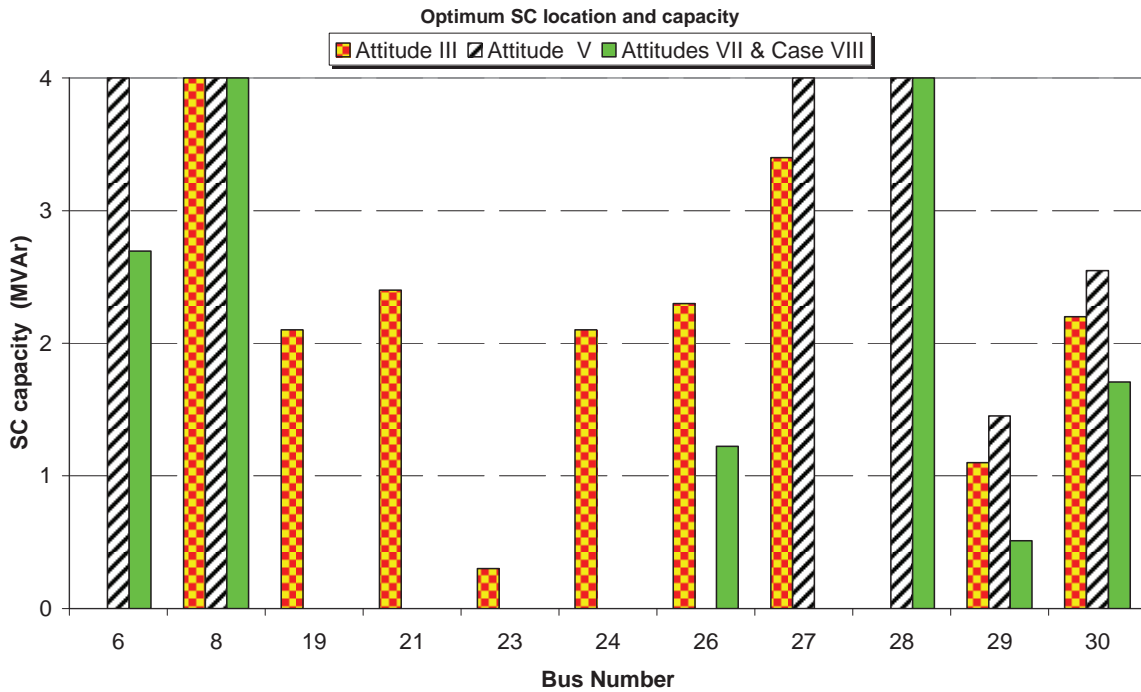

Figure 4.22: Optimum location and size of SC in attitudes III, V, VII&VII.

The results of simulations illustrate that in this attitude, voltage profile of buses 7 and 8 violate their lower bound to converge the load flow equations in sample day (Figure 4.23).

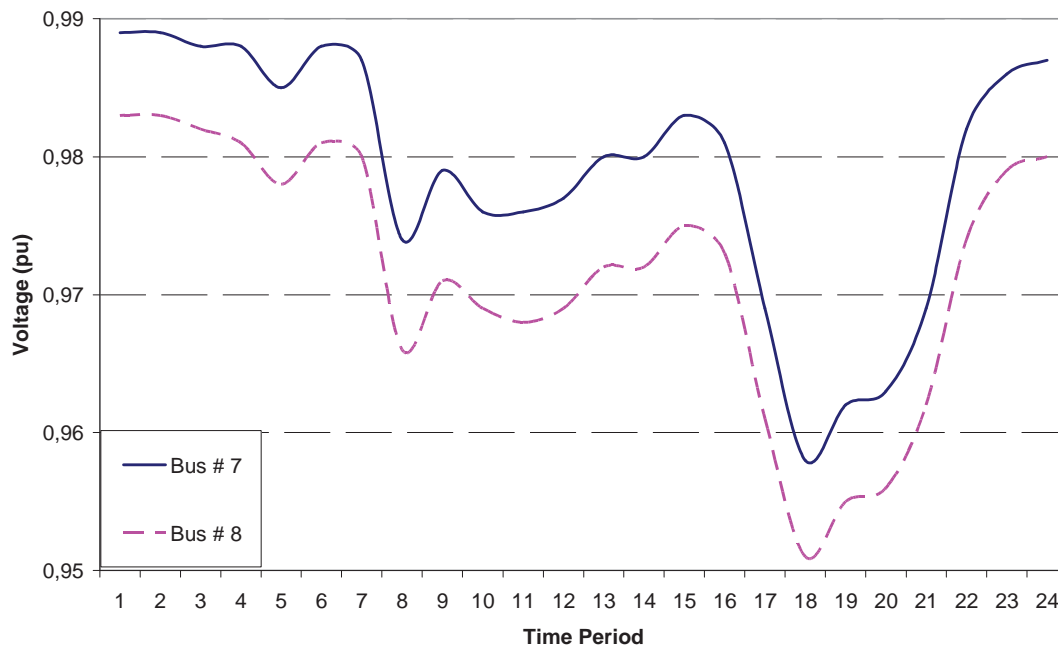

Figure 4.23: Voltage profile versus time period at sensitive buses in attitude III.

4.7.4 Analysis and Results of Attitude IV

In this attitude the effect of DG installation on system improvement is studied. The optimal size and site of DG installation will be shown in Figure 4.24.

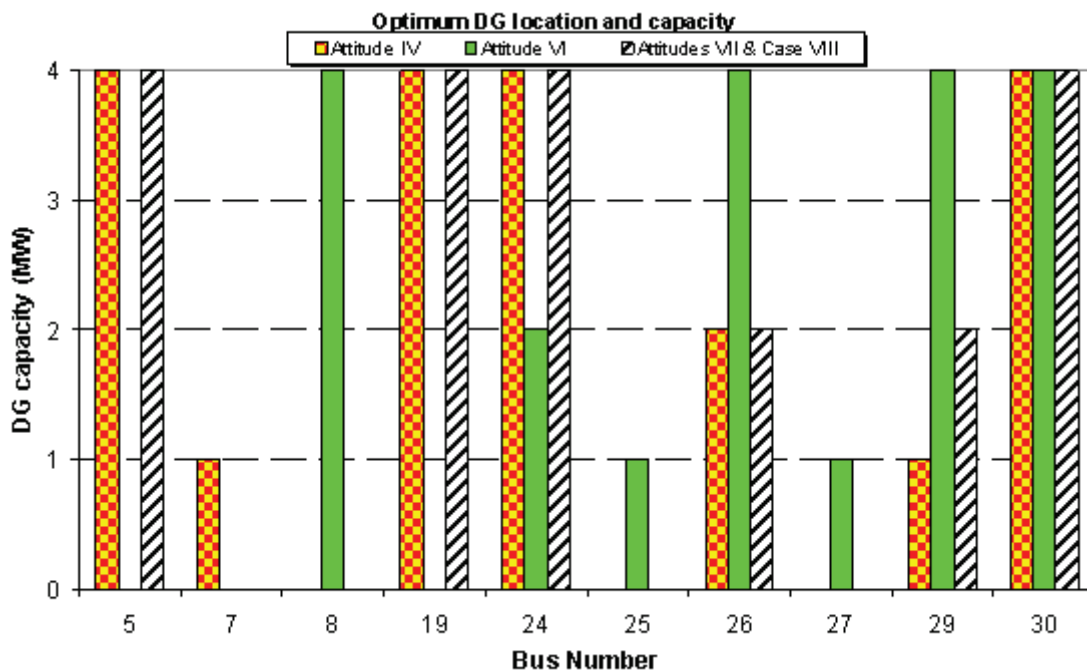

Figure 4.24: Optimum location and size of DG in attitudes II, VI, VII&VII.

In this attitude voltage profiles of six buses are violated in above mentioned sample day (see Figure 4.25).

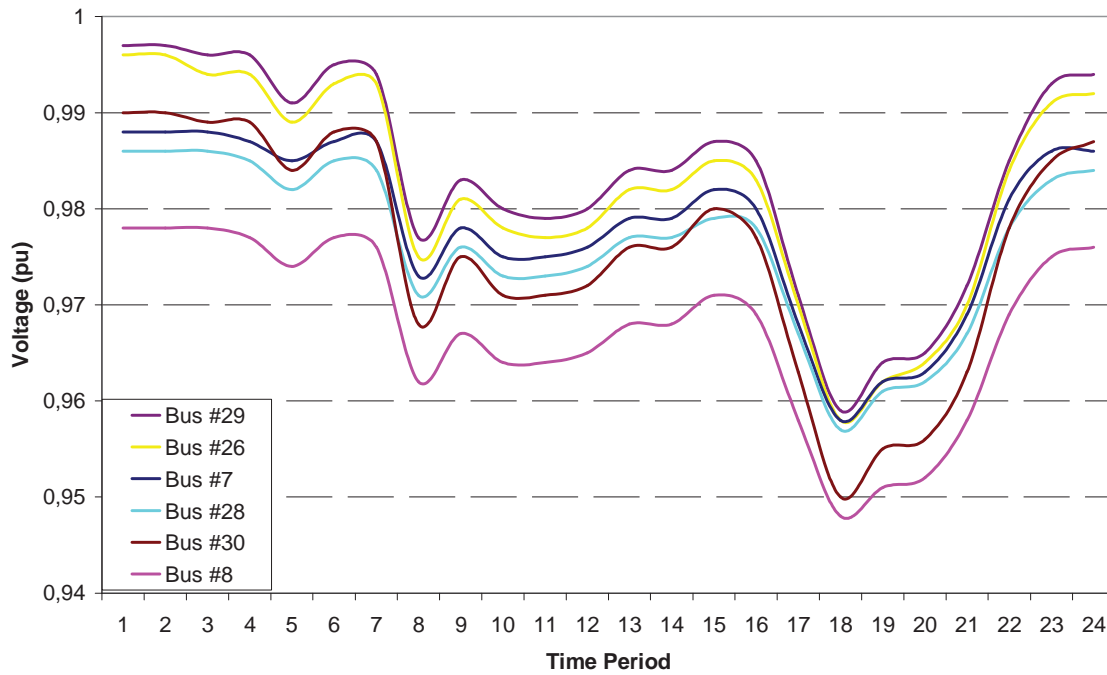

Figure 4.25: Voltage profile versus time period at sensitive buses in attitude IV.

4.7.5 Analysis and Results of Attitude V

To overcome the problem which is mentioned in attitude III in this attitude the combination of SC installation and load shedding is considered. Figure 4.26 and 4.27 show the optimum active and reactive load curtailment in each hour of sample day, respectively. Percentage and amount of total curtailed load is shown in Table 4.6. Optimum capacity and location of SC in this attitude are shown in Figure 4.22.

Table 4.6: Optimum curtailed load at each time period and bus in attitude V.

Bus #	Time Period			sum
	18	19	20	
Curtailed load at bus # 8 (%)	11.1	4.1	2.2	
Total active load shedding (MW)	3.6	1.3	0.7	5.6
Total reactive load shedding (MVar)	3.6	1.3	0.7	5.6

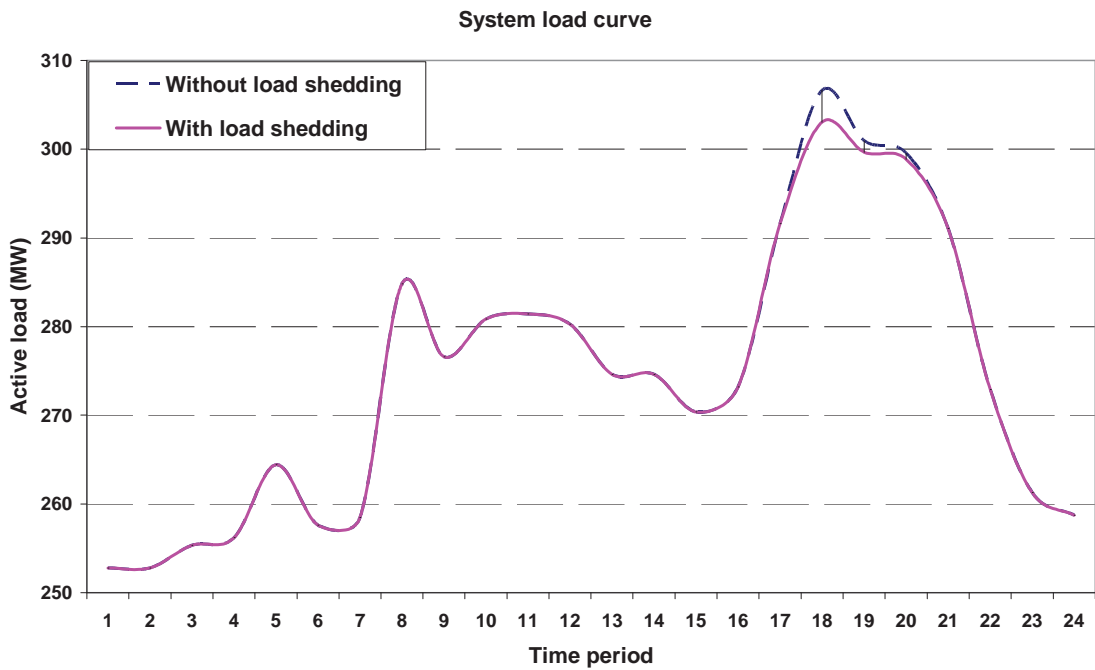

Figure 4.26: Total system active load before and after load shedding in attitude V.

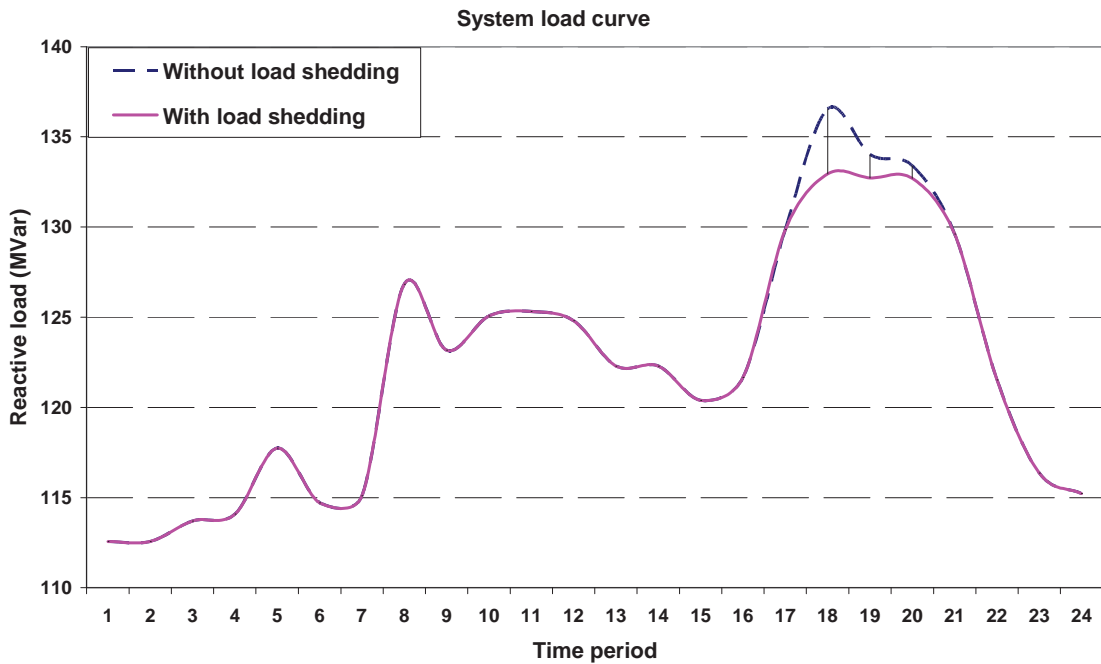

Figure 4.27: Total system reactive load before and after load shedding in attitude V

4.7.6 Analysis and Results of Attitude VI

In this attitude the best solution considering DG installation and load shedding is studied. Optimum size and site of is shown in Figure 4.24. Time, location and amount of curtailed load vs. hours of sample day are shown in Table 4.7, Figure 4.28 and Figure 4.29. Hatched

area illustrates ENS.

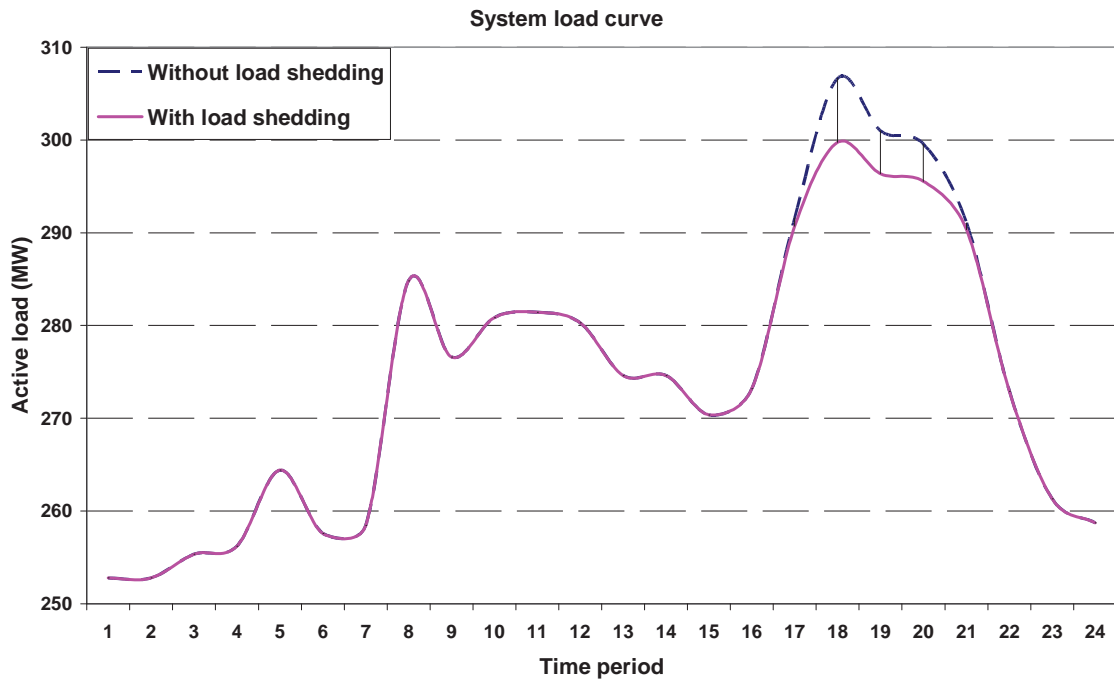

Figure 4.28: Total system active load before and after load shedding in attitude VI.

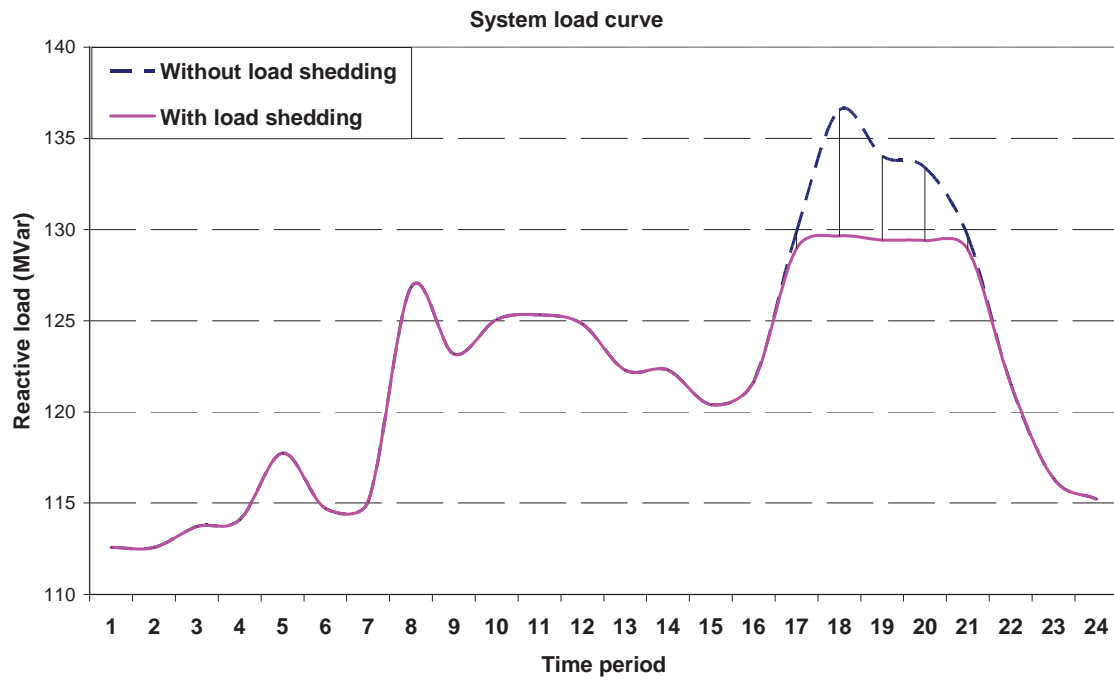

Figure 4.29: Total system reactive load before and after load shedding in attitude VI.

Table 4.7: Optimum curtailed load at each time period and bus in attitude VI.

Bus #	Time Period					sum
	17	18	19	20	21	
Curtailed load at bus # 8 (%)	2.9	21.2	14.4	12.6	2.3	
Total active load shedding (MW)	0.9	6.9	4.6	4	0.7	17.1
Total reactive load shedding (MVar)	0.9	6.9	4.6	4	0.7	17.1

4.7.7 Analysis and Results of Attitudes VII & VIII

The results of attitudes VII and VIII are similar. Because in attitude VIII by considering DG and SC installation, load shedding is not necessary. Optimum size and site of SC and DG in these attitudes are shown in Figure 4.22 and Figure 4.24, respectively.

The results illustrate that the size and capacity of DG or SC is depended to planning options. It is to be noted that in this section the size of DG, in contrast of SC, is considered an integer variable (MINLP).

Figure 4.30 compares total system losses versus time period from up to down in attitudes I, III, IV, VII and VIII, respectively. Attitudes II, V and VI are not considered in this comparison because the load shedding effects directly on total losses and cause the comparison unacceptable. It is shown that however, SC installation has negligible effect on total system losses reduction DG installation has significant effect on total system losses.

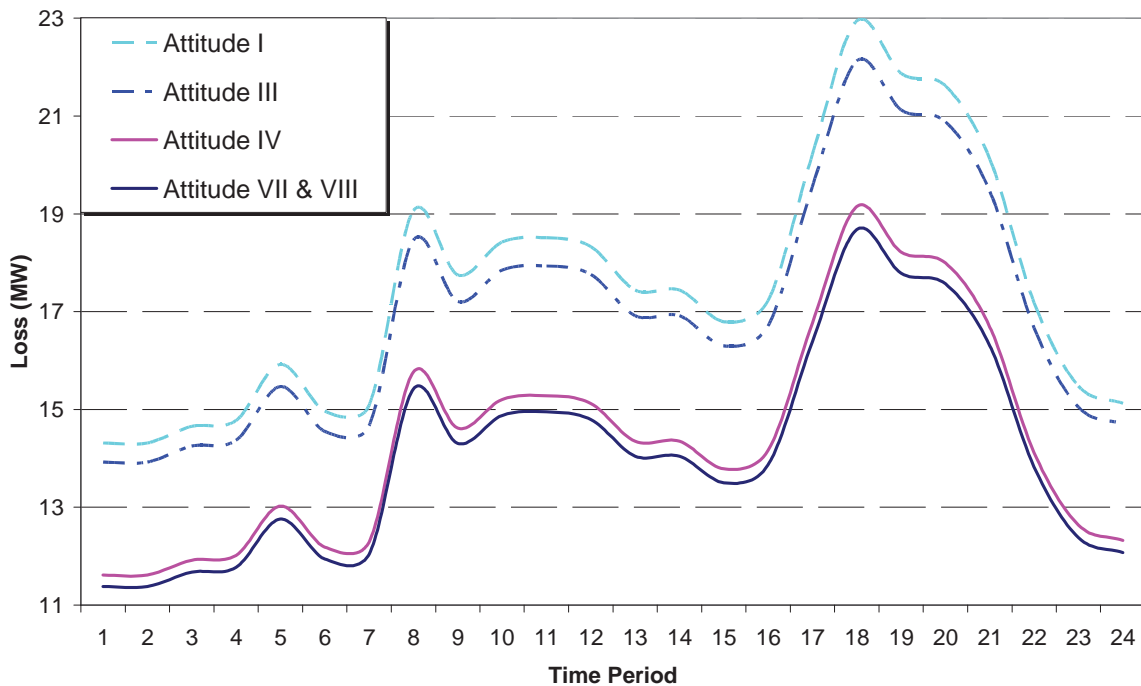

Figure 4.30: Total system losses versus time period in attitudes I, III, IV, VII&VIII.

Table 4.8 summarizes the best solution of each attitude. As it is clear in this table the optimum attitude between these attitudes is attitude IV or DG installation. As before mentioned the adduction of this attitude is the voltage violation in some buses at some time periods. If the protection devices permit these violations this attitude will be the best. Otherwise, the best solution will be attitude VII & VIII. In the other word by installing almost 14 MVar SC this problem will be eliminated.

Table 4.8: Optimum solution in each attitude.

	Attitude I	Attitude II	Attitude III	Attitude IV	Attitude V	Attitude VI	Attitude VII & VIII
Total system cost in 24-period time (M\$)	0.406	0.471	0.405	0.393	0.413	0.409	0.394
Total purchased power from TRANSCOs # 1,2 (MVAh)	6996.6	6893.5	6983.9	6442.4	6978.4	6427.6	6434.9
Total installed DG (MW)	-	-	-	20	-	20	20
Total installed condenser (MVA _r)	-	-	20	-	20	-	14.138
Total active load shedding (MW)	-	85.8	-	-	5.6	17.1	-
Total reactive load shedding (MVA _r)	-	57.4	-	-	5.6	17.1	-
Total loss in sample day (MWh)	419.5	402.475	406.712	345.21	406.85	347.515	337.765

4.8 Conclusion

This chapter is concerned with implementing DG as an appealing tool to solve the distribution system planning problem to meet the electric load growth in certain DISCO territories. Two models are proposed in this chapter. The proposed DG planning model (Section 4.6) investigates the cost-effectiveness of implementing DG in solving the distribution system planning problem. This framework obtains DG investment decisions which are mainly based on electricity market structures and prices. The outcomes of the simulation are the size and site of DG, the additional purchased power from TRANSCOs, and new market price. Three cases (depending on system conditions) and three scenarios (depending on different planning categories and electrical market structures) have been considered. The results of simulations illustrate DG economical and electrical benefits. It is shown that DG can solve the distribution system planning problem and improve power quality of distribution system. Depending on the studied cases and scenarios, the results are different. In any studied cases, the results show that DG installation increases the feeders' lifetime by reducing their loading and adds the benefit of using the existing distribution system for further load growth without the need for feeders upgrading. The framework can be also used to calculate the electricity market price. It is shown that by investing in DG, the DISCO can minimize its total planning cost and reduce its customers' bills.

In comparative market model (Section 4.7), it is assumed that the planner to system expansion has three planning alternatives: utilization of DG, installation voltage regulator devices such as SC and load shedding. This framework considers all of possible

combination of these planning alternatives which is depended to planner decision, system limitation and investment budget. Mathematical programming method has been used to obtain the optimum solution.

To solve power distribution system planning problems, especially presented frameworks in this thesis, a new software package by interfacing between two powerful softwares (MATLAB and GAMS) has been developed (Section 4.3).

Chapter 5

DG Planning and Pricing in an Electricity Market

This chapter presents a new methodology for optimal placement, size and investment payback time of different types of DG considering electricity market price fluctuation. In this method, the DG placement problem is formulated for the new two-stage methodology: total costs minimization to find optimal sizing and siting of the different DG types vs. investment payback times and Total System Benefit (TSB) maximization to find optimal payback time as well as optimal DG electricity price vs. DG life time. In order to provide some cases of variety of DGs available in the market, several DG types with different cost characteristics are assumed. For each DG type and each life time, an optimal placement, size and investment payback time is identified. The proposed two-stage model acts as good indicators to find optimal DG placement and DG electricity price, especially in a deregulated electricity market environment. Mathematical formulation is presented in Section 5.1. Section 5.2 illustrated simulation results and discussion. Section 5.3 concludes this chapter by emphasizing the viability of the DG implementation as a key element in the distribution system planning.

5.1 Mathematical Formulation

This section presents mathematical model formulation for distribution system planning problem. In this model the local DISCO is considered to be performing distribution system extension planning, with the aim of reducing their power losses and operating the distribution system efficiently and encouraging RESCOs to own and operate DGs. RESCOs aim to sell power to the customer and seek maximizing their profits. As before mentioned, when a DISCO invests directly in DGs, that value is a direct benefit to the distribution system in its territory and when it tries to encourage wire companies such as RESCOs to own and operate DGs, the value is to the both shareholder and DISCO. In the recent case, RESCOs maximize their profits and DISCO remains responsible for the technical aspects of the power quality and the technical state of the network.

In this framework, the problem of optimal placement and size is formulated in two stages; minimization the total costs to find optimal sizing and siting of the different types of DG vs. different investment payback time, and maximization the TSB function to find optimal investment payback time vs. different DG life time. In this methodology, cost function (in the first stage) is investment costs, which evaluated as annualized total cost, plus to total running cost as well as cost of ENS and losses and TSB function (in the second stage) is defined as the difference between total system costs before and after DG installation. Different system condition is assumed to indicate the effect of the system conditions on planning decision as well as the effect of DG placement on improvement of system conditions.

5.1.1 Cost function minimization

In the first stage, cost function can include costs of network upgrading consist of DG and/or SC installation (C_{DG} , C_{SC}), purchased energy (C_E), energy losses (C_{Loss}), and ENS (C_{ENS}). Therefore, the objective functions are expressed as follows:

$$\text{Min } C(X(U)) = \min [C_{DG}, C_{SC}, C_E, C_{Loss}, C_{ENS}] \quad (5-1)$$

where $X(U)$ is the power flow solution with case or condition U which represents the size and site of DG and/or SC. Due to competing objective functions, solutions are non-inferior to each other. In other words, improvements in one objective function can make other objective functions to perform worse.

Using aggregating approach, the consumer payment, evaluated as annualized total costs, is proposed as a method to identify optimal DG and SC placement and sizing. The mathematical formulation of the total system planning costs minimization is described in Eq. (5-2):

$$\text{Minimize} \quad \text{cost}(\$/h) = C_{In\ DG} + C_{O\&M\ DG} + C_{In\ SC} + C_{O\&M\ SC} + C_E + C_{loss} + C_{LS} \quad (5-2)$$

The constraints of this objective function are the same constraints which are discussed in Subsection 4.2.2 (Mathematical Planning Problem Constraints). It is to be noted that in this situation, the maximum DG installed capacity in DISCO territory is limited by available DG investors' bids which is presented by Eq. 4-24.

5.1.2 Total System Benefit (TSB) maximization

Payback time is the time that it takes for investment to pay for itself, considering the discount. The output of the first stage is the location and maximum DG capacity (installed capacity) according to its investment payback time. It is clear that the operating capacity is depended on operating condition and price of energy, especially in deregulated environment. So, DG electricity price, which is depended on investment payback time (see Eq. (5-11)), is a affective factor to determine active power generated by DG at bus i vs. time ($P_{DG\ i}(t)$) because of electricity market price fluctuation. Consequently, purchasing power from TRANSCOs, total system losses and energy not supplied will change by fluctuation of DG life time.

In this second stage, TSB function is defined as the difference between total system costs before and after DG installation. The goal of this stage is TSB maximization to find the optimal payback time as well as DG electricity price:

$$\text{Maximize} \quad TSB(\$) = C_{DG_Save} + A * \sum_{t=1}^{8760} (C_{E_Save}(t) + C_{loss_Save}(t) + C_{LS_Save}(t)) \quad (5-3)$$

where:

$$A = \frac{1 - (1 + d)^{-T}}{d} \quad (5-4)$$

$$C_{E_Save}(t) = C_{E_B}(t) - C_{E_A}(t) \quad (5-5)$$

$$C_{loss_Save}(t) = C_{loss_B}(t) - C_{loss_A}(t) \quad (5-6)$$

$$C_{LS_Save}(t) = C_{LS_B}(t) - C_{LS_A}(t) \quad (5-7)$$

$$C_{DG_Save}(t) = DG \text{ Revenue} - DG \text{ Expenses} \quad (5-8)$$

where:

$$DG \text{ Revenue} = A * \sum_{t=1}^{8760} \sum_{i=1}^B C_{E\ DG} * P_{DG\ i}(t) \quad (5-9)$$

$$DG \text{ Expenses} = \sum_{i=1}^B C_{Inv_{DG\ i}} * P_{DG\ i}^{\max} + A * \sum_{t=1}^{8760} \sum_{i=1}^B C_{O\&M\ DG} * P_{DG\ i}(t) \quad (5-10)$$

where :

$$C_{E\ DG} = \left(\frac{\sum_{i=1}^B C_{Inv_{DG\ i}} * P_{DG\ i}^{\max}}{A_{PB} * 8760} + \sum_{i=1}^B C_{O\&M_{DG\ i}} * P_{DG\ i}^{\max} \right) / \sum_{i=1}^B P_{DG\ i}^{\max} \quad (5-11)$$

To determine the optimal payback time; it is very important to know optimal DG life time (T). DG life time mainly depends on the type of DG technology, its manufacturer and its operation condition.

In this stage, location of DG and SC, maximum size of DG and SC, and system data before DG installation, which are calculated in previous stage, are considered as input data. So in this stage, Eq. (5-3) is the objective function and Eq. (4-11)-Eq. (4-22) and Eq. (4-24) are their constraints.

5.2 Simulation results and discussion

As mentioned in previous chapter and will be discussed in Appendix A, there are wide varieties of DG technologies with varying operating characteristics in the market. Choice of DG technology today depends on what the likely technical and environmental requirements of the future. CHP application, fuel cost, distance to fuel centres, environmental regulations and emissions, especially in non-attainment areas, can affect economics and choice of DG technology. Another important element is the timing of projects. In this section, five types of DG are studied to compare the varieties of DG and

determine the best strategy for decision makers. However, the choice of each technology is limited to environment and system constraints, this comparison can be very useful. Each technology has different cost. The investment, operation and maintenance cost of these five DG technologies are summarized in Table 5.1 [10], [195], [196]. The candidate individual and total DG capacity for installation at each bus is assumed 1MW and 4MW, respectively. The maximum total candidate DG capacities are assumed to be equal to 20 MW which represents about 9% of the total load in the primary distribution area.

Table 5.1: Different DG technology cost.

	Investment cost (M\$/MVA)	O&M cost (\$/MWh)	Fuel cost (\$/MWh)
Microturbine	1	5	55
Gas turbine	0.5	5	42
Fuel cell	3	5	34
Photovoltaic	4	3	0
Wind turbine	1	8	0

In this section, Figure 4.5 is considered as electricity base market price. The discount rate is taken as 10%. The penalty of energy not supply is assumed to be 500 \$/MW [200]. The proposed two-stage model has been implemented on different system conditions (three case studies) which are discussed in Section 4.5.1.

5.3.1 Case 1

I. Cost minimization (first stage)

The results of simulation of case 1 are summarized in Table 5.2. In this table the effect of DG investment payback time on optimal DG placement and size as well as effect of DG placement on total system loss is indicated. The necessary upgrading investment of this system is also determined. As it is shown in this table in some payback times, the installation of DG is not economic. For instance, in this case the installation of fuel cell in each payback time less or equal to ten is not economic. Although its investment and O&M costs are lower than DG costs, the results of simulation don't propose SC installation in any states of this case study.

Table 5.2: Optimal solution for different DG technology in Case 1.

No.		T_{PB} (yr)	Purchased active power from TRANSCOs (MW)	Purchased reactive power from TRANSCOs (MVar)	Purchased reactive power from condensers (MVar)	DG Capacity (MW) & Location	Loss (MW)	Investment (M\$)
1	Without DG installation	-	301.4	83	101.3	-	18.031	-
2	Gas turbine (CGT)	$2 \leq T_{PB} \leq 10$	278.3	63.6	92.9	4 @ Bus# 5, 19, 30 3 @ Bus# 24 2 @ Bus# 7, 26 1 @ Bus# 29	14.936	10
3	Wind turbine	$2 \leq T_{PB} \leq 10$			Similar to row 2			20
4	Fuel cell	$2 \leq T_{PB} \leq 10$			Similar to row 1			-
		≥ 7			Similar to row 2			20
5	Microturbine	6	292.1	64.5	97.5	4 @ Bus# 30 3 @ Bus# 5 1 @ Bus# 26	16.675	8
		≤ 5			Similar to row 1			-
		9, 10			Similar to row 2			80
6	Photovoltaic	8	300.2	63.3	100.8	1 @ Bus# 30	17.838	4
		≤ 7			Similar to row 1			-

II. TSB maximization (second stage)

In this chapter, individual investment payback times for different DG life times (from 10 to 20 years) are determined. TSB curves e.g., for different wind turbine life times are shown in Figure 5.1. Table 5.3 indicates optimal investment payback time and TSB in terms of different life times for wind turbine, gas turbine, Microturbine, and photovoltaic only for life time equal to 20 years.

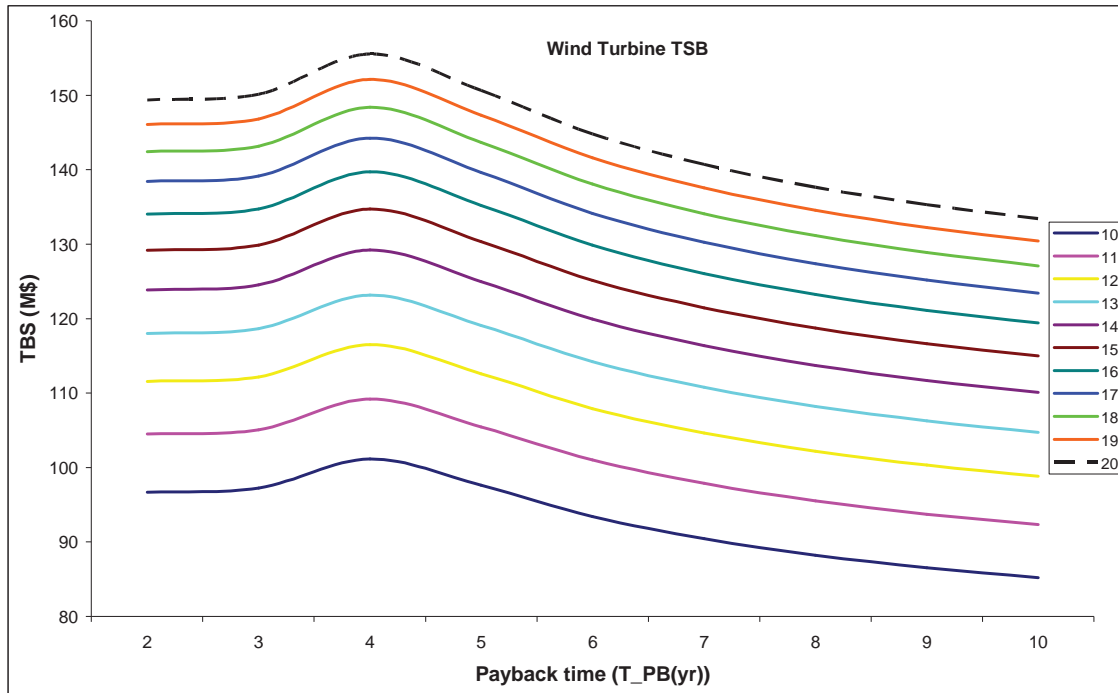

Figure 5.1: TSB according to different payback time (T_{PB}) and different wind turbine life time (T).

Table 5.3: Optimal payback time and its related total TSB for different DG technology in case 1.

T (yr)	Wind turbine		Gas turbine		Microturbine		Photovoltaic	
	T _{PB} (yr)	TSB (M\$)	T _{PB} (yr)	TSB (M\$)	T _{PB} (yr)	TSB (M\$)	T _{PB} (yr)	TSB (M\$)
10	4	101	4	97.7	10	60	10	41
11	4	109	4	104	10	64.6	10	47.9
12	4	117	4	109	10	68.7	10	54.2
13	4	123	4	115	10	72.5	10	59.9
14	4	129	4	119	10	75.9	10	65.1
15	4	135	4	123	10	79	10	69.8
16	4	140	4	127	10	81.8	10	74.1
17	4	144	4	131	10	84.4	10	78
18	4	148	4	134	10	86.8	10	81.5
19	4	152	4	137	10	88.9	10	84.7
20	4	156	4	139	10	90.8	10	87.6

5.3.2 Case 2

I. Cost minimization (first stage)

In this case, without DG or SC installation to avoid voltage collapse in the system it is necessary to curtail some loads. The optimum solution in this condition is to interrupt 9.7% and 21.7% of load in buses No. 8 and 30, respectively. Table 5.4 shows the optimal DG and SC placement and size for different types of DG technology and their different investment payback time. In this case, there are two solutions by considering planning options:

- Solution A: in this solution, it is assumed that the DG is the only planner option. In the other word it is assumed that the decision maker plans to utilize DG to improvement system condition and minimize cost function.
- Solution B: in this solution DG is considered as a planning option comparing SC.

The results of this decision are shown in Table 5.4. It is to be noted that solution B changes results of simulation for fuel cell, Microturbine (for $T_{PB} \leq 5$) and Photovoltaic (for $T_{PB} \leq 8$) and in the other conditions the results of solution B and A are similar.

II. TSB maximization (second stage)

Table 5.5 shows the optimal investment payback time and TSB for different types of DG. As it is shown in this table, in this case, optimal DG investment payback times are smaller or equal their optimal value resulted in the pervious case. This also means that DG can purchase its electricity much more expensive in the market. So, DG has more revenues in the weak systems. The results of simulation also indicate that solution A has more TSB

than solution B (e.g., see column Fuel cell in Table 5.5).

Table 5.4: Optimal solution for different DG technology in Case 2.

No.		T_{PB} (yr)	Purchased active power from TRANSCOs (MW)	Purchased reactive power from TRANSCOs (MVar)	Purchased reactive power from condensers (MVar)	DG Capacity (MW) & Location	SC size (MVar) & location	Loss (MW)	Investment (M\$)	
1	Without DG* installation	-	296.0	62.2	74.3	-	-	17.830	-	
2	Gas turbine	$2 \leq T_{PB} \leq 10$	279	58.5	71.3	4 @ Bus#5,19,24,30 2 @ Bus# 26 1 @ Bus# 7, 29	-	15.564	10	
3	Wind turbine	$2 \leq T_{PB} \leq 10$	Similar to row 2							20
4	Fuel cell	$2 \leq T_{PB} \leq 10$	A 288.3	61.6	73.7	4 @ Bus# 29, 30 3 @ Bus# 26 1 @ Bus# 24	-	16.851	36	
			B 302	62	74.2	-	5 @ Bus# 8, 1.5 @ Bus#30	18.598	0.065	
		≥ 7	Similar to row 2							20
		6	285.8	60.7	73.2	4 @ Bus# 5, 30 2 @ Bus# 19, 26 1 @ Bus# 24, 29	-	16.446	14	
5	Microturbine	5	A	Similar to row 4 solution A						12
			B 298.5	61.9	74.2	3 @ Bus# 30	3.5 @ Bus#8 1 @ Bus#30	18.078	3.045	
		≤ 4	A	Similar to row 4 solution A						12
			B	Similar to row 4 solution B						0.065
		9, 10	Similar to row 2							80
6	Photovoltaic	8	A	Similar to row 4 solution A						48
			B 296.2	62	74.3	4 @ Bus# 30 1 @ Bus# 26	3.2 @ Bus# 8	17.782	20.03	
		≤ 7	A	Similar to row 4 solution A						48
			B	Similar to row 4 solution B						0.065

* With shedding (2.9+j2.9) MVA (9.7% load) and (2.3+j4) MVA (21.7% load) at bus No. 8 and 30, respectively.
A or B indicates solution without and with considering SC, respectively.

Table 5.5: Optimal payback time and its related total TSB for different DG technology in Case 2

T (yr)	Wind turbine		Gas turbine		Microturbine		Photovoltaic		Fuel cell	
	T_{PB} (yr)	TSB (MS)	T_{PB} (yr)	TSB (MS)	T_{PB} (yr)	TSB (MS)	T_{PB} (yr)	TSB (MS)	TSB (MS) $T_{PB} = 10$	
									B	A
10	2	235	3	224	8	203	10	194	114	164
11	2	250	3	237	8	216	10	210	121	176
12	2	265	3	249	8	227	10	224	127	187
13	2	277	3	260	8	238	10	237	132	197
14	2	289	3	270	8	247	10	249	137	206
15	2	300	3	279	8	256	10	259	141	214
16	2	310	3	287	8	264	10	269	145	221
17	2	319	3	295	8	271	10	278	149	228
18	2	327	3	302	8	278	10	286	152	234
19	2	334	3	308	8	284	10	293	155	240
20	2	340	3	314	8	289	10	300	158	245

5.3.3 Case 3

I. Cost minimization (first stage)

Similar to case 2, in this case it is necessary to interrupt some loads to avoid voltage collapse and line congestion. The optimal solution in this situation is to shed 100%, 95% and 21% of load in buses no. 14, 15 and 30, respectively. As discussed before, the target of this case is to determine optimal placement and size of DG and SC with consideration of improvement of power quality and feeder congestion as well as obtain of the minimum costs. The results of the simulation without and with SC consideration (solution A and B discussed in case 2) are shown in Table 5.6. It is to be noted that in this table, except fuel cell, Microturbine (for $T_{PB} \leq 4$) and Photovoltaic (for $T_{PB} \leq 7$), the results of solution B are similar to results of solution A.

Table 5.6: Optimal solution for different DG technology in Case 3.

No.		T_{PB} (yr)	Purchased active power from TRANSCOs (MW)	Purchased reactive power from TRANSCOs (MVar)	Purchased reactive power from condensers (MVar)	DG Capacity (MW) & Location	SC size (MVar) & location	Loss (MW)	Investment (M\$)	
1	Without DG * installation	-	283.6	61.3	66.9	-	-	16.488	-	
2	Gas turbine	$2 \leq T_{PB} \leq 10$	279.2	59.1	70.6	4 @ Bus# 15, 30 3 @ Bus# 18,19,23 2 @ Bus# 14 1 @ Bus# 26	-	15.779	10	
3	Wind turbine	$2 \leq T_{PB} \leq 10$	Similar to row 2			-	-	-	20	
4	Fuel cell	4-1	Solution A $2 \leq T_{PB} \leq 10$	282.8	60.6	71.7	4 @ Bus# 12,14,15 3 @ Bus# 30 1 @ Bus# 18, 23	-	16.405	51
		4-2	9, 10 B	286.3	60.9	70.7	4 @ Bus#12,14,15 2 @ Bus# 13	1.5 @ Bus# 26,30	16.935	42
		4-3	8 B	288.6	61.8	64.3	4 @ Bus#12,13,14	4 @ Bus# 27 2.5 @ Bus# 30 2 @ Bus# 26 1 @ Bus# 29	17.182	36
5	Microturbine	≥ 6	Similar to row 2			-	-	-	20	
		5	-	280.4	59.7	70.9	4 @ Bus# 14,15,18 3 @ Bus# 23, 30 1 @ Bus# 19	-	15.993	19
		4	A	281.7	60.3	71.4	4 @ Bus# 12, 14 4 @ Bus# 15, 30 2 @ Bus# 13	-	16.305	18
			B	Similar to row 4-2			-	-	-	14
			≤ 3	Similar to row 4-1			-	-	-	17
6	Photovoltaic	$8 \leq T_{PB} \leq 10$	Similar to row 2			-	-	-	80	
		7	B	Similar to row 4-2			-	-	-	56
			A	Similar to Microturbine ($T_{PB}=4$) solution A			-	-	-	72
	≤ 6	Similar to row 4-1			-	-	-	68		

* With shedding (2.2+j0.4), (7.8+j2.4) and (6.2+j1.6) or 21%, 95% and 100% load at buses No. 30, 15 and 14, respectively. A or B indicates solution without and with considering SC, respectively.

II. TSB maximization (second stage)

Table 5.7 shows the optimal investment payback time for different types of DGs in the case of implementing DG and SC together. In this situation, even the fuel cell appears as a better economic option compared to load shedding.

As a result, DG technologies can provide a stand-alone power option for areas where transmission and distribution infrastructure does not exist or is too expensive to build.

It is also shown, in the weaker systems DG has smaller optimal investment payback time. In the other words, DG can obtain more incomes in weaker systems. Also such as previous case, solution A has more TSB than solution B (e.g., see column Fuel cell in Table 5.7).

Table 5.7: Optimal payback time and its related total TSB for different DG technology in Case 3.

T (yr)	Wind turbine		Gas turbine		Microturbine		Photovoltaic		Fuel cell	
	T _{PB} (yr)	TSB (M\$)	T _{PB} (yr)	TSB (M\$)	T _{PB} (yr)	TSB (M\$)	T _{PB} (yr)	TSB (M\$)	TSB (M\$) T _{PB} =10	
									B	A
10	2	438	2	481	6	462	8	463	411	424
11	2	465	2	509	6	490	8	494	437	452
12	2	490	2	534	6	515	8	522	461	478
13	2	513	2	557	6	538	8	548	483	501
14	2	533	2	578	6	558	8	571	503	522
15	2	552	2	597	6	577	8	592	521	541
16	2	569	2	615	6	594	8	612	538	558
17	2	584	2	630	6	610	8	629	553	574
18	2	598	2	645	6	624	8	645	567	589
19	2	611	2	658	6	637	8	660	579	602
20	2	622	2	670	6	648	8	673	590	614

5.3 Conclusion

Cost is one of the most essential factors that influence many decisions taken in the distribution system planning. In general, cost can be defined as anything that should be sacrificed in order to gain some desired results. In this chapter, a two-stage methodology is presented to find optimal placement, size and investment payback time of DG as an attractive option in competition of voltage regulator devices such as SC. In first stage, the object is minimization the total costs function to find the optimal sizing and siting of DG and SC vs. DG investment payback times. In the second stage, the goal consists of the maximization of the TSB function to find the optimal DG investment payback time as well as the optimum DG electricity price. In the other word, the first stage determines optimal

installed capacity for different DG type and investment payback time, and the second stage results optimal operation capacity according to DG life time.

With so much to consider, it is often difficult for the planners to determine which technology is the best suited to meet their specific energy needs. The various DG technologies offer the opportunity of selecting the right energy solution at the right location. However this chapter doesn't aim to compare different technologies (because application of each DG technology is depended to environment conditions or available fuel), five types of DG are tested to give system deciders some choices.

This chapter discusses the effects of DG implementation under different distribution system conditions and stats not only to decrease system costs and losses but also to improve power quality, system voltage and line congestion. Different system conditions are simulated to illustrate gross effect of DG on distribution system as well as ability of the proposed methodology. In this chapter it is shown that, although DGs may never supply the total distribution loads, these can be a powerful option especially when the system voltage profile is unsuitable or congestion in distribution and/or transmission network lines prevents economic or least expensive supply of demand. However, penetration of DG at a particular location is influenced by technical factors as well as economic factors.

Chapter 6

Conclusions

The aim of the distribution system planning is to assure that the growing load demand can be fulfilled technically and economically by optimal distribution system expansion. Power system planning is a crucial process in the electric power system that is studied thoroughly throughout this thesis. The main objective of this thesis is to create a new distribution system planning framework that can overcome the deficiencies associated with the traditional distribution system planning approaches, and can handle the existing challenges changes, and available circumstances coming into sight under the deregulated electricity environment.

Electric power deregulation has drastically affected the engineering aspects of planning. In addition need flexible electric systems, changing regulatory and economic scenarios, energy savings and environmental impact are providing impetus to the development of DG, which is predicted to play an increasing role in the electric power system of the future. This

opens the venue for DISCOs aims to minimize their investment risks by developing optimum new planning strategies to meet the load growth and satisfy the system performance at minimum cost different electricity structures.

Due to unbundling of the electric power system activities, fundamental changes occurred in electricity economics and planning. The traditional distribution system planning approaches emphasized long-term demand growth optimization under stable electric system economies and regulated electricity prices. These approaches and factors are not valid anymore. Therefore, the research taking place in this thesis emphasized approaches that are based on long-term demand growth, long-term planning horizons, budget, resource limitation, cost-benefit analysis, and electricity market price variations.

Under electric industry privatization several new planning options have come to view as opportunities for distribution planners. Therefore, the research carried out in this thesis took the opportunity of implementing DG as an attractive option for solving the distribution system planning problem locally. DG is introduced to participate in electricity market with competition of voltage regulator devices, to solve the lacking electric power supply problem and meet the load growth requirements with a reasonable price as well as improve power quality.

Cost is one of the most essential factors that influence many decisions taken in the distribution system planning. In general, cost can be defined as anything that must be sacrificed to gain some desired results. Also, much greater emphasis has been given to operational and economical benefits that can be obtained from introducing the concept of localized active power generation (injection) in the distribution system to solve the distribution system planning problem locally. This research makes full use of DG, as a likely to arise planning option under electricity liberalization, combined with the traditional distribution planning options and philosophies. The optimal planning of power delivery system expansion can be carried out by using one of the following frameworks, each with its developed mathematical model:

The first framework:

This framework is concerned with implementing DG as an appealing tool to solve the distribution system planning problem to meet the electric load growth in certain DISCO territories. The new proposed distribution system planning model investigates the cost-effectiveness of implementing DG in solving the distribution system planning problem.

This framework obtains DG investment decisions which are mainly based on electricity market structures and prices. The proposed mathematical optimization model employs binary decision variables that provide the optimal solution without rounding. The proposed model is valid as both a single- and multi-period model.

The proposed optimization model minimize total system planning containing costs of DG investment, DG operation and maintenance, purchase of power from the existing TRANSCOs and system power losses. In other words, total system costs must be minimized with simultaneously guarantying system voltage profiles and preventing feeder congestion. The outcomes of the simulation are the size and site of DG, the additional purchased power from TRANSCOs, and new market price. Three cases (depending on system conditions) and three scenarios (depending on different planning alternatives and electrical market structures) have been considered.

This framework can be also used to calculate the electricity market price. It is shown that by investing in DG, the DISCO can minimize its total planning cost and reduce its customers' bills. The resulting framework was implemented successfully to estimate the optimal DG capacity investment (sizing and siting) to serve peak demands optimally, integrated with purchasing power from TRANSCOs. The optimal DG sizing and siting was obtained at the horizon planning year by implementing the proposed model as a single- and multi-period models.

The second framework:

In this framework DG is introduced to participate in electricity market as an attractive planning option with competition of voltage regulator devices and Interruptible load to solve the electric power supply problem and meet the load growth requirement with a reasonable price as well as improve power quality. According to planner policy to choice between three above mentioned planning alternatives there are eight possible cases. In this framework, some effects of DG on the distribution system such as voltage profile improvement and losses reduction and effect of planning condition on the optimal DG sitting and sizing are discussed. It is also shown that DG will play an increasing role in the electrical power system of the future, not only for the cost savings but also for the additional power quality.

To study fluctuation of load and electricity market price versus time period (uncertainty on fuel price and load) electricity market price and system load is considered to be

variable. The shape of the daily, seasonal, and annual load curves is important characteristic for operation and expansion of generation systems to meet the system load. Utilities record the chronological hourly loads on a continuous basis. In this framework, total load and electricity market price are considered to be variable due to time.

The best solution considering the planner policy and its facilities including kind, capacity and location of usage of these alternatives are obtained. It was shown that, although DGs may never supply the total distribution loads, these can be a powerful option. However, penetration of DG at a particular location is influenced by technical as well as economic factors.

The third framework:

In this framework, the goals are to obtain optimal placement, size and investment payback time of DG in order to minimize total cost and maximize TSB. This framework proposes a new two-stage methodology for distribution system planning. In this study it is assumed that the planner has three possible options; SC and DG installation or load shedding. Optimal placement and size of DG and/or SC vs. DG investment payback times are identified as total cost minimization problem (first stage). For each DG cost characteristics and for each investment payback time, there is an optimal location and size. Then, the optimal payback time as well as the optimum DG electricity price is obtained by TSB maximization problem (second stage). In the other word, the first stage determines optimal installed capacity for different DG type and investment payback time, and the second stage results optimal operation capacity according to DG life time.

The various DG technologies offer the opportunity of selecting the right energy solution at the right location. In this framework, five types of DG were tested to give system deciders some choices. Different system conditions were simulated to illustrate significant effect of DG on distribution system as well as the ability of the proposed methodology.

This framework creates an electric market price forecasting model to predict the electricity market price. TSB is incorporated with the proposed optimization model (first or second framework) to provide a modified integrated electric-market investment model.

To solve these three proposed methodologies a new software package interfacing between two powerful softwares (MATLAB and GAMS) has been developed. This new software package is a powerful tool able to set up large scale power system, to solve

complex planning problems and finally to visualize results by means of a user-friendly GUI. This GUI allows the user selecting the optimization model, setting model parameters, entering network data and displaying GAMS results. Therefore, using this package does not require the user to know anything about MATLAB and/or GAMS programming language. The other advantage of this package is solving complex problems such as large systems very fast.

The modified IEEE 30-Bus system has been chosen as study case. In order to illustrate the effect of network conditions on distribution system planning, three cases are considered by changing network constraints.

The results of simulations illustrate DG economical and electrical benefits. It is shown that DG can solve the distribution system planning problem and improve power quality of distribution system. Depending on the studied cases and scenarios, the results are different. In any studied cases, the results show that DG installation increases the feeders' lifetime by reducing their loading and adds the benefit of using the existing distribution system for further load growth without the need for feeders upgrading.

The obtained results from this system under study reported the positive impact of introducing DG as a planning option as it minimizes the total local distribution company's planning cost, improves the system voltage profile, reduces the power flow in the primary distribution, feeders, minimizes the system losses (i.e. the total payment spent for compensating the losses), and increases the feeders' lifetime by reducing their loading. Implementing DG as a planning option provides the optimal least-cost investment scenario without installing or upgrading feeders.

However, including other planning aspects make the DG planning option more cost effective. These DG units have limited dimensions that can fit in relatively small areas. It is also to be noted that because of the small unit size chosen, for the DG capacities, these can be expected to have fast response times to load changes with fast ramp rates. Therefore, the issue of unit commitment constraints (ramp up or ramp down, minimum up and down times, etc.) can be ignored for simplification of the model.

6.1 Future Work Recommendations

The proposed research can be expanded to include some possible expected future research areas. Recommended areas for future research are:

1. Extending the proposed objective function to include each distribution planning facility's reliability.
2. Introducing the reliability of distribution planning facilities as a new objective function formulation instead of using the proposed cost minimization objective function.
3. Investigating different DG technologies' feasibility for the implementation in the proposed cost function, taking into consideration DG by-products such as CHP.
4. Supplementing the proposed optimization model by formulating an estimation procedure for the contribution power levels of customer-owned DGs.
5. The model treated here is very fundamental and there is a large potential for its improvement or extension. First and foremost, the set of attributes can be extended by for example power quality or environmental impact criteria.

Appendix A

Distributed Generation

A.1 Introduction

Distributed generation (DG) or embedded generation (the European term) refers to generation applied at the distribution level. [201] defines DG as the “utilization of small (0 to 5 MW), modular power generation technologies dispersed throughout a utility’s distribution system in order to reduce T&D loading or load growth and thereby defer the upgrade of T&D facilities, reduce system losses, improve power quality, and reliability.”

A distributed electricity system is one in which small and micro generators are connected directly to factories, offices, households and lower voltage distribution networks. Electricity not demanded by the directly connected customers is fed into the active distribution network to meet demand elsewhere. Electricity storage systems may be utilized to store any excess generation. Large power stations and large-scale renewable, e.g. offshore wind turbine remain connected to the high voltage transmission network providing national back up and ensure quality of supply. Again, storage may be utilized to accommodate the variable output of some forms of generation.

Distribution systems were never designed to include generation; they were designed for one-way power flow, from the utility substation to the end users. Generators violate this basic assumption, and generators can disrupt distribution operations if they are not

carefully applied. One of the most critical situations is that a distribution interrupter may isolate a section of circuit, and the generator might continue supplying the load on that section in an island. Islanding poses safety hazards, and islanded generators can cause overvoltage on the circuit. In addition to islanding, generators can disturb protection, upset voltage regulation, and cause other power quality problems.

In addition to the technical difficulties, distributed generation raises several other issues. How do we meter a generator? What is a fair price to pay a generator injecting power into the system? How can DGs be dispatched or controlled, especially if they are owned by end users? How can we apply the generators to optimal locations on the system, rather than just accepting it wherever end users install it?

Significant technological advances through decades of intensive research have yielded major improvements in the economic, operational, and environmental performance of small, modular gas-fuelled power generation options. Forecasts predict a total 520GW from newly installed DG around the globe by 2030 [202].

A.2 DG Technologies and Status

According to some authors, in the future a substantial share of electricity will be produced by technologies associated with DG [202]. These technologies encompass a wide range of subcategories characterized by fuel type, generation capacity, environmental impact, and operation flexibility.

The technical and commercial status of DG globally depends very much on the past history of a country's power industry. Countries, whether developed or developing, with power sectors that are largely state controlled either remain tied to a centrally controlled transmission system that is connected to large-scale fossil fuel, hydro or nuclear power stations, or are developing such systems. Countries where liberalization has taken place, on the other hand, have the incentive to consider alternatives. It is in these countries that DG has started to gain a foothold because of its lower capital cost, modular construction and short build times.

There are various types of DG technologies listed in Figure A.1. Each DG technology is suitable for certain situations. The different traditional and non-traditional kinds of DG are now finding a niche in power generation. These DG technologies are discussed below:

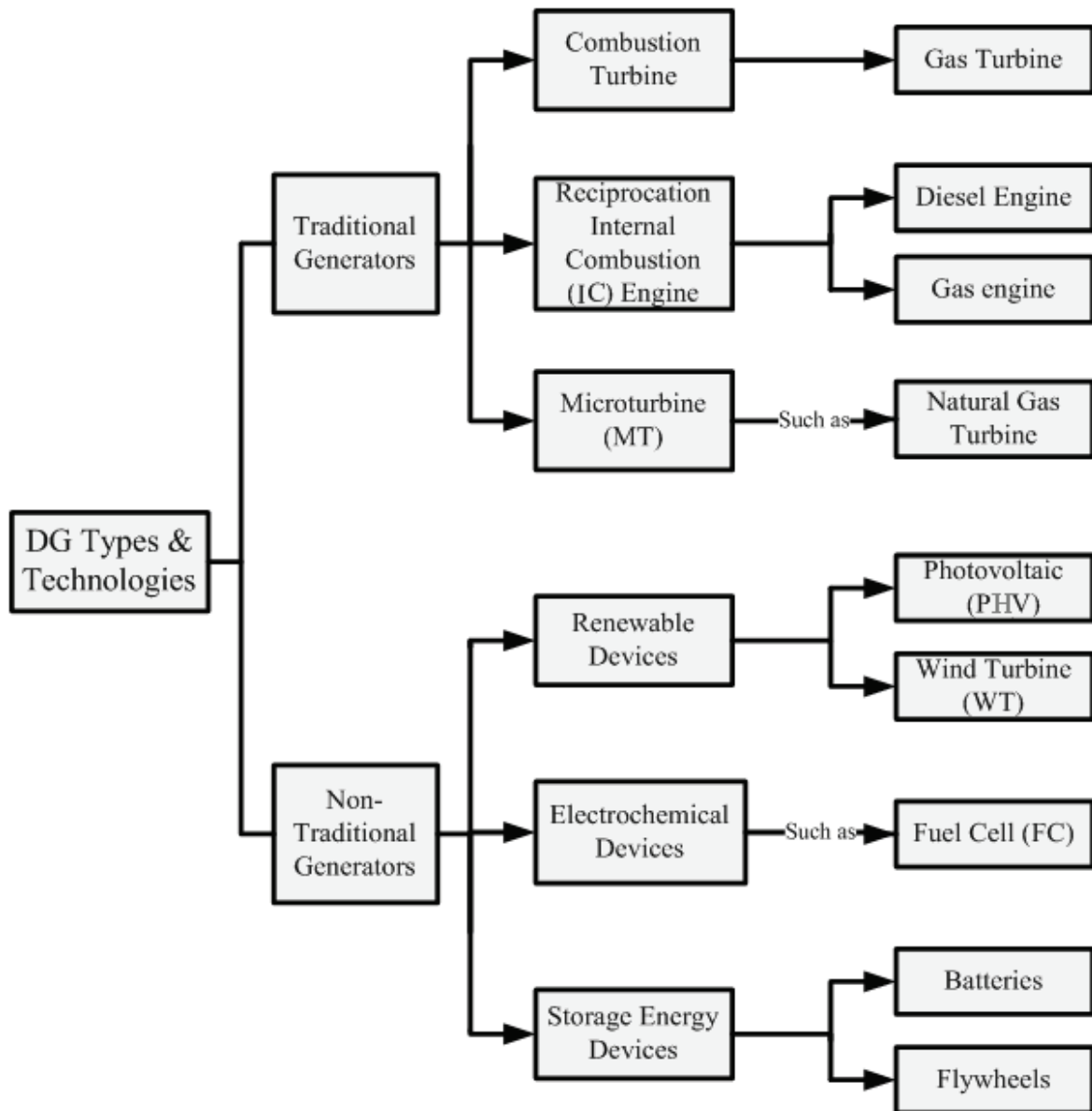

Figure A.1: DG types and technologies.

Combustion turbine [29], [191]: A mature technology, combustion turbines range from 0.5-30MW. They have low capital cost, low emission levels, but also usually low electric efficiency ratings. Development efforts are focused on increasing efficiency levels for this widely available technology. Industrial combustion turbines are being used primarily for peaking power and in cogeneration applications. They are usually set up to burn natural gas which is called Combustion Gas Turbine (CGT).

Reciprocating engine [203]: This DG technology which is well known Internal Combustion (IC) engine, was developed more than a century ago, and is still widely utilized in a broad array of applications. The engines range in size from less than 30kW to over 6 MW, and use diesel, natural gas, or waste gas as their fuel source. Development

efforts remain focused on improving efficiency and on reducing emission levels. Reciprocating engines are being used primarily for backup power, peaking power, and in cogeneration applications.

Microturbine (MT): Applications on Microturbine have become well known for their efficiency and reliability [191], [204]. Individual units range from 25 kW–25 MW, but can be combined readily into a system of multiple units. Another important feature of these units is its low combustion temperature, which can assure low NO_x emissions levels. Hydraulic Microturbines correspond to small hydraulic generating units. Their benefits are the low environmental contamination, low maintenance costs and high efficiency.

Fuel Cell (FC): Fuel cells are an emerging technology with compact, quiet power generators that use hydrogen and oxygen to produce electricity. These units are able to convert fuels (rich in H_2) to electricity at very high efficiencies (36%–57%) as compared with conventional technologies. The dc current produced by FC can be transferred to the power system by using inverters. Emission of NO_x and CO_2 related with this technology refers to the reformer process (production of hydrogen) in the case of using fuel (as natural gas, methanol, etc.) [191], [204].

Photovoltaic systems (PHVs): The photovoltaic systems are also a popular renewable resources technology. The power of a single module varies between 50 and 100W and its efficiency are near 15%. Usually PHVs are built in arrays with series and parallel connections, and coupled to the network thorough an inverter. PHV systems show high investment and very low maintenance costs [29], [191], [204].

However, they can be quite costly. Less expensive components and advancements in the manufacturing process are required to eliminate the economic barriers now impeding widespread use of PHV systems. Photovoltaic is currently being used primarily in remote locations without grid connections and also to generate green power.

Wind turbine (WT): Wind turbines are currently available from many manufacturers and range in size from less than 10 kW to over 4 MW. They provide a relatively inexpensive (compared to other renewable energies) way to produce electricity, but as they rely upon the variable and somewhat unpredictable wind, are unsuitable for continuous power needs. Development efforts look to pair wind turbines with battery storage systems that can provide power in those times when the turbine is not turning. Wind turbines are being used primarily in remote locations not connected to the grid and by energy

companies to provide green power [29].

Irrespective of the specific DG technology, when interconnected to a power grid either they use a synchronous generator or a power electronic inverter [204]. Consequently, from a steady state point of view, these different technologies can be represented by standard load flow equations with minimum and maximum power limits (active and reactive), complex power limit, and voltage limits at the connection busbar.

Storage device: Deep cycle batteries, flywheels (provide up to 700 kW in 5 second [205]) ultra-capacitors (28 cells provide 12.5 kW for a few seconds [206]), and other devices, which are charged during low load demand and are used when required. They are usually combined with other DG types to supply the required peak load demand [205]. Advantages of storage devices are: they provide instantaneous energy in case of need and used as a standby source. A drawback of storage devices is that they provide energy for a very small time and require maintenance and inspection.

A.3 DG Applications

DG is currently being used by some customers to provide some or all of their electricity needs. There are many different potential applications for DG technologies. For example, some customers use DG to reduce demand charges imposed by their electric utility, while others use it to provide primary power or reduce environmental emissions. DG can also be used by electric utilities to enhance their distribution systems. Many other applications for DG solutions exist. The following is a list of those of potential interest to electric utilities and their customers [207].

Continuous Power - In this application, the DG technology is operated at least 6,000 hours a year to allow a facility to generate some or all of its power on a relatively continuous basis. Important DG characteristics for continuous power include:

- High electric efficiency,
- Low variable maintenance costs
- Low emissions

Currently, DG is being utilized most often in a continuous power capacity for industrial applications such as food manufacturing, plastics, rubber, metals and chemical production. Commercial sector usage, while a fraction of total industrial usage, includes sectors such as

grocery stores and hospitals.

Combined Heat and Power (CHP) - Also referred to as Cooling, Heating, and Power or cogeneration, this DG technology is operated at least 6,000 hours per year to allow a facility to generate some or all of its power. A portion of the DG waste heat is used for water heating, space heating, steam generation or other thermal needs. In some instances this thermal energy can also be used to operate special cooling equipment. Important DG characteristics for combined heat and power include:

- High useable thermal output (leading to high overall efficiency),
- Low variable maintenance costs
- Low emissions

CHP characteristics are similar to those of Continuous Power, and thus the two applications have almost identical customer profiles, though the high thermal demand here is not necessary for Continuous Power applications. As with Continuous Power, CHP is most commonly used by industry clients, with a small portion of overall installations in the commercial sector.

Peaking Power - In a peaking power application, DG is operated between 200-3000 hours per year to reduce overall electricity costs. Units can be operated to reduce the utility's demand charges, to defer buying electricity during high-price periods, or to allow for lower rates from power providers by smoothing site demand. Important DG characteristics for peaking power include:

- Low installed cost
- Quick startup
- Low fixed maintenance costs

Peaking power applications can be offered by energy companies to clients who want to reduce the cost of buying electricity during high-price periods. Currently DG peaking units are being used mostly in the commercial sector, as load profiles in the industrial sector are relatively flat. The most common applications are in educational facilities, lodging, miscellaneous retail sites and some industrial facilities with peaky load profiles.

Green Power - DG units can be operated by a facility to reduce environmental emissions from generating its power supply. Important DG characteristics for green power applications include:

- Low emissions
- High efficiency
- Low variable maintenance costs

Green power could also be used by energy companies to supply customers who want to purchase power generated with low emissions.

Emergency Power System - This is an independent system that automatically provides electricity within a specified time frame to replace the normal source if it fails. The system is used to power critical devices whose failure would result in property damage and/or threatened health and safety. Customers include apartment, office and commercial buildings, hotels, schools, and a wide range of public gathering places.

Standby Power System - This independent system provides electricity to replace the normal source if it fails and thus allows the customer's entire facility to continue to operate satisfactorily. Such a system is critical for clients like airports, fire and police stations, military bases, prisons, water supply and sewage treatment plants, natural gas transmission and distribution systems and dairy farms.

Transmission and Distribution Deferral - In some cases, placing DG units in strategic locations can help delay the purchase of new T&D systems and equipment such as distribution lines and substations. A detailed analysis of the life-cycle costs of the various alternatives is critical and issues relating to equipment deferrals must also be examined closely. Important DG characteristics for transmission and distribution deferral (when used as a "peak deferral") include:

- Low installed cost
- Low fixed maintenance costs

Ancillary Service Power - DG is used by an electric utility to provide ancillary services (interconnected operations necessary to affect the transfer of electricity between the purchaser and the seller) at the transmission or distribution level. In markets where the electric industry has been deregulated and ancillary services unbundled (in the United Kingdom, for example), DG applications offer advantages over currently employed technologies. Ancillary services include spinning reserves (unloaded generation, which is synchronized and ready to serve additional demand) and non-spinning, or supplemental, reserves (operating reserve is not connected to the system but is capable of serving demand

within a specific time or interruptible demand that can be removed from the system within a specified time). Other potential services range from transmission market reactive supply and voltage control, which uses generating facilities to maintain a proper transmission line voltage, to distribution level local area security, which provides back up power to end users in the case of a system fault. The characteristics that may influence the adoption of DG technologies for ancillary service applications will vary according to the service performed and the ultimate shape of the ancillary service market. Figure A.2 summarizes the different kinds of DG applications [208].

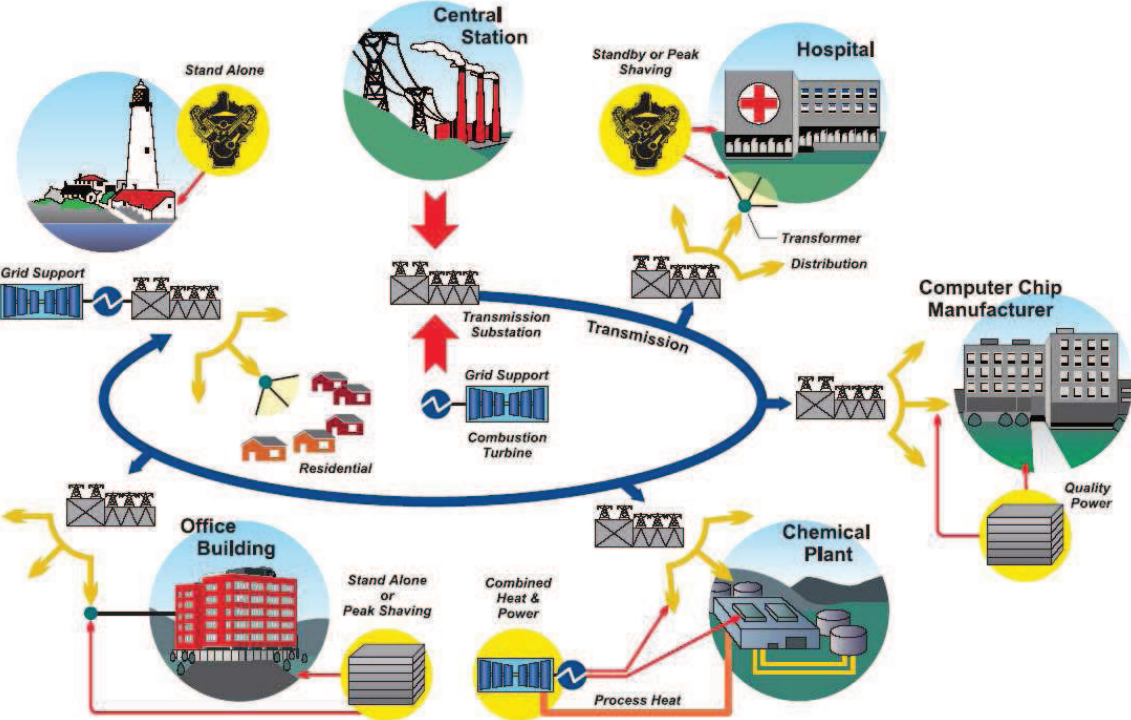

Figure A.2: Summary of DG applications.

A.4 Benefits of DG

A.4.1 Customer Benefits

- Properly located, installed and operated DG can improve reliability of energy supply, increasingly critical to business and industry in general, and essential to some where interruption of service is unacceptable economically or where health and safety is impacted.
- The various DG technologies offer the opportunity of selecting the right energy solution at the right location. DG technologies can provide a stand-alone power

option for areas where transmission and distribution infrastructure does not exist or is too expensive to build.

- DG may offer efficiency gains for on-site applications by avoiding line losses, and using both electricity and the heat produced in power generation for processes or heating and air conditioning.
- Its flexibility of operation because of small modular units enables savings on electricity rates by self generating during high-cost peak power periods and adopting relatively low cost interruptible power rates.
- Benefits for environmental quality may come from DG's role in promoting renewable energy sources, less-polluting forms of fossil energy, and high efficiency technologies. DG allows power to be delivered in environmentally sensitive and pristine areas by having characteristically high efficiency and near-zero pollutant emissions.
- Affords customers a choice in satisfying their particular energy needs.
- Provides siting flexibility by virtue of the small size, superior environmental performance, and fuel flexibility.

A.4.2 Supplier Benefits

- DG limits capital exposure and risk because of the size, siting flexibility, and rapid installation time afforded by the small, modularly constructed, environmentally friendly, and fuel flexible systems.
- Unnecessary capital expenditure can be prevented by closely matching capacity increases to growth in demand.
- DG avoids major investments in transmission and distribution system upgrades by siting new generation near the customer.
- It offers a relatively low cost entry point into a new and competitive market.
- Opens markets in remote areas without transmission and distribution systems, and areas without power because of environmental concerns.

A.4.3 National Benefits

- DG technologies that relied on renewable energy sources could yield environmental benefits in the form of reduced emissions of pollutants and greenhouse gases if those technologies displaced utility-supplied power, much of which is generated from coal. Technologies that relied on conventional fuels would yield environmental benefits if they resulted in a shift to less-polluting energy sources—for example, natural gas rather than coal. High-efficiency technologies could yield benefits by reducing the amount of energy required to produce a unit of electricity.
- DG responds to increasing energy demands and pollutant emission concerns while providing low-cost, reliable energy essential to maintaining competitiveness in the world market.
- Establishes a new industry worth billions of dollars in sales and hundreds of thousands of jobs and enhances productivity through improved reliability and quality of power delivered, valued at billions of dollars per year.

A.5 Issues of DG

A.5.1 DG Electrical Interconnection

The interconnection with the network is a complicated procedure that involves the realization of a DG application. The DG operation is usually referred to as synchronized or parallel operation. In this configuration the DG is connected to the network the same time that it's producing power and in the case that the load is met any excess energy is also transmitted to that.

A.5.2 Islanding Issues

Islanding is a major interconnection issue. Islanding is a situation where one or more generators and a portion of the utility system operate separately from the rest of the utility system. The formation of an unintentional island is a problem for the utility company. The most important concerns are

- Worker and public safety
- Damage to utility and customer equipment due to out-of-phase reclosure
- Voltage problems

- High over voltages to utility equipment and customers caused by neutral shifts or Ferro-resonance

DGs create danger for workers and the public. Line crews might work on a section of line that they thought was de-energized. A DG could energize this line, even though it is disconnected from the utility source. The danger also extends to the general public. Islanded generators may energize downed conductors within public reach (that might have been de-energized by upstream utility switchgear had the island not developed).

Once an island forms, it typically drifts out of phase with the utility system voltage. If the main system is closed into the island, the out-of-phase reclosure may cause damage to the generator, customer loads, and/or utility switchgear as well as being a significant power quality disturbance for customers upstream of the island. An island may also prevent the clearing of fault currents on the system, increasing damage at the location of the fault, and perhaps burning conductors down.

The most common means to prevent islanding is to use voltage and frequency relays on the generator to trip whenever either of these two parameters migrate outside a selected window. This form of islanding protection is known as *passive* protection. It prevents islanding in most cases because when a section of the distribution system and one or more generators separate together, the output of the generator will not match the load on the island. For synchronous or induction generators, the voltage and frequency will drift, which will trip the relays in a short time. Typically the relays are set to a tight frequency range of perhaps +1 Hz or even +0.5 Hz. Voltage relays have a bit wider window to allow for typical voltage regulation excursions on the circuit (+5 to 10% is typical). Later in this chapter, specific setting requirements per IEEE standards are discussed.

Synchronous generators, induction generators, self-commutated inverters, and line-commutated inverters — all can island. Synchronous generators and self-commutated inverters are most likely to island because they do not require external excitation. Induction generators and line-commutated inverters can island if they have external excitation, either from capacitor banks or from other generators in the island.

A.5.3 Protection Issues

Power system protection is a technical issue that is sufficiently important to deserve separate discussion. The objective of power system protection is to detect a fault condition

(perhaps due to a lightning strike or equipment failure) and isolate the faulted section of the system as rapidly as possible while restoring normal operation to the rest of the system.

Connecting DG to a distribution network introduces a source of energy at a point where there may not have been a source before. This may increase the “fault level” in the network (that is, the fault current that may flow when a fault occurs) and may complicate fault detection and isolation. In a typical urban network, DG may be connected at voltage levels ranging from 240V single phase to 132 kV (line-line). Connections at 132 kV are complex but well understood, whereas connections at 240/415V and 11 kV can be more difficult, particularly if they involve net injections into the network.

The goal of protection design in the presence of DG is to maintain the pre-existing standard of network reliability, security and quality, coordinate with existing network protection and provide reasonable backup. Protection engineers recommend the use of dedicated, utility quality protection devices rather than rely on DG control equipment that is used in normal operation. Because each DG installation involves a unique combination of generation and system factors, protection must be designed for each project, and should be undertaken as early in project design as possible.

A.5.4 Commercial and Planning Issues

Uncertainties surround the costs and benefits of DG. In some circumstances, DG may be able to defer network augmentation costs, reduce network losses and improve power system security and quality of supply. In other circumstances, DG may impose additional power system operating costs and require investment in network assets. On the one hand, network service providers and system operators may feel that DG proponents overstate the benefits of DG, while on the other hand DG proponents may feel that network service providers and system operators overstate the costs.

This difference in views may be inevitable given the innovative nature of DG and its potential to radically change the electricity industry. However the shared nature of electricity industry operation and investment also contributes by blurring accountabilities and thus blurring both the nature of appropriate commercial obligations and assessments of whether those obligations have been met. Internationally, solutions are being pursued through uniform business practices and regulatory protocols, although this process is

hampered by the rudimentary nature of retail electricity markets in which both consumers and DG participate.

Prior to the introduction of DG, distribution network planners only had to consider the effect of supply from the main grid generators. DG introduces energy sources in distribution networks where they had not existed before, with a wide variety of technology types and characteristics. As the network provides the main conduit for the distribution of electricity, the planner's main challenge is to be able to estimate and forecast the location and magnitude of DG connected to the network and to ensure that the principle objectives as set out above are achieved. DG can bring both positive and negative values from the perspective of distribution planning:

- Positives can include the potential to defer expenditure on network augmentation, reduce network losses and improve outcomes for the environment, voltage control and/or availability and quality of supply
- Negatives can include concerns about safety and protection, increased capital expenditure, deleterious effects on security and reliability of availability of supply, and worse outcomes for the local environment, voltage control and quality of supply.

DG installations must be assessed on an individual basis, with the exception of very small <10kW units, because of the variation in DG sizes and technology types, and because the impact on the network can be location specific. This results in long application processing times and may incur significant costs. With improved knowledge and understanding of the issues by all parties, the assessment of impacts will improve. For small installations, there is a need for better standardization of conditions of connection. For larger installations, there are significant issues to be addressed which tend to result in long application processing times and unexpected costs for the proponent.

A.6 Impacts of DG on Power Quality

Interconnecting a DG to the distribution feeder can have significant effects on the system such as power flow, voltage regulation, reliability etc. A DG installation changes traditional characteristics of the distribution system. Most of the distribution systems are designed such that the power flows in one direction. The installation of a DG introduces

another source in the system. When the DG power is more than the downstream load, it sends power upstream reversing the direction of power flow and at some point between the DG and substation; the real power flow is zero due to back flow of power from DG.

A few papers [209], [210] present guidelines for DG interconnection. In [209], the author defined rules for studying the impacts of interconnecting DG to a distribution feeder. The rules are defined for power flow reversal, optimal DG placement for reduction of losses and the impacts of DG on over-current protection. In [210], the author also discussed zero point analysis and rules for modeling of DG interaction with the system.

The 1547 series of IEEE standards for interconnecting distributed resources to the power system is a set of standards consisting of 6 parts [211]. The standards provide criteria and requirement for interconnecting DGs to the power system. The IEEE 1547.1 [212] defines the requirement for interconnecting equipment that connects the DG to the electric power system is presented. The IEEE 1547.2 [213] provides technical details and application to understand the IEEE standard is presented. The IEEE 1547.3 [214] guide addresses engineering concerns of design, operation and integration of DG island systems. The IEEE 1547.6 [215] standard focuses on criteria, test and requirements for interconnection distribution secondary network of area electric power system with local electric power system having DG.

A.6.1 Voltage Impact

The DG installation can impact the overall voltage profile of the system. Inclusion of DG can improve feeder voltage of distribution networks in areas where voltage dip or blackouts are of concern for utilities. The voltage issues related to the installation of DG on current electrical system have been discussed in several papers. In [216], the impact of DG on electric losses, voltage profile and reliability were discussed. The purpose is to find optimal DG allocation and sizing for minimal losses and proper voltage and reliability support. In [23], the impacts of DG on power system were analyzed. The paper analyzes impact of DG on voltage regulation and losses, as well as the voltage flicker and harmonics that can be caused by the DG. The paper also addresses DG impacts on short circuit levels and the islanding operation of DG.

However, the DG can also confuse the voltage regulator settings and can cause the voltage to deviate above or below the permissible range. In [217] and [218], a technique to

regulate voltage using DG was proposed. The paper presents a simulation that uses a voltage control method for optimal power injection from DG. In [219], the impacts of DG on voltage regulation by Load Tap Changing (LTC) transformer were studied. The paper shows that DG can cause under-voltages and over-voltages if proper LTC tap transformer controls are not applied.

Several papers have presented control models for the efficient operation of DG. In [220], the author presented operation and control for DG installation. The paper presents a DG control model to improve the network voltage efficiently. In [221], the author addressed network issues when multiple DGs are included in the network. The paper presents analytical methods and solutions to develop design criteria for DG installation. The authors of [222] presented a simple analytical method to estimate voltage profile for radial distribution system when placing DG units with specific active and reactive power generation. The authors of [223] also discussed voltage regulation coordination methods of DG in a distribution system. The approach makes use of controlling DGs reactive power based on its real power to satisfy system voltage requirements.

A.6.2 Losses

Installation of DG also impacts the losses and power factor of the distribution system. A few papers have talked about the reduction of losses by inserting power from DG into the system. In [216], the authors discussed the role of DG in loss reduction based on a power summation method. In [23], the authors briefly presented the impact of DG on losses of the feeder. However, no analysis is presented. In this research, the loss analysis at different penetration levels of DG and distributing it across several locations are presented.

A.7 Cost of DG Technologies

The direct costs of DG to customers include the installed cost of the equipment, fuel costs, non-fuel O&M expenses, and certain costs that the customers' utility imposes.

In order to make this comparison of costs most useful, the following cost data are based on the assumption that for each technology there are used an installed capacity, a rate of utilization, and (in some cases) a geographic location that would be suitable for serving the electricity needs of individual customers. For example, the costs for the wind turbine discussed here are for a size that might be used in a small rural business (such as a farm) in

a location with favorable wind resources. On that basis, data compiled from various industry and government sources describe the current costs of the most common types of electricity generation technologies (Table A.1) [191], [207], [224]-[226]. Data for a combined-cycle unit are presented as well; as the largest source of additional electricity from utilities and independent power producers, combined-cycle systems provide a representative benchmark against which the costs of other technologies can be measured.

Table A.1: Summary of DG technologies.

Technology	IC Diesel	IC Gas	MT	CGT	FC	PHVs	WT
Size	30kW – 6MW	30kW – 6MW	25kW-25MW	0.5 - 30MW	0.1-3 MW	1kW-1MW	10 kW - 4 MW
Installed Cost (M\$/MW) ¹²	0.6-1	0.7-1.2	0.45-1	0.4-0.9	3-5	4.5-10	0.8-3.5
Elec. Efficiency	30-43%	30-42%	14-30%	21-40%	36-57%	Free fuel	Free fuel
Overall Efficiency ¹³	~80-85%	~80-85%	~80-85%	~80-90%	~80-85%	-	-
O&M Costs ¹⁴ (\$/MWh)	5 - 15	7-20	5-6.5	4-10	1.7-15.3	1-4	0.3-1.9
Footprint (sqft/kW)	.22-.31	.28-.37	.15-.35	.02-.61	.9	-	-
Emissions (gm / bhp-hr unless otherwise noted)	NO _x : 7-9 CO: 0.3-0.7	NO _x : 0.7-13 CO: 1-2	NO _x : 9-50ppm CO: 9-50ppm	NO _x : <9-50ppm CO:<15-50ppm	NO _x : <0.02 CO: <0.01	0	0

The costs of acquiring and installing generating units vary widely, depending on technology, capacity, and other factors. The U.S. Department of Energy estimates that the typical installed capital costs for distributed generators range from under \$1,000 per kilowatt for a combustion turbine to almost \$7,000 per kilowatt for a solar photovoltaic system [207]. Among small-capacity technologies, internal combustion engines (fuelled by diesel and gasoline) have the lowest capital costs and highest operating costs. Renewable technologies (using wind and solar power) have the highest capital costs and lowest operating costs. New high-efficiency technologies (Microturbines and fuel cells) fall in between. Table A.1 shows the costs of the basic DG technologies.

A.8 Market

DG appears especially attractive to policymakers, regulators and the market generally because it provides the option of reducing investments in transmission and distribution systems and also the option of minimizing the T&D energy losses. One of the powerful

¹² Cost varies significantly based on siting and interconnection requirements, as well as unit size and configuration.
¹³ Assuming CHP.
¹⁴ O&M costs do not include fuel.

forces driving that transition in the market structure has been advances in electricity generation technologies that have reduced the costs of smaller-capacity systems.

Technologies such as Microturbines are available in capacities under 100 kilowatts (roughly the size of an automobile engine). Large-scale power plants (100 megawatts or greater), which are typically used by vertically integrated utilities, no longer have significantly lower costs than smaller plants do. That change has weakened one of the main rationales for maintaining electric power production as a regulated monopoly and the next reasonable step would be to fully exploit the savings in generation and transmission costs from large-scale, centrally located power plants.

Policymakers have an interest in the future of DG, not only for the cost savings it can provide to the homes and businesses that produce it but also for the cost savings and additional reliability that it may be able to offer to the entire electricity market. DG may play a larger role, along with demand-management techniques and further innovations in wholesale and retail markets, in reducing the cost of electricity when traditional supply is tight or market demand is strong. For example, DG may offer retail customers greater flexibility to alter their demand for electricity in response to hourly changes in prices (real-time pricing), thereby promoting the efficient operation and stability of energy markets as they become increasingly competitive. Some observers expect DG to play a role in the commercial development of renewable energy and high-efficiency technologies, adding the associated environmental and safety benefits.

Appendix B

Economic and Financial Aspects

B.1 Introduction

A rational decision is based on the true total cost. That is the sum of the present values of all cost components, and it is called life cycle cost. The cost components relevant to DG analyses are capital cost (total initial investment) net of tax credits; energy costs, for example, gas fuel for Microturbines; costs for maintenance, including major repairs; resale value; insurance; and taxes.

There is some arbitrariness in this assignment of categories. One could make a separate category for repairs, or one could include energy among O&M cost as is done in some industries. There is, however, a good reason for keeping energy apart. In DG analyses, energy costs dominate O&M costs and can grow at a different rate. Furthermore, electric rates usually contain charges for peak demand in addition to charges for energy. As a general rule, if an item is important, it merits separate treatment.

Quite generally, when comparing two or more options, there is no need to include terms that would be the same for each. For instance, when choosing between two Microturbine manufacturers, one can restrict one's attention to the costs associated directly with the turbines (capital cost, energy, maintenance) without worrying about the electrical distribution system if that is not affected.

Finally, in some cases, it becomes necessary to account for the effects of taxes, due to tax deductions for interest payments and depreciation; hence, these items are discussed first, before the equation for the complete system cost is presented.

The planning process essentially involves estimation of economic consequences of each alternative plan. The planner is usually restricted by the operational constraints, standards and guidelines, but within these frames the goal is to minimize cost. Every alternative plan implies certain costs: equipment, installation labor, operating and maintenance, and many others. The total costs are important, but also when the costs are incurred – how much must be spent now and how much later.

The fact that different expenses or incomes might not coincide in time when comparing the costs of alternative solutions, especially for the existing system reinforcement, is a difficulty to deal with. It means that a method of economic assessment to take into account the timing of cash flows is needed.

Optimization in the context of this dissertation means selecting the DG system configuration that maximizes financial benefit to its owner and social. In principle, the process of optimizing the design of a distributed generation system for a building or campus of buildings is simple: evaluate all possible design variations and select the one with the largest social welfare and system owner benefit. In practice, it would be a daunting task to find the true optimum among all conceivable designs. The difficulties, some of which have already been discussed, are:

- The enormous number of possible design variations (DG system types, building configurations, electrical use systems, types and models of HVAC equipment, and control modes)
- Uncertainties (costs, future energy prices, reliability, occupant behaviour, and future uses of buildings)

Fortunately, there is a certain tolerance for moderate errors, as shown below. That greatly facilitates the job, because one can reduce the number of steps in the search for the optimum. Also, within narrow ranges, some variables can be sub-optimized without worrying about their effect on others.

B.2 Effect of Time on the Value of Money

Before comparing capital costs and operating costs, it should apply a correction, because a currency unit to be paid in the future does not have the same value as a dollar available today. This time dependence of money is due to two quite different causes. The first is inflation, the well known and ever present erosion of the value of our currency. The second reflects the fact that a currency unit today can buy goods to be enjoyed immediately or can be invested to increase its value by profit or interest. Thus, money that becomes available in the future is less desirable than a dollar today; its value must therefore be discounted. This is true even without inflation. Both inflation and discounting are characterized in terms of annual rates.

Present Value (or Worth) analysis is a method of measuring and comparing costs and savings that occur at different times on a consistent and equitable basis for decision making. The discussion begins with inflation. Actually, the definition and measure of the inflation rate are not without ambiguities, since different prices escalate at different rates and an average inflation rate depends on the mix of goods assumed. The relationship between present value (PV) and its future value (FV), t years from now is given by the discount rate r_d , defined such that:

$$PV = \frac{1}{(1 + r_{\text{inf}})^t} \cdot FV \quad (\text{B.1})$$

where FV is a value of future amount in year t , PV is the value of the same amount at time zero and r_{inf} is the inflation rate.

B.3 Discounting of Future Cash Flows

As mentioned above, even if there were no inflation, a future cash amount FV is not equal to its present value PV ; it must be discounted. The relationship between PV and its future value FV , t years from now is given by the discount rate r_d , defined such that:

$$PV = \frac{1}{(1 + r_d)^t} \cdot FV \quad (\text{B.2})$$

The situation becomes more complex when there are several different investment possibilities offering different returns at different risks, such as savings accounts, stocks,

real estate, or a new business venture. By and large, if one wants the prospect of a higher rate of return, one has to accept a higher risk. Thus, a more general rule would state that the appropriate discount rate for the analysis of an investment is the rate of return on alternative investments of comparable risk. In practice, that is sometimes quite difficult to determine, and it may be desirable to have an evaluation criterion that bypasses the need to choose a discount rate. Such a criterion is obtained by calculating the profitability of an investment in terms of an unspecified discount rate and then solving for the value of the rate at which the profitability goes to zero.

Present values can be calculated with real rates and real currency or with market rates and inflating currency; the result is readily seen to be the same because multiplying the numerator and denominator of Eq. (B.2) by $(1 + r_{\text{inf}})^t$ yields

$$PV = \frac{FV}{(1 + r_d)^t} = \frac{FV(1 + r_{\text{inf}})^t}{(1 + r_{\text{inf}})^t(1 + r_d)^t} \quad (\text{B.3})$$

which is equal to

$$PV = \frac{FV_0}{(1 + r_d)^t} \quad (\text{B.4})$$

since

$$FV_0 = \frac{FV}{(1 + r_{\text{inf}})^t} \quad (\text{B.5})$$

The ratio PV/FV of present and future value is called the present worth factor, which is designated here with the mnemonic notation

$$(PV / FV, r, t) = PV / FV = (1 + r)^{-t} \quad (\text{B.6})$$

It is plotted in Figure B.1.

Its inverse

$$(FV / PV, r, t) = \frac{1}{(PV / FV, r, t)} \quad (\text{B.7})$$

is called the compound amount factor. These factors are the basic tool for comparing cash flows at different times. Note that the so-called end-of-year convention has been chosen here by designating FV as the value at the end of the t -th year. Also, annual

intervals have been assumed, generally an adequate time step for engineering economic analysis; accountants, by contrast, tend to work with monthly intervals, corresponding to the way most regular bills are paid. The basic formulas are the same, but the numerical results differ slightly because of differences in the compounding of interest; this point will be explained more fully later when we pass to the continuous limit by letting the time step approach zero.

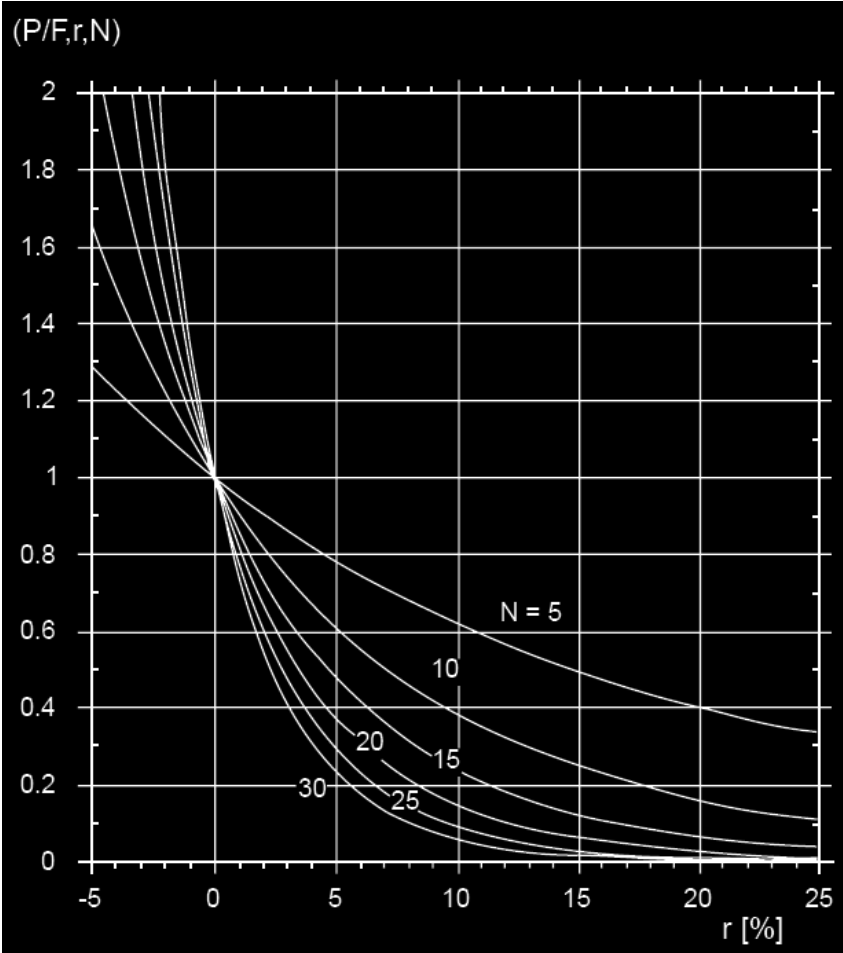

Figure B.1: The present worth factor $(P/F,r,N)$ as function of rate r and number of years N .

B.4 Annuity Depreciation and Equivalent Cash Flows

It is also possible to express the annual charge for depreciation as an equivalent uniform annual charge. It is convenient to express a series of payments that are irregular or variable as equivalent equal payments in regular intervals; in other words, one replaces nonuniform series by equivalent uniform or level series. This technique is referred to as levelizing. It is useful because regularity facilitates understanding and planning. To develop the formulas, one must calculate the present value PV of a series of N equal annual payments A . If the

first payment occurs at the end of the first year, its present value is $A/(1+r_d)$. For the second year it is $A/(1+r_d)^2$, etc. Adding all the present values from year 1 to N gives the total present value

$$PV = \frac{A}{1+r_d} + \frac{A}{(1+r_d)^2} + \dots + \frac{A}{(1+r_d)^N} \quad (\text{B.8})$$

This is a simple geometric series, and the result is readily summed to

$$PV = A \frac{1 - (1+r_d)^{-N}}{r_d} \quad \text{for } r_d \neq 0 \quad (\text{B.9})$$

For zero discount rate this equation is indeterminate, but its limit $r_d \rightarrow 0$ is A/N , reflecting the fact that the N present values all become equal to A in that case. Analogous to the notation for the present worth factor, the ratio of A and P is designated by

$$(A/PV, r_d, N) = \begin{cases} \frac{r_d}{1 - (1+r_d)^{-N}} & \text{for } r_d \neq 0 \\ \frac{1}{N} & \text{for } r_d = 0 \end{cases} \quad (\text{B.10})$$

This is called the capital recovery factor and is plotted in Figure B.2. For the limit of long life, it is worth noting that $(A/PV, r_d, N) \rightarrow r_d$ if $r_d > 0$. The inverse is known as the series present worth factor since PV is the present value of a series of equal payments A .

In the network planning tasks different alternatives are usually analyzed over a longer period of time corresponding to the lifetime of the equipment. However, the lifetimes of different units of the equipment may differ considerably. One solution to the problem of dynamic allocation of assets is to use one of the depreciation accounting methods. Depreciation may be defined as the lessening in value of a physical asset with the passage of time. Thus, the alternative investments, which do not coincide in time, can be compared based on the Present Value of the investments and the salvage value.

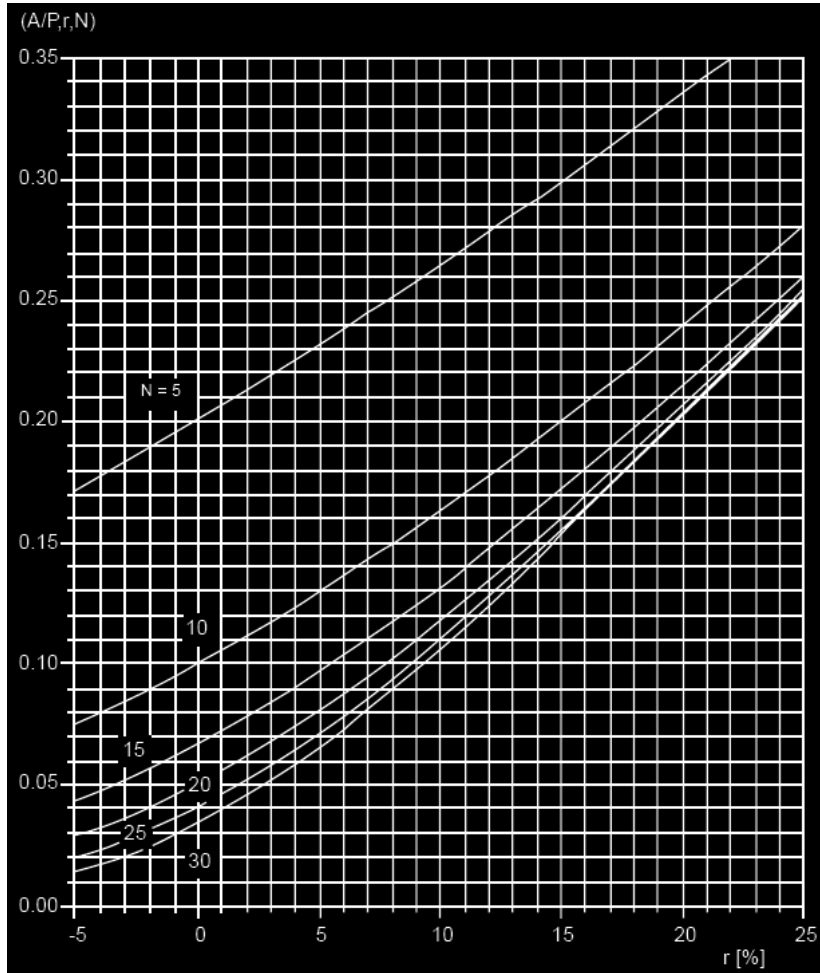

Figure B.2: The capital recovery factor $(A/P, r, N)$ as function of rate r and number of years N .

If one defines the lifetime of the particular unit of the equipment as depreciation time and assign the planning period, the following cases may need to be compared with each other:

Planning period is shorter than the unit depreciation time and the investment is made at present time. The planner is only interested in payments to be made during the planning period. A series of annualized costs can be found from the following equation:

$$A_{Depr} = \left[\frac{r_d (1 + r_d)^{T_{Depr}}}{(1 + r_d)^{T_{Depr}} - 1} \right] \cdot PV \quad (B.11)$$

The present value of the investments during the planning period may be found applying the Eq. (B.10).

Planning period may be shorter than (or equal to) the unit depreciation time, but the investment is postponed by a number of years more than $T_{Depr} - T_{pl}$.

In this case a series of annualized costs to be found from Eq. (B.11), and used to find the future investment value as follows:

$$FV_{pl} = \left[\frac{(1+r_d)^{T_{pl}-T_0} - 1}{r_d(1+r_d)^{T_{pl}-T_0}} \right] \cdot A_{Depr} \quad (B.12)$$

where T_0 is the time of delay of the investment in comparison to the present time. The present value of the investment can be obtained either from Eq. (B.12) applying Eq. (B.10) or directly from the physical value of investment according to:

$$PV_{pl} = (1+r_d)^{-T_0} \left[\frac{1 - (1+r_d)^{-(T_{pl}-T_0)}}{1 - (1+r_d)^{-T_{Depr}}} \right] \cdot PV \quad (B.13)$$

Eq. (B.13) was obtained from equations Eq. (B.10)- Eq. (B.12). Unit depreciation time is shorter than (or equal to) planning period. In this case the present value of the investment is equal to its physical value, but annuity can be calculated using Eq. (B.11).

B.5 Procedure for Economic Studies

The procedures for commencing an economic study may be laid out in a sequence of steps:

1. The facts concerning the different plans that could be used to meet the requirements of the problem should be set down. The plans should be made as comparable as possible.
2. The capital expenditures which will be incurred under each of the plans and the timing of these expenditures should be determined. The amounts and timing of operating and maintenance expenses must be estimated; allocations of cost to capital and expense must be adhered to.
3. A study period must be selected during which the revenue requirements incurred by the plans will be evaluated. In economic studies, it is seldom possible to find a study period which will precisely reflect the timing inherent in each of the plans under study. It will often be helpful to draw a diagram of the timing of capital and expense dollars for each of the plans in determining the study period. The study period chosen must be one determined on the basis of judgment. In every case, it

must be sufficiently long to approximate the overall effects, over a long period of time, of the money reasonably to be spent for both capital and operating expenses.

4. The annual charges resulting from the capital expenditures in each phase must be calculated if broad annual charges cannot be applied. In considering alternate plans, items common to the several plans may be omitted from the calculations. The effect of temporary installations, salvage, and of the removal of equipment which can be used elsewhere on the system must be taken into account.
5. When annual revenue requirements are non-uniform, the present worth of the revenue requirements for each plan must be calculated. The most economical plan will have the lowest present worth of revenue requirements. In the case where annual revenue requirements are uniform throughout the study period, the plan with the lowest annual requirements will be the most economical.
6. The comparison of the economic differences among the plans may be made on the dollar differences among the present worths of the revenue requirements. If percentage difference is considered, the dollar differences may be misleading as, in conducting the study, charges which are the same in the several plans are generally omitted; this will distort the base upon which a percentage difference is derived.
7. A recommendation of the most advantageous plan must be made. The plan with the minimum revenue requirements would be recommended from an economic point of view. Other considerations may indicate the recommendation of one of the other plans despite higher revenue requirements.

B.6 Conclusion

Economic studies constitute perhaps the most important ingredient in the implementation of a project. In sum, the consideration of any undertaking must answer satisfactorily three basic requirements or questions:

1. Why do it at all?
2. Why do it now?
3. Why do it this way?

The answers to these can, in large part, be supplied by the results of economic studies.

Appendix C

Modified IEEE 30-Bus System

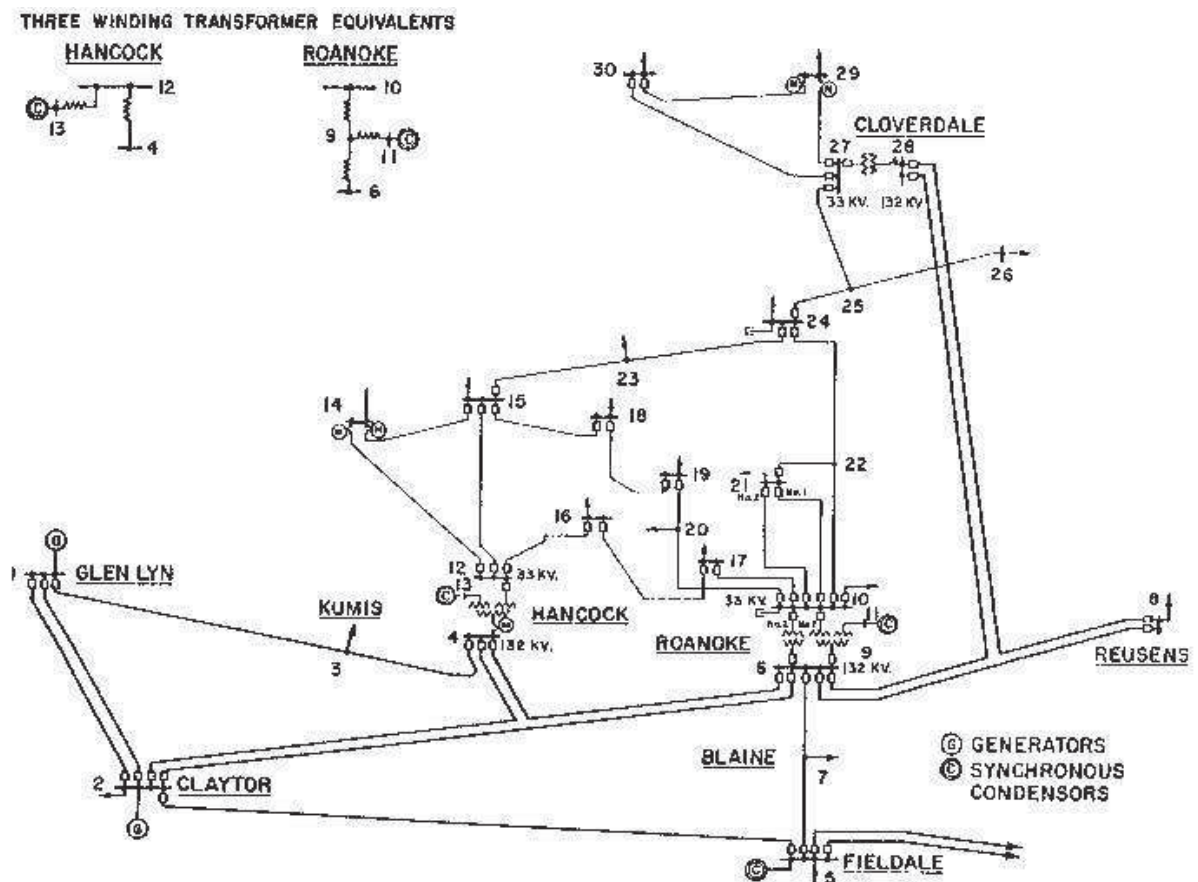

Figure C.1: Portion of the Midwestern US distribution system.

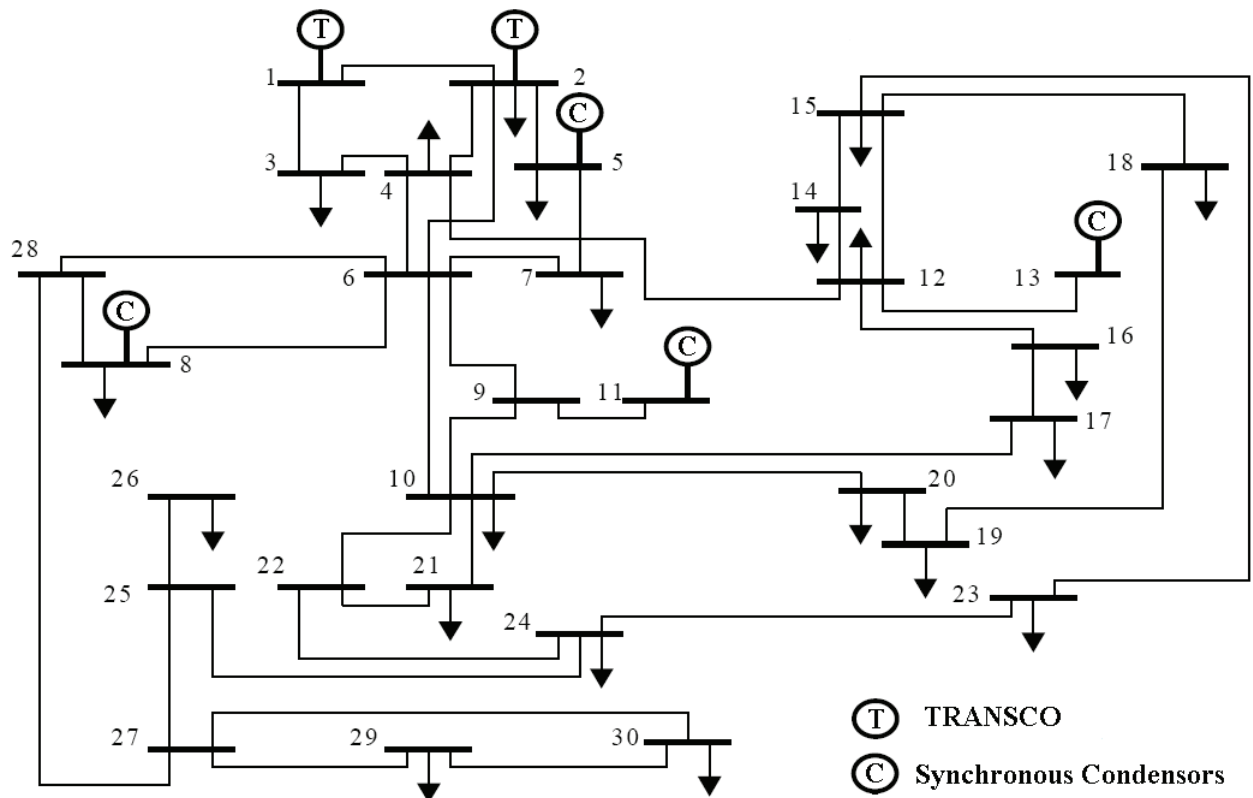

Figure C.2: Modified IEEE 30-Bus system under study.

Table C.1: Base load data of modified IEEE 30-Bus System.

Bus No.	Load (MW)	Load (MVAR)
2	21.7	12.7
3	2.4	1.2
4	7.6	1.6
5	94.2	19
7	22.8	10.9
8	30.0	30.0
10	5.8	2.0
12	11.2	7.5
14	6.2	1.6
15	8.2	2.5
16	3.5	1.8
17	9.0	5.8
18	3.2	0.9
19	9.5	3.4
20	2.2	0.7
21	17.5	11.2
23	3.2	1.6
24	8.7	6.7
26	3.5	2.3
29	2.4	0.9
30	10.6	1.9
Sum	283.4	126.2

Table C.2: Active and reactive power limit of modified IEEE 30-Bus System.

Bus No.	P_{\min} (p.u.)	Q_{\max} (p.u.)	Q_{\min} (p.u.)
1	3.000	1.000	-0.500
2	0.400	0.500	-0.400
5	0	0.400	-0.400
8	0	0.400	-0.100
11	0	0.240	-0.060
13	0	0.240	-0.060

Table C.3: Network Data.

Branch No	From Bus	To Bus	Branch resistance R (p.u.)	Branch reactance X (p.u.)	Line charging B (p.u.)	Rating (p.u.)
1	1	2	0.0192	0.0575	0.0528	0.300
2	1	3	0.0452	0.1852	0.0408	0.300
3	2	4	0.0570	0.1737	0.0368	0.300
4	3	4	0.0132	0.0379	0.0084	0.300
5	2	5	0.0472	0.1983	0.0418	0.300
6	2	6	0.0581	0.1763	0.0374	0.300
7	4	6	0.0119	0.0414	0.0090	0.300
8	5	7	0.0460	0.1160	0.0204	0.300
9	6	7	0.0267	0.0820	0.0170	0.300
10	6	8	0.0120	0.0420	0.0090	0.300
11	6	9	0.0000	0.2080	0	0.300
12	6	10	0.0000	0.5560	0	0.300
13	9	11	0.0000	0.2080	0	0.300
14	9	10	0.0000	0.1100	0	0.300
15	4	12	0.0000	0.2560	0	0.650
16	12	13	0.0000	0.1400	0	0.650
17	12	14	0.1231	0.2559	0	0.320
18	12	15	0.0662	0.1304	0	0.320
19	12	16	0.0945	0.1987	0	0.320
20	14	15	0.2210	0.1997	0	0.160
21	16	17	0.0824	0.1932	0	0.160
22	15	18	0.1070	0.2185	0	0.160
23	18	19	0.0639	0.1292	0	0.160
24	19	20	0.0340	0.0680	0	0.320
25	10	20	0.0936	0.2090	0	0.320
26	10	17	0.0324	0.0845	0	0.320
27	10	21	0.0348	0.0749	0	0.300
28	10	22	0.0727	0.1499	0	0.300
29	21	22	0.0116	0.0236	0	0.300
30	15	23	0.1000	0.2020	0	0.160
31	22	24	0.1150	0.1790	0	0.300
32	23	24	0.1320	0.2700	0	0.160
33	24	25	0.1885	0.3292	0	0.300
34	25	26	0.2544	0.3800	0	0.300
35	25	27	0.1093	0.2087	0	0.300
36	28	27	0.0000	0.3960	0	0.300
37	27	29	0.2198	0.4153	0	0.300
38	27	30	0.3202	0.6027	0	0.300
39	29	30	0.2399	0.4533	0	0.300
40	8	28	0.0636	0.2000	0.0428	0.300
41	6	28	0.0169	0.0599	0.0130	0.300

Reference

- [1] H. P. Chao and H. G. Huntington, "Designing Competitive Electricity Markets", Kluwer Academic Publishers, 1998.
- [2] G. Rothwell and T. Gomez, "Electricity Economics: Regulation and Deregulation", John Wiley and Sons, 2003.
- [3] K. Bhattacharya, M. H. J. Bollen and J.E. Daalder, "Operation of Restructured Power Systems", Kluwer Academic Publishers, 2001.
- [4] D. Kirschen and G. Strbac, "Fundamental of Power System Economics", John Wiley and Sons, 2004.
- [5] M. Shahidehpour, H. Yamin, and Z. Li, "Market Operation in Electric Power System: Forecasting, Scheduling and Risk Management", John Wiley and Sons, 2002.
- [6] S. Haffner, L. F. A. Pereira, L. A. Pereira, and L. S. Barreto, "Multistage Model for Distribution Expansion Planning With Distributed Generation—Part I: Problem Formulation", *IEEE Trans. Power Del.*, Vol. 23, No. 2, pp. 915-923, April 2008.
- [7] R. Palma-Behnke, J. L. Cerda A., L. S. Vargas, and A. Jofré, "A Distribution Company Energy Acquisition Market Model With Integration of Distributed Generation and Load Curtailment Options", *IEEE Trans. Power Syst.*, Vol. 20, No. 4, Nov. 2005, pp. 1718-1727.
- [8] A. Keane, and M. O'Malley, "Optimal Allocation of Embedded Generation on Distribution Networks", *IEEE Trans. Power Syst.*, Vol. 20, No. 3, August 2005, pp. 1640-1646.
- [9] L. Philipson and H. L. Willis, "Understanding Electric Utilities and De-Regulation", volume 6 of *Power Engineering*. Marcel Dekker, New York, 1998.
- [10] H. L. Willis, "Power Distribution Planning Reference Book", 2nd ed New York: Marcel Dekker, 2004.
- [11] Hunt S, Shuttleworth G, "Competition and Choice in Electricity", Wiley, Chichester, 1996.
- [12] Hunt S, "Making Competition Work in electricity", Wiley, 2002.
- [13] R. C. Dugan, T. E. McDermott, and G. J. Ball, "Planning for distributed generation," *IEEE Industry Applications Magazine*, vol. 7, no. Issue: 2, March/April 2001, pp. 80-88.
- [14] R. C. Dugan, T. E. McDermott, and G. J. Ball, "Distribution planning for distributed generation," *Rural Electric Power Conference*, vol. C, 7-9 May 2000, pp. C4/1-C4/7.
- [15] G. W. Ault, C. E. T. Foote, and J. R. McDonald, "Distribution system planning in focus," *IEEE Power Engineering Review*, vol. 22, no. Issue: 1, January 2002, pp. 60-62.
- [16] T. W. Berrie, "Electricity Economics and Planning", *Power Engineering*. Peter Peregrinus, 1992.
- [17] H. L. Willis, Gregory V. Welch, and Randall R. Schrieber, "Aging Power Delivery Infrastructures", volume 12 of *Power Engineering*. Marcel Dekker, 2001.
- [18] M. Ponnaivaikko, K. S. P. Rao, and S.S. Venkata, "Distribution system planning through a quadratic mixed integer programming approach," *IEEE Transaction on Power Delivery*, vol. 2, no. 4, 1987, pp. 1157-1163.
- [19] S. K. Khator and L. C. Leung, "Power distribution planning: a review of models and issues," *IEEE Transactions on Power Systems*, vol. 12, Issue: 3, August 1997, pp. 1151-1159.
- [20] V. H. Quintana, H. K. Temraz, and K. W. Hipel, "Two-stage power system distribution planning algorithm", *IEE Proceedings-C*, vol. 140, no: Issue: 1, January 1993, pp. 17-29.
- [21] E. Van Geert, "Towards new challenges for distribution system planners," *14th International Conference and Exhibition on Electricity Distribution*. Part 1, vol. 6, no. IEE Conf. Publ. No. 438,2-5 June 1997, pp. 11/1-11/3.
- [22] T. Griffin, K. Tomsovic, D. Secrest, and A. Law, "Placement of dispersed generations systems for reduced losses," *Proceedings of the 33rd. Annual Hawaii International Conference on System Sciences*, January 2000, pp. 1446-1454.
- [23] P. P. Barker and R. W. De Mello, "Determining the impact of distributed generation on power systems. I. radial distribution systems," *IEEE Power Engineering Society Summer Meeting*, vol. 3, 2000, pp. 1645-1656.
- [24] Xu. Ding and A. A. Girgis, "Optimal load shedding strategy in power systems with distributed generation", *IEEE Power Engineering's 2001*, pp. 788-793.
- [25] N. Hadjsaid, J. F. Canard, and F. Dumas, "Dispersed generation impact on distribution networks", *IEEE Computer Applications in Power*, vol. 12, no. Issue: 2, April 1999, pp. 22-28.
- [26] L. Coles and R. W. Beck, "Distributed generation can provide an appropriate customer price response to help fix wholesale price volatility," *IEEE Power Engineering Society Winter Meeting*, vol. 1, 2001, pp. 141-143.
- [27] T. Gonen, "Electric Power Distribution System Engineering", McGraw Hill, 1986.
- [28] W. H. Kersting, "Distribution System Modeling and Analysis", Taylor & Francis Group, 2007.

- [29] O. Richardot, "Réglage Coordonné de Tension dans les Réseaux de Distribution à l'aide de la Production Décentralisée", Thèse de doctorat de l'INPG, octobre 2006.
- [30] R. Billinton, R.N. Allan, "Reliability Evaluation of Power Systems", Pitman Publishing Inc., 1984.
- [31] D.A. Arzamastev, A.V. Lipes, A.L. Mizin, "Models of Optimization of Power System Development", Vissaja Skola, 1987.
- [32] J. G. Sootweg, "Applicability of engineering design concepts to power system planning and operation," International Conference on Electric Utility Deregulation and Restructuring and Power Technologies, Proceedings. DRPT 2000, April 2000, pp. 566-571.
- [33] T. M. Taylor, H. L. Willis, and M. V. Engel, "New considerations for distribution network planning and design," CIREN. 14th International Conference and Exhibition on Electricity Distribution, Part 1: Contributions. (IEE Conf. Publ. No. 138), vol. 6, 1997, pp. 1/1-1/5.
- [34] T. Laine, M. Lehtonen, E. Antila, M. Seppänen, "Feasibility Study of DA in Rural Distribution Company", Proceedings of the DA/DSM Europe 96 Conference, Vienna, Austria, October 8-10 1996.
- [35] A.L. Shenkman, "Energy Loss Computation by Using Statistical Techniques", IEEE Transactions on Power Delivery, Vol.5, No.1, January 1990, pp.254-258.
- [36] R. N. Allan, M.G. Da Silva, "Evaluation of Reliability Indices and Outage Costs in Distribution Systems", IEEE Trans. On Power system, Vol. 10, No. 1, Feb. 1995, pp. 413-419.
- [37] W. El-khattam and M. M. A. Salama, "Impact of distributed generation on voltage profile in deregulated distribution system", Proceeding of the power systems, Clemson, SC, USA, March 2002.
- [38] A. Girgis and S. Brahma, "Effect of distributed generation on protective device coordination in distribution system," Conference on Large Engineering Systems, Power Engineering, LESCOPE '01, 2001, pp. 115-119.
- [39] D. Thirault, "Architectures des Réseaux de Distribution pour l'Electrification rurale des Pays en Développement", Thèse de doctorat de l'INPG, mars 2004.
- [40] W. El-Khattam, Y. G. Hegazy, and M.M.A Salama, "Stochastic power flow analysis of electrical distributed generation systems," IEEE Power Engineering Society Meeting, vol. 2, 2003, pp. 1141-1144.
- [41] W. El-Khattam, Y.G.Hegazy, and M.M.A Salama, "Stochastic estimation of the contribution levels of customer operated distributed generation," IEEE Power Engineering Society Meeting, June 2004, pp. 119-128.
- [42] W. El-Khattam, Y. Hegazy and M. M. A. Salama, "Investigating Distributed Generation Systems Performance Using Monte Carlo Simulation," IEEE Transactions on Power Systems, vol. 21, pp. 524-532, May 2006.
- [43] E. Lakervi, E. J. Holmes, "Electricity Distribution Network Design", 2nd ed. London, U.K.: IEE Power Ser. 21, 1995, p. 325.
- [44] H. K. Temraz and V. H. Quintana, "Distribution system expansion planning models: An overview," Elect. Power Syst. Res., vol. 26, pp. 61-70, 1993.
- [45] U. G. Knight, "The logical design of electrical networks using linear programming methods," Proc. Inst. Elect. Eng., vol. 33, pp. 306-314, 1960.
- [46] D. I. Sun, D. R. Farris, P. J. Cote, R. R. Shoults, and M. S. Chen, "Optimal distribution substation and primary feeder planning via the fixed charge network formulation," IEEE Trans. Power App. Syst., vol. PAS-101, no. 3, pp. 602-609, Mar. 1982.
- [47] M. A. El-Kady, "Computer-aided planning of distribution substation and primary feeders," IEEE Trans. Power App. Syst., vol. PAS-103, no. 6, pp. 1183-1189, Jun. 1984.
- [48] K. Aoki, K. Nara, T. Satoh, M. Kitagawa, and K. Yamanaka, "New approximate optimization method for distribution system planning," IEEE Trans. Power Syst., vol. 5, no. 1, pp. 126-132, Feb. 1990.
- [49] T. Gönen and B. L. Foote, "Mathematical dynamic optimization model for electrical distribution system planning," Elect. Power Energy Syst., vol. 4, no. 2, pp. 129-136, Apr. 1982.
- [50] I. J. Ramírez-Rosado and T. Gönen, "Pseudo-dynamic planning for expansion of power distribution systems," IEEE Trans. Power Syst., vol. 6, no. 1, pp. 245-254, Feb. 1991.
- [51] K. Nara, T. Satoh, K. Aoki, and M. Kitagawa, "Multi-year expansion planning for distribution systems," IEEE Trans. Power Syst., vol. 6, no. 3, pp. 952-958, Aug. 1991.
- [52] K. Nara, T. Satoh, H. Kuwabara, K. Aoki, M. Kitagawa, and T. Ishihara, "Distribution systems expansion planning by multi-stage branch exchange," IEEE Trans. Power Syst., vol. 7, no. 1, pp. 208-214, Feb. 1992.
- [53] H. Kuwabara, K. Nara, "Multi-year and multi-state distribution systems expansion planning by multi-stage branch exchange," IEEE Trans. Power Del., vol. 12, no. 1, pp. 457-463, Jan. 1997.
- [54] M. E. Baran, F. F. Wu, "Network reconfiguration in distribution systems for loss reduction and load balancing," IEEE Transactions on Power Delivery, pp. 1401-1407, Apr 1989.

- [55] D. Das, H. S. Negi, D.P Kothari, "Novel method for solving radial distribution networks", IEE Proceedings on Generation, Transmission and Distribution, pp. 291-298, July 1994.
- [56] A. G. Exposito, E. R. Ramos, "Reliable load flow technique for radial distribution networks," IEEE Transactions on Power Systems, Vol. 14, pp.1063-1069, Aug. 1999.
- [57] R. A. Jabr, "Radial distribution load flow using conic programming," IEEE Transactions on Power Systems, Vol. 21, pp. 1458-1459, August 2006.
- [58] Y. Deng, X. Ren, C. Zhao, and D. Zhao, "A heuristic and algorithmic combined approach for reactive power optimization with time-varying load demand in distribution systems", IEEE Transactions on Power Systems, Vol. 17, pp. 206-1231, Nov. 2002.
- [59] S. F. Mekhamer, S. A. Soliman, M. A. Moustafa, and M. E. El-Hawary, "Application of fuzzy logic for reactive-power compensation of radial distribution feeders", IEEE Transactions on Power Systems, Vol. 18, pp. 206-1231, February 2003,
- [60] G. K. V. Raju, and P. R. Bijwe, "An Efficient Algorithm for Minimum Loss Reconfiguration of Distribution System Based on Sensitivity and Heuristics", IEEE Transactions on Power Systems, vol. 23, no. 3, pp. 1280-1287, Aug. 2008.
- [61] A. Ahuja and A. Pahwa, "Using Ant Colony Optimization for Loss Minimization in Distribution Networks," Proceedings of the 37th North American Power Symposium, Iowa State University, pp. 470-474, Oct.2005
- [62] D. Zhang, Z. Fu, and L. Zhang, "Joint Optimization for Power Loss Reduction in Distribution Systems", IEEE Transactions on Power Systems, vol. 23, no. 1, pp. 161-169, Feb. 2008
- [63] N. S. Rau and Y.-H. Wan, "Optimum location of resources in distributed planning", IEEE Transactions on Power Systems, Vol. 9, pp. 2014-2020, Nov. 1994.
- [64] S. Mandal and A. Pahwa, "Optimal Selection of Conductors for Distribution Feeders," IEEE Transactions on Power systems, pp. 192-197, Feb.2002.
- [65] S. Sundhararajan and A. Pahwa, "Optimal selection of capacitors for radial distribution systems using a genetic algorithm," IEEE Transactions on Power Systems, Vol. 9, No. 3, pp.1499-1507, Aug. 1994
- [66] H. A. Gil and G. Joos, "On the quantification of the network capacity deferral value of distributed generation," IEEE Transactions on Power Systems, Vol. 21, pp. 1592-1599, Nov. 2006.
- [67] P. M. De Oliveira-De Jesús, M. T. Ponce de Leão, J. M. Yusta, H. M. Khodr, and A. J. Urdaneta, "Uniform marginal pricing for the remuneration of distribution networks," IEEE Transactions on Power Systems, Vol. 20, pp. 1302-1310, August 2005.
- [68] E. Carpaneto, G. Chicco, and J. S. Akilimali, "Branch current decomposition method for loss allocation in radial distribution systems with distributed generation," IEEE Transactions on Power Systems, Vol.21, pp.1170-1179, August 2006
- [69] S. Tong and K. N. Miu, "A network-based distributed slack bus model for DGs in unbalanced power flow studies," IEEE Transactions on Power Systems, Vol. 20, pp. 835-842, May 2005.
- [70] F. Abou Chacra, P. Bastard, G. Fleury, and R. Clavreul, "Impact of energy storage costs on economical performance in a distribution substation," IEEE Transactions on Power Systems, Vol. 20, pp. 684-691, May 2005.
- [71] P. M. Costa and M. A. Matos, "Loss allocation in distribution networks with embedded generation", IEEE Transactions on Power Systems, Vol. 19, pp. 384-389, February 2004,
- [72] M. Thomson and D. G. Infield, "Network power flow analysis for a high penetration of distributed generation", IEEE Transactions on Power Systems, vol. 22, pp. 1157-1162, Aug. 2007
- [73] H. Li, Y. Li, and Z. Li, "A multi-period energy acquisition model for a distribution company with distributed generation and interruptible load," IEEE Transactions on Power Systems, vol. 22, pp. 588-596, May 2007.
- [74] H. A. Gil, and G. Joos, "Customer-owned back-up generators for energy management by distribution utilities", IEEE Transactions on power systems, vol. 22, pp. 1044-1050, August 2007.
- [75] G. A. Jiménez-Estévez, R. Palma-Behnke, R. Torres-Avila, and L. Vargas, "A competitive market integration model for distributed generation", IEEE Transactions on power systems, vol. 22, no. 4, pp. 2161-2169, Nov2007.
- [76] M. E. Baran and I. M. El-Markabi, "A multiagent-based dispatching scheme for distributed generators for voltage support on distribution feeders," IEEE Transactions on power systems, vol.22, no.1, pp. 52-59, Feb 2007.
- [77] H. A. Gil, and G. Joos, "Models for Quantifying the Economic Benefits of Distributed Generation", IEEE Transactions on Power Systems, vol. 23, no. 2, pp. 327-335, May 2008
- [78] H.H. Zeineldin, K. Bhattacharya, E.F. El-Saadany and M.M.A. Salama, "Impact of intentional islanding of distributed generation on electricity market prices," IEE Proc.-Gener. Transm. Distrib., Vol. 153, No. 2, pp.147-154, March 2006.

- [79] C. Wang and M. H. Nehrir, "Analytical approaches for optimal placement of distributed generation sources in power systems", IEEE Transactions on Power Systems, Vol. 19, pp. 2068-2076, November 2004.
- [80] W. El-Khattam, Y. Hegazy and M. M. A. Salama, "An integrated distributed generation optimization model for distribution system planning," IEEE Transactions on Power Systems, vol. 20, pp. 1158-1165, May 2005.
- [81] W. El-Khattam, K. Bhattacharya, Y. Hegazy and M. M. A. Salama, "Optimal investment planning for distributed generation in a competitive electricity market," IEEE Transactions on Power Systems, vol. 19, pp. 1674-1684, August 2004.
- [82] J. M. Nahman, D. M. Peric, "Optimal Planning of Radial Distribution Networks by Simulated Annealing Technique", IEEE Transactions on Power Systems, vol. 23, no. 2, pp. 790-795, May 2008
- [83] A. Chowdhury, S. K. Agarwal, and D. O. Koval, "Reliability modeling of distributed generation in conventional distribution systems planning and analysis," IEEE Ind. Appl. Mag., vol. 39, no. 5, pp. 1493-1498, Sep. 2003.
- [84] S. McCusker and B. F. Hobbs, "A nested decomposition approach to locating distributed generation in a multiarea power system," Networks and Spatial Economics, vol. 3, no. 2, pp.197-223, Jun. 2003.
- [85] A. Agalgaonkar, S. Kulkarni, S. Khaparde, and S. Soman, "Placement and penetration of distributed generation under standard market design," International Journal of Emerging Electric Power Systems, vol. 1, no. 1, pp. 1-16, 2004.
- [86] T. Gomez, J. Rivier, "Distribution and Power Quality Regulation under Electricity Competition, A Comparative Study", Proceedings. Ninth International Conference on Harmonics and Quality of Power, 2000, Vol.2, pp. 462-468.
- [87] T.H. Fawzi, K.F. Ali, S.M. El-Sobki, "A New Planning Model for Distribution Systems", IEEE Transactions on Power Apparatus and Systems, Vol. PAS-102, No.9, September 1983.
- [88] Y. Tang, "Power Distribution System Planning with Reliability Modeling and Optimization", IEEE Transactions on Power Systems, Vol.11, No.1, February 1996, pp. 181-187.
- [89] G. Wacker, E. Wojczynski, R. Billinton, "Comprehensive Bibliography of Electrical Service Interruption Costs", IEEE Transactions on Power Apparatus, 1983, PAS-102(6), pp.1831-1837.
- [90] K.H. Cheong, P. Forsgren, "In Search of an Implementation Strategy for Distribution Management Functionality", Proceedings of the DA/DSM Europe 96 Conference, Vienna, Austria, October 8-10 1996.
- [91] M. E. Baran, F. F. Wu, "Optimal Sizing of Capacitors Placed on a Radial Distribution System", IEEE Transactions on Power Delivery, Vol.4, No. 1, January 1989, pp. 735-742.
- [92] R. Cherkaoui, A. Bart, A.J. Germond, "Optimal Configuration of Electrical Distribution Networks Using Heuristic Methods", 11th Power Systems Computation Conference (PSCC), Avignon, Switzerland, 1993.
- [93] Y.Y. Hsu, Y. Jwo-Hwu, "Planning of Distribution Substations, Feeders and Sectionalizing Switches Using Heuristic Algorithms", Electrical Power & Energy Systems, Vol.18, No.5, 1996, pp. 315-322.
- [94] J. Peco, E.F. Sanchez-Ubeda, T. Gomez, "Enhancing Optimal Transmission or Subtransmission Planning by Using Decision Trees", Proceedings of Budapest Power Tech, Budapest, September 1999.
- [95] J. Partanen, "A Modified Dynamic Programming Algorithm for Sizing, Locating and Timing of Feeder Reinforcements", IEEE Transactions on Power Delivery, Vol.5, No.1, January 1990, pp. 277-283.
- [96] V. Dale, Z. Krishan, O. Paegle, Dynamic Optimization of Power Networks Development, Zinatne, 1990.
- [97] Z. Krishans, V. Neimane, G. Andersson, "Dynamic model for planning of reinforcement investments in distribution networks", Power Systems Computation Conference (PSCC'99), Trondheim, Norway, June 1999.
- [98] V. Miranda, L.M. Proenca, L. Oliveira, L. Carvalho, "Dynamic Planning of Distribution Networks for Minimum Regret Strategies", 13th International Conference on Electricity Distribution (CIRED), Belgium, Liege, 1995.
- [99] I.J Ramirez-Rosado, J.A. Dominguez-Navarro, J.M. Yusta-Loyo, "A New Model for Optimal Electricity Distribution Planning Based on Fuzzy Set Techniques", IEEE/PES Summer Meeting, 1999, Vol. 2, pp. 1048-1054.
- [100] N. Kagan, R.N. Adams, "Application of Benders Decomposition Technique to the Distribution Planning Problem", Tenth Power System Computation Conference (PSCC), Graz, Austria, 19-24 August 1990.
- [101] P.M.S. Carvalho, L.A.F.M. Ferreira, "Planning Large-Scale Distribution Networks for Robust Expansion under Deregulation", IEEE/PES Summer Meeting, 2000.
- [102] K. Nara, A. Shiose, M. Kitagawa, T. Ishihara, "Implementation of Genetic Algorithm for Distribution Systems Loss Minimum Reconfiguration", IEEE Transactions on Power Systems, Vol.7, No.3, August 1992, pp. 1044-1051.

- [103] L.M. Proenca, "Towards a Comprehensive Methodology for Power System Planning", Doctoral dissertation at the University of Porto, Portugal, November 1997.
- [104] V. Miranda, L.M. Proenca, "A general Methodology for Distribution Planning under Uncertainty, Including Genetic Algorithms and Fuzzy Models in a Multi-Criteria Environment", IEEE/KTH Stockholm Power Tech Conference, Stockholm, Sweden, June 18-22, 1995, pp. 832-837.
- [105] F. Glover, "Future paths for Integer Programming and Links to Artificial Intelligence", *Computer and Operations Research*, Vol. 13, No.5, 1986, pp. 533-549.
- [106] V. Miranda, D. Srinivasan, L.M. Proenca, "Evolutionary Computation in Power Systems", *Power Systems Computation Conference (PSCC'96)*, Dresden, 1996.
- [107] V. Nissen, J. Propach, "On the Robustness of Population-Based Versus Point-Based Optimization in the Presence of Noise", *IEEE Transactions on Evolutionary Computation*, Vol.2, No.3, September 1998, pp.107-119.
- [108] Chang, N.B., Wen, C.G., Chen, Y.L., "A grey fuzzy multiobjective programming approach for the optimal planning of a reservoir watershed: B. Application", *Water Research* 30, 2335– 2340, 1996.
- [109] Brown, K., Adger, W.N., Tompkins, E., et al., "Trade-off analysis for marine protected area management", *Ecological Economics* 37, 417–434, 2001.
- [110] Prato, T., "Multiple-attribute evaluation of ecosystem management for the Missouri River system", *Ecological Economics* 45, 297– 309, 2003.
- [111] Hwang, C.L., Yoon, K., "Multiple Attribute Decision Making: Methods and Applications", Springer-Verlag, Berlin, 1981.
- [112] Lahdelma, R., Salminen, P., Hookkanen, J., "Using multicriteria methods in environmental planning and management", *Environmental Management* 26, 595– 605, 2000.
- [113] Alidi, A.S., "A multiobjective optimization model for the waste management of the petrochemical industry", *Applied Mathematical Modelling* 20, 925– 933, 1996.
- [114] Wen, C.G., Lee, C.S., "A neural network approach to multiobjective optimization for water quality management in a river basin", *Water Resources Research* 34, 427–436, 1998.
- [115] Chang, C.T., Hwang, J.R., "A multiobjective programming approach to waste minimization in the utility systems of chemical processes", *Chemical Engineering Science* 51, 3951– 3965, 1996.
- [116] Chang, N.B., Wei, Y.L., "Strategic planning of recycling drop-off stations and collection network by multiobjective programming", *Environmental Management* 24, 247–263, 1999.
- [117] Coello Coello, CA, "Comprehensive Survey of Evolutionary-Based Multiobjective Optimization Techniques", *International Journal of Knowledge and Information Systems*, 1999; 1(3):269-308.
- [118] Kyoto Protocol Reference Manual on Accounting of Emissions and Assigned Amounts December 1997.
- [119] A. J. Pansini, "Electrical Distribution Engineering", 3rd Edition, 2007.
- [120] M. Dicorato, G. Forte, M. Trovato, "Environmental-constrained energy planning using energy-efficiency and distributed-generation facilities", Elsevier, *Renewable Energy*, Volume 33, Issue 6, June 2008, Pages 1297-1313.
- [121] C. L.T. Borges, D. M. Falcão, "Optimal distributed generation allocation for reliability, losses, and voltage improvement", Elsevier, *International Journal of Electrical Power & Energy Systems*, Volume 28, Issue 6, July 2006, Pages 413-420.
- [122] Coello Coello, CA, Van Veldhuizen, DA, and Lamont, GB, "Evolutionary Algorithms for Solving Multi-Objective Problems", Kluwer Academic Publishers, New York, May 2002.
- [123] Coello Coello, CA, "A Comprehensive Survey of Evolutionary-Based Multiobjective Optimization Techniques", *Knowledge and Information Systems. An International Journal*, 1(3):269–308, August 1999.
- [124] Coello Coello, CA, M. Romero, CE, "Evolutionary Algorithms and Multiple Objective Optimization". In Ehrgott, M and Gandibleux, X (eds.), *Multiple Criteria Optimization: State of the Art Annotated Bibliographic Surveys*, pp. 277–331. Kluwer Academic Publishers, Boston, 2002.
- [125] Kuhn, HW and Tucker, AW, "Nonlinear programming", *Second Berkeley Symposium on Mathematical Statistics and Probability*, pp. 481–492, Berkeley, CA, 1951.
- [126] R. Caire, "Gestion de la production décentralisée dans les réseaux de distribution", Thèse de doctorat de l'INPG, Avril 2004.
- [127] Rao, SS, "Game theory approach for multiobjective structural optimization", *Computers and Structures*, 25(1):119–127, 1987.
- [128] Périaux, J, Sefrioui, M, Mantel, B, "GA multiple objective optimization strategies for electromagnetic back-scattering", *Recent Advances and Industrial Applications*, chapter 11, pp. 225–243, John Wiley and Sons, West Sussex, England, 1997.
- [129] Deb, K, "Solving goal programming problems using multi-objective genetic algorithms", *Congress on Evolutionary Computation*, pp. 77–84, Piscataway, NJ, July 1999.

- [130] Wienke, PB, Lucasius, C, and Kateman, G, "Multicriteria target optimization of analytical procedures using a genetic algorithm", *Analytical Chimica Acta*, 265(2):211–225, 1992.
- [131] Wilson, PB and Macleod, MD, "Low implementation cost IIR digital filter design using genetic algorithms", In *IEE/IEEE Workshop on Natural Algorithms in Signal Processing*, pp. 4/1–4/8, Chelmsford, U.K., 1993.
- [132] Zebulum, RS, Pacheco, MA, and Vellasco, M, "A multi-objective optimisation methodology applied to the synthesis of low-power operational amplifiers", *XIII International Conference in Microelectronics and Packaging*, volume 1, pp. 264–271, Curitiba, Brazil, August 1998.
- [133] Hajela, P and Lin, CY, "Genetic search strategies in multicriterion optimal design", *Structural Optimization*, 4:99–107, 1992.
- [134] Coello Coello, CA and Christiansen, AD, "Two new GA-based methods for multiobjective optimization", *Civil Engineering Systems*, 15(3):207–243, 1998.
- [135] Konstantinos E. Parsopoulos Michael N. Vrahatis, "Particle swarm optimization method in multiobjective problems", *ACM Symposium on Applied Computing (SAC'2002)*, pp. 603–607, Madrid, Spain, 2002.
- [136] Yaochu Jin, Tatsuya Okabe, Bernhard Sendhoff, "Dynamic weighted aggregation for evolutionary multiobjective optimization: Why does it work and how?", *Genetic and Evolutionary Computation Conference (GECCO'2001)*, pp. 1042–1049, San Francisco, California, 2001.
- [137] Indraneel Das and John Dennis, "A closer look at drawbacks of minimizing weighted sums of objectives for pareto set generation in multicriteria optimization problems", *Structural Optimization*, 14(1):63–69, 1997.
- [138] K. Miettinen. "Nonlinear Multiobjective Optimization", Kluwer Academic Publishers, Boston, Massachusetts, 1999.
- [139] Coello Coello, CA, "Treating Constraints as Objectives for Single-Objective Evolutionary Optimization. Engineering", *Optimization*, 32(3):275–308, 2000.
- [140] Goldberg, DE, "Genetic Algorithms in Search, Optimization and Machine Learning", Addison-Wesley Publishing Company, Reading, MA, 1989.
- [141] M. Vaziri, K. Tomsovic, and A. Bose, "A direct graph formulation of the multistage distribution expansion problem," *IEEE Trans. Power Del.*, vol. 19, no. 3, pp. 1335–1341, Jul. 2004.
- [142] M. Vaziri, K. Tomsovic, and A. Bose, "Numerical analyses of a direct graph formulation of the multistage distribution expansion problem," *IEEE Trans. Power Del.*, vol. 19, no. 3, pp. 1348–1354, Jul. 2004.
- [143] P. C. Paiva, H. M. Khodr, J. A. Domínguez-Navarro, J. M. Yusta, and A. J. Urdaneta, "Integral planning of primary-secondary distribution systems using mixed integer linear programming," *IEEE Trans. Power Syst.*, vol. 20, no. 2, pp. 1134–1143, May 2005.
- [144] H. K. Youssef and R. Hackam, "Dynamic solution of distribution planning in intermediate time range," *IEEE Trans. Power Del.*, vol. 3, no. 1, pp. 341–348, Jan. 1988.
- [145] M. A. Farrag, M. M. El-Metwally, and M. S. El-Bages, "A new model for distribution system planning", *Elect. Power Energy Syst.*, vol. 21, pp. 523–531, 1999.
- [146] M. Vaziri, K. Tomsovic, and T. Gönen, "Distribution expansion problem revisited: Part 2—Proposed modeling and formulation," in *Proc. 4th Int. Conf. Power Energy Systems*, Marbella, Spain, Sep. 19–22, 2000, pp. 283–290.
- [147] K. Nara, Y. Hayashi, S. Muto, and K. Tsuchida, "A new algorithm for distribution feeder expansion planning in urban area," *Elect. Power Syst. Res.*, vol. 46, pp. 185–193, 1998.
- [148] E. Míguez, J. Cidrás, E. Díaz-Dorado, and J. L. García-Dornelas, "An improved branch-exchange algorithm for large-scale distribution network planning," *IEEE Trans. Power Syst.*, vol. 17, no. 4, pp. 931–936, Nov. 2002.
- [149] V. Miranda, J. V. Ranito, L. M. Proença, "Genetic algorithms in optimal multistage distribution network planning," *IEEE Trans. Power Syst.*, vol. 9, no. 4, pp. 1927–1933, Nov. 1994.
- [150] I. J. Ramírez-Rosado, J. L. Bernal-Augustín, "Genetic algorithms applied to the design of large power distribution systems," *IEEE Trans. Power Syst.*, vol. 13, no. 2, pp. 696–703, May 1998.
- [151] I. J. Ramírez-Rosado, J. L. Bernal-Augustín, "Reliability and costs optimization for distribution networks expansion using an evolutionary algorithm," *IEEE Trans. Power Syst.*, vol. 16, no. 1, pp. 111–118, Feb. 2001.
- [152] E. Díaz-Dorado, J. Cidrás, and E. Míguez, "Application of evolutionary algorithms for the planning of urban distribution networks of medium voltage," *IEEE Trans. Power Syst.*, vol. 17, no. 3, pp. 1151–1159, Aug. 2002.
- [153] Y. Y. Hsu, J. L. Chen, "Distribution planning using a knowledge based expert systems," *IEEE Trans. Power Del.*, vol. 5, no. 3, pp. 1514–1519, Jul. 1990.

- [154] R. Ranjan, B. Venkatesh, D. Das, "A new algorithm for power distribution system planning", *Elect. Power Syst. Res.*, vol. 62, no. 1, pp. 55–65, 2002.
- [155] J. F. Gómez, H. M. Khodr, P. M. de Oliveira, L. Ocque, J. M. Yusta, R. Villasana, A. J. Urdaneta, "Ant colony system algorithm for the planning of primary distribution circuits," *IEEE Trans. Power Syst.*, vol. 19, no. 2, pp. 996–1004, May 2004.
- [156] V. Parada, J. A. Ferland, M. Arias, and K. Daniels, "Optimization of electrical distribution feeders using simulated annealing," *IEEE Trans. Power Del.*, vol. 19, no. 3, pp. 1135–1141, Jul. 2004.
- [157] N. G. Boulaxis and M. P. Papadopoulos, "Optimal feeder routing in distribution system planning using dynamic programming technique and GIS facilities," *IEEE Trans. Power Del.*, vol. 17, no. 1, pp. 242–247, Jan. 2002.
- [158] E. Díaz-Dorado and J. C. Pidre, "Optimal planning of unbalanced networks using dynamic programming optimization," *IEEE Trans. Power Syst.*, vol. 19, no. 4, pp. 2077–2085, Nov. 2004.
- [159] A. Augugliaro, L. Dusonchet, and E. R. Sanseverino, "An evolutionary parallel tabu search approach for distribution systems reinforcement planning," *Adv. Eng. Inform.*, no. 16, pp. 205–215, 2002.
- [160] O. M. Mikic, "Mathematical dynamic model for long-term distribution system planning," *IEEE Trans. on Power Systems*, vol. 1, no. 1, 1986, pp. 34-40.
- [161] M. Ponnavaikko and K. S. Prakasa Rao, "Optimal distribution system planning," *IEEE Transactions on PAS*, vol. 100, no. 6, 1981, pp. 2969-2976.
- [162] R. N. Adams and M. A. Laughton, "Optimal planning of networks using mixed- integer programming," *Proceedings of IEE*, vol. 121, no. 2, 1974, pp. 139-148.
- [163] D. M. Crawford and Jr. S. B. Holt, "A mathematical optimization technique for locating and sizing distribution substations, and deriving their optimal service areas," *IEEE Transactions on PAS*, vol. 94, no. 2, 1975, pp. 230-235.
- [164] D. L. Wall, G. L. Thompson, and J.E.D. Northcote-Green, "An optimization model for planning radial distribution networks," *IEEE Transactions on PAS*, vol. 98, no. 3, 1979, pp. 1061-1068.
- [165] G. L. Thompson and D. L. Wall, "A branch and bound model for choosing optimal substation locations," *IEEE Transactions on PAS*, vol. 100, no. 1981, pp. 2683-2687.
- [166] T. Gonen and B. L. Foote, "Distribution system planning using mixed integer programming," *IEE Proceedings-C*, vol. 128, no. 2, 1981, pp. 70-7.
- [167] M.A. Abu-El-Magd and W. T. Miller, "Application of optimization techniques to the long-range planning of distribution systems," 14th Annual Modeling and Simulation Conference, Pittsburgh, U.S.A, 1983.
- [168] T. Gonen and L. Ramirez-Rosado, "Review of distribution system planning models: a model for optimal multi-stage planning," *IEE Proceedings-C*, vol. 133, no. 7, 1986, pp. 397-408.
- [169] T. Gonen and L. Ramirez-Rosado, "Optimal multi-stage planning of power distribution systems," *IEEE Transactions on Power Delivery*, vol. 2, no. 2, 1987, pp. 512-519.
- [170] W. El-Khattam and M. M. A. Salama, "Distribution system planning using distributed generation," *IEEE Canadian Conference on Electrical and Computer Engineering, CCECE*, vol. 1, 4-7 May 2003, pp. 579-582.
- [171] G. Rackliffe, "Guidelines for planning distributed generation systems," *IEEE Power Engineering Society Summer Meeting*, vol. 3, 16-20 July 2000, pp. 1666-1667.
- [172] G. W. Ault, A. Cruden, and J. R. McDonald, "Specification and testing of a comprehensive strategic analysis framework for distributed generation," *IEEE Power Engineering Society Summer Meeting*, vol. 3, 16-20 July 2000, pp. 1817-1822.
- [173] G. W. Ault and J. R. McDonald, "Planning for distributed generation within distribution networks in restructured electricity markets," *IEEE Power Engineering Review*, vol. 20, no. Issue: 2, February 2000, pp. 52-54.
- [174] G. W. Ault, J. R. McDonald, and G. M. Burt, "Strategic analysis framework for evaluating distributed generation and utility strategies," *IEE Proceedings Generation, Transmission and Distribution*, vol. 150, no. Issue: 4, July 2003, pp. 475-481.
- [175] A. Silvestri, A. Berizzi, and S. Buonanno, "Distributed generation planning using genetic algorithms," *International Conference on Electric Power Engineering, PowerTech Budapest 99*, 29 Aug.-2 Sept. 1999, p. 257.
- [176] R. E. Brown, Pan Jiuping, Feng Xiaorning, K. Koutlev, "Siting distributed generation to defer T&D expansion", *IEEE/PES Transmission and Distribution Conference and Exposition*, vol. 2, 28 Oct.-2 Nov. 2001, pp. 622-627.
- [177] L. Jacobsson, "Impact of IT and DA for Utility Efficiency", *Proceedings of the DA/DSM Europe 96 Conference*, Vienna, Austria, October 8-10 1996.
- [178] M.T. Ponce de Leao, J.T. Saraiva, "A Simulated Annealing Approach to Evaluate Long Term Marginal

- Costs and Investment Decisions”, IEEE/PES Summer Meeting, 2000.
- [179] H.-D. Chiang, J.-C. Wang, J. Tong, G. Darling, “Optimal Capacitor Placement, Replacement and Control in Large-Scale Unbalanced Distribution Systems: Modeling and a New Formulation”, IEEE Transactions on Power Systems, Vol. 10, No.1, February 1995, pp. 356 –362.
- [180] H.-D. Chiang, J.-C. Wang, J. Tong, G. Darling, “Optimal Capacitor Placement, Replacement and Control in Large-Scale Unbalanced Distribution Systems: System Solution Algorithms and Numerical Studies”, IEEE Transactions on Power Systems, Vol. 10, No.1, February 1995, pp. 363 –369.
- [181] K. Nara, J. Hasegawa, “Configuration of New Power Delivery System for Reliable Power Supply”, IEEE/PES Summer Meeting, 1999, Vol. 1, pp. 248-253.
- [182] Z. Krishans, V. Bochkareva, G. Andersson, “Dynamic Model for Reinforcement Planning of Distribution System under Uncertainty”, Universities Power Engineering Conference (UPEC’97), Manchester, UK, September 1997, pp.1089-1092.
- [183] V. Nissen, “Evolutionary Algorithms in Management Science, An Overview and List of References”, University of Goettingen, Germany, 1993.
- [184] R.E. Brown, S. Gupta, R.D. Christie, S.S. Venkata, R. Fletcher, “Automated Primary Distribution System Design: Reliability and Cost Optimization”, IEEE Transactions on Power Delivery, Vol.12, No.2, April 1997, pp.1017-1022.
- [185] V. Miranda, L.M. Proenca, “Genetic Algorithms and Fuzzy Models - An Application to Gas and Electricity Distribution Planning Under Uncertainty”, RSSC’94, San Jose, California, USA, November 10-12, 1994, pp. 43-50.
- [186] P.Finlay, “Steps Towards Scenario Planning”, Engineering Management Journal, October 1998, pp.243-246.
- [187] H. K. Temraz and M. M. A. Salama, "A planning model for siting, sizing and timing of distribution substations and defining the associated service area", Electric Power Systems Research, vol. 62, 2002, pp. 145-151.
- [188] Z. Wang, H. Liu, D. C. Yu, X. Wang, H. Song, "A practical approach to the conductor size selection in planning radial distribution systems," IEEE Transactions on Power Delivery, vol. 15, no. Issue: 1, 2000, pp. 350-354.
- [189] A. Brooke, D. Kendrick, and A. Meeraus, GAMS -A User's Guide. The Scientific Press, 1988.
- [190] S. Porkar, A. Abbaspour-Tehrani-fard, S. Saadate, “An Approach to Distribution System Planning by Implementing Distributed Generation in a Deregulated Electricity Market”, Power Engineering, 2007 Large Engineering Systems Conference on 10-12 Oct. 2007 Page(s):90 - 95
- [191] A. M. Borbely, J. F. Kreider, “Distributed Generation, The power paradigm for the new millennium”, CRC Press, 2001.
- [192] S. Porkar, P. Poure, A. Abbaspour-Tehrani-fard, S. Saadate, “Distributed Generation Planning for Losses, Voltage Profile, Line Congestion and Total System Cost Improvement”, International Review of Electrical Engineering (IREE), Vol 4, No. 3, pp. 434-440, June 2009.
- [193] M. Shahidehpour and Y. Wang, "Communication and Control of Electric Power Systems," John Wiley and Sons, June 2003.
- [194] A. Y. Abdelaziz, H. E. A. Talaat, A. I. Nosseir and Ammar A. Hajjar, “An adaptive protection scheme for optimal coordination of overcurrent relays”, Electric Power Systems Research, Vol. 61, No. 1, pp 1-9, Feb. 2002.
- [195] M. C. Ferris, “MATLAB and GAMS: Interfacing optimization and visualization software”, Mathematical Programming Technical Report 98-19, Computer Sciences Department, University of Wisconsin, Madison, Wisconsin, 1998.
- [196] F. Milano, “A Graphical and Open Source Matlab-GAMS Interface for Electricity Market Models”, 9th Spanish Portuguese Congress on Electrical Engineering, 30 June - 2 July 2005, Marbella, Spain.
- [197] <http://powernext.fr/>
- [198] E. Carpaneto, G. Chicco, J. S. Akilimali, “Characterization of the loss allocation techniques for radial systems with distributed generation”, Elsevier, Electric Power Systems Research, Volume 78, Issue 8, August 2008, Pages 1396-1406.
- [199] W. El-Khattam, M.M.A. Salama, “Distributed generation technologies, definitions and benefits”, Elsevier, Electric Power Syst. Volume 71, Issue 2, October 2004, Pages 119-128.
- [200] J. H. Teng, C. N. Lu, “Optimum Fault Current Limiter Placement”, International Conference on Intelligent Systems Applications to Power Systems, Nov. 2007.
- [201] EPRI TR-111489, Integration of Distributed Resources in Electric Utility Systems: Current Interconnection Practice and Unified Approach, Electric Power Research Institute, Palo Alto, CA, 1998.
- [202] D. Arthur, “Distributed Generation: Understanding the Economics”, Little White Paper, 1999.
- [203] International Energy Agency, Organisation for Economic Co-operation, and Development, Distributed

- generation in liberalised electricity markets. Paris% France : OECD/IEA, 2002.
- [204] A. P. Sakis Meliopoulos, "Distributed energy source: Needs for analysis and design tools," in Proc. IEEE Vancouver Summer Meeting, Vancouver, BC, Canada, 2001.
- [205] B. Lasseter, "Microgrids [distributed power generation]," IEEE Power Engineering Society Winter Meeting, vol. 1, 2001, pp. 146-149.
- [206] R. H. Lasseter, "Control of distributed resources," Proceedings: Bulk Power System Dynamics and Control IV - Restructuring Conference, Organized by MEP and National Technical University of Athens, Santorini, Greece, vol. L. H. Fink, C.D. Vournas (Eds.), 24-28 August 1998, pp. 323-329.
- [207] <http://www.distributed-generation.com>, "Assessment of DG Technology Applications", Resource Dynamics Corporation, February 2001.
- [208] <http://www.distributed-generation.com>, "Distributed Generation: Securing America's Future with Reliable and Flexible Power", U.S. Department of Energy, Federal Energy Technology Center, October 1999.
- [209] Baghzouz, Y., "General rules for distributed generation - feeder interaction," Power Engineering Society General Meeting, 2006. IEEE , vol., no., pp. 4 pp.-, 18-22 June 2006.
- [210] Willis, H.L., "Analytical methods and rules of thumb for modeling DG-distribution interaction," Power Engineering Society Summer Meeting, 2000. IEEE , vol.3, no., pp.1643-1644 vol. 3, 2000.
- [211] IEEE 1547.1 < http://grouper.ieee.org/groups/scc21/dr_shared/ >
- [212] IEEE Std 1547.1-2005, "IEEE Standard Conformance Test Procedures for Equipment Interconnecting Distributed Resources with Electric Power Systems".
- [213] IEEE 1547.2 http://grouper.ieee.org/groups/scc21/1547.2/1547.2_archives.html
- [214] IEEE 1547.3 http://grouper.ieee.org/groups/scc21/1547.3/1547.3_index.html
- [215] IEEE 1547.6 <http://grouper.ieee.org/groups/scc21/1547.6/1547.6_index.html>
- [216] Borges, C.L.T.; Falcao, D.M., "Impact of distributed generation allocation and sizing on reliability, losses and voltage profile," Power Tech Conference Proceedings, 2003 IEEE Bologna , vol.2, no., pp. 5 pp. Vol.2-, 23-26 June 2003.
- [217] Le, A.D.T. Kashem, M.A. Negnevitsky, G. M. Ledwich, "Control Strategy of Distributed Generation for Voltage Support in Distribution Systems", International Conference on Power Electronics, Drives and Energy Systems, PEDES '06, pp.1-6, 12-15 Dec. 2006.
- [218] G. Rami, "Contrôle de tension auto adaptatif pour des productions décentralisées d'énergies connectées au réseau de distribution", Thèse de doctorat de l'INPG, 2006.
- [219] Chensong Dai, Y. Baghzouz, "Impact of distributed generation on voltage regulation by LTC transformer", 11th International Conference on Harmonics and Quality of Power, vol., no., pp. 770-773, 12-15 Sept. 2004.
- [220] Kashem, M.A. Ledwich, G., "Distributed generation as Voltage support for single wire Earth return systems," Power Delivery, IEEE Transactions on , vol.19, no.3, pp. 1002-1011, July 2004.
- [221] Kashem, M.A. Ledwich, G., "Multiple Distributed Generators for Distribution Feeder Voltage Support," Energy Conversion, IEEE Transaction on , vol.20, no.3, pp. 676-684, Sept. 2005.
- [222] Dai, C.; Baghzouz, Y., "On the voltage profile of distribution feeders with distributed generation," Power Engineering Society General Meeting, 2003, IEEE , vol.2, no., pp.-1140 Vol. 2, 13-17 July 2003.
- [223] T.E. Kim, J.E.Kim, "Voltage regulation coordination of distributed generation system in distribution system", IEEE Power Engineering Society Summer Meeting, vol.1., pp.480-484, vol.1, 2001.
- [224] <http://www.energy.ca.gov/distgen/economics/operation.html>
- [225] <http://www.solarbuzz.com/DistributedGeneration.htm>
- [226] W. Clark, "The Next California Economy: Hybrid Technologies", Governor's Office of Planning and Research State of California.