



HAL
open science

A two-stage thermal modification of wood

Michiel Boonstra

► **To cite this version:**

Michiel Boonstra. A two-stage thermal modification of wood. Other. Université Henri Poincaré - Nancy 1, 2008. English. NNT : 2008NAN10002 . tel-01748345

HAL Id: tel-01748345

<https://hal.univ-lorraine.fr/tel-01748345>

Submitted on 29 Mar 2018

HAL is a multi-disciplinary open access archive for the deposit and dissemination of scientific research documents, whether they are published or not. The documents may come from teaching and research institutions in France or abroad, or from public or private research centers.

L'archive ouverte pluridisciplinaire **HAL**, est destinée au dépôt et à la diffusion de documents scientifiques de niveau recherche, publiés ou non, émanant des établissements d'enseignement et de recherche français ou étrangers, des laboratoires publics ou privés.



AVERTISSEMENT

Ce document est le fruit d'un long travail approuvé par le jury de soutenance et mis à disposition de l'ensemble de la communauté universitaire élargie.

Il est soumis à la propriété intellectuelle de l'auteur. Ceci implique une obligation de citation et de référencement lors de l'utilisation de ce document.

D'autre part, toute contrefaçon, plagiat, reproduction illicite encourt une poursuite pénale.

Contact : ddoc-theses-contact@univ-lorraine.fr

LIENS

Code de la Propriété Intellectuelle. articles L 122. 4

Code de la Propriété Intellectuelle. articles L 335.2- L 335.10

http://www.cfcopies.com/V2/leg/leg_droi.php

<http://www.culture.gouv.fr/culture/infos-pratiques/droits/protection.htm>



Faculteit Bio-ingenieurswetenschappen
Faculty of Bioscience Engineering

GENT UNIVERSITY

Faculty of Bioscience Engineering

Department of Forest and water management

Laboratory of Wood Technology

Discipline : Wood Science

THESIS in cosupervision Belgium -
France

To obtain the rank of

**DOCTOR of GENT UNIVERSITY and
of the UNIVERSITY HENRI
POINCARÉ – NANCY 1**

Presented and defended in public by



UNIVERSITÉ

HENRI POINCARÉ – NANCY 1

Ecole Nationale Supérieure des Technologies
et Industries du Bois

Laboratoire d'Études et de Recherche
sur le Matériau Bois – UMR INRA/UHP
1093

École Doctorale RP2E

Discipline : Sciences du bois

THÈSE en co-tutelle France - Belgique

pour obtenir le grade de

**DOCTEUR de l'UNIVERSITÉ
HENRI POINCARÉ – NANCY 1
et de l'UNIVERSITÉ GENT**

et soutenue publiquement par

Michiel Boonstra

Title / Titre

**A two-stage thermal modification of wood
*Une modification thermique du bois en deux étapes***

Supervisors of thesis / Directeurs de thèse

Pr Joris Van Acker : Professor, Ghent University, Belgium

Pr Antonio PIZZI : Professeur, Université Henri Poincaré – Nancy 1 – ENSTIB, France

Date de la soutenance : 18 janvier 2008 à Gent, Belgium

President / Président :

Reporters / Rapporteurs:	Holger Militz	Professor Göttingen University, Germany
	Anton Broekhuis	Professor Groningen University, The Netherlands
Inspectors / Examineurs:	Norbert De Kimpe	Professor Gent University, Belgium
	Marc Stevens	Professor Gent University, Belgium
	Chris Stevens	Professor Gent University, Belgium
	Monica Höfte	Professor Gent University, Belgium
	Philippe Gerardin	Professeur, Université Henri Poincaré, France
	Antonio Pizzi	Professeur, Université Henri Poincaré, France

Promotors / Directeurs de Thèse:

Joris Van Acker
Professor, Ghent University - Laboratory of Wood Technology, Belgium

Antonio Pizzi
Professeur, Henri Poincaré University - Nancy 1 - ENSTIB, France

Reporters / Rapporteurs:

Holger Militz Professor Georg August University Göttingen, Germany
Anton Broekhuis Professor Groningen University, the Netherlands

Examinators / Examineurs

Norbert De Kimpe Professor Ghent University, Belgium
Marc Stevens Professor Ghent University, Belgium
Chris Stevens Professor Ghent University, Belgium
Monica Höfte Professor Ghent University, Belgium
Philippe Gerardin Professor Henri Poincaré University, France



A two-stage thermal modification of wood

by

Michiel Boonstra

Thesis in cosupervision Belgium - France submitted in fulfilment of the requirements for the degree of Doctor (Ph.D.) in Applied Biological Sciences: Soil and Forest management

Thèse en co-tutelle France - Belgique pour obtenir le grade de docteur de l'Université Henry Poincaré - Nancy 1

On the authority of president

Prof. Dr. Paul Van Cauwenberge, Ghent University

Prof. Dr. Jean-Pierre Finance, Henri Poincaré University - Nancy 1



Faculteit Bio-Ingenieurswetenschappen
Faculty of Bioscience Engineering

French translation of the title:

Une modification thermique du bois en deux étapes

Dutch translation of the title:

Een twee-staps thermische modificatie van hout

Boonstra M.J. 2008 A two-stage thermal modification of wood. Ph.D. dissertation in cosupervision Ghent University and Université Henry Poincaré - Nancy 1, 297 p.

ISBN 978-90-5989-210-1

The author and the promotors give the authorisation to consult and to copy parts of this work for personal use only. Every other use is subject to the copyright laws. Permission to reproduce any material contained in this work should be obtained from the author.

ABSTRACT

English

Thermal modification or heat treatment is an effective method to improve the dimensional stability and biological durability of wood. An undesired side effect is the reduction of mechanical properties of wood, mainly due to the high temperatures involved (150-280°C). In this thesis the effects of heat treatment on wood properties are discussed in relation to anatomical and molecular changes found in wood after heat treatment. The results are based on investigations of a full-scale industrial heat treatment method under relative mild conditions (< 200°C) including a moist and dry treatment stage. Several changes and/or modifications of the main components of wood (cellulose, hemicelluloses and lignin) appear to be involved in the effects of heat treatment on important wood properties like dimensional stability, strength/stiffness and biological durability. Although the effect of heat treatment on the anatomical structure of wood is limited, changes have been found affecting the properties of wood. This thesis provides a better understanding of thermal modification, which probably contributes to a more controlled use of heat-treated wood in service conditions.

Français

La modification thermique est une façon efficace de améliorer la stabilité dimensionnelle et la durabilité biologique du bois. Un effet non souhaité est la réduction des propriétés mécaniques du bois, due principalement à l'effet de la haute température (150°-280°C) utilisée. Les effets du traitement thermique sur le propriétés du bois ont été présentées et discutées en cette thèse en relation avec les changements soit au niveau anatomiques soit au niveau moléculaire. Les résultats présentes ont été bases sur de la recherche effectuées au niveau de un procédé industriel de traitement thermique du bois sur de conditions de chauffage relativement douces (< 200°C) comprenant de un traitement en milieu humide suivi de un traitement en milieu sec. Plusieurs changements ou modifications des constituants principaux du bois (cellulose, hémicelluloses et lignine) en conséquence du traitement thermique semblent influencer des importantes propriétés macroscopiques du bois telle que sa stabilité dimensionnelle, sa résistance mécanique et sa durabilité aux attaques biologiques. Bien que l'effet du traitement thermique sur la structure anatomique du bois est limité, les changement qui ne dérivent influencent les propriétés du bois. La thèse donne une base plus complète à la compréhension au traitement thermique du bois qui en toute probabilité contribue à une utilisation plus contrôlée de son utilisation en service.

Nederlands

Thermische houtmodificatie is een effectieve methode om de dimensiestabiliteit en duurzaamheid tegen biologische aantasting te verbeteren. Helaas leidt een thermische modificatie ook tot reductie van de mechanische eigenschappen van hout, met name veroorzaakt door de hoge temperaturen die bij thermische modificatie gebruikt worden (150-280°C). In dit proefschrift worden de effecten van thermische modificatie op de eigenschappen van hout beschreven en gerelateerd aan anatomische en moleculaire veranderingen in hout na thermische modificatie. De resultaten zijn gebaseerd op een industriële thermische modificatie methode bestaande uit een natte en een droge verhitte waarbij gebruik wordt gemaakt van relatief milde proces condities (<200°C). Veranderingen en/of modificaties van de belangrijkste houtcomponenten (cellulose, hemicelluloses en lignine) blijken van invloed te zijn op de effecten van thermische modificatie op belangrijke houteigenschappen zoals dimensiestabiliteit, sterkte/stijfheid en duurzaamheid tegen biologische aantasting. Alhoewel een thermische modificatie slechts een beperkt effect heeft op de anatomische structuur van hout, hebben deze anatomische veranderingen toch een effect op de houteigenschappen. Dit proefschrift kan leiden tot een beter begrip van de processen die tijdens thermische houtmodificatie plaatsvinden en wat waarschijnlijk zal bijdragen aan een verantwoord gebruik van thermisch behandeld hout.

Keywords: thermal wood modification, heat treatment, hygroscopicity, dimensional stability, durability, strength, stiffness, cellulose, hemicelluloses, lignin

PREFACE

In 1996 Henk Groeneveld asked me to work for the Plato Hout BV company in their development centre in Wageningen. In those days I was working for TNO Centre for Timber Research doing projects on wood modification, preservative treatment and environmental pollution of preservative treated wood. Plato Hout BV was just founded and its main activities were the optimisation and commercialisation of the Plato[®]Process, an innovative thermal modification process invented and patented by Shell. Because commercial alternatives for tropical hardwood species and traditional preservative treated timber were still in its infancy it was a challenge to work on the development of a wood modification method like the Plato[®]Process. The upgrading of fast-grown and non-durable wood species into a durable and dimensional stable wood product with low environmental impact could be the answer to the increasing demand for sustainable (wood) products.

Together with an enthusiastic crew I have been working on the development of the Plato[®]Process making it suitable for industrial application. This included optimisation of the Plato[®]Process for different softwood and hardwood species, testing of the wood species treated (e.g. durability against fungal attack, dimensional stability, strength), determining the effect of process variables on wood properties, product development (e.g. paint-ability, glue-ability, certification) and development of new wood based products (e.g. panel products, wood plastic composites). Based on the process developed in the pilot plant of Plato Hout BV in Wageningen a commercial plant was build in 1999/2000 in Arnhem called Plato Holland Production BV. This company started the commercial production of Plato[®]Wood for the Dutch and German market in 2000. This company went bankrupt in 2001 due to several management mistakes, such as an unrealistic market introduction (35,000 m³ Plato[®]Wood timber in the second production year), and the purchase of large quantities of timber with a quality not useful for the Dutch market. Under the leadership of Henk Groeneveld and Edo Kegel a group of key employees of the Plato companies realised a new start of the Plato[®]Wood production facilities. Together with a group of dedicated private investors Plato International BV was founded and in the spring of 2002 Plato was back in business. A realistic business plan was used as a guide and a powerful dealer network was selected to sell Plato[®]Wood on the Dutch, German, Belgium and British market. This resulted in a steady increase of the Plato[®]Wood sales number with a volume of approximately 10,000 m³ in 2006.

In 2004 Tony Pizzi contacted me about a joint publication on a research project we completed in 1999. While writing the manuscript the idea was born to do a PhD and in Tony Pizzi and Joris Van Acker two excellent supervisors were found. Personally I always wanted to do a doctorate in wood technology after finalising my MSc study Biology in Wageningen. Furthermore, since 1996 I have worked on several projects related to the Plato heat treatment technology, including

international and national projects. Most of the results of these projects were never published in scientific papers, although they were very promising. From a scientific point of view a PhD was a good opportunity for me to investigate two important questions:

1. What happens in wood during thermal treatment; and
2. How does it affect wood properties?

I hope this thesis and the papers published so far give a useful answer to these two questions and provide a basis of knowledge about heat treatment and especially the Plato[®]Process. It also shows that Plato International BV is aware of its responsibility with respect to knowledge transfer of its technology and product properties.

I am grateful that Plato International BV offered me the opportunity to do a PhD and to publish lots of its intellectual property. Therefore many thanks to Nikel Lambrechtsen, general director of Plato International BV, and Edo Kegel, managing director of Plato International BV.

I also want to thank everyone of the old and new Plato crew who were/are dedicated to make this innovative technology to a success. Special thanks to Gerard Pott, Henk Groeneveld and Volker Aurich; the three Shell managers who have founded Plato Hout BV in 1995 and succeeded in the commercialisation of the Plato technology. Without them no Plato[®]Wood products were available on the market right now. My thoughts are with Herman Ruyter, Frans Zomers and George Adamson; they worked hard on the Plato project but, unfortunately, they are no longer there anymore.

Special thanks also to Jan Rijdsdijk, my guide in wood anatomy and wood technology who has been of great importance to Plato with his advises on the Plato process. Many thanks to Bert Hanekamp for helping me to prepare the test material making life much more easier. Of course, I also want to thank Bôke Tjeerdsma, my scientific partner in several projects, and the SHR-crew for doing lots of test work for Plato.

Finally I want to thank my supervisors, Tony Pizzi and Joris Van Acker for their inspiring contribution and discussions, which resulted in this thesis.

The thesis is dedicated to my father and mother, to both my sisters, to my wife and her family, to my beautiful two sons, and last but not least to my friends. They all have supported me great during my PhD-study.

LIST OF PAPERS

This thesis is based on the following 13 papers:

Boonstra MJ, Rijdsdijk JF, Sander C, Kegel E, Tjeerdsma BF, Militz H, Van Acker J, Stevens M (2006a) Microstructural and physical aspects of heat-treated wood. Part 1. Softwoods. *Maderas. Ciencia y tecnología*. 8:193-208 (Chapter 2)

Boonstra MJ, Rijdsdijk JF, Sander C, Kegel E, Tjeerdsma BF, Militz H, Van Acker J, Stevens M (2006b) Microstructural and physical aspects of heat-treated wood. Part 2. Hardwoods. *Maderas. Ciencia y tecnología*. 8:209-217 (Chapter 3)

Tjeerdsma BF, Boonstra M, Pizzi A, Tekely P, Militz H (1998a) Characterisation of thermally modified wood: molecular reasons for wood performance improvement. *Holz als Roh- und Werkstoff* 56:149-153 (Chapter 4)

Boonstra MJ, Tjeerdsma BF (2006) Chemical analysis of heat-treated softwoods. *Holz als Roh und Werkstoff* 64:204-211 (Chapter 5)

Boonstra MJ, Van Acker J, Kegel E, Stevens M (2007c) Optimisation of a two-stage heat treatment process. Durability aspects. *Wood Science and Technology* 41(1):31-57 (Chapter 6)

Boonstra MJ, Pizzi A, Rigolet S (2006c) Correlation of ¹³C NMR analysis with fungal decay tests of polymeric structural wood constituents. I. Basidiomycetes. *Journal of Applied Polymer Science* 101:2639-2649 (Chapter 7)

Boonstra MJ, Pizzi A, Rigolet S (2006d) Correlation of ¹³C NMR analysis with fungal decay tests of polymeric structural wood constituents. II. Ground contact tests. *Journal of Applied Polymer Science* 102:616-622 (Chapter 8)

Boonstra MJ, Van Acker J, Tjeerdsma BF, Kegel E (2007a) Strength properties of thermally modified softwoods and its relation to polymeric structural wood constituents. *Annals of Forest Science* 64: 679-690 (Chapter 9)

Boonstra MJ, Van Acker J, Kegel E (2008) The effect of a two-stage heat treatment process on the mechanical properties of full construction timber. Accepted for publication in *Wood Material Science and Engineering* (Chapter 10)

List of papers

Boonstra MJ, Blomberg J (2007) Semi-isostatic densification of heat-treated radiata pine. *Wood Science and Technology* 41: 607-617 (Chapter 11)

Boonstra M, Pizzi A, Ganne-Chedeville C, Properzi M, Leban JM, Pichelin F (2006e) Vibration welding of heat-treated wood. *Journal of Adhesion Science and Technology* 20(4):359-369 (Chapter 12)

Boonstra MJ, Pizzi A, Zomers F, Ohlmeyer M, Paul W (2006f) The effects of a two-stage heat treatment process on the properties of particleboard. *Holz als Roh- und Werkstoff* 64:157-164 (Chapter 13)

Boonstra MJ, Van Acker J, Pizzi A (2007c) Anatomical and molecular reasons for property changes of wood after full-scale industrial heat treatment. Paper of the 3rd European conference on wood modification ECWM3 Cardiff, 15-17 October 2007. ISBN 184-220-096-8

These papers are integrated as separate chapters using the original text. However, those paragraphs that were already detailed in an earlier chapter are no longer included. For each chapter the paper considered is mentioned in a footnote. The chapters are combined in three parts:

Part I. Molecular and physical characterisation of heat-treated wood

Part II. Properties of heat-treated wood

Part III. Innovative applications of thermal modification

Each part contains an introductory page and a summary.

TABLE OF CONTENTS

Abstract	7
Preface	9
List of papers	11
Table of contents	13
Summary	17
Résumé.....	25
Samenvatting	33
1 Introduction	41
1.1 Wood modification.....	41
1.2 The Plato treatment.....	44
1.3 Objectives and limitations.....	47
 PART I MOLECULAR AND PHYSICAL CHARACTERISATION OF HEAT TREATED WOOD	
2 Microstructural and physical aspects of heat-treated softwoods	51
2.1 Introduction	52
2.2 Materials and Methods.....	52
2.3 Results and discussion.....	54
2.4 Conclusions.....	65
3 Microstructural and physical aspects of heat-treated hardwoods	67
3.1 Introduction	68
3.2 Materials and Methods.....	68
3.3 Results and discussion.....	68
3.4 Conclusions.....	74
4 A solid-state ¹³C-NMR study of heat-treated wood	75
4.1 Introduction	76
4.2 Materials and Methods.....	76
4.3 Results and discussion.....	76
4.4 Conclusions.....	82
5 Chemical analysis of heat-treated softwoods	83
5.1 Introduction	84
5.2 Materials and Methods.....	84

Table of contents

5.3 Results and discussion.....	87
5.4 Conclusions.....	93
Summary of Part I	95
PART II PROPERTIES OF HEAT-TREATED WOOD	
6 Durability of heat-treated wood against fungal decay	101
6.1 Introduction	102
6.2 Materials and methods.....	103
6.3 Results	105
6.4 Discussion.....	113
6.5 Conclusions.....	122
7 Correlation of ¹³C-NMR analysis with fungal decay tests: Basidiomycetes	125
7.1 Introduction	126
7.2 Materials and Methods.....	126
7.3 Results and discussion.....	128
7.4 Conclusions.....	139
8 Correlation of ¹³C-NMR analysis with fungal decay tests: Ground contact tests ..	141
8.1 Introduction	142
8.2 Materials and methods.....	142
8.3 Results and discussion.....	143
8.4 Conclusions.....	150
9 Strength properties of heat-treated softwoods	153
9.1 Introduction	154
9.2 Materials and methods.....	154
9.3 Results	156
9.4 Discussion.....	163
9.5 Conclusions.....	171
10 mechanical properties of heat-treated full size construction timber	173
10.1 Introduction	174
10.2 Materials and methods.....	174
10.3 Results	178
10.4 Discussion.....	182
10.5 Conclusions.....	184
Summary of Part II	187
PART III INNOVATIVE APPLICATIONS OF THERMAL MODIFICATION	
11 Semi-isostatic densification of heat-treated radiata pine.....	197
11.1 Introduction	198
11.2 Materials and methods.....	198
11.3 Results	200
11.4 Discussion.....	203
11.5 Conclusions.....	206

12 Vibration welding of heat-treated wood	207
12.1 Introduction	208
12.2 Materials and methods.....	208
12.3 Results and discussion.....	210
12.4 Conclusions.....	214
13 The effect of heat treatment on the properties of particleboard	215
13.1 Introduction	216
13.2 Materials and methods.....	216
13.3 Results and discussion.....	218
13.4 Conclusions.....	228
Summary of Part III	229
14 Utilisation potential and perspectives	233
14.1 Material properties	234
14.2 Dimensions and wood quality.....	239
14.3 Environmental profile.....	240
14.4 Market aspects.....	241
Reference list	247
Annex 1. Chemical composition of wood	267
Annex 2. Examples of different projects in the Netherlands	271
Annex 3. FTIR analysis of heat-treated wood	277
Annex 4. Curriculum vitae	293

SUMMARY

Thermal modification or heat treatment is a technology, which enables the upgrading of lower durability softwood and hardwood species into wood products of constant quality. Heat-treated wood products can be used for a broad range of applications such as garden fences and channel linings or even cladding, decking and exterior joinery. The main effect gained by a heat treatment of wood is reduced wood hygroscopicity. Foremost advantages of wood treated in this manner are increased resistance to different types of biodegradation and improved dimensional stability. However, originally some undesired side effects, in particular loss of strength and increased brittleness of the treated wood were the main objections for overall commercial utilisation of heated timber. Development of suitable thermal modification techniques is in essence optimisation of the process for a maximum increase of the dimensional stability and durability, while minimising the decrease of the strength. The Plato process embodies an effective two-stage process under relatively mild conditions (<200°C) minimising these disadvantages and hence yielding more noticeable and consistent improvements. This effective heat treatment method includes:

1. a hydro-thermolysis stage, the timber is heated to 150°C-180°C in an aqueous environment at superatmospheric pressure; and
2. a curing stage, the timber is heated once again to 150°C-190°C, but now under dry and atmospheric conditions;

Experimental work revealed the hydro-thermolysis stage to be the most critical process stage in the two-stage heat treatment method, affecting both wood quality and wood properties. Variations of the process conditions (e.g. temperature, effective process time) during the hydro-thermolysis stage showed a larger impact on the quality and properties of treated wood than variations during the curing stage. For this reason much attention has been focussed on the development of the first treatment stage and its effect on the anatomical structure and wood properties.

In order to optimise the process it is of considerable importance to understand which modifications and reactions occur in wood resulting in environmental and performance advantages of heat-treated wood. In this thesis the effects of the two-stage heat treatment on primary wood properties are discussed in relation to the chemical and physical changes of wood after heat treatment. This provides a better understanding of thermal modification, which probably contributes to a more controlled use of heat-treated timber in service conditions.

Microstructural, physical and chemical aspects of thermal modification

Microstructural and physical changes of wood after heat treatment

The wood colour after the first treatment stage (hydro-thermolysis) varies from light to dark brown, caused by the formation of quinones or the caramellisation of holocellulose components. An increase of the treatment temperature changed the colour into a darker tinge. Most of the colour changes occur during the hydro-thermolysis, whereas treatment of wood specimens without the first treatment stage (only the curing) resulted in a light brown colour, much lighter than after the hydro-thermolysis. The colour change also depends on the timber species used and appears to be correlated to the density of the wood since the colour is becoming darker with an increasing density. A microscopic analysis revealed that the colour of the cell wall changes from white to brown. This colour change involves both the compound middle lamella and the secondary cell wall. This is believed to be due to the formation of reaction products in the cell wall or to the diffusion of such reaction products within the cell wall.

The effects of heat treatment on the anatomical structure of wood are rather limited, although this depends on the wood species considered and on the process method and conditions used. Softwood species with narrow annual rings and/or an abrupt transition from earlywood into latewood are sensitive to tangential cracks in the latewood section. Radial cracks occur mainly in impermeable wood species such as Norway spruce, caused by large stresses in the wood structure during treatment. Sapwood of treated pine species reveal some damage to parenchyma cells in the rays and epithelial cells around resin canals, whereas this phenomenon has not been noticed in the heartwood section. Treated radiata pine results in a very open and permeable wood structure limiting the applications of this species.

Hardwood species such as beech and poplar are predominantly sensitive to collapse of the vessels and some deformation of the libriform fibres directly near the vessels. In treated beech and birch radial cracks are observed near the rays. Optimisation of the process conditions including the application of a steam hydro-thermolysis stage reduced such damages to a minimum.

Broken cell walls perpendicular to the fibre direction resulting in transverse ruptures have been noticed in treated softwood and hardwood species. This contributes to abrupt fractures of treated wood as observed in bending tests, which can lead to considerably different failure behavior after impact or mechanical stress. In some treated softwood and hardwood species maceration (small cracks between tracheids) was noticed after heat treatment. Heat treatment does not cause damage to the ray parenchyma pit membranes, bordered pits and large window pit membranes; the margo fibrils appear without damage.

Chemical changes of wood after heat treatment

In the moist treatment stage, the hydro-thermolysis, hemicelluloses are depolymerised by hydrolysis reactions to oligomers and monomers. This involves cleavage of the sidechain constituents (arabinose and galactose), followed by degradation of the main chain constituents (mannose, glucose and xylose). The

corresponding pentoses and hexoses are dehydrated to respectively furfural and hydroxymethylfurfural. Other aldehydes such as formaldehyde have also been found due to cleavage of the carbohydrates C6 as well as from the C γ of lignin. Furthermore, cleavage of acetic acid from acetyl side chains of hemicelluloses occurs and reduces the acetyl content of wood. The degradation of the hemicelluloses and the release of acids depend on the process conditions applied, such as process temperature and treatment time. However, it appears that it is the process temperature and possibly the corresponding pressure, which play an important role in the degradation of hemicelluloses during the hydro-thermolysis stage. The presence of water is important since less degradation of the hemicelluloses is observed under dry and atmospheric conditions. Furthermore, hydronium ions generated by water autoionization and acetic acid cleavage are thought to act as catalysts in the reaction mechanism of the hydro-thermolysis stage.

The hydro-thermolysis stage did not result in cellulose degradation, whereas during the curing stage some (amorphous) cellulose degradation is observed. An increase of the relative amount of crystalline cellulose is observed, but it can be questioned whether this is due to degradation or to crystallization of amorphous cellulose (or both).

During heat treatment lignin can be subject to degradation, but also to condensation or repolymerisation reactions. The covalent bonds between lignin and hemicelluloses will be broken and low molecular weight lignin fragments with high reactivity are produced. Demethylation or more likely demethoxylation of the methoxy groups at the C3 position of the aromatic nuclei of lignin has been observed during the hydro-thermolysis treatment stage. This results in a higher number of aromatic lignin sites available for reactions and an increased reactivity of the aromatic nuclei of lignin. An increase in the proportion of methylene bridges connecting two phenolic nuclei has been noticed. Formaldehyde and furfuraldehyde, which are produced during the hydro-thermolysis stage, are the likely contributors to the formation of these methylene bridges. Lignin cleavage at the O4 and at the C α of some lignin units appears to occur followed by autocondensation of the reactive -CH $_2$ group formed with a free reactive site on the phenolic nuclei of another lignin unit. In ^{13}C -NMR spectra of treated wood a decrease of the C=O peak at 175 ppm (esters and/or organic acids) is observed after the hydro-thermolysis stage whereas this peak increased after the curing stage. Since the aldehyde and ketone peaks at respectively 190 and 200 ppm are unchanged this favours the formation of esters and/or organic acids during the curing stage (or both). Interesting are the UV absorption spectra of the secondary cell wall and middle lamella, before and after heat treatment. The UV spectrum of the secondary cell wall shows a clear increase of the maximum absorption at 280 nm, much higher than that of the middle lamella. This can be caused by condensation reactions in which the lignin complex is involved and/or to the formation of other aromatic structures during heat treatment, such as furfural and hydroxymethylfurfural. The secondary cell wall contains more hemicelluloses than

the middle lamella and thermal depolymerisation results in a higher production of furfural from them.

The autocondensation and/or repolymerisation reactions as described above have been noticed during the hydro-thermolysis stage and continue during the curing stage resulting in new lignin based polymers and/or in an increased cross-linking of the existing lignin network.

Durability against fungal attack

Many organisms can deteriorate wood and fungal decay is the prominent kind of microbiological deterioration since it can cause (a rapid) structural failure. Heat treatment appears to be an effective method to improve the resistance against fungal attack. Heat-treated radiata pine sapwood revealed a clear improvement of the resistance against the brown rot fungus *Coniophora puteana* and a limited resistance against *Poria placenta* attack. Increasing process temperature and/or effective process time during the first process stage, the hydro thermolysis, appear to have a positive effect on the resistance against *C. puteana* attack, but the effect on the resistance against *P. placenta* was rather limited. Heat-treated radiata pine showed a limited resistance against the white rot fungus *Coriolus versicolor* and process variations during the hydro thermolysis stage appear not to affect this resistance. A clear difference between the resistance of heat-treated Scots pine sapwood and heartwood against fungal attack is observed. Scots pine heartwood showed a higher resistance against *C. puteana* and *P. placenta* but also against the white rot fungus *C. versicolor*.

Heat-treated birch showed an improved resistance against *C. puteana* attack, especially when higher temperatures during the hydro-thermolysis stage were used. A clear improvement of the durability was also observed after exposure to the white rot fungi *C. versicolor* and especially *Stereum hirsutum*. However, in contrast to *C. puteana* the effect of a higher process temperature during the hydro thermolysis stage on the resistance against *C. versicolor* attack was only limited.

Heat-treated radiata pine and Norway spruce were still susceptible for mold growth on the wood surface, probably due to the formation of hemicelluloses degradation products (e.g. sugars) during heat treatment. Remarkable is the absence of blue stain fungi on heat-treated wood specimen, also because the abundant blue stain fungi were observed on untreated specimen.

Fungal decay is a very complex process and depends on the fungi (brown rot, white rot and/or soft rot) and wood species involved, wood structures, (micro)environments, as well as interactive competition between fungi. During decay the main wood components (cellulose, hemicelluloses and lignin) are depolymerised and/or modified in order to provide energy and metabolites for fungal growth. Other important requirements for fungal growth are the occurrence of free water and oxygen, a favourable pH and temperature, the occurrence of chemical growth factors, and the absence of toxic extractives. Since heat treatment improves the resistance against biodegrading organisms it must affect one or more essential conditions for fungal growth. Possible effects of heat treatment on these conditions are discussed in detail in Part II of this thesis.

A solid-state CP MAS ^{13}C -NMR study of heat-treated Norway spruce revealed similarities but also clear differences after exposure to brown-rot and white-rot fungi when compared to untreated Scots pine sapwood. Brown rot fungi appear to have a preference to attack the carbohydrates at C4 and especially C1 cleaving the skeleton of cellulose and glucomannans. In untreated Scots pine sapwood this attack mainly occurred at C4, the non-reducing end of the glucose unit. Attack on the out of the ring alcoholic group CH_2OH of the carbohydrates of heat-treated Norway spruce is observed but less obvious than in untreated Scots pine. Remarkable is the attack on the C3/C5 of the carbohydrates, indicating ring opening of the glucose units, which was not observed in untreated Scots pine sapwood. Lignin degradation is limited to demethoxylation and low or no aromatic ring opening is observed, even after exposure to the white-rot fungus *C. versicolor*. Fungal exposure in ground contact revealed an attack of the carbohydrates of heat-treated wood at C1 and possibly at C4 in order to cleave and eventually depolymerise cellulose and hemicelluloses. An attack on the out of the ring alcoholic group, $-\text{CH}_2\text{OH}$, of the carbohydrates was also observed. The opening of the glucose pyranose ring in heat-treated simaruba after ground contact exposure, not observed in untreated simaruba, was remarkable. Demethoxylation and some ring opening of the aromatic structure of lignin have been observed, for treated and untreated wood species.

Physical properties

One of the most striking effects of heat treatment is a reduction of the hygroscopicity while the typical sigmoid curve of the water sorption isotherm is maintained. This reduces the overall swelling and shrinkage of wood, hence improving its dimensional stability. Molecular reasons for this improvement are discussed in part I of this thesis.

A material property, which is clearly altered during heat treatment, is the density of wood. The main reasons for the decrease of the density of wood after heat treatment are: the degradation of wood components (mainly hemicelluloses) into volatile products, which evaporate during treatment; the evaporation of extractives; and a lower equilibrium moisture content since heat-treated wood is less hygroscopic.

Mechanical properties

The two-stage heat treatment method revealed a clear effect on the mechanical properties of wood. The tensile strength parallel to the grain shows a large decrease and it is expected that also the shear strength reduces after heat treatment. On the other hand, the compressive strength parallel to the fibre and hardness increases after heat treatment. The bending strength, which is a combination of the three primary stresses (tensile, compressive and shear stress), is lower after heat treatment. However, this decrease is not as high as the decrease of only the tensile strength. An increase of the modulus of elasticity (MOE) during the bending test has been noticed, whereas the impact strength shows a rather large decrease after heat treatment.

The mechanical properties of wood are closely related to the moisture content of the timber. Heat treatment provides a positive contribution to the mechanical strength properties since heat-treated wood is less hygroscopic and the (maximum) amount of bound water is reduced.

The main components of the cell wall (cellulose, hemicelluloses and lignin) contribute in different degree to the strength of wood. Degradation and/or modification of these components and microstructural changes during heat treatment appear to affect the mechanical properties of wood. Possible effects are discussed in Part II of this thesis.

Large-scale experiments of full construction Norway spruce timber revealed a decrease of the bending strength after heat treatment, much higher than the decrease of defect free specimens. The effect of natural defects, such as knots, resin pockets, deviating slope of grain and reaction wood, on the mechanical properties of timber appears to be affected by heat treatment. At failure heat-treated timber reveals a rather large and abrupt fracture, whereas untreated timber shows a more gradual decrease of the stress. The external forces heat-treated wood can bear after initial failure are much lower than for untreated wood. Broken cell walls perpendicular to the grain could be the cause for this phenomenon. Changes of the main wood components might also be involved, especially degradation of the carbohydrates and/or crystallization of amorphous cellulose (making wood more brittle). The displacement until failure is much lower for heat-treated timber confirming a rather stiff and brittle character. Contrary to the bending strength the modulus of elasticity of full construction timber is still increased after heat treatment.

The effect of a three-year period of outdoor exposure on the strength properties of heat-treated Norway spruce timber was limited. Especially for the 5%-value low strength range where wood defects strongly determines the mechanical properties of timber, a three-years outdoors exposure did not change the bending strength and modulus of elasticity of heat-treated timber.

Novel applications of thermal modification

Densification

Compression in the transverse directions is a method to increase the density of wood in order to improve its mechanical properties, such as strength and stiffness. A major disadvantage of this method is the recovery of the original dimensions when densified wood is exposed to moisture (swelling due to cell wall bulking and cell-shape recovery). It was expected that heat treatment, which improves the dimensional stability of wood, could provide a fixation effect for densified wood when exposed to moisture. Unfortunately, heat treatment did not prevent shape-recovery when densified radiata pine was exposed to moisture. Densification was performed before (after the hydro-thermolysis stage), during (combination of densification and curing) and after the curing stage. In all cases a clear shape-recovery of densified radiata pine was visible, although some improvement (less

swelling) was observed for the specimens, which were densified before and during the curing stage.

Vibration welding

Vibration welding of heat-treated wood indicated that such wood could weld and yield welded joints of acceptable strength. The joints strength is, however, markedly lower than what obtained when welding untreated timber. In general, weld strength of the timber is poor if welding is done on hydro-thermolysed wood. The strength results are instead much better if welding is done at the end of the complete heat treatment process (including the curing stage).

Panel products

Panel products like particleboards are subject to reversible and/or irreversible thickness swelling under wet and moist conditions. Heat pre-treatment of wood particles (a mixture of Norway spruce and Scots pine) resulted in an improved dimensional stability of a melamine ureum formaldehyde (MUF) based particleboard. Variations of the process conditions (e.g. process time and temperature) showed an effect on the swelling properties of the particleboard. Variation in hydro-thermolysis conditions, especially the effective process temperature, resulted in greater impact on the swelling properties than variation in curing conditions. Remarkable is the swelling of particleboard made with particles, which were only thermolysed (without a curing). The reduction in swelling is increased compared to the standard treatment with a curing stage, especially after a longer immersion period in water and after the cyclic test.

Heat pre-treatment results in a reduction of the internal bond (dry and after a cyclic V313 test), probably due to the reduction of shear strength of the wood particles. After the boiling test (V100) the internal bond is similar or slightly higher than for the untreated reference. The treatment without curing gave the best internal bond strength results, significantly higher than a full treatment.

The adhesive system does have a rather marked effect on the swelling properties of the particleboards, mainly caused by the intrinsic differences between the adhesive systems used: MUF, methyl diphenyl diisocyanate (MDI), phenol-formaldehyde (PF) and tannin. MUF and MDI gave the best results after 24 hours immersion in cold water. The swelling of the PF- and Tannin-bonded particleboards were significantly higher. The swelling of the boards after the cyclic test, however, shows no significant differences between the adhesive systems used, although the swelling of MUF-bonded particleboards was slightly higher than for the other three adhesive systems. The rather high swelling observed for the boards bonded with phenol-formaldehyde adhesive after immersion in water might be due to the curing mechanism active during pressing. The internal bond properties showed some minor differences in the adhesive system used, although the internal bond of the tannin-bonded particleboard appears to be lower than the other three systems.

RESUMÉ

Le traitement et modification thermique du bois est une des techniques permettant la revalorisation d'espèces résineuses et feuillus non durables en produits bois de qualité constante utilisables pour une gamme d'applications variées. L'effet principale du traitement thermique est la réduction de sa hygroscopicité. Autres importants avantages du bois traite de cette façon sont sa résistance à des types différents de biodégradation et l'amélioration de sa stabilité dimensionnelle. Néanmoins, des effets collatérales non désirés, plus particulièrement diminution de la résistance mécanique et une plus grande fragilité du bois traite thermiquement ont été les empêchement plus importantes à l'utilisation commerciale des cette technique. L'optimisation commerciale du procédé de traitement thermique dépende donc de la maximisation de la stabilisation dimensionnelle et de la biodurabilité du bois en minimisant la diminution de sa résistance mécanique. Le procédé Plato qui inclus un traitement en deux étapes à des conditions douces (< 200°C) minimise les effets adverses résultants en une amélioration plus évidente et plus constante. Cet méthode efficace de traitement thermique inclue:

1. Une étape dite de hydrothermolyse, pendant la quelle le bois est chauffé à 150°-180°C en milieu aqueux à pression plus haute que la pression atmosphérique.
2. Une deuxième étape dite ce durcissement, pendant la quelle le bois est à nouveau chauffé à 150°-190°C mais en milieu sec et à pression atmosphérique.

Le travail expérimental a montre que l'étape de hydrothermolyse est la plus critique du procédé, influencent soit la qualité du produit fini soit les propriété du bois. Les variations des conditions de hydrothermolyse (pour exemple, température, temps de traitement) ont montre une influence bien plus marquée que les conditions pendant la phase de durcissement. Donc, beaucoup plus d'attention a été focalisée sur l'optimisation de la première étape de traitement et sur ces effets sur les propriétés du bois et sur sa structure anatomique.

La compréhension des modifications et réactions chimiques qui résultent sur les propriétés améliorées du bois est essentielle pour l'optimisation du procédé. La thèse présente et discute les effets du procédé thermique à deux étapes sur les propriétés du bois et le met en relation avec les changements chimiques et physiques des quels ils dérivent. Cette étude donne donc une meilleure compréhension de la modification thermique du bois qui contribue à une utilisation bien plus contrôlée de son utilisation dans les conditions de service.

Aspects microstructuraux, physiques et chimiques du traitement thermique du bois

Changements physiques et microstructuraux du bois après traitement thermique

La couleur du bois après l'étape de hydrothermolyse peut varier de marron clair à marron plus ou moins foncé, ceci étant la conséquence de la formation de quinones et/ou de la caramélisation de la holocellulose. Plus haute la température du traitement, plus foncé est la couleur du bois qui en résulte. La plus grande partie des changements de couleur se passent pendant l'étape de hydrothermolyse, tandis que un traitement thermique sec seulement (durcissement) donne une couleur bien plus claire que après une étape de hydrothermolyse. Le changement de la couleur dépend aussi de l'espèce de bois et est corrélé à la densité du bois traité parce que la couleur devient plus foncée plus haute est la densité de l'espèce de bois utilisée. L'analyse au microscope du bois traité montre que c'est la couleur de la paroi cellulaire même qui change de clair à marron. Le changement de couleur est observé soit pour la paroi cellulaire secondaire, soit pour la lamelle moyenne. La raison a été attribuée soit à la génération des produits de réaction soit par leur diffusion dans la paroi cellulaire.

L'effet du traitement thermique sur la structure anatomique du bois est assez limité, bien que il dépende du type de bois utilisé, du type de procédé thermique et des conditions utilisées. Résineux avec des petits anneaux de croissance et/ou une transition brutale entre bois d'été et d'hiver sont sensibles à la formation de fissures tangentielles dans le bois d'hiver. Des fissures se présentent dans la direction radiale principalement pour des espèces de bois comme l'épicéa et sont la conséquence de un stress important de la structure du bois pendant le traitement thermique. L'aubier des espèces de pins traitées montre aussi quelque endommagement aux cellules du parenchyme des rayons et des cellules épithéliales autour des canaux résineux. Le même n'a pas été observé pour le duramen des mêmes espèces. Le pin radiata traité thermiquement possède une structure du bois très ouverte et perméable qui limite les applications de cette espèce.

Feuillus, comme l'hêtre et le peuplier, sont en prédominance sensibles au collapsus des vaisseaux cellulaires et à la déformation des fibres libriformes en proximité de ces vaisseaux. Pour l'hêtre et le bouleau traité thermiquement des fissures radiales sont observées près des rayons. L'optimisation des conditions du procédé qui a été effectuée, incluant l'utilisation de vapeur dans la phase de hydrothermolyse, a minimisé ce type de dommage.

Des parois cellulaires cassées normales à la direction de la fibre et qui résultent en des ruptures transversales ont été notées soit en résineux soit en feuillus traités thermiquement. Ceci contribue aux fractures soudaines qui ont été observées pour le bois traité thermiquement en essais de flexion et qui peuvent conduire à une variété considérable de comportements de défaillance suite à des impacts ou un stress mécanique. Pour certaines espèces de bois des petites fissures

entre les trachéides ont été notées après les traitement thermique. Le traitement thermique n'endommage pas aucune des membranes.

Changements chimiques du bois après le traitement thermique

Les réactions et modifications suivant ont été suivies par CP-MAS RMN au C13. Pendant l'étape humide de hydrothermolyse les hémicelluloses dépolymérisent à oligomères et monomères par des réactions d'hydrolyse. Les constituants des chaînes latérales (arabinose et galactose) sont coupés, ceci étant suivi de la dégradation des constituants des chaînes squeletales principales (mannose, glucose, et xylose). Les pentoses et hexoses hydratent à furfural et hydroxyméthyl furfural. Des autres aldéhydes telle que la formaldéhyde ont été observées, parce que les carbohydrates ont été coupés au C6 et la lignine au C γ . En plus, formation d'acide acétique par hydrolyse des groupes acétyles des hémicelluloses est observées, donc une diminution du contenu en acétyle groupes du bois. Le niveau de dégradation des hémicelluloses et la formation de l'acide dépendent des conditions opératoires du traitement thermique comme la température et le temps de traitement. La température du procédé et possiblement la pression qui l'accompagne semblent être des paramètres importants pour la dégradation des hémicelluloses pendant l'étape de hydrothermolyse. La présence d'eau a une importance primordiale vu que la dégradation est bien moins importante quand le traitement est fait à sec et à pression atmosphérique. En outre, les ions hydronium générés par l'auto ionisation de l'eau et par la formation d'acide acétique semblent agir comme des catalyseurs du mécanisme réactionnel pendant l'étape de hydrothermolyse.

L'étape de hydrothermolyse ne conduit pas à dégradation de la cellulose, tandis que quelque dégradation de la cellulose amorphe est observée pendant l'étape de durcissement. Donc, une augmentation de la proportion de cellulose cristalline est observée, mais est à débattre si ceci est due à la dégradation ou à la cristallisation ultérieure de la cellulose, ou au deux.

Pendant le traitement thermique la lignine peut subir quelque dégradation, mais aussi peut subir des réactions de condensation et repolymérisation. Les liaisons covalentes entre lignine et hémicelluloses se cassent et cette réaction produit des fragments de lignine de bas poids moléculaire et de haute réactivité. Perte de groupes méthyles et plus probablement de groupes méthoxyles au site C3 de l'anneau aromatique de la lignine a été observée pendant la phase de hydrothermolyse. Le résultat est une plus haute proportion de sites aromatiques libres de la lignine capables de réagir, et donc une réactivité accrue de la lignine même. Une augmentation de la proportion des ponts méthylènes(-CH₂- et -CHR-) entre des cycles aromatiques a été observée par RMN. La formaldéhyde et le furfural produits par hydrothermolyse sont le contribuable plus probables à la formations de ces ponts méthylènes. Clivage au O4 et au C α de quelque type de unité de lignine a été observée suivie par l'auto-condensation des sites réactifs formes au -CH₂ avec les sites réactifs libres de l'anneau aromatique de une autre unité de lignine. Le CP-MAS RMN au C13 a montré une diminution de la bande à 175 ppm du C=O (esters ou acides organiques) après l'étape de hydrothermolyse.

Au contraire cette bande augmente après la deuxième phase de durcissement à sec. Parce que les carbonyles des aldéhydes et cétones qui se présentent autour de 190 à 200 ppm restent de la même intensité, le changement du C=O à 175 ppm que on note indique que ceci est un acide libre (acide acétique) ou un ester. Les spectres UV de la parois cellulaire secondaire et de la lamelle moyenne (intercellulaire), avant et après le traitement thermique, sont d'intérêt. Les spectres UV de la parois cellulaire secondaire montrent une augmentation bien définie du maximum d'absorption à 280 nm, bien plus intense que pour le cas de la lamelle moyenne. Les causes peuvent être des réactions de condensation de la lignine et/ou la formation de autres structures aromatiques telles que le furfural et l'hydroxyméthyl furfural (la formation des deux dernier déjà observée par RMN). Parce que la parois cellulaire secondaire est plus riche en hémicelluloses que la lamelle moyenne la dépolymérisation thermique porte à une production de furfural plus importante.

On a notes les réactions d'auto condensation et/ou repolymérisation comme décrites ci-dessus pendant la phase de hydro-thermolyse et elles continuent pendant la phase de durcissement avec par effet la formation de nouveaux types de polymères de lignine et un niveau accru de réticulation du réseau de la lignine pre-existent.

Durabilité à la dégradation fongique

Plusieurs organismes peuvent attaquer et dégrader le bois et la dégradation fongique est une cause prédominante de défaillance parce que il peut conduire rapidement à une défaillance structurale. Le traitement thermique semble être une méthode efficace pour améliorer la résistance du bois à l'attaque fongique. Pour exemple, le pin radiata a montre une amélioration évidente de sa résistance à l'attaque de la pourriture brunâtre *Coniophora puteana* et une résistance limitée a *Poria placenta*. Une augmentation de la température ou du temps du traitement pendant la première étape de hydrothermolyse semble influencer la résistance du bois à l'attaque de la *C. puteana*, mais son influence sur la résistance à la *P. placenta* est très limitée. Le pin radiata traite thermiquement a montre une résistance assez limitée à la pourriture blanchâtre *Coriolus versicolor* et des variation de procédé pendant l'hydrothermolyse ne semblent pas influencer sa résistance a ce type de pourriture. On observe une différence nette entre la résistance à l'attaque aux champignons de l'aubier et du duramen de pin. Le duramen du pin montre une résistance supérieure pas seulement à *C. puteana* et *P. placenta* mais aussi à la pourriture blanche *C. versicolor*.

Le boulot traite thermiquement montre une résistance accrue à *C. puteana*, en particulier quand des températures plus élevées sont utilisées pendant la hydro-thermolyse. On observe aussi une amélioration nette de la durabilité à l'attaque des pourritures blanches *C. versicolor* et en particulier *Stereum hirsutum*.

Néanmoins, à différence de *C. puteana*, l'effet de une plus haute température de traitement pendant la hydro-thermolyse est assez limite sur la résistance à *C. versicolor*.

Le pin radiata et l'épicéa présentent encore de moisissures sur la surface du bois, probablement due à la formation de produits de dégradation provenant des

hémicelluloses (sucres) pendant le traitement thermique. C'est intéressant que il n'y a pas la présence de taches bleues sur le bois traites quand ce type d'attaque est très évident sur la surface du bois non traite.

La dégradation fongique est un procédé très complexe et dépend du type de pourriture (blanchâtre, brunastre ou molle) et de l'espèce de bois, du type de structure, du micromilieu et aussi sur la compétition interactive des différents types de pourriture. Les constituants principaux du bois (cellulose, hémicelluloses et lignine) dépolymérisent ou sont modifiés pendant la dégradation fongique pour donner énergie et métabolites à la croissance fongique. Autres nécessités importantes pour la croissance fongique sont la présence d'eau libre et d'oxygène, de un pH et d'une température favorables, la présence de facteurs chimiques de croissance et l'absence d'extractibles toxiques. Parce que le traitement thermique améliore la résistance aux organismes de biodégradation il doit influencer un ou plusieurs des paramètres nécessaires pour la croissance fongique. Les effets du traitement thermique qui sont possibles pour freiner la croissance fongique ont été décrits en détail dans la deuxième partie de cette thèse.

Une étude comparative par CP-MAS RMN au C13 de du pin et de l'épicéa traites thermiquement a montre des similarités mais aussi des différences après l'exposition à l'attaque de pourritures blanchâtres et brunastres. Les pourritures brunastre préfèrent attaquer les carbohydrates au C4 et in particulier au C1 avec le conséquent clivage du skelete de la cellulose et des glucomannans. Pour l'aubier du pin sylvestre l'attaque est principalement dirige au C4, la terminaison non-reductive de l'unité repetente de glucose dans la chaîne. L'attaque sur le C6 du groupe $-CH_2OH$ externe à l'anneau pyranose des carbohydrates peut être observe pour l'épicéa mais est moins évident que pour le pin sylvestre non traite. A noter est aussi l'attaque au C3/C5 des carbohydrates qui indique l'ouverture des un nombre de anneaux pyranoses, attaque qui n'est pas observe pour le pin sylvestre non traite. La dégradation de la lignine est limitée à la demetoxylation, et l'ouverture de l'anneau aromatique n'est pas observée ou pas nombreuse, même après l'exposition à l'attaque de la pourriture blanchâtre *Coriolus versicolor*.

Exposition du bois traite thermiquement à l'attaque fongique au contact avec le sol, l'essai le plus sévère, a montre des attaque au C1 et possiblement C4 des carbohydrates pour dépolymériser cellulose et hémicelluloses. Dans ce cas aussi un attaque sur le C6 du groupe $-CH_2OH$ externe à l'anneau pyranose des carbohydrates est observe. L'ouverture de l'anneau pyranose du glucose pour le simaruba traite thermiquement après essais au contact avec le sol est observée très clairement, ouverture que n'est pas observée du tout pour le simaruba non traite. Apres des essais au contact avec le sol soit demetoxylation soit quelque ouverture des anneaux aromatiques de la lignine ont été également observes, soit pour de bois traites et non traites.

Propriétés physiques

Un des effets plus importants du traitement thermique est la réduction de la hygroscopticité du bois néanmoins que la courbe sigmoïdale caractéristique de

l'absorption d'eau du bois est maintenue. Le résultats est une réduction du gonflement et de la contraction du bois, donc une meilleur stabilité dimensionnelle. Une autre propriété qui change en conséquence du traitement thermique est la densité du bois. Les raisons de cette diminution sont: la dégradation des constituants du bois (principalement les hémicelluloses) et la conséquente formation de produits volatiles qui évaporent pendant le traitement; l'évaporation des extractibles; et une humidité d'équilibre plus basse parce que le bois traite thermiquement est moins hygroscopique.

Propriétés mécaniques

Le traitement thermique en deux étapes montre un effet bien défini sur les propriétés mécaniques du bois. La résistance mécanique à la traction dans la direction du fil diminue fortement et on attend que la contrainte de cisaillement diminue aussi après le traitement thermique. Au contraire, la résistance mécanique à la compression dans la direction du fil et la dureté du bois augmentent après le traitement thermique. La résistance à la flexion qui est la combinaison de trois stress différents (traction, compression et cisaillement) baisse après le traitement. Cette diminution n'est pas cependant importante comme la diminution de la résistance à la traction. La valeur du module de élasticité (MOE) augment pendant les essais en flexion, tandis que la résistance à un impact diminue après le traitement thermique.

Les propriétés mécaniques du bois sont corrélées de façon étroite avec l'humidité relative du bois. Le traitement thermique résulte en une contribution positive à la résistance mécanique du bois parce que après traitement le bois est moins hygroscopique et donc la proportion maximale d'eau liée est réduite.

Les constituants principaux de la parois cellulaire du bois (cellulose, hémicelluloses et lignine) contribuent à un niveau différent à la résistance mécanique du bois. Quiconque dégradation ou modification de ces constituants et de leur microstructure pendant le traitement thermique influencent les propriétés mécaniques du bois. Les effets qui ne résultent ont été discutés en détail dans la deuxième partie de cette thèse.

Des expériences à grande échelle sur de l'épicéa pour construction industrielle ont révèle une diminution de la résistance à la flexion après le traitement thermique plus grande que la diminution notée sur du bois sans défaut. L'effet des défauts naturels tel que nœuds, poches de résine, déviation du fil du bois et bois de réaction est influence par le traitement thermique. Au moment de sa défaillance, quand on le casse, le bois traite thermiquement présente une fracture soudaine, tandis que le bois non traite montre une diminution du stress bien plus graduelle. Les forces qui le bois traite peut résister après se défaillance initiale sont bien plus basses du bois non traite. Des parois cellulaires cassées en direction perpendiculaire à la direction du fil du bois peuvent être les causes de cette observation. Des changement des les constituants principaux du bois peuvent aussi y participer, en particulier la dégradation des carbohydrates et/ou la cristallisation des parte de la cellulose amorphe, qui donnent au bois une fragilité accrue.

L'effet de trois ans de exposition au climat sur la résistance mécanique d'épicéa traite thermiquement a été trouvée limitée. En particulier pour le 5 percentile des valeur plus bas de résistance mécanique, ou les défauts déterminent les propriétés mécaniques du bois, une exposition au climat extérieur de trois ans n'a pas change soit la résistance à la flexion soit le module d'élasticité du bois traite thermiquement.

Applications nouvelles de la modification thermique

Densification

Compression du bois dans sa direction transversale est une méthodologie reconnue pour accroître la densité du bois et donc améliorer ses propriétés mécaniques, comme sa résistance mécanique et raideur. Un désavantage majeur de cet approche est la récupération des dimensions originaires du bois quand le bois densifie est en milieu humide (gonflement due à la récupération des dimension et forme des parois cellulaires). On attendait que le traitement thermique qui améliore la stabilité dimensionnelle du bois, pourrait aussi fixer les parois cellulaires dans leur forme déformée, et limiter le gonflement du bois en milieu humide. Malheureusement le traitement thermique n'est pas été capable de éliminer la récupération de forme de la parois cellulaire quand le pin radiata utilise pour cette expérience a été expose à une humidité plus haute. La densification a été essayée avant (après la phase de hydrothermolyse), pendant (par densification et durcissement combines) et après la phase ce durcissement du procédé. Récupération de forme a été observée dans tout les cas, bien que quelque niveau d'amélioration du gonflement a été observe pour les échantillons densifiés avant et pendant la phase de durcissement.

Soudage par friction mécanique

Soudage par friction mécanique linéaire a montre que le bois traite thermiquement peut souder et donne des joints soudés de résistance mécanique acceptable. La résistance mécanique des joints est néanmoins décidément plus basse que a été obtenu pour du bois non traite. Plus en général, la résistance mécanique du joint soude est assez mauvaise si le soudage est effectue sur du bois seulement thermohydrolyse. La résistance mécanique est décidément meilleure quand le soudage est effectue sur du bois qui a subi le traitement thermique complet en deux étapes.

Panneaux

Panneaux comme panneaux de particules présentent des composants réversibles et irréversibles de gonflement en milieux humides. Le traitement thermique des coupeaux de bois avant l'assemblage du panneau, quand un mélange de coupeaux d'épicéa et de pin sylvestre on été utilises, a donne des panneaux melamine ureum formaldéhyde (MUF) de stabilité dimensionnelle améliorée. La variation des conditions utilisées pour le procédé (temps et température) ont montre un effet sur le propriété de gonflement des panneaux de particules. La

variation des conditions de hydrothermolyse, en particulier la température réelle du procédé, a un impact majeur sur les propriétés de gonflement que la variation des paramètres de durcissement. Le gonflement de panneaux fabriqués avec des copeaux qui ont été seulement hydrothermolyés est remarquable. L'amélioration du gonflement est plus intense que quand des copeaux ayant subi le traitement thermique complet ont été utilisés, en particulier après de longues périodes d'immersion en eau et après des essais cycliques.

Le prétraitement thermique des copeaux de bois donne une diminution de la résistance mécanique à la traction perpendiculaire au plan du panneau (IB), soit à sec soit pour l'essai cyclique V313), très probablement conséquent à la diminution de la contrainte de cisaillement des copeaux de bois même. La résistance mécanique à la traction perpendiculaire au plan du panneau (IB) après l'essai standard dans l'eau bouillante (V100) pour des panneaux de type extérieur est équivalente ou légèrement améliorée en relation avec des panneaux fabriqués avec des copeaux non traités thermiquement. Le traitement thermique sans la phase de durcissement a donné le meilleur résultat pour la résistance mécanique à la traction perpendiculaire au plan du panneau (IB), sensiblement meilleur que si les copeaux avaient subi le traitement thermique complet.

Le type d'adhésif utilisé a un effet important sur le gonflement des panneaux, principalement dû à la différence des types d'adhésifs utilisés : MUF, méthylène diphenyl diisocyanate (MDI), phénol-formaldéhyde (PF) et tannin. Les colles MUF et MDI (isocyanates) ont donné les meilleurs résultats après l'essai de 24 heures en eau froide. Le gonflement obtenu quand on utilise les colles PF et le tannin a été plus grand. Ceci est dû principalement à l'acidité accrue du bois traité thermiquement qui influence les colles à durcissement basique et pas celles à durcissement acide, donc au mécanisme de durcissement de la résine. Le gonflement après les essais cycliques ne montre pas néanmoins une grande différence pour les différents colles utilisées, bien que les panneaux collés avec des MUF aient été légèrement meilleurs que pour les autres colles.

SAMENVATTING

Thermische houtmodificatie is een technologie voor het veredelen van naald- en loofhoutsoorten met een lage duurzaamheid tegen biologische aantasting. Thermisch gemodificeerde houtproducten kunnen voor diverse toepassingen gebruikt worden zoals schuttingen en damwanden, of zelfs gevelbekleding, dekdelen en geveltimmerwerk. Het belangrijkste effect van thermische houtmodificatie is een reductie van de hygroscopiciteit. Belangrijke voordelen van thermisch gemodificeerde houtproducten zijn een verbeterde weerstand tegen biologische houtaantasting en een verbeterde dimensiestabiliteit. Ongewenste neveneffecten van thermische houtmodificatie, met name afname van de sterkte en toename van brosheid, waren aanvankelijk de bezwaren om thermisch behandeld hout op grote schaal toe te gaan passen. Bij het ontwikkelen van thermische modificatie methoden is het dan ook van belang het proces zodanig te optimaliseren dat de duurzaamheid en dimensiestabiliteit voldoende verbeterd worden terwijl de sterkte van het hout niet of nauwelijks afneemt. Het Plato proces is een effectief twee-staps proces waarbij gebruik wordt gemaakt van relatief milde proces condities (<200°C) waardoor aantoonbare en consistente verbeteringen verkregen worden. Deze effectieve thermische modificatie methode bevat:

1. een hydro-thermolyse behandeling, waarbij het hout tot 150-180°C verhit wordt onder vochtige omstandigheden en een verhoogde druk; en
2. een curing behandeling, waarbij het hout nogmaals tot 150-190°C verhit wordt maar dan onder droge omstandigheden bij atmosferische druk.

Experimenteel onderzoek heeft uitgewezen dat de hydro-thermolyse de meest kritische stap van de twee-staps thermische modificatie methode is die zowel de houtkwaliteit als de eigenschappen van het hout beïnvloedt. Variaties van de proces condities (o.a. temperatuur, proces tijd) tijdens de hydro-thermolyse vertonen een groter effect op de kwaliteit en eigenschappen van het behandelde hout dan variaties van de proces condities tijdens de curing. Om deze reden is er veel aandacht besteedt aan de ontwikkeling van de eerste proces stap en het effect hiervan op de anatomische structuur van hout en de houteigenschappen.

Om het proces te optimaliseren is het van belang te weten welke modificaties en reacties in hout plaats vinden waardoor milieuvordelen en betere prestaties van het thermisch behandelde hout worden verkregen. In dit proefschrift worden de effecten van thermische houtmodificatie op de eigenschappen van hout beschreven en gerelateerd aan de chemische en fysische veranderingen in hout na thermische behandeling. Dit kan leiden tot een beter begrip van de processen die tijdens thermische houtmodificatie plaatsvinden en zal tevens bijdragen aan een verantwoord gebruik van thermisch behandeld hout.

Microstructurele, fysieke en chemische aspecten van thermische modificatie

Microstructurele en fysieke veranderingen van hout na thermische behandeling

Na de eerste proces stap (hydro-thermolyse) is de kleur van het hout licht tot donker bruin, veroorzaakt door de vorming van Quinonen of door het caramelliseren van hemicellulose componenten. Het verhogen van de proces temperatuur leidt tot een donkerder tint. Het grootste deel van de kleurverandering vindt plaats na de hydro-thermolyse, terwijl een behandeling zonder deze eerste proces stap (dus alleen een curing) tot een lichte bruine kleur leidt, veel lichter dan een behandeling met hydro-thermolyse. De kleurverandering hangt ook af van de behandelde houtsoort en is gecorreleerd aan de volumieke massa van het hout aangezien de kleur donkerder wordt bij een toenemende volumieke massa. Uit een microscopisch onderzoek is gebleken dat de kleur van de celwand veranderd is van wit in bruin. Deze kleurverandering heeft betrekking op zowel de middenlamel als op de secundaire celwand. Deze kleurverandering wordt waarschijnlijk veroorzaakt door de vorming van reactieproducten in de celwand of door diffusie van dergelijke producten in de celwand.

De effecten van een thermische behandeling op de anatomische structuur van hout is beperkt, afhankelijk van de behandelde houtsoorten en de gebruikte proces condities. Naaldhoutsoorten met smalle jaarringen en/of een abrupte overgang van vroeghout naar laathout blijken gevoelig te zijn voor tangentele scheuren in het laathout. Radiale scheuren ontstaan meestal in impermeabele houtsoorten zoals vuren, veroorzaakt door grote spanningen in de houtstructuur tijdens de thermische behandeling. In spinhout van grenen soorten blijkt het parenchymweefsel in de straalcellen en de epitheelcellen rondom hars kanalen te zijn beschadigd. Dit fenomeen is niet waargenomen in het kernhout. De thermische behandeling van radiata pine resulteert in een open en permeabele houtstructuur die de toepasbaarheid van dit soort houtsoorten sterk beperkt.

Loofhoutsoorten zoals beuken en populier zijn voornamelijk gevoelig voor een collaps van de vaten en vervorming van de libriform vezels naast de tracheïden. In thermisch behandeld beuken en berken zijn radiale scheuren waargenomen bij de stralen. Door het optimaliseren van de proces condities waaronder het toepassen van een stoom hydro-thermolyse worden dergelijke beschadigingen van de houtstructuur tot een minimum beperkt.

Zowel in thermisch behandelde naald- als loofhoutsoorten zijn breukvlakken in de celwand waargenomen loodrecht op de vezelrichting van het hout. Dit kan bijdragen aan het ontstaan van plotselinge breuken in thermisch behandeld hout zoals is waargenomen in buigsterkte testen. In vergelijking tot onbehandeld hout kan dit leiden tot afwijkend breukgedrag indien het hout mechanisch belast wordt. Bij enkele naald- en loofhoutsoorten is maceratie (kleine scheurtjes tussen de tracheïden) waargenomen na thermische behandeling. Thermische behandeling heeft niet geleid tot een schade aan het sluitvlies van de stippels van het straalparenchym, het sluitvlies van de hofstippels en stippels, en de margo lijkt onaangetast.

Chemische houtveranderingen na thermische behandeling

In de eerste processtap, de vochtige hydro-thermolyse, wordt hemicellulose door hydrolytische reacties gedepolymeriseerd tot oligomeren en monomeren. Dit betreft het afsplitsen van zijketens (arabinose en galactose), gevolgd door het afbreken van de hoofdketen (mannose, glucose en xylose). De pentoses en hexoses die hieruit ontstaan worden gedehydrateerd tot respectievelijk furfural en hydroxymethylfurfural. Andere aldehyden zoals formaldehyde zijn ook waargenomen, veroorzaakt door het afsplitsen van zowel de C6 van de koolhydraten als de C γ van lignine. Afsplitsing van de acetyl zijketens in azijnzuur vindt eveneens plaats waardoor het acetyl gehalte afneemt. De afbraak van hemicellulose en het afsplitsen van organische zuren hangen af van de proces condities die tijdens de thermische behandeling worden toegepast, zoals temperatuur en tijd. Het blijkt echter dat de proces temperatuur en waarschijnlijk de daarbij ontstane druktoename een belangrijke rol speelt bij de afbraak van hemicellulose tijdens de hydro-thermolyse. De aanwezigheid van water is daarbij van groot belang aangezien de afbraak van hemicellulose minder groot is wanneer de thermische behandeling onder droge en atmosferische condities plaats vindt. Daarnaast is de verwachting dat protonen die vrijgemaakt worden door auto-ionisatie van water en door het afsplitsen van azijnzuur, als katalysatoren fungeren in het reactie mechanisme van de hydro-thermolyse.

Tijdens de hydro-thermolyse is geen afbraak van het cellulose waargenomen, terwijl er tijdens de curing daarentegen wel enige afbraak van (amorf) cellulose is waargenomen. Daarnaast is een toename van de relatieve hoeveelheid kristallijn cellulose waargenomen, maar het is de vraag of dit wordt veroorzaakt door de afbraak of door de kristallisatie van amorf cellulose (of beide).

Tijdens de thermische behandeling kan lignine worden afgebroken, maar er kunnen ook condensatie en repolymerisatie reacties plaatsvinden. De covalente bindingen tussen lignine en hemicellulose worden verbroken en laagmoleculaire lignine fragmenten met een hoge reactiviteit worden geproduceerd. Demethylatie of eigenlijk demethoxylatie van de methoxygroepen op de C3 positie van de aromatische ring van lignine vindt plaats tijdens de hydro-thermolyse. Hierdoor neemt het aantal plaatsen waar reacties kunnen plaatsvinden toe waardoor de reactiviteit van de aromatische ring van lignine vergroot wordt. Een toename van het aantal methyleen bruggen tussen twee fenolgroepen is waargenomen. Formaldehyde of furfuraldehyde die tijdens de hydro-thermolyse worden geproduceerd, lijken betrokken te zijn bij de vorming van deze methyleenbruggen. Waarschijnlijk worden lignine-eenheden gesplitst op de O4 of de C α positie en zal de reactieve -CH $_2$ groep die daarna gevormd wordt, een autocondensatie reactie vertonen met een vrije reactieve plaats op de fenolring van een andere lignine eenheid. In de ^{13}C -NMR spectra van thermische behandeld hout is een afname van de C=O piek op 175 ppm (behorende bij esters en/of organische zuren) waargenomen na de hydro-thermolyse, terwijl deze piek juist weer is toegenomen na de curing. Aangezien de aldehyde en keton pieken op respectievelijk 190 en 200 ppm onveranderd zijn lijkt het erop dat er tijdens de curing esters en/of

organische zuren gevormd zijn. De UV absorptiespectra van de secundaire celwand en de middenlamel voor en na thermische behandeling zijn opvallend te noemen. Het UV spectrum van de secundaire celwand vertoont een duidelijke toename van de maximale absorptie op 280 nm, veel meer dan het spectrum van de middenlamel. Dit kan veroorzaakt zijn door condensatiereacties waarbij het lignine polymeer is betrokken en/of door de vorming van andere aromatische structuren tijdens thermische behandeling, zoals furfural of hydroxymethylfurfural. De secundaire celwand bevat meer hemicellulose dan de middenlamel en een thermische depolymerisatie zal dan ook tot een grotere productie van furfural kunnen leiden.

Autocondensatie en/of repolymerisatie reacties zoals hierboven beschreven vinden plaats tijdens de hydro-thermolyse en worden voortgezet tijdens de curing. Hierdoor ontstaan nieuwe op lignine gebaseerde polymeren en/of een verdere vernetting (*cross-linking*) in het bestaande lignine polymeer.

Duurzaamheid ten opzichte van schimmelaantasting

Diverse organismen zijn in staat hout aan te tasten en schimmelaantasting is de belangrijkste vorm van microbiologische aantasting aangezien het kan leiden tot (een snelle) structurele afname van de sterkte. Een thermische behandeling blijkt een effectieve methode te zijn om de resistentie tegen schimmelaantasting te verbeteren. Thermisch behandeld radiata pine vertoont een duidelijk verbeterde weerstand tegen de bruinrotschimmel *Coniophora puteana* en enige weerstand tegen *Poria placenta*. Een hogere procestemperatuur en/of een langere procestijd tijdens de hydro-thermolyse blijkt een positief effect te hebben op de resistentie tegen *C. puteana* aantasting. Het effect op de resistentie tegen *P. placenta* was daarentegen beperkt. Thermisch behandeld radiata pine vertoont een beperkte resistentie tegen aantasting door de witrotschimmel *Coriolus versicolor*. Proces variaties tijdens de hydro-thermolyse blijken geen effect te hebben deze resistentie. Er is een duidelijk verschil in de resistentie tegen schimmelaantasting waargenomen tussen het spinhout en het kernhout van thermisch behandeld grenen. Het kernhout vertoont een grotere resistentie tegen aantasting door de bruinrotschimmels *C. puteana* en *P. placenta* maar ook tegen aantasting door de witrotschimmel *C. versicolor*.

Thermisch behandeld berken vertoont een verbeterde resistentie tegen *C. puteana* aantasting, met name als er hogere temperaturen tijdens de hydro-thermolyse zijn gebruikt. Een duidelijke verbetering van de duurzaamheid werd bereikt na blootstelling aan de witrotschimmel *C. versicolor* en met name *Stereum hirsutum*. Het effect van een hogere procestemperatuur tijdens de hydro-thermolyse op de aantasting door *C. versicolor* was in tegenstelling tot *C. puteana* slechts beperkt.

Thermisch behandeld radiata pine en vuren zijn nog steeds gevoelig voor oppervlakteschimmels die op het houtoppervlak kunnen groeien, waarschijnlijk door de vorming van afbraakproducten van hemicellulose (o.a. suikermoleculen) tijdens de thermische behandeling. Opmerkelijk is de afwezigheid van blauwschimmels op het thermisch behandelde hout, met name omdat deze schimmels wel zijn waargenomen op de onbehandelde referentie monsters.

Schimmelaantasting is een complex proces en hangt onder meer af van de schimmelsoort (bruinrot, witrot en/of zachtrot) en houtsoort, de houtstructuur, de (micro)omgeving, alsmede interactieve competitie tussen schimmels. Tijdens schimmelaantasting worden de belangrijkste houtcomponenten (cellulose, hemicellulose en lignine) gedepolymeriseerd en/of gemodificeerd om energie en metaboliëten vrij te maken voor schimmelgroei. Andere belangrijke vereisten voor schimmelgroei zijn de aanwezigheid van water en zuurstof, een gunstige pH en temperatuur, de aanwezigheid van groeifactoren, en de afwezigheid van toxische inhoudsstoffen. Aangezien een thermische behandeling de resistentie tegen schimmelaantasting verbeterd moet het één of meerdere vereisten voor schimmelaantasting beïnvloeden. Mogelijke effecten van een thermische behandeling op de vereisten voor schimmelaantasting worden gedetailleerd behandeld in deel II van dit proefschrift.

Uit een vaste stof CP MAS ^{13}C -NMR onderzoek is gebleken dat thermisch behandeld vuren zowel overeenkomsten als verschillen vertoont met onbehandeld grenen spint na blootstelling aan bruinrot- en witrotschimmels. Bruinrotschimmels blijken een voorkeur te hebben voor een aanval op de C4 en met name de C1 van de koolhydraten om de hoofdketen van cellulose en glucomannans open te breken. In onbehandeld grenen spint vindt deze aanval hoofdzakelijk plaats op de C4, het niet-gereduceerde einde van de glucose eenheid. Een aanval op de CH_2OH groep die zich buiten de acetal ring bevindt, van de koolhydraten van thermisch behandeld vuren, is waargenomen maar minder duidelijk dan in het geval van het onbehandelde grenen. Opmerkelijk is de aanval op C3/C5, een indicatie van ringopening van de koolhydraten. Deze aanval is daarentegen niet waargenomen bij het grenen spint. De degradatie van lignine is beperkt tot demethoxylatie er is geen of nauwelijks sprake van een opening van de aromatische ring, zelf niet na blootstelling aan de witrotschimmel *C. versicolor*. Blootstelling van thermisch behandeld hout aan schimmels in grondcontact vertoonde een aanval op de C1 en waarschijnlijk C4 van de carbohydrates zodat het cellulose en hemicellulose open gebroken en uiteindelijk gedepolymeriseerd wordt. Een aanval op de alcoholische CH_2OH groep die zich buiten de acetal ring bevindt, is ook waargenomen. Opmerkelijk is de opening van de pyranosering in thermisch behandeld simaruba na grond contact, die niet is waargenomen in het onbehandelde simaruba. Demethoxylatie en enige ringopening van de aromatische structuur van lignine is waargenomen, zowel voor behandelde als onbehandelde houtsoorten.

Fysische eigenschappen

Een van de meest in het oog springende eigenschappen van een thermische behandeling is een reductie van de hygroscopiciteit terwijl de typische hysteresis curve behouden is. Het krimpen en zwellen van het hout wordt gereduceerd waardoor de dimensiestabiliteit verbeterd wordt. Moleculaire oorzaken voor deze verbetering worden behandeld in deel I van dit proefschrift.

Een materiaal eigenschap die duidelijk verandert tijdens de thermische behandeling is de volumieke massa van hout. De belangrijkste oorzaak voor de afname van de volumieke massa na een thermische behandeling zijn: de afbraak

van houtcomponenten (met name hemicellulose) in vluchtige componenten die verdampen tijdens de behandeling; de verdamping van inhoudsstoffen; en een lager evenwichtsvochtgehalte aangezien thermisch behandeld hout minder hygroscopisch is geworden.

Mechanische eigenschappen

De twee-staps thermische houtmodificatie vertoont een duidelijk effect op de mechanische eigenschappen van hout. De treksterkte parallel aan de vezelrichting neemt duidelijk af en de verwachting is dat dit ook geldt voor de afschuifsterkte. De druksterkte parallel aan de vezelrichting en de hardheid nemen daarentegen toe na thermische behandeling. De buigsterkte dat een combinatie is van de drie primaire sterkte-eigenschappen (trek-, druk- en afschuifsterkte), neemt af na thermische modificatie. Deze afname is echter minder groot dan de afname van de treksterkte. De elasticiteitsmodulus tijdens de buigsterketest is toegenomen, terwijl de breukslagarbeid een enigszins grote afname vertoont na een thermische behandeling.

De mechanische eigenschappen van hout zijn sterk gecorreleerd aan het houtvochtgehalte. In dat opzicht levert thermische houtmodificatie een positieve bijdrage aan de mechanische eigenschappen aangezien thermisch behandeld hout minder hygroscopisch is en de (maximale) hoeveelheid gebonden water gereduceerd is.

De belangrijkste componenten van de celwand (cellulose, hemicellulose en lignine) dragen in verschillende mate bij aan de sterkte van hout. Degradatie en/of modificatie van deze componenten en microstructurele veranderingen tijdens thermische behandeling blijken de mechanische eigenschappen van hout te beïnvloeden. In deel II van dit proefschrift wordt hier nader op ingegaan.

Uit experimenten met vuren constructiehout blijkt dat de buigsterkte afneemt na thermische behandeling, veel meer dan in het geval van foutvrije proefstukken. Het effect van natuurlijke defecten zoals kwasten, harszakken, een afwijkende draadrichting en reactiehout, op de sterkte eigenschappen van hout blijkt te worden beïnvloedt door thermische behandeling. Thermisch behandeld hout vertoont een tamelijk grote en abrupte afname van de sterkte bij breuk, terwijl onbehandeld hout een meer gelijkmatige afname van de sterkte vertoont. De belasting die thermisch behandeld hout nog kan ondergaan na breuk is veel lager dan het onbehandeld hout. Dit fenomeen kan veroorzaakt worden door gebroken celwanden loodrecht op de vezelrichting. Verandering van de houtcomponenten kunnen ook een rol spelen, met name de degradatie van de koolhydraten en/of de kristallisatie van amorf cellulose (waardoor hout meer bros wordt). De doorbuiging tot breuk is veel lager voor thermisch behandeld hout en dit bevestigt het enigszins stijve en brosse karakter van thermisch behandeld hout. De elasticiteitsmodulus van constructiehout vertoont in tegenstelling tot de buigsterkte nog steeds een toename na thermische behandeling.

Het effect van een driejarige buitenexpositie op de sterkte eigenschappen van thermisch behandeld vuren was beperkt. Met name ten aanzien van de 5%-waarde waar de sterkte van hout in grote mate bepaald wordt door houtdefecten,

blijkt dat de buitenexpositie de buigsterkte en elasticiteitsmodulus niet heeft veranderd.

Innovatieve toepassingen van thermische modificatie

Verdichting

Het samendrukken van hout loodrecht op de vezelrichting is een methode om de dichtheid van hout te vergroten zodat mechanische eigenschappen zoals sterkte en stijfheid verbeterd worden. Een belangrijk nadeel van deze methode is het herstel van de oorspronkelijke afmetingen wanneer het verdichte hout wordt blootgesteld aan vocht (zwellings als gevolg van celwand *bulking* en het herstel van de oorspronkelijke celvorm). Aangezien thermische behandeling de dimensiestabiliteit van hout verbeterd zou het tevens een fixerend effect kunnen bewerkstelligen wanneer verdicht hout wordt blootgesteld aan vocht. Helaas is gebleken dat thermische behandeling een herstel van de celvorm niet kan voorkomen wanneer verdicht radiata pine wordt blootgesteld aan vocht. De betreffende verdichting was uitgevoerd voor (na hydro-thermolysen), tijdens (combinatie van verdichting en curing) en na de curing. In alle gevallen was een duidelijke celvormherstel van het verdichte radiata pine zichtbaar, alhoewel enige verbetering (minder zwellings) is waargenomen bij de proefstukken die verdicht zijn voor en tijdens de curing.

Mechanisch frictielassen

Thermische behandeld hout kan middels frictielassen gelijmd worden waarbij lijmverbindingen met een acceptabele sterkte verkregen worden. De lijmverbindingen zijn echter aanzienlijk minder sterk dan bij het onbehandelde hout. Frictielassen van gethermolysed hout leidt in het algemeen tot een geringe lijmsterkte. De sterkteresultaten worden daarentegen veel beter indien frictielassen wordt uitgevoerd na het complete proces (dus inclusief de curing).

Plaatmateriaal

Plaatmateriaal, zoals spaanplaat, is gevoelig voor reversibele en/of niet reversibele diktezwellings onder natte en vochtige condities. Een thermische voorbehandeling van houtchips (een mengsel van vuren en grenen) leidde tot een verbeterde dimensiestabiliteit van met melamine ureum formaldehyde (MUF) gelijmd spaanplaat. Variaties van de procescondities (o.a. proces tijd en temperatuur) hebben een effect op de zwellingseigenschappen van spaanplaat. Variaties van de hydro-thermolysen procescondities, met name de effectieve proces temperatuur, hadden een grotere impact op de zwellingseigenschappen dan variaties van de curing procescondities. Opmerkelijk is de zwellings van spaanplaat dat geproduceerd is met chips die alleen gethermolysed zijn (exclusief de curing). In vergelijking tot de standaardbehandeling met een curing is de zwellings verder afgenomen, met name na een lange dompelperiode in water en na de cyclische test.

Samenvatting

Een thermische voorbehandeling van chips leidt tot een afname van de treksterkte loodrecht op het plaatoppervlak (droog en na de cyclische V313 test). Dit is waarschijnlijk veroorzaakt door een reductie van de afschuifsterkte van de houtchips. Na de kooktest (V100) is de treksterkte gelijk of enigszins groter dan de onbehandelde referentie. Een behandeling zonder curing gaf de beste treksterkteresultaten, significant groter dan de volledige behandeling.

De lijmsort heeft een aantoonbaar effect op de zwellingeigenschappen van het spaanplaat, hoofdzakelijk veroorzaakt door de intrinsieke verschillen tussen de betreffende lijmsorten: MUF, methyl diphenyl diisocyanate (MDI), phenol-formaldehyde (PF) en tannine. MUF en MDI spaanplaat vertoonden de beste resultaten na een dompelperiode van 24 uur in koud water. De zwelling van PF en tannine spaanplaat was significant groter. De zwelling van de platen na de cyclische test vertoont daarentegen weinig verschillen tussen de gebruikte lijmsystemen, alhoewel de zwelling van de MUF spaanplaat enigszins groter is dan de andere drie lijmsystemen. De relatief grote zwelling die is waargenomen na dompeling van de PF spaanplaat kan veroorzaakt zijn door het uithardingsmechanisme tijdens de persfase. De treksterkte vertoonde enkele kleine verschillen tussen de verschillende lijmsystemen, alhoewel de treksterkte van tannine spaanplaat kleiner lijkt dan de andere drie spaanplaatssystemen.

1 INTRODUCTION

1.1 Wood modification

All over the world there is an increasing demand for sustainable building materials in order to reduce the CO₂ emission and energy consumption. Wood is a ubiquitous and dependable material for construction works and used in a very broad range of applications like furniture, building, road works, water works etc. The huge diversity in timber species guarantees that there is always a species with the required properties for a specific purpose. The economic impact of timber products is therefore considerable. However, the growth of the human population is causing an increasing pressure on forests with high quality timber for construction and other purposes. Furthermore, in the last decades a significant increase of large-scale deforestation of especially (sub-)tropical forests is observed, which contributes to the green house effect, the erosion of fertile soil, and the reduction of the bio diversity. There is clearly a declining production of high quality or more specifically of durable timber from the current forests available. As a consequence of increased introduction of governmental restrictive regulations protecting the environment the availability of this material will be even more reduced. A solution to this could be the increased use of the adequate reserve of less durable timber species. To that end, technologies for improving timber dimensional stability and/or durability are indispensable. A number of technologies exist, e.g.:

- Impregnation with pesticides
- Densification and/or resin impregnation
- Chemical modification of the cell wall components
- Thermal modification

Impregnation with pesticides

In order to protect wood against biodegradation caused by bacteria, fungi, insects, termites and/or marine organism, it can be impregnated with pesticides or wood preservatives. This conventional preservation method utilizes toxic chemicals like heavy metals (chrome, copper, arsenic) and creosote. Although preservative treatment is a cheap and effective method to protect wood against biodegradation the resistance against this method is growing caused by health and environmental concern. In general the commonly used wood preservatives (creosote and CCA) are rather poisonous for humans and animals and treated wood possess an environmental hazard during service conditions and after waste disposal (e.g. emissions of toxic chemicals). Less toxic alternatives (e.g. triazoles) have been developed but imply reduced effectiveness limiting its application.

Densification and/or resin impregnation

Several modification methods, such as chemical and compressive treatments, have been developed to increase the density of wood in order to improve the mechanical properties (strength, stiffness and/or hardness). Impregnating the void volume of wood with bulking chemicals (e.g. monomers, polymers, resins, waxes) is a method, which has been developed since the 1960's (Stamm 1964, Meyer 1984, Kumar 1994, Schneider 1994). Such a treatment might also improve other properties like durability against biodegradation, dimensional stability, electrical resistance, wearing resistance and immunity to corrosion. The treatment costs are relative high when compared to the other technologies, due to the process costs and the costs of the bulking chemicals used. This limits commercial utilisation, although treated wood has been used for a large range of specific applications (Kumar 1994).

Another method to increase the density of wood is compression in the transverse directions (Kollmann et al. 1975). A major disadvantage of this method is the recovery of the original dimensions when densified wood is exposed to moisture (swelling). This swelling is mainly due to cell wall bulking and especially cell-shape recovery (Blomberg et al. 2006).

Chemical modification of the cell wall components

Chemical modification is based on reactions between reactive groups of the main components of the cell wall* (cellulose, hemicelluloses and lignin) and an externally applied reagent. Hydroxyl and phenyl groups of the wood components are mainly involved, whereas the ether group, which occurs in cellulose and hemicelluloses, is not very reactive.

Chemical modification research mainly focussed on reactions with the hydroxyl group since this group is responsible for water absorption resulting in swelling and shrinkage of the cell wall. A chemical reaction (e.g. ester formation) can 'block' these hydroxyl groups reducing the hygroscopicity and hence improving the dimensional stability of wood. Especially the hydroxyl groups of hemicelluloses and lignin play an important role, whereas the hydroxyl groups of cellulose are less involved in the reaction mechanism. A relative high percentage of cellulose is crystalline (60%) and the hydroxyl groups of crystalline cellulose are physically blocked and unable to react with the applied reagent. On the other hand, the hydroxyl groups of amorphous cellulose can be involved in the reaction mechanism.

A hydroxyl group acts as an alcohol with its accompanying chemical properties. Most reagents of alcohols have therefore been tested for wood modification purposes: halogen alkanes (e.g. methyl iodide, alkyl chloride), epoxides (e.g. ethylene-, propylene- and butylene oxide, epichlorohydrine), inorganic ethers (e.g. silyl ethers), aldehydes (e.g. formaldehyde, acetaldehyde, benzaldehyde, dialdehydes), anhydrides and carbonic acids (e.g. acetic anhydride, phthalic anhydride, maleic anhydride, ketene, acid chlorides) and several other reagents (e.g. dimethyl sulphate, acrylonitrile, isocyanides).

* A short description of the chemical composition of wood (including the structural formulas of the main wood components) is given in annex 1.

The hydroxyl (and methoxy) groups of lignin are located on the propane unit but are also connected to the aromatic ring, the phenyl group. Phenol groups show the same electrophilic substitution reactions as benzene (e.g. halogenations, nitration, sulfonation, alkylation and acylation), although the reactions will be activated since the intermediate cation is stabilized by the free electron pair of the oxygen atom. A methoxy group shall also activate electrophilic aromatic substitution reactions of the phenyl group due to the electron stowing effect of the oxygen atom. In an alkaline environment the phenol can be converted to a phenolate anion, which shows different reactions, e.g. an SN₂-reaction with methyl iodide and a nucleophilic acyl substitution with acetyl chloride. A phenolate anion can also act as a carbanion due to mesomery of the negative charge on the ortho- and para sites of the aromatic ring. An example is the reaction of phenolate anion with formaldehyde, resulting in the formation of ortho- and para-benzylalcohols. This can react further to a highly cross-linked polymer (bakelite).

Thermal modification or heat treatment

Since the 1950's research has been done on thermal modification of wood, based on heat treatment of (fresh or conditioned) wood at relative high temperatures: 230-260°C (Seborg et al, 1953, Kollmann and Schneider, 1963; Stamm, 1964; Kollmann and Fengel, 1965; Noack, 1969; Burmester, 1973 and 1975; Giebeler, 1983; Hillis, 1984; Bourgois and Guyonnet, 1988). This technology enables the upgrading of lower durability softwood and hardwood species like Scots pine, Norway spruce, Douglas fir, birch, and poplar, into wood products of constant quality. These products can be used for a broad range of applications such as garden fences and channel linings or even cladding, decking and exterior joinery. The main effect gained by heat treatment of wood is reduced hygroscopicity. The main advantages of wood treated in this manner are increased resistance to different types of biodegradation and improved dimensional stability, without the use of (toxic) chemicals. However, some undesired side effects, in particular loss of strength and increased brittleness were in the beginning the main objections for overall commercial utilisation of heat-treated timber. Development of suitable thermal modification techniques therefore focussed on optimisation of the process for a maximum increase of the dimensional stability and durability, while minimising the decrease of the strength.

Over the last decades several European research groups developed methods, which are based on thermal treatment of wood (e.g. Bourgois and Guyonnet 1988, Viitaniemi and Jämsä 1996, Weiland and Guyonnet 1997, Boonstra et al 1998, Sailer et al. 2000). The main differences between these methods are based on the materials used (e.g. wood species, fresh or dried wood, moisture content, dimensions), process conditions applied (e.g. one or two process stages, wet or dry process, heating medium, oxygen or nitrogen as sheltering gas, heating and cooling down velocity) and the equipment necessary for treatment (e.g. process vessel, kiln). The specifications of the various heat treatment methods are documented in several patents (e.g. EP0018446 1982, EP0612595 1994, EP0623433 1994, EP0622163 1994, EP0759137 1995, US5678324 1997).

In France mainly two processes are in use (Vernois 2000):

1. Retification (Retified wood), developed by Ecole des Mines de Saint-Etienne. Timber with a moisture content of approximately 12% is heated slowly in a specific kiln up to 210-240°C in a nitrogen atmosphere with less than 2% in oxygen.
2. Le Bois Perdure, developed by the French holding BCI-MBS. Fresh timber is used and the first step of the process consists in an artificial drying in the kiln. Then the timber is heated to 230°C in a steam atmosphere (steam generated from moisture of the timber).

The Finnish heat treatment method is based on a fast preliminary heating stage (up to 100°C), then a kiln dry process between 100-150°C if necessary, and a slow temperature-heating period to the actual treatment temperature (150-240°C), which is remained for 0.5 to 4 hrs (Syrjänen et al. 2000). After the actual heat treatment a cooling and stabilizing period is applied, up to 24 hours. The total process takes about 72 hours. The Finnish Wood Preserving Association's classifies heat-treated wood into three different heat treatment classes (based on the process temperature used during treatment):

1. very weak heat treatment (mainly for colour changes);
2. weak heat treatment (to be used in constructions above ground where there is a risk of accidental wetting or condensation); and
3. strong heat treatment (to be used in constructions above ground in situations where the timber will be continually exposed to the weather or to other sources of wetting such as condensation during service).

In Germany a heat treatment method is developed based on a thermal treatment in a hot bath of oil. Temperatures between 180-220°C are used for a 2-4 hours period, excl. heating up and cooling down (Rapp and Sailer 2000). The process is performed in a closed vessel with hot oil circulating around the wood. The heating medium is crude vegetable oil (e.g. rape seed, linseed oil or sunflower oil) that also excludes oxygen from the wood during treatment.

1.2 The Plato treatment

The heat treatment method, developed in the Netherlands, is the Plato^{*} technology. This technology embodies an effective two-stage treatment under relatively mild conditions (<200°C). The Plato treatment finds its origin in a technology development after the oil crisis in the 1970's and early 80's: the hydrothermal conversion of biomass, including wood, into liquid fuels (Bobleter and Concini 1979, Bobleter and Binder 1980, Garves 1982, Bonn et al 1983, Torres et al 1986). In this hydrothermal technology rather extreme conditions were required (250-400°C, up to 280 bar steam pressure). A combination of existing knowledge of wood chemistry and treatment of wood under less extreme conditions provided the basis for the idea of employing a two-stage process to upgrade wood species (Ruyter 1989). In the late 90's a pilot scale process was

^{*} Providing Lasting Advanced Timber Option

developed in a research plant in Wageningen and optimised for commercial utilisation (Boonstra et al 1998). This resulted in an industrial plant and since 2001 Plato[®] Wood has been commercially produced for a variety of applications, e.g. waterworks, garden wood and the building industry (examples of different projects are given in annex 2). Currently, five distinct process stages can be distinguished including the two effective heat treatment stages (state of the art 2007):

1. pre-drying stage in a conventional industrial wood kiln to a moisture content of 14-18%;
2. hydro-thermolysis stage in a stainless steel reactor (Fig. 1.1 and 1.2), the timber is heated to 150°C-180°C in an aqueous environment at superatmospheric pressure (including saturated steam as the heating medium);
3. drying stage in a conventional industrial wood kiln (Fig. 1.3) using common procedures to a moisture content of 8-9%;
4. curing stage in a special stainless steel curing kiln (Fig. 1.4), the timber is heated once again to 150°C-190°C, but now under dry and atmospheric conditions; and
5. conditioning stage, the moisture content of the timber is elevated to a level, which is necessary for manufacturing (4-6%). Conditioning is done in the same conventional industrial wood kiln as the drying stage, including the use of saturated steam to increase the moisture content of the treated timber.



Fig. 1.1 Pilot plant for the hydro-thermolysis stage

In the hydro-thermolysis stage saturated steam (a so-called steam hydro-thermolysis) or liquid water (a so-called liquid full hydro-thermolysis) is used as the heating medium to increase the temperature of the timber. The first stage of the heating phase (up to 100°C) during steam hydro-thermolysis is rather uncontrolled, since the conditions in the vessel are still atmospheric, which hinders a controlled heating velocity. Above 100°C the reactor is heated with a controlled velocity (between 0.5 - 2.0°C per min.). Cooling down is accomplished by flashing the reactor (a quick but controlled release of the pressure) to atmospheric conditions followed by a cold-water circulation in the wall of the reactor (pilot plant) or by spraying the inner site of the reactor with cold water (industrial plant).



Fig. 1.2 Industrial plant for the hydro-thermolysis stage

During the liquid full hydro-thermolysis a heat exchanger is used to heat and cool the process water in the reactor. A liquid full hydro-thermolysis facilitates a better control of the process conditions during the complete temperature range of the treatment (stable heating and cooling down velocity). It prevents a fast and controlled increase of the temperature to 100°C (and higher up); and it also prevents an uncontrolled drying process of the wood surface during cooling down stage. Furthermore, addition of NaOH to the process water is possible stabilising the pH, and other components like fire retardants can be added to the process water, which than are absorbed by the timber.



Fig. 1.3 Industrial kiln for pre-drying, drying and conditioning of timber during heat treatment

In the curing stage the timber is heated with hot air, generated by heaters and circulated with ventilators. Above 110°C superheated steam or nitrogen is add as a sheltering gas to exclude oxygen and to prevent oxidation reactions.

As can be concluded from the description of the Plato technology, no chemicals are used. Small quantities of organic compounds in the liquid waste steam extracted during hydro-thermolysis (condensate), drying (wood moisture) and curing (wood moisture) are dealt within water treatment facilities. Gaseous compounds extracted from the curing oven are treated in a scrubber system to condense water from the gas stream – including any organic matter and extractives from wood – and to minimise odour.



Fig. 1.4 Industrial kiln for the curing stage

1.3 Objectives and limitations

In order to optimise the process it is of considerable importance to understand which modifications and reactions occur in wood resulting in environmental and performance advantages. The objective of this thesis is to determine the effects of the two-stage heat treatment on primary properties of wood (dimensional stability, durability against biodegradation, and strength) and relate these effects to chemical and physical changes of wood after heat treatment. This provides a better understanding of thermal modification and probably contributes to a more controlled use of heat-treated wood in service conditions.

The main objectives were:

1. What are the microstructural and physical characteristics of heat-treated wood components?
2. What are the molecular and chemical effects of heat treatment on wood?
3. What are the properties of heat-treated wood (e.g. hygroscopicity, dimensional stability, durability against biodegradation, strength and stiffness) and what is its relation to the molecular and physical characterization of heat-treated wood?
4. Are there new and innovative applications of heat treatment possible?

The results, which are presented in this thesis, are part of a large industrial research project with different objectives, which is performed during a 10-year period (1996-2006). For this reason it appears that research is not always carried out systematically (e.g. chemical analysis, biological durability and strength tests), especially the wood species used varied due to commercial priorities. However, the results do give a substantial contribution to a better understanding of heat treatment (e.g. chemical reaction mechanism, microstructural characterisation) and its effect on wood properties.

The chemical composition of (untreated) wood might differ from what is commonly found in the literature (Fengel and Wegener 1989, Hon and Shiraishi 2001). This can be due to natural variations within a wood species and/or to the analysis methods used.

According to the CEN/TS 15083-1 agar test method Scots pine sapwood and beech have been used as references for biological durability testing and to control the virulence of the test fungi. For a complete comparison it was better to use also the untreated wood species (e.g. radiata pine, birch, Norway spruce). However, results of other tests (not presented in this thesis) showed that the mass loss of these wood species is at the same level as the references. This corresponds with the EN 350-2 standard, which classifies these wood species as non-durable.

Due to limitations of the equipment only a 3-point bending test could be performed on full size specimens. During bending the pressure was spread over three load points instead of the more commonly used four points resulting in a rather deep imprint on the wood surface, especially the untreated posts (66x66 mm). This might have affected the modulus of elasticity of the specimens.

PART I

MOLECULAR AND PHYSICAL CHARACTERISATION OF HEAT-TREATED WOOD

In this part the effect of the two-stage heat treatment on the anatomical structure and physical appearance of different softwood and hardwood species is discussed (respectively Chapter 2 and 3). An overview is given of the process development and optimisation of this heat treatment method, which resulted in good quality timber, suitable for commercial utilisation.

The effect of the two-stage heat treatment on the chemical characterisation of heat-treated wood is described in the Chapters 4 and 5 by means of a solid-state CP-MAS ^{13}C -NMR study (Chapter 4) and a chemical analysis (Chapter 5) including a wood component analysis, CHNO-elemental analysis, a UV-spectroscopic study, and an analysis of the acetyl and free hydroxyl group content. The changes and/or modifications of the main wood components (cellulose, hemicelluloses and lignin) after heat treatment are presented as well as its effect on the composition of these wood components. The difference between the hydro-thermolysis and the curing stage is discussed in order to demonstrate the usefulness of two different treatment stages.

The main effect of heat treatment is a substantial decrease of the hygroscopicity, hence improving the dimensional stability. In Chapter 4 and 5 this effect is discussed in relation to the chemical changes and/or modifications, which have been noticed during heat treatment.

2 MICROSTRUCTURAL AND PHYSICAL ASPECTS OF HEAT-TREATED SOFTWOODS*

Abstract

Optimisation of the two-stage heat treatment process at relatively mild conditions (<200°C) and its effect on the anatomical structure of softwoods were investigated by means of a light and scanning electron microscopic analysis. Heat treatment appears to affect the anatomical structure of wood, although this depends on the wood species considered and on the process method and conditions used. Softwood species with narrow annual rings and/or an abrupt transition from earlywood into latewood were sensitive to tangential cracks in the latewood section. Radial cracks occurred mainly in impermeable wood species such as Norway spruce, caused by large stresses in the wood structure during treatment. Sapwood of treated pine species revealed some damage to parenchyma cells in the rays and epithelial cells around resin canals, whereas this phenomenon has not been noticed in the heartwood section. Treated radiata pine resulted in a very open and permeable wood structure limiting the applications of this species. Broken cell walls perpendicular to the fibre direction resulting in transverse ruptures have been noticed in treated softwood species. This contributes to abrupt fractures of treated wood as observed in bending tests, which can lead to considerably different failure behaviour after impact or mechanical stress. In some treated softwood species maceration (small cracks between tracheids) was noticed after heat treatment. Heat treatment did not cause damage to the ray parenchyma pit membranes, bordered pits and large window pit membranes; the margo fibrils appear without damage. Compared to the other softwood timbers tested European grown Douglas fir was the timber that stands heat treatment the best.

* Boonstra MJ, Rijdsdijk JF, Sander C, Kegel E, Tjeerdsma BF, Militz H, Van Acker J, Stevens M (2006a) Physical aspects of heat-treated wood. Part 1. Softwoods. *Maderas. Ciencia y tecnologia* 8:193-208

2.1 Introduction

Originally this two-stage heat treatment is based on findings of H. Ruyter (1989) who started the development of this process in the Koninklijke Shell Laboratorium Amsterdam (KSLA). As a result of the oil crisis in the 1970's and an increasing concern about global warming, there was a worldwide interest in fuels and chemicals from renewable sources. In the KSLA laboratory of Shell, heat treatment processes at very high temperatures and pressures were developed in order to obtain fuels and chemicals from organic material. As a spin-off of this research a new process concept for the upgrading of wood was invented (Ruyter 1989), based on an adaptation of the process conditions. Developments in the 1990's, such as reduced oil prices and an increased industrial competition on a shrinking world market, forced companies back to their core business, and have led to the decision not to implement this project in Shell. In 1994 an independent research group was established in Wageningen (The Netherlands) to continue the development of this two-stage heat treatment method and to optimise the process conditions in order to develop an industrially applicable process and product.

In this chapter an overview is given of the process development of the two-stage heat treatment method with respect to microstructural and physical aspects of different heat-treated softwood species. In general, during the development of heat treatment methods of wood the attention is mainly focussed on primary properties like dimensional stability, durability against biodegradation and strength. Beside these material improvements the timber quality after heat treatment is also of importance, especially for commercial reasons. Heat treatment of wood might result in defects such as cracking (internal and/or surface cracks), collapse and deformation (e.g. bow, spring, twist and cup) due to changes of the anatomical structure of wood. These defects are thought to be caused by chemical and especially physical processes in wood during heat treatment. Heat-treated softwood specimens were investigated by means of light and scanning electron microscopy in order to reveal possible damages or changes of the wood structure.

2.2 Materials and Methods

Materials

The following wood species were used for heat treatment: European grown Douglas fir (*Pseudotsuga menziesii* Franco), Scots pine (*Pinus sylvestris* L.), Norway spruce (*Picea abies* Karst), and radiata pine (*Pinus radiata* D. Don).

For each species at least 10 boards or poles were treated per process condition. Cross sections of the boards had a thickness of 25-50 mm and a width of 100-150 mm while the diameter of the poles was 10 cm. The length of the boards/poles was approximately 3.0 m. The moisture content of the boards/poles before treatment was varied, respectively fresh, water-soaked, shipping dry (16-20%) or conditioned to a relatively low moisture content (12-14%).

Untreated control specimens were used for comparison purposes.

Heat treatment

The heat treatment was performed in two separate heat treatment stages and a drying stage in between. In the first stage of the heat treatment the timber was treated in an aqueous environment at superatmospheric pressure (8-10 bar), a so-called hydro-thermolysis treatment. This was done in a 600 litres pilot plant and the treatment temperature varied between 165 and 185°C. The specimens were then dried in a 1 m³ (net) kiln, using a conventional drying process at 50-60°C. After drying the wood specimens were heat-treated again in a special curing kiln for the second stage, now under dry and atmospheric conditions, a so-called "curing" treatment (at 160-190°C). During this stage superheated steam or nitrogen gas was used as a sheltering gas to exclude oxygen.

During the first stage of the heat treatment saturated steam (a so-called steam hydro-thermolysis) or liquid water (a so-called liquid full hydro-thermolysis) was used as the heating medium to increase the temperature of the boards/poles. A heat exchanger was used to heat and cool the process water in the reactor during liquid full hydro-thermolysis. NaOH was added to the process water to control the pH. During steam hydro-thermolysis cooling down was accomplished by flashing the reactor (a quick but controlled release of the pressure) to atmospheric conditions followed by a cold-water circulation in the wall of the reactor.

Light microscopy

Small blocks were cut from the treated and untreated boards and boiled carefully in water for approximately 15 minutes. Boiling softened the wood and thus it was possible to prepare smooth surfaces for microscopy using a microtome. If possible, sections of 30-35 µm were cut whereas sections of 60-70 µm were cut when stresses were observed in the specimens. Cross-sectional, tangential and radial surfaces of wood were cut and prepared for analysis with an Olympus binocular microscope. Enlargements of 4x, 10x, 40x, 60x (objective), 10x (oc), and 3.3x (photo oc.) were used.

Scanning electron microscopy

Small wood blocks (ca. 5x5x10mm) were cut from treated and untreated boards and boiled in water in a microwave for 15 minutes. Since damages could occur due to microtomy, the specimens were temporally embedded in ice by shock-freezing the wet specimens in liquid nitrogen. The ice served as an embedding material for a short time, which allowed carefully cutting with a microtome. Cross and radial surfaces of wood were cut. The small specimens were subsequently kiln dried, sputter coated with gold-palladium under vacuum (ca. 20 nm), mounted on a specimen holder with carbon glue, and scanned in a Jeol Scanning Electron Microscope (JSM 5200) with magnification up to 7.500x at 15-20kV. Digital images were online transferred to a personal computer and saved as image files. To improve image quality, resolution, contrast and brightness were corrected digitally on the computer.

The electron microscopic analysis was performed on completely treated wood (including the curing treatment stage) and was mainly focused on the cross sectional and radial sectional level of wood.

2.3 Results and discussion

Process development

During the development of this two-stage heat treatment process it was found that the first process stage (the hydro-thermolysis) was critical to maintain the wood quality during treatment. Defects, which occurred after the complete treatment, were already visible after the first process stage. It was also found that when the visual wood quality was retained after the first treatment stage, the wood quality did not change after drying and the second treatment stage (curing). For this reason much attention has been focussed on the development of the first treatment stage and its effect on the anatomical structure of wood.

Three heating methods have been considered to perform the first process stage:

1. Conductive heating with saturated steam
2. Dielectric heating with microwave and radio frequency fields; and
3. Resistance (Ohmic) heating.

Dielectric and resistance heating methods have been used in laboratory tests. However, these methods have practical limitations when applied on an industrial scale and therefore, external conductive heating with saturated steam was chosen as the heating medium.

Originally the two-stage heat treatment was performed on fresh timber. If necessary the test specimens were pre-soaked in water in order to keep the wood fresh. During the steam hydro-thermolysis treatment of fresh timber, it was not possible to prevent serious drying defects (surface cracks, collapse and/or deformation). These defects probably occurred during the cooling-down phase, since the reduction and eventually absence of (saturated) steam resulted in an uncontrolled drying process. In the first lab experiments the wood boards were pressed during the curing stage in order to increase the density. As a result, the surface cracks that were observed after the steam hydro-thermolysis treatment and/or the drying phase, were closed and not visible anymore. On an industrial (bulk) scale it is not possible to perform the curing in a press and for this reason a special kiln was used. Closing of surface cracks during curing was not possible anymore in this kiln.

In order to prevent defects such as surface cracks the hydro-thermolysis was then performed with liquid water as a heating medium, which was heated and cooled down in a heat exchanger. A liquid full hydro-thermolysis facilitates a better control of the process conditions (heating and especially cooling down velocity) preventing an uncontrolled drying process of the wood surface. Furthermore, addition of NaOH to the process water is possible in order to control the pH during heat treatment.

Although the visual wood quality was slightly improved after treatment of fresh and pre-soaked timber, much better results were obtained using shipping dry timber (MC 18-22%). Permeable wood species like radiata pine gave good results without any loss of the visual wood quality. Hardwood species and non-permeable softwood species like Norway spruce were still difficult to treat and significant losses (30-50%) in wood quality were found (cracks, collapse and/or deformation).

An important improvement was obtained when shipping dry timber was hydro-thermolysis treated using saturated steam as a heating medium. This gave the possibility to treat several hardwood species and non-permeable softwood species without a serious loss of the visual wood quality. A further fine tuning of the process conditions was performed in order to find the optimal hydro-thermolysis treatment method, including moisture content before treatment, heating and cooling down velocity, final treatment temperature and process time, and equipment setting. The optimal process conditions were determined per wood species based on the wood quality after treatment.

Drying of hydro thermolysed boards/poles was performed in a conventional kiln at relatively moderate temperatures (50-60°C), which seemed best to retain the wood quality. In order to reduce emission of volatile compounds an enclosed drying system instead of a fresh air kiln was used to dry the intermediate product on an industrial scale. The moisture content after drying must be low enough (7-8%) to permit the curing stage, because in the first phase of this curing stage timber was heated rather fast (1-2°C/min) to a temperature of 100-110°C with a risk of cracks and deformation. After evaporating wood moisture the temperature is elevated again to a temperature of 170-180°C, while superheated steam was added to exclude oxygen (<2%) preventing fire risks and undesirable oxidation reactions. The heating-up and cooling-down velocity depended on the timber species used and the dimensions of the boards/poles. It is important that the temperature gradient between the surface and inner site of the boards/poles did not exceed 15-20°C during heating-up and cooling-down in order to retain the wood quality. After curing the treated timber was conditioned to a moisture content of 3-4%, since no water is available anymore (evaporated). The timber is then ready for processing (e.g. sawing, planing, etc), since the equilibrium moisture content of heat-treated timber is much lower than of untreated timber (Boonstra et al. 1998, Tjeerdsma et al. 1998b).

Special care must be taken when scaling-up a heat treatment process, because practical problems such as waste treatment may arise. The liquid waste stream includes small quantities of organic compounds extracted during thermolysis (condensate), drying (wood moisture) and curing (wood moisture), which should be treated before being discharged. Gaseous compounds extracted from the curing kiln should be treated in a scrubber system to remove the VOC's – including any organic matter and extractives from wood – from the gas stream and to minimise odour.

In Figure 2.1 an overview of the different treatment stages is shown.

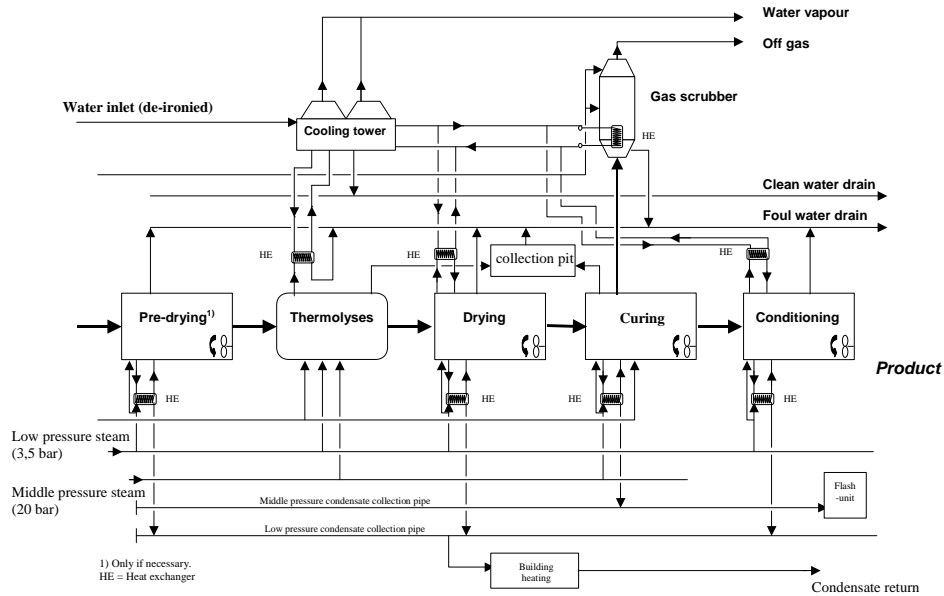

Fig. 2.1 Schematic overview of a two-stage heat treatment process

Colour changes due to heat treatment

The wood colour after the first treatment stage (hydro-thermolysis) varied from light to dark brown, caused by the formation of quinones (described in Chapter 4) or the caramellisation of holocellulose components (described in Chapter 5). An increase of the treatment temperature changed the colour into a darker tinge. Most of the colour changes occurred during the hydro-thermolysis, whereas treatment of wood specimens without the first treatment stage (only the curing) resulted in a light brown colour, much lighter than after the hydro-thermolysis. The colour change also depends on the timber used and is correlated to the density of the wood since the colour is becoming darker with an increasing density. The colour of the wood surface is slightly darker than the colour of the inner wood giving a lighter colour after planing. During heat treatment, extraction and/or diffusion of dark brown reaction products occurred and were depleted at the wood surface. Some timber species with a high resin content like Scots pine showed resin spots on the surface after treatment.

Dipping treated wood specimens in water resulted in an emission of a brown component, indicating a polar characteristic. This emission has also been noticed when treated timber was painted with waterborne paint systems, resulting in light brown spots in the paint layer. This was not observed for solvent borne paint systems.

During the first microscopic analysis of several wood species after the hydro-thermolysis treatment stage it was noticed that the colour of the cell wall changes

from white to brown. This colour change involved the compound middle lamella and the secondary cell wall. This is believed to be due to the formation of reaction products in the cell wall or to the diffusion of such reaction products within the cell wall.

Light microscopic analysis

Unfortunately it was not possible to prepare light microscopic slices using an embedding method. However, after the hydro-thermolysis stage the wood structure is still rather soft and not brittle, and it is not expected that this will lead to slicing artefacts. The typical effects of the hydro-thermolysis treatment on the anatomical wood structure are discussed below. Due to an apparent decrease of the visual wood quality (cracks, collaps and/or deformation), no light microscopic observations were made after the hydro-thermolysis treatment of fresh (or pre-soaked) timber.

Liquid full hydro-thermolysis treatment of shipping dry softwood

The liquid full hydro-thermolysis treatment of shipping dry Scots pine and Norway spruce reveals tangential cracks in the latewood section (Fig. 2.2a). Both timber species were characterized by very narrow annual rings (approximately 1 mm per annual ring) and an abrupt transition from earlywood into latewood. During treatment large stresses must have occurred between the earlywood and latewood tracheids due to differences in shrinkage/swelling behaviour, resulting in these tangential cracks. In Norway spruce specimens with wider annual rings (2.5-3 mm per annual ring) and a gradual transition from earlywood to latewood, no tangential cracks were observed (Fig. 2.2b).

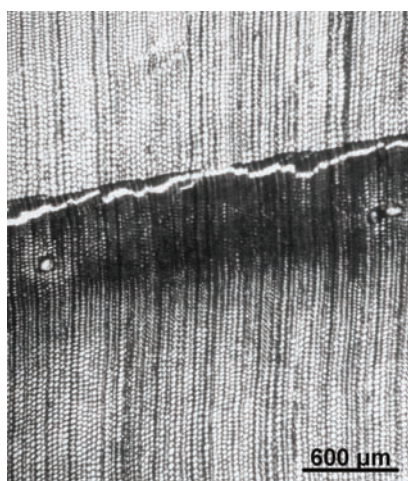

Fig. 2.2a Liquid full hydro-thermolysed treated Norway spruce (cross section), tangential cracks in the latewood section

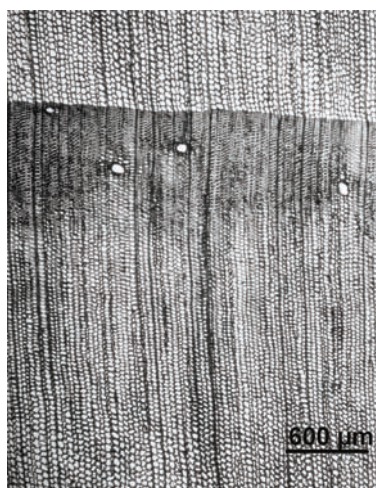

Fig. 2.2b Liquid full hydro-thermolysed treated Norway spruce (cross section), with larger annual rings and a gradual transition from earlywood to latewood. No tangential cracks in the latewood section are visible

The differences in the shrinkage/swelling behaviour are more gradual reducing the stresses between earlywood and latewood. Shipping dry radiata pine sapwood boards*, characterized by a gradual transition from earlywood to latewood and a similar cell wall thickness for the earlywood and latewood tracheids, did not reveal tangential cracks after treatment. Although the transition from earlywood to latewood is rather sharp for Douglas fir no tangential nor radial cracks were observed after treatment.

In Scots pine, radial cracks were noticed starting in the earlywood section (Fig. 2.3a). The tracheids were cleaved but the cell walls seemed still intact, whereas the crack runs near the compound middle lamella (Fig. 2.3b). In the latewood section the cracks were closed and it seemed that the tracheids were pushed against each other.

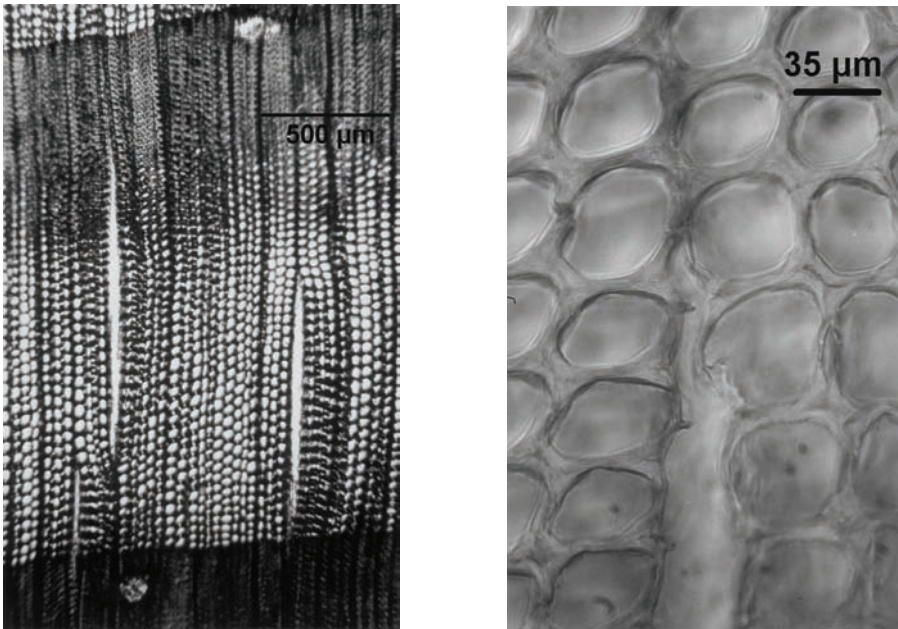

Fig. 2.3a,b Liquid full hydro thermolysed treated Scots pine (cross section), radial cracks in the earlywood

The earlywood and latewood tracheids of Scots pine were still intact after liquid full hydro-thermolysis treatment, although the linear structure of the tracheid rows and rays were slightly curved. The earlywood tracheids of Norway spruce were slightly deformed, but this was also found for the untreated reference (so it might not be an effect of the treatment). The liquid full hydro-thermolysis treatment of shipping dry Douglas fir resulted in a strong deformation of the earlywood tracheids near the latewood - earlywood border (Figs. 2.4a,b). The cell walls of these tracheids were partly cleaved and curved. However, this type of tracheids can be found very

* South Africa and New Zealand grown radiata pine with cross section sizes only containing sapwood

often in the earlywood of untreated Douglas fir, so this does not have to imply an effect of heat treatment. The latewood tracheids were still intact and straight.

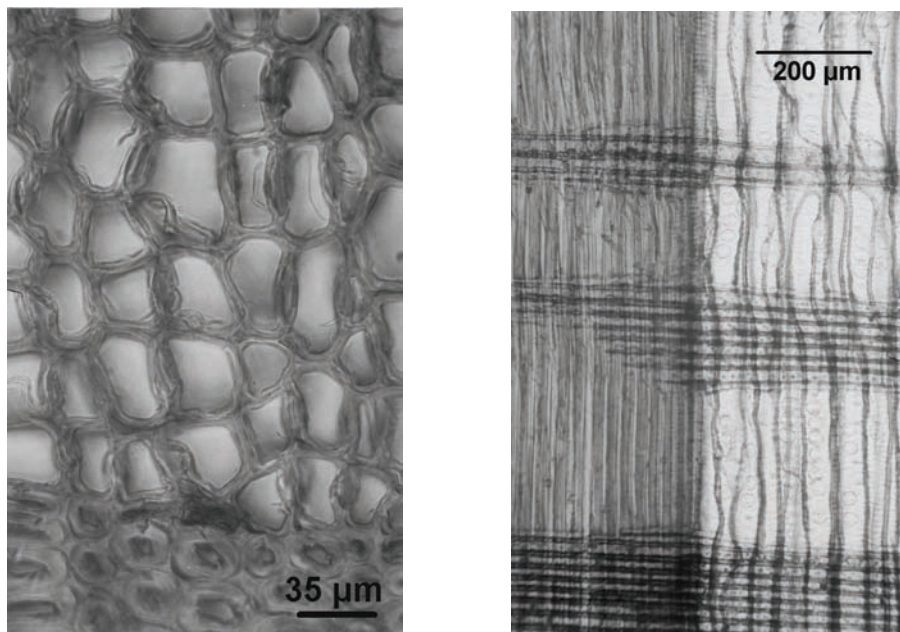

Fig. 2.4a,b Liquid full hydro-thermolysed treated Douglas fir (cross and radial section, 400x), deformed earlywood tracheid cells near the earlywood – latewood border

The deformations of these earlywood tracheids could indicate large stresses during the hydro-thermolysis treatment, caused by differences in the shrinkage/swelling behaviour between earlywood and latewood tracheids. The typical structure of the tracheid cell wall in Douglas fir, spiral thickening of the cell wall, which is thought to improve its strength, might be of importance in the maintenance of the wood structure during heat treatment.

The ray parenchyma cells of pine sapwood (e.g. Scots pine, radiata pine) seemed to be damaged after hydro-thermolysis and remainders of the thin cell wall were still visible (Fig. 2.5a). The ray tracheids were not damaged and still intact. The thin-walled epithelial cells around longitudinal resin canals seemed also to be damaged (Fig. 2.5b). The damage of these parenchymatic and epithelial cells decreases in the intermediate zone between sapwood and heartwood, and was not observed in the heartwood section of Scots pine. There could be several reasons for the damage of the parenchymatic and epithelial cells:

- According to Fujita and Harada (2001) the ray parenchyma cell wall in the Diploxylon of *Pinus* develops in two stages: the primary wall and inner protective layer are formed in the sapwood, and just before the heartwood is developed, the secondary wall and protective layer are deposited. Furthermore ray parenchyma cells from the sapwood of softwood species tend to be non-lignified, while adjacent ray tracheids are lignified (Daniel, 2003).

This reveals a rather thin parenchymatic cell wall without lignin, which should be more sensitive for the process conditions used (high temperature and pressure).

- Degradation of hemicelluloses, which is in a relatively high content available in the compound middle lamella, during heat treatment (described in Chapter 4 and 5).
- The action of the microtome knife when preparing thin slides.

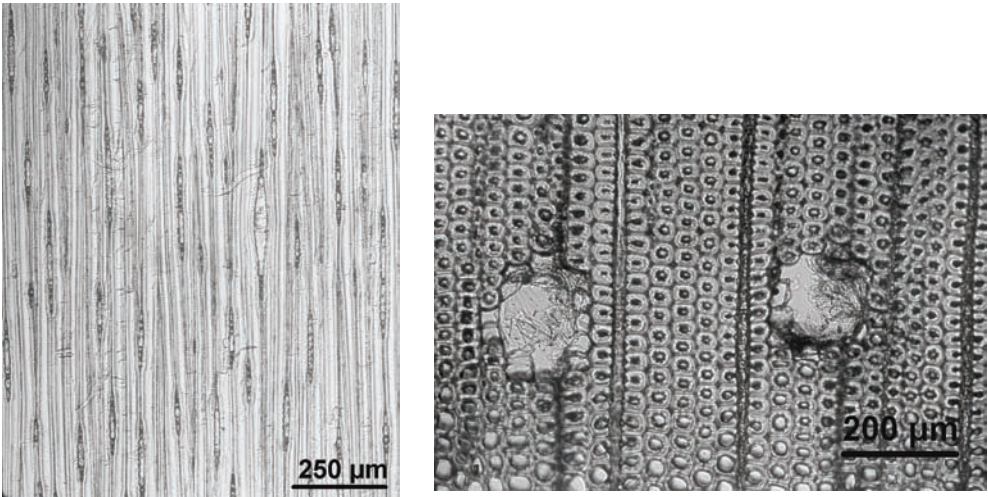

Fig. 2.5a,b Liquid full hydro-thermolysed treated Scots pine (tangential and cross section), damaged parenchyma ray cells (a) and epithelial cells of resin canals (b). The ray tracheids are still intact

Damage of ray parenchyma cells and the rather thick-walled epithelial cells around the resin canals of Norway spruce was not observed in the treated specimens. Norway spruce consists mainly heartwood and it is expected that the ray and axial parenchyma cell contains a secondary cell wall and is lignified. The parenchyma cells of the rays and the thick-walled epithelial cells around resin canals of Douglas fir were not damaged and were still intact (Figs. 2.6a,b). The cell walls of these cell structures were rather thick (including a secondary cell wall) preventing damage during the hydro-thermolysis treatment.

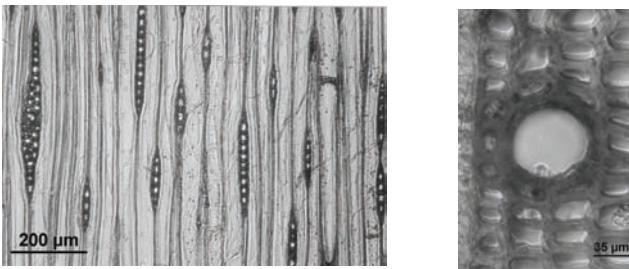

Fig. 2.6a,b Liquid full hydro-thermolysed treated Douglas fir (tangential and cross section), the parenchyma ray cells (a) and epithelial cells of resin canals (b) are not degraded and still intact

After sawing small blocks of treated Scots pine for the microscopic analysis, the transverse section was slightly hairy and during sawing in the fibre direction loose fibres were formed. This is an indication that maceration, visible as small cracks between tracheids, occurred during the liquid full hydro-thermolysis treatment stage.

Steam hydro-thermolysis of shipping dry softwood

In general the application of the steam hydro-thermolysis revealed positive effects on the visual wood quality after treatment compared to the liquid full hydro-thermolysis. The first steam hydro-thermolysis trials resulted however in a lot of stresses in the wood specimens preventing the cutting of thin sections. If it was possible to cut (thick) sections and they were often characterised by large radial cracks. Deformation of the tracheids occurred and small cracks between the tracheids were observed indicating maceration. Optimisation of the process conditions (e.g. conditioning of wood samples to a moisture content between 14% and 18% before treatment, heating and cooling down velocity, final treatment temperature and process time) was therefore necessary to prevent serious defects of the wood structure.

The application of an optimised steam hydro-thermolysis treatment prevented the formation of radial cracks in earlywood section of Scandinavian grown Scots pine. However, Scots pine from German origin still revealed some radial cracks in the latewood section, probably caused by the tangential shrinkage during drying before or during the heat treatment. The Scots Pine specimens were still sensitive to tangential cracks in the latewood section and some deformation of the earlywood tracheids occurred. According to Schweingrubber (1990), the transition from earlywood to latewood is generally abrupt for Scots pine, which might limit its use for this heat treatment. Small cracks between the tracheids were observed indicating some maceration. Degradation of parenchyma cells of the rays and the thin-walled epithelial cells around resin canals were still noticed in the sapwood of Scots pine.

Optimisation of the process conditions and a reduction of the moisture content before treatment were necessary to improve the wood quality of Norway spruce after treatment. Treated Norway spruce, which was kiln dried to a moisture content of approximately 14%, did not show tangential cracks in the latewood section. Although the amount and size of the radial cracks were decreased it was not possible to prevent the occurrence of radial cracks, especially with an increasing thickness of the boards. Norway spruce, which mainly consists of heartwood, is very impermeable due to the occurrence of closed (encrusted) pits (Kollmann and Coté, 1968). During the hydro-thermolysis treatment the Norway spruce specimens must be subject to large stresses, especially during the:

- warming up phase (evaporation of moisture into steam increasing the pressure in the cell lumina); and
- cooling down phase (condensation of vapours such as steam reducing the pressure and a possible vacuum formation).

Delamination (raising grain) between earlywood and latewood on the growth ring boundary is typical for tangentially sawn heat-treated softwood species (located at the heartwood side of the boards). In order to prevent delamination, radial sawn Norway spruce was treated with an optimised steam hydro-thermolysis process. The results were rather disappointing since large radial cracks occurred after treatment, even in 25 mm thick Norway spruce wood specimens. This must be due to large stresses in the wood specimens during treatment closely related to the limited effect of the rays on the permeability of Norway spruce.

It was also found that the difference in temperature between the surface and the core of the wood sample should not be too high ($<30^{\circ}\text{C}$) in order to prevent or reduce serious damage to the wood structure (e.g. internal cracks), especially when an impermeable wood species was used.

An interesting phenomenon, which was observed in the tangential section of treated Norway spruce was that the tracheid cell walls were broken at several places perpendicular to the tracheid direction resulting in transverse ruptures (Fig. 2.7a). The occurrence of this phenomenon in heat-treated wood must be closely related to the abrupt fractures as observed in bending tests (Fig. 2.7b).

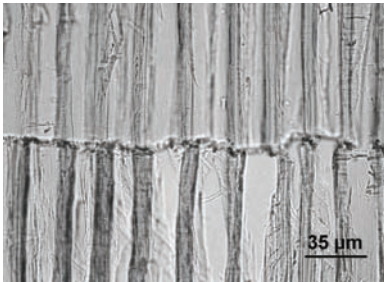

Fig. 2.7a Hydro-thermolysed treated Norway spruce (tangential section), broken tracheid cell walls perpendicular to the fibre direction



Fig. 2.7b The typical fracture of a completely treated Norway spruce specimen after a bending test

Damages to ray parenchyma cells and epithelial cells around resin canals were still observed after an optimised hydro-thermolysis treatment of radiata pine with saturated steam instead of liquid water. This, however, was also observed before treatment, possibly caused by steaming and/or kiln drying at high temperatures. Damages of such cells in treated radiata pine sapwood specimens, which are also observed in other pine wood species such as Scots pine, Ponderosa pine and Slash pine, resulted in a very open and permeable wood structure as revealed by a simple experiment. A wad of cotton wool was wetted with a Rhodamine B solution and placed horizontally on treated radiata pine sapwood specimen with a (radial) thickness of 25 mm. After 2 days the Rhodamine B solution was transported through the entire wood specimen indicating a rather permeable wood structure.

The open structure of treated radiata pine revealed practical problems when applied in service conditions. The wood surface is subject to a fast and rather unlimited absorption and desorption (evaporation) of moisture. This results in the occurrence of deformation and/or surface cracks, already visible after a few weeks in service conditions, hazard class 3 (Fig. 2.8). Furthermore, a relatively long period of high moisture content can stimulate the growth of blue stain fungi and/or moulds as observed in treated radiata pine. Degradation of parenchyma ray cells reduces the physical barrier for spores and other microorganism, which can settle in the wood more easily. A permeable wood structure can also affect the penetration of paint and adhesive systems affecting the performance of the paint-layer.

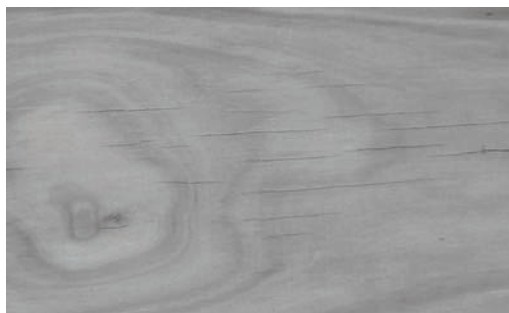

Fig. 2.8 Fast weathering of completely treated radiata pine (including steam hydrothermolysis) with surface cracks

Scanning electron microscopic analysis

Within the cross fields between axially oriented tracheids and radially oriented ray parenchyma's of treated radiata pine, thin pit membranes appeared not to be affected (Fig. 2.9). Also in Scots pine no distinct changes of anatomical feature were found. Bordered pits (interconnecting tracheids) were not affected (Figs. 2.10a,b) and also the large window pit membranes did not reveal any damage, which can be attributed to the heat treatment (Fig. 2.10c).

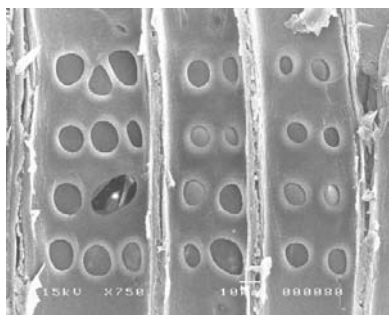

Fig. 2.9 Two-stage heat-treated radiata pine: radial section of crossing field

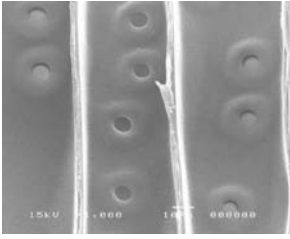

Fig. 2.10a Two-stage heat-treated Scots pine: radial section of tracheids

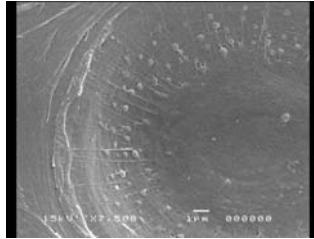

Fig. 2.10b Two-stage heat-treated Scots pine, bordered pit with opened pit chamber

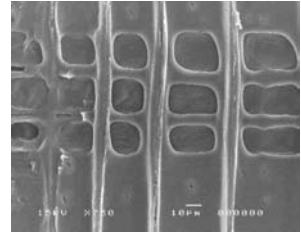

Fig. 2.10c Two-stage heat-treated Scots pine, radial section, crossing field

Norway spruce (Figs. 2.11a,b) neither revealed damages like detachment of cells or cell wall layers nor destruction or degradation of pits. Pit membranes of bordered pits between tracheids were intact; the margo fibrils appeared without damage. There was only some indication of plasticisation and starting liquefaction of pit torus material, flowing along the margo fibrils into the margo region (Figs. 2.11b,c). Kollmann and Sachs (1967) have found comparable features in spruce after thermal treatment between 190°C and 240°C. Nevertheless, such type of changes were not distinct and it appears very likely that plasticisation of cell wall material appears only to a very limited degree during this heat treatment.

Sticks from heat-treated and untreated radiata pine (20x20x360 mm) were tested for bending strength and modulus of elasticity. The heat-treated specimens revealed a considerably altered breaking behaviour compared to the untreated specimens. For treated wood specimens the fracture surfaces were mainly brittle and abrupt.

These differences in breaking behaviour were confirmed by SEM analysis. The fracture surface appeared brittle and flat (Figs. 2.12a-c). Fractures in untreated control specimens (Figs. 2.13a-c) lead to defibrillation of tissue and delamination of cell walls, resulting in a more axial orientation of detachments. In contrast to this, treated wood had straight fractures favouring detachments perpendicular to the longitudinal axis. In some cases (Fig. 2.12c) the fracture surface resembles a cut appearance, which appears to be most prominent in the secondary cell wall.

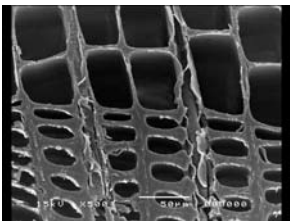

Fig. 2.11a Two-stage heat-treated Spruce, cross section

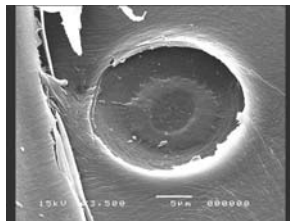

Fig. 2.11b Two-stage heat-treated Spruce, bordered pit with opened pit chamber

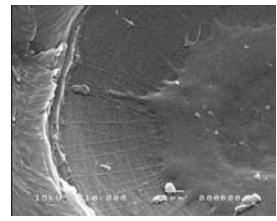

Fig. 2.11c Magnification of Figure 2.11b

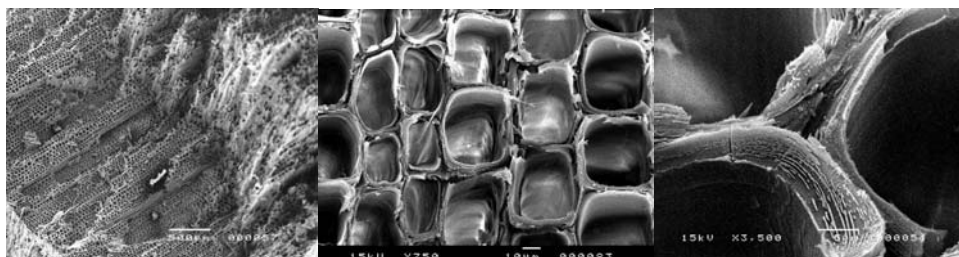

Fig. 2.12a-c Two-stage heat-treated radiata pine, fracture surface after bending test

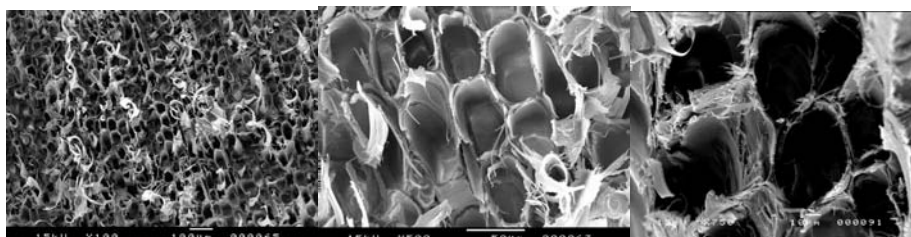

Fig. 2.13a-c Untreated radiata pine, fracture surface after bending test

2.4 Conclusions

A two-stage heat treatment does have an effect on the anatomical structure of wood, although this depends on the wood species considered and on the process method and conditions used. Softwood species with narrow annual rings and/or an abrupt transition from earlywood into latewood were sensitive to tangential cracks in the latewood section. Radial cracks occurred mainly in impermeable wood such as Norway spruce, caused by large stresses in the wood structure during treatment. Sapwood of treated pine species revealed some damage to parenchyma cells in the rays and epithelial cells around resin canals, whereas this phenomenon has not been noticed in the heartwood section (Scots pine). Treated radiata pine resulted in a very open and permeable wood structure limiting the applications of this species. Broken cell walls perpendicular to the fibre direction resulting in transverse ruptures, have been noticed in treated softwood species. This contributes to abrupt fractures of treated wood as observed in bending tests, which can lead to considerably different failure behaviour after impact or mechanical stress. In some treated softwood species maceration (small cracks between tracheids) was noticed after heat treatment. Heat treatment did not cause damage to the ray parenchyma pit membranes, bordered pits and large window pit membranes; the margo fibrils appeared without damage. Compared to the other softwood timbers tested European grown Douglas fir was the timber that stands heat treatment the best.

After process optimisation a well-controlled heat treatment process was developed suitable for an industrial production of timber species. Changes of the anatomical

structure after heat treatment should not limit the use of treated timber in the usual timber applications. However, some treated wood species require special attention in service conditions.

3 MICROSTRUCTURAL AND PHYSICAL ASPECTS OF HEAT-TREATED HARDWOODS*

Abstract

Optimisation of a two-stage heat treatment process at relatively mild conditions (<200°C) and its effect on the anatomical structure of hardwoods were investigated by means of a light and scanning electron microscopic analysis. Hardwood species such as beech and poplar, were predominantly sensitive to collapse of the vessels and some deformation of the libriform fibres directly near the vessels. In treated beech and birch radial cracks were observed near the rays. Optimisation of the heat treatment process conditions including the application of a steam hydro thermolysis stage reduced such damages to a minimum. Broken cell walls perpendicular to the fibre direction resulting in transverse ruptures has been noticed in heat-treated hardwood species. This contributes to abrupt fractures of treated wood as observed in bending tests, which can lead to considerably different failure behaviour after impact of mechanical stress. In some treated hardwood species maceration (small cracks between tracheids) was noticed after heat treatment. Heat treatment did not reveal damage to the ray parenchyma pit membranes, bordered pits and large window pit membranes; and the macro fibrils appeared without damage.

* Boonstra MJ, Rijdsijk JF, Sander C, Kegel E, Tjeerdsma BF, Millitz H, Van Acker J, Stevens M (2006b) Physical aspects of heat-treated wood. Part 2. Hardwoods. *Maderas. Ciencia y tecnología* 8:209-217

3.1 Introduction

The anatomical structure of softwood species, or *gymnosperms*, differs from hardwood species, so-called *angiosperms*. Softwood species are characterized by a relative simple anatomical structure containing longitudinal fiber tracheids (approx. 90-95%), ray cells (5-10%) and resin cells (0.5-1.0%). The anatomical structure of hardwood species is much more complex. Hardwood species contain fiber tracheids and libriform fibres (36-70%), vessel elements (20-55%), ray cells (6-20%) and parenchyma cells (approx. 2%).

In this chapter the effect of the two-stage heat treatment process on the anatomical structure of different hardwood species is described. Heat-treated hardwood specimens were investigated by means of light and scanning electron microscopy in order to reveal possible damages or changes of the wood structure.

3.2 Materials and Methods

The following timber species were used for heat treatment: European beech (*Fagus sylvatica* L.), poplar (*Populus species*, mainly Aspen, Robusta and I214), simaruba (*Simaruba amara* Aubl.), birch (*Betula pendula* Roth and/or *Betula pubescens* Ehrh), alder (*Alnus glutinosa* Gaertn. and/or *Alnus incana* Moench.), and ash (*Fraxinus excelsior* L.). For each species at least 10 boards were treated per process condition. Cross sections of the boards had a thickness of 25-50 mm and a width of 100-150 mm. The length of the boards/poles was approximately 3.0 m. The moisture content of the boards/poles before treatment was varied, respectively fresh, water-soaked, shipping dry (16-20%) or conditioned to a relatively low moisture content (12-14%). Untreated control specimens were used for comparison purposes.

The boards were treated according the two-stage heat treatment method as described in detail in chapter 2. The methods used to analyse the wood structure of the boards, light microscopy and scanning electron microscopy (SEM), were also the same as reported in chapter 2.

3.3 Results and discussion

Since the first treatment stage (hydro-thermolysis) is very critical to maintain the wood quality during further treatment (drying and curing) much attention has been focussed on the effect of this treatment stage on the anatomical structure of the hardwood species. The typical effects of the hydro-thermolysis treatment on the anatomical wood structure of different hardwood species are discussed below. Results of the SEM study are based on fully heat-treated wood.

Liquid full hydro-thermolysis treatment of shipping dry hardwood

During the liquid full hydro-thermolysis treatment of shipping dry wood (18-22% MC) the specimens absorbs water and the moisture content increases to values, which could be far above the fibre saturation point (depending on the permeability

of the wood species used). The occurrence of free water flowing into the cell lumens increases the possibility of collaps of wood cells, especially the vessels. Softening of the cell wall, which occurs during the hydro-thermolysis treatment further increases the possibility of collaps. In beech and poplar collaps was noticed after drying and even a slow and carefully controlled drying process did not prevent collaps of the vessels.

In Figure 3.1a a strong collaps of the vessels and ray parenchyma cells of beech after the drying stage is visible. The parenchyma fibres between the libriform fibres with thick walls seemed not to be deformed. Radial cracks were observed close to large and broad rays. The ray parenchyma cells, which were clean and open before treatment (in the untreated wood), contained a brown-red extractive after hydro-thermolysis treatment (Figs. 3.1b,c). This extractive is situated on the cell wall blocking the pits and preventing the transport of air and moisture through the pits in the radial direction. This probably caused a vacuum during the cooling down phase of the heat treatment resulting in collaps of vessels. The observed cracks could be the result of this collaps and/or a large difference in the tangential and radial shrinkage behaviour of the wood during heat treatment.

Unlike poplar and beech the liquid full hydro-thermolysis treatment did not have an effect on the anatomical structure of simaruba, in which only some damage of the ray parenchyma cells has been observed. The anatomical structure and/or cell wall construction of simaruba is apparently strong enough to resist stresses during treatment.

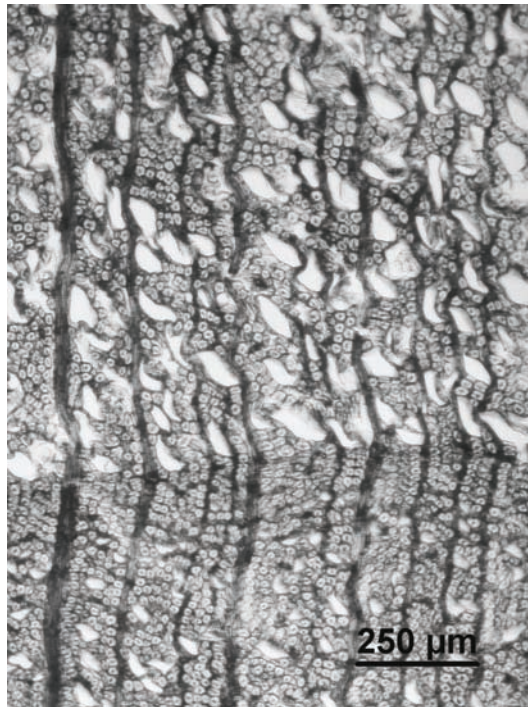

Fig. 3.1a Hydro-thermolysed treated beech (cross section), serious collaps of vessels

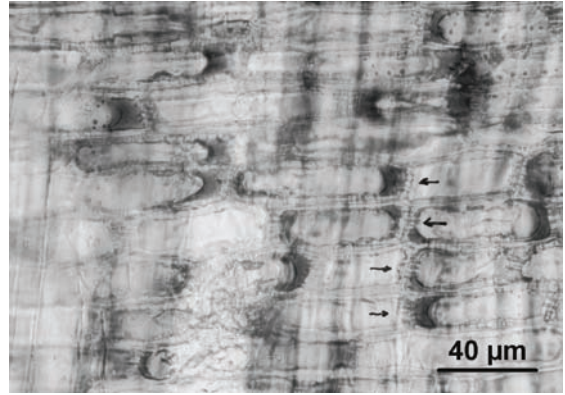
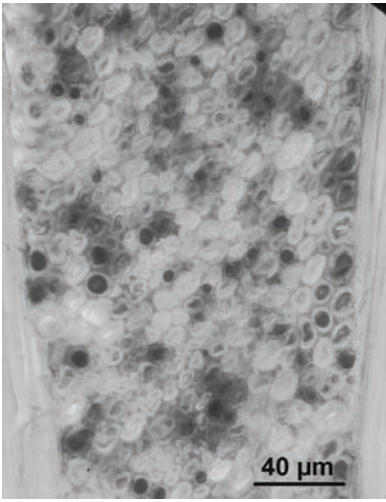

Fig. 3.1b,c Hydro-thermolysed treated beech (cross and tangential section), depletion of extractives on the cell wall

Steam hydro-thermolysis of shipping dry hardwood

The application of a hydro-thermolysis treatment with saturated steam resulted in a better (visual) wood quality than the liquid full hydro-thermolysis treatment.

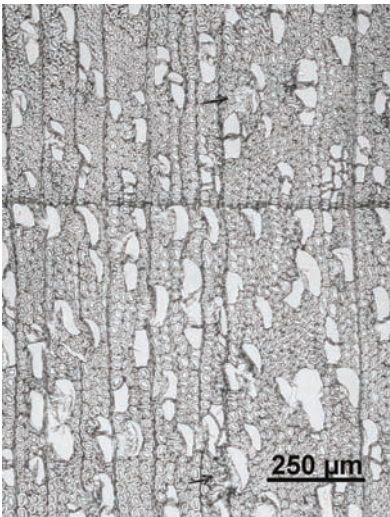

Fig. 3.2a First steam hydro-thermolysis trials on poplar (cross section), serious collapses of vessels

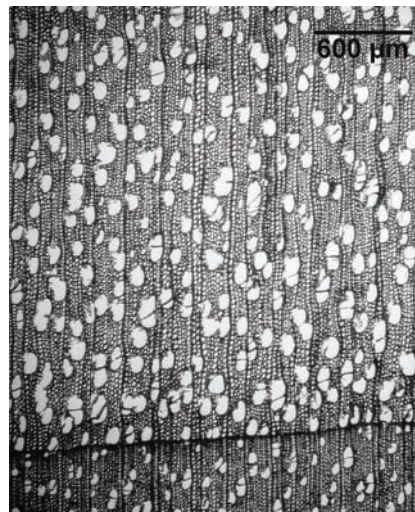

Fig. 3.2b Optimised steam hydro-thermolysis of poplar (cross section), without damages of the wood structure

The first steam hydro-thermolysis trials of poplar resulted in stresses in the wood specimens preventing the cutting of thin sections. Deformation of the fibres

occurred and small cracks between the fibres were observed indicating maceration. A strong collapse was observed in the vessels, but also in the libriform fibres (Fig. 3.2a). The vessels collapsed at one side resulting in a deformation of the libriform fibres directly near the vessel. The occurrence of collapse was not common since in some specimens no collapse was observed. This might be related to the occurrence of tension wood. Optimisation of the steam hydro-thermolysis treatment (conditioning of wood samples to a moisture content of 14-16% before treatment, a careful and controlled heating and cooling down phase without abrupt temperature and pressure fluctuations, final treatment temperature and process time) prevented the occurrence of collapse of the vessels and no damages were observed after the drying stage (Fig. 3.2b). The existence of fibres on the surface of planed poplar in service conditions (due to weathering) indicates some maceration, which could appear during or possibly after the treatment.

The phenomenon of transverse ruptures as discussed in Chapter 2 was also observed in treated poplar. In the tangential cross section the tracheid cell walls were broken at several places perpendicular to the fibre direction (Figs. 3.3a,b). It is expected that the cause for this phenomenon could be related to the presence of tension wood. The fibres of tension wood exhibit a longitudinal shrinkage, which is much larger compared to normal wood, and the fibres are shorter compared to normal wood. Both of these factors might contribute to the abrupt fracture of treated poplar as observed in bending tests.

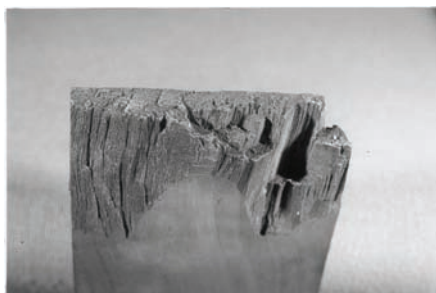

Fig. 3.3a The typical fracture of a completely treated poplar specimen after a bending test

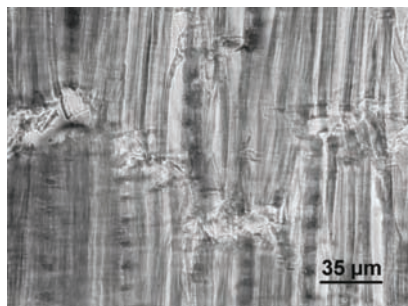

Fig. 3.3b Hydro-thermolysed treated poplar (cross and tangential section), broken tracheid cell walls perpendicular to the fibre direction

The first steam hydro-thermolysis treatment trials of birch resulted in large radial cracks in the vicinity of the rays, and collapse of the vessels (Fig. 3.4a). Optimisation of the treatment including a careful cooling down phase prevented the occurrence of radial cracks and collapse of the vessels (Fig. 3.4b).

Bending tests, which were performed on treated birch, revealed in many occasions an abrupt fracture, especially for specimens, which were sawn near the pith of the tree. This also indicates broken cell walls of the fibres perpendicular to the fibre direction resulting in transverse ruptures. The occurrence of juvenile wood with its typical characteristics (e.g. a shorter fibre length) could be a reason for this phenomenon.



Fig. 3.4a First steam hydro-thermolysis trials on birch (cross section), radial cracks and collaps of the vessels

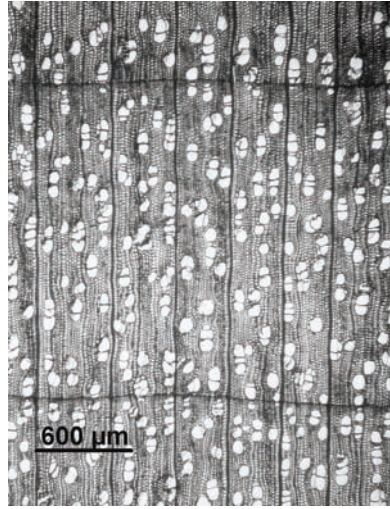

Fig. 3.4b Optimised steam hydro-thermolysis of birch (cross section), without damages of wood structure

An optimised steam hydro-thermolysis treatment of alder, which was carefully kiln dried to a moisture content of approximately 14% before treatment, revealed only slight collaps of the vessels and some damage to the fibres directly near the vessels (Fig. 3.5). No radial or tangential cracks were observed. Ash showed no damages after an optimised steam hydro-thermolysis treatment, although it was expected that its characteristic ring-porous wood structure might cause some damage during treatment (Fig. 3.6).

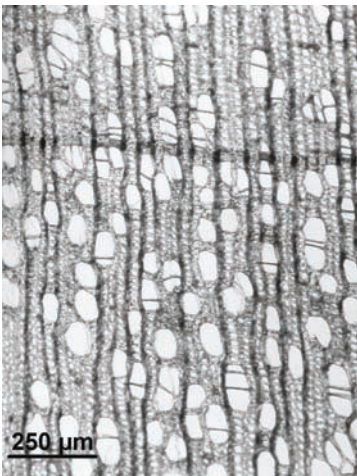

Fig. 3.5 Optimised steam hydro-thermolysis of alder (cross section), with a light collaps of the vessels and some damage directly near the vessels

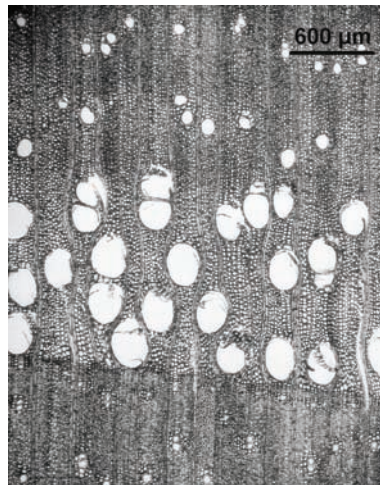

Fig. 3.6 Optimised steam hydro-thermolysis of ash (cross section), without damages of wood structure

Although some improvement was achieved after the application of steam hydro-thermolysis, it was still difficult to treat beech without a serious loss of the (visual) wood quality. Even after optimisation of the hydro-thermolysis stage, local occurrence of collaps, deformation and cracks in boards were still visible. This limits the application of treated beech in service conditions. Heat treatment of beech without the hydro-thermolysis stage did not have an effect on the visual wood quality. This indicates that beech is very sensitive for damage to the wood structure during (or after) the hydro-thermolysis treatment stage.

SEM analysis of fully heat-treated beech did not reveal damage to the ray parenchyma pit membranes, bordered pits and large window pit membranes; and the margo fibrils appeared without damage. Kollmann and Sachs (1967) established a flow of the warty layer in beech, which they attributed to a plasticisation of lignin. There was only a slight indication that this might also hold true for heat-treated wood, leading to a deformation of the warty structures (Fig. 3.7a,b). Nevertheless, such type of changes were not distinct and it appears that plasticisation of cell wall material has only a very limited effect during this heat treatment.

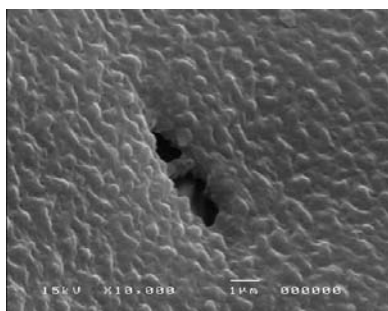

Fig. 3.7a Two-stage heat-treated beech, warty layer around a vessel pit

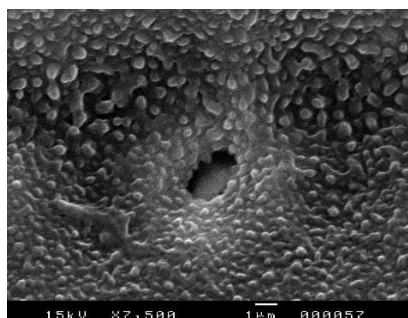

Fig. 3.7b beech, non-untreated, warty layer around a vessel pit

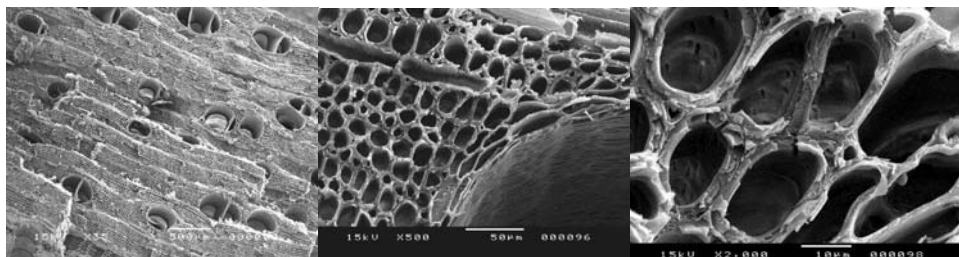

Fig. 3.8a-c Two-stage heat-treated simaruba, fracture surface after bending test

In simaruba, the differences of breaking behaviour between fully treated wood specimen and untreated control specimens were confirmed by SEM analysis. The fracture surface of heat-treated simaruba appeared brittle and flat (Figs. 3.8a,b,c). Fractures in untreated control specimens (Figs. 3.9a,b,c) lead to defibrillation of

tissue and delamination of cell walls, resulting in a more axial orientation of detachments. In contrast to this, treated wood had straight fractures favouring detachments perpendicular to the longitudinal axis.

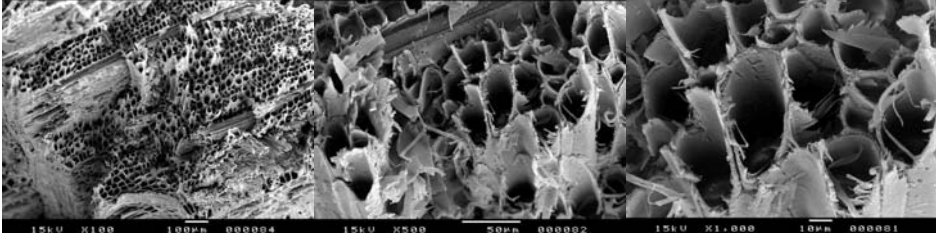

Fig. 3.9a-c Untreated simaruba, fracture surface after bending test

3.4 Conclusions

A two-stage heat treatment did reveal an effect on the anatomical structure of hardwood, depending on the wood species used and the process method or conditions applied. Hardwood species were predominantly sensitive to collaps of the vessels and some deformation of the libriform fibres directly near the vessels. In treated beech and birch radial cracks were observed near the rays. Optimisation of the heat treatment process conditions including the application of a steam hydro-thermolysis stage reduced such damages to a minimum. Broken cell walls perpendicular to the fibre direction resulting in transverse ruptures has been noticed in heat-treated hardwood species. This contributes to abrupt fractures of treated wood as observed in bending tests, which can lead to considerably different failure behaviour after impact or mechanical stress. In some treated hardwood species maceration (small cracks between tracheids) was noticed after heat treatment. Heat treatment did not reveal damage to the ray parenchyma pit membranes, bordered pits and large window pit membranes; and the margo fibrils appeared without damage.

4 A SOLID-STATE ¹³C-NMR STUDY OF HEAT-TREATED WOOD*

Abstract

The relatively mild two-stage heat treatment of wood was investigated by solid phase CP-MAS ¹³C-NMR to understand at molecular level the reasons for the improved wood properties, e.g. dimensional stability and durability. All the occurrences described appear to be the consequence of reactions, which are known in wood chemistry. These are the formation of acetic acid liberated from the hemicelluloses, which further catalyses carbohydrates cleavage, causing a reduction of degree of polymerisation of the carbohydrates. Acid catalysed degradation results in the formation of formaldehyde, furfural and other aldehydes as well as some lignin cleavage at C α and O4 and believed to cause some aldehyde production from lignin units C γ , all occurring in the first reaction stage. Lignin autocondensation through the cleaved, positively charged benzylic C α to form some methylene bridges presumably starts already to occur in this first stage (hydro-thermolysis). The increase in the number of free reactive sites on the aromatic ring of some lignin units already occurs in this phase but continues into the next. In the second treatment stage (curing) completion of the autocondensation of lignin is believed to occur through the formation of methylene bridges connecting aromatic rings. The aromatic nuclei sites are released by demethoxylation and through the cleaved, positively charged benzylic C α . Reactions of some of the aldehyde groups formed in the first stage occur with lignin aromatic nuclei sites to connect aromatic rings through methylene bridges. The extent of these reactions is mild, but nonetheless they lead to an increase in cross-linking with consequent improvement in dimensional stability and decreased hygroscopicity of wood.

* Tjeerdsma BF, Boonstra M, Pizzi A, Tekely P, Militz H (1998a) Characterisation of thermally modified wood: molecular reasons for wood performance improvement. Holz als Roh- und Werkstoff 56:149-153

4.1 Introduction

Solid-state ^{13}C -NMR spectroscopy is a useful method to analyse the structure of the main components of wood without isolation of the individual components, which might change the structure of the components and/or the interaction between components. Molecular changes and modifications will be visible in the ^{13}C -NMR spectra of wood after heat treatment. Unfortunately, it is difficult to obtain quantitative information about the individual components because the ^{13}C -NMR spectra contain frequent overlap of the various peaks, due to a distribution of chemical shifts of similar chemical moieties (Sivonen et al. 2002). Therefore, the interpretation of ^{13}C -NMR spectra should be done with some cautiousness and should be affirmed by other analysing methods*.

In this chapter modifications and reactions, which occur in wood constituents at the molecular level, are described, based on a solid-state CP-MAS ^{13}C -NMR study. Furthermore, the effect of these modifications and reactions on the hygroscopicity and dimensional stability of heat-treated wood is discussed.

4.2 Materials and Methods

Scots Pine (*Pinus sylvestris* L.) sapwood matched wood specimens were treated in a two-stage process. First, solid wood blocks saturated in a NaAc buffer solution (10 g/l) were exposed to high temperatures under moist conditions (hydrothermolysis), followed by high temperatures under dry conditions in the second stage (curing). The first treatment stage was performed in an autoclave heated in an oil bath, whereas the second stage was performed in an oven excluding oxygen by flushing with nitrogen gas. The intermediate, fully treated and untreated samples were mechanically ground to a fine powder and made extract-free performing a water extraction followed by a 1:1 (v/v) ethanol:cyclohexane extraction, both executed at elevated temperature in a soxhlet apparatus. The extract free wood samples were then analysed by solid phase CP-MAS ^{13}C -NMR. The solid-state CP-MAS ^{13}C -NMR spectra of the treated and untreated timber specimens were obtained with a Bruker MSL 300 FT-NMR spectrometer at a frequency of 75.45 MHz and at sample spin of 4.5 kHz and CP = 1 ms. Chemical shifts were calculated relative to TMS for NMR control. Acquisition time was 0.026 s. with number of transients of about 1000. The spectra were accurate to 1 ppm. The spectra were run with suppression of spinning side bands.

4.3 Results and discussion

In Table 4.1 typical ^{13}C -chemical shifts (δ) in ppm from tetramethylsilane (TMS) are given, which could be of relevance during thermal treatment (based on the specifications given by Sakakibara and Sano 2001). In Figures 4.1 and 4.2 the ^{13}C -NMR spectra of heat-treated Scots pine sapwood are shown. The trends are similar for all the treatments but the modifications observed are more marked after

* The reader should keep these remarks in mind when reading chapter 7 and 8.

a more extreme treatment. On the total spectrum a noticeable variation is that the level of amorphous carbohydrates increases in the hydro-thermolysis stage and then decreases in the curing stage but never back to the level before treatment.

Table 4.1 Relevant ¹³C-chemical shifts (δ) in ppm from TMS of softwood during heat treatment

Carbon type	Chemical shift (ppm)
Aldehyde peaks	190-220
CHO of formaldehyde*	196
CHO of furfuraldehyde	191-192
CO carboxylgroup of acetyl group	175
C1 of the aromatic ring of furfural (linked to the aldehyde group)	151-153
C3, C4 of the aromatic ring of lignin	151
C3 of the aromatic ring of lignin (connected to methoxy group)	148
C4 of the aromatic ring of furfural (not linked to the aldehyde group)	148
C4 of the aromatic ring of lignin (connected to hydroxyl group)	145
C1 of the aromatic ring of lignin	130
C5, C6 of the aromatic ring of lignin	118-121
C2 of the aromatic ring of lignin	112
C1 of cellulose	105
C1 of hemicelluloses	100
C4 of crystalline carbohydrates	89
C4 of amorphous carbohydrates	82
Cβ of lignin	81
Cβ of lignin	80
C2 of carbohydrates	75
C3, C5 of carbohydrates	72
Cγ of lignin	68
C6 of crystalline carbohydrates	65
Cγ of lignin	64
C6 of amorphous carbohydrates	62
O-CH ₃ methoxygroup of lignin (connected to the aromatic C3)	55
CH ₂ -COOH methyl group of acetyl group	21-22

* Formaldehyde is not present in the form of methylene glycol (the way it is generally present in solution).

As it appears clearly that the major changes occurring could be followed by the region between 100 and 150 ppm, the spectra were expanded in the NMR spectrometer itself, in order to be able to follow the variation of the peaks of interest better. In the Figures 4.1 and 4.2 is shown that the heat treatment causes:

1. An increase in the proportion of free sites ortho to the lignin aromatic-OH as a consequence of the increase of the peak at 117 ppm. This can be the result of only two occurrences, namely:

- a greater amount of phenolic-OH groups are present after the treatment as a consequence of demethylation of the methoxy groups of the guaiacyl and syringyl nuclei of lignin; or
- most likely a greater proportion of free ortho sites due to demethoxylation of the same methoxy groups.

In both cases this infers that a greater number of aromatic lignin sites are available for reaction and an increased reactivity of the aromatic nuclei of lignin affected by the change as hydroxyl groups activate the aromatic ring more than methoxy or

ether groups. This will result in all cases in an increase of the cross-linking level of the material with a concomitant increase in wood dimensional stability as discussed below.

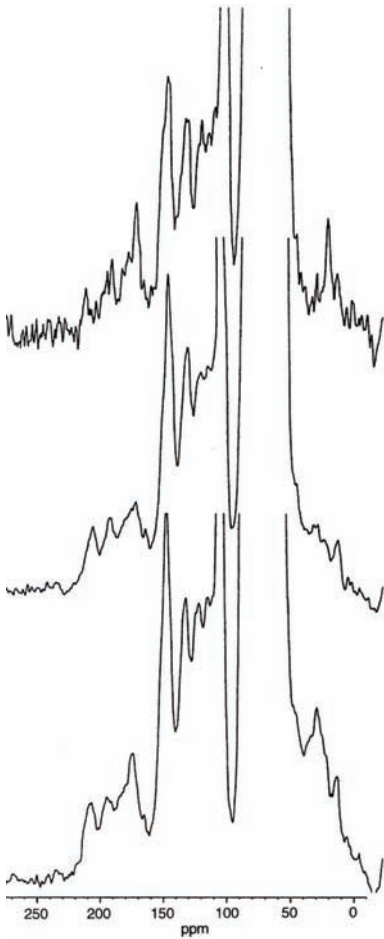

Fig. 4.1 Expanded to maximize 100-200 ppm region CP-MAS ¹³C-NMR spectra of untreated (top), intermediate (middle) and fully treated (below) Scots pinewood

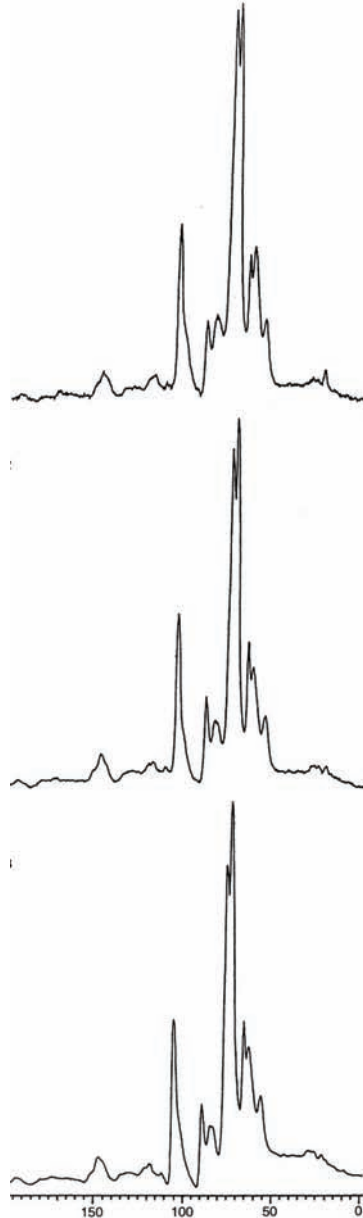

Fig. 4.2 Standard CP-MAS ¹³C-NMR spectra of untreated (top), intermediate (middle) and fully treated (below) Scots pinewood

2. An increase in the proportion of methylene (-CH₂)-bridges connecting two phenolic nuclei, and this particularly in the second, dry stage of the treatment. This is shown by the noticeable increase in the intensity of the peak at 29 ppm indicating that lignin cross-linking, which did not exist at such sites in the non-treated wood, has indeed occurred as a consequence of the heat treatment. Detected are more than one type of methylene bridges, which are formed as indicated by the number of peaks and shoulders in the 20-37 ppm region of the spectrum. The more intense of them at 29 ppm indicates by its shift to be an ortho-para or ortho-ortho methylene linking two phenolic sites. This infers that the methylene bridge obtained by autocondensation is not only due to reaction of aldehydes on the aromatic nuclei of lignin but is also due to a classical lignin cleavage at the O4 and at the C α of some lignin units followed by the autocondensation of the reactive -CH₂-group formed with a site of negative charge, namely one of the free reactive sites on the phenolic nuclei of another lignin unit.

3. Aldehyde peaks are found present in the 190-220 ppm range. These peaks appear in the spectra before treatment as well as after treatment, however the intensity increases in the first stage of the reaction. With respect to the study after the occurrence of the chemical reactions in wood during a thermal treatment it is of interest to examine what sort of aldehydes are represented by the observed peaks. The NMR shifts of the peaks are at 196 ppm and at 191-192 ppm. The first can only be the signal from formaldehyde and the second is the signal from furfuraldehyde. Furfuraldehyde is known to be formed during a heat-treatment of wood under acid conditions and detection of furfuraldehyde on the occasion of different studies after chemical reactions of wood under the influence of temperature has been reported in the literature (Bobleter and Binder 1980, Fengel and Wegener 1989; Dietrichs et al. 1978, Burtscher and Bobleter 1987). Both aldehyde peaks decrease in intensity in the second stage of the treatment and thus they are likely contributors to the formation of methylene bridges between lignin aromatic nuclei. The furfural peak increases more markedly in the first stage and decreases more markedly in the second stage, but both aldehydes decrease. The peak at 207-209 ppm is that of a quinone or of a ketone group, were the first is known to darken the wood, which also is observed by all the heat-treated wood samples in this research.

4. Strongly connected to the preceding arguments is the appearance in the second stage of the treatment of a peak at 127-128 ppm. This appearance of a peak in the region of reacted carbons of phenolic aromatic nuclei indicates condensation on the carbons of the aromatic ring. The same conversion to a more substituted aromatic ring is also confirmed by FTIR analyses of thermal modified wood (Annex 3) by a shift of the aromatic signal at 1510 cm⁻¹ in the FTIR spectra. This indicates that indeed lignin aromatic ring sites, which were free before the treatment and still free after the first treatment stage, have reacted after the second stage, and are occupied by a methylene group, most likely the same methylene group coming from C α cleavage of lignin described in point 2 above.

5. The peak at 175 ppm is the signal of the carbon of the carboxyl group (C=O) of acetic acid and its intensity decreases quite noticeably in the first, humid stage of the reaction. Its shift value of 175 ppm indicates that this can only be obtained by deacetylation of the hemicelluloses induced by the moisture and heat of the first treatment stage. This is also confirmed by the decrease with heat treatment of the methyl group signal of acetic acid at 21-22 ppm. In comparative research using FTIR to study the chemical transformations during a heat treatment of wood, this observation of deacetylation of hemicelluloses is also being confirmed by the decrease of the C=O signal for esters at 1740 cm⁻¹ in the FTIR spectra. It can therefore be concluded that acetic acid is liberated in the first stage of the treatment. In the second treatment stage the C=O peak at 175 ppm appears to increase. Since the aldehyde and ketone peaks at respectively 190 and 200 ppm are unchanged this favours the formation of esters and/or organic acids during the curing stage (or both). The organic acids can be situated free in the woody structure or they are bounded to the remaining and/or modified wood components (Gerardin et al. 2007).

6. Regarding the carbohydrates, the NMR spectra indicate also a decrease in the intensity of the carbohydrates C2 peak at 74-75 ppm particularly in the second, dry stage of the treatment, which might be a consequence of the deacetylation or of the opening of some of the pyranose rings. In this context it is interesting to note that while the crystalline carbohydrates C4 and C6 signals at 89 and 65 ppm respectively slightly increase during the treatment, the amorphous carbohydrates C4 and C6 signals at 84 and 62 ppm decrease markedly as a consequence of the treatment. This indicates that the aldehyde peaks produced are not only likely to be due to formaldehyde but also to a compound of the type of CH₂=CH-CHO (same signal region as formaldehyde) and possibly also due to glycoaldehyde HO-CH₂-CHO, which is well known to be produced in the thermal treatments of wood carbohydrates (Fengel and Wegener, 1989).

All the occurrences described above appear to be the consequence of reactions, which are not unfamiliar in wood chemistry describing the reactions in wood exposed to high temperatures and moist conditions. Thus the lignin cleavage at O4 and at C α and its autocondensation reactions (points 1 and 2 above) are occurrences commonly understood in for instance high temperature pulping (Sjöström 1981, Goyal and Lora 1991). The formation of aldehydes and furfural has been established on numerous occasions (Runkel 1951, Kollmann and Fengel 1965, Bobleter and Binder 1980, Ellis and Paszner 1994) and the stopping of this reaction at the level of furfural without further degradation can easily be ascribed to the relatively mild temperature and reaction time conditions used in the process. The formation of formaldehyde in acid/neutral conditions is not usual but instances of formaldehyde production from the cleavage of the carbohydrates C6 in wood, as well as from the C γ of lignin are reported (Fengel and Wegener 1989). It has been recognised that the reaction of aldehydes with phenolic nuclei of lignin (points 2, 3 and 4) to form methylene bridges other than those obtained by C α can occur (Fengel and Wegener 1989). Equally, the cleavage of the acetyl groups is known to occur in wood at high temperature and moisture conditions (Kollmann

and Fengel 1965, Dietrichs et al. 1978, Bourgois and Guyonnet 1988), as well as the carbohydrate reactions outlined in point 6 above (Fengel and Wegener 1989). An important reason to perform the second heat treatment stage (curing) is that condensation reactions are relatively slow (Garrotte et al. 1999). This enables further autocondensation reactions (repolymerisation) resulting in new lignin based polymers and/or in an increased cross-linking of the existing lignin network (as described above). The formation of a lignin-cellulose complex due to condensation reactions has also been suggested (Košíková et al. 1999).

Considering all the above-described occurrences it is now important to understand how these reactions combine to give the improvement in performance characteristic of heat-treated wood. A possible explanation can be given as follows:

1. First treatment stage (hydro-thermolysis)

Formation of acetic acid from the hemicelluloses, acetic acid which further catalyses carbohydrates cleavage, with some reduction of degree of polymerisation and some degradation to form formaldehyde, furfural and other aldehydes as well as some lignin cleavage at C α and O4 and some aldehyde production from lignin units C γ . Lignin autocondensation through the cleaved, positively charged benzylic C α to form some methylene bridges already starts to occur in the first phase of the process. The increase in the number of free reactive sites on the aromatic ring of some lignin units already occurs in this stage but continues into the next stage.

2. Second treatment stage (curing)

Completion of the autocondensation of lignin to some methylene bridges connecting aromatic nuclei. Reactive sites at the aromatic ring are created by the cleavage at C α and O4 as well as by the demethoxylation at the aromatic ring of guaiacyl and syringyl units of the lignin complex.

The extent of these reactions is very mild, but nonetheless they result in an increase in cross-linking within the lignin-carbohydrate-complex (LCC) with consequent improvement of the hygroscopicity and the dimensional stability of wood. The formation, or better the reinforcing of a natural phenolic resin based on lignin in the wood network, results also in an increase in water repellence of wood, as any synthetic phenolic resin would achieve too. The reduced hygroscopicity and dimensional stability of wood after a heat treatment is explained by the fact that the cellulose microfibrils are surrounded by a firm and more inelastic network due to increased cross-linking within the lignin complex. The cellulose microfibrils present a decreased expansion possibility and therefore less capacity to adsorb water between the cellulose chains, impeding the cell wall to swell. This results in wood with a consequent lower fibre saturation point (FSP), along with a higher resistance against biological deterioration. Assumed to respond to a lower extent, both effects are also positively influenced by the transformed chemical composition of the wood (substrate). Hemicelluloses, the most hydrophilic and easily digested wood component, has been transformed selectively and reacted into a hydrophobic network. The progressively darker wood colour, which

becomes more noticeable the more severe are the treatments, is due to oxidation products such as quinones, which are observed in the NMR analysis.

4.4 Conclusions

A solid phase CP-MAS ^{13}C -NMR study of heat-treated wood revealed reactions, which are known in wood chemistry.

The formation of acetic acid liberated from the hemicelluloses, which further catalyses carbohydrates cleavage, causing a reduction of degree of polymerisation of the carbohydrates. Acid catalysed degradation of hemicelluloses results in the formation of formaldehyde, furfural and other aldehydes as well as some lignin cleavage at $\text{C}\alpha$ and O4 and believed to cause some aldehyde production from lignin units $\text{C}\gamma$, all occurring in the first reaction stage.

Lignin autocondensation through the cleaved, positively charged benzylic $\text{C}\alpha$ to form some methylene bridges presumably starts already to occur in this first stage (hydro-thermolysis). The increase in the number of free reactive sites on the aromatic ring of some lignin units already occurs in this phase but continues into the next.

In the second treatment stage (curing) completion of the autocondensation of lignin is believed to occur through the formation of methylene bridges connecting aromatic rings. The aromatic nuclei sites are released by demethoxylation and through the cleaved, positively charged benzylic $\text{C}\alpha$. Reactions of some of the aldehyde groups formed in the first stage occur with lignin aromatic nuclei sites to connect aromatic rings through methylene bridges.

The extent of these reactions is mild, but nonetheless they lead to an increase in cross-linking with consequent improvement in dimensional stability and decreased hygroscopicity of wood.

5 CHEMICAL ANALYSIS OF HEAT-TREATED SOFTWOODS*

Abstract

A chemical analysis was carried out to investigate the reaction mechanisms of the two-stage heat treatment method under relatively mild treatment conditions (< 200°C). Different chemical analysing methods were used, such as a wood component analysis, CHNO-elemental analysis, UV-spectroscopy, and analysis of the acetyl and free hydroxyl group content. The results of this extensive chemical analysis showed that there are significant differences between the first process stage, which is performed in an aqueous environment at superatmospheric pressure (hydro-thermolysis), and the second process stage, which is performed under dry and atmospheric conditions (curing). During the first process stage (hydro-thermolysis) depolymerisation of the hemicelluloses and hydrolysis cleavage of acetic acid from their acetyl groups occur. The presence of water is important for the cleavage of acetyl groups to yield acetic acid, which plays the further role of catalyst in the depolymerisation of carbohydrates (autocatalysis of the process). The effect of the second process stage (performed under dry and atmospheric conditions) on the depolymerisation of hemicelluloses and on the cleavage of the acetyl groups is instead rather limited. The lignin content of treated wood is increased, especially after the second process stage. This is mainly due to the depolymerisation of the carbohydrates. There is, however, a strong indication that polycondensation reactions occur, which also contributes to the increase of the lignin content. Such polycondensation reactions results in a further cross-linking of the lignin network. UV analyses reveal the occurrence of such condensation reactions and/or the formation of other aromatic structures during heat treatment, such as furfural and/or methyl furfural. This was especially true for the secondary cell walls. The effect of this two-stage heat treatment on cellulose is rather limited, although during the second process stage (curing) some depolymerisation of the cellulose occurs. The reduction in water adsorption as observed for heat-treated wood favours the effect of increased cross-linking of the lignin network, since the proportion of free hydroxyl groups still available after heat treatment did not changed.

* Boonstra MJ, Tjeerdsma BF (2006) Chemical analysis of heat-treated softwoods. Holz als Roh und Werkstoff 64:204-211

5.1 Introduction

Complimentary to the solid-state CP-MAS ^{13}C -NMR study (Chapter 3) different chemical analysing methods were performed in order to provide more information about the modifications and reactions, which occur in wood during heat treatment. In this chapter the results of a wood component analysis, CHNO-elemental analysis, UV-spectroscopic analysis, and analysis of the acetyl and free hydroxyl group content, are given. The effect of heat treatment on the main components of wood is described and differences between the hydro-thermolysis stage and the curing stage are discussed. Furthermore, molecular reasons for the reduced hygroscopicity of wood after heat treatment are discussed in more detail. Results of a FTIR analysis of similar heat-treated wood have been reported by Tjeerdsma and Militz (2005) and included as copy in annex 3.

5.2 Materials and Methods

Material

The following softwood species were used for heat treatment and chemical analysis: Norway spruce (*Picea abies* Karst), Scots pine (*Pinus sylvestris* L.) and radiata pine (*Pinus radiata* D. Don).

Per wood species at least 10 boards were treated (per treatment condition). Standard cross section sizes were used (thickness: 25-40 mm; width: 150 mm) and the length of the samples was approx. 3.0 m before heat treatment. The moisture content before treatment was 16-20% ('shipping dry').

Untreated wood specimens were also used for chemical analysis.

Heat treatment

The heat treatment was performed in two separate stages. In the first stage of the heat-treatment the wood boards were treated in an aqueous environment at superatmospheric pressure (6-8 bar), a so-called "hydro-thermolysis" treatment. This was done in a 600 l. pilot plant and the treatment temperature varied between 165-185°C (at an effective treatment time of 30 minutes). A heat exchanger has been used to heat and cool the process water in the reactor. NaOH or NaAc was added to the process water to control the pH. The wood boards were then dried in a (net) 1 m³ kiln, using a conventional drying process at 50-60°C. After drying the wood samples were heat-treated again in a special curing kiln (second stage), under dry and atmospheric conditions, a so-called "curing" treatment (170-180°C at an effective treatment time of 4 hours). During this process stage superheated steam or nitrogen gas was used as a sheltering gas to exclude oxygen (reducing fire risks and preventing non desired oxidation reactions).

Wet chemical analysis of wood components

The wet chemical analysis of the wood components has been performed on untreated Scots pine, the intermediate wood product (after hydro-thermolysis) and fully treated Scots pine (after curing). A schematic overview of the wet chemical

analysing methods used to determine the wood components, is given in Figure 5.1.

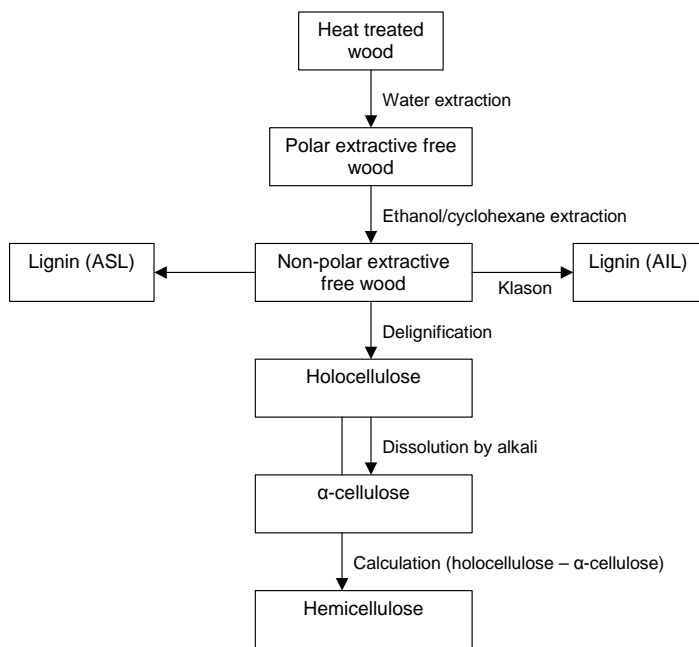

Fig. 5.1 Wet chemical analysis procedure of untreated, intermediate and heat-treated Scots pine

Before chemical analysis the wood specimen were grinded, sieved (<0,25 mm) and dried (60°C, 2 days). About 50 g of grinded specimen was then extracted with water according a method described by Rowell (1984) in order to determine the polar extractive fraction in untreated, the intermediate and treated wood. After drying (60°C, 2 days) the water extracted grinded specimen were extracted with an ethanol-cyclohexane solution (1:2) in order to determine the non-polar extractive fraction (Rowel, 1984). Because of the carcinogenic properties of benzene cyclohexane was used.

After drying about 3 gram of the extracted specimen was used to determine the Klason lignin content (Acid Insoluble Lignin or AIL), according the ASTM-standard D1106-84. The acid soluble lignin (ASL) content was determined according to the Tappi-standard UM250.

About 3 gram of dried extracted specimen was used to determine the holocellulose content according to the sodium chlorite method of Wise et al (1946). In the holocellulose fraction the α-cellulose content was determined according the NaOH hydrolysis method of Fengel (1980). Based on these results the hemicelluloses content was calculated. The lignin content of the holocellulose fraction was determined according the ASTM-standard D1106-84.

CHNO-elemental analysis

The CHNO-elemental analysis has been performed on untreated, the intermediate and the treated radiata pine. Before analysis the samples were grinded and dried at 103°C (oven dry). The CHNO-elemental analysis has been performed with a Carlo-Erba multi-elementanalyser according the following method.

CHN-analysis

The sample is burned in a reaction column at 1000°C, in which helium gas flows. When the sample falls into a tin cup oxygen is injected in the reaction column and the sample will be burned completely. The temperature rises to 1700°C due to the combustion of the tin cup. The combustion gases are oxidized using chromic oxides. The halogen is removed with silvered cobalt oxides. The excess oxygen is subsequently removed with copper and nitrogen oxides are reduced to nitrogen. Nitrogen, carbon dioxide and water are separated on a gas chromatograph fitted with a porapak QS column at 120°C and detected with a katharometer (thermal conductivity detector). Previously the Carlo-Erba multi-elementanalyser has been calibrated with TRIS standard.

O-analysis

The sample will be pyrolyzed in a reaction column at 1060°C in which helium gas flows. The arising gases are conducted over nickel activated carbon resulting in carbon monoxide production. The pyrolysis gases are conducted over an anhydrous ascarite column to remove carbon dioxide, subsequently separated on a porapak QS column at room temperature and detected with a katharometer. Previously the Carlo-Erba multi-elementanalyser has been calibrated with benzoic acid standard.

UV spectroscopic analysis

For orientating analysis the light absorption characteristics of treated and untreated Scots pinewood samples have been investigated with an UV-VIS spectrometer on the surface of the samples (reflection mode), without the use of mounting media or cover glasses. The maximums as well as the intensity at the maximum wavelength were recorded and the UV-absorption spectra were calculated using a control (zero) beam.

Small Norway spruce wood samples were embedded in Spurr's resin (Spurr 1969), cut with a rotary microtome and the thin slides (1 µm) mounted on quartz object glasses and analysed using an UV micro spectrophotometer (Zeiss UMSP). The spectrophotometer was attached to an UV microscope, which enables UV-micro-spectroscopy measurements of UV-absorption on cell wall level. Absorption spectra were measured within the compound middle lamella (CML), cell corners (CC) and secondary wall (S2).

Chemical analysis of the acetyl content

The acetyl content analysis has been performed on treated and untreated radiata pine. The radiata pine wood samples were treated at 165°C in the first process stage (hydro-thermolysis). In the second process stage (curing) the treatment temperature was varied between 160-190°C with the process time ranging from 1

to 16 hours. The radiata pine wood samples were also heat-treated without the first process stage at 160°C to 190°C with the process time ranging from 1 to 16 hours.

The wood samples were grinded and diluted with an excess sodium hydroxide, using sodium butyrate as the internal standard. The butyrate-acetyl proportion in solution is determined with a HPLC-analysis, including a Bio-Rad-Micro-Guard pre-column (with cation-H refill cartridges), a Bio-Rad Aminex HPX-87H analysis column and a UV-spectrophotometer (210 nm). The test results were controlled with the help of a calibration line of known butyrate/acetate solutions.

Analysis of free hydroxyl group content

Small blocks (5x5x5 cm) of untreated Scots pine wood, the intermediate product and the treated product were extracted with water followed by ethanol/cyclohexane (Rowell 1984). The specimens were then treated with acetic anhydride to a maximum weight percent gain (about 20% according to Boonstra et al. 1996). This treatment involved an impregnation with acetic anhydride, treatment at 140°C (4 hours) in boiling acetic anhydride, and kiln drying at 105°C to remove acetic acid and non-reacted acetic anhydride.

5.3 Results and discussion

Chemical analysis of wood components

The results of the chemical analysis of the wood components are given in Table 5.1. The increase in the concentration of the soluble fraction in the intermediate product is due to depolymerisation of the cell wall components during the first process stage (hydro-thermolysis). The increase of the water-soluble fraction was higher than the increase of the non-polar fraction. This indicates a depolymerisation of the carbohydrate, especially of the hemicelluloses. A higher treatment temperature during the hydro-thermolysis appears to have an effect on the concentration of the soluble fraction, due to the formation of furfural and/or some degradation products of the lignin wood component.

After the curing stage the soluble fraction is lower than that of the intermediate product. This is caused by:

- evaporation of some cleaved products during drying/curing; and/or
- polymerisation reactions of such products with the wood components during the curing stage (e.g. condensation reactions with lignin).

The two-stage heat treatment used resulted in a reduction of the hemicelluloses percentage. Hemicelluloses are non-crystalline, highly disordered, heteropolymers (Fengel and Wegener 1989, Ishii and Shimizu 2001) relatively easy to hydrolyse at elevated temperatures (200-230°C), even without the presence of an acid catalyst (Abatzoglou et al. 1990). The oligomers produced during acid attack (e.g. acetic acid, formic acid), are water soluble and readily hydrolysable to monomers. Further degradation reactions lead to the formation of furfural, hydroxymethyl furfural (HMF), acids and other condensation products (Bobleter and Binder 1980, Abatzoglou et al. 1990). Depolymerisation of the hemicelluloses increased after

the hydro-thermolysis treatment temperature was raised to 185°C, since the hemicelluloses content was decreased. During the curing stage the hemicelluloses content does not change, which indicates that the process conditions during a dry atmospheric heat treatment at 180°C are less effective to depolymerise hemicelluloses. According to Belkacemi et al. (1991) hydrolysis of hemicelluloses are affected by the pressure during treatment, which is increased during hydro-thermolysis (6-8 bar). Other factors, which affect the hydrolysis of hemicelluloses, are the formation of acids (quantity and type) and the accessibility of the reactants.

Table 5.1 Chemical analysis of the wood components of heat-treated Scots pine

		<u>Untreated</u>	<u>Hydro-thermolysis 165°C</u>		<u>Hydro-thermolysis 185°C</u>	
			<u>Intermediate</u>	<u>Curing 180°C</u>	<u>Intermediate</u>	<u>Curing 180°C</u>
Extractives						
- Polar	%	2.8	6.9	3.8	8.2	2.6
- Non-polar	%	2.8	2.6	2.3	4.7	3.1
Total	%	5.6	9.5	6.1	12.9	5.7
Klason lignin	%	27.7	28.3	30.3	32.7	36.0
Duplicate	%	24.0	27.0	30.0	30.0	35.0
Average	%	25.9	27.7	30.2	31.4	35.5
Acid soluble lignin	%	0.37	0.55	0.55	0.65	0.56
ASL						
Duplicate	%	0.26	0.22	0.55	0.23	0.60
Average	%	0.32	0.39	0.55	0.44	0.58
Holocellulose	%	79.7	70.3	66.7	66.7	63.3
Duplicate	%	82.3	71.7	67.3	67.7	63.0
Average	%	81.0	71.0	67.0	67.2	63.2
Lignin	in %	0.95	0.37	0.45	0	0
holocellulose						
α -cellulose	in %	60.0	70.7	68.0	82.0	82.0
holocellulose						
Duplicate	%	61.3	68.7	66.0	78.7	75.3
Average	%	60.7	69.7	67.0	80.3	78.7
α -cellulose in wood	%	48.6	50.2	45.6	55.1	51.8
Duplicate	%	49.7	48.8	44.2	52.9	47.6
Average	%	49.1	49.5	44.9	54.0	49.7
Hemicelluloses	in %	39.3	30.3	33.0	19.7	21.3
holocellulose*						
Hemicelluloses	in %	31.9	21.5	22.1	13.2	13.5
wood**						

* Based on the α -cellulose content the hemicelluloses is calculated

** A mass balance of 98-101% is generally acceptable, however values deficient or in excess by about 10% are frequently obtained (Baeza and Freer 2001)

The holocellulose content decreases during treatment caused by depolymerisation of the hemicelluloses during hydro-thermolysis and some degradation of the cellulose during curing. According to Torres et al. (1986) very little cellulose passes into solution at temperatures below 200°C, whereas the solubilisation of cellulose becomes important beyond 220°C. Cellulose has a highly ordered crystalline structure, which provides a great stability to the cellulose chains and protects them against acid attack during hydrolysis (Fengel and Wegener 1989). The accessibility of the glucosidic bonds is very limited when compared to those of hemicelluloses. Due to this, acid diffusion throughout the cellulosic structure is

difficult. According to Abatzoglou et al. (1990) the inter- and intra-hydrogen bonds within the crystalline cellulosic structure stabilizes the glucosidic bonds in such a way that even if the acid penetrates into the cellulosic structure endogenous hydrolytic actions are much more limited than exogenous ones. As expected, there occurs to be no cellulose degradation during hydro-thermolysis of wood. However, during curing some cellulose degradation is observed, probably due to the different process conditions applied (dry atmospheric heat treatment) and/or to a longer effective treatment time (4 hours instead of 30 minutes).

The relative lignin percentage was slightly increased during heat treatment, this being mainly caused by degradation of the hemicelluloses (during hydro-thermolysis) and cellulose (during curing). Condensation reactions of lignin as suggested in Chapter 4, most probably also contributed to this higher lignin content. Especially when the hydro-thermolysis temperature was raised to 185°C more hemicelluloses cleavage products (depolymerisation) are available, which can contribute to polymerisation reactions of lignin (e.g. condensation) during curing.

CHNO analysis

The differences in the CHNO element ratio between untreated, intermediate and treated radiata pine are rather small (Table 5.2). There is a slight reduction of the H- and O-content, whereas the C-content is slightly increased.

It is known that heat treatment of wood results in the elimination of water, caused by dehydration of the carbohydrates to yield aldehydes (see Chapter 4 and Bobleter and Binder 1980, Abatzoglou et al. 1990). This results in a reduction H- and O-content. The decarboxylation (cleavage of acetic acid from hemicelluloses), which is also characteristic for heat treatment, results in a reduction in O-content. Condensation reactions contribute to a further decrease in H- and O-content. Thus, the C-content increases during heat treatment.

It is difficult to conclude whether these small differences in the CHNO elemental analysis results between treated and untreated wood confirm or not the suggested reaction mechanism during the two-stage heat treatment (see Chapter 4). However, the results are not in contradiction with the reaction mechanism suggested.

Table 5.2 CHNO elemental analysis of untreated, intermediate and fully treated radiata pine

	Percentage on dry weight			
	C	H	N	O
Untreated	49.6	5.7	0.11	43.7
Intermediate	50.2	5.9	0.10	43.0
Fully treated	50.6	5.6	0.09	42.3

UV spectroscopic analysis

Due to its aromatic structure, lignin is the substance mainly responsible for UV-absorption, while carbohydrates affect UV-absorption much less (Okamura 2001, Sakakibara 2001). Distinct absorption maximums for lignin are found at 205 and approx. 280 nm (Goldschmid 1971; Fukazawa 1992). Softwood and hardwood

lignin differ, the 280 nm peak is shifted to 274-276 nm in many hardwood lignins, while in softwood lignins it is shifted at 280-285 nm (Hon 1991). The absorption spectra of treated and untreated Scots pine are shown in Figure 5.2. The strong near-UV absorption reflecting the aromatic structure of lignin (Goldschmid 1971) is clearly visible in the spectra of untreated wood samples. After heat-treatment this maximum is slightly increased but an increase in absorption in the visible spectrum (>400 nm) also corresponds to this.

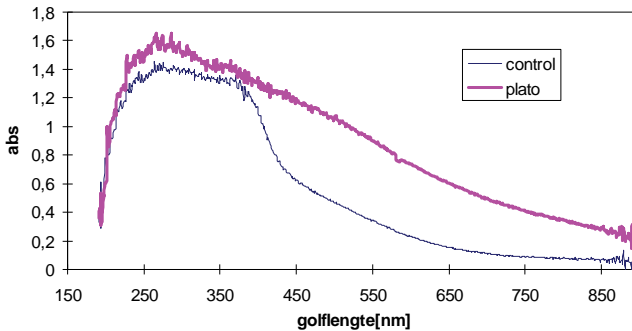

Fig. 5.2 UV-VIS absorption spectra of treated and untreated Scots pine

Degradation of the aromatic monomers appears unlikely. Such changes would show a reduced absorption maximum at 280 nm. The appearance of a second range of stronger UV-absorption peaks between 320 and 350 nm is likely to be caused by side chain reactions of lignin (Goldschmid 1971).

The UV-absorption spectra from the secondary cell wall and middle lamella of treated and untreated Norway spruce is shown in Figure 5.3. Untreated Norway spruce samples showed a distinct UV-absorption maximum at 280 nm and a rapid decrease in absorption as frequencies shifted towards the visible spectrum. The lignin-rich compound middle lamella and cell corners revealed the highest UV-absorption values. The treated wood samples spectra differed considerably from those of untreated samples. The 280 nm maximum increased and another maximum appeared in the visible spectrum range. An additional difference between treated and untreated wood is that the absorption in the middle lamella spectrum appears to decrease to frequencies lower than 270 nm in treated wood. This is an indication of changes in the aromatic ring of lignin (e.g. ring opening). Remarkable is the increase in the 280 nm peak for the secondary cell wall, which is higher than for the middle lamella. This could be caused by the occurrence of condensation reactions resulting in further cross-linking of the lignin network (see Chapter 4). According to Pizzi et al. (1994) this hinders water absorption by the cellulose microfibrils in the secondary cell wall resulting in a reduced hygroscopicity and swelling properties. This contributes to the dimensional stability of wood after heat treatment. Another reason for the rather large increase of the 280 nm peak is the formation of other aromatic structures during heat treatment, such as furfural and/or methyl furfural (see Chapter 4). The secondary cell wall

contains more hemicelluloses than the middle lamella (Fengel and Wegener 1989) and thermal depolymerisation results in a higher production of furfural from them.

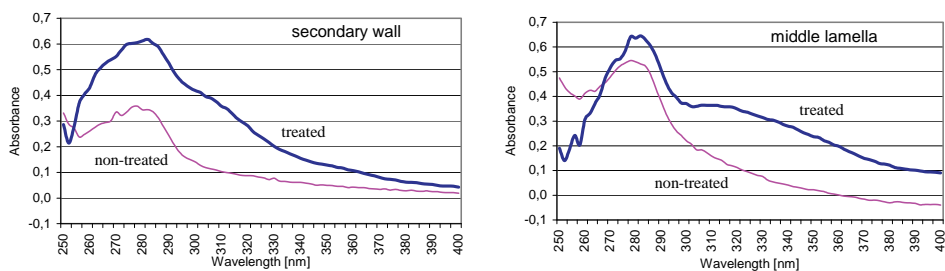

Fig. 5.3 UV absorption from the secondary cell wall and middle lamella of treated and untreated Norway spruce

Table 5.3 Acetyl content of treated and untreated radiata pine

Thermolysis Temperature (°C)	Curing Temperature (°C)	Curing Time (Hrs)	Acetyl Content (%)
Untreated			1.48
165	160	4	0.95
165	170	4	0.96
165	180	1	0.95
165	180	2	1.03
165	180	4	0.80
165	180	8	0.80
165	180	16	0.76
165	190	4	0.78
---	160	4	1.54
---	180	1	1.46
---	180	4	1.73
---	180	16	1.40
---	190	4	1.60

Analysis of the acetyl content

The acetyl group content determined experimentally for treated and untreated radiata pine is shown in Table 5.3. The acetyl group content of wood, which was treated without the first process stage, is also given. The two-stage heat treatment seemed to result in a reduction in acetyl content of the wood specimen. This has also been confirmed by FTIR analysis (Annex 3). The curing conditions had a rather limited effect on the reduction in acetyl content. Heat treatment of the wood under dry and atmospheric conditions (without the first process stage) did not reveal an effect on the acetyl content. Therefore, it is rather the hydro-thermolysis, which affects the acetyl content, and acetic acid must be formed in this process stage. This is also suggested in Chapter 4, stating that acetic acid is liberated from hemicelluloses during the first process stage (hydro-thermolysis), which further catalyses carbohydrates cleavage causing a reduction in degree of the polymerisation of the carbohydrates.

In conclusion, acetic acid cleavage from hemicelluloses mainly occurs during the first process stage (hydro-thermolysis) at higher temperature. Presence of enough water is necessary for this reaction to occur. This corresponds to findings of Weiland and Guyonnet (1997) showing no reactivity of the wood components at a treatment temperature below 180°C under dry and atmospheric conditions.

Analysis of free hydroxyl group content

In order to investigate the changes in the free hydroxyl group content during heat treatment, untreated, the intermediate and treated Scots pine specimen were treated with acetic anhydride. Acetic anhydride is known as a very effective chemical to esterify the free hydroxyl groups of wood, both of lignin and holocellulose (Rowell et al. 1994, Pizzi et al. 1994, Boonstra et al. 1996). Table 5.4 shows the maximum weight percent gain (WPG) of heat-treated, the intermediate and untreated Scots pine after treatment with acetic anhydride.

Table 5.4. Weight percent gain of untreated, intermediate and fully treated Scots pine after acetic anhydride treatment

	Thermolysis Temperature (°C)	%	WPG Stdev
Untreated		19.5	0.28
Intermediate	165	19.0	0.47
	185	18.6	0.86
Fully treated	165	20.8	0.79
	185	16.7	1.09

The maximum WPG of the intermediate product is slightly lower than the untreated wood whereas the maximum WPG of treated wood (treated at 165°) is slightly increased. The maximum WPG of wood treated at 185°C seems to be lower than that of untreated wood, especially after the second treatment stage.

In the FTIR study of Tjeerdsma and Militz (Annex 3) the carbonyl peak at 1740 cm⁻¹ is specific to the acetyl groups in wood. During heat treatment this peak decreases significantly after the first process stage, most likely due to the cleavage of the acetyl groups in hemicelluloses. This peak clearly increases after an acetic anhydride treatment due to esterification of free hydroxyl groups to acetyl groups. Heat treatment at 165°C does not affect the intensity of this peak, which remains constant. These FTIR analysis and WPG results indicates that a heat treatment at 165°C does not affect the free hydroxyl group content. This confirms the CHNO-elemental analysis, which showed very small changes in the CHNO ratio (Table 5.2), whereas a significant reduction of the hydroxyl group content should have an effect on the CHNO ratio.

During the heat treatment at 185°C in the first process stage, there is a significant reduction in the intensity of the carbonyl peak for the intermediate and even more for fully treated wood. This corresponds to the reduction of the maximum WPG after acetic anhydride treatment (Table 5.4), indicating a decrease in acetyl groups. The reduced reactivity of the treated wood specimens during acetic anhydride treatment is probably due to a decrease in free hydroxyl groups, caused

by increased depolymerisation of carbohydrates and especially of the hemicelluloses (Table 5.1). The cleaved products are leached and/or caramelised during the treatment (explaining the darker colour of treated wood) hence indicating a decrease in the total amount of free hydroxyl groups. Another cause might be an increase in the crystalline/non-crystalline cellulose ratio as in crystalline cellulose the hydroxyl groups are not accessible for acetic anhydride molecules (Tjeerdsma et al. 1998a, Pott 2004).

It is not known whether the physicochemical structure of the heat-treated samples is changed during an acetic anhydride treatment at elevated temperatures (140°C). This also could have an effect on the availability and/or accessibility of the free hydroxyl groups.

As reported earlier a two-stage heat treatment of wood results in a significant reduction in water adsorption (Boonstra et al. 1998, Tjeerdsma et al. 1998b). The availability and/or accessibility of the free hydroxyl groups of the wood carbohydrates play an important role in the process of water adsorption and desorption. The reasons for this are multifold, as already discussed by other authors:

- depolymerisation of the carbohydrates and especially hemicelluloses, resulting in a reduction in the total amount of hydroxyl groups, including the free hydroxyl groups (Kollmann and Schneider 1963, Burmester 1975).
- an increase in the relative proportion of the crystalline cellulose, in which the hydroxyl groups are not easily accessible to water molecules (see Chapter 4 and Pott 2004).
- further cross-linking of the lignin network (see Chapter 4 and Burmester 1975, Bobleter and Binder 1980), which hinders accessibility of free hydroxyl groups to water (Pizzi et al. 1994).

The reduction of the accessible, free hydroxyl groups after heat treatment is most probably due to a combination of such effects. It is difficult, however, to conclude which effect contributes the most to the reduction in water adsorption. The results of the acetic anhydride treatment indicate that there is no reduction of the free hydroxyl groups in the heat-treated wood samples (treated at 165°C). This favours increased cross-linking of the lignin. Heat treatments at higher temperatures (185 °C) results instead in a further decrease in water adsorption, in which the decrease in free hydroxyl groups also occurs.

5.4 Conclusions

The results of this extensive chemical analysis of a two-stage heat treatment of wood showed that there are significant differences between the first process stage, which is performed in an aqueous environment at superatmospheric pressure (hydro-thermolysis), and the second process stage, which is performed under dry and atmospheric conditions (curing).

During the first process stage (hydro-thermolysis) depolymerisation of the hemicelluloses and hydrolysis cleavage of acetic acid from their acetyl groups occur. The presence of water is important for the cleavage of acetyl groups to

yield acetic acid, which plays the further role of catalyst in the depolymerisation of carbohydrates (autocatalysis of the process). The effect of the second process stage (performed under dry and atmospheric conditions) on the depolymerisation of hemicelluloses and on the cleavage of the acetyl groups is instead rather limited. The lignin content of treated wood is increased, especially after the second process stage. This is mainly due to the depolymerisation of the carbohydrates. There is, however, a strong indication that polycondensation reactions occur, which also contribute to the increase of the lignin content. Such polycondensation reactions result in a further cross-linking of the lignin network. UV analyses reveal the occurrence of such condensation reactions and/or the formation of other aromatic structures during heat treatment, such as furfural and/or methyl furfural. This was especially true for the secondary cell walls. The effect of this two-stage heat treatment on cellulose is rather limited, although during the second process stage (curing) some depolymerisation of the cellulose occurs. The reduction in water adsorption as observed for heat-treated wood favours the effect of increased cross-linking of the lignin network, since the proportion of free hydroxyl groups still available after heat treatment did not change.

These findings contribute to a better understanding of the reaction mechanism of a two-stage heat treatment process of wood and of the effect that such a treatment has on the properties of wood. It also indicates that there are significant differences in the chemistry of a two-stage treatment as compared to a one-stage heat treatment, performed in dry and atmospheric conditions.

SUMMARY OF PART I*

Microstructural and physical changes of wood after heat treatment

The wood colour after the first treatment stage (hydro-thermolysis) varies from light to dark brown, caused by the formation of quinones or the caramellisation of holocellulose components. An increase of the treatment temperature changed the colour into a darker tinge. Most of the colour changes occur during the hydro-thermolysis, whereas treatment of wood specimens without the first treatment stage (only the curing) resulted in a light brown colour, much lighter than after the hydro-thermolysis. The colour change also depends on the timber species used and appears to be correlated to the density of the wood since the colour is becoming darker with an increasing density. A microscopic analysis revealed that the colour of the cell wall changes from white to brown. This colour change involves both the compound middle lamella and the secondary cell wall. This is believed to be due to the formation of reaction products in the cell wall or to the diffusion of such reaction products within the cell wall.

The effect of heat treatment on the anatomical structure of wood is rather limited, although this depends on the wood species considered and on the process method and conditions used. Softwood species with narrow annual rings and/or an abrupt transition from earlywood into latewood are sensitive to tangential cracks in the latewood section. Radial cracks occur mainly in impermeable wood species such as Norway spruce, caused by large stresses in the wood structure during treatment. Sapwood of treated pine species reveal some damage to parenchyma cells in the rays and epithelial cells around resin canals, whereas this phenomenon has not been noticed in the heartwood section. Treated radiata pine results in a very open and permeable wood structure limiting the applications of this species.

Hardwood species such as beech and poplar, are predominantly sensitive to collaps of the vessels and some deformation of the libriform fibres directly near the vessels. In treated beech and birch radial cracks are observed near the rays. Optimisation of the process conditions including the application of a steam hydro-thermolysis stage reduced such damages to a minimum.

Broken cell walls perpendicular to the fibre direction resulting in transverse ruptures, have been noticed in treated softwood and hardwood species. This contributes to abrupt fractures of treated wood as observed in bending tests, which can lead to considerably different failure behaviour after impact or mechanical stress. In some treated softwood and hardwood species maceration (small cracks between tracheids) was noticed after heat treatment. Heat treatment

* Boonstra MJ, Van Acker J, Pizzi A (2007c) Anatomical and molecular reasons for property changes of wood after full-scale industrial heat treatment. Paper of the 3th European conference on wood modification ECWM3 Cardiff, 15-17 October 2007. ISBN 184-220-096-8

does not cause damage to the ray parenchyma pit membranes, bordered pits and large window pit membranes; the margo fibrils appear without damage.

Chemical changes of wood after heat treatment

In the moist treatment stage, the hydro-thermolysis, hemicelluloses are depolymerised by hydrolysis reactions to oligomers and monomers. This involves cleavage of the sidechain constituents (arabinose and galactose), followed by degradation of the main chain constituents (mannose, glucose and xylose). The corresponding pentoses and hexoses are dehydrated to respectively furfural and hydroxymethylfurfural. Other aldehydes such as formaldehyde have also been found due to cleavage of the carbohydrates C₆ as well as from the C_γ of lignin. Furthermore, cleavage of acetic acid from acetyl side chains of hemicelluloses occurs and reduces the acetyl content of wood. Hydronium ions generated by water autoionisation are thought to act as catalysts in the initial reaction stages. In further reaction stages, the hydronium ions of acetic acid generated after acetyl side chain cleavage (and possibly hydronium ions from other acids such as levulinic and formic acid) also acts as catalysts and their contribution become more important than that of water autoionisation (Garrotte et al 1999). The degradation of the hemicelluloses and the release of acids depend on the process conditions applied, such as process temperature and treatment time. However, it appears that it is the process temperature and possibly the corresponding pressure, which play an important role in the degradation of hemicelluloses during the hydro-thermolysis stage. The presence of water is of eminent importance since no reactivity of the hemicelluloses is observed at a treatment temperature below 180°C under dry and atmospheric conditions. Furthermore, during the second heat treatment stage (curing) performed under dry and atmospheric conditions at a very low oxygen level, no further degradation of the remaining hemicelluloses was observed.

Degradation of cellulose is limited since the temperatures used during this heat treatment process are too low (165-185°C). Cellulose has a highly ordered crystalline structure, which provides a high stability to the cellulose chains and protects them against acid attack during hydrolysis. Although no cellulose degradation occurs during the hydro-thermolysis stage of wood, heat treatment under moist conditions (such as the hydro-thermolysis) appears to have a stimulating effect on the crystallization of amorphous cellulose (Bhuiyan and Hirai 2000). During curing some (amorphous) cellulose degradation is observed, probably due to the different process conditions applied (dry atmospheric heat treatment) and/or due to a longer effective treatment time. Thus, an increase of the relative amount of crystalline cellulose is observed, but it can be questioned whether this is due to the degradation or to the crystallization of amorphous cellulose (or both).

During heat treatment lignin can be subject to degradation, but also to condensation or repolymerisation reactions. The covalent bonds between lignin and hemicelluloses will be broken and low molecular weight lignin fragments with high reactivity are produced. Demethylation or more likely demethoxylation of the

methoxy groups at the C3 position of the aromatic nuclei of lignin has been observed during the hydro-thermolysis treatment stage. This results in a higher number of aromatic lignin sites available for reactions and an increased reactivity of the aromatic nuclei of lignin. An increase in the proportion of methylene bridges connecting two phenolic nuclei has been noticed. Formaldehyde and furfuraldehyde, which are produced during the hydro-thermolysis stage, are the likely contributors to the formation of these methylene bridges. Lignin cleavage at the O4 and at the C α of some lignin units appears to occur followed by autocondensation of the reactive -CH₂ group formed with a free reactive site on the phenolic nuclei of another lignin unit. Sivonen et al. (2002) have found stable free radical centres after a dry heat treatment and suggested that these radical centres are most likely involved in the condensation reactions of lignin. A decrease of the C=O absorption band at 1650 cm⁻¹ and 1740 cm⁻¹ has been observed in the FTIR spectra of wood after the hydro-thermolysis stage. This is an indication of degradation of conjugated *p*-substituted aryl ketones (1640 cm⁻¹) and of unconjugated ketone, carbonyl and ester groups (1740 cm⁻¹). It is expected that the functional groups of lignin are mainly involved since these absorption bands are characteristic for lignin and to a much lesser extent hemicelluloses (Baeza and Freer 2001). After the curing stage a noticeable increase of the C=O absorption band at 1650 cm⁻¹ and 1740 cm⁻¹ was observed. According to Tjeerdsma and Militz (2005) this is due to esterification reactions and the newly formed carbonyl groups were mainly linked to the lignin complex. However, an increase of these absorption bands after the curing stage might be related to the formation of esters, but also to the formation of ketons and carbonyl groups. In ¹³C-NMR spectra of treated wood a decrease of the C=O peak at 175 ppm (esters and/or organic acids) is observed after the hydro-thermolysis stage whereas this peak increased after the curing stage. Since the aldehyde and ketone peaks at respectively 190 and 200 ppm are unchanged this favours the formation of esters and/or organic acids during the curing stage (or both). The organic acids can be situated free in the woody structure or they are bounded to the remaining and/or modified wood components (Gerardin et al. 2007). Interesting are the UV absorption spectra of the secondary cell wall and middle lamella, before and after heat treatment. The UV spectrum of the secondary cell wall shows a clear increase of the maximum absorption at 280 nm, much higher than that of the middle lamella. This can be caused by condensation reactions in which the lignin complex is involved and/or to the formation of other aromatic structures during heat treatment, such as furfural and hydroxymethylfurfural. The secondary cell wall contains more hemicelluloses than the middle lamella and thermal depolymerisation results in a higher production of furfural from them. The autocondensation and/or repolymerisation reactions have been noticed during the hydro-thermolysis stage and continue during the curing stage resulting in new lignin based polymers and/or in an increased cross-linking of the existing lignin network.

PART II

PROPERTIES OF HEAT-TREATED WOOD

Thermal modification or heat treatment is an effective method to improve the dimensional stability of wood and the resistance against biodegradation. However, reduction of mechanical properties is noticed after heat treatment, mainly due to the high temperatures involved (150-280°C). It is therefore important that a well-balanced process is developed, which improves the biological durability and/or dimensional stability with no or only a slight loss of mechanical properties. In the industrial two-stage heat treatment method relative mild process conditions (<200°C) were used to treat the timber. The combination of a hydro-thermolysis and curing stage performed at a relative low process temperature could provide a well-balanced process. In this part results of fungal decay tests are given providing useful information about the biological durability of heat-treated wood (Chapter 6, 7 and 8). Molecular reasons for the resistance of heat-treated wood against fungal attack are discussed, based on the requirements necessary for fungal growth (Chapter 6). A solid-state CP-MAS ¹³C-NMR study reveals information about the way fungi attack heat-treated wood and whether this differs from untreated wood (Chapter 7 and 8).

The effect of heat treatment on the mechanical properties of wood is discussed in Chapter 9, including the bending strength, modulus of elasticity, hardness, tensile strength and compressive strength. Since the strength properties of wood are closely related to the chemical wood composition, the effects of heat treatment on the strength properties are discussed in relation to changes and/or modifications of the main wood components (cellulose, hemicelluloses and lignin). Results of bending strength tests of full construction timber are given and the possible effect of natural defects (such as knots, resin pockets, deviating slope of grain and reaction wood) on the bending strength and stiffness of heat-treated wood is discussed (Chapter 9 and 10). The findings of full-scale tests are used to elaborate on the potential to use heat-treated wood in constructions.

6 DURABILITY OF HEAT-TREATED WOOD AGAINST FUNGAL DECAY*

Abstract

This study was performed to investigate the effect of the two-stage heat treatment process on the resistance against fungal attack, including basidiomycetes, molds and blue stain fungi. Heat treatment of radiata pine sapwood revealed a clear improvement of the resistance against the brown rot fungi *Coniophora puteana* and *Poria placenta*. Increasing process temperature and/or effective process time during the first process stage, the hydro thermolysis, appeared to affect the resistance against *C. puteana* attack, but the effect on the resistance against *P. placenta* was rather limited. Heat-treated radiata pine showed a limited resistance against the white rot fungus *Coriolus versicolor* and different process conditions during the hydro thermolysis stage appear not to affect this resistance. A clear difference between the resistance of heat-treated Scots pine sapwood and heartwood against fungal attack is observed. Scots pine heartwood showed a higher resistance against *C. puteana* and *P. placenta* but also against the white rot fungus *C. versicolor*. Similar results were obtained when heat-treated birch was exposed to brown and white rot fungi. Heat treatment showed an improved resistance against *C. puteana* attack, especially at higher temperatures during the hydro-thermolysis stage. A clear improvement of the durability was also observed after exposure to the white rot fungus *C. versicolor* and especially *Stereum hirsutum*. Increasing the process temperature or process time during the hydro thermolysis stage appeared to have a limited effect on the resistance against *C. versicolor* attack. Heat-treated radiata pine and Norway spruce were still susceptible to mold growth on the wood surface, probably due to the formation of hemicelluloses degradation products (e.g. sugars) during heat treatment. Remarkable is the absence of blue stain fungi on heat-treated wood specimen, also because the abundant blue stain fungi were observed on untreated specimen. Molecular reasons for the resistance of heat-treated wood against fungal attack are discussed in detail contributing to a better understanding of heat treatment methods.

* Boonstra MJ, Van Acker J, Kegel E, Stevens M (2007b) Optimisation of a two-stage heat treatment process. Durability aspects. Wood Science and Technology 41(1):31-57

6.1 Introduction

Many organisms can deteriorate wood and fungal decay is by far the most serious kind of microbiological deterioration since it can cause (a rapid) structural failure. Wood can be colonized and degraded by a variety of fungi including brown rot, white rot and soft rot fungi. Fungal decay is a very complex process and depends on the fungi and wood species involved, wood structures, (micro)environments, as well as interactive competition. During decay the major wood components (cellulose, hemicelluloses and lignin) are depolymerised and/or modified in order to provide energy and metabolites for fungal growth.

A major effect of heat treatment is a reduction of the hygroscopicity hence improving the dimensional stability of wood. Another important effect is the improvement of the durability against fungal attack limiting or preventing biodegradation of wood (Baechler 1959, Stamm 1964, Highley 1970, Giebelier 1983, Weiland and Guyonnet 1997 and 2003, Tjeerdsma et al. 1998b and 2002). Several authors have suggested molecular reasons for the durability improvement of heat-treated wood against fungal decay. According to Stamm (1964) there is a link between the improvement of the dimensional stability and the durability after heat treatment. This dimensional stability improvement is thought to be caused by hemicellulose degradation into furfural polymers that are less hygroscopic toward water.

Baechler (1959) suggested that chemical transformations of minor wood constituents (e.g. minerals and vitamins) that are essential to the metabolism of fungi are involved in the decay resistance of heat-treated wood. Baechler also suggested that changes in wood components, such as low-molecular-weight carbohydrates, which may be necessary for the initial attack by the fungal organisms, are involved in the decay resistance. Highley (1970) suggested that the modification of carbohydrates and the formation of toxic compounds are involved. The results of a ^{13}C -NMR study (see Chapter 4) indicate that an increase in cross-linking within the lignin-carbohydrate complex occurs with a consequent improvement of the hygroscopicity (a lower fiber saturation point). This appears to play a role in a higher resistance against biological deterioration under certain conditions. The modification of the polymeric structural wood components is also believed to contribute to fungal decay resistance, though to a lower extent. Hemicelluloses, the most hydrophilic and easily digested wood component, have been shown to be transformed selectively into a hydrophobic network.

Some decay resistance against lignin-degrading fungi has been found. According to Weiland and Guyonnet (2003) no degradation of cellulose was observed after the addition of cellulase to heat-treated wood. Cellulase is a multi-enzymatic system consisting of different enzymatic components that are able to convert (isolated) cellulose to glucose. However, because of their molecular weights (30–182 kD), cellulase enzymes cannot penetrate the cell wall in the initial stages of decay (Eriksson et al. 1990) and therefore cannot cause degradation of cellulose after addition to heat-treated wood. The metabolic mechanism of fungal decay in wood is much more complex, including the occurrence of different enzymatic and non-enzymatic systems. They furthermore claimed that the decay resistance of heat-treated wood is caused by:

- A decrease in wood substrates and especially hemicelluloses;
- A chemical modification of the lignin, which cannot be degraded by fungal enzymatic systems; and
- A reduction of the hygroscopic wood properties.

Durability experiments with heat-treated maritime pine have shown that despite strong hemicelluloses degradation by heat treatment, fungal attack still occurs. The effect of an initial colonization inhibition due to the thermal degradation of pentosanes seems less than expected. Lignin modifications and the formation of new ether linkages have therefore been suggested as possible causes of decay resistance. The fungal enzymatic systems are thought to be obsolete and not (or less) capable of degrading the modified wood components.

The presence of traces of polynuclear aromatic hydrocarbons has been observed in heat-treated wood (Kamden et al. 2000). It has been suggested that the presence of such compounds might contribute to the resistance of wood to fungal attack. However, the removal of such compounds by extraction (with water, acetone, and chloroform) did not result in any significant change in the mass loss after fungal attack (Kamden et al. 2002). This indicates that the contribution of these compounds to decay resistance is rather limited.

In this chapter the effect of heat treatment and process optimisation on the resistance of wood against fungal attack, including basidiomycetes, molds and blue stain fungi, is described. Molecular reasons for the improved resistance of heat-treated wood against fungal attack are discussed. Results of initial durability and soil block tests have been reported and discussed elsewhere (Tjeerdsma et al. 1998b and 2002).

6.2 Materials and methods

Materials

The following timber species were used for heat treatment:

- Radiata pine (*Pinus radiata* D. Don), which contains only sapwood, Scots pine sapwood and heartwood (*Pinus sylvestris* L.) and Norway spruce (*Picea abies* Karst) as softwood species.
- Birch (*Betula pendula* Roth and/or *Betula pubescens* Ehrh.) as hardwood species.

For each timber species at least 10 boards were treated for a set of process conditions. Standard cross section had a thickness of 25-50 mm and a width of 100-150 mm. The length of the boards was approx. 3.0 m. The moisture content of the boards was 16-20% (shipping dry). After heat treatment the boards were used to prepare specimen for pH, hygroscopicity and fungal testing.

Untreated Scots pine sapwood and beech specimens were used as references for biological durability testing and to control the virulence of the test fungi.

Heat treatment

The heat treatment was performed in two separate heat treatment stages and a drying stage in between. In the first stage of the heat-treatment the timber was treated in an aqueous environment at superatmospheric pressure (8-10 bar), a so-called hydro-thermolysis treatment. This was done in a 600 l pilot plant and the treatment temperature varied between 165-185°C. The specimens were then dried in a 1 m³ kiln, using a conventional fresh air-drying process at 50-60°C. After drying, the wood specimens were heat-treated again in a special curing kiln for the second stage, now under dry and atmospheric conditions, a so-called “curing” treatment (180°C, 6 hours). During this stage superheated steam or nitrogen gas was used as a sheltering gas to exclude oxygen.

pH measurement

The slope-intercept method (Stamm 1961) was used to measure the pH of treated and untreated birch, Norway spruce and radiata pine. After heat treatment small slices were prepared and conditioned at 65% RH (20°C). The slices were grinded and about 2 gram of ground wood was mixed with 8 dilute solutions of NaOH or HCl. The pH of these solutions varied between 2 and 7. After addition of ground wood the pH of the solution was measured. The pH of the solution, which did not change after addition of ground wood, corresponded with the pH of the wood samples. Per wood species 3 boards were selected and 3 samples per board were used for pH measurement.

Hygroscopicity testing

Small slices (thickness 20 mm, width 20 mm, length 10 mm) of treated wood and untreated references were prepared and oven dried (105°C, 16 hours) before hygroscopicity testing. The oven-dry specimens were stored in a box (incl. a ventilator) for three days above a saturated potassium nitrate solution (20°C, 95% RH). Before and after the test the specimen were weighed to determine the equilibrium moisture content. Per wood species 3 boards were selected and 3 specimens per board were used for the hygroscopicity tests.

Fungal testing

Basidiomycetes

Treated boards and untreated references were used to prepare test specimen with a cross section of 15±0.5 x 25±0.5 mm and length of 50±0.5 mm. The test specimens were exposed to brown rot fungi (*Coniophora puteana*, *Gloeophyllum trabeum* and/or *Poria placenta*) and white rot fungi (*Coriolus versicolor* and/or *Stereum hirsutum*) during a 16-week period according the CEN/TS 15083-1 agar test (using the principles of the EN 113 wood preservative efficacy test). After exposure the specimen were oven dried and weighed to determine the mass loss and moisture content. Per wood species 3 boards were selected and 4-5 specimens per board were used for the CEN/TS 15083-1 basidiomycetes test.

Molds and blue stain

Test specimen with a cross section of 15±0.5 x 100±0.5 mm and length of 150±0.5 mm were prepared using treated boards and untreated references. The test

specimens were exposed to molds and blue stain fungi during a 3-month period according a modified EN 152 test method (Van Acker et al. 1998a and 1998b). Before exposure the surface of the specimen was saturated with demineralised water and sprayed with water including a suspense of several molds and blue stain fungi (originating from infected wood). The specimens were placed in a box at a relative humidity of 98% (20°C). Every week the specimens were sprayed with demineralised water. After 3 days, 1 week, 2 weeks, 1 month and 3 months the specimen were inspected and assessed visually on molds growth and blue stain growth. A rating from 0 to 5 based on the percentage of the surface covered with fungi was used to score the specimens:

0: non

1: less than 1%

2: 1-10%

3: 10-30%

4: 30-70%

5: more than 70%

After exposure the specimen were oven dried and weighed to determine the moisture content and mass changes. This gives an indication whether decay fungi are present during the test, since such fungi result in a relatively large mass loss of (untreated) specimens whereas molds and blue stain do not result in mass loss. Per wood species 4 boards were selected and 1-2 specimen per board were used for the modified EN 152 test.

6.3 Results

Preliminary experimental work revealed the hydro-thermolysis stage to be the most critical process stage in the two-stage heat treatment method, affecting both wood quality and wood properties (e.g. durability, dimensional stability, strength). Variations of the process conditions (e.g. temperature, effective process time) during the hydro-thermolysis stage showed a larger impact on the properties of treated wood than variations during the curing stage (Tjeerdsma et al. 1998b and 2002). For this reason a treatment temperature of 180°C and an effective process time of 6 hours was used to treat the specimens during the curing stage. These process conditions were found to represent a good balance between the improvement of the durability and loss of mechanical properties.

In agreement with the CEN/TS 15083-1 test method untreated Scots pine sapwood and beech specimens were used as references and to control the virulence of the test fungi. Unfortunately no untreated radiata pine sapwood, Norway spruce and birch specimens were used in these tests. However, results of other tests showed that the mass loss of the untreated softwood species (radiata pine sapwood and Norway spruce) and hardwood species (birch) was at the same level as the references used for this study, respectively Scots pine sapwood and beech (unpublished results). This corresponds with the European standard EN 350-2, which classifies radiata pine sapwood (durability class 5), Norway spruce (durability class 4) and birch (durability class 5) as non-durable wood species.

The treatment temperature during the hydro-thermolysis stage appeared to have an effect on the resistance of heat-treated radiata pine against *C. puteana* attack (Fig. 6.1a). The mass loss of the specimen decreased when the treatment temperature was raised to 185°C. This was not observed when the heat-treated specimens were exposed to *P. placenta*, since an increase of the temperature to 185°C did not have an effect on the mass loss (Fig 6.1a). Although heat treatment of radiata pine improved the resistance against the brown rot fungi *C. puteana* and *P. placenta*, no or low effect has been observed after exposure to the white rot fungus *C. versicolor* (Fig. 6.1a). The mass loss of heat-treated specimens was equal to the reference specimen (untreated Scots pine sapwood) and raising the temperature to 185°C did not affect the decay resistance against *C. versicolor*.

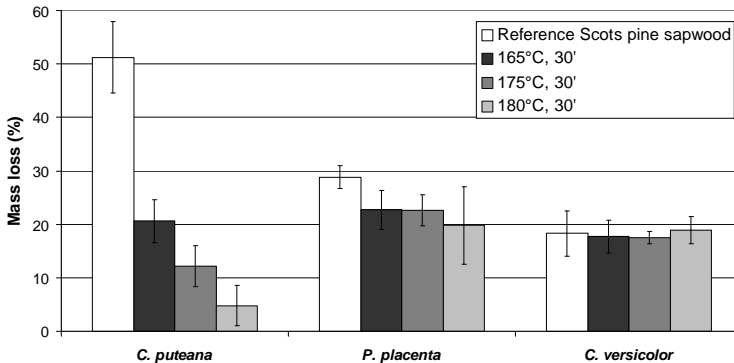

Fig. 6.1a Effect of the hydro-thermolysis temperature on the mass loss of heat-treated radiata pine after exposure to *C. puteana*, *P. placenta* and *C. versicolor* (CEN/TS 15083-1)

Similar results were observed when heat-treated birch specimens were exposed to brown and white rot fungi (Fig 6.1b). Raising the temperature to 175/185°C reduced the mass loss of the CEN/TS 15083-1 specimens in a large extent when exposed to *C. puteana*. A higher treatment temperature did not have an effect on the mass loss of the CEN/TS 15083-1 specimens when exposed to *C. versicolor*, although the mass loss of heat-treated birch is much lower compared to the mass loss of untreated beech sapwood reference. *S. hirsutum* appears to cause no or low decay of heat-treated birch and it is difficult to say whether a higher treatment temperature affects decay resistance.

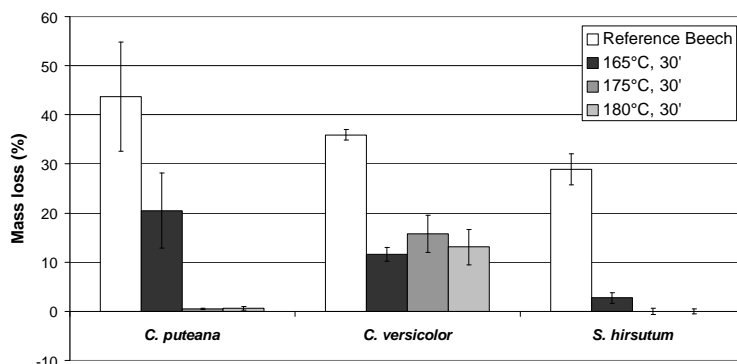

Fig. 6.1b Effect of the hydro-thermolysis temperature on the mass loss of heat-treated birch after exposure to *C. puteana*, *C. versicolor* and *S. hirsutum* (CEN/TS 15083-1)

During hydro-thermolysis treatment the effective process time starts when the centre of the boards reached the process temperature (165/175/185°C). The effect of a short process time of 15 minutes at 165°C on the resistance against decay appears to be limited (Fig. 6.2). Although the mass loss of the treated radiata pine specimen after *C. puteana* exposure is lower than the Scots pine sapwood reference specimens, the mass loss is much higher than the specimens treated at an effective process time of 30 minutes or longer. The mass loss of the specimens, treated for 15', after exposure to *P. placenta* (Fig. 6.2) is even higher than the mass loss of the reference specimens (Scots pine sapwood). However, increasing the effective process time to 30 minutes or longer did result in an improvement of the resistance against *P. placenta*. The effect of a longer effective process time (45-60-90 minutes) on the decay resistance against *C. puteana* and *P. placenta* attack appeared to be rather limited, although the treatment with an effective process time of 90 minutes did result in the lowest mass losses, especially after exposure to *C. puteana*. The effect of the treatment time on the resistance against *C. versicolor* attack was rather limited. The mass loss of the test specimens appeared to be slightly lower when the treatment time was increased to 45-90 minutes. Remarkable is the variation of the test results when the treatment time is increased. The variation of the test results, which is rather high for a treatment period of 15-45 minutes, decreased when the effective process time was increased to 60-90 minutes.

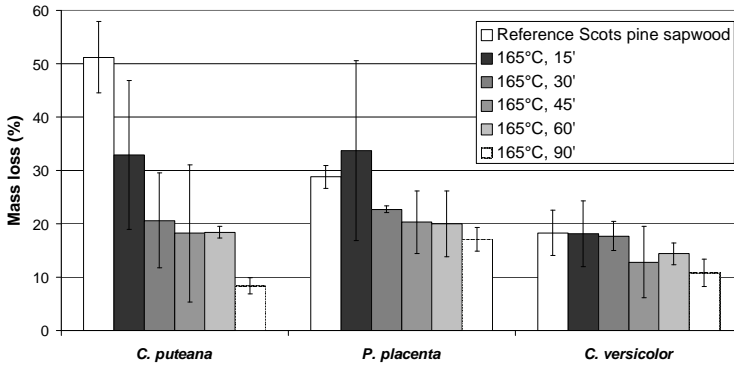

Fig. 6.2 Effect of the hydro-thermolysis process time on the mass loss of heat-treated radiata pine after exposure to *C. puteana*, *P. placenta* and *C. versicolor* (CEN/TS 15083-1).

A heat treatment was also performed without an effective process time (at 175°C), only consisting a heating up and cooling down stage, in order to reduce the total process time. During this treatment the heating and cooling down rate was 1.3 K per minute, so the temperature of the boards was at least 15 minutes above 165°C. The absence of an effective process time did not affect the resistance of treated radiata pine against *C. puteana* attack, since the mass loss is similar to the mass loss of the specimens treated for 30 minutes at 175°C (Fig. 6.3a). The mass loss of specimen exposed to *P. placenta* and *C. versicolor* appears to be a bit higher when compared to specimen treated for 30 minutes.

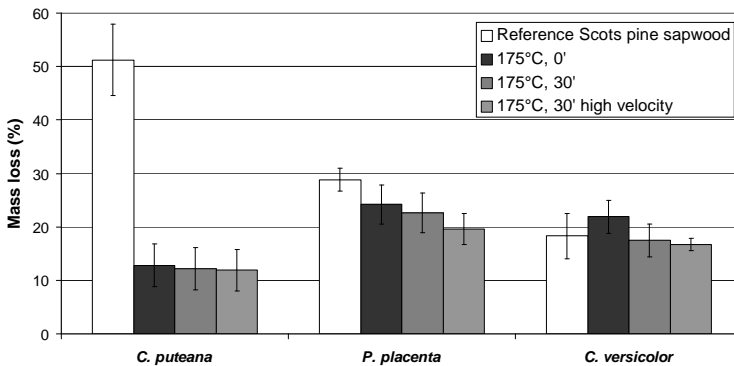

Fig. 6.3a Effect of different hydro-thermolysis process conditions on the mass loss of heat-treated radiata pine after exposure to *C. puteana*, *P. placenta* and *C. versicolor* (CEN/TS 15083-1). High velocity: heating 2.75 K/minute; cooling down 2.0 K/minute.

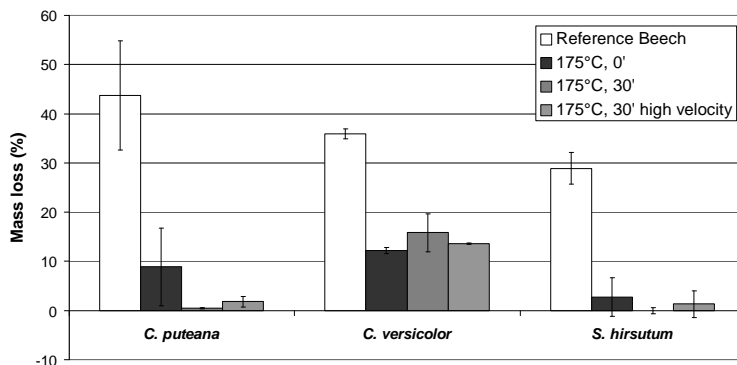

Fig. 6.3b Effect of different hydro-thermolysis process conditions on the mass loss of heat-treated birch after exposure to *C. puteana*, *C. versicolor* and *S. hirsutum* (CEN/TS 15083-1). High velocity: heating 2.75 K/minute; cooling down 2.0 K/minute.

The total process time can also be reduced by increasing the heating and cooling down velocity (respectively 2.8 K and 2.0 K per minute). Although the total time of the boards at a temperature higher than 165°C was reduced (ca. 7 minutes), it did not affect the resistance against decay (Fig. 6.3a). The mass loss of the specimens after exposure to *C. puteana*, *P. placenta* and *C. versicolor* was similar to the mass loss of the specimens treated at a lower heating and cooling down velocity (1.3 K per minute). Similar results were also obtained for heat-treated birch, although the absence of an effective process time did have an effect on the resistance against *C. puteana* attack, since the mass loss of the treated birch specimens was rather high (Fig. 6.3b).

During steam or liquid full hydro-thermolysis of wood differences occur in the chemical reaction mechanism and/or physical processes of wood. So far no differences in the properties of treated wood has been found. There appears to be no difference in the resistance against fungal attack, since the mass loss of heat-treated Scots pine after exposure to *C. puteana* or *C. versicolor* is almost equal (Fig 6.4).

A clear difference between the resistance of heat-treated sapwood and heartwood against brown rot attack is observed. Scots pine boards of the same origin with either sapwood or heartwood were heat-treated and tested according the CEN/TS 15083-1 basidiomycetes test. The mass loss of the treated sapwood specimens was much higher than the heartwood specimens after exposure to *C. puteana* (Fig. 6.4). The mass loss of heat-treated Norway spruce, consisting only of heartwood, was even lower than the mass loss of Scots pine heartwood (Fig. 6.4). An improved resistance of treated heartwood against the white rot fungus *C. versicolor* was also observed, but less definite compared to the brown rot fungus *C. puteana* (Fig. 6.4).

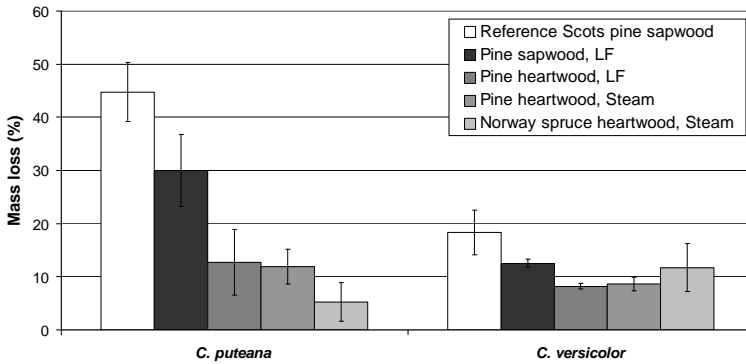

Fig. 6.4 Mass loss of heat-treated Scots pine sapwood, Scots pine and Norway spruce heartwood after exposure to *C. puteana* and *C. versicolor*. LF = liquid full hydro-thermolysis.

According to Tjeerdsma et al (2002) there appears to be a good correlation between the hygroscopicity (EMC at 96% RH) and the increased decay resistance of heat-treated wood. This might be true for heat-treated radiata pine and birch after exposure to *C. puteana* (Fig. 6.5a,b), since both wood species showed a rather high correlation coefficient (0.89). But this is not the case for the exposure of the treated wood to *P. placenta* and/or *C. versicolor*, which showed a much lower correlation coefficient (Fig. 6.5a,b). The EMC might give a good prediction of the treatment quality, but this does not automatically mean a good resistance against fungal attack.

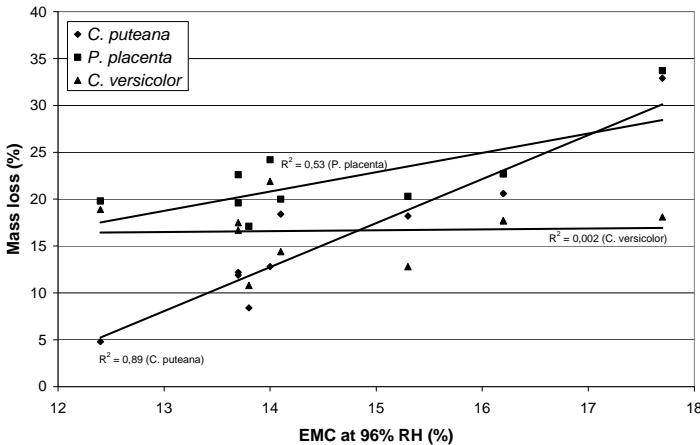

Fig. 6.5a Correlation between the hygroscopicity (EMC at 95% RH) and mass loss of heat-treated radiata pine after exposure to *C. puteana*, *P. placenta* and *C. versicolor*

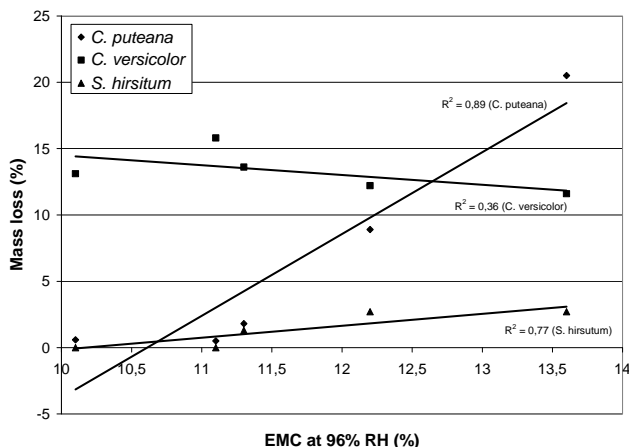

Fig. 6.5b Correlation between the hygroscopicity (EMC at 95% RH) and mass loss of heat-treated birch after exposure to *C. puteana*, *C. versicolor* and *S. hirsutum*

After a liquid full hydro-thermolysis process stage radiata pine is saturated with water and it is very sensitive for molds. Degradation products of the carbohydrates (e.g. sugars) accelerate the growth of molds on the surface of the wood and it is therefore important that storage time of the treated wood before drying is limited. Growth of molds on the surface of radiata pine is also observed after the complete heat treatment process, and treated wood appeared to be more sensitive than untreated wood (Fig 6.6).

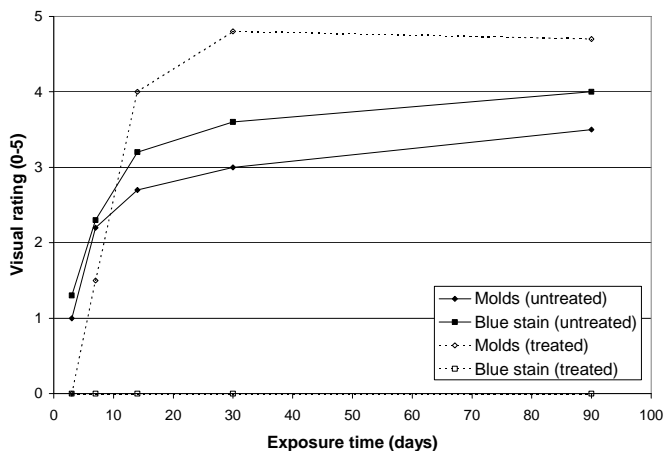

Fig. 6.6 Visual assessment of treated and untreated radiata pine during a modified EN 152 test. 0 = no fungal growth on the surface; 5 = severe fungal growth on the surface

At a high moisture content radiata pine, which only contained sapwood, is very sensitive for blue stain fungi and molds, and for this reason fresh timber should be dried directly after sawing (especially at temperatures above 15°C). It was no

surprise that blue stain fungi were observed on the surface of untreated radiata pine specimens after the modified EN 152 test (Fig. 6.6). It is however remarkable that blue stain fungi were absent on the surface of the heat-treated radiata pine specimens, although the moisture content of the treated radiata pine specimens was high enough during the test revealing good conditions for blue stain growth (Table 6.1).

Table 6.1 Moisture content and mass loss of heat-treated and untreated radiata pine and Norway spruce after 3 months exposure to molds and blue stain fungi (according a modified EN 152 test method)

Wood species	Moisture content (%)		Mass loss (%)	
	Untreated	Treated	Untreated	Treated
Radiata pine	148	172	0.6	1.6
Norway spruce	89	49	0.3	0.8

Untreated Norway spruce specimens, which only contained heartwood, showed some blue stain fungi growing on the surface of the specimens after the modified EN 152 test (Fig. 6.7). On heat-treated Norway spruce specimens no blue stain fungi were observed, similar to treated radiata pine. On the surface of heat-treated Norway spruce only some molds were visible, however not as much as on the treated radiata pine specimens. Exposure of heat-treated radiata pine and Norway spruce to molds and blue stain fungi did not result in any significant mass loss (Table 6.1).

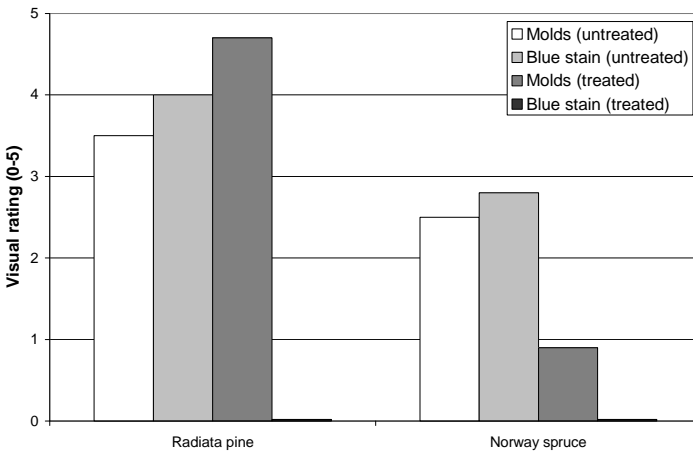

Fig. 6.7 Visual assessment treated and untreated radiata pine and Norway spruce after 3 months exposure to molds and blue stain fungi according a modified EN 152 test. 0 = no fungal growth on the surface; 5 = severe fungal growth on the surface

6.4 Discussion

The major requirements for fungal growth in wood are (Highley et al. 1992, Zabel and Morell 1992):

1. free water on the surfaces of cell lumina;
2. atmospheric oxygen and/or chemical oxygen present in wood;
3. a favourable pH range;
4. a favourable temperature range ;
5. chemical growth factors like nitrogen compound, vitamins and essential elements;
6. the absence of toxic extractives, which prevent or slow down fungal decay; and
7. a digestible substrate, which provides energy and metabolites for synthesis via metabolism.

Since heat treatment improves the resistance against biodegrading organisms it must affect one or more requirements necessary for fungal growth. Based on the test results and the requirements given above, molecular reasons for decay resistance of heat-treated wood are discussed in more detail.

Free water

Although heat treatment reduces the water adsorption of wood (Boonstra et al. 1998, Tjeerdsma et al. 1998b) it does not prevent the occurrence of free water on the surfaces of cell lumina, the moisture content can still increase much higher than the fibre saturation point (Tables 6.1 and 6.2). Free water can therefore still serve as reactant in chemical decay processes (e.g. hydrolysis), as a diffusion medium for enzymes and solubilised substrate molecules, and as a solvent or medium for life systems within the fungal hyphae.

Table 6.2 Moisture content of the CEN/TS 15083-1 test specimen after exposure to *C. puteana*, *P. placenta*, *C. versicolor* and/or *S. hirsutum*. Heat treatment included a thermolysis (165°C, 30 min) and curing (170°C, 6 hrs)

Wood species	Moisture content (%) after CEN/TS 15083-1			
	<i>C. puteana</i>	<i>P. placenta</i>	<i>C. versicolor</i>	<i>S. hirsutum</i>
Heat-treated radiata pine	43.1	57.3	59.7	---
Heat-treated birch	44.2	---	42.1	28.5
Untreated Scots pine sapwood	75.1	73.6	54.6	---
Untreated beech	70.1	---	56.0	66.8

Water also serves as wood-capillary swelling agent permitting the penetration of both free water, fungal (non-)enzymatic systems deep into the transient capillary zone (this is the area where initial decay often develop) and eventually facilitating the penetration of digestive enzymes into the cell wall (Zabel and Morrell 1992). Heat treatment causes a significant reduction of the fibre saturation point (FSP) of the cell wall, 16-18% is commonly found for heat-treated wood whereas 28-30% is an average FSP for untreated wood (Tjeerdsma et al. 1998b). This reduces the swelling of the cell wall preventing or limiting the penetration of (non-)enzymatic

systems into the transient capillary zones. Furthermore less water is available in the cell wall to allow diffusion of degradation products of carbohydrates to the fungal hyphae in the cell lumina.

Oxygen

The obligate aerobic fungi require free oxygen for several metabolic reactions (e.g. energy release, synthesis) and it is expected that heat treatment does not affect the occurrence of free oxygen in wood (in cell lumina and cell wall). A low oxygen level or absence of free oxygen limit or prevent fungal growth and this happens when wood is saturated with moisture and there is none or very little free oxygen available in cell lumina. A void volume of at least 20% appears to be necessary to allow fungal growth (Scheffer 1986). In the agar tests performed in this study the moisture content of the test specimen did not caused a deficiency of free oxygen, since the moisture content of the test specimen varied between 29-60% at the end of the CEN/TS 15083-1 basidiomycetes test (Table 6.1). This indicates that there was enough free oxygen available for fungal growth.

pH

Wood-decaying basidiomycetes have pH optima ranging from 3 to 6 (Keilich et al. 1970; Highley 1975; Zabel and Morrel 1992) with brown rot fungi having the lowest optima (around 3). During decay the pH of wood decreases and the presence of a pH gradient appears to be required to allow decay processes (Goodell 2003). Fungal production of oxalic acid (conversion of pyruvic acid \rightarrow oxalic acid + CO₂ + H₂), an important physiological metabolise of brown-rot fungi (necessary for Fenton reactions), is responsible for the low pH of wood during brown rot decay (Cowling 1961, Takao 1965). Although the external pH does not affect the pH of cytoplasm it can affect substrate availability, rate of exo-enzymatic reactions, exo-enzyme stability, cell permeability, extracellular components, and solubility of minerals and vitamins (Zabel and Morrell 2003). Heat treatment reduces the pH of wood to 3.5-4 (Table 6.3) due to the production of acetic acid and formic acid, whereas a pH of 5.0-5.5 is common for untreated wood. The significant higher hydrogen concentration probably affects decay processes, e.g. it inhibits minor metal solubility's affecting exocellular decay processes in wood and/or it destabilises exo-enzymes. Changes of the pH during the service life of heat-treated wood products, resulting in a higher pH, might alter the sensitivity of heat-treated wood to wood-decaying fungi.

Table 6.3 pH of treated and untreated birch, Norway spruce and radiata pine

Wood species	pH		
	Untreated	After hydro-thermolysis	After Curing
Radiata pine	5.0-5.5	3.5-4.0	---
Norway spruce	5.5	3.5-4.0	4.0
Birch	4.5-5.0	3.5	3.5
Poplar	5.0	3.5	4.0

Temperature

Most wood decay fungi grow best within a 15 to 40°C temperature range and within these limits, fungi have adapted to utilize various substrates under different temperature conditions (Zabel and Morrel 1992). It is not expected that heat treatment does have an effect on the temperature requirement of fungi.

Chemical growth factors

The destruction of thiamine, a vital co-enzyme, which is necessary for the decarboxylation of organic acids, during heat treatment (Baechler 1959) is an example that heat treatment could affect chemical growth factors (nitrogen, vitamins, minor metals and mineral elements), which are necessary for fungal growth. Prosthetic groups attached to enzymes are necessary in some cases for activation and vitamins such as thiamine may play this role. The absence of growth factors like thiamine could contribute to decay resistance, however, such growth factors are still available from sources outside the wood in the form of surface molds, air-borne spores, organic dust, washings from overhanging trees, and others. It is therefore to be expected that wood-destroying fungi can still get access to such components, in one way or another.

Table 6.4 Chemical analysis (extraction) of heat-treated radiata pine (unpublished results)

Phenolic compounds	Fatty acids	Resin acid neutrals	Resin acids	Sterols
Guaiacol	Palmitic acid (F16:0)	None	Pimaric acid	Campesterol
Eugenol	Margaric acid (17:0)		Sandaracopimaric acid	Sitosterol
Hydroxymethyl-furancarboxal	Linoleic acid (F18:2)		Isopimaric acid	
Vanillin	Oleic acid (F18:1)		Dehydroabietic acid	
Acetovanillone	Elaidic acid (F18:1)		Abietic acid	
Homovanillic acid	Stearic acid (F18:0)		Seco-1-dehydroabietic acid	
	F20:0		Seco-2-dehydroabietic acid	
	F22:0		7-Oxodehydroabietic acid	

Toxic extractives

Chemical analysis (extraction) of heat-treated radiata pine revealed the presence of several phenolic compounds such as guaiacol, eugenol, hydroxymethylfurancarboxal, vanillin, acetovanillone, vanillic acid and homo vanillic acid (Table 6.4, unpublished results). Although most phenols are not toxic to wood degrading fungi vanillin is known to prevent or slow down fungal growth since it can inhibit the enzyme production (endoglucanase) of *P. placenta* (Highley and Micales 1990). According to Kamden et al. (2000) polynuclear aromatic hydrocarbon derivatives of phenanthrene and acenaphthylene and other classes of poly-aromatic compounds are produced during a one-stage heat treatment at temperatures above 200°C. Such compounds can be toxic to wood degrading fungi and prevent or slow down fungal growth. However, no effect on fungal decay after removal of such compounds by extraction was reported and the contribution of toxic compounds to decay resistance seems therefore limited (Kamden et al. 2002).

Substrate

Fungal decay is a complex enzymatic and non-enzymatic mechanism and changes of wood components, which are necessary to provide energy and metabolites for fungal growth might affect this mechanism. For instance, enzymes necessary to degrade wood components (e.g. hydrolases and oxidases) are highly specific to the substrate and the reaction catalysed. A substrate change alters or blocks the enzymatic mechanism affecting the metabolism and the many processes involved in wood decay. Heat treatment causes a modification of the main components of wood (cellulose, hemicelluloses and lignin) and changes the composition of these components. These changes, especially of hemicelluloses and lignin, most probably affect the decomposition of such wood components during decay.

Despite several decades of intensive research fungal degradation of (untreated) wood is still not completely understood and it is therefore difficult to distinguish which heat treatment effect contributes to the improved resistance against fungal attack. Below relevant aspects of decay mechanisms in relation to substrate changes (due to heat treatment) are discussed.

In initial stages of decay wood degrading enzymes, such as ligninolytic, cellulolytic, hemicellulolytic, and glucose oxidizing enzymes, are unable to penetrate into the cell wall matrix, since their molecular weights are too large (Cowling 1961, Cowling and Brown 1969, Highley et al. 1983, Strebotnik and Messner 1988 and 1990, Flournoy et al. 1991). Such enzymes probably act in the outer regions of the decay zones and/or penetrate the cell wall in a later stadium of decay. Low molecular weight agents (< 6 kD) must therefore be involved in the initial stages of decay (Daniel et al. 1989, Flournoy et al. 1991). Various oxidizing agents, superoxide anion (O_2^-), singlet oxygen (1O_2) and especially the hydroxyl radical (HO^\cdot), have been implicated for the initial attack of wood components in the cell wall (Koenigs 1974, Eriksson 1981, Schmidt et al. 1981, Enoki et al. 1988, Illman et al. 1989, Henry 2003). Hydrogen peroxide (H_2O_2) appears to act as the likely precursor of the hydroxyl radical. Oxidative fungal enzymes may form these oxidizing agents directly or indirectly and these agents probably penetrate the cell wall matrix through the hyphal sheath. This non-enzymatic attack reveals degradation of wood components (e.g. depolymerisation) and/or creates openings through which the relatively large enzymes can diffuse. Metals such as Mn, Fe and possibly Cu have variously been reported as being implicated in the oxidative mechanisms of non-enzymatic attack by both white and brown rot fungi (Halliwell 1965, Koenigs 1972 and 1974, Schmidt et al. 1981, Illman et al. 1988 and 1989, Highley et al. 1989, Enoki et al. 1992, Hirano et al. 1995, Tanaka et al. 1996, Hyde and Wood 1997, Goodell et al. 1997, Tanaka et al. 2000, Jensen et al. 2001).

In wood decay hemicelluloses are often the first cell wall components degraded, probably owing to their shorter chain lengths, solubility, and exposed locations around the cellulose microfibrils (Zabel and Morell 1992). The various sugars composing the polymer backbone are attacked by non-enzymatic oxidizing agents and endo-enzymes producing progressively shorter chains, which are hydrolysed

to simple sugars by glycosidases (Zabel and Morell 1992, Highley and Dashek 1997). Furthermore, the galactose and acetyl side chains are cleaved. This degradation mechanism requires the combined action of several enzymes (e.g. endo- β -1,4-xylanases, β -1,4-xylosidases, α -glucuronidase, α -arabinosidase and acetyl esterase), which are primarily hydrolytic in nature. It has been suggested that either hemicelluloses or perhaps lignin is critical to the mechanism involved in brown rot degradation of cellulose. Both polymeric components surround wood cellulose microfibrils and it is likely that they come into contact with the fungal agents before cellulose. Brown rot fungi have been reported to be incapable of degrading pure cellulose in the absence of other wood components (Highley 1977, Enoki et al. 1988, Lyr 1960). Lyr (1960) has shown that glucomannan is initially removed more rapidly than cellulose and its decomposition is associated with the release of H_2O_2 . Nonenzymatic oxidizing agents including H_2O_2 are suggested to initiate the first steps in brown rot decay by depolymerising the crystalline zones of the cellulose (Cowling and Brown 1969, Koenigs 1974).

During heat treatment the hemicelluloses are strongly depolymerised decreasing their occurrence in the cell wall (see Chapter 4 and 5). The structure of the hemicelluloses, which are still available in heat-treated wood, is altered through cleavage of acetic acid from their acetyl side chains. A significant lower hemicelluloses content and/or hemicelluloses modification could have an indirect effect on the decomposition of cellulose, e.g.

- less hemicelluloses are available to provide energy and metabolites for fungal growth, especially in the initial stage of decay;
- easier access to cellulose since less hemicelluloses surround the cellulose microfibrils. However, the decreased water absorption of the cell wall might hinder the access of (non-)enzymatic agents to cellulose; and
- less H_2O_2 could be released since the amount of hemicelluloses decreased. However, more mechanisms for H_2O_2 release have been postulated, not necessarily related to the degradation of hemicelluloses (Henry 2003).

Oxidation and hydrolysis appears to be the mechanism involved in cellulose degradation. Non-enzymatic oxidizing agents, such as oxygen radicals, are believed to cause cellulose depolymerising cleaving long-chain cellulose into smaller fragments (Cowling and Brown 1969, Koenigs 1974). Amorphous cellulose appears to be accessible for water and non-enzymatic oxidizing agents allowing cellulose depolymerisation. The crystalline zone within the highly ordered cellulose microfibrils inhibit penetration of reactants, however small molecules, such as oxygen radicals, might penetrate the intermolecular spaces. After cellulose depolymerisation soluble oligosaccharides with a DP of 150-200 (Highley et al. 1989) diffuse through the waterly fungal glucan matrix (hyphal sheath) to the wood cell lumen. Endo- β -1,4-glucanase and exoglucanase randomly hydrolyses the β -1,4 linkage of these oligosaccharides and β -glucosidase then convert the resulting cellobiose to glucose, which is metabolised by the fungus (e.g. glycolysis, citric acid cycle) (Zabel and Morell 1992, Highley and Dashek 1997).

In the early stages of decay brown rot fungi appear to attack the entire secondary cell wall zone (especially S1 and S2) and carbohydrates are depolymerised more rapidly than the decay products can be metabolised (Cowling 1961). For this

reason enzymatic attack of cellulose occurs both at C1 and C4 while white rot fungi mainly attack at C4 (Zabel and Morell 1992). Brown-rot fungi cause a rapid decrease in strength properties, which reflect rapid depolymerisation of cellulose. White rot fungi attack the cell wall from the cell lumen surface and progress slowly into the cell wall. The depolymerisation rate of cellulose appears to be regulated and is adjusted to the capacity of the fungus to utilize glucose. Cellulase synthesis is induced by cellulose and repressed by glucose (Highley and Dashek 1997). Simultaneous white rot fungi degrade all the cell wall components (including crystalline cellulose) uniformly during all decay stages, whereas selective white rot fungi have the ability to degrade large quantities of hemicelluloses and lignin without destructing cellulose (especially crystalline cellulose). The mechanism of cellulose and hemicelluloses degradation is rather similar for brown-rot and white-rot fungi.

Although the changes of cellulose are limited after heat treatment there might be a direct or indirect effect on the decay processes during fungal exposure. An increase in the crystalline cellulose proportion (see Chapter 4, 5 and Pott 2004) might limit or slow down the initial attack of non-enzymatic oxidizing agents and/or prevent diffusion of soluble oligosaccharides or monosaccharides to the wood cell lumen. Furthermore enzymes produced by brown rot fungi are thought to cooperate with each other as well as with non-enzymatic systems after initial stages of cell wall degradation (Goodell 2003). Substrate changes and/or changes of the microenvironment necessary to allow decay mechanisms might affect brown rot attack.

Brown rot fungi have the capacity to depolymerise and metabolise the carbohydrates of the cell wall, but they also modify and/or remove the lignin fraction (Kirk and Chang 1974 and 1975, Kirk 1975, Jin et al. 1990, Goodell 2003). These fungi do not produce ligninolytic enzymes, but they do have a non-enzymatic mechanism that results in oxidative demethylation and oxidation of the propyl side chains of lignin. Chemical analysis of residual lignin from brown-rotted wood included a decreased methoxyl content, oxidations of some alcohol and aldehyde groups to carboxyls, and the introduction of some phenolic hydroxyls. Goodell (2003) suggested that both the level and the type of lignin have very little effect on the decay of brown rot fungi. This indicates that lignin changes, which occur during heat treatment should have no direct effect on the decay resistance against brown rot fungi. There might be an indirect effect since cross-linking reactions of lignin are believed to cause a significant reduction of the water adsorption of heat-treated wood (see Chapter 4 and 5). The possible role of water adsorption in the decay mechanisms has been discussed above.

White-rot fungi differ from brown-rot fungi in their extensive degradation of lignin. Since ligninolytic enzymes are not capable to penetrate the cell wall, low molecular weight oxidizing agents appear to participate in delignification starting at the cell lumen surface and penetrating deeper into the cell wall (Koenigs 1974, Schmidt et al. 1981, Illman et al. 1989, Messner et al. 2003). Lignin decomposition proceeds by oxidative reactions that separate carbon-to-carbon bonds or ether linkages and separate various functional groups, side chains, and aromatic rings randomly from the huge, amorphous lignin macromolecule. Non-enzymatic oxidative attack also creates openings through which relatively large ligninolytic

enzymes can diffuse. Ligninolytic enzymes involved in decay are oxidative and various enzymes appear to be involved in lignin degradation, such as lignin peroxidase (LIP), manganese-peroxidase (MnP), H₂O₂ producing enzymes, and other phenol oxidizing enzymes such as laccase (Zabel and Morell 1992, Highley and Dashek 1997). The two peroxidase enzymes require H₂O₂ in their catalytic reactions with lignin. MnP has been reported to oxidize syringil lignin units better than the corresponding guaiacyl units (Zabel and Morell 1992) and this might explain the higher susceptibility of hardwood species to white-rot attack than softwood species. Low molecular weight degradation products of lignin include vanillin, syringaldehyde, coniferyl aldehyde, vanilic acid, syringic acid, and a wide range of aliphatic acids and phenols.

Heat-treated birch showed a clear improvement of the resistance against white rot attack, *C. versicolor* and especially *S. hirsutum* (Fig. 6.1). These fungi are capable to degrade both the carbohydrates and lignin and there is probably more than one reason for this heat treatment effect, e.g.

- changes of the external conditions affecting the microenvironment (extracellular slime layer) needed for lignin degradation. Exo-enzymes can be destabilized, which then prevent production of non-enzymatic oxidizing agents and/or prevent degradation reactions by ligninolytic enzymes. However, exo-enzymes were found to be quite stable (Micales et al 1987, Highley and Micales 1990), so this effect might be limited;
- blocking the (radical) reactions of non-enzymatic oxidizing agents in initial stages of decay. Phenolic compounds, formic acid (or formate) and acetic acid (or acetate) present in heat-treated wood can act as a scavenger of the hydroxyl radical affecting Fenton reactions; and
- changes (modification) of the substrate, especially hemicelluloses and lignin. Non-enzymatic oxidizing agents can still be active, but the enzymatic mechanism in the outer decay zone can be affected since enzymes are highly specific to the substrate.

C. versicolor has been classified as a simultaneous white rot fungus, capable to degrade all the cell wall components uniformly (Zabel and Morrell 1992). If substrate changes are of importance it is difficult to distinguish which heat treatment effect contributes to the improved resistance against *C. versicolor*.

The effect of heat treatment on the resistance of radiata pine against *C. versicolor* is rather limited, especially when compared to the effect on birch (although the mass loss level of radiata pine is much lower than that of birch) (Fig. 6.1a,b). This can be due to differences in the chemical composition between radiata pine and birch. Softwood species like radiata pine contain fewer hemicelluloses with mannose being the major constituent whereas the major constituent in birch is xylose (Fengel and Wegener 1989). Furthermore the amount of acetyl side groups is higher in birch. Lignin is believed to play a significant and governing role in natural wood protection with high lignin levels and presence of guaiacyl lignin in softwoods considered to provide better natural protection than low lignin levels and syringyl lignin in hardwoods (Daniel 2003). This could explain why untreated birch showed a much higher mass loss than untreated radiata pine after exposure to *C. versicolor*. The differences in chemical composition affect the chemical

reaction mechanism during heat treatment revealing a different behaviour of heat-treated wood towards decay, especially when softwoods are compared with hardwoods. A relatively high degradation level of the hemicelluloses (increasing the lignin content) and/or differences in the modification of the lignin network might explain the relatively high improvement of the resistance of heat-treated birch against *C. versicolor*.

Heat treatment may indirectly affect gene expression of enzymes. H₂O₂ is known to regulate MnP genes at the level of gene transcription (Rodriguez et al. 2003) and changes of the H₂O₂ production probably affect this mechanism. Metals present in the micro environment are not only important as an integral component of enzymes, but are also believed to be essential elements in the regulation of gene transcription for several enzymes (Rodriguez et al. 2003). Heat treatment may affect the solubility of metals and eventually the mechanism of gene transcription.

Interesting results in the resistance against decay were obtained after an increase of the temperature and process time during the hydro-thermolysis stage. An increase of these process conditions causes a further degradation and/or modification of the hemicelluloses in the cell wall (see Chapter 5). Since there are more reactive intermediates (e.g. furfural) available more cross-linking reactions (e.g. polycondensation) occur increasing the lignin polymer network. More severe process conditions probably also increases the relative proportion of the crystalline cellulose.

Decay of heat-treated wood during exposure to the brown rot fungus *C. puteana* was clearly affected after increasing the temperature and process time during hydro-thermolysis treatment (Fig. 6.1). Changes of the substrate (cellulose and especially hemicelluloses) during these severe heat treatment process conditions might contribute to the further improved resistance against *C. puteana* decay. Remarkable is the minimal effect on the decay of heat-treated wood during exposure to *P. placenta* when more severe process conditions were applied (Fig. 6.1 and 6.2). It is known that hemicelluloses are necessary for the degradation of cellulose by *P. placenta* (Lyr 1960, Highley 1977, Enoki et al. 1988). An increase of the temperature during hydro-thermolysis strongly degrades (and modifies) the hemicelluloses and it was expected that this should have an effect on the *P. placenta* decay. However, an increase of the treatment temperature did not have an effect on the mass loss after *P. placenta* exposure. It is possible that the amount of hemicelluloses still available is high enough to initiate *P. placenta* decay and/or that the role of hemicelluloses in the mechanism of decay is of less importance than previously assumed.

Similar results were obtained when heat-treated wood was exposed to the white rot fungus *C. versicolor*. More severe process conditions during the hydro-thermolysis stage revealed no or low effect on the decay of heat-treated wood after exposure to *C. versicolor*. This is in agreement with results of an initial study in which was found that the process conditions during the second process stage (curing) affected the resistance against *C. versicolor* attack more than the hydro-thermolysis stage (Tjeerdsma et al. 2002). Degradation and modification of the hemicelluloses, which occur mainly during the hydro-thermolysis stage (see

Chapter 4 and 5), appeared to have no or low effect on the resistance against *C. versicolor* attack. Degradation of amorphous cellulose, which occurs mainly during the second process stage and/or modification of the lignin network (cross-linking reactions), are therefore believed to affect *C. versicolor* attack.

The durability tests also revealed clear differences between Scots pine sapwood and heartwood after heat treatment (Fig. 6.4). Several reasons can be the basis for these differences, more or less related to substrate changes, e.g.:

- the occurrence of (modified) toxic extractives, still present in heartwood after heat treatment;
- in sapwood specific cells (e.g. ray parenchyma cells) are non-lignified, whereas these cells are lignified in heartwood (Fujita and Harada 2001). The presence of lignin reveals a better protection against decay (Zabel and Morrell 1992, Goodell 2003) and/or it affects the reaction mechanism since lignin is an important component during heat treatment; and
- differences in physical and chemical processes during heat treatment. Since sapwood has a rather permeable characteristic, diffusion and/or extraction of reactive intermediates probably occur during treatment affecting the reaction mechanism. In impermeable heartwood diffusion and extraction of reactive intermediates is limited revealing a more effective reaction mechanism.

Heat treatment did not affect the growth of non-decaying wood fungi on the surface of wet wood. Molds and sap stain fungi use wood extractives (e.g. proteins) for their metabolism (Fengel and Wegener 1989, Zabel and Morrell 1992). Substrate changes of the main components of wood (cellulose, hemicelluloses and lignin) appeared not to affect the growth of such fungi. Degradation products of the hemicelluloses (e.g. sugars) might even accelerate the growth of molds, as found on heat-treated radiata pine (Fig. 6.6). It is not known why blue stain fungi were not observed on heat-treated wood during the modified EN 152 test. Blue stain fungi do not grow on the surface of wood, but invade (sap)wood through the parenchyma cells. Changes, e.g. of chemical nature, within these parenchyma cells and/or the production of toxic compounds (e.g. vanillin) might affect the growth of blue stain fungi. It is also possible that blue stain fungi were present in heat-treated wood specimen, but not observed because discoloration was limited or inhibited.

An interesting question is what happens when wood, which has been (partially) degraded by fungal decay, is heat-treated. It is obvious that decay fungi still present in wood are destroyed during treatment, but the chemical reaction mechanism can be affected too. As described above decay of wood results in degradation and/or modification of the main wood components, depending on the fungi involved. An example is the extensive degradation and modification of hemicelluloses in initial stages of brown and white rot decay. Since hemicelluloses and its successive reaction products play an important role during heat treatment it is expected that fungal degradation and/or modification of hemicelluloses before heat treatment affect the reaction mechanism during heat treatment. This might

result in changes of the properties of wood (e.g. durability, dimensional stability and strength) when compared to the heat treatment of sound wood.

Whether heat-treated wood is suitable for a certain application depends on the wood species involved and on the typical (biological) hazards of such an application. For instance, heat-treated radiata pine appeared to be resistant against *C. puteana* attack, but its resistance against *P. placenta* was limited. Therefore, the application of heat-treated radiata pine should be restricted to applications in which no or low fungal decay of *P. placenta* is expected. Heat-treated Norway spruce revealed a higher resistance against *P. placenta*, which might enable the application of heat-treated Norway spruce poles (*P. placenta* occurs frequently in poles). However, other possible biological hazards of a certain application should also be taken into account, such as soft rot fungi, bacteria, maritime organisms, insects and termites. In the example of heat-treated Norway spruce the resistance against soft rot fungi might restrict its application. Soil block tests (ENV 807) revealed a good resistance against soft rot fungi, hence heat-treated Norway spruce appears to be a durable material for poles (Tjeerdsma et al. 1998b). Furthermore, (semi-) practice or service tests at different locations are inevitable to predict the suitability of heat-treated wood for a certain application. Other wood properties than durability, such as strength and dimensional stability, should also be taken into account when heat-treated wood is considered for a certain application.

Assessment of the durability class based on the basidiomycetes tests performed in this study depends on the methodology used. The criterion according the EN 113 methodology, which is used for the assessment of preservative treatment (a threshold value of maximal 3% mass loss), appears not very realistic for heat-treated wood. In CEN/TS 15083-1 a rating scale is proposed to determine the natural durability of solid wood against wood destroying fungi (basidiomycetes). Based on this provisional durability rating scale the durability class of heat-treated wood varies between class 2 or 3, depending on the wood species used and the process conditions applied.

6.5 Conclusions

Heat treatment of radiata pine sapwood revealed a clear improvement of the resistance against the brown rot fungi *C. puteana* and *P. placenta*. Increasing process temperature and/or effective process time during the first process stage, the hydro-thermolysis, appeared to affect the resistance against *C. puteana* attack, but the effect on the resistance against *P. placenta* was rather limited. Heat-treated radiata pine showed a limited resistance against the white rot fungus *C. versicolor* and process variations during the hydro-thermolysis stage appeared not to affect this resistance.

A clear difference between the resistance of heat-treated Scots pine sapwood and heartwood against fungal attack is observed. Scots pine heartwood showed a higher resistance against *C. puteana* and *P. placenta*, and also against the white rot fungus *C. versicolor*.

Similar results were obtained when heat-treated birch was exposed to brown and white rot fungi. Heat treatment showed an improved resistance against *C. puteana* attack, especially at higher temperatures during the hydro-thermolysis stage. A clear improvement of the durability was also observed after exposure to the white rot fungus *C. versicolor* and especially *S. hirsutum*. Increasing the process temperature or process time during the hydro-thermolysis stage appeared to have a limited effect on the resistance against *C. versicolor* attack.

Heat-treated radiata pine and Norway spruce were still susceptible for mold growth on the wood surface, probably due to the formation of hemicelluloses degradation products (e.g. sugars) during heat treatment. Remarkable is the observed absence of blue stain fungi on heat-treated wood specimen, especially since blue stain fungi were observed on untreated specimen.

It is difficult to distinguish which heat treatment effect contributes to the improved resistance against fungal attack, since fungal decay is a complex mechanism of enzymatic and non-enzymatic processes. Changes of the external conditions affecting the microenvironment (e.g. pH, chemical growth factors), blocking of (radical) reactions of non-enzymatic oxidizing agents and substrate changes (cellulose and especially hemicelluloses and lignin) after heat treatment are thought to affect the decay mechanism of heat-treated wood increasing its resistance against fungal attack.

7 CORRELATION OF ^{13}C -NMR ANALYSIS WITH FUNGAL DECAY TESTS: BASIDIOMYCETES*

Abstract

This study investigated the reasons for the decay resistance of heat-treated and untreated wood with respect to the polymeric structural constituents by solid-state cross-polarization/magic-angle spinning (CP-MAS) ^{13}C -NMR analysis before and after exposure to brown rot and white rot fungi. Brown rot fungi attack polymeric carbohydrates of untreated Scots pine sapwood at C4, resulting in cleavage and eventually depolymerisation of cellulose and hemicelluloses. The attack at the carbohydrate C6, which has never been observed before, is remarkable because the C6 $-\text{CH}_2\text{OH}$ group has no covalent structural function but acts in fixing the three-dimensional carbohydrate configuration just by secondary forces. The $-\text{CH}_2\text{OH}$ group carries $-\text{OH}$, which forms some of the strongest hydrogen bonds in the structure of the crystalline native cellulose. It is suggested that the fungus tries to cleave this group to open the cellulose crystalline structure into an amorphous structure to decrease its water repellency to facilitate enzymatic cellulose degradation. Considerable degradation of the hemicelluloses occurs during brown rot fungal exposure, whereas in general the attack on lignin is rather limited, being mainly demethoxylation. However, *Gloeophyllum trabeum* is an active brown rot fungus in the fungal exposure. Aromatic ring opening has also been observed after exposure to *Coriolus versicolor*, a white rot fungus. The demethoxylation of lignin and some attack on wood carbohydrates are also characteristic of the attack of this white rot fungus. The CP-MAS ^{13}C -NMR spectra of heat-treated Norway spruce reveal similarities but also clear differences after fungal exposure in comparison with untreated Scots pine sapwood. Brown rot fungi seem to have a preference to attack the carbohydrates of heat-treated wood at C4 and especially C1, cleaving the skeleton of cellulose and glucomannans. In untreated Scots pine sapwood, this attack mainly occurs at C4, the nonreducing end of the glucose unit. An attack on the out-of-the-ring alcoholic group $-\text{CH}_2\text{OH}$ of the carbohydrates of heat-treated Norway spruce is less obvious than that in untreated Scots pine. The attack on C3/C5 of the carbohydrates is remarkable, indicating ring opening of the glucose units, which has not been observed in untreated Scots pine sapwood. Lignin degradation is limited to demethoxylation, and low or no aromatic ring opening is observed, even after *C. versicolor* exposure.

* Boonstra MJ, Pizzi A, Rigolet S (2006c) Correlation of ^{13}C -NMR analysis with fungal decay tests of polymeric structural wood constituents. I. Basidiomycetes. Journal of Applied Polymer Science 101:2639-2649

7.1 Introduction

Solid-state ^{13}C -NMR analysis is a useful method to characterize molecular changes of wood after heat treatment. It can also be used to characterize the molecular changes of wood after fungal exposure, e.g. degradation of main wood components, which reveal information on how fungi attack wood. In this chapter the results are given of a crosspolarisation/magic-angle spinning (CP-MAS) ^{13}C -NMR analysis of heat-treated and untreated wood before and after fungal exposure to basidiomycetes. Differences in fungal attack between treated and untreated wood are discussed, which reveal more information about reasons for the decay resistance of heat-treated wood.

7.2 Materials and Methods

Materials

Norway spruce (*Picea abies* Karst) specimens were used for heat treatment and chemical analysis. Untreated Scots pine sapwood (*Pinus sylvestris* L.) specimens were used as references. Norway spruce boards with standard cross-section sizes (32 mm thick and 150 mm wide) and a length of at least 3.0 m were used for heat treatment. The moisture content before the treatment was 16–20% (shipping dry).

Heat treatment

The heat treatment was performed in two separate stages. In the first stage, the wood samples were treated in an aqueous environment at superatmospheric pressure (6–8 bar) with saturated steam as the heating medium to increase the temperature of the boards. This so-called steam hydro-thermolysis treatment was performed in an industrial plant at an effective treatment temperature of 165°C. Cooling was accomplished by the flashing of the reactor (a quick but controlled release of the pressure) to atmospheric conditions followed by cold-water circulation at the wall of the reactor. The wood samples were then dried with a conventional drying process at 50–60°C. After drying, the wood samples were heat-treated again in a special curing kiln (second stage) under dry and atmospheric conditions for a so-called curing treatment (at 170–180°C). During this stage, superheated steam was used as a sheltering gas to exclude oxygen (reducing fire risks and preventing undesired oxidation reactions).

Fungal testing

Treated Norway spruce and untreated Scots pine sapwood reference specimens (15 X 25 X 50 mm) were prepared and exposed to brown rot fungi (*Coniophora puteana*, *Gloeophyllum trabeum*, and *Poria placenta*) and white rot fungi (*Coriolus versicolor*) for 16 weeks according to the EN 113 agar test. After exposure, the specimens were oven-dried and weighed to determine the mass loss and moisture content. The Norway spruce boards were heat-treated with the steam hydro-thermolysis treatment.

Solid-state CP–MAS ¹³C-NMR analysis

Fungus-treated Norway spruce EN 113 specimens with a relative low mass loss (1–4%) and a high mass loss (20–23%) were selected for analysis. The specimens were ground before analysis. Untreated Scots pine sapwood references were also used for analysis. Treated EN 113 specimens with low-to-high mass losses were selected to determine the equilibrium moisture content (EMC) at 90 and 95% relative humidity (RH).

The treated and untreated timber specimens were analysed by solid-state CP–MAS ¹³C-NMR. Spectra were obtained on a Bruker MSL 300 FT-NMR spectrometer (Germany) at a frequency of 75.47 MHz and at a sample spin of 4.0 kHz. The impulse duration at 90° was 4.2 ms, the contact time was 1 ms, the number of transients was about 1000, and the decoupling field was 59.5 kHz. Chemical shifts were determined with respect to tetramethylsilane as a control. The spectra were accurate to 1 ppm. The spectra were run with suppression of spinning sidebands.

Hygroscopicity testing

After fungal testing, treated Norway spruce and untreated Scots pine sapwood reference specimens (15 X 25 X 50 mm) were oven-dried (at 105°C for 16 h). The oven-dried specimens were stored in a box (including a ventilator) for 3 days above a saturated potassium nitrate solution (20°C and 95% RH). Before and after the test, the specimens were weighed to determine the EMC. Treated Norway spruce and untreated pine sapwood reference specimens (without fungal testing) were also tested.

Table 7.1 Mass loss and moisture content of heat-treated Norway spruce and untreated Scots pine specimen after fungal exposure to brown and white rot basidiomycetes (EN 113)

EN 113 Specimen	Mass loss (%)	Moisture content (%)
1. <i>Coniophora puteana</i> (brown rot)		
- Treated Norway spruce, low mass loss	0.87	36
- Treated Norway spruce, high mass loss	23.08	29
- Scots pine sapwood reference	45.35	38
2. <i>Gloeophyllum trabeum</i> (brown rot)		
- Treated Norway spruce, low mass loss	0.17	21
- Treated Norway spruce, high mass loss	20.46	27
- Scots pine sapwood reference	31.4	29
3. <i>Poria placenta</i> (brown rot)		
- Treated Norway spruce, low mass loss	3.95	36
- Treated Norway spruce, high mass loss	21.10	32
- Scots pine sapwood reference	38.12	33
4. <i>Coriolus versicolor</i> (white rot)		
- Treated Norway spruce, low mass loss	3.97	21
- Treated Norway spruce, high mass loss	19.98	32
- Scots pine sapwood reference	27.84	41

7.3 Results and discussion

Characterization of the wood after fungal exposure

The mass loss and moisture content of the EN 113 specimens that were used for NMR analysis are shown in Table 7.1. In Figures 7.1–7.4 are shown the CP–MAS ^{13}C -NMR spectra of heat-treated Norway spruce and the untreated Scots pine sapwood reference after fungal exposure to brown rot (*C. puteana*, *G. trabeum*, and *P. placenta*) and white rot fungi (*C. versicolor*). The major changes due to fungal degradation are described below.

Untreated Scots pine reference

Fungal exposure to *C. puteana* results in a strong attack on the carbohydrates (cellulose and hemicelluloses) of untreated Scots pine (Fig. 7.1a). The crystalline peak (89 ppm) and especially the amorphous peak (82 ppm) of the carbohydrate C4 decrease after fungal exposure.

The high peak at 105 ppm shows a clear decrease, and the shoulder on the right side of this peak has almost disappeared. This peak and its shoulder belong to C1 of the carbohydrates (respectively cellulose and hemicelluloses). Fungal attack at C1 and C4 is believed to cause cleavage of hemicelluloses and cellulose, reducing the degree of polymerisation. The decrease after the fungal exposure of the crystalline (65 ppm) and amorphous (62 ppm) peaks of the carbohydrate C6 band is remarkable. This attack at C6, the out-of-the-ring alcoholic function CH_2OH , is very interesting, especially because this group has no covalent structural function. One reason is likely that the carbohydrate C6 is a pendant external group that is easier to attack. However, as enzymes work by evolutionary adaptation, a very different reason could be the cause. The $-\text{CH}_2\text{OH}$ group carries the $-\text{OH}$, which forms the strongest and more complete hydrogen bonds in the structure of crystalline native cellulose (Fengel and Wegener 1989). The fungus tries to cleave this group to open the cellulose crystalline structure, step by step, to an amorphous structure both to facilitate cellulose degradation and to decrease the water repellence of the (crystalline) structure. The C2 peak at 75 ppm and C3 and C5 peaks at 72 ppm do not change, and this indicates that no ring opening of the glucose units occurs during fungal exposure. The acetate group ($\text{CH}_3\text{COO}-$) peak of hemicelluloses (at 23 ppm) disappears, and this indicates marked degradation of hemicelluloses.

The attack on lignin of untreated Scots pine after exposure to *C. puteana* is rather limited. There is a slight decrease of the $-\text{OCH}_3$ peak (56 ppm), which means some, but not too extensive, demethoxylation of lignin. A peak around 148 ppm can be taken as furfural formation superimposed to (Ar)-OH of lignin. The shifts of solid-state NMR are not as well defined as those of liquid-state NMR, and the band (or shoulder, more often) that sometimes appears at 152–153 ppm means that two things can occur. The band at 152–153 ppm is like that of an Ar-OH phenolic group of lignin with no methoxy group as a substituent, whereas the band at 148 ppm is the same type of carbon but with an Ar- OCH_3 group as a substituent. Superimposed on the 148 ppm peak is the band of furfural too. Thus,

^{*} In wood chemistry acetyl ($\text{CH}_3\text{CO}-$) is a more commonly used expression than acetate

when the 153 ppm band appears, it likely indicates demethoxylation of lignin and hence a proportionally higher level of phenolic hydroxyl groups. Both furfural production and demethoxylation can be due to radical reactions characteristic of fungal enzymatic and nonenzymatic degradation mechanisms (Eriksson et al. 1990, Zabel and Morell 1992, Goodell et al. 2003).

All three wood components (cellulose, hemicelluloses, and lignin) are attacked after fungal exposure to *G. trabeum*, *P. placenta*, and *C. versicolor* fungal species. *G. trabeum* shows a clear preference to attack the amorphous carbohydrates at C4 and C6 because the C4 peak (at 82 ppm) and the C6 peak (at 62 ppm) decrease after fungal exposure (Fig. 7.2a). A slight decrease of the 83 ppm peak (amorphous C4) and a clear decrease of the 62 ppm peak (amorphous C6) are visible after exposure to *P. placenta* (Fig. 2.3a). Therefore, this fungus shows a preference to attack the amorphous carbohydrates at C6, although some attack at amorphous C4 also occurs. The C1 peak of the carbohydrates (at 105 ppm) does not change, and the shoulder on the right side of this peak is still visible after fungal exposure to *G. trabeum* and *P. placenta*. The depolymerisation of the carbohydrates occurs at C4 and probably either later or not at all at C1 when untreated Scots pine sapwood is exposed to these fungi.

The white rot fungus *C. versicolor* shows an attack on the amorphous carbohydrates at C4 and C6 because the amorphous peaks of C4 (82 ppm) and especially C6 (62 ppm) are reduced after fungal exposure. Furthermore, the high C1 peak at 105 ppm clearly decreases, whereas its shoulder is still visible. Thus, this fungus tries to depolymerise the carbohydrates through an attack at C1 and C4.

The CH_3COO - hemicelluloses peak (23 ppm) is still visible after exposure to *G. trabeum* (Fig. 7.2a) and *C. versicolor* (Fig. 7.4a), indicating the presence of some hemicelluloses. After exposure to *P. placenta*, the CH_3COO - hemicelluloses peak disappears (Fig. 7.3a), and this indicates greater hemicelluloses degradation after fungal exposure.

The Ar-OH peak at 148 ppm and the Ar-OCH₃ peak at 145 ppm clearly decrease after *G. trabeum* exposure, and this possibly indicates ring opening of the lignin aromatic structure (Fig. 7.2a). *G. trabeum* seems to be an active brown rot fungus, partially degrading lignin. In this way, the fungus has better access to the carbohydrates. Neither peak changes after exposure to *P. placenta* (Fig. 7.3a). Nevertheless, it seems that this fungus also tries to open the aromatic structure of lignin because the Ar-OH peaks at 112 and 132 ppm decrease slightly. Exposure to the white rot fungus *C. versicolor* results in a clear attack on lignin (Fig. 7.4a). A clear decrease of the 145 ppm peak (Ar-OCH₃) and 148 ppm peak (Ar-OH) is visible, indicating ring opening and degradation of the aromatic nuclei. A decrease of the 56 ppm peak (-OCH₃) after exposure to *G. trabeum*, *P. placenta*, and *C. versicolor* indicates demethoxylation of lignin.

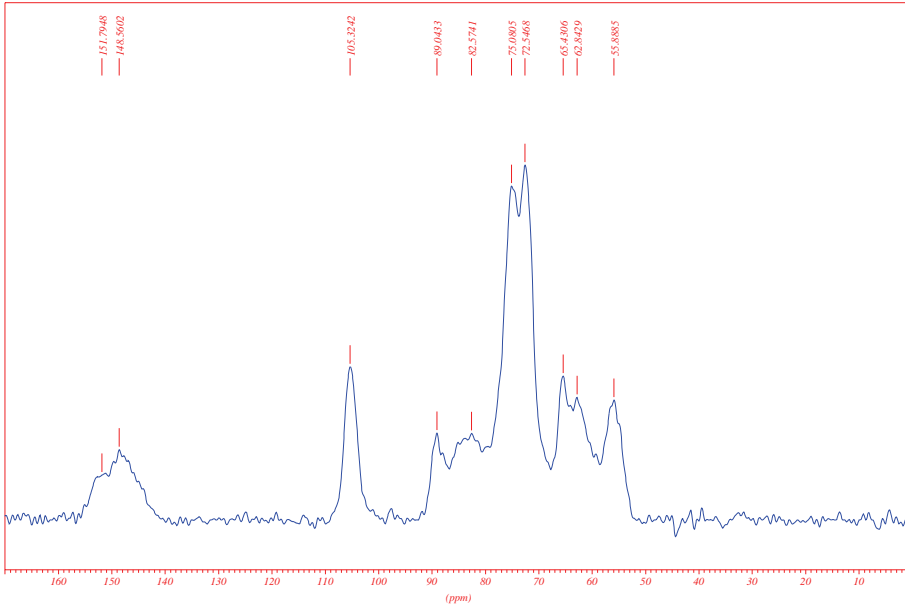

Fig. 7.1a CP-MAS ¹³C-NMR spectra after *C. puteana* exposure (EN 113) of untreated Scots pine sapwood (mass loss 45.4%)

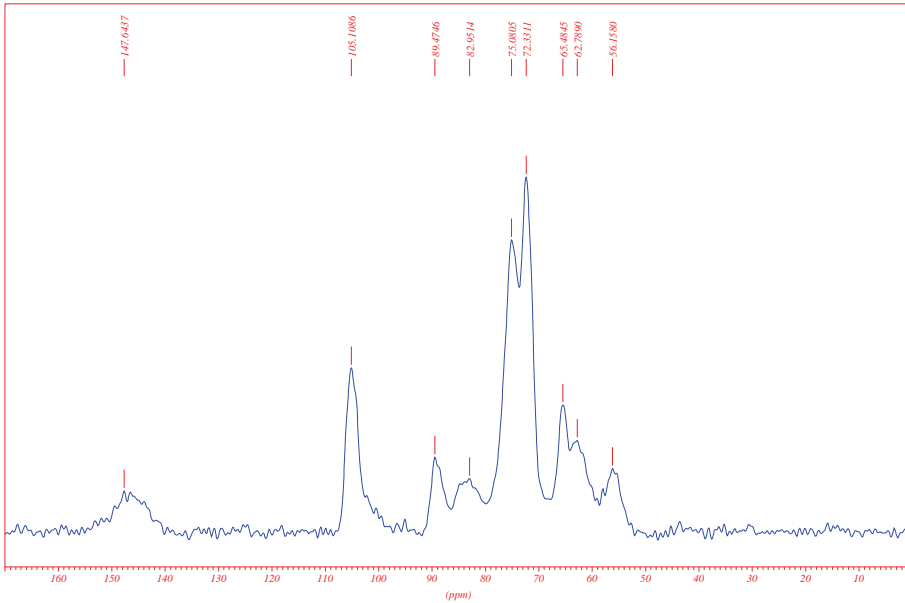

Fig. 7.1b CP-MAS ¹³C-NMR spectra after *C. puteana* exposure (EN 113) of heat-treated Norway spruce at low mass loss (0.87%)

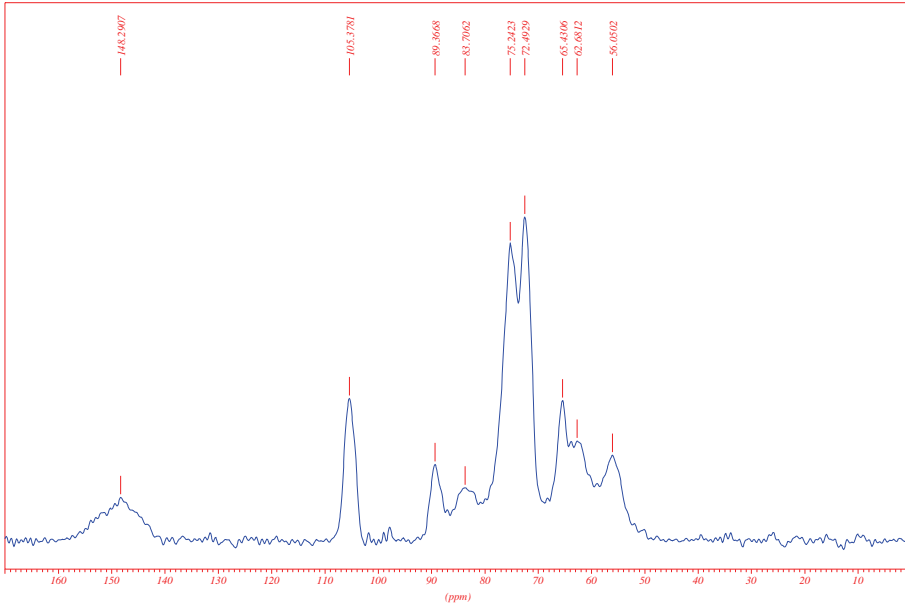

Fig. 7.1c CP-MAS ^{13}C -NMR spectra after *C. puteana* exposure (EN 113) of heat-treated Norway spruce at high mass loss (23.1%)

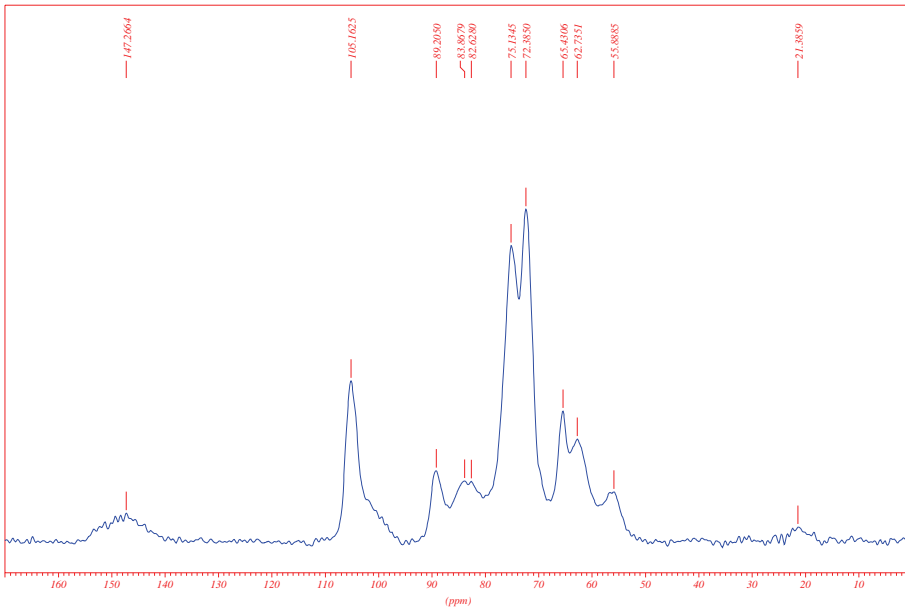

Fig. 7.2a CP-MAS ^{13}C -NMR spectra after *G. trabeum* exposure (EN 113) of untreated Scots pine sapwood (mass loss 31.4%)

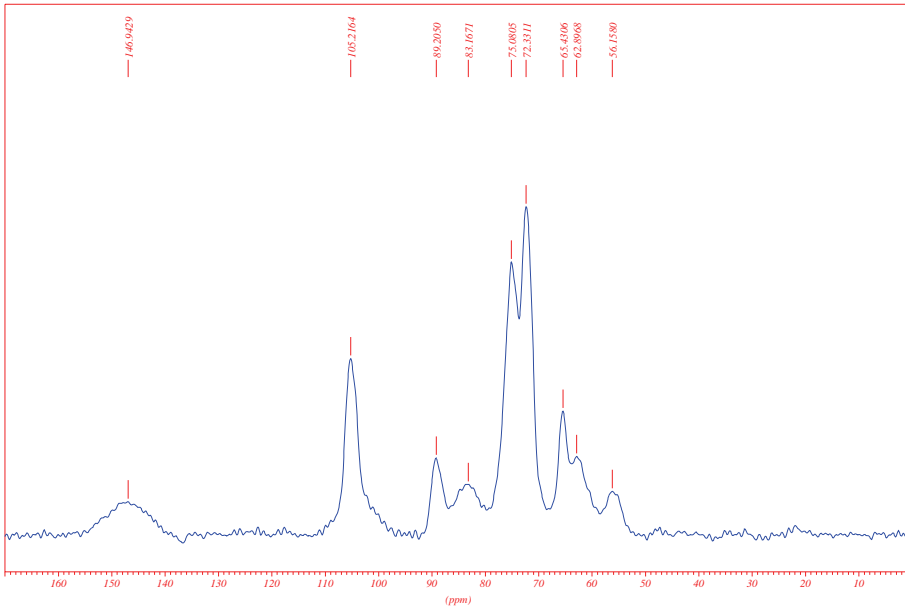

Fig. 7.2b CP-MAS ¹³C-NMR spectra after *G. trabeum* exposure (EN 113) of heat-treated Norway spruce at low mass loss (0.17%)

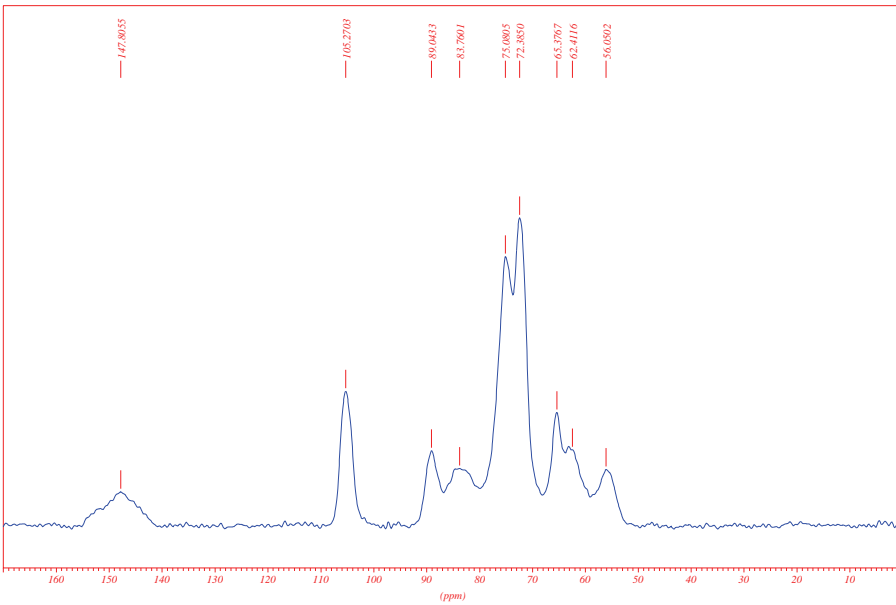

Fig. 7.2c CP-MAS ¹³C-NMR spectra after *G. trabeum* exposure (EN 113) of heat-treated Norway spruce at high mass loss (20.5%)

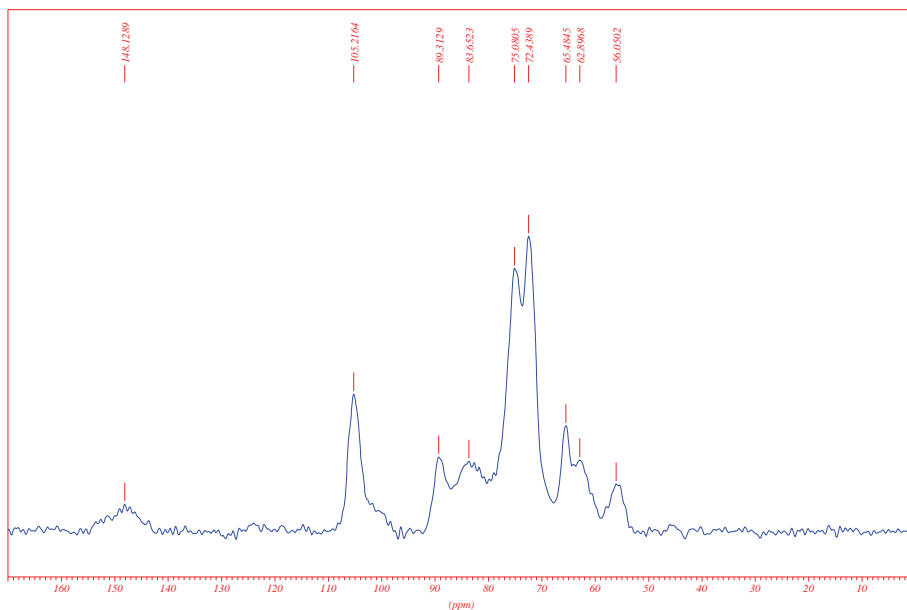

Fig. 7.3a CP-MAS ^{13}C -NMR spectra after *P. placenta* exposure (EN 113) of untreated Scots pine sapwood (mass loss 38.1%)

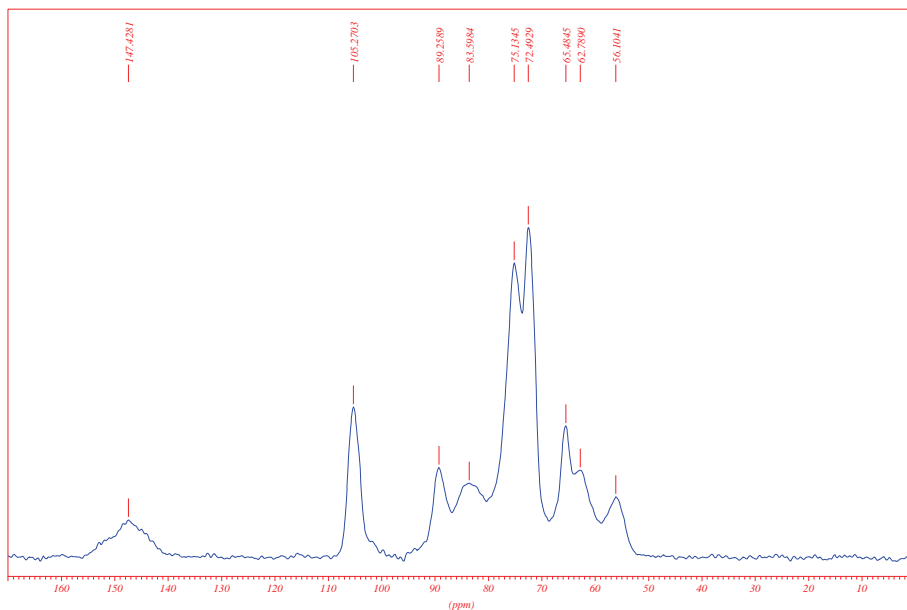

Fig. 7.3b CP-MAS ^{13}C -NMR spectra after *P. placenta* exposure (EN 113) of heat-treated Norway spruce at low mass loss (3.95%)

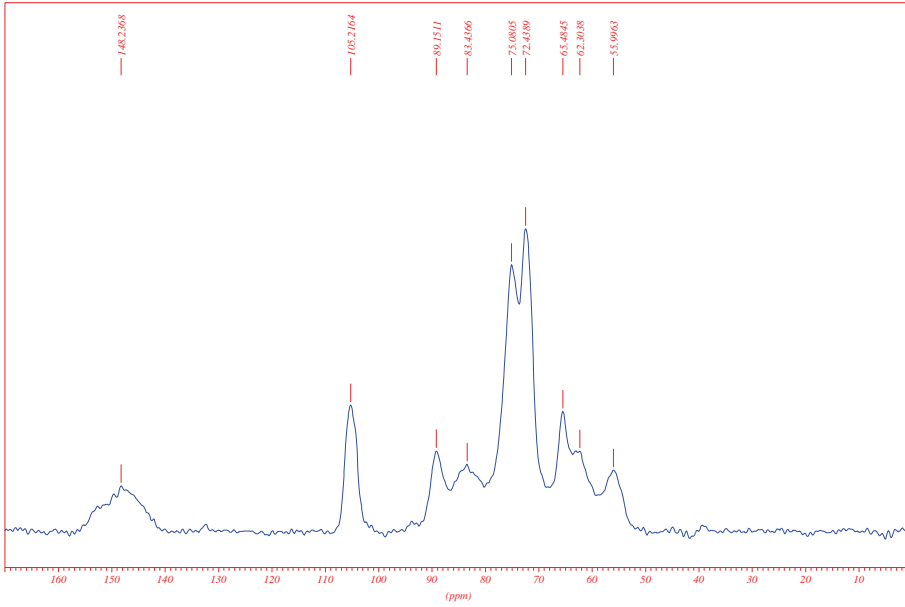

Fig. 7.3c CP-MAS ^{13}C -NMR spectra after *P. placenta* exposure (EN 113) of heat-treated Norway spruce at high mass loss (21.1%)

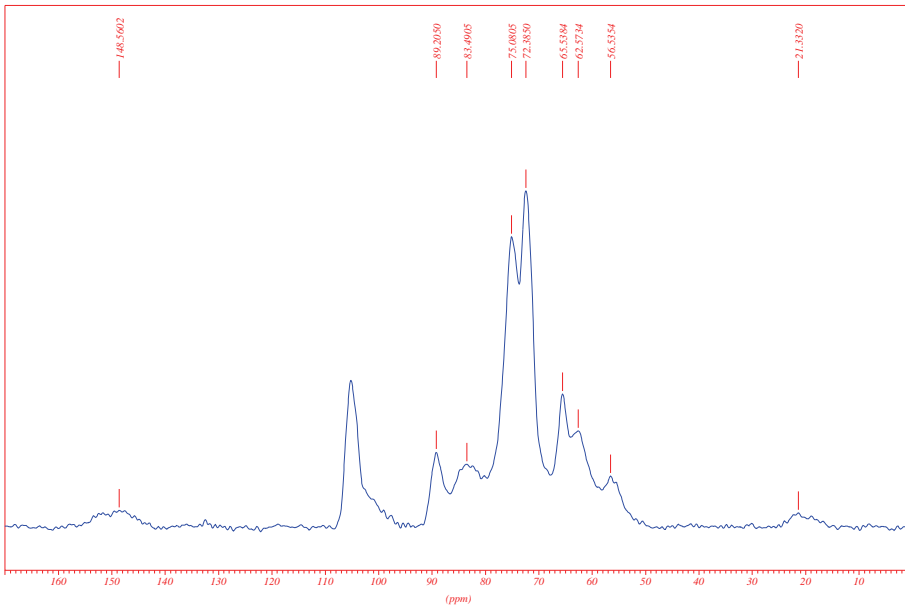

Fig. 7.4a CP-MAS ^{13}C -NMR spectra after *C. versicolor* exposure (EN 113) of untreated Scots pine sapwood (mass loss 27.8%)

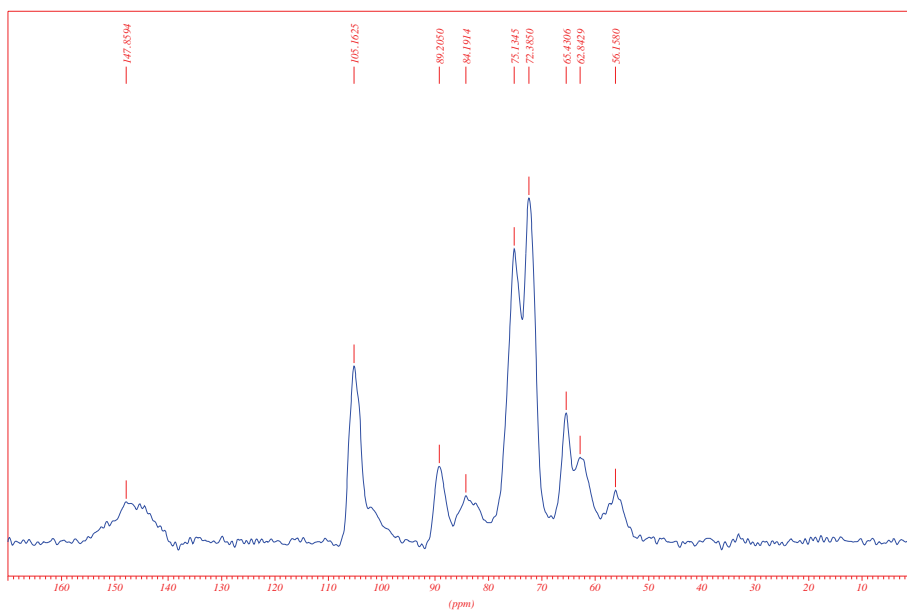

Fig. 7.4b CP-MAS ^{13}C -NMR spectra after *C. versicolor* exposure (EN 113) of heat-treated Norway spruce at low mass loss (3.97%)

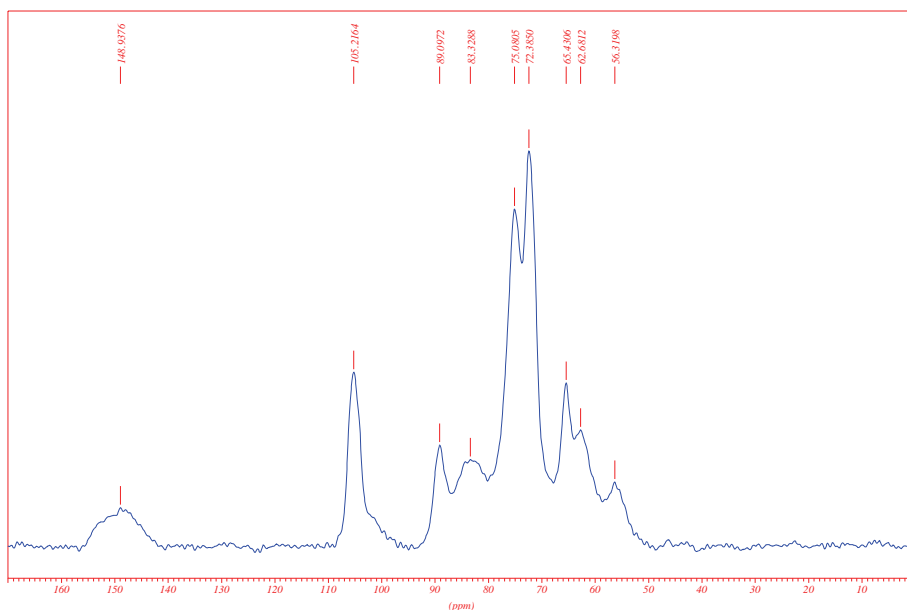

Fig. 7.4c CP-MAS ^{13}C -NMR spectra after *C. versicolor* exposure (EN 113) of heat-treated Norway spruce at high mass loss (27.8%)

Heat-treated Norway spruce

In Figures 7.1b and 7.2b, ^{13}C -NMR spectra are given of heat-treated Norway spruce after exposure to *C. puteana* and *G. trabeum* at a very low mass loss (0.87 and 0.17%, respectively). At such a low mass loss, the decay of wood components is still rather limited, and changes due to the heat treatment are clearly visible. The acetate group (CH_3COO -) peak of hemicelluloses (at 23 ppm) has disappeared, and this indicates thermal degradation of hemicelluloses. A clear decrease of the amorphous C4 (83 ppm) and C6 (62 ppm) peaks of the carbohydrates is visible because of the thermal degradation of hemicelluloses and amorphous cellulose.

The ^{13}C -NMR spectra of heat-treated Norway spruce (Fig. 7.1c) reveal a clear attack on the carbohydrates (cellulose and hemicelluloses) after exposure to *C. puteana* at a high mass loss (23.1%). The amorphous (83 ppm) and crystalline (82 ppm) peaks of C4 decrease after fungal exposure. The 105 ppm peak of C1 shows a clear decrease, and the shoulder on the right side of this peak disappears. The fungus attacks the carbohydrates at both C1 and C4 to cleave and eventually depolymerise cellulose and hemicelluloses. Some decrease of the amorphous (62 ppm) and crystalline (65 ppm) peaks of C6 are visible, indicating some attack on the out-of-the-ring alcoholic group $-\text{CH}_2\text{OH}$ of the carbohydrates. The clear decrease of the 72 ppm peak, which belongs to C3/C5 of the carbohydrates, is remarkable, indicating ring opening of the glucose units. No changes in the $-\text{OCH}_3$ peak at 56 ppm, the Ar- OCH_3 peak at 145 ppm, and the Ar-OH peak at 148 ppm have been observed, and this indicates that this *C. puteana* does not attack or attacks only slightly the aromatic structure of lignin.

G. trabeum and *P. placenta* show a preference to attack the carbohydrates of heat-treated Norway spruce at C1, rather than at C4. The 105 ppm peak of C1 shows a clear decrease, and the shoulder on the right of this peak has disappeared, whereas the amorphous and crystalline peaks of C4 (83 and 89 ppm) and C6 (62 and 65 ppm) do not change after fungal exposure (Figs. 7.2c and 7.3c). The attack at C1 has already occurred after exposure to *P. placenta* at a low mass loss (3.95%) because the 105 ppm peak of C1 decreases and the shoulder on the right side of this peak almost disappears (Fig. 7.3b). The fungus probably tries to cleave the carbohydrates at C1 in the initial stages of decay. *C. versicolor* also attacks the carbohydrates at C1 because the 105 ppm peak clearly decreases after fungal exposure. However, the shoulder on the right side of this peak is still visible as in the spectra of untreated Scots pine sapwood. The crystalline C4 peak at 89 ppm, which decreases after fungal exposure to *C. versicolor*, is remarkable. In some unknown way, the fungus can attack crystalline cellulose. *G. trabeum*, *P. placenta*, and *C. versicolor* do not attack or attack only slightly the carbohydrates at C6 because the amorphous and crystalline C6 signals (at 62 and 65 ppm, respectively) do not change after fungal exposure. Less obvious but still visible is the decrease of the C3/C5 peak at 72 ppm after exposure to *G. trabeum* and *P. placenta*, indicating some ring opening of the glucose units of the carbohydrates. This is not observed after exposure to the white rot fungus *C. versicolor*.

The exposure of heat-treated Norway spruce to *G. trabeum* seems to have little or no effect on lignin, especially in comparison with untreated Scots pine (Fig. 7.2a). The Ar-OCH₃ peak at 145 ppm and the Ar-OH peak at 148 ppm do not change after fungal exposure (Fig. 7.2c). However, the decrease of Ar-OH at 119 and 123 ppm indicates some attack of the fungus on the aromatic structure of lignin. The increase of the peak at 148 ppm in the spectra of *P. placenta* (Fig. 7.3c) at a high mass loss (21.1%) is remarkable. This must be due to a higher proportion of furfural probably produced from the carbohydrates by fungal attack because the 148 ppm peak is slightly but noticeably higher than that in the spectra of *P. placenta* (Fig. 7.3b) at a low mass loss (3.95%). Heat-treated wood lignin can also be observed as a separate, distinct peak at 153 ppm, and in many cases it exists as a shoulder at a slightly higher point than the 148 ppm peak, a shoulder always smaller than the furfural peak at 148 ppm. It is believed that the depression of the isotherm and the increased water repellency of heat-treated wood are caused by furfural self-polymerisation and cross-linking coupled to some cross-linking of lignin (see Chapter 4). The ring opening of the aromatic structure of lignin probably does not occur because the increase of the 148 ppm peak is rather small and the Ar-OCH₃ peak at 145 ppm does not change after fungal exposure to *P. placenta*. The 148 ppm peak in the heat-treated Norway spruce spectra after *C. versicolor* exposure (Fig. 7.4c) is much higher in comparison with the untreated Scots pine reference (Fig. 7.4a), indicating lower or no opening of some of the lignin aromatic rings and/or the presence of furfural. The 132 ppm peak (Ar-OH or C_v) disappears (Fig. 7.4c), and this indicates a certain proportion of lignin skeleton cleavage and a decrease in the molecular weight. The 119 peak (Ar-OH) decreases (Fig. 7.4c), and this means some attack on the aromatic rings of lignin. A clear decrease of the 56 ppm peak (-OCH₃) is visible after exposure to *C. versicolor*, indicating demethoxylation of lignin. Some demethoxylation also occurs after exposure to *G. trabeum* because the -OCH₃ peak at 56 ppm is slightly decreased.

Hygroscopicity of the wood after fungal testing

The fungal decay of untreated Scots pine results in a reduction of the EMC due to the degradation of carbohydrates (Table 7.2). Less (amorphous) cellulose and hemicelluloses are available to adsorb moisture. Differences in EMC between the fungi used can be explained by the mass loss of the specimen, with the highest mass loss giving the lowest EMC (fewer carbohydrates available to adsorb moisture). Fungal preference to attack a specific wood component could also be a reason for these differences.

The EMC of treated Norway spruce increases after fungal testing (Table 7.2), despite fungal degradation of some hemicelluloses that are still available after heat treatment and fungal degradation of (amorphous) cellulose. This increase might be due to the transformation of crystalline cellulose in amorphous cellulose and/or specific (oxidation) reactions of wood components during fungal decay making the wood more hygroscopic. It is striking that the EMC of heat-treated Norway spruce after *C. versicolor* exposure is somewhat higher than that after brown rot fungal exposure. In Chapter 4 an increase in cross-linking within the lignin-carbohydrate complex after heat treatment is demonstrated, and it is

suggested that this could be the reason for improved hygroscopicity. Lignin degradation during fungal exposure could reduce the cross-linking network around the cellulose fibrils, making wood more hygroscopic, especially when *C. versicolor* acts as a selective white rot fungus and cellulose is not degraded.

Table 7.2 Equilibrium moisture content at 95% RH (20°C) of heat-treated Norway spruce and untreated Scots pine sapwood after fungal testing

Mass loss (%)	Equilibrium moisture content (%) at 95% RH, 20°C	
	Treated Norway spruce	Untreated Scots pine sapwood
<i>C. puteana</i>		
0	12.5	21.0
9.3	13.8	
23.5	13.4	
58.4		15.4
<i>G. trabeum</i>		
0	12.5	21.0
5.93	13.4	
19.1	14.1	
36.6		17.7
<i>P. placenta</i>		
0	12.5	21.0
8.3	12.8	
24.1	14.1	
40.4		17.3
<i>C. versicolor</i>		
0	12.5	21.0
4.3	12.7	
8.5	13.5	
19.0	15.2	
29.2		19.5

Degradation mechanism of fungal decay: treated versus untreated wood

In general heat treatment of wood results in an improvement of the resistance against fungal attack. In chapter 4 the decay mechanism of fungal attack is described and possible effects of heat treatment are discussed. Heat treatment causes degradation and/or modification of the main wood components (cellulose, hemicelluloses and lignin) and changes the composition of these components. These changes could affect the decomposition of the main wood components (the substrate) during fungal decay. The ¹³C-NMR spectra presented in this chapter, give an indication where the fungi attack the main wood components and it revealed similarities but also differences between treated and untreated wood as described above.

During decay, the brown rot fungi start with the wood components, which are accessible and easy to degrade (amorphous cellulose and especially the hemicelluloses). This results in an attack on the C1 and amorphous C4 in order to cleave and eventually depolymerise these carbohydrates. Since these components are (partially) degraded and/or modified after heat treatment, it is expected that in initial stages of decay the fungus must also attack the wood components, which are less easy to degrade. The attack on crystalline C4 of cellulose, which is not observed for untreated wood, is an indication that the fungus tries to attack the crystalline cellulose. The attack on the C3/C5, not

observed for untreated wood, indicating ring opening of the glucose units of the carbohydrates, might also be an attempt to attack the (crystalline) cellulose trying to cleave fragments from the cellulose fibril. Transformation of crystalline cellulose in amorphous cellulose appears to be affirmed in the EMC test results. It seems that the fungus is trying to find alternative routes to degrade the wood components of heat-treated wood but the decay mechanism is less effective and it takes more time to degrade the wood components.

Since brown rot fungi are not able to degrade lignin, the attack on the lignin polymer was limited (for treated and untreated wood). It is remarkable that only some demethoxylation was observed after the exposure of heat-treated wood to the white rot fungus. Aromatic ring opening was not observed, whereas for untreated wood a clear attack on the aromatic ring was observed. It is a question whether modification of the lignin polymer (e.g. cross-linking) is involved. Changes of the other components (cellulose and hemicelluloses) might also affect the degradation of lignin since *C. versicolor* has been classified as a simultaneous white rot fungus.

7.4 Conclusions

CP-MAS ^{13}C -NMR spectra have revealed similarities but also clear differences in the polymeric structural wood constituents of heat-treated wood and untreated wood after fungal exposure. Brown rot fungi attack the polymeric carbohydrates of untreated Scots pine sapwood at C4, indicating cleavage and eventually depolymerisation of cellulose and hemicelluloses. Attack on the out-of-the-ring alcoholic group $-\text{CH}_2\text{OH}$ of the carbohydrates of heat-treated wood was observed. It is possible that the fungus tried to cleave this group to open the cellulose crystalline structure to an amorphous structure in order to decrease its water repellency to facilitate enzymatic cellulose degradation. Considerable degradation of the hemicelluloses occurs during brown rot fungal exposure, whereas in general the attack on lignin is rather limited, being mainly demethoxylation. However, *G. trabeum* has been found to be an active brown rot fungus in the (partial) degradation of lignin because there is some indication of ring opening of the aromatic ring of lignin during fungal exposure. Aromatic ring opening is also observed after exposure to *C. versicolor*, a white rot fungus. The demethoxylation of lignin and some attack on wood carbohydrates are also characteristic of the attack of this white rot fungus.

Brown rot fungi seem to have a preference to attack the carbohydrates of heat-treated Norway spruce at C4 and especially C1, indicating cleavage of the skeleton of cellulose and glucomannans. In untreated Scots pine sapwood, this attack mainly occurs at C4, the nonreducing end of the glucose unit. The attack on the out-of-the-ring alcoholic group CH_2OH of the carbohydrates of heat-treated Norway spruce is less obvious than that in untreated Scots pine. The attack on the C3/C5 of the carbohydrates is remarkable, indicating ring opening of the glucose units, which has not been observed in untreated Scots pine sapwood. Lignin degradation is limited to demethoxylation, and low or no aromatic ring opening is observed, even after *C. versicolor* exposure.

8 CORRELATION OF ^{13}C -NMR ANALYSIS WITH FUNGAL DECAY TESTS: GROUND CONTACT TESTS*

Abstract

This study investigated the reasons for the decay resistance of heat-treated and untreated wood as composed of polymeric structural constituents by solid-state CP-MAS ^{13}C -NMR analysis after fungal exposure in ground contact. Fungal exposure in ground contact resulted in strong degradation of the carbohydrates (cellulose and hemicelluloses) of treated and untreated Scots pine, radiata pine, and simaruba. Fungal attack of the carbohydrates appeared to occur mainly at C4, resulting in cleavage and eventually depolymerisation of cellulose and hemicelluloses. The CP-MAS ^{13}C -NMR spectra of heat-treated wood revealed similarities but also clear differences after fungal exposure in ground contact with untreated wood. In ground contact fungi appear to attack the carbohydrates of heat-treated wood at C1 and possibly at C4 in order to cleave and eventually depolymerise cellulose and hemicelluloses. An attack on the out-of-the-ring alcoholic group, $-\text{CH}_2\text{OH}$, of the carbohydrates of the heat-treated wood was observed (particularly in treated radiata pine). The fungus possibly tried to cleave the out-of-the-ring $-\text{CH}_2\text{OH}$ group on the main H-bond fixing sites of the crystalline cellulose structure in order to open the cellulose crystalline structure to an amorphous structure to decrease its water repellency and facilitate enzymatic cellulose degradation. This was also observed, but to a lesser extent, in untreated radiata pine and untreated Scots pine. The opening of the glucose pyranose ring in heat-treated simaruba after fungal exposure, not observed in the untreated wood, was remarkable, and the thermal degradation of α -arabinofuranose during heat treatment indicated more extensive decay. Demethoxylation and ring opening of the aromatic structure of lignin were observed, especially in the heat-treated radiata pine, Douglas fir, and simaruba.

* Boonstra MJ, Pizzi A, Rigolet S (2006d) Correlation of ^{13}C -NMR analysis with fungal decay tests of polymeric structural wood constituents. II. Ground contact tests. *Journal of Applied Polymer Science* 102:616-622

8.1 Introduction

In ground contact the decay of wood can not only be caused by basidiomycetes (brown and white rot fungi), but also by soft rot fungi (*Fungi imperfecti* and *ascmycetes*) and bacteria. The preferences of these decay organisms might differ for the (treated) wood species involved. In this chapter heat-treated and untreated wood are subject of the crosspolarisation/magic-angle spinning (CP-MAS) ^{13}C -NMR analysis after fungal exposure in ground contact. This provides information about the biological attack of treated and untreated wood and whether this differs from the attack of basidiomycetes as discussed in the previous chapter. Furthermore differences between treated and untreated wood are discussed. A ground contact study without standard controlled conditions (EN 252) was used to reproduce the real situation of heat-treated timber in service.

8.2 Materials and methods

Materials

Scots pine (*Pinus sylvestris* L.), Norway spruce (*Picea abies* Karst), Douglas fir (*Pseudotsuga menziesii* Franco), radiata pine (*Pinus radiata* D. Don), and simaruba (*Simaruba amara* Aubl.) specimens were used for heat treatment and chemical analyses. Untreated specimens were used as references. Boards with standard cross-section sizes (thickness: 32–38 mm; width: 150 mm) and a length of at least 3.0 m were used for heat treatment. The moisture content before treatment was 16%–20% (“shipping dry”).

Heat treatment

The heat treatment was performed in two stages. In the first stage the wood boards were treated in an aqueous environment at superatmospheric pressure (6–8 bar) using liquid water as the heating medium to increase the temperature of the boards. This so-called liquid full hydro-thermolysis treatment was done in a 600-L reactor at an effective treatment temperature of 165°C. A heat exchanger was used to heat and cool the process water in the reactor, and NaOH was added to control the pH. The wood samples were then dried using a conventional drying process at 50°C–60°C. After drying, the wood samples were heat-treated again in a special curing kiln (the second stage) under dry and atmospheric conditions, the so-called curing treatment (at 170°C–180°C). During this stage, the superheated steam was used as a sheltering gas to exclude oxygen (reducing fire risks and preventing undesired oxidation reactions).

Fungal testing

Thirty treated and 30 untreated specimens (each 25 X 50 X 600 mm) of each wood species tested were prepared and exposed to soil according to the graveyard test (EN 252) in Wageningen, The Netherlands. Each year the test specimens were inspected, and the failed stakes were removed, dried, and stored.

Solid-state CP-MAS ^{13}C -NMR analysis

Failed stakes from the EN 252 graveyard test were selected to prepare the NMR samples. Small slices (25 X 50 X 10 mm) with a clearly visible decayed surface (brown, white, and/or soft rot) were sawn near the soil-air level. The samples were grinded before analysis. Treated and untreated wood specimens were used for NMR analysis.

The treated and untreated timber specimens were analysed by solid-state CP-MAS ^{13}C -NMR. Spectra were obtained on a Bruker MSL 300 FT-NMR spectrometer at a frequency of 75.47 MHz and at a sample spin of 4.0 kHz. The impulse duration at 90° was 4.2 ms, contact time was 1 ms, number of transients was about 1000, and the decoupling field was 59.5 kHz. Chemical shifts were determined relative to tetramethylsilane (TMS), which was used as the control. The spectra were accurate to 1 ppm. The spectra were run with suppression of spinning side bands.

8.3 Results and discussion

Figures 8.1–8.5 show the CP-MAS ^{13}C -NMR spectra of the heat-treated and untreated Scots pine, radiata pine, Norway spruce, Douglas fir, and simaruba specimens after fungal exposure in ground contact. The major changes from fungal degradation are described below.

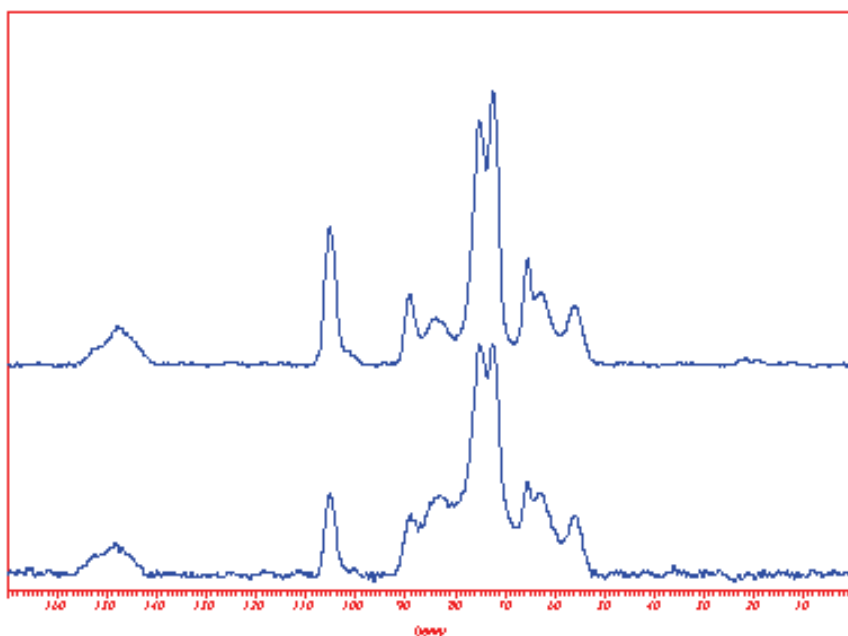

Fig. 8.1 CP MAS ^{13}C NMR spectra after fungal exposure in ground contact (EN 252) of untreated (below) and heat-treated (above) Scots pine

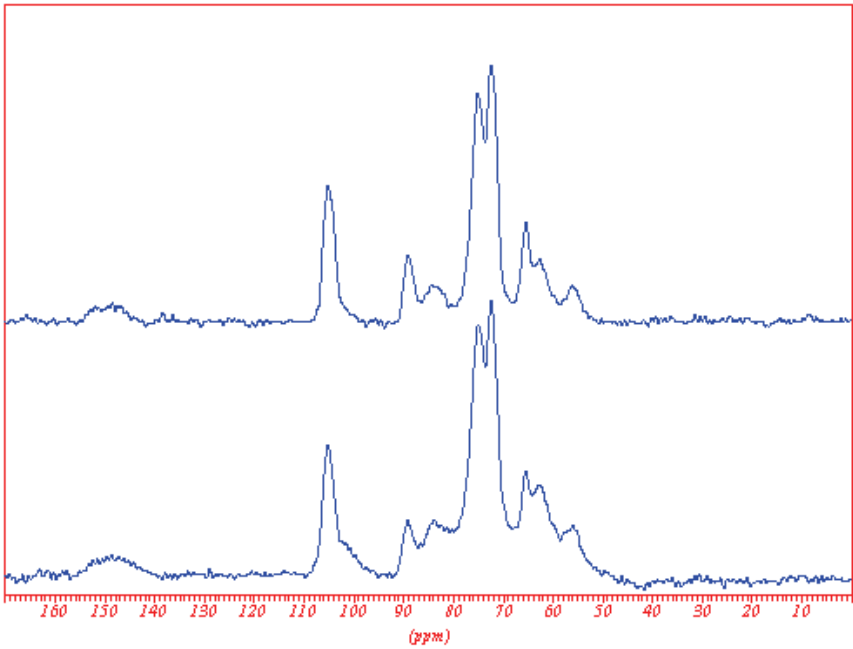

Fig. 8.2 CP MAS ¹³C NMR spectra after fungal exposure in ground contact (EN 252) of untreated (below) and heat-treated (above) radiata pine

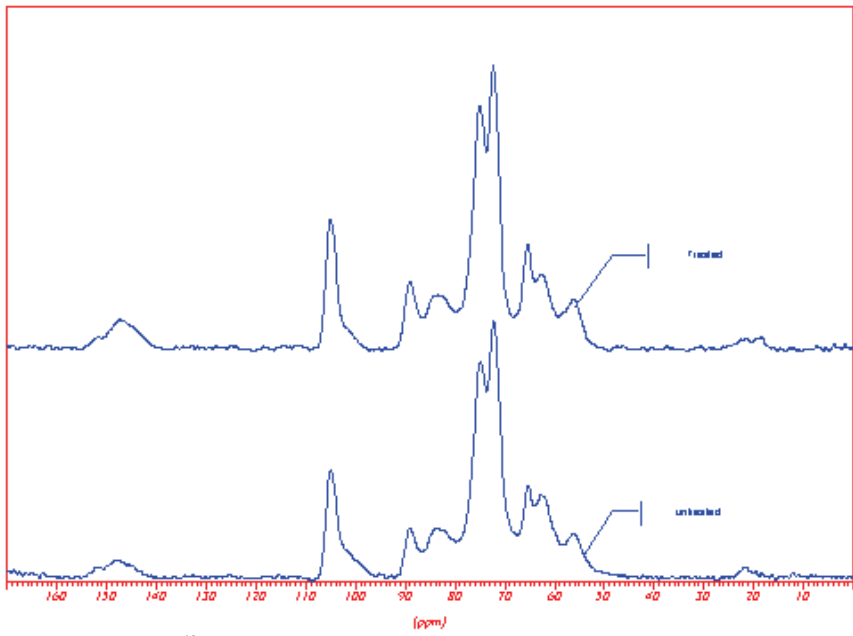

Fig. 8.3 CP MAS ¹³C NMR spectra after fungal exposure in ground contact (EN 252) of untreated (below) and heat-treated (above) Norway spruce

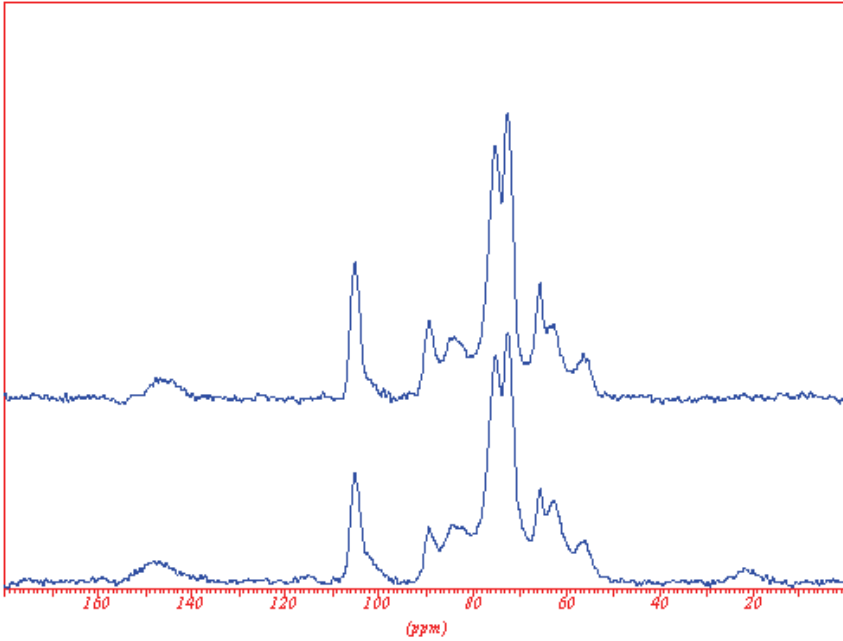

Fig. 8.4 CP MAS ^{13}C NMR spectra after fungal exposure in ground contact (EN 252) of untreated (below) and heat-treated (above) Douglas fir

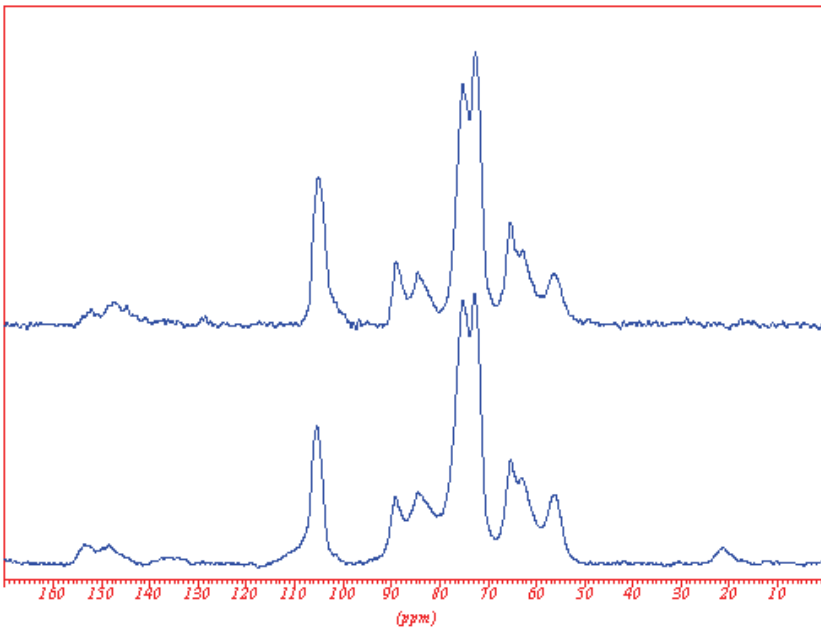

Fig. 8.5 CP MAS ^{13}C NMR spectra after fungal exposure in ground contact (EN 252) of untreated (below) and heat-treated (above) simaruba

Untreated wood

Fungal exposure in ground contact resulted in a strong attack on the carbohydrates (cellulose and hemicelluloses) of the untreated Scots pine (Fig. 8.1). The crystalline peak (89 ppm) and especially the amorphous peak (82 ppm) of the C4 of the carbohydrates decreased after fungal exposure. The high peak at 105 ppm showed a clear decrease, and the shoulder on the right side of this peak almost disappeared (respectively cellulose and hemicelluloses). This peak and its shoulder belong to the C1 of the carbohydrates (respectively cellulose and hemicelluloses). Fungal attack at C1 and C4 was believed to cause cleavage of hemicelluloses and cellulose, decreasing the degree of polymerisation. A decrease in the crystalline (65 ppm) and amorphous (62 ppm) peaks of the carbohydrate C6 band was found after fungal exposure. It was also found after fungal exposure to basidiomycetes (see Chapter 7). It was suggested that the fungus tries to cleave this out-of-the-ring CH₂OH group to open the cellulose crystalline structure to an amorphous structure, both to facilitate cellulose degradation and to decrease the water repellence of the (crystalline) structure. This is the first time that attack at this site has been observed. It was not observed on untreated wood by any of the previous NMR studies of normal timber decay (Hortling et al. 1992, Davis et al. 1994a, 1994b and 1994c).

The C2 (75 ppm) and C3,C5 (72 ppm) carbohydrate peaks also appeared to be badly affected, implying a relatively small but observable opening of the glucose pyranose ring. The acetate group (CH₃COO⁻) peak of hemicelluloses (at 23 ppm) disappeared, indicating marked degradation of hemicelluloses (Fig. 8.1).

The attack on lignin of untreated Scots pine after fungal exposure was rather limited. There was a slight decrease in the -OCH₃ peak (56 ppm), which means some but not too extensive demethoxylation of lignin. Ring opening of the aromatic structure of lignin probably did not occur since the Ar-OH peak at 148 ppm and the Ar-OCH₃ peak at 145 ppm did not change after fungal exposure (Fig. 8.1).

A serious attack on the amorphous carbohydrates of untreated radiata pine was observed because the amorphous C4 (82 ppm) and C6 (62 ppm) peaks were clearly decreased after fungal exposure in ground contact (Fig. 8.2). There was a slight decrease in the crystalline C6 (65 ppm) and C4 (89 ppm) peaks, and the C1 peak (105 ppm) appeared to be unchanged. Therefore, fungal attack of the carbohydrates mainly occurred at the amorphous C4, causing cleavage of hemicelluloses and cellulose decreasing the degree of polymerisation. The acetate group (CH₃COO⁻) peak of hemicelluloses (at 23 ppm) disappeared, indicating marked degradation of hemicelluloses (Fig. 8.2). The NMR spectra also show a clear attack on the lignin of the untreated radiata pine after fungal exposure in ground contact. Although the -OCH₃ peak decreased (56 ppm), meaning there was some demethoxylation of lignin, but still rather limited, the Ar-OH peak at 148 ppm and the Ar-OCH₃ peak at 145 ppm were clearly decreased, indicating ring opening and degradation of the aromatic nuclei (Fig. 8.2). White rot fungi could cause this aromatic ring opening, although soft rot fungi are also capable to degrade lignin (Eriksson et al. 1990).

Degradation of the carbohydrates of untreated Douglas fir and Norway spruce revealed similarities and was less marked after fungal attack than in the other species (Figs. 8.3 and 8.4). A decrease in the C6 peak at 62 ppm revealed some attack on the amorphous carbohydrates. The C4 peaks at 82 (amorphous) and 89 (crystalline) ppm and the C1 peak appeared to be unchanged, indicating no or low cleavage/depolymerisation of the carbohydrates. The CH_3COO - hemicelluloses peak (23 ppm) was still visible, indicating the presence of some hemicelluloses (Figs. 8.3 and 8.4). The ^{13}C -NMR spectra of untreated Douglas fir revealed a slight decrease in the $-\text{OCH}_3$ peak (56 ppm) after fungal exposure, which means some demethoxylation of lignin occurred. This was not observed in the ^{13}C -NMR spectra of the untreated Norway spruce. There appears to have been some ring opening of the aromatic structure of lignin because the Ar-OH peak at 148 ppm and the Ar- OCH_3 peak at 145 ppm were slightly decreased after Norway spruce and Douglas fir were subjected to fungal exposure (Figs. 8.3 and 8.4).

The ^{13}C -NMR spectra of untreated simaruba revealed a decreased level of amorphous carbohydrates after fungal exposure in ground contact because the amorphous C4 peak (82 ppm) and especially the amorphous C6 peak (62 ppm) were decreased (Fig. 8.5). The crystalline C6 (65 ppm) and C4 (89 ppm) peaks and the C1 peak at 105 ppm appeared to be unchanged, although the shoulder on the right side of the C1 peak disappeared. Therefore, cleavage of hemicelluloses and cellulose, which caused a decreased degree of polymerisation, mainly occurred at the amorphous C4. The C2 (75 ppm) and the C3,C5 (72 ppm) peaks of the carbohydrates were unchanged, meaning there was no pyranose ring opening. The CH_3COO - hemicelluloses peak (23 ppm) was still visible, indicating the presence of some hemicelluloses (Fig. 8.5). The low shoulder at 108-110 ppm in the untreated simaruba was the C1 of a α -arabinofuranose; hence, it was a pectic substance. This means that amorphous carbohydrates such as pectic substances are rather difficult to degrade. It is not known why this is so. Possible explanations include that they have a much higher degree of polymerisation in simaruba than in other wood species, that they could have been treated with water repellents or anti-blue stains, or that they could have slightly different structures. No or low demethoxylation of lignin occurred because the decrease in the $-\text{OCH}_3$ peak (56 ppm) was rather limited. The presence of the broad peak at 133-140 ppm (aromatic C-1 of guaiacyl and syringyl lignin), the Ar- OCH_3 peak at 145 ppm, the Ar-OH peak at 148 ppm, and the peak at 153 ppm (aromatic C-3, C-5, or C-4e of guaiacyl and syringyl lignin) indicate no or little ring opening of the aromatic nuclei (Fig. 8.5).

Heat-treated wood

In the spectra of the heat-treated wood (Figs. 8.1, 8.2, 8.4, and 8.5) the acetate group (CH_3COO -) peak of hemicelluloses (at 23 ppm) disappeared. This could have been a result of fungal decay, but it has been found that heat treatment causes thermal degradation of hemicelluloses including cleavage of the acetate group (see Chapter 4, 5 and 7). A clear decrease in the amorphous C4 (83 ppm) and C6 (62 ppm) peaks of the carbohydrates also was found after heat treatment

because of thermal degradation of hemicelluloses and amorphous cellulose (See Chapter 4 and 7, and Pott 2004).

The ^{13}C -NMR spectra of heat-treated Scots pine revealed an attack on the carbohydrates (cellulose and hemicelluloses) after fungal exposure in ground contact (Fig. 8.1). The amorphous C6 (62 ppm) and C4 (83 ppm) peaks decreased, which could have been a result of fungal decay and/or thermal degradation during heat treatment. The 105 ppm peak of C1 did not change, although its shoulder on the right side disappeared. Therefore, an attack on the carbohydrates of heat-treated Scots pine in ground contact occurred at C1 and possibly at C4 in order to cleave and eventually depolymerise cellulose and hemicelluloses. The C2 (75 ppm) and C3,C5 (72 ppm) carbohydrate peaks appeared to be unchanged, indicating no or little opening of the glucose pyranose ring.

A slight decrease in the $-\text{OCH}_3$ peak (56 ppm) was observed after fungal exposure, which means there was some demethoxylation of lignin. The same has been observed in previous studies of untreated wood (Chau et al. 1982, Chen et al. 1982, Robert and Chen 1989, Hortling et al. 1992, Davis et al. 1994a, 1994b and 1994c). The Ar- OCH_3 peak at 145 ppm and the Ar-OH peak at 148 ppm appeared to be unchanged, indicating no or only a slight attack on the aromatic structure of lignin (Fig. 8.1).

Fungal exposure in ground contact caused a clear attack on the carbohydrates of heat-treated radiata pine (Fig. 8.2). The amorphous C6 (62 ppm) and C4 (83 ppm) peaks decreased, which could have been a result of fungal decay and/or thermal degradation during heat treatment. The crystalline C4 peak (89 ppm) appeared to be unchanged, but the crystalline C6 peak (65 ppm) was slightly decreased, indicating some attack on the out-of-the-ring CH_2OH group at the C6 of the carbohydrates. The C1 peak (105 ppm) was decreased, and its shoulder on the right side had disappeared. In ground contact fungi appeared to have attacked the carbohydrates of heat-treated radiata pine at C1 and possibly at C4 in order to cleave and eventually depolymerise cellulose and hemicelluloses. The C2 (75 ppm) and C3,C5 (72 ppm) carbohydrate peaks appeared unchanged, indicating no or little opening of the glucose pyranose ring.

Similar to untreated wood, demethoxylation and ring opening of the aromatic nuclei were observed when heat-treated radiata pine was exposed to fungi in ground contact because the $-\text{OCH}_3$ peak (56 ppm), the Ar- OCH_3 peak at 145 ppm, and the Ar-OH peak at 148 ppm were clearly decreased (Fig. 8.2). This aromatic ring opening was not observed when heat treated wood (Norway spruce) was exposed to the white rot fungus *C. versicolor* (Chapter 7). There is probably more than one reason for this effect, e.g. the wood species tested, the type of white rot fungus and the possibility of soft rot fungi attacking the treated wood.

The attack on the wood components of heat-treated Norway spruce during exposure in ground contact was rather limited (Fig. 8.3). The amorphous carbohydrate C6 (62 ppm) and C4 (83 ppm) peaks decreased. This could have been a result of fungal decay but also to thermal degradation during heat treatment. The crystalline carbohydrate C6 (65 ppm) and C4 (89 ppm) peaks appeared unchanged. Some attack on the carbohydrate's C1 was observed

because its shoulder on the right side was slightly decreased. It was remarkable that the CH_3COO - peak of hemicelluloses at 23 ppm was present (Fig. 8.3); this was not visible after exposure to *C. puteana*, *G. trabeum*, *P. placenta*, and *C. versicolor* (See Chapter 7). The CH_3COO -side group must be present after heat treatment, and it is not degraded during exposure in ground contact. Furthermore, the ^{13}C -NMR spectra of Norway spruce showed a small peak at 18 ppm belonging to the CH_3 - group, indicating that hemicelluloses was less degraded in this type of timber. The $-\text{OCH}_3$ peak at 56 ppm, the Ar-OCH_3 peak at 145 ppm, and the Ar-OH peak at 148 ppm appeared to be unchanged, indicating no or only a slight attack on lignin (Fig. 8.3).

The main difference between the ^{13}C -NMR spectra of the treated and untreated Douglas fir specimens was the decrease in the amorphous C4 (82 ppm) and C6 (62 ppm) peaks and the absence of the CH_3COO - peak of hemicelluloses (23 ppm) in the heat-treated Douglas fir spectra (Fig. 8.4). This could have been a result of fungal degradation, but it more probably resulted from thermal degradation of the carbohydrates during heat treatment. Therefore, it appears that the fungal attack on the carbohydrates during exposure in ground contact was rather limited under EN 252 standard test conditions although some attack on the carbohydrate's C1 was observed because its shoulder on the right side was slightly decreased. It appears that an attack on the lignin component of the heat-treated Douglas fir occurred during fungal exposure in ground contact. A slight decrease in the $-\text{OCH}_3$ peak (56 ppm), meaning some demethoxylation of lignin occurred, and a decrease in the Ar-OH peak at 148 ppm and the Ar-OCH_3 peak at 145 ppm, indicating ring opening of the aromatic nuclei, were observed (Fig. 8.4).

A strong decrease in the amount of the amorphous carbohydrates of heat-treated simaruba was observed, because the amorphous C4 peak (82 ppm) and especially the C6 peak (62 ppm) decreased after fungal exposure in ground contact (Fig. 8.5). This could have been caused by fungal attack, but was more probably a result of degradation of the carbohydrates during heat treatment. The C1 peak (105 ppm) was clearly decreased, and its shoulder on the right side partially disappeared. The attack on the carbohydrates of heat-treated simaruba in ground contact appeared to occur mainly at C1 in order to cleave and eventually depolymerise cellulose and hemicelluloses. Furthermore, there is a clearly visible decrease in the C2 peak (75 ppm), indicating glucose pyranose ring opening of the carbohydrates.

The low shoulder at 108–110 ppm, reflecting the C1 of a α -arabinofuranose, almost disappeared in heat-treated simaruba after fungal exposure in ground contact. Because this peak was still clearly visible in the ^{13}C -NMR spectra of untreated simaruba (Fig. 8.5), heat treatment must have cleaved these pectic substances extremely easily.

Lignin of heat-treated simaruba seems to have been more affected than untreated wood after fungal exposure in ground contact (Fig. 8.5). A clear decrease in the $-\text{OCH}_3$ peak (56 ppm) indicated strong demethoxylation of lignin. The broad peak at 133–140 ppm (aromatic C-1 of guaiacyl and syringyl lignin) had almost disappeared, and the 153 ppm peak (aromatic C-3, C-5, or C-4e of guaiacyl and syringyl lignin) was strongly decreased, indicating ring opening and degradation of

the aromatic nuclei. However, the Ar-OCH₃ peak at 145 ppm and the Ar-OH peak at 148 ppm appeared unchanged after fungal exposure. The 148 ppm peak could have been a result of the production of furfural.

A comparison of the ¹³C-NMR spectra of the different wood species used in this study (Figs. 8.1–8.5) showed similarities but also clear differences in the way the wood polymeric structural constituents were degraded during exposure in ground contact (the toughest type of exposure). In general, there were similarities in the way wood-degrading fungi attacked wood (treated and untreated), such as hemicelluloses degradation and demethoxylation of lignin, also revealed in other ¹³C-NMR studies (Chau et al. 1982, Chen et al. 1982, Robert and Chen 1989, Hortling et al. 1992, Davis et al. 1994a, 1994b and 1994c). This chapter does not pretend to evaluate the relative extent of decay of treated and untreated wood, only its differences and similarities at a molecular level. The differences can have been caused by the wood species involved, softwood (Scots pine, radiata pine, Norway spruce, and Douglas fir) versus hardwood species (simaruba), sapwood versus heartwood, the level of decay (Norway spruce and Douglas fir appeared less degraded than the Scots pine and radiata pine), and the fungi involved on the location of the EN 252 stakes (brown rot, white rot, soft rot fungi and/or bacteria). Although a soil test method is subject to several unknown variables, especially when compared to the basidiomycetes lab test under controlled conditions (Chapter 7), this study revealed useful information about the degradation of untreated and heat-treated wood species in ground contact in a “real” work situation, reflecting as closely as possible the real performance of heat-treated wood in service conditions.

8.4 Conclusions

CP-MAS ¹³C-NMR spectra revealed similarities but also clear differences in the polymeric structural wood constituents between heat-treated and untreated wood after fungal exposure.

Fungal exposure in ground contact resulted in strong degradation of the carbohydrates (cellulose and hemicelluloses) of untreated Scots pine, radiata pine, and simaruba. Fungal attack of the carbohydrates appeared to occur mainly at C4, indicating cleavage and eventually depolymerisation of cellulose and hemicelluloses. In untreated Scots pine, which appeared to be strongly degraded, the C1 of the carbohydrates also was attacked during fungal exposure in ground contact. Furthermore, the C2 and C3,C5 carbohydrate peaks of untreated Scots pine appeared also to be affected, suggesting there was a relatively small but observable ring opening of the glucose units. Attack on the out-of-the-ring alcoholic group -CH₂OH of the carbohydrates of untreated wood was also observed.

Such a fungal attack strategy implies considerable decay under EN 252 conditions and supports the validity of this type of standard ground-contact test. A considerable attack on the acetate group of the hemicelluloses occurs during fungal exposure of untreated Scots pine and radiata pine in ground contact. This hemicelluloses degradation was less marked for untreated simaruba.

It was remarkable that α -arabinofuranose, a pectic substance, appeared in the untreated simaruba, which appeared not to be degraded during fungal exposure in ground contact. This means that amorphous carbohydrates such as pectic substances are rather difficult to degrade. The reasons for this are not known. Possible explanations include that they could have a much higher degree of polymerisation than in other wood species, that they could have been treated with water repellents or anti-blue stains, or that they could have slightly different structures.

Degradation of the carbohydrates of untreated Norway spruce and Douglas fir was less marked after fungal attack than in the other wood species. However, it appears that the lignin component of untreated Douglas fir was attacked during fungal exposure, as there was an indication of ring opening of the aromatic structure. This also occurred in untreated radiata pine but to a lesser extent or not at all in untreated Scots pine and simaruba.

In ground contact fungi appeared to attack the carbohydrates of heat-treated wood at C1 and possibly at C4 indicating cleavage and eventually depolymerisation of cellulose and hemicelluloses. An attack on the out-of-the-ring alcoholic group was observed (in treated radiata pine). The opening of the glucose pyranose ring in heat-treated simaruba after fungal exposure, suggesting noticeable decay, not observed in the untreated wood, and the thermal degradation of α -arabinofuranose during heat treatment were remarkable. Demethoxylation and ring opening of the aromatic structure of lignin was observed, especially in heat-treated radiata pine, Douglas fir, and simaruba.

9 STRENGTH PROPERTIES OF HEAT-TREATED SOFTWOODS*

Abstract

This study was performed to investigate the impact of the two-stage heat treatment on the mechanical properties of wood. Heat treatment reveals a clear effect on the mechanical properties of softwood species. The tensile strength parallel to the grain showed a rather large decrease, whereas the compressive strength parallel to the fibre increased after heat treatment. The bending strength, which is a combination of the tensile stress, compressive stress and shear stress, was lower after heat treatment. This decrease was less than the decrease of only the tensile strength. The impact strength showed a rather large decrease after heat treatment. An increase of the modulus of elasticity during the bending test has been noticed after heat treatment. Changes and/or modifications of the main wood components appear to be involved in the effects of heat treatment on the mechanical properties. The possible effect of degradation and modification of hemicelluloses, degradation and/or crystallization of amorphous cellulose, and polycondensation reactions of lignin on the mechanical properties of heat-treated wood have been discussed. The effect of natural defects, such as knots, resin pockets, deviating slope of grain and reaction wood, on the strength properties of wood appears to be affected by heat treatment. Heat-treated timber shows potential for use in constructions, but it is important to carefully consider the stresses that occur in a construction and some practical consequences when heat-treated timber is used.

* Boonstra MJ, Van Acker J, Tjeerdma BF, Kegel E (2007a) Strength properties of thermally modified softwoods and its relation to polymeric structural wood constituents. *Annals of Forest Science* 64: 679-690

9.1 Introduction

Although heat treatment is an effective modification method to improve the dimensional stability and resistance against fungal attack (Seborg et al. 1953, Kollmann and Schneider 1963, Stamm 1964, Kollmann and Fengel 1965, Burmester 1973 and 1975, Giebeler 1983, Hillis 1984, Bourgois and Guyonnet 1988) there are undesired side effects, mainly due to the high temperatures involved (150-280°C). Reductions of mechanical properties of wood were noticed after heat treatment, e.g. the resistance to shock, modulus of elasticity (MOE), bending strength (MOR), compressive resistance, shear strength, and abrasion resistance (Seborg et al. 1953, Stamm 1964, Davis and Thompson 1964, Noack 1969, Rusche 1973, Giebeler 1983, Tjeerdsma et al. 1998b, Kubojima et al. 2000, Bekhta and Niemz 2003). A reduction of mechanical properties might limit the range of feasible applications for heat treatment technologies to wood and wood products. Therefore, it is important that a well-balanced process is applied, which improves the biological durability and/or dimensional stability with no or only a slight loss of mechanical properties.

In this chapter the effects of the industrial two-stage heat treatment process on the mechanical properties of defect free and full size construction wood are described. Since the strength properties of wood are closely related to the chemical wood composition (Stamm 1964, Winandy and Rowell 1984), the effects of heat treatment on the strength properties are discussed in relation to changes of the main wood components (cellulose, hemicelluloses and lignin). Furthermore, these findings are used to elaborate on the potential to use heat-treated wood in constructions.

9.2 Materials and methods

Materials

Radiata pine (*Pinus radiata* D. Don), Scots pine (*Pinus sylvestris* L.) and Norway spruce (*Picea abies* Karst) boards were heat-treated. The standard cross section of the boards had a thickness of 25-44 mm and a width of 150 mm. The length of the boards was approximately 3.0-5.1 m. The moisture content of the boards before treatment was 16-20% (shipping dry). Untreated boards were used as references for strength testing.

Heat treatment

For each timber species at least 10 boards were treated for each set of process conditions. The heat treatment was performed in two separate heat treatment stages and a drying stage in between. In the first stage of the heat-treatment the timber was treated in an aqueous environment at superatmospheric pressure (8-10 bar), a so-called hydro-thermolysis treatment. This was done in a 600 l pilot plant or in an industrial treatment vessel and the effective treatment temperature used was 165°C (30 minutes effective treatment time). The treatment temperature for radiata pine boards varied between 165°C and 185°C and the treatment time applied was 0, 30, 45, 60 or 90 minutes. The specimens were subsequently dried

using a conventional drying process at 50-60°C. After drying the wood specimens were heat-treated again in a special curing kiln for the second stage, now under dry and atmospheric conditions, a so-called “curing” treatment (temperature 180°C, 6 hours effective treatment time). During this stage superheated steam or nitrogen gas was used as a sheltering gas to exclude oxygen.

Strength and stiffness testing

Heat-treated and untreated boards were used to prepare strength test specimens, which were stored in a conditioning room (20°C, 65% RH). Before testing the dimensions and weight of the specimens were recorded for density calculation. Furthermore small slices (10 mm thick) of treated and untreated wood were prepared to determine the moisture content using the oven-dry method (104°C, 16 hours).

Per wood species 3 boards were selected and at least 5 specimens per board were used for the strength tests.

A stock of Scots pine boards containing a mix of sapwood and heartwood, was used for testing the different strength properties. One half of the stock was used for heat treatment and the other half was used as untreated reference. Heat-treated and untreated (defect free) Scots pine specimens were prepared to determine the bending strength (DIN 52186), compressive strength (parallel and perpendicular to the grain; respectively DIN 52185 and DIN 52192), and tensile strength (parallel to the grain; DIN 52188), and Brinell hardness (parallel and perpendicular to the grain). The dimensions of the Scots pine test specimens were:

- bending strength: cross section size 20x20 mm, length 360 mm;
- compressive strength parallel to the grain: cross section size 20x20 mm, length 30 mm;
- compressive strength perpendicular to the grain (radial and tangential): cross section size 20x20 mm, length 60 mm;
- tensile strength: width 50 mm, depth 15 mm, length 450mm. In the middle of the specimens the width and depth is limited to respectively 20 mm and 6 mm (over a length of 163 mm); and
- hardness: cross section size 20x20 mm, length 60 mm.

The bending, compressive and tensile strength of the test specimens were determined using an universal test machine TIRatest 24100. For the Brinell hardness an iron bullet (diameter 10 mm) was used, which was pressed on a defect free sample for 30 seconds with a force of 500 N. After testing the imprint was measured and the Brinell hardness was calculated.

The impact strength of heat-treated and untreated Scots pine, radiata pine and Norway spruce defect free specimens with a cross section size of 20x20 mm and length 400 mm, was measured according the hammer method (DIN 52189). Since the amount of boards available for testing was limited, only 10-12 defect free specimens were tested for each wood species. The treated and untreated radiata pine specimens were of the same origin, whereas the untreated Scots pine and

Norway spruce specimens were randomly taken from the stock available at that time.

The bending strength (MOR) and modulus of elasticity (MOE) of heat-treated and untreated radiata pine defect free specimens with a cross section size of 20x20 mm and length 400 mm, was measured on an Instron test machine according the DIN 52186, using the 4-point loading test method. The radiata pine boards, which were used to prepare the test specimens, were treated at different process conditions (hydro-thermolysis). In order to determine the effect of the moisture content on the bending strength and modulus of elasticity, heat-treated and untreated radiata pine defect free specimens were conditioned at different relative humidity. Three treated radiata pine boards and three untreated radiata pine boards (from the same stack) were used to prepare the defect free specimens (cross section 20x20 mm; length 400 mm). The radiata pine specimens were oven dried (16 hrs, 104°C) and conditioned at 43%, 63%, 91%, 97%, 100% RH until constant weight. From each board 5 specimens were taken randomly for conditioning at each relative humidity level. After conditioning, the MOR and MOE of the specimens were determined on an Instron test machine according the DIN 52186 using the 4-point loading test method.

Twelve treated and untreated Norway spruce boards were used to prepare full size specimens (cross section 40x125 mm) including the natural defects for a bending strength test. The untreated boards were graded into quality class C according the Dutch standard NEN 5466. The treated and untreated boards were matched and after treatment the boards were stored in an open storage room for several months. The prepared specimens were divided into two parts of 120 cm (part A and B) and weighed. The bending strength and modulus of elasticity of each part were measured on an Instron 1195 test machine according the EN 408, using the 3-point loading test method with a span of 1000 mm.

9.3 Results

In Table 9.1 the mechanical properties of heat-treated and untreated Scots pine are shown. The two-stage heat treatment clearly affects the tensile strength of the Scots pine specimens, which is strongly reduced (39%). The two-stage heat treatment resulted in a small reduction (3%) of the bending strength (MOR). The compressive strength parallel to the grain is clearly increased after heat treatment (28%). The radial compressive strength is decreased (43%) and the tangential compressive strength is slightly increased (8%) after heat treatment. The Brinell hardness parallel to the grain is clearly increased (48%) whereas the hardness perpendicular to the grain is slightly increased (5%) after heat treatment. In general the variation of the results of the different strength tests was increased after heat treatment. The Scots pine specimens showed a decrease of the density (2% to 14%) whereas the modulus of elasticity during the bending test was increased (10%).

Table 9.1 Mechanical properties of heat-treated and untreated Scots pine defect free specimens

Properties		Untreated	Heat-treated
Bending strength	N/mm ²	88.7	85.9
Stdev	%	10.4	20.8
MC	%	14.8	4.1
Density	kg/m ³	578	503
Annual ring width	mm	1.0	1.0
Modulus of elasticity	N/mm ²	9660	10660
Compressive parallel	N/mm ²	51.3	65.7
Stdev	%	6.4	11.3
MC	%	13.5	4.6
Density	kg/m ³	578	498
Annual ring width	mm	1.0	0.9
Compressive radial	N/mm ²	4.2	2.4
Stdev	%	6.9	30.4
MC	%	12.6	4.8
Density	kg/m ³	580	531
Annual ring width	mm	1.0	0.9
Compressive tangential	N/mm ²	3.8	4.1
Stdev	%	8.4	13.7
MC	%	13.4	4.0
Density	kg/m ³	598	566
Annual ring width	mm	1.0	0.9
Tensile parallel	N/mm ²	95.5	58.6
Stdev	%	22.5	37.5
MC	%	13.2	4.2
Density	kg/m ³	567	556
Annual ring width	mm	1.1	1.0
Hardness			
Parallel to grain	N	36.0	53.2
Perpendicular	N	17.5	18.4

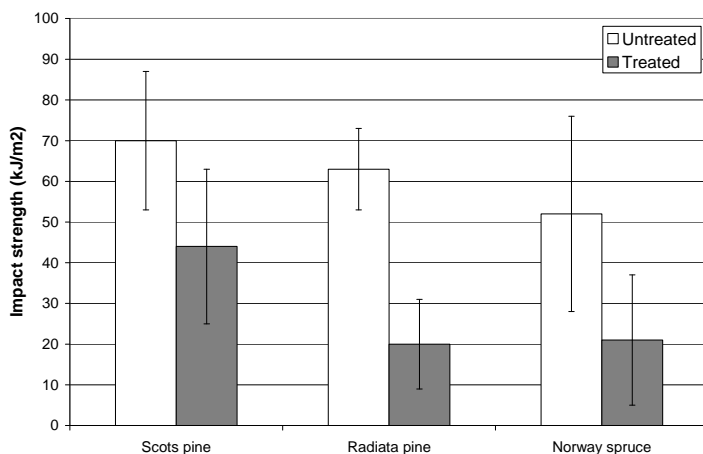

Fig. 9.1 Impact strength of untreated and heat-treated Scots pine, radiata pine and Norway spruce defect free specimens. Treatment conditions: hydro-thermolysis 165°C, 30 minutes; curing 180°C, 6 hrs

The impact strength of Scots pine, radiata pine and Norway spruce specimens showed a decrease after heat treatment (Fig. 9.1). The lower impact strength of heat-treated radiata pine and Norway spruce was respectively 80% and 79%, while the decrease of heat-treated Scots pine was less (56%). The relative high difference in impact strength between untreated and treated Norway spruce could be due to the significant lower density of the treated specimens (respectively 515 kg/m³ and 372 kg/m³).

Heat treatment of radiata pine at 165°C (effective hydro-thermolysis temperature) resulted in a decrease of the bending strength (9%) and an increase of the modulus of elasticity (13%) (Fig. 9.2). An increase of the effective treatment temperature to 185°C during the hydro-thermolysis stage resulted in a further reduction of the bending strength (38%). The absence of a dwell time (effective treatment time) during a treatment at 175°C (0 minutes dwell time) did not result in a higher bending strength than the treatment with a dwell time of 30 minutes. Remarkable is the increase of the MOE (26%) of the radiata pine specimens when the hydro-thermolysis treatment temperature was raised to 175°C (0 minutes dwell time) and the successive decrease of the MOE (-2%) of the radiata pine specimens when treated at 175°C (30 minutes dwell time) and treated at 185°C. An increase of the dwell time during a hydro-thermolysis at 165°C (30 to 90 minutes) resulted in a further reduction (20%) of the bending strength (Fig. 9.3). Although there is no difference in the average bending strength between an effective treatment time of 60 and 90 minutes, the variation in test results of the radiata pine specimens treated for 90 minutes is higher than that of the specimens treated for 60 minutes indicating some differences. The MOE appears to increase when the effective treatment time is increased to 90 minutes.

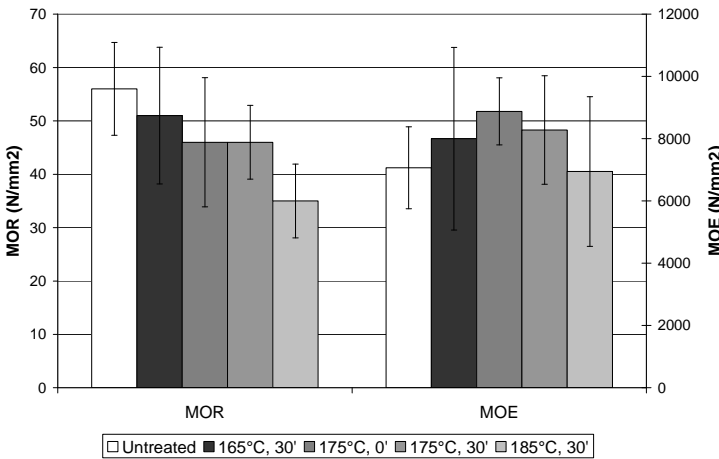

Fig. 9.2 Effect of the hydro-thermolysis temperature on the bending strength (MOR) and Modulus of Elasticity (MOE) of heat-treated radiata pine defect free specimens. Curing: 180°C, 6 hrs

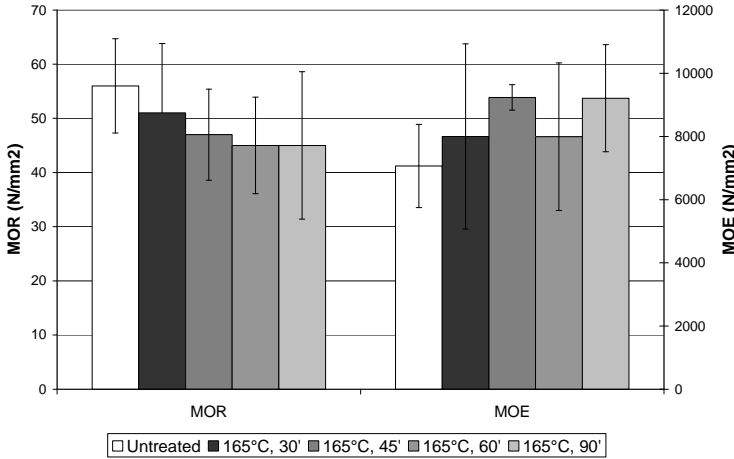

Fig. 9.3 Effect of the hydro-thermolysis process time on the bending strength (MOR) and Modulus of Elasticity (MOE) of heat-treated radiata pine defect free specimens. Curing: 180°C, 6 hrs

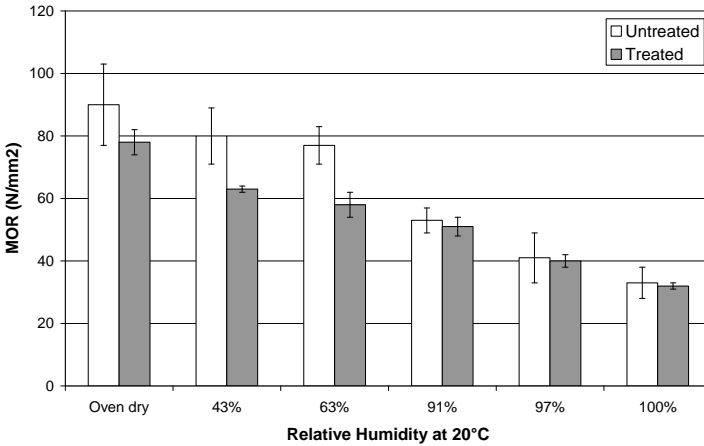

Fig. 9.4a Effects of conditioning on the bending strength of heat-treated and untreated radiata pine specimens (defect free). Treatment conditions: hydro-thermolysis 165°C, 30 minutes; curing 180°C, 6 hrs

The bending strength and modulus of elasticity of untreated and heat-treated radiata pine, conditioned at different relative humidity are given in Figures 9.4a and b. The moisture content of the specimens at the different relative humidity is given in Figure 9.5, which shows the typical hysteresis of wood (including heat-treated wood). The bending strength of untreated and treated radiata pine decreases with increasing moisture content. The bending strength of radiata pine conditioned at 63% RH (and lower) decreased clearly after heat treatment. Remarkable is therefore the difference in MOR between untreated and heat-treated radiata pine conditioned at a relative humidity of 91%, 97% and 100% RH. At high moisture content there is nearly no difference in MOR. Radiata pine showed an increase in MOE after heat treatment and the moisture content of the specimens appeared not to affect this difference.

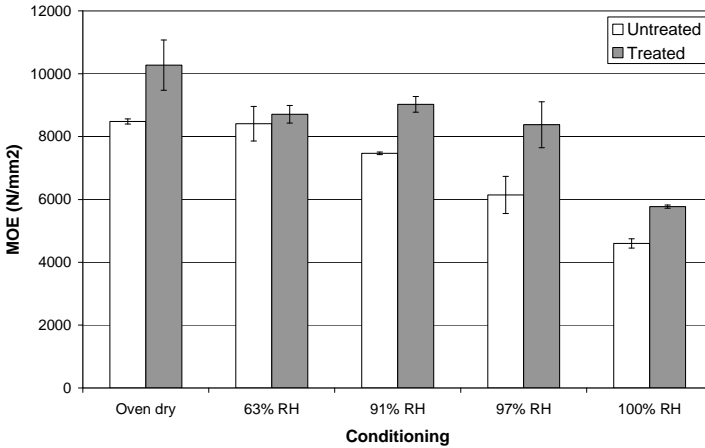

Fig. 9.4b Effects of conditioning on the Modulus of Elasticity of heat-treated and untreated radiata pine specimens (defect free). Treatment conditions: hydro-thermolysis 165°C, 30 minutes; curing 180°C, 6 hrs

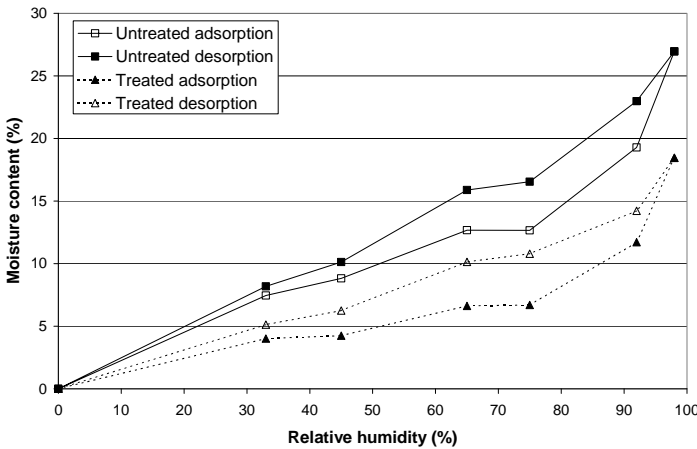

Fig. 9.5 Moisture content of untreated and heat-treated radiata pine conditioned at different relative humidity (hysteresis). Treatment conditions: hydro-thermolysis 165°C, 30 minutes; curing 180°C, 6 hrs

Several effects of heat treatment on the wood quality of full size Norway spruce boards have been noticed, such as cracks (internal, on the surface and at the board ends) and deformation (twist, bow, spring). Furthermore, large knots (>20 mm) were broken or showed rather large fissures. Resin pockets were 'opened' and the size appeared to be increased after heat treatment. The density, bending strength and modulus of elasticity of the full size Norway spruce boards including natural defects, are shown in Table 9.2 (the averages of part A and B of each board are shown). Heat treatment resulted in a decrease of the density (-9%) and bending strength (-31%), whereas the modulus of elasticity increased after heat

treatment (+5%). The variation in the bending test (MOR and MOE) appeared to be rather similar for treated and untreated boards. A clear difference of the maximum displacement at failure between untreated and heat-treated Norway spruce boards was noticed. Untreated Norway spruce boards failed at 24 to 40 mm, whereas the heat-treated Norway spruce boards failed at a displacement of 10 to 24 mm (span 1000 mm, cross section size 40x125 mm). At failure the treated Norway spruce boards showed an important and abrupt fracture. Untreated Norway spruce boards showed a more gradual decrease. The boards are tougher than the somewhat brittle treated boards.

Table 9.2 Density, bending strength and modulus of elasticity of full size treated and untreated Norway spruce boards (cross section 40x125 mm)

Properties		Untreated	Treated
Moisture content (%)	%	14	6
Density	kg/m ³	434	397
Stdev	%	5.7	5.3
Min	kg/m ³	390	356
Max	kg/m ³	484	431
Bending strength	N/mm ²	57.2	39.3
Stdev	%	12.3	21.9
Min	N/mm ²	46.6	21.9
Max	N/mm ²	69.8	53.9
Displacement at failure	mm	24-40	10-24
Modulus of Elasticity	N/mm ²	10669	11225
Stdev	%	10.6	8.3
Min	N/mm ²	9042	8944
Max	N/mm ²	12131	12187

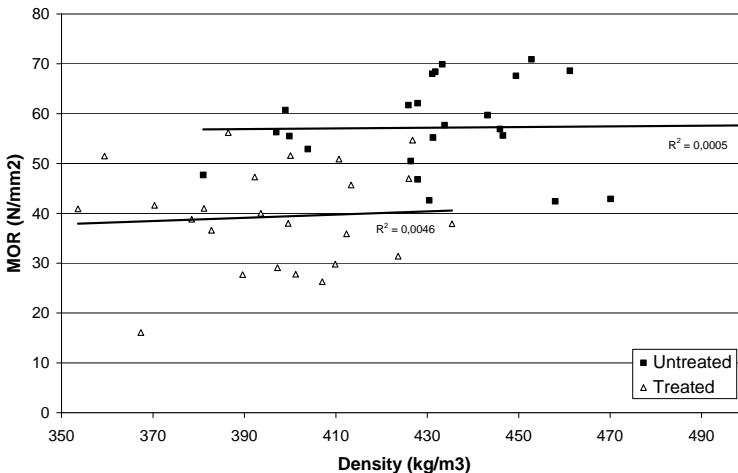

Fig. 9.6 Bending strength (MOR) for different density of full size Norway spruce boards (cross section 40x125 mm), treated and untreated

In Figures 9.6, 9.7 and 9.8 the test results are shown of the individual Norway spruce boards, which were used for the bending test. There appears to be no clear relationship between the density and bending strength of untreated and heat-

treated Norway spruce boards. In Figure 9.7 the modulus of elasticity of treated and untreated boards is shown for different density. The R^2 of untreated and especially treated Norway spruce boards is higher (respectively 0.034 and 0.250) indicating a limited dependency on density differences. There appears to be a clear relationship between the bending strength and the modulus of elasticity, especially for the untreated Norway spruce boards (Fig. 9.8).

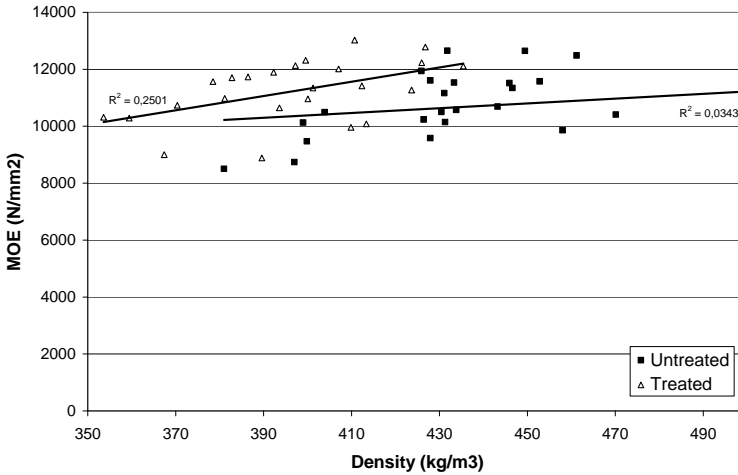

Fig. 9.7 Modulus of elasticity (MOE) for different density of full size Norway spruce boards (cross section 40x125 mm), treated and untreated

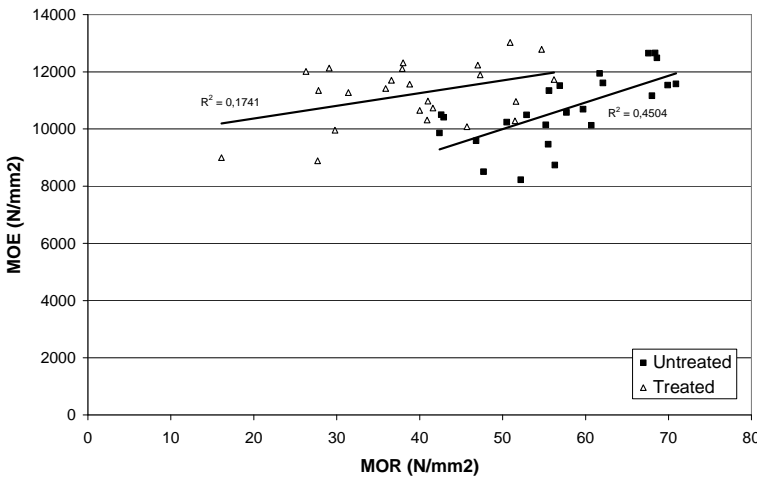

Fig. 9.8 Correlation between the bending strength and modulus of elasticity of full size Norway spruce boards (cross section 40x125 mm), treated and untreated

9.4 Discussion

The main polymeric components of the cell wall (cellulose, hemicelluloses and lignin) contribute in different degrees to the strength of wood as proposed in a hypothetical model by Winandy and Rowell (1984). They suggest that mechanical properties, which relates to internal stress and strain, are simply functions of chemical bond strength: covalent and hydrogen intrapolymer bonds (molecular level); covalent and hydrogen interpolymer bonds and cell wall layer bonds (microscopic level); and fiber-to-fiber bonding with the middle lamella acting as the adhesive (macroscopic level). According to Sweet and Winandy (1999) wood fibres can be regarded as a composite material and a single microfibril or a group of microfibrils cannot entirely account for the strength of an entire wood fibre. The chemical-mechanical linkages between cellulose microfibrils and the lignin-hemicelluloses matrix must allow load sharing among the microfibrils. They suggest that internal stresses can be distributed across the cell wall and throughout the entire fibre, if the cellulose microfibrils and the lignin-hemicelluloses act as a continuum. Whistler and Chen (1991) suggested that hemicelluloses and microfibrils are closely associated by intermixing (i.e. physical entanglement at molecular level), which might also contribute to the distribution of internal stresses. Any chemical or thermal modification method that affects the individual wood components and their interaction must therefore affect the mechanical properties of wood. Heat treatment such as the two-stage treatment method, causes a modification of the main components and changes the chemical composition of wood as described in this thesis (Chapter 4, 5 and Annex 3) and by several other authors (Seborg et al. 1953, Sanderman and Augustin 1963, Stamm et al. 1964, Burmester 1975, Bobleter and Binder 1980, Bourgois and Guyonnet 1988, Garrote et al. 1999, Sivonen et al. 2002, Rousset et al. 2006). Below the effects of this two-stage heat treatment on physical and strength properties of softwoods are discussed in relation to the changes of the chemical composition of wood after heat treatment.

Physical properties

Heat treatment of wood resulted in a significant reduction of water adsorption (Fig. 9.5). The availability and/or accessibility of the free hydroxyl groups of the wood carbohydrates play an important role in the process of water adsorption and desorption (see Chapter 5). It is by no doubt that heat treatment results in a reduction of the accessible, free hydroxyl groups and several causes are reported, e.g. depolymerisation of the carbohydrates and especially hemicelluloses causing a reduction of the total amount of hydroxyl groups, including the free hydroxyl groups (Kollmann and Schneider 1963, Burmester 1975); an increase of the relative proportion of the crystalline cellulose, in which the hydroxyl groups are not easily accessible to water molecules (see Chapter 4 and Pott 2004); and cross-linking of the lignin network (see Chapter 4 and Burmester 1975, Bobleter and Binder 1980), which might hinder the accessibility of free hydroxyl groups to water (Pizzi et al. 1994).

It is well known that bound water strongly affects the strength properties of wood. Increased amounts of bound water interfere with and reduce hydrogen bonding

between the organic polymers of the cell wall and thereby decrease the strength properties of wood since strength is related to covalent but also to hydrogen intrapolymer bonds (Winandy and Rowell 1984, Fengel and Wegener 1989). Heat treatment must therefore have a positive contribution to the strength properties since heat-treated wood is less hygroscopic and the (maximum) amount of bound water is reduced (Fig. 9.5). Such an effect is shown in Figure 9.4a. An increase of the moisture content of treated and untreated radiata pine resulted in a reduction of the bending strength. This reduction is clearly lower for treated radiata pine and at a very high relative humidity (91-100%) the difference in MOR between treated and untreated radiata pine is very limited.

A material property, which is clearly altered during heat treatment, is the weight of the boards and thus the density of wood (Table 9.1 and 9.2). The main reasons for the decrease of the density of wood after heat treatment are: degradation of wood components (mainly hemicelluloses) into volatile products, which evaporate during treatment; evaporation of extractives; and a lower equilibrium moisture content of the boards since heat-treated wood is less hygroscopic. Although a lower density after heat treatment implicates a decrease of the strength properties (Winandy and Rowell 1984, Winandy 1996), this conclusion can be premature. Degradation of the main wood components with its corresponding loss in woody material and weight, decreases strength properties since the internal stresses must be distributed over less molecular material. On the other hand, a lower moisture content does have a positive effect on the strength properties reducing the effect of mass loss (Fig. 9.4a).

Tensile strength

With regard to the three primary stresses it is probably the tensile strength, which is affected the most by heat treatment, at least at ultimate strength levels (Table 9.1). Originally cellulose was thought to be primarily responsible for the (tensile) strength of wood and in particular of wood fibres (Stamm 1964, Kollmann 1968). When tensile stresses occur in wood the cellulose microfibrils and/or fibrils are sliding and pulling one from another, which must require breaking of covalent bonds. Degradation (e.g. depolymerisation) of the cellulose polymer, decreasing the DP, was suggested to be the main cause for tensile strength losses (Ifju 1964, Mark 1967, Kass et al. 1970, Winandy and Rowell 1984).

Heat treatment results in a small but noticeable degradation of amorphous cellulose causing some disturbance and/or depolymerisation of the cellulose polymer (see Chapter 5). This could be a reason for the observed decrease of the tensile strength. However, according to Stamm (1964) internal stresses are distributed among several cellulose microfibrils/fibrils. Furthermore, the effect of the cellulose polymer length on the strength is limited since the tensile strength is not changing at DP's over 300. Whether or not the crystallization of amorphous cellulose is involved is not clear. Crystalline cellulose with its highly ordered and rigid structure might break more easily than amorphous cellulose, which appears to be more flexible. Therefore, an increase of the amount of crystalline cellulose might have a negative impact on the tensile strength.

Degradation of hemicelluloses during heat treatment might also be involved in the decrease of the tensile strength. The main effects of hemicelluloses degradation appear to be: cleavage of the secondary bonds (hydrogen and Van der Waals bonds, physical entanglement) within the hemicellulosic polymer; cleavage of the secondary bonds between the hemicelluloses and cellulose; and cleavage of the covalent bonds between hemicelluloses and lignin. These effects disrupt the load-sharing capacity of the lignin-hemicelluloses matrix in which the cellulose microfibrils and/or fibrils are encrusted (LeVan et al. 1990). A cellulose micro fibril/fibril cannot or to a lesser extent share forces with the next microfibril/fibril.

It is not expected that changes of lignin during heat treatment are involved in the decrease of the tensile strength. According to Winandy and Rowell (1984) it must be the carbohydrate framework, which causes failure since the strength of the lignin network is high enough to resist internal stresses. Further cross-linking of the lignin network probably increases the strength of this polymer.

An anatomical study of heat-treated wood revealed limited effects on the macrostructure, depending on the wood species used and the process method or conditions applied (see Chapter 2). Broken cell walls perpendicular to the grain resulting in transverse ruptures, have been noticed in treated softwood and hardwood species. This contributes to abrupt fractures of treated wood as observed in bending or tensile strength tests, which can lead to considerably different failure behaviour.

Compressive strength

Remarkable is the anisotropic effect of heat treatment on the compressive strength and hardness (Table 9.1). In longitudinal direction the compressive strength increased clearly, while in the radial and tangential direction a decrease (radial) or small increase (tangential) was noticed. The increase of the compressive strength in longitudinal direction might be due to a lower amount of bound water in heat-treated wood, however it is expected that the amount of bound water must be higher to affect the strength properties (Fig. 9.4a). During heat treatment the amount of the highly ordered crystalline cellulose increases due to degradation and/or crystallization of amorphous cellulose. Since crystalline cellulose shows significant anisotropy, its stiff and rigid structure might be responsible for the observed increase of the compressive strength in longitudinal direction. However, the increase of crystalline cellulose after the two-stage heat treatment is rather small (see Chapter 5) and its effect on the compressive strength might be limited. An increased cross-linking of the lignin polymer network could be another reason for this improvement. Lignin acts as a stiffener of the cellulose microfibrils/fibrils (Sweet and Winandy 1999) and an increased cross-linking of this polymer appears to prevent or limit movement perpendicular to the grain (which occurs during compressive loading parallel to the grain). Furthermore, lignin is the main component of the middle lamella (Fengel and Wegener 1989) and an increased cross-linking of the lignin polymer network improves the strength of the middle lamella, which subsequently affects the strength properties of the cell wall. This can be an indication that the lignin polymer network contributes directly

to the strength of wood. Findings of Banoub and Delmas (2003) indicating a regular structure within the lignin polymer network support this statement, since regular structures are expected to add a constructive contribution to the strength of wood.

The compressive strength and hardness perpendicular to the grain (radial and tangential) is much lower than parallel to the grain (longitudinal). The presence of different types of bonds, strong and stiff bonds along the chain axis and weak and soft secondary bonds acting in the transverse directions; and orientation of the polymer molecules in wood, such as microfibril angle of the crystalline cellulose and/or a rather regular structure of the lignin polymer network, are thought to be the main cause for this anisotropic difference (Winandy and Rowell 1984). In the radial and tangential direction the effect of the cellulose microfibrils/fibrils on the compressive strength is thus limited compared to the longitudinal direction, due to the anisotropic character of cellulose. Changes within the lignin-hemicelluloses matrix after heat treatment might have a more prominent effect on the compressive strength in transverse directions. Degradation of the hemicelluloses reducing the load sharing capacity of the lignin-hemicelluloses matrix probably has a negative impact on the compressive strength. An increased cross-linking of the lignin polymer network could have a positive effect on the compressive strength. However, it appears that the effects of such changes are rather limited since the compressive strength and hardness is not changed after heat treatment, at least in tangential direction. The decrease of the radial compressive strength after heat treatment might be caused by small radial fissures, which were noticed in Scots pine after heat treatment (see Chapter 2).

Shear strength

Unfortunately no tests were performed to determine the effect of the two-stage heat treatment on the shear strength of wood. In other studies a reduction of the shear strength has been found after heat treatment and according to Stamm (1964) this can be explained by the (partial) conversion of the polyoses, which make up about 20% of the middle lamella, into furfural polymers. Such degradation of the hemicelluloses reducing the load sharing capacity between cellulose microfibrils/fibrils, most probably have a negative impact on the shear strength. On the other hand, an increased cross-linking within the lignin polymer network could have a positive effect on the shear strength, especially because lignin is the main component of the middle lamella, which plays an important role in shear strength. On the macrostructure level there is an indication that heat treatment must affect the shear strength (see Chapter 2). Softwood species with narrow annual rings and/or an abrupt transition from earlywood into latewood were sensitive for tangential cracks in the latewood section. Radial cracks were also observed, mainly in wood species with an impermeable wood structure such as Norway spruce. Such defects can lead to a faster and/or increased failure when external forces, causing internal shear stresses, are applied on wood.

Bending and impact strength

In the bending test the specimens are loaded with an increasing force during several minutes until failure occurs. The internal stresses, which occur during bending, are a combination of the compressive stress (topside of the specimens), tensile stress (lower side of the specimens) and shear stress (middle of the specimens). Although the decrease of the tensile strength and probably the shear strength was rather large the bending strength showed only a slight reduction after heat treatment of Scots pine (Table 9.1). Therefore, the influence of the individual primary stress type on the bending strength appears to be limited.

There appears to be a relationship between the decrease of the bending strength and the degradation of the hemicelluloses (Kass et al. 1970, LeVan et al. 1990, Winandy 1995) and it has been suggested that changes in the hemicelluloses content and structure are primarily responsible for the initial loss of the bending strength (Sweet and Winandy 1999, Winandy and Lebow 2001), since hemicelluloses are the most thermal-chemically sensitive component of wood (Kollmann and Fengel 1963). Raising the effective treatment temperature and/or increasing the treatment time during the hydro-thermolysis stage resulted in a further decrease of the bending strength (Fig. 9.2 and 9.3). It has also been found that more severe process conditions during this process stage resulted in a further degradation of the hemicelluloses (see Chapter 5) confirming a possible relationship. LeVan et al. (1990) proposed that cleavage of the sidechains of hemicelluloses within the lignin-hemicelluloses matrix caused disruption of load-sharing capacity and therefore might be responsible for the observed strength losses. Another explanation, which is given for the observed initial strength loss, was a reduction of the DP of hemicelluloses, which means a degradation of the hemicelluloses backbone. In this case the hemicelluloses must contribute directly to the strength of the wood fibre, more than previously was assumed. It is however rather hypothetical whether a polymer of such short DP and situated around the (amorphous) cellulose microfibrils, can contribute in this way to the strength of wood fibres. It appeared that cellulose and lignin were not affected until strength losses exceeded 30-40% (Sweet and Winandy 1999, Winandy and Lebow 2001), since neither depolymerisation nor degradation products of these polymers were observed. However, the possibility of rearrangements of the molecular structure of cellulose and/or lignin, and its effects on the strength properties of wood, were not considered (e.g. reorientation and/or crystallisation of cellulose, polycondensation reactions of lignin). Furthermore, the bending strength is a combination of the primary internal stresses in wood, which are the tensile, compressive and shear stress. No specification was made how these primary stresses were affected when hemicelluloses were degraded. It is thus rather unclear in what way the bending strength is affected and more research is necessary including precise mechanical testing and detailed chemical analysis on wood specimens treated in various temperature-moisture conditions.

Remarkable for the treated specimens is the abrupt failure during the bending test, which is more gradual for untreated specimens. The energy consumed up to total fracture is lower for the treated specimens than for the untreated specimens. The external forces heat-treated wood can bear after failure are much lower than for

untreated wood. Broken cell walls perpendicular to the grain appears to be the cause for this phenomenon as described above, although changes of the main wood components might also be involved, especially degradation of the carbohydrates and/or crystallization of amorphous cellulose (making wood more brittle).

The relative large decrease of the bending strength of radiata pine after heat treatment (Figs. 9.2 and 9.3) might be related to the occurrence of a relative large amount of juvenile wood in radiata pine (Hillis and Rozsa 1985). The chemical composition of juvenile wood differs from mature wood with a higher hemicelluloses and lignin content (Hillis 1984). The composition of the hemicelluloses also changes from the pith outwards over the first 20 growth rings (decrease of galactose, xylose and arabinose content and an increase of the mannose content). A higher hemicelluloses content and/or a different composition of the hemicelluloses affects the chemical reaction mechanism during heat treatment and subsequently the strength properties can be affected as discussed above. Differences between juvenile and mature wood in the anatomical and ultrastructural characteristics might also result in different strength properties after heat treatment. The larger microfibrillar angle of juvenile wood resulting in a higher longitudinal and lower transverse shrinkage (Hillis 1984) might cause internal stresses in wood affecting strength properties, especially since the specimens are almost completely dried during the curing stage (maximal shrinkage).

In the impact strength test the specimens are loaded during a very short period (a few milliseconds) with a rather high force. Heat treatment resulted in a large reduction of the impact strength (Fig. 9.1), especially when compared to the decrease of the bending strength. According to Davis and Thompson (1964) degradation of hemicelluloses is mainly responsible for the decrease of toughness. Since the interaction between cellulose and hemicelluloses are based on secondary bonds, this implicates that it must be cleavage of these secondary bonds, which determines the impact strength. However, based on the rather high decrease of the impact strength it must also be cleavage of covalent bonds during heat treatment, which contributes to this decrease. Cleavage of covalent bonds between hemicelluloses and lignin might be involved but also the cleavage of covalent bonds within the cellulose microfibrils/fibrils (depolymerisation). An increase of the amount of crystalline cellulose due to degradation and/or crystallization of amorphous cellulose might also have a negative impact on the impact strength as discussed above.

Modulus of elasticity

The effects of heat treatment on the elastic properties of wood are rather limited, although an increase of the MOE during the bending test has been noticed (Table 9.1, Figs. 9.2, 9.3 and 9.4). Degradation of the hemicelluloses, disrupting the load-sharing capacity of the lignin-hemicelluloses matrix, and increase of the relative amount of crystalline cellulose could contribute to the increase of the MOE. The increased cross-linking of the lignin network probably also affects the MOE, since it is expected that an increased cross-linking improves the rigid structure around

the cellulose microfibrils/fibrils and the strength characteristics of the middle lamella. Furthermore, heat-treated wood is less hygroscopic than untreated wood (it contains less bound water in the cell wall), which affects the MOE making wood less pliable. The decrease of the correlation (R^2) between the bending strength and the MOE (Fig. 9.8) is probably due to different effects of heat treatment as discussed above.

Another phenomenon, which can affect the strength properties of wood after heat treatment, is the thermoplastic behaviour of wood (Goring 1963, Hillis and Rozsa 1978 and 1985, Shiraishi 2001). Above a certain temperature the physical characteristics of hemicelluloses (127-235°C), lignin (167-217°C) and the cellulose (231-253°C) changes into a rubbery or plastic state. Thermal softening of wood as a whole occurs at temperatures over 200°C, although steaming reduces the softening point (180°C) since water acts as a plasticizer. The thermal behaviour of lignin and hemicelluloses seems to be restricted by interactions due to secondary intermolecular bonding with the cellulose (Hillis and Rozsa 1978, Shiraishi 2001). Degradation of the hemicelluloses during the hydro-thermolysis stage affects these secondary bonding, which enables the plastification of the remaining hemicelluloses and lignin. In the cooling down phase these components become rigid again and the molecular polymer structure might be changed (described in Chapter 11). This probably affects the interaction between the main components of wood affecting the strength properties.

Effect of natural defects on strength properties

Testing of defect free specimens is a good method to compare the effects of different treatment processes and/or different treatment conditions. However, results of tests cannot be used for the calculation of constructive elements, at least not without the use of several safety factors (Brown et al. 1952, Kollmann 1968, McKenzie 2000, Natterer et al. 2004). The occurrence of natural defects in wood, such as knots, resin pockets, reaction wood and a deviating slope of grain, decreases the strength properties of timber. A clear example is the bending strength of full size Norway spruce boards, which is significant lower than the bending strength of defect free specimens (Fig. 9.9)*.

Heat treatment appeared to affect the influence of natural defects on the strength properties of timber. The bending strength of full size Norway spruce boards showed a clear decrease (-31%) after heat treatment (Fig. 9.9), whereas this effect appeared to be less obvious (-7%) for defect free specimen (Scheiding et al. 2005). During heat treatment (curing stage) the boards were dried to a very low moisture content (0-1%) with a corresponding maximal shrinkage. This can cause deformation, especially when reaction wood or juvenile wood is present. Furthermore, shrinkage of knots differs from the surrounding wood causing internal stresses between the wood fibres situated around the knots. This affects the macrostructure of wood and subsequently the mechanical properties of the timber.

* The values of defect free specimens are based on a study by Scheiding et al. (2005) in which Norway spruce boards were treated according the two-stage heat treatment method, and treated and untreated defect free specimens were tested according the 4-point loading test method

A large scale bending test with heat-treated posts (66x66 mm) showed that the bending strength and MOE was particularly low for treated posts with a combination of several natural defects, e.g. large knots, enclosed pith and a deviating slope of grain (described in Chapter 10). This was less obvious for untreated posts confirming a relationship between the wood quality and strength properties after heat treatment.

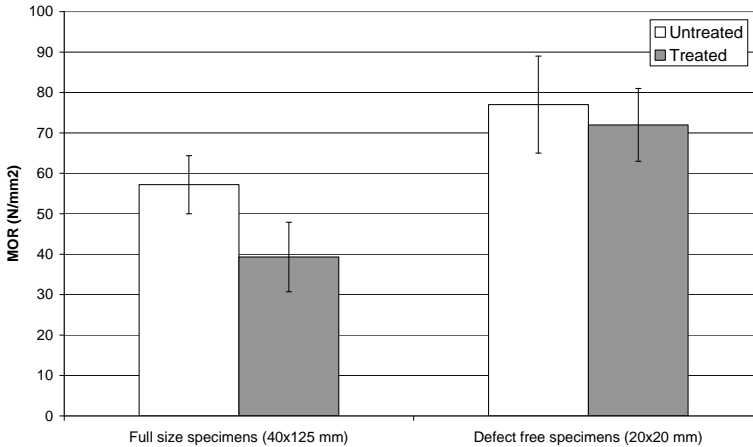

Fig. 9.9 Bending strength of heat-treated and untreated Norway spruce, full size versus defect free specimens

Based on the strength properties of full size timber as found in this study, it is clear that heat-treated timber shows potential for use in constructions. Heat treatment improves the durability and dimensional stability of wood, which are important factors for applications under higher biological hazard circumstances and therefore have an impact on the mechanical properties of timber. However, the application and the typical forces, which occur in a construction, should be considered carefully taking into account the typical strength characteristics and failure behaviour of heat-treated wood (e.g. tensile strength and abrupt fractures of heat-treated timber). On the other hand, improved strength properties like compressive strength, hardness and stiffness might favour the use of heat-treated timber for certain applications.

There are still relevant questions, which should be considered if heat-treated timber is used for constructions, such as:

1. What is the effect of heat treatment on the strength class of timber?
2. What is the long-term behaviour of heat-treated wood?
3. How does heat-treated wood respond to cyclic or repeated loadings?

It is a question whether visual grading (according EN 518) or stress grading (based on non-destructive bending or ultrasonic sound methods) are suitable for heat-treated timber. Heat treatment showed a different effect on the natural defects of wood in relation to the strength properties affecting visual grading. Since the relationship between the bending strength and the MOE is rather poor (Fig. 9.8), stress grading appeared not very suitable for heat-treated timber. A

combination of several methods, such as visual grading and non-destructive stress grading, might result in a better prediction of the bending strength and subsequently the strength class.

An alternative is to grade the boards before heat treatment, but then the effect of heat treatment on the strength class of a timber species should be verified. This includes effects on the strength characteristics of timber, such as bending strength (5% characteristic value) and modulus of elasticity (average and 5% characteristic value), but also the effect on the compressive, tensile and shear strength, which are not commonly tested when the strength class is determined (according EN 338). Especially the tensile strength can be of importance, depending on the application, since heat treatment shows a major impact on this strength characteristic.

Important test variations for constructive applications of heat-treated timber, which are still unknown, are time dependant and impact of repeated loadings. The ability of wood to resist stresses is dependent upon the duration of load and the strength tests performed in this study reflect a rather short-term loading. Heat-treated timber might also respond differently to cyclic or repeated loadings, which often induce fatigue failures. The stress levels necessary to cause such failures are far lower (25-30%) than those required to cause static failure (Winandy and Rowell 1984). According to Winandy and Rowell (1984) repeated or fatigue-type stresses usually result in a slow thermal build-up within the material and initiate and propagate tiny microchecks that eventually grow to a detrimental size. It can be of importance to know what the characteristics of heat-treated timber are when subjected to cyclic or repeated loadings.

9.5 Conclusions

Heat treatment revealed a clear effect on the mechanical properties of softwood species. The tensile strength parallel to the grain showed a rather large decrease, whereas the compressive strength parallel to the fibre increased after heat treatment. The bending strength, which is a combination of the tensile stress, compressive stress and shear stress, was lower after heat treatment. This decrease was less than the decrease of only the tensile strength. The impact strength showed a rather large decrease after heat treatment. An increase of the modulus of elasticity during the bending test has been noticed after heat treatment. Changes and/or modifications of the main wood components appear to be involved in the effects of heat treatment on the mechanical properties. The possible effect of degradation and modification of hemicelluloses, degradation and/or crystallization of amorphous cellulose, and polycondensation reactions of lignin on the mechanical properties of heat-treated wood are discussed. Since the effects of such chemical changes on the internal stresses and subsequently the strength of wood are complicated more research is necessary including precise mechanical testing and detailed chemical analysis on wood specimens treated in various temperature-moisture conditions.

The effect of natural defects, such as knots, resin pockets, deviating slope of grain and reaction wood, on the strength properties of wood appeared to be affected by

heat treatment. Nevertheless, heat-treated timber shows potential for use in constructions. Since MOE is often the most critical parameter for a construction, higher stiffness results in lower deflection for a given load, heat treatment appears not to lower the potential for constructive applications. It is, however, important to carefully consider the stresses that occur in a construction and some practical consequences when heat-treated timber is used as the impact of heat treatment on different strength properties is not proportional. Furthermore more test work is required to study the effect of heat treatment on long-term and repeated loadings, for indoor and outdoor conditions.

10 MECHANICAL PROPERTIES OF HEAT-TREATED FULL SIZE CONSTRUCTION TIMBER*

Abstract

This study was performed to investigate the impact of the two-stage heat treatment method on the mechanical properties of full construction timber. Bending tests of full size Norway spruce posts demonstrated changes due to heat treatment, such as a decrease of the density and bending strength, as well as an increase of the modulus of elasticity. The variability in bending strength and MOE appears to be higher for treated posts and as a result the 5%-values decreased, especially for the bending strength. The modulus of elasticity was depending on the density both for treated and untreated posts, but this was not so for the bending strength. There appears to be some relationship between the bending strength and the modulus of elasticity although it is rather weak, especially for treated posts. It was difficult to correlate the occurrence of natural defects in treated Norway spruce posts with an effect on the mechanical properties. Only a combination of several defects, such as large knots, enclosed pith and an abnormal slope of grain, appears to decrease the bending strength and MOE of treated posts, at least more than for untreated posts. The effect of a three-year period of outdoor exposure on the strength properties of heat-treated terrace planking was limited. Especially for the 5%-value low strength range where wood defects strongly determines the mechanical properties of wood, a three years outdoor exposure did not changed the bending strength and modulus of elasticity of heat-treated timber.

* Boonstra MJ, Van Acker J, Kegel E (2008) The effect of a two-stage heat treatment process on the mechanical properties of full construction timber. Accepted for publication in Wood Material Science and Engineering

10.1 Introduction

In most studies defect free specimens are used to determine the effect of heat treatment on the mechanical properties. Defect free specimens can be used to compare the effects of different treatment processes and/or different treatment conditions but not for the calculation of constructive elements, at least not without the use of several safety factors (Brown et al. 1952, Kollmann 1968, McKenzie 2000, Natterer et al. 2004). The occurrence of natural defects in wood, such as knots, resin pockets, reaction wood and a deviating slope of grain, decreases the strength properties of wood. Because there is a growing interest to use heat-treated timber for constructive elements, it is important to know what the strength characteristics are of heat treated full construction timber.

In this chapter the bending strength and modulus of elasticity of full size construction timber including natural defects are given and discussed. The results of strength tests of heat-treated terrace planking boards after a three-year weathering period are given providing information about losses of strength/stiffness when heat-treated timber is used in service conditions.

10.2 Materials and methods

Materials

Shipping dry Norway spruce (*Picea abies* Karst) posts and boards of Russian origin (MC 18-22%) were used for heat treatment. The posts were derived from 2 ex-log sawn boards (75x150 mm), which were cut in two parts. The standard cross section of the posts was 75x75 mm and length was 3.0 m. The boards were 4 ex-log sawn and the standard cross section of the boards was 32x150 mm, the length varied between 3.0 and 5.4 m. Before heat treatment the timber was kiln dried to a moisture content of 16% (+/- 2%), using a conventional drying process at 50-60°C. After drying, twenty-five untreated posts were taken randomly from the stack and used as references. The posts were graded into quality class C according to the Dutch standard NEN 5466 and relevant features are: maximum size of round/oval knots 45 mm; dead knots allowed; no requirement for knot number; maximum face shakes 0.4 x timber length per shake with a maximum total length of 0.8 x timber length; end shakes limited permitted; maximum bow, spring, twist and cup respectively 16, 8, 8 and 4 mm per 2 m timber length; maximum slope of grain 1:7; reaction wood limited permitted; rot not permitted; wane not permitted; pith permitted. No untreated boards were selected because the treated boards were originally used for a quality control of an industrial production batch.

The treated posts are commercially used for ground contact applications and waterworks, whereas the boards are mainly used for terrace planking.

Heat treatment

The heat treatment was performed in two separate heat treatment stages and a drying stage in between. In the first stage of the heat treatment the posts/boards were treated in an aqueous environment at superatmospheric pressure (8-10 bar), a so-called hydro-thermolysis treatment. The effective treatment temperature used

was 165°C for 30 minutes effective treatment time. The timber was then dried to a moisture content of 8-9% using a conventional drying process at 50-60°C. After drying the timber was heat-treated again in a special curing kiln for the second stage, now under dry and atmospheric conditions, a so-called “curing” treatment (temperature 180°C, 4 hours effective treatment time). During this stage superheated steam was used as a sheltering gas to exclude oxygen. The treatment was performed in an industrial plant and the total volume of the production batch was 69 m³ (posts) and about 50 m³ (boards).

Strength and stiffness testing of full size timber

Treated and untreated Norway spruce posts were used to prepare full size specimens (cross section 66x66 mm, length 1400 mm) for a bending strength test. After heat treatment 60 posts were randomly taken from the production batch. Before testing the specimens were weighed, however not conditioned in order to simulate practice situations. The bending strength and modulus of elasticity of the treated and untreated specimens were measured on an Instron 1195 test machine according the EN 408, using the 3-point loading test method with a span of 1000 mm.

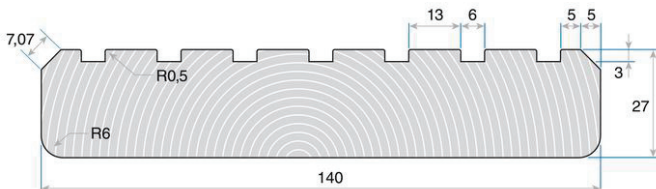

Fig. 10.1 Detailed profile of heat-treated Norway spruce terrace planking boards (27x140 mm)

The production batch of heat-treated boards was planed into a terrace planking profile (cross section 27x140 mm) by a commercial machining company (Fig. 10.1). Direct after planing the terrace planking boards were graded according the Dutch standard NEN 5466 with some adaptations of which the most important are: the maximum size of round/oval knots (not higher than 30 mm), dead knots (not allowed) and open resin pockets (only a few allowed per board). About 61 boards were taken randomly from the treated terrace planking production batch. From 41 terrace planking boards a part of 1200 mm (cross section 27x140 mm) was cut and from the other 20 boards a part of 600 mm was cut, which gives 41 samples of 1200 mm and 20 samples of 600 mm (C parts). The 1200 mm samples were divided into two parts, entitled part A (20 boards) and part B (21 boards). The 600 mm samples were entitled as C parts. The B part samples (1200 mm) were fastened on two posts (100x100 mm) above the ground and exposed outside to weathering (Fig. 10.2).



Fig. 10.2 Three-year outdoor exposure of heat-treated Norway spruce terrace planking boards (2004-2006)

A bottom layer of (dark) root cloth was placed on the ground below the terrace planking boards to prevent growth of weeds. The A part and C part samples of each board were directly tested on the instron 1195 test machine, using the 3-point loading test method with a span of respectively 1000 mm and 500 mm. These two different spans were chosen to determine the maximum bending force and displacement to failure, since in a terrace construction the span varies between approximately 500 and 1000 mm. Before testing full size specimens (cross section 27x125 mm) were prepared and weighed but not conditioned in order to simulate practice conditions. The B part samples were tested on the instron 1195 test machine after three years outdoor exposure (3-point loading test, span 500 mm). Each B part was cut into two equal parts of 600 mm, B1 and B2. The B1 parts were tested directly after outdoor exposure (the terrace planking boards were removed in December after a very wet period). The B2-parts were conditioned in a conditioning room (20°C, 65-70% RH) until constant weight and than tested. Before testing full size specimens (cross section 27x125 mm) were prepared and weighed. After testing the specimens were oven dried (104°C, 48 hours) to determine the moisture content.

In Figure 10.3 an overview of the specimen preparation of heat-treated Norway spruce terrace planking boards is shown.

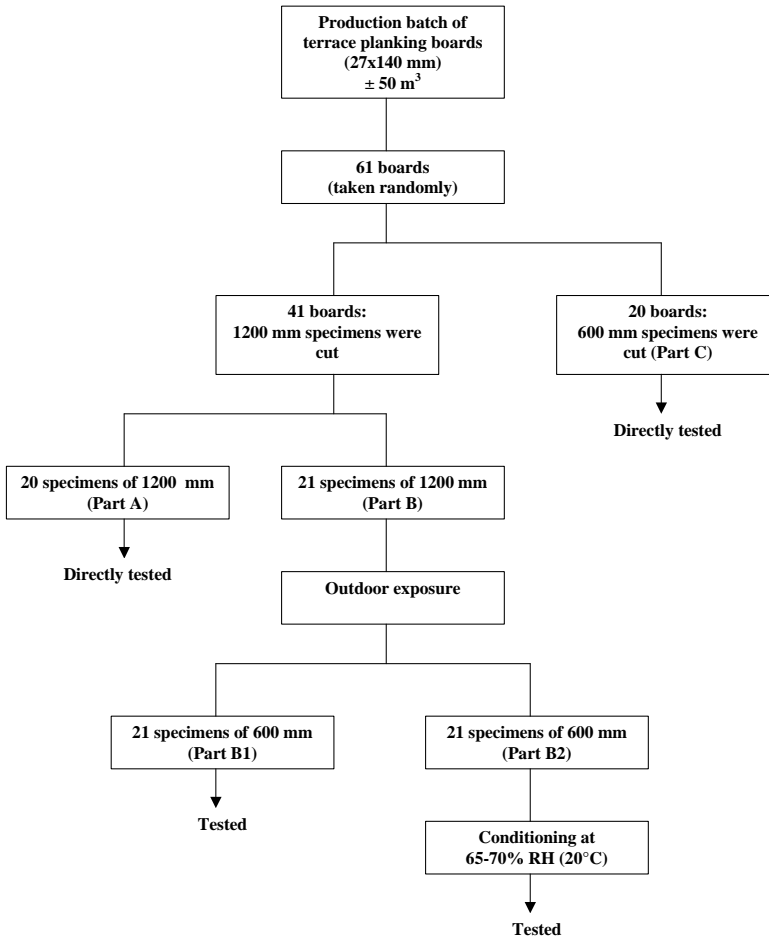

Fig. 10.3 Overview of the specimen preparation of heat-treated Norway spruce terrace planking boards

Hygroscopicity testing

After the bending test small slices (thickness 10 mm) of heat-treated terrace planking boards (B-part samples) were prepared and oven dried (105°C, 16 hours) before hygroscopicity testing. The oven-dry specimens were conditioned at 20°C in different relative humidity: 98% (above water), 95% (above a saturated potassium nitrate solution), 90% (above a saturated zinc sulphate heptahydrate solution), and 65-70% (in the conditioning room). Before and after the test the specimens were weighed to determine the equilibrium moisture content. Twelve boards were randomly taken and 3 specimens per board were tested per relative humidity condition.

10.3 Results

The density, bending strength and modulus of elasticity of treated and untreated Norway spruce posts are shown in Table 10.1. After heat treatment the density decreased (-11%) and the variation in test results appeared to increase. The average bending strength of treated posts was 6% lower than untreated posts and the 5%-value was 41% lower after heat treatment. The average modulus of elasticity of treated posts is higher (+17%) than for the untreated posts, although the 5%-value decreased slightly after heat treatment (-6%). The variability in the bending strength and MOE appears to be higher for the treated posts. Untreated posts failed at a displacement of 18 to 37 mm, whereas heat-treated posts failed at 6 to 25 mm. At failure the treated posts showed a large and abrupt fracture, whereas untreated posts showed a more gradual decrease. Untreated posts are tougher and there is a substantial residual bending strength present after failure.

Table 10.1 Density, bending strength and modulus of elasticity of heat-treated and untreated full size Norway spruce posts (cross section 66x66 mm)

Properties	Untreated	Treated
Posts tested	25	60
Density (kg/m³)		
Average	437	389
Stdev	20	32
5% value	418	325
Min	397	312
Max	482	461
MOR (N/mm²)		
Average	45.2	42.3
Stdev	4.4	10.7
5% value	39	23
Min	36.4	10.6
Max	56.0	57.5
Bending to fracture (mm)	18-37	6-25
MOE (N/mm²)		
Average	7558	8861
Stdev	454	1392
5% value	6915	6503
Min	6624	3385
Max	8424	11369

It was difficult to correlate the quality of the Norway spruce posts with the test results. Large face shakes over the length of heat-treated posts appeared not to affect the bending strength and MOE. Treated posts with large knots (diameter > 30 mm) showed test results near or above the average bending strength and MOE. Some treated posts, which seemed defect free showed low bending strength and MOE values. However, the bending strength and MOE of heat-treated Norway spruce posts, which contained a combination of defects, such as large knots, enclosed pith and a deviating slope of grain, appeared to be low. It might be possible that the 3-point loading test method used in this study affects a possible relationship between the wood quality and strength properties (especially the MOE).

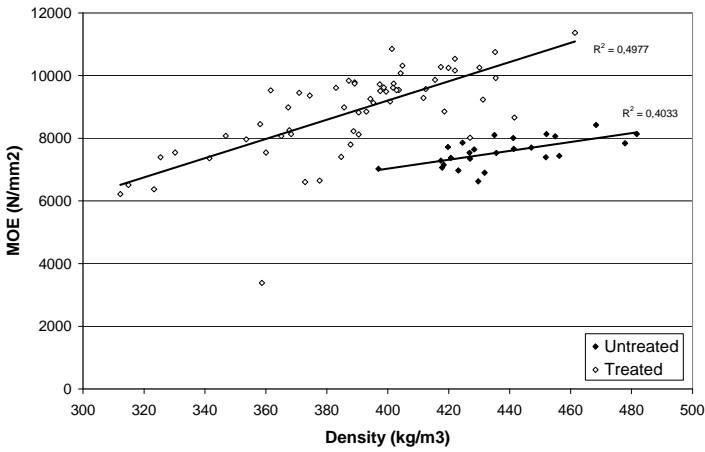

Fig 10.4 Modulus of elasticity (MOE) depending on density for full size Norway spruce posts (cross section size 66x66 mm), treated and untreated

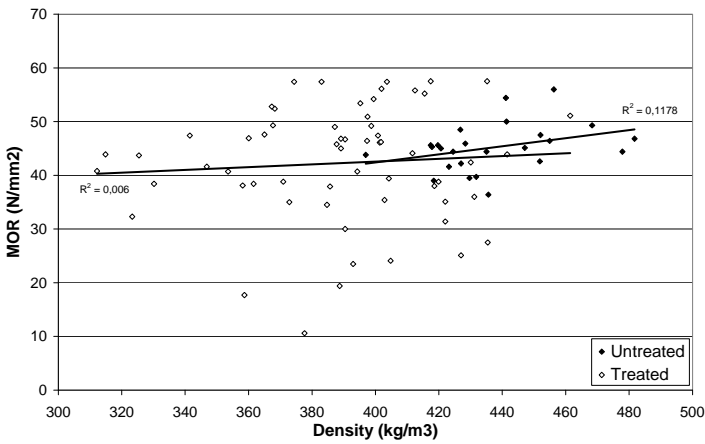

Fig 10.5 Bending strength (MOR) depending on density for full size Norway spruce posts (cross section size 66x66 mm), treated and untreated

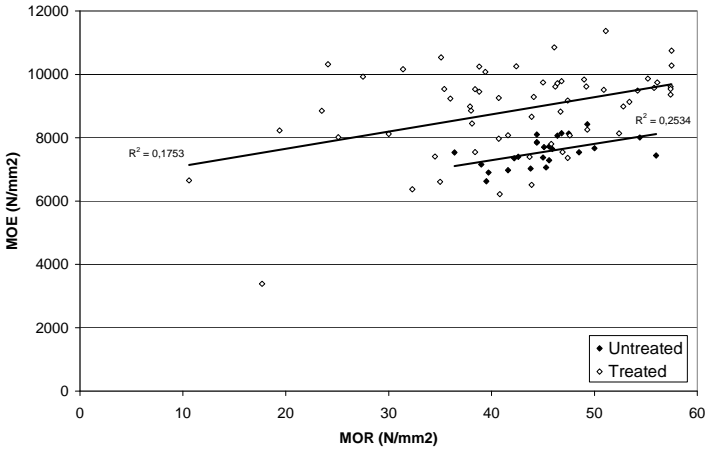

Fig. 10.6 Correlation between the bending strength and modulus of elasticity of full size Norway spruce posts (cross section size 66x66 mm), treated and untreated

In Figures 10.4, 10.5 and 10.6 the test results are shown of the individual Norway spruce posts, which were used for the bending test. With a R^2 of 0.498 and 0.403 for respectively treated and untreated posts, the modulus of elasticity showed some dependency on density (Fig. 10.4). This was not found for the bending strength of untreated and especially treated posts (Fig. 10.5), since the R^2 was low (respectively 0.118 and 0.006). There appears to be some relationship between the bending strength and the modulus of elasticity (Fig. 10.6), although it is rather weak (especially for the treated Norway spruce posts).

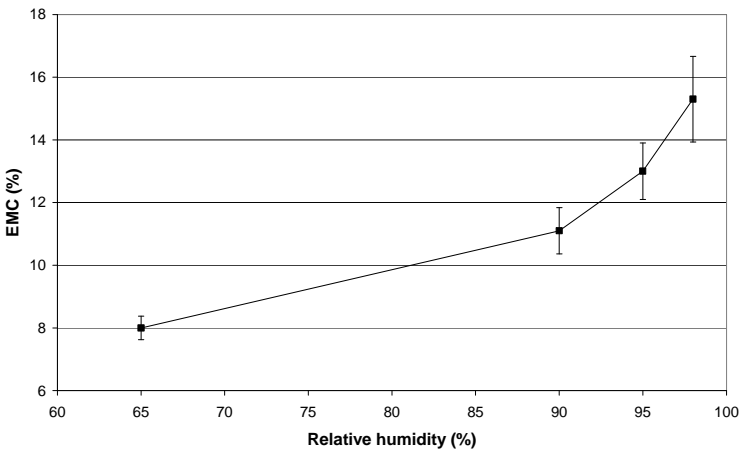

Fig. 10.7 Equilibrium moisture content (EMC) of heat-treated Norway spruce terrace planking boards (cross section 27x125 mm) at 65%, 90%, 95% and 98% relative humidity (20°C) after three years outdoor exposure

Table 10.2 Density, bending strength and modulus of elasticity of heat-treated Norway spruce terrace planking boards (cross section 27x125 mm)

Properties	Directly after treatment		After 3 years outdoor exposure	
	Part A	Part C	Part B1	Part B2
Boards tested	20	20	21	21
Length (mm)	1200	600	600	600
Span (mm)	1000	500	500	500
Density (kg/m ³)	408	404	454	403
Stdev	31	48	49	47
Moisture content (%)	6	6	23	9
Max. bending Force (N)				
Average	2874	5865	4626	5101
Stdev	848	1572	1125	1577
5% value	1418	3042	2809	2828
Minimum	1297	2762	2794	2647
Maximum	4161	8397	6637	8699
MOR (N/mm ²)				
Average	45.4	47.5	36.6	39.8
Stdev	13.7	13.2	8.9	12.2
5% value	22	24	22	22
Minimum	21.5	22.2	22.2	20.4
Maximum	67.8	70.2	54.0	67.8
Bending to fracture (mm)	30	12	12	10
MOE (N/mm ²)				
Average	10232	8407	6668	7380
Stdev	1688	1292	1055	891
5% value	7900	6376	5319	6038
Minimum	7339	6036	5170	5919
Maximum	12818	10458	9172	8949

The density, maximum bending force, bending strength and elasticity of heat-treated Norway spruce terrace planking are shown in Table 10.2. The density of the B1 specimens was higher than that of the A-, C- and B2- specimens due to a higher moisture content (23%). This moisture content indicates a saturated cell wall and the occurrence of free water in the cell lumina since the average equilibrium moisture content at 98% relative humidity of heat-treated Norway spruce specimens was 15.3% (Fig. 10.7). The maximum bending force, which is necessary to break the heat-treated specimens on the three point loading test machine, appeared to show a decrease after 3 years outdoor exposure, however the decrease of the 5%-value was less obvious (Fig. 10.8). The maximum bending force of the 1200 mm specimens (part A) was lower than that of the 600 mm specimens (part A and C) due to a longer span used during the bending test. A span of 1000 mm resulted in a higher displacement to failure (failure at average 30 mm) compared to a span of 500 mm (failure at average 10-12 mm). Since the bending strength (MOR) is derived from the maximum bending force the results were similar for the MOR. The modulus of elasticity (MOE) also showed a decrease after three years outdoor exposure (Fig. 10.9), similar to the decrease of the maximum bending force and MOR. Again, the effect of three years outdoor exposure on the 5%-value of the MOE was less obvious. Remarkable is the MOE of the 1200 mm specimens, which was much higher than the MOE of the 600 mm specimens (tested with a span of respectively 1000 and 500 mm).

Note: The MOR and MOE are based on a cross section of approximately 27x125 mm, without a correction for the planed profile. The MOR and MOE shall be a fraction higher when a correction is applied.

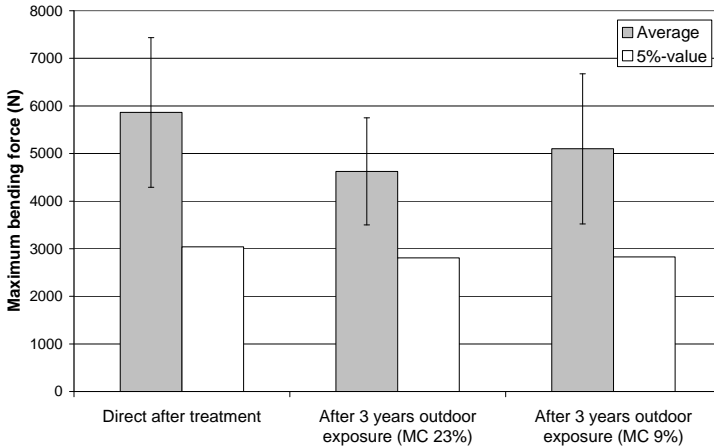

Fig. 10.8 Maximum bending force of heat-treated Norway spruce terrace planking boards (cross section 27x125 mm, length 600 mm) before and after three years outdoor exposure

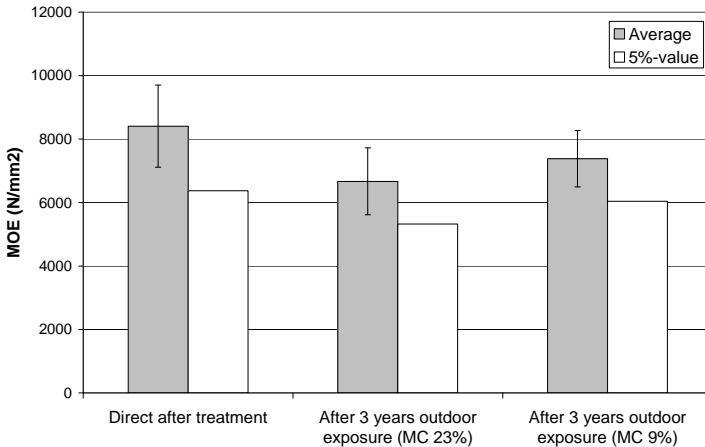

Fig 10.9 Modulus of elasticity (MOE) of heat-treated Norway spruce terrace planking boards (cross section 27x125 mm, length 600 mm) before and after three years outdoor exposure

10.4 Discussion

The bending strength tests of full size Norway spruce posts with a cross section of 66x66 mm demonstrated changes of the timber strength after heat treatment, such as a decrease of density and bending strength, and an increase of the modulus of elasticity. The decrease of the bending strength of full construction boards (40x125 mm) after heat treatment (Chapter 9) was much higher than found in this

study. This could be caused by the size of the test specimens (40x125 mm versus 66x66 mm) indicating an increasing effect of wood defects on strength properties with a decreasing thickness, or by the relative low amount of test specimens, which were used in Chapter 9. Frequently, treated posts of low quality with a combination of several natural defects (e.g. large knots, enclosed pith and a deviating slope of grain) showed low values of the bending strength and MOE. This was less obvious for untreated posts indicating a relationship between the wood quality and strength properties after heat treatment, as suggested in Chapter 9.

When heat-treated timber is applied in a construction practical consequences should be considered, such as described in the following example. Posts with a cross section of for instance 75x75 mm, which were not positioned correctly in the lower part of water linings, are sometimes pushed mechanically in the correct position with a crane. The use of heat-treated Norway spruce posts revealed some broken posts, at least more than when untreated posts were used. Since the 5%-value of the bending strength clearly decreases after heat treatment it was expected that more posts could fail when installed. Furthermore, heat-treated posts showed a decrease of the maximal displacement at failure. This means that handling should be done with care limiting position correction when compared to untreated timber. The residual strength after fracture is rather low since heat-treated timber showed a rather abrupt fracture. Therefore, other position methods than a crane could be preferred when heat-treated wood is involved.

Grading according the European standard EN 338 is based on the bending strength (5%-value), modulus of elasticity (average and 5%-value) and density (average and 5%-value). Based on these characteristic strength properties the Norway spruce posts revealed no or only a slight decrease of the strength class after heat treatment. The strength class of treated and untreated Norway spruce posts is mainly due to the relative low MOE (Table 10.2). This can originate from the natural defects present in the posts and/or is due to the 3-point loading test method used. During bending the pressure is spread over three load points instead of the more commonly used four points, which resulted in a rather deep imprint on the wood surface. This might have affected the MOE. Based on the bending strength and density values the strength of the timber could be graded in a higher class, especially for untreated Norway spruce posts. A reduction of the density, which is commonly found after heat treatment (Table 10.1), does not automatically mean a decrease of the strength properties (Fig. 10.5). The characteristic density values (average and 5% value) given in the European standard EN 338 should therefore be reconsidered when heat-treated wood is applied.

Furthermore, stress grading of heat-treated wood into a strength class should be studied in more detail and not just applied as for untreated wood, since heat treatment revealed different effects on the strength characteristics specified within the European EN 338 standard, e.g. bending strength, modulus of elasticity, tensile strength, compressive strength and shear strength (see Chapter 9). Heat-treated timber might therefore respond different to stresses applied on the construction, limiting or favouring this material for constructions.

Another important question is how heat-treated wood behaves in service conditions. The effect of weathering on the strength properties of heat-treated terrace planking appears to be limited (Table 10.2). Although a decrease of the average bending strength and modulus of elasticity is noticed after three years outdoor exposure, the effect on the 5%-value is rather limited (Figs. 10.8 and 10.9). The decrease of the average bending strength and MOE after three years outdoor exposure is therefore due to a reduction of the strength properties of the terrace planking boards in the higher strength range. In the lower strength range it is expected that the effect of wood defects on the strength properties is rather high, whereas such effects are less important in the higher strength range. Chemical and/or physical effects of heat treatment during the outdoor exposure might be involved, for instance a further degradation of cellulose by an acid catalysed hydrolysis, which has been noticed during heat treatment. Degradation of the main wood components (cellulose, hemicelluloses and lignin) due to weathering is not expected to be involved since this is only a surface phenomenon. Furthermore, heat-treated wood appears to be more resistant to natural weathering than untreated wood, probably due to condensation reactions within the lignin polymer network during heat treatment (Nuopponen et al. 2003). Chemical and/or physical effects during outdoor exposure on the strength properties of boards in the lower range are less important since in this range the strength properties are more dependent on the occurrence of wood defects. Even the effect of a higher moisture content on the lower range of the bending strength is limited, since the 5%-value of the terrace planking boards with a high moisture content is similar to the boards with a low moisture content (Fig. 10.8). In the higher strength range (bounded) water does have an effect on the bending strength and MOE confirming bending test results of defect free heat-treated radiata pine with a moisture content between 7% and 18% (see Chapter 9). The 5%-value of the modulus of elasticity is lower for heat-treated terrace planking boards with a high moisture content (Fig. 10.9). Below the proportional limit of the bending test the amount of bound water clearly affects the stiffness of heat-treated wood. Increasing the span of the three-point loading test method resulted in higher MOE values (Table 10.2), probably due to a reduced imprint, which was also noticed during testing (as discussed above).

10.5 Conclusions

Bending tests of full size Norway spruce posts demonstrated changes due to heat treatment, such as a decrease of the density and bending strength, as well as an increase of the modulus of elasticity. The variability in bending strength and MOE appears to be higher for treated posts and as a result the 5%-values decreased, especially for the bending strength. The modulus of elasticity was depending on the density both for treated and untreated posts, but this was not so for the bending strength. There appears to be some relationship between the bending strength and the modulus of elasticity although it is rather weak, especially for treated posts. It was difficult to correlate the occurrence of natural defects in treated Norway spruce posts with an effect on the mechanical properties. Only a combination of several defects, such as large knots, enclosed pith and a deviating

slope of grain, appears to decrease the bending strength and MOE of treated posts, at least more than for untreated posts. The effect of a three-year period of outdoor exposure on the strength properties of heat-treated terrace planking was limited. Especially for the 5%-value low strength range where wood defects strongly determines the mechanical properties of wood, a three years outdoor exposure did not changed the bending strength and modulus of elasticity of heat-treated wood.

Heat treatment, which is an effective modification method to improve the dimensional stability and biological durability of wood, can be used to treat construction timber. However, it is of importance to carefully consider the stresses, which can occur on a construction, and the practical consequences when heat-treated timber is applied. Based on the differences in mechanical properties between heat-treated and untreated timber, stress grading into a strength class according the European standard EN 338 must be reconsidered when heat-treated timber is involved.

SUMMARY OF PART II*

Durability against fungal attack

Many organisms can deteriorate wood and fungal decay is the prominent kind of microbiological deterioration since it can cause (a rapid) structural failure. Fungal decay is a very complex process and depends on the fungi (brown rot, white rot and/or soft rot) and wood species involved, wood structures, (micro)environments, as well as interactive competition. During decay the main wood components (cellulose, hemicelluloses and lignin) are depolymerised and/or modified in order to provide energy and metabolites for fungal growth. Other important requirements for fungal growth are the occurrence of free water and oxygen, a favourable pH and temperature, the occurrence of chemical growth factors, and the absence of toxic extractives. Since heat treatment improves the resistance against biodegrading organisms it must affect one or more requirements necessary for fungal growth.

Although heat treatment reduces the water absorption of wood, it does not prevent the occurrence of free water on the surfaces of cell lumina. The moisture content can still increase much higher than the fibre saturation point. Free water can therefore serve as reactant in chemical decay processes (e.g. hydrolysis), as a diffusion medium for enzymes and solubilised substrate molecules, and as a solvent or medium for life systems within the fungal hyphae. However, heat treatment causes a significant reduction of the fibre saturation point of the cell wall: 16-18% whereas 28-30% is commonly found for untreated wood. This reduces the swelling of the cell wall preventing or limiting the penetration of (non-) enzymatic systems necessary for fungal decay. Furthermore, less water is available in the cell wall to allow diffusion of degradation products of carbohydrates to the fungal hyphae in the cell lumina. The obligate aerobic fungi require free oxygen for several metabolic reactions (e.g. energy release, synthesis) and it is expected that heat treatment does not affect the occurrence of free oxygen in wood (in cell lumina and cell wall).

Heat treatment reduces the pH of wood to 3.5-4.0 due to the production of acetic acid and formic acid, whereas a pH of 5.0-5.5 is commonly found for untreated wood. The significant higher hydrogen concentration probably affects decay processes, e.g. it inhibits minor metal solubility's affecting exocellular decay processes in wood and/or it destabilises exo-enzymes. Changes of the pH during the service life of heat-treated wood products, resulting in a higher pH, might alter the sensitivity of heat-treated wood to wood-decaying fungi. Most wood-decaying

* Boonstra MJ, Van Acker J, Pizzi A (2007c) Anatomical and molecular reasons for property changes of wood after full-scale industrial heat treatment. Paper of the 3th European conference on wood modification ECWM3 Cardiff, 15-17 October 2007. ISBN 184-220-096-8

fungi grow best within a 15 to 40°C temperature range, but it is not expected that heat treatment does have an effect on the temperature requirement of fungi.

Heat treatment could affect chemical growth factors (nitrogen, vitamins, minor metals and mineral elements), which are necessary for fungal growth. For example, heat treatment results in the degradation of thiamine and the absence of growth factors like thiamine could contribute to decay resistance (Baechler 1959). However, it is expected that wood destroying fungi can still get access to such components since such growth factors are still available from sources outside the wood in the form of surface molds, air-borne spores, organic dust, washings from overhanging trees, and others.

During heat treatment several phenolic compounds, polynuclear hydrocarbon derivatives of phenanthrene and acenaphthylene and other classes of polyaromatic compounds are produced. Such compounds can be toxic to wood degrading fungi and prevent or slow down fungal growth. However, Kamden et al. (1992) showed no effect on fungal decay after removal of such compounds by extraction and the contribution of toxic compounds to decay resistance seems therefore limited.

As described above, heat treatment causes a modification of the main components of wood and changes the composition of these components. This plays an important role in the resistance of heat-treated wood against fungal attack. Changes of the main wood components, which are necessary to provide energy and metabolites for fungal growth, might affect the enzymatic and non-enzymatic mechanism of wood decay.

In wood decay hemicelluloses are often the first cell wall components degraded, probably owing to their shorter chain lengths, solubility, and exposed locations around the cellulose microfibrils. Heat-treated wood contains significant lower hemicelluloses content and most of the remaining hemicelluloses are modified (e.g. cleavage of acetyl side chains). As a result less hemicelluloses are available to provide energy and metabolites for fungal growth, especially in the initial stage of decay. It appears that hemicelluloses and perhaps lignin are critical to the mechanism involved in degradation of cellulose and less or modified hemicelluloses might therefore affect cellulose degradation. On the other hand, the access to cellulose might be easier since less hemicelluloses surround the cellulose microfibrils.

Oxidation and hydrolysis appears to be the mechanism involved in cellulose degradation and this mechanism is thought to be rather similar for brown-rot and white-rot fungi. Although the changes of cellulose are limited after heat treatment there might be a direct or indirect effect on the decay processes during fungal exposure. The increase in the crystalline cellulose proportion might limit or slow down the initial attack of non-enzymatic oxidizing agents and/or prevent diffusion of soluble oligosaccharides or monosaccharides to the wood cell lumen.

Although brown rot fungi do not produce ligninolytic enzymes, they do have a non-enzymatic mechanism that results in oxidative demethylation and oxidation of the propyl side chains of lignin. According to Goodell (2003) both the level and the type of lignin have very little effect on the decay of brown rot fungi. This indicates that lignin changes, which occur during heat treatment, should have no direct effect on the decay resistance against brown rot fungi. White rot fungi are capable to degrade lignin due to a non-enzymatic and enzymatic (ligninolytic) mechanism.

Heat-treated birch showed a clear improvement of the resistance against white rot attack, *Coriolus versicolor* and especially *Stereum hirsutum*. These fungi are capable to degrade both the carbohydrates and lignin and there is probably more than one reason for this heat treatment effect, e.g.

- changes of the external conditions affecting the micro-environment (extracellular slime layer) needed for lignin degradation;
- blocking the (radical) reactions of non-enzymatic oxidizing agents in initial stages of decay; and
- changes (modification) of the substrate, especially hemicelluloses and lignin.

A solid-state CP MAS ^{13}C -NMR study of heat-treated Norway spruce revealed similarities but also clear differences after exposure to brown-rot and white-rot fungi when compared to untreated Scots pine sapwood. Brown rot fungi appear to have a preference to attack the carbohydrates at C4 and especially C1 cleaving the skeleton of cellulose and glucomannans. In untreated Scots pine sapwood this attack mainly occurred at C4, the non-reducing end of the glucose unit. Attack on the out-of-the-ring alcoholic group CH_2OH of the carbohydrates of heat-treated Norway spruce is observed but less obvious than in untreated Scots pine. The fungus possibly tried to cleave the out-of-the-ring CH_2OH group on the main H-bond fixing sites of the crystalline structure in order to open the cellulose crystalline structure to an amorphous structure to decrease its water repellency and facilitate enzymatic cellulose degradation. Remarkable is the attack on the C3/C5 of the carbohydrates, indicating ring opening of the glucose units, which was not observed in untreated Scots pine sapwood. Lignin degradation is limited to demethoxylation and low or no aromatic ring opening is observed, even after exposure to the white-rot fungus *C. versicolor*. Fungal exposure in ground contact revealed an attack of the carbohydrates of heat-treated wood at C1 and possibly at C4 in order to cleave and eventually depolymerise cellulose and hemicelluloses. An attack on the out of the ring alcoholic group, $-\text{CH}_2\text{OH}$, of the carbohydrates was also observed. The opening of the glucose pyranose ring in heat-treated tropical wood species simaruba after ground contact exposure, not observed in untreated wood, was remarkable. Demethoxylation and some ring opening of the aromatic structure of lignin have been observed, for treated and untreated wood species.

Fungal attack of heat-treated wood can be affected by the treatment conditions used, e.g. process time and especially temperature. An increase of the temperature and process time during the hydro-thermolysis stage causes a further degradation and/or modification of the hemicelluloses in the cell wall. Since there are more reactive intermediates (e.g. furfural) available more cross-linking reactions (e.g. polycondensation) occur increasing the lignin polymer network. More severe process conditions probably also increases the relative proportion of the crystalline cellulose. The decay of heat-treated wood during exposure to the brown rot fungus *Coniophora puteana* decreased after increasing the temperature and/or process time during the hydro-thermolysis treatment. The increased changes of the wood components during these severe heat treatment conditions might have contributed to this improved resistance against *C. puteana* decay. The minimal effect of more severe treatment conditions on the attack of the brown-rot

fungus *Poria placenta*, is remarkable. It is known that hemicelluloses are necessary for the degradation of cellulose by *P. placenta* (Lyr 1960, Highley 1977, Enoki et al. 1988). An increased degradation and/or modification of the hemicelluloses did not affect the *P. placenta* decay of heat-treated wood. It is possible that the amount of hemicelluloses still available is high enough to initiate *P. placenta* decay and/or that the role of hemicelluloses in the mechanism of decay are of less importance than previously assumed. Similar results were obtained when heat-treated wood was exposed to the white rot fungus *C. versicolor*. More severe process conditions during the hydro-thermolysis stage revealed no or low effect on the decay of heat-treated wood after exposure to *C. versicolor*. This is in agreement with results of an initial study in which was found that variations of the process conditions during the second process stage (curing) affected the resistance against *C. versicolor* attack more than process variations of the hydro-thermolysis stage. Degradation and modification of the hemicelluloses, which occur mainly during the hydro-thermolysis stage appeared to have no or low effect on the resistance against *C. versicolor* attack. Degradation of amorphous cellulose, which occurs mainly during the second process stage, and/or modification of the lignin network (cross-linking reactions) are therefore believed to affect *C. versicolor* attack.

Heat treatment did not affect the growth of non-decaying wood fungi on the surface of wet wood. Molds and sap stain fungi use wood extractives (e.g. proteins) for their metabolism. Substrate changes of the main components of wood appeared not to affect the growth of such fungi. Degradation products of the hemicelluloses (e.g. sugars) might even accelerate the growth of molds, as found on heat-treated radiata pine.

Whether heat-treated wood is suitable for a certain application depends on the wood species involved and on the typical (biological) hazards of such an application. For instance, heat-treated radiata pine appeared to be resistant against *C. puteana* attack, but its resistance against *P. placenta* was limited. Therefore, the application of heat-treated radiata pine should be restricted to applications in which no or low fungal decay of *P. placenta* is expected. Heat-treated Norway spruce revealed a higher resistance against *P. placenta*, which might enable the application of heat-treated Norway spruce poles since *P. placenta* occurs frequently in poles. However, other possible biological hazards of a certain application should also be taken into account, such as soft rot fungi, bacteria, maritime organisms, insects and termites. Furthermore, (semi-) practice or service commodity tests at different locations are inevitable to predict the suitability of heat-treated wood for a certain application.

Physical properties

One of the most striking effects of heat treatment is a reduction of the hygroscopicity while the typical sigmoid curve of the hysteresis of the water isotherm is maintained. A positive effect of the hysteresis is that small changes in relative humidity do not immediately result in a change of the moisture content of the treated wood. This contributes to the dimensional stability of the treated wood,

because swelling and shrinkage is due to the water absorption and desorption of wood. Moreover, a reduction in water absorption reduces the overall swelling and shrinkage of wood, hence improving its dimensional stability.

It has been found that wood hygroscopicity is influenced by the process conditions (temperature, time, and/or pressure) and the process temperature appears to be the most influential parameter. The availability and/or accessibility of the free hydroxyl groups of the wood carbohydrates play an important role in the process of water adsorption and desorption. Heat treatment results in a reduction of free hydroxyl groups, which might hinder the accessibility to water. Several causes are at the origin of this, e.g. depolymerisation of the carbohydrates and especially hemicelluloses causing a reduction of the total amount of hydroxyl groups, including the free hydroxyl groups; an increase of the relative proportion of the crystalline cellulose, in which the hydroxyl groups are not easily accessible to water molecules; and cross-linking of the lignin network, which decreases the accessibility of the free hydroxyl groups.

A material property, which is clearly altered during heat treatment, is the density of wood. The main reasons for the decrease of the density of wood after heat treatment are: the degradation of wood components (mainly hemicelluloses) into volatile products, which evaporate during treatment; the evaporation of extractives; and a lower equilibrium moisture content since heat-treated wood is less hygroscopic.

Mechanical properties

Heat treatment causes a reduction of mechanical properties of wood, due to the relative severe process conditions used, especially at high temperatures between 150-280°C. The industrial two-stage heat treatment method also revealed a clear effect on the mechanical properties of wood. The tensile strength parallel to the grain shows a large decrease and it is expected that also the shear strength reduces after heat treatment. On the other hand, the compressive strength parallel to the fibre and hardness increases after heat treatment. The bending strength, which is a combination of the three primary stresses (tensile, compressive and shear stress), is lower after heat treatment. However, this decrease is not as high as the decrease of only the tensile strength. An increase of the modulus of elasticity (MOE) during the bending test has been noticed, whereas the impact strength shows a rather large decrease after heat treatment.

The mechanical properties of wood are closely related to the moisture content of the timber. Increased amounts of bound water interfere with and reduce hydrogen bonding between the main polymeric components of the cell wall and thereby decrease the strength properties of wood since strength is related to covalent but also to hydrogen intrapolymer bonds. Therefore, heat treatment shows a positive contribution to the strength properties since heat-treated wood is less hygroscopic and the (maximum) amount of bound water is reduced.

According a hypothetical model by Winandy and Rowell (1984) the main components of the cell wall (cellulose, hemicelluloses en lignin) contribute in different degrees to the strength of wood. A chemical or thermal modification

method that affects the individual wood components and their interaction must therefore affect the mechanical properties of wood. Cellulose is thought to be primarily responsible for strength in the wood fibre because of its high degree of polymerisation (DP 5000-10000 units) and linear (crystalline) orientation. Heat treatment results in a small but noticeable degradation of amorphous cellulose causing some disturbance and/or depolymerisation of the cellulose polymer. This could be an important reason for the observed decrease of the tensile strength. However, according to Stamm (1964) internal stresses are distributed among several cellulose microfibrils/fibrils. Furthermore, the effect of the cellulose polymer length on the strength is limited since the tensile strength is not changing at DP's over 300. Whether or not the crystallization of amorphous cellulose is involved in the decrease of the tensile strength is not clear.

Since crystalline cellulose shows significant anisotropy, its stiff and rigid structure might contribute to the increase of the compressive strength in longitudinal direction. Due to this anisotropic character, the compressive strength is limited in the radial and tangential direction. The decrease of the radial compressive strength after heat treatment might be caused by small radial fissures, which were noticed in Scots pine after heat treatment. Another reason might be the damage of parenchyma cells in the rays and epithelial cells around resin canals during heat treatment. Rays appear to contribute to the compressive strength in radial direction and damages of the rays might decrease the compressive strength.

It has been suggested that degradation and/or modification of the hemicelluloses are primarily responsible for the initial loss of bending strength, since neither depolymerisation nor degradation of cellulose and lignin were observed during heat treatment. Raising the effective treatment temperature and/or increasing the treatment time during the hydro-thermolysis stage resulted in a further decrease of the bending strength. Hemicelluloses are the most thermal-chemically sensitive component of wood and it has been found that more severe process conditions during this hydro-thermolysis stage resulted in a further degradation of the hemicelluloses confirming a possible relationship. LeVan (1990) proposed that cleavage of the sidechains of hemicelluloses within the lignin-hemicelluloses matrix caused disruption of load-sharing capacity and therefore might be responsible for the observed strength losses. Another explanation, which is given for the observed initial strength loss, was a reduction of the DP of hemicelluloses, which means a degradation of the hemicelluloses backbone.

The small but noticeable increase of the MOE is probably due to the increase of the relative amount of crystalline cellulose after heat treatment, although degradation and/or modification of the hemicelluloses, disrupting the load-sharing capacity of the lignin-hemicelluloses matrix, might also have an effect on the MOE. Furthermore, heat-treated wood is less hygroscopic than untreated wood (it contains less bound water in the cell wall), which affects the MOE making wood less elastic.

Whether or not lignin is directly involved in the effect of heat treatment on the mechanical properties is not clear. Lignin acts as a stiffener of the cellulose microfibrils/fibrils and an increased cross-linking of this polymer appears to prevent or limit movement perpendicular to the grain. Furthermore, lignin is the main component of the middle lamella and an increased cross-linking of the lignin polymer network improves the strength of the middle lamella, which subsequently

affects the strength properties of the cell wall. This can be an indication that the lignin polymer network contributes directly to the strength of wood. Findings of Banoub and Delmas (2003) indicating a regular structure within the lignin polymer network support this statement, since regular structures are expected to add a constructive contribution to the strength of wood.

In most studies defect free specimens are used to determine the effect of heat treatment. Defect free specimens can be used to compare the effects of different treatment processes and/or different treatment conditions but not for the calculation of constructive elements, at least not without the use of several safety factors. Large-scale experiments of full construction Norway spruce timber revealed a decrease of the bending strength after heat treatment, much higher than the decrease of defect free specimens. The effect of natural defects, such as knots, resin pockets, deviating slope of grain and reaction wood, on the mechanical properties of timber appeared to be affected by heat treatment. At failure, heat-treated timber reveals a rather large and abrupt fracture, whereas untreated timber shows a more gradual decrease of the stress. The external forces heat-treated wood can bear after initial failure, are much lower than for untreated wood. Broken cell walls perpendicular to the grain appears to be the cause for this phenomenon, although changes of the main wood components might also be involved, especially degradation of the carbohydrates and/or crystallization of amorphous cellulose (making wood more brittle). The displacement until failure is much lower for heat-treated timber confirming a rather stiff and brittle character. Contrary to the bending strength the modulus of elasticity (MOE) of full construction timber is still increased after heat treatment. Since MOE is often the most critical parameter for a construction, higher stiffness results in lower deflection for a given load, heat treatment appears not to lower the potential for constructive applications. The effect of a three-year period of outdoor exposure on the strength properties of heat-treated Norway spruce timber was limited. Especially for the 5%-value low strength range, where wood defects strongly determines the mechanical properties of timber, a three years outdoor exposure did not change the bending strength and modulus of elasticity of heat-treated timber. Thus, heat-treated timber shows potential for use in constructions. However, it is important to carefully consider the stresses that occur in a construction and some practical consequences when heat-treated timber is used since the impact of heat treatment on different strength properties is not proportional. Heat-treated timber might therefore respond different to stresses applied on the construction, limiting or favouring this material for constructions.

PART III

INNOVATIVE APPLICATIONS OF THERMAL MODIFICATION

Thermal modification methods might have potential for new and innovative applications and some examples are given in this part. In Chapter 11 the effect of the two-stage heat treatment method on the cell-shape recovery of densified wood is discussed. Densification is a method to increase the density of wood and to improve the mechanical properties (e.g. hardness). A major disadvantage of this method is the recovery of the original dimensions when exposed to moisture (cell-shape recovery) and heat treatment might have a positive effect on the dimensional stability of densified wood.

Mechanically induced vibration welding of wood is a rather new method to obtain wood joints, which can be used for structural applications. Considering the high dimensional stability of heat-treated wood it is of interest to see if a good welded joint strength could also be obtained, notwithstanding the structural modifications heat-treated wood has undergone. Chapter 12 deals with the investigation of mechanically induced vibration welding of heat-treated wood, both the intermediate product and the fully treated product.

Panel products, such as particleboard, are subject to reversible and/or irreversible thickness swelling under wet and moist conditions. Heat treatment and in particular steam treatment can improve the dimensional stability of panel products such as particleboard, fibreboard and OSB. In Chapter 13 the possibility to use the two-stage heat treatment for the production of heat-treated particleboard with an improved dimensional stability and sufficient mechanical properties is discussed.

11 SEMI-ISOSTATIC DENSIFICATION OF HEAT-TREATED RADIATA PINE*

Abstract

Semi-isostatic densification is a useful method to increase the density and to improve the mechanical properties of fast-grown softwood species like radiata pine. A major disadvantage of this method is the almost completely recovery of the original dimensions when densified wood is exposed to moisture. Heat treatment improves the dimensional stability of wood and might be a useful method to prevent this shape-recovery after densification. However, no or only a limited effect on the shape-recovery was found when densified radiata pine was exposed to moisture.

* Boonstra MJ, Blomberg J (2007) Semi-isostatic densification of heat-treated radiata pine. *Wood Science and Technology* 41: 607-617

11.1 Introduction

Radiata pine is a fast grown softwood species with a worldwide production in commercial forestry plantations (about 25 million hectares). It is characterized by wide grow rings (1-2 cm), a relatively low density (400-500 kg/m³) and it contains a high percentage of juvenile wood since it is harvested at an age of less than 25 years. Several modification methods, such as chemical and compressive treatments, have been developed to increase the density of softwood species like radiata pine in order to improve the mechanical properties (strength and stiffness). Impregnating the void volume of wood with bulking chemicals (e.g. monomers, polymers, resins, waxes) is a method, which has been developed since the 1960's (Stamm 1964, Meyer 1984). Another method to increase the density of wood is compression in the transverse directions (Kollmann et al. 1975). A major disadvantage of this method is the recovery of the original dimensions when densified wood is exposed to moisture (swelling). This swelling is mainly due to cell wall bulking and especially cell-shape recovery (Blomberg et al. 2006). Heat treatment appears to have a positive effect on the dimensional stability of densified wood as described in several studies (Hsu et al. 1988, Inoue et al 1993 and 1996, Dwianto et al. 1996, Ito et al. 1998, Navi and Girardet 2000, Rowell et al. 2002, Wolcott and Shutler 2003, Heger et al. 2004, Kamke 2006). In this chapter the effects of the two-stage heat treatment method on the recovery of densified radiata pine when exposed to moisture are described.

11.2 Materials and methods

Materials

Radiata pine boards (*Pinus radiata* D. Don.) were used for heat treatment and densification. Cross sections of the boards had a thickness of 30 mm and a width of 150 mm. The length of the boards was approximately 3.0 m. The boards were tangentially sawn. The moisture content of the boards was approximately 14-16% before treatment.

Heat treatment and densification

The heat treatment was performed in two separate heat treatment stages and a drying stage in between. In the first stage of the heat-treatment the timber was treated in an aqueous environment at superatmospheric pressure (0.8 MPa), a so-called hydro-thermolysis treatment. This was done in a 600 l pilot plant at treatment temperature of 165°C or 185°C (30 minutes effective treatment time). The specimens were then dried in a 1 m³ (net) kiln, using a conventional drying process at 50-60°C. After drying the wood specimens were heat-treated again for the second stage, now under dry and atmospheric pressure conditions, a so-called "curing" treatment (180°C, 6 hours). During this stage superheated steam or nitrogen gas was used as a sheltering gas to exclude oxygen. The curing stage was performed in a special curing kiln or in a press (with dimensions of approximately 1x2 m). In the last case the length of the boards was reduced to 2 m before curing and six boards were treated in one curing charge. A static

pressure of 10 MPa was applied during curing to compress the boards and the treatment temperature varied between 160°C and 190°C (4 hours). These boards were not used for semi-isostatically densification.

Untreated, hydro-thermolysed and fully treated radiata pine boards were used for semi-isostatic densification (in duplicate). Untreated and treated boards with a thickness of 25 mm, a width of 140 mm and a length of approximately 1.5 m were prepared (planed) before densification. The moisture content of the untreated, hydro-thermolysed and fully treated radiata pine boards was respectively 8.3%, 8.5% and 7.0% before densification. The treated and untreated boards were semi-isostatically compressed (at 20°C) according the CaLignum process (Lindhe and Castwall 1997) in a Quintus press to a pressure of approximately 140 MPa, which is reached after 2 minutes. The pressure is mediated through a rubber membrane backed with oil. This enables weaker (low density) wood to be more compressed than harder structures (high density) such as knots. After the pressing period, the pressure was immediately released to atmospheric pressure. The boards were placed in the Quintus press with their pith sides to the press table. After densification the hydro-thermolysed radiata pine boards were heat-treated again in a kiln according to the curing process as described above.

Property testing

Before and after densification the dimensions of the treated and untreated boards were measured using a sliding calliper (accuracy 0.03 mm, repeatability 0.01 mm). After densification the thickness was measured on 3 positions: the left side (H1), on the right side (H2) and in the middle (H3) of the test boards. Furthermore the maximum (Hmax) and minimum (Hmin) thickness of the densified test boards was measured. The width was measured on the top side (W1) and bottom side (W2) of the test boards.

Densified specimens (cross section 10x10 mm; length 30 mm) were prepared (Fig. 11.1) and used to determine the swelling by measuring the dimensions of the specimens before and after soaking in water (20°C) for 24 hours. A drop of soap was added to the water to avoid the influence of surface tension. After soaking the densified specimens were oven dried for 24 hours at 102±2°C and the dimensions were again measured. The specimens were weighed at each test condition. Three replicates per board were used for this test.

Densified specimen (thickness 10 mm, width 30 mm, length 30 mm) were prepared (Fig. 11) and conditioned at 65% relative humidity (RH) for hygroscopicity testing. The specimens were then conditioned at 95% RH (above a saturated potassium nitrate solution at 20°C) or at 98% RH (above water at 20°C) until equilibrium moisture content (EMC) was reached. Subsequently, the specimens were oven dried (24 hours at 102±2°C). Dimensions and weight of the specimens were measured before and after hygroscopicity testing. Three replicates per board were used for this test.

The Brinell hardness of densified specimens was determined according to the EN 1534 using an indenting ball with a diameter of 10 mm that was forced to the tangential surface (1 kN) for 30 seconds. The indentation was measured by image processing on a picture with a magnification of 30x. The diameter of the

indentation was measured in four directions and the mean diameter was used to calculate the Brinell hardness.

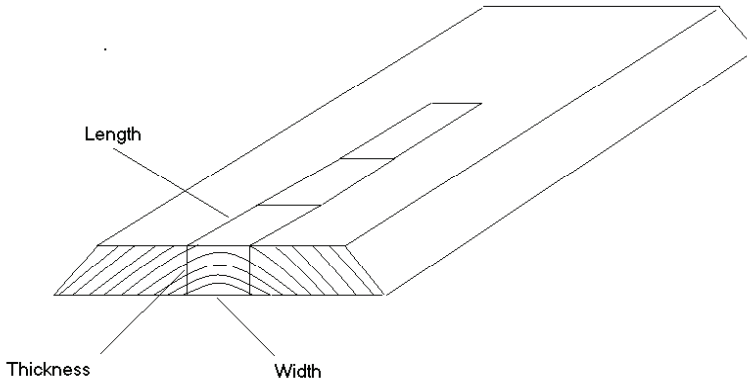

Fig. 11.1 Schematic overview of specimen preparation

11.3 Results

Densification of heat-treated radiata pine boards revealed small surface cracks parallel to the grain. Densification of knots in the fibre direction revealed more resistance and some raised areas of the wood surface around knots were noticed. During planing these raisings were removed without difficulty. However, very hard densified knots could damage knives of planing machines and/or make them blunt more easily giving marks (e.g. stripes) on the wood surface. Chisels made of flexible metal are therefore recommended instead of hard steel.

Table 11.1 Thickness and width of heat-treated and untreated radiata pine boards after semi-isostatic densification (thermolysis 165°C, 30 minutes; curing 180°C, 6 hours)

Radiata pine	Thickness T (mm)						Width W (mm)		
	Tmax	Tmin	T1	T2	T3	Tmean	W1	W2	Wmean
Untreated	14.4	12.2	14.4	12.9	12.3	13.2	148.9	150.0	149.5
Hydro-thermolysed	11.3	10.2	11.2	10.2	11.3	10.8	142.4	148.1	145.3
Fully treated	13.7	11.2	12.3	12.6	11.9	12.3	143.1	148.3	145.7

The dimensions of the specimens after densification are shown in table 11.1. The thickness of the boards was clearly decreased (47-56%) whereas the width was slightly increased (4-7%). This resulted in a reduction of the total volume by 45% to 55% and the density increased by 82 to 123% after densification (table 11.2).

Table 11.2. Volume decrease and increase in density of treated and untreated radiata pine after semi-isostatic densification (thermolysis 165°C, 30 minutes; curing 180°C, 6 hours)

Radiata pine Densified	Volume decrease in percent of the original volume (%)	Increase in density (%)
Untreated	45.1	82.1
Hydro-thermolysed	55.1	122.7
Fully treated	48.7	94.9

Water absorption, moisture content, swelling and shrinkage (tangential, radial, longitudinal and volumetric) of densified specimens during water soaking and EMC test are shown in respectively Table 11.3 and 11.4. During the soaking test, water absorption of 88% and 99% was found for respectively untreated and treated radiata pine. This is far above the fibre saturation point, which means occurrence of free water in the cell lumina. Swelling of densified specimens in radial direction was 49% and 57% for respectively untreated and treated radiata pine, indicating shape-recovery. Swelling of densified radiata pine specimens after conditioning at 95% relative humidity (RH) was also rather high, although at a lower degree than after the water-soaking test (Table 11.4). The swelling of the radiata pine specimens, which were densified before the curing stage, appeared to be lower than the untreated specimens and the specimens, which were densified after the curing stage (Tables 11.3 and 11.4).

Table 11.3 Water absorption, swelling, shrinkage, and moisture content (MC) of semi-isostatically densified radiata pine specimens during the soaking test (treatment conditions: thermolysis 165°C, 30 minutes; curing 180°C, 6 hours)

	Radiata pine densified		
	Untreated	Fully treated 1*	Fully treated 2**
Swelling after soaking (%)			
Radial	49.4	57.2	40.5
Tangential	0.3	5.8	7.2
Longitudinal	0.2	0.2	0.1
Volume	50.2	66.7	50.7
Shrinkage after oven drying (%)			
Radial	10.5	25.8	31.0
Tangential	4.7	5.2	8.4
Longitudinal	-0.1	0.2	0.3
Volume	14.6	29.8	37.0
Moisture content (%)			
Start	11.9	8.7	9.1
Wet	110.8	116.5	90.3
Absorption (%)	88.4	99.2	74.3

* The specimens were compressed after the two-stage heat treatment

** The specimens were compressed after the hydro-thermolysis stage and subsequently treated by the curing stage

Table 11.4 Water absorption, swelling and shrinkage, and moisture content (MC) of semi-isostatically densified radiata pine specimens during the hygroscopicity test (treatment conditions: thermolysis 165°C, 30 minutes; curing 180°C, 6 hours)

	Radiata pine densified		
	Untreated	Fully treated 1*	Fully treated 2**
Swelling from 65% to 95% RH (%)			
Radial	33.0	39.0	27.4
Tangential	2.0	4.3	5.0
Longitudinal	0.3	0.2	0.0
Volume	36.0	45.3	33.8
Shrinkage from 95% RH to oven dry (%)			
Radial	15.8	---	21.8
Tangential	4.0	---	6.0
Longitudinal	0.3	---	0.0
Volume	19.5	---	26.4
Moisture content (%)			
Start	11.9	6.2	4.9
Wet	25.8	15.5	15.7
Absorption (%)	12.4	8.8	10.3

* The specimens were compressed after the two-stage heat treatment

** The specimens were compressed after the hydro-thermolysis stage and subsequently treated by the curing stage

The best results (=lowest swelling) were obtained with radiata pine specimens, which were compressed during the curing stage (Table 11.5), although a swelling of 20-26% in radial direction still indicates a clear shape-recovery. An increase of the curing temperature to 190°C appeared to reduce the swelling and thus the shape-recovery.

Table 11.5 Moisture content and swelling of densified radiata pine specimens during the hygroscopicity test (treatment conditions: thermolysis 185°C, 30 minutes; curing 160-190°C, 4 hours including compression at 10 MPa)

Curing temperature	Swelling from 65% to 98% RH (%)		MC at 98% RH (%)
	Rad	Tang	
R. pine densified*			
160°C	26.5	3.1	21.4
170°C	26.0	3.6	21.6
180°C	21.8	3.5	17.2
190°C	20.0	3.6	17.3

* The radiata pine specimens were compressed (10 MPa) during the curing stage

In order to get an impression of the hygroscopicity and dimensional stability of non-densified radiata pine, the shrinkage (from saturated to oven dry) and EMC (at 65% and 98% RH) of treated and untreated radiata pine are shown in Table 11.6. The specimens showed a clear reduction of the shrinkage (radial and tangential) and EMC (especially at 98% RH) after heat treatment indicating an improvement of the dimensional stability.

Table 11.6 Shrinkage (from saturated to oven dry) and EMC (at 65% and 98% RH) of treated and untreated radiata pine, without densification (treatment conditions: thermolysis 165°C, 30 minutes; curing 180°C, 6 hours)

Radiata pine	Shrinkage from saturated to oven dry (%)			EMC (%)		
	Non-densified	Rad	Tang	Long	65% RH	98% RH
Untreated		4.3	7.9	0.39	12.0	25.9
Fully treated		2.8	4.3	0.23	6.7	17.2

Oven drying of the saturated specimens resulted in shrinkage in radial direction, which was much higher for densified specimens than for non-densified specimens (Tables 11.3 and 11.6). The shrinkage of heat-treated densified radiata pine was higher than untreated densified wood (Tables 11.3 and 11.4). The radiata pine specimens, which were densified before the curing stage, revealed the highest shrinkage.

The Brinell hardness of untreated radiata pine is increased by 271% after densification (Table 11.7). Heat treatment appeared to affect the Brinell hardness of densified radiata pine since it is lower than for the untreated wood. However, because the density of heat-treated radiata pine is lower after densification, a lower Brinell hardness was expected. Highest Brinell hardness was found for hydro-thermolysed radiata pine, but these specimens also showed the highest density (Table 11.7).

Table 11.7. Density and Brinell hardness of semi-isostatically densified and non-densified radiata pine specimens (at 20°C, 65% RH)

Radiata pine	Density (10 ³ kg/m ³)	Hardness (N/mm ²)
Densified		
Untreated	1.049	71.4
Hydro-thermolysed	1.100	109.9
Fully treated	0.969	65.7
Non-densified		
Untreated	0.489	19.2

11.4 Discussion

Resistance against densification depends on the compressive strength in the transverse direction. A semi-isostatic pressure of 140 MPa was apparently high enough to compress the radiata pine boards and to obtain a significant increase of the density (about 100%). Since the effect of heat treatment on the compressive strength perpendicular to the grain is rather limited no or only a limited effect on densification was expected (see Chapter 9). The difference between fully treated and untreated radiata pine was indeed rather small, although treated wood appeared to be more compressed than untreated wood (Table 11.2). Remarkable is the densification of hydro-thermolysed radiata pine, which resulted in a higher volume loss and subsequently a larger increase of the density than untreated or fully treated wood. This can be due to differences in compression during

densification and/or differences in elastic springback (immediate/delayed) after densification.

There are several chemical and physical factors, which could affect densification (compression and/or springback) of heat-treated wood. According to Blomberg et al. (2006) semi-isostatic densification results in a compression of the tracheids, which were flattened and irregularly shaped, and deformation of the rays into a curly and tilted shape. They have also noticed shearing and cracking of the cell walls, especially in the first formed earlywood. The effect of heat treatment on the anatomical structure of wood is rather limited (see Chapter 2). Heat treatment of radiata pine appears to cause some damage to parenchyma cells in the rays and epithelial cells around resin canals. Rays contributes to the compressive strength in radial direction (Kennedy 1968, Ellis and Steiner 2002) and damages of the rays might improve this compression since less resistance of the rays during pressing is expected.

Chemical changes of the main wood components (cellulose, hemicelluloses and lignin) during heat treatment could also have an effect on the densification of heat-treated wood (see Chapter 4, 5 and Annex 3). Although the strength properties of the cell wall are closely related to the occurrence of cellulose fibrils and microfibrils, the hemicelluloses-lignin matrix is also thought to play an important role in wood strength properties (Winandy and Rowell 1984, LeVan 1990, Sweet and Winandy 1999, Winandy and Lebow 2001, Boonstra et al. 2007a). Degradation and/or modification of hemicelluloses, which mainly occurs during the hydro-thermolysis stage, might have a negative effect on the compressive strength of wood. Another phenomenon, which occurs during the hydro-thermolysis stage, is softening of the cell wall due to plastization of the main wood components, especially lignin and the remaining hemicelluloses (Goring 1963, Hillis and Rozsa 1978, Hillis and Rozsa 1985, Shiraishi 2001). Softening of the cell wall is probably still noticeable after the hydro-thermolysis stage facilitating the compression of the cells during densification. However, it is expected that this plastization effect should be higher when the boards were heated during pressing. The curing treatment stage, which is characterized by an increase of the relative proportion of crystalline cellulose and an increased cross-linking of the lignin polymer network, changes the properties of the cell wall, making it more brittle and less susceptible to elastic deformation. This provides a positive contribution to the compressive strength of the cell wall restricting compression of the cells during densification. This might explain the lower degree of compression of fully treated radiata pine compared to hydro-thermolysis treated wood (Table 11.2).

Although heat treatment of non-densified radiata pine resulted in a reduction of the shrinkage and swelling behaviour (Table 11.6), it did not provide a fixation effect for densified wood (Fig. 11.2). The swelling of heat-treated densified radiata pine during the water-soaking test is even higher than for untreated densified radiata pine (Table 11.3). This could be due to the higher degree of compression of fully treated radiata pine compared to untreated wood (Table 11.2). The same tendency was noticed in the EMC test. Although the swelling of densified wood after conditioning at a relative humidity of 95% was slightly lower than after the soaking test, a clear shape-recovery was visible with untreated radiata pine performing better than fully treated radiata pine (Table 11.4). A hydro-thermolysis

treatment is therefore not advisable as post-treatment of densified wood, since this treatment stage is performed in a saturated environment and shape-recovery is then expected.

Densification before the curing treatment stage of radiata pine appeared to have some effect on the shape-recovery. The swelling of the specimens after water soaking or conditioning at 95% RH is lower than for untreated densified radiata pine. This was remarkable because both the degree of compression and density of the specimens were higher than for the untreated wood, but this did not result in a higher shape-recovery. However, there is no question that shape-recovery still occurred when the densified specimens were exposed to moisture.

It was expected that a better fixation could be obtained when the curing and pressing stage were combined (heat treatment during pressing). Plastification of the remaining hemicelluloses and/or the lignin polymer network, and condensation reactions within the lignin polymer network might result in a fixation of the cell wall to a more permanent structure, which is less susceptible to moisture. However, a combination of curing and compression (at 10 MPa) did not prevent recovery of the dimensions since a significant swelling still occurred when the specimens were exposed to moisture (Table 11.5). Increasing the curing temperature to 190°C did reduce the swelling of the densified radiata pine specimens but a significant recovery of the dimensions still occurred.

Application of a higher pressure during densification might result in an increased cracking of the cell wall limiting or preventing swelling of the cell wall when exposed to moisture. This, however, might also disturb the cohesion between cells affecting the mechanical properties (Blomberg et al. 2005).

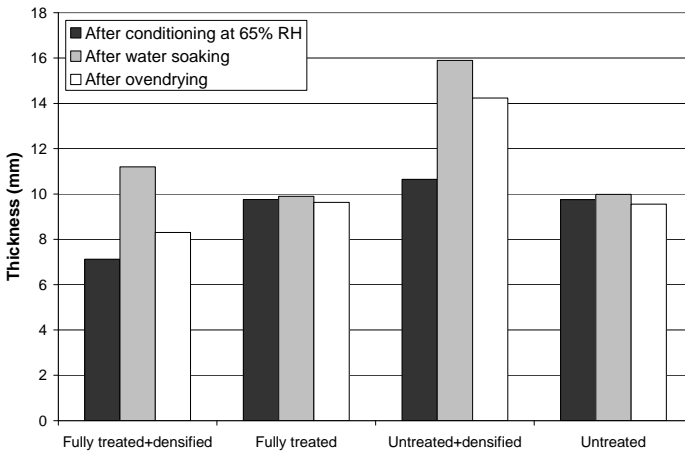

Fig. 11.2 Thickness (radial direction) of treated and untreated radiata pine specimens after conditioning at 65% relative humidity (20°C), after water soaking (20°C), and after oven drying (102°C, 24 hrs)

Remarkable is the shrinkage of densified specimens from saturated (swollen) to oven dry conditions, which is significantly higher than for non-densified wood, indicating a (partly) recovery of the cell-shape of densified wood (Fig. 11.2). Heat

treatment appeared to have an effect on this recovery since the shrinkage of treated densified wood is higher than for untreated wood. The specimens, which were compressed before the curing stage, showed the highest shrinkage. This observation is again an indication that heat treatment affects the densification of wood, but it is not completely clear how it affects densification.

11.5 Conclusions

Semi-isostatic densification is a useful method to increase the density and to improve the mechanical properties of fast-grown softwood species like radiata pine. Although heat treatment improves the dimensional stability of wood no or only a limited effect was found on the recovery of the dimensions when densified radiata pine was exposed to moisture.

12 VIBRATION WELDING OF HEAT-TREATED WOOD*

Abstract

Vibration welding wood that has been preheated according to the industrial two-stage process indicates that such wood can be welded and can yield welded joints of acceptable strength. The joint strength is, however, markedly lower than obtained when welding non-heat-treated timber. In general, weld strength of the timber is poor if welding is done on hydro-thermolysed wood. The strength results are instead much better if welding is done at the end of the complete heat treatment process, i.e. after the dry heat step. The weld lines of heat-treated wood show entangled cells where there is none or very little of the molten matrix intercellular material usually observed in welded timber. Furthermore, in weldlines obtained after hydro-thermolysis an increase in rigidity and brittleness of the wood cells is observed. Hence, the wood cells are not entangled at all or only to a very limited extent. Both observations indicate that heat treatment has affected the main melting region of the wood, namely the intercellular material. As most of this material is already either lost or heavily cross-linked during heat treatment, only little of it is now available to melt and bind the wood surfaces during vibrational wood welding.

* Boonstra M, Pizzi A, Ganne-Chedeville C, Properzi M, Leban JM, Pichelin F (2006e) Vibration welding of heat-treated wood. *Journal of Adhesion Science and Technology* 20(4):359-369

12.1 Introduction

Mechanically induced vibration welding of wood, without any adhesive, has been shown to rapidly yield wood joints satisfying the relevant requirements for structural applications (Gfeller et al. 2003). The mechanism of mechanically-induced vibrational wood welding was shown to be mostly the melting and flowing of the amorphous materials between wood cells, mainly lignin and hemicelluloses (Gfeller et al. 2003). This causes partial detachment, the 'ungluing' of long wood cells and wood fibres, and the formation of an entanglement network in a matrix of molten material, which then solidifies. A wood cell/fibre entanglement network composite of much higher density than wood is formed at the interface with a molten and re-solidified lignin/hemicelluloses matrix.

Considering the high dimensional stability of heat-treated wood it would be of applied interest to see if a good welded joint strength could also be obtained, notwithstanding the structural modifications the heat-treated wood has undergone. Equally, it is of conceptual interest to see if enough flowability is left in the lignin/hemicelluloses of heat-treated wood to yield a welded joint. This is of interest because welding might be more difficult or more limited to achieve, since cross-linking of some wood constituents occurs during heat treatment (see Chapter 4 and Burmester 1975, Bobleter and Binder 1980, Sivonen et al. 2002, Weiland and Guyonnet 2003, Nuopponen et al. 2004, Repellin and Guyonnet 2005, Hakkou et al 2005). Cross-linked networks, even only partially/poorly cross-linked ones, flow with more difficulty, or do not flow at all, due to the increase in the glass transition temperature (T_g) of the system. Therefore, this chapter deals with the investigation of these two points.

The first production step in the Plato wood treatment process is the hydrothermolysis, based on a relatively low-temperature heat-treatment in the presence of steam injection. The second step is a dry heat-treatment to 180°C. Consequently, mechanical vibration wood welding of both the intermediate wood products obtained after hydro-thermolysis and of the finished heat-treated wood was carried out.

12.2 Materials and methods

Industrial preparation of Plato wood specimens

Beech (*Fagus sylvatica* L.), birch (*Betula pendula* Roth and/or *Betula pubescens* Ehrh.) and poplar (*Populus sp.*) were the wood species used for heat treatment and welding tests. For each wood species at least 6 samples were treated. Standard sizes were used (thickness 25–40 mm and width 100–150 mm) and the length of the samples varied between 1.6 and 3.0 m before heat treatment. The moisture content before heat treatment was 16–20%.

The heat treatment was performed in two separate stages. In the first stage of the heat-treatment the wood samples were treated in a humid environment at superatmospheric pressure (6–8 bar) using saturated steam as the heating medium to increase the temperature of the boards. This so-called 'steam hydrothermolysis' treatment was done in an industrial plant at an effective treatment

temperature of 165°C. Cooling down was accomplished by a quick but controlled release of the pressure in the reactor to atmospheric conditions followed by a cold water circulation on the wall of the reactor. The wood samples were then dried using a conventional drying process at 50–60°C. After drying, the wood samples were heat-treated again in a special curing kiln (second stage), under dry and atmospheric conditions, the so-called ‘curing’ treatment (at 170–180°C). During this process stage superheated steam was used to exclude oxygen, thus reducing fire risks and preventing undesired oxidation reactions.

The full-scale industrial samples were then cut to prepare specimens for welding of dimensions 150 × 20 × 15 mm.

Preparation of joints by mechanically-induced wood flow welding

The mechanical welding machine used was a Branson 2700 welding machine (Geneva, Switzerland) capable of vibrating the wood at a frequency of 100 Hz, normally used to vibrationally weld metals.

Specimens composed of two pieces of intermediate hydro-thermolysed or fully heat-treated birch, beech and poplar wood each of dimensions 150 × 20 × 15 mm were welded together to form 20 bonded joints of 150 × 20 × 30 mm dimensions for each species by vibrational movement of one wood surface relative to the other of 3 mm amplitude at a frequency of 100 Hz. The equilibrium moisture content (MC) of the samples before welding was 12%. The conditions of welding used are shown in Table 12.1. After stopping the vibration process, the clamping pressure was still briefly maintained until solidification of the bond. The welded samples were conditioned for one week in an environmental chamber (20°C and 65% RH) before testing.

The tensile strength was measured on samples in which saw cuts perpendicular to the longitudinal wood grain of the specimens, down to the bondline, were made. The distance between the two cuts was 2.5 cm. The specimens were then tested in tension on a Zwick 1454 universal testing machine using Zwick 8406 self-squeezing pincers at a rate of 6 mm/min according to European Norm EN 205 (2003). The results obtained and the conditions used are shown in Table 12.1 and 12.2.

Table 12.1 Welding conditions of friction welded, heat-treated wood of different species after the first hydro-thermolysis treatment step and after final dry heat curing treatment step

	WT (s)	WP (MPa)	HT (s)	HP (MPa)
Birch				
Hydro-thermolysed	4	4	7	4
Fully heat-treated	3	4	7	4
Fully heat-treated	3	4	10	4
Fully heat-treated	3	4	7/10	4
Untreated		4	7/10	4
Poplar				
Hydro-thermolysed	2	4	7/10	4.5
Fully heat-treated	2	4	7/10	4.5
Beech				
Fully heat-treated	3	4	7/10	4.5
Untreated	3	4	7/10	4.5

Table 12.2 Weld strength results of friction welded, heat-treated wood of different species after the first hydro-thermolysis treatment step and after final dry heat curing treatment step

	Density (kg/m ³)	Strength (MPa)	Stdev	Max strength value (MPa)	Min strength value (MPa)
Birch					
Hydro-thermolysed	515	2.08	0.82	3.49	1.10
Fully heat-treated	568	3.71	1.04	5.29	2.91
Fully heat-treated	591	5.50	1.45	7.25	4.26
Fully heat-treated	577	4.34	1.50	7.35	2.91
Untreated	561	5.97	0.68	6.51	5.35
Poplar					
Hydro-thermolysed	423	2.64	0.65	3.53	1.44
Fully heat-treated	444	2.29	0.94	3.53	1.17
Beech					
Fully heat-treated	661	4.32	2.31	8.82	1.29
Untreated	657	8.07	1.06	8.61	7.44

Scanning electron microscopy (SEM)

The surfaces of the joints were analysed with SEM after metallising with gold palladium. The SEM equipment used was a Hitachi S-520 scanning electron microscope. A LEO 1450 VP scanning electron microscope with variable pressure was used. The samples were introduced in the chamber without any carbon coating. All images were obtained with an acceleration voltage of 20 kV, the filament current was 2.715 A. The pressure in the chamber ranged between 50 and 54 Pa. The magnification was 230× for Fig. 12.1a, 299× for Fig. 12.1b, 123× for Fig. 12.2a and 1020× for Fig. 12.2b.

X-ray microdensitometry analyses

Sections of 1.88 ± 1 mm in thickness were obtained from each sample and analysed by X-ray microdensitometry (Leban et al. 2004). The X-ray microdensitometry equipment used consisted of an X-ray tube producing long waves 'soft rays' (low energy level) emitted through a beryllium window. These were used to produce X-ray negative photographs of approx. 2-mm-thick samples, conditioned at 12% moisture content, at a distance of 2.5 m from the tube. This distance is important to minimise blurring of the image on the film frame (18 × 24 cm) used. The usual exposure conditions were: 4 h, 7.5 kW and 12 mA. Two calibration samples were placed on each negative photograph in order to calculate the wood density values. The specimens were tested in this manner on an equipment consisting of an electric generator (Inel XRG3000), an X-ray tube (Siemens FK60-04 Mo, 60 kV, 2.0 kW) and a Kodak film negative, Industrex type M100.

12.3 Results and discussion

The results in Table 12.2 indicate that the heat-treated wood can give good strength results but, in general, the values are lower than that obtained with untreated wood (Gfeller et al. 2003) as indicated by the birch and beech untreated controls in Table 12.2. This is expected because cell walls degradation induced by

heat treatment (Kamden et al 1999 and 2000) is well known to induce lower strength and greater brittleness of the treated wood (Kamden et al. 2000). Heat treatment of timber especially decreases the tensile strength of wood (cellulose hydrolysis causing cleavage of the fibrils), whereas its compressive strength (and hardness) is slightly improved (due to an increased cross-linking of lignin due to chemical reactions the lignin undergoes under heat treatment) (see Chapter 4 and 9).

This result is also expected as a certain amount of cross-linking of wood constituents does occur during heat treatment (see Chapter 4), increasing the T_g and decreasing the flow of the 'melt' at any given temperature or increasing the temperature at which flow starts. That this is one of the main causes of the lower strength obtained in welding heat-treated timber can also be deduced by the scanning electron microscope pictures of the interface in Figures 12.1 and 12.2. In Figures 12.1 and 12.2 one can see that:

the long wood cells are only partially detached and entangled, less than that observed in normal timber welding (Gfeller et al. 2003), but with a lack of molten amorphous material surrounding and binding them, or underneath them (Fig. 12.1). This means that the material that normally melts to form the interfacial welded composite is present in much lower proportion than usual, or is not present at all. This is a consequence of the heat treatment of the wood and the concomitant loss of intercellular material. This means lower wood cells entanglement, much lower proportion of molten material binding the cells, and hence the interfacial strength is lower.

in Figure 12.2 the cells have not detached and have not entangled as normally observed when welding untreated timber. They appear rigid and unaffected by the welding process. This may indicate that it is the increased rigidity of the cell walls introduced by the heat treatment that stops the cells from detaching and entangling during welding.

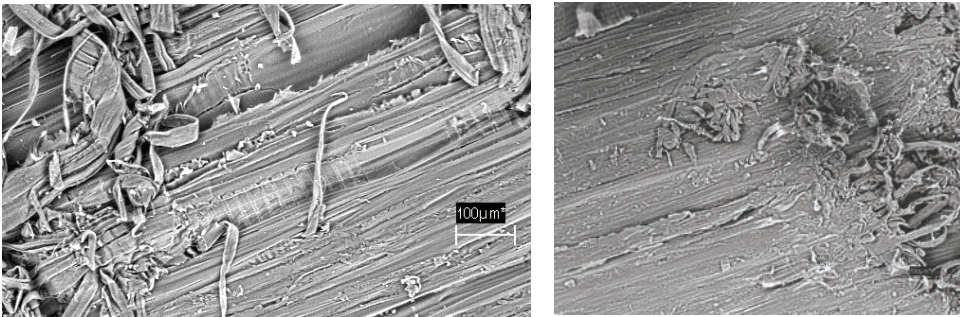

Fig. 12.1 (a) Scanning electron micrograph of heat-treated poplar wood after the last dry heat curing step showing entangled cells where there is none or very little of the molten matrix intercellular material usual in welded timber. (b) Scanning electron micrograph of heat-treated birch wood just after the first hydro-thermolysis treatment step showing entangled cells where there is none or very little of the molten matrix intercellular material usual in welded timber

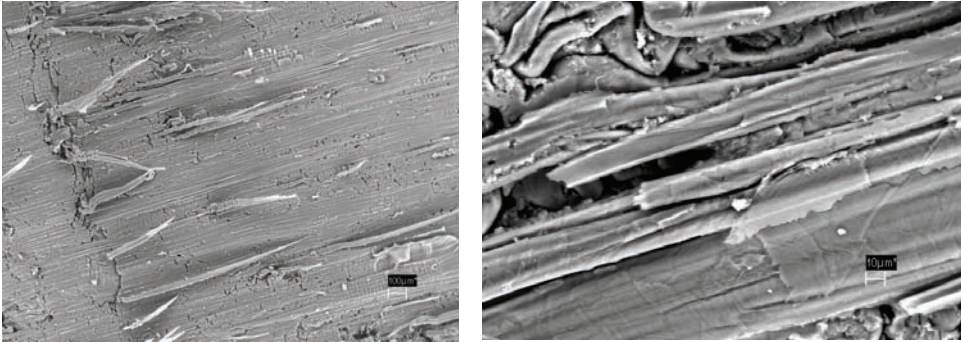

Fig. 12.2 (a) Scanning electron micrographs of heat-treated poplar wood just after the first hydrothermolysis treatment step showing apparently rigidified wood cells that have not detached from the wood surface, that have not entangled and where there is none or very little of the molten matrix intercellular material usual in welded timber (Gfeller et al. 2003). (b) Higher magnification detail of (a)

The conditions of welding thus need to be more extreme than the pressures and holding times optimised for untreated wood (Gfeller et al. 2003). Thus, in Table 12.1 higher pressures and longer holding times had to be used for heat-treated wood. Also, the much greater variability in the results obtained with heat-treated wood as can be seen by the high values of the standard deviations for the different cases in Table 12.2 should be noted. In this regard the max and min values in Table 12.2 (some very high strength results were obtained too) indicate a high variability at the anatomical level of heat-treated wood. The variability at the anatomical level is due to the effect of physical and/or chemical processes during heat treatment on the different wood structural constituents (see Chapter 4 and Kamden et al. 1999 and 2002, Nuopponen 2004).

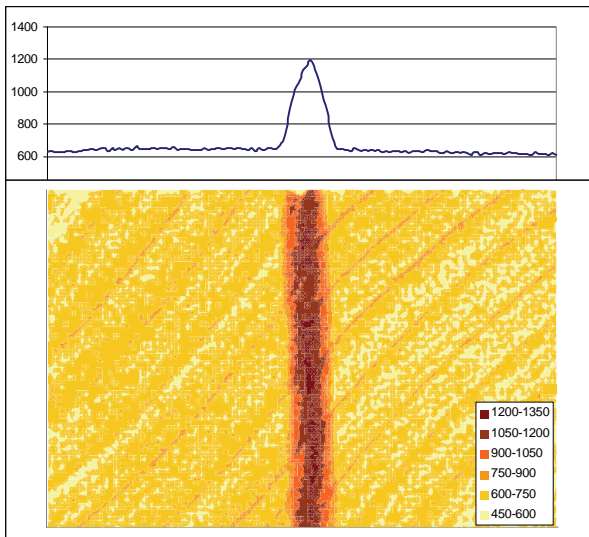

Fig. 12.3 X-ray microdensitometry map of friction welded hydrothermally treated birch wood. Upper microdensitometry graph expresses density in kg/m³ of the wood as a function of the sample weld interface position in mm. The bottom panel is the colour intensity microdensitometry map expressing increasing density in kg/m³ by progressive darkening. Scale of sample weld interface position is the same for the two panels

Fully heat-treated wood, however, appears to give better results than the intermediate hydro-thermolysed wood. This is shown in Table 12.2 and in the X-ray microdensitometry maps of welded joints just after the first wet step of the process (the hydro-thermolysis) (Fig. 12.3) and at the end of the second and final treatment, i.e., the dry heat curing (Fig. 12.4). Unusual and unexpected is the wider densified weldline of the hydro-thermally treated wood in comparison to the cured wood (Fig. 12.3 and 12.4). This means that (i) the second dry heating step in the Plato treatment process is essential to obtain good strength results. (ii) The high temperature reached for a very short time in wood welding cannot, under any circumstances, replace the 4-h heating of the second dry treatment in the heat treatment process.

However, that fully treated wood welds are better than the intermediate hydro-thermolysed wood welds is a rather unexpected result. During the first hydrothermal treatment rearrangements and condensation reactions occurred extensively and have been reported (see Chapter 4, 5 and Annex 3). During the same hydro-thermolysis step extensive hydrolysis reactions of wood constituents also occur. The presence of all these reactions in the wet step of the process implies that their mechanisms depend on and are favoured by the presence of water in the form of steam. Furthermore, the use of water in the form of steam at high temperature and pressure definitely lowers the softening point of the main wood constituents. It is, however, difficult to say whether this softening is due to the reduced interaction between the different wood components, which definitely occurs (see Chapter 4, 5 and Annex 3), or to a decrease in cellulose crystallinity during hydro-thermolysis. During the second dry heat phase of the treatment instead, condensation reactions still occur, but not hydrolysis, as water is absent (see Chapter 4, 5 and Annex 3).

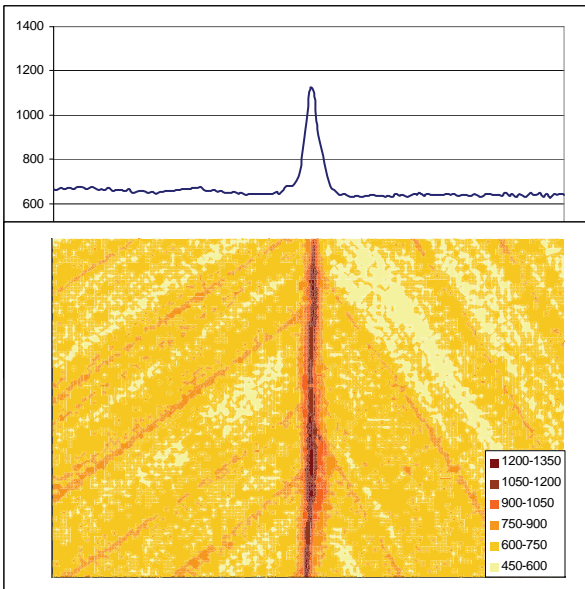

Fig. 12.4 X-ray microdensitometry map of friction welded birch wood after final dry heat cure treatment. Upper microdensitometry graph expresses density in kg/m³ of the wood as a function of the sample weld interface position in mm. The bottom panel is the colour intensity microdensitometry map expressing increasing density in kg/m³ by progressive darkening. Scale of sample weld interface position is the same for the two panels

Thus, hydro-thermolysed wood yields welded wood joints of lower strength, while the fully treated wood after the dry heat phase yields welded wood joints of higher strength.

There can be several reasons for the difference in strength between hydro-thermally treated and fully treated wood:

- chemical and physical differences, such as an increased rigidity of the cell walls and loss of a large proportion of intercellular material, as discussed above
- the difference in moisture content between hydro-thermally treated wood (ca. 14–18%) and fully treated wood (5–7%) before welding. This affects both the chemical reactions and physical processes during welding (Gfeller et al. 2003).
- the quality of the surface of the specimens of hydro-thermally-treated wood is inferior to that of fully treated wood. It is not possible to produce hydro-thermally treated wood with a smooth surface during planing, because fibres are torn out of the wood surface (data not shown). This again indicates chemical differences in the intercellular material.

The results in Table 12.2 indicate that there is some sort of correlation between the density of wood before treatment and the welded joint strength but such a correlation is not direct. Thus, the low strength values of poplar-welded joints are definitely due to the much lower density of poplar compared to that of birch and beech. However, the welded joint strength differences between birch and beech are not explainable on the basis of density alone (Table 12.2: birch 4343 MPa at 577 kg/m³, compared to beech 4321 MPa at 661 kg/m³ density).

12.4 Conclusions

Heat-treated wood obtained in industrial production under controlled conditions has been used to obtain welded wood joints by mechanical vibration welding. The strength of the welded wood joints was lower than of welded untreated wood joints. The joints were produced both with the hydro-thermolysed wood obtained after the first wet step of the heat-treatment process, and with the wood obtained after the two-stage heat treatment process was completed. The weld strengths obtained after the full treatment has been completed were markedly better than those obtained with hydro-thermolysed wood.

The weld strengths of heat-treated wood were lower than in the case of untreated wood because the molten intercellular material was markedly less and cells entanglement at the interface was also markedly lower. Increased rigidity and brittleness of the wood cells at the welding interface, induced by the heat treatment, were inferred by the much lower level of cells entanglement observed. This effect was very marked in all the weldlines of hydro-thermolysed wood explaining the lower strength obtained with it. It appears that heat treatment affects the main melting region of the wood, namely the intercellular material. As most of this material is already either lost or heavily cross-linked during heat treatment only little of it is now available to melt and bind the wood surfaces during vibrational wood welding, with a consequent decrease in strength.

13 THE EFFECT OF HEAT TREATMENT ON THE PROPERTIES OF PARTICLEBOARD*

Abstract

Steam pre-treatment can effectively improve the dimensional stability of panel products such as particleboard and fibreboard. At temperatures above 200-210°C steam pre-treatment might result in a significant reduction of the bond strength of the panel product. The results of the two-stage heat pre-treatment process, in which treatment temperatures below 200°C are used, are given in this chapter. The variations in process conditions, which affect the particleboard properties, are described in detail. A two-stage heat pre-treatment with temperatures below 200°C appears to improve the dimensional stability of panel products. The process conditions used showed an effect on thickness swelling and internal bond properties of particleboard, especially during the first process stage (hydrothermolysis). The best results were obtained with wood particles, which were only hydrothermolysed (without curing).

* Boonstra MJ, Pizzi A, Zomers F, Ohlmeyer M, Paul W (2006f) The effects of a two-stage heat treatment process on the properties of particleboard. Holz als Roh- und Werkstoff 64:157-164

13.1 Introduction

Panel products, such as particleboard, are subject to reversible and/or irreversible thickness swelling under wet and moist conditions. According to Sekino et al (1998) this dimensional variability is due to a complex process, based on the potential thickness recovery of densified particles and the breaking of the wood-adhesive bond network.

Heat treatment and in particular steam treatment can improve the dimensional stability of panel products such as particleboard, fibreboard and OSB (e.g. Heebink and Hefty 1969, Shen 1973, Tomimura and Matsuda 1986, Hsu et al 1989, Subiyanto et al. 1991, Sekino et al. 1997, Goroyias and Hale 2002, Ohlmeyer and Lukowsky 2004). According to Sekino et al (1998) heat treatment can be classified into three groups: pre-treatment of the wood before pressing; steam injection pressing in which steam not only treats the wood but also affects adhesive curing; and a steam post-treatment of the panels after pressing. Among these methods steam pre-treatment is seen as the most obvious method for improving panels dimensional stability. Pre-treatment does not limit the choice of adhesive used in panel production, whereas steam injection and post-treatment only work with isocyanate, PMUF, MUF and phenol-formaldehyde adhesives. Furthermore, post treatment results in shrinkage of the wood particles, possibly affecting the wood-adhesive bond network (e.g. breakages and cracks).

Steam pre-treatment temperatures above 200°C are very effective to improve the dimensional stability of particleboard. However, Sekino et al (1998) reported a significant reduction of the bond strength of particleboard with steam pre-treated particles when temperatures above 200-210°C are applied. According to Stamm (1964) this can be explained by the (partial) conversion of the polyoses, which make up about 20% of the middle lamella, into furfural polymers. This results in increased embrittlement and a significant reduction (up to 50%) of shear strength. This reduction in mechanical properties might limit the applications of such a technology to particleboard.

In this chapter the possibility to use the two-stage heat treatment for the production of heat-treated particleboard with an improved dimensional stability and sufficient mechanical properties is discussed.

13.2 Materials and methods

Materials

A mix of Norway spruce (*Picea abies* Karst) and Scots pine (*Pinus sylvestris* L.) chips from an industrial particleboard plant were used for the two-stage heat pre-treatment. The chips were sifted at a diameter of 1.25 mm to 5.00 mm. This size fraction, which is normally used for the core of particleboards, was chosen because it makes it easier to keep the chips in the treatment reactor, it reduces the possibility of contamination and it achieves good heat distribution. Furthermore, the production of test panels with top layers composed of small dimension wood chips is more complex and at this stage not really necessary to

study the effect of pre-treated chips. After the pre-treatment the chips were again sifted to exclude small parts and dust (which might have an effect on the properties of the test panel samples).

The standard moisture content of the chips before treatment was 55%. This moisture content is used because it is near the average moisture content of fresh chips. The effect of variations in the moisture content of the chips between 18% and 75% has been examined. Experiments with chips pre-soaked in warm water in combination with steam treatments have also been performed.

Heat treatment

The heat pre-treatment was performed in two separate stages and a drying stage in between. In the first stage of the heat treatment the chips were treated in an aqueous environment at superatmospheric pressure with saturated steam (8-10 bar), a so-called "hydro-thermolysis" treatment. This was done in a 16 litre or a 600-litre reactor (at 165-185°C). In the 600-litre reactor the chips were placed in stainless steel baskets with a steam injector lance. Cooling down the chips was accomplished by flashing the reactor (a very quick but controlled release of the pressure) to atmospheric conditions followed by a cold-water circulation in the wall of the reactor or pilot plant. The chips were then dried in a kiln at 80°C (shuffling them a few times). After drying, the chips were heat-treated again in a kiln (second stage), now under dry and atmospheric conditions, a so-called "curing" treatment (at 180°C). During this stage superheated steam or N₂ was used as a sheltering gas to exclude oxygen (reducing fire risks and preventing non-desired oxidation reactions).

The standard treatment involved:

- the use of steam as a heating medium in the first process stage (hydro-thermolysis);
- an effective treatment temperature of 165°C (30 minutes) during the first process stage; and
- an effective treatment temperature of 180°C (30 minutes) during the second process stage (curing).

The treatment temperature and process time were varied to investigate possible effects on the material properties.

The hydro-thermolysis stage has also been performed in liquid water instead of using saturated steam, a so-called "liquid full thermolysis" treatment. A heat exchanger has been used to heat and cool the process water in the reactor. Normally a 0.6 g/l NaAc solution was used in order to control the pH (buffering).

Test sample production

After the two-stage heat treatment one layer particleboard test samples were made in a lab press according the following process:

1. the adhesive melamine ureum formaldehyde (MUF; 10% and 13.5% on dry weight basis) was added to the chips with a nozzle, while the chips were

mechanically stirred (stirring has been done slowly to prevent a possible reduction of the chip sizes);

2. the chips were spread by hand on a lab press (50x50 cm or 30x30 cm); and
3. after a cold pre-press period the chips were pressed at a temperature of 180°C during 8, 10 or 12 seconds (per mm).

The thickness of the particleboard samples was ca. 16 mm after sanding and the density varied between 750-800 kg/m³.

Beside the MUF adhesive several other adhesives were used for the production of particleboard test samples:

- phenol formaldehyde PF (10% on dry weight basis);
- methyl diphenyl diisocyanate MDI (5% on dry weight basis); and
- tannin adhesive (15% quebracho tannin extract + 0.75% paraformaldehyde on dry wood weight basis).

The density of these particleboard samples varied between 700-800 kg/m³, with a higher density for the Tannine test samples (825-910 kg/m³).

Untreated chips were also used to make reference samples.

Property testing

In order to determine the treatment effect of the different process conditions on the treated chips, the equilibrium moisture content of the chips was determined at 90% relative humidity (20°C).

The particleboard test samples has been tested with the emphasis on swelling, internal bond (tensile strength perpendicular to the plane of the board) and durability:

- swelling in water at 20°C after 2 hours, 24 hours (EN 317), at equilibrium and after the cyclic test (V313); and
- the internal bond according EN 319 (V20), EN 1087 (V100, after boiling) and EN 321 (V313, after the cyclic test).

13.3 Results and discussion

One of the most striking effects of heat treatment is the reduction in water absorption while maintaining the hysteresis of the typical sigmoid curve of the isotherm (Fig. 13.1). A positive effect of the hysteresis is that small changes in relative humidity do not immediately result in a change of the moisture content of the treated wood. This contributes to the dimensional stability of the treated wood, because swelling and shrinkage is due to the water absorption and desorption of wood. Moreover, a reduction in water absorption reduces the overall swelling and shrinkage of wood, hence improving its dimensional stability (Tjeerdsma et al 1998b).

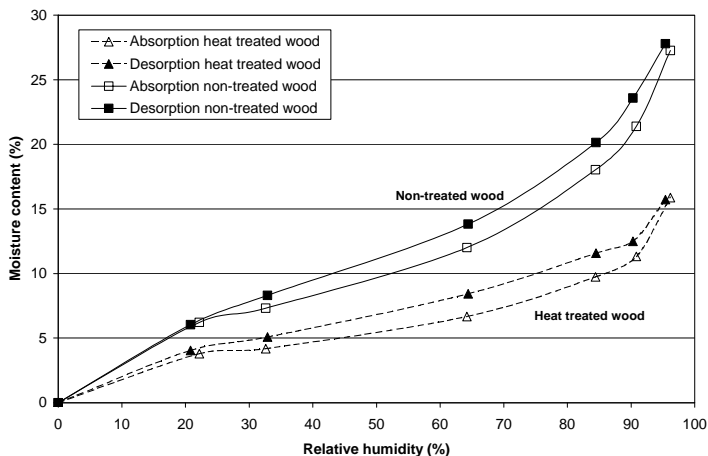

Fig. 13.1 Hysteresis curves of treated and untreated Scots pine

Heat pre-treatment of the particles also resulted in a reduction of the water absorption, as can be concluded from the equilibrium moisture content of treated versus untreated wood particles at 90% RH (Fig. 13.2). A higher relative humidity is not suitable due to the possibility of micro capillary condensation, which results in free water in the cell lumina. Moreover, there is also a risk of moulds growing on the wood chips, which might faulse the test results.

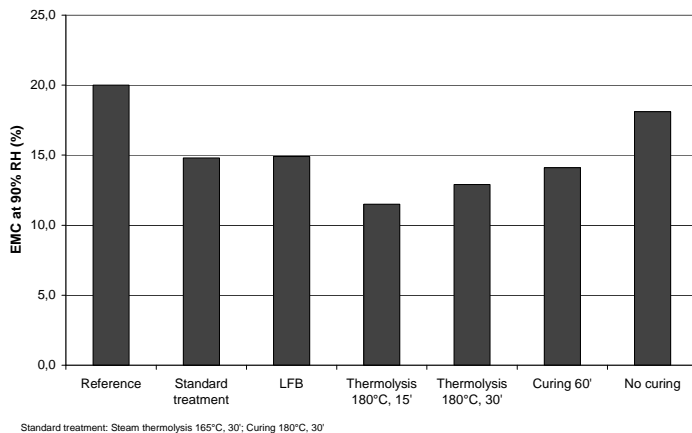

Fig 13.2 Equilibrium moisture content (EMC) of treated and untreated wood particles at 90% RH

The effectiveness of the process used is indicated by the wood EMC at 90% RH. The lower is the EMC the more effective is the treatment. An increase in thermolysis temperature, 180°C instead of 165°C, results in a further reduction of the EMC. There is no difference in the particles EMC either with a steam treatment or a treatment in liquid water with buffering. The effect of a longer curing period, 60 minutes instead of 30 minutes is rather limited. Whereas no curing results in a

reduction of the EMC of the particles compared to untreated wood particles, the EMC is nonetheless significantly higher than the standard two-stage heat treatment (hydro-thermolysis and curing).

The swelling of treated and untreated particleboard test samples during immersion in water at 20°C, up to equilibrium being reached, is shown in Fig. 13.3. The heat pre-treatment might have an effect on the potential thickness recovery (due to chemical modifications of wood components in the cell wall), but it certainly does have an effect on the swelling of the wood particles when immersed in water (Figs. 13.1 and 13.2). It is therefore obvious that heat pre-treatment of the particles results in a reduction of swelling when compared to the untreated reference (Fig. 13.3).

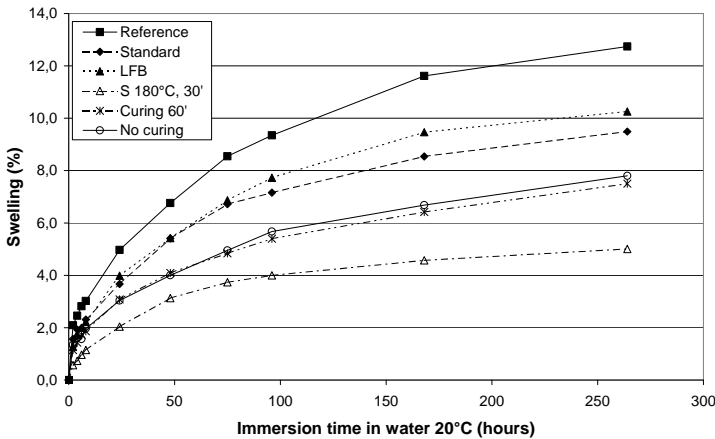

Fig. 13.3 Swelling of treated and untreated particleboard test samples (MUF, 13.5%) in water at 20°C. Standard treatment: steam hydro-thermolysis 165°C, 30 min; curing 180°C, 30 min

The process conditions applied during heat treatment have an effect on the swelling properties of the particleboard test samples (Figs. 13.4 and 13.5). An increase of the thermolysis temperature (180°C) resulted in a further reduction of swelling. A reduction of the hydro-thermolysis process time from 30 to 15 minutes at 180°C resulted in slightly higher swelling properties. A hydro-thermolysis in liquid water (LFB) gave similar results when compared to a steam treatment. An increase to 60 minutes of the curing at 180°C resulted in a further reduction of swelling properties compared to the standard treatment (30 minutes), although this reduction is less comparable to the use of a higher thermolysis temperature. This confirms the results obtained by heat treatment of solid wood, also showing that the variation in (steam) hydro-thermolysis does have a greater impact on swelling properties than the variation in curing conditions (unpublished results).

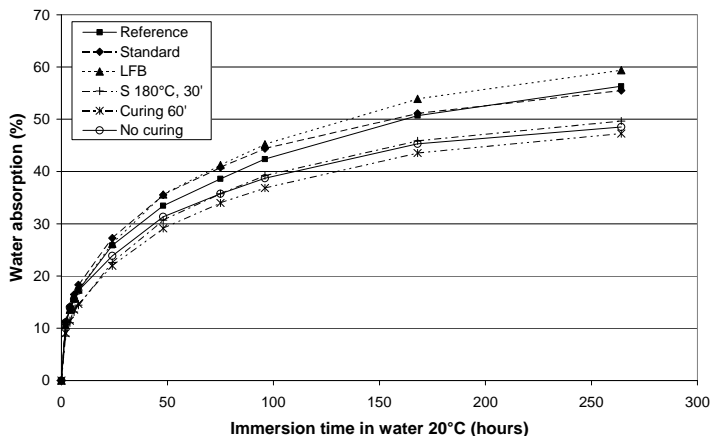

Fig. 13.4 Water absorption of treated and untreated particleboard test samples (MUF, 13.5%) in water at 20°C. Standard treatment: steam hydro-thermolysis 165°C, 30 min; curing 180°C, 30 min

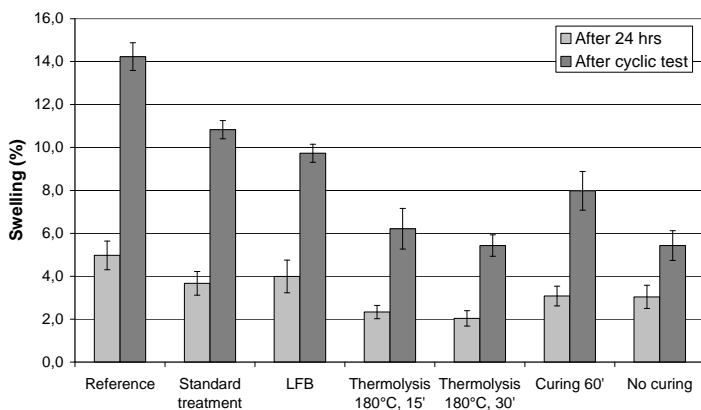

Fig. 13.5 Swelling of treated and untreated particleboard test samples (MUF, 13.5%) after 24 hours immersion in water at 20°C and after the cyclic test. Standard treatment: steam hydro-thermolysis 165°C, 30 min; curing 180°C, 30 min

The swelling of the particleboard made with particles, which were only thermolysed (without a curing), were surprising. The reduction in swelling is increased compared to the standard treatment with a curing stage, especially after a longer immersion period in water and after the cyclic test (Figs. 13.3 and 13.5). There could be several reasons for this result:

1. the distribution of the adhesive system on the wood surface and in the wood pores might be improved, due to the more hydrophobic properties of the particles (Fig. 13.2). This could have a positive effect on the adhesion forces of the adhesive system;

2. during pressing at 180°C curing reactions already reported (see Chapter 4) occur in the wood cell walls, resulting in improved dimensional stability (lower swelling);
3. in Chapter 4 an increase in the number of free reactive sites on the aromatic ring of some lignin units during the first treatment stage (hydro-thermolysis) is demonstrated. In the second treatment stage lignin autocondensation occurs through the formation of methylene bridges connecting aromatic rings (a cross-linking mechanism). These reactions might also occur during pressing at 180°C, also for particles, which are only hydro-thermolysed (without curing). The MUF adhesive system is also likely to be involved in this reaction mechanism, resulting in an improved wood-adhesive bond network; and
4. less reactive sites are likely to be available on treated rather than untreated wood particles when a standard treatment, hence including a curing stage, is used. This is due to autocondensation of the lignin units. This might result in a lower quality wood-adhesive bond network, affecting the swelling properties of the test samples.

Although the swelling of particleboards made with hydro-thermolysed particles is better than those with the complete two-stage heat treatment particles, it is not clear whether this treatment is enough to improve durability against biological degradation. The pressing temperature (180°C) should be high enough, but the effective process time at this temperature is rather low (2-3 minutes) and only the first 1-3 mm at the top and bottom of the particle test boards will be heated to 180°C. Experimental work with solid wood showed that proper curing (180°C for several hours) is necessary to obtain a significant improvement of the durability against the degradation induced by brown rot and white rot fungi (unpublished results). The situation is more complex for treated particleboards, due to the wood-adhesive bond network. Unfortunately, the experience with, and the significance of fungal durability experiments of treated panel products are still rather limited. Furthermore, the effect of heat pre-treatment on the long-term performance under exterior service conditions is not clear, in particular for a hydro-thermolysis treatment without curing. The swelling tests, which are commonly used to determine the performance of panel products, do give an indication, but whether or not there is good correlation with long term, exterior service conditions is not known.

During immersion in water the test samples absorb water, which is either free or bonded. Free water is located in the cell lumen, the intercellular spaces and in free spaces in the wood-adhesive bond network. Bonded water is located in the cell wall and possibly also in the wood-adhesive network. The difference in water adsorption between treated and untreated test samples is rather small. However, some process conditions seem to result in a significant reduction in water adsorption, especially a higher hydro-thermolysis temperature and a longer curing process time (Fig. 13.4). This reduction could be due to lower water absorption of bonded water in the cell wall, although this effect is rather limited (Fig. 13.2).

Heat treatment generally results in a reduction in dry internal bond (Fig. 13.6), due to the reduction of shear strength of the wood particles (mainly caused by the acid

catylased cleavage of the carbohydrates). After the boiling test (V100) however the internal bond of the treated samples is similar or higher than the untreated reference. In the untreated reference samples this might be due to the potential thickness recovery of the densified particles and swelling of these particles resulting in breaking of the wood-adhesive bond network. In treated particleboard the swelling of the treated particles (and possibly also their thickness recovery) is reduced, resulting in a relative lower impact (less breaking) of the wood-adhesive bond network.

The internal bond (IB) strength of the untreated reference after the cyclic V313 test is significantly higher than the IB strength of the treated boards, except for the uncured boards. The test conditions during the cyclic test are less rigid than during the boiling test. This might have a positive effect on the internal bond strength of the untreated reference, when compared to the treated boards. The treatment without curing gave the best IB strength results, significantly higher than the other treatments. The differences in internal bond strength between the other treatments are rather limited.

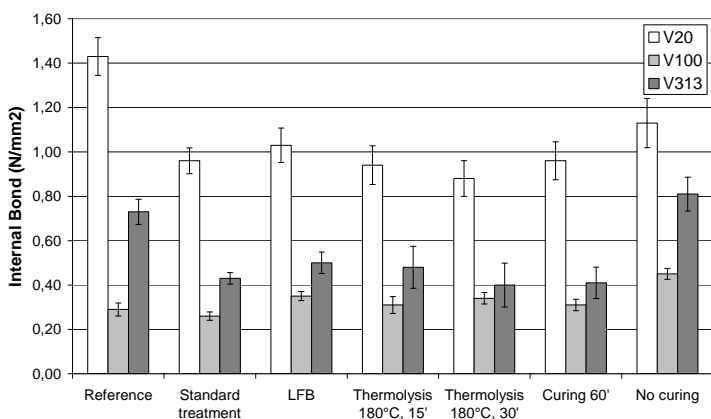

Fig. 13.6 Internal bond of treated and untreated particleboard test samples (MUF, 13.5%) at 20°C (V20), after the boiling test (V100) and after the cyclic test (V313). Standard treatment: steam hydro-thermolysis 165°C, 30 min; curing 180°C, 30 min

The main reason for the execution of a liquid full thermolysis is the possibility of adding a buffer to the process water (to control the pH at 4.2). During steam thermolysis the pH of the particles is reduced to 3-3.5, due to the formation of acetic and formic acid. These acids are important as catalysts of the reactions occurring during thermolysis (see Chapter 4 and 5), but are also present in cleavage reactions (e.g. hydrolysis) of cellulose and hemicelluloses. This results in a worsening of mechanical properties. The use of a buffer might reduce such cleavage reactions in order to maintain the mechanical properties at the same level. The effect on the internal bond strength of the particleboard is, however, rather limited (Fig. 13.6). The contribution of the buffer to prevent hydrolysis reactions is probably limited too.

Pre-soaking the particles (up to a moisture content of 200%) before heat treatment (steam hydro-thermolysis + curing) seems to have a positive effect on the internal bond of particleboard (Fig. 13.7). A lower acid concentration (dilution) might have a positive effect reducing the undesirable cleavage reactions of the carbohydrates.

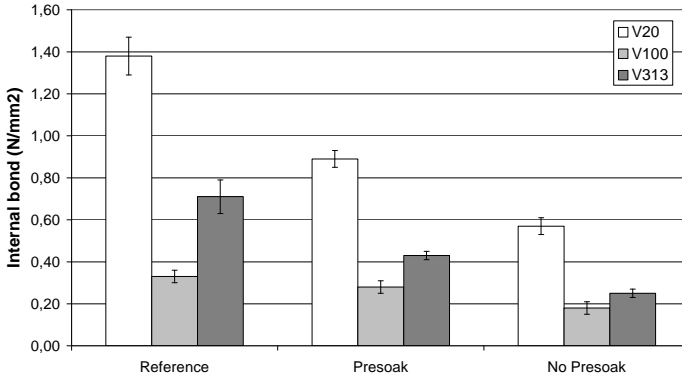

Fig. 13.7 The effect of pre-soaking the particles on the internal bond of treated and untreated test samples (MUF, 13.5%)

The amount of water present in the wood particles might play an important role in the reaction mechanism during the first heat treatment stage (hydro-thermolysis). Changes in the moisture content of the particles, ranging from 18% to 75% and water-soaked particles, gave similar results in swelling and internal bond properties. The amount of water molecules in the particles at a moisture content of 18% is probably enough for the typical heat treatment reactions in the cell wall to occur.

Nitrogen gas and superheated steam is used to exclude oxygen during the curing stage. The effect on the swelling and internal bond properties of the treated test samples is rather limited. However, superheated steam seems to have a positive effect on the swelling properties (lower) and internal bond (higher). Although superheated steam is used, the conditions might be a bit moist during the curing, hence affecting the reaction mechanism.

The adhesive system used for the board test samples does have a rather marked effect on the swelling properties of the boards (Figs. 13.8 and 13.9), mainly caused by the intrinsic differences between the adhesive systems used. Changes of the material properties of the wood particles after heat pre-treatment (e.g. hydrophobicity, pH), which affects the bonding network, could have an effect on the swelling properties as well.

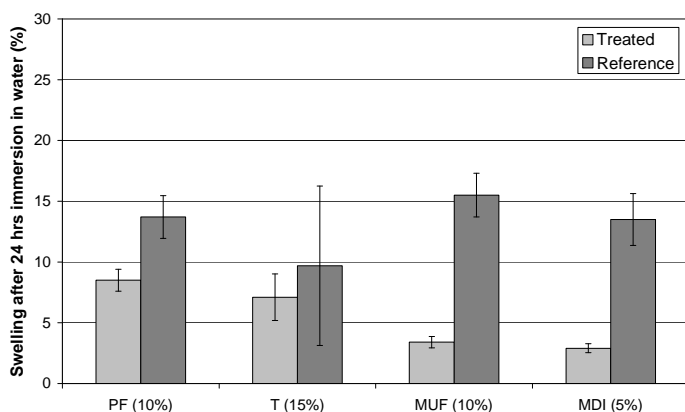

Fig. 13.8 Swelling of treated and untreated particleboard test samples after 24 hours immersion in water at 20°C. The effect of different adhesives. Hydro-thermolysis: LF 185°C; curing: 180°C, 240 min

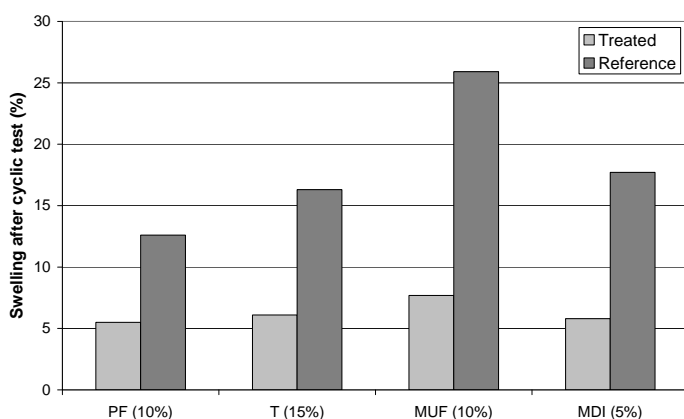

Fig. 13.9 Swelling of treated and untreated particleboard test samples after the cyclic test. The effect of different adhesives. Hydro-thermolysis: LF 185°C; curing: 180°C, 240 min

MUF and MDI gave the best results after 24 hours immersion in cold water. The swelling of the PF- and Tannin-bonded boards were significantly higher. The swelling of the boards after the cyclic test, however, shows no significant differences between the adhesive systems used, although the swelling of MUF-bonded boards was slightly higher than for the other three adhesive systems. The swelling of the untreated MUF-bonded boards is also significantly higher than that of boards bonded with the other adhesive systems. The MUF adhesive system might be more sensitive to swelling after the cyclic test and the test conditions used in this test method. The swelling of the untreated reference MUF samples were higher than the results given in Figure 13.3 and Figure 13.5. This might be

due to a lower adhesive percentage (10% versus 13.5%) and/or to the use of another MUF adhesive of lower melamine content.

Phenol-formaldehyde adhesives are known as one of the most durable bonding systems, suitable for exterior application. The rather high swelling observed for the boards bonded with this adhesive after immersion in water might be due to the curing mechanism active during pressing. The alkali-catalysed curing mechanism of PF resins might be negatively influenced by the rather high acid character of the treated wood particles, resulting in a wood-adhesive bonded network of lower performance. Quebracho tannin adhesives are known to be sometime less effective adhesives for particleboards than PF resins. The variation in the test results of the untreated reference panels bonded with quebracho tannin adhesive is rather high. This is due to the characteristic polymerisation/depolymerisation equilibrium present exclusively in quebracho tannin, which introduce a greater variability for this type of tannin adhesive (Pizzi and Stephanou 1994). Furthermore, as these adhesives are also used in alkaline environment, this peculiarity is compounded by the decrease in rate of curing that applies also to PF adhesives due to the acid response of heat-treated wood.

The internal bond properties of the test samples show some minor differences in the adhesive system used (Figs. 13.10, 13.11 and 13.12). The dry internal bond of the MUF samples seems a bit higher than PF and MDI samples, whereas after the boiling and cyclic test there is almost no difference in internal bond between MUF and the PF/MDI boards. The internal bond of the quebracho tannin-bonded boards is lower than for the other three adhesive-bonded boards, with a higher variation in the test results. The heat treatment of the particles resulted in an improvement of the internal bond after the cyclic test, especially for the MUF and MDI boards.

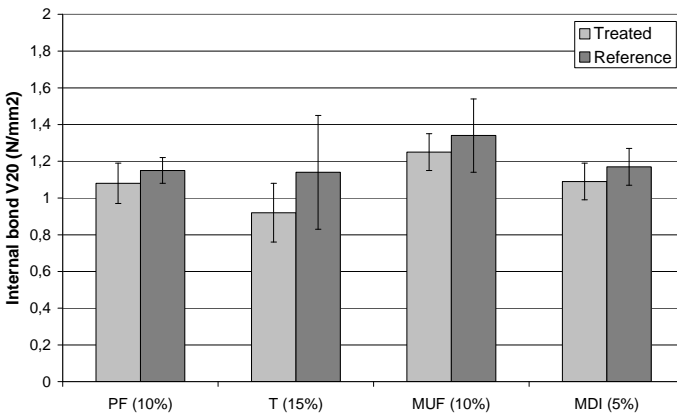

Fig. 13.10 The dry internal bond (V20) of treated and untreated particleboard test samples. The effect of different adhesives. Hydro-thermolysis: LF 185°C; curing: 180°C, 240 min

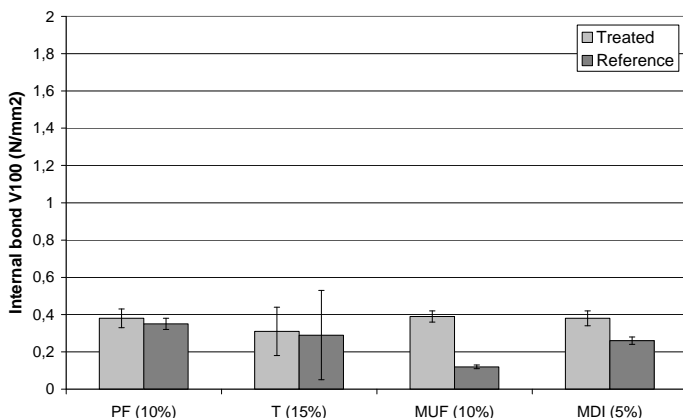

Fig. 13.11 The internal bond of treated and untreated particleboard test samples after the boiling test. The effect of different adhesives. Hydro-thermolysis: LF 185°C; curing: 180°C, 240 min

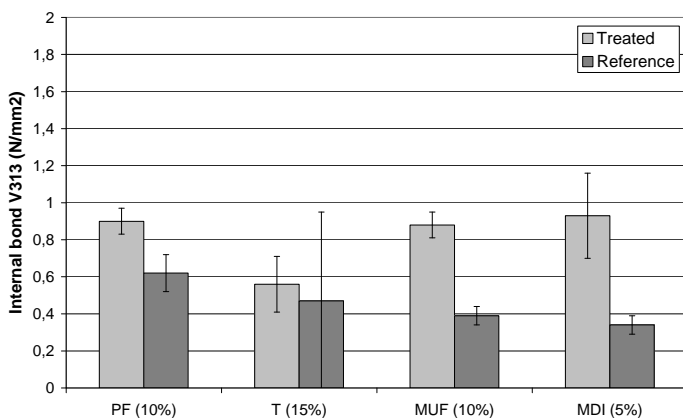

Fig. 13.12 The internal bond of treated and untreated particleboard test samples after the cyclic test (V313). The effect of different adhesives. Hydro-thermolysis: LF 185°C; curing: 180°C, 240 min

There is no difference in swelling and internal bond properties observed between an effective pressing time of 10 versus 12 seconds (per mm). A pressing time of 8 seconds per mm panel thickness resulted in blow-out within the particleboard .

Whether or not a heat pre-treatment technology can be successfully applied as an add-on device in a panel production plant depends on various factors, such as:

1. does the surplus value counter balance the costs? For instance, particleboard is seen as a 'low value' and inexpensive panel product. The extra costs of a heat-treated particleboard might be too high to counter balance the added value (exterior applications). The possibilities of heat-treated OSB or

- fibreboard could be better, because these products are set in the market at a higher value level and the extra costs might counter balance the added value;
2. it is obvious that a heat pre-treatment must be a cost effective and efficient process in order to obtain a profitable product. Because the material for panel products is in general a lower value material, the requirements for it to meet such demands are rather high;
 3. the use of heat pre-treated wood in panel products does change some other aspects of the product, such as its odour (caramelised) and its colour (brown). Would the market accept these changes?
 4. what is the minimal equipment necessary to perform a heat pre-treatment? What are the engineering uncertainties and what is the up-scaling effect of such a treatment process from lab-scale to a full scale production plant; and
 5. which tests should be done to determine the swelling and durability properties of the panel product. Is it possible to quantify the improvement and/or to determine the values of these properties (for use in exterior applications)? Does these tests reflects common practice and/or what test results are required for use in exterior applications?

13.4 Conclusions

A two-stage heat pre-treatment with temperatures below 200°C seems to have a potential to improve the dimensional stability of panel products. The process conditions applied do have an effect on the swelling and internal bond properties of the particleboard test samples, especially during the first process stage (hydro-thermolysis). The best results were obtained with the particles, which were only hydro-thermolysed (without curing). However it is not known whether such a treatment is enough against biological degradation and what long-term durability under service conditions is.

SUMMARY OF PART III

Densification

Compression in the transverse directions is a method to increase the density of wood in order to improve its mechanical properties, such as strength and stiffness. A major disadvantage of this method is the recovery of the original dimensions when densified wood is exposed to moisture (swelling). According to Blomberg (2006) this swelling is mainly due to cell wall bulking and especially cell-shape recovery. It was expected that heat treatment, which improves the dimensional stability of wood, could provide a fixation effect for densified wood when exposed to moisture. Unfortunately, heat treatment did not prevent shape-recovery when densified radiata pine was exposed to moisture. Densification was performed before (after the hydro-thermolysis stage), during (combination of densification and curing) and after the curing stage. In all cases a clear shape-recovery of densified radiata pine was visible, although some improvement (less swelling) was observed for the specimens, which were densified before and during the curing stage. Plastization of the remaining hemicelluloses and/or the lignin polymer network, and condensation reactions within the lignin polymer network might play a role in this improvement resulting in some fixation of the cell wall to a more permanent structure, which is less susceptible to moisture.

Remarkable is the densification of hydro-thermolysed radiata pine, which resulted in a higher volume loss and subsequently a larger increase of the density than untreated and fully treated wood. This must be due to differences in compression during densification and/or to differences in elastic springback (immediate or delayed) after densification.

Vibration welding

Mechanically induced vibration welding of wood, without any adhesive, is known to rapidly yield wood joints satisfying the relevant requirements for structural applications. Vibration welding of heat-treated wood indicated that such wood could weld and yield welded joints of acceptable strength. The joints strength is, however, markedly lower than what obtained when welding untreated timber. In general, weld strength of the timber is poor if welding is done on hydro-thermolysed wood. The strength results are instead much better if welding is done at the end of the complete heat treatment process (including the curing stage). The weld lines of heat-treated wood show entangled cells where there is none or very little of the molten matrix intercellular material usually observed in welded timber. Furthermore, in weldlines obtained after hydro-thermolysis an increased rigidity and brittleness of the wood cells is observed. Hence, the wood cells are not entangled at all or only to a very limited extent. Both observations indicate that heat treatment has affected the main melting region of wood, namely the intercellular material. As most of this material is already either lost or heavily

cross-linked during heat treatment, only little of it is now available to melt and bind the wood surfaces during vibrational wood welding.

Panel products

Panel products like particleboards are subject to reversible and/or irreversible thickness swelling under wet and moist conditions. Heat pre-treatment of wood particles (an industrial mixture of Norway spruce and Scots pine particles) resulted in an improved dimensional stability of a melamine ureum formaldehyde (MUF) based particleboard. Variations of the process conditions (e.g. process time and temperature) showed an effect on the swelling properties of the particleboard. Variation in hydro-thermolysis conditions, especially the effective process temperature, resulted in greater impact on the swelling properties than variation in curing conditions. Remarkable is the swelling of particleboard made with particles, which were only thermolysed (without a curing). The reduction in swelling is increased compared to the standard treatment with a curing stage, especially after a longer immersion period in water and after the cyclic test. Several reasons have been suggested for this difference:

1. the distribution of the adhesive system on the wood surface and in the wood pores might be improved, due to the more hydrophobic properties of the particles;
2. during pressing at 180°C the typical curing reactions (e.g. autocondensation reactions) occur in the wood cell walls, resulting in improved dimensional stability (less swelling);
3. the MUF adhesive system is also likely to be involved in this reaction mechanism, resulting in an improved wood-adhesive bond network; and
4. less reactive sites are likely to be available on fully treated wood, due to autocondensation reactions of the lignin units. This might result in a lower quality wood-adhesive bond network, affecting the swelling properties of treated particleboard.

Heat pre-treatment results in a reduction of the internal bond (dry and after a cyclic V313 test), probably due to the reduction of shear strength of the wood particles. After the boiling test (V100) the internal bond is similar or slightly higher than for the untreated reference. In treated particleboard the swelling of the pre-treated particles (and possibly also their thickness recovery) is reduced, resulting in a relative lower impact (less breaking) of the wood-adhesive bond network during the boiling test. The treatment without curing gave the best internal bond strength results, significantly higher than a full treatment. This can be caused by (better) strength properties of the hydro-thermolysed particles and/or to a higher quality wood-adhesive bond network as discussed above.

The adhesive system does have a rather marked effect on the swelling properties of the particleboards, mainly caused by the intrinsic differences between the adhesive systems used: MUF, methyl diphenyl diisocyanate (MDI), phenol-formaldehyde (PF) and tannin. Changes of the material properties of the wood particles after heat pre-treatment (e.g. hydrophobicity, pH), which affects the bonding network, could have an effect on the swelling properties as well. MUF and

MDI gave the best results after 24 hours immersion in cold water. The swelling of the PF- and tannin-bonded particleboards were significantly higher. The swelling of the boards after the cyclic test, however, showed no significant differences between the adhesive systems used, although the swelling of MUF-bonded particleboards was slightly higher than for the other three adhesive systems. The rather high swelling observed for the boards bonded with PF adhesive after immersion in water might be due to the curing mechanism active during pressing. The alkali-catalysed curing mechanism of PF resins might be negatively influenced by the rather high acid character of the treated wood particles, resulting in a wood-adhesive bonded network of lower performance.

The internal bond properties showed some minor differences in the adhesive system used, although the internal bond of the tannin-bonded particleboard appears to be lower than the other three systems.

14 UTILISATION POTENTIAL AND PERSPECTIVES

Heat treatment technologies, such as the Plato process, provide an economically attractive option to upgrade fast-grown and lower durability softwood and hardwood species. The relative simplicity of a heat treatment process enables realisation of industrial plants and in the last decade several plants have been build. In Table 14.1 an overview is shown of the industrial plants build in Europe and the production of heat-treated timber in 2007. Commercial utilisation has been realised and heat treatment technologies appear to be cost effective providing a competitive material for a range of different products.

What the potential markets are for heat-treated timber and whether heat-treated timber can be used for certain applications, depends on several factors, such as:

- material properties;
- dimensions and wood quality;
- environmental profile; and
- market aspects.

Table 14.1 Production of heat-treated timber in Europe (Source: Holzkurier 38, 20 September 2007)

Producer	Production 2007 (m ³)	Max. Capacity (m ³)
Austria		
Mafi, Schneegattern	4500	5000
Mitteramskogler, Gafrenz	7000	10000
Stia, Admont	---	---
Denmark		
Fromsseier, Vorbasse	---	---
Estland		
Tretimber, Talinn	4500	---
Finland		
Ekosampo, Kerimäki	13000	13000
Finnforest, Metsä	22000	22000
Heinolan Ruskopuu, Heinola	---	---
HJT-Holz, Vippula	7500	7500
Oy Brown, Vampulantie	---	---
Oy Lunawood, Soinlahti,	22000	22000
SWM Wood, Mikkeli,	8500	10000
Stora Enso Timber, Porvoo,	17000	17000
Suomen Lämpöpöy, Teuva	10000	10000
Germany		
Hagensieker, Bad Essen	---	10000
Menz Holz, Ehrenberg-Reulbach	800	1000
Thermoholz Spreewald, Lübbenau	4000	6000
Netherlands		
Plato International BV, Arnhem	7000	15000
Switzerland		
Balz, Langnau/CH	3000	3500
Total	130800	152000

14.1 Material properties

The main effect of heat treatment is the decrease of the hygroscopicity, hence improving the dimensional stability of wood. In general, heat-treated wood is rather hydrophobic with low shrinkage and swelling values. This, however, depends on the wood species used for heat treatment and variations between treated wood species still occur (Table 14.2). For instance, heat-treated Norway spruce shows low shrinkage and swelling values. Furthermore, the water absorption rate is rather low since Norway spruce consists mainly non-permeable heartwood. Heat-treated Norway spruce is therefore a material suitable for applications where dimensional stability is very important such as exterior joinery (window frames, doors, cladding).

An example of the performance of heat-treated Norway spruce in service is the application as cladding. In the Netherlands heat-treated Norway spruce has been used for several hundreds of cladding projects. So far, no complaints were noticed with respect to dimensional stability, even when the cladding was fastened without an expansion distance between the individual cladding boards (an expansion distance of at least 4 mm is required by Dutch directives). This was not the case when heat-treated South-African (SA) pine was used for a cladding without an expansion distance between the individual boards. Commercial sold SA pine timber contains only sapwood and the moisture absorption of this wood species is very fast, even after heat treatment (Fig. 14.1). Although the shrinkage and swelling properties of SA pine are improved after heat treatment, this material is not really dimensional stable since it responds immediately on changes in humidity. The cladding in question showed stresses between the individual boards due to swelling/shrinkage and an expansion distance is therefore necessary.

Table 14.2a Physical properties of several industrial heat-treated timber softwood species (non-published data)

Properties		Fir	Larch	Norway spruce	SA pine**	Scots pine
Density	kg/m ³			421	552	524
Stdev	kg/m ³			40	36	
Moisture content	%			5.0	7.2	5.1
EMC*						
65% RH, 20°C	%			6.0		5.1
90% RH, 20°C	%	11.9	9.6	9.8	13.2	9.9
95% RH, 20°C	%	15.9	10.4	11.5	15.3	
Radial shrinkage						
saturated->65% RH	%			1.0	1.2	
65%->oven dry	%			1.0	1.6	
saturated->oven dry	%	2.8	1.8	1.9	2.8	1.9
Tangential shrinkage						
saturated->65% RH	%			1.8	2.1	
65%->oven dry	%			1.7	3.0	
saturated->oven dry	%	5.6	4.5	3.5	5.1	3.6

* Adsorption

** South African pine is sold as a pine group containing *P. elliottii*, *P. taeda*, *P. patula* and *P. palustris*

Table 14.2b Physical properties of several industrial heat-treated timber hardwood species (non-published data)

Properties		Alder	Ash	Beech	Birch	Poplar
Density	kg/m ³	473	671		601	361
Stdev	kg/m ³	21	46		22	33
Moisture content	%	5.7	4.3		5.7	4.0
EMC*						
65% RH, 20°C	%					
90% RH, 20°C	%	11.2	10.4		12.0	10.1
95% RH, 20°C	%	12.9	12.2		14.3	12.2
Radial shrinkage						
saturated->65% RH	%	0.8	1.3		1.8	1.0
65%->oven dry	%	1.3	2.0		2.1	1.1
saturated->oven dry	%	2.1	3.3	3.6	3.9	2.1
Tangential shrinkage						
saturated->65% RH	%	1.7	2.1		3.7	2.1
65%->oven dry	%	2.5	3.3		3.1	2.0
saturated->oven dry	%	4.2	5.4	7.8	6.8	4.1

* Adsorption

Another example is related to wood species with relative high shrinkage and swelling values such as beech. Although heat treatment reduces the shrinkage and swelling values of these wood species (by 30-40%), these values are still rather large when compared to for instance heat-treated Norway spruce (Table 14.2). The application of such wood species is therefore limited, especially when dimensional stability is of importance.

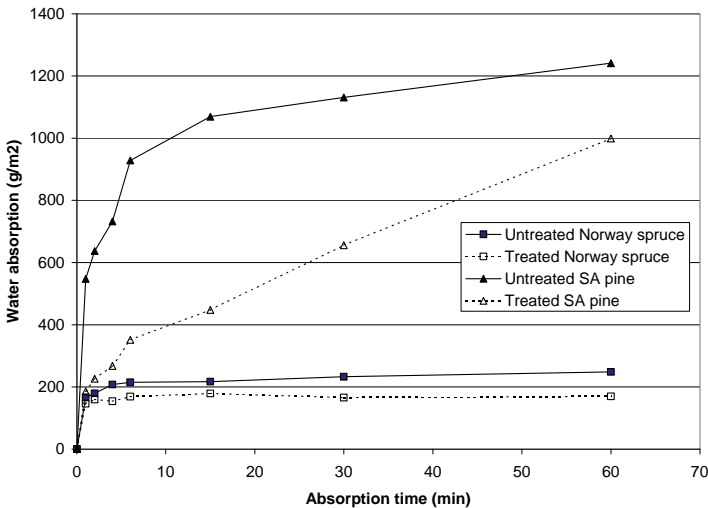

Fig. 14.1 Longitudinal water absorption of treated and untreated Norway spruce and SA pine (non-published data)

An important wood property, which is also improved after heat treatment is the resistance against fungal attack. Heat-treated timber can therefore be used in applications with high risk of fungal decay. Nevertheless, differences in durability have been noticed between heat-treated wood species favouring or restricting

these species for certain applications. The difference in durability between heartwood and sapwood is another factor, which should be taken into account. Although the durability of sapwood is improved after heat treatment, it is still lower than the durability of treated heartwood. This is important for wood species, which contains mainly sapwood (e.g. radiata pine), but also for wood species with a rather high percentage of sapwood (e.g. Scots pine, Douglas fir). A characteristic of heat-treated wood is that the treatment is through and through, which results in an enhanced overall durability. Therefore, heat-treated wood can be sawn or planed without loss of durability and damages (e.g. cracks) do not result in a higher risk of deterioration.

According to Syrjänen et al. (2000) the Finnish heat-treated wood species are not suitable for use in class 4 applications (ground/water contact) probably due to the presence of soft rot fungi. Contrary to these Finnish products some two-stage heat-treated wood species appear to be suitable for hazard class 4 applications, e.g. Norway spruce and Douglas fir (heartwood). This is based on results of ENV 807 soft rot tests (Tjeerdsma et al. 1998b and 2002) and ongoing EN 252 graveyard tests. Semi-practice tests such as the EN 252 graveyard and EN 330 L-joint test (performed at different locations) are very important to determine the performance of heat-treated wood in service conditions, e.g. with respect to biological decay. Unfortunately, the duration of semi-practice tests is rather long (several years), which might restrict commercial utilization of new wood products. Short-term tests such as the CEN/TS 15038-1 basidiomycetes and ENV 807 soft rot test are therefore useful tools to predict the biological durability.

As expressed in Chapter 6, for certain applications other biological hazards should also be taken into account, such as bacteria, maritime organisms, insects and termites. This depends on the application and the location where heat-treated timber is applied. For instance, in the south of Europe termites are a hazard to (unprotected) wood products, whereas this is not a hazard in northwest Europe.

In the past the main objection for using heat-treated wood was the decreased mechanical properties. Currently, most heat treatment processes are optimised with adequate strength and stiffness properties for most timber applications, non-constructive but also constructive elements. However, it is important to carefully consider the stresses that occur in a construction. Furthermore, some practical consequences when using heat-treated timber are important related to the impact of heat treatment on different strength properties, which is not proportional. This also includes mechanical fasteners, which are used to connect two or more constructive elements, since heat treatment could affect the rigidity of the joint. An example is shown in Figure 14.2, which shows a decrease of the maximal screw tensile strength after heat treatment of Norway spruce (non-published data).

Furthermore, there are relevant questions, which should be considered if heat-treated wood is used for constructions, such as:

1. What is the effect of heat treatment on the characteristic strength values and subsequently the strength class of timber (EN 338)?
2. What is the long-term behaviour of heat-treated timber (e.g. creep)?
3. How does heat-treated wood respond to cyclic or repeated loadings (fatigue)?

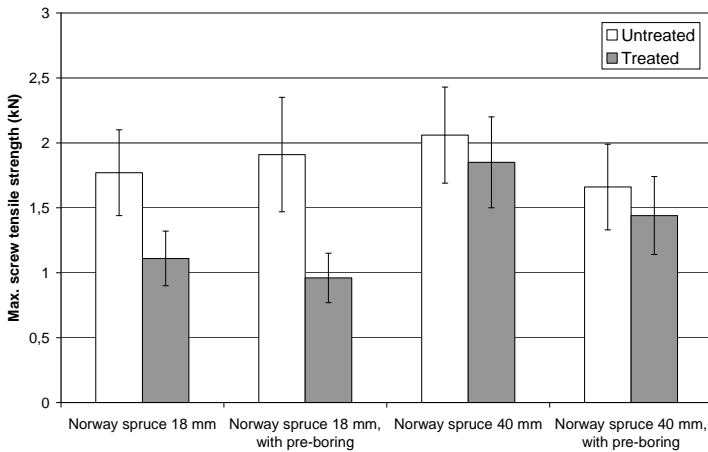

Fig. 14.2 Maximal screw tensile strength of heat-treated and untreated Norway spruce (non-published data). Wood screws were used with a length of 30 mm and a thickness of 3.5 mm

Other relevant properties, which could influence commercialisation of heat-treated wood, are discussed below.

Colour

Colour is an aesthetic topic. The brown colour could limit or favour the application of heat-treated timber. The typical wood texture is still visible or even accentuated.

Smell

Directly after heat treatment the timber has a strong smell. This smell decreases in intensity after a few days and is almost disappeared after a few months. Machining of heat-treated timber recovers this specific smell.

Raising grain

After machining, some timber species are sensitive for raising grain between earlywood and latewood at the pith site of the board (e.g. Norway spruce, larch). Raising grain can still occur after heat treatment. It is therefore important to plane the boards with the sapwood site as the visual top site.

Weathering and UV-resistance

The surface of heat-treated timber is naturally weathered due to the influence of sunlight, rain and wind. This does not affect the durability of the timber, but the wood surface will become grey after a while. This colour change is more obvious for heat-treated timber than for untreated since heat-treated timber is dark brown before weathering.

Paint ability

The surface of heat-treated timber can be painted, to prevent weathering or for aesthetic reasons. Penetration and adhesion of the paint system can be affected

by heat treatment. Heat-treated wood is more hydrophobic than untreated wood and a longer time might be necessary to dry the film layer of waterborne paint systems. Therefore, it is recommended to use two thin film layers instead of one thick film layer (e.g. two dry film layers of 40 µm instead of one dry film layer of 80 µm). If needed the surface tension can be adjusted by adding additives to the paint system. Exudation of resins during heat treatment can be a problem when painting resinous timber species. Heat-treated timber can be painted with organic solvent-based paint systems (e.g. alkyd systems) and with the commonly used stains and oils. It is not recommended to use transparent film-forming coating systems, since there is a risk of weathering under the film layer affecting the adhesion. If a transparent film-forming system is used for the coating of heat-treated timber, it must be a coating system containing a UV-absorber (pigmented) and an anti-sapstain fungicide.

Bonding properties

Preliminary experimental work revealed that heat-treated timber can be bonded with the commonly used adhesives such as polyphenylacetate (PVAc), melamine ureum formaldehyde (MUF) and methyl diphenyl diisocyanate (MDI). However, it is expected that heat treatment affects the bonding performance of wood. The improved dimensional stability should have a positive effect on the bonding properties. For instance, stresses on the adhesive layer between two laminates or within a finger joint will be reduced. Such stresses might occur when the relative humidity and subsequent the wood moisture content changes (resulting in shrinkage/swelling). On the other hand, heat treatment might also result in some disadvantages. Currently used and recently introduced adhesives in the timber industry are waterborne-based systems (emulsions and dispersions). The water content of common adhesives is about 50-60% and a relevant part of the moisture is absorbed by the wood surface during the hardening stage. The water absorption rate might affect the hardening process of the adhesive and subsequently the quality of the bond. For instance, a surface that absorbs less water and/or absorbs water slower might delay the hardening process affecting the bond quality. Furthermore, the distribution of the adhesive on the wood surface and (partial) penetration of the adhesive in the wood (pores), which is necessary to achieve a good bond, might also be affected by heat treatment.

A critical aspect is the moisture content, which is rather low after heat treatment (ca. 3-4% after treatment and 7-8% at service conditions). This affects the bonding process of a one-component MDI system, since water is necessary for the hardening process. A practical solution is wetting the wood surface before the addition of the adhesive. A two-component MDI adhesive is also an alternative but the application of such systems might give practical problems, since it bonds the equipment (e.g. press) if not properly applied. The low pH (3.5-4.0) of heat-treated wood is another critical aspect affecting bonding processes, especially when phenol resorcine formaldehyde (PRF) adhesives are used. Acetic and formic acids, present in wood after heat treatment, might neutralize the alkaline hardeners used for PRF adhesives affecting the adhesive hardening.

In conclusion: in order to obtain a good bonding performance it might be necessary to change the bonding process and/or adhesive formulation.

In Europe and more specific in the Netherlands, wood applications are specified in different directives and standards, including specific requirements for wood and woody material. These requirements could be related to the timber species used, wood quality, density, machined profile, durability class (EN 350-1), dimensional stability, moisture content, strength class (EN 338), paint ability, finger jointing and laminating properties, and/or fire behaviour, depending on the application. It is obvious that new materials such as heat-treated timber must fulfil these requirements when used in wood applications. It is necessary to reconsider some requirements since the characteristics of heat-treated timber differ from untreated wood. An example is the equilibrium moisture content, which is much lower for heat-treated wood than for untreated timber. A moisture content of 14-16%, which is commonly required for joinery, is therefore not useful for heat-treated wood. This requirement corresponds with a moisture content of 8-9% for heat-treated wood, based on a relative humidity of approximately 70-80%. Another example, as described in Chapter 10, is the determination of the strength class based on bending strength, modulus of elasticity and density. The reduction of the density, which is commonly found after heat treatment, does not automatically mean a decrease of the strength properties. The characteristic density values (average and 5% value) given in the European standard EN 338 should therefore be reconsidered when heat-treated timber is applied.

Implementation of an appropriate internal quality control system is important to provide quality assurance of heat-treated timber. This involves a quality control of the timber before and after heat treatment. Before heat treatment important parameters as sawing method, wood quality and moisture content should be checked and registered. After heat treatment the attention must be focussed on wood quality (e.g. collaps, deformation, cracks) and product control. On a regular basis products tests such as an equilibrium moisture content (EMC) test at high relative humidity (>90% RH) and a strength test (bending test according EN 408) should be done as a control of the heat treatment process. The process conditions (temperature, time, pressure) are monitored and controlled during heat treatment. Deviations of the process conditions should be registered and if necessary the process conditions can be adjusted (e.g. heating and cooling down rate).

A special task for producers of heat-treated timber is the release of specific information and instructions for dealers, clients and consumers. In general heat-treated timber behaves as untreated timber, but typical differences exist (e.g. machining, paint ability, glue ability).

14.2 Dimensions and wood quality

A practical consequence of heat treatment is a reduction of wood dimensions caused by shrinkage. Most commercially sold (soft)wood species are available in a limited number of cross section sizes. This means that the thickness and width of heat-treated timber are somewhat reduced and subsequently the dimensions of heat-treated wood products after machining. In Table 14.4 an example from

practice is given of treated and untreated Norway spruce, before and after planning.

Table 14.4 Cross section dimensions of Norway spruce timber before and after heat treatment

Untreated	Heat-treated	Heat-treated planed
20 x 150	19 x 146	15 x 140
23 x 100	22 x 97	18 x 90
23 x 150	22 x 146	18 x 140
23 x 200	22 x 195	18 x 189
32 x 150	30.5 x 146	27 x 140
38 x 150	36.5 x 146	32 x 140
47 x 150	45 x 146	40 x 140 (40 x 66)
50 x 150	48 x 146	42 x 140
75 x 75	73 x 73	66 x 66
75 x 150	73 x 146	66 x 140
75 x 175	73 x 170	66 x 164
75 x 200	73 x 195	66 x 185
100 x 100	97 x 97	85 x 85

Heat treatment can be applied to full size construction timber, but there are practical limitations to the maximum dimensions. During heat treatment the temperature gradient between the surface and the inner part of the timber should be lower than approximately 15-20°C, otherwise the wood quality decreases (e.g. cracks, deformation). An increase of the thickness (e.g. 25-32 mm to 50-100 mm) does not require major changes of the process conditions during the hydrothermolysis stage, mainly because saturated steam is used as heating medium under superatmospheric conditions (8-10 bar). During the curing stage a thicker dimension does have an effect on the process conditions, since this treatment stage is only based on heat conduction and there is more mass to heat. This results in a reduction of the heating and cooling down velocity hence increasing the process time. For practical and economical reasons the maximal thickness of for instance Norway spruce boards is approximately 100 mm.

The wood quality of softwood species decreases slightly after heat treatment, mainly due to cracks in knots and opening of resin pockets. Large dimension softwood timber (thickness > 40-50 mm) shows internal cracks and/or some deformation. The occurrence of (enclosed) pith stimulates the occurrence of such defects (in general, large dimension Norway spruce is 2 ex-log sawn including a pith). For certain applications (e.g. joinery) such a quality is not sufficient. However, high quality products can be obtained by using optimisation methods such as finger jointing and/or laminating.

Most hardwood species are available in a defect free quality. The length might be a limitation for commercial utilisation since the logs of several hardwood species (e.g. birch, alder, ash) are maximum 3 m long.

14.3 Environmental profile

In Europe, the governments stimulate the use of sustainable building materials in order to reduce the CO₂ emission and energy consumption. An extensive Life Cycle Analysis (LCA) study showed that heat-treated timber has substantially

better environmental benefits compared to other materials such as preservative treated timber, meranti, PVC, aluminium and steel (Jantzen et al. 1998). The study covered all steps of the Life Cycle (production, transport, use and disposal) and was based on two approaches: Life Cycle Assessment (environmental impacts) and Life Cycle Costing (environmental costs and production costs). The results showed that during production of heat-treated wood the amount of energy used and the amount of CO₂ formed is limited compared to other materials, especially meranti, PVC, aluminium and steel. Heat-treated wood, after its service life, can be used as a fuel source in power plants providing green energy, thereby reducing CO₂-emissions from the use of fossil fuels. The amount of CO₂ emitted when burning heat-treated wood is equal to the CO₂ fixated during the growth of trees (CO₂ neutral).

The legislative and consumer pressure to reduce the use of less sustainable produced materials (e.g. tropical hardwoods, preservative treated wood, plastics, metals and concrete) stimulates the use of sustainable materials such as heat-treated timber. Heat treatment technologies furthermore allow a better utilisation of homegrown timber species and/or timber species from sustainable plantations by increasing their service life and increasing their potential market. Thus, heat treatment also contributes to a sustainable management of raw materials.

14.4 Market aspects

The European commercial production of heat-treated timber on an industrial scale started in the late 90's. The improved characteristics of heat-treated timber offered the timber industry a new and innovative material suitable for a range of different wood products. On the timber market heat-treated timber can be regarded as:

1. a substitution for (defect free) tropical hardwood species;
2. a substitution for untreated and preservative treated softwood species;
3. a substitution or re-substitution for other building materials, such as plastic, metals and concrete; and
4. a new timber product for a completely new application.

A detailed market analysis including market volume and development, provides information about the possibilities for heat-treated timber. Based on such a market analysis the strategy for marketing, price and distribution can be determined. In table 14.5 an overview is shown of the Dutch wood market in 2000, for products, which are relevant for heat-treated timber. This gives an indication of the potential market for heat-treated timber.

Table 14.5 Dutch wood market in 2000

Sector	Products	Market volume (1000 m3)
Building industry	Cladding, bevelling	45-50
	Salvages and sheds	27
	Window frames and windows (wood)	210-310
	Exterior doors	50-60
Ground and waterworks	Canal sidings, sheet piling, decking, poles, posts, retaining walls	125-175
Garden wood	Terrace and garden planking, poles	200-225

The potential market of heat-treated wood as expressed in Table 14.5 depends on several factors. For cladding products commercial aspects (price) is very important, but also the aesthetic quality. In the Netherlands western red cedar (WRC) is a commonly used wood species for defect free cladding, whereas preservative treated softwood is used as a cheap alternative. Panel products and wood plastic composites are also used for cladding.

The Dutch exterior window frame and window wood market uses 50% hardwood species (mainly meranti and merbau) and 50% softwood species. The wood quality is very important: it should be defect free. The position of tropical hardwood species is therefore very strong and heat-treated timber can only compete when the price of tropical hardwood species increases and/or the availability of these timber species decreases. However, the increasing demand for sustainable building material probably stimulates the utilization of new materials such as heat-treated timber. Price is an important aspect with respect to softwood species used for joinery.

Most of the timber in waterworks is used for sheet piling and the material is mainly selected on basis of price. Nevertheless, during the last decade the environmental profile of the material gained an important role in the selection criteria. Alternatives for non-sustainable tropical hardwood species and preservative treated wood are searched for. Other materials such as concrete, steel and plastic are also used for waterworks but are not always suitable and/or preferred.

For garden wood, price is the most important criterion and on a price basis it is difficult to compete with the commonly used materials such as preservative treated softwood species and low price tropical hardwood species.

Currently, heat-treated timber is used for several applications listed in Table 14.5 and its market share is growing steady. Appropriate guidance about the product and the possibilities together with an increased market acceptance provide a basis to extend the market share. Product development is necessary to increase the market share on the long term, e.g. new wood species for heat treatment, new applications, etc. In Table 14.6 a SWOT-analysis of the heat treatment upgrading technology is given, reflecting the potential and perspectives of heat-treated timber.

Table 14.6 SWOT analysis of thermal modification of wood

<p>Strength</p> <ul style="list-style-type: none"> ● Relative simple wood modification process based on steam and heat treatment ● Value added technology for the upgrading of wood, a natural and sustainable material ● Applicable to many timber species, softwoods and hardwoods ● Applicable to many timber products (e.g. boards, beams, posts, poles) ● Low environmental impact, no addition of (toxic) chemicals and no toxic waste produced ● Many improved wood properties, especially dimensional stability and durability 	<p>Weakness</p> <ul style="list-style-type: none"> ● Decrease of some mechanical properties such as bending strength and especially tensile strength. However, the effect on the strength class appears to be limited ● Slight quality loss of softwood species, especially cracks in knots and open resin pockets. Internal cracks in thick dimension timber ● Limited supply of defect free timber, only available in relative short lengths
<p>Opportunities</p> <ul style="list-style-type: none"> ● Construction timber ● New wood species, especially defect free hardwoods ● Reduced availability of Western red cedar and tropical hardwood species ● Increased resistance against preservative treated wood ● Stimulation of the building industry to use sustainable materials ● Commercial realization of environmental profile of heat-treated timber (e.g. green guide) ● Relative new product, very interesting for architects and prescribing bodies 	<p>Threats</p> <ul style="list-style-type: none"> ● With respect to the acceptance of new products, the timber industry is rather conservative ● The timber market is a rather conservative and defensive market, mainly focussed on purchase and sales and less on marketing aspects

REFERENCE LIST

REFERENCE LIST

Abatzoglou N, Koeberle PG, Chornet E, Overend RP, Koukios EG (1990) An application to medium consistency suspension of hardwoods using a plug flow reactor. *The Canadian Journal of Chemical Engineering* 68:627-638

Baechler RH (1959) Improving wood's durability through chemical modification. *Forest Products Journal* 9:166-171

Baeza J, Freer J (2001) Chemical characterization of wood and its components. In *Wood and cellulosic chemistry* by D.N.-S. Hon and N. Shiraishi. Marcel Dekker Inc. New York. Chapter 8:275-384

Banoub JH, Delmas M (2003) JMS letters. *Journal of mass spectrometry* 38:900-903

Bekhta P, Niemz P (2003) Effect of high temperature on the change in colour, dimensional stability and mechanical properties of spruce wood. *Holzforschung* 57:539-546

Belkacemi K, Abatzoglou N, Overend RP, Chornet E (1991) Phenomenological kinetics of complex systems: mechanistic considerations in the solubilization of hemicellulose following aqueous/steam treatment. *Ind. Eng. Chem. Res.* 30:2416-2425

Bhuiyan MTR, Hirai N (2000) Changes in crystallinity in wood cellulose by heat treatment under dried and moist conditions. *Journal of Wood Science* 46:431-436

Blomberg J, Persson B, Blomberg A (2005) Effects of semi-isostatical densification of wood on the variation in strength properties with density. *Wood Science and Technology* 39:339-350

Blomberg J, Persson B, Bexell U (2006) Effects of semi-isostatic densification on anatomy and cell-shape recovery on soaking. *Holzforschung* 60:322-331

Bobleter O, Concin R (1979) Degradation of polar lignin by hydrothermal treatment. *Cellulose Chem. Technol.* 13:583-593

Bobleter O, Binder H (1980) Dynamischer hydrothormaler Abbau von Holz. *Holzforschung* 34:48-51

Bonn G, Concin R, Bobleter O (1983) Hydro-thermolysis – a new process for the utilization of biomass. *Wood Science and Technology* 17:195-202

Reference list

- Boonstra MJ, Tjeerdsma BF (2006) Chemical analysis of heat-treated softwoods. *Holz als Roh und Werkstoff* 64:204-211
- Boonstra MJ, Blomberg J (2007) Semi-isostatic densification of heat-treated radiata pine. *Wood Science and Technology* 41: 607-617
- Boonstra MJ, Pizzi A, Tekely P, Pendlebury J (1996). Chemical modification of Norway spruce and Scots pine. A ¹³C NMR CP-MAS study of the reactivity and reactions of polymeric wood components with acetic anhydride. *Holzforschung* 50:215-220
- Boonstra MJ, Tjeerdsma BF, Groeneveld HAC (1998) Thermal modification of non-durable wood species. Part 1. The Plato technology: thermal modification of wood. International Research Group on Wood Preservation, Document no. IRG/WP 98-40123
- Boonstra MJ, Rijdsdijk JF, Sander C, Kegel E, Tjeerdsma BF, Militz H, Van Acker J, Stevens M (2006a) Microstructural and physical aspects of heat-treated wood. Part 1. Softwoods. *Maderas. Ciencia y tecnología*. 8:193-208
- Boonstra MJ, Rijdsdijk JF, Sander C, Kegel E, Tjeerdsma BF, Militz H, Van Acker J, Stevens M (2006b) Microstructural and physical aspects of heat-treated wood. Part 1. Hardwoods. *Maderas. Ciencia y tecnología*. 8:209-217
- Boonstra MJ, Pizzi A, Rigolet S (2006c) Correlation of ¹³C NMR analysis with fungal decay tests of polymeric structural wood constituents. I. Basidiomycetes *Journal of Applied Polymer Science* 101:2639-2649
- Boonstra MJ, Pizzi A, Rigolet S (2006d) Correlation of ¹³C NMR analysis with fungal decay tests of polymeric structural wood constituents. II. Ground contact tests. *Journal of Applied Polymer Science* 102:616-622
- Boonstra M, Pizzi A, Ganne-Chedeville C, Properzi M, Leban JM, Pichelin F (2006e) Vibration welding of heat-treated wood. *Journal of Adhesion Science and Technology* 20(4):359-369
- Boonstra MJ, Pizzi A, Zomers F, Ohlmeyer M, Paul W (2006f) The effects of a two-stage heat treatment process on the properties of particleboard. *Holz als Roh- und Werkstoff* 64:157-164
- Boonstra MJ, Van Acker J, Tjeerdsma BF, Kegel E (2007a) Strength properties of thermally modified softwoods and its relation to polymeric structural wood constituents. *Annals of Forest Science* 64: 679-690
- Boonstra MJ, Van Acker J, Kegel E, Stevens M (2007b) Optimisation of a two-stage heat treatment process. Durability aspects. *Wood Science and Technology* 41(1):31-57

Boonstra MJ, Van Acker J, Pizzi A (2007c) Anatomical and molecular reasons for property changes of wood after full-scale industrial heat treatment. Paper of the 3th European conference on wood modification ECWM3 Cardiff, 15-17 October 2007

Boonstra MJ, Van Acker J, Kegel E (2008) The effect of a two-stage heat treatment process on the mechanical properties of full construction timber. Submitted to Wood Material Science and Engineering

Bourgois J, Guyonnet R (1988) Characterization and analysis of torrefied wood. *Wood Science and Technology* 22:143-155

Brown HP, Panshin AJ, Forsaith CC (1952) Working stresses for wood. In: *Textbook of wood technology*. McGraw-Hill, Book company, Inc. New York Toronto London, pp. 474-499

Burmester A (1973) Einfluss einer Wärme-Druck-Behandlung haldtrockenen Holzes auf seine Formbeständigkeit. *Holz als Roh- und Werkstoff* 31:237-243

Burmester A (1975) Zur Dimensionsstabilisierung von Holz. *Holz als Roh- und Werkstoff* 33:333-335

Burtscher E, Bobleter O (1987) Chromatographic analysis of biomass reaction products produced by hydrothermolysis of poplar wood. *Journal of Chromatography* 390:410-412

Chau MGS, Chen C-L, Evans J, Chang H-M, Kirk TK (1982) ¹³C NMR spectroscopic study of spruce lignin degraded by *Phanerochaete chrysosporium*. I. New structures. *Holzforschung* 36: 165-172

Chen C-L, Chua MGS, Evans J, Chang H-M (1982) ¹³C NMR spectroscopic study of spruce lignin degraded by *Phanerochaete chrysosporium*. II. Synthesis and chemical shifts of model compounds *Holzforschung* 36:239-247

Cowling EB (1961) Comparative biochemistry of the decay of sweetgum sapwood by white-rot and brown-rot fungi. Technical bulletin No. 1258. Washington, DC, USA; US Department of Agriculture

Cowling EB, Brown W (1969) Structural features of cellulosic materials in relation to enzymatic hydrolysis. In *Cellulases and their applications* (by Hajny and Reese); *Advanced Chemical Series 95*, American Chemical Society Press, Washington DC pp.152-187

Daniel G, Nilsson T, Petterson B (1989) Intra- and extracellular localization of solid wood and wood fragments by *Phanerochaete chrysosporium* by using transmission electron microscopy and immuno-gold labeling. *Applied environmental microbiology* 55: 871-881

Reference list

- Daniel G (2003) Microview of wood under degradation by bacteria and fungi. In Wood Deterioration and preservation. Advances in our changing world (by Goodell, Nicholas and Schultz). ACS symposium series 845, American Chemical Society, Washington DC, chapter 4: 34-72
- Davis WH, Thompson WS (1964) Influence of thermal treatments of short duration on the toughness and chemical composition of wood. Forest products journal 14:350-356
- Davis MF, Schroeder HR, Maciel GE (1994a) Solid state ¹³C Nuclear Magnetic Resonance studies of wood decay. I. White rot decay of Colorado blue spruce. Holzforschung 48:99-105
- Davis MF, Schroeder HR, Maciel GE (1994b) Solid state ¹³C Nuclear Magnetic Resonance studies of wood decay. II. White rot decay of paper birch. Holzforschung 48:186-192
- Davis MF, Schroeder HR, Maciel GE (1994c) Solid state ¹³C Nuclear Magnetic Resonance studies of wood decay. III. Decay of Colorado blue spruce and paper birch by *Postia Placenta*. Holzforschung 48:301-307
- Dietrichs HH, Sinner M, Puls J (1978) Potential of Steaming Hardwoods and Straw for Feed and Food Production. Holzforschung 32(6):193-199
- Dwianto W, Inoue M, Tanaka F, Norimoto M (1996) The permanent fixation of compressive deformation in wood by heat treatment. In: Proceedings from the 3rd Pacific Rim Bio-Based Composites Symposium, Kyoto, Japan
- Ellis S, Paszner L (1994) Activated selfbonding of wood and agricultural residues. Holzforschung 48 (suppl):82-90
- Ellis S, Steiner P (2002) The behaviour of five wood species in compression. IAWA Journal 23:201-211
- Enoki A, Tanaka H, Fuse G (1988) Degradation of lignin-related compounds, pure cellulose, and wood components by white-rot and brown-rot fungi. Holzforschung 42(2):85-93
- Enoki A, Hirano T, Tanaka H (1992) Extracellular substance from the brown-rot basidiomycete *Gloeophyllum trabeum* that produces and reduces hydrogen peroxide. Material und Organism 27: 247-261
- Eriksson KE (1981) Microbial degradation of cellulose and lignin. Proceedings of international symposium on wood and pulping chemistry, Stockholm. Vol. 3: 60-65
- Eriksson KE, Blanchette RA, Ander P (1990) Microbial and enzymatic degradation of wood and wood components; Springer-Verlag berlin Heidelberg New York

Fengel D (1980) Experiments on the alkaline extraction of polyoses from spruce holocellulose. *Das Papier* 34:428-433

Fengel D, Wegener G (1989) *Wood: Chemistry, Ultrastructure, Reactions*. Walter de Gruyter and Co. Berlin, New York

Flournoy DS, Kirk TK, Highley TL (1991) Wood decay by brown-rot fungi: changes in pore structure and cell wall volume. *Holzforschung* 45(5): 383-388

Fujita M, Harada H (2001) Ultrastructure and formation of wood cell wall. In: Hon N-S and Shiraishi N (2001). *Wood and cellulosic chemistry*. Marcel Dekker Inc. New York. Chapter 1: 1-50

Fukazawa K (1992) Ultraviolet microscopy. In: Lin, S.Y. ; Dence, C.W.: *Methods in lignin chemistry*. Berlin [etc.]: Springer, 578 S.

Garrote G, Dominguez H, Parajo JC (1999) Hydrothermal processing of lignocellulosic materials. *Holz als Roh- und Werkstoff* 57:191-202

Garves K (1982) Öl und Chemikalien aus Holz und Cellulose. Ein Überblick neuerer Ergebnisse. *Holz als Roh- und Werkstoff* 40:41-44

Gerardin P, Petric M, Petrissans M, Lambert J, Ehrhardt (2007) Evolution of wood surface free energy after heat treatment. *Polymer Degradation and Stability* 92(4): 653-657

Gfeller B, Zanetti M, Properzi M, Pizzi A, Pichelin F, Lehmann M, Delmotte L (2003) Wood bonding by vibrational welding. *Journal of adhesion science and technology* 17: 1573-1589

Giebeler E (1983) Dimensionsstabilisierung von Holz durch eine Feuchte/Wärme/Druck-Behandlung. *Holz als Roh- und Werkstoff* 41:87-94

Goldschmid O (1971) Ultraviolet spectra. In: SARKANEN, KV, LUDWIG, CH: *Lignins. Occurrence, formation, structure and reactions*. Wiley Interscience, New York, London, Sidney, Toronto, 241-266

Goodell B (2003) Brown-rot fungal degradation of wood: our evolving view. In *Wood Deterioration and preservation. Advances in our changing world* (by Goodell, Nicholas and Schultz). ACS symposium series 845, American Chemical Society, Washington DC, chapter 6:97-118

Goodell B, Jellison J, Liu J, Daniel G, Paszczynski A, Fekete F, Krishnamurthy S, Jun L, Xu GJ (1997) Low molecular weight chelators and phenolic compounds isolated from wood decay fungi and their role in the fungal biodegradation of wood. *Journal of Biotechnology* 53:133-162

Reference list

- Goring DAI (1963) Thermal softening of lignin, hemicelluloses and cellulose. Pulp Paper Magazine Canada 64:T-517-527
- Goroyias GJ, Hale MD (2002) Heat treatment of wood strands for OSB production: Effect on the mechanical properties, water absorption and dimensional stability. International Research Group on Wood Preservation, Document no. IRG/WP 02-40238
- Goyal GC, Lora JH (1991) Kinetics of delignification and lignin characteristics in autocatalyzed organosolv pulping of hardwoods. Proc. Int. Symp. Wood Pulp. Chem., Melbourne, Australia, vol. 1:205-212
- Halliwell G (1965) Catalytic decomposition of cellulose under biological conditions. Biochemical Journal 95: 35-40
- Hakkou M, Pétrissans M, Zoulalian A, Gérardin P (2005) Investigation of the reasons for the increase of wood durability after heat treatment based on changes of wettability and chemical composition. The second European conference on wood modification ECWM 2005. pp. 38-46
- Heebink BG, Hefty FV (1969) Treatment to reduce thickness swelling of phenolic bonded particleboard. Forest Products Journal 19(11):17-29
- Heger F, Groux M, Girardet F, Welzbacher C, Rapp AO, Navi P (2004) Mechanical and durability performance of THM-densified wood. Final Workshop COST Action E22 'Environmental optimisation of wood protection' Lisboa-Portugal, 22-23 March 2004
- Henry WP (2003) Non-enzymatic iron, manganese, and copper chemistry of potential importance in wood decay. In Wood Deterioration and preservation. Advances in our changing world (by Goodell, Nicholas and Schultz). ACS symposium series 845, American Chemical Society, Washington DC, chapter 10: 175-194
- Highley TL (1970) Decay resistance of four woods treated to destroy thiamine. Phytopathology 60: 1660-1661
- Highley TL (1975) Properties of cellulases of two brown-rot and two white-rot fungi. Wood fiber 6: 275-281
- Highley TL (1977) Requirements for cellulose degradation by a brown-rot fungus. Material und Organismen 12(1):25-36
- Highley TL, Micales JA (1990) Effect of aromatic monomers on production of carbohydrate-degrading enzymes by white-rot and brown-rot fungi. FEMS Microbiology Letters 66:15-22

Highley TL; Dashek WV (1997) Biotechnology in the study of brown- and white-rot decay. In Forest products biotechnology (edited by A. Bruce and J.W. Palfreyman). UK Taylor & Francis Ltd, London. ISBN 0-7484-0415-5. Chapter 2: 15-36

Highley TL, Murmanis LL, Palmer JG (1983) Electron microscopy of cellulose decomposition by brown-rot fungi. *Holzforschung* 37(6): 271-278

Highley TL, Kirk TK, Ibach R (1989) Effects of brown-rot fungi on cellulose. In Biodeterioration Research (by O' Rear and Llewellyn); Plenum Press, New York p 511-525

Highley TL, Clausen CA, Croan SC, Green F, Illman BL, Micales JA (1992) Research on biodeterioration of wood, 1987-1992. United States Department of Agriculture Forest Products Laboratory Research Paper FPL-RP-529

Hillis WE (1984) High temperature and chemical effects on wood stability. Part 1. General considerations. *Wood Science and Technology* 18:281-293

Hillis WE, Rozsa AN (1978) The softening temperatures of wood. *Holzforschung* 32:69-73

Hillis WE, Rozsa AN (1985) High temperature and chemical effects on wood stability. Part 2. The effect of heat on the softening of radiata pine. *Wood Science and Technology* 19:57-66

Hirano T, Tanaka H, Enoki A (1995) Extracellular Substance from the Brown Rot Basidiomycete *Tyromyces palustris* that reduces Molecular Oxygen to Hydroxyl Radicals and Ferric Iron to Ferrous Iron . *Mokuzai Gakkaishi* 41: 334-341

Hon DNS (1991) Photochemistry of wood. In: HON, SHIRAIISHI: Wood and cellulosic chemistry. Marcel Dekker, Inc., New York, Basel, 525-555

Hon DNS, Shiraishi N (2001). Wood and cellulosic chemistry. Marcel Dekker Inc. New York. Chapter 3 and 4, 83-174

Hortling B, Forsskahl I, Janson J, Sundquist J, Viikari L. (1992) Investigations of fresh and biologically decayed birch. *Holzforschung* 46:9-19

Hsu WE, Schwald W, Schwald J, Shields A (1988) Chemical and physical changes required for producing dimensionally stable wood-based composites. Part 1: Steam pre-treatment. *Wood Science Technology* 22:281-289

Hyde SM, Wood PM (1997) A mechanism for production of hydroxyl radicals by the brown-rot fungus *Coniophora puteana*: Fe(III) reduction by cellobiose dehydrogenase and Fe(II) oxidation at a distance from the hyphae. *Microbiology* 143: 259-266

Reference list

- Ifju G (1964) Tensile strength behaviour as a function of cellulose in wood. *Forest Products Journal* 14:366-372
- Illman BL, Meinholtz DC, Highley TL (1988) An electron spin resonance study of manganese changes in wood decayed by the brown-rot fungus *Postia placenta*. International Research Group on Wood Preservation, Document no. IRG/WP 88-1359
- Illman BL, Meinholtz DC, Highley TL (1989) Manganese as a probe of fungal degradation of wood. In *Biodeterioration Research* (by O' Rear and Llewellyn); Plenum Press, New York p 485-496
- Inoue M, Norimoto M, Tanahashi M, Rowell RM (1993) Steam or heat fixation of compressed wood. *Wood and Fiber Science* 25(3):224-235
- Ishii T, Shimizu K (2001) Chemistry of cell wall polysaccharides. In *Wood and cellulosic chemistry* by D.N.-S. Hon and N. Shiraishi. Marcel Dekker Inc. New York. Chapter 8: 175-212
- Ito Y, Tanahashi M, Shigematsu M, Shinoda Y, Ohta C (1998) Compressive-molding of wood by high-pressure steam-treatment. Part 1. Development of compressively molded squares from thinnings. *Holzforschung* 52(2):211-216
- Jantzen J, Krozer J, Nypels M (1998) Environmental economic assessment of Plato products. TME report
- Jensen KA, Houtman CJ, Ryan ZC, Hammel KE (2001) Pathways for extracellular Fenton chemistry in the brown rot basidiomycete *Gloeophyllum trabeum*. *Applied environmental microbiology* 67: 2705-2711
- Jin L, Nicholas DD, Kirk TK (1990) Mineralization of the methoxyl carbon of isolated lignin by brown-rot fungi under solid substrate conditions. *Wood science and technology* 24(3): 277-288
- Kamdem DP, Pizzi A, Guyonnet R, Jermannaud A (1999) Durability of heat-treated wood. IRG International Research Group on Wood Preservation Proceedings, Document IRG/WP 99-40145, Rosenheim, Germany, June 1999, pp 1-15
- Kamdem DP, Pizzi A, Triboulot MC (2000) Heat-treated timber: potentially toxic byproducts presence and extent of wood cell wall degradation. *Holz als Roh- und Werkstoff* 58: 253-257
- Kamdem DP, Pizzi A, Jermannaud A (2002) Durability of heat-treated wood. *Holz als Roh- und Werkstoff* 60: 1-6
- Kamke FA (2006) Densified radiata pine for structural composites. *Maderas. Ciencia y tecnologia* 8(2):83-92

- Kass A., Wangaard FF, Schroeder HA (1970) Chemical degradation of wood: the relationship between strength retention and pentosan content. *Wood fiber* 2:31-39
- Keilich G, Bailey PJ, Liese M (1970) Enzymatic degradation of cellulose, cellulose derivatives, and hemicelluloses in relation to the fungal decay of wood. *Wood Science and technology* 4:273-283
- Kennedy RW (1968) Wood in transverse compression. *Forest Products Journal* 18:36-40
- Kirk TK (1975) Effects of brown-rot fungus, *Lenzites trabea*, on ligin in spruce wood. *Holzforschung* 29(3): 99-107
- Kirk TK, Chang HM (1974) Decomposition of lignin by white-rot fungi. I. Isolation of heavily degraded lignins from decayed spruce. *Holzforschung* 28: 217-222
- Kirk TK, Chang HM (1975) Decomposition of lignin by white-rot fungi. II. Isolation of heavily degraded lignins from decayed spruce. *Holzforschung* 29: 56-64
- Koenigs JW (1972) Production of extracellular hydrogen peroxide and peroxidase by wood-rotting fungi. *Phytopathology* 62: 100-110
- Koenigs JW (1974) Hydrogen peroxide and iron: a proposed system for decomposition of wood by brown-rot basidiomycetes. *Wood and Fiber* 6: 66-79
- Kollmann FFP (1968) Mechanics and rheology of wood, in (Kollmann and Coté (eds) *Principles of wood science and technology. I. Solid wood*, Springer-Verlag Berlin Heidelberg New York pp. 292-414
- Kollmann F, Coté W (1968) *Principles of wood science and technology*. Springer-Verlag Heidelberg
- Kollmann F and Schneider A (1963) Über das Sorptionsverhalten wärmebehandelter Hölzer. *Holz als Roh- und Werkstoff* 41:87-94
- Kollmann F and Fengel D (1965) Änderungen der chemischen Zusammensetzung von Holz durch thermische Behandlung. *Holz als Roh- und Werkstoff* 21(3):77-85
- Kollmann F, Sachs IB (1967) The effects of elevated temperature on certain wood cells. *Wood Science and Technology* 1:14-25
- Kollmann FP, Kuenzi EW, Stamm AJ (1975) *Principles of wood science and technology. Vol. II Wood based materials*. Springer-Verlag New York Heidelberg Berlin. pp 139-149
- Košíková B, Hricovini M, Cosentino C (1999) Interaction of lignin and polysaccharides in beech wood (*Fagus sylvatica*) during drying processes. *Wood Science and Technology* 33:373-380

Reference list

- Kuboijima Y, Okano T, Ohta M (2000) Bending strength and toughness of heat-treated wood. *Journal of Wood Science* 46:8-15
- Kumar S (1994) Chemical modification of wood. *Wood and fiber science* 26(2):270-280
- Leban J-M, Pizzi A, Wieland S, Zanetti M, Properzi M, Pichelin F (2004) X-ray microdensitometry analysis of vibration-welded wood. *Journal of Adhesion Science and Technology* 18:673-685
- LeVan SL, Ross RJ, Winandy JE (1990) Effects of fire retardant chemicals on bending properties of wood at elevated temperatures. Res. Pap. FPL-RP-498
- Lindhe C, Castwall L (1997) Process for producing hard elements of wood. U.S. Patent No. 5,678,618
- Lyr H (1960) Formation of ecto-enzymes by wood-destroying and wood-inhabiting fungi on various culture media. V. Complex medium as carbon source. *Archives of Microbiology* 35:258
- Mark R.E. Cell wall mechanics of tracheids. Yale University Press, New Haven, CT, 1967
- McKenzie WMC (2000) Design of Structural Timber. MacMillan Press Ltd, ISBN 0-333-79236-X. 286 pp
- Messner K, Fackler K, Pongsak L, Gindl W, Srebotnik E, Watanabe T (2003) Overview of white-rot research: where are we today. In *Wood Deterioration and preservation. Advances in our changing world* (by Goodell, Nicholas and Schultz). ACS symposium series 845, American Chemical Society, Washington DC chapter 5: 73-96
- Meyer JA (1984) Wood-polymer materials. In: Rowell (ed) *The chemistry of solid wood*. American Chemical Society, Washington, DC. pp 257-290
- Micales JA, Green F, Clausen CA, Highley TL (1987) Physical properties of b-1,4-Xylanase produced by *Postia* (= *Poria*) *placenta*: Implications for the control of brown rot. International Research Group on Wood Preservation, Document no. IRG/WP 87-1318
- Natterer J, Sandoz JL, Rey M (2004) Construction en bois. Matériau, technologie et dimensionnement. Presses polytechniques et universitaires Romandes. ISBN: 2-88074-609-4. Volume 13. 560 pp
- Navi P, Girardet F (2000) Effects of thermo-hydro-mechanical treatment on the structure and properties of wood. *Holzforschung* 54(3):287-293

Noack D (1969) Über die Heisswasserbehandlung von Rotbuchenholz im Temperaturbereich von 100 bis 180°C. *Holzforschung und Holzverwertung* 21(5):118-124

Nuopponen M, Wikberg H, Vuorinen T, Maunu SL, Jämsä S, Viitaniemi P (2003) Heat-treated softwood exposed to weathering. *Journal of Applied Polymer Science* 91:2128-2134

Ohlmeyer M, Lukowsky D (2004) Wood-based panels produced from thermal treated wood - Properties and perspectives. Wood-frame housing durability and disaster issues conference. October 4-6, 2004, Las Vegas, USA

Okamura K (2001) Structure of cellulose. In: Hon, Shiraishi (Eds) *Wood and cellulosic chemistry*. Marcel Dekker INC, New York Basel pp. 83-108

Pizzi A, Stephanou (1994) A ¹³C NMR study of polyflavonoid tannin adhesives intermediates, Part 1: non-colloidal, performance-determining rearrangements, *J.Appl.Polymer Sci.*, 51: 2109-2124

Pizzi A., Stephanou A., Boonstra MJ, Pendlebury A.J (1994). A new concept on the chemical modification of wood by organic anhydrides. *Holzforschung* 48 Suppl.:91-94

Pott GT (2004) Natural fibers with low moisture sensitivity. Chapter 8 in: *Natural fibers, plastics and composites*. Kluwer Academic Publishers ISBN 1 4020 7643 6

Rapp AO, Sailer M (2000) Heat treatment in Germany. Proceedings of Seminar "Production and development of heat treated wood in Europe", Nov. 2000, Helsinki, Stockholm, Oslo

Repellin V, Guyonnet R (2005) Evaluation of heat-treated wood swelling by differential scanning calorimetry in relation to chemical composition. *Holzforschung* 59:28-34

Robert D, Chen C-L (1989) Biodegradation of lignin in spruce wood by *Phanerochaete chrysosporium*: Quantitative analysis of biodegraded spruce lignins by ¹³C NMR spectroscopy. *Holzforschung* 43:323-332

Rodriguez J, Ferraz A, de Mello MP (2003) Role of metals in wood biodegradation. In *Wood Deterioration and preservation*. Advances in our changing world (by Goodell, Nicholas and Schultz). ACS symposium series 845, American Chemical Society, Washington DC, chapter 9: 154-174

Rowell RM (1984). Penetration and reactivity of cell wall components. In Rowell (Ed) *The chemistry of solid wood*. American Chemical Society, Washington D.C., pp. 175-210

Reference list

- Rowell RM (1996) Physical and mechanical properties of chemically modified wood, in: Hon (ed) Chemical Modification of Lignocellulosic Materials, M. Dekker, New York, pp. 295-310
- Rowell RM, Simonson S, Hess DV, Plackett DV, Cronshaw D, Dunningham E (1994) Acetyl distribution in acetylated whole wood and reactivity of wood cell wall components to acetic anhydride. *Wood and Fiber Science* 26:11-18
- Rowell R, Lange S, McSweeney J, Davis M (2002) Modification of wood fiber using steam. In: proceedings from the 6th Pacific Rim Bio-Based Composites Symposium & Workshop on the Chemical Modification of Cellulistics, Portland, Oregon, USA, 2002
- Rousset P, Turner I, Donnot A, Perré P (2006) Choix d'un modèle de pyrolyse ménagée du bois à l'échelle de la microparticule en vue de la modélisation macroscopique. *Annals of Forest Science* 63: 213-229
- Runkel ROH (1951) Zur Kenntnis des thermoplastischen Verhaltens von Holz. *Holz als Roh- Werkstoff* 9:41-53
- Rusche H (1973) Thermal degradation of wood at temperatures up to 200°C. Part 1: Strength properties of dried wood after heat treatment. *Holz als Roh- und Werkstoff* 31:273-281
- Ruyter HP (1989) European patent Appl. No. 89-203170.9
- Sailer M, Rapp AO, Leithoff H, Peek R-D (2000) Vergütung von Holz durch Anwendung einer Öl-Hitzebehandlung. *Holz als Roh- und Werkstoff* 58: 15-22
- Sakakibara A, Sano Y (2001) Chemistry of lignin. In: Hon, Shiraishi (Eds) *Wood and cellulosic chemistry*. Marcel Dekker INC, New York Basel pp. 109-173
- Sanderman W, Augustin H (1963) Chemical investigations on the thermal decomposition of wood. Part I: Stand of research. *Holz als Roh und Werkstoff* 21:256-265
- Scheffer TC (1986) O₂ requirements for growth and survival of wood-decaying and sapwood-staining fungi. *Canadian Journal of Botany* 64: 1957-1963.
- Scheiding W, Kruse K, Plaschkies K, Weiss B (2005) Thermally modified timber (TMT) for playground toys: Investigations on 13 industrially manufactured products, paper of the 2nd European conference on wood modification Goettingen / Germany, October 2005
- Schmidt CJ, Whitter BK, Nicholas DD (1981) A proposed role for oxalic acid in non-enzymatic wood decay by brown rot fungi. In *Proceedings American Wood Preservation Association* 77: 157-164

Schneider MH (1994) Wood polymer composites. Wood and fiber science 26:142-151

Schweingrubber F H (1990). Anatomy of European woods. ISBN 3-258-04258-6

Seborg RM, Tarkow H, Stamm AJ (1953) Effect of heat upon the dimensional stabilisation of wood. Journal Forest Products Research Society 3(9):59-67

Sekino N, Inoue M, Irle, MA (1997) Thickness swelling and internal bond strength of particles made of steam-pretreated particles. Mokuzai Gakkaishi 43(12):1009-1015

Sekino N, Inoue M, Irle M (1998) The bond quality of steam pre-treated particles. The 2nd European Panel Products Symposium:30-38

Shen KC (1973) Steam-press process for curing phenolic-bonded particleboard. Forest Products Journal 23(3):21-29

Shiraishi N (2001) Wood plasticization. In: Hon, Shiraishi (eds) Wood and cellulosic chemistry. Marcel Dekker, Inc., New York, Basel, pp 655-700

Sivonen H, Maunu SL, Sundholm F, Jamsa S, Viitaniemi P (2002) Magnetic resonance studies of thermally modified wood. Holzforschung 56:648-654

Sjöström E (1981) Wood chemistry: Fundamentals and Applications. Academic Press, Inc. San Diego. 293pp

Spurr AR (1969) A low viscosity epoxy resin embedding medium for electron microscopy. J. Ultrastruct. Res. 26 : 31-43

Stamm AJ (1961) Comparison of three methods for determining the pH of wood and paper. Forest Products Journal 11:310-312

Stamm AJ (1964) Wood and cellulose science. The Ronald Press Company. USA

Strebotnik E, Messner K (1988) Spatial arrangement of lignin peroxidase in pine decayed by *Phanerochaete chrysosporium* and *Fomitopsis pinicola*. International Research Group on Wood Preservation, Document no. IRG/WP 88-1343

Strebotnik E, Messner K (1990) Immunogold labelling of size marker proteins in brown-rot-degraded pine wood. International Research Group on Wood Preservation, Document no. IRG/WP 90-1428

Subiyanto B, Takino S, Kawai S, Sasaki H (1991) Production of thick low-density particleboard with a semi-continuous steam-injection press. Mokuzai Gakkaishi 37(1):24-30

Reference list

- Sweet MS, Winandy JE (1999) The influence of degree of polymerisation (DP) of cellulose and hemicellulose on the strength loss of fire-retardant-treated wood. *Holzforschung* 53(3):311-317
- Syrjänen T, Jämsä S, Viitaniemi P (2000) Heat treatment of wood in Finland. Proceedings of Seminar "Production and development of heat treated wood in Europe", Nov. 2000, Helsinki, Stockholm, Oslo
- Takao S (1965) Organic acid production by basidiomycetes. *Applied microbiology* 13:732-737
- Tanaka H, Itakura S, Hirano T, Enoki A (1996) An Extracellular Substance from the White-Rot Basidiomycete *Phanerochaete chrysosporium* for Reducing Molecular Oxygen and Ferric Iron. *Holzforschung* 50: 541-548
- Tanaka H, Itakura S, Enoki A (2000) Hydroxyl radical generation and phenol oxidase activity in wood degradation by the white-rot basidiomycete *Irpex lacteus*. *Material und Organism* 33: 91-105
- Tjeerdsma BF, Militz H (2005) Chemical changes in hydrothermal treated wood: FTIR analysis of combined hydrothermal and dry heat-treated wood. *Holz als Roh- und Werkstoff* 63:102-111
- Tjeerdsma BF, Boonstra M, Pizzi A, Tekely P, Militz H (1998a) Characterisation of thermally modified wood: molecular reasons for wood performance improvement. *Holz als Roh- und Werkstoff* 56:149-153
- Tjeerdsma BF, Boonstra M, Militz H (1998b) Thermal modification of non-durable wood species. Part 2. Improved wood properties of thermally treated wood. International Research Group on Wood Preservation, Document no. IRG/WP 98-40124
- Tjeerdsma BF, Stevens M, Militz H (2000) Durability aspects of (hydro)thermal treated wood; International Research Group on Wood Preservation, Document no. IRG/WP 00-40160
- Tjeerdsma B, Stevens M, Militz H, Van Acker J (2002) Effect of process conditions on moisture content and decay resistance of hydro-thermally treated wood. *Holzforschung und Holzverwertung* 5:94-99
- Tomimura Y, Matsuda T (1986). Particleboard made of steamed flakes. *Mokuzai Gakkaishi* 32(3):170-175
- Torres MR, Heitz M, Chauvette G, Chornet E (1986) Conversion and solubilization profiles of a prototype hardwood (*Populus tremuloides*) following aqueous thermomechanical pre-treatment. *Biomass* 10:85-96

Van Acker J, Stevens M, Brauwers C, Rijckaert V, Mol E (1998a) Blue stain resistance of exterior wood coatings as a function of their typology. International Research Group on Wood Preservation, Document no. IRG/WP/98-20145

Van Acker J, Stevens M, Brauwers C, Rijckaert V, Mol E (1998b) Laboratory blue stain testing of low VOC paints. Conferentie 'Advances in exterior wood coatings and CEN standardisation', Brussel, Paper 15

Vernois M (2000) Heat treatment in France. Proceedings of Seminar "Production and development of heat treated wood in Europe", Nov. 2000, Helsinki, Stockholm, Oslo

Viitaniemi P, Jämsä S (1996) Puun modifionti lampokassittelylla (Modification of wood with heat treatment). Espoo 1996, VTT Juskaisuja - Publikationer 814

Weiland JJ, Guyonnet R (1997) Retifiziertes Holz. 16. Verdichter Holzbau in Europa. Motivation, Erfahrung, Entwicklung. Dreilander Holztagung. 10. Joanneum Research Fachtage. 2.-5.11.1997. Grazer Congress. Graz, Austria

Weiland JJ, Guyonnet R (2003) Study of chemical modifications and fungi degradation of thermally modified wood using DRIFT spectroscopy. Holz als Roh- und Werkstoff 61: 216-220

Whistler RL, Chen C-C (1991) Hemicelluloses. In: Lewin, Goldstein (eds) Wood structure and composition. International fiber science and technology series. Vol. 11. Marcel Decker. Inc., New York, NY, pp. 287-320

Winandy JE (1995) Effects of fire retardant treatments after 18 months of exposure at 150°F (66°C). Res.Note FPL-RN-0264

Winandy JE (1996) Effects of treatment, incising and drying on mechanical properties of wood. Gen. Tech. Rep. FPL-GTR 94:371-378

Winandy JE, Rowell RM (1984) The chemistry of wood strength. In: Rowell (ed) The Chemistry of solid wood. American Chemical Society, Washington, DC. pp 211-256

Winandy JE, Lebow PK (2001) Modelling strength loss in wood by chemical composition. Part I. An individual component model for southern pine. Wood and fiber science 33(2):239-254

Wise LE, Murphy M, D'Addieco AA (1946) Chlorite holocellulose, its fractionation and bearing on summative wood analysis and studies on the hemicelluloses. Paper Trade Journal 122(2):35-43

Wolcott MP, Shutler EL (2003) Temperature and moisture influence on compression-recovery behavior of wood. Wood and Fiber Science 35(4):540-551

Reference list

Zabel RA, Morrell JJ (1992) Wood Microbiology. Decay and its prevention; Academic Press, Inc. San Diego

Standards and directives

CEN/TS 15038-1 (2004) Durability of wood and wood-based products - Determination of the natural durability of solid wood against wood-destroying fungi, test methods - Part 1: Basidiomycetes. European standard

DIN 52186 (1978) Prüfung von Holz. Biegeversuch. Deutsche Industrie Norm

EN 113 (1996) Wood preservatives – Testing methods to determine protection effectiveness against basydiomicetes – Determination of the effectiveness threshold. European standard

EN 252 (1991) Wood preservatives - Determination of the relative protective effectiveness in ground contact - Field test methods. European standard

EN 317 (1993) Particleboards and fibreboards. Determination of swelling in thickness after immersion in water. European standard

EN 319 (1993) Particleboards and fibreboards. Determination of tensile strength perpendicular to the plane of the board. European standard

EN 321 (2001) Wood-based panels - Determination of moisture resistance under cyclic test conditions. European standard

EN 338 (1996) Structural timber - Strength classes. European standard

EN 350-2 (1994) Durability of wood and wood-based products - Natural durability of solid wood - Part 2: Guide to natural durability and treatability of selected wood species of importance in Europe. European standard

EN 408 (2003) Timber structures - Structural timber and glued laminated timber - Determination of some physical and mechanical properties. European standard

EN 518 (1995) Structural timber. Grading. Requirements for visual strength grading standards. European standard

EN 1087-1 (1995) Particleboards. Determination of the moisture resistance - Part 1: Boil test. European standard

EN 1534 (2000) Wood and parquet flooring - Determination of resistance to indentation (Brinell) - Test method. European standard

ENV 807 (1993) Wood preservatives. Determination of the effectiveness against soft rotting micro-fungi and other soil inhabiting micro-organisms. European standard

NEN 5466 (1983). Quality requirements for timber - Species European spruce. Dutch standard.

Patents

EP0018446 1982 : Verfahren zur Vergütung von Holz

EP0373726 1989: Cellulosic fibrous aggregate and a process for its preparation

EP0612595 1994: Process for upgrading low-quality wood

EP0623433 1994: Process for upgrading low-quality wood

EP0622163 1994: Process for upgrading low-quality wood

EP0852174 1997: Process for preparing cellulosic fibrous aggregates

EP0759137 1995: Method for processing of wood at elevated temperatures

US5678324 1997: Method for improving biodegradation resistance and dimensional stability of cellulosic products

ANNEXES

ANNEX 1 CHEMICAL COMPOSITION OF WOOD

Wood is a natural composite material and a chemical complex of cellulose, hemicelluloses, lignin, and extractives. Cellulose is the framework substance, hemicelluloses are the matrix substances present between the cellulose microfibrils, and lignin is the encrusting substance solidifying the cell wall associated with the matrix substances. Below, a short description of the main components of wood is given based on various textbooks (e.g. Stamm 1964, Kollmann and Coté 1968, Fengel and Wegener 1989, Hon and Shiraishi 2001).

Cellulose

Cellulose is the major chemical component of the cell wall and contributes 40-45% of the wood's dry weight. It is an unbranched, rigid chain, linear polymer composed of anhydro-D-glucopyranose ring units bonded together by beta-1-4-glycosidic linkages. Each glucose unit possesses hydroxyl groups at C2, C3, and C6 positions, capable of undergoing the typical reactions known for primary and secondary alcohols.

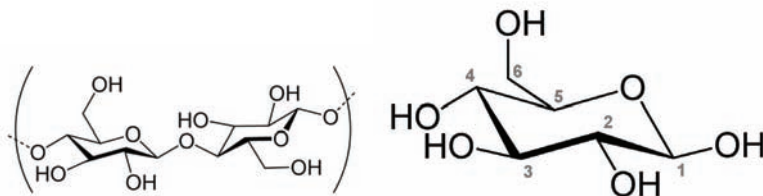

Fig 1. Molecular structure of cellulose (left) and β -D-glucopyranose (right)

The molecular structure imparts cellulose with its characteristic properties: hydrophilicity, chirality, degradability, and broad chemical variability initiated by the high donor reactivity of the hydroxyl groups. Cellulose has a strong tendency to form intra- and inter-molecular hydrogen bonds by the hydroxyl groups on these linear cellulose chains, which stiffen the straight chain and promote aggregation into a crystalline structure and give cellulose a multitude of partially crystalline fiber structures and morphologies. The degree of crystallinity varies from 60% to 70% for wood species. Crystalline cellulose has a very limited accessibility to water and chemicals. Chemical attack can therefore be expected to occur primarily on amorphous cellulose and the crystalline surface.

The cellulose within the cell wall is organized in fibrils, which are associated in higher systems, the microfibrils. The concentration of cellulose in the compound middle lamella is low (approximately 14%) whereas the proportion of cellulose in the secondary cell wall is much higher (approximately 35% for the S1 layer and nearly 60% for the S2 layer).

Cellulose is primarily responsible for strength in the wood fibre because of its high degree of polymerisation (DP 5000-10000 units) and linear (crystalline) orientation. Cellulose has found to be extremely resistant to tensile stress due to the covalent bonding within the pyranose ring and between the individual units. Although the tensile strength of cellulose fibres with a DP of 80 or less is low, it increases linearly with an increase in the DP to about 300 and above this value, there is little further increase in tensile strength.

Hemicelluloses

The hemicelluloses contribute 20-30% of the wood's dry weight. Hemicelluloses consist of various elementary sugar units, primarily the hexosans, D-glucose, D-galactose, and D-mannose; and the pentosans, L-arabinose and D-xylose. The main hemicelluloses of softwood are galactoglucomannans (20%) and arabinoglucuronoxylan (5-10%), while in hardwood it is mainly glucuronoxylan (15-30%) and a small amount of glucomannan (2-5%). Unlike glucomannan, xylan contains acidic groups (glucuronic acid) and has a molecular backbone structure similar to cellulose.

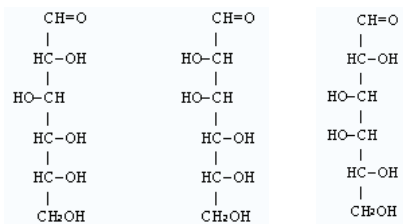

Fig. 2a Hexose monomer components of hemicelluloses (D-glucose, D-mannose and D-galactose)

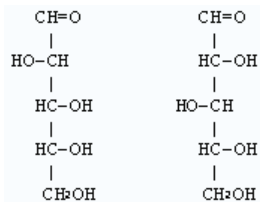

Fig. 2a Pentose monomers of hemicelluloses (L-arabinose and D-xylose)

Hemicelluloses have linear chain backbones that are highly branched and have a lower degree of polymerisation than cellulose (100-200). The monomer ring units are bonded together by beta-1-4-glycosidic linkages, similar to cellulose. Most hemicelluloses are found in the amorphous regions of the cellulose chains and in close association with the lignin. It appears to be a matrix for the cellulose (hemicelluloses are thought to be the connecting material between cellulose and lignin) and increases the packing density of the cell wall. The sugars of hemicelluloses are believed to be covalently bonded to the lignin polymer. The most frequently suggested LCC-linkages in native wood are benzyl ester, benzyl

ether, and glycosidic linkages. Hydrogen bonding exists both within the hemicelluloses chain as well as between other hemicelluloses and cellulose chains. It has been suggested that hemicelluloses and cellulose microfibrils are closely associated by intermixing (i.e. physical entanglement at molecular level). The polyoses concentration of the compound middle lamella is approximately 27%. The S1 layer of the secondary cell wall contains a polyoses concentration of about 35%, whereas the polyoses concentration of the S2 layer is lower (approximately 15%).

Lignin

Lignin, the most hydrophobic component of the wood cell wall, appears to be an encrusting agent on and around the carbohydrates. The lignin amount in wood ranges from 20-40%. Lignin is a phenolic compound and is considered as an irregular array of variously bonded hydroxy- and methoxy-substituted phenyl propane units with p-coumaryl alcohol, coniferyl alcohol and sinapyl alcohol as the precursors of lignin biosynthesis (Fig. 3). Lignin of softwood species consist mainly guaiacyl^{*} units and a small amount of p-hydroxyphenyl units. The p-hydroxyphenyl units are mainly found in compression wood and the compound middle lamella. In spruce species the lignin of the secondary walls contains twice as many phenolic OH-groups as the lignin in the compound middle lamella. Lignin of hardwood species consist both syringyl^{**} and guaiacyl units. The lignin of the compound middle lamella contains both guaiacyl and syringyl units, the lignin of the secondary cell wall layers consisting predominantly of syringyl units. Chemical bonds to link the lignin units are mainly ether bonds and carbon-to-carbon bonds. The most common ether bond is between the β -carbon and the O4 of an adjacent phenyl propane unit (approximately 35%), whereas α -aryl-ether and α -O-4 bonds also exist (Fig. 4). In general, ether bonds are much more unstable and susceptible to degradation by chemicals and heat than the carbon-to-carbon bonds. In softwood species 10-30% of the lignin units contain phenolic groups whereas in hardwood species 9-15% contain phenolic groups.

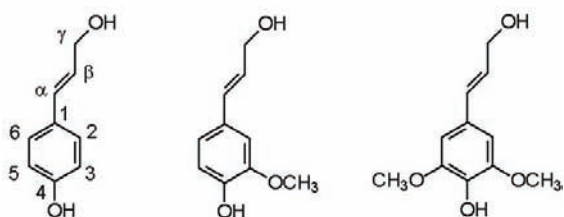

Fig 3. Precursors of the lignin biosynthesis (p-coumaryl alcohol, coniferyl alcohol and sinapyl alcohol)

The compound middle lamella contains a high lignin concentration (nearly 60%) whereas the proportion of lignin of the secondary cell wall is about 27-30% (similar for the S1 and S2 layer). In the cell wall corners the volume portion of lignin is very high.

^{*} Guaiacyl units originates from coniferyl alcohol

^{**} Syringyl units originates from sinapyl alcohol

Lignin holds the fibres together and acts as a stiffening agent for the cellulose molecules within the fibre cell wall. Furthermore, it limits the access of water to the carbohydrates and thereby lesser the influence of water on wood's hydrogen-bonded structure.

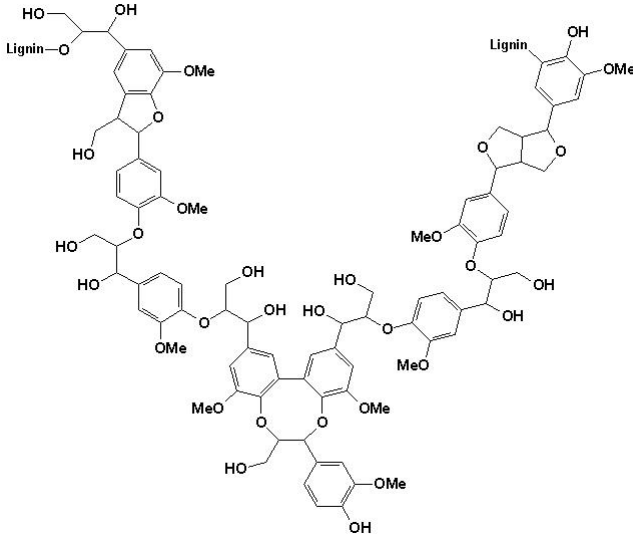

Fig 4. A small fragment of the lignin polymer

Pectines and starch

Wood contains minor amounts of other polysaccharides than cellulose and hemicelluloses: pectins (less than 1%) and a very small amount of starch. The structure of pectins is similar to the hemicelluloses and it consists of galacturonans, rhamnogalacturonans, arabinans and galactans. Pectins are found in the compound middle lamella and the tori of bordered pit membranes. In the middle lamella pectins help to bind cells and regulate water.

Starch consists of various components (e.g. amyloses and amylopectin), which exist only in the form of granules and not as fibrils. It can be found in the parenchyma cells of wood tissue where it serves as storage or nutrition for the living tree.

Extractives

Wood contains small amounts of low molecular weight compounds, which can be extracted with polar and non-polar solvents (in general 2-8% of wood's dry weight). Based on their chemical constitution, extractives can be categorized in different groups, e.g. saccharides, nitrogenous extractives, organic acids, fatty acids, waxes, terpenoids and steroids, phenolic compounds, and inorganic components.

ANNEX 2. EXAMPLES OF DIFFERENT PROJECTS IN THE NETHERLANDS



Channel siding: Plato®Wood Norway spruce
Location: Natuurgebied Korenburgerveen nabij
Dwardsdijk, Winterswijk



Sheet-piling: Plato®Wood Norway spruce
Location: Hoogheemraadschap van Delfland



Channel siding: Plato®Wood Norway spruce
Location: De Hoorn in Houten



Noise retaining wall: Plato®Wood Norway spruce
Location: Sint Joost, A2 (afrit 44)



Fence: Plato®Wood Norway spruce
Location: Middelbuurt, Schokland



Wild observation post: Plato®Wood Douglas fir
Location: National Park Hoge Veluwe

Examples of different projects in the Netherlands



Roof terrace: Plato®Wood Norway spruce
Location: Amsterdam



Salvages, doors and fencing: Plato®Wood Norway spruce
Location: Leidsche Rijn, Utrecht



Salvages: Plato®Wood Norway spruce
Location: Zuid Beijerland



Fencing: Plato® Wood poplar
Location: Openlucht Museum, Arnhem



Vertical cladding: Plato® Wood poplar with Olympic Stain
Location: Aalsmeer



Salvages and cladding: Platomium® Oslo with Olympic Stain
Location: Vleuterweide in Vleuten

Examples of different projects in the Netherlands



Cladding: Platomium® Oslo
Location: Wormerveer



Salvages and cladding: Platomium® Oslo
Location: 't Fort, Apeldoorn



Open cladding: Plato® Wood Norway spruce
Location: City hall of Slochteren



Cladding: Plato®Wood Norway spruce
Location: Harkstede



Open Cladding: Plato®Wood Norway spruce
with Olympic Stain
Location: Helmond



Vertical cladding: Plato®Wood Norway
spruce
Location: Triodos bank in Zeist

ANNEX 3. FTIR ANALYSIS OF HEAT-TREATED WOOD*

Abstract Wood specimens of beech (*Fagus sylvatica* L.) and Scots pine (*Pinus sylvestris* L.) modified by a hydrothermal treatment process were analysed by means of Fourier transform infra red spectroscopy (FTIR). The chemical transformation of the cell wall material was studied and associated with improved wood qualities. For this purpose, FTIR spectroscopy was used as since this technique has been found appropriate to determine the intensity of specific bonds and functional groups within the polymeric structure. Cleavage of acetyl groups of the hemicelluloses has been found to occur in the first treatment stage under moist conditions and elevated temperature. This results in the formation of carbonic acids, mainly acetic acid. Most of the acetyl groups were found to be cleaved during the treatment of wood at high temperature, whereas only partial deacetylation was found to occur at moderate treatment temperature. The concentration of accessible hydroxyl groups was measured by acetylation and found reduced after treating at high temperature. Esterification reactions were found to occur under dry conditions at elevated temperature in the curing stage, indicated by the increase of the specific ester carbonyl peak at 1740 cm^{-1} in the FTIR spectrum. The esters that were formed turned out to be mainly linked to the lignin complex, considering that the newly formed carbonyl groups were found present in heat-treated wood, yet were found to be absent in the isolated holocellulose. Esterification contributes to a decrease of hygroscopicity of wood and consequently improvements of its dimensional stability and durability. However, the role of esterification in the decrease of hygroscopicity in the hydrothermal treatment process examined is believed to be minor compared to the influence of cross-linking reactions known to occur during thermal treatment of wood.

1. Introduction

During the last decades, an increased interest in novel methods to modify the chemical structure of wood has come into view. These new modification methods aim to improve various properties of wood, among which hygroscopicity, dimensional stability and durability are the most significant ones. Over the last 50 years, heat treatment of wood has been considered as an effective method to modify wood (Stamm 1942; Seborg et al. 1953; Burmester 1973, 1975; Burmester and Wille 1976; Giebeler 1983). Heat treatment has been established as a method

* B. F. Tjeerdsma and H. Militz (2005) Chemical changes in hydrothermal treated wood: FTIR analysis of combined hydrothermal and dry heat-treated wood. Holz als Roh- und Werkstoff 63:102-111

in which the hygroscopicity of wood is reduced substantially (Runkel and Witt 1953; Seborg et al. 1953; Stamm 1956; Kollmann and Schneider 1963; Kollmann and Fengel 1965; Noack 1969; Hillis 1984). Strongly associated with the reduction of the hygroscopicity, the dimensional stability and the durability are increased resulting in a product with essential improved properties. However, the loss of strength properties has always been one of the main drawbacks for a commercial utilisation of thermal treatment of wood. Distinct from other chemical modification methods (Militz et al. 1997), in most thermal treatment processes, no reacting chemicals are added to the treatment of wood. Principally, in thermal treatment of wood, transformations of the chemical wood structure are caused by autocatalytic reactions of the cell wall constituents. The woody cell wall is primarily composed of the three polymeric components cellulose, hemicelluloses and lignin. It is known that during a thermal treatment of wood under moist conditions, initially carbonic acids, mainly acetic acid, will be formed as a result of cleavage of the acetyl groups of particular hemicelluloses (Kollmann and Fengel 1965; Dietrichs et al. 1978; Bourgois and Guyonnet 1988). Depending on acid concentration and temperature applied, hemicelluloses as the most reactive wood component will be hydrolysed into oligomeric and monomeric structures (Klauditz and Stegmann 1955; Bobleter and Binder 1980; Carrasco and Roy 1992). Subsequently, the monomeric sugar units will be dehydrated to aldehydes, of which furfural is being formed out of pentoses and hydroxymethylfurfural out of dehydration of hexose sugar units (Burtscher et al. 1987; Ellis and Paszner 1994; Kaar et al. 1991). Lignin is the least reactive wood component, but at high temperatures, bonds within the lignin complex will be cleaved, resulting in a higher concentration of phenolic groups (Runkel 1951; Kollmann and Fengel 1965). This state of increased reactivity of the lignin exposes the occurrence of various condensation reactions of aldehydes and lignin and of autocondensation of lignin. At present, different heat-treatment processes are under development or already marketed. A complete overview of the techniques and material properties is given by Militz (2002). The studies described were performed on the former developed and earlier reported 'PLATO process' (Ruyter 1989; Boonstra et al. 1998). The 'PLATO process' consists, dissimilar to known thermal treatment processes, of two succeeding phases in which the cell wall material is modified. This process is based on the assumption of several dominant chemical reactions occurring successively but also partial at the same time in the cell wall during the two succeeding stages of the process. Stage one is a hydrothermal phase believed to be characterised by a partial depolymerisation of the cell wall components ('hydro-thermolysis'). The second stage is believed to be dominated by curing reactions ('curing'), where reaction products are (re)condensed into a modified polymeric complex.

The aim of this paper is to study the chemical transformations of the cell wall components during hydrothermal treatment and to correlate these changes with improved wood qualities. Conventional analytical methods are essentially based

on separation of the different components to determine the chemical composition of wood. Fourier Transform Infra Red (FTIR) spectroscopy has been found effective to analyse the chemical structure of wood as a whole (Faix 1988). Analysing the entire polymeric complex is advantageous with respect to understanding the behaviour of thermally modified wood. Complementary to NMR analyses that were performed earlier (see Chapter 4), in this paper, FTIR analyses have been used to study the chemical transformations in hydrothermal treated wood.

2. Material and methods

Beech (*Fagus sylvatica* L.) and Scots Pine (*Pinus sylvestris* L.) sapwood were heat treated in a two-stage process. In the first stage, solid wood specimens of 15x15x62 mm were exposed to high temperatures under moist conditions in a 16-l laboratory-scale autoclave. The pH in the humid phase is controlled at 5.5 by the addition of sodium acetate solution. For the determination of the pH as a function of the temperature, no buffer was added. In different experiments, the temperature of the first stage was varied in the range from 165 to 195 °C. In the second stage, the wood specimens were exposed to high temperatures (180 °C) under dry conditions, in an oven flushed with a continuous N₂ gas flow. Samples of untreated as well as hydro-thermolysis-treated (intermediate product after stage 1) and fully heat-treated wood (final product after stage 2) specimens were grinded and extracted subsequently with hot water and a 1:2 (v/v) ethanol:cyclohexane mixture in a soxhlet extraction, according to Rowell (1984). Holocellulose was separated from the wood specimens by the chlorite method according to Wise et al. (1946). The holocellulose was split into α -cellulose and hemicelluloses in a caustic solution, as described by Browning (1967). Using the method by Faix and Bottcher (1992), extract-free wood meal, α -cellulose and hemicelluloses from untreated, hydro-thermolysis-treated and fully heat-treated wood were analysed by means of FTIR-spectroscopy after embedding the samples in KBr pellets (1 mg/300 mg). The spectra were obtained in a Biorad FTS 165 spectrophotometer with a resolution of 4 cm^{-1} (32 scans). For analytical reasons, in order to determine the amount of “accessible” hydroxyl groups, acetylation was performed on untreated, hydro-thermolysis-treated and fully heat-treated wood samples. Small blocks of 5.5x5.5 mm were heated in acetic anhydride for 4 h at 140 °C. The concentration of the “accessible” hydroxyl groups was determined by FTIR analysis, measuring the intensity of the (hydroxyl) peak at 3350 cm^{-1} and the (carbonyl) peak at 1740 cm^{-1} .

3. Results and discussion

3.1 Acidity

The acidity of wood during the hydro-thermolysis of the treatment has been determined by measuring the pH of the process fluid directly after stage 1. In Fig.

1, the course of acidity during the hydro-thermolysis has been lined out as a function of process time and temperature. The acidity increases with both process time and temperature. The release of acid is predominantly limited by the temperature applied regarding the trend of the curves of the pH value with the increasing process time (Fig. 1). The rate of carbonic acid being formed in the hydro-thermolysis is an important parameter since it catalyses the depolymerisation of the carbohydrates in the succeeding reactions of the treatment. The aim of this type of thermal treatment is a partial depolymerisation of the hemicelluloses, while leaving the cellulose unaffected. This involves a regulation of the pH by means of well chosen process conditions. Hemicelluloses will be hydrolysed preferentially, in a mild heat treatment of wood in acid medium, because hemicelluloses are hydrolysed more easily than cellulose. Dehydration reactions occur typically during thermal treatments of polysaccharides, causing a decomposition of hydrolysed sugars (Fengel and Wegener 1989). Pyranosidic ring structures will be dehydrated into hydroxymethylfurfural and furanosidic ring structures in furfural (Bobleter and Binder 1980).

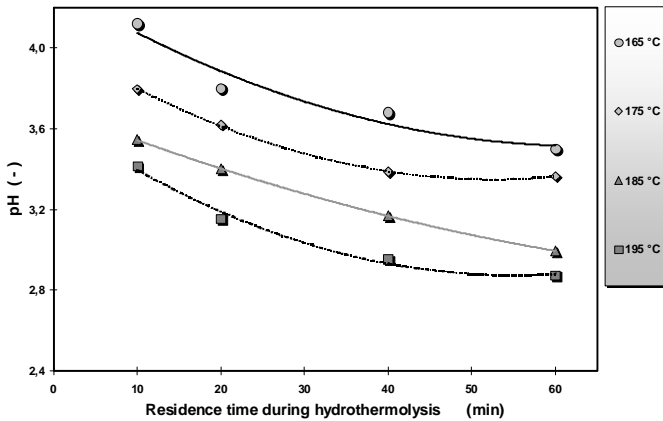

Fig. 1. Course of acidity during the first stage (hydrothermolysis) of heat treatment of Scots Pine

3.2 Deacetylation during hydro-thermolysis

Primarily with an increase of the temperature during hydro-thermolysis, deacetylation is caused by the cleavage of acetyl groups linked as an ester group to the hemicelluloses (Carrasco and Roy 1992). The acetyl content of wood is depending on wood species and ranges average from 1 to 6% (Rowell 1984). In the presence of water, the acid catalysed hydrolysis of this ester occurs according to the reaction equation (1):



The most significant absorption peak of the carbonyl group of this ester appears in the FTIR spectrum at 1740 cm^{-1} . In Fig. 2, FTIR spectra of untreated, hydro-thermolysis-treated and fully treated Scots pine and beech wood are shown. Comparing the spectra of untreated beech to beech treated at high temperatures ($185\text{ }^{\circ}\text{C}$) in the hydro-thermolysis, the strong reduction of the intensity of the peak at 1740 cm^{-1} in the latest indicates that cleavage of the acetyl groups indeed occurs to a high extent (Figure 2d).

3.3 Influence of temperature on deacetylation

Release of acid during hydro-thermolysis was found to be dependent especially on the temperature applied (Fig. 1). Accordingly, the strong influence of process temperature is furthermore confirmed by the FTIR study. The intensity of the carbonyl peak (1740 cm^{-1}) of beech wood treated at moderate temperature ($165\text{ }^{\circ}\text{C}$) is decreased compared with the carbonyl peak of untreated beech wood (Fig. 2c). However, even more clear is the complete disappearance of the carbonyl peak in the spectrum of hydro-thermolysis-treated beech wood, at high temperature ($185\text{ }^{\circ}\text{C}$) (Fig. 2d). This indicates that by applying a high temperature in the hydro-thermolysis about all the conceivable acetyl groups in the wood are deacetylated. For pinewood the same effect, but to a lower extent, can be seen (Figs. 2a and 3b).

3.4 Esterification during the curing

Comparing the spectra of the hydro-thermolysis-treated product with the fully treated wood (Fig. 2b and d), a noticeable increase of the carbonyl peak becomes apparent. This increase indicates the occurrence of esterification reactions in the second stage of the treatment. The formation of new carbonyl groups in the curing can be explained by esterification reactions occurring when the attendant acid reacts with hydroxyl groups of the cell wall material. From earlier research, it is known that these esterification reactions can occur under the conditions applied (Fengel and Wegener 1989).

3.5 Esterification in the modified lignin complex

To understand the reactions that occur during thermal treatment of wood, it is important to distinguish which wood components are predominantly involved in the esterification reactions, and to examine if the esterification reactions found do not simply represent the reverse reaction represented by equation (1). For this purpose, the individual components, holocellulose, α -cellulose, and hemicelluloses, were extracted from the treated and untreated whole-wood samples and analysed by FTIR spectroscopy. In Fig. 3, the FTIR spectra of holocellulose separated from untreated, hydro-thermolysis-treated and fully treated wood samples are shown. Comparing the infra red spectra of whole-wood samples (Fig. 2) with the spectra of holocellulose (Fig. 3), a number differences appear. As might be expected, the holocellulose spectra evidently reveals the absence of the aromatic peak at 1510 cm^{-1} , generally appearing in the infrared spectra of wood.

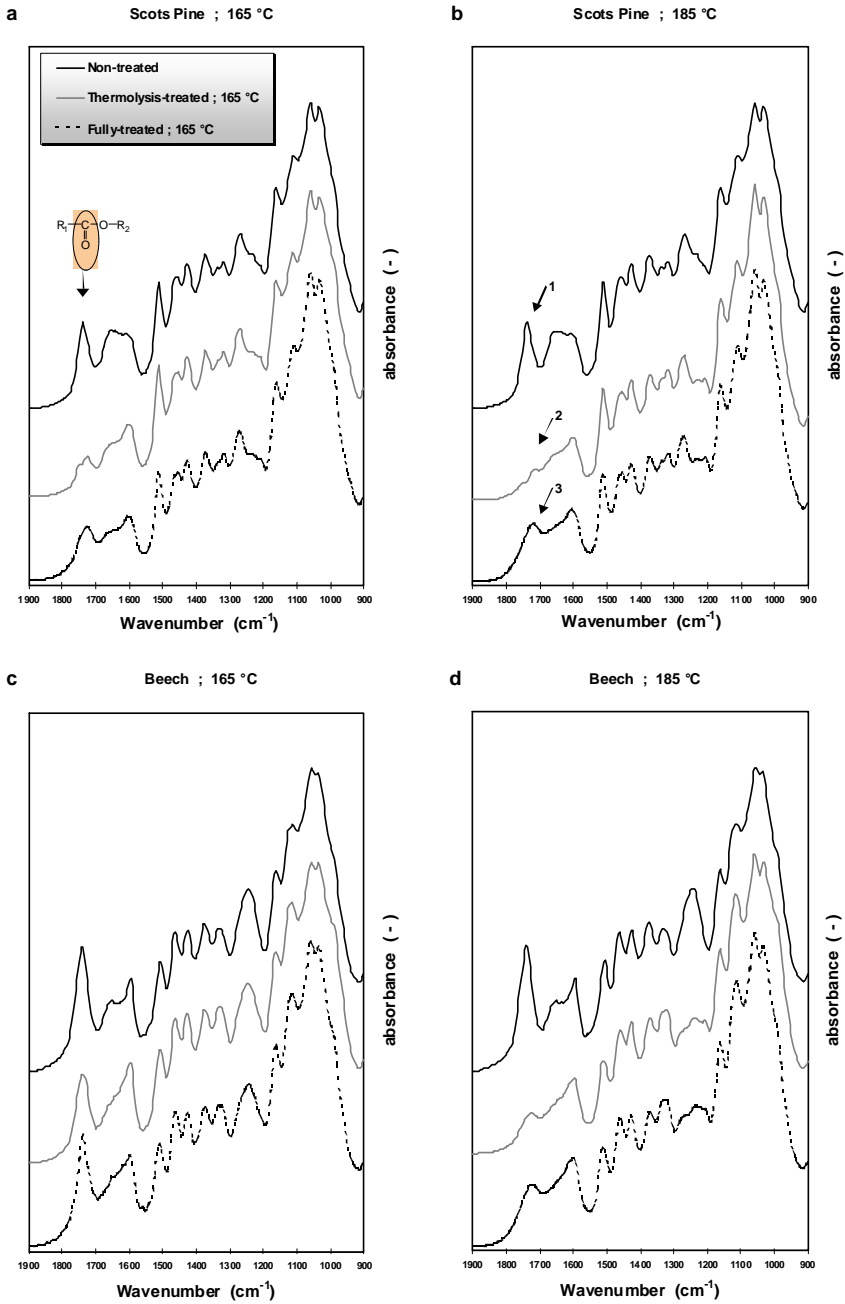

Fig. 2a–d FTIR spectra of heat treated Scots Pine and beech. Untreated, half-treated and fully treated wood, low temperature (a and c) and high temperature (b and d) treatment in the hydrothermal stage of the process

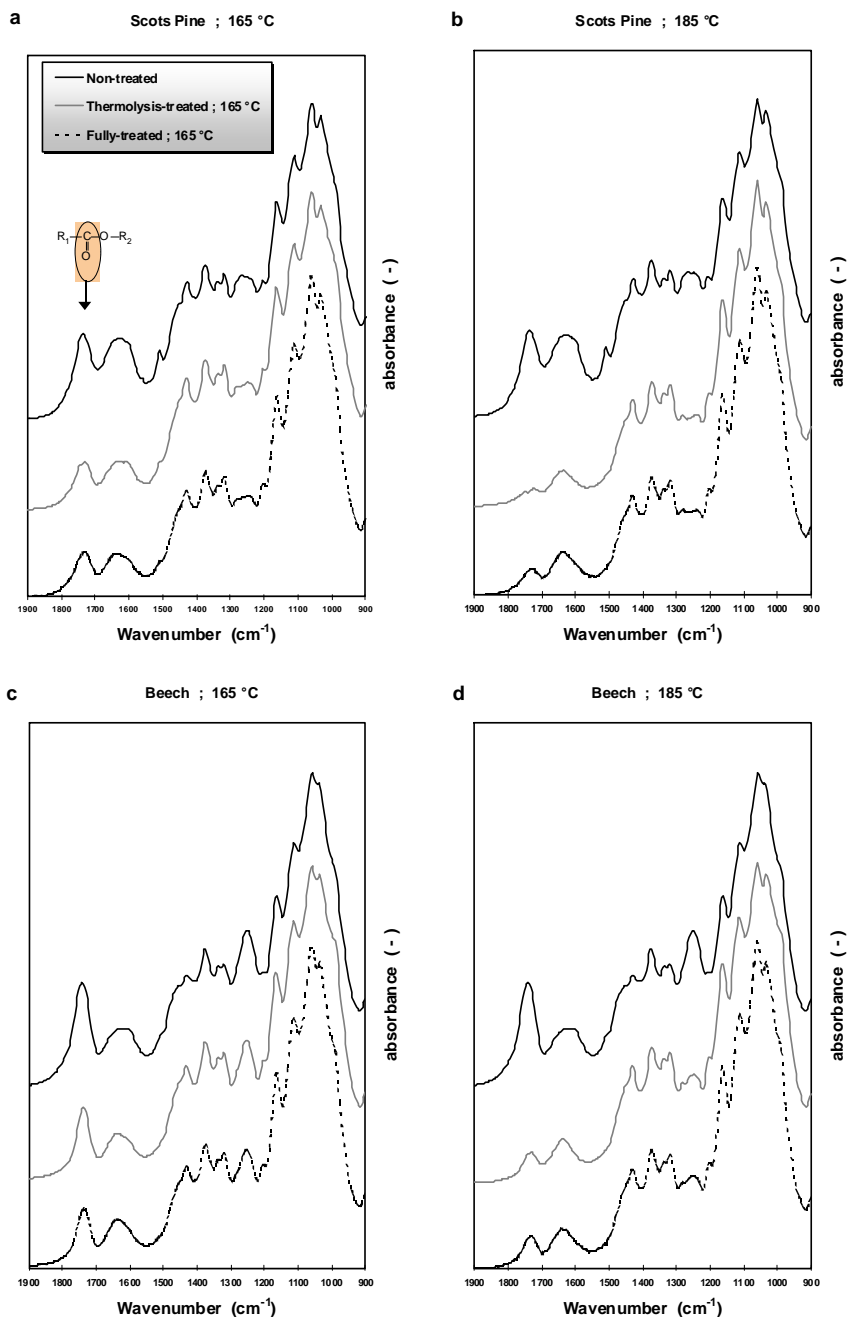

Fig. 3a–d FTIR spectra of holocellulose isolated from heat-treated Scots Pine and beech. Untreated, intermediate and fully treated wood, low temperature (a and c) and high temperature (b and d) treatment in the hydrothermal stage of the process

Distinct from the whole-wood samples, the holocellulose spectra show no shift in the intensity of the carbonyl peak at 1740 cm^{-1} , comparing the hydro-thermolysis samples with the fully treated samples. This implies that the formation of carbonyl groups during the curing stage must be occurring in the lignin network rather than in the holocellulose. In Fig. 4, the relative intensity of the carbonyl peak of heat-treated wood is compared with that of the separated holocellulose. The figure shows that for holocellulose the concentration of the carbonyl groups stabilises after hydro-thermolysis, where as for the whole-wood samples, this concentration increases during curing. This effect is valid for treatment at moderate temperatures ($165\text{ }^{\circ}\text{C}$) as well as at high temperature ($185\text{ }^{\circ}\text{C}$) in the hydro-thermolysis stage. The figure also demonstrates that for a high temperature treatment this esterification reactions occur to a higher extent.

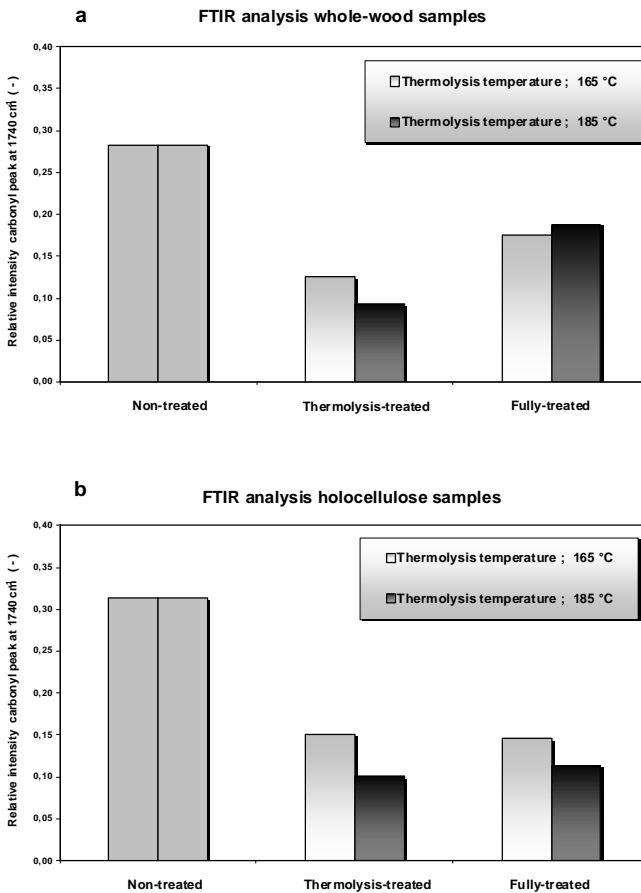

Fig. 4a and b Relative intensity of carbonyl peak in the FTIR spectra of heat-treated Scots Pine at different temperatures; (a) pine wood; (b) holocellulose

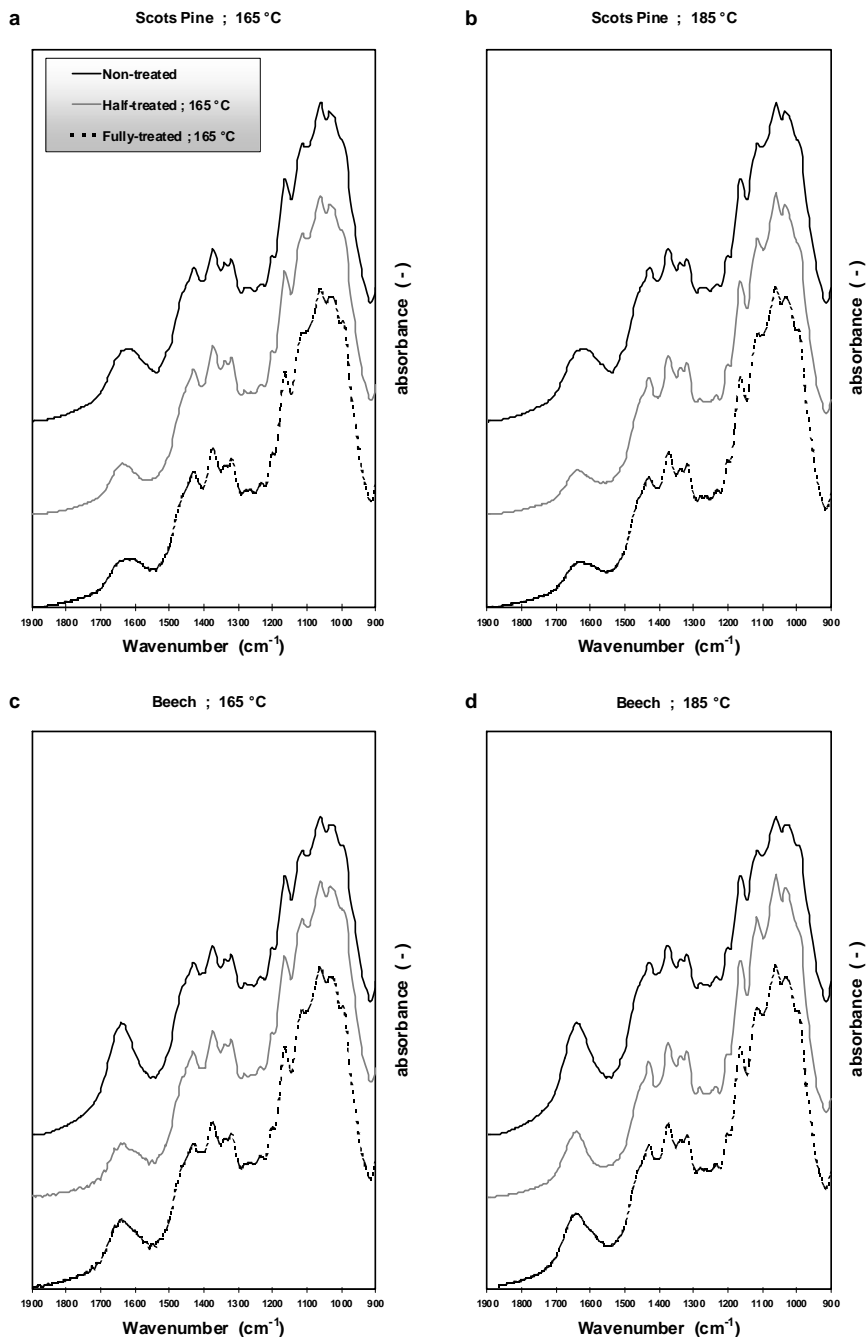

Fig. 5a–d FTIR spectra of α -cellulose isolated from heat treated Scots Pine and beech. Untreated, intermediate and fully treated wood, low temperature (a and c) and high temperature (b and d) treatment in the hydrothermal stage of the process

3.6 Cellulose

In Fig. 5, the FTIR spectra of α -cellulose separated from the holocellulose are lined out. Characteristic for the FTIR spectra of α -cellulose is the absence of the carbonyl peak at 1740 cm^{-1} and the aromatic peak at 1510 cm^{-1} , both important functional groups in a thermal treatment of wood. The identical appearances of the spectra correlate with the assumption that cellulose is the least-transformed wood constituent during thermal treatment, which has also been confirmed by earlier NMR studies (see Chapter 4). Because the appearance of cellulose has a great influence on the strength properties, this relative low transformation of cellulose is assumed to indicate a minor decrease of the strength of wood (Tjeerdsma et al. 1998b).

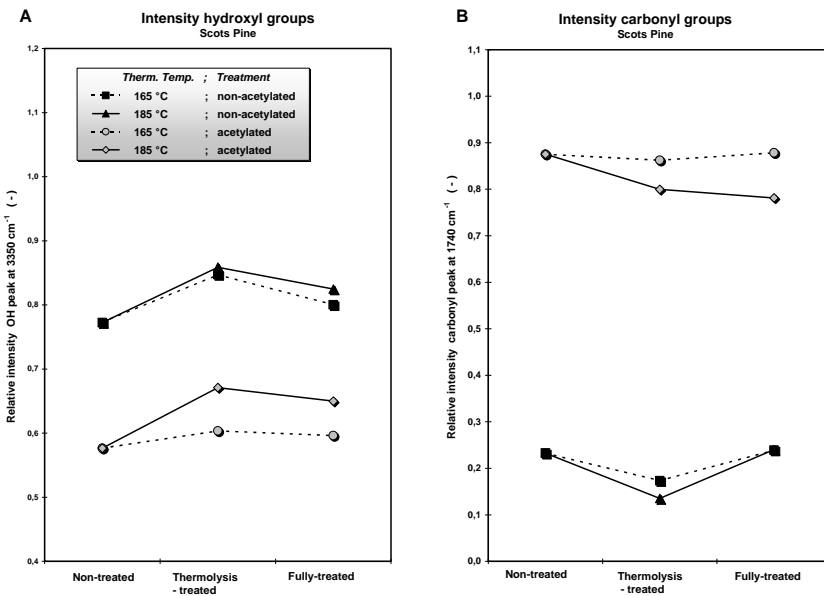

Fig. 6. Relative intensity of hydroxyl (3350 cm^{-1}) and carbonyl (1740 cm^{-1}) peak in the FTIR spectra of acetylated and non-acetylated heat-treated Scots Pine

3.7 Concentration of accessible hydroxyl groups and hygroscopicity

Hygroscopicity is highly correlated with the accessible hydroxyl groups in wood. Although the absolute quantity of hydroxyl groups in wood is high (approximately three hydroxyl groups per ring structure), all of these groups are not accessible for water molecules to form H-bridges. The concentration of accessible hydroxyl groups in wood is measured by determining the degree of acetylation after treatment with acetic anhydride. In Fig. 6, the intensity of the hydroxyl and carbonyl groups in the FTIR-spectra of acetylated and nonacetylated samples are shown. The course of intensity in the three phases is given in the figure. Regarding the course of the non-acetylated samples, an increase of the concentration of

hydroxyl groups after hydro-thermolysis and subsequently a reduction after curing is demonstrated in Fig. 6a. This reduction can be partly explained by esterification during the curing stage, which is also confirmed by the increase of the carbonyl peak (Fig. 6b).

3.8 Influence of temperature on accessible hydroxyl groups

Acetylation reduces the number of hydroxyl groups in wood, and therefore the intensity of the hydroxyl peak at 3350 cm^{-1} in the FTIR spectra (Fig. 6a) will be reduced after acetylation. Further considering the reduction of the intensity of the hydroxyl peak in Fig. 6a, the reduction for the wood treated at low temperature ($165\text{ }^{\circ}\text{C}$) is larger than for the wood treated at high ($185\text{ }^{\circ}\text{C}$) temperature. This indicates that in wood treated at high temperatures less hydroxyl groups are accessible to be acetylated. This effect is confirmed by the measurement of intensity of the carbonyl peak, characteristic of the occurrence of acetylation. Consequently, for the same samples, the increase of the carbonyl peak (Fig. 6b) after acetylation is higher for wood treated at low temperatures. The accessibility of hydroxyl groups to be acetylated is strongly correlated with the accessibility of water and therefore explains to a high extent the hygroscopicity of wood. The reduction of accessible hydroxyl groups demonstrated by Fig. 6 can be explained by the earlier found occurrence of cross-linking reactions (see Chapter 4) or by recrystallisation of cellulose found to occur during hydrothermal treatment of wood (Runkel 1951; Dwianto et al. 1996). Although the results shown in figure 4 clearly point out the occurrence of esterification, the impact on the absolute amount of hydroxyl groups is considered only minor. Subsequently, the esterification that was found is believed to contribute only to a small extent to the reduction of the hygroscopicity of wood after thermal treatment.

3.9 Occurrence of chemical reactions and hygroscopicity

Since the main goal of modification is to improve dimensional stability and durability, the reduced hygroscopicity of the wood after treatment is an important parameter. Previous research on important properties of heat-treated wood show that hygroscopicity can be reduced to 60% compared to untreated wood and an improved dimensional stability demonstrated by an anti-shrinkage efficiency (ASE) of 50% (Tjeerdsma et al. 1998b). The reduction of hemicelluloses and the esterification of hydroxyl groups can explain the high reduction of the hygroscopicity for a minor part. The apparent but small increase of the carbonyl peak that was concluded indicates esterification of a limited number on an abundant total of hydroxyl groups. The occurrence of cross-linking has revealed that, though appearing in small quantities, it can strongly increase wood hydrophobicity and consequently, dimensional stability (see Chapter 4, 5 and Tjeerdsma et al. 2000). FTIR analysis can be regarded complementary to the previous work on NMR analysis of heat treated wood.

4. Conclusions

In the first hydrothermal stage of the heat-treatment of wood under moist conditions, carbonic acid, mainly acetic acid, is formed by the cleavage of the acetyl groups of the hemicelluloses in wood. As shown by FTIR spectrometry analysis of heat-treated wood, at high temperature treatment (185 °C), approximately all the accessible acetyl groups are cleaved, where as for moderate temperature treatment (165 °C) only a substantial fraction of the acetyl groups is cleaved. The concentration of accessible hydroxyl groups was found to be reduced after treating at high temperature. Esterification reactions have been found to occur in the second treatment stage indicated by the increase of the specific carbonyl peak at 1740 cm⁻¹ in the FTIR spectrum of heat-treated beech and Scots pine. The esters that were formed are mainly linked to the lignin complex, considering that the newly formed carbonyl groups were present in heat-treated whole-wood samples, yet were found absent in the isolated holocellulose. Esterification of hydroxyl groups result in a decreased hygroscopicity of wood and consequently, improvements of its dimensional stability and durability. For modification of wood by the hydrothermal treatment examined in this work, the role of esterification in the decrease of hygroscopicity is believed to be minor compared to the influence of cross-linking, known to occur during thermal treatment of wood.

References

- Bobleter O, Binder H (1980) Dynamischer hydrothormaler Abbau von Holz. *Holzforschung* 34:48–51
- Boonstra MJ, Tjeerdsma BF, Groeneveld HAC (1998) Thermal modification of non-durable wood species. 1. The PLATO technology: thermal modification of wood. International Research Group on Wood Preservation, Document no. IRG/WP98-40123
- Bourgois J, Guyonnet R (1988) Characterization and analysis of torrefied wood. *Wood Sci Technol* 22:143–155
- Browning BL (1967) *Methods of wood chemistry*. John Wiley Sons, Inc., New York, 882p.
- Burmester A (1973) Einfluß einer Wärme-Druck-Behandlung halbtrockenen Holzes auf seine Formbeständigkeit. *Holz Roh- Werkstoff* 31:237–243
- Burmester A (1975) Zur Dimensionsstabilisierung von Holz. *Holz Roh- Werkstoff* 33:333–335
- Burmester A, Wille WE (1976) Quellungsverminderung von Holz in Teilbereichen der relativen Luftfeuchtigkeit. *Holz Roh- Werkstoff* 34:87–90

Burtscher E, Bobleter O, Schwald W, Concin R, Binder H (1987) Chromatographic analysis of biomass reaction products produced by hydrothermolysis of poplar wood. *J Chrom* 390:401–412

Carrasco F, Roy C (1992) Kinetic study of dilute-acid prehydrolysis of xylan-containing biomass. *Wood Sci Technol* 26:189–208

Davids WH, Thompson WS (1964) Influence of thermal treatments of short duration on the toughness and chemical composition of wood. *Forest Prod J* 8:350–356

Dietrichs HH, Sinner H, Puls J (1978) potential of steaming hardwoods and straw for feed and food production. *Holzforschung* 32:193–199

Dwianto W, Tanaka F, Inoue M, Norimoto M (1996) Crystallinity changes of wood by heat or steam treatment. *Wood Research* 83:47–49

Ellis S, Paszner L (1994) Activated selfbonding of wood and agricultural residues. *Holzforschung* 48:82–90

Faix O (1988) Practical uses of FTIR spectroscopy in wood science and technology. *Mikrochimica Acta* 1:21–25

Faix O, Bottcher JH (1992) The influence of particle size and concentration in transmission and diffuse reflectance spectroscopy of wood. *Holz Roh- Werkstoff* 50:221–226

Fengel D, Wegener G (1989) *Wood: chemistry, ultrastructure, reactions*. W de Gruyter, Berlin, 613p

Giebeler E (1983) Dimensionsstabilisierung von Holz durch eine Feuchte/Warme/Druck-Behandlung. *Holz Roh- Werkstoff* 41:87–94

Goyal GC, Lora JH (1991) Kinetics of delignification and lignin characteristics in autocatalyzed organosolv pulping of hardwoods. *Proc Int Symp Wood Pulp Chem Melbourne, Australia* 1:205–212

Hillis WE (1984) High temperature and chemical effects on wood stability. *Wood Sci Technol* 18:281–293

Kaar WE, Cool LG, Merriman MM, Brink DL (1991) The complete analysis of wood polysaccharides using HPLC. *J Wood Chem Technol* 11:447–463

Klauditz W, Stegmann G (1955) Beiträge zur Kenntnis des Ablaufes und der Wirkung thermischer Reaktionen bei der Bildung von Holzwerkstoffen. Holz Roh-Werkstoff 13:434–440

Kollmann F (1963) Über das Sorptionsverhalten warmebehandelter Holzer. Holz Roh- Werkstoff 21:77–85

Kollmann F, Fengel D (1965) Änderungen der chemischen Zusammensetzung von Holz durch thermische Behandlung. Holz Roh- Werkstoff 23:461–468

Kollmann F, Schneider A (1963) Über das Sorptionsverhalten warmebehandelter Holzer. Holz Roh- Werkstoff 21:77–85

Militz H (2002) Heat treatment technologies in Europe: Scientific background and technological state of art. In: Enhancing the durability of lumber and engineered wood products, FPS/Madison US, Conference, Florida 11–13, February 2002

Militz H, Beckers EPJ, Homan WJ (1997) Modification of solid wood: research and practical potential, International Research Group on Wood Preservation, Document no. IRG/WP 97-40098

Noack D (1969) Über die Heißwasserbehandlung von Rotbuchenholz im Temperaturbereich von 100 bis 180°C. Holzforschung Holzverwertung 21:118–124

Rowell RM (1984) The chemistry of solid wood. American Chemical Society, Washington D.C., 614p.

Rowell RM, Tillman AM, Simonson R (1986) A simplified procedure for the acetylation of hardwood and softwood flakes for flakeboard production. J Wood Chem Technol 6:427–448

Runkel ROH (1951) Zur Kenntnis des thermoplastischen Verhaltens von Holz. Holz Roh- Werkstoff 9:41–53

Runkel ROH, Witt H (1953) Zur Kenntnis des thermoplastischen Verhaltens von Holz. Holz Roh- Werkstoff 11:457–461

Ruyter HP (1989) European patent Appl. No. 89-203170.9

Seborg RM, Tarkow H, Stamm AJ (1953) Effect of heat upon the dimensional stabilisation of wood. J For Prod Res Soc 3:59–67

Sjostro ME (1981) Wood chemistry: fundamentals and applications. Academic Press, Inc. San Diego, 293p.

Stamm AJ (1956) Thermal degradation of wood and cellulose. *Ind Eng Chem* 48:413–417

Tjeerdsma BF, Boonstra M, Pizzi A, Tekely P, Militz H (1998a) Characterisation of thermal modified wood: molecular reasons for wood performance improvement. CP-MAS ¹³C NMR characterisation of thermal modified wood. *Holz Roh-Werkstoff*. 56:149–153

Tjeerdsma BF, Boonstra M, Militz H (1998b) Thermal modification of non-durable wood species. 2. Improved wood properties of thermally treated wood. International Research Group on Wood Preservation, Document no. IRG/WP 98-40124

Tjeerdsma BF, Stevens M, Militz H (2000) Durability aspects of hydrothermal treated wood. International Research Group on Wood Preservation, Document no. IRG/WP 00-40160

Wise LE, Murphy M, D'Addieco AA (1946) *Pap Trade J* 122(2):35–43

ANNEX 4 CURRICULUM VITAE

Michiel Jan Boonstra

Current position	Quality and product manager at Plato International BV, The Netherlands
Home Address	Aardaker 20, 4007 SH Tiel The Netherlands Tel. +31 (0)344 614244
Work Address	Plato International BV P.O. Box 2159, 6802 CD Arnhem, The Netherlands Tel. +31 (0)26 3664666 Fax +31 (0)263661553
Date of birth	21 June 1965
Place of birth	Waalre, The Netherlands
Sex	Male
Nationality	Dutch
Marital status	Married, 2 children

Education

1977-1982	Havo, St. Joriscollege, Eindhoven, The Netherlands
1982-1984	Athenaeum, St. Joriscollege, Eindhoven, The Netherlands
1984-1990	Agricultural University of Wageningen, The Netherlands Biology. Specialisation in Bio-Organic Chemistry, Plant physiology and Biochemistry. Graduated August 1990: M.Sc., Agricultural Engineer
2005-2007	PhD study at the University Henry Poincaré (Nancy) and University of Ghent

Work experience

- a) Present position as quality and product manager at Plato International BV
Plato International BV is a commercial company producing and selling
thermally modified wood in the Netherlands, Belgium, Germany and the
United Kingdom. Plato International BV has a 15 person staff and a turn over
of about € 2.5 M per year. My responsibilities include the successful

preparation and execution of research projects (product development); perform quality control and dealing claims; certifying activities (FSC, KOMO); technical and commercial assistance of purchase and selling department; contact with industry, universities and research institutes; and management and use of equipment for scientific purposes.

b) Product manager at Plato Development and Licensing BV (1996-2001)

The aim of Plato Development and Licensing BV was to optimise and commercialise the Plato technology. This is a heat treatment method, which improves the durability and dimensional stability of non-durable and fast grown wood species. Plato Development and Licensing BV had an 8 person staff and a turn over of € 0.5 M per year. My responsibilities include process and product development of the Plato technology, the development of new product market combinations, the successful preparation and execution of research projects; set up of a quality system in order to perform the quality control of product and process; contact with industry, universities and research institutes; and management and use of equipment for scientific purposes.

c) Research Employee at the Centre for Timber Research (1 February 1991 - 1996)

This was a research position within the TNO organisation. The Centre for Timber Research was a division of TNO Building & Construction Research. The Centre for Timber Research had 17 person staff and a budget of 1.6 million Euros and had four workgroups namely: timber technology; structural applications of timber; non-structural applications of timber and environmental services. My responsibilities include the successful preparation and execution of research projects; contact with industry, universities and research institutes; coaching of students; and management and use of equipment for scientific purposes (e.g. pilot treatment plant, density profile apparatus). Work was performed on the field of timber technology (e.g. timber preservation and modification, gas diffusion treatment, local treatment) and environmental services (e.g. leaching tests: shower tests, stand tests).

Professional activities

Paper presented at IRG Conference in Denmark 1995 entitled "Thermal modification of non-durable wood species. 1. The Plato technology: Thermal modification of wood" (IRG/WP 98-40123).

Paper presented at IRG Conference in Denmark 1995 entitled "A comparison of shower test results from CCF, CCZF, CCB and Cu-quat treated timber" (IRG/WP 95-50054).

Paper presented at IRG Conference in Cannes 1993 entitled "The showertest method. A leaching test for assessing preservative losses from treated timber under simulated open storage conditions (IRG/WP 93-50001, pp. 77-90)".

Writing a chapter entitled "Preservative treated wood" for a book entitled "Harmonization of leaching/extraction tests. Studies in environmental science" (1997).

Writing a chapter entitled "Houtmodificatie" for a book entitled "Houtdocumentatie. Informatie voor de hout en bouwbranche" (1999).

Paper presented at the 3rd European conference on wood modification ECWM3 in Cardiff 2007 entitled "Anatomical and molecular reasons for property changes of wood after full-scale industrial heat treatment".

Research reports

45-50 TNO contract research reports in the period 1 October 1990 - 1 January 1995.

Several internal reports concerning process- and product development, quality control and purchase.

International publications: refereed

Pizzi A, Stephanou A, Boonstra MJ, Pendlebury AJ (1994) A new concept on the chemical modification of wood by organic anhydrides. *Holzforschung* 48 (1994) Suppl. 91-94.

Boonstra MJ, Pizzi A, Tekely P, Pendlebury AJ (1996) Chemical modification of Norway spruce and Scots pine. A ¹³C NMR CP-MAS study of the reactivity and reactions of polymeric wood components with acetic anhydride. *Holzforschung* 50 (1996) pp. 215-220.

Boonstra MJ, Pizzi A, Tekely P, Pendlebury AJ (1997) A study of the influence of solvents on the modification of wood with organic anhydrides. *Holzforschung* 51 (1997) pp. 62-66.

Tjeerdsma BF, Boonstra MJ, Pizzi A, Tekely P, Militz H (1998) Characterisation of thermally modified wood: molecular reasons for wood performance improvement. *Holz als Roh- und Werkstoff* 56 (1998) pp. 149-153.

Boonstra MJ, Tjeerdsma BF (2006) Chemical analysis of heat-treated softwoods. *Holz als Roh und Werkstoff* 64:204-211.

Boonstra MJ, Rijdsdijk JF, Sander C, Kegel E, Tjeerdsma BF, Militz H, Van Acker J, Stevens M (2006) Physical aspects of heat-treated wood. Part 1. Softwoods. *Maderas. Ciencia y tecnología*. 8:193-208.

Boonstra MJ, Rijdsdijk JF, Sander C, Kegel E, Tjeerdsma BF, Militz H, Van Acker J, Stevens M (2006) Physical aspects of heat-treated wood. Part 1. Hardwoods. *Maderas. Ciencia y tecnología*. 8:209-217.

Boonstra MJ, Pizzi A, Rigolet S (2006) Correlation of ¹³C NMR analysis with fungal decay tests of polymeric structural wood constituents. I. Basidiomycetes. *Journal of Applied Polymer Science* 101:2639-2649.

Boonstra MJ, Pizzi A, Rigolet S (2006) Correlation of ¹³C NMR analysis with fungal decay tests of polymeric structural wood constituents. II. Ground contact tests. *Journal of Applied Polymer Science* 102:616-622.

Boonstra M, Pizzi A, Ganne-Chedeville C, Properzi M, Leban JM, Pichelin F (2006) Vibration welding of heat-treated wood. *Journal of Adhesion Science and Technology* 20(4):359-369.

Boonstra MJ, Pizzi A, Zomers F, Ohlmeyer M, Paul W (2006) The effects of a two-stage heat treatment process on the properties of particleboard. *Holz als Roh- und Werkstoff* 64:157-164.

Paul W, Ohlmeyer M, Leithoff H, Boonstra MJ, Pizzi A (2006) Optimising the properties of OSB by a one-step heat pre-treatment process. *Holz als Roh- und Werkstoff* 64:227-234.

Boonstra MJ, Van Acker J, Kegel E, Stevens M (2007) Optimisation of a two-stage heat treatment process. Durability aspects. *Wood Science and Technology* 41(1):31-57.

Boonstra MJ, Blomberg J (2007) Semi-isostatic densification of heat-treated radiata pine. *Wood Science and Technology* 41: 607-617.

Boonstra MJ, Van Acker J, Tjeerdsma BF, Kegel E (2007) Strength properties of thermally modified softwoods and its relation to polymeric structural wood constituents. *Annals of Forest Science* 64: 679-690.

Boonstra MJ, Van Acker J, Kegel E (2008) The effect of a two-stage heat treatment process on the mechanical properties of full construction timber. Accepted for publication in *Wood Material Science and Engineering*.

Sernek M, Boonstra MJ, Pizzi A, Despres A, Gérardin P (2007) Bonding performance of heat treated wood with structural adhesives. Accepted for publication in *Holz als Roh- und Werkstoff*.

(Inter)national publications: non-refereed

Boonstra MJ (1997) Preservative treated wood. Chapter 11. In "Harmonization of leaching/extraction tests. *Studies in environmental science*". ISBN 0-444-82808-7.

Boonstra MJ (1999) Houtmodificatie. 20 pp. Chapter D2-200. In "Houtdocumentatie. Informatie voor de hout en bouwbranche". ISBN 90-5404-644-9.

Havermans JBGA, Homan W, Boonstra MJ (1993) The showertest method. A leaching test for assessing preservative losses from treated timber under simulated open storage conditions. International Research Group on Wood Preservation Doc. IRG/WP 93-50001, pp. 77-90.

Pendlebury AJ, Riepen M, Boonstra MJ, Gard WF (1994) Discussion Paper: Industrial fixation systems: key factors, limitations and optimisation through the use of computer simulation modelling. International Research Group on Wood Preservation Doc. IRG/WP/94-40026, 17pp.

Boonstra MJ, Pendlebury AJ, Esser PM (1995) A comparison of shower test results from CCF, CCZF, CCB and Cu-quat treated timber. International Research Group on Wood Preservation Doc. IRG/WP 95-50054, 10 pp.

Boonstra MJ, Tjeerdsma BF, Groeneveld HAC (1998) Thermal modification of non-durable wood species. 1. The Plato technology: Thermal modification of wood. International Research Group on Wood Preservation Doc. IRG/WP 98-40123.

Tjeerdsma BF, Boonstra MJ, Militz H (1998) Thermal modification of non-durable wood species. 2. Improved wood properties of thermally treated wood. International Research Group on Wood Preservation Doc. IRG/WP 98-40124.

Boonstra MJ, Van Acker J, Pizzi A (2007c) Anatomical and molecular reasons for property changes of wood after full-scale industrial heat treatment. Paper of the 3rd European conference on wood modification ECWM3 Cardiff, 15-17 October 2007. ISBN 184-220-096-8

International EU projects

Improvement of Efficiency and Environmental Characteristics of Preservative treatment MA2B-CT91-0036 (1992-1996).

The Plato Wood Upgrading Process LIFE 95/NL/A12/NL/277/NHL (1997).

National Dutch projects

Plato voor duurzaam en milieuvriendelijk plaatmateriaal PBTS MIL 96067 (1997-1999).

Uitbouw van de Plato Technologie - Houtveredeling BTS 98035 (1998-2001).

Opwaardering laagwaardig FSC-hout middels de Plato-Technologie AIR (2007).

