



HAL
open science

Photophysical and photobiological characteristics of liposomal forms of mTHPC

Dzmitry Kachatkou

► **To cite this version:**

Dzmitry Kachatkou. Photophysical and photobiological characteristics of liposomal forms of mTHPC. Human health and pathology. Université Henri Poincaré - Nancy 1, 2009. English. NNT : 2009NAN10060 . tel-01748386

HAL Id: tel-01748386

<https://hal.univ-lorraine.fr/tel-01748386>

Submitted on 29 Mar 2018

HAL is a multi-disciplinary open access archive for the deposit and dissemination of scientific research documents, whether they are published or not. The documents may come from teaching and research institutions in France or abroad, or from public or private research centers.

L'archive ouverte pluridisciplinaire **HAL**, est destinée au dépôt et à la diffusion de documents scientifiques de niveau recherche, publiés ou non, émanant des établissements d'enseignement et de recherche français ou étrangers, des laboratoires publics ou privés.



AVERTISSEMENT

Ce document est le fruit d'un long travail approuvé par le jury de soutenance et mis à disposition de l'ensemble de la communauté universitaire élargie.

Il est soumis à la propriété intellectuelle de l'auteur. Ceci implique une obligation de citation et de référencement lors de l'utilisation de ce document.

D'autre part, toute contrefaçon, plagiat, reproduction illicite encourt une poursuite pénale.

Contact : ddoc-theses-contact@univ-lorraine.fr

LIENS

Code de la Propriété Intellectuelle. articles L 122. 4

Code de la Propriété Intellectuelle. articles L 335.2- L 335.10

http://www.cfcopies.com/V2/leg/leg_droi.php

<http://www.culture.gouv.fr/culture/infos-pratiques/droits/protection.htm>

UNIVERSITE HENRI POINCARÉ – NANCY 1

Ecole Doctorale « Biologie Santé Environnement »

THESE

Pour obtenir le titre de

Docteur de l'Université Henri Poincaré – Nancy I

Discipline : Ingénierie Cellulaire et Tissulaire

Thèse présentée et soutenue publiquement par

Dzmitry KACHATKOU

Le 13 juillet 2009

Photophysical and photobiological characteristics of liposomal forms of mTHPC

Propriétés photophysiques et photobiologiques des formes liposomales de la
mTHPC

Directeurs de thèse : Dr L Bezdetsnaya-Bolotina
Dr V Zorin

Rapporteurs :

Dr Patricia VICENDO (IMRCP, Toulouse)

Pr Herbert SCHNECKENBURGER (Fachhochschule Aalen)

Membres du jury :

Dr Lina BEZDETNYAYA-BOLOTINA (CAV CRAN UMR CNRS 7039)

Pr François GUILLEMIN (CAV CRAN UMR CNRS 7039)

Pr Vladimir ZORIN, Minsk, Biélorussie (BSU, Minsk)

Pr Serguei MELNOV, Minsk, Biélorussie (BSU, Minsk)

SUMMARY

I GENERAL INTRODUCTION.....	4
II ORIGINS AND CLINICAL APPLICATIONS OF PHOTODYNAMIC THERAPY.....	6
III PHOTSENSITIZATION MECHANISMS.....	8
<i>III.1 Pathways of molecular excitation and deactivation.....</i>	<i>8</i>
<i>III.2 Mechanism of photosensitized reactions.....</i>	<i>9</i>
<i>III.3 Type I photosensitization processes.....</i>	<i>10</i>
<i>III.4 Type II photosensitization processes.....</i>	<i>12</i>
<i>III.5 Photosensitisers.....</i>	<i>13</i>
<i>III.5 5,10,15,20-meta-tetra(hydroxyphenyl)chlorin.....</i>	<i>16</i>
IV PHOTBLEACHING.....	20
<i>IV.1 Photobleaching mechanisms.....</i>	<i>20</i>
<i>IV.2 Parameters affecting photobleaching. Aggregation state, pH, ionic strength and oxygen concentration.....</i>	<i>21</i>
<i>IV.3 Photoproducts formation.....</i>	<i>24</i>
V LIPOSOMES.....	27
<i>V.1 Amphiphilic lipids.....</i>	<i>27</i>
<i>V.2 Lipid bilayers.....</i>	<i>28</i>
<i>V.3 Steric stabilization.....</i>	<i>29</i>
VI LIPOSOMES FOR ANTI-CANCER DRUG DELIVERY.....	31
<i>VI.1 Liposomes for drug delivery.....</i>	<i>31</i>
<i>VI.2 Pharmacokinetics and biodistribution of liposomes and liposomal drugs.....</i>	<i>33</i>
<i>VI.3 Accumulation of liposomal drugs in tumors.....</i>	<i>35</i>
<i>VI.4 Stability in plasma and storage.....</i>	<i>36</i>
<i>VI.5 Bioavailability of encapsulated drug.....</i>	<i>37</i>
<i>VI.6 Partitioning of lipophilic and amphiphatic drugs into liposomes.....</i>	<i>39</i>
VII LIPOSOMES FOR PHOTODYNAMIC THERAPY.....	41
<i>VII.1 Liposomal photosensitizing agents.....</i>	<i>41</i>
<i>VII.2 Photophysical properties of liposomal photosensitizing agents.....</i>	<i>43</i>
<i>VII.3 Pharmacokinetic of liposomal photosensitizing agents.....</i>	<i>45</i>

VII.4 Liposomal formulations of meta(tetrahydroxyphenyl)chlorin.....	47
VIII OBJECTIVES.....	49
IX RESULTS.....	50
IX.1 Unusual photoinduced response of mTHPC liposomal formulation (Foslip).....	50
IX.2 Study of meso-tetra(hydroxyphenil)chlorin (mTHPC) redistribution from lipid vesicles to biological substrates	57
IX.3 Photodynamic therapy with intratumoral administration of lipid-based mTHPC in a model of breast cancer recurrence.....	83
X GENERAL DISCUSSION.....	91
X CONCLUSIONS AND PERSPECTIVES.....	97
REFERENCES.....	99
APPENDICES.....	120

I GENERAL INTRODUCTION

Photodynamic therapy (PDT) has been developed as a treatment modality for a number of malignant and non-malignant disorders. PDT treatment is based on the presence of a drug with photosensitising and tumour localizing properties combined with visible light and oxygen. Separately, these three components are harmless, but in combination they may destroy tissue and inactivate cells.

Meta-tetra(hydroxyphenyl)chlorin (mTHPC) or Foscan® is a second-generation photosensitiser and one of the most effective studied to date. It is about two orders of magnitude more active compared to Photofrin. Foscan® has been granted European approval for palliative treatment of patients with advanced head and neck cancers and also it has been successfully employed for treatment of early squamous cell carcinoma, basal cell carcinoma, prostate, pancreatic cancer. Clinical application of mTHPC meets several difficulties due to high hydrophobicity of this photosensitiser. In aqueous media like blood plasma, mTHPC strongly aggregates and as such is ineffective in producing singlet oxygen, thus resulting in a drop of its photosensitizing efficiency. To avoid aggregation effects and to reach monomerization of hydrophobic drugs various delivery vehicles have been used, one of the most effective being lipid vesicles. Liposomal drug carriers possess some additional advantages. They are non-toxic, biodegradable and their membrane melts with the cell membranes, leading to intracellular delivery of the liposomal drugs. The correlation between liposomal size and the diameter of the pores in the tumour capillaries makes it possible to carry out passive drug delivery.

There are several commercial liposomal mTHPC formulations, such as Foslip and Fospeg. Foslip is a recently designed third generation photosensitiser based on unilamellar dipalmitoylphosphatidylcholine/dipalmitoylphosphatidylglycerol (DPPC/DPPG) liposomal formulation of meta-tetra(hydroxyphenyl)chlorine provided by Biolitec AG (Jena, Germany). Fospeg is a sterically stabilized form of Foslip, which in addition contains small amount of PEG-phosphatidylethanolamine.

Inclusion of a photosensitiser into a lipid membrane can significantly change its pharmacokinetic and photophysical properties. For successful application of liposomal photosensitiser formulations, the detailed knowledge about their interactions with biomembranes and proteins is required. Due to intensive energy transfer processes between photosensitiser

molecules under the conditions of a high local concentration inside the lipid bilayer, where the average distance between molecules is less than Förster radius, there could be significant changes in absorbance and fluorescence properties of the sensitiser as compared to free sensitiser. Intermolecular interactions could even cause a concentration fluorescence quenching. It is therefore necessary to take into account information about such processes while interpreting the results obtained through the application of different optical techniques to investigate liposomal behaviour in biological systems.

The main objective of the present work was to study photosensitiser redistribution processes between liposomal mTHPC formulations and lipid membranes or plasma proteins. Due to the high local mTHPC concentration inside the membrane of the commercial liposomal mTHPC formulations, direct application of well-known spectroscopic techniques to estimate the pattern of photosensitiser redistribution meets several difficulties. We describe the phenomenon of photoinduced fluorescence quenching, which takes place at high local photosensitiser concentrations. In those conditions, small light doses can almost completely quench the fluorescence of the sample. This phenomenon was found to be of great importance while investigating distribution patterns of liposomal mTHPC formulations using optical techniques. We have also applied this phenomenon to analyze photosensitiser redistribution kinetics from liposomal mTHPC formulations to lipid membranes and plasma proteins.

II ORIGINS AND CLINICAL APPLICATIONS OF PHOTODYNAMIC THERAPY

Phototherapy has been known for over 3000 years by the Egyptians, the Indians and the Chinese (Spikes, 1985). The first “modern” scientist in the field of phototherapy was Niels Rydberg Finsen. From 1895 until 1903, he performed phototherapy on 800 patients and was awarded the Nobel Prize in 1903 for Physiology-Medicine for his work on the use of light from a carbon arc in the treatment of skin tuberculosis (Szeimies *et al.*, 2001). The concept of cell death being induced by the interaction of light and chemicals has first been reported by a German medical student Oscar Raab. In the winter semester of 1897-1898 he started an investigation on the toxicity of acridine to paramecia. This work was carried out under the direction of Professor Dr. Hermann von Tappeiner. Initially, Raab found that the apparent toxicity of low concentrations of acridine varied significantly from day to day; however he soon noted that the toxicity depended on the sunlight intensity in the laboratory. He was then able to show that low concentration of acridine and some other dyes such as eosin, that had no effect in the dark, provoked the rapid killing of paramecia in the presence of light (Raab, 1900). In 1902, C. Ledoux-Lebards observed that eosin killed paramecia more efficiently in open flasks than in a closed bottles (Ledoux-Lebards, 1902) and he postulated that the presence of oxygen was essential for photoinactivation. It is in 1904 that von Tappeiner and Jodlbauer coined the term “Photodynamische Wirkung“ (von Tappeiner and Jodlbauer, 1904) which we translate as “photodynamic action” for oxygen-requiring photosensitized reactions in biological systems.

Although the mechanism of action was still unknown, it did not take long for this new therapeutic approach to be tried out on patients. The first paper reporting a clinical trial was published in November 1903 by von Tappeiner and Jesionek (von Tappeiner and Jesionek, 1903). Several other trials were performed on patients, mainly by Dreyer and Neisser, that were unfortunately were rapidly terminated because of severe side effects or temporary therapeutic efficacy. The photosensitisers used were dyes like chinidine, acridine or eosin and further studies were devoted to the development of new clinically relevant photosensitisers.

In 1911, Walter Hausmann injected 2 mg hematoporphyrin subcutaneously in mice, which were exposed to sunlight and he observed edema, erythema and skin necrosis (Hausman, 1911). The first report on the use of hematoporphyrin in humans was done by Meyer-Betz who injected himself with 200 mg hematoporphyrin and became extremely photosensitive for more than two months (Meyer-Betz, 1913). Accumulation and retention of hematoporphyrin in human

neoplastic tissue was evidenced by Auler and Banzer in 1942 (Auler and Banzer, 1942). Interrupted by the Second World War, clinical studies on photodynamic treatments were no longer performed until the middle 70's, largely through the efforts of Dougherty.

The improved understanding of the tissular and cellular factors that control PDT as well as an increased experience have led to much larger and better-controlled clinical trials, leading to the approval of PDT drugs. Photofrin® was the first approved in 1993 in Canada for bladder cancer PDT. It is now approved in more than 40 countries (1995 approval in USA, Canada, Japan and Europe) for advanced and early stage lung cancer, superficial gastric cancer, oesophageal adenocarcinoma, cervical cancer and bladder cancer. Levulan® received FDA approval in 1999 for treatment of actinic keratosis and blue light, followed in 2001 by Foscan®, approved for advanced head and neck cancer, in Europe, Norway and Iceland. Metvix® was approved for treating actinic keratosis, superficial and nodular basal-cell carcinoma in Europe. PDT is also indicated in non-oncological diseases such as wet age related macular degeneration (Visudyne®, FDA and European approval in 2000). A number of other conditions have also been treated including psoriasis, rheumatoid arthritis, menorrhagia and benign prostatic hyperplasia. In addition, PDT-mediated immune-modulation, bone marrow purging and PDT of certain bacterial, fungal and viral infections are being evaluated.

III PHOTSENSITIZATION MECHANISMS

III.1 Pathways of molecular excitation and deactivation

The absorption of light by a chromophore is the initial step in all photophysical and photochemical reactions. The energy of the absorbed light promotes molecules from their ground state to higher energy states (excited states). At room temperature, almost all the molecules are in their ground state, which is the electronic state associated with the lowest energy and a configuration where all electrons are orbitally paired. During an electronic transition, one of the electrons is excited from an initially occupied orbital of low energy to a previously unoccupied orbital of higher energy. This process transforms the molecule from its ground state into an excited state.

The excited state S_1 has a different electronic distribution than the ground state S_0 and is energetically less stable than S_0 . De-excitation must take place to permit the release of the surplus of energy. Several physical pathways leading to deactivation can be followed, represented in the Jablonski diagram (**fig. 3.1**). A molecule in a high vibrational level of the excited state S_n will quickly fall to the lowest vibrational level of this state (Vibrational Relaxation: VR). Also, a molecule in a higher excited state S_n will finally fall to the first excited singlet state S_1 (Internal Conversion: IC). Then, the singlet state S_1 can rapidly return to the ground state level S_0 by two mechanisms, a radiative process which is fluorescence, or a non radiative process (IC). During this internal conversion, the excess of energy of the singlet state is released as heat, which dissipates into the tissue or the solvent. Concerning the radiative process, a photon is emitted with an energy equal to the energy gap between the ground state (S_0) and the excited singlet state (S_1) levels. This implies that the fluorescence does not depend on the excitation wavelength (Vavilov's rule). Emitted photons have lower energy than absorbed photons, so fluorescence emission maximum is red-shifted as compared to the absorption maximum, this is known as the Stokes-Lommel's law ($h\nu_{\text{emission}} > h\nu_{\text{absorption}}$).

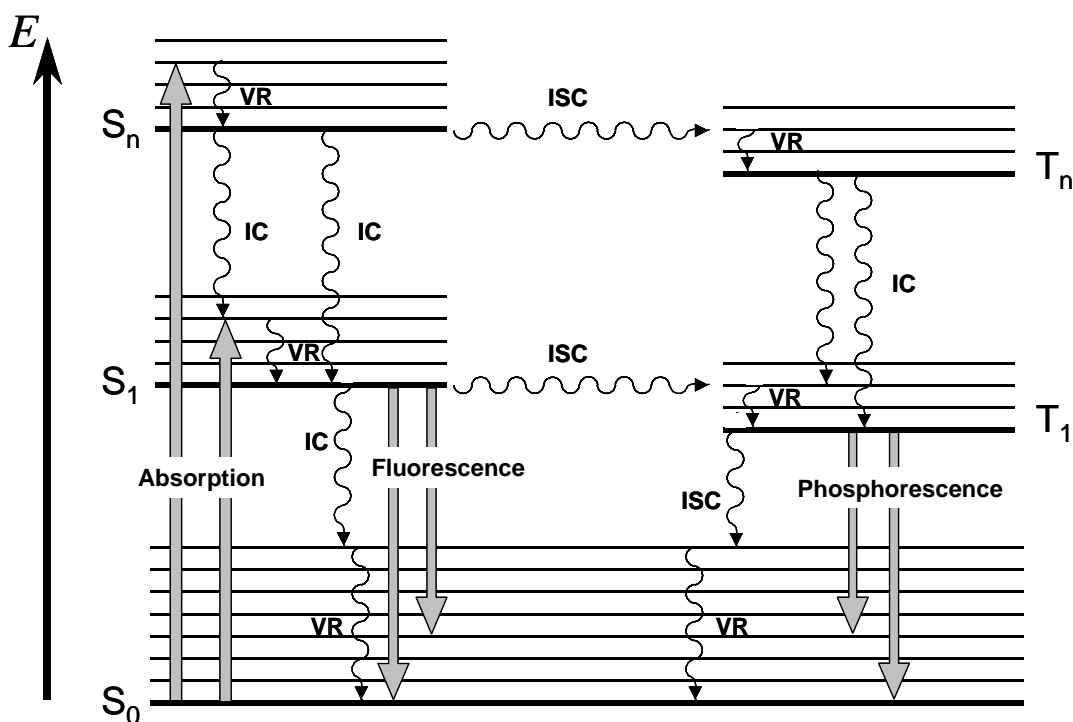

Figure 3.1: Jablonski diagram, where IC stands for internal conversion, ICS for intersystem crossing and VR, for vibrational relaxation.

In addition to radiationless and radiative processes, the singlet state can undergo a change to a triplet state T₁ via a pathway called intersystem crossing (ISC). The lifetime of the triplet state is much longer ($\tau \sim 10^{-7}$ s) than the lifetime of the singlet state ($\tau \sim 10^{-10}$ s), thus increasing dramatically the probability of a reaction with a neighbouring molecule. There are several pathways for the triplet state T₁ to return to the ground state S₀. De-excitation can occur with the emission of a photon, called phosphorescence, but at room temperature and due to Vavilov's rule, phosphorescence is very weak and difficult to detect. The excited triplet state T₁ can alternatively deactivate by undergoing intersystem crossing followed by vibrational relaxation.

For most of the organic molecules, only the singlet state S₁ and triplet state T₁ of lowest energy can be considered as likely candidates for the initiation of photochemical and photophysical reactions. This is due to the fact that higher order electronic state ($n \geq 2$) undergoes very rapid internal conversion from S_n to S₁ and from T_n to T₁. This generalization (which was used here in the description of the Jablonski diagram **fig. 3.1**) is known as Kasha's rule.

III.2 Mechanism of photosensitized reactions

Photosensitized reactions can be defined as a process in which light activation of a chromophore induces chemical changes in another molecule than the chromophore itself. The

initial step of this reaction is the absorption of a photon by the photosensitiser, leading to the generation of an excited state (^3P). In the presence of oxygen the reaction can follow two competing pathways called Type I and Type II reactions (Sharman *et al.*, 2000). According to the definition established by Foote (Foote, 1991) and as shown in **fig. 3.2**, a Type I mechanism involves the direct interaction of ^3P with a substrate (S), whereas in a type II process, ^3P reacts first with molecular oxygen to produce highly reactive oxygen intermediates that easily initiate further reactions.

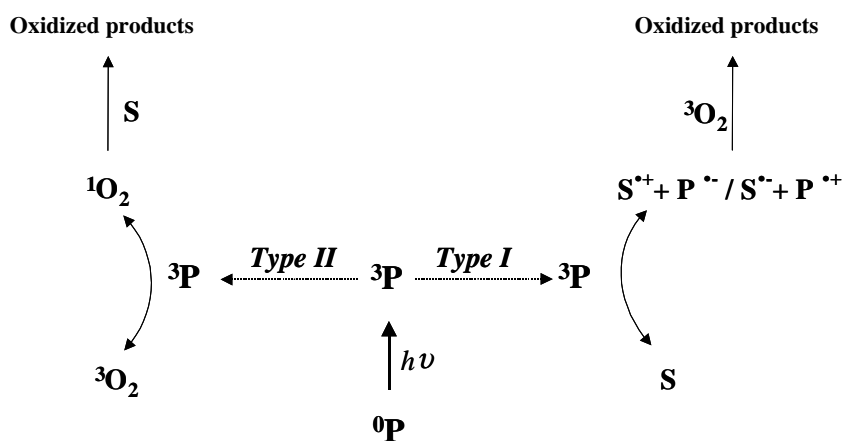
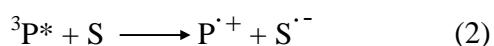
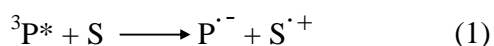

Figure 3.2: Diagram of photosensitizations mechanisms occurring after absorption of photons by a photosensitiser.

III.3 Type I photosensitization processes.

In a type I photochemical reaction, the excited triplet state of the photosensitiser ($^3\text{P}^*$) interacts directly with the substrate molecule (S) and leads to the formation of pairs of neutral radicals or radical ions following an electron or hydrogen transfer as shown in the Eqs. 1 & 2. Most biological substrates undergo an oxidation : (Eq. 1).



Both the excited photosensitiser and the ground state substrate can act as a hydrogen donor (Eq. 3-4).

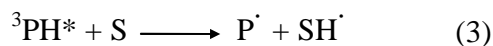

The resulting radical species from these Type I primary processes can subsequently participate to different kinds of reactions. In the presence of oxygen, for example, oxidized forms of both sensitiser or substrate readily react with O_2 to give peroxy radicals, thus initiating a radical chain auto-oxidation (as described by Eqs (5) and (6)).

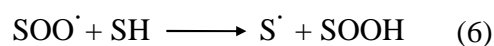

Semireduced forms of the photosensitiser or of the substrate also interact efficiently with oxygen and the electron transfer which takes place between the reactants, generates superoxide radical anion (Eqs. 7).

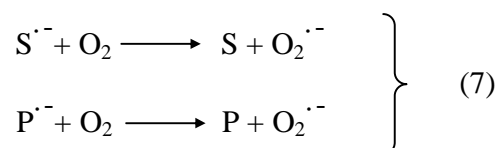

Any reaction that generates $\text{O}_2^{\cdot-}$ will also produce hydroperoxide H_2O_2 by spontaneous dismutation (eq. 8) or one-electron reduction (eq. 9).

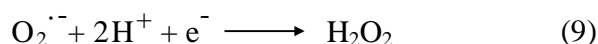
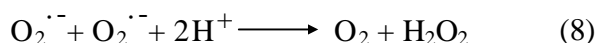

Hydroperoxide is a moderate oxidant, but when it accumulates, it can react with superoxide radical anions (eq. 10) or undergo ferrous ion catalysed reduction to give rise to an extremely reactive hydroxyl radical (Haber-Weiss reaction) (eqs. 11 & 12).

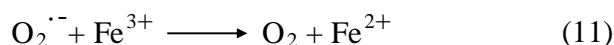
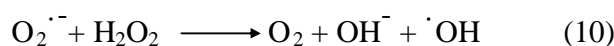

} Haber-Weiss
reaction

III.4 Type II photosensitization processes.

This type of reaction requires the presence of molecular oxygen. In most cases, the reaction proceeds via energy transfer from the excited triplet state photosensitiser to the oxygen molecule in its triplet state. Singlet oxygen can only be generated by photosensitisers that possess an energy gap between the ground state and the excited triplet state which is higher than the energy $E\Delta$ needed to excite oxygen into its excited singlet state (**fig. 3.3**). $E\Delta$ being very low (94 kJ mol^{-1} (van Lier and Spikes, 1989)), almost all tetrapyrrolic photosensitisers can mediate generation of singlet oxygen. Theoretically all molecules absorbing light at wavelengths $\lambda < 1260 \text{ nm}$ can mediate generation of $^1\text{O}_2$.

Due to the higher lifetime of triplet state of porphyrin-like photosensitiser compared to the singlet state, photochemical reactions most likely occur from the triplet state. The oxygen is then excited from its ground state into excited single state:

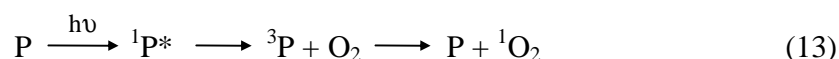

For pure Type II reaction, the quantum yield formation of singlet oxygen can be defined as:

$$\Phi_{\Delta} = \Phi_R^T = \frac{k_R^T[T_1] \cdot [S]}{k_{phosph}[T_1] + k_{ISC}^T[T_1] + k_R^T[T_1] \cdot [S]} \quad (14)$$

Singlet oxygen is a very reactive species, it is much more electrophilic than its ground state and can oxidize biomolecules very rapidly. It is a metastable species with a lifetime varying from about 4 μ s in water to 25-100 μ s in non polar organic solutions, which can be considered as a model for lipid regions of the cell (Kohen *et al.*, 1995). The life time of singlet oxygen decreases in biological environment due to the presence of various quenchers, and is calculated to be about 170-330 ns (Baker and Kanofsky, 1992). According to Moan and coworkers, this short lifetime allows the diffusion of singlet oxygen to a maximal distance of 50 nm at the sub-cellular level (Moan, 1990; Moan and Berg, 1991; Moan and Boye, 1981). Singlet oxygen can be either deactivated by returning to the ground state, or react with electron-rich regions of many biomolecules to give oxidized species.

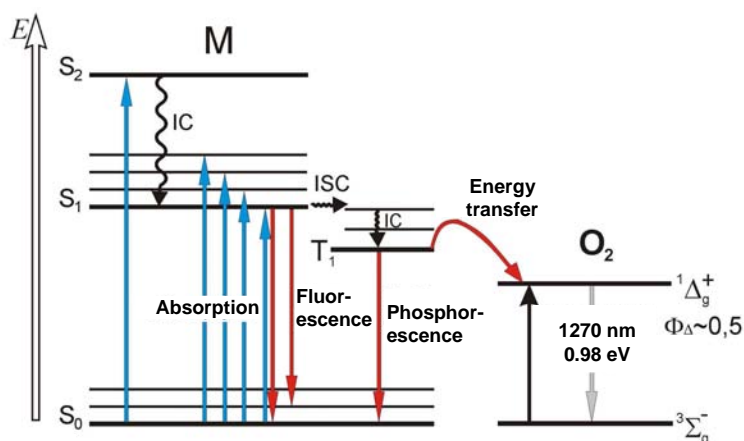

Figure 3.3 : Simplified Jablonski diagram, showing the activation and deactivation pathways during a Type II reaction.

III.5 Photosensitisers

Haematoporphyrin derivative (HpD) has been for a very long time the only photosensitiser used in clinical PDT. It belongs to the so called first generation photosensitisers. During the 80's

it has become evident that HpD was not a perfect photosensitizer. It is a very complex mixture and the exact composition of such a mix is rather difficult to reproduce. The absorption band in the red is at 630 nm with a rather limited tissue penetration, at the beginning of the “therapeutic window” and the molar extinction coefficient is rather low (about $1170 \text{ M}^{-1}\text{cm}^{-1}$). Although HpD photodynamic activity is acceptable, it is still modest. Finally, the selectivity for the target (tumour) is low, therefore inducing side effects such as skin sensitization for several weeks. Bonnett established several requirements for an ideal photosensitizer (Bonnett *et al.*, 1989):

- Strong absorption in the red part of the visible spectrum ($> 650\text{nm}$)
- High quantum yield of triplet formation, with a triplet energy greater than 94 kJmol^{-1} , the excitation energy for Δ_g singlet oxygen
- High singlet oxygen quantum yield
- Lack of dark toxicity
- Pharmacokinetic profile with rapid clearing from the body
- High selectivity for the tumour tissue versus the healthy tissue
- Uniform stable composition, and preferably a single substance

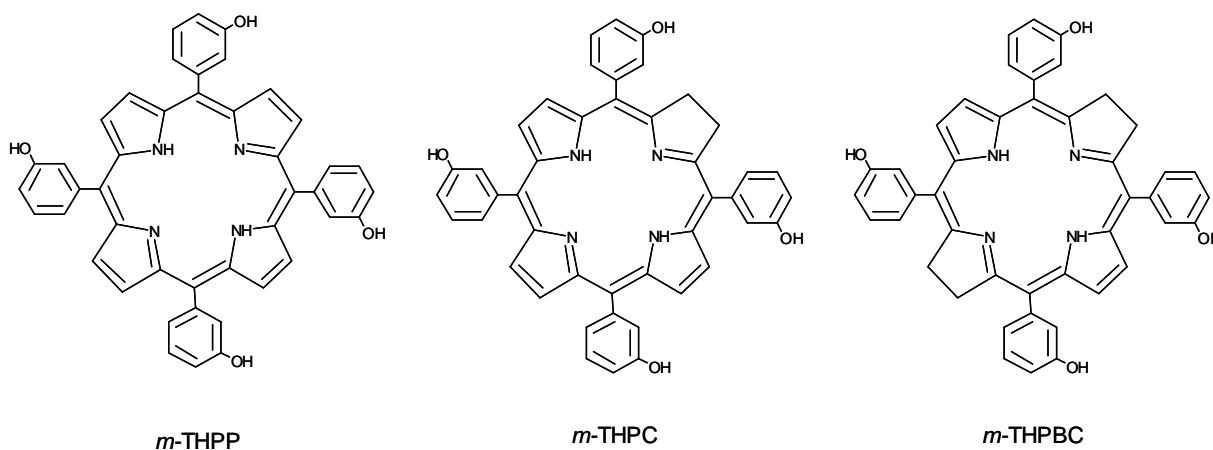

Figure 3.4 : Molecular structure of *m*-THPP, *m*-THPC and *m*-THPBC.

Second generation photosensitizers have been developed so far in agreement with the above requirements of the ideal photosensitizer. They are constituted by pure molecular synthetic structures (Phthalocyanines, naphthalocyanines, benzoporphyrins, purpurins, chlorines and

porphycenes) and natural porphyrinoids (pheophorbides, bacteriochlorins, bacterio-pheophorbides). Most of the second generation photosensitisers are tetrapyrrolic compounds with side chains, added to stabilise and improve the absorption in the red. Phthalocyanines are tetrapyrrolic compounds, where pyrrole groups are condensed with a benzenic group and where a nitrogenous bridge replaces a methene one, thus enhancing the molar absorption coefficient of these molecules and with a λ_{max} absorption around 700 nm. Texaphyrins are also synthetic relatives of porphyrins. Due to their side chains, these molecules are water soluble and rapidly cleared from the circulation and possess a wide absorption band centered at 732 nm. Unfortunately 2nd generation sensitisers generally do not manifest a large tumour localizing selectivity. Therefore research has been focused on developing third generation photosensitisers. With this aim 2nd generation photosensitiser are introduced into a vehicle (e.g. liposomes) which will drive the molecule towards the desired target. Another method is to graft amino-acids, proteins, polymers, carbohydrates or anti-bodies on an existent photosensitiser (Moser, 1998).

The photosensitisers of tetraphenylchlorin series are derived from the meso-tetra(hydroxyphenyl)porphyrins, they are namely the meso-tetra(hydroxyphenyl)chlorin (m-THPC) and the meso-tetra(hydroxyphenyl)-bacteriochlorin (m-THPBC) (**fig. 3.4**). The discovery and the chemical synthesis pathway of these compounds was performed by Bonnett *et al.* (Berenbaum *et al.*, 1986; Bonnett *et al.*, 1989). The ortho, meta and para isomers of porphyrin and chlorin have been tested (**fig. 3.5**) and the meta isomer m-THPP was found to be the most active isomer in the *in vivo* assays (Berenbaum *et al.*, 1986). The same meta isomer of chlorin m-THPC was also identified as the most active chlorin isomer (Bonnett *et al.*, 1989).

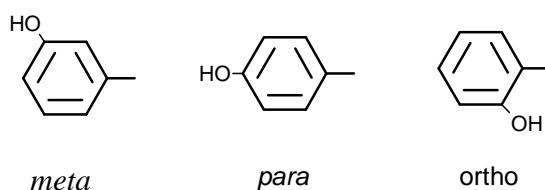

Figure 3.5 : *m*, *p* and *o* isomers of the hydroxyphenyl substituent.

The attractive properties of this series are the strong absorption in the far red region. Where the molar extinction coefficient in ethanol is 1170 $\text{M}^{-1}\text{cm}^{-1}$ for Photofrin® at 630 nm, it is 3400 $\text{M}^{-1}\text{cm}^{-1}$ at 644 nm for m-THPP, 29600 $\text{M}^{-1}\text{cm}^{-1}$ at 650 nm for m-THPC and 91000 $\text{M}^{-1}\text{cm}^{-1}$ at

735 nm for m-THPBC. They have a high triplet state quantum yield formation ranging between 0.69-0.89 and a good quantum yield in singlet oxygen formation (0.43-0.45).

Because of these photophysical properties those photosensitisers were expected to be valuable compounds for PDT. Actually it has been shown that m-THPP was 25-30 times as potent as haematoporphyrin derivative in sensitising tumours (Berenbaum *et al.*, 1986) and m-THPC, considering global photodynamic doses (light doses x photosensitizer dose), was found to be 100 to 200 times as potent as haematoporphyrin derivative (Savary *et al.*, 1998; Savary *et al.*, 1997).

III.6 5,10,15,20-meta-tetra(hydroxyphenyl)chlorin

5,10,15,20-meta-tetra(hydroxyphenyl)chlorin (mTHPC) is a photosensitizer of the second-generation (Bonnett *et al.* 1989). It mediates cell photodamage, principally through singlet oxygen formation (Melnikova, Bezdetsnaya *et al.* 1999) and its efficacy is sensitive to oxygenation conditions (Coutier *et al.* 2002). In 2001, mTHPC has been granted European approval for palliative treatment of patients with advanced head and neck cancers and it has been successfully employed for treatment of early squamous cell carcinoma (Copper *et al.* 2003; Hopper *et al.* 2004), basal cell carcinoma (Baas *et al.*, 2001), prostate (Moore *et al.*, 2006), pancreatic cancer (Bown *et al.*, 2002).

mTHPC is a highly hydrophobic compound and this defines its affinity to cell membranes and plasma proteins. Since interactions with plasma components and blood cells can play an important role in mTHPC-PDT efficacy, they are intensively studied (Michael-Titus *et al.* 1995; Hopkinson *et al.* 1999; Kessel 1999). Sasnouski *et al.* studied the kinetics of Foscan disaggregation in albumin-enriched solutions and found them to be very sensitive to the protein concentration and incubation temperature. Kinetic analysis demonstrated that two types of Foscan aggregated species with different rate constants could be involved in disaggregation: dimers and higher aggregates. Disaggregation considerably increases with temperature rise. Compared to albumin, Foscan disaggregation kinetics in the presence of lipoproteins displayed less dependency on lipoprotein concentrations and smaller variations in disaggregation rate constants (Sasnouski *et al.*, 2005). The same group studied the processes of mTHPC redistribution from plasma proteins to model membranes and demonstrated very slow kinetics of mTHPC release from protein complexes. Thermodynamic considerations proposed that sensitizer

release from high-density lipoproteins into the aqueous medium is unfavourable and collision mechanism appeared to be the preferred mode of transfer in biological environments (Sasnouski *et al.*, 2006). mTHPC displays some unusual properties *in vitro* and *in vivo* compared to many other sensitizers. Gradient-density ultracentrifugation demonstrated the presence of weakly fluorescing aggregated mTHPC species in the regions of albumin or HDL/albumin (Hopkinson *et al.* 1999; Kessel and Sykes 1999). mTHPC forms large-scale aggregates in aqueous media, that monomerize upon interaction with plasma proteins (Bonnett, 2001). This sensitizer is rigidly fixed in model membranes and is strongly retained in cells *in vitro* (Ball *et al.* 1999; Bombelli *et al.* 2005). mTHPC displays an unusual pharmacokinetic behaviour in human and rabbit plasma, with a secondary peak at about 10 and 6 h after intravenous injection, respectively (Ronn *et al.* 1997; Glanzmann *et al.* 1998). These phenomena were supposed to be explained by initial retention of PS in the liver or sensitizer aggregates in the vasculature. A similar pharmacokinetic profile was only reported for hexyl-ether derivative of pyropheophorbide-a in mice (Bellnier *et al.* 1993). mTHPC has small initial volume of distribution with high retention in the vasculature together with two peaks of PDT efficacy (2h and 24h) in mice (Jones *et al.* 2003).

It has been demonstrated that the Golgi apparatus and endoplasmic reticulum (ER) are preferential sites of mTHPC accumulation in MCF-7 human adenocarcinoma cells after 3h of incubation (Teiten *et al.* 2003). Golgi apparatus and ER were also shown to be the primary PDT-induced damage sites as measured by enzymes photoinactivation technique (Teiten *et al.* 2003; Teiten *et al.* 2003). Damage to Golgi apparatus was confirmed by fluence-dependent alterations of Golgi apparatus and mitochondrial morphology (Melnikova *et al.*, 1999). Using fluorescence anisotropy imaging, Foster *et al.* demonstrated an unusual localization of mTHPC in the nuclear envelope, indicating that this structure is a target of photodynamic damage with this sensitizer (Foster *et al.* 2005). Both apoptotic and necrotic pathways are implicated in mTHPC-mediated HT29 cell photoinactivation that is governed by mitochondrial membrane photodamage manifested by cytochrome C release and dissipation of mitochondrial membrane potential (Marchal *et al.* 2005). Investigation of the relationship between the subcellular localisation of Foscan and intrinsic apoptotic pathway post Foscan-based photodynamic therapy demonstrated that Foscan localisation in endoplasmic reticulum improves the photoactivation of the caspase-7 apoptotic pathway, which is poorly related to mitochondrial damage (Marchal *et al.* 2007).

During irradiation of mTHPC in organic, PBS and PBS containing 10% FCS at 650 nm in the absorption spectra the major absorption bands at 380-450 and 650 nm decreased (Hadjur *et al.* 1998). A new absorption band was observed at 320 nm, attributed to the formation of a photoproduct. The spectra of mTHPC fluorescence also decreased upon irradiation but no fluorescent photoproducts were detected. A strong dependence of oxygen concentration on photodegradation on formation of photoproducts has been reported (Hadjur *et al.* 1998). Hadjur *et al.* determined the quantum yields of photobleaching Φ_{pb} in aqueous solution containing 10 % FCS to be 1.54×10^{-5} for air saturated conditions and 1.8×10^{-6} after N_2 bubling. In aerobic conditions, the photodegradation as well as the formation of photoproducts, have been competitively inhibited by singlet oxygen quenchers. On the basis of photobleaching experiments Hadjur *et al.* also determined the quantum yield of singlet oxygen production (Φ_{Δ}) by mTHPC, which appeared to be 0.3 in ethanol and 0.01 in PBS suggesting that mTHPC is highly aggregated in aqueous media (Hadjur *et al.* 1998). Products of mTHPC oxidation irradiated in methanol have been separated and identified by high-performance liquid chromatography. The major compound of oxygenation process has been described as β -hydroxy-mTHPC with an absorption band around 423 nm (Jones *et al.* 1996). mTHPC has been reported to be a moderately photolabile compound. A comparative study of mTHPBC and mTHPC in methanol–water (3:2, v/v) solution demonstrated a 90 fold greater mTHPBC photobleaching rate compared to mTHPC (Bonnett, Djelal *et al.* 1999). Rovers *et al.* in an *in vivo* study on Colo 26 tumour bearing mice showed that the rate of bleaching of mTHPBC was approximately 20 times greater than that of mTHPC (Rovers, de Jode, Rezzoug *et al.* 2000). The Φ_{pb} value for mTHPC in PBS with 10 % FCS solution is an order of magnitude lower compared to BPD-MA ($\Phi_{pb} = 2.07 \times 10^{-4}$) (Aveline *et al.* 1994).

mTHPC has a strong absorbance in the red region (650 nm) with high molar extinction coefficient (Bonnett, Djelal *et al.* 1999). This offers promising therapeutic perspectives for PDT of deep tumours and pigmented tissues. Pre-clinical studies have demonstrated a significant depth of necrosis for mTHPC (Bonnett *et al.* 1989; Rovers *et al.*, 2000). The absence of correlation between PS concentration in tumor and PDT efficiency was observed *in vivo* (Veenhuizen *et al.* 1997; Ris *et al.* 1998). It was also demonstrated that in the case of mTHPC-PDT, singlet oxygen dose to the tumor volume does not track even qualitatively with tumor response, so in this case any PDT dose metric that is proportional to singlet oxygen creation and/or deposition would fail

to predict the tumor response (Wang *et al.* 2008). Study of the impact of different aggregation states of mTHPC on the photoinactivation of cells showed that the photosensitizing efficiency was 1.8 times greater at 3 h of incubation than at 24 h. Also, intracellular photobleaching of mTHPC slowed down and the profile changed from mono- to bi-exponential upon incubation. The loss of photosensitizing efficiency at higher mTHPC concentrations was attributed to self-quenching of the triplet states of the sensitizers (Sasnouski *et al.* 2007).

IV PHOTOBLEACHING

IV.1 Photobleaching mechanisms

During photodynamic treatment, in addition to the reaction with biological substrate, self-photosensitization occurs and reactive oxygen intermediates interact with the photosensitiser, leading to its transformation and/or destruction. This phenomenon is called photobleaching. The first relevant observation of photobleaching in the photodynamic therapy field was made in 1986 by Moan (Moan, 1986).

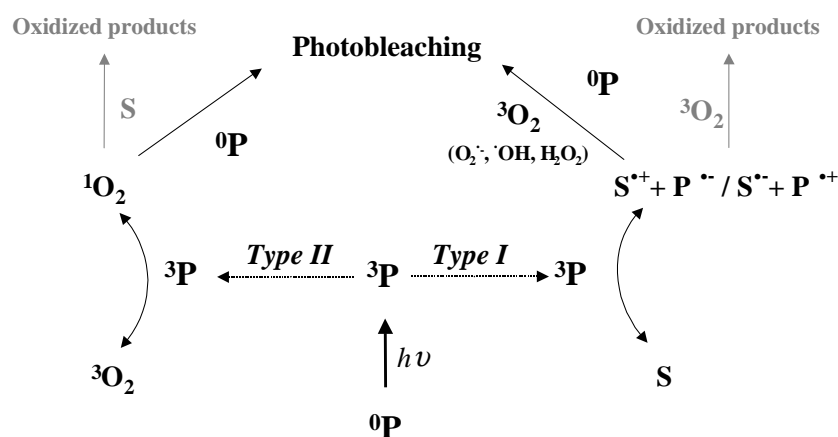

Figure 4.1 : Diagram of photobleaching mechanisms occurring after absorption of photons by a photosensitiser.

The main reactions leading to photobleaching are presented in **fig. 4.1**. The photosensitiser undergoes Type I and/or Type II mechanisms upon light irradiation, leading to the production of oxygen radical species. These oxygen radical species react with the neighbouring molecules, including the photosensitisers, leading to their destruction. Thus photobleaching can occur via two pathways, the Type I way involving reactive oxygen species and Type II way involving singlet oxygen. Photobleaching quantum yield of different photosensitisers varies significantly and can be attributed to oxidation potential, lipophilicity, presence of a metallic ion, kind of reactions involved (Type I or II).

Kinetic parameters of photobleaching are mainly derived from spectroscopic measurements assessed by UV-Vis or fluorescence spectroscopy. Several important mechanistic issues of photobleaching were obtained from the detailed analysis of spectroscopic modifications. In the earlier studies on photobleaching of photosensitizer molecules, the kinetic decay of photosensitiser

was considered as a mechanism depending only on the light dose delivered to the tissue, materialized by the mono-exponential decay $e^{-\alpha D}$, where α stands for the photobleaching constant and D stands for the fluence of irradiation (J/cm^2). It became clear later on that the photobleaching is a complex phenomenon, which cannot be described by a single exponential decrease (Moan *et al.*, 2000; Sørensen *et al.*, 1998). For some photosensitisers the decay rates have been shown to be practically independent of the concentration of the dye during illumination (Mang *et al.*, 1987; Moan, 1986; Sørensen *et al.*, 1998) and thus exhibit a first order decay. However, for the majority of dyes, the photobleaching decay is highly dependent on the initial photosensitiser concentration (Moan *et al.*, 1988), meaning that the photoproducts from the chromophore can cause the decay of a neighbouring chromophore (Moan *et al.*, 1997).

IV.2 Parameters affecting photobleaching. Aggregation state, pH, ionic strength and oxygen concentration

Bezdetnaya *et al.* (Bezdetnaya *et al.*, 1996) demonstrated that for HpD and PpIX, quantum yield of photobleaching obtained by matching fluorescence were higher than those obtained by matching absorbance (10 and 11 times for HpD and PpIX respectively). The authors concluded that this difference reflected the preferential photobleaching of photolabile monomeric forms compared to aggregates. Another study confirmed the preferential photobleaching of monomeric species of m-THPC (Belitchenko *et al.*, 1998).

Several studies of Rotomskis and co-workers demonstrated that photobleaching efficiency of haematoporphyrin-like sensitizers seemed to be consistent with their aggregation state and the presence of covalently linked structures. Both dimethoxyhaematoporphyrin (DMHp) and Hp are present in an equilibrium of monomeric and aggregated forms in aqueous solutions (Strekyte and Rotomskis, 1993). Their absorption bleaching rate constants are two to four times higher than that of HpD, a sensitizer containing mostly linear structures of porphyrins linked by ether, ester and/or carbon-carbon bonds (Dougherty *et al.*, 1984). It is also 10 to 20 times higher than that of Photofrin® (PF), which contains covalently linked "sandwich" type structure (Strekyte and Rotomskis, 1993b). In HpD, some of the side chains are involved in ether and ester linkages and therefore this compound is more photostable than DMHp and Hp. In PF and Photosan-3 (PS) (highly aggregated "sandwich" type structure (Strekyte and Rotomskis, 1993)), almost all side chains are involved in covalently linked structures, probably accounting for the high

photostability of these sensitisers. The presence of a certain amount of protoporphyrin in PS is probably responsible for its lower photostability compared to PF.

Lowering the pH value of a photosensitiser solution results in a shift of both the absorption and the fluorescence spectra as well as in a decrease of the fluorescence intensity, indicating an aggregation at low pH values ($\text{pH} < 5$) (Cunderlikova *et al.*, 1999). Reddi *et al.* (Reddi and Jori, 1988) also demonstrated an aggregation of hematoporphyrin and Photofrin® when decreasing the pH from 7.4 to 5.0 and they also demonstrated the decrease of the photobleaching quantum yield to 70 % for hematoporphyrin and 30 % for Photofrin®, thus suggesting a resistance toward photobleaching of aggregated species.

Changing the ionic strength by varying the buffer concentration can affect the aggregation state of a sensitiser. An increase of the buffer concentration of a TPPS₄ solution increases the aggregation of the sensitiser and reduces the photobleaching quantum yield by 50 % (Davila and Harriman, 1990). Thus, it follows from all these studies that the quantum yield of photobleaching is inversely proportional to the aggregation state of the photosensitisers.

Strečkyte *et al.* (Strečkyte and Rotomskis, 1993) showed that in micellar media (Triton X-100), which leads to the monomerisation of the photosensitisers, several dyes such as DMHp and HP had a different photostability and different photoproducts formation compared to aqueous media. Spikes (Spikes, 1992) reported that adding CTAB (cetyltrimethylammonium bromide) to PBS solution increases the quantum yield of PF photobleaching by 90%. The photobleaching of uroporphyrin I and hematoporphyrin in the same conditions was unchanged and the bleaching of TPPS₄ decreased by 25%. Spectroscopic studies demonstrated that there was significant monomerisation of hematoporphyrin, TPPS₄ and PF in CTAB, however the reasons for this opposite effect between TPPS₄ and PF were not clear. The authors proposed that TPPS₄ penetrates into the CTAB micelles (Reddi and Jori, 1988) and that it localizes in a low dielectric constant region and that under these conditions photobleaching would probably be slower.

Spikes (Spikes, 1992) investigated the quantum yield of photobleaching of several porphyrins in phosphate buffer solution, and found that the bleaching was reduced by nitrogen bubbling. Also, Strečkyte and co-workers demonstrated that the photobleaching process of ALA-induced PpIX in cells was slowed down by bubbling nitrogen through the sample (Strečkyte *et al.*, 1994). König *et al.* also made the same observation for endogenously formed porphyrins in bacteria during argon flushing (König *et al.*, 1993). An observation of the involvement of oxygen

in vivo has been realised by Robinson and co-workers (Robinson *et al.*, 1998). During a photobleaching experiment with ALA-induced PpIX, the mice died and they observed a slowdown of the photobleaching. They correlated this bleaching decrease to the oxygen decline in the skin, due to the death of the animal.

Several studies from the laboratory of TH. Foster documented oxygen depletion during PDT. Oxygen consumption model was refined by Georgakoudi and co-workers (Georgakoudi and Foster, 1998; Georgakoudi *et al.*, 1997) by taking into account the parameter of photobleaching of Photofrin in EMT6 spheroids. This improvement considerably changed the kinetic profile of the oxygen aspects of Photofrin-PDT. The authors observed a rapid decrease in oxygen concentration during irradiation followed by a progressive return to the values measured before the irradiation. The first phase is due to the photochemical oxygen consumption which is faster than the diffusion of the oxygen through the spheroid. The second phase, corresponding to the comeback of oxygen to the initial value, is due to a slowdown of the photochemical consumption of the oxygen explained by a decrease in photosensitiser concentration (photobleaching), together with the diffusion of oxygen. This was in total agreement with the data from the mathematical model that they had developed, assuming that the photobleaching was based on a reaction between singlet oxygen and photosensitiser at the ground state. The validity of the developed model was confirmed by applying it to the experimental results on photobleaching in NHIK 3025 cells loaded with Photofrin from the study of Moan (Moan, 1986).

In their further studies Foster and co-workers investigated the impact of irradiance on photobleaching (Finlay *et al.*, 2001; Finlay *et al.*, 2002). In a study reporting the photobleaching of ALA-induced Protoporphyrin IX (Pp IX) in normal rat skin (Finlay *et al.*, 2001) it was demonstrated that the photobleaching kinetics were different with different irradiances. High irradiance led to rapid oxygen consumption and a slow down of the photobleaching. In addition, the photoproducts of PpIX also exhibited an irradiance dependant photobleaching. In a second study, Finlay *et al.* (Finlay *et al.*, 2002) showed that photobleaching kinetics of m-THPC on normal rat skin exhibited two distinct phases. The first phase was shown to be irradiance independent, whereas the second phase revealed an irradiance dependency consistent with an oxygen-dependant reaction process.

IV.3 Photoproducts formation

Presently, two mechanisms of photobleaching are acknowledged (Bonnett and Martínez, 2001). The first one, true photobleaching, corresponds to the photodegradation of the porphyrin macrocycle with the formation of photoproducts, which do not absorb in the visible light region. The second mechanism is called photomodification, where the chromophore is retained in a modified form with the formation of new visible spectral bands. For the majority of photosensitisers the photoproducts arise from both photodegradation pathways.

Photomodification is featured by the loss of absorbance or fluorescence at some wavelength and the appearance of new spectral bands, this being in agreement with the photoformation of new compounds. For macrocyclic compounds, photomodification appears when the rupture of the macrocycle doesn't occur. While true photobleaching leads to the destruction of the tetrapyrrolic cycle and results in the formation of small products that do not absorb visible light. It appears that, where photomodification occurs, true photobleaching often occurs concomitantly and one also should notice that photomodification can be mistaken for photorelocalisation.

The photobleaching of tetraphenylchlorin series sensitisers have been extensively studied because of the large clinical potential of the m-THPC and also because of their important absorption in the red region of the visible spectrum. Bonnett *et al.* have made a comparative study of the photobleaching of this sensitiser series by absorption measurements (Bonnett *et al.*, 1999). The authors demonstrated that in methanol-water solution m-THPC and m-THPBC underwent only true photobleaching and photomodification mainly occurs for m-THPP. The products formed after the irradiation of m-THPP methanol-water were hydroxylated m-THPP (mono-, di-, tri- and tetra-hydroxylated m-THPP) (Bonnett and Martinez, 2002) with mono-hydroxylated m-THPP being the major photoproduct (25%). While in pure methanol small photoproducts appeared such as maleimide and methyl-3-hydroxybenzoate, the mono-hydroxylated m-THPP was still photoproducted. A recent study (Lourette *et al.*, 2005) regarding the photobleaching of m-THPP in ethanol-water (1/99, v/v) solution revealed that using a pulsed laser as light source, m-THPP undergoes phototransformation to a hydroxylated product and several covalent oligomeric structures as dimer, trimer, tetramer and pentamer of m-THPP.

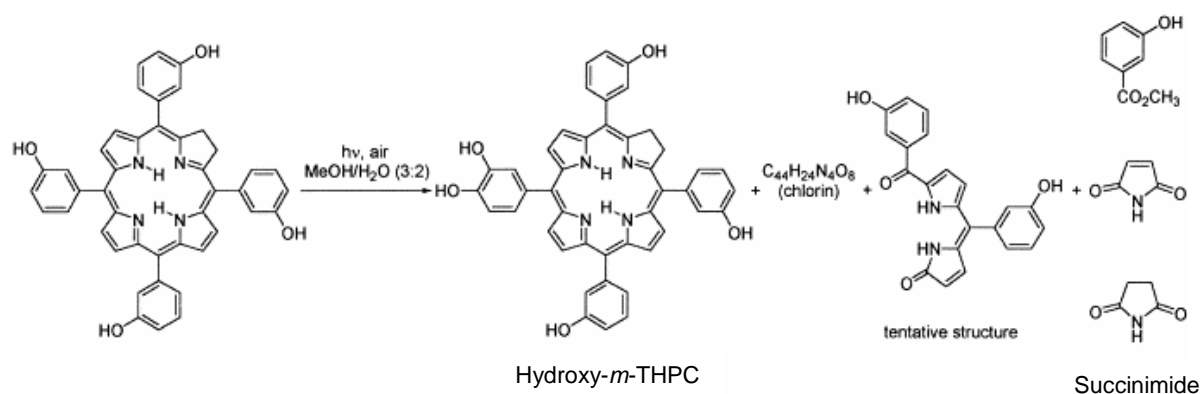

Figure 4.2 : Photooxidation of *m*-THPC in methanol-water from (Bonnett and Martínez, 2001).

Several studies on *m*-THPC photobleaching demonstrated a rapid true photobleaching of *m*-THPC, accompanied by a photoproduct formation at $\lambda_{\text{abs}} = 320$ nm when the photosensitiser was in a PBS solution supplemented with 2% fetal calf serum (FCS) (Angotti *et al.*, 1999, 2001; Belitchenko *et al.*, 1998). This result was confirmed by Hadjur *et al.* (Hadjur *et al.*, 1998) who showed a large formation of a 320 nm absorbing product in a 10% FCS solution. In methanol or methanol-water solution it appears that *m*-THPC undergoes true photobleaching (Bonnett *et al.*, 1999), since no photoproduct at 320 nm was detected. These three observations let us propose that the photoproduct formation correlates with the FCS concentration in the incubation solutions. Mass spectrometry studies were carried out to identify the spectroscopically invisible photoproducts (Angotti *et al.*, 1999, 2001; Jones *et al.*, 1996; Kasselouri *et al.*, 1999). The photobleaching was performed on *m*-THPC methanol solution or water-methanol solution and the products obtained are presented in the **fig. 4.2** and **4.3**.

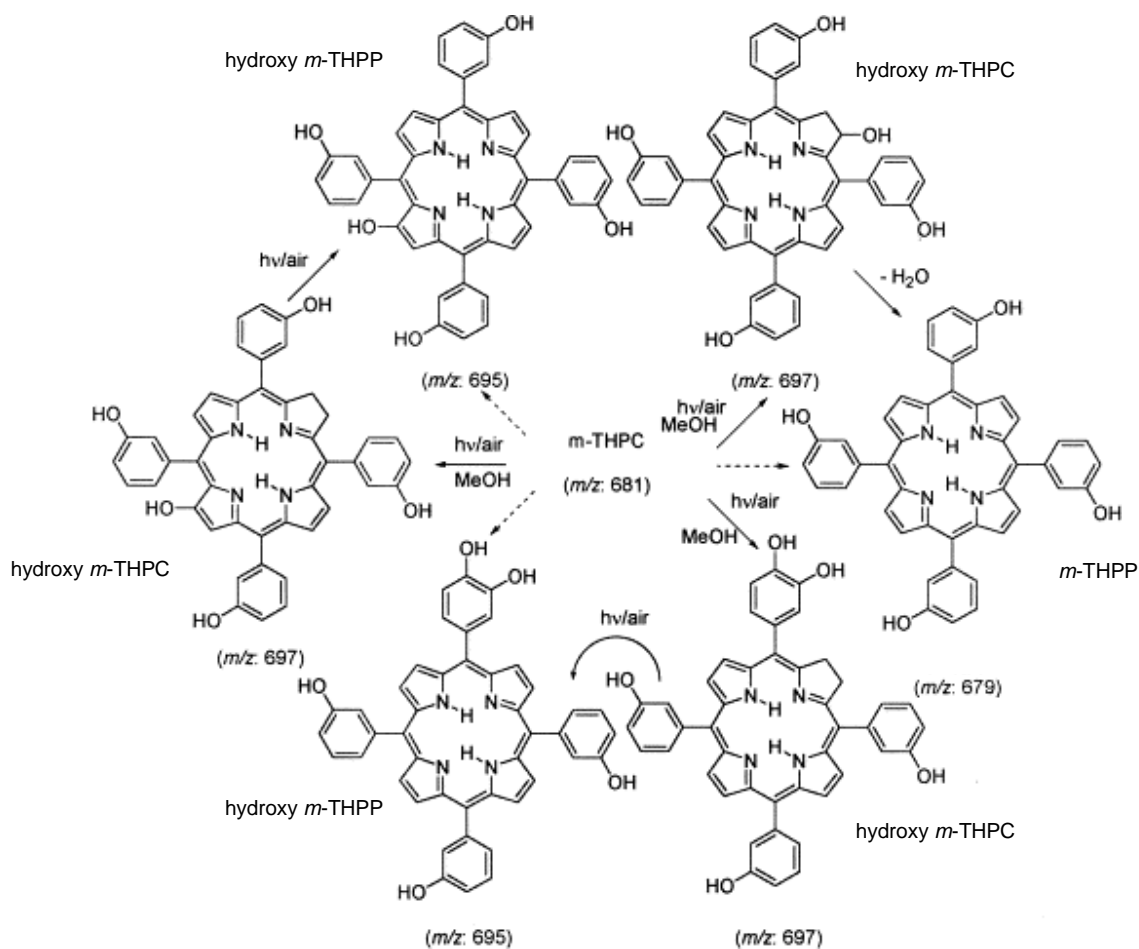

Figure 4.3 : Photooxidation products of *m*-THPC in methanol from (Bonnett and Martínez, 2001)

The major photoproducts observed were hydroxy- and di-hydroxy-*m*-THPC, hydroxy-*m*-THPP, still the position of the hydroxyl(s) group(s) is(are) not determined, these penta or hexahydroxylated chlorin have almost the same absorption peak than *m*-THPC (Jones *et al.*, 1996; Kasselouri *et al.*, 1999). Bonnett (Bonnett and Martinez, 2002) identified several products like a chlorin and four minor products coming from true photobleaching. They are dipyrin derivative, succinimide, and the two afore mentioned products maleimide and methyl-3-hydroxybenzoate, which were also photoproducts from *m*-THPP.

V LIPOSOMES

Liposomes are spherical self-closed structures, composed of curved lipid bilayers, which enclose part of the surrounding solvent into their interior. The size of a liposome ranges from some 20 nm up to several micrometers and they may be composed of one or several concentric membranes, each with a thickness of about 4 nm. Liposomes possess unique properties owing to the amphiphilic character of the lipids, which make them suitable for drug delivery.

V.1 Amphiphilic lipids

Amphiphilic lipids, used for liposome preparation, consist of hydrophilic polar headgroup and hydrophobic hydrocarbon chains. This means that a polar environment, such as water solutions, promote the spontaneous aggregation of such molecules and the formation of a variety of microstructures (Tanford, 1991).

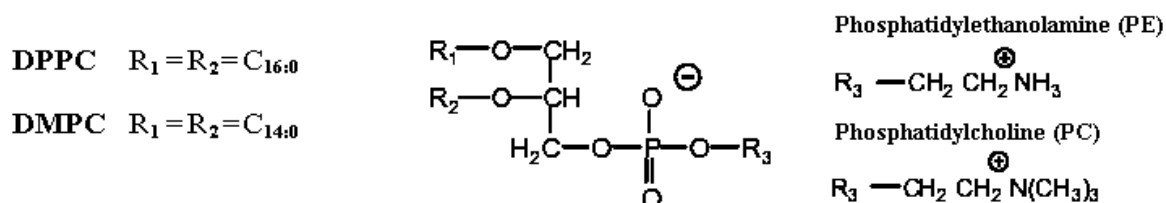

Figure 5.1 : structure of the typical lipids used for preparation of unilamellar vesicles.

This selforganisation is usually accompanied by an increased entropy of the system. Supposedly this increase is due to the water-hydrocarbon interactions that force the water molecules to form an ordered structure around the hydrophobic part when the amphiphilic molecules are freely suspended as monomers. Release of the ordered water can be achieved by driving the hydrophobic parts out of the aqueous solution and sequestering them within the interior of the aggregate. Thus the increased entropy gained by the water molecules may lead to an overall gain in free energy so that aggregation occurs spontaneously.

Spontaneous aggregation is also related to the molecular parameters of the amphiphile molecule. The so-called surfactant parameter (Israelachvili *et al.* 1977), which takes into account the hydrophobic volume, chain length and head group area, is a useful guide for predicting the optimal aggregate structure. The surfactant parameter, S , is defined by

$$S = \frac{v}{la_0}$$

where v stands for the volume of the hydrophobic portion of the amphiphile, l is the length of the hydrocarbon chains and a_0 is the effective area per head group. These parameters contain information about the geometrical shape of the molecule and the surfactant parameter can be considered to use geometrical packing constraints to restrict the number of forms available to the aggregate. The value of the surfactant parameter relates the properties of the molecule to the mean curvature of the formed aggregates. By convention the curvature of an aggregate is positive if the aggregate is curved around the hydrophobic part and negative if it is curved towards the polar part. The former produces normal aggregates and phases, while the latter forms reversed ones. For example, small values of S imply highly curved aggregates, micelles, while for $S \sim 1$ planar bilayers are formed.

V.2 Lipid bilayers

Phospholipid lamellar phases may exist in different physical states since the character of the bilayer changes with, for instance, lipid composition or temperature. Low temperatures or a high degree of saturation force the bilayer into a gel state, in which hydrocarbon chains exhibit close packing and a more or less frozen conformation. Increasing the temperature or introducing unsaturated acyl chains results in a bilayer of a liquid crystalline (or fluid) state, where the chains are disordered and have a high mobility. The temperature where the gel-to-liquid crystalline phase transition occurs is function of the chemical composition of the bilayer, especially of the acyl chains. This transition was at first supposed to be an isothermal first-order process (Albon and Sturtevant, 1978), but proved later on to possess both first-order and second-order characters (Mitaku *et al.* 1983). Comparing an unsaturated phosphatidylcholine with its saturated analogue, the temperature for the unsaturated lipid will be significantly lower since the double bond introduces kinks in the chain that do not allow for close packing.

Many potential mechanisms have been suggested for the formation of liposomes (Lasic, 1988). One approach is to consider the self-closing of a bilayer into a liposome as a competition between two effects, the bending or curvature energy and the edge energy of a bilayer. For a flat lamellar fragment, in a hydrophilic surrounding, there will be a high surface tension at the rim of the lamellar sheet. Bending can reduce this edge energy but bending also implies an energy penalty due to the induced curvature. To further minimise the edge energy, a higher curvature is

required and finally a closed sphere will be formed, where the edge energy is reduced to zero. The bending energy, on the other hand, has now reached its maximum. Thus, larger liposomes are energetically favoured, while entropy would favour many small ones. However, liposomes are usually stable due to the relatively high values of energy needed for pore formation. This means that a very long time is required before they collapse into a lamellar phase.

Most of the *in vivo* experimental work using liposomal formulations has been performed with conventional liposomes that were used in particular as carriers for hydrophobic photosensitisers. Conventional or unmodified liposomes are multilamellar or unilamellar vesicles composed of phospholipids (e.g. phosphatidylcholines) but cholesterol is often included as a constituent. The latter improves the rigidity of the bilayer membrane and in doing so reduces the permeability for encapsulated molecules and enhances the stability of the bilayer in the presence of biological fluids (Vemuri and Rhodes, 1995).

Liposomes can differ in size, ranging from the smallest vesicle (diameter 20nm) to liposomes that are visible under the light microscope, with a diameter of 1µm or greater, equal to the dimensions of living cells. They are classified structurally into multilamellar vesicles and unilamellar vesicles (Perez-Solar, 1989). Unilamellar vesicles have a single phospholipid bilayer membrane and a diameter of 0.05–0.25 µm. Such liposomes can be further classified into large unilamellar vesicles with a diameter of 0.10–0.25 µm and small unilamellar vesicles with a diameter of 0.05–0.10 µm.

V.3 Steric stabilisation

Polymer-coated liposomes are often used to create sterically stabilized liposomes. Stabilisation can be obtained by grafting or by adsorption of the polymer to the liposomal surface (Edwards *et al.*, 1997; Jamshid *et al.* 1988; Woodle *et al.*, 1992). The grafting method is the most commonly used and normally stabilisation is achieved by incorporation of so-called PEG-lipids, poly(ethylene glycol)-phospholipids (Edwards *et al.*, 1997). The hydrophilic PEG chains are placed on the surface of the liposome. When two polymer-covered surfaces approach each other they experience a repulsive force as soon as the outer polymer segments start to overlap. This repulsive force is due to the unfavourable entropy associated with compressing (the loss of conformational freedom) the polymer chains between the two surfaces (Israelachvili, 1992). In addition, the difference in chemical potential between the water in the bulk and in the interaction region induces an osmotic repulsive force (de Gennes, 1987).

To describe the repulsive interactions between polymer-coated surfaces, two limiting cases have to be distinguished. At a low surface coverage of the polymer, that is, without overlapping of neighbouring chains, each chain can interact with the opposite surface independently of the other chains. Going from low to high coverage, the polymers come so close to each other that they are forced to adopt extended configurations. Thereby the thickness of the polymer layer increases and hence, within this extended region, the steric stabilisation is more efficient (Israelachvili, 1992).

VI LIPOSOMES FOR ANTI-CANCER DRUG DELIVERY

Tumor blood vessels have several abnormalities compared with physiological vessels, such as a relatively high proportion of proliferating endothelial cells, an increased tortuosity and an aberrant basement membrane formation. The rapidly expanding tumor vasculature often has a discontinuous endothelium, with gaps between the cells that may be several hundred nanometers large. Macromolecular transport pathways across tumor vessels occur via open gaps (interendothelial junctions and transendothelial channels), vesicular vacuolar organelles and fenestrations.

Tumor interstitium is also characterized by a high interstitial pressure, leading to an outward convective interstitial fluid flow, as well as the absence of an anatomically well-defined functioning lymphatic network. Hence, the transport of an anticancer drug in the interstitium will be governed by the physiological and physicochemical properties of the interstitium and by the physicochemical properties of the molecule itself.

VI.1 Liposomes for drug delivery

Liposomes have been studied for many years as carrier systems for drugs (Storm and Crommelin, 1998), with advantages such as enhancement of therapeutic efficacy at low dosage and hence, reduction in toxicity of the encapsulated agent, improved pharmacokinetic profiles and targeting to tumour tissues as well as increased stability of the drug, particularly against enzymatic degradation (Fielding, 1991; Gregoriadis, 1991; Xian-rong *et al.*, 1995).

Liposomes are made from pure lipids or a combination of lipids. The lipids commonly employed in liposomal formulations are phospholipids (Uhumwangho and Okor, 2005). Liposomes have been prepared from a variety of synthetic and naturally occurring phospholipids, generally containing cholesterol (Rogers and Aderson, 1998). The incorporation of cholesterol into the lipid bilayer membrane enhances the stability of liposomes in serum, reduces the permeability of the membranes to water soluble molecules and increases the fluidity or microviscosity of the bilayer (Weiner *et al.*, 1989; Senior and Gregoriadis, 1982). Usually, a zwitterionic or non-ionic lipid is used as basic lipid for the preparation of liposomes. The net surface charge of liposome can be modified by the incorporation of positively charged lipids such as stearylamine, or negatively charged lipids such as diacetylphosphate, phosphatidyl glycerol or phosphatidyl serine (Frezard, 1999). The presence of negatively or positively charged lipids leads

to a greater overall volume for aqueous entrapment and reduces the likelihood of aggregation after preparation of the liposomes (Goldbach *et al.*, 1995).

The extents of drug entrapment and retention as well as the factors influencing them are important considerations in the design of liposome-mediated drug delivery systems. Drugs may be entrapped in the aqueous and/or lipid phase of the liposome (Uhumwangho and Okor, 2005).

Aqueous entrapment relates to the aqueous volume in the liposome. The larger the aqueous volume, the greater the amount of polar drugs that can be encapsulated (Fendler, 1980). Multiple compartment liposomes encapsulate a higher percentages of aqueous soluble drugs than single compartment vesicles, because of the larger volume of encapsulated aqueous space in the former. Formulations that promote formation of multilamellar vesicles are thus associated with higher aqueous entrapment. Cholesterol modifies the fluidity of lipid membranes, thereby influencing the degree of retention of drugs by vesicles as well as stabilising the system against enzymatic degradation (Weiner *et al.*, 1989). Large molecules are better retained than smaller ones, which can diffuse slowly through the lipid layers (Uhumwangho and Okor, 2005).

Lipid soluble drugs are entrapped in the lipid layers of liposome. Here, the entrapment efficiency can be as high as 100%, irrespective of liposomal type and composition. The retention of such hydrophobic drugs is very high when the liposomes are placed in aqueous biological environment because of their high lipid-water partition coefficients.

Active targeting encompasses the strategy of coupling a specific targeting entity to the surface of liposomes, enhancing their selective interaction with cells or tissues through binding with specific membrane-located markers (Derycke, 2004). The targeting technique can be applied to conventional liposomes, especially in *in vitro* conditions, but is much more appealing in case of long-circulating liposomes. Indeed, sufficient plasma stability is needed to assure satisfactory extravasation, followed by an encounter of the intact liposome with its target. The objective of active targeting is the enhancement of tumor-selective accumulation by site-directed retention through target binding and a possible increase in the photodynamic effect through cellular internalisation of the liposome-bound photosensitiser. In this way, active targeting aims at minimizing undesired side-effects related to non-specific photosensitiser accumulation (Allen, 1994).

A potential drawback of active targeting is related to the existence of the so-called 'binding site barrier'. This concept predicts that targeting molecules bind to the first target they encounter,

e.g. the tumor cells proximal to the blood vessel or in case of topical administration the cells at the tumor periphery, retarding or even preventing the penetration of targeted liposomes into the tumor interior. Thus, when solid tumors are to be treated, non-targeted liposomes may have a greater penetrability through the tumor tissue than have targeted liposomes (Allen *et al.*, 1998).

VI.2 Pharmacokinetics and biodistribution of liposomes and liposomal drugs

There is a number of factors that influence pharmacokinetic parameters of liposomal drug formulations. The first being their size. The general trend for liposomes of similar compositions is that increasing size translates into more rapid uptake by the reticuloendothelial system (Abra and Hunt, 1981; Hwang, 1987; Senior, 1987). However, although the trend remains the same, the clearance of liposomes is affected at different extents by their composition. The dependency of size on liposomeal clearance rates is relatively less for stabilized formulations than for conventional liposomes (Ahl *et al.*, 1997; Woodle *et al.*, 1992). For neutral conventional liposomes, the window for optimal behavior is narrow, meaning that for effective application, liposomes should be small enough (preferably, <100 nm) but still maintain reasonable drug encapsulation efficiencies (Drummond *et al.*, 1999).

Early studies have shown that the presence of negatively charged lipids in liposomes, including phosphatidic acid, phosphatidylserine and phosphatidylglycerol, results in a rapid uptake by the reticuloendothelial system (Senior *et al.*, 1985; Senior, 1987). However, this relationship between the presence of charged lipids and circulation lifetimes is extremely complex and cannot be readily explained with simple models in which the presence of an anionic lipid necessitates increased clearance from the circulation. Indeed, it now appears that each lipid must be analyzed separately and in the context of similar liposomes with respect to size, membrane packing constraints and surface charge density (Drummond *et al.*, 1999).

The effect of bilayer fluidity and the relative nature of the lipid components can have a considerable impact on the clearance from the circulation of both the liposome and the associated drug. These effects can either be direct effects, such as inhibition of penetration and thus binding of serum proteins (Papahadjopoulos *et al.*, 1973), or indirect effects, such as stabilization of the drug formulation to reduce the rate of drug leakage. The presence of cholesterol probably has one of the most important roles in the maintenance of membrane bilayer stability and long circulation times *in vivo* (Gregoriadis and Davis, 1979; Senior and Gregoriadis, 1982; Senior, 1987). In the absence of cholesterol, conventional liposomes are destabilized by high density lipoproteins

(Chobanian *et al.*, 1979; Damen *et al.*, 1980) and upon release, their components can be readily eliminated from the circulation. For liposomes with and without cholesterol, clearance rates were shown to negatively correlate with increased stability in plasma (Senior and Gregoriadis, 1982). The presence of steric stabilization makes the need for cholesterol less apparent for empty liposomes, but for drug-loaded liposomes, cholesterol is necessary for maintenance of the drug in the liposomal interior. The phospholipid component also plays a prominent role in the maintenance of high plasma levels of liposomes (Drummond *et al.*, 1999).

The rate of elimination of a liposomal drug from the circulation also depends on the rate of drug leakage from the carrier. Because drugs considered for liposomal encapsulation often have circulation times significantly shorter than the liposomal carrier, premature release can lead to an apparent increase in elimination rate from the circulation. For conventional liposomes, a membrane composed of cholesterol and high-phase transition phospholipids appears to be imperative for maintaining long circulation times and subsequent delivery of high levels of liposomes to solid tumors (Bally *et al.*, 1990). Sterically stabilized liposomes are more pliable and can be used with fluid-phase lipids to obtain long circulation times and high tumor levels of liposomes (Gabizon *et al.*, 1993). For both types of liposomes, the lipid composition of the liposomal membrane is essential for maintaining a stable encapsulation of the drug while in the circulation. For most amphipathic drugs that are either weak acids or weak bases (the majority of classic chemotherapeutic agents), this is of considerable importance because these drugs will leak more rapidly from the carrier while in the circulation, unless high-phase transition lipids are used.

Original attempts to mimic the surface of red blood cells by including the sterically hindered monosialotetrahexosylganglioside or phosphatidylinositol in liposome preparations led to the development of longcirculating liposomes (Allen and Chonn, 1987; Gabizon and Papahadjopoulos, 1988; Gabizon *et al.*, 1990). Later, *N*-(polyethylene glycol) distearoylphosphatidylethanolamine was substituted for monosialotetrahexosylganglioside or phosphatidylinositol (Klibanov *et al.*, 1990; Allen *et al.*, 1991; Papahadjopoulos *et al.*, 1991). The attachment of PEG to the surface of a liposome does not prevent liposome uptake by the reticuloendothelial system but only reduces the uptake rate (Drummond *et al.*, 1999). One of the most significant advantages of sterically stabilized liposomes is the nonsaturable, log-linear pharmacokinetics. Sterically stabilized liposomes likely resist uptake by the high-affinity, low-

capacity reticuloendothelial system macrophages, resulting in increased circulation lifetimes (Allen *et al.*, 1995).

The administered dose can also play a significant role in the circulation lifetime of a carrier. Conventional liposomes are removed from the circulation in a dose-dependent manner, indicating a saturation of the mechanisms responsible for their uptake (Gregoriadis and Senior, 1980; Abra and Hunt, 1981; Senior *et al.*, 1985; Hwang, 1987). Circulation lifetimes typically increase as a function of increasing lipid dose. This effect is likely due to a decreased phagocytic capacity of reticuloendothelial system macrophages after the ingestion of high lipid doses or to a saturation of plasma factors that bind to circulating liposomes and result in their opsonization. The fact that liposomes composed of high-phase transition lipids, such as sphingomyelin / cholesterol or 1,2-distearoyl-3-sn-phosphatidylcholine / cholesterol, can more readily saturate reticuloendothelial system uptake may indicate that these difficult-to-metabolize lipids saturate metabolic pathways responsible for their destruction (Senior *et al.*, 1985; Hwang, 1987). Alternatively, liposomes have been shown to bind serum proteins in a manner inversely proportional to their blood clearance rates (Chonn *et al.*, 1992; Semple and Chonn, 1996; Semple *et al.*, 1996), giving rise to the hypothesis that the depletion of plasma opsonins at high lipid doses results in an increase in blood circulation half-lives (Harashima *et al.*, 1993; Oja *et al.*, 1996). Steric stabilization with N-(polyethylene glycol) distearoylphosphatidylethanolamine offers a unique advantage to liposome delivery since clearance kinetics become dose independent (Allen and Hansen, 1991; Huang *et al.*, 1992; Woodle *et al.*, 1992).

VI.3 Accumulation of liposomal drugs in tumors

The accumulation of liposomes or large macromolecules in tumors is a result of a “leaky” microvasculature and impaired lymphatics supporting the tumor area (Matsumura and Maeda, 1986; Huang *et al.*, 1992; Yuan *et al.*, 1994). This effect is often referred to as the enhanced permeability and retention effect (Matsumura and Maeda, 1986). The principal pathway for the movement of liposomes into the tumor interstitium is via extravasation through the discontinuous endothelium, while transcytosis is thought to be a relatively minor pathway. Once in the tumor, nontargeted liposomes are localized in the interstitium surrounding the tumor cells (Huang *et al.*, 1992; Yuan *et al.*, 1994). Liposomes were not seen within tumor cells, although they were observed in resident tumor macrophages. The limited distribution of liposomes within the tumor interstitium results from a high interstitial pressure and a large interstitial space, compared to

normal tissues (Jain, 1990). Large tumors are more difficult to treat than small ones, partly because of the resulting increase in interstitial pressure, which prevents access of drugs to the necrotic core (Jain, 1990). The rate of accumulation and subsequent removal of liposomal drugs are affected by a variety of factors. The absence of functioning lymphatics, in combination with a high interstitial pressure, results in the trapping of liposomes within the tumor area (Yuan *et al.*, 1994). The result is a relatively slow rate of elimination from the tumor.

In addition to using liposomes as slow-release liposomal carriers, they can be used as rapid-release systems. The low-phase transition phospholipid component phosphatidylcholine, derived from egg yolk, of rapid-release liposomal carriers allows for the drug to leak more quickly from the liposome, at least partially while in the circulation (Bally *et al.*, 1990; Gabizon *et al.*, 1993).

VI.4 Stability in plasma and storage

The stability of drug-loaded liposomes over time is an important concern in pharmaceutical formulations. Stability can refer to several different aspects of a liposomal drug formulation: chemical stability of both drug and lipid components, colloidal stability and drug retention (Drummond *et al.*, 1999). For applications of liposomes where specific delivery of liposome-associated drug to solid tumors is desired, liposomes must substantially retain their contents while in circulation (Senior, 1987). In other applications, such as the delivery of photosensitisers to tumors in photodynamic therapy, liposome-associated photosensitisers immediately redistribute to other hydrophobic sites, such as plasma lipoproteins in the circulation, which in turn accumulate in tumors (Allison *et al.*, 1990; Reddi, 1997). Various factors can affect the relative stabilities of such preparations in the presence of plasma. This plasma-induced destabilization is extremely sensitive to the lipid composition of the liposome. To be more attractive for pharmaceutical development, liposomal drug formulations also must be stable during prolonged storage. Liposomes have either been stored preloaded with, as in the case of PEG-coated liposomes, or as “empty” liposomes that are loaded by a pH gradient immediately before injection (Lasic *et al.*, 1995; Cullis *et al.*, 1997). Compositions containing more fluid lipid components, such as phosphatidylcholine derived from egg yolk, require remote-loading just before injection, due to a high level of leakage during storage.

For amphipathic drugs that can readily cross membranes, there are a variety of factors that can influence the stability of a liposomal formulation. The presence of cholesterol and saturated

phospholipids appears to be the most important factors for reducing membrane permeability of these drugs (Gabizon *et al.*, 1993).

An optimal drug / lipid ratio is known to be important in the development of a stable formulation (Drummond *et al.*, 1999). The drug / lipid ratio should be as high as possible to maximize the payload of drug reaching the tumor, without compromising stability. The maximal amount of drug loaded per liposome depends on the method used for drug loading, liposome size and the presence of trapping components such as acidic lipids to which the drug can bind. Because the latter two factors are traditionally associated with negative effects on pharmacokinetic parameters, the drug-loading method is the most readily adjustable. Drug / lipid ratios that are too high can also form less stable formulations, presumably due to the dissipation of the pH gradient during drug loading (Mayer *et al.*, 1993).

Although conventional liposomes leak drug very slowly, they are difficult to work with due to increased flocculation and aggregation over time (Barenholz *et al.*, 1993). Early preparations were often stabilized with small quantities of negatively charged lipids such as phosphatidylglycerol to prevent aggregation occurring during storage. The presence of PEG on the surface provides a steric barrier that prevents liposome aggregation. PEG-coated liposomes are stable with respect to both size and drug-encapsulation over the period of many months to years when stored below the phase transition of the phosphatidylcholine component (Drummond *et al.*, 1999).

VI.5 Bioavailability of encapsulated drug

Drugs which are considered to be membrane active are amphipathic in nature and able to transverse the bilayer at a rate dependent on the physical properties of the membrane, as well as any ionic or pH gradients across the membrane (Lasic *et al.*, 1995; Cullis *et al.*, 1997). Other drugs are more water soluble and after a slow release from the carrier can be taken up by specific transporters located in the plasma membrane of tumor cells (Allen *et al.*, 1992). The bioavailability of such compounds depends on how readily they are able to escape their liposomal carrier. Bioavailability in the case of liposomal carriers is usually defined as the amount of free drug that is able to escape the confines of the carrier and is thus available for redistribution to neighboring tissues and tumor. A fine balance is required to prevent premature leakage in the circulation and thus nonspecific toxicities, but still allows for drug release upon reaching the tumor (Drummond *et al.*, 1999).

The mechanisms responsible for liposomal breakdown and drug release in tumors have not been well elucidated. Several potential mechanisms have been proposed, but all are highly speculative and little direct evidence has been provided, primarily due to technical difficulties associated with monitoring drug release *in vivo* (Drummond *et al.*, 1999). Some of the properties of the tumor microenvironment believed to play a role in liposome destabilization include the slightly acidic pH found in interstitial fluids surrounding tumors, lipases released from dying tumor cells, inflammatory cells present in response to tumor release factors, enzymes and oxidizing agents (Martin, 1998). With sterically stabilized liposomes, a certain amount of *N*-(polyethylene glycol) distearoylphosphatidylethanolamine can be released from the liposome over time, allowing liposomes to undergo more interactions with neighboring cells and / or plasma components.

One strategy for increasing drug bioavailability and distribution within the tumor has been to target liposomes to internalizing receptors. Release of the drug within the tumor itself presumably increases the bioavailability of the drug to the more-difficult-to-reach cells within the solid tumor mass. Indeed, this property is most likely responsible for the increased therapeutic effect observed with these carriers, as there was no overall increase in liposome localization to the tumor (Drummond *et al.*, 1999). Active targeting of pharmaceuticals is often perceived as a means of getting increased amounts of drug into the diseased site. However, the passive trapping of liposomes due to a discontinuous tumor microvasculature, the lack of a functioning lymphatics and a high interstitial pressure result in a rate-limiting accumulation of liposomal drug in solid tumors. It is unlikely that active targeting to cell surface proteins of solid tumors that are not internalized, will offer a significant therapeutic benefit.

Hyperthermia has also been used to increase the bioavailability of liposomal drugs in the tumor area. In addition to simply increasing the amount of liposomes that enter the tumor area, hyperthermia makes the distribution of liposomes within the tumor more uniform, increasing the bioavailability of the released drug to cells within the tumor. Hyperthermia can also be used to increase drug bioavailability via another mechanism. Liposomes can be rendered thermosensitive by adding some specific lipid components into bilayer, resulting in an increased leakage of the encapsulated material when heated.

Currently, it is difficult to resolve the complex relationships existing between various liposomal properties (size, charge, permeability characteristics) and pharmacological factors

(dose, route of administration) regulating liposomal delivery *in vivo*. The ability to manipulate these processes will undoubtedly provide a greater avenue for increasing drug bioavailability *in vivo* for difficult-to-treat solid tumors.

VI.6 Partitioning of lipophilic and amphiphatic drugs into liposomes

Most lipophilic drugs do not have a structural similarity with phospholipids and do not orientate in a bilayer configuration like cylindrically shaped phospholipids. However, the models describing the spontaneous transfer from membrane to membrane of these natural membrane components need to be considered to understand the drug migration between liposomes. In the case of compounds, which show structural similarities with natural membrane components, like e.g. steroids and cholesterol, the proposed mechanisms of transfer for cholesterol may apply. The transfer process of natural membrane lipids in aqueous liposomal dispersions (when passage through the water phase between membranes is the main transfer route) can be divided into the following sequential steps (Fahr *et al.*, 2005): flip-flop movement of the membrane component from the inner to the outer leaflet (monolayer) of the donor membrane (spontaneous and/or catalysed by proteins); departure of the membrane component from the membrane into the aqueous phase; association of the membrane component in the aqueous phase with the acceptor membrane and finally flip flop to the inner membrane leaflet. Lipophilic drugs, that do not have membrane lipid like structures, probably are not subject to flip-flop. The transfer steps are therefore (Fahr *et al.*, 2005): drug dissolved in the lipid domain of the membrane; departure of the drug from the membrane into the aqueous phase; association of the drug component in the aqueous phase with the acceptor membrane and dissolving of the drug in the acceptor membrane. These steps may differ at high phospholipid concentrations, at which it is believed that collision between the lipid vesicles is the main transferring mechanism. Given that the lipophilicity of a drug is a measure of its ability to intrude into the hydrophobic region of the lipid membrane, one consequently expects a highly lipophilic drug to be buried deeply into the hydrocarbon core of the host membrane. At this fully membrane-inserted state, a drug is supposed to be highly immobilized with respect to leaving the membrane and exchange with the aqueous environment.

The lipophilicity of a drug determines the partition equilibrium between an aqueous and oily phase. The more lipophilic the drug is, the further partition equilibrium is shifted to the oily phase. The oily phase can be an alkane phase or – in order to better represent the amphiphatic nature of a lipid bilayer – consist of an alcohol such as octanol. Regarding its lipophilicity, the

lipid chain region of a lipid bilayer is comparable to an oily phase. There is however a significant difference: the structural properties of the oil phase are uniform, isotropic and homogeneous. In contrast, a lipid bilayer is a thin, self-assembled, film with strongly inhomogeneous properties. The lipid chains within a membrane – despite being in the fluid-like state – are orientated in an ordered manner and thus render the bilayer anisotropic. The packing properties of the hydrocarbon chains in a lipid bilayer are significantly different from those in an alkane phase. The free energy of the transfer process related to this difference in packing properties is described as (Fahr *et al.*, 2005):

$$\Delta F = \Delta F_{sol} + \Delta F_{lip}$$

ΔF is the difference of the free energy of a drug when it transfers from the water phase into the lipid bilayer or with the opposite sign for ΔF , when it transfers from lipid layer to the water phase. The equation is composed of two major contributions. The first contribution is the solvation free energy, ΔF_{sol} , which accounts for changes in electrostatic and hydrophobic interactions of membrane-drug associations and constitutes the classical hydrophobic effect. The second contribution, ΔF_{lip} , is characteristic for a lipid bilayer and arises from the drug-induced structural membrane perturbation. The presence of the contribution ΔF_{lip} is a consequence of the anisotropic orientation of the lipid chains within the lipid bilayer.

Based on these theoretical thermodynamic considerations and in spite of high solubility in an oily phase, it may be speculated that drugs may be repelled / excluded from a lipid bilayer, because of packing defects caused by the incorporation of the drug into the fatty acid chain region (Fahr *et al.*, 2005). The magnitude of this tendency is governed by the individual properties of the drug molecule such as its size, shape, orientation and hydrophobic moment. As a result, an equilibrium exists between the drug dissolved in the membrane and drug dissolved in the water phase. Upon addition of an acceptor membrane, a flux of the drug through the water phase, from the donor to the acceptor membrane will be initiated. Alternatively, when the transfer occurs through collision of vesicles, the drug moves directly along its concentration gradient from the donor lipid domain to the acceptor lipid domain at the moment of collision.

VII LIPOSOMES FOR PHOTODYNAMIC THERAPY

Two primary purposes are associated with the application of drug delivery systems for photosensitizing agents. One is to formulate them in preparations suitable for intravenous administration and the other is to increase tumour selectivity. Photosensitising agents usually possess hydrophobic properties because this is necessary for drug penetration through cell membranes. But hydrophobicity of drugs usually causes delivery problems. In photodynamic therapy, there are several approaches used for the formulation of photosensitisers: encapsulation in colloidal carriers, such as oil-based dispersions, micelle systems, liposomes and biodegradable nanoparticles and conjugation of the photosensitiser with hydrophilic polymers such as polyethylene glycol and polysine.

VII.1 Liposomal photosensitizing agents

The photophysical properties of porphyrins strongly depend on their aggregation state (Ricchelli, 1995; Abós *et al.*, 1997; Ricchelli *et al.*, 1998). Porphyrin monomers exhibit a well-known visible spectrum consisting in an intense Soret band ($\lambda_{\text{max}} = 390\text{--}415\text{ nm}$, $\varepsilon = 1 \times 10^5$ to $2 \times 10^5 \text{M}^{-1} \text{cm}^{-1}$) and four weaker bands (called Q-bands) in the 450–700 nm range. Porphyrin monomers show a significant fluorescence emission, with two bands (620–640 and 660–690 nm) and fluorescence lifetimes (τ) in the 10–18 ns range (Ricchelli *et al.*, 1998). These properties dramatically change upon aggregation; for large self-associated suprastructures, the porphyrin absorption coefficient decreases drastically, the Soret band is shifted and the fluorescence yields and lifetimes become very low. Moreover, aggregation reduces the yield and the lifetime of the porphyrin triplet state, thus reducing the $^1\text{O}_2$ formation yield (Boyle and Dolphin, 1996; Ricchelli *et al.*, 1998). In this way, the literature describes two modes of porphyrin aggregation: a face-to-face aggregation (H-aggregates) (Hunter and Sanders, 1990; Ribó *et al.*, 1994) and an edge-to-edge interaction (J-aggregates) (Ribó *et al.*, 1994; Akins *et al.*, 1996; Micali *et al.*, 2000), but only monomeric species and possible planar aggregates, observed in liposomal and mitochondrial membranes, are endowed with significant photosensitising ability (Ricchelli, 1995; Ricchelli *et al.*, 1998).

To avoid aggregation and to reach monomerization of hydrophobic drug, various delivery vehicles have been used, one of the most effective being lipid vesicles. Postigo *et al.* showed that hydrophobic photosensitisers which tend to aggregate in watery media and hydrophobic

porphyrin derived structures or other sensitizers, that do not aggregate in a watery media and with Q-bands shifted to higher λ values than 5,10,15,20-tetraphenyl-21*H*,23*H*-porphine zinc, will be efficiently incorporated into liposomes and are thus useful for clinical applications (Postigo *et al.*, 2004).

There are three main effects of liposomes on the sensitizers (Lang *et al.*, 2004):

Monomerization effect. Monomerization of aggregated hydrophobic sensitizers occurs as a result of the localization of sensitizer molecules within hydrophobic bilayers (Angeli *et al.*, 2000; Blum and Grossweiner, 1985; Gottfried *et al.*, 1988). For instance, Hoebeke *et al.* using fluorescence and electron spin resonance measurements showed that incorporation into the lipid phase of dimyristoyl-L-K-phosphatidylcholine liposomes induces dye monomerization (Hoebeke *et al.*, 1999). Also, monomerization was demonstrated for azaphthalocyanines loaded into dioleoylphosphatidylcholine unilamellar vesicles (Zimcik *et al.*, 2007).

Concentration effect. The local concentration of the sensitizer inside a vesicle is larger, by several orders of magnitude, than in a solvent. High local concentrations can even lead to structurally controlled aggregation process in liposomal bilayers (Borovkov *et al.*, 1996).

Viscosity effect. After incorporation in a liposomal bilayer, the sensitizer is located in a structured microenvironment. Increased microviscosity slows down internal movements of the embedded molecule and all collisional processes of excited states by restricting their diffusion motion (Gottfried *et al.*, 1988).

The lipid bilayer is a complex structure formed by amphiphilic molecules and the binding of the sensitizers originates from a combination of hydrophobic and electronic interactions. Photosensitizer binding is also influenced by the hydrophobic / hydrophilic character of the surrounding medium and by the presence of electrostatically charged interfaces. The sensitizers can be incorporated into a lipid bilayer or encapsulated into a water pool. The balance between the hydrophobicity / hydrophilicity of the sensitizer and lipid bilayers influences the distribution of the sensitizer over different regions of the liposomal structure. Hydrophobic sensitizers penetrate into a lipidic bilayer. Hydrophilic sensitizers are usually located on the surface of liposomes or in an endoliposomal aqueous compartment near the polar heads, weakly interacting with the hydrophobic region of liposome (Angeli *et al.*, 2000). The hydrophobic parts of amphiphilic sensitizers are situated in a microenvironment of low polarity (a lipidic bilayer)

while the charged peripheral substituents are oriented towards the polar heads of lipid molecules (Brault, 1990).

Bronshtein *et al.* used iodide fluorescence quenching and the parallax method to demonstrate that the vertical localization of a photosensitizer in a lipid membrane can be modulated by inserting spacer moieties into the molecular structure, while anchoring one end of the molecule at the lipid / water interface. Porphyrins with a longer spacer generate singlet oxygen, via photosensitization, at a deeper point, which in turn results in greater photodamage caused to a membrane-residing singlet oxygen target. The depth of the porphyrin's core in the membrane is not affected by the temperature when the membrane is in the liquid phase. However, upon changing to the solid phase, lowering the temperature buoys up, or rather extrudes, the hemo- and protoporphyrins toward the water interface (Bronshtein *et al.*, 2004).

Liposomes are suitable models mimicking specific situations occurring *in vivo* and they allow study of the influence of physicochemical, photobiological and biochemical factors on the uptake of photosensitizers by tissues, their mechanisms of action and subsequent photoinduced tumor necrosis. For example, in the work of Mojziso娃 *et al.* small unilamellar vesicles were used as models to investigate the dynamics of interactions of chlorin e6 with membranes (Mojziso娃 *et al.*, 2007). Voszka *et al.* using electron paramagnetic resonance spectroscopy studied the depth of localisation of glycosylated tetraphenyl-porphyrin derivative inside lipid bilayer and its interaction with unsaturated lipids (Voszka *et al.*, 2005).

VII.2 Photophysical properties of liposomal photosensitizing agents

The photophysical properties and production of $^1\text{O}_2$ are sensitive to the interfacial characteristics of specific microdomains that host the sensitizer. The assessment of these photophysical and photochemical parameters can be used to probe the surroundings of the sensitizer and its localization (Lang *et al.*, 2004).

After incorporation of the sensitizers into liposomes, the corresponding absorption and fluorescence emission bands are usually red shifted and fluorescence intensity and fluorescence anisotropy are increased (Richelly, 1995; Ricchelli and Jori, 1986; Sekher and Garbo, 1993; Brault *et al.* 1986; Ricchelli *et al.*, 1991; Ehrenberg *et al.*, 1985). These spectroscopic changes provide a tool for the investigation of the sensitizer uptake and distribution in liposomes. Typically, hematoporphyrin and deuteroporphyrin exhibit a red shift of the absorption and emission maxima of about 10–20 nm after incorporation into a liposomal matrix (Brault *et al.*

1986). Such large red shifts in absorption spectra are often ascribed to monomerization of aggregated sensitizers. In contrast, polar uroporphyrin is monomeric in aqueous media and shows only minor spectroscopic changes following insertion in a liposome. This indicates that uroporphyrin is predominantly confined to the endoliposomal aqueous compartment because its microenvironment is not changed after interaction with DPPC liposomes (Ricchelli and Jori, 1986).

Incorporation of a porphyrin sensitizer into a lipid bilayer affects the conformational dynamics of the molecule in the ground (S_0) and excited singlet (S_1) states. These changes influence the Stokes shift, i.e. the energy difference between absorption and emission bands from lowest vibration levels of the S_0 and S_1 states (Lang *et al.*, 2004).

Furthermore, the position of a sensitizer in a liposomal bilayer is indicated by fluorescence anisotropy (Ricchelli and Jori, 1986). The anisotropy values reveal the degree of a restriction of rotational freedom of the imbedded molecules in the anisotropic membrane environment (Richelly, 1995; Angeli *et al.*, 2000; Ricchelli *et al.*, 1991). The anisotropy is sensitive to the phase transition temperature of liposomes. Hence, the temperature dependent anisotropy can be used to probe the physical properties of various domains of vesicles.

The major factors affecting quantum yields of the excited states and consequently of singlet oxygen formation in organized liposomal media are as follows (Gottfried *et al.*, 1988):

- *Viscosity.* Increased microviscosity causes an enhancement of the fluorescence intensity.
- *Intersystem crossing.* The non-radiative relaxation channels are weakened by higher microviscosity.
- *Monomerization.* Dimers or higher aggregates produce little or no 1O_2 .
- *Concentration.* The local concentration of the sensitizer is different from the concentration in solution.
- *Competing reaction channels.* Oxidation of oleic acid side chains in egg phosphatidylcholine consuming 1O_2 is an example.

However, because the production of 1O_2 by liposome-bound sensitizer is controlled by many factors, often acting against each other, the overall effect of liposomes on quantum yield of singlet oxygen formation can hardly be generalized. An unusual increase of quantum yield of singlet oxygen formation in the presence of liposomes can be attributed to the monomerization

effect of the vesicles. Usually, a decrease of quantum yield of singlet oxygen formation can be ascribed to aggregation occurring in liposomes due to the concentration effect.

Liposome-bound sensitizers effectively produce $^1\text{O}_2$. After $^1\text{O}_2$ formation, it diffuses freely between the lipidic and aqueous phases. In the absence of any quenching process the equilibrium distribution of $^1\text{O}_2$ between the lipid bilayer and aqueous phases is attained before $^1\text{O}_2$ decays. Small unilamellar vesicles ensure that $^1\text{O}_2$ is mostly located in the aqueous phase. Although the lifetime is different in both phases since the lipid volume represents only several percent of the total volume, the lifetimes of $^1\text{O}_2$ are practically independent of the localization of the sensitizer and correspond to those in homogeneous aqueous solutions (Angeli *et al.*, 2000; Nonell *et al.*, 1990).

Molnar *et al.* using the time- and spectrally-resolved phosphorescence measurements of protoporphyrin IX, haematoporphyrin and singlet oxygen in liposomal samples under different oxygen concentrations, proposed a model where an increase in oxygen concentration in the aqueous medium was accompanied by only a slight increase in oxygen concentration inside the lipid bilayer (Molnar *et al.*, 2008).

Photobleaching processes inside the lipid bilayer have some peculiarities. The mechanisms of sensitizer photodegradation are complex and media-dependent. For example, the rate of photobleaching of Chlorin e6 is almost three times higher in liposomes suspended in phosphate buffer compared to dimethyl formamide. This difference appears to be due to the change in the polarity of the microenvironment around the sensitizer molecules (Hongying *et al.*, 1999). In contrast, Chlorin p6 due to its amphiphilic character solubilizes readily in polar solvents but in nonpolar solvents, its solubility is reduced and forms aggregated species in lipid bilayers and does not photobleach as efficiently (Das *et al.*, 2005).

VII.3 Pharmacokinetics of liposomal photosensitizing agents

Inclusion of photosensitisers into lipid bilayers can change their pharmacological properties and as a result improve PDT efficiency. For example, incorporation of bacteriochlorin-a in dimyristoyl phosphatidylcholine liposomes increased oxygen consumption 9-fold in comparison to the value in phosphate buffer, by promoting the monomerization of the photosensitiser (Damoiseau *et al.*, 2001). Also, polyethyleneglycol modified liposomes containing coproporphyrin I were confirmed to show a better tissue distribution, elevated photosensitiser concentration in the tumor cells, to effectively produce singlet oxygen and enhance cytotoxicity

by photodynamic therapy (Sadzuka *et al.*, 2008). Roby *et al.* demonstrated that the solubility problem of meso-tetratphenylporphine could be solved by incorporating the drug into polymeric micelles prepared of polyethylene glycol/phosphatidyl ethanolamine conjugate, which improved cytotoxicity (Roby *et al.*, 2006).

The fate and pharmacokinetics of liposomal photosensitisers are dramatically affected by the fact that liposomes show a short plasma half-life, in the range of minutes (Lasic *et al.*, 1991). Two different phenomena impair the circulation time of conventional liposomes (Derycke and de Witte, 2004). First of all, a lipid exchange between the liposomes and lipoproteins, especially high density lipoproteins, leads to an irreversible disintegration of the liposome. The fast disintegration process releases the photosensitiser in the bloodstream and provokes subsequent associating with lipoproteins and other plasma proteins. On the other hand, conventional liposomes easily become opsonized by plasma proteins after which they are quickly taken up by cells of the mononuclear phagocyte system. As a result, they become concentrated in organs and tissues with a rich mononuclear phagocyte system, predominantly in mononuclear phagocytes residing in the liver, spleen, bone marrow and blood circulation (Schroit *et al.*, 1986).

The final protein association pattern of the photosensitiser, gradually released from disintegrating liposomes over a longer period of time, might vary substantially from the pattern seen after injection of the free photosensitiser. The fact that a released hydrophobic photosensitiser initially presents in the blood in its non-aggregated form, while the non-liposomal photosensitiser is administered in an aggregated state, could explain this variable association pattern. Whatever principle contributes most, PDT outcome of a photosensitiser might be dramatically different upon association with different (lipo)proteins (Richter *et al.*, 1993).

Liposomal formulations can also be applied to alter the subcellular distribution or to increase the uptake of a photosensitiser. For instance, in case of liposome-bound haematoporphyrin or haematoporphyrin dimethylester, it was demonstrated that the photosensitisers accumulated intracellularly in a 2-fold larger amount than the water-dissolved haematoporphyrin, resulting in a more efficient photosensitization upon irradiation. Liposomal porphyrins appeared to induce early and extensive endocytosplasmic damage, leading to the swelling of mitochondria and vesiculation, while water-dissolved haematoporphyrin predominantly photosensitized the plasma membrane. The different patterns of cell photodamage

reflect a different subcellular distribution of the photosensitizing compounds (Milanesi *et al.*, 1989).

Long-circulating liposomes, with their hydrophilic surface, do not interact effectively with cells. This is critical since the cytotoxic singlet oxygen generated by the irradiated photosensitiser shows an extremely short migration radius. For instance, Gijssens *et al.* demonstrated that sterically stabilized liposomes containing hydrophilic photosensitiser aluminium phthalocyanine tetrasulphonate did not display any *in vitro* photocytotoxic activity on malignant cells, while the free compound did (Gijssens *et al.* 2002). Ichikawa *et al.* noted that tumor accumulation of benzoporphyrin derivative monoacid ring A at 3 h after its injection with PEG-liposomes in Meth A-sarcoma bearing mice was significantly higher than the one observed after injection with non-modified liposomes. However, on the contrary, significant tumor growth suppression after PDT was only observed for conventional but not for PEGylated formulation (Ichikawa *et al.*, 2004). Inversely, Sadzuka *et al.* showed that *in vitro* application of PEGylated liposomes containing photofrin increased phototoxicity (Sadzuka *et al.* 2006).

These observations have stimulated new efforts directed toward the development of liposomes with active targeting characteristics and energy-activated release mechanisms that accelerate drug release rates and promote efficacy (Shum *et al.*, 2001). Active triggering mechanisms developed to date have all been based on methods that cause destabilization of the liposomal bilayer. Photoactivation is an attractive option for triggering liposomal contents release since it provides a very broad range of adjustable parameters (e.g., wavelength, duration, intensity) that can be optimized to suit a given application. Spatial and temporal control of the light source provides an additional element of control that can be used to regulate drug release rates.

VII.4 Liposomal formulations of meta(tetrahydroxyphenyl)chlorin

Clinical applications of mTHPC mediated PDT meet several difficulties due to high hydrophobicity of this photosensitiser. To overcome such problem and improve PDT efficacy, many different delivery systems were designed. Among them conjugates with folic acid (Gravier *et al.*, 2008), nanoemulsions (for skin cancer treatment) (Primo *et al.*, 2008), PEGylated mTHPC (Tran *et al.*, 2007), liposomes formed by DMPC / geminy surfactant (Bombelli *et al.*, 2005), cationic liposomes (Bombelli *et al.*, 2008), invasomes (liposomes, containing in addition to phospholipids a mixture of terpens) (Dragicevic-Curic *et al.*, 2008) and several commercial

liposomal formulations, such as Foslip and Fospeg. Foslip is a recently designed third generation photosensitiser based on unilamellar dipalmitoylphosphatidylcholine / dipalmitoylphosphatidylglycerol (DPPC / DPPG) liposomal formulations of meta-tetra(hydroxyphenyl)chlorine provided by Biolitec AG (Jena, Germany). Fospeg is sterically stabilized form of Foslip, which in addition contains small amount of PEG-phosphatidylethanolamine.

Several studies were dedicated to investigate properties of liposomal mTHPC formulations. Buchholz *et al.* (Buchholz *et al.*, 2005) compared mTHPC and its pegylated liposomal formulation (Fospeg) in feline squamous cell carcinoma in terms of tumour, skin and plasma pharmacokinetics. The authors demonstrated that fluorescence intensities and fluorescence ratio (tumour / skin) were 2 to 4 times higher for the liposomal formulation. Also, maximal fluorescence intensity in the tumour was shown to occur 5.5 times earlier with Fospeg. Another recent report (Svensson *et al.*, 2007), which addressed Foslip pharmacokinetics from 2 h to 8 h following sensitiser i.v. administration demonstrated a rapid clearance from the plasma and an average tumour / muscle ratio of 6.6 in a murine tumour model. Pegaz *et al.* studied the ability of meso-tetra(hydroxyphenyl)chlorin (m-THPC) encapsulated into liposomal formulations (Fospeg) to occlude neovascularization and showed that Foslip appears to be less potent than Fospeg in terms of photothrombic activity on the chick chorioallantoic membrane model. The light dose necessary to induce the desired vascular damage with Foslip was twice higher than with Fospeg. It can be inferred that the formulation based on PEGylated liposomes technology offers a suitable delivery system for the treatment of choroidal neovascularization associated with age-related macular degeneration (Pegaz *et al.*, 2006). Lassalle *et al.* investigated Foslip behaviour and photodynamic efficiency in EMT6 xenografted nude mice at different times following i.v. administration. The highest tumour to muscle ratios were observed at 6 and 15 h post-administration. The best tumour response was obtained for a drug-light interval of 6 h, interval for which mTHPC was present in both endothelial and parenchyma cells (Lassalle *et al.*, 2008).

VIII OBJECTIVES

The first objective of the work was to study the photophysical properties of liposomal mTHPC formulations, especially to study the mTHPC photodegradation inside the lipid bilayer. We investigated several aspects such as

- absorption and fluorescence properties of mTHPC in different types of lipid vesicles.
- observations on the nature and properties of photoinduced fluorescence quenching
- analysis of applicability of photoinduced fluorescence quenching for studying the redistribution from liposomes.

The second part of the work was dedicated to the investigation of the interactions of liposomal mTHPC formulations with biological substrates *in vitro*.

- kinetics of mTHPC redistribution from lipid vesicles to membranes and plasma proteins.
- stability of lipid vesicles loaded with mTHPC in human blood serum.
- determination of the pattern of distribution of mTHPC molecules between human blood plasma elements at different times of incubation

The third part of the work is related to the *in vivo* observation of mTHPC distribution after intratumoral Foslip injection in an animal model of breast cancer recurrence.

IX RESULTS

IX.1 Unusual photoinduced response of mTHPC liposomal formulation (Foslip)

The main objective of this study was to evaluate photophysical properties of mTHPC encapsulated into dipalmitoylphosphatidylcholine (DPPC) liposomes or Foslip. Properties of the microenvironment could influence the fluorescence and absorbance properties of liposome-embedded mTHPC molecules, so application of any optical technique for analyzing peculiarities of liposomal drug behavior *in vivo* requires deep understanding of the main photophysical properties of the photosensitizer in such medium. Our studies demonstrate that spectral properties of Foslip in DPBS are similar to those in mTHPC ethanol solution, thus indicating a monomeric state of the sensitizer inside the bilayer. We did not observe significant concentration quenching effects for Foslip formulations, but, surprisingly, an irradiation of Foslip suspensions by small light doses ($<50 \text{ mJ/cm}^2$) resulted in a substantial drop in fluorescence, which however could be restored after destruction of the liposomes. We attributed this behavior to photoinduced fluorescence quenching. This effect depended strongly on the molar DPPC / mTHPC ratio and was revealed only for high local mTHPC concentrations. The results were interpreted supposing an energy migration between closely located mTHPC molecules. For Foslip formulations the estimated average distance between photosensitizer molecules is approximately two times less than Förster radius for them. This implies a high probability of energy migration between neighboring mTHPC molecules. In such conditions a small amount of weakly-fluorescent mTHPC photoproducts could act as excitation energy traps and effectively quench mTHPC fluorescence of Foslip suspension. We further assessed the effect of photoinduced quenching in plasma protein solutions to demonstrate that changes in mTHPC distribution pattern in biological systems are consistent with changes in photoinduced quenching and could thus provide valuable information on mTHPC interactions with a biological environment.

This part of the work was published in *Photochemistry and Photobiology* and is presented thereafter in its published form.

Unusual Photoinduced Response of mTHPC Liposomal Formulation (Foslip)

Dzmitry Kachatkou^{1,2}, Siarhei Sasnouski^{1,†}, Vladimir Zorin², Tatyana Zorina², Marie-Ange D'Hallewin¹, Francois Guillemin¹ and Lina Bezdetsnaya^{*1}

¹Centre de Recherche en Automatique de Nancy, Nancy-University, CNRS, Centre Alexis Vautrin, Vandœuvre-Les-Nancy, France

²Laboratory of Biophysics and Biotechnology, Physics Faculty, Belorussian State University, Nezalegnasti, Minsk, Belarus

Received 2 June 2008, accepted 27 August 2008, DOI: 10.1111/j.1751-1097.2008.00466.x

ABSTRACT

Liposomal formulations of meso-tetra(hydroxyphenyl)chlorin (mTHPC) have already been proposed with the aim to optimize photodynamic therapy. Spectral modifications of these compounds upon irradiation have not yet been investigated. The objective of this study was to evaluate photobleaching properties of mTHPC encapsulated into dipalmitoylphosphatidylcholine (DPPC) liposomes, Foslip. Fluorescence measurements in DPPC liposomes with different DPPC:mTHPC ratios demonstrated a dramatic decrease in fluorescence anisotropy with increasing local mTHPC concentration, thus suggesting strong interactions between mTHPC molecules in lipid bulk medium. Exposure of Foslip suspensions to small light doses ($< 50 \text{ mJ/cm}^2$) resulted in a substantial drop in fluorescence, which, however, was restored after addition to the sample of a non-ionic surfactant Triton X-100. We attributed this behavior to photoinduced fluorescence quenching. This effect depended strongly on the molar DPPC:mTHPC ratio and was revealed only for high local mTHPC concentrations. The results were interpreted supposing energy migration between closely located mTHPC molecules with its subsequent dissipation by the molecules of photoproduct acting as excitation energy traps. We further assessed the effect of photoinduced quenching in plasma protein solution. Relatively slow kinetics of photoinduced Foslip response during incubation in the presence of proteins was attributed to mTHPC redistribution from liposomal formulations to proteins. Therefore, changes in mTHPC distribution pattern in biological systems would be consistent with changes in photoinduced quenching and would provide valuable information on mTHPC interactions with a biological environment.

INTRODUCTION

Photodynamic therapy (PDT) is an emerging treatment protocol for a variety of malignant and premalignant conditions (1). The technique involves the systemic administration

of a photosensitizer, followed by light irradiation after a predefined time interval with successive formation of highly toxic reactive oxygen species.

Meso-tetra(hydroxyphenyl)chlorin (mTHPC) has been reported as one of the most efficient sensitizers (2). Only relatively small drug and light doses are required to achieve treatment response. However, in aqueous media the hydrophobic mTHPC molecules form aggregates, leading to limitations in sensitizer transportation within biological media, tumor selectivity and PDT efficacy (3,4).

During the continuous search for improving the efficacy and safety of PDT, liposomes with a high loading capacity and flexibility to accommodate photosensitizers with variable physicochemical properties, came into focus as valuable carriers and delivery systems (5,6). mTHPC formulations embedded into conventional (Foslip) or pegylated (Fospeg) liposomes are now intensively investigated (7–9). mTHPC liposomal formulations have been considered as interesting candidates for topical mTHPC-PDT, annihilating the effect of extended skin photosensitivity associated with systemic mTHPC administration (7). Their advantageous pharmacokinetic properties, such as rapid biodistribution and clearance from the bloodstream, have also been reported (8,9).

Compared with conventional solutions, the lipid-based dye formulations are subject to specific environmental factors like low polarity, high viscosity and increased local oxygen concentration (10). Importantly, in liposomal formulations a lipophilic sensitizer is confined to the lipid phase at a high concentration. Therefore, spectral modifications upon irradiation of lipid-based dye formulations should be interpreted with caution.

The absorption of visible light by a photosensitizer causes different photophysical events, including its self-sensitized oxidation, the process called photobleaching (photodegradation). Bonnett and Martínez (11) divided photobleaching into two different types: true photobleaching and photomodification. In the case of true photobleaching chemical changes are deep-seated, and result in small fragments that no longer have appreciable absorption in the visible region. When photomodification takes place, a loss of absorbance or fluorescence occurs at some wavelengths, but the chromophore remains,

[†]Present address: Ecole Supérieure de Physique et de Chimie Industrielles de la Ville de Paris, Paris, France.

*Corresponding author email: l.bolotina@nancy.fnclcc.fr (Lina Bezdetsnaya)

© 2008 The Authors. Journal Compilation. The American Society of Photobiology 0031-8655/09

albeit in a modified form. The understanding of photosensitizer photobleaching is important not only for mechanistic studies, but also because it is often coupled to the photodynamic action and as such can improve control of PDT dosimetry (12).

Numerous studies have addressed the mechanism of mTHPC photobleaching in cells and cell-free systems (13–19). This process is oxygen dependent and is inhibited by singlet oxygen quenchers in serum-enriched solutions (13). The monomer forms of mTHPC are supposed to be particularly receptive to irradiation in solution, demonstrating a much higher photobleaching rate than aggregates (14). Kasselouri *et al.* (15) detected mono-, di- and tri-hydroxy-mTHPC as major photoproducts of mTHPC in ethanol–water medium. mTHPC photobleaching kinetics in spheroids and monolayer cultured cells were consistent with singlet oxygen-mediated mechanism (16) and depended on the dye intracellular concentration, fluence rate and oxygen partial pressure (17–19). Except for a single study where photobleaching of a liposomal mTHPC gel formulation was registered after its topical application in patients with skin carcinomas (20), this process has not been yet investigated for liposomal forms of mTHPC.

The present study focuses on the photobleaching properties of mTHPC encapsulated into conventional liposomes (Foslip) based on dipalmitoylphosphatidylcholine (DPPC). We report an unusual effect of photoinduced quenching of Foslip fluorescence, likely related to energy migration between closely located mTHPC molecules in lipid membrane bulk. This phenomenon should be credited when studying the processes of drug delivery, distribution and accumulation by different fluorescence-based approaches.

MATERIALS AND METHODS

Chemicals. The photosensitizer Foscan® (mTHPC, temoporfin), and its liposomal formulation Foslip were kindly provided by Biolitec AG (Jena, Germany). Foslip is composed of DPPC, glucose, dipalmitoylphosphatidylglycerol (DPPG) and water with lipid to dye ratio of ca.10:1.

Dulbecco's PBS (DPBS, without CaCl₂ and MgCl₂; pH 7.4) was obtained from Invitrogen (Cergy-Pontoise, France). Fetal bovine serum (FBS) was purchased from PAN-Biotech GmbH (Aidenbach, Germany) and *t*-octylphenoxypolyethoxyethanol (Triton X-100) from Sigma (Saint Quentin Fallavier, France). DPPC was purchased from Avanti (Alabaster, Alabama). Stock solution of mTHPC was made by dissolving the powder in 100% ethanol.

Liposome-based mTHPC preparations. Foslip was reconstituted in PBS. Lipid vesicles were prepared using the injection method (21). In brief, 60 μ L of DPPC/ethanol solution (2.2×10^{-2} M) with or without mTHPC ethanol solution was added to 4 mL of DPBS at a rate of 1 μ L/s, thus resulting in a final concentration of DPPC of 3×10^{-4} M. The final suspension was stored at 37°C. The liposomal hydrodynamic radius, measured by photon correlation spectroscopy (Zetasizer 3000 HAS, Malvern, UK) was 58 nm. Concentration of mTHPC in stock ethanol solution was estimated using mTHPC absorption spectra considering molar extinction coefficient (ϵ) at 650 nm as $35\,000\text{ M}^{-1}\text{ cm}^{-1}$.

Spectroscopic studies. Approximately 2 mL of a liposomal dispersion, containing mTHPC-loaded liposomes, was placed in a 1 cm path length cuvette. Temperature of the dispersion was 37°C. Fluorescence was measured using Perkin-Elmer LS50B spectrofluorimeter. Absorbance spectra were registered using Perkin Elmer Lambda 35 spectrophotometer. Fluorescence anisotropy was measured using SOLAR spectrofluorimeter SFL 1211A ("SOLAR," Minsk, Belarus) equipped

with polarizers. Samples were excited at the wavelength of 435 nm (λ_{ex}) and fluorescence emission was registered at 650 nm (λ_{em}). Fluorescence intensity in experimental samples was measured before (I) and after addition of 0.1% Triton X-100 ($I_{\text{X-100}}$). The ratio ($I/I_{\text{X-100}}$) was qualified as normalized fluorescence, which reflects the degree of mTHPC fluorescence quenching in liposomes.

Irradiation. Irradiation (652 nm) of liposomal mTHPC suspension was performed by coupling an optical fiber with frontal diffuser to a dye laser (Spectra Physics 375 B, Les Ulis, France) pumped by an Argon laser (Spectra Physics 2020). Fluence rate was set to 10 mW/cm². Irradiation was made at room temperature under continuous stirring.

RESULTS

Foslip spectral properties

Figure 1 represents a typical absorbance spectrum of mTHPC in ethanol together with the absorbance spectra of Foslip suspension in DPBS before and after addition of neutral detergent Triton X-100. Spectral properties of mTHPC in liposomes were almost equivalent to these in ethanol solution, displaying a Soret band at 420 nm and four Q-bands with a prominent long-wave spectral line at 650 nm. After destruction of liposomes with Triton X-100, mTHPC spectral properties were only slightly altered.

Similar to absorbance measurements, fluorescence properties of Foslip suspension in DPBS were close to those of mTHPC in ethanol, whereas after addition of Triton X-100 to Foslip suspension fluorescence intensity at 652 nm increased by 15% (data not shown).

Fluorescence properties of mTHPC liposomal formulation

In Foslip formulations the lipid to mTHPC ratio is about 10, thus suggesting a high local mTHPC concentration in the lipid bilayer. Based on this fact, we anticipated specific interactions between mTHPC molecules included in the liposomes. We thus conducted fluorescence measurements in DPPC liposomes with different DPPC:mTHPC ratios, but maintaining an identical

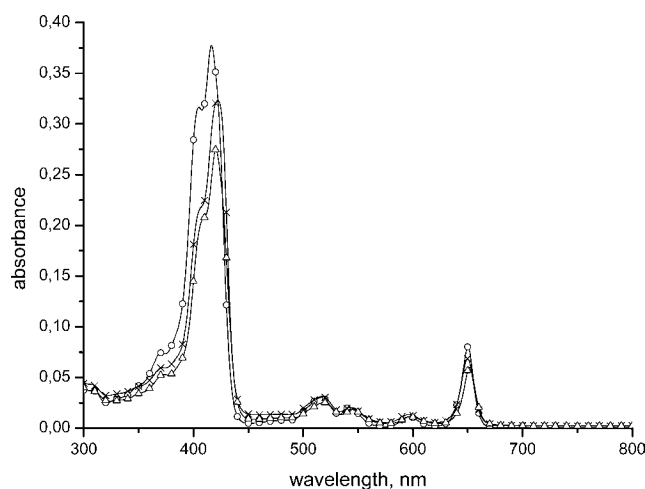

Figure 1. Absorption spectra of mTHPC in different media. Absorption spectrum of mTHPC in ethanol solution (○); absorption spectrum of Foslip in DPBS before (×) and after injection of 0.1% Triton X-100 (△). The mTHPC concentration was 2 μ M.

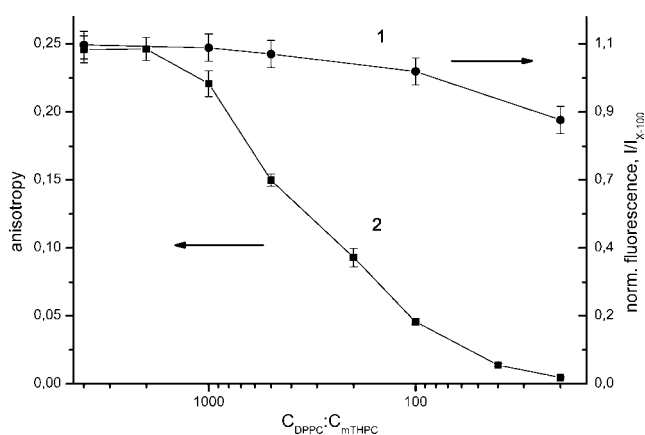

Figure 2. Relative mTHPC fluorescence quantum yield (curve 1, ●) and anisotropy (curve 2, ■) at different $C_{\text{DPPC}}:C_{\text{mTHPC}}$ ratios. mTHPC fluorescence intensities were measured at $\lambda_{\text{em}} = 650$ nm ($\lambda_{\text{ex}} = 420$ nm). Fluorescence anisotropy was measured at $\lambda_{\text{em}} = 650$ nm ($\lambda_{\text{ex}} = 435$ nm). The mTHPC concentration in liposomal suspension was $0.5 \mu\text{M}$.

total mTHPC concentration (5×10^{-7} M) for all conditions. Variations in DPPC:mTHPC ratios from 4×10^3 to 20 result in minor decrease (by 10%) of normalized fluorescence along with a substantial decrease in anisotropy (Fig. 2). At high DPPC:mTHPC ratio, the anisotropy of mTHPC fluorescence is about 0.25, thus indicating a strong fixation of the sensitizer molecules in the lipid bilayer. A progressive decrease in anisotropy is observed from a DPPC:mTHPC ratio of 10^3 with a complete depolarization at that of 60 (Fig. 2).

Photoinduced fluorescence quenching in Foslip suspension

Foslip suspension in DPBS was irradiated with red laser light and spectroscopic measurements were performed after each irradiation time. Absorbance measurements revealed a slow decrease in Soret band with irradiation time, not exceeding 30% at the highest dose of 1800 mJ/cm^2 (Fig. 3). In contrast, very low irradiation doses ($< 50 \text{ mJ/cm}^2$) almost completely quenched the fluorescence to 10% of the initial value. Surprisingly, mTHPC fluorescence was restored after addition of Triton X-100 to pre-irradiated samples and the fluorescence intensity values almost perfectly matched the absorbance kinetics.

We have attributed this pattern of liposomal mTHPC fluorescence behavior, which consists in a loss of fluorescence upon irradiation followed by its restoration in the presence of surfactant, to photoinduced fluorescence quenching. The ratio of fluorescence intensities without and with Triton (normalized fluorescence, $I/I_{\text{x-100}}$) could be taken as a relatively good indicator of this phenomenon. Variations in normalized fluorescence in function of the light dose are displayed in Fig. 3. It should be noted that irradiated solutions were characterized by very subtle spectral changes in the Soret band region (data not shown).

Effects of intramembrane mTHPC concentration on photoinduced fluorescence quenching

To estimate the influence of the local dye concentration on photoinduced loss of fluorescence, DPPC liposomes with different DPPC:mTHPC ratios were irradiated with light

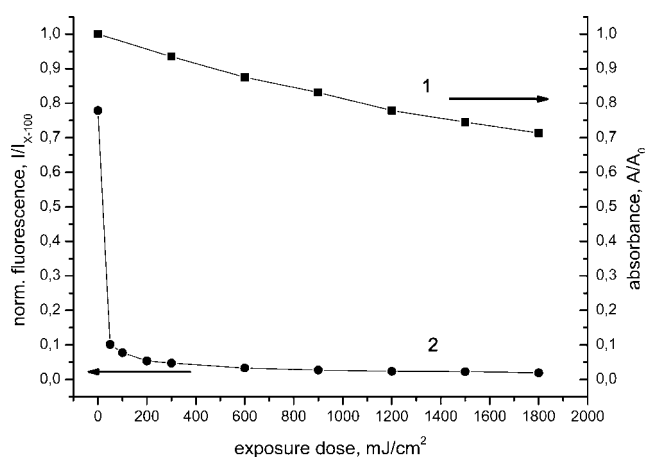

Figure 3. mTHPC absorbance in Soret band (curve 1, ■) and fluorescence (curve 2, ●) in Foslip under laser red light irradiation. Fluorescence intensity was measured before (I) and after addition of 0.1% Triton X-100 ($I_{\text{x-100}}$). mTHPC fluorescence intensities were measured at $\lambda_{\text{em}} 650$ nm ($\lambda_{\text{ex}} = 420$ nm). Absorbance in Soret band ($\lambda = 420$ nm) in samples was normalized to that in non-irradiated ones. The mTHPC concentration in liposomal suspension was $0.5 \mu\text{M}$. DPPC:mTHPC molar ratio for Foslip suspension was 10.

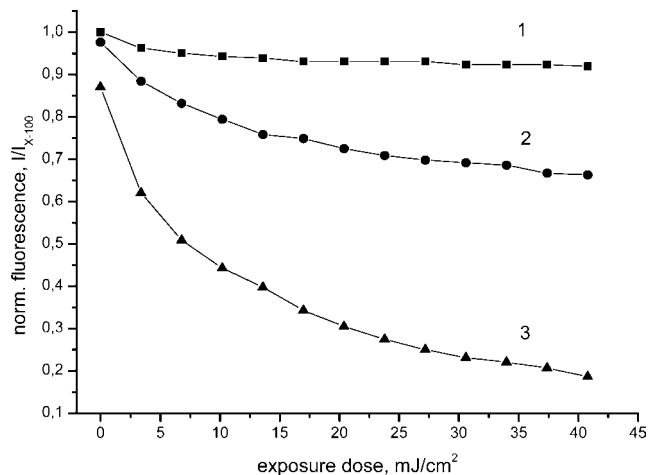

Figure 4. Photoinduced mTHPC fluorescence quenching in DPPC liposomes with different DPPC:mTHPC ratios. DPPC:mTHPC *ca.* 1000 (curve 1, ■), *ca.* 100 (curve 2, ●), *ca.* 25 (curve 3, ▲). mTHPC fluorescence intensities were measured at $\lambda_{\text{em}} 650$ nm ($\lambda_{\text{ex}} = 420$ nm). Fluorescence intensity was measured before (I) and after addition of 0.1% Triton X-100 ($I_{\text{x-100}}$). mTHPC fluorescence intensities were measured at $\lambda_{\text{em}} = 650$ nm ($\lambda_{\text{ex}} = 420$ nm). The mTHPC concentration in liposomal suspension was $0.5 \mu\text{M}$.

fluores in the range $3\text{--}45 \text{ mJ/cm}^2$. The dose–response plot of normalized fluorescence strongly depended on the local dye concentration in liposomes (Fig. 4). The most significant quenching was observed at DPPC:mTHPC ratio of 25, in contrast to higher DPPC:mTHPC values, where the decrease in normalized fluorescence was very slow (Fig. 4) and was consistent with the decrease in absorbance.

Photoinduced fluorescence quenching of Foslip in serum-enriched solutions

Foslip solution in DPBS supplemented with 5% FBS was irradiated with a single light dose of 100 mJ/cm^2 and further

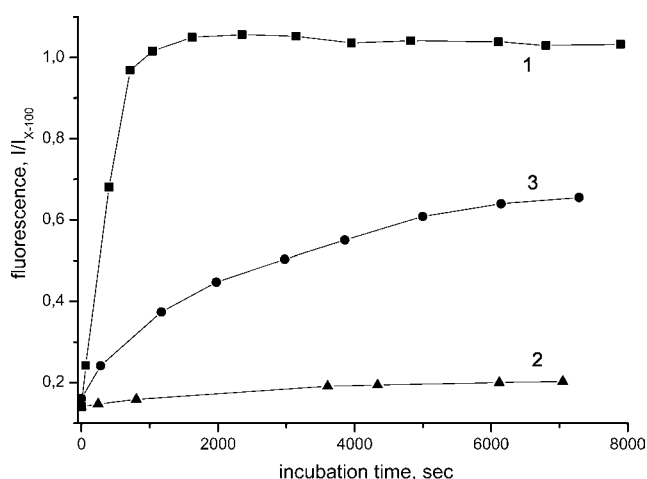

Figure 5. Foslip photoinduced response during incubation in DPBS. Foslip solution in DPBS supplemented or not with 5% FBS was irradiated with a single light dose of *ca.* 100 mJ/cm² and further incubated at 37°C. Normalized fluorescence was measured at selected time points for Foslip solution irradiated in the presence of 5% FBS (curve 1, ■) or in DPBS only (curve 2, ▲). Foslip stock solution was incubated in DPBS supplemented with 5% FBS, at selected time points aliquots were taken and subjected to irradiation (*ca.* 100 mJ/cm²) with successive measurements of normalized fluorescence (curve 3, ●). mTHPC fluorescence intensities were measured at $\lambda_{em} = 650$ nm ($\lambda_{ex} = 420$ nm). The mTHPC concentration in liposomal suspension was 0.5 μ M. DPPC:mTHPC molar ratio for Foslip suspension was 10.

incubated at 37°C with successive measurements of normalized fluorescence at selected time points (Fig. 5, curve 1). Normalized fluorescence increased rapidly during the first 20 min of incubation and did not change up to 2 h incubation (Fig. 5, curve 1). Foslip suspension, irradiated in DPBS only, displayed a very low emission with a 20% increase in normalized fluorescence after 1 h incubation (Fig. 5, curve 2).

Foslip stock solution was incubated in DPBS supplemented with 5% FBS and at selected time points aliquots were taken and subjected to irradiation (100 mJ/cm²) with successive measurements of normalized fluorescence. For each point we observed photoinduced fluorescence quenching but the normalized fluorescence increased moderately with increasing incubation time (Fig. 5, curve 3). A two-fold increase in irradiation dose (200 mJ/cm²) had no significant effect on measured values of normalized fluorescence (data not shown).

DISCUSSION

Liposomal formulations of drugs have been advocated as carriers for hydrophobic compounds (22) and are particularly interesting when dealing with photosensitizers due to enhanced monomerization (23) and decreased plasma half-life time (9). Foslip is a liposomal formulation of mTHPC, composed of DPPC, DPPG, mTHPC and glucose. Because of its intramembrane localization in liposomes, spectral properties of Foslip in DPBS are similar to those in mTHPC ethanol solution thus indicating a monomeric state of the sensitizer (Fig. 1). In lipid-based formulations, the dye is mostly restricted to the lipid phase (24,25) yielding a high local concentration, and as such suggesting strong interactions

between sensitizer molecules in a limited intramembrane spacing. These interactions can contribute to specific photochemical and photophysical photosensitizer properties, including concentration-dependent fluorescence quenching previously reported for liposomes-embedded benzoporphyrin derivative mono-acid ring A (BPDMA, vertoporphin) liposomes (26). Based on the spectroscopic results of the present study, we, however, did not observe significant concentration effects for innate Foslip formulations. Indeed, destruction of lipid vesicles by Triton X-100 only slightly modified mTHPC absorbance (Fig. 1) and fluorescence spectra (data not shown). Lack of concentration effect was supported by measurements of normalized fluorescence at different DPPC:mTHPC ratios, which correspond to different mTHPC local concentrations in liposomes (Fig. 2). Even the highest local mTHPC concentration (DPPC:mTHPC ratio of 20) induced only a 10% decrease in normalized fluorescence (Fig. 2). The molar ratio of DPPC:mTHPC in Foslip is about 10, the average radius of a liposome is approximately 60 nm (present study) and the reported average area per phospholipid molecule in a bilayer is 53Å² (27). We can thus assume that local mTHPC concentration in liposomes varies between 0.1 M (when dye is localized inside the lipid bilayer) and 2.8×10^{-2} M (in the case of uniform dye distribution in the whole volume of liposome). Due to the hydrophobicity of mTHPC, the former situation is more realistic (28) and if we consider the local mTHPC concentration of 0.1 M, then the average distance between mTHPC molecules (*ca.* 2.6 nm) is approximately two times less than the calculated Förster radius ($R_0 = 5.4$ nm). This implies a high probability of energy migration between neighboring mTHPC molecules, which are embedded in the lipid bilayer. Our experiments on mTHPC concentration-dependent anisotropy confirm this proposal. Anisotropy of lipid-based mTHPC fluorescence strongly depends on the local sensitizer concentration with a complete depolarization at the highest mTHPC concentrations (Fig. 2). Direct Förster energy transfer between monomeric species at high local dye concentrations was already established by fluorescence depolarization studies with other dyes and appeared to be a major factor in fluorescence quenching of the sensitizers at high concentrations (29,30). Thus, a dramatic decrease in fluorescence anisotropy with increasing local mTHPC concentrations is most likely a consequence of an energy migration process and presumes strong interactions between mTHPC molecules in lipid bulk medium. The above-mentioned process can have a variety of consequences especially when attempting to interpret the light-induced spectral modifications in lipid-based dye suspensions. This issue was further unfolded in our study of Foslip behavior upon irradiation.

Exposure to small light doses (< 50 mJ/cm²) leads to a substantial reduction of mTHPC fluorescence intensity by 90% (Fig. 3). In irradiated samples we did not observe any notable changes in fluorescence spectra while in the absorption spectra only a small increase in short-wavelength shoulder of a Soret band was registered (data not shown). Further irradiation resulted in a slow decrease in absorbance without significant changes in fluorescence (Fig. 3). This discrepancy between fluorescence and absorbance decays has been reported earlier for porphyrins and chlorins (14,31,32) and was attributed to the preferential photodegradation of photolabile monomer forms of photosensitizers. In our case, this

explanation should be discarded as mTHPC embedded in liposomes exists only in monomeric form (Fig. 1).

Restoration of fluorescence to the level of pre-irradiated samples after Triton-induced demolition of Foslip suggests that the rapid drop of fluorescence at the onset of illumination might be due to the location of mTHPC in lipid vesicles. This effect of photoinduced fluorescence quenching is supposedly related to the formation of mTHPC photoproducts, which in the case of high local dye concentration effectively quench mTHPC fluorescence, thus acting as excitation energy traps. As was shown earlier, irradiation of 0.3 mM ethanol-water solution of mTHPC resulted in the formation of one non-fluorescent (relative fluorescence quantum yield 0.06) and two weakly fluorescent photoproducts (relative fluorescence quantum yields of 0.65 and 0.15) with the absorption spectra similar to that of mTHPC (15). These photoproducts were isolated and identified by MS technique as mono-, di- and tri-hydroxy-mTHPC (15). Theoretical considerations (33,34) suggest that accumulation of a few percentages of weakly fluorescent products under the condition of high local mTHPC concentration in lipid vesicle could lead to fluorescence quenching of the whole population of intact mTHPC molecules in a process of excitation energy migration to the quenching centers. HPLC and MS-based identification of photoproducts formed upon our experimental conditions is the subject of ongoing experiments.

The hypothesis of photoproducts acting as energy traps is consistent with the fact that photoinduced fluorescence quenching depends on the molar DPPC:mTHPC ratio (Fig. 4). For liposomal samples with a low mTHPC content (DPPC:mTHPC of 10^3) at which according to polarization studies (Fig. 2) the energy migration is negligible, we observed only a slight decrease in normalized fluorescence (Fig. 4, curve 1). When mTHPC concentration in liposomes was sufficient for excitation energy exchange, an exposure to low light doses induced a considerable decrease in normalized fluorescence (Fig. 4, curves 2 and 3). Furthermore, formation of photoproducts depends on the presence of oxygen in the medium and when a Foslip suspension was subjected to 30 min nitrogen bubbling before irradiation, we observed a significant decrease in effectiveness of fluorescence quenching (data not shown).

The last part of the present study addressed the effect of photoinduced fluorescence quenching in plasma protein solutions. In contrast to the DPBS solution only, a rapid increase of mTHPC fluorescence was observed after introduction of pre-irradiated Foslip into diluted serum (Fig. 5). The observed abolition of fluorescence quenching could be a consequence of several processes. One of the possible reasons is related to mTHPC release from liposomes due to either dye transfer to plasma proteins or to destruction of liposomes. Although conventional liposomes are renowned for being rapidly released in the bloodstream, Foslip shows a rather slower release pattern (35). We also recently observed (36) very low rate of mTHPC distribution from lipid vesicles, requiring at least 6 h to attain a steady equilibrium. Considering a very rapid (15 min) fluorescence restoration observed in the present study (Fig. 5, curve 1), the possibility of mTHPC release in a dye transfer processes must be ruled out. The destruction of liposomes also seems unlikely in view of a very slow redistribution rate observed in biological environment, either upon

Foslip incubation with plasma proteins or after its direct intratumoral injection (36). However, the contribution from liposomal destruction to increased fluorescence at short time points postirradiation can not be totally ruled out. The most plausible explanation for the rapid fluorescence restoration could be a redistribution of photoproducts, acting as quenchers. Photoproducts more polar than the native mTHPC, as observed by Kasselouri *et al.* (15), might possess higher rates of distribution from Foslip.

Relatively slow kinetics of photoinduced Foslip response during incubation (Fig. 5, curve 3) are in all probability related to mTHPC redistribution from liposomal formulations to FBS proteins. Therefore, changes in Foslip-induced mTHPC distribution pattern in biological systems would be consistent with changes in photoinduced fluorescence quenching. As a matter of fact, this latter parameter may provide us with valuable information on the occurrence of mTHPC intermolecular interactions in the loci with high photosensitizer concentrations. Monitoring variations in relative fluorescence intensity immediately after irradiation could be exploited to assess the redistribution of mTHPC from liposomes to a biological substrate. Fluorescence assessed Foslip biodistribution studies must be cautiously interpreted, taking into account the phenomenon of photoinduced fluorescence quenching.

Acknowledgements—This work was supported by Alexis Vautrin Cancer Center research funds, French Ligue Nationale contre le Cancer (Departments 54 and 57). We acknowledge the financial support of the Belorussian Fond of Fundamental Research (Grant B07MC-046). We also thank the Ministry of Foreign Affairs of France for awarding fellowship to D.K. and Biolitec (Jena, Germany) for providing us with mTHPC and Foslip.

REFERENCES

- Schuitmaker, J. J., P. Baas, H. L. L. M. van Leengoed, F. W. van der Meulen, W. M. Star and N. van Zandwijk (1996) Photodynamic therapy: A promising new modality for the treatment of cancer. *J. Photochem. Photobiol. B Biol.* **34**, 3–12.
- Mitra, S. and T. H. Foster (2005) Photophysical parameters, photosensitizer retention and tissue optical properties completely account for the higher photodynamic efficacy of meso-tetrahydroxyphenyl-chlorin vs photofrin. *Photochem. Photobiol.* **81**, 849–859.
- Bonnett, R., B. D. Djelal and A. Nguyen (2001) Physical and chemical studies related to the development of m-THPC (FOSCAN®) for the photodynamic therapy (PDT) of tumours. *J. Porphyrins Phtalocyanines* **5**, 652–661.
- Sasnouski, S., V. Zorin, F. Guillemin and L. Bezdetnaya (2007) Influence of incubation time and sensitizer localization on meta-tetra(hydroxyphenyl)chlorin (mTHPC)-induced photoinactivation of cells. *Radiat. Res.* **168**, 209–217.
- Derycke, A. S. L. and P. A. M. de Witte (2004) Liposomes for photodynamic therapy. *Adv. Drug Deliv. Rev.* **56**, 17–30.
- Bombelli, C., G. Caracciolo, P. Di Profio, M. Diociaiuti, P. Luciani, G. Mancini, C. Mazzuca, M. Marra, A. Molinari, D. Monti, L. Toccaciel and M. Venanzi (2005) Inclusion of a photosensitizer in liposomes formed by DMPC/Gemini surfactant: Correlation between physicochemical and biological features of the complexes. *J. Med. Chem.* **48**, 4882–4891.
- Johanson, A., J. Svensson, N. Bendsoe, K. Svanberg, E. Alexandratou, M. Kyriazi, D. Yova, S. Gräfe, T. Trebst and S. Andersson-Engels (2007) Fluorescence and absorption assessment of a lipid mTHPC formulation following topical application in a non-melanotic skin tumor model. *J. Biomed. Opt.* **12**, 034026 (9 pages).

8. Svensson, J., A. Johansson, S. Gräfe, B. Gitter, T. Trebst, N. Bendsoe, S. Andersson-Engels and K. Svanberg (2007) Tumor selectivity at short times following systemic administration of a liposomal temoporfin formulation in a murine tumor model. *Photochem. Photobiol.* **83**, 1211–1219.
9. Buchholz, J., B. Kaser-Hotz, T. Khan, C. Rohrer Bley, K. Melzer, R. A. Schwendener, M. Roos and H. Walt (2005) Optimizing photodynamic therapy: In vivo pharmacokinetics of liposomal meta-(tetrahydroxyphenyl)chlorin in feline squamous cell carcinoma. *Clin. Cancer Res.* **11**, 7538–7544.
10. Fischkoff, S. and J. M. Vanderkooi (1975) Oxygen diffusion in biological and artificial membranes determined by the fluorochrome pyrene. *J. Gen. Physiol.* **65**, 663–676.
11. Bonnett, R. and G. Martínez (2001) Photobleaching of sensitizers used in photodynamic therapy. *Tetrahedron* **57**, 9513–9547.
12. Wilson, B. C., M. S. Patterson and L. Lilge (1997) Implicit and explicit dosimetry in photodynamic therapy: A new paradigm. *Lasers Med. Sci.* **12**, 182–199.
13. Hadjur, C., N. Lange, J. Rebstein, P. Monnier, H. van den Berg and G. Wagnières (1998) Spectroscopic studies of photobleaching and photoproduct formation of meta-(tetrahydroxyphenyl)chlorin (m-THPC) used in photodynamic therapy. The production of singlet oxygen by m-THPC. *J. Photochem. Photobiol. B Biol.* **45**, 170–178.
14. Belitchenko, I., V. Melnikova, L. Bezdetnaya, H. Rezzoug, J. L. Merlin, A. Potapenko and F. Guillemin (1998) Characterization of photodegradation of meta-tetra (hydroxyphenyl)chlorin (mTHPC) in solution: Biological consequences in human tumor cells. *Photochem. Photobiol.* **67**, 584–590.
15. Kasselouri, A., O. Bourdon, D. Demore, J. C. Blais, P. Prognon, G. Bourg-Heckly and J. Blais (1999) Fluorescence and mass spectrometry studies of meta-tetra(hydroxyphenyl)chlorin photoproducts. *Photochem. Photobiol.* **70**, 275–279.
16. Coutier, S., S. Mitra, L. N. Bezdetnaya, R. M. Parache, I. Georgakoudi, T. H. Foster and F. Guillemin (2001) Effects of fluence rate on cell survival and photobleaching in meta-tetra-(hydroxyphenyl)chlorin-photosensitized colo 26 multicell tumor spheroids. *Photochem. Photobiol.* **73**, 297–303.
17. Atif, M., M. R. Stringer, J. E. Cruse-Sawyer and S. B. Brown (2004) Fluence-rate effects upon m-THPC photobleaching in a formalin-fixed cell system. *Photodiagn. Photodyn. Ther.* **1**, 173–180.
18. Atif, M., M. R. Stringer, J. E. Cruse-Sawyer, P. E. Dyerand and S. B. Brown (2005) The influence of intracellular mTHPC concentration upon photobleaching dynamics. *Photodiagn. Photodyn. Ther.* **2**, 235–238.
19. Kunz, L. and A. J. MacRobert (2001) Intracellular photobleaching of 5,10,15,20-tetrakis(m-hydroxyphenyl) chlorin (Foscan®) exhibits a complex dependence on oxygen level and fluence rate. *Photochem. Photobiol.* **75**, 28–35.
20. Bendsoe, N., L. Persson, A. Johansson, J. Axelsson, J. Svensson, S. Gräfe, T. Trebst, S. Andersson-Engels, S. Svanberg and K. Svanberg (2007) Fluorescence monitoring of a topically applied liposomal Temoporfin formulation and photodynamic therapy of nonpigmented skin malignancies. *J. Environ. Pathol. Toxicol. Oncol.* **26**, 117–126.
21. Kremer, J. M., M. W. Esker, C. Pathmamanoharan and P. H. Wiersma (1977) Vesicles of variable diameter prepared by a modified injection method. *Biochemistry* **16**, 3932–3935.
22. Chen, B., B. W. Pogue and T. Hasan (2005) Liposomal delivery of photosensitising agents. *Expert Opin. Drug Deliv.* **2**, 477–487.
23. Damoiseau, X., H. J. Schuitmaker, J. W. M. Lagerberg and M. Hoebeke (2001) Increase of the photosensitizing efficiency of the Bacteriochlorin a by liposome-incorporation. *J. Photochem. Photobiol. B Biol.* **60**, 50–60.
24. Lavi, A., H. Weitman, R. T. Holmes, K. M. Smith and B. Ehrenberg (2002) The depth of porphyrin in a membrane and the membrane's physical properties affect the photosensitizing efficiency. *Biophys. J.* **82**, 2101–2110.
25. Bronshtein, I., M. Afri, H. Weitman, A. A. Frimer, K. M. Smith and B. Ehrenberg (2004) Porphyrin depth in lipid bilayers as determined by iodide and parallax fluorescence quenching methods and its effect on photosensitizing efficiency. *Biophys. J.* **87**, 1155–1164.
26. Chowdhary, R. K. and D. Dolphin (2003) Drug release characteristics of lipid based benzoporphyrin derivatives. *J. Pharm. Pharmaceut. Sci.* **6**, 13–19.
27. MacDonald, R. C. and S. A. Simon (1987) Lipid monolayer states and their relationships to bilayers. *Proc. Natl Acad. Sci. USA* **84**, 4089–4093.
28. Kępczyński, M., R. P. Pandian, K. M. Smith and B. Ehrenberg (2002) Do liposome-binding constants of porphyrins correlate with their measured and predicted partitioning between octanol and water? *Photochem. Photobiol.* **76**, 127–134.
29. Frolov, A. A. and E. I. Zenkevich (1990) Chlorin e6-liposome interaction. Investigation by the methods of fluorescence spectroscopy and inductive resonance energy transfer. *J. Photochem. Photobiol. B Biol.* **7**, 43–56.
30. Chen, R. F. and J. R. Knutson (1988) Mechanism of fluorescence concentration quenching of carboxyfluorescein in liposomes: Energy transfer to nonfluorescent dimers. *Anal. Biochem.* **172**, 61–67.
31. Bezdetnaya, L., N. Zeghari, I. Belitchenko, M. Barberl-Heyob, J.-L. Merlin, A. Potapenko and F. Guillemin (1996) Spectroscopic and biological testing of photobleaching of porphyrins in solutions. *Photochem. Photobiol.* **64**, 382–386.
32. Lassalle, H.-P., N. Lourette, B. Maunit, J.-F. Muller, F. Guillemin and L. Bezdetnaya-Bolotine (2004) MALDI-TOF mass spectrometric analysis for the characterization of the 5,10,15,20-tetrakis(m-hydroxyphenyl)bacteriochlorin (m-THPBC) photoproducts in biological environment. *J. Mass Spectrom.* **40**, 1149–1156.
33. Goc, J., M. Hara, T. Tateishi and J. Miyake (1996) Reconstructed light-harvesting system for photosynthetic reaction centers. *J. Photochem. Photobiol. A Chem.* **93**, 137–144.
34. Lin, H., S. R. Tabaei, D. Thomsson, O. Mirzov, P.-O. Larsson and I. Scheblykin (2008) Fluorescence blinking, excitation dynamics, and energy transfer domains in single conjugated polymer chains. *J. Am. Chem. Soc.* **130**, 7042–7051.
35. Pegaz, B., E. Debeve, J. P. Ballini, G. Wagnieres, S. Spaniol, V. Albrecht, D. V. Scheglmann, N. E. Nifantiev, H. van den Bergh and Y. N. Konan-Kouakou (2006) Photothrombic activity of m-THPC-loaded liposomal formulations: Pre-clinical assessment on chick chorioallantoic membrane model. *Eur. J. Pharm. Sci.* **28**, 134–140.
36. D'Hallewin, M.-A., D. Kochetkov, Y. Viry-Babel, E. Werkmeister, D. Dumas, S. Gräfe, V. Zorin, F. Guillemin and L. Bezdetnaya (2008) Photodynamic therapy with intratumoral administration of lipid-based mTHPC in a model of breast cancer recurrence. *Lasers Surg. Med.* **40**, 543–549.

IX.2 Study of meso-tetra(hydroxyphenyl)chlorin (mTHPC) redistribution from lipid vesicles to biological substrates

The aim of the second part of our work was to study the mTHPC redistribution processes from Foslip to biological substrates and to evaluate the stability of liposomal mTHPC formulations against membrane-protein and membrane-membrane interactions. For this purposes the technique of photoinduced fluorescence quenching and gel-filtration chromatography were used. Both of them indicated a low mTHPC redistribution rate from liposomal carriers to an excess of pure DPPC liposomes or to the serum proteins. The rate of mTHPC redistribution strongly depends on incubation temperature and weakly on concentration of acceptor structures. Increase in the temperature of incubation from 5 to 50°C dramatically changes the redistribution rate whereas an increase in serum concentration from 5 to 50% leads to a smooth growth of the quenching amplitude not exceeding 5 %. The almost complete redistribution takes about 6 hours at 37°C. We suppose that at physiological conditions both aqueous phase and collision mechanisms are involved however the distribution through the aqueous phase is strongly favored. The results of gel-chromatography studies demonstrate that at least after 30 min of Foslip incubation with human blood serum the liposomes remain intact and the local photosensitiser concentration inside their lipid bilayer is high enough to provide an intensive excitation energy migration between mTHPC molecules. The redistribution is not completed even after 3h of incubation. Long term time (15h) results in liposomes destruction and mTHPC complete redistribution.

This part of the work is in preparation for the submission to *Biochem Biophys Acta*

Study of meso-tetra(hydroxyphenyl)chlorin (mTHPC) redistribution from lipid vesicles to biological substrates

Dzmitry Kachatkou^{1,2}, Vadzim Reshetov², Vladimir Zorin², Ivan Khludeyev², Marie-Ange D'Hallewin¹, Francois Guillemin¹ and Lina Bezdetnaya^{*1}

¹*Centre de Recherche en Automatique de Nancy, Nancy-University, CNRS, Centre Alexis Vautrin, Vandœuvre-Les-Nancy, France*

²*Laboratory of Biophysics and Biotechnology, Physics Faculty, Belorussian State University, Nezalegnasti, Minsk, Belarus*

*Corresponding author email: l.bolotine@nancy.fnclcc.fr (Lina Bezdetnaya)

Key words : mTHPC, liposomes, serum proteins, gel-chromatography, re-distribution

SUMMARY

We previously described the phenomenon of photoinduced fluorescence quenching for meso-tetra(hydroxyphenyl)chlorine (mTHPC) incorporated in conventional dipalmitoylphosphatidylcholine (DPPC) liposomes (Foslip), which consists in a significant decrease of fluorescence after photoirradiation with its successive restoration after destruction of liposomes with the detergent. In the present study we used this phenomenon to evaluate the transfer of mTHPC from liposomes to plasma proteins. Redistribution of photoactive molecules is an essential element for the understanding its further delivery to target tissues.

It appears that migration occurs mainly through the aqueous phase rather than in a collision process and mostly depends on the incubation temperature. As evaluated by gel-chromatography, the affinity pattern towards various proteins does not differ from that of liposome-free mTHPC. However, as opposed to conventional liposomes with a very rapid disruption of the lipid vesicles, the redistribution of Foslip -induced mTHPC to plasma proteins is a very slow process, which is not completed even after 3 hours of Foslip incubation in serum. This Foslip behavior in serum proteins should be considered for better comprehension of in vivo pharmacokinetics and as such for the designing of preclinical and clinical protocols.

1. Introduction

Photodynamic Therapy (PDT) was shown to be highly effective in the curative and palliative treatment of malignant tumors and other diseases [1, 2]. The principle of PDT is based on the administration of a photosensitizer (PS) followed by illumination of the tumour area at the appropriate wavelength. The effect of PDT on tumor cells involves a complex combination of events, where highly reactive singlet oxygen generated by the photodynamic action plays a major role in cell killing [3].

Porphyrins are most frequently used in PDT to achieve therapeutic effect. The important limitation on their use for clinical application is their low water solubility. To overcome these problems, photosensitizer can be loaded into nano-sized drug delivery systems, which enhance drug solubility and bioavailability [4,5].

Lipid based micelles, liposomes, are popular pharmaceutical carriers for poorly soluble drugs [6], since they can be solubilized through the micelle hydrophobic core. Because of their characteristic small size (between 40 and 100 nm), good solubilization efficiency and stability, liposomes represent an ideal delivery system for apolar PDT drugs. Incorporation into lipid vesicles allows remaining in a monomeric state for many tetrapyrrolic sensitizers, providing a high photosensitizing activity [7]. An additional advantage of such systems is the phenomenon of passive targeting, which is based on enhanced liposomal permeability through discontinuous tumor microvasculature [8]. In this perspective, a clinically approved photosensitizer meta-tetra(hydroxyphenyl)chlorin (mTHPC, Foscan®), has been loaded into dipalmitoylphosphatidylcholine /dipalmitoylphosphatidylglycerol (DPPC/DPPG) liposomes. The resulting compound, Foslip, was recently tested in xenografted tumors and demonstrated favourable pharmacokinetic properties, consisting in a better tumor/healthy tissue selectivity and a rapid plasma clearance [9,10,11].

We have recently reported that Foslip revealed an unusual behaviour upon irradiation related to strong interactions between mTHPC molecules in a lipid bulk medium [12]. Exposure of Foslip suspensions to feeble light doses ($< 50 \text{ mJ/cm}^2$) resulted in a substantial drop in fluorescence with its successive restoration after addition of a detergent. We attributed this behaviour to photoinduced fluorescence quenching. We also proposed that changes in photoinduced fluorescence quenching could be used to estimate mTHPC distribution /repartition pattern in plasma proteins.

The present study addresses the kinetics of re-distribution of mTHPC from Foslip to biological substrates (lipids and plasma proteins) using the technique of photoinduced fluorescence quenching. We further studied the changes in Foslip distribution pattern in blood serum by gel-filtration chromatography.

2. Materials and methods

2.1. mTHPC and Foslip preparations

The photosensitizer mTHPC (meta-tetrahydroxyphenylchlorin, Foscan®) and its liposomal formulation Foslip were provided by Biolitec AG (Jena, Germany). Stock solution of mTHPC was prepared by dissolving mTHPC powder in 99.6% ethanol. mTHPC liposomal formulation Foslip was reconstituted in PBS. Foslip is based on L- α -dipalmitoylphosphatidylcholine (DPPC) (Sigma-Aldrich), dipalmitoylphosphatidylglycerol (DPPG; Sigma-Aldrich), glucose and water, lipid to a dye ratio of approximately 10:1.

2.2. Preparation of liposomes

Unilamellar lipid vesicles were prepared using the ultrasonic method [13]. In brief, 40 mg of DPPC was dissolved in 1 ml of ethanol, which was afterwards evaporated to form a lipid film on the walls of a flask. Upon addition of 4 ml of PBS, the lipid film was hydrated, removed from the flask walls by vortexing for 15 min and sonicated in a ultrasonic dispergator UZDN-2T for 3

min [14]. The final suspension was stored at 37°C. Liposomes containing mTHPC were prepared using a similar protocol, mTHPC being added to DPPC/ethanol solution to obtain the required lipid to dye ratio. Concentration of mTHPC in lipid suspension was estimated by spectrophotometric method considering the similarity of absorption spectra in ethanol and in lipids and using the molar extinction coefficient of mTHPC at 650 nm as $35\,000\text{ M}^{-1}\text{cm}^{-1}$.

2.3. Spectroscopic measurements

Electronic absorption spectra were measured on Perkin Elmer Lambda 35 and Solar PV 1251A (Solar, Belarus) spectrophotometers using 1 cm optical path quartz cuvette. Fluorescence spectra were recorded on Perkin Elmer LS50B and Solar SFL 1211A spectrofluorimeters equipped with thermostated cuvette compartments. Fluorescence polarization was measured on Solar SFL 1211A equipped with polarizers. Samples were excited at 435 nm and fluorescence was registered at 650 nm. Photosensitiser fluorescence lifetime was measured on PRA-3000 pulse fluorometer operating in the single-photon counting mode.

2.4. Photoinduced fluorescence quenching

Samples were subjected to irradiation by coupling an optical fiber with frontal diffuser to a 660 nm semiconductor laser ILM-660-0.5 (LEMT, Belarus). Fluence rate was set at 50 mW/cm^2 , and irradiation was made under continuous stirring at room temperature. Irradiation time was 10 s, corresponding to a light fluence of 0.5 J cm^2 . Irradiation at such doses is accompanied by changes in photosensitiser concentration of less than 2%, but induce a phenomenon of fluorescence quenching. Normalized fluorescence, the ratio (I/I_{X-100}) of mTHPC fluorescence intensity measured immediately after irradiation (I) to fluorescence intensity measured after addition of 0.2% Triton® X-100 to the same sample (I_{X-100}), was used as an indicator of photoinduced quenching [12].

2.5. Blood serum

Human blood was collected from healthy donors. Blood coagulation operation was carried out according to established protocols [15]. Venous blood was precipitated in a glass test-tube without anticoagulants at room temperature (~15°C) for 30 minutes until clot formation. The clot was separated from the test-tube walls and the sample was centrifugated for 10 minutes at 1000-1200 g. The serum obtained was stored in plastic test tubes at -18°C until use. Immediately before experiment serum was centrifuged at 400 G for 5 min and supernatant was collected.

2.6. Gel exclusion chromatography

Chromatographic separation was performed on Sigma 1.2x45 cm column filled with Sephacryl 400-HR gel (Amersham Biosciences) pre-equilibrated with PBS. For protein separation experimental conditions were as follows: loading volume 0.5—0.9 ml, flow speed 0.5 ml/min, fraction sample volume 0.9-1.5 ml. Fractions with elution volume from 30 to 90 ml were collected and analyzed for protein and dye content. mTHPC content in chromatographic fractions was analyzed by spectrofluorimetric method after addition of Triton® X-100.

Protein concentration was determined by Lowry method [16]. Triglyceride and cholesterol concentrations were determined by enzymatic assay according to Tietz *et al.* [17] due to formation of 4-(p-benzoquinone-monoimino)-phenazon, which effectively absorbs light at 500 nm (Analysis Plus, Minsk, Belarus). Absorption of samples was estimated and compared with external linear calibration curves for proteins, triglycerides and cholesterol respectively.

2.7. Redistribution of mTHPC from Foslip

Foslip was added to a suspension of liposomes or to diluted human blood serum. Samples were taken immediately after addition of Foslip or after incubation for 1, 2, 4, 6 and 24 hours. The local photosensitiser concentration of the sample was estimated by photoinduced

fluorescence quenching. Changes in local mTHPC concentration were attributed to the redistribution of mTHPC molecules from Foslip vesicles.

3. Results

3.1. Spectral properties of mTHPC in lipid vesicles

The spectroscopic characteristics of mTHPC in liposomes at different mTHPC:DPPC ratios are shown in Table 1. A slight bathochromic shift in the maximum and shape alterations of Soret band were observed for liposomal formulations as compared to mTHPC in ethanol, without significant changes in the first Q-band (650 nm). Fluorescence lifetimes for mTHPC:DPPC from 1:1000 to 1:100 were around 9.7 ns and were close to the one in ethanol (9.41 ns). Only liposomes with an mTHPC/lipid ratio superior to 1:50 showed a progressive decrease in fluorescence lifetime from 9.0 ns to 5.5 ns (Foslip). No significant changes were noticed in relative fluorescence quantum yield for different local mTHPC concentrations in lipid vesicles. Increasing mTHPC content up to 1:50 results in a 10-15% decrease of fluorescence yield, whereas this decline reaches 30-35 % for mTHPC in Foslip (1:10) (data not shown).

The parameters that were strongly related to the local mTHPC concentration in liposomes appeared to be fluorescence polarization and normalized fluorescence. Changes in dye/lipid ratio from 1:400 to 1:50 provokes a drastic drop in fluorescence polarization. As displays Table 1, the fluorescence of liposome samples with mTHPC content above 1:100 is completely depolarized. Increase in local mTHPC concentration was also accompanied by a significant decrease in normalized fluorescence, with a higher value of normalized fluorescence at low local mTHPC concentrations.

3.2. Kinetics of Foslip-induced mTHPC distribution in an excess of liposomes or human serum

Foslip incubation in PBS for over 24 hours did not provoke any changes in normalized fluorescence or polarization (Fig. 1, curves 1 and 2). When Foslip was incubated at 37°C with an excess of sensitizer-free DPPC liposomes, we observed a slow increase in normalized fluorescence (Fig. 1, curve 3) along with an increase in polarization (curve 4). During the first 6h of incubation, polarization increased from 4% to 15% without significant further changes up to 24h (curve 4). In parallel, normalized fluorescence increased from 0.12 to 0.7 (curve 3). Since polarization and relative fluorescence showed an identical behavior, we further assessed mTHPC redistribution kinetics by measuring only normalized fluorescence to study mTHPC redistribution from Foslip to serum proteins. Figure 2 displays the kinetics of normalized Foslip fluorescence incubated in PBS (Fig. 2A, curve 1) and 5% human blood serum (Fig. 2A, curve 2) at 37°C. Presence of serum proteins induced an increase in normalized fluorescence till 6h. From figure 2 B, it appears that serum concentration only slightly affects redistribution rate since normalized fluorescence is only slightly influenced by an increase in protein content from 0.5% to 50%.

However, Foslip-induced mTHPC redistribution rate strongly depends on the incubation temperature. Figure 2C represents photoinduced fluorescence quenching measured in terms of normalized fluorescence, in function of temperature after 2h incubation in blood serum. Foslip incubation at 30°C and higher is characterized by a considerable acceleration of the redistribution processes monitored using normalized fluorescence.

3.3. Redistribution of mTHPC from Foslip to serum proteins assessed by gel-chromatography

In order to perform a more precise analysis of the process of Foslip-induced photosensitizer distribution to serum proteins we used a gel filtration technique based on the separation of main

serum carrier proteins in accordance to their molecular size. We first investigated the affinity of free mTHPC towards different serum constituents (Fig. 3). mTHPC was incubated in 1 mL of 5% blood serum for 6h, introduced into the chromatography column Sephacryle S-400 and elution profile was analyzed by measuring the fluorescence intensity after injection of Triton® X-100 in the different fractions (Fig. 3, curve 1). Also a total protein content in eluted fractions was determined (curve 2). Total cholesterol, triglycerides and human serum albumin (HSA) elution profiles were registered separately and used as reference chromatograms.

A typical chromatogram of mTHPC-loaded serum displays two bands, the first weak band with a peak around 47 mL and a second major band (85% of total chromophore) with a peak at 54-56 ml and poorly resolved shoulder at 62 ml (Fig. 3, curve 1). The total protein profile (curve 2) is significantly shifted to larger elution volumes as compared to mTHPC. Maximum serum protein content is detected in fractions eluting through the column simultaneously with isolated albumin (62 mL) (curve 4). The maximal elution profile of mTHPC is found in the serum proteins fractions containing cholesterol (45-58 mL, curve 3) and triglycerides (45-53 mL; data not shown).

We then evaluated redistribution of mTHPC from Foslip to serum proteins by gel chromatography (Fig. 4). We first investigated the elution band of an aqueous solution of Foslip, without any pre-incubation (curves 1, panels A-C). Secondly, Foslip solutions were studied after incubation with human serum at 37°C for time intervals of 0.5, 3 and 15 H (curves 2, panels A-C). Fluorescence intensity after photo irradiation was determined for every fraction in order to observe the impact of local liposomal mTHPC concentration through the measurements of photoinduced fluorescence quenching (curves 3, panels A-C). All fractions were assessed for protein content (curves 4).

The major part of mTHPC injected into the column in aqueous Foslip solution was eluted much faster (32-33 mL) (Fig. 4, curves 1) than protein-bound mTHPC (55-57 mL) (Fig. 3).

Foslip incubation with serum proteins resulted in mTHPC elution in two bands (Fig. 4, curves 2). The first band corresponds to liposomal mTHPC, as shown through photoinduced fluorescence quenching observed upon irradiation (curves 3) and through comparison with elution peak of serum-free sample (curves 1). The second band apparently corresponds to (lipo)protein bound mTHPC. Compared to serum-free Foslip, broadening and shift to a greater elution volume of the first band after thirty minutes of incubation evidenced the significant changes in the size of lipid vesicles. Increasing incubation time resulted in a progressive reduction of weight of the first band attributed to mTHPC embedded into lipid vesicles and concomitant increase of protein-based band (Fig. 4B, C, curves 2). After long incubation time distribution pattern was similar to elution profile of serum containing free mTHPC (Fig. 4 C).

There was no significant photoinduced fluorescence quenching effect for mTHPC bound to serum proteins (Fig.4 curves 2-3). However, a significant quenching was observed in the first elution band (liposomal mTHPC). This effect was most prominent for the short incubation times (normalized fluorescence varies from 2.5 to 4 for the samples obtained after 0.5 H of incubation) and progressively decreased with a following increase in incubation time.

4. Discussion

Liposomal delivery of drugs is highly favored in order to enhance tissue distribution and plasma clearance. In case of photosensitizer delivery, an additional advantage relies in the monomerization of the drug [18]. While mTHPC remains aggregated even in the presence of serum albumin [19], the embedding of the dye into lipid vesicles prevents its aggregation. As a result its absorption and fluorescence spectra are consistent with monomeric mTHPC [12]. In the present study, we have extended the spectroscopic characteristics of mTHPC in liposomes at

different mTHPC:DPPC ratios (Table 1). Absorption and fluorescence spectral properties weakly depend on the dye:lipid ratio indicating the absence of mTHPC aggregation even at high liposomal loading. Consistent with this observation, quantum yields of singlet oxygen generation for mTHPC in ethanol solution and embedded in vesicles are equal [20]. The high values of fluorescence anisotropy at low local mTHPC concentrations, together with relatively long fluorescence lifetimes certify a rigid fixation of the mTHPC molecules in the lipid vesicles. On the other hand, the enhanced local concentration of mTHPC molecules in lipid vesicles suggests a high probability of resonance excitation energy transfer resulting in concentration dependent fluorescence depolarization in liposomes. We previously observed this for Foslip where the high local mTHPC concentration in lipid vesicles is responsible for photoinduced fluorescence quenching [12]. With regard to the strong dependency of the local mTHPC concentration in liposomes on normalized fluorescence, we investigated whether fluorescence quenching might be utilized for the analysis of photosensitiser distribution / repartition in biological systems.

Liposomal mTHPC in PBS does not induce any fluorescent changes over time, thus indicating the absence of liposomal alterations (Fig. 1). However, when drug-free liposomes are added, both polarization and normalized fluorescence increase. This is due to migration of mTHPC from Foslip to unloaded liposomes, thus reducing local mTHPC content. The two curves are almost perfectly overlapping, indicating that both parameters can be used to observe energy transfer between mTHPC molecules.

From Figure 1, it appears that redistribution of mTHPC from Foslip to lipid membranes is a very slow process and final distribution is only achieved after 6-8 hours of incubation. Similar results were obtained for mTHPC redistribution from Foslip to human blood serum. Conventional liposomes have been shown to have extremely short half-lives in blood, in the order of minutes [21]. This is due to phagocytosis by the reticular endothelial system (RES). Another reason for

liposomal elimination could be their interactions with plasma proteins with successive redistribution of the drug [22-26]. As a result, in human blood serum a relatively rapid distribution of liposomal drugs between plasma proteins, preferentially lipoproteins, is reached. From the present study it appears that Foslip does not show a similar behavior. Indeed, distribution of mTHPC from Foslip to plasma proteins is only achieved after 1 to 2 hours (Fig. 2), which significantly exceeds the values for DPPC lipid vesicles [27,28]. Our chromatographic data confirm this observation (Fig. 4). After 0.5 and 3 hours of Foslip incubation in serum, a significant part of the sensitizer molecules still localizes in liposomal structures and elutes from the column before serum proteins. Only after 3 hours of incubation do we notice a reduction of fluorescence quenching in all elution fractions, thus indicating that redistribution has taken place, without complete destruction of the liposomes. This liposomal disruption is completed by 15 hours of incubation.

Prolonged lifetime of Foslip in serum may reflect physico-chemical peculiarities of the lipid vesicles under investigation. Indeed, not only liposomal formulation affects drug properties, but also the drug itself can change liposomal characteristics. Inclusion of a great amount of photosensitizer molecules into lipid vesicles could influence their interactions with plasma proteins. A significant decrease of liposomal destruction in blood serum has been observed for other drugs such as doxorubicin and was attributed to altered interaction patterns with RES macrophages [29]. Investigation of liposomes loaded with ibuprofen using scanning electron microscopy, demonstrated the existence of a direct effect of the drug inclusion on the structural stability of the lipid bilayer [30].

It is of great interest to consider thermodynamic mechanisms of mTHPC release from lipid vesicles and redistribution to human blood serum. Photosensitizer redistribution from lipid vesicles may proceed through water phase or due to contact interactions of drug-loaded

liposomes with plasma proteins [31]. In the first case the rate of sensitizer exit is determined by the kinetic constant of the molecules desorption from the lipid bilayer and usually weakly depends on the concentration of acceptor structures. In the second case, the redistribution of photosensitizer molecules takes place mainly due to collision between Foslip and plasma proteins. This process can occur simultaneously or independently from the destruction of the lipid vesicles [31]. Its rate is determined by the frequency of collisions and as a consequence of serum concentration. Measurements of photoinduced fluorescence quenching amplitude for samples incubated with different serum concentration show a relatively high exit rate of photosensitizer, even with the minimal concentration of human blood serum (Fig. 2B). Increase in serum concentration from 5 to 50% leads to a very slight growth of the quenching amplitude of less than 5 %. It thus appears that the relative contributions of contact-dependent or contact-independent mechanisms of mTHPC redistribution from Foslip to serum proteins are essentially unequal and distribution through the aqueous phase is favored in physiological conditions.

The release rate of liposomal drugs strongly depends on the temperature due to its influence on the structure of the lipid bilayer [32]. At low temperatures DPPC vesicles are in a gel state with close packing and frozen conformation of the hydrocarbon chains. Increasing the temperature will result in a transition to a liquid crystalline state where the acyl chains are disordered and have a high mobility. Such a phase transition facilitates the process of sensitizer exit from the lipid bilayer to the water bulk. The lipid bilayer from pure DPPC liposomes undergoes such a phase transition at 41-43 °C [33], but is also very sensitive to incorporation of various additives into the vesicles [34]. The Foslip formulation contains besides DPPC about 10 % DPPG and 10 % (W/W) mTHPC. The presence of these components may significantly influence the phase transition properties of the lipid bilayer, which most probably lies somewhere between 30°C and 45°C (Fig.2 C).

Despite the fact that sensitizer binding to plasma proteins has been shown to have an impact on their distribution and PDT effect [35-39], this issue has not yet been assessed for Foslip. Binding to albumin favors localization in the vascular stroma, whereas photosensitisers are mostly internalized into tumor cells following binding to lipoproteins [35-39]. Only a small part of mTHPC molecules (10-15%) is found in the fraction of albumins and other heavy proteins [40]. This conclusion is in good agreement with our chromatography results (Fig. 3, 4). The affinity of Foscan® and Foslip induced mTHPC towards different plasma proteins is almost similar. The major part of photosensitiser localizes in the fractions with high cholesterol content, which is one of the main components of lipoproteins (Fig. 3, 4). This results are in good agreement with conclusions made by Jori *et al.* about protein binding pattern of hydrophobic photosensitizers [41]. A minor sensitizer fraction passes through the column with the proteins of big size, probably low-density lipoproteins, which have significantly higher molecular weight than high-density lipoproteins.

As opposed to conventional liposomes with a very rapid disruption of the lipid vesicles and fast clearance rates, mTHPC loaded DPPC/DPPG liposomes show a very slow release of the active component. This will have to be taken into account when designing preclinical and clinical protocols. Furthermore, due to the phenomenon of photoinduced fluorescence quenching, fluorescence can no longer be used as a measure to estimate photosensitiser accumulation. Photoinduced quenching however could be very useful to estimate local photosensitiser concentration and thus redistribution to biological substrates.

Acknowledgements

This work was supported by Alexis Vautrin Cancer Center research funds, French Ligue Nationale contre le Cancer. We also thank the Ministry of Foreign Affaires of France for awarding fellowship to D.K. and Biolitec (Jena, Germany) for providing us with the Foslip.

References

- [1] S.B. Brown, E.A. Brown, I. Walker, The present and future role of photodynamic therapy in cancer treatment, *Lancet Oncol.* 5(8) (2004) 497–508.
- [2] K.W. Woodburn, C.J. Engelman, M.S. Blumenkranz, Photodynamic therapy for choroidal neovascularization: a review. *Retina* 22 (4) (2002) 391–405.
- [3] T.J. Dougherty, Photodynamic therapy. *Clin Chest Med* 6 (1985) 219–236.
- [4] Y.N. Konan, R. Gurny, E. Allémann, State of the art in the delivery of photosensitizers for photodynamic therapy. *J Photochem Photobiol B.* 66(2) (2002) 89-106.
- [5] D.K. Chatterjee, L.S. Fong, Y. Zhang, Nanoparticles in photodynamic therapy: an emerging paradigm. *Adv Drug Deliv Rev.* 60(15) (2008) 1627-37.
- [6] D.C. Drummond, O. Meyer, K. Hong, D.B. Kirpotin, D. Papahadjopoulos, Optimizing liposomes for delivery of chemotherapeutic agents to solid tumors. *Pharmacol Rev.* 51(4) (1999) 691-743.
- [7] K. Lang, J. Mosinger, D.M. Wagnerová, Photophysical properties of porphyrinoid sensitizers non-covalently bound to host molecules; models for photodynamic therapy. *Coord Chem Rev.* 248 (2004) 321-350.
- [8] A.S. Derycke, P.A. de Witte, Liposomes for photodynamic therapy. *Adv Drug Deliv Rev.* 56(1) (2004) 17-30.
- [9] J. Svensson, A. Johansson, S. Gräfe, B. Gitter, T. Trebst, N. Bendsoe, S. Andersson-Engels, K. Svanberg, Tumor selectivity at short times following systemic administration of a liposomal temoporfin formulation in a murine tumor model. *Photochem Photobiol.* 83(5) (2007) 1211-9.

- [10] M.A. D'Hallewin, D. Kochetkov, Y. Viry-Babel, A. Leroux, E. Werkmeister, D. Dumas, S. Gräfe, V. Zorin, F. Guillemin, L. Bezdetnaya, Photodynamic therapy with intratumoral administration of Lipid-Based mTHPC in a model of breast cancer recurrence. *Lasers Surg Med.* 40(8) (2008) 543-9.
- [11] H.P. Lassalle, D. Dumas, S. Gräfe, M.A. D'Hallewin, F. Guillemin, L. Bezdetnaya, Correlation between in vivo pharmacokinetics, intratumoral distribution and photodynamic efficiency of liposomal mTHPC. *J Control Release.* 134(2) (2009) 118-24.
- [12] D. Kachatkou, S. Sasnouski, V. Zorin, T. Zorina, M.A. D'Hallewin, F. Guillemin, L. Bezdetnaya, Unusual Photoinduced Response of mTHPC Liposomal Formulation (Foslip). *Photochem. Photobiol.* 85(3) (2009) 719 – 724.
- [13] H. Hauser, D. Oldani, M.C. Phillips, Mechanism of ion escape from phosphatidylcholine and phosphatidylserine single bilayer vesicles. *Biochemistry.* 12(22) (1973) 4507–4517.
- [14] V. P. Zorin, T. E. Zorina, I. S. Mikhalovskii, I. I. Khludeev and S. N. Cherenkevich, Investigation of the intramembrane distribution of chlorin e6 derivatives by using fluorescence quenching. *J. Appl. Spectroscopy,* 62(2) (1995) 334-341.
- [15] V.V. Menshikov (ed.), *Laboratory research techniques in clinics.* Moscow, 1987.
- [16] O.H. Lowry, N. J. Rosebrough, A. L. Farr and R. J. Randall, Protein measurement with the Folin phenol reagent. *J. Biol. Chem.* 193 (1951) 265-275.
- [17] N.W. Tietz, *Clinical guide to laboratory tests,* 2nd ed. Saunders Co, 1991.
- [18] X. Damoiseau, H.J. Schuitmaker, J.W. Lagerberg, M. Hoebeke, Increase of the photosensitizing efficiency of the Bacteriochlorin a by liposome-incorporation. *J Photochem Photobiol B.* 60(1) (2001) 50-60.

- [19] S. Sasnouski, V. Zorin, I. Khludeyev, M.-A. D'Hallewin, F. Guillemin, L. Bezdetnaya, Investigation of Foscan® interactions with plasma proteins. *Biochim Biophys Acta*. 1725 (2005) 394-402.
- [20] H. Mojzisoava, S. Bonneau, P. Maillard, K. Berg, D. Brault, Photosensitizing properties of chlorins in solution and in membrane-mimicking systems. *Photochem Photobiol Sci*. 8(6) (2009) 778-87.
- [21] D.D. Lasic, F.J. Martin, A. Gabizon, S.K. Huang, D. Papahadjopoulos, Sterically stabilized liposomes: a hypothesis on the molecular origin of the extended circulation times. *Biochim Biophys Acta*. 1070(1) (1991) 187-92.
- [22] J.H. Senior, Fate and behaviour of liposomes in vivo: A review of controlling factors. *CRC Crit Rev Ther Drug Carrier Syst* 3 (1987) 123-193.
- [23] H.M. Patel, Serum opsonins and liposomes: Their interaction and opsonophagocytosis. *CRC Crit Rev Ther Drug Carrier Syst* 9 (1992) 39-90.
- [24] D.V.Devine, K. Wong, K. Serrano, A. Chonn and P.R. Cullis, Liposome-complement interactions in rat serum: Implications for liposome survival studies. *Biochim Biophys Acta* 1191 (1994) 43-51.
- [25] A. Chonn, S.C. Semple and P.R. Cullis, β_2 -Glycoprotein I is a major protein associated with very rapidly cleared liposomes in vivo, suggesting a significant role in the immune clearance of "non-self" particles. *J Biol Chem* 270 (1995) 25845-25849.
- [26] D.V. Devine and J.M.J. Marjan, The role of immunoproteins in the survival of liposomes in the circulation. *CRC Crit Rev Ther Drug Carrier Syst* 14 (1997) 105-131.
- [27] S.C. Semple, A. Chonn, P.R. Cullis, Influence of cholesterol on the association of plasma proteins with liposomes. *Biochemistry*. 35(8) (1996) 2521-5.

- [28] A. Chonn, S.C. Semple, P.R. Cullis, Association of blood proteins with large unilamellar liposomes in vivo. Relation to circulation lifetimes. *J Biol Chem.* 267(26) (1992) 18759-65.
- [29] M.B. Bally, R. Nayar, D. Masin, M.J. Hope, P.R. Cullis, L.D. Mayer, Liposomes with entrapped doxorubicin exhibit extended blood residence times. *Biochim. Biophys. Acta* 1023(1) (1990) 133-139.
- [30] A.R. Mohammed, N. Weston, A.G.A. Coombes, M. Fitzgerald and Y. Perrie, Liposomal formulation of poorly water soluble drugs: optimisation of drug loading and ESEM analysis of stability. *Int.J.Pharm.* 285 (2004) 23-34.
- [31] A. Fahr, P. van Hoogevest, S. May, N. Bergstrand and S.L.M. Leigh, Transfer of lipophilic drugs between liposomal membranes and biological interfaces: consequences for drug delivery. *Eur. J. Pharm. Sci.* 26(3-4) (2005) 251-65.
- [32] K. Kuzelová, D. Brault, Kinetic and equilibrium studies of porphyrin interactions with unilamellar lipidic vesicles. *Biochemistry.* 33(32) (1994) 9447-59.
- [33] B.D. Ladbroke and D. Chapman, Thermal analysis of lipids, proteins and biological membranes. A review and summary of some recent studies. *Chem. Phys. Lipids* 3 (1969) 304–367.
- [34] K.M.G. Taylor and R.M. Morris, Thermal analysis of phase transition behaviour in liposomes. *Thermochimica Acta.* 248 (1995) 289-301.
- [35] D. Kessel, P. Thompson, K. Saatio, K.D. Nantwi, Tumor localization and photosensitization by sulfonated derivatives of tetraphenylporphin. *Photochem. Photobiol.* 45 (1987) 787–790.
- [36] M. Korbelik, J. Hung, Cellular delivery and retention of Photofrin II: the effects of interaction with human plasma proteins. *Photochem. Photobiol.* 53 (1991) 501–510.

- [37] M. Kongshaug, Distribution of tetrapyrrole photosensitisers among human plasma proteins. *Int. J. Biochem.* 24 (1992) 1239–1265.
- [38] M.O. Obochi, R.W. Boyle, J.E. van Lier, Biological activities of phthalocyanines. XIII. The effects of human serum components on the in vitro uptake and photodynamic activity of zinc phthalocyanine. *Photochem. Photobiol.* 57 (1993) 634–640.
- [39] M. Kongshaug, J. Moan, S.B. Brown, The distribution of porphyrins with different tumour localising ability among human plasma proteins. *Br. J. Cancer* 59 (1989) 184–188.
- [40] D. Kessel, Transport and localisation of m-THPC in vitro. *Int J Clin Pract.* 53(4) (1999) 263-7.
- [41] G. Jori, In vivo transport and pharmacokinetic behavior of tumour photosensitizers. *Ciba Found Symp.* 146 (1989) 78-86.

Table 1 Spectroscopic characteristics of mTHPC in liposomes

mTHPC / lipid ratio	1:10 (Foslip)	1:20	1:50	1:100	1:400	1:800	1:1000	mTHPC in ethanol
λ_D^{Soret} , nm	421	420	419	419	419	419	419	416
λ_D , nm	650	650	650	650	650	650	650	652
p	0.05	0.04	0.06	0.08	0.17	0.24	0.26	nd
τ_{Fl} , ns	5.48	6.7	9.05	9.66	9.75	9.74	9.75	9.41
Δ_{hv}	0.12	0.22	0.31	0.48	0.81	0.98	0.99	nd

λ_D^{Soret} - absorbance maximum of Soret band

λ_D - absorbance maximum of most prominent Q-band

p - polarization

τ_{Fl} - fluorescence lifetime

Δ_{hv} - normalized fluorescence, = I_{hv}/I_{X-100} , exposure dose 2040 mJ/cm²

nd - not done

Fig. 1. Comparison of mTHPC redistribution kinetics estimated by two different spectroscopic techniques. 1, 2 – reference curves for Foslip incubated in PBS determined by polarization (1) and photoinduced fluorescence quenching (2). 3, 4 – redistribution of mTHPC from Foslip incubated with an excess of dye-free DPPC liposomes as measured by fluorescence quenching (3) and polarization (4).

Fig. 2. Redistribution of mTHPC from Foslip to human blood serum. A: (1)– reference curve (Foslip in PBS at 37 °C), (2)– Foslip in 5 % serum at 37 °C. B: mTHPC distribution after two-hour of Foslip incubation with human blood serum in function of serum concentration. C: Foslip-induced redistribution of mTHPC after two-hour incubation with 5 % human blood serum in function of a temperature.

Fig. 3. Gel chromatograms of mTHPC loaded serum obtained with Sephacryle S-400 column (1 ml 5% serum incubated 6 h with $5.5 \cdot 10^{-6}$ M mTHPC). 1 - elution profile of mTHPC, estimated by fluorescence of the samples; 2 - total protein content determined by Lowry method; 3,4 – elution profiles of cholesterol (3) and HSA (4).

Fig. 4. Gel chromatograms of human serum incubated with Foslip at 37⁰C obtained with Sephacryle S-400 column after 30 min, 3 and 15 hours of preincubation. 1 – elution peak of free Foslip (1ml Foslip solution in PBS, 10 µg/ml) determined as a reference in order to characterize elution volume of liposomal structures. 2 – Foslip-induced mTHPC distribution in serum proteins estimated by fluorescence intensity after addition of Triton X-100. 3 – mTHPC fluorescence in the eluted samples registered after 10 sec of laser irradiation. 4 – total protein content in the samples determined by Lowry method.

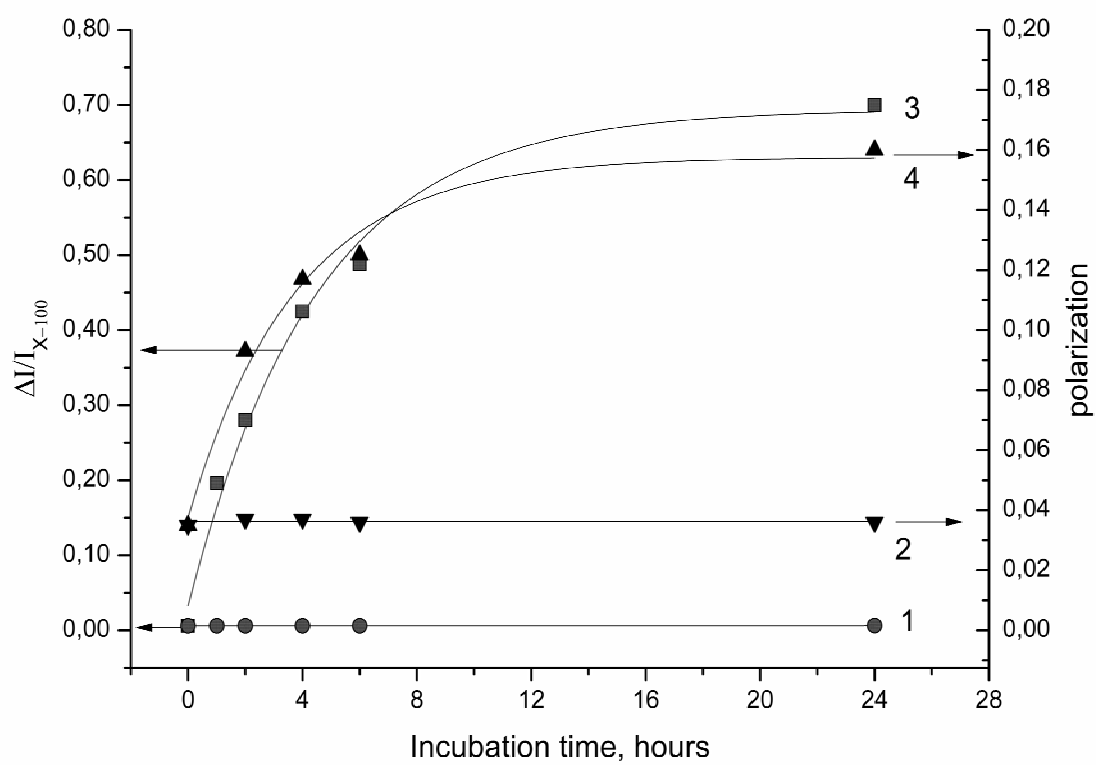

Fig.1.

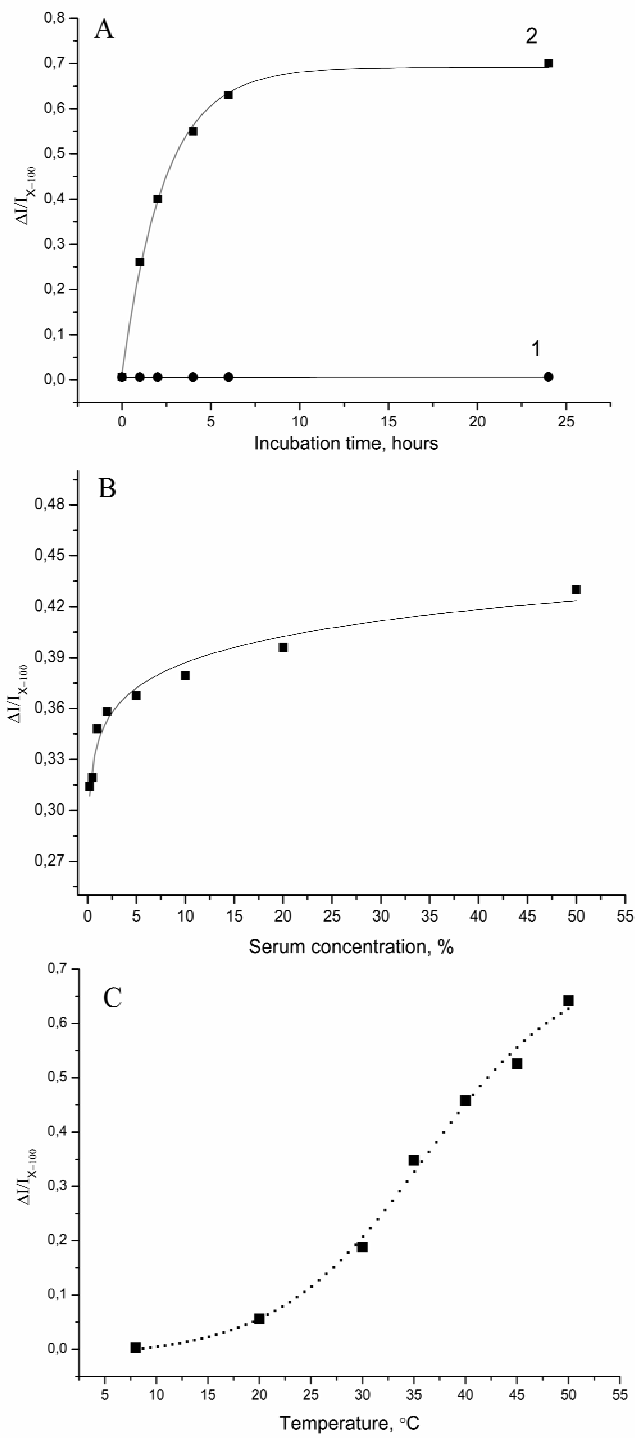

Fig.2.

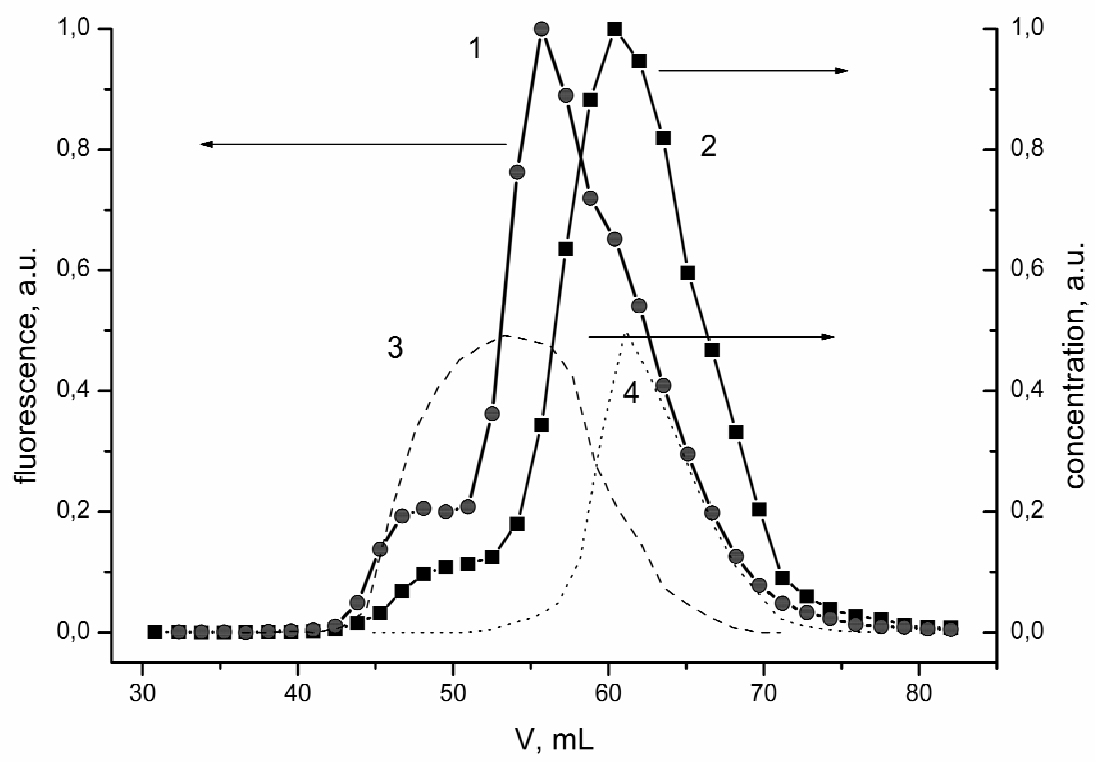

Fig.3.

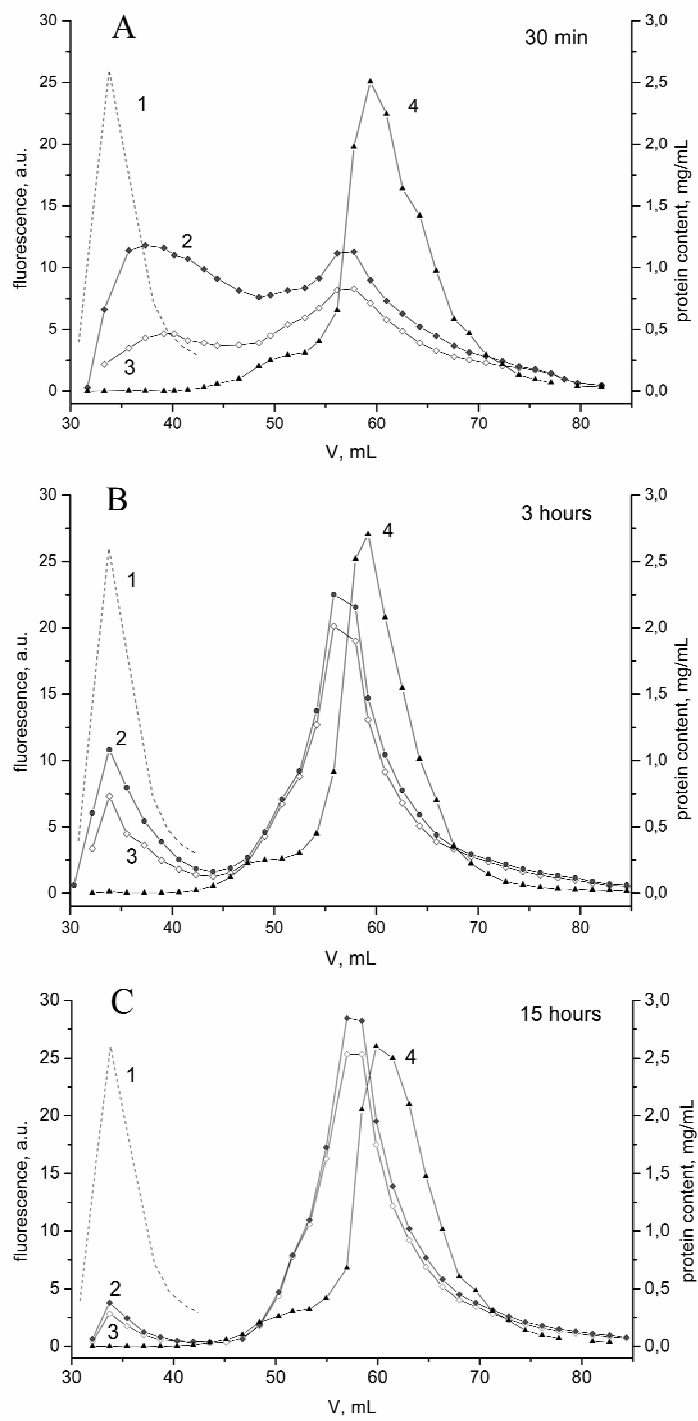

Fig.4.

IX.3 Photodynamic Therapy with Intratumoral Administration of Lipid-Based mTHPC in a Model of Breast Cancer Recurrence

The third part of our work investigated *in vivo* intratumoral Foslip injection in a mouse model of breast cancer recurrence. The initial working hypothesis for this study was that direct intratumoral injection of liposomal, thus monomerized mTHPC, would make possible to reduce the drug light interval. However, highest tumor eradication was obtained after 24 hours, time point coinciding with maximal fluorescence intensity of the tumor. In this study the weak intratumoral fluorescence at early time points after intratumoral Foslip injection could be explained by the strong fixation of mTHPC molecules inside the injected liposomes, slow kinetic of photosensitiser redistribution, and, as such the phenomenon of photoinduced mTHPC fluorescence quenching in the liposome would affect the results of macrofluorescence imaging. Restoration of fluorescence occurred after several hours and is probably due to the transfer of the drug from the liposomal membranes to the tumor tissue, thus lowering the average local mTHPC concentration in liposomes. These *in vivo* results are coherent with our previous *in vitro* studies of mTHPC redistribution processes.

This part of the work was published in *Lasers in Surgery and Medicine* and is presented thereafter in its published form.

Photodynamic Therapy with Intratumoral Administration of Lipid-Based mTHPC in a Model of Breast Cancer Recurrence

Marie Ange D'Hallewin, MD, PhD,^{1*} Dmitri Kochetkov, MSc,^{1,2} Yan Viry-Babel, MSc,¹ Agnes Leroux, MD,¹ Elisabeth Werkmeister, MSc,³ Dominique Dumas, PhD,³ Susanna Gräfe, PhD,⁴ Vladimir Zorin, PhD,² François Guillemin, MD, PhD,¹ and Lina Bezdetsnaya, PhD¹

¹Centre de Recherche en Automatique de Nancy, Nancy-University, CNRS, Centre Alexis Vautrin, Vandoeuvre les Nancy, France

²Laboratory of Biophysics and Biotechnology, Physics Faculty, Belorussian State University, Minsk, Belarus

³Faculty of Medicine, LEMTA, Nancy University, IFR 111 and CNRS UMR 7563, BP 184, Vandoeuvre-les-Nancy, France

⁴Biolitec AG, Research and Development, Jena, Germany

Background and Objectives: Generalized skin sensitization is a main drawback of photodynamic therapy with systemic administration of photosensitizers. We have evaluated the potential use of an intratumoral injection of a liposomal formulation of mTHPC (Foslip) in a mouse model of local recurrence of breast cancer.

Materials and Methods: Mice were directly injected into the tumor (IT) with 25 μ l of a Foslip suspension (0.15 mg/ml) and illumination (652 nm, 20 J/cm²) was performed at different time points with pathological assessment after 48 hours. In a parallel mice series plasma samples were obtained at different endpoints after IT Foslip injection for HPLC analysis and the tumors were subjected *in toto* to macrofluorescence imaging. Fluorescence polarization measurements were conducted *in vitro* to estimate the rate of sensitizer redistribution from liposomes.

Results: Optimal, albeit partial, cure rates were obtained at 24 hours post-sensitizer and unistration. Inhomogeneous and weak fluorescence was observed at early time points and became maximal at 24 hours. Plasma levels of mTHPC increased until 15 hours. Fluorescence polarization measurements showed a slow sensitizer transfer from liposomes to model membranes.

Discussion and Conclusion: The weak intratumoral fluorescence at early time points could be explained by concentration quenching within the liposomes as evidenced from fluorescence polarization studies. Progressive mTHPC redistribution from liposomes and its further incorporation into tumor tissue resulted in fluorescence build-up over time with a maximum at 24 hours post-injection. This correlates perfectly with the best therapeutic effect at this time point. The absence of total cure can be attributed to inhomogeneous photosensitizer distribution. mTHPC is reabsorbed into the blood stream but the total administered amount is much reduced as opposed to systemic administration so that repeated PDT sessions might be favorable in terms of side effects and tumor response. *Lasers Surg. Med.* 40:543–549, 2008.

© 2008 Wiley-Liss, Inc.

Key words: photodynamic therapy; mTHPC; Foslip[®]; intratumoral; fluorescence quenching; breast cancer

INTRODUCTION

Breast cancer represents 10% of the global cancer burden and mortality rates have been steadily growing for nearly a century [1]. Stereotactic- or ultrasound-guided biopsies have greatly improved diagnosis but these procedures have been shown to induce tumor displacement, either as cell clusters or small tumor fragments, in \pm 30% of the patients [2]. This seeding is not clinically relevant since the host immune system will eliminate most surviving tumor cells, as will subsequent surgery, radio or chemotherapy [2]. Skin sparing mastectomy however offers a different scenario with \pm 5% observed local recurrences within the biopsy tract [3]. Treatment options are frequently limited with regard to previous surgery and adjuvant therapies. Photodynamic therapy (PDT) could be considered a valuable alternative cure [4]. PDT is based on the action of light on a tissue that has previously been sensitized with a photoactive substance called photosensitizer, to create reactive oxygen species that will lead to the destruction of the host tissue [5].

One of the main drawbacks of PDT, due to systemic administration of the drug, is skin sensitization and compulsory light restriction of the patient for several weeks. Two photosensitizers have recently gained European approval for topical use: Hexvix[®] (hexylaminolevulinat) for diagnostic purposes in bladder cancer and Metvix[®] (methylaminolevulinat) for PDT of actinic keratosis and non-melanoma skin cancer. Penetration of those drugs following topical application is shallow and PDT must be limited to

*Correspondence to: Dr. Marie Ange D'Hallewin, Centre Alexis Vautrin, Avenue de Bourgogne, 545111 Vandoeuvre les Nancy, France. E-mail: m.dhallewin@nancy.fnclcc.fr

Accepted 2 June 2008

Published online in Wiley InterScience

(www.interscience.wiley.com).

DOI 10.1002/lsm.20662

superficial disease [6]. Intratumoral (IT) injection of first generation photosensitizers has been proposed earlier for cerebral or bladder tumors in order to maximize intratumoral photosensitizer load, minimize damage to adjacent healthy organs and reduce skin sensitisation due to the reduced total amount of administered photosensitizer [7–9].

Meso-tetra(hydroxyphenyl)chlorin (mTHPC–Foscan[®]) has been reported to be one of the most active photosensitizers, since relatively small drug as well as light doses are required to obtain significant and deep destruction of the irradiated tissue [10]. Liposomal formulations of drugs have been advocated as carriers for hydrophobic compounds and are particularly interesting when dealing with photosensitizers, due to enhanced monomerization and decreased plasma half-life [11]. Recently, a liposomal formulation of mTHPC (Fospeg) was investigated in feline patients affected with cutaneous squamous cell carcinoma [12,13]. Intravenous administration resulted in a faster and more selective tumor accumulation, as opposed to Foscan[®], together with a shorter distribution half-life. Response rates were very promising with 100% immediate complete response and 75% of the animals tumor free at 1 year.

The aim of the present study was to investigate photosensitizer distribution and PDT effect after IT injection of a new liposomal mTHPC formulation (Foslip) in a mice model of subcutaneous breast cancer recurrence.

MATERIALS AND METHODS

Photosensitizer Preparation

A novel liposomal formulation of mTHPC, Foslip[®], was used (Biolitec AG, Jena, Germany). It is based on dipalmitoylphosphatidylcholine (DPPC), dipalmitoylphosphatidylglycerol (DPPG), glucose and water. The liposomes were reconstituted in 3 ml sterile water to obtain a sensitizer concentration of 1.5 mg/ml, which was used for HPLC and microscopy studies. Further dilution in 5% aqueous glucose solution resulted in a sensitizer concentration of 0.15 mg/ml Foslip, used for PDT experiments.

Animal Model and PDT

All animal procedures were performed according to institutional and national guidelines. Mouse mammary EMT6 tumors were initiated by subcutaneous injection of 0.5×10^4 cells in both hind legs of female 6–8 weeks old Balb/c mice. The animals were subjected to an intratumoral injection of 25 μ l Foslip solution at a concentration of 0.15 mg/ml when tumors reached a diameter of 4–5 mm. PDT was carried out under general anesthesia (IP ketamine-xylazine, 90–10 mg/kg body weight). Irradiation at 652 nm (20 J/cm², 100 mW/cm²) was carried out with an optical fiber with frontal diffuser and an argon-pumped dye laser (Spectra Physics 375 B, Spectra Physics 2020, Les Ulis, France). Three mice were used for each time point (30 minutes, 3, 6, 15 and 24 hours), equivalent to six tumors. Animals were sacrificed at 24–48 hours, and the tumors processed for pathological assessment. The area of necrosis was measured in function

of the total tumor volume using Image J software. Five different pathology slides were investigated per tumor (30 per time point). Data were analyzed with Origin 7.5[®] (OriginLab, Coporation) software to create a box plot diagram. For fluorescence microscopy studies, a concentration of 1.5 mg/ml Foslip[®] was used. Two animals were used for each time point corresponding to four tumors. The animals were euthanized after 30 minutes, 1, 3, 6, 15 and 24 hours.

HPLC Analysis

Four mice were used for each time point: 1, 3, 6, 15 and 24 hours. Plasma samples were weighed and freeze dried (freeze drying system Alpha 1-4 LSC, Martin Christ Gefriertrocknungsanlagen GmbH, Osterode, Germany). This powdered sample (10–20 mg) was transferred to a 2.0 ml reaction tube and 1.5 ml of methanol:DMSO (3:5, v:v) was added. The samples were incubated at 60°C under continuous shaking for at least 12 hours. All samples were spun at 16,000 g in a centrifuge for 5 minutes. One ml of the supernatant was used for HPLC analysis with the following specifications; pump: “System Gold, 126 Solvent Module” (Beckman Coulter Inc., Fullerton, CA, USA), Autosampler: “Triathlon”, diode Array Detector: “System Gold, Module 168” (Beckman Coulter Inc., Fullerton, CA, USA) and a fluorescence detector: “RF-10A XL” with interface SS420x (Shimadzu Europa GmbH, Duisburg, Germany). Fluorescence was excited at 410 nm and detected at 653 nm. The separation was carried out on a “LiChroCART 250-4” column (Merck KGaA, Darmstadt, Germany) with Purospher STAR RP-18 endcapped; 5 μ m Guard column: “LiChroCART 4-4” with Purospher STAR RP-18e; 5 μ m (Merck KGaA, Darmstadt, Germany) Temperature: 30°C. The mobile phase consisted of acetonitrile: H₂O+0.1% trifluoroacetic acid (TFA) = 57.5%: 42.5% with a flow rate of 1 ml/min. The tissue concentration of mTHPC, given in ng/mg wet weight, was calculated from a calibration curve constructed by plotting the peak height values of mTHPC standard solutions versus their concentrations.

Macrofluorescence Imaging System

The imaging system was composed of a microscope (MacroFluo[™] Z6 APO A, Leica Microsystems Mannheim, Germany) combined to a fluorescence excitation source (Hg) and a CCD camera. The emitted fluorescence was collected in the way of incident light. A dichroic filter at 595 nm and two band-pass filters (BP560/40 and BP 645/75 nm) were used to select the excitation and emission spectral range specific for Foslip[®]. An objective 1 \times enabled to image samples in their integrity (1392 \times 1040 pixels²) with a zoom factor of 0.57 and an exposure time of 630 ms. Tumors were excised *in toto* with the skin and placed on the objective in order to illuminate the tumor side.

Liposomal Preparation and Polarization Studies

Lipid vesicles were prepared using the injection method. Sixty microliters of a DPPC/ethanol solution (2.2×10^{-2} M) was added to 4 ml of PBS at a rate of 1 μ l/s. To obtain vesicles with different mTHPC concentrations, the dye/ethanol

solution was added to a DPPC solution before adding PBS and the liposomes were stored at 37°C. Liposomal size, as measured by photon correlation spectroscopy (Zetasizer 3000 HAS, Malvern, UK) was 116 nm. Approximately 2 ml of the mTHPC-loaded liposomal solution was placed in a 1 cm path length cuvette at 37°C. Fluorescence polarization was measured using SOLAR spectrofluorimeter SFL 1211A ("SOLAR", Minsk, Belarus) equipped with polarizers. Because of the presence of two different spectral lines in the main maximum of the Soret band in both excitation and fluorescence spectra, samples were excited at 435 nm. Fluorescence was measured at 650 nm.

Statistical Analysis

StatView 5.0.1 software was used for statistical analysis. Mann–Whitney U-test was applied for statistics $P < 0.05$ was considered significant.

RESULTS

Tumor Necrosis

Figure 1 represents typical pathology slides obtained at 24–48 hours post-PDT at different drug light intervals. Response pattern is very similar at all time points and shows an inhomogeneous distribution of necrotic areas. Necrotic features are most prominent in the center of the tumor and are frequently associated with hemorrhage. With larger magnification, even apparently necrotic tumor zones, contain small amounts of undamaged cells ($\pm 8\%$) (data not shown). Damage to the overlying skin is minimal.

The percentage of necrosis within the tumor is represented graphically by box plot investigation in Figure 2. There is no statistical difference between the first four time points ($P = 0.27$) whereas a significant better amount of

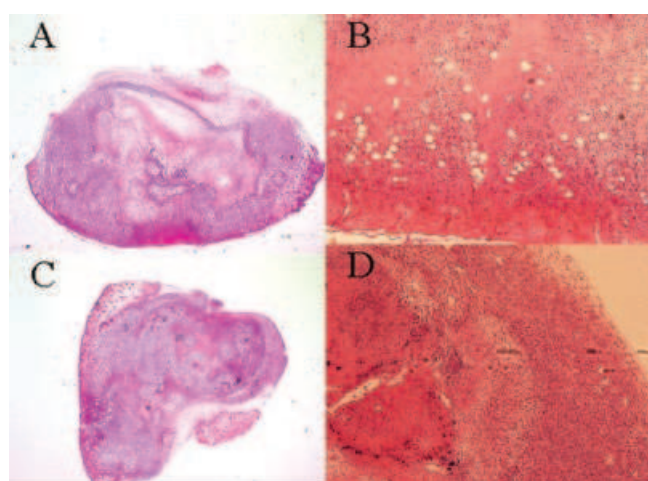

Fig. 1. Typical pathological observation of a tumor 24–48 H after PDT. (HES 1.25 \times and 10 \times) Light drug interval 30 minutes (A), 3 hours (B), 15 hours (C), 24 hours (D). An inhomogeneous necrosis pattern can be observed throughout the tumor, with minimal damage to the skin (A and C). Necrotic islets surrounded by viable tumor cells with intact skin (B). Central necrosis with tumor rim (D).

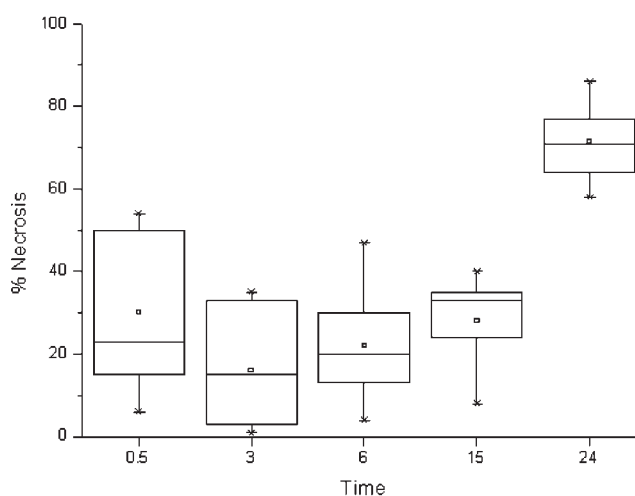

Fig. 2. Box plot diagram representing percentage of post-PDT necrosis in function of light drug interval.

necrosis was observed when illumination was performed 24 hours after IT injection ($P = 0.031$).

mTHPC Measurements in Plasma

mTHPC was detected in the plasma at all time points, with a maximum at 15 hours (1.5 ng/mg wet weight), where after plasma levels decrease (Fig. 3). In comparison, we tested the plasma levels in a limited number of mice (4) after IV injection of 0.15 mg/kg Foslip[®]. The mean maximal plasma level reached was 1.21 ng/mg wet weight, although the total amount of mTHPC was ten times less (0.00375 mg) as compared to IT (0.0375 mg).

Fluorescence Microscopy

mTHPC fluorescence in excised tumors, assessed by macrofluorescence, is inhomogeneous at all time points, and extremely weak at short intervals (Fig. 4). Fluorescence

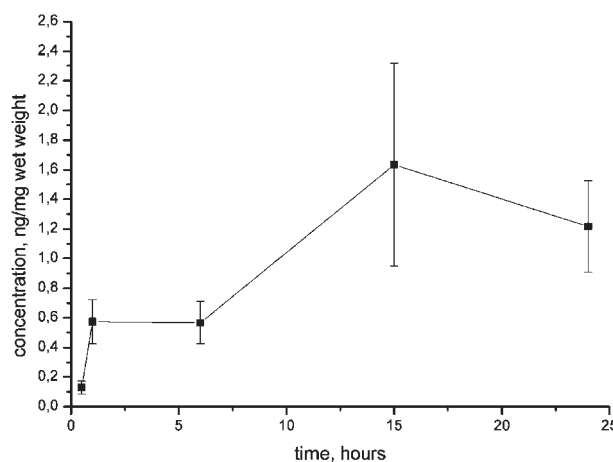

Fig. 3. Plasma profiles of mTHPC assessed by HPLC in function of time after IT injection of 25 μ l Foslip[®] (0.15 mg/ml).

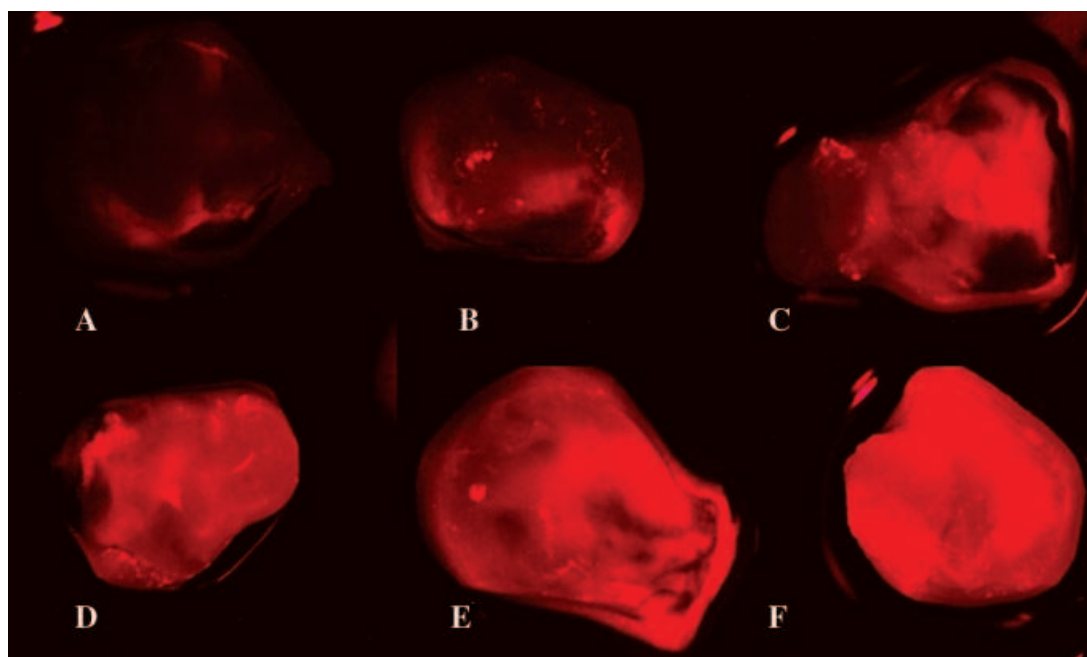

Fig. 4. Fluorescence following IT administration of 25 μ l Foslip[®] (1.5 mg/ml) at (A) 30 minutes, (B) 1 H, (C) 3 H, (D) 6 H, (E) 15 H and (F) 24 H. Exposure time 630 ms, gain 10 \times , objective 1 \times , zoom 0,57.

gradually increases and is maximal, although still inhomogeneous at 24 hours post-IT injection of Foslip.

Polarization Studies

In order to explain changes in the intratumoral mTHPC fluorescence pattern, we performed model studies of mTHPC redistribution, using a fluorescence polarization technique. Fluorescence of a fluorophore bound to biological structures is polarized due to mobility restrictions. Fluorescence polarization of mTHPC in lipid vesicles is strongly dependent on the lipid to dye ratio (M_l/M_d) as shown in Figure 5A. Maximal polarization is obtained at M_l/M_d of 1000 with a value of >0.28 , thus indicating a strong fixation of the sensitizer molecules in lipid bilayer. M_l/M_d ratios below this value lead to progressive depolarisation of fluorescence by a factor 2 for M_l/M_d of 200 whereas this value does not exceed 0.05 for Foslip with an M_l/M_d ratio of 10. This interrelationship can be used to obtain information related to sensitizer redistribution. With this purpose, the Foslip suspension was incubated during 24 hours at 37 $^{\circ}$ C with an excess of DPPC liposomes and fluorescence polarization was registered at the selected times (Fig. 5B). Polarization increased slowly with incubation time, thus pointing out to a slow transfer of lipid-based mTHPC to non-loaded liposomes.

DISCUSSION

One of the first photodynamic treatments dates from a century ago when Jesionek and von Tappeiner treated patients suffering from various skin diseases with intra-

lesional or topical eosin and light [14]. PDT, following direct intratumoral injection, failed however to produce total cures, independent of the photosensitizer used. Direct delivery of aluminium phthalocyanines or meso-tetra(4-*N*-methylpyridinium)porphine only resulted in delaying tumor growth by 1 month, even when repeated PDT sessions were applied [15,16]. In a comparative study between IP and IT delivery of HpD, Lin et al. noticed identical killing effect, although the concentration of HpD was four to five times higher following IT injection [17]. They attributed this PDT resistance to the absence of vascular events. Identical absence of vascular involvement was observed in orthotopic brain tumors in rats as well as in patients [18,19]. In the present study, necrosis is most prominent in the center of the tumor (Fig. 1) and is associated with hemorrhage, indicating a certain amount of vascular effects. This is clearly due to progressive reabsorption into the bloodstream rather than direct accidental intravenous injection, since plasma pharmacokinetics indicate increasing mTHPC amounts up to 15 hours (Fig. 3). The absence of total cures in our study is thus probably rather related to the inhomogeneous drug distribution and consecutive inhomogeneous necrosis pattern.

Very little is known about photosensitizer distribution following intratumoral injection. In the present study, fluorescence is very inhomogeneous, and most prominent at the periphery of the tumor, although injection has been aimed at the center of the nodule. Gupta et al. have investigated the distribution of antibody conjugated and

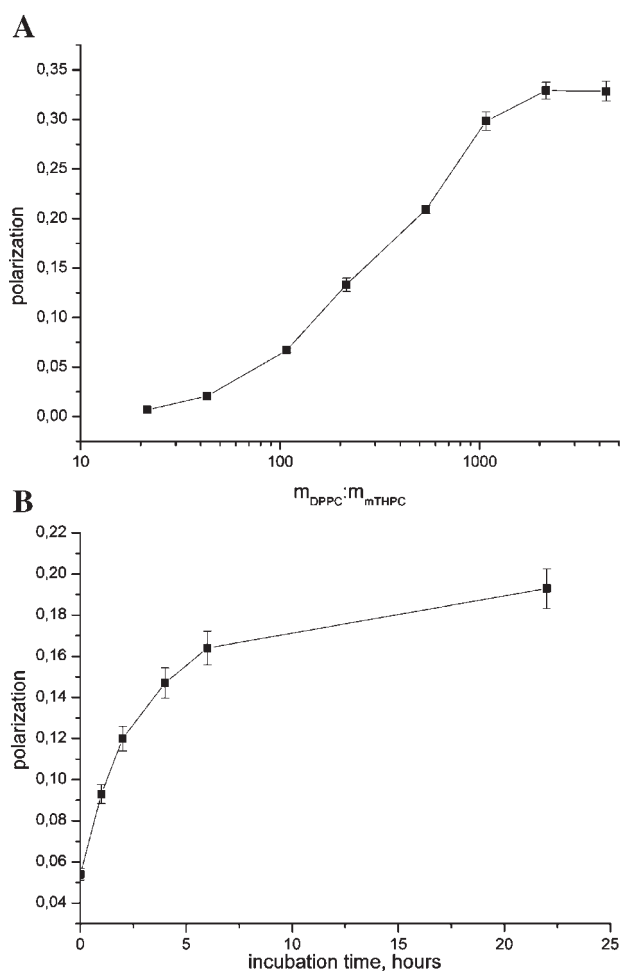

Fig. 5. **A:** Polarization of mTHPC fluorescence according to liposomal DPPC/mTHPC ratio ($M_{\text{DPPC}}:M_{\text{mTHPC}}$) $\lambda_{\text{ex}} = 435$ nm, $\lambda_{\text{em}} = 650$ nm. **B:** Fluorescence polarization of Foslip incubated in non-loaded DPPC liposomes at 37°C ($\lambda_{\text{ex}} 435$ nm, $\lambda_{\text{em}} 650$ nm, mTHPC concentration 4×10^{-7} M).

radiolabeled HpD in a subcutaneous murine tumor model [20]. Following injection close to the tumor implantation site, scintigraphic images show that radioactivity is limited to the tumor for the first two hours, with the highest signal in the central zone, where after it progressively diffuses to neighboring healthy tissue. HpD fluorescence was also investigated in an orthotopic gliosarcoma model [21]. The percentage of fluorescence observed within the tumor increased with increasing injection volume (at identical drug concentrations), and time after injection (from 1 hour to 5 days) but never reached complete sensitisation (<60%). From their study it also appeared that the injection site is very important since a central positioning of the needle tip resulted in a larger fluorescence volume than an injection within a 1 mm distance from the tumor rim. Although the topography of the fluorescence was not investigated,

coronal sections of the brain 48 hours post-PDT, revealed a very inhomogeneous necrosis pattern, comparable to the one observed in our study [18].

The formulation of a photosensitizer is of utmost importance with regard to its biodistribution. Incorporation of various photosensitizers into liposomes has been shown to increase drug uptake as well as tumor eradication [22]. Recently, a new liposomal formulation of mTHPC (Fospeg) was tested in cats with spontaneous occurring cutaneous squamous cell carcinoma [12]. Upon IV administration, a reduced distribution half-life was noted, together with increased fluorescence in the tumor as well as increased tumor to normal ratios, occurring at the time of maximal tumor fluorescence. Another interesting aspect of liposomal drug delivery resides in the fact that photosensitizers are monomerized, which has been shown to lead to enhanced oxygen consumption and reduced cell survival [23]. The initial working hypothesis for the current study was that direct intratumoral injection of liposomal, thus monomerized mTHPC, would make it possible to reduce the drug light interval. As shown in Figure 2 however, highest tumor eradication is obtained after 24 hours, time point where maximal fluorescence intensities are observed (Fig. 4).

A possible explanation could be that within liposomes, a phenomenon of concentration quenching occurs, which reduces fluorescence emission. The molar lipid/mTHPC ratio in Foslip is about 10 and considering an average phospholipid molecules surface of 60 \AA^2 , we can anticipate a high local mTHPC concentration in a lipid bilayer (about 0.11 M) and consecutive fluorescence quenching [24]. A strong concentration-induced fluorescence quenching was reported earlier for liposomal formulations of benzoporphyrin derivative (BPD-MA, verteporfin) *in vitro* [25]. Restoration of fluorescence occurred after several minutes due to the rapid transfer of the drug to serum proteins [25]. The rate transfer of the lipid-based mTHPC formulation used in the present study was evaluated with fluorescence polarization, which can be applied to investigate transfer of a dye to liposomes, acting as a model for cellular membranes. Maximal mTHPC fluorescence polarization was obtained at 24 hours incubation in an excess of DPPC liposomes (Fig. 5B), thus suggesting that at this time point mTHPC has migrated from its lipid-based formulation to non-loaded liposomes. This relatively low rate of redistribution of mTHPC to lipids has been shown previously [26]. We also conducted polarization studies of Foslip in fetal calf serum in function of incubation time, which demonstrated a similar kinetic behavior (data not shown). This slow rate of mTHPC transfer is consistent with the progressive increase in fluorescence intensity observed in Figure 4. It also correlates with the best efficacy observed at the 24 hours time point (Fig. 2). Indeed, due to the short lifetime of singlet oxygen (170–330 ns) and consecutive limited distance of diffusion (50 nm), mTHPC has to be incorporated into the cell to produce a cytotoxic effect [27].

Phase I–II PDT trials for chest wall recurrence of breast cancer have been described previously for systemically

administered photosensitizers such as Photofrin or mono-L-aspartyl chlorin e6 [4,28–30]. Since series are small and different light and drug doses have been applied, only general trends can be highlighted. The best results are obtained with small nodular disease. The quality of the post-necrosis skin healing is very important with regard to the patients having previously been irradiated after surgery. The balance between limited damage to non-cancerous tissue and tumor cure is very delicate and one has to reduce drug dose as much as possible and concomitantly increase a light maximally to induce photobleaching of surrounding skin, while effectively inducing necrosis of the recurrence. In a vast majority, the patients showed only partly cures and complete response, when observed, were rather short lived (2.5–12 months). From the present study, it appears that complete response is not to be expected after a single IT sensitization in humans. The advantage of IT over IV PDT however is that generalized skin sensitization will be minimal. We have observed comparable maximal mTHPC plasma levels (± 1 ng/mg tissue weight) following IV or IT administration of Foslip, although the total amount of drug was one order of magnitude higher in case of IT administration in mice. Furthermore, the dilution factor in humans will be at least three orders of magnitudes higher than in mice, which will result in an extreme low final total amount of circulating mTHPC. Local skin toxicity, in patients with already compromised skin conditions, can thus be expected to be extremely reduced, as was observed in our mice series. Repeated PDT with intratumoral injections could thus be envisaged with minimal inconvenience for patients suffering from subcutaneous breast cancer metastases.

ACKNOWLEDGMENTS

We thank Biolitec AG for providing Foslip and the French Cancer Foundation “Ligue Contre le Cancer” for funding the study.

REFERENCES

- Boyle P. Breast cancer control: Signs of progress, but more work required. *Breast* 2005;14:429–438.
- Chao C, Torosian MH, Boraas MC, Sigurdson ER, Hoffman JP, Eisenberg BL, Fowble B. Local recurrence of breast cancer in the stereotactic core needle biopsy site: Case reports and review of the literature. *Breast J* 2001;7:124–127.
- Uriburu JL, Vuoto HD, Cogorno L, Isetta JA, Candas G, Imach GC, Bernabo OL. Local recurrence of breast cancer after skin-sparing mastectomy following core needle biopsy: Case reports and review of the literature. *Breast J* 2006;12:194–198.
- Allison R, Mang T, Hewson G, Snider W, Dougherty D. Photodynamic therapy for chest wall progression from breast carcinoma is an underutilized treatment modality. *Cancer* 2001;91:1–8.
- Dougherty TJ. Photodynamic therapy. *Clin Chest Med* 1985;6:219–236.
- Peng Q, Warloe T, Moan J, Heyerdahl H, Steen HB, Nesland JM, Giercksky KE. Distribution of 5-aminolevulinic acid-induced porphyrins in noduloulcerative basal cell carcinoma. *Photochem Photobiol* 1995;62:906–913.
- Amano T, Prout GR Jr, Lin CW. Intratumor injection as a more effective means of porphyrin administration for photodynamic therapy. *J Urol* 1988;139:392–395.
- Kostron H, Bellnier DA, Lin CW, Swartz MR, Martuza RL. Distribution, retention, and phototoxicity of hematoporphyrin derivative in a rat glioma. Intraneoplastic versus intraperitoneal injection. *J Neurosurg* 1986;64:768–774.
- Steichen JD, Dashner K, Martuza RL. Distribution of hematoporphyrin derivative in canine glioma following intraneoplastic and intraperitoneal injection. *J Neurosurg* 1986;65:364–369.
- Mitra S, Foster TH. Photophysical parameters, photosensitizer retention and tissue optical properties completely account for the higher photodynamic efficacy of meso-tetrahydroxyphenyl-chlorin vs Photofrin. *Photochem Photobiol* 2005;81:849–859.
- Lasic DD, Martin FJ, Gabizon A, Huang SK, Papahadiopoulos D. Sterically stabilized liposomes: a hypothesis on the molecular origin of the extended circulation times. *Biochim Biophys Acta* 1991;1070:187–192.
- Buchholz J, Wergin M, Walt H, Grafe S, Kaser-Hotz B. Photodynamic therapy of feline cutaneous squamous cell carcinoma using a newly developed liposomal photosensitizer: Preliminary results concerning drug safety and efficacy. *J Vet Intern Med* 2007;21:770–775.
- Buchholz J, Kaser-Hotz B, Khan T, Rohrer Bley C, Melzer K, Schewendener RA, Roos M, Walt H. Optimizing photodynamic therapy: in vivo pharmacokinetics of liposomal meta-(tetrahydroxyphenyl)chlorin in feline squamous cell carcinoma. *Clin Cancer Res* 2005;11:7538–7544.
- Jesionek A, von Tappeiner H. Die behandlung des hautkarzinome mit fluoreszierende stoffen. *Arch Klein Med* 1905;82:72–76.
- Orth K, Russ D, Beck G, Ruck A, Beger HG. Photodynamic therapy of experimental colonic tumours with intra-tumorally applied methylene blue. *Langenbecks Arch Surg* 1998;383:276–281.
- Colombo LL, Vanzulli SI, Villanueva A, Canete M, Juarranz A, Stockert JC. Long-term regression of the murine mammary adenocarcinoma, LM3, by repeated photodynamic treatments using meso-tetra (4-N-methylpyridinium) porphine. *Int J Oncol* 2005;27:1053–1059.
- Lin CW, Amano T, Rutledge AR, Shulok JR, Prout GR Jr. Photodynamic effect in an experimental bladder tumor treated with intratumor injection of hematoporphyrin derivative. *Cancer Res* 1988;48:6115–6120.
- Hebeda KM, Wolbers JG, Sterenberg HJ, Kamphorst W, van Gemert MJ, van Alphen HA. Fluorescence localization in tumour and normal brain after intratumoral injection of haematoporphyrin derivative into rat brain tumour. *J Photochem Photobiol B* 1995;27:85–92.
- Kostron H, Weiser G, Fritsch E, Grunert V. Photodynamic therapy of malignant brain tumors: Clinical and neuropathological results. *Photochem Photobiol* 1987;46:937–943.
- Gupta S, Mishra AK, Muralidhar K, Jain V. Improved targeting of photosensitizers by intratumoral administration of immunoconjugates. *Technol Cancer Res Treat* 2004;3:295–301.
- Hebeda KM, Kamphorst W, Sterenberg HJ, Wolbers JG. Damage to tumour and brain by interstitial photodynamic therapy in the 9L rat tumour model comparing intravenous and intratumoral administration of the photosensitizer. *Acta Neurochir (Wien)* 1998;140:495–501.
- Lilge L, Wilson BC. Photodynamic therapy of intracranial tissues: A preclinical comparative study of four different photosensitizers. *J Clin Laser Med Surg* 1998;16:81–91.
- Damoiseau X, Schuitmaker HJ, Lagerberg JW, Hoebeke M. Increase of the photosensitizing efficiency of the Bacteriochlorin a by liposome-incorporation. *J Photochem Photobiol B Biol* 2001;60:50–60.
- MacDonald RC, Simon SA. Lipid monolayer states and their relationships to bilayers. *Proc Natl Acad Sci* 1987;84:4089–4093.

25. Chowdhary RK, Dolphin D. Drug release characteristics of lipid based benzoporphyrin derivatives. *J Pharm Pharmaceut Sci* 2003;6:13–19.
26. Sasnouski S, Kachatkou D, Zorin V, Guillemin F, Bezdetnaya L. Redistribution of Foscan from plasma proteins to model membranes. *Photochem Photobiol Sci* 2006;5:770–777.
27. Moan J, Berg K. The photodegradation of porphyrins in cells can be used to estimate the lifetime of singlet oxygen. *Photochem Photobiol* 1991;53:549–553.
28. Sperduto PW, Delaney TF, Thomas G. Photodynamic therapy for chest wall recurrence in breast carcinoma. *Int J Radiat Oncol Biol Phys* 1991;21:441–446.
29. Khan SA, Dougherty TJ, Mang TS. An evaluation of photodynamic therapy in the management of cutaneous metastases of breast cancer. *Eur J Cancer* 1993;29:1686–1690.
30. Taber SW, Fingar VH, Coots CT, Wieman TJ. Photodynamic therapy using mono-L aspartyl chlorin e₆ (Npe6) for the treatment of cutaneous disease: A phase I clinical study. *Clin Cancer Res* 1998;4:2741–2746.

X GENERAL DISCUSSION

Liposomes have been studied for many years as carrier systems for drugs (Storm and Crommelin, 1998) with advantages such as enhancement of therapeutic efficacy at low dosage, reduction in toxicity of the encapsulated agent, improved pharmacokinetic profiles and targeting to tumour tissues. Also an increased stability of the drug has been mentioned, particularly against enzymatic degradation (Fielding, 1991; Gregoriadis, 1991; Xian-rong *et al.*, 1995).

Because of their characteristic small size (between 40 and 100 nm), good solubilization efficiency and stability, liposomes may represent an ideal delivery system for apolar PDT drugs. Incorporation into lipid vesicles allows to maintain a monomeric state for many tetrapyrrolic sensitizers, providing a high photosensitizing activity. An additional advantage of such systems is the phenomenon of passive targeting, which is based on enhanced liposomal permeability through discontinuous tumor microvasculature. In this perspective, meta-tetra(hydroxyphenyl)chlorine (mTHPC) has been loaded into lipid vesicles. The resulting compounds, like Foslip, were recently tested in different xenografted tumors and demonstrated favourable pharmacokinetic properties, which consisted in a better tumor/healthy tissue selectivity and a rapid plasma clearance (Svensson *et al.*, 2007; Lassalle *et al.*, 2009; Buchholz *et al.* 2005).

Lipid-based photosensitisers have several peculiarities, related to specific environmental factors like low polarity, high viscosity and increased local oxygen concentration (Fischkoff and Vanderkooi, 1975). In lipid-based formulations, the hydrophobic dye is mostly restricted to the lipid phase (Lavi *et al.*, 2002; Bronshtein *et al.*, 2004), yielding a high local concentration and as such suggesting strong interactions between sensitizer molecules in a limited intramembrane space. Despite a considerable amount of papers attesting the physical mechanisms of photosensitiser action in lipid bilayers, there are only few observations on the contribution of these interactions to specific photochemical and photobiological properties of the photosensitiser. A concentration-dependent fluorescence quenching was previously reported for liposomes-embedded benzoporphyrin derivative mono-acid ring A (BPDMA, vertoporphin) (Chowdhary and Dolphin, 2003). Therefore, any observable spectral modifications of lipid-based dye formulations should be interpreted with caution.

The first part of the study focuses on the photophysical properties of mTHPC encapsulated into conventional liposomes (Foslip). Because of the intramembraneous mTHPC localization in

liposomes, spectral properties of Foslip in DPBS are similar to those in mTHPC ethanol solution, thus indicating a monomeric state of the sensitizer (Kachatkou *et al.* 2009). We did not observe significant concentration quenching effects for innate Foslip formulations since estimated fluorescence loss due to concentration effects was less than 30%. The molar ratio of DPPC:mTHPC in Foslip is about 10, the average radius of a liposome is approximately 60 nm and the reported average area per phospholipid molecule in a bilayer is 53\AA^2 (MacDonald and Simon, 1987). We can thus calculate that the local mTHPC concentration in liposomes is approximately 0.1 M since due to the hydrophobic nature of mTHPC, the sensitizer localizes inside the hydrophobic area of the bilayer (Kępczyński *et al.*, 2002). Therefore the average distance between mTHPC molecules (*ca.* 2.6 nm) is approximately two times less than the calculated Förster radius ($R_0 = 5.4$ nm). This implies a high probability of energy migration between neighboring mTHPC molecules, which are embedded in the lipid bilayer. Our experiments on mTHPC concentration-dependent anisotropy confirm this proposal. Anisotropy of lipid-based mTHPC fluorescence strongly depends on the local sensitizer concentration with a complete depolarization at the highest mTHPC concentrations (Kachatkou *et al.* 2009). The high values of fluorescence anisotropy together with relatively long fluorescence lifetimes when dealing with vesicles with a low local mTHPC concentration, certify a rigid fixation of the mTHPC molecules in the lipid bilayer. A dramatic decrease in fluorescence anisotropy with increasing local mTHPC concentrations is a consequence of an energy migration process and presumes strong interactions between mTHPC molecules. Direct Förster energy transfer between monomeric species at high local dye concentrations was already established by fluorescence depolarization studies with other dyes and appeared to be a major factor in fluorescence quenching of fluorophores at high concentrations (Frolov and Zenkevich, 1990; Chen and Knutson, 1988).

The absorption of visible light by photosensitizer causes different photophysical events, including self-sensitized oxidation and the process of photobleaching (photodegradation). Bonnett and Martinez (Bonnett and Martinez, 2001) divided photobleaching into two different types: true photobleaching and photomodification. In the case of true photobleaching chemical changes are deep-seated and result in destruction of the photosensitizer into small fragments that no longer have appreciable absorption in the visible region. When photomodification takes place, a loss of absorbance or fluorescence occurs at some wavelengths, but the chromophore remains,

albeit in a modified form. Photobleaching with different photosensitisers is usually described as the main source of light-induced fluorescence loss. These spectral modifications could be a consequence of photoinduced aggregation (Belitchenko *et al.*, 1998) or photoinduced intracellular PS re-localisation (Moan *et al.*, 1997). Another pathway for light-induced fluorescence changes could be offered if we consider an intensive energy migration processes between closely-located photosensitiser molecules. Foslip exposure to small light doses ($<50 \text{ mJ/cm}^2$) leads to a substantial reduction of mTHPC fluorescence intensity by 90% (Kachatkou *et al.* 2009). Restoration of fluorescence to the level of pre-irradiated samples after Foslip destruction with neutral detergents, suggests that the rapid drop of fluorescence at the onset of illumination is only due to mTHPC localised inside lipid vesicles. This effect of photoinduced fluorescence quenching is supposedly related to the formation of mTHPC photoproducts, which in the case of high local dye concentration effectively quench mTHPC fluorescence, thus acting as excitation energy traps. Indeed, theoretical considerations (Goc *et al.*, 1996; Lin *et al.*, 2008) suggest that accumulation of a small percentage of weakly fluorescent products under the condition of a high local mTHPC concentration in the lipid vesicle, could lead to fluorescence quenching of the whole population of intact mTHPC molecules in a process of migration of excitation energy to the quenching centers. The nature of the photoproducts needs to be clarified and HPLC seems to be the most appropriate for this purpose.

Based on the observed unusual behavior of Foslip upon irradiation, referred as photoinduced quenching, we can reasonably assume a new pathway of photodegradation related to specific interactions between photosensitiser molecules in the lipid bilayer. It remains to be determined whether this behavior pattern is common to other sensitizers embedded in liposomes.

The second part of this work addresses the kinetics of re-distribution of mTHPC from Foslip to plasma proteins using the techniques of photoinduced fluorescence quenching and gel-filtration chromatography.

The information on the time necessary to establish equilibrium dye distribution between donor-acceptor structures is extremely important since it provides valuable indications to optimal pharmacokinetic parameters. In the blood circulation, the situation with liposomal embedded photosensitisers is more complex because of the additional factors influencing liposomal lifetimes. In fact, conventional liposomes have been shown to have extremely short lifetimes in blood, in the order of minutes (Lasic *et al.*, 1991). This is probably due to phagocytosis by the

reticular endothelial system and/or their opsonization by plasma proteins with successive redistribution of the drug (Senior, 1987; Patel, 1992; Devine *et al.*, 1994; Chonn *et al.*, 1995; Devine and Marjan, 1997). As a result, in human blood serum, a relatively rapid distribution of liposomal drugs between plasma proteins, preferentially lipoproteins, is reached. The nature of photosensitizer incorporated into conventional liposomes may also play a role in liposomal stability in plasma. Different studies demonstrated that the drug lipophilicity, its location and charge affect stability of the liposomes (Khan *et al.*, 2008; Nounou *et al.*, 2006; Lostritto *et al.*, 1987; Silvestri *et al.*, 1992). Therefore we further studied the rate of mTHPC redistribution from Foslip to plasma components for the characterization of the redistribution processes and for evaluation of the stability of liposomal mTHPC formulations against membrane-protein and membrane-membrane interactions.

As indicated by our results, Foslip-induced mTHPC redistribution in human plasma measured at 37°C by photoinduced quenching, reaches a plateau at 6h after Foslip administration. The rate of distribution is very close to the one observed with an excess of dye-free liposomes. Based on this fact, we assume that processes of re-distribution of Foslip-induced mTHPC in plasma solution cannot be only due to liposomal destruction. We suppose that a delay of at least 6 h is required for mTHPC re-distribution on plasma proteins, leading to a considerable decrease in local photosensitizer concentration within the lipid membrane. This long time span was anticipated considering the unusual aptitude of mTHPC to be sequestered in biological substrates (Hopkinson *et al.*, 1999; Mitra and Foster 2005). The redistribution process strongly correlated to the temperature of incubation with a dramatic increase in redistribution rate in the temperature interval from 5 to 50°C. On the opposite we registered a weak dependence of distribution rate on serum concentrations. A serum concentration increase by one order (from 5 to 50%) was accompanied by less than 5% increase in distribution rate. Data obtained from the studies of the influence of temperature and serum concentration on Foslip-induced mTHPC distribution rates allow to draw some conclusions on the thermodynamic parameters of the studied system. In general, photosensitizer redistribution from lipid vesicles may proceed from water phase or due to contact interactions of drug-loaded liposomes with plasma proteins (Jones and Thompson, 1989; Steck *et al.* 1988; McLean and Philips, 1981; Lange *et al.*, 1983; Schulthess *et al.*, 1994). In the first case, the rate of sensitizer release is determined by the kinetic constant of the molecules desorption from the lipid bilayer and as a matter of fact weakly depends on the concentration of

acceptor structures. In the second case, the redistribution of photosensitizer molecules takes place mainly due to collision between Foslip and plasma proteins. This process can occur simultaneously or independently from the destruction of the lipid vesicles (Hunta, 1982). In our case it appears that for Foslip-induced mTHPC at temperatures above 30°C, the aqueous phase distribution is favored.

It should be noted that the results of our *in vitro* study of mTHPC redistribution can be compared to *in vivo* studies. Indeed, recently Lassalle *et al.* (Lassalle *et al.*, 2009) investigated Foslip behavior and photodynamic efficiency in EMT6 xenografted nude mice at different time intervals following i.v. administration of Foslip and demonstrated that the highest tumor to muscle ratios were observed at 6h and 15h post administration with the best tumor response at identical drug-light intervals. From our study, it appears that long intervals (3 to 15 hours) are needed, in order to obtain migration from the active component to plasma proteins and destruction of the liposomal structure. During the first hours following IV administration, we can assume that passive targeting occurs due to leakage from the liposomes to the tumor tissue, followed by progressive release of mTHPC from liposomes to the lipoprotein components of the cellular membranes.

The third part of our work was attributed to the application and comparison of our *in vitro* data to the *in vivo* study of intratumoral Foslip injection in a mouse model of breast cancer recurrence. The initial working hypothesis for this study was that direct intratumoral injection of liposomal, thus monomerized mTHPC, would make it possible to reduce the drug light interval. However, highest tumor eradication was obtained after 24 hours, time point coinciding with maximal fluorescence intensity of the tumor.

A possible explanation of the very weak tumoral fluorescence observed the first hours after intratumoral Foslip injection could be that at this time points, mTHPC molecules are still strongly fixed in the lipid membranes of the liposomes. Following illumination in order to obtain fluorescence imaging, fluorescence quenching occurs, which significantly reduces fluorescence emission. Restoration of fluorescence occurred after several hours due to the transfer of the drug from the liposomal membranes to the tumor tissue, thus lowering the average local mTHPC concentration. The rate transfer of the lipid-based mTHPC formulation in this part of the work was evaluated using fluorescence polarization, which was applied to investigate transfer of the dye to liposomes, acting as a model for cellular membranes. Maximal mTHPC fluorescence

polarization was obtained at 24 hours incubation in an excess of DPPC liposomes thus suggesting that at this time point mTHPC has migrated from its lipid-based formulation to non-loaded liposomes. These *in vivo* results are coherent with our previous *in vitro* studies. They are compatible with the highest PDT efficacy since singlet oxygen, with a very short life times (170–330 ns) (Moan and Berg, 1991) and thus limited diffusion possibility (50 nm) (Moan and Berg, 1991) must be produce in the close vicinity of organelle whose destruction will induce cellular death, in our case cellular membranes.

XI CONCLUSIONS AND PERSPECTIVES

Foslip solution upon irradiation revealed unusual properties consisting in a substantial reduction of mTHPC fluorescence intensity with a successive restoration of fluorescence to the level of non irradiated samples after liposomal destruction with detergents. This phenomenon was referred to as Photoinduced Fluorescence Quenching (PFQ). The PFQ is supposedly related to the formation of mTHPC photoproducts, which in the case of high local dye concentration effectively quench mTHPC fluorescence, thus acting as excitation energy traps.

Perspectives: -

- Identification of mTHPC photoproducts in irradiated Foslip solutions by HPLC technique along with the nature of photoproduct(s) responsible for PFQ.
- Study the phenomenon of PFQ for other types of liposomal photosensitisers
- Development of a theoretical model for predicting this effect.
- Development of light-sensible nanoparticles for nanotechnological applications.

Photoinduced fluorescence quenching together with polarization techniques and liquid chromatography was successfully applied for estimating the redistribution rate of mTHPC molecules from liposomes to plasma proteins and lipid membranes. The time required for mTHPC re-distribution on plasma proteins was estimated to be approximately 6 hours. Thermodynamic considerations supposed a predominance of the aqueous phase distribution for Foslip-induced mTHPC at physiological temperatures.

Perspectives:

- Comparison of the kinetic parameters of Foslip-induced mTHPC distribution with those of Fospeg (mTHPC in pegylated liposomes) to estimate the influence of PEGylation on the mTHPC redistribution rate. Sterical stabilization of liposomes should increase their stability, but it can significantly change the pattern of mTHPC leakage from lipid vesicles.
- Exact location of Foslip and Fospeg induced mTHPC in phospholipid bilayer could be determined, for instance, by studying UV-Vis linear dichroism or by parallax fluorescence quenching method.

Foslip liposomes were shown to be stable in human blood serum for at least 3 hours. Such unusually increased stability could be attributed to high sequestering of mTHPC into lipid bilayer. Inclusion of high quantities of highly hydrophobic molecules into lipid bilayer may affect its structure and whole stability.

Perspectives

- Studies of the effect of photosensitizer inclusion into lipid bilayer on the liposomal stability will allow to verify this hypothesis. It could be achieved, for instance, by chromatography of suspensions of liposomes with different lipid/dye ratios after incubation in human blood serum.

mTHPC distribution after intratumoral Foslip injection in a model of breast cancer recurrence revealed a progressive increase in fluorescence with increasing post-injection time. The Foslip-induced mTHPC distribution from liposomes to tissue structures results in a decrease in local mTHPC concentration and as such could explain the fluorescence increase. This increased fluorescence corresponded to the maximal photodynamic activity, related to the better availability of mTHPC for target tissues.

Perspectives:

- Studying the interactions between Foslip vesicles and tumor cells in order to characterize the processes taking place *in vivo* after i.t. injection of Foslip or after accumulating of i.v. injected liposomes in tumor tissue due to “enhanced permeability-retention” phenomena. This will make possible to predict the fate of liposomes in tumor tissue and to optimize methods of Foslip delivery in photodynamic therapy.

REFERENCES

- Abós P., Artigas C., Bertolotti S., Braslavsky S.E., Fors P., Lang K., Nonell S., Rodriguez F.J., Sesé M.L., Trull F.R., 1997, Polymer-bound pyrrole compounds, IX. Photophysical and singlet molecular oxygen photosensitizing properties of mesoporphyrin IX covalently bound to a low molecular weight polyethylene glycol. *J. Photochem. Photobiol. B: Biol.* 41: 53–59.
- Abra R.M. and Hunt C.A., 1981, Liposome disposition *in vivo*. III. Dose and vesicle-size effects. *Biochim. Biophys. Acta* 666: 493-503.
- Ahl P.L., Bhatia S.K., Meers P., Roberts P., Stevens R., Dause R., Perkins W.R. and Janoff A.S., 1997, Enhancement of the *in vivo* circulation lifetime of L- α -distearoylphosphatidylcholine liposomes: Importance of liposomal aggregation versus complement opsonization. *Biochim. Biophys. Acta* 1329: 370-382.
- Akins, D.L., Zhu H., Guo C., 1996, Aggregation of tetraarylsubstituted porphyrins in homogeneous solution. *J. Phys. Chem.* 100: 5420–5425.
- Albon, N. and Sturtevant, J.M., 1978, Nature of gel to liquid crystal transition of synthetic phosphatidylcholines. *Proc. Natl. Acad. Sci. USA* 75(5): 2258-2260.
- Allen T.M., 1994, Long-circulating (sterically stabilized) liposomes for targeted drug delivery, *TIPS* 15: 215– 220.
- Allen T.M. and Chonn A., 1987, Large unilamellar liposomes with low uptake into the reticuloendothelial system. *FEBS Lett.* 223: 42-46.
- Allen T.M. and Hansen C., 1991, Pharmacokinetics of stealth versus conventional liposomes: Effect of dose. *Biochim. Biophys. Acta* 1068: 133-141.
- Allen T.M., Hansen C.B. and Lopes de Menezes D.E., 1995, Pharmacokinetics of long-circulating liposomes. *Adv. Drug Del. Rev.* 16: 267-284.
- Allen T.M., Hansen C., Martin F., Redemann C. and Yau-Young A., 1991, Liposomes containing synthetic lipid derivatives of poly(ethylene glycol) show prolonged circulation half-lives *in vivo*. *Biochim. Biophys. Acta* 1066: 29-36.
- Allen T.M., Lopes de Menezes D., Hansen C.B., Moase E.H., Stealth liposomes for the targeting of drugs in cancer therapy, in: McC. Gregoriadis (Ed.), Targeting of Drugs 6: Strategies for Stealth Therapeutic Systems, Plenum, New York, 1998, 61– 75.

- Allen T.M., T. Mehra, C. Hansen and Y.C. Chin, 1992, Stealth liposomes: An improved sustained release system for 1- β -D-arabinofuranosylcytosine. *Cancer Res.* 52: 2431-2439.
- Allison B.A., P.H. Pritchard, A.M. Richter and J.G. Levy, 1990, The plasma distribution of benzoporphyrin derivative and the effects of plasma lipoproteins on its biodistribution. *Photochem. Photobiol.* 52: 501-507
- Angeli N.G., Lagorio M.G., San Roman E.A., Dixelio L.E., 2000, Meso-substituted cationic porphyrins of biological interest. Photophysical and physicochemical properties in solution and bound to liposomes. *Photochem. Photobiol.* 72: 49-56.
- Angotti M., Maunit B., Muller J.F., Bezdetnaya L., Guillemin F., 1999, Matrix-assisted laser desorption/ionization coupled to Fourier transform ion cyclotron resonance mass spectrometry: a method to characterize temoporfin photoproducts. *Rapid Commun. Mass Spectrom.* 13: 597-603.
- Angotti M., Maunit B., Muller J.F., Bezdetnaya L., Guillemin F., 2001, Characterization by matrix-assisted laser desorption/ionization Fourier transform ion cyclotron resonance mass spectrometry of the major photoproducts of temoporfin (m-THPC) and bacteriochlorin (m-THPBC). *J. Mass. Spectrom.* 36: 825-831.
- Auler H., Banzer G., 1942, Untersuchungen über die Rolle der Porphyrine bei geschwulstkranken Menschen und Tieren. *Z. Krebsforsch.* 53: 65-68.
- Aveline B., Hasan T., Redmond R.W., 1994, Photophysical and photosensitizing properties of benzoporphyrin derivative monoacid ring A (BPD-MA). *Photochem. Photobiol.* 59: 328-335.
- Baas P., A.E. Saarnak, H. Oppelaar, H. Neering, F.A. Stewart, 2001, Photodynamic therapy with meta-tetrahydroxyphenylchlorin for basal cell carcinoma: a phase I/II study. *Br. J. Dermatol.* 145 (1): 75-78.
- Baker A., Kanofsky J.R., 1992, Quenching of singlet oxygen by biomolecules from L1210 leukemia cells. *Photochem. Photobiol.* 55: 523-528.
- Ball D. J., Mayhew S., Wood S. R., Griffiths J., Vernon D. I. and Brown S. B., 1999, A comparative study of the cellular uptake and photodynamic efficacy of three novel zinc phthalocyanines of differing charge. *Photochem. Photobiol.* 69(3): 390-6.

- Ball D. J., Vernon D. I. and Brown S. B., 1999, The high photoactivity of m-THPC in photodynamic therapy. Unusually strong retention of m-THPC by RIF-1 cells in culture. *Photochem. Photobiol.* 69(3): 360-3.
- Bally M.B., Nayar R., Masin D., Hope M.J., Cullis P.R. and Mayer L.D., 1990, Liposomes with entrapped doxorubicin exhibit extended blood residence times. *Biochim. Biophys. Acta* 1023: 133-139.
- Barenholz Y., Amselem S., Goren D., Cohen R., Gelvan D., Samuni A., Golden E.B. and Gabizon A., 1993, Stability of liposomal doxorubicin formulations: Problems and prospects. *Med. Res. Rev.* 13: 449-491.
- Belitchenko I., Melnikova V., Bezdetnaya L., Rezzoug H., Merlin J.L., Potapenko A., Guillemin F., 1998, Characterization of photodegradation of meta-tetra(hydroxyphenyl)chlorin (mTHPC) in solution: biological consequences in human tumor cells. *Photochem. Photobiol.* 67: 584-590.
- Bellnier D. A., Henderson B. W., Pandey R. K., Potter W. R. and Dougherty T. J., 1993, Murine pharmacokinetics and antitumor efficacy of the photodynamic sensitizer 2-[1-hexyloxyethyl]-2-devinyl pyropheophorbide-a. *J. Photochem. Photobiol. B* 20(1): 55-61.
- Berenbaum M.C., Akande S.L., Bonnett R., Kaur H., Ioannou S., White R.D., Winfield U.J., 1986, Meso-Tetra(hydroxyphenyl)porphyrins, a new class of potent tumour photosensitisers with favourable selectivity. *Br. J. Cancer.* 54: 717-725.
- Bezdetnaya L., Zeghari N., Belitchenko I., Barberi-Heyob M., Merlin J.L., Potapenko A., Guillemin F., 1996, Spectroscopic and biological testing of photobleaching of porphyrins in solutions. *Photochem. Photobiol.* 64: 382-386.
- Blum A. and Grossweiner L.I., 1985, Singlet oxygen generation by hematoporphyrin IX, Uroporphyrin I and hematoporphyrin derivative at 546 nm in phosphate buffer and in the presence of egg phosphatidylcholine liposomes. *Photochem. Photobiol.* 41: 27-32.
- Boyle, R.W., D. Dolphin, 1996. Structure and biodistribution relationships of photodynamic sensitizers. *Photochem. Photobiol.* 64: 469-485.
- Bombelli C., F. Bordi, S. Ferro, L. Giansanti, G. Jori, Mancini G., C. Mazzuca, D. Monti, F. Ricchelli, S. Sennato, M. Venanzi, 2008, New cationic liposomes as vehicles of m-tetrahydroxyphenylchlorin in photodynamic therapy of infectious diseases. *Mol Pharm.* 5(4):672-9.

- Bombelli C., G. Caracciolo, P. Di Profio, M. Diociaiuti, P. Luciani, G. Mancini, C. Mazzuca, M. Marra, A. Molinari, D. Monti, L. Toccaceli and M. Venanzi, 2005, Inclusion of a photosensitiser in liposomes formed by DMPC/gemini surfactant: correlation between physicochemical and biological features of the complexes. *J. Med. Chem.* 48(15): 4882-91.
- Bonnett R., B.D. Djelal, P.A. Hamilton, G. Martinez, F. Wierrani, 1999, Photobleaching of 5,10,15,20-tetrakis(m-hydroxyphenyl)porphyrin (m-THPP) and the corresponding chlorin (m-THPC) and bacteriochlorin(m-THPBC). A comparative study. *J. Photochem. Photobiol. B* 53: 136-143.
- Bonnett R., G. Martinez, 2002, Photobleaching of compounds of the 5,10,15,20-Tetrakis(m-hydroxyphenyl)porphyrin Series (m-THPP, m-THPC, and m-THPBC). *Org. Lett.* 4: 2013-2016.
- Bonnett R., G. Martínez, 2001, Photobleaching of sensitisers used in photodynamic therapy. *Tetrahedron* report number 591 57: 9513-9547.
- Bonnett R., R.D. White, U.J. Winfield, M.C. Berenbaum, 1989, Hydroporphyrins of the meso-tetra(hydroxyphenyl)porphyrin series as tumour photosensitisers. *Biochem. J.* 261: 277-280.
- Borovkov V.V., M. Anikin, K. Wasa, Y. Sakata, 1996, Structurally Controlled Porphyrin-Aggregation Process in Phospholipid Membranes. *Photochem. Photobiol.* 63: 477-482.
- Bown S.G., A.Z. Rogowska, D.E. Whitelaw, W.R. Lees, L.B. Lovat, P. Ripley, L. Jones, P. Wyld, A. Gillams, A.W. Hatfield, 2002, Photodynamic therapy for cancer of the pancreas. *Gut.* 50 (4): 549-557.
- Brault D., 1990, Physical chemistry of porphyrins and their interactions with membranes: the importance of pH. *J. Photochem. Photobiol. B: Biol* 6:79-86.
- Brault D., C. Vever-Bizet, T. Le Doan, 1986, Spectrofluorimetric study of porphyrin incorporation into membrane models--evidence for pH effects. *Biochim. Biophys. Acta.* 857(2):238-250.
- Bronshtein I., M. Afri, H. Weitman, A.A. Frimer, K.M. Smith and B. Ehrenberg, 2004, Porphyrin Depth in Lipid Bilayers as Determined by Iodide and Parallax Fluorescence Quenching Methods and Its Effect on Photosensitizing Efficiency. *Biophys. J.* 87: 1155-1164.

- Buchholz J., B. Kaser-Hotz, T. Khan, C. Rohrer Bley, K. Melzer, R.A. Schwendener, M. Roos, H. Walt, 2005, Optimizing photodynamic therapy: *in vivo* pharmacokinetics of liposomal meta-(tetrahydroxyphenyl)chlorin in feline squamous cell carcinoma. *Clin. Cancer. Res.* 11(20):7538-44.
- Chen R. F. and J. R. Knutson, 1988, Mechanism of fluorescence concentration quenching of carboxyfluorescein in liposomes: Energy transfer to non.uorescent dimmers. *Anal. Biochem.* 172: 61–67.
- Chobanian J.V., A.R.Tall and P.I. Brecher, 1979, Interaction between unilamellar egg yolk lecithin vesicles and human high density lipoprotein. *Biochemistry* 18: 180-187.
- Chonn A., S.C. Semple and P. Cullis, 1992, Association of blood proteins with large unilamellar liposomes *in vivo*: Relation to circulation lifetimes. *J. Biol. Chem.* 267: 18759-18765.
- Chonn A., S.C. Semple and P.R. Cullis, 1995, β_2 -Glycoprotein I is a major protein associated with very rapidly cleared liposomes *in vivo*, suggesting a significant role in the immune clearance of "non-self" particles. *J. Biol. Chem.* 270: 25845-25849.
- Chowdhary R.K. and D. Dolphin, 2003, Drug release characteristics of lipid based benzoporphyrin derivatives. *J. Pharm. Pharmaceut. Sci.* 6: 13–19.
- Copper M.P., I.B. Tan, H. Oppelaar, M.C. Ruevekamp and F. A. Stewart, 2003, Metatetra(hydroxyphenyl)chlorin photodynamic therapy in early-stage squamous cell carcinoma of the head and neck. *Arch. Otolaryngol. Head Neck Surg.* 129(7): 709-11.
- Coutier S., L.N. Bezdetnaya, T.H. Foster, R.M. Parache and F.Guillemin, 2002, Effect of irradiation fluence rate on the efficacy of photodynamic therapy and tumoroxxygenation in meta-tetra (hydroxyphenyl) chlorin (mTHPC)-sensitized HT29 xenografts in nude mice. *Radiat. Res.* 158(3): 339-45.
- Cullis P.R., M.J. Hope, M.B. Bally, T.D. Madden, L.D. Mayer and D.B. Fenske, 1997, Influence of pH gradients on the transbilayer transport of drugs, lipids, peptides and metal ions into large unilamellar vesicles. *Biochim. Biophys. Acta* 1331: 187-211.
- Cunderlikova B., L. Gangeskar, J. Moan, 1999, Acid-base properties of chlorin e6: relation to cellular uptake. *J. Photochem. Photobiol. B* 53(1-3): 81-90.
- Damen J., J. Dijkstra, J. Regts and G. Scherphof, 1980, Effect of lipoprotein-free plasma on the interaction of human plasma high density lipoprotein with egg yolk phosphatidylcholine liposomes. *Biochim. Biophys. Acta* 620: 90-99.

- Damoiseau X., H.J. Schuitmaker, J.W.M. Lagerberg and M. Hoebeke, 2001, Increase of the photosensitizing efficiency of the Bacteriochlorin *a* by liposome-incorporation. *J. Photochem. Photobiol. B: Biol.* 60: 50–60.
- Das K., A. Dube, P.K. Gupta, 2005, A spectroscopic study of photobleaching of Chlorin p6 in different environments. *Dyes and Pigments* 64: 201-205.
- Davila J., A. Harriman, 1990, Photoreactions of macrocyclic dyes bound to human serum albumin. *Photochem. Photobiol.* 51: 9-19.
- de Gennes P.G., 1987, Polymers at interfaces, a simplified view. *Advances in Colloid and Interface Science* 27: 189-209.
- Derycke A.S.L. and de P.A.M. Witte, 2004, Liposomes for photodynamic therapy. *Adv. Drug Deliv. Rev.* 56: 17– 30.
- Devine D.V. and J.M.J. Marjan, 1997, The role of immunoproteins in the survival of liposomes in the circulation. *CRC Crit. Rev. Ther. Drug Carrier Syst.* 14: 105-131.
- Devine D.V., K. Wong, K. Serrano, A. Chonn and P.R. Cullis, 1994, Liposome-complement interactions in rat serum: Implications for liposome survival studies. *Biochim. Biophys. Acta* 1191: 43-51.
- Dougherty T.J., W.R. Potter, K.R. Weinshaupt, 1984, The structure of the active component of hematoporphyrin derivative, In: Andreoni, A., Cubeddu, R. (Eds.) *Porphyrins in Tumor Phototherapy*. Plenum, New-York, 23-35.
- Dragicevic-Curic N., S. Gräfe, V. A. Albrecht, Fahr, 2008, Topical application of temoporfin-loaded invasomes for photodynamic therapy of subcutaneously implanted tumours in mice: a pilot study. *J. Photochem. Photobiol. B.* 91(1):41-50.
- Dragicevic-Curic N., D. Scheglmann, V. Albrecht, A. Fahr, 2008, Temoporfin-loaded invasomes: development, characterization and *in vitro* skin penetration studies. *J. Control. Release.* 127(1):59-69.
- Drummond D.C., O. Meyer, K. Hong, D.B. Kirpotin and D. Papahadjopoulos, 1999, Optimizing Liposomes for Delivery of Chemotherapeutic Agents to Solid Tumors. *Pharm. Rev.* 51(4): 691-744.
- Edwards K., M. Johnsson M., G. Karlsson, M. Silvander, 1997, Effect of polyethyleneglycol-phospholipids on aggregate structure in preparations of small unilamellar liposomes. *Biophys. J.* 73(1):258–266.

- Ehrenberg B., Z. Malik, Y. Nitzan, 1985, Fluorescence spectral changes of hematoporphyrin derivative upon binding to lipid vesicles, *Staphylococcus aureus* and *Escherichia coli* cells. *Photochem. Photobiol.* 41(4):429–435.
- Fahr A., P. van Hoogevest, S. May, N. Bergstrand, M.L.S. Leigh, 2005, Transfer of lipophilic drugs between liposomal membranes and biological interfaces: Consequences for drug delivery. *Eur. J. of Pharm. Sci.* 26: 251–265.
- Fendler J.H., 1980, Optimising drug entrapment in liposomes: chemical and biophysical consideration in liposomes in biological systems. In: G Gregoriadis and AC Allison (Eds.). New York: John Wiley and Sons Ltd. 87–100.
- Fielding M.R., 1991, Liposomal drug delivery: advantages and limitations from a clinical pharmacokinetics and therapeutic perspective. *Clin. Pharmacokinet.* 21: 155–164.
- Finlay J.C., D.L. Conover, E.L. Hull, T.H. Foster, 2001, Porphyrin bleaching and PDT-induced spectral changes are irradiance dependent in ALA-sensitized normal rat skin *in vivo*. *Photochem. Photobiol.* 73: 54–63.
- Finlay J.C., S. Mitra, T.H. Foster, 2002, *In vivo* mTHPC photobleaching in normal rat skin exhibits unique irradiance-dependent features. *Photochem. Photobiol.* 75: 282–288.
- Fischkoff, S. and J. M. Vanderkooi, 1975, Oxygen diffusion in biological and artificial membranes determined by the fluorochrome pyrene. *J. Gen. Physiol.* 65: 663–676.
- Foote C.S., 1991, Definition of type I and type II photosensitized oxidation. *Photochem. Photobiol.* 54: 659.
- Foster T.H., B.D. Pearson, S. Mitra, C.E. Bigelow, 2005, Fluorescence anisotropy imaging reveals localization of meso-tetrahydroxyphenyl chlorin in the nuclear envelope. *Photochem. Photobiol.* 81(6):1544–7.
- Frezard F., 1999, Liposomes: from biophysics to the design of peptide vaccines. *Braz. J. Biol. Res.* 32(2): 181–189.
- Frolov A. A. and E. I. Zenkevich, 1990, Chlorin e6-liposome interaction. Investigation by the methods of fluorescence spectroscopy and inductive resonance energy transfer. *J. Photochem. Photobiol. B Biol.* 7: 43–56.
- Gabizon A.A., Y. Barenholz and M. Bialer, 1993, Prolongation of the circulation time of doxorubicin encapsulated in liposomes containing polyethylene glycol-derivatized phospholipid: Pharmacokinetic studies in rodents and dogs. *Pharm. Res.* 10: 703–708.

- Gabizon A. and D. Papahadjopoulos, 1988, Liposome formulations with prolonged circulation time in blood and enhanced uptake in tumors. *Proc. Natl. Acad. Sci. USA* 85: 6949-6953.
- Gabizon A., D.C. Price, J. Huberty, R.S. Bresalier and D. Papahadjopoulos, 1990, Effect of liposome composition and other factors on the targeting of liposomes to experimental tumors: Biodistribution and imaging studies. *Cancer. Res.* 50: 6371-6378.
- Georgakoudi I., T.H. Foster, 1998, Singlet oxygen- versus nonsinglet oxygen-mediated mechanisms of sensitizer photobleaching and their effects on photodynamic dosimetry. *Photochem. Photobiol.* 67: 612-625.
- Georgakoudi I., M.G. Nichols, T.H. Foster, 1997, The mechanism of Photofrin photobleaching and its consequences for photodynamic dosimetry. *Photochem. Photobiol.* 65: 135-144.
- Gijssens A., A. Derycke, L. Missiaen, D. De Vos, J. Huwyler, A. Eberle, P. de Witte, 2002, Targeting of the photocytotoxic compound ALPcS4 to HeLa cells by transferrin conjugated PEGliposomes, *Int. J. Cancer* 101: 78– 85.
- Glanzmann T., C. Hadjur, M. Zellweger, P. Grosjean, M. Forrer, J. P. Ballini, P. Monnier, H. van den Bergh, C. K. Lim and G. Wagnieres, 1998, Pharmacokinetics of tetra(m-hydroxyphenyl)chlorin in human plasma and individualized light dosimetry in photodynamic therapy. *Photochem. Photobiol.* 67(5): 596-602.
- Goc J., M. Hara, T. Tateishi and J. Miyake, 1996, Reconstructed light-harvesting system for photosynthetic reaction centers. *J. Photochem. Photobiol. A Chem.* 93: 137–144.
- Gottfried V., D. Peled, J.W. Winkelman and S. Kimel, 1988, Photosensitisers in organized media: singlet oxygen production and spectral properties. *Photochem. Photobiol.* 48(2): 157 – 163.
- Goldbach P, B. Herve, W. Pascal and S. Andre, 1995, Sterile filtration of liposomes: retention of encapsulated carboxyfluorescein. *Int. J. Pharm.* 117: 225–230.
- Gravier J., R. Schneider, C. Frochot, T. Bastogne, F. Schmitt, J. Didelon, F. Guillemin, M. Barberi-Heyob, 2008, Improvement of meta-tetra(hydroxyphenyl)chlorin-like photosensitiser selectivity with folate-based targeted delivery. synthesis and *in vivo* delivery studies. *J. Med. Chem.* 51(13):3867-77.
- Gregoriadis G., 1991, Overview of liposomes. *J Antimicrob Chemother* 28(supp. B):39–48.

- Gregoriadis G. and C. Davis, 1979, Stability of liposome *in vivo* and *in vitro* is promoted by their cholesterol content and the presence of blood cells. *Biochem. Biophys. Res. Commun.* 89: 1287-1293.
- Gregoriadis G. and J. Senior, 1980, The phospholipid component of small unilamellar liposomes controls the rate of clearance of entrapped solutes from the circulation. *FEBS Lett.* 119: 43-46.
- Hadjur C., N. Lange, J. Rebstein, P. Monnier, H. van den Bergh, G. Wagnières, 1998, Spectroscopic studies of photobleaching and photoproduct formation of meta(tetrahydroxyphenyl) chlorin (m-THPC) used in photodynamic therapy. The production of singlet oxygen by m-THPC. *J. Photochem. Photobiol. B* 45.
- Harashima H., K. Sakata and H. Kiwada, 1993, Distinction between depletion of opsonins and the saturation of uptake in the dose-dependent hepatic uptake of liposomes. *Pharm. Res.* 10: 606-610.
- Hausman W., 1911, Die sensibilisierende Wirkung des hämatoporphyrins. *Biochem. Z.* 30: 276-316.
- Hoebeke M., X. Damoiseau, H.J. Schuitmaker, A. Van de Vorst, 1999, Fluorescence, absorption and electron spin resonance study of bacteriochlorin a incorporation into membrane models. *Biochim. Biophys. Acta* 1420: 73-85.
- Hongying Y., W. Fuyuan, and Z. Zhiyi, 1999, Photobleaching of chlorins in homogeneous and heterogeneous media. *Dyes and Pigments* 43: 109-117.
- Hopkinson, H.J., D.I. Vernon, S.B. Brown, 1999, Identification and partial characterization of an unusual distribution of the photosensitizer meta-tetrahydroxyphenyl chlorin (temoporfin) in human plasma. *Photochem. Photobiol.* 69: 482-488.
- Hopper, C., A. Kubler, H. Lewis, I. B. Tan and G. Putnam, 2004, mTHPC-mediated photodynamic therapy for early oral squamous cell carcinoma. *Int. J. Cancer* 111(1):138-46.
- Huang S.K., E. Mayhew, S. Gilani, D.D. Lasic, F.J. Martin and D. Papahadjopoulos, 1992, Pharmacokinetics and therapeutics of sterically stabilized liposomes in mice bearing C-26 colon carcinoma. *Cancer Res.* 52: 6774-6781.
- Hunta C.A., 1982, Liposomes disposition *in vivo* V. Liposome stability in plasma and implications for drug carrier function. *Biochim. Biophys. Acta* 719(3): 450-463.

- Hunter C.A., J.K.M. Sanders, 1990, The nature of π - π interactions. *J. Am. Chem. Soc.* 112: 5525–5534.
- Hwang K.J., 1987, Liposome Pharmacokinetics, in *Liposomes: From Biophysics to Therapeutics* (Ostro MJ ed), Marcel Dekker, Inc, New York, 109-156
- Ichikawa K., T. Nikita, N. Maed, Y. Takeuchi, Y. Namba and N. Oku, 2004, PEGylation of Liposome Decreases the Susceptibility of Liposomal Drug in Cancer Photodynamic Therapy. *Biol. Pharm. Bull.* 27(3): 443—444.
- Israelachvili J.N., D.J. Mitchell and B.W. Ninham, 1977, Theory of self-assembly of lipid bilayers and vesicles. *Biochim. Biophys. Acta* 470: 185-201
- Israelachvili, J. *Intermolecular and surface forces* 2nd ed., Academic Press, 1992
- Jain R.K., 1990, Physiological barriers to delivery of monoclonal antibodies and other macromolecules in tumors. *Cancer. Res.* 50 (3 Suppl): 814-819.
- Jamshaid M., S.J. Farr, P. Kearney, I.W. and Kellaway, 1988, Poloxamer sorption on liposomes: comparison with polystyrene latex and influence on solute efflux. *Int. J. Pharm.* 48: 125–131.
- Jones J.D. and T.E. Thompson, 1989, Spontaneous phosphatidylcholine transfer by collision between vesicles at high lipid concentration. *Biochemistry* 28(1): 129-34.
- Jones H. J., D. I. Vernon and S. B. Brown, 2003, Photodynamic therapy effect of m-THPC (Foscan) *in vivo*: correlation with pharmacokinetics. *Br. J. Cancer* 89(2): 398-404.
- Jones R.M., Q. Wang, J.H. Lamb, B.D. Djelal, R. Bonnett, C.K. Lim, 1996, Identification of photochemical oxidation products of 5,10,15,20-tetra(m-hydroxyphenyl)chlorin by on-line high-performance liquid chromatography-electrospray ionization tandem mass spectrometry. *J. Chromatogr. A* 722: 257-265.
- Kasselouri A., O. Bourdon, D. Demore, J.C.Blais, P. Prognon, G. Bourg-Heckly, J. Blais, 1999, Fluorescence and mass spectrometry studies of meta-tetra(hydroxyphenyl)chlorin photoproducts. *Photochem. Photobiol.* 70: 275-279.
- Kępczyński M., R. P. Pandian, K. M. Smith and B. Ehrenberg, 2002, Do liposome-binding constants of porphyrins correlate with their measured and predicted partitioning between octanol and water? *Photochem. Photobiol.* 76: 127–134.
- Kessel D., 1999, Transport and localisation of m-THPC *in vitro*. *Int. J. Clin. Pract.* 53(4):263-7.

- Kessel D. and E. Sykes, 1999, Transport, localization, and phototoxicity of m-THPC. *Proc. SPIE* 3592: 37–42.
- Khan D.R., E.M. Rezler, J. Lauer-Fields, G.B. Fields, 2008, Effects of drug hydrophobicity on liposomal stability. *Chem. Biol. Drug. Des.* 71(1):3-7.
- Klibanov A.L., K. Maruyama, V.P. Torchilin and L. Huang, 1990, Amphipathic polyethyleneglycols effectively prolong the circulation time of liposomes. *FEBS Lett.* 268: 235-237.
- Kohen E., R. Santus, J. Hirschberg, 1995, *Photobiology*. Academic Press, San Diego.
- König K., H. Meyer, H. Schneckenburger, A. Rück, 1993, The study of endogenous porphyrins in human skin and their potential for photodynamic therapy by laser induced fluorescence spectroscopy. *Lasers Med. Sci.* 8: 127-132.
- Lang K., J. Mosinger, D.M. Wagnerová, 2004, Photophysical properties of porphyrinoid sensitizers non-covalently bound to host molecules; models for photodynamic therapy. *Coord. Chem. Rev.* 248: 321–350.
- Lange Y., A.L. Molinaro, T.R. Chauncey and T.L. Steck, 1983, On the mechanism of transfer of cholesterol between human erythrocytes and plasma. *J. Biol. Chem.* 258(11): 6920-6.
- Lasic, D.D., 1988, The mechanism of vesicle formation. *Biochem. J.* 256: 1-11.
- Lasic D.D., B. Ceh, M.C.A. Stuart, L. Guo, P.M. Frederik and Y. Barenholz, 1995, Transmembrane gradient driven phase transitions within vesicles: Lessons for drug delivery. *Biochim. Biophys. Acta* 1239: 145-156.
- Lasic D.D., F.J. Martin, A. Gabizon, S.K. Huang, D. Papahadjopoulos, 1991, Sterically stabilized liposomes: a hypothesis on the molecular origin of the extended circulation times, *Biochim. Biophys. Acta* 1070: 187–192.
- Lassalle H.P., D. Dumas, S. Gräfe, M.-A. D'Hallewin, F. Guillemin, L. Bezdetsnaya, 2009, Correlation between *in vivo* pharmacokinetics, intratumoral distribution and photodynamic efficiency of liposomal mTHPC. *J. Controlled Release* 134:118-124.
- Lassalle H.-P., N. Lourette, B. Maunit, J.-F. Muller, F. Guillemin and L. Bezdetsnaya-Bolotina, 2004, MALDI-TOF mass spectrometric analysis for the characterization of the 5,10,15,20-tetrakis-(m-hydroxyphenyl)bacteriochlorin (m-THPBC) photoproducts in biological environment. *J. Mass Spectrom.* 40: 1149–1156.

- Lassalle H.P., M. Wagner, L. Bezdetnaya, F. Guillemin, H. Schneckenburger, 2008, Fluorescence imaging of Foscan and Foslip in the plasma membrane and in whole cells. *J. Photochem. Photobiol. B.* 92(1):47-53.
- Lavi A., H. Weitman, R. T. Holmes, K. M. Smith and B. Ehrenberg, 2002, The depth of porphyrin in a membrane and the membrane's physical properties affect the photosensitizing efficiency. *Biophys. J.* 82: 2101–2110.
- Ledoux-Lebard C., 1902, *Annales de l'institut Pasteur* 16: 593.
- Lin H., S. R. Tabaei, D. Thomsson, O. Mirzov, P.-O. Larsson and I. Scheblykin, 2008, Fluorescence blinking, excitation dynamics, and energy transfer domains in single conjugated polymer chains. *J. Am. Chem. Soc.* 130: 7042–7051.
- Lostritto R.T., L. Goei, and S.L. Silvestri, 1987, Theoretical considerations of drug release from submicron oil in water emulsions. *J. Parenteral. Sci. Technol.* 41: 214-224.
- Lourette N., B. Maunit, L. Bezdetnaya, H.P. Lassalle, F. Guillemin, J.F. Muller, 2005, Characterization of Photoproducts of m-THPP in Aqueous Solution. *Photochem Photobiol* 81: 691-696.
- MacDonald R. C. and S. A. Simon, 1987, Lipid monolayer states and their relationships to bilayers. *Proc. Natl Acad. Sci. USA* 84: 4089–4093.
- Mang T.S., T.J. Dougherty, W.R. Potter, D.G. Boyle, S. Somer, J. Moan, 1987, Photobleaching of porphyrins used in photodynamic therapy and implications for therapy. *Photochem. Photobiol.* 45: 501-506.
- Marchal S., A. Fadloun, E. Maugain, M.A. D'Hallewin, F. Guillemin, L. Bezdetnaya, 2005, Necrotic and apoptotic features of cell death in response to Foscan photosensitization of HT29 monolayer and multicell spheroids. *Biochem. Pharmacol.* 69: 1167-1176.
- Marchal S., A. François, D. Dumas, F. Guillemin, L. Bezdetnaya, 2007, Relationship between subcellular localisation of Foscan and caspase activation in photosensitised MCF-7 cells. *Br. J. Cancer.* 96(6):944-51.
- Martin F.J., 1998, Clinical pharmacology and antitumor efficacy of DOXIL (pegylated liposomal doxorubicin), in *Medical Applications of Liposomes* (Lasic D.D. and Papahadjopoulos D. eds), Elsevier Science BV, New York, 635-688

- Matsumura Y. and H. Maeda, 1986, A new concept for macromolecular therapeutics in cancer chemotherapy: mechanism of tumoritropic accumulation of proteins and the antitumor agent SMANCS. *Cancer. Res.* 46: 6387-6392.
- Mayer L.D., R. Nayar, R.L. Thies, N.L. Boman, P.R. Cullis and M.B. Bally, 1993, Identification of vesicle properties that enhance the antitumor activity of liposomal vincristine against murine L1210 leukemia. *Cancer Chemother. Pharmacol.* 33: 17-24.
- McLean L. R. and M.C. Phillips, 1981, Mechanism of cholesterol and phosphatidylcholine exchange or transfer between unilamellar vesicles. *Biochemistry* 20(10): 2893-900.
- Melnikova V.O., L.N. Bezdetsnaya, C. Bour, E. Festor, M.P. Gramain, J.L. Merlin, A. Potapenko, F. Guillemin, 1999, Subcellular localization of meta-tetra (hydroxyphenyl) chlorin in human tumor cells subjected to photodynamic treatment. *J. Photochem. Photobiol. B* 49: 96-103.
- Melnikova V.O., L.N. Bezdetsnaya, A.Y. Potapenko, F. Guillemin, 1999, Photodynamic properties of meta-tetra(hydroxyphenyl)chlorin in human tumor cells. *Radiat. Res.* 152: 428-435.
- Meyer-Betz F., 1913, Untersuchungen über die biologische (photodynamische) Wirkung des Hämatoporphyrins und andere Derivate des Blut- und Gallenfarbstoffes. *Dtsch. Arch. Klin. Med.* 112: 476-503.
- Micali, N., A. Romeo, R. Lauceri, R. Purrello, F. Mallamace, L.M. Scolaro, 2000, Fractal structures in homo- and heteroaggregated water soluble porphyrins. *J. Phys. Chem. B.* 104: 9416–9420.
- Michael-Titus A. T., R. Whelpton and Z. Yaqub, 1995, Binding of temoporfin to the lipoprotein fractions of human serum. *Br. J. Clin. Pharmacol.* 40(6): 594-7.
- Milanesi C., F. Sorgato, G. Jori, 1989, Photokinetic and ultrastructural studies on porphyrin photosensitization of HeLa cells. *Int. J. Radiat. Biol.* 55, 59–69.
- Mitaku S., T. Jippo and R. Kataoka, 1983, Thermodynamic properties of the lipid bilayer transition: pseudocritical phenomena. *Biophys. J.*, 42: 137-144.
- Mitra S. and T.H. Foster, 2005, Photophysical Parameters, Photosensitizer Retention and Tissue Optical Properties Completely Account for the Higher Photodynamic Efficacy of meso-Tetra-Hydroxyphenyl-Chlorin vs Photofrin. *Photochem. Photobiol.* 81(4):849-859.

- Moan J., 1986, Effect of bleaching of porphyrin sensitizers during photodynamic therapy. *Cancer Lett.* 33: 45-53.
- Moan J., 1990, On the diffusion length of singlet oxygen in cells and tissues. *J. Photochem. Photobiol. B* 6: 343-344.
- Moan J., Berg K., 1991, The photodegradation of porphyrins in cells can be used to estimate the lifetime of singlet oxygen. *Photochem. Photobiol.* 53: 549-553.
- Moan J., E. Boye, 1981, Photodynamic effect on DNA and cell survival of human cells sensitized by hematoporphyrin. *Photobiochem. Photobiophys.* 2: 301-307.
- Moan J., P. Juzenas, S. Bagdonas, 2000, Degradation and transformation of photosensitisers during light exposure. *Recent Res. Devel. Photochem. Photobiol.* 4: 121-132.
- Moan J., G. Streckyte, S. Bagdonas, O. Bech, K. Berg, 1997, Photobleaching of protoporphyrin IX in cells incubated with 5-aminolevulinic acid. *Int. J. Cancer* 70: 90-97.
- Moan J., A. Western, C. Rimington, 1988, Photomodification of porphyrins in biological systems., In: Moreno, G., Pottier, R.H., Truscott, T.G. (Eds.) *Photosensitization*. Springer-Verlag, Berlin, Heidelberg, New York, London, Paris, Tokyo: 407-418.
- Mojzisova H., S. Bonneau, C. Vever-Bizet, D. Brault, 2007, Cellular uptake and subcellular distribution of chlorin e6 as functions of pH and interactions with membranes and lipoproteins. *Biochim. et Biophys. Acta* 1768: 2748–2756.
- Molnar A., R. Dedic, A. Svoboda, J. Hala, 2008, Spectroscopic study of singlet oxygen photogeneration by lipophilic photosensitiser in liposomes. *J. Luminesc.* 128: 783–785.
- Moore C.M., T.R. Nathan, W.R. Lees, C.A. Mosse, A. Freeman, M. Emberton, S.G. Bown, 2006, Photodynamic therapy using meso tetra hydroxy phenyl chlorin (mTHPC) in early prostate cancer. *Lasers Surg. Med.* 38(5): 356–363.
- Moser J.G., 1998, Definition and general properties of 2nd and 3rd generation photosensitisers, In: Moser, J.G. (Ed.) *Photodynamic tumor therapy. 2nd and 3rd generation photosensitisers*. Harwood Academic Publishers, Amsterdam: 3-7.
- Nonell S., S.E. Braslavsky, K. Schaffner, 1990, Quantum yield of production of singlet molecular oxygen in aqueous dispersions of small unilamellar lipid vesicles. A time-resolved near-IR phosphorescence study. *Photochem. Photobiol.* 51: 551-556.

- Nounou M.M., L.K. El-Khordagui, N.A. Khalafallah and S.A. Khalil, 2006, *In vitro* release of hydrophilic and hydrophobic drugs from liposomal dispersions and gels. *Acta Pharm.* 56: 311-324.
- Oja C.D., S.C. Semple, A. Chonn and P.R. Cullis, 1996, Influence of dose on liposome clearance: Critical role of blood proteins. *Biochim. Biophys. Acta* 1281: 31-37.
- Papahadjopoulos D., T.M. Allen, A. Gabizon, E. Mayhew, K. Matthay, S.K. Huang, K.-D. Lee, M.C. Woodle, D.D. Lasic, C. Redemann and F.J. Martin, 1991, Sterically stabilized liposomes: Improvements in pharmacokinetics and antitumor therapeutic efficacy. *Proc. Natl. Acad. Sci. USA* 88: 11460-11464.
- Papahadjopoulos D., K. Jacobson, S. Nir and T. Isac, 1973, Phase transitions in phospholipid vesicles: Fluorescence polarization and permeability measurements concerning the effect of temperature and cholesterol. *Biochim. Biophys. Acta* 311: 330-348.
- Patel H.M., 1992, Serum opsonins and liposomes: Their interaction and opsonophagocytosis. *CRC Crit. Rev. Ther. Drug. Carrier Syst.* 9: 39-90.
- Pegaz B., E. Debeve, J.P. Ballini, G. Wagnières, S. Spaniol, V. Albrecht, D.V. Scheglmann, N.E. Nifantiev, H. van den Bergh, Y.N. Konan-Kouakou, 2006, Photothrombic activity of m-THPC-loaded liposomal formulations: pre-clinical assessment on chick chorioallantoic membrane model. *Eur. J. Pharm. Sci.* 28(1-2):134-40.
- Perez-Solar R., 1989, Liposomes as carriers of antitumor agents: toward a clinical reality. *Cancer Treat. Rev.* 16: 67-82.
- Postigo F., M. Mora, M.A. De Madariaga, S. Nonell, M.L. Sagristá, 2004, Incorporation of hydrophobic porphyrins into liposomes: characterization and structural requirements. *Int. J. Pharm.* 278: 239-254.
- Primo F.L., M.V. Bentley, A.C. Tedesco, 2008, Photophysical studies and *in vitro* skin permeation/retention of Foscan/nanoemulsion (NE) applicable to photodynamic therapy skin cancer treatment. *J. Nanosci. Nanotechnol.* 8(1):340-7.
- Raab O., 1900, Ueber die Wirkung fluorescirender Stoffe auf Infusorien. *Z. Biol (Munich)* 39: 524-546.
- Reddi E., 1997, Role of delivery vehicles for photosensitizers in the photodynamic therapy of tumors. *J. Photochem. Photobiol. B* 37: 189-195.

- Reddi E., G. Jori, 1988, Steady state and time resolved spectroscopic studies of photodynamic sensitizers: porphyrins and phthalocyanines. *Recv. Chem. Intermed.* 10: 241-268.
- Ribó, J.M., J. Crusats, J.A. Farrera, M.L. Valero, 1994, Aggregation in water solutions of tetrasodium diprotonated meso-tetrakis(4-sulfonatophenyl)porphyrin. *J. Chem. Soc., Chem. Commun.*: 681-682.
- Ricchelli, F., 1995, Photophysical properties of porphyrins in biological membranes. *J. Photochem. Photobiol., B: Biol.* 29: 109-118.
- Ricchelli F., S. Gobbo, G. Moreno, C. Salet, L. Brancaleon, A. Mazzini, 1998, Photophysical properties of porphyrin planar aggregates in liposomes. *Eur. J. Biochem.* 253: 760-765.
- Ricchelli F. and G. Jori, 1986, Distribution of porphyrins in the various compartments of unilamellar liposomes of dipalmitoyl-phosphatidylcholine as probed by fluorescence spectroscopy. *Photochem. Photobiol.* 44: 151-157.
- Ricchelli F., G. Jori, S. Gobbo and M. Tronchin, 1991, Liposomes as models to study the distribution of porphyrins in cell membranes. *Biochim. Biophys. Acta* 1065: 42-48.
- Richter A.M., E. Waterfield, A.K. Jain, A.J. Canaan, B.A. Allison, J.G. Levy, 1993, Liposomal delivery of a photosensitizer, benzoporphyrin derivative monoacid ring A (BPD), to tumor tissue in a mouse tumor model. *Photochem. Photobiol.* 57: 1000-1006.
- Ris H. B., Q. Li, T. Krueger, C. K. Lim, B. Reynolds, U. Althaus and H. J. Altermatt, 1998, Photosensitizing effects of m-tetrahydroxyphenylchlorin on human tumor xenografts: correlation with sensitizer uptake, tumor doubling time and tumor histology. *Int. J. Cancer* 76(6): 872-4.
- Robinson D.J., H.S. de Bruijn, N. van der Veen, M.R. Stringer, S.B. Brown, W.M. Star, 1998, Fluorescence photobleaching of ALA-induced protoporphyrin IX during photodynamic therapy of normal hairless mouse skin: the effect of light dose and irradiance and the resulting biological effect. *Photochem. Photobiol.* 67: 140-149.
- Roby A., S. Erdogan, V.P. Torchilin, 2006, Solubilization of poorly soluble PDT agent, meso-tetraphenylporphyrin, in plain or immunotargeted PEG-PE micelles results in dramatically improved cancer cell killing *in vitro*. *Eur. J. Pharm. Biopharm.* 62: 235-240.
- Rogers J.A. and K.E. Aderson, 1998, The potential of liposomes in oral drug delivery. *Crit. Rev. Ther. Drug Carrier System.* 13(5): 421-480.

- Ronn A.M., J. Batti, C.J. Lee, D. Yoo, M.E. Siegel, M. Nouri, L.A. Lofgren, B.M. Steinberg, 1997, Comparative biodistribution of meta-Tetra(Hydroxyphenyl) chlorin in multiple species: clinical implications for photodynamic therapy. *Lasers Surg. Med.* 20: 437-442.
- Rotomskis R., S. Bagdonas, G. Streckyte, 1996, Spectroscopic studies of photobleaching and photoproduct formation of porphyrins used in tumour therapy. *J. Photochem. Photobiol. B* 33: 61-67.
- Rovers J.P., M.L. de Jode, M.F. Grahn, 2000, Significantly increased lesion size by using the near-infrared photosensitizer 5,10,15,20-tetrakis (m-hydroxyphenyl) bacteriochlorin in interstitial photodynamic therapy of normal rat liver tissue. *Lasers Surg. Med.* 27: 235-240.
- Rovers J.P., M.L. de Jode, H. Rezzoug, M.F. Grahn, 2000, *In vivo* photodynamic characteristics of the near-infrared photosensitizer 5,10,15,20-tetrakis(M-hydroxyphenyl) bacteriochlorin. *Photochem. Photobiol.* 72: 358-364.
- Sadzuka Y., F. Iwasaki, I. Sugiyama, K. Horiuchi, T. Hirano, H. Ozawa, N. Kanayama and N. Oku, 2008, Phototoxicity of coproporphyrin as a novel photodynamic therapy was enhanced by liposomalization. *Toxicology Lett.* 182: 110–114.
- Sadzuka Y., K. Tokutomi, F. Iwasaki, I. Sugiyama, T. Hirano, H. Konno, N. Oku, T. Sonobe, 2006, The phototoxicity of photofrin was enhanced by PEGylated liposome *in vitro*. *Cancer Lett.* 241: 42–48.
- Sasnouski S., D. Kachatkou, V. Zorin, F. Guillemin, L. Bezdetnaya, 2006, Redistribution of Foscan from plasma proteins to model membranes. *Photochem. Photobiol. Sci.* 5: 770-777.
- Sasnouski S., E. Pic, D. Dumas, V. Zorin, M.-A. D'Hallewin, F. Guillemin and L. Bezdetnaya, 2007, Influence of Incubation Time and Sensitizer Localization on Meta-tetra(hydroxyphenyl)chlorin (mTHPC)-Induced Photoinactivation of Cells. *Radiat. Res.* 168: 209–217.
- Sasnouski S, V. Zorin, I. Khludeyev, M.A. D'Hallewin, F. Guillemin, L. Bezdetnaya, 2005, Investigation of Foscan interactions with plasma proteins. *Biochim. Biophys. Acta* 1725(3): 394-402.

- Savary J.F., P. Grosjean, P. Monnier, C. Fontolliet, G. Wagnieres, D. Braichotte, H. van den Bergh, 1998, Photodynamic therapy of early squamous cell carcinomas of the esophagus: a review of 31 cases. *Endoscopy* 30: 258-265.
- Savary J.F., P. Monnier, C. Fontolliet, J. Mizeret, G. Wagnieres, D. Braichotte, H. van den Bergh, 1997, Photodynamic therapy for early squamous cell carcinomas of the esophagus, bronchi, and mouth with m-tetra (hydroxyphenyl) chlorin. *Arch. Otolaryngol. Head Neck Surg.* 123: 162-168.
- Schroit A.J., J. Madsen, R. Nayar, 1986, Liposome– cell interactions: *in vitro* discrimination of uptake mechanism and *in vivo* targeting strategies to mononuclear phagocytes. *Chem. Phys. Lipids* 40: 373– 393.
- Schulthess G., G. Lipka, S. Compassi, D. Boffelli, F.E. Weber, F. Paltauf and H. Hauser, 1994, Absorption of monoacylglycerols by small intestinal brush border membrane. *Biochemistry* 33(15): 4500-8.
- Sekher P. and G.M. Garbo, 1993, Spectroscopic studies of tin ethyl etiopurpurin in homogeneous and heterogeneous systems. *J. Photochem. Photobiol. B: Biol.* 20: 117–125.
- Semple S.C. and A. Chonn, 1996, Liposome-blood protein interactions in relation to liposome clearance. *J. Liposome Res.* 6: 33-60.
- Semple S.C., A. Chonn and P.R. Cullis, 1996, Influence of cholesterol on the association of plasma proteins with liposomes. *Biochemistry* 35: 2521-2525.
- Senior J.H., 1987, Fate and behaviour of liposomes *in vivo*: A review of controlling factors. *CRC Crit. Rev. Ther. Drug. Carrier. Syst.* 3: 123-193.
- Senior J., J.C.W. Crawley and G. Gregoriadis, 1985, Tissue distribution of liposomes exhibiting long half-lives in the circulation after intravenous injection. *Biochim. Biophys. Acta* 839: 1-8.
- Senior J. and G. Gregoriadis, 1982, Stability of small unilamellar liposomes in serum and clearance from the circulation: The effect of the phospholipid and cholesterol components. *Life Sci.* 30: 2123-2136.
- Sharman W.M., C.M. Allen, J.E. van Lier, 2000, Role of activated oxygen species in photodynamic therapy. *Methods Enzymol.* 319: 376-400.
- Shum P., J.-M. Kim, D.H. Thompson, 2001, Phototriggering of liposomal drug delivery systems. *Adv. Drug Deliv. Rev.* 53: 273–284.

- Silvestri S., L.L. Wu and B. Bowser, 1992, Release of polyionizable compounds from submicrometer oil-in-water emulsions. *J. Pharm. Sci.* 81: 413-418.
- Sørensen R., V. Iani, J. Moan, 1998, Kinetics of photobleaching of protoporphyrin IX in the skin of nude mice exposed to different fluence rates of red light. *Photochem. Photobiol.* 68: 835-840.
- Spikes J.D., 1985, The historical development of ideas on applications of photosensitised reactions in health sciences, In: Bergasson, R.V., Jori, G., Land, E.J., Truscott, T.G. (Eds.) Primary photoprocesses in Biology and Medicine. *Plenum Press*, New York, New York: 209-227.
- Spikes J.D., 1992, Quantum yields and kinetics of the photobleaching of hematoporphyrin, Photofrin II, tetra(4-sulfonatophenyl)-porphine and uroporphyrin. *Photochem. Photobiol.* 55: 797-808.
- Steck T.L., F.J. Kezdy and Y. Lange, 1988, An activation-collision mechanism for cholesterol transfer between membranes. *J. Biol. Chem.* 263(26): 13023-31.
- Storm G. and D.J.A. Crommelin, 1998, Liposomes: quo vadis. *Pharm. Sci. Tech. Today* 1:19–31.
- Streckyte G., K. Berg, J. Moan, 1994, Photomodification of ALA-induced protoporphyrin IX in cells *in vitro*. *SPIE Photodynamic of Cancer II* 2325: 58-65.
- Streckyte G., R. Rotomskis, 1993, Phototransformation of porphyrins in aqueous and micellar media. *J. Photochem. Photobiol. B* 18: 259-263.
- Streckyte G., R. Rotomskis, 1993, Phototransformation of porphyrins under clinically relevant light irradiation. *Biology* 3: 26-31.
- Svensson J., A. Johansson, S. Gräfe, B. Gitter, T. Trebst, N. Bendsoe, S. Andersson-Engels, K. Svanberg, 2007, Tumor selectivity at short times following systemic administration of a liposomal temoporfin formulation in a murine tumor model. *Photochem. Photobiol.* 83(5):1211-9.
- Szeimies R.M., J. Dräger, C. Abels, M. Landthaler, 2001, History of photodynamic therapy in dermatology, In: Calzavara-Pinton, P., Szeimies, R.M., Ortel, B. (Eds.) Photodynamic therapy and fluorescence diagnosis in dermatology. Elsevier Science.
- Tanford C., 1991, The hydrophobic effect: formation of micelles and biological membranes, 2nd ed., Krieger Publishing Company

- Teiten M.H., L. Bezdetnaya, P. Morliere, R. Santus, F. Guillemin, 2003, Endoplasmic reticulum and Golgi apparatus are the preferential sites of Foscan localisation in cultured tumour cells. *Br. J. Cancer* 88: 146-152.
- Teiten M. H., S. Marchal, M.A. D'Hallewin, F. Guillemin and L. Bezdetnaya, 2003, Primary photodamage sites and mitochondrial events after Foscan photosensitization of MCF-7 human breast cancer cells. *Photochem. Photobiol.* 78(1): 9-14.
- Tran N., T. Krueger, Y. Pan, H. Yan, C. Cheng, H.J. Altermatt, J.P. Ballini, F. Borle, H.B. Ris, S. Andrejevic-Blant, 2007, Correlation of photodynamic activity and fluorescence signaling for free and pegylated mTHPC in mesothelioma xenografts. *Lasers Surg. Med.* 39(3):237-44.
- Uhumwangho M.U. and R.S. Okor, 2005, Current trends in the production and biomedical applications of liposomes: a review. *J. of Med. and Biomed. Res.* 4(1): 9-21.
- van Lier J.E., J.D. Spikes, 1989, The chemistry, photophysics and photosensitizing properties of phthalocyanines. *Ciba Found. Symp.* 146: 17-26.
- Veenhuizen R., H. Oppelaar, M. Ruevekamp, J. Schellens, O. Dalesio and F. Stewart, 1997, Does tumour uptake of Foscan determine PDT efficacy? *Int. J. Cancer* 73(2): 236-9.
- Vemuri S., C.T. Rhodes, 1995, Preparation and characterization of liposomes as therapeutic delivery systems: a review. *Pharm. Acta Helv.* 70: 95– 111.
- von Tappeiner H., A. Jesionek, 1903, Therapeutische versuche mit fluoreszierenden Stoffen. *Münch. Med. Wochenschr.* 50: 2042-2044.
- von Tappeiner H., A. Jodlbauer, 1904, Ueber die Wirkung der photodynamischen (fluoreszierenden) Stoffe auf Protozoen und Enzyme. *Arch. Klin. Med.* 80: 427-487.
- Voszka I., Z. Szabo, G. Csik, P. Maillard, P. Grof, 2005, Interaction of tetraphenyl-porphyrin derivatives with DPPC-liposomes: an EPR study, *J. Photochem. Photobiol. B: Biol.* 79: 83–88.
- Wang K.K-H., S. Mitra, T.H. Foster, 2008, Photodynamic dose does not correlate with long-term tumor response to mTHPC-PDT performed at several drug-light intervals. *Med. Phys.* 35 (8): 3518-3526.
- Weiner N, F Martin and M. Riox, 1989, Liposomes as drug delivery system. *Drug. Dev. Ind. Pharm.* 15(10): 1523–1554.

- Woodle M.C., K.K. Matthay, M.S. Newman, J.E. Hidayat, L.R. Collins, C. Redemann, F.J. Martin and D. Papahadjopoulos, 1992, Versatility in lipid compositions showing prolonged circulation with sterically stabilized liposomes. *Biochim. Biophys. Acta* 1105: 193-200.
- Woodle M.C., M.S. Newman and F.J. Martin, 1992., Liposome leakage and blood circulation: comparison of adsorbed block copolymers with covalent attachment of PEG. *Int. J. Pharm.* 88: 327–334.
- Xian-rong Q., M. Yoshie and N. Tsuneji, 1995, Effect of soybean-derived sterols on the *in vitro* stability and the blood circulation of liposomes in mice. *Int. J. Pharm.* 114: 33–41.
- Yuan F., M. Lwunig, S.K. Huang, D.A. Berk, D. Papahadjopoulos and R.K. Jain, 1994, Microvascular permeability and interstitial penetration of sterically stabilized (stealth) liposomes in a human tumor xenograft. *Cancer Res.* 54: 3352-3356.
- Zimcik P., M. Miletin, K. Kopecky, Z. Musil, P. Berka, V. Horakova, H. Kucerova, J. Zbytovska and D. Brault, 2007, Influence of Aggregation on Interaction of Lipophilic, Water-Insoluble Azaphthalocyanines with DOPC Vesicles. *Photochem. Photobiol.* 83: 1497–1504.

APPENDICES

List of abbreviations

ALA – aminolevulinic acid
BPD-MA – benzoporphyrin derivative mono-acid ring A (vertoporphin)
CTAB - cetyltrimethylammonium bromide
DMHp – dimethoxyhaematoporphyrin
DMPC - dimiristoylphosphatidylcholine
DPBS – Dulbecco's phosphate-buffered salines
DPPC - dipalmitoylphosphatidylcholine
DPPG - dipalmitoylphosphatidylglycerol
ER – endoplasmic reticulum
FBS - fetal bovine serum
FCS - fetal calf serum
HDL – high-density lipoproteins
Hp – haematoporphyrin
HpD - haematoporphyrin derivative
HSA - human serum albumin
IC - internal conversion
IP - intraperitoneal
ISC - intersystem crossing
IT - intratumoral
IV - intravenous
M_l/M_d - lipid to dye ratio
mTHPBC - meso-tetra(hydroxyphenyl)-bacteriochlorin
mTHPC - meta-tetra(hydroxyphenyl)chlorin (Foscan®)
mTHPP - meso-tetra(hydroxyphenyl)porphyrins
PBS – phosphate-buffered salines
PDT - photodynamic therapy
PEG - poly(ethylene glycol)
PF - Photofrin®
PFQ – photoinduced fluorescence quenching
PpIX - protoporphyrin IX
PS - photosensitizer
RES - reticular endothelial system
TFA - trifluoroacetic acid
TPPS₄ - meso-tetra (4-sulfonatophenyl) porphine
UV - ultraviolet
Vis - visible
VR - vibrational relaxation

Definitions

Fluorescence anisotropy – a parameter measured by the excitation of the sample by the polarized light and registering two components of the fluorescence polarized in the same direction as an incident light (I_{\parallel}), and in the perpendicular direction (I_{\perp}). After that the polarization could be calculated as $r = (I_{\parallel} - I_{\perp}) / (I_{\parallel} + 2I_{\perp})$.

Fluorescence polarization – a parameter measured by the excitation of the sample by the polarized light and registering two components of the fluorescence polarized in the same direction as an incident light (I_{\parallel}), and in the perpendicular direction (I_{\perp}). After that the polarization could be calculated as $p = (I_{\parallel} - I_{\perp}) / (I_{\parallel} + I_{\perp})$.

Förster resonance energy transfer, is a mechanism describing energy transfer between two chromophores. A donor chromophore, initially in its electronic excited state, may transfer energy to an acceptor chromophore through nonradiative dipole–dipole coupling.

Förster radius – the distance at which the Förster energy transfer efficiency is 50%. The Förster distance depends on the overlap integral of the donor emission spectrum with the acceptor absorption spectrum and their mutual molecular orientation.

PEG-liposomes (sterically stabilized, Stealth liposomes) – polyethyleneglycol-coated liposomes. The PEG stabilizing effect results from local surface concentration of highly hydrated groups that sterically inhibit both hydrophobic and electrostatic interactions of a variety of blood components at the liposome surface.

Rate of photobleaching – is a parameter which could characterize the dye depletion under light irradiation. In the case, when photobleaching kinetic could be approximated by a single-exponential decay, $I = A + Be^{-kt}$ this parameter could be attributed to the k value in this formula.