



**HAL**  
open science

# The valorization of export information and its impact upon the international performance of SMEs

Raluca Mogos Descotes

► **To cite this version:**

Raluca Mogos Descotes. The valorization of export information and its impact upon the international performance of SMEs. Business administration. Université Nancy 2, 2009. English. NNT : 2009NAN22001 . tel-01749051

**HAL Id: tel-01749051**

**<https://hal.univ-lorraine.fr/tel-01749051v1>**

Submitted on 29 Mar 2018

**HAL** is a multi-disciplinary open access archive for the deposit and dissemination of scientific research documents, whether they are published or not. The documents may come from teaching and research institutions in France or abroad, or from public or private research centers.

L'archive ouverte pluridisciplinaire **HAL**, est destinée au dépôt et à la diffusion de documents scientifiques de niveau recherche, publiés ou non, émanant des établissements d'enseignement et de recherche français ou étrangers, des laboratoires publics ou privés.



## AVERTISSEMENT

Ce document est le fruit d'un long travail approuvé par le jury de soutenance et mis à disposition de l'ensemble de la communauté universitaire élargie.

Il est soumis à la propriété intellectuelle de l'auteur. Ceci implique une obligation de citation et de référencement lors de l'utilisation de ce document.

D'autre part, toute contrefaçon, plagiat, reproduction illicite encourt une poursuite pénale.

Contact : [ddoc-theses-contact@univ-lorraine.fr](mailto:ddoc-theses-contact@univ-lorraine.fr)

## LIENS

Code de la Propriété Intellectuelle. articles L 122. 4

Code de la Propriété Intellectuelle. articles L 335.2- L 335.10

[http://www.cfcopies.com/V2/leg/leg\\_droi.php](http://www.cfcopies.com/V2/leg/leg_droi.php)

<http://www.culture.gouv.fr/culture/infos-pratiques/droits/protection.htm>

**UNIVERSITY OF NANCY and UNIVERSITY OF DORTMUND  
DOCTORAL SCHOOL OF LEGAL SCIENCE, POLITICAL SCIENCE,  
ECONOMICS AND BUSINESS ADMINISTRATION, NANCY**

**AUTHOR: Raluca MOGOS DESCOTES**

**The valorization of export information and its impact  
upon the international performance of SMEs**

**THESIS SUPERVISORS:**

Prof. Hartmut HOLZMÜLLER, University of Dortmund, Germany  
Prof. Björn WALLISER, University of Nancy, France

**THESIS COMMITTEE:**

Prof. Vincenzo ESPOSITO VINZI, ESSEC Business School, Paris, Cergy  
Pontoise, France  
Prof. Thomas FROEHLICHER, University of Nancy, France  
Prof. Jean-Luc GIANNELLONI, University of Savoie, France  
Prof. Hartmut HOLZMÜLLER, University of Dortmund, Germany  
Prof. Björn WALLISER, University of Nancy, France  
Prof. David WOISETSCHLÄGER, University of Dortmund, Germany

**Defended the 6<sup>th</sup> of February 2009**



## LIST OF ABBREVIATIONS USED

AC = Absorptive Capacity

CR = Critical Ratio

DC = Dynamic Capability

EMR = Export Market Research

EA = Export assistance

EMI = Export Market Intelligence

EMO = Export Market Orientation

LV = Latent Variable

MO = Market Orientation

MV = Manifest Variable

PACAP = Potential Absorptive CAPacity

PLS = Partial Least Squares

RACAP = Realized Absorptive CAPacity

SME = Small and Mid-Sized Enterprise

SEM = Structural Equations Modeling

## Pre-amble: How many words are too many?

*To my beloved mother Maria, without you I would have never go so far in my studies...*

Let me guide you, my beloved friends and readers, to the events leading to my enlightenment on the question "*How many words are too many?*"

A while ago I was attending one of my doctoral school classes in Nancy and I was pretty interplead by the expression of the needs, in terms of training in statistics, expressed by myself and my PhD fellows that could have been a matter of a few words. One ten minute speech might have been a story of a very few words, "*I do not know how to exploit the data I gathered for my thesis and I desperately need help*". This event refreshed my memory of participating in an earlier conference, where sometimes the same person has to do an one-hour speech every year... It would be so much easier to say "*I do not have anything new to add to what I said the last time I had to do this bloody early speech*". Indeed, dear friends and readers, many fundamental feelings and thoughts can be expressed with very few words, and sometimes words are not even necessary. You can express disgust with "*ugh*", surprise with "*wow*". You can look in some peoples' eyes and you will just know exactly what they mean.

As any person aspiring to be a scientist, I would like to see myself as a person of few words, but this is far from the truth... I become lyric and talkative when I begin to speak even though sometimes I just stay home with my thesis, saying nothing at all. Writing PhDs does not drive people especially social beings...

In my case, writing or speaking translates my deepest inner feelings and thoughts to the outer world, (this is how I get so easily so complicate...). I have a restless mind, which goes up and down, not always in a useful manner; this explains my need for writing essays, research papers, and so forth. They are expressions of my disordered way of thinking and sometimes, somehow, help me find the satisfaction of organizing parts of the chaos in my mind. It is all about a self-absorbed and personal exercise, my writing. My writing is directed towards people that appreciate dialogue and those that read my essays or research papers at best, I do admit it.

I believe that writing has to do with the way we deal with passion in our lives (one should have convictions in a lifetime...). Passion has a different effect on each human-being. When I get emotional, I cannot stop speaking non-sense, while some people stay wordless... the same goes for my writing. I am so afraid that I will be misunderstood that I will always try to get into the details with a certain risk of loosing the big picture I sight. Thankfully, Professor Walliser was always there to correct my systematic deviations into the details and to help me find my way when I lost myself in the translations. Otherwise,

my thesis would have reached so many more pages. Once again I will take advantage of this occasion to thank him for the tremendous work he did with me over all these years.

To resume, the fundamental question when one cuts down justification, inner introspection, and useless explanation, does not need many words. One can simply say “I love you” or “international performance is important” by using three or four words. The rest simply justifies these words, puts them into a context in order to make sure the message is correctly transmitted. For instance, “super flou” words could explain why it is important to study the impact of SMEs’ information activities on their international performance and this is what my introduction stands for.

If we use too many words, people stop reading or listening. Fidel Castro was well known for his 7-hour speeches that no one remembers anymore. I guess that when one writes dissertations or essays that are too long, no one bothers to read them anymore except the people that have to. Nonetheless, if you do not use enough words, the context is lost and the significance is misunderstood. I deeply believe that correctly transmitting messages through written format is not only an academic challenge, but also an interpersonal matter. How many misunderstandings exist between people because of the lack of communication or due its excess?

Well, all this digression helps me emphasize that the question that blew my mind at the end of my thesis was “*How many words are too many?*”, or more precisely: “*What is the optimal number of words one needs to use to justify a message without risking that the reader wouldn’t sink in a sea of words or the reader would not get the message correctly due to a lack of words?* (sadly, completely complicated again...).

If you ever have an answer to this question, which is one of my many unanswered questions thanks to the American Army, Bill Gates and the Internet, you can always send me an e-mail to enlighten the bearings of my deepest knowledge. And if you don’t, life goes on and there is always someone to blame: Gandhi, Berlusconi or Martin Luther King...

*Sanary sur Mer, August 2008*

## Acknowledgements

The publication of this dissertation is the final outcome of the process that started about five years ago. In 2002, during my Master Research, I was introduced to a new research project related to the international performance of SMEs from the eastern France. Conseil Général de la Lorraine financed the whole project under the direction of my supervisor, Professor Björn WALLISER. After graduating my Master Research, I obtained three years worth of financing from the Ministère de l'Education Nationale and began writing a PhD on the impact of SMEs' export information activities on the levels of international performance they achieve in foreign settings.

Since writing the first research proposal for obtaining the three-years of financing and later a first "proper" research plan, I have gotten help and valuable support from a number of people. I owe thanks to all of them. I have benefited from the co-operation and guidance of professors Björn WALLISER and Hartmut HOLZMÜLLER. They have given me their time, expertise, and moral support for my research throughout the entire process. Professor HOLZMÜLLER was of a great support for my French-German co-direction and was always helpful and open to our collaboration in spite of the geographical distance between Dortmund and Nancy. I take this occasion to thank him for everything.

My co-operation with Professor WALLISER began when I was still a student in the Research Master and it has since been long, fruitful and enjoyable. I had the chance to enjoy his collaboration and professionalism for most of the research paper we wrote together during my PhD. Most of the things I was able to learn in research come from him and I take this occasion to thank him for everything. For the work he did with me during all these years, his constant support and for his never-ending optimism that always helped me through all the difficult stages of my dissertation.

I would also like to thank Professor Vincenzo ESPOSITO VINZI. Thanks to him, I was able to attend the class on PLS path modeling at the ESSEC Business School and I always received advice on my data analysis. Our collaboration was very enjoyable and useful for my research. He was always available to advise me with regard to the data analysis issues in my dissertation. I thank him very, very much for that. Concerning my data analysis issues, I also thank Professor Jörg Henseler who constantly answered my e-mails when I needed advice concerning the statistical exploitation of my data.

Professor Olli KUIVALAINEN was the person who introduced me to the knowledge-based approach and was always there to discuss issues with me on the theoretical front. Professor Pierre-André JULIEN was also always available to answer my e-mails and exchange theoretical issues with me in my dissertation. I take this occasion to express my gratefulness for their precious time and advice.

In addition, I have also learned a lot from the courses and programs of the Doctoral Program for Business Studies and all the people involved in the courses that I participated in, especially Professor



Jean-Claude RAY and Professor Jean-Luc KOP. Professor Jean-Luc KOP helped me improve my research questionnaire and also gave me the basis to understand Structural Equation Modeling.

I would also like to thank Professors Jean-Luc GIANNELLONI and David WOISETSCHLÄGER for acting as external reviewers of this thesis, and Professor Thomas FROEHLICHER for acting as a member of the jury committee.

I also gratefully acknowledge the financial support from the following foundations: CEREFIGE (Centre Européen de Recherche en Finance et Gestion des Entreprises), Conseil Général de la Lorraine and the ICN Business School.

I appreciate the professional help that Ms. Milagros CUEVA and Ms. Kathryn BOARDMAN have given me in revising my English in this dissertation. I also want to thank Claude and Olga LIORET, Michel, Rémi and Sophie DESCOTES, Mathieu KACHA, Renaud GARCIA-BARDIDIA, and Haifa NAFFAKHI for reviewing my French résumé. Especially Mister Claude LIORET did a huge work with the reviewing of my French résumé, so I take the occasion to thank him for all the work he has accomplished.

Finally, I would like to thank all the members of my family, and my dear friends and relatives who have supported me through this project. I would especially like to mention Maria MOGOS, my mother, who was my main moral help during all these years for my dissertation, my husband Rémi DESCOTES, my father Mircea MOGOS, and my parents in law who were always very supportive.

A big thank you to my dear friends Xiaoling GUO, Violeta MOSKALU, Haifa NAFFAKHI, Yosra BOUGHATTAS, Grace NGAMINI, Stephane LEA, Mathieu KACHA, Michael BENEDIC, Antoine and Carine VIBERT, Eric KAARSEMAKER, Isabelle ANDRIAMANALINA and Ryan KOHL. You were always there for me, to support me all these years. Some of my new colleagues at IESEG Business School have been also of a great support over the last months of my thesis: Michael ANTIOCO, Loredana URECHE-RANGAU, Maud DERBAIX, Jacques ANGOT, Xavier LECOCQ, Loïc PLE, Ilkaï SENDENIZ YULKU, Wolfram BERGER and Ruben CHUMPITAZ. To all of you, a very big, big THANK YOU!

*Sanary sur Mer, August 2008*

## Résumé

### *Main objectives and theoretical ground of the study*

The Absorptive Capacity (AC) and the Knowledge-Based View (KBV) perspectives have generated significant scholarly interest across a large number of disciplines over the last decade. Despite this important scholarly interest, both the AC and KBV literature streams have focused primarily on technology-intensive and dynamic industries, aiming to primarily model innovation on the basis of technological and R&D knowledge absorption. As a result, knowledge and information relating to an organization's international market environment were mainly ignored, even though their utmost importance for foreign business development is overall emphasized within the international marketing literature. Especially in the case of SMEs, it is oftenly suggested that in order to handle the international market place turbulence, they shall better manage information and develop superior knowledge and capabilities relative to the management of foreign operations (Kuivalainen and Bell 2004). This dissertation aims to address this gap in the literature and provides two major contributions. First, a conceptualization of the AC of export information adapted in the case of SMEs is proposed, based on Zahra and George's (2002) re-lecture of the AC concept. Second, insights from the AC, marketing, international business, market orientation (MO) and knowledge management literature were combined to develop a framework for describing the export information state evolution in SMEs and its impact on their international performance.

The point of departure of this research was the general belief relative to the critical importance of firms' capabilities and skills to manage foreign market-related information in order to better perform and compete in international settings. As a result, it was implicitly postulated that the more SMEs are skilled in terms of export information exploitation, the higher levels of international performance they will achieve in foreign market settings. In order to answer the research question, three underlying research questions had to be addressed: (1) the conceptualization and the operationalization of the process of export information exploitation in SMEs and (2) of the international performance construct, and (3) the modelisation of the influence exerted by the process of export information exploitation in SMEs upon their levels of international performance.

The analysis of the relevant literature in the field led to the conclusion that the AC concept best captures the process of information exploitation at the firm level of analysis. As a result, the main assumption guiding this research was that SMEs' efficiency in terms of export information exploitation is reflected through their levels of AC of export information. In order to best describe the relationship between firms' information activities and organizational performance, the analysis of the literature review brought into light six main theoretical frameworks approaching the relationship existing between information and

organizational performance. It was concluded that the KBV perspective represents the most appealing theoretical framework in the case of the present research mainly because of its integrative power and its dynamic character. Furthermore, in order to link the AC to business performances under a KBV perspective, Zahra and George's (2002) framework was used. The authors propose a theoretical model describing the impact of firms' AC levels on their organizational performance. Zahra and George (2002) conceptualized AC as a dynamic capability, which exists as two sub-sets of potential (PACAP) and realized AC (RACAP). The PACAP is driven by the previous experience of the firm and the quality of the exposure to information sources within its external environment (the two constitutive dimensions of PACAP's antecedents). While PACAP (information acquisition and assimilation) has a direct impact on RACAP, only RACAP (information transformation and exploitation) has a direct impact upon organizational performance. Recapitulating, the three main research propositions advanced by Zahra and George (2002), representing the stepping-stones of this research model were the following:

<p><b>PI: PACAP's antecedents, previous experience and exposure to information sources, positively and significantly impact a firm's success in developing PACAP.</b></p> <p><b>PII: A firm's PACAP levels, levels of information acquisition and assimilation, positively and significantly impact RACAP's development (information transformation and exploitation).</b></p> <p><b>PIII: RACAP development levels positively and significantly impact a firm's degree of organizational performance.</b></p>
--

After having operationalized PACAP's antecedents, PACAP, and RACAP in the specific case of exporting SMEs, these three main research propositions were declined into ten underlying research propositions, building the research model describing the influence of the AC of export information in SMEs upon their levels of international performance.

### *Research methodology*

The causal nature of the research question led us to the retaining of a quantitative methodology. Nonetheless, taking into account the preponderant qualitative and multi-dimensional nature of information, a first qualitative preliminary research has been undertaken aiming to explore whether the use of insights from the KBV, MO and AC literature for describing the impact of the evolution of export information state in SMEs on their levels of international performance was consistent with the managerial perceptions. To this end, 24 semi-structured interviews were realized with French and Romanian SMEs' managers. Furthermore, based on the literature review and the preliminary qualitative investigation, a questionnaire was developed. The questionnaire was pre-tested with several scholars and 12 SMEs' managers in order to make sure that the questions were best understood by potential respondents. The final survey instrument, which was modified after the pre-test, was sent to the

managers of exporting SMEs from the steel industry. Data gathered (107 usable questionnaires) was exploited by means of descriptive analysis and allowed for a first general overview of the characteristics of companies in the sample in terms of AC and international performance levels. Furthermore, the PLS path modeling method has been retained to test the research propositions and subsequently the quality of the measurement instruments used to capture the constructs in the research model.

### *Results of the study*

Both qualitative and quantitative approaches have been used in order to answer the research question. The preliminary qualitative research aimed to check the consistency of the emitted theoretical assumptions with the managerial view. An additional aim of the qualitative study was the identification of the export information sources perceived as “rich” by SMEs’ export managers and which are used on a current basis by the latter. The qualitative study suggested that foreign clients and customers, agents, trade fairs, Chambers of Commerce and Industry, export market research and Internet are the main export information sources considered as “rich” by SMEs’ managers. The preliminary qualitative investigation provided as well insights into the reasons evoked by SMEs’ managers for explaining their preference in terms of export information sources. SMEs’ managers mainly mention information sources’ richness attributes, such as information reliability, contacts facility, and the interactivity with information sources for explaining why they prefer certain information sources instead of others. Regarding the use of export information, several ideas came out of the interviews: managers learn by means of responding to the acquired export information, they use information for undertaking export decisions and for grasping new business opportunities in export markets. In light of these findings, it can be concluded that elements from multiple theoretical frameworks can explain export information processing in SMEs (e.g. the organizational learning theory, the market orientation perspective, the entrepreneurial framework, or the decision-making theory). SMEs’ managers mainly acquire export information concerning clients and competitors. Besides clients and competitors, on a less extended scale, enterprises access marketing mix-related information and rarely general foreign market-related information.

The factors enhancing export information use according to the managerial vision were also investigated. Managers generally state that their previous foreign market knowledge and export experience helps them better exploit the new incoming export information. Furthermore, the efficiency of several information assimilation procedures, such as the coordination, communication, information transfer and integration, centralization and formalization were explored specifically. The coordination and the information transfer and integration procedures appear as barely formalized in SMEs. Most of the managers interviewed state that formalized information integration procedures are almost non-existent in SMEs. Coordination efficiency does not appear as a generic feature characterizing the SMEs

interviewed; in “bigger” SMEs, coordination is less efficient. When asked what drives them competitive in export markets, both French and Romanian managers interviewed mainly mentioned their competences in terms of product development and more largely the general export know-how of the company.

Overall, the findings of the qualitative research seem to confirm the theoretical assumptions mobilized for building the research model. More precisely, managers seem to support the idea that information flows nurture foreign market-related knowledge levels. They also believe that their levels of export experience determine their efficiency in terms of export information acquisition and assimilation. These empirical results are in line with Zahra and George’s (2002) assumptions that the access to information sources and the previous experience of firms are antecedents of their capacity to efficiently acquire and assimilate information. Furthermore, the role of information in designing organization response was widely supported by the interviews. Moreover, several managerial statements also show that firms seem to learn on the basis of the ongoing strategic or tactical actions implemented for responding to environmental shifts, and in this way build foreign market competences that finally seem to enhance their levels of performance in foreign markets. Resuming, the results obtained through the qualitative research support the idea of the influence of PACAP’s dimensions on RACAP relative to information use in response to foreign market shifts and competence building. Moreover, according to the managerial vision, it is finally their foreign market-related know-how that drives them competitive in foreign settings. As a result, the research proposition emitted concerning the impact of the positional advantage of SMEs in terms of foreign market-related competences on their degree of international performance seems to be consistent with the managerial vision.

Concluding, it can be suggested that overall the empirical results issued from the qualitative phase seem to support the research model built on theoretical ground. Nonetheless, because of the qualitative nature of the research, these results can be regarded as more suggestive rather than conclusive. The research propositions’ test has been realized by means of the quantitative research that has been further carried out. 107 usable questionnaires were obtained from exporting SMEs operating in the steel industry yielding a response rate of 19,10%. The quantitative study allowed for a descriptive basis of a general overview of the AC characteristics of companies in this sample and their international performance levels. The companies interviewed seem to be rather successful exporters, they are bigger and more internationally involved than the average company in the population and high levels of AC also characterize them.

PACAP’s antecedents appear as fairly developed. Very few “beginners” in exporting play a role in this sample. Most of enterprises in the sample operate in a relatively important number of foreign countries. SMEs interviewed employ mainly basic foreign presence modes to sell their products abroad such as

direct and indirect exporting. Nevertheless, one third of the companies use associative modes or have established subsidiaries abroad for exporting their products. More than half of the enterprises interviewed have an export department, which is testimony of their engagement towards the development of international activities in their company. This feature is also supported by the results attesting that companies interviewed register high levels of international orientation. Generally, an important number of employees are dealing with the development of their firms' international activities. The export experience of these employees, called "export employees", can be judged as rather "rich" in terms of complementarity, variety and length.

The richness of information sources they use in order to inform themselves concerning foreign markets appears generally slightly above-average concerning most of the relational information sources such as the clients, agents-distributors, and participation at trade fairs. Average levels of richness characterize Chambers of Commerce and Industry, export marketing research, and the Internet. The only information source registering richness levels below the average are competitors. As a result, it was concluded that they cannot be considered as a rich export information source and could not be further included for the research propositions test-related analysis.

Regarding the levels of PACAP of companies in the sample, they appear as fairly developed in terms of assimilation practices, they coordinate rather efficiently and they perform well in terms of knowledge transfer and integration. The export information acquisition dimension is less developed than the assimilation dimension. Companies interviewed are only slightly more informed concerning foreign markets, compared to their main competitors. They seem to privilege the collection of export information concerning foreign clients and product-related information.

In terms of RACAP, the SMEs interviewed score highly above-average in terms of export responsiveness capacity (information transformation dimension). They perform generally slightly above-average in terms of international marketing competences compared to their main competitors in foreign markets. They register the higher levels of positional advantage in terms of foreign networking competences and international product development, and the lowest levels of positional advantage for the international marketing management-related competences.

The descriptive results also allowed for an overview concerning the international performance levels companies attain in foreign markets. Responding managers appear rather satisfied with the evolution of the main export objectives over the past year, they perceive themselves as fairly competitive, and compared to main competitors in foreign markets, they rate themselves as slightly superior in terms of attaining export objectives abroad. Their progression in terms of export sales and profits over the last three years is important as well. Their foreign sales appear as slightly more profitable than the domestic ones.

The estimation of the causal relationships of influence with PLS path modeling (XLSTAT software) in this research model led to the validation of nine out of the ten research propositions composing the research model. The results suggest that the AC perspective of Zahra and George (2002) is an appealing and efficient framework for exploring the dynamics associated with export information processing in small firms and their impact upon SMEs' international performance levels. The three research propositions emitted with respect to the impact of PACAP's antecedents on PACAP are entirely supported. The richness of export information sources, the real export experience of SMEs, and the richness of the international experiences of export employees positively and significantly influence the efficiency of export information acquisition in small firms. The positive impact of PACAP upon RACAP has found as well empirical support. Export information acquisition and the assimilation practices, namely knowledge transfer and integration and coordination efficiency, determine the export responsiveness capacity of SMEs. In order of importance, the main determinant of the SME's export responsiveness capacity is the efficiency of knowledge transfer and integration practices followed by the coordination capacity of small firms and the richness of the export information sources. Regarding the impact of the determinants of the SMEs' positional advantage in terms of international marketing competences, a strong impact of the export responsiveness capacity of small firms can be observed. The results suggest that by means of responding and taking corrective action in order to better manage foreign market shifts, firms appear to build superior levels of positional advantage in terms of foreign market-related competences compared to their competitors. The real international experience of small firms also significantly and positively impacts the degree of positional advantage in terms of international marketing competences that SMEs achieve in export markets. Surprisingly, the richness of the export experiences of export employees does not have a significant influence upon the positional advantage in terms of international marketing competences. Finally, the impact of RACAP on the international performance of SMEs is highly significant. Detaining a positional advantage in terms of foreign market-related marketing competences drives firms to be more successful in international settings. This result suggests that the main KBV assumption is strongly validated by the current study. The exporting SMEs attain high levels of international performance if they achieve superior levels of positional advantage in terms of international marketing competences compared to their competitors in foreign settings.

# SUMMARY

<i>INTRODUCTION</i>	1
1 The relevance of the research question	2
1.1 Academic relevance	3
1.2 Managerial relevance	4
1.3 Relevance for policy-makers	5
2 Dissertation structure	5
<i>PART I. LITERATURE REVIEW</i>	7
CHAPTER I. THE IMPACT OF EXPORT INFORMATION UPON THE INTERNATIONAL PERFORMANCE OF SMEs. EMPIRICAL EVIDENCE	7
I.1 Defining exporting SMEs	8
I.1.1 SMEs' specificities	10
I.2 The empirical evidence concerning the link between export information and international performance	12
I.2.1 The scope of the review	14
I.2.2 Characteristics of the studies under review	15
I.2.3 The operationalization of the main constructs of the study: export information-related constructs and international performance	21
I.2.3.1 International performance measurement	21
I.2.3.2 Export information study and measurement	24
I.2.3.2.1 The operationalization of the most widely used measures for capturing information related activities	24
I.2.3.2.2 Proposing a classification of the different export information related measures	25
I.2.3.2.3 Taxonomies of export information acquisition and use	32
I.2.4 The link between international performance and export information	37
I.2.4.1 The relationship between export information sources (acquisition and use) and international performance	37
I.2.4.1.1 The relationship between export assistance and international performance	37
I.2.4.1.2 The relationship between export market research and international performance	39
I.2.4.1.3 The relationship between export market intelligence and international performance	40
I.2.4.2 The relationships between other measures used to capture export information related behaviors and international performance.	41
I.2.4.3 The relationship between the acquisition of different information elements on foreign markets and international performance	42
I.2.4.4 The studies examining the indirect relationship between information acquisition, its use and international performance	43
I.2.5 Discussion	49



I.2.5.1 Methodological shortcomings and future research avenues _____	49
I.2.5.2 Theoretical shortcomings and future research avenues _____	51
I.2.5.3 Operationalization shortcomings and future research avenues _____	51
I.2.5.3.1 Shortcomings in terms of international performance operationalization _____	51
I.2.5.3.2 Shortcomings in terms of export information acquisition and use operationalization _____	52
I.2.5.3.3 Shortcomings of the study of the relationship between the behaviors in terms of export information acquisition and use and international performance _____	55
<b>CHAPTER II. A SYNTHESIS OF THE MAIN THEORETICAL ADVANCES DESCRIBING THE</b>	
<b>RELATIONSHIP BETWEEN INFORMATION AND PERFORMANCE _____</b>	<b>59</b>
<b>II.1 Defining information _____</b>	<b>59</b>
II.1.1 Syntactic and semantic aspects of information _____	60
II.1.2 The distinction between information and knowledge _____	61
<b>II. 2 The main theoretical frameworks explaining the link between information and organizational performance _____</b>	<b>65</b>
II.2.1 Contingency theory _____	65
II.2.2 Decision-making theory _____	68
II.2.3 Resource based view of the firm _____	72
II.2.4 Entrepreneurial theoretical advances _____	74
II.2.5 Organizational learning theory _____	77
II.2.6 Market orientation theoretical advances _____	80
II.2.6.1 The two conceptualizations of organizational market orientation _____	80
II.2.6.2 From market orientation to market-based learning _____	81
II.2.6.3 Market orientation theoretical advances _____	84
<b>II.3 Critical analysis of the theoretical frameworks explaining the link between information and organizational performance _____</b>	<b>86</b>
II.3.1 Converging aspects of the theoretical frameworks reviewed _____	87
II.3.1.1 Information quality or richness _____	87
II.3.1.2 The organizational mechanisms necessary to improve information dissemination within organizations _____	88
II.3.2 Diverging aspects of the five theoretical frameworks reviewed _____	90
II.3.2.1 Main focus, organization's conceptualization and organizational performance sources _____	90
II.3.2.2 The different theses proposed on the relationship between information and organizational performance _____	91
II.3.3 Critical analysis of the theoretical frameworks reviewed _____	93
II.3.3.1 Towards an integrative theoretical framework over the impact of information activities on organizational performance _____	93
II.3.3.2 Absorptive capacity, a suitable perspective for looking at the relationship between information activities and organizational performance _____	100
<b>II.4 Absorptive capacity: a dynamic capability enhancing organizational performance _____</b>	<b>105</b>
II.4.1 Potential and realized absorptive capacity and their link to organizational performance _____	106

<b>CHAPTER III. THE RESEARCH MODEL DEVELOPMENT</b>	<b>112</b>
<b>III.1 The impact of PACAP's antecedents on the Potential Absorptive CAPacity (PACAP)</b>	<b>114</b>
III.1.1 The conceptualization of PACAP's antecedents and PACAP	115
III.1.1.1 PACAP's antecedents conceptualization	115
III.1.1.1.1 The exposure to rich export information sources	115
III.1.1.1.2 The previous international experiences of the firm	116
III.1.1.2 PACAP conceptualization	119
III.1.1.2.1 Export information acquisition dimension	119
III.1.1.2.2 Export information assimilation dimension	121
III.1.3 The impact of PACAP's antecedents upon PACAP development	125
III.1.3.1 The impact of SMEs' exposure to rich export information sources on export information acquisition	127
III.1.3.2 The impact of SMEs' international experiences richness on export information acquisition	128
<b>III.2 The impact of PACAP on RACAP (Realized Absorptive CAPacity) development</b>	<b>130</b>
III.2.1 RACAP conceptualization	131
III.2.1.1 Conceptualization of the transformation dimension of RACAP: the export responsiveness of SMEs	131
III.2.2.2 Conceptualization of the exploitation dimension of RACAP: the competitive advantage in terms of international marketing competences of SMEs	133
III.2.2 The influence of PACAP on RACAP	136
III.2.2.1 The impact of PACAP on the transformation dimension of RACAP	137
III.2.2.1.1 The impact of the export information acquisition on the export responsiveness of SMEs	137
III.2.2.1.2 The impact of the information assimilation on the export responsiveness of SMEs	138
III.2.2.2 The impact of SMEs' international experiences and export responsiveness on the exploitation dimension of RACAP	139
III.2.2.2.1 The impact of the international experiences of SMEs	140
III.2.2.2.2 The impact of the export responsiveness of SMEs	142
<b>III.3 The impact of RACAP on the international performance of SMEs</b>	<b>145</b>
III.3.1 The impact of RACAP's transformation dimension	146
III.3.2 The impact of RACAP's exploitation dimension	150
<b>CHAPTER IV. CONSTRUCTS OPERATIONALIZATION</b>	<b>155</b>
<b>IV.1 The antecedents of PACAP</b>	<b>155</b>
IV.1.1 Operationalization of the exposure to information sources	155
IV.1.2 Operationalization of the experiential dimension	158
<b>IV.2 PACAP dimensions</b>	<b>159</b>
IV.2.1 Operationalization of the information acquisition dimension	160
IV.2.2 Operationalization of the information assimilation dimension	162
<b>IV.3 RACAP dimensions</b>	<b>163</b>
IV.3.1 Operationalization of the transformation dimension of RACAP	163
IV.3.2 Operationalization of the exploitation dimension of RACAP	165
<b>IV.4 The dependent construct: the international performance of SMEs</b>	<b>166</b>
<b>IV.5 Operationalization of the control variables</b>	<b>168</b>

<b>CHAPTER V. RESEARCH METHODOLOGY</b>	<b>172</b>
V.1 The level of analysis: the firm	174
V.2 The results of the preliminary qualitative research	174
V.2.1 Results of the interviews realized with the Romanian enterprises	178
V.2.1.1 Export information acquisition	178
V.2.1.1.1 Information sources consulted on foreign markets	178
V.2.1.1.2 Export information elements acquired on foreign markets	182
V.2.1.2 Export information use	184
V.2.1.3 The factors enhancing export information exploitation (managerial perspective)	188
V.2.1.4 The practices enhancing export information use within firms	188
V.2.1.5 Proposition of a classification of Romanian enterprises based on their international experience	189
V.2.1.6 Other aspects	190
V.2.2 Results of the interviews realized with the French enterprises	191
V.2.2.1 Export information acquisition	191
V.2.2.1.1 Information sources consulted on foreign markets	191
V.2.2.1.2 Export information elements acquired on foreign markets	195
V.2.2.2 Export information use	197
V.2.2.3 The factors enhancing export information exploitation (managerial perception)	199
V.2.2.4 The practices enhancing information use within firms	200
V.2.2.5 Other aspects	202
V.2.3 General conclusions relative to the export information management by exporting companies from France and Romania. A comparative analysis	202
V.2.3.1 Export information acquisition	202
V.2.3.2 Export information use	205
V.2.3.3 The factors enhancing export information exploitation (managerial perspective)	206
V.2.3.4 The practices enhancing export information assimilation within firms	207
V.2.3.5 Other aspects	208
V.2.3.6 General conclusions impacting the research design	209
V.3 Questionnaire development	213
V.3.1 The “qualitative” questionnaire pre-test	214
V.3.2 The “quantitative” pre-test of the knowledge transfer and integration scale	221
<b>CHAPTER VI. QUESTIONNAIRE ADMINISTRATION AND DESCRIPTIVE RESULTS</b>	<b>226</b>
VI.1 Questionnaire administration	226
VI.2 Descriptive analysis of the results	229
VI.2.1 Sample description	230
VI.2.2 PACAP’s antecedents	232
VI.2.2.1 International experiences	232
VI.2.2.2 Export information sources richness	235
VI.2.3 PACAP levels	237
VI.2.3.1 Export information acquisition	237

VI.2.3.2 Assimilation practices _____	238
VI.2.4 RACAP levels _____	240
VI.2.4.1 Export responsiveness _____	240
VI.2.4.2 The positional advantage in terms of international marketing competences _____	242
VI.2.4 The levels of international performance _____	243
VI.2.5 The control variables _____	246
VI.2.6 Synthesis of the descriptive analysis _____	246
<b>VI.3 Measurement model validation _____</b>	<b>248</b>
VI.3.1 The psychometrical properties of the dependent variable: the international performance of SMEs _____	252
VI.3.2 Outer model estimation _____	263
<b>CHAPTER VII. RESEARCH PROPOSITIONS' TEST, CONCLUSIONS, LIMITATIONS, IMPLICATIONS AND FUTURE RESEARCH AVENUES _____</b>	<b>275</b>
<b>VII.1 Research propositions' test, results, discussion _____</b>	<b>275</b>
VII.1.1 The impact of PACAP's antecedents on PACAP _____	276
VII.1.1.1 The impact of the richness of export information sources upon export information acquisition _____	276
VII.1.1.2 The impact of the international experiences of SMEs upon export information acquisition _____	278
VII.1.1.3 Synthesis of the results of the research propositions concerning the impact of PACAP's antecedents upon PACAP levels of SMEs _____	279
VII.1.2 The impact of PACAP on RACAP _____	281
VII.1.2.1 The impact of the determinants of the transformation dimension of RACAP (SMEs' export responsiveness capacity) _____	281
VII.1.2.1.1 The impact of export information acquisition _____	281
VII.1.2.1.2 The impact of export information assimilation _____	282
VII.1.2.1.3 Synthesis of the results of the research propositions concerning the impact of PACAP upon RACAP's transformation dimension _____	284
VII.1.2.2 The impact of the determinants of the exploitation dimension of RACAP (the positional advantage in terms of international marketing competences of SMEs) _____	285
VII.1.2.2.1 The impact of the SMEs' international experiences _____	285
VII.1.2.2.2 The impact of the SMEs' responsiveness capacity _____	286
VII.1.2.2.3 Synthesis of the results of the impact of the determinants of RACAP's exploitation dimension	287
VII.1.3 The impact of RACAP on SMEs' international performance _____	289
VII.1.4 Global evaluation of the research model _____	290
<b>VII. 2 Conclusions, limits, research contributions and avenues for future research _____</b>	<b>295</b>
VII.2.1 The main objectives, main theoretical and methodological choices of the current research _____	295
VII.2.2 Synthesis of the results _____	297
VII.2.3 Research contributions and implications _____	306
VII.2.3.1 Theoretical contributions and implications _____	306
VII.2.3.2 Methodological contributions and implications _____	310
VII.2.3.3 Research contributions and implications for managers _____	311
VII.2.3.4 Research contributions and implications for policy makers _____	319

VII.2.4 Limits and future research avenues _____	321
VII.2.4.1 Theoretical limits and prolongations _____	321
VII.2.4.2 Methodological limits and prolongations _____	326
VII.2.4.2 Limits and prolongations related to the results of the research _____	328
<b>BIBLIOGRAPHY</b> _____	<b>332</b>

## LIST OF FIGURES AND TABLES

<i>Table 1. The measures used by the reviewed studies to capture the international performance construct</i>	22
<i>Table 2. Objective measures used to capture export information activities within the reviewed studies</i>	26
<i>Table 3. Subjective measure used to capture export information activities within the reviewed studies</i>	27
<i>Table 4. Hybrid measures used to capture export information activities used within the reviewed studies</i>	31
<i>Table 5. The main results of the reviewed studies with respect to the influence of firms' export information related activities upon export performance</i>	44
<i>Table 6. Summary of some of the distinctions operated between information and knowledge</i>	63
<i>Figure 1. Synthesizing the effect of information upon organizational performance according to contingency theory</i>	68
<i>Figure 2. Synthesizing the effect of information upon organizational performance according to the decision-making theory</i>	72
<i>Figure 3. Synthesizing the effect of information upon organizational performance according to the RBV of the firm</i>	74
<i>Figure 4. Synthesizing the effect of information upon organizational performance according to the entrepreneurial theoretical advances</i>	76
<i>Figure 5. Synthesizing the effect of information upon organizational performance according to organizational learning theory</i>	79
<i>Figure 6. The two approaches of market orientation</i>	81
<i>Figure 7. The process of organizational learning according to Slater and Narver (1995)</i>	82
<i>Figure 8. Sinkula et al.'s (1997) market-based learning model</i>	84
<i>Figure 9. Synthesizing the effect of information upon organizational performance according to the market orientation literature</i>	86
<i>Figure 10. The relationships between PACAP, RACAP and organizational performance</i>	108
<i>Figure 11. The main relationships between PACAP, RACAP and organizational performance</i>	114
<i>Table 7. Different conceptualizations of international experience according to the level of analysis</i>	118
<i>Figure 12. The influence of PACAP's antecedents on PACAP</i>	130
<i>Table 8. The international marketing competences of exporting SMEs</i>	135
<i>Figure 13. The influence of the determinants of the PACAP on RACAP</i>	145
<i>Figure 14. The influence of RACAP on SMEs' international performance</i>	152
<i>Figure 15. The research model</i>	153
<i>Table 9. The perceived importance of information sources of French SMEs from the steel industry</i>	156
<i>Table 10. The operationalization of the richness of export information sources</i>	157
<i>Table 11. International experiences' richness operationalization</i>	159
<i>Table 12. Export information acquisition dimension operationalization</i>	161
<i>Table 13. Information assimilation operationalization</i>	163
<i>Table 14. RACAP's transformation dimension operationalization: the export responsiveness capacity of SMEs</i>	164
<i>Table 15. RACAP's exploitation dimension operationalization: the positional advantage of SMEs in terms of international marketing competences</i>	165
<i>Table 16. The operationalization of the SMEs' international performance</i>	167
<i>Table 17. Operationalization of the control variables</i>	168

<i>Table 18. Operationalization of the main groups of constructs mobilized within the research model: PACAP's antecedents, PACAP, RACAP and the international performance of SMEs</i>	169
<i>Table 19. Synthetic presentation of the Romanian interviewees and their enterprises</i>	177
<i>Table 20. Export information sources mentioned by the Romanian interviewees</i>	182
<i>Table 21. Overview of the export information state of Romanian enterprises interviewed</i>	183
<i>Table 22. Information use and factors enhancing information use in Romanian SMEs</i>	187
<i>Table 23. Synthetic presentation of the French interviewees and their enterprises</i>	192
<i>Table 24. Export information sources mentioned by the French managers</i>	195
<i>Table 25. Overview of the export information practices of French SMEs</i>	196
<i>Table 26. Information use and factors enhancing information use in French SMEs</i>	201
<i>Table 27. Recapitulative table of the changes undertaken within the questionnaire after the "qualitative" pre-test</i>	219
<i>Table 28. Knowledge transfer and integration scale, PCA</i>	222
<i>Table 29. Constructs operationalization after the pre-test</i>	223
<i>Table 30. Ranges of enterprise sizes in this sample compared to the population</i>	230
<i>Table 31. Ranges of export sales percentages in this sample compared to the population</i>	231
<i>Table 32. Foreign presence modes used by the SMEs</i>	234
<i>Table 33. Export experience richness of the "export employees"</i>	234
<i>Table 34. Export information source richness</i>	236
<i>Table 35. Export information acquisition levels</i>	237
<i>Table 36. Coordination practices</i>	238
<i>Table 37. Knowledge transfer and integration</i>	239
<i>Table 38. Export responsiveness, descriptive analysis</i>	241
<i>Table 39. Positional advantage in terms of international marketing competences</i>	243
<i>Table 40. The satisfaction with the evolution of the export objectives over the last year</i>	244
<i>Table 41. Perceived competitiveness in terms of evolution of the export objectives over the last year</i>	244
<i>Table 42. Perceived relative competitiveness in terms of evolution of the export objectives over the last year</i>	245
<i>Table 43. The international orientation levels of SMEs in the sample</i>	246
<i>Table 44. Comparison of the co-variance and variance-based SEM</i>	250
<i>Table 45. Scales validity and reliability, convergent and discriminant validity</i>	254
<i>Figure 16. CFA of the three reflexive constructs measuring the perceived satisfaction, competitiveness and relative competitiveness of SMEs</i>	254
<i>Table 46. Exploratory PCA of international performance construct (on the items composing the LVs)</i>	255
<i>Table 47. The main psychometrical properties of the LV "the perceived strategic international performance of SMEs"</i>	259
<i>Table 48. Psychometrical properties of SMEs international performance (formative) construct</i>	260
<i>Table 49. Exploratory PCA on the international performance indicators</i>	261
<i>Table 50. Exploratory PCA on the international performance indicators</i>	262
<i>Table 51. Abbreviations used for the MVs used to capture the LVs in the research model</i>	265
<i>Table 52. Recapitulative table of the main psychometrical properties of the reflexive LVs in our research model</i>	270
<i>Table 53. Psychometrical properties of the second order construct the richness of export information sources</i>	272
<i>Table 54. Discriminant and convergent validity assessment</i>	273
<i>Table 55. The impact of the richness of export information sources on export information acquisition</i>	277

<i>Table 56. The impact of the real international experience on export information acquisition</i>	278
<i>Table 57. The impact of the international experiences richness of "export employees" on export information acquisition</i>	279
<i>Table 58. Recapitulative table of the structural paths of influence of the impact of PACAP's antecedents upon export information acquisition</i>	280
<i>Table 59. The impact of export information acquisition on SMEs' export responsiveness</i>	282
<i>Table 61. The influence of the coordination efficiency on SMEs' export responsiveness</i>	283
<i>Table 62. Recapitulative table of the structural paths of influence of the impact of PACAP on RACAP's transformation dimension</i>	284
<i>Table 63. The impact of the real number of exporting years on SMEs' positional advantage in terms of international marketing competences</i>	285
<i>Table 64. The influence of the richness of the international experiences of "export employees" upon the positional advantage of SMEs in terms of international marketing competences</i>	286
<i>Table 65. The influence of export responsiveness of SMEs upon their positional advantage in terms of international marketing competences</i>	287
<i>Table 66. Recapitulative of the structural paths of influence of the determinants of RACAP's exploitation dimension</i>	288
<i>Table 68. Recapitulative of the validation of the research propositions</i>	290
<i>Table 69. Recapitulative table of the main characteristics of the international performance model assessment</i>	293
<i>Table 70. GoF indexes for the research model</i>	294



# INTRODUCTION

The emergence of globalization and knowledge management seems to be the result of the increasing complexity of the new business environment, where worldwide exportation accounts for more than 10% of global economic activity (International Monetary Fund 2001; World Bank 2001). It is worth to be noted that world trade has increased 16-fold between 1950 and 2000, and international trade flows relative to GDP (Gross Domestic Product) have doubled between 1970 and 2000 (OECD 2005). As a result, exportation has become worldwide a major source of national income, as well as a source of growth and survival for many micro, small, medium, and large enterprises. This phenomenon is especially preponderant in Europe, where the political evolutions seem to enhance the internationalization of enterprises. European firms are confronted with both opportunities and threats due to the suppression of commercial barriers and the emergence of Eastern European countries over the last years. The introduction of new markets to conquer can be seen as an opportunity, while human resources that are well trained at a low cost could pose as a threat. Because of the new countries entering into the European Union, European enterprises will be further exposed to international competition. Regardless of size, European enterprises will have to revise their priorities and deeply modify their organization and ways of functioning because the increase of competition in the European market. Nowadays, these reasons force the exporting SMEs (small and mid-sized enterprises) to learn faster and adapt more efficiently to the continuously changing business environment. The continuously decreasing costs of transports and communication enhance as well the SMEs' international development (Knight and Cavusgil 1996). Thus, the SMEs count on the penetration of foreign markets in order to assure their development or their very survival in the new market environment, which is increasingly more complex and dynamic. As a result, firms must increase their ability to gather information in order to react appropriately to environmental changes (Conant *et al.* 1990).

In a global economy, the capacity to manage information and knowledge related to foreign markets is believed to be of utmost importance. As Czinkota (2000, p. 22) suggested: “*information and its management is even more important in the international setting, where entirely new parameters and environments are encountered*”. This proposition especially holds true for SMEs; they are more sensitive to changes of economical-political order due to their lack of resources, information, knowledge and qualified personnel (e.g. Holmlund and

Kock 1998; Riddle and Gillespie 2003). As a result, for SMEs one of the most widely cited barriers to export is the lack of access to export information concerning the export process, procedures and paperwork, general foreign market information, as well as potential clients or suppliers (e.g. Bell 1992; Dichtl *et al.* 1994; Moini 1995). Moreover, information is increasingly becoming a component in product fabrication at the same level as technical development or raw materials. Even though scholars unanimously recognize the key role of export information in achieving international performance, a relatively reduced number of empirical studies exist on the subject. However, the evidence from the empirical studies undertaken until now is frequently contradictory and no clear conclusions can be drawn with respect to the impact of firms' export information activities on their levels of international performance. Scholars like Souchon *et al.* (2003) have stressed the fact that multiple methodological and theoretical shortcomings characterize this research field, and that "*while our understanding of information use has certainly increased since the 1980s, little evidence exists of the relationship between utilization of information when making marketing decisions and business performance*" (Souchon *et al.* 2003, p. 1). Thus, the purpose of this dissertation is to further explain and get additional insights into the relationship existing between the evolution of the export information state of exporting SMEs and the level of performance they achieve on international markets. Within the next section, the relevance of the research question, namely the relationship existing between the evolution of the export information state of exporting SMEs and the level of performance they achieve on international markets, is discussed.

## 1 The relevance of the research question

Increased globalization of trade has led a growing number of firms to search beyond their traditional domestic markets and focus on high-growth export markets not only to expand but also to ensure their very survival. As a result, the role of exporting in a firm's activities has become increasingly important. Its recognition is reflected by the fact that the area of export information behaviors of firms and their impact on export performance has been gaining increased attention among policymakers, academics, and managers.

## 1.1 Academic relevance

Export performance is now, more than ever, of academic relevance. However, little is still known about the determinants and the measurement of export performance. However, the definition and the study of the determinants of export performance (e.g. Samiee and Anckar 1998; Cavusgil and Kirpalani 1993; Sousa and Alserhan 2002) or factors contributing to export performance have received notable research attention (e.g. Aaby and Slater 1989; Cavusgil and Zou 1994; *Zou et. al* 1998; Sousa 2004). Scholars are still far from a basic agreement among each other. The impact of export information state of firms on their levels of international performance remains a topic that is not overly explored (Ramangalahy 2001). Most scholars state that an effective method for reducing perceived risk and creating a greater feeling of security regarding foreign markets is the acquisition and use of foreign market information about environmental conditions, market characteristics, and marketing mix elements (e.g. Johanson and Vahlne 1977, 1990; Leonidou and Katsikeas 1997). This dominant assumption of the export information literature stems from the Galbraithian view of information as an uncertainty reducer. Indeed, most of the scholars seem to agree upon the crucial role of export information. Information collection provides a means of detecting opportunities and threats in foreign markets (Moorman 1995) and more generally for reducing uncertainty and risk inherent to the internationalization process (McAuley 1993; Hart and Tzokas 1999). Information assists firms in improving marketing expertise, enhances international customer orientation, adopting market driven strategies, and ultimately achieving positional advantage (Seringhaus 1987; 1933). Additionally, information is crucial in designing, implementing, and monitoring successful export marketing policies and planning (Diamantopoulos *et al.* 1990; Souchon *et al.* 2003). Export information is widely believed to impact the export performance of companies (e.g. Denis and Depelteau 1985; Kleinschmidt and Ross 1986; Seringhaus 1993; Souchon and Diamantopoulos 1999; Souchon and Durden 2002; Julien and Ramangalahy 2003; Andersen 2006).

Notwithstanding the importance of export information activities and their overall recognized impact upon the international success of companies, this stream of literature received disproportionately little empirical interest (Leonidou and Katsikeas 1997). Academics have begun to explore the export information activities of enterprises and their relationship with international performance since the seminal work of Johanson and Vahlne (1977) and Reid (1981). In spite of the growing research interest, very little is still known about this topic.

Therefore, more research in the field is needed and this dissertation aims to respond to this need.

## 1.2 Managerial relevance

From the managerial point of view, export performance is considered as an important tool to boost corporate growth, ensure company survival, and strengthen competitive edge in a highly competitive international marketplace (Samiee and Walters 1990; Terpstra and Sarathy 2000). The literature on export barriers reveals that managers perceive the lack of information and knowledge as a major barrier for expanding in foreign markets (e.g. Leonidou 1995; Leonidou and Adams-Florou 1999; Leonidou 2004).

From the managerial standpoint, the first aim within this study is to provide a detailed description of the characteristics of French SMEs in terms of export information and knowledge management practices, their level of competences, export implication and export performance. This overview could help SMEs' managers evaluate their company in comparison to their domestic competitors in export markets. In addition, through this study, it is aimed to provide recommendations for SMEs' managers regarding how to efficiently manage export information activities for creating international market-related knowledge and competences, which they lack so frequently.

The study also seeks to evaluate the impact of a large number of international performance determinants and their dynamics upon SMEs' levels of foreign market performance. Based on the results of the study, SMEs' managers can better understand which are the mechanisms that drive them successful in foreign markets operations. Moreover, they can decide how to manage their foreign markets' operations in order to achieve higher levels of international performance. More precisely, they could get additional insights into how to manage the export information search activities, their level of international marketing competences, the internal mechanisms of adjustment of the organizational structure to foreign markets operations, or their levels of international responsiveness, etc.

Finally, the current research combines both quantitative and qualitative methodologies. Exporting SMEs' managers can gain additional insights through the qualitative study concerning the way their domestic competitors more broadly approach the way they do business abroad, why they prefer some export information sources to others, and how they conceive the improvement and sustainability of their international activities.

### 1.3 Relevance for policy-makers

Nowadays, all governments in the world are concerned with increasing exports for improving the commercial balance as well as sustaining economic growth and development. Thus, almost every government in the world creates support development programs at the national and regional level for enhancing training and providing information or financial aid for supporting the exporting activities of firms (Gencturk and Kotabe 2001). As a result, the study of the impact of SMEs' export information state upon their levels of export performance should have strong implications for policy-makers. They could gain insights within the determinant factors for SMEs' international performance and design more suitable support programs for enhancing knowledge and information management within SMEs.

## 2 Dissertation structure

Beyond the introduction, this dissertation is organized into two parts and seven chapters.

### ***First part: Literature review***

The first part presents the literature review composed of three chapters.

In chapter I, exporting SMEs are defined. Second, a critical literature review of the empirical research work undertaken on the impact of export information activities upon the firms' international performance levels along with presenting several propositions of future research directions in the field are presented.

Chapter II begins by defining information. Chapter II then proceeds to describe the main theoretical frameworks, namely contingency theory, decision-making theory, organizational learning theory and market orientation theoretical advancements, resource based view (RBV) of the firm, and entrepreneurial field theoretical advancements, explaining the link between information and organizational performance. Next, a discussion around the common and divergent points of the reviewed theories is realized along with a critical analysis of the forces and weaknesses of the reviewed theories when approaching the relationship between a firm's information processing activities and organizational performance.

In the fourth part of chapter II, the main perspectives approaching information conceptualization are presented. The only perspective approaching information activities under a managerial angle and at the firm level appears to be the absorptive capacity of information (Cohen and Levinthal 1990). Lastly, in the fifth part of chapter II, based on Zahra and George's (2002) article, a generalized business performance model linking the absorptive capacity concept to business performance is proposed. The main research propositions are emitted.

Within Chapter III, the research model is developed. The generalized business performance model, inspired from Zahra and George's (2002), is adapted in the case of exporting SMEs while taking into account their structural and behavioral specificities. The measurement scales used in order to capture the main constructs within the research model are presented in Chapter IV.

### ***Second part: research methodology and results of the study***

Three chapters describing the research methodology, the results and conclusions, along with the implications, the limits and future research avenues of the study compose the second part of the dissertation.

In the first part of chapter V, the choice of the level of analysis and the methodology employed is explained. In the second part of chapter V, the results of the qualitative interviews undertaken with exporting SMEs managers are presented. In the third part of chapter V, the results of the questionnaire pre-test are reported.

Chapter VI describes the results of the quantitative study undertaken with exporting French SMEs from the steel industry. First, the descriptive analysis of the enterprises interviewed is presented. Second, the validation of the measurement scales used for capturing the main constructs comprised within the research model are presented.

In chapter VII, the test of the research propositions is exposed along with the presentation of the conclusions, limits, implications, and prolongations of the study.

# PART I. LITERATURE REVIEW

## CHAPTER I. THE IMPACT OF EXPORT INFORMATION UPON THE INTERNATIONAL PERFORMANCE OF SMEs. EMPIRICAL EVIDENCE

### **Introduction to Chapter I**

Increased globalization has led a growing number of firms to search beyond their domestic markets and focus on high-growth export markets not only to expand, but also to ensure their very survival. The key role of export information is widely believed to assist them in their international expansion and have impact upon the export performance of companies (e.g. Denis and Depelteau 1985; Kleinschmidt and Ross 1986; Seringhaus 1993; Souchon and Diamantopoulos 1999; Souchon and Durden 2002; Julien and Ramangalahy 2003). The empirical literature focusing on the link between international performance and the export information processing in organizations dates back to the 1980's. Since then, relatively numerous studies on this topic have been published. However, in spite of these research efforts, not only is there is a lack of synthesis of this stream of literature, but also a lack of agreement in the conceptualization and operationalization of export information processing behaviors of firms.

This chapter reviews the literature focusing upon the relationship between export information and export performance based on 37 empirical studies published since the pioneering work of Rosson and Ford (1982). The chapter is organized in five sections.

First, exporting SMEs are defined and their managerial and information behavior specificities are presented. Furthermore, an introduction will present the criteria used for a study to be eligible for inclusion in the current review of literature as well as the review methods. The descriptive properties of the 37 studies selected are summarized and evaluated along four dimensions: (1) fieldwork characteristics (country of study, industrial sector, and firm size), (2) sampling and data collection (sample size, data collection method, response rate, non-response bias, key informant, and unit of analysis), (3) statistical analysis and (4) theoretical considerations (the use of a grounded theory for building the research model and the use of research hypothesis or propositions).

Third, export information and export performance measures employed in the literature are analyzed. The fourth section includes findings of the studies reviewed with respect to the relationship existing between export information behaviors and international performance. Lastly, in the fifth section, the findings are discussed in detail along with directions for future research.

## I.1 Defining exporting SMEs

Before getting any further into the current dissertation, the exporting SME must be defined. The SME concept in itself is a controversial subject of discussion among researchers and policy makers. For this reason, it is important to delineate SME's definition from the beginning. The literature provides a wide plethora of possible definitions of SMEs but no common agreement exists yet among scholars or policy-makers. Nonetheless, two main types of criteria can be retained to define SMEs: (1) quantitative or objective and (2) qualitative or subjective. The quantitative criteria can be expressed in terms of the number of employees, amount of wages and salaries paid to the personnel, total fixed assets, total capital, and total sales (Turker and Kavut 2004). The qualitative criteria may be expressed in terms of the independence of the management (whether the owner and the manager are the same person), the extent of the property rights of the owner or manager, centralization in terms of decision-making, the negotiation power of the enterprise in supplies and sales, and the risks level taken by the owner of the enterprise (Turker and Kavut 2004). It is worth noting that quantitative criteria use prevails over the qualitative criteria, which are less employed by academics. However, quantitative criteria are not the same across countries, industrial sectors, and governmental programs (Turker and Kavut 2004). The most widely used qualitative criteria generally reflect the property rights over the enterprise or the centralization in terms of decision-making. Guilhon (1998) proposed the controllability criteria in order to distinguish SMEs from large organizations. Filion (1990) observed that operating a choice between choosing qualitative and quantitative criteria should be done with respect to the context of reference of the studies.

Eurostat and the majority of the European countries consider enterprises with less than 250 employees to be an SME. In 2003, the European Union (E. U.) actualized the definition of SMEs. According to the recommendation n° 2003/361/CE, an SME represents any enterprise with less than 250 employees and a turnover of less than 50 million euro or a balance sheet not exceeding 43 million euro per year (Journal Officiel de l'U. E. 2003). Among the SMEs, the E. U. further distinguishes the difference between micro-enterprises and small enterprises. A micro-firm has less than ten or ten employees and a balance sheet of less than two million euro. A small enterprise has less than 50 employees and a balance sheet with less than ten million euro (Journal Officiel de l'Union Européenne 2003).



When it comes to the definition of exporting SMEs, different concepts are used within the literature to indicate companies that extended their activities of production and/or sales beyond the national borders. The notion of “*exporting SMEs*” can be seen as a rather common expression used in the literature for referring to SMEs that develop international activities under various direct and indirect modes of presence abroad (Doole and Lowe 2004; Muehlbacher *et al.* 2006) such as direct or indirect exporting, franchising, licensing, piggy-backing, joint ventures, strategic alliances or by creating subsidiaries abroad, etc.

Nevertheless, direct or indirect exporting constitutes the essential form of the SMEs’ implication abroad (e.g. Bell *et al.* 1992; Bell 1995; Coviello and McAuley 1999; Kuivalainen and Bell 2004). Several scholars specify that exporting refers to the sale of products and/or services beyond national borders under two main forms that include direct and indirect exporting (e.g. Miesembock 1988; Young *et al.* 1989). Direct exporting requires a greater implication of the exporting company and is accompanied consequently by a level of higher risk and a higher control over the development of the international activities (Walliser 2002; Muehlbacher *et al.* 2006). Indirect exporting, on the other hand, implies the use of intermediaries (e.g. agents, representatives, distributors) that ensure the setting in the foreign market. Indirect exporting implies less risks but also less control over the international activities of the company.

In the actual European business environment, it becomes increasingly difficult to define what exporting actually means. This difficulty is due to the suppression of borders and duties between the E. U. member countries. For example, the question may arise whether it is more psychologically difficult for a French Alsatian enterprise to conduct business with a bordering German enterprise or one from the south of France. The south of France, although still French, may be more culturally quite different. Thus, for a company located in one of the border regions of France, it could be more difficult to work with a company from the south of France than with a German one. Often times, bordering countries have strong cultural similarities and people living in bordering regions speak the language of the two bordering countries.

During the current dissertation, the exporting SME is defined as an independent company and not the subsidiary of a larger company, with a maximum of 250 employees that realizes sales beyond national borders directly or indirectly.

Micro-firms, which consist of one to ten employees, have not been considered in this research. Numerous studies have emphasized the fact that these firms are less active in undertaking export information acquisition and use activities. Moreover, a firm’s small size

grants it specific characteristics because of the increased importance of the owner or manager's role in comparison to bigger firms (Torres 2003). Management in micro-firms is generally qualified as highly centralized, even personalized, depending on the entrepreneur's personality, values, psychological profile, and vision. All of these characteristics are seen through various facets of the daily management of a micro-company. Management style is traditional and conservative using short-term strategies that are rooted in a strong local economy (Auvolat 1999). Micro-firms are characterized by the dominance of the relationship between the owner and his company (Kotey and Meredith 1997), the convergence of functions, the preponderance of the intuitive management (Torrès et Plane 2003), and a subjective business perspective (Gueguen 2001). In regards to the flow of information within micro-firms, it tends to be naturally efficient and informal. Managers of micro-firms generally act under a "*proximity perspective*", exporting to geographically close countries, developing "*glocal*" activities (Johanisson 1994) and co-existing in "*internationalizing milieus*"<sup>1</sup> (Torrès 1998; Fourcade et Torrès 2001) where the proximity represents an inherent component in the definition of their export strategy. They also seem to rather react to the pressure of the surrounding environment instead of proactively coping with it, as their bigger counterparts are able to do (Gundolf 2004). Moreover, they inform themselves on foreign markets by means of "*weak ties*" which are close personal contacts (Torres 2003). For these reasons, micro-enterprises have been excluded from this analysis.

In conclusion, the current dissertation refers to exporting SMEs as independent firms (they are not subsidiaries of a bigger company). They are comprised of anywhere from 11 to 250 employees and have sales beyond the national borders either with or without the help of intermediaries.

### 1.1.1 SMEs' specificities

Some scholars seem to indicate that with present day Information and Communication Technology (ICT) advancements, SMEs are beginning to resemble large enterprises (e.g. Leyronas and Torres 1996; Boutary and Monnoyer 2005; Boutary 2007). Nevertheless, most of the scholars agree that SMEs present specific features related to their organizational structure (e.g. Welch and Young 1982; Lang *et al.* 1997; Torrès 2003). Centralization of decision-making (Julien 1993, 1994; Brouthers *et al.* 1998; Torrès 1999), low formalization

---

<sup>1</sup> Free translation from the French "milieux internationalisants"

(Julien 1994; D'Amboise 1995; Torrès 2000; Gueguen 2001; Torrès 2003), and scarcity in terms of resources and competences (D'Amboise 1995) seem to characterize most of the SMEs. The small size, centralized management (Julien 1990; 1994; 1998) and a low level of labor specialization (Marchesnay 1991; Mahé de Boislandelle 1996) characterize as well SMEs. They are simple, informal structures and they use direct internal and external information systems (Boutary 2000). SMEs' strategies are intuitive, implicit, and short-term oriented (Torrès 2004). Communication is generally effective and barely formalized within these enterprises (Julien 1998; Torrès 2004) and information systems are very basic (Bili and Raymond 1993; Lang *et al.* 1997; Boutary 1998, 2000).

Frequently, within the manufacturing industries, SMEs are confined to sub-supplying to several main clients. Sub-supplying partly explains their scarce diversity in roles' definition; managerial team members are generally polyvalent (Julien 1994; Machat 2003), assuming more functions at the same time. In SMEs, export departments frequently do not exist. It is generally the production or the marketing manager who deals with exporting activities. Due to the small size of an SME, the hierarchical distance is reduced (Machat 2003) and that explains the reduced number of employees dealing with information activities in SMEs. The main disadvantage, however, is that only a reduced number of people exchange points of view around the acquired information, therefore reducing information redundancy (Inkpen 1996). These features have implications for the information processing and the learning process in SMEs.

After drawing a generalized picture of SMEs' specificities and information behavioral patterns, the second part of this chapter will further discuss the results of the studies dealing with the relationship between SMEs' export information behaviors and the levels of international performance they attain in foreign markets.

## 1.2 The empirical evidence concerning the link between export information and international performance

The research work that focuses more generally on a firm's export information behavior began in the 1960's (Ramangalahy 2001). Furthermore, in the 1970's, two important publications were initiated by Keegan (1974) and Johanson and Valhne (1977). Since then, several studies have been carried out, attempting to describe different aspects related to export information behaviors of enterprises and their link with international performance, and/or the contingency factors affecting the export information acquisition and use behaviors.

The pioneering study of Keegan (1974) was qualitative by nature and it aimed to conceive taxonomies of export information elements and export information acquisition modes. Additionally, other qualitative studies have been developed in the field. For example, Souchon and Diamantopoulos (1997) developed a taxonomy capturing firms' behaviors in terms of export information use. Andersen (2006) also designed a qualitative study within the export information field for exploring the outputs of personal contacts as an information vehicle for acquiring information on export markets. Nevertheless, to the best of our knowledge, no qualitative study was carried out until recently in order to explore the relationship between SMEs export information activities and their levels of international performance. The field of research is strongly "*quantitative*". The fact can be explained by the causal nature of the research question. Nonetheless, qualitative studies on the topic might have been useful in order to reveal dynamics related to the process of acquisition and use of export information by firms that are more difficult to capture within quantitative studies.

The research stream, covering the empirical (quantitative) contributions that explore the relationship between SMEs' export information behaviors and international performance goes back to the pioneering work of Rosson and Ford (1982), followed by Cavusgil (1984a, 1984b), Denis and Depelteau (1985), and Kleinschmidt and Ross (1986).

Within this next section, the studies dealing with the impact of firms' export information activities upon their levels of international performance are reviewed. Thirty-seven studies were identified on this topic. Among the 37 studies, only 16 studies focus specifically on the impact of firms' export information activities on the international performance level. The rest of the studies approach the firms' export information activities as a part of a broader research

topic. Some general tendencies in terms of export information behaviors can be reported as characterizing SMEs.

The literature dealing with this specific field has often highlighted the preference of SMEs' managers for informal export information sources acquired by means of direct observations and discussions (Fann and Smeltzer 1989; Fallery 1983): "*small companies function by means of dialogue or direct contact*" (Julien 1998, p. 35). Indeed, SMEs managers seem to prefer more personal, oral and abstract information sources (Daft *et al.* 1988; Smeltzer *et al.* 1988; Bruschi 1992). The use of the social network for business purposes by managers is a stepping stone, ensuring the efficiency of the collaboration among enterprises (Froelicher 1999). In addition to being easy to contact, personal information sources are perceived as more credible and allow for the exchange around the collected information. Therefore, SMEs mainly possess qualitative information (D'Amboise 1995; Vidal 2003) and they mainly use their personal contacts in order to gather it. Generally, empirical research indicates that SMEs limit their activities of information acquisition to the immediate environment and more specifically to the market, competition, and technology (Brusch 1992; Daft *et al.* 1988; Johnson and Kuehn 1987; Smeltzer *et al.* 1988). The most popular information sources include customers, suppliers, agents or distributors, employees, friends, competitors, newspapers, bankers, accountants and reviews of businesses (Fann and Smeltzer 1989; Hartman *et al.* 1994; Johnson and Kuehn 1987). The empirical studies also report that the information management process is minimally developed or formalized in SMEs (Brusch 1992; Raymond and Lesca 1995). The collection, analysis, and diffusion of information rely on the manager (Julien *et al.* 1999) and it is ensured by means of mechanisms of mutual adjustment. In small companies, the owner or director mainly gathers information by means of dialogue and direct contact with members of the staff as well as with his clients and suppliers, thus gaining direct knowledge of their needs and tastes, or explaining the different aspects of his products (Julien 1998). The information systems are simple because they are based on close physical proximity between the SMEs' managers and the main leading players in the environment.

Regarding information systems implementation in SMEs, Lang *et al.* (1997) and Vidal (2003) noticed that small firms use less sophisticated information systems. Information systems in SMEs context appear undersized and they need to be improved for successfully operating in foreign markets (Alvarez 2004). This characteristic is often interpreted as a consequence of the little interest SMEs' executives generally express concerning the strategic value of information (Chapellier 1995).

In foreign markets, SMEs' information behaviors do not differ much from the way they approach domestic markets. Smaller firms are consistently less active in gathering primary export market data than larger firms (Samiee and Walters 1990). Compared with larger firms, the information generation possibilities of export managers in SMEs are more limited. SMEs favor the use of networking and personal contacts over more formalized export information techniques as, for example, marketing research (e.g. Reid 1984; Samiee and Walters 1990; Seringhaus 1993; Crick *et al.* 1994; Boutary 1998; Hodgkinson and McPhee 2002; Andersen 2006). SMEs use national information sources rather than foreign information sources in order to inform themselves concerning foreign markets states (Hodgkinson and McPhee 2002; Voerman 2003). Export information is often gathered through personal contacts (Denis and Depelteau 1985), relying on the mutual interest supported by the exchange of information between firms (Uzzi 1999; Andersen 2006).

In the light of the statements above, it can be concluded that focusing on the relevance of more formal information techniques has little relevance in the case of the SMEs. With respect to the impact of export information practices upon their levels of export performance, it also appears that using less formalized information procedures are generally beneficial for the success of SMEs in foreign markets (Ramangalahy 2001). With respect to the information elements enterprises gather on foreign markets (e.g. information related to the general market characteristics, competition, clients, etc.), results are quite mixed. Relatively little is known about the impact of the organizational export information use on international performance (Souchon and Durden 2002). In order to get a deeper insight as to the influence of firms' export information behaviors, within this next section, the studies dealing with the impact of firms' export information activities on their levels of international performance are reviewed.

### **1.2.1 The scope of the review**

The review focuses on the empirical literature published between 1982 and 2008 that explores the relationship between firms' export information behaviors and export performance. To the best of knowledge, no important research work was undertaken before 1982 on the topic.

For the inclusion in the present literature review, the studies that met the following four criteria were considered: (1) the examination of firms engaged in exporting, (2) the approach of exporting from a micro-business perspective, (3) the study of the link between export performance and export information behaviors either as a primary objective or as part of a

wider research problem and (4) the empirical nature of the study, data analysis report and statistical tests.

Recall that to the best of knowledge, no notable publications on the impact of firms' export information activities on their levels of export performance using qualitative methodology was undertaken that have appeared in non-English or non-French publication outlets. The non-English or non-French publications have not been taken into account because these publications are not included in electronic data bases and foreign language skills are necessary to be able to read these publications.

The studies included in this literature review were identified by combining electronic and manual/bibliographic search methods. They led to the identification of 37 studies, yielding a sufficient sample for review purposes according to Sousa (2004). These studies were published in some of the most established journals in marketing and international business including: the Journal of Small Business Management (5 articles), the Journal of International Business Studies (5 articles), the International Marketing Review (4 articles), the Journal of International Marketing (2 articles), the Journal of Euromarketing (2 articles), the International Business Review (2 articles), and the Journal of Global Marketing (2 articles). One article in each of the following reviews were also used: Entrepreneurship, Theory and Practice, FACEF PESQUISA, Journal of Strategic Management, Journal of Strategic Marketing, Journal of Marketing Management, R&D Management, Research in Marketing, Decision Sciences, European Business Review, International Journal of Management, Journal of Management, Small Business Economics, Journal of Asia Pacific Marketing and Revue Internationale des PME. Three doctoral dissertations undertaken on the topic were also included in the present literature review from the Netherlands, Canada and France. Two of the authors of the dissertations published more journal articles resuming their work, namely Boutary (1998, 2000) and Voerman (2003). Thus, both the dissertation and the journal publication were cited. Nonetheless, they were considered as a single study since the theoretical and empirical content reported in the article is very similar to the dissertation.

## 1.2.2 Characteristics of the studies under review

As the findings of empirical studies tend to be idiosyncratic according to the research methodology (Leonidou *et al.* 2002), it is essential to examine the methodological aspects of the studies included in this review. The design of our literature review is inspired from

Sousa's (2004) literature review on the international performance measurement for describing the characteristics of the studies reviewed. Similar to the study conducted by Sousa (2004), the studies were evaluated in terms of: (1) fieldwork characteristics (country of study, industrial sector, and firm size), (2) sampling and data collection (sample size, data collection method, response rate, non-response bias, key informant, and units of analysis), (3) statistical analysis, and also added are (4) theoretical considerations (the use of a grounded theory for explaining the research model and the use of research hypothesis or research propositions). Table 1 from Appendix 1 summarizes the descriptive properties of the 37 studies selected for review purposes.

It is worth to note that the analysis was not exclusively limited to the studies undertaken on SMEs (as defined in the previous section I.1) for mainly three reasons. The first reason is that there are not many studies conducted in the field. The second reason is that even though they did not specifically aim to focus on SMEs, it can be observed from the sample composition that there are mostly SMEs in each sample of the reviewed studies. The third reason is that the definition of SMEs varies along the geographical location of the studies. For example, a study conducted in the United States of America (U.S.A.) will account for enterprises with less than 500 employees for SMEs, whereas in Europe, SMEs are considered to have less than 250 employees.

Although most research on the impact of export information-related behaviors on international performance was conducted in the U.S.A., an increasing number of studies have been carried out in other countries. Of the studies reviewed, 10 took place in the U.S.A., followed by Canada and the United Kingdom with six, and New Zealand, the Netherlands, France, China and Austria with two studies each. In the following countries a single research study has been conducted: Scotland, Denmark, Norway, Cyprus, Brazil, Costa Rica, El Salvador, Guatemala, Honduras, Nicaragua, Sweden, Belgium, Switzerland, Norway, Sweden, Australia, Chile, Turkey and Finland.

Three important observations have to be made about the geographic focus of the studies under review. First, five of the studies reviewed conducted their research by collecting data from more than one country. The study of Dominguez and Sequiera (1993) collected data from Costa Rica, El Salvador, Guatemala, Honduras and Nicaragua. The authors did not check for cross cultural differences in terms of information behaviors from one country to another but instead assumed that these South American countries are characterized by a homogeneous cultural basis. The study of Seringhaus (1993) was conducted in Canada and Austria. Seringhaus (1993) checked for cross-country differences in terms of firms' export information



behaviors. In addition, both studies, namely the one of Souchon and Durden (2002) and the one of Voerman (2003) were conducted in more than one country. The study of Souchon and Durden (2002) was conducted in New Zealand and the U.K. The study of Voerman (2003) exploited data from Austria, Belgium, the Netherlands, Switzerland, Norway and Sweden. Voerman (2003) checked for cross-cultural differences regarding export information behaviors of firms among these countries. The study of Morgan *et al.* (2003) was conducted in China and the U.K; the authors tested their research model in both countries without exploring specifically for cross-national differences. Second, the bulk of the research was conducted in more developed countries perhaps because most researchers were affiliated with institutions based in these countries. Third, 11 studies restricted their analysis to specific regions within a given country. Five of the “*regional studies*” were conducted in the U.S.A., three in Canada, and one in Brazil (Sao Paulo area), France (eastern France) and in the U.K. (Welch).

The vast majority of the 37 reviewed studies involved samples drawn from multiple industrial sectors and put emphasis on the manufacturers or industry rather than consumer products. Only two studies focused on firms representing one industrial sector, namely the machine tool industry (MacPherson 2000), and the textile industry (Akyol and Akehurst 2003). Four other studies concentrated on two or three industries. Only one study specifically addressed the high-tech firms (Seringhaus 1993). The last approach allows for the control of industry-specific influences such as the type of product or level of technology.

Studies conducted in the 1980’s generally tended to use relatively small sample sizes sometimes with fewer than 50 firms. The size of the samples used in the reviewed studies ranges from 39 to one 1112 (the study of Voerman 2003, which can rather be seen as an exception). The average sample size is 176,85<sup>2</sup> (standard deviation = 99,58, and median = 175). One should note that only 24 studies have used samples greater than 100 observations and seven studies used samples with 50 or less observations. Overall, sample sizes are larger in more recent studies in comparison to prior research.

The overwhelming majority of the 37 studies reviewed relied on postal data collection (33 studies). This number can be partly explained by the difficulties in physically reaching firms that are geographically dispersed. These difficulties are exacerbated in the case of cross-cultural studies where firms are located in different countries. Three studies employed personal interviews instead of a mail survey in order to collect data mainly to solve problems

---

<sup>2</sup> The study of Voerman is considered as an “outlier”, so it was not accounted for in calculating the mean.

of distrust and access to respondents and in order to increase response rate due to the length of the questionnaire. Additionally, personal interviews are generally more appropriate for gaining deeper insight into the problem though more appropriate for exploratory and sometimes descriptive research. Personal interviews also provide a better alternative to surveys in terms of data reliability (Cavusgil and Zou 1994). In one study, the questionnaire was administered by fax (MacPherson 2000).

The studies reported response rates ranging from 10,7% to 88%. The average response rate is 34,32% (standard deviation = 15,63 and the median = 26%). In the case of cross-cultural studies, the average response rate was above 20%. An important number of studies did not check for non-response bias. Only 19 studies tested the non-response bias and one study provided rather unclear information concerning this matter. The study of De Luz (1993) was the only one that explains that on a descriptive basis, it seems that the characteristics of the enterprises interviewed are similar to the one in the total study population.

Since information is a “*key ingredient*” for successful decision-making, management should be considered a major force behind the initiation and development of firms’ information activities (Miesenbock 1988). Sixteen out of the 37 studies did not identify their source of information. Two of the studies by Ramangalahy (2001) and Spence (2003) did not provide clear information on this issue. For instance, Ramangalahy (2001) explained that the questionnaire was addressed to the manager of the company but failed to provide any additional information about the real respondents. In most studies, data was collected from the CEOs or the export managers (in six studies) or from the executives responsible for exporting activities or the marketing directors (in five studies). Less often, respondents are other executives of the company. Even though the general manager of the company frequently makes export decisions, the tendency to view firms as having only one decision-maker is misleading since decisions are often made by more than one person in the company (Leonidou and Katsikeas 1997).

The information processing specificity characterizing SMEs with respect to their larger counterparts is a generally accepted idea among scholars. Large firms generally have more resources to allocate information gathering and dissemination activities (Samiee and Walters 1990; Denis and Depelteau 1985; Crick *et al.* 1994). Despite this generally admitted idea, 17 of the reviewed studies provided no information concerning the firm size or any clear information. Of the nine studies that reported the size of the firm, most focused on the relationship between export performance and export information behaviors of small to medium-sized firms (SMEs). This can be partly attributed to the fact that smaller to medium-

sized firms play an important role in many economies since they often account for the largest part of the industrial base. Moreover, SMEs present specificities in terms of information processing behaviors (as it was already previously explained). Eleven studies addressed all ranges of sizes of firms and only the study of Boutary (1998, 2001) addressed only middle-sized firms; she defined the middle enterprise arbitrarily according to its size ranging from 100 to 200 employees. In relation to the firm size, only two important points are worth mentioning. First, the definition criteria differed among the studies (e.g. number of employees, annual sales). Second, because of the geographic focus of these studies, the meaning of the terms “*small*”, “*medium*”, and “*large*” varies greatly in an international context. In the U.S.A., SMEs account for less than 500 employees, whereas in the E.U. SMEs have been defined as having less than 250 employees since 1996. It can nevertheless be observed that in spite of the official definitions, some studies chose other criteria in terms of size. MacPherson (2000) mainly targeted firms with less than 20 employees and Boutary (1998, 2001) studied firms that had from 100 to 200 employees. Alvarez (2004) did not consider micro-firms within his analysis.

Most of the studies reviewed used the firm as the unit of analysis. In the case of using the firm as the unit of analysis, the export performance is assessed in the context of the firm's overall activities in international markets. This assessment of the international performance can be attributed to the greater willingness of key informants to disclose information at this broad level (Matthyssens and Pauwels 1996). This approach challenges the argument of Cavusgil and Zou (1994) and Cavusgil *et al.* (1993) in that the proper unit of analysis in export performance research should be the export venture as a single product or product line exported to a single foreign market. Firms may have more than one product line, and each of them may have different effects on export performance and the information activities carried out in foreign markets with this respect. Only two studies adopted export venture as the unit of analysis, namely the study of Madsen (1989) and the study of Cadogan *et al.* (2002). The study conducted by Rosson and Ford (1982) took the relationship between suppliers and foreign distributors as the level of analysis.

In comparing the principal method of analysis of the latest studies with older studies from the 1980's, one can observe that the level of statistical sophistication has changed. The majority of the more recent studies after 1995 use multivariate data analysis techniques such as factor analysis, cluster analysis, discriminant analysis, multiple regression analysis, and structural equation modeling (SEM). Mainly descriptive statistical techniques such as correlation and analysis of variance, T-tests, and Chi Square were employed more extensively in the early

stages. Despite the other methods of analysis, descriptive statistical methods prevail. Only 18 studies used explicative statistical techniques as regression analysis or SEM.

Among the reviewed studies, only three studies (Hart *et al.* 1994; Souchon and Diamantopoulos 1997; Walliser and Mogos-Descotes 2004) declare themselves as exploratory. However, the majority of the studies (19 studies) use descriptive statistics techniques.

Only 20 of the studies reviewed used research hypothesis. This relatively reduced number may also be explained by the exploratory nature of most of the studies. Out of the 37 studies reviewed, only three studies used a theory for grounding the research hypothesis. Of the three studies, two relied upon the resource-based view (RBV), namely the study of Ramangalahy (2001) and Julien and Ramangalahy (2003), and one used insights from the knowledge-based view of the firm (KBV), the study of Morgan *et al.* (2003).

It is worth to note that the number of studies specifically addressing the link between export performance and export information behaviors is reduced. During the last 26 years, only 16 studies have focused specifically on the relationship between international performance and firms' export information behaviors. The remaining studies addressed the relationship between export performance and export information rather periferically as a part of a more general research question.

Several of the studies specifically addressed the acquisition or use of export information by means of export assistance (Donthu and Kim 1993; Weaver *et al.* 1998; Diamantopoulos and Inglis 1988; Gencturk and Kotabe 2001; Spence 2003; Alvarez 2004; Wilkinson and Brouthers 2006) while three other studies focused on the export marketing research practices of enterprises (Cavusgil 1884a; Bijmolt and Zwart 1994; De Luz 1993). Additionally, other studies concentrated exclusively on export market intelligence practices (Mac Pherson 2000; Rosson and Ford 1982). Three of the reviewed studies pertain to the export market orientation literature, namely the studies of Cadogan *et al.* (2002), Akyol and Akehurst (2003), and Cadogan and Cui (2004). Finally, the rest of the reviewed studies addressed general export information related activities without highlighting specifically certain export information acquisition techniques.

### 1.2.3 The operationalization of the main constructs of the study: export information-related constructs and international performance

In this section, the way export performance and export information-related activities have been studied and operationalized will be further explained.

#### *1.2.3.1 International performance measurement*

Based on Table 1, one can see an evolution of the export performance measures over the years. Older studies generally only use objective or absolute measures of international performance such as the export sales ratio and export sales ratio growth. Studies that are more recent use both objective and subjective measures. Examples of subjective measures are the perceived progression of foreign sales profits compared to domestic markets, the perceived overall export development, the general satisfaction with exporting activities or the perceived achievement of strategic exporting goals, etc.

In the 1980s, objective measures were prevalent yet nowadays some scholars support the use of subjective over objective indicators (e.g. Katsikeas *et al.* 1997; Robertson and Chetty 2000). Scholars argue this preference by the facts that: (1) firms are reluctant to provide the objective data (Francis and Collins-Dodd 2000; Leonidou *et al.* 2002); (2) objective data is sometimes difficult to access, and thus it is uneasy to check for the accuracy of the reported financial export performance figures (Robertson and Chetty 2000), (3) managers are mainly guided by their subjective perceptions when making decisions (Madsen 1989), etc.

The general agreement among researchers is that both types of measures are equally important and should be used given the advantages of each of the two approaches and their complementary nature (Shoham 1998; Sousa 2004). Nonetheless, international performance measures generally vary from one study to another, making the comparison of the findings of different studies difficult. Table 1 refers to the measures used by the reviewed studies to capture the international performance construct.

Table 1. The measures used by the reviewed studies to capture the international performance construct

Authors	International performance measure
Rosson and Ford (1982)	PADR, FSLUK
Cavusgil (1884a)	EP
Cavusgil (1984b)	ESR
Denis et Depelteau (1985)	ESVG, ESRG over the last 5 years
Kleinschmidt and Ross (1986)	ESR and ESRG
Diamantopoulos and Inglis (1988)	ESR
Madsen (1989)	ESG, TS and EP over the last 2 years
Koh (1991)	EPR
De Luz (1993)	ESR
Dominguez and Sequeira (1993)	ESR
Donthu and Kim (1993)	ESR
Seringhaus (1993)	ESR
Bijmolt and Zwart (1994)	ESP, REP, PED over the last 5 years, GS
Hart <i>et al.</i> (1994)	ESR and EP
Moini (1995)	ESR and ESRG
Leonidou and Katsikeas (1997) <sup>3</sup>	ESR and EP
Souchon and Diamantopoulos (1997)	ESR, ESRG EP and REP, PSEO
Weaver <i>et al.</i> (1998)	EP
Ogunmokun and Ng (1999)	ESR, ESRG, EP4
Hart and Tzokas (1999)	ESR and EP
Boutary (1998, 2000)	ESR
Mac Pherson (2000)	ESR, ESRG over the last 5 years
Yeoh (2000)	ESR EP
Gencturk and Kotabe (2001)	REP, ESRG, PSEG, OQM, CP
Ramangalahy (2001)	ESRG, ESR, REP, NEG, TSG, PTSG, PEG, PGEP, PC, PEN, PEV, ASG
Cadogan <i>et al.</i> (2002)	PGEP, PGESR, PCESR, PCMS, PSNME, PMP, PSEP, PSMS, ESC, REP

<sup>3</sup> The study does not look explicitly at the link with EP, but draws an analysis between export intensity, profitability (frequent measures of international performance) and the usage of export information sources. For this reason, we enclosed it in the present literature review.

<sup>4</sup> On the basis of these three indicators, high performing enterprises were defined as: exporting more than 10% of their sales, growing in terms of export activities, making profit out of export operations.

Souchon and Durden (2002)	Formative index : PGEP, PGESR, PCESR, PCMS, PCNME, PMP, PSEP, PSMS, ESC, REP
Akyol and Akehurst (2003)	OPSE, PSEMS, PSEPS, PCEG, PGEP, PSNME, ESRG, ESGV
Morgan <i>et al.</i> (2003)	AP
Voerman <i>et al.</i> (2003)	ESR
Spence (2003)	PACMK, PACEP
Julien and Ramangalahy (2003)	IN, ESR, ESRG and EP
Cadogan and Cui (2004)	PGEP, PGESR, PCESR, PCMS, PCNME, PMP, PSEP, PSMS, ESC, REP
Walliser and Mogos-Descotes (2004)	ESR, PSET, PSEMS, PGSEP, PSGP
Souchon <i>et al.</i> (2004)	Cadogan and Diamantopoulos (1998) measure
Alvarez (2004)	Distinction between sporadic and permanent exporters: permanent were considered those that exported three years consecutively
Wilkinson and Brouthers (2006)	PGESR, NC, OPEP

**Legend: Abbreviations used for export performance measures:**

AP = Adaptive Performance  
ASG = Achievement of Strategic Goals  
PSET = Perceived Satisfaction with the Export Turnover  
CP = Competitive Position  
CFP = Current Financial Profitability  
ESR = Export Sales Ratio  
EP = Export Profits  
RSP = Relative Sales Profits (compared to domestic markets)  
ESC = Export Sales per Country  
TES = Total Export Sales  
ESRG = Export Sales Ratio Growth  
ESVG = Export Sales Volume Growth  
FSLUK = Foreign Sales Level of the United Kingdom  
GSEA= General Satisfaction with Exporting Activities  
IN = International Notoriety  
OPSE = Overall Perceived Success with Export  
OQM = Overall Perceived Quality of Management  
PADR = Perceived Accomplishment that has resulted from the manufacturer-distributor  
PACMK= Perceived Acquired Competence in terms of Market Knowledge  
PACEPS = Perceived Acquired Competence in terms of Export Process Skills  
PCMS = perceived competitiveness in terms of the market share obtained on export markets

PCNME = perceived competitiveness in terms of the rate of new market entry  
PED = Perceived Export Development  
PEG = Overall Perceived Export Growth  
PEN = Perceived Enterprise Notoriety  
PESV = Perceived Export Sales Volume  
PGEP = Perceived Growth in Export Profits  
PGES = Perceived Growth in Export Sales  
GSEP = General Satisfaction with Export Profitability  
PSGP = Perceived Satisfaction with Global Performance  
PSMS = Perceived Satisfaction with Market Share progression  
PSNME = Perceived Success with the Rate of New Market Entry  
PMP = Perceived Market Position (being a market leader, major or minor supplier within export markets)  
PCEG = Perceived Contribution of Exporting to firm Growth  
PSEMS = Perceived Satisfaction with Export Market Share  
PSESP = Perceived Satisfaction with Export Sales Profits  
PSEO = Perceived Satisfaction with Exporting Operations  
PC = Perceived Competitiveness of the firm  
PCESR = Perceived Competitiveness in terms of Export Sales Ratio  
NEC= Number of Exporting Countries  
OPEP= Overall Perceived Export Performance

### ***1.2.3.2 Export information study and measurement***

In regards to the operationalization of export information acquisition and use, with four exceptions, studies generally provide clear information about the way measures of the concepts were assessed. As it follows, first presented are the operationalization of the most widely used measures for capturing export information related behaviors, which include the perceived frequency and usefulness of export information elements and information sources. Secondly, a classification of the measures capturing export information behaviors is to be proposed. Lastly, the third section will expose the taxonomies existing in the literature designed for describing export information acquisition and use.

#### **1.2.3.2.1 The operationalization of the most widely used measures for capturing information related activities**

The most commonly used measures for describing the use of information and information sources are their frequency of use and their perceived importance. The frequency of use of information sources was measured as a nominal variable with four modalities, which were “never”, “seldom”, “about twice a year” and “others” in Moini’s (1995) study; as a nominal variable with five modalities (“less than once a year”, “once or twice a year”, “three to four times a year”, “from six to ten times a year”, “more than ten times a year”) in Weaver *et al.*’s (1998); as a nominal variable with four modalities in Koh’s (1991) study (“none at all”, “less than once a year”, “once a year”, and “more than once a year”). Other studies assessed the frequency of use of export information as a subjective measure, operationalized as an interval variable measures on a 5-point scale, ranging from 1 = “rarely” to 5 = “very often” in Leonidou and Katsikeas’s (1997) study, as an interval variable, measured on a 4-point scale, ranging from 1 = “never undertaken” to 4 = “always undertakes”; as an interval variable in Seringhaus’s (1993) study, and also as an interval variable measured on a 5-point scale, ranging from 1 = “never use” to 5 = “always use” in Yeoh’s study (2000). One can notice the six different operationalizations in six different studies. Thus, it can be concluded that researchers have not yet reached an agreement on what exactly a frequently used information source is.

Another common measure within the literature is the perceived usefulness of information sources. Weaver *et al.* (1998) assessed the perceived helpfulness of governmental financial services. Similar measures were also used in other studies. Such examples are the perceived



criticality of information sources, assessed on a 5-point scale, ranging from 1 = “no importance” to 5 = “critically important” (MacPherson 2000), and the perceived importance of information sources, assessed on a 5-point scale ranging from 1 = “not important” to 5 = “very important” (Leonidou and Katsikeas 1997; Julien and Ramangalahy 2003; Walliser and Mogos-Descotes 2004), etc. Cavusgil (1984a) assessed the perceived importance of foreign market research by means of comparison with the domestic market research. He used a nominal measure with three categories that included “much less important than domestic market research”, “less important than domestic market research” and “equally important to domestic market research”.

One can observe that no clear agreement exists between researchers concerning the measurement of the frequency of use or of the perceived usefulness of information elements and information sources. Generally, the measures employed by the researchers are heterogeneous from one study to another and not easily classifiable. Despite the relatively important number of studies that have been concerned with export information in general, no uniformly accepted conceptualization and operationalization exists (Leonidou and Katsikeas 1997).

During this literature review, as many as 74 different export information indicators were discovered that were relative to both export information acquisition and use and export information processing. The large number of indicators show a lack of consensus with regard to both conceptualization and operationalization of the export information constructs. The large number of different export information measures also restricts the advance of the export marketing literature because it makes it hard to compare and contrast the findings from different studies (Leonidou and Katsikeas 1997).

#### **1.2.3.2.2 Proposing a classification of the different export information related measures**

Presently, no classification of the current measures employed by scholars to capture export information behaviors of enterprises exists. A classification is proposed into objective, subjective and hybrid measures according to the nature of the variables used to capture export information related behaviors, which are nominal for hybrid measures, ratio for objective measures, and interval variables for subjective measures.

Table 2. Objective measures used to capture export information activities within the reviewed studies

Study	Objective measures employed
Rosson and Ford (1982)	Channel contact intensity between manufacturers and distributors measured by: <ul style="list-style-type: none"> <li>▪ Number of letters exchanged bi-annually between manufacturers and distributors</li> <li>▪ Number of visits made to each other biannually</li> <li>▪ Frequency with which contact individuals interact with persons in the manufacturer/distributor's firm - other than the primary contact</li> </ul>
Denis and Depelteau (1985)	<ul style="list-style-type: none"> <li>▪ Use of export assistance and other private information sources (number of public and private information sources used)</li> <li>▪ Participation at trade fairs and missions abroad (time spent at foreign fairs or on business missions abroad)</li> </ul>
Kleinschmidt and Ross (1986)	<ul style="list-style-type: none"> <li>▪ Extent of use of information (number of information sources used both public and private)</li> <li>▪ Participation in trade fairs and missions abroad (time spent at foreign fairs or on business missions abroad man/day/year)</li> </ul>
Diamantopoulos and Inglis (1988)	<ul style="list-style-type: none"> <li>▪ Use of export assistance (number of different export agencies used)</li> </ul>
Madsen (1989)	<ul style="list-style-type: none"> <li>▪ A priori market research (number of information sources used and knowledge about market when starting exporting<sup>5</sup>)</li> <li>▪ Channel relationship (the amount of sales support to channel members)</li> <li>▪ Size of profit given to channel members<sup>6</sup></li> </ul>
Donthu and Kim (1993)	<ul style="list-style-type: none"> <li>▪ Acquisition of information by means of outside export assistance (number of information sources used)</li> <li>▪ Extent of search for export assistance</li> </ul>
Bijmolt and Zwart (1994)	<ul style="list-style-type: none"> <li>▪ Number of marketing research practices used within the company<sup>7</sup></li> </ul>
Mac Pherson (2000)	<ul style="list-style-type: none"> <li>▪ Budget allocated to the market intelligence acquisition over the last five years</li> </ul>
Yeoh (2000)	<ul style="list-style-type: none"> <li>▪ Amount of information search<sup>8</sup></li> </ul>
Gencturk and Kotabe (2001)	<ul style="list-style-type: none"> <li>▪ Export assistance use (number of EA programs used out of 14 programs)</li> <li>▪ Awareness of EA programs (how many programs are known out of 14 programs)</li> </ul>
Souchon and Durden (2002)	<ul style="list-style-type: none"> <li>▪ Number of people in charge of information use in the firm (Weiss 1981)</li> </ul>
Spence (2003)	<ul style="list-style-type: none"> <li>▪ General export knowledge (captured by the number of years of export experience, export intensity, number of trade missions the firm attended, diversification of export sales by country and region)</li> <li>▪ Market specific experiential knowledge (number of previous visits to the market and presence of turnover in the market)</li> </ul>
Voerman <i>et al.</i> (2003)	<ul style="list-style-type: none"> <li>▪ The amount of export information collected in the home and export markets (the number of information sources consulted home and abroad out of 12 information sources)<sup>9</sup></li> </ul>
Wilkinson and Brouthers (2006)	<ul style="list-style-type: none"> <li>▪ Number of times firms accessed export promotion programs to assist in identifying agents and distributors over the last five years</li> <li>▪ Number of trade missions and trade shows the enterprise has attended over the last five years</li> </ul>

<sup>5</sup> No clear information about the operationalization of this variable.

<sup>6</sup> Ibidem.

<sup>7</sup> These items are studied as marketing planning.

<sup>8</sup> No information about this measure, it is supposed that it was operationalized as the number of information sources used by the company.

<sup>9</sup> The classification of Souchon and Diamantopoulos (1999) and Hart *et. al* (1994) was used in order to assess the relationships between the acquisition of export information and international performance.

Objective measures refer to the indicators that are based on absolute values such as the number of public and private information sources used (Denis and Depelteau 1985), the budget allocated to the market intelligence acquisition (MacPherson 2000), the amount of sales given to channel members, the size of the profit given to channel members (Madsen 1989), etc. The objective measures used to capture firms' export information activities are synthetically presented in Table 2.

Subjective measures refer to indicators that measure the perceptual or attitudinal elements such as the perceived importance and richness of export information elements and sources (e.g. Webb *et al.* 1994; Hart and Tsokas 1999; Walliser and Mogos-Descotes 2004; Ramangalahy 2001). Subjective information measures usually assess the perceived usefulness or importance of different information sources on 5-point scales although scales with a higher number of intervals were also employed. For instance, Donthu and Kim 1993 asked the respondents to rate EA information sources with a number between 0 and 20, where 0 = "seek no export assistance" to 20 = "seek all possible assistance".

Subjective measures can be classified into uni-dimensional and multidimensional subjective measures. Uni-dimensional subjective measures capture only one aspect related to export information or information sources, for example, the rating of the overall perceived usefulness of information sources. Multi-dimensional subjective measures capture latent constructs as the richness of information sources referring to several aspects/dimensions of information sources such as contacts facility, information reliability, interactivity, information quantity and contact density (Ramangalahy 2001). Another multi-dimensional subjective measure is the information-elements' richness that regroups the following dimensions: access opportunity (at the right time), pertinence (needs), instructive potential (enhancing the comprehension of foreign markets), the quantity, and the exclusivity of the possessed information (Ramangalahy 2001). Table 3 synthetically reviews the subjective measures used within the reviewed studies.

Table 3. Subjective measure used to capture export information activities within the reviewed studies

Study	Subjective measures employed
Donthu and Kim (1993)	<ul style="list-style-type: none"> <li>▪ Rating EA information sources with a number between 0 and 20, where 0 = "seek no export assistance" to 20 = "seek all possible assistance"</li> </ul>
Seringhaus (1993)	<ul style="list-style-type: none"> <li>▪ Marketing research practices (5-point scale from 1 = "never undertaken" to 5 = "always undertakes")</li> <li>▪ Perceived importance of information sources (4 point scale from 1 = "not important" to 5 = "very important")</li> </ul>
Hart <i>et al.</i> (1994)	<ul style="list-style-type: none"> <li>▪ Export information collection, assessed in terms of the perceived importance of export information sources, information elements and marketing research activities carried out by exporters, measured on a 5-point scale from 1= "least importance" to 5 = "most importance"</li> </ul>

	<ul style="list-style-type: none"> <li>▪ Export information use: to back up managerial hunches, to support their view, to take alternative actions and not take decisions without information measured by means of an agreement degree with four statements measured on 5 point Likert scale ranging from 1 = "completely disagree" to 5 = "completely agree"</li> </ul>
Moini (1995)	<ul style="list-style-type: none"> <li>▪ Perception of the management expertise in marketing as competitive advantage, measured on a 5-point scale, ranging from 1 = "great weakness" to 5 = "great strength"</li> </ul>
Leonidou and Katsikeas (1997) <sup>10</sup>	<ul style="list-style-type: none"> <li>▪ Export information sources use frequency measured on a 5-point scale, ranging from 1 = "rarely" to 5 = "very often"</li> <li>▪ Perceived importance of information sources measured on a 5-point scale, ranging from 1 = "not important" to 5 = "very important" of 26 export information sources<sup>11</sup></li> </ul>
Souchon and Diamantopoulos (1997)	<ul style="list-style-type: none"> <li>▪ Awareness of export information sources (agreement degree on a 5-point scale, ranging from 1= "totally disagree" to 5 = "totally agree" with "we are aware of the following export information sources: ...")</li> <li>▪ Information overload (agreement degree with three statements, scale <i>ibidem</i> awareness)</li> <li>▪ Export information use: immediate and future use, consideration and rejection, ignore (measured on a 5-point scale from 1 = "never" to 5 = "very often")</li> </ul>
Weaver <i>et al.</i> (1998)	<ul style="list-style-type: none"> <li>▪ Perceived criticism of analysis of competitors to exporting activities, measured on a 5-point scale, ranging from 1 = "strongly disagree" to 5 = "strongly agree" with several statements</li> <li>▪ Perceived helpfulness of financial services from the government in exporting, the agreement degree with several statements measured on a 5-point scale, ranging from 1 = "strongly disagree" to 5 = "strongly agree")</li> </ul>
Hart and Tzokas (1999)	<ul style="list-style-type: none"> <li>▪ Export information sources used, measured on a 5-point scale, ranging from 1 = "not used at all" to 5 = "used to a great extent")</li> <li>▪ Information elements collected, measured similar to export information sources</li> <li>▪ Managerial use of information to back up hunches, take alternative decisions, ignoring MKR and not making decisions without MKR (statements measured on a 5-point Likert scale from 1 = "strongly disagree" to 5 = "strongly agree")</li> </ul>
Mac Pherson (2000)	<ul style="list-style-type: none"> <li>▪ Perceived importance of the EMI information sources, measured on a 5-point scale ranging from 1 = "no importance" to 5 = "critically important"</li> </ul>
Yeoh (2000)	<ul style="list-style-type: none"> <li>▪ Perceived usefulness of information sources, measured on a 5-point scale, ranging from 1 = "not useful" to 5 = "very useful"</li> <li>▪ Frequency of information source use, measured on a 5-point scale, ranging from 1 = "never use" to 5 = "always use"</li> </ul>
Ramangalahy (2001)	<ul style="list-style-type: none"> <li>▪ Export information sources richness (6 information sources groups related to market and distribution, to supply, industry branch, institutional branch, internal sources and electronic sources) - assessed in terms of contact facility, information reliability, interactivity, information quantity and contact density on a 5-point scale, ranging from 1 = "very limited" to 5 = "very extended"</li> <li>▪ Information richness (CFA on 33 information elements, yielding seven factors related to markets and clients, competition, products, prices, publicity, promotion, distribution, and general environment of foreign markets), assessed on a 5-point scale, ranging from 1 = "very limited" to 5 = "very extended" on the following dimensions: access opportunity (at the right time), pertinence (needs), instructive potential (enhancing the comprehension of foreign markets), and the quantity and the exclusivity of the possessed information</li> </ul>

<sup>10</sup> The study does not look explicitly at the link with EP but draws an analysis between export intensity, profitability (frequent measures of international performance) and the usage of export information sources. For this reason, it is enclosed in the present literature review.

<sup>11</sup> They multiply the frequency of use with the perceived importance of export information sources

Cadogan <i>et al.</i> (2002)	<ul style="list-style-type: none"> <li>▪ The scale export market orientation (EMO), developed by Cadogan <i>et al.</i> (1999), composed by export intelligence generation (11 items), dissemination (18 items) and responsiveness to export information (18 items), assessed on a 5-point Likert scale, ranging from 1 = “completely disagree” to 5 = “completely agree”</li> </ul>
Akyol and Akehurst (2003)	<ul style="list-style-type: none"> <li>▪ The scale export market orientation (EMO), developed by Cadogan <i>et al.</i> (1999), composed by export intelligence generation, dissemination and responsiveness to export information, assessed on a 5-point Likert scale, ranging from 1 = “completely disagree” to 5 = “completely agree”</li> </ul>
Morgan <i>et al.</i> (2003)	<ul style="list-style-type: none"> <li>▪ Export informational knowledge: 4 items relative to customer knowledge in export markets, knowledge of competitors in export markets, information relative to doing business in export markets, knowledge of distributors in foreign markets; measured on a 7-point scale ranging from "much worse" to "much better",</li> </ul>
Souchon and Durden (2002)	<ul style="list-style-type: none"> <li>▪ Export information acquisition, the scale of export information acquisition developed by Souchon and Diamantopoulos 1999: EMR, EA, EMI information sources assessed on a 5-point scale of frequency of use</li> <li>▪ Use of export market information: conceptual/instrumental and symbolic use, scale developed by Souchon and Diamantopoulos (1999)</li> <li>▪ Information use : immediate use, translation into practical action, ignore, stored for future use, measured on a 5-point frequency scale</li> </ul>
Julien and Ramangalahy (2003)	<ul style="list-style-type: none"> <li>▪ Perceived usefulness of six categories of export information types and six categories of information sources, measured on a 5-point scale, ranging from 1 = "not important at all" to 5 = "very important"</li> </ul>
Cadogan and Cui (2004)	<ul style="list-style-type: none"> <li>▪ The scale export market orientation (EMO), developed by Cadogan <i>et al.</i> (1999), composed by export intelligence generation, dissemination and responsiveness to export information, assessed on a 5-point Likert scale, ranging from 1 = “completely disagree” to 5 = “completely agree”</li> </ul>
Walliser and Mogos-Descotes (2004)	<ul style="list-style-type: none"> <li>▪ Perceived usefulness of different export information sources (Hart and Tsokas 1999 scale, assessed on a 5-point scale, ranging from 1 = "not important at all" to 5 = "very important")</li> <li>▪ Impact of gathering general background information (infrastructure, aid to exporting, social or political and economic background), measured on a 5-point scale, ranging from 1 = "not important at all" to 5 = "very important"</li> </ul>
Souchon <i>et al.</i> (2004)	<ul style="list-style-type: none"> <li>▪ Export information use (symbolic and instrumental/conceptual (Diamantopoulos and Souchon’s 1999 scale)</li> </ul>

Finally, hybrid measures can be defined as the measures that cannot be classified in objective or subjective measures. One important observation is that these measures could have in most of the cases been assessed by means of subjective measures. For example, some of them are measures for determining the frequency operationalized as a nominal variable. Some other examples include: frequency of information sources use, frequency of identifying and analyzing foreign markets (Cavusgil 1884a), frequency of international marketing research use, frequency of face-to-face contact with distributors or dealers (Koh 1991), frequency of informal visits to foreign markets (Moini 1995), and frequency of business travel (Weaver *et al.* 1998). One can imagine that these studies could have measured the frequency of use by means of a 5-point interval scale, as Yeoh did in his 2000 study, ranging from 1 = “never” to 5 = “always”.

Other examples of hybrid measures were used by Cavusgil (1984a) such as the degree of formalization of foreign EMR (nominal variable with three categories: “informal, with no standard procedure”, “somewhat formalized process”, and “fairly formalized procedure”), the nature of data analysis (nominal variable with three categories “only simple techniques”, “moderate level”, “rigorous techniques”); or by Koh (1991) whom assessed the extent of marketing research use (nominal scale: “none at all”, “hazaphard”, “formal plan”) and the level of dealer support ( nominal scale: “no support”, “moderate support” = advertising or training support, “strong support” = advertising and training support). These measures could also have been assessed by means of interval variables. For example, the degree of formalization of foreign EMR (Cavusgil 1984a) could have been assessed on a scale ranging from 1 = “not formalized at all” to 5 = “very formalized”.

Other hybrid measures were assessed by means of dummy variables such as the proximity to the market (Cavusgil 1984b), the systematic exploration of foreign markets (Cavusgil 1984b; Moini 1995), and marketing research use (De Luz 1993). Even more recent studies, such as the study of Ogunmokun and Ng (1999) assessed the structure and policy for researching the market by means of three dummy variables, which are the systematic method for exploring export possibilities, a formal structure for evaluating export opportunities, and a fixed policy regarding exporting activities. Also assessed were the frequency of foreign markets by means of a nominal variable in terms of whether the firms visit foreign customers more or less than two times a year, the types of information collected in foreign markets (socio-cultural trends, customer characteristics, customer opinion or attitudes, behaviors, and market growth and segments) and the export information sources used to gather the information about foreign markets (annual reports, government publications, customers, etc. ).

Boutary (1998, 2000) operationalized the information processing behaviors by means of nominal variables, capturing the sensitivity to information, the relationships with export assistance export bodies, the existence of the budget allocated for the search of information, evolution in terms of information processing, vigilance, and characteristics of acquired information which may include the professionalism of the provider, prospective character and confidentiality to name a few. The hybrid measures used by the studies comprised within this review are exposed in Table 4.

Table 4. Hybrid measures used to capture export information activities used within the reviewed studies

Study	Hybrid measures used
Cavusgil (1884a)	<ul style="list-style-type: none"> <li>▪ Perceived importance of EMR, assessed as a nominal variable with three modalities that include: “much less important than domestic market research”, “less important...”, “equally important...”</li> <li>▪ Perceived complexity of EMR, assessed as a nominal variable with three categories that include “very simple”, “simple”, “complex”</li> <li>▪ Frequency of identifying and analyzing foreign markets, assessed as a nominal variable with three categories that include: “infrequently = less than once a year”, “occasionally = once a year”, “frequently = several times a year”</li> <li>▪ Degree of formalization of a foreign EMR, assessed as a nominal variable with three categories that include “informal, with no standard procedure”, “somewhat formalized process,” “fairly formalized...”</li> <li>▪ Nature of the data analysis, assessed as a nominal variable with three categories “only simple techniques are analyzed”, “moderate level”, “rigorous techniques”</li> </ul>
Cavusgil (1984b)	<ul style="list-style-type: none"> <li>▪ Proximity to the market (as a dummy variable: yes or no)</li> <li>▪ Systematic exploration of foreign markets (as a dummy variable: yes/ or no)</li> </ul>
Koh (1991)	<ul style="list-style-type: none"> <li>▪ Frequency of international marketing research use (nominal scale: "none at all", "less than once a year", "once a year", "more than once a year")</li> <li>▪ Extent of marketing research (nominal scale: "none at all", "haphazard", "formal plan")</li> <li>▪ Frequency of face-to-face contact with distributors/dealers (nominal scale: "never", "once every 2 to 5 years", "once to twice a year", "at least quarterly");</li> <li>▪ Level of dealer support ( nominal scale: "no support", "moderate support"</li> <li>▪ Advertising or training support, "strong support" = advertising and training support)</li> </ul>
De Luz (1993)	<ul style="list-style-type: none"> <li>• Marketing research use (model variable: yes or no)</li> </ul>
Dominguez and Sequeira (1993)	<ul style="list-style-type: none"> <li>▪ Use of formal studies, informal studies and export promotion agencies (operationalized as a dummy variables)</li> </ul>
Moini (1995)	<ul style="list-style-type: none"> <li>▪ Frequency of informal visits to foreign markets (nominal variable, with 1 = “never”, 2 = “seldom” ... 5 = “about twice a year”, 6 = “other”)</li> <li>▪ Systematic exploration of foreign markets (nominal variable, with 3 modalities: “no”, “yes” or “other”)</li> </ul>
Weaver <i>et al.</i> (1998)	<ul style="list-style-type: none"> <li>▪ Frequency of business travel ("less than once/year", "1 to 2 times a year", "3 to 4 times a year", "6 to 10 times a year", "more than 10 times a year")</li> </ul>
Ogunmokun and Ng (1988)	<ul style="list-style-type: none"> <li>▪ Structure and policy for researching the market: the systematic method for exploring export possibilities, a formal structure for evaluating export opportunities, and a fixed policy regarding exporting activities (dummy variables)</li> <li>▪ Frequency of foreign market visits for example( the number of visits per year)</li> <li>▪ Collecting information about socio-cultural trends, customer characteristics, customer opinion or attitudes, behaviors, market growth and segments, and sources such as annual reports, government publications, and customers (dummy variables)</li> </ul>
Boutary (1998, 2000)	<p>Information processing behaviors, assessed as dummy variables<sup>12</sup>:</p> <ul style="list-style-type: none"> <li>▪ Sensitivity to information</li> <li>▪ Access to foreign business publications</li> <li>▪ Relationships with export assistance export bodies</li> <li>▪ Existence and evolution of the budget allocated for the search of information and the evolution in terms of information processing</li> <li>▪ Vigilance</li> </ul>

<sup>12</sup> Boutary (1998, 2000) operationalized all information behaviours as dummy variables.

	<ul style="list-style-type: none"> <li>▪ Openness of information systems which means having a classification system of information, acquiring information according to needs, and buying information such as address lists, norms, confidential letters, and partnership research</li> <li>▪ Characteristics of the acquired information which include the professionalism of the provider, prospective character and confidentiality</li> </ul>
Spence (2003)	<ul style="list-style-type: none"> <li>▪ Objective export knowledge which is the adaptation of marketing mix (product, price, place, promotion), assessed as dummy variables</li> </ul>
Alvarez (2004)	<ul style="list-style-type: none"> <li>▪ Acquisition in regards to efforts in international business (dummy variables): <ul style="list-style-type: none"> <li>▪ Promoting goods abroad</li> <li>▪ Improving the information system about external markets</li> <li>▪ Obtaining information from external clients</li> </ul> </li> </ul>

**Legend:** Abbreviations used for export information collection techniques:  
EMR = Export Marketing Research  
EMI = Export Market Intelligence  
EA = Export Assistance

Of the different information-related indicators referenced in Tables 2, 3 and 4, 22 are objective measures, 28 are subjective measures and 30 are hybrid measures. It worth to be noted that the study of Boutary (1998, 2001) used 11 out of the 30 hybrid measures referenced. Moreover, the measures employed by Boutary (1998, 2001) have not been further employed by other studies. In terms of the frequency of occurrence, 14 of the studies used objective measures, 15 used subjective measures, and finally, 11 studies used hybrid measures. Three studies used both objective and subjective measures, two studies used subjective and hybrid measures, and only one study used both objective and hybrid measures for assessing firms' export information-related activities. Only five of the conducted studies combined several types of measures, while nine studies solely used objective measures. Ten studies used subjective measures and six studies exclusively used hybrid measures.

It is worth mentioning that in the beginning studies between 1982 and 1993, the researchers used only objective and hybrid measures to capture firms' related export information activities. Recent studies mainly use subjective measures.

**I.2.3.2.3 Taxonomies of export information acquisition and use**

While some scholars concentrated on studying the information elements and information sources one by one, others tried to develop measurement scales (taxonomies) for simplifying and reducing the important number of export information sources or elements. Such measurement scales exist for either measuring information elements' acquisition, export information source use, or the use of export information within the organization.



Hart *et al.* (1994) developed a bi-dimensional measurement scale for the export information acquisition by classifying information sources into informal information sources (customers, distributor agents and competitors visits, participating at trade fairs) and formal information sources (undertaking marketing tests, mail surveys and telephone interviews, information seminars). However, the perceived division of these same information collection vehicles into formal and informal instruments as perceived by companies in the U.K. (Hart and Tzokas 1999) was not confirmed in France. Instead, a three-dimensional structure of (the same) information vehicles emerged, made up of direct market information, distant information instruments and relational information as found in the study of Walliser and Mogos-Descotes (2004). This structure implies that the scale is not cross-nationally stable.

Souchon and Diamantopoulos (1999) developed a tri-dimensional information acquisition scale where information sources are classified into export market intelligence, export marketing research and export assistance information vehicles.

Export Market Intelligence (EMI) is an informal acquisition mode very similar to informal information sources found by Hart *et al.* (1994). EMI consists of gathering information on a continuing basis from the company's staff abroad, customers, competitors, agents or distributors, and possibly with the occasion of participating at trade-fairs or conferences.

Export Marketing Research (EMR) can be distinguished from the other acquisition forms by its formalized, structured, and objective character. EMR can be carried out internally if the enterprise owns an in-house research unit and can also externalize to a specialized market research agency or a consulting company. EMR can be developed by commissioning to outside agencies, from marketing research conducted in-house, or from information purchased on a subscription basis.

Finally, Export Assistance (EA) is collected from governmental bodies, Chambers of Commerce, conferences, trade missions, embassies, trade associations, export associations, or banks. EA provides general guidance on export operations or special programs meant to aid and prepare exporters when visiting foreign markets or participating at international trade fairs (Seringhaus 1985). The stability of this tri-dimensional structure was assessed cross-culturally (Souchon *et al.* 2003) in a study based in five countries.

Yeoh (2000) developed new measures for information acquisition. He differentiates between personal sources (Internet, personal visits to foreign markets, contacts with foreign suppliers and distributors, foreign trade fairs and missions), quasi-governmental sources (Chambers of Commerce, government export promotion programs, foreign commercial attaches located in

overseas countries), and documented sources (trade publications, industry or trade associations, periodicals or newspapers).

The three classifications presented above can somehow be combined into formal information sources incorporating both export market research and export assistance or the quasi-governmental and documented sources of export information, and informal information sources which are very close to export market intelligence or personal export information sources.

Ramangalahy (2001) and Julien and Ramangalahy (2003), inspired from Porter (1980) used five categories to classify information sources related to foreign markets and distribution (customers, agents and representatives, retailers, and export marketing firms), supply interfaces (bankers and suppliers), the industrial sector (fairs, specialized journals and reviews, industrial associations and other firms), the institutional environment (government offices and publications), internal sources (database, employee, sales subsidiaries, and foreign missions), and electronic sources (private and public database, and the Internet). Notably, Julien and Ramangalahy (2003) did not empirically test the scale but used it *a priori* as a definition.

In conclusion, although researchers developed several taxonomies for information acquisition and use, it seems that no agreement has yet been reached for capturing the use of information sources. Some of the studies investigate the use of information sources by employing the scale developed by Souchon and Diamantopoulos (1999b) and classifying information use into symbolic and instrumental or conceptual use. Theoretically, the instrumental and the conceptual use as defined by Peltz (1978) or Rich (1977) are defined as separate dimensions of information use. In practice, it appeared that they were facets of a same dimension (Souchon and Diamantopoulos 1999). The instrumental use corresponds to the “*specific decision or action that can be clearly designated*” for the use of information (Peltz 1978, p. 349). It corresponds to the deterministic input-output approach of the rational use of information for decision-making. The conceptual use is the “*knowledge for understanding*” (Rich cited by Peltz 1978, p. 349). The conceptual use helps the users to broaden their general knowledge about a special issue. The symbolic use also known as a legitimative use (Peltz 1978) refers to the use of information for legitimizing a decision that has already been made or a position that has already been taken (Knorr 1977 – cited by Peltz 1978, p. 351) based on the decision-maker’s instinct or “*when information is distorted in order to support the decision’s maker opinion in the eyes of the subordinates, colleagues or superiors*”

(Diamantopoulos and Souchon 1999, p. 2). This type of symbolic use is surrounded by considerations that are, for example, more ethical as the distortion of information.

The study of Souchon and Diamantopoulos (1997) considered other aspects of information use as the immediate or future use of export information, consideration, and rejection of export information and ignoring of export information. Hart and Tzokas (1999) used four items for exploring the managerial use of marketing research (MKR) which were to back up hunches, take alternative decisions, ignore MKR and not make decisions without MKR. These constructs were captured by the agreement degree of managers with several statements measured on a 5-point Likert scale from “strongly disagree” to “strongly agree”.

The heterogeneity of measures employed within the different studies for capturing the export information acquisition and use provides a testimony of the development and measures evolution over time. The main problem associated with this issue is that the results of different studies are difficult to compare. Out of the 37 reviewed studies, only five studies concentrated upon the collection of different information types from foreign markets. Several studies tried to design measurement scales for capturing the collection of the large numbers of possible information types relative to foreign markets under a reduced number of variables. Other studies, especially in the early years of researching, looked up the relationship between the acquisition of a certain number of information types and the international performance. For example, the study of Hart *et al.* (1994) assessed the perceived importance for export operations of 67 different information types. The factorial analysis performed upon the 67 information types revealed a three-dimensional structure consisting of a first factor called market feasibility that accounts for the competitive products available, international competition, buyers’ preferences, price trends, local competitors, buyers’ key purchase criterion and market size all in the export markets. The second factor called adaptation information is defined as ways to adapt current product for export and legal requirements in export market entry, exchange rate fluctuations and potential barriers to exporting. The third dimension is background information; it includes government aid to exporters, social or political background of export markets, economic background of the export market country, and the rate of transport infrastructure and market growth.

The same scales were employed in the study of Hart and Tzokas (1999), the factorial analysis revealed the same three-dimensional structure. One should be aware that the measurement scale used by Hart and Tzokas (1999) for assessing the same scales was slightly different. In their study, they assessed the frequency of the use instead of the perceived usefulness of the same background information. Nevertheless, one can observe that several items composing

the market feasibility dimension - as the buyer preferences for example - could have logically pertained to the adaptation information dimension. The same observation can be made concerning the item “legal requirements” that could have pertained to the background information dimension. Seemingly, however, the three categories are not mutually exclusive and the delimitation among them is not very clear. Only one of the three dimensions highlighted by Hart and Tsokas (1999), namely the background information, was used within the study of Walliser and Mogos-Descotes (2004). They assessed the scale in terms of perceived importance as it was originally assessed in the study of *Hart et al.* (1994). The measure did not prove to be cross-culturally stable. It appears that in France, for example, the item relative to the perceived usefulness of the governmental aids to exporting had to be removed.

Furthermore, another measurement scale was developed by Julien and Ramangalahy (2003) that assesses the perceived importance of 25 information elements. The factorial analysis of the 21 items revealed five dimensions that include: (1) markets described through market prices, product potential and adaptation, new products, customer tastes and needs, general information, and promotional methods, (2) competition which is described through strengths, weaknesses, and strategies, (3) norms which include delivery times or services, standards and regulations, and import or export licenses, (4) opportunities such as potential customers, contacts, relations, and partnership possibilities, and (5) operations that include payment methods and contracts, transportation, distribution, commissions or profits and margins, customs operations, international trade and government assistance.

Cadogan *et al.* (1999) extended the market orientation construct to export markets. They designed a measurement tool for assessing the three dimensions of the market orientation construct on export markets, namely (1) export intelligence generation, (2) dissemination and (2) responsiveness. Export intelligence generation refers to the generation of key export market information relative to foreign clients and competitors and key elements in the export environment (e.g. technology, regulation). Export intelligence dissemination refers to the organizational mechanisms (e.g. communication, coordination) enhancing the export information diffusion through the organization. Finally, export responsiveness refers to the actions undertaken by organization based on the incoming export information gathered. Cadogan *et al.* (1999) designed 11 items for capturing the export intelligence generation, 18 items for the export intelligence dissemination dimension, and finally 17 items for export responsiveness. They were assessed on a 5-point Likert scale, ranging from 1 = “completely disagree” to 5 = “completely agree”.

## **I.2.4 The link between international performance and export information**

### ***I.2.4.1 The relationship between export information sources (acquisition and use) and international performance***

In order to more easily describe the link existing between export information acquisition and use and international performance, the Souchon and Diamantopoulos' (1999) classification of information sources will be used in regards to export assistance, export market research, and export market intelligence. Even though the three categories are not mutually exclusive, they allow the simplification in presenting the results of the reviewed studies. Table 5 provides a global overview of the main results of the studies reviewed.

#### **I.2.4.1.1 The relationship between export assistance and international performance**

The results reported in the export assistance (EA) studies can be characterized as mixed. With respect to the number of EA information sources consulted, Donthu and Kim (1993) and Gencturk and Kotabe (2001) found a positive link between the number of information sources (export assistance related) consulted and export performance. However, Denis and Depelteau (1985) found the relationship between the number of export information sources consulted and international performance insignificant.

Diamantopoulos and Inglis (1988) conclude that more export intensive firms consult relatively few export assistance information sources as a result of the learning effect. These firms are characterized by a higher internal capacity to cope with the complexity of exporting, in this way diminishing the need for external information sources.

Relatively few positive relationships were acknowledged within the literature between the use of EA related information sources and international performance. Nonetheless, the use of industry trade associations, the export country's government agencies, and the attendance to information seminars are positively correlated with international performance in Hart *et al.*'s (1994) study. Some other studies report for these same afore-mentioned information sources insignificant relationships with international performance: for the use of export country's government agencies (Leonidou and Katsikeas 1997), for industry trade associations (Seringhaus 1993 in Canada; Leonidou and Katsikeas 1997), for export country's government agencies (Leonidou and Katsikeas 1997) or even negative associations for the use of industry

trade associations (Seringhaus 1993, Austria) or the attendance to information seminars (Walliser and Mogos-Descotes 2004).

Most of the time, the direct association between EA information sources and international performance is insignificant. Collecting information from embassies, international agencies (Leonidou and Katsikeas 1997), domestic government agencies (Hart *et al.* 1994), government offices (Seringhaus 1993 in Canada; Leonidou and Katsikeas 1997), exporters associations (Leonidou and Katsikeas 1997), banks (Seringhaus 1993 in Canada; Hart *et al.* 1994; Leonidou and Katsikeas 1997), and Chambers of Commerce (Seringhaus 1993 Austria; Leonidou and Katsikeas 1997) is insignificantly correlated with international performance. It appears that sometimes some information sources seem to present negative relationships with international performance - such as Chambers of Commerce (Seringhaus 1993 in Canada), banks (Seringhaus 1993 in Austria), government offices (Seringhaus 1993, Austria), and financial government offices (Weaver *et al.* 1998). These associations with international performance can be explained by the fact that information provided by government and local agencies seem to be inadequate and somewhat far behind (Seringhaus 1993). Additionally, it seems that EA information is beneficial to companies in the beginning of exporting when more procedural information is needed. Afterwards, when companies gain more international experience, EA information becomes less useful (Souchon *et al.* 2003).

A more recent longitudinal study, undertaken by Spence (2003) in the U.K. brings additional insights with specific respect to trade missions' exploitation. The author suggests that specific knowledge about targeted markets should be acquired prior to participating in the trade missions, that contact with the potential business partners should be made prior to the trade mission, and that business relationships should be maintained after trade fairs through visits and not only by means of communication technology. Spence (2003) also suggests that the beneficial results of trade missions' attendances could rather be captured in the long run. Wilkinson and Brouthers (2006) observed that firms attending export promotion programs aimed to help with prospects abroad for agents or distributors, and the ones helping firms to participate in trade shows have a positive impact over export performance. The programs for aid in participating in trade missions have an insignificant effect upon export performance.

Aggregate level measures of EA sources, which sum up the use of various forms of EA information sources, as the formal information collection vehicles (Hart and Tzokas 1999)<sup>13</sup> or the quasi-governmental information sources of Yeoh (2000) are positively influencing the

---

<sup>13</sup> Informal information collection vehicles measures of Hart and Tzokas (1999) encompass both EMR and EA information measures.

international performance of firms. Voerman (2003) also found a positive association between the acquisition of export information by means of export assistance in foreign markets and international performance within her three year-long longitudinal study<sup>14</sup>. She also found that acquiring EA information in domestic markets does not have a constant or annual impact upon international performance. Ignoring EA information, storing it for future or immediate use leads to negative performance. On the contrary, the conceptual or instrumental use of EA leads to higher levels of performance (Souchon and Durden 2002; Souchon *et al.* 2004). Resuming, because empirical studies mainly report insignificant associations between EA information sources and international performance, it is difficult to draw a general conclusion on these findings.

#### 1.2.4.1.2 The relationship between export market research and international performance

In the export success literature, several studies occupied themselves with the association between export market research (EMR) techniques and export performance. Donthu and Kim (1993), Dominguez and Sequeira (1993), Bijmolt and Zwart (1994), Hart and Tzokas (1999) and Yeoh (2000), all conclude that the extent to which firms use formal export market research techniques leads to higher levels of export performance. Moini (1995) also recommends formalized and active exploration of export markets as long as it is combined with informal visits to foreign markets. In Seringhaus' (1993) study, undertaking market research abroad is positively correlated with the international performance of Canadian companies while it is non-significantly correlated with the international performance of Austrian ones. Nonetheless, few studies, such as the one of Madsen (1989), Koh (1991), De Luz (1991), Leonidou and Katsikeas (1997), found no significant influence of marketing research activities on the international performance of enterprises. Walliser and Mogos-Descotes (2004) found rather negative associations between formalized market research practices, which include test marketing and mail surveys, and international performance. In addition, there are also studies focusing on specific aspects of marketing research use. For example, considering marketing research for making alternative decisions or not making any decisions without considering market research first (Hart *et al.* 1994; Hart and Tsokas 1999), the instrumental or conceptual use of export information (Souchon and Durden 2002; Souchon *et al.* 2004) and also the immediate and future use (Souchon and Diamantopoulos

---

<sup>14</sup> Voerman (2002) reported the results of the longitudinal study in her dissertation but she did not report the results in the articles published in 2004.

1997) of EMR were positively associated with international performance. The non-use (Hart and Tsokas 1999) or the ignorance of export marketing research (Souchon and Diamantopoulos 1997) is negatively associated with international performance. Market research used to back up managerial hunches was positively correlated with international performance in the study of Hart and Tsokas (1999), but negatively correlated with international performance in the study of Hart *et al.* (1994). Several studies associated certain specific aspects of EMR which include export marketing evaluation, search for new markets, transport costs or methods, products tests, market entry options, market feasibility studies, buyer needs analysis, mail survey, and telephone interviews with international performance. Such examples are the studies of Seringhaus (1993), Hart *et al.* (1994), and Walliser and Mogos-Descotes (2004). Voerman (2003) found that consulting EMR information sources in both foreign and domestic markets positively impact the export performance of SMEs on a longitudinal basis. One can conclude that at the aggregate level, most of the studies support the positive impact of EMR on the international performance of firms.

#### 1.2.4.1.3 The relationship between export market intelligence and international performance

The Export Market Intelligence (EMI) information sources seem to be the most popular information sources among exporters. The bulk of the literature focusing on investigating the use of EMI information sources acknowledges the success of these personal information vehicles among exporters (e.g. Reid 1984; Samiee and Walters 1990; Coviello and Munro 1997; Ellis 2000; Chetty and Holm 2000; Andersen 2006). As in the case of export marketing research, most of the empirical studies acknowledge their positive impact upon international performance. Such positive associations have been reported for trade fairs (Denis and Depelteau 1985; Kleinschmidt and Ross 1986; Seringhaus 1993 in Canada), visits abroad (Kleinschmidt and Ross 1986; Cavusgil and Naor 1987; Seringhaus 1993 in Canada; Moini 1995; Leonidou and Katsikeas 1997), client and customer visits (Walliser and Mogos-Descotes 2004), business travel (Weaver *et al.* 1998), and participation in missions abroad (Denis and Depelteau 1985; Dominguez and Sequeira 1993; Leonidou and Katsikeas 1997). Information obtained by means of channel relationships such as distributor agents, international sales personnel, suppliers, channel, intermediary (Madsen 1989; Cavusgil 1984a) or personal contacts abroad (Leonidou and Katsikeas 1997) also positively impact international performance. Nevertheless, some of the studies report insignificant influences of these same information sources upon the international performance, for information acquired



by means of participation to trade fairs (De Luz 1993), visits abroad (De Luz 1993; Seringhaus 1993 Austria), clients or customer visits (Hart *et al.* 1994; Leonidou and Katsikeas 1997), participation in missions abroad (Seringhaus 1993 in Austria) or channel based information sources (Koh 1991, Seringhaus 1993 in both countries Canada and Austria, Hart *et al.* 1994; Moini 1995; Leonidou and Katsikeas 1997). In the meanwhile, no negative impact upon the international performance of SMEs was reported for the information sources mentioned above. The other impersonal information sources, which are included within the market intelligence information, report rather insignificant relationships with the international performance. It is the case of export information acquired from universities or polytechnics, computerized databases, and public or commercial libraries (Leonidou and Katsikeas 1997). Surprisingly, the use of the internal company reports seems rather negative for companies' performances (Leonidou and Katsikeas 1997). Aggregate level measures of EMI sources such as the use of informal information collection vehicles (Hart and Tzokas 1999) and the personal information techniques of Yeoh (2000) are positively influencing the international performance of firms.

The studies of Souchon and Durden (2002) and Souchon *et al.* (2004)<sup>15</sup> report that the instrumental or conceptual use of EMI has a positive influence upon the international performance of SMEs. Ignoring EMI export information is not significantly related to international performance while immediate use and storing EMI related export information appears to be a negative practice for achieving success in international foreign markets (Souchon and Diamantopoulos 1997). The longitudinal study of Voerman (2003) shows that acquiring information by means of EMI from both foreign and local markets have the strongest impact on export performance compared to EA or EMR information vehicles. At the aggregate level, one can conclude that EMI sources seem to have a positive impact on the international performance of the firms.

#### *1.2.4.2 The relationships between other measures used to capture export information related behaviors and international performance.*

The reviewed empirical studies also used some other measures for capturing aspects related to the acquisition and use of export information. Among these measures, several of them report a positive impact upon the international performance. Such examples are the amount of

---

<sup>15</sup> Instrumental/conceptual use of export information positively influences the formalization of planning, negatively the speed ; the speed and formalization of planning have a positive impact upon international performance.

acquired information (Yeoh 2000), the proximity to the export market (Cavusgil 1984b), the systematic exploration of foreign markets (Cavusgil 1984b; Moini 1995), the existence and evolution of the budget allocated for the search of information (Boutary 1998, 2000), the budget allocated for the export information intelligence acquisition over a five year time period (Mac Pherson 2000), the firm's evolution in terms of information processing, the use of a classification system of the acquired information inside the company, and acquiring information according to the needs or the confidentiality of acquired information (Boutary 1998, 2000). Measures such as partnership research, professionalism of the information provider or the prospective character of acquired information are not significantly different between successful and less successful exporters (Boutary 1998, 2000). Voerman (2003) made a distinction between export information sources consulted abroad and those consulted within the domestic or national market. She observed that enterprises that consulted information sources on foreign markets were more successful than enterprises that consulted domestic information sources.

Three studies linked the export market orientation (EMO) to export performance directly. They all found empirical support concerning the aggregate impact of the three dimensions of EMO, namely export intelligence generation, dissemination and export responsiveness, on export performance (Cadogan *et al.* 2002; Akyol and Akehurst 2003; Cadogan and Cui 2004). A single study explored specifically the reliance between each of the three dimensions of the EMO and several export performance measures. Akyol and Akehurst (2003) have found that only the export responsiveness dimension has a positive and significant effect upon the export sales and export growth and the perceived satisfaction with the attainment of export objectives. Meanwhile, no significant impact was reported upon the competitive and overall export performance.

#### *1.2.4.3 The relationship between the acquisition of different information elements on foreign markets and international performance*

The studies of Hart *et al.* (1994) and of Hart and Tzokas (1999) show a positive influence of the perceived importance of background information on the international performance of SMEs. On the contrary, the study of Walliser and Mogos-Descotes (2004) found an insignificant influence of the background information on international performance. Moreover, the item relative to the governmental aid in exporting was found to be negatively

correlated with the international performance of the French SMEs. The study of Julien and Ramangalahy (2003) revealed that the perceived importance of markets, competition, and norms positively and indirectly impact SMEs' export performances by enhancing their competitive strategy.

#### *1.2.4.4 The studies examining the indirect relationship between information acquisition, its use and international performance*

It is worth mentioning that generally studies assess the direct relationship between international performance and export information and that the empirical evidences are somehow contradictory. Very few of the cited studies, seven studies to be more specific, observed indirect effects of export information on international performance. The study of Seringhaus (1993) concluded that there is an indirect positive influence of the extent and frequency of the EMR use through the improvement of the pricing strategy, direct buyer strategy, and channel strategy that further enhance performance. However, one cannot be sure of this indirect effect since testing indirect relationships is mainly assessed by using Structural Equations Modeling (SEM); Seringhaus (1993) did not use SEM in his study. The study conducted in the U.S. by MacPherson (2000) also observed a positive correlation between the budget allocated to the collection of market intelligence over the last five years and the international design orientation of the product. The study did not report any direct impact of export market intelligence upon international performance but did report the impact of the international design orientation of the product upon international performance. Ramangalahy's dissertation (2001) found a positive and indirect effect of the richness of export information sources and the quality of information collected on export markets upon the international performance of SMEs through the improvement of their competitive advantage. The study of Souchon and Durden (2002) concluded by using the SEM that the conceptual or instrumental export information use is a mediator between export information acquisition and international performance. The study of Morgan *et al.* (2003) found that export market informational knowledge impacts the marketing planning capabilities, which in turn impacts the marketing implementation capabilities, which have a direct impact upon the adaptative performance of export ventures. The study of Julien and Ramangalahy (2003) reported an indirect effect of export information acquisition on international performance by means of improving the competitive advantage of SMEs.

Table 5. The main results of the reviewed studies with respect to the influence of firms' export information related activities upon export performance

Study	Main results
Rosson and Ford (1982)	Channel contact intensity has an important impact upon international performance. The number of letters exchanged bi-annually between the manufacturer and the distributor is positively correlated with the perceived and real sales trend but not with the number of visits and other contact frequency.
Cavusgil (1984a)	More profitable international firms place greater emphasis on EMR, engage in foreign market analysis more frequently and in more formalized ways using more rigorous data analysis and perceive EMR as more complex.
Cavusgil (1984b)	The proximity to foreign markets and the systematic exploration of foreign markets do not appear to have any influence upon the international performance.
Denis et Depelteau (1985)	Attending trade fairs and missions abroad appear to be positively correlated with the geographical spread of export destinations. The number of export information sources consulted in foreign markets plays a minor role in the determination of the spread of export destinations.
Kleinschmidt and Ross (1986)	The authors did not provide any clear information with respect to the impact of firms' export information activities on export performance.
Diamantopoulos and Inglis (1988)	More export-intensive firms consult relatively fewer export assistance agencies than the less export-intensive counterparts consult, and have lower export percentage sales from the total turnover of the company.
Madsen (1989)	Informal export information techniques, namely the closeness of personal contact with foreign markets, and the channel relationships with agents and/or distributors, have a positive influence upon the export performance indicators. Meanwhile, formalized export information techniques such as market research have an insignificant impact upon a firm's foreign market performance.
Koh (1991)	The results suggest that there could be a positive indirect influence of the extent and frequency of the use of marketing research upon the international performance of firms through the improvement of pricing, direct buying and channel strategy. While pricing, direct buying, and channel strategy appear to be correlated with both international performance indicators and export information related measures, the export information related does not present significant positive correlations with international performance indicators.
Dominguez and Sequeira (1993)	Successful exporters use more formal market research techniques and deal directly with overseas clients.

Seringhaus (1993)	There is a strong impact of the export marketing expertise use upon firms' international performance levels. Meanwhile, the frequency of use of the marketing expertise does not appear as a strong antecedent of international performance. Companies from the two countries where the study has been conducted, Austria and Canada, exhibit differences with respect to the firms' information behaviors.
Donthu and Kim (1993)	The use of export assistance positively influences the levels of export performance of the firms.
De Luz (1993)	Market research use does not influence the level of a firm's international success.
Hart <i>et al.</i> (1994)	The collection of foreign market related background information, infrastructure and social or political background and key buyer's purchase information, is associated with higher export profits. The firm's export ratio is positively associated with the use of the country's government agencies, foreign embassies and Trade Associations to collect information related to foreign markets. The export ratio is also positively correlated with the use of several market research techniques such as mail surveys, interviews with buyers and information seminars, and with the perceived importance of the use of marketing research for taking or valuing export decisions.
Bijmolt and Zwart (1994)	Positive impact of the marketing research practices on international performance at the aggregate level.
Moini (1995)	Undertaking marketing expertise and systematic exploration of foreign markets, the frequency of informal visits to foreign markets and the efficiency of the foreign distribution network are elements positively related to the international performance indices.
Leonidou and Katsikeas (1997)	There is a general positive impact of the perceived importance of personal information sources such as foreign market visits and personal contacts and also the participation to trade missions upon international performance indicators. Firms exporting towards a larger number of countries inform themselves more by visiting the foreign markets, suppliers, salespeople and sales offices abroad.
Souchon and Diamantopoulos (1997)	The results suggest that ignoring export information is negatively correlated with international performance indicators. The immediate use of EMR information has a positive influence upon firms' international performance levels while the immediate use of information stemming from EMI and EA related sources is negatively correlated with international performance levels. Meanwhile, when storing for future use, EMR is also positive correlated with high levels of export performance. Storing EA and EMI information appear to be negatively correlated with international performance. Enterprises having the feeling of being overloaded by the export information amount available to them are more likely to consider or reject export information and no relationship has been found with the rejection, non-use or immediate and future use of export information. Results also suggest that generally EMR and EMI export information is rather stored for future use or used immediately than rejected or ignored. EA export information is generally stored for future use and few companies consider, reject or ignore this kind of foreign market related information.

Weaver <i>et al.</i> (1998)	The frequency of business travel in foreign markets and the perceived criticality of the analysis of the competitors on export markets have a positive influence upon the levels of international performance. EA associated measures as the perceived helpfulness of governmental financial services for exporting are negatively associated with international performance levels.
Boutary (1998, 2000)	Several hybrid measures used for capturing SMEs' sensitivity towards export information, the information system openness, and sustained orientation towards information needs positively influence international performance.
Ogunmokun and Ng (1999)	Significant differences exist between high and low involved exporters from the point of view of: the formalization of the structure and policy used for researching the market, the frequency of foreign market visits, some of the information sources and types collected in foreign markets, and the types of export information collected about socio-cultural trends, customer characteristics, customer opinion or attitudes, behaviors, market growth and market segments, sources, annual reports, government publications, or customers.
Hart and Tsokas (1999)	The successful U.K. exporters perceive as critically important export information collection by means of both formal and informal export information vehicles, and acquiring background information about the foreign markets they are exporting in.
MacPherson (2000)	Positive correlation between what the budget exporters allocate for gathering export market related information. The international design orientation ultimately has a positive impact upon a firm's degree of international performance.
Yeoh (2000)	The international performance levels of firms are positively influenced by the frequency and the perceived usefulness of export information gathered through different information sources and by the amount of export information collected. A firm's entrepreneurial orientation has been found to be positively associated with an extensive use of informal export information sources.
Ramangalahy (2001)	The quality of information types and sources used to gather export information both positively and indirectly influence the international performance of SMEs through the enhancement of the competitive advantage of firms.
Gencturk and Kotabe (2001)	Positive impact of the number of export assistance programs used by firms on their perceived levels of competitiveness in foreign markets.
Cadogan <i>et al.</i> (2002)	EMO has a positive and significant impact upon the perceived and overall export performance, but not upon the export sales growth (the objective measure of international performance).
Souchon and Durden (2002)	Export information conceptual or instrumental and symbolic use is a mediator between export information acquisition from EMI, EA, EMR export information related sources and international performance.

Akyol and Akehurst (2003)	The aggregate measure of EMO has a positive impact upon all dimensions of export performance used (the objective measures: export sales and export percentage growth over 3 years, and the subjective measures: perceived satisfaction and competitive performance with the evolution of export objectives and overall export performance). When analyzed one by one, among the three dimensions of EMO, only the export responsiveness has a positive and significant effect upon the export sales, export growth, and the perceived satisfaction with the attainment of export objectives. Meanwhile, no significant impact was reported upon the perceived competitive and overall export performance.
Morgan <i>et al.</i> (2003)	Export market informational knowledge impacts the marketing planning capabilities, which in turn impacts the marketing implementation capabilities, which have a direct impact upon the adaptative performance of export ventures.
Voerman (2003) <sup>16</sup>	<p>The use of foreign market information sources, in terms of the amount, positively influences SMEs' export performances. The strongest influence is exerted by EMI related information sources, followed by EMR and EA.</p> <p>Among the domestic information sources used to become informed about the foreign markets, only informal or EMI related information sources influence foreign market sales. The three-year long longitudinal analysis reveals the importance of using foreign market information sources while using domestic information sources for obtaining information about foreign markets does not impact SMEs levels of export performance every year.</p> <p>Several countries of origin effects have been also pointed out. Swedish and Norwegian companies consult less foreign and domestic information sources while Austrian companies lag behind with foreign information sources and Finnish firms consult the most important number of information sources both foreign and domestic. Also, the branch of industry companies belong to induces variations into the way enterprises acquire information about foreign markets. For example, enterprises in the metal industry consult more domestic sources than enterprises from the textile, furniture and electronics industry. On the contrary, firms from the textile and metal industry consult foreign information providers more often. Another salient element appears to be a firm's size; smaller firms consult less information sources in both domestic and foreign markets. In addition, joint effects of the country and industry branch upon the number of information sources consulted were revealed within this study. Dutch and Swedish firms often use business consultants, the Chambers of Commerce and national trade fairs to gather export information while Finnish companies mainly consult their customers and Swedish companies especially use export clubs.</p>
Spence (2003)	<p>Specific knowledge about targeted markets should be acquired prior to participating in the trade missions. In addition, the contact with the potential business partners should be established prior to the trade mission's attendance.</p> <p>Business relationships should be maintained after the trade fairs by means of personal visits not only by means of communication technology.</p> <p>The levels of general export knowledge that firms possess influence performance measures. Objective knowledge acquired before trade mission attendance influences relationship building with both foreign partners and with international performance measures as well.</p>

<sup>16</sup> Longitudinal study during 1991, 1993 and 1995.

Julien and Ramangalahy (2003)	There is an indirect effect of export information research in terms of the use of export information sources and collection of export information elements on international performance through enhancing SMEs' competitive advantage on foreign markets.
Alvarez (2004)	Efforts in international business, process innovation, and the use of export programs positively contribute to the export performance levels of firms. Attending trade shows and missions do not affect the probability of exporting permanently but exporters' committees show a positive and significant impact upon the continuity in exporting.
Cadogan and Cui (2004)	EMO has a positive and significant impact upon the international performance.
Souchon <i>et al.</i> (2004)	Instrumental or conceptual use of export information acquired from EMI, EA or EMR related sources positively influence the formality of planning and negatively influences the speed and formality of planning activities. The formality of planning activities positively affects international performance levels of companies. In conclusion, the impact of export information use upon international performance is indirect through the enhancement of the planning activity formalization within firms.
Walliser and Mogos-Descotes (2004)	Clients are of utmost importance as information sources in export markets. The use of clients as an information source promotes higher levels of objective measures of international performance. Negative relationships with international performance measures have been found in firms that expose higher appreciation of more formalized export information techniques such as test marketing, mail surveys, and participation at information seminars. The collection of the foreign market background information relative to the governmental aid to exporting was negatively correlated with both objective and subjective measures of international performance.
Wilkinson and Brouters (2006)	Firms attending export promotion programs aimed to help them prospect foreign markets for agents or distributors and promotion programs aimed at helping firms participate in trade shows abroad have a positive impact over export performance. The aid programs for participating in trade missions have an insignificant effect upon export performance. Firms' technological resources are also performing better. Smaller firms who used available state promotion programs enjoyed greater success.

**Legend:** EA = Export Assistance, EMR = Export Market Research, EMI = Export Market Intelligence; EMO = Export Market Orientation



Finally, the study of Souchon *et al.* (2004) observed that the instrumental/conceptual use of export information positively influences international performance indirectly by enhancing the formalization degree of planning activities.

## 1.2.5 Discussion

Over the last 26 years, scholars emphasized the key role of export information for achieving international performance. This chapter presents a literature review of the empirical articles studying the relationship between export information acquisition and use, and the international performance of enterprises. The general conclusion of the current review is that research on this topic remains somewhat underdeveloped because until now no consensus exists about the conceptual and operational definitions of export information behaviors and international performance. The results of the different studies are rather disparate. Continuing with the existing literature, several shortcomings can be noticed that will be discussed hereafter.

### *1.2.5.1 Methodological shortcomings and future research avenues*

From a methodological point of view, the size of the samples of the reviewed studies is rather small. Only 19 studies have used samples with over 100 observations and six studies used samples with 50 observations or less. It worth to be noted that for studies that reported small sample sizes, external validity and generality of conclusions can be questioned (Sousa 2004). Moreover, the sample itself may not be representative of the population and limits the use of adequate statistical analysis to test the relationships of influence. Therefore, specific conclusions are attenuated and should be regarded as suggestive rather than conclusive. Furthermore, studies should try to increase sample size.

Frequently, samples of the reviewed studies were drawn from a large pool of various industries. On one hand, this way allows a wider extrapolation of the results. On the other hand, previous studies reported differences among enterprises from different industries in terms of information behaviors and studies reporting results based on a sample composed of multiple industries most of the times ignored these differences. Focusing only on one industrial sector does not permit generalizing the results to other industrial sectors as it casts doubts on the external validity of the findings.

Another notable observation is that five of the reviewed studies drew samples from more than one country. The advantage of using this multi-country approach is that it provides a strong indication of the external validity of the results and allows the identification of cross-cultural differences related to the use of export information. Another observation is that 11 studies restricted their analysis to specific regions within a given country. This restriction can be explained by the size of the countries, which are mainly large countries such as the U.S.A., Canada, and Brazil to name a few. The restriction can also be explained by the fact that nowadays governments try to adapt and sometimes accord decision autonomy to regional governmental bodies in order to design export policies “*sur mesure*” by taking into consideration regional specificities. Another reason may be the fact that often times “*regional cultures*” may exist in one country. For instance, between the “*French*” and the “*English*” regions in Canada differences are expected to be quite evident and distinct.

Only 16 of the reviewed studies provide clear information concerning the size of the enterprises interviewed. The size has been widely acknowledged as a factor with an important influence upon export information activities (Samiee and Walters 1990; Denis and Depelteau 1985; Hart *et al.* 1994). Bigger firms generally have more resources and can therefore allocate a more substantial budget to information collection. As a result, larger firms use more extensive and formalized information techniques when compared to smaller firms (Souchon *et al.* 2003). Thus, future studies should draw sharp distinctions regarding the size of the targeted firms.

Response rates in the reviewed studies can be considered as satisfactory. The average response rate is of 34,32% (standard deviation = 15,63 and the median = 26%). This percentage constitutes fairly high response rates since the average top management response rates are generally ranging from 15% to 20% (Menon *et al.* 1999). In the case of cross-cultural-studies, the average response rate was above 20%, which is quite high considering that collecting data from abroad is more difficult than from the country of origin due to the numerous obstacles that must be overcome in transnational research (e.g. Douglas and Craig 1983; Sousa 2004).

The majority of reviewed studies were not checked for non-response bias. Only 13 of the 37 studies provide information on this issue. It is surprising that many studies did not carry out such controls and cast some doubt on the representativeness of the samples and on the robustness of the data obtained. The same observation can be made concerning key informants. Even though the majority of the studies disclosed their key informants, 15 of the studies did not provide any information at all or provided unclear information. This instability

is considered an important issue since it is well known that not every employee or member of the management team can provide accurate information for studying export information activities. Future studies should consider these aspects of non-response bias and key informants as well.

Another shortcoming was the nature of the statistical analysis employed. Mainly descriptive statistical techniques such as correlation and analysis of variance, T-tests, and Chi-square analysis were employed though more extensively in older studies. Only 15 studies employed explicative statistical techniques making it difficult to further theory building and testimonies of the mainly descriptive nature of this research field.

### *1.2.5.2 Theoretical shortcomings and future research avenues*

Despite the use of the firm level of analysis in the studies reviewed, only four studies built the research model based on a grounded firm theory, namely the resource based view of the firm (RBV) and one study integrated insights from the knowledge-based view (KBV) perspective. Although not mentioned in the rest of the reviewed studies, it seems that the contingency theory paradigm is the most prevalent. Generally, studies focus on the quantity and volume of information as a reducer of uncertainty, which is a basic premise of the contingency theory. Within the contingency theory, the information exploitation represents the “generic solution” proposed by numerous scholars for achieving performance (Lawrence and Lorsch 1967; Thompson 1967; Aguilar 1967; Ackoff 1970; Ansoff 1970; Andrews 1971; Galbraith 1973; Porter 1986; Baumard 1991). The view of one of the pioneers of the uncertainty theory, Galbraith (1973), is especially highlighted. The emphasis is put on the quantity and volume of information in most of the reviewed studies. The observations made translate the relatively poor theoretical and methodological foundation of these studies. It is recommended that future studies should build research models based on a more solid theoretical basis in order to capture the impact of export information behaviors on international performance.

### *1.2.5.3 Operationalization shortcomings and future research avenues*

#### **1.2.5.3.1 Shortcomings in terms of international performance operationalization**

In terms of modes of international performance assessment, the reviewed studies used objective or subjective measures or even both. Because the studies used different international

performance measures, it is difficult to compare the results. It seems however that the use of multiple measures of export performance is necessary in order to fully realize the strengths of each indicator and minimize the impact of their shortcomings (Evangelista 1994). The heterogeneity of international performance measures employed by the reviewed studies testifies to this problem and makes the comparison of results from one study to another difficult.

#### **1.2.5.3.2 Shortcomings in terms of export information acquisition and use operationalization**

When studies try to measure export information acquisition and use, they face several challenges that highlight the complexity of assessing these intangible constructs. The most frequently used measures by the researchers were the frequency of use and the perceived usefulness of information sources. Although many studies employed these measures, there is still not a clear picture of what a frequently used or an important information source represents. Even more, the perceived usefulness measure does not provide any indication about the real utilization of information sources. Important gaps might exist between perception and use of export information sources by managers. Moreover, most of the studies concentrate on a more or less important number of information sources also differing from one study to another.

As previously mentioned, a classification of the existing measures capture export information related behaviors into three main classes, namely objective, hybrid, and subjective measures can be suggested. Among the subjective measures, a distinction was made between uni-dimensional and multi-dimensional measures. Multi-dimensional measures were developed recently within the research work of Ramangalahy (2001) and Toften and Olsen (2003). It is important to stress the significance of these last measures aiming to capture multi-dimensional aspects related to information sources and information elements such as the quality of information and information sources. Information is rather an abstract, multi-dimensional construct difficult to capture by means of single measures. The use of specific types of information or information sources depends on several qualities they provide to end users. Therefore, general perceived satisfaction or usefulness indications are somehow insufficient for capturing the essence of the multi-facet information construct.

Another observation made is that among the perceptual or subjective measures, no relative measures have yet been used. Relative measures such as the frequency of use of information sources compared to competitors have the advantage of balancing managerial perceptions by

the means of the comparison to a reference. The main disadvantage of subjective measures is their subjective character; they are the result of the perception of the person answering the questionnaire. However, managerial perceptions are vital in the decision-making process. For example, it is very likely that a manager who perceives that the budget allocated to export information search for the last year was not sufficient, or believes that the main competitors allocate more resources to export information search, would increase the budget allocated to foreign market scanning for the next year. This example also proves the relative reliance existing between the two types of measures, subjective and objective.

Objective measures have been mainly used in older studies. One can observe that the use of subjective measures (19 studies) prevails over the use of objective measures (11 studies). There are several motives associated to the reduced number of objective measures employed by the researchers over the last years: (1) generally firms are somehow reluctant to provide objective data in general (Francis and Collins-Dodd 2000; Leonidou *et al.* 2002); (2) objective data, for example the amount of the budget allocated to information search, are not publicly available and thus it is impossible to check the data accuracy; (3) decision-makers are guided by their subjective perceptions rather than by objective figures (Madsen 1989); (4) difficulty in establishing a fixed reference point across firms since all firms do not function in the same way; firms might access the right information by several means, either more personal information or more formal information sources as marketing research that are more expensive and thus not requiring the same budget. Also, a firm might consult a relatively reduced number of rich information sources and acquire the right information easier than a firm accessing numerous but not rich enough information sources. Moreover, (5) using objective measures makes comparisons across businesses, especially in cross-country studies, difficult since there are differences in cross-national behaviors in terms of export information (Seringhaus 1993, Souchon *et al.* 2003).

In addition, the decision to allocate more resources and effort for acquiring export information depends on many contingency factors, for example<sup>17</sup>: (1) the export orientation of the company and the short or long-term orientation - a manager of a firm that focuses on the long term to increase the market share in a foreign market may allocate more financial and human resources to export information activities; (2) the size of the firm - managers of smaller firms allocate fewer resources and thus employ less formalized information acquisition techniques. Nevertheless, objective measures have the advantage of balancing the subjectivity of

---

<sup>17</sup> For a complete review of the literature concerning the contingency factors affecting export acquisition information and use behaviours, see the study of Souchon *et al.* (2003).

managerial perceptions and it is believed that both types of measures, objective and subjective, are useful for capturing export information related behaviors.

In terms of time frame, all the studies presented in Table 2 used objective information measures conceived in a static way but not taking past information-related actions into account. By means of using a dynamic orientation, the respondents could be asked to go back in time and report on the activities undertaken over the last three to five years. For instance, they could consider whether they increased or decreased the number of information sources they were using on export markets or whether they were allocating more or less people to make use of export information over the last three years. This type of assessment would allow the researcher to get an idea of the evolution of the information activities. In the meanwhile, dynamic oriented measures are based on managers' recall capacity, thus, limiting the precision of the data gathered.

Under the name hybrid measures are grouped all the measures that cannot be enclosed either within the objective or within the subjective class. They were usually measured by means of nominal variables. A suggestion for the future is that researchers should give up the use of hybrid measures in favor of subjective measures operationalized by means of ordinal scales. The operationalization by means of ordinal measures leaves room for a more extended choice range for respondents and allows for the possibility of using more developed statistical techniques for testing a research hypothesis.

Whereas objective measures are meant to balance the intangible and complex nature of information, subjective measures such as the richness or quality of information sources are maybe more appropriate for capturing the multifaceted, complex and intangible nature of information. As a result, the use of both objective and subjective measures is also recommended, as they are complementary to each other. One should note that only five of the reviewed studies combine the use of objective, subjective and hybrid measures. It can be observed that until now, empirical studies have mainly emphasized quantitative aspects of information use, trying to answer questions on how frequently information sources are used, or how many information sources exporters use. Only two of the reviewed studies focused on more qualitative aspects related to the information and information sources. The first study, the study of Boutary (1998, 2000), emphasized the professionalism of the information provider or on some aspects related to the nature of the acquired information, its prospective character and the confidentiality of the acquired information. The second study, the study of Ramagalahy (2001), used subjective multi-dimensional measures for capturing information quality and information sources richness. The under-exploitation of the study of information

qualities could be argued by the theory of media invariance that suggests that all media provide equivalent information (Carlson and Zmud 1994, 1998). In spite of this position sustained by Carlson and Zmud (1994, 1998), most of the scholars in management literature agree with the fact that the qualities that information and information sources provide such as richness, value, utility and interactivity (Lawrence and Lorsch 1967; Wilensky 1967; Ramangalahy 2001) are critical for improving decision-making or leveraging the response to environmental changes. Future studies should explore more qualitative aspects related to the information sources used.

Another observation is that only recently, beginning with the study of Cadogan *et al.* (2002), scholars have considered the extension of the market orientation construct to export markets. These studies have the advantage of considering the organizational export information dissemination processes (e.g. communication, coordination) through the organization, and thus, enclosing the organizational dimension, which has been mostly neglected by previous studies in the field.

Although some progress has been made in developing theory and knowledge of the measures of export information acquisition and use compared to earlier studies, there is still a long way to go before it is possible to clearly delineate and achieve an agreement among scholars concerning the conceptualization of export information acquisition and use and to identify their dimensions. Several measurement scales capturing export information acquisition and use were developed and employed by empirical studies in the field. As one can notice in the previous section, the scholars do not agree upon the scales to be used. Therefore, they continuously develop new measurement instruments that also limit the comparison of existing results. It is an issue that should be further developed in the future.

#### **1.2.5.3.3 Shortcomings of the study of the relationship between the behaviors in terms of export information acquisition and use and international performance**

The link between export information acquisition and use and international performance was assessed by disparate measures that vary from one study to another. These variations partly explain the existing “*pros*” and “*cons*” for supporting the relationship between export performance and the three main classes of information acquisition techniques, which are EMR, EA, and EMI. Nevertheless, on the aggregate level, it seems that EMI and EMR are positively related to international performance, while EA appears as rather insignificantly related to international performance. However, clear conclusions cannot be drawn because of

the operationalizations of international performance on one side, and export information acquisition and use on the other side differ significantly from one study to another.

The studies linking EMO to export performance seem to rather sustain the existence of a link between the aggregate measure of EMO and export performance. Nonetheless, it worth to be noted that the only one study explored one by one the reliance existing between the three dimensions of EMO and export performance (Akyol and Akehurst 2002). The authors found that only the export responsiveness dimension of EMO impacts positively several measures of export performance, while export intelligence generation and dissemination have no significant impact upon the export performance.

Another important issue is that generally the link between export information and international performance was studied as direct. Only recently have scholars begun to focus more extensively on indirect effects. In fact, the six existing studies that explore the indirect effects of export information upon international performance seem to shed some more light on how export information is used within the organization after its prior acquisition. Export information impacts international performance indirectly through the conceptual/instrumental use of information (Souchon and Durden 2002), through improving competitive advantage of firms (Ramangalahy 2001; Julien and Ramangalahy 2003) or through improving planning activities (Morgan *et al.* 2003; Souchon *et al.* 2004), and firms' implementation marketing capabilities (Morgan *et al.* 2003). On a more descriptive basis, Seringhaus (1993) concluded that there is an indirect positive influence of the extent and frequency of use of marketing research and international performance through the improvement of pricing strategy, direct buyer strategy and channel strategy. In addition, MacPherson (2000) observed a positive correlation between the budget allocated to the collection of market intelligence over the last five years and the international design orientation of the product, which in turn impacts international performance. The two studies of MacPherson (2000) and Seringhaus (1993) did not use SEM thus it is difficult to be sure of the existence of the previously indirect effects reported upon international performance. In the future, more insight into the study of the indirect effects of export information activities upon international performance should be explored. In addition, researchers should employ SEM more frequently. This method allows for simultaneously estimating the measurement errors and structural relations of the model and enables multiple and interrelated dependence relationships between unobserved constructs to be estimated (Diamantopoulos 1999). Moreover, constructs can be both dependent and independent variables (Diamantopoulos 1999).



Another observation is that generally, the studies focusing on the link between international performance and export information rarely tried to ascertain the existence of mediating or interaction effects of firms' characteristics and information behaviors on international performance. It seems that the literature on the contingency factors affecting the export information behaviors developed independently from the literature on the link between export information and international performance. There are studies, such as the study of Belich and Dubinski (1999) or the study of Souchon *et al.* (2003) that provided important insights into contingency factors but did not report the relationship existing between the interaction of export information contingency factors, export information behaviors and international performance. Such evidence would be interesting to report.

As a general conclusion for the present study, one can observe that scholars have used many different measures to assess both export information acquisition use behaviors and export performance making the comparison of the findings difficult and leaving room for inconsistency and confusion. It seems that the export information literature presents rather fragmented results and is not able to develop a widely accepted model or pattern regarding the impact of export information acquisition and use upon international performance thus limiting theoretical advancement in this field. A possible explanation is that the existing empirical studies, with three exceptions, did not use any grounded theories for developing research models.

Finally, only 16 studies over the last 26 years focused specifically on the relationship between international performance and firms' export information behaviors. Notwithstanding the generally accepted belief of the key role played by export information processing activities for achieving international performance, this stream of research has received disproportionately less empirical attention compared to other determinant factors of international performance in exporting literature.

To conclude, although this research field has numerous shortcomings, the reduced number of existing empirical studies and the relative youth of the research field can explain them. Further research work should be carried out in the future on this research topic to develop more knowledge in the field.

## **Conclusion of Chapter I**

Within the first chapter, the concept of exporting SME was defined and the importance of distinguishing between middle-sized firms and micro-firms when studying export behaviors was stressed. Because of the specific characteristics of micro-firms, scholars suggest they should be studied specifically (Torrès 2003).

Furthermore, the studies dealing with the relationship between export information and international performance were analyzed. Only 16 studies over the last 26 years specifically addressed the research question regarding the influence of export information behaviors upon the international performance levels.

The export information literature is mostly characterized by quantitative studies that are idiosyncratic from the point of view of the research methodology. Studies were analyzed through several features including general characteristics such as sample size, response rate, key respondents, non-response bias report, and statistical methods used, to name a few .

Most of the studies were undertaken in the U.S. Sample sizes seem to increase over time. Studies undertaken between the 1980's and the 1990's generally report sample sizes of less than 100 enterprises; recent studies generally employ larger samples and more developed statistical techniques such as SEM. Recent studies also disclose the key respondents more often and refer to response bias.

The study and operationalization of export information behaviors of firms were also described in terms of measurement and existing taxonomies developed within the literature. A possible classification of export information related measures was proposed based on the nature of the measures used to capture the constructs, distinguishing between qualitative, quantitative and hybrid measures. Additionally, a distinction between uni-dimensional and multi-dimensional qualitative measures was proposed. The general conclusion was that several types of measures, more specifically multi-dimensional measures such as information sources richness, capturing the best multi-faceted nature of firms' information activities, should be used.

Theoretical features such as the use of a grounded theory for establishing research hypothesis or propositions, the exploratory, descriptive or causal nature of the study were also analyzed. It appears that most of the studies did not rely on solid, grounded theories in order to set up the research propositions; this explains the important number of studies exploratory by nature. Only three among the 37 studies reviewed relied on a grounded theory for establishing research hypothesis or propositions. In order to palliate this gap in the literature, the main theoretical frameworks and theories approaching the relationship between firms' export information behaviors and business performance will be presented and discussed in chapter II.

# CHAPTER II. A SYNTHESIS OF THE MAIN THEORETICAL ADVANCES DESCRIBING THE RELATIONSHIP BETWEEN INFORMATION AND PERFORMANCE

## **Introduction to Chapter II**

The second chapter aims to define information, one of the main concepts, mobilized in this research. Thus, the first section II.1 defines information by introducing it under the semantic and syntactic perspectives. The difference with the concept of knowledge is also discussed.

After defining the concept of information in the second part of chapter II, section II.2, the main theoretical frameworks explaining the link between information and organizational performance are reviewed.

Furthermore, in section II.3, a critical analysis of the theoretical frameworks explaining the link between information and organizational performance is assessed. Similarities and differences among the theoretical frameworks are discussed along with the analysis on the application of the different research frameworks and perspectives for best capturing the relationship under study, which is the influence of information activities on organizational performance.

Finally, in section II.4, based on the previously drawn conclusions the generalized research model linking firms' information activities to organizational performance is developed.

## **II.1 Defining information**

Information is at the heart of numerous theories developed in various disciplines such as cybernetics, communication, marketing, sociology, cognitive psychology and economics. The numerous application fields of information partly explain the variety and the controversies existing in the literature with respect to information definition.

The etymology of the verb “*to inform*” has roots in the Latin word, “*informare*”, and its first synonym is “*to learn*”, implying the knowledge connotation of the word. In addition, according to Webster’s Collegiate Dictionary, “*to inform*” is defined as “*the communication or the reception of knowledge or intelligence*”.

The information has seldom been clearly defined in spite of the fact that the concept of information is commonly used (Glazer 1991; Lesca and Lesca 1995), trying to define it is like walking on shifting sands (Bawden 2001). Even though there is no agreement concerning the

definition of information, it is usual to introduce information as having the two aspects “*syntactic*” and “*semantic*” (Nonaka and Takeuchi 1995; Jerez-Gomez *et al.* 2005).

### II.1.1 Syntactic and semantic aspects of information

The syntactic aspect of information highlights the quantifiable character of information. One of the first “*quantitative*” definitions given to the word “*information*” stems from cybernetics. Norbert Wiener (1948) defined information in terms of thermodynamics as opposed to entropy. Entropy refers to the state of disorder whereas information measures the degree of order or organization of a system. Later on, in information and communication science, Shannon and Weaver (1959) defined information as a quantitative measure of the communication flow. They distinguished the elementary message and the sum of elementary messages that composes communication flows. They stressed the difference between the concept of information and the meaning of the message the information conveys. Information is stripped of any semantic value. It is dissociated from knowledge, which is the result of a creation process.

The semantic aspect of information refers to the qualitative character of information, the meaning, signal and learning potential information conveys. Nonaka (1994) defined information as a flux of messages or signals. Huber (1991) defined information as a structured assembly of data characterized by a meaning or a signal. In order to improve strategic planning methods, Igor Ansoff invented the concept and theory of weak signals in the mid-1970s. He defined strong signals as sufficiently visible and concrete information pieces, while weak signals are “*imprecise early indications about impending impactful events*” (Uskali 2005, p. 4). Ansoff claimed that enterprises need weak signal “*mentalities*.” At the same time, managers’ experiences are based on strong signals, strategic planning is based on information conveying strong signals as well. Thus, it is not always easy for managers to grasp weak signal’s sense. Ansoff’s theory of weak and strong signals has received a growing interest since then and some of the researchers name information conveying weak signals as “*signe d’alerte precoce*” (Castagnons and Lesca 2000; Lesca 2001). Reviewing Ansoff’s theory, Lesca and Blanco (2002) defined the weak signals as fragmentary information with low visibility, ambiguous meaning, and low usability and relevance.

Beyond signals, some of the scholars have highlighted the learning potential of information. For instance, Nonaka (1994) stressed the new meaning information brings along with respect

to a given phenomenon. This new meaning, which is context-bound, provides a new basis for the interpretation of events, enabling the comprehension of facts not understood *ex ante*. Nonaka and Takeuchi (1995) acknowledged the importance of the semantic perspective and highlighted the role of information in knowledge creation. According to them, it is the meaning and the quality of information that enhances the understanding of new situations, based on the knowledge accumulation over time. Several authors have suggested that information represents an input for knowledge creation (e.g. Cohen and Levinthal 1990, 1994; Huber 1991; Argyris 1993; Nonaka 1994; Nonaka and Takeuchi 1995; Choo 1999). If information is an input for knowledge creation, the two concepts cannot be regarded as an equivalent (Huber 1991; Nonaka 1994; Jerez-Gomez *et al.* 2005) and a distinction should be made between the two concepts.

### II.1.2 The distinction between information and knowledge

When it comes to the distinction between information and knowledge, scholars have adopted a so-called “*hierarchical view*” which is: data → information → knowledge (e.g. Dretske 1981; Malchup 1983; Davenport and Prusak 1998). Data are raw numbers and facts, information is processed data and knowledge is authenticated information (Dretske 1981; Malchup 1983; Vance 1997). The hierarchical view rarely survives scrupulous evaluation (Jerez-Gomez *et al.* 2005). For example, Tuomi (1999) argued that the hierarchy data → information → knowledge is actually reversed. Knowledge must exist before information can be formulated and before data can form information. Thus, raw data does not exist and every piece of data has already been influenced by the knowledge that led to its identification. Knowledge can be transformed into information by articulating, verbalizing, and structuring knowledge. Information becomes data when it is assigned to a fixed representation and standard interpretation. Tuomi’s view can be criticized by accepting that knowledge does not exist outside of an agent, namely the knower (Fahey and Prusak 1998; Tuomi 1999). Hence, knowledge is the result of cognitive processes triggered by the inflow of new stimuli (Jerez-Gomez *et al.* 2005). In a similar vein, Huber (1991) deemed that information indicates a structured whole of data conveying a meaning, whereas knowledge is a product or result generated by processing information. Similarly, Glazer (1991) defined information as an organized body of data in a given context conveying a certain meaning.

Alavi and Laidner (2001) observe that to effectively distinguish between information and knowledge, authors should not focus on the content, structure, accuracy, or utility of the supposed information or knowledge. They should rather distinguish knowledge as information possessed in the mind of individuals, in other words, personalized information, which may or may not be new, unique, useful, or accurate in relation to facts, procedures, concepts, interpretations, ideas, observations and judgments.

Nonaka and Takeuchi (1995, p. 58) note that “*information provides a new point of view for interpreting objects and events,*” whereas “*knowledge unlike information is about beliefs and commitment. Knowledge, unlike information, is about action.*” Stehr (1994, p. 120) observed that the interpretive skills of the knowledge creator are essential in overlapping contextual circumstances since “*information merely reflects the products from which it is abstracted and it is used to set an action into motion.*” The active involvement of an agent is fundamental to knowledge creation, while information has more of the characteristics of a public good (Jerez-Gomez *et al.* 2005).

For Malchup (1983), information is a flow of data or signals that nurtures change and structures knowledge. Dretske (1981) accepts the idea that by means of information processing, knowledge can be created. One can supplement the distinction between these two concepts, based on the position defended by Nonaka (1994), by specifying that information rely on a fact or an amount of facts with different degrees of complexity whereas knowledge relies on a process or an activity. Schultze (2000, p. 6) also concluded that “*knowledge is closely related to action*” and Stehr (1994) defined knowledge as the capacity to act.

There are also some other authors sustaining the hypothesis that information is the lowest form of knowledge, objective facts (Wikstrom and Norman 1994), or codified knowledge, facts data, and declarative or publicly available knowledge (Kogut and Zander 1992). Indeed, it is appealing to believe that information is very close to the tacit knowledge like Nonaka and Takeuchi (1995) and Polanyi (1966) define it. Nonaka and Takeuchi (1995) have dichotomized knowledge into two types: tacit and explicit. Polanyi’s (1966, p. 4) observation that “*we can know more than we can tell*” alludes to the tacit dimension of knowledge. Tacit knowledge is embedded in its possessor and can only be acquired through experience or imitation. “*Indwelling*” is used to conceptualize the means through which confrontation with the environment produces specific attributes of knowledge accumulation at the individual level. It is tacit knowledge, not codifiable, and thus not transferable through formal language. Conversely, explicit knowledge is objective, sequential, and digital (Nonaka and Takeuchi

1995). It is acquired from books, lectures, social exchanges and other formalized and non-formalized means as information.

Table 6. Summary of some of the distinctions operated between information and knowledge

Authors	Knowledge	Information
Kogut and Zander (1993)	<ul style="list-style-type: none"> <li>▪ Know-how, recipes, practices, accumulated expertise and skills</li> <li>▪ Procedural knowledge</li> <li>▪ Tech (craft knowledge)</li> </ul>	<ul style="list-style-type: none"> <li>▪ Codified knowledge, facts, data</li> <li>▪ Declarative knowledge</li> <li>▪ Log that is publicly available</li> </ul>
Drucker (1993)	<ul style="list-style-type: none"> <li>▪ Embodied in people</li> </ul>	<ul style="list-style-type: none"> <li>▪ Represented in books and databases</li> </ul>
Davenport and Prusak (1998)	<ul style="list-style-type: none"> <li>▪ Originates in the minds of people</li> <li>▪ Applied in the minds of people</li> </ul>	<ul style="list-style-type: none"> <li>▪ Contextualized, categorized, calculated, corrected and condensed data that makes a difference</li> <li>▪ Message usually in the form of written, audible or visual communication</li> </ul>
Nonaka and Takeuchi (1995)	<ul style="list-style-type: none"> <li>▪ Stock</li> <li>▪ Related to action</li> </ul>	<ul style="list-style-type: none"> <li>▪ Flow</li> <li>▪ Input for knowledge creation</li> </ul>
Wikstrom and Norman (1994)	<ul style="list-style-type: none"> <li>▪ Know-how, understanding and explanation</li> </ul>	<ul style="list-style-type: none"> <li>▪ Lowest form of knowledge and objective facts</li> </ul>

Source: Schultze, U. (2000, p.35).

Knowledge is the result of information processing by a “*knower*”. Davenport and Prusak (1998) viewed knowledge as the combination of human context and information that makes information actionable. Unlike information, knowledge is “*essentially related to human action*” (Patriotta 2004, p. 29) and to the capacity of acting (Kolb 1976).

In the light of the above statements and drawing on Nonaka’s (1994) or Argyris’ (1993) conception, it is proposed that the main difference between information and knowledge is that information can be acquired and knowledge must be developed. Information constitutes a necessary input to the initiation and the formalization of learning and knowledge creation. Nonaka’s (1994) initial conception of information and knowledge is adopted in this study:

*“Information provides a new point of view for interpreting events or objects, which makes visible previously invisible meanings or sheds light on unexpected connections. Thus, information is a necessary medium or material for eliciting and constructing knowledge.”* (Nonaka and Takeuchi 2004, p. 49).

*“Knowledge unlike information is about beliefs and commitment. Knowledge is a function of a particular stance, perspective, or intention. Second, knowledge unlike information is about*

*action. It is always 'knowledge to some end'. Third, knowledge like information is about meaning. It is context specific and relational.*" (Nonaka and Takeuchi 2004, p. 49)

Nonaka (1994) defined information as a flow of messages and the knowledge as a stock of verified beliefs concerning human action. Knowledge is triggered by information flows. Thus, it is concluded that information is a set of data, signals, and messages conveying a meaning, and bearing a learning potential. Then the question how information can enhance learning and knowledge creation arises. Argyris (1993) proposed that the precision, clearness, coherence and the fit between information and context enhance learning. New knowledge development results from the association of new information to the information already available. Thus, the process of association between the "new" and "old" information base will be all the more difficult when new information is vague, ambiguous, incoherent, and non-congruent with the involved situation and the existing firm's information base. Cohen and Levinthal (1990) have also highlighted the contextuality of information. Cohen and Levinthal's (1990) main thesis is that converting information into knowledge depends on information absorptive capacity (AC) of individuals or organizations. AC is enhanced by the prior knowledge, experience, and cognitive capacity to grasp, detect, and exploit information characterizing organizations. Therefore, the transferability and the real appropriation of information are limited by the cognitive capacities of the purchaser (individual or organization) that may or may not have the appropriate capacity to use it.

After having clarified the understanding of information and knowledge, the presentation of the main theoretical frameworks explaining the link between information activities and organizational performance will now be discussed.



## II. 2 The main theoretical frameworks explaining the link between information and organizational performance

Six main theoretical frameworks that explain the relationship between information and performance are identified. They are the contingency theory, decision-making theory, organizational learning theory, Resource Based View of the firm (RBV), entrepreneurial theoretical advancements, and the Market Orientation (MO) theoretical advancements. Among the six theoretical frameworks, the entrepreneurial field and MO theoretical advancements cannot yet be seen as grounded or mature theories. All by accepting the rapid development over the last decade of these young and very dynamic theoretical fields of entrepreneurship and MO, they still cannot be “*labeled*” as (grounded) theories. Nevertheless, both theoretical fields propose several important theses with respect to the relationship existing between information and organizational performance. Therefore, they are included in this second part of this chapter with the same title as the contingency theory, decision-making theory, learning theory and the RBV of the firm.

MO theoretical advances are presented after exposing the learning literature theoretical advances because some scholars see MO as a prolongation of the organizational learning literature. For this reason, additional explanations are also provided discussing the way the MO field advanced towards the wide organizational learning literature theories.

### II.2.1 Contingency theory

*"Contingency theory is guided by the general orienting hypothesis that organizations whose internal features best match the demands of their environments will achieve the best adaptation" (Scott 1992, p. 89).*

This affirmation by Scott (1992) refers to the pioneers of the contingency theory, Lawrence and Lorsch (1967), who argued that the amount of uncertainty and the rate of environmental change impact the development of internal features inside the organizations.

The focus of contingency theory is uncertainty reduction and the organizational adaptation to environmental shifts. The organization is viewed as an open system or a sub-set of systems continuously confronted with uncertainty. Organizations have to adapt their organizational mechanisms to the surrounding environment in order to survive and perform.

Performance can be seen as a result of the effectiveness of choices meant to reduce uncertainty. These choices regarding uncertainty can be related to structure adaptation, strategy formulation, planning, and organizing. Performance is liable to numerous environment and organization specific contingencies that must overcome each other (Barnard 1968; March and Olsen 1976; Duncan and Weiss 1979).

The role of information is crucial for reducing uncertainty and adapting to environmental constraints. Thus, most scholars agree that information plays a key role in attaining high levels of business performance (e.g. Thompson 1967; Aguilar 1967; Ansoff 1970; Ackoff 1970; Andrews 1971; Galbraith 1973; Porter 1986; Baumard 1991).

Even though the authors do not explain explicitly, it seems that the relationship between information and performance is rather indirect. Information helps organizations reduce uncertainty and adapt to environmental constraints that in turn, directly impact organizational performance. If this thesis is accepted, then the question of how information would reduce uncertainty and help organizations to adapt to environmental constraints arises. Within the original conception of Lawrence and Lorsch (1967), organizations have to dispose of valid information related to their environment in order to adapt or respond efficiently to environmental shifts. Wilensky (1967) emphasized the clarity, opportunity, reliability, validity and adequacy of the content of information. Later on, Galbraith (1973) emphasized the quantity and the volume of information. He explained that as uncertainty increases, the amount of information required for decision-making also increases. He stressed the importance of the quantity of information flows. In Galbraith's conception, uncertainty can be calculated as the difference between the quantity of information the organizations need and dispose of. Galbraith (1973) concluded that it is vital that enterprises develop their capacity to acquire information. Baumard (1991) simultaneously embraced both the quantity and the quality of information as determining the performance of scanning systems.

Some scholars, such as Porter (1986), emphasized more explicitly the types of information enterprises should dispose of. His environmental analysis is based on the five main forces or actors fostering environments, which are the competitors, suppliers, clients, new entrants and substitute products. Porter (1986) suggested that the more organizations are informed about the main actors within their environment, the more they are competitive. Andrew (1971) highlighted the importance of scanning activities. He highlighted the need to identify opportunities and threats for designing an efficient strategy. Aguilar (1967) noticed the surveillance role for elaborating strategy and implementing future development actions. In a similar vein, Mintzberg (1994) stressed the role of information in strategic planning.

Makridakis (1996) or Pant and Starbuck (1990) emphasized information's contribution in provisional planning. They all postulate the role of strategic planning in reducing uncertainty and strategy development but they discuss very poorly the way information is managed in order to elaborate strategic planning or the mechanisms needed in order to improve information efficiency.

Information is vital for improving the adjustments needed to respond to environmental constraints. In the meanwhile, organizations also need to implement mechanisms that assure efficient information discovery (Ansoff 1965; Andrews 1971; Ghoshal and Kim 1986; Baumard 1991). According to Baumard (1991), the organizational knowledge exchange mechanisms improve information use. Scott (1992, p. 89) also noted that "*various structural arrangements, such as rules, hierarchy, and decentralization are mechanisms determining the information-processing capacity of the system.*" In order to cope with internal and external constraints, organizations create specialized subunits with differing structural features, for example, different levels of formalization, centralization, or planning time horizons. Lawrence and Lorsch's (1967) classic study advanced the argument that in complex environments organizations create separate departments to deal with different environmental segments. Furthermore, the more differentiated, the more difficult it will be to coordinate the activities of the subunits and more resources need to be applied for coordination.

In conclusion, the extent to which companies can divide their structure to the level required by the environment and at the same time integrate these different departments into collective action determines the success rate of the organization. However, there is no one "*best way*" to manage organizations in order to be effective (Galbraith 1973). Planning, organizing, leading, and controlling must be tailored to the particular circumstances faced by the given organization (Scott 1992).

Resuming, according to the contingency theory organizations should dispose of a sufficient quantity of quality information about the main actors within the environment. Furthermore, organizations have to adapt their structure in terms of communication practices, coordination practices, formalization, and centralization among others in order to favor information exploitation. In this way, the organizations can effectively address environmental constraints, reduce uncertainty and thus, perform. Nevertheless, "*best practices*" do not exist; they are contingent on organization and environment specific characteristics.

Figure 1 is a schematically representation of the relationship between information and organizational performance according to the contingency theory. It is worth to note that only the main relationships supported by the contingency theory are resumed in Figure 1.

Figure 1. Synthesizing the effect of information upon organizational performance according to contingency theory

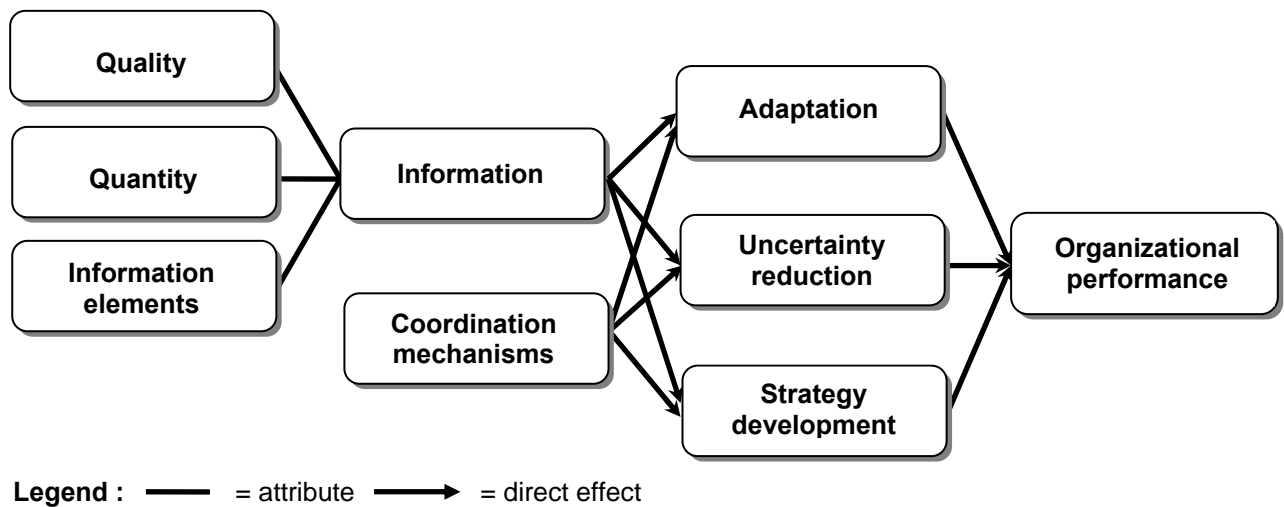

## II.2.2 Decision-making theory

*“The essence of ultimate decision remains impenetrable to the observer – often, indeed, to the decider himself... There will always be the dark and tangled stretches in the decision-making process – mysterious even to those who may be the most intimately involved” (John Fitzgerald Kennedy, Preface to “Decision-Making in the White House” by Theodore Sorensen 1963)*

The efficiency of the organizational decision-making process represents the focus of decision-making theory. Organizational performance is mainly interpreted in terms of decision-making efficiency and organizations represent entities that make decisions. Decision-making is the most important organizational processes with which managers assure the life and the growth of organizations (Aguilar 1967). For Barnard (1968), decision-making consists of analyzing and choosing among a set of potential possibilities. Information plays an important role in this process. For most decision-making scholars, information represents a key input for decision-making efficiency (Simon 1945; Cyert and March 1963; Barnard 1968; Feldman and March 1991; March 1991). The relationship between information and performance seems to be rather indirect. Information improves decision-making efficiency and decision-making efficiency directly determines performance. Nevertheless, the link between information and decision-making efficiency is complex (Cyert and March 1963; Bower 1970). For example, March (1991) suggested that organizations might be successful even though they do not use information according to the rational efficiency principles. They emphasized the human and

organizational limits in using information. These limits can be related to: (1) the analytical judgment capacity of decision makers, (2) the perception of the information quality, (3) organizational coordination efficiency, (4) appreciating whether the information cost covers the benefits it can provide, and (5) information distortion.

It can be seen that decision makers' profiles occupy an important place in the decision-making theory. Several scholars asserted the role played by heuristics, mental models based on previous experiences in information processing (e.g. Kolb 1976; Levinthal and March 1993; Nonaka 1994). More precisely, managers examine and interpret situations as a whole, relying on the "*big picture*", without taking into account every piece of existing information. As a result, when interpreting the link between decision-making and information, subjective factors such as decision-makers' personal interests should be taken into account. Besides heuristics and shortcuts, decision-makers are also biased by their tendency to seek and use information confirming their beliefs and increase confidence into their own choices (O'Reilly 1983). Meltsner (1976) made a distinction between the information used to make decisions and support decisions already made. Even more, according to March (1991), decision-makers might sometimes act according to their own personal interests. Thus, the political dimension of information is present in decision-making theories. Lyles and Mitroff (1980), Lyles (1987), as well as March (1991), highlighted the power and political dimensions that interfere in decision-making. Fear and political power are recurring themes that affect the way decision-makers formulate and solve problems and sometimes even cause volunteer information distortion. As Feldman (1989, p. 93) observed in his analysis of bureaucratic analysts' work, "*decisions about policies seem to be made on the basis of politics and personal loyalties than the information and expertise*". Decision-makers' preferences and interests can evolve and change, their past and on-going experiences and knowledge shape the way they see the world and solve problems (March 1991). March (1991) also stressed the complexity of the causal relationships existing between the problems and the actions undertaken for solving problems within organizations. Among all these personal and organizational related contingencies, one single piece of information seems to sometimes have a marginal and indirect contribution for making decisions. Isolated information either confirms or rejects an already on-going judgment based on an already existing amount of information related to a problem (Lainée 1991; March 1991). Thus, the relationship between decision-making and information is rather ambiguous (Tyler 1991).

Some other scholars, such as O'Reilly (1983) define the decision-making process as the process of information assimilation and use. According to him, decision-making efficiency

depends upon the quality of information. Information has to be pertinent to the problem to be solved by the decision-making process, it should be reliable and accessible to decision makers and should have an important opportunity potential (O'Reilly 1983). Argyris (1976) suggested that efficient decision-making is based on valid and rich information. Most of the authors that referred specifically to the impact of information on decision-making efficiency emphasized the attributes of information, the decision-maker's capabilities or the organizational mechanisms necessary to efficiently manage the informational process. The generic assumption is that decision-making in organizations is structured by procedures and rules that specify roles, methods and norms. *"Rules and routines would lighten the information processing required of complex problems, embody efficient or reliable techniques learned from experience, and coordinate the actions and results of disparate organizational groups"* (Choo 1997, p. 155).

In order to make completely rational choices, decision-makers have to *"identify all available alternatives, predict what consequences would be produced by each alternative, and evaluate these consequences according to goals and preferences"* (Choo 1997, p. 164). Simon (1945) stressed the cognitive limits of a decision-maker's rationality or bounded rationality. They also did not observe that decision-makers do not dispose of all information relative to the complex environment surrounding them or of the time needed to search for it. Simon (1945) suggests that an organizational decision-maker's rationality is bounded in at least three ways. First, rationality requires a complete knowledge and anticipation of the consequences following each choice and knowledge of consequences is always fragmentary. Second, consequences lie in the future and thus imagination must supply the lack of experienced feelings in attaching imperfectly anticipated value to them. Third, rationality requires choice among possible alternatives. Only a few of all possible alternatives ever come to mind. In order to overcome these problems, Simon (1945) proposed four organizational mechanisms for overcoming *"bounded rationality"* limits: (1) authority decentralization, (2) communication and coordination mechanisms, (3) training programs for employees, and (4) promotion and development of the employees' loyalties towards the organization. The author suggests that an efficient way of allocating decision-making responsibilities consists in assigning every individual within the organization decisions relative to the information each individual possesses. Since a single person cannot be aware of the all of the information necessary, responsibilities should be divided between more individuals. Thus, authority should be decentralized. On the other hand, decentralization causes complexity. Decentralizing responsibilities demands the existence of efficient formal and informal

communication and coordination systems linking the different groups in order to adopt decisions and favor the convergence of opinions.

Cyert and March (1963) stressed that the efficiency of decision-making hangs on information availability, which depends on internal communication techniques. In order to alleviate communication flows, enterprises should implement and formalize information filtering, evaluation and transmission procedures. Specific competent organizational units should be allocated for these tasks of maintaining and controlling regular contact with information sources known as gatekeepers. The role of gatekeepers is crucial since they must collect, synthesize, evaluate, and diffuse or communicate information. According to Cyert and March (1963), organizational decision-making efficiency furthermore relies upon the information that organizations dispose of, their capabilities to scan environments, retrieval and processing of information, and on information communication and diffusion structures they implement. Therefore, managers should maintain a fluid information exchange system, triggering the efficient mobilization and coordination of efforts (Barnard 1968; O'Reilly 1983). Barnard (1968) and O'Reilly (1983) suggest that organizations are more informed if they dispose of rich information but also of the capacity to exploit information by means of communication and integration within the company. In order to acquire the competences necessary for doing so “... *employees should be trained and motivated through promotion programs meant to develop their loyalty towards the organization*” (Simon 1945, p. 115).

In conclusion, according to the decision-making theory, organizations need to access good quality information in order to make efficient decisions and further perform. The effective management of information hangs upon the existence of efficient information flows, decentralization, coordination and communication mechanisms, and training and promotion programs meant to develop the employee's loyalty towards the organization. Another important variable in decision-making theory is the decision-makers' profiles. The capabilities that decision-makers have to exploit information are a determinant for decision-making efficiency. Even more, their personal interest plays an important role. They sometimes make decisions in order to achieve their own objectives that sometimes do not fit in with the organization's objectives. Thus, the organizational mechanisms and the decision-makers profile cannot only be seen both as moderators of the relationship between information and performance but also as inputs towards achieving decision-making efficiency. The link between information and decision-making is rather ambiguous and limited by the bounded rationality characterizing decision-makers and organizations.

Figure 2. Synthesizing the effect of information upon organizational performance according to the decision-making theory

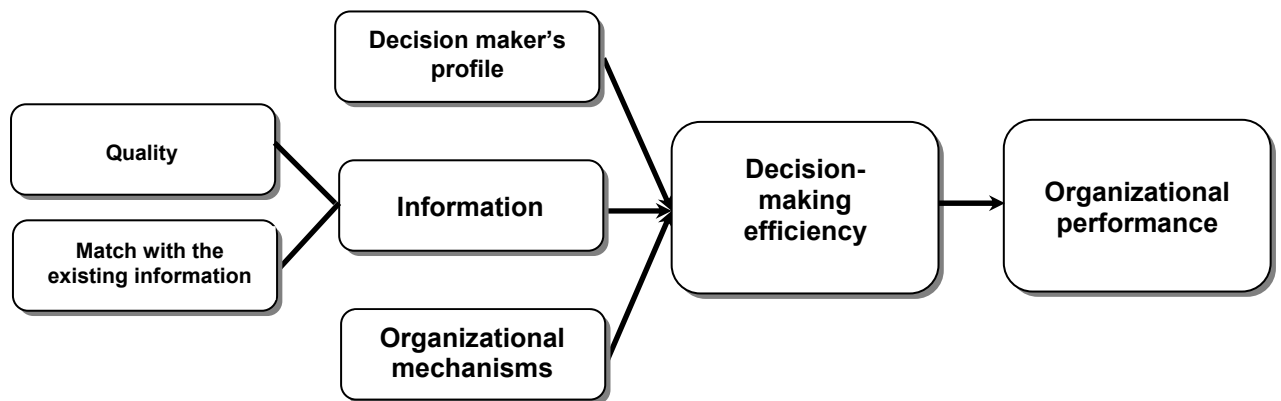

Legend : — = attribute —→ = direct effect

Please note that Figure 2 is a schematical representation of the relationship between information and organizational performance according to the decision-making theory. Only the main relationships are represented in Figure 2.

### II.2.3 Resource based view of the firm

The Resource Based View (RBV) of the firm concentrates upon the sources of organizational performance and competitive advantage. Organizations are seen as bundles of tangible and intangible resources. The attributes of these resources determine the competitiveness and the performance of organizations. Within the RBV of the firm, performance is driven by the achievement of competitive advantage or competitiveness. Resources determine competitiveness and competitiveness determines organizational performance (Barney 1991; Grant 1991; Hunt and Morgan 1995). Amit and Shoemaker (1993) and Chi (1994) observed that not all the resources determine competitive advantage, only strategic resources do. Amit and Shoemaker (1993) stressed the so-called VRIN attributes, meaning the value, rarity, idiosyncrasy, and the non-substitutability qualities these resources should possess.

Information is also a resource according to the RBV of the firm. Porter and Miller (1991) suggests that enterprises achieving strong competitive positions already own developed capacities in acquiring and exploiting information in innovative ways. They value information disregarded by their competitors. Information and information sources are intangible resources that generate a competitive advantage (Wernerfelt 1984; Barney 1991; Grant 1991;



Mahoney and Pandian 1992; Amit and Shoemaker 1993; Li and Calantone 1998). Numerous scholars support the strategic nature of information as a resource. For example, Leboulch and Le Floch (1993) deem that the intangible character of information makes it un-appropriable to competitors. Adding on, the availability of information does not necessary conduct to its appropriation. Information appropriation depends on the capacity to grasp its meaning and to further use it more efficiently. Many researchers support the cumulative character of information (Lainée 1991; Julien 1996; Carlson and Zmud 1998). Information is valuable when it is used and new information has to be related to the existing organization's information base. Some scholars concentrated upon the information types needed in order to be competitive. Cyert and March (1993) believe that acquiring information relative to market needs, suppliers or efficient production rationalization are sources of competitive advantage. Barney and Zahac (1994) referred specifically to the importance of information processing behaviors as strategic resources of firms for enhancing information flows and use within organizations. The RBV of the firms further stressed the importance of several elements of managerial practices. Wernerfelt (1984) highlighted the importance of organizational procedures and Barney (1991) stressed the importance of formalized structure, planning, control and coordination systems, and internal and external communication channels. Grant (1991) mentioned the importance of the coordination mechanisms, strategy, and leadership. To sum up, under the RBV perspective, information and information sources are strategic resources and strategic resources drive competitive advantage. The relationship between information and performance is indirect. Information indirectly affects performance by enhancing competitive advantage. Information's strategic character consists in its contextuality; its transfer does not guarantee its usability. Organizations need to adopt several organizational mechanisms for improving information use such as the coordination practices. Organizations have to be informed concerning market needs, suppliers, and concerning the efficient production rationalization techniques.

Figure 3 is a schematical representation of the information-organizational performance relationship according to the RBV.

Figure 3. Synthesizing the effect of information upon organizational performance according to the RBV of the firm

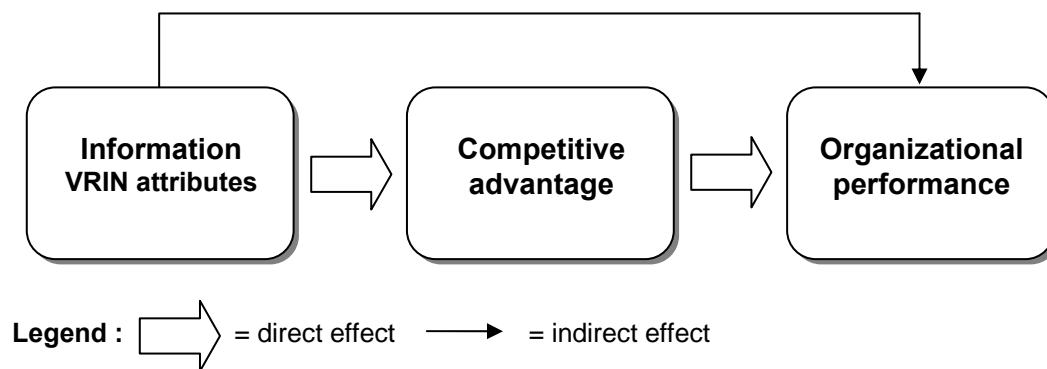

## II.2.4 Entrepreneurial theoretical advances

Even though the entrepreneurial field has been developing very fast over the last years and tempts to propose a new theory of the firm, entrepreneurial theoretical advances represent a research project (Bygrave and Hofer 1991; Bull and Willard 1993; Fillion 1997; Danjou 2004). For this reason, the term of “*entrepreneurial theoretical advances*” is preferred over “*entrepreneurial theory*”. Fayolle and Verstraete (2005) suggested that it is better to speak in terms of main conceptual approaches of entrepreneurship.

It is common to see entrepreneurship as a process, namely the process of exploiting opportunities for innovation in terms of products or services (Shane and Venkatraman 2000), or the process of new venture creation (e.g. Herron and Sapienza 1992; Aldrich 1999; Thornton 1999; Sharma and Chrisman 1999). The entrepreneurial literature focus is on opportunity detection and exploitation. According to the entrepreneurial theoretical advances, an organization’s main function is innovation. Organizations can be seen as innovation entities or agents.

Sometimes entrepreneurship theoretical advances stress the context that enhances or hinders the development of the entrepreneurial initiative, carried out most of the time by the entrepreneur himself (Busenitz *et al.* 2000). For this reason, sometimes the entrepreneurship is identified to the entrepreneur himself (Bruyat 1994; Fillion 1997; Fayolle 2004). His capabilities to grasp and exploit business opportunities and his creativity are critical to the survival, growth, and profitability of organizations (Drucker 1985; Kirzner 1973; Porter and Millar 1985; Ray 1991). Most frequently, performance is expressed in terms of competitiveness and profitability.

Hayeck (1937, 1945) was the first pioneer of entrepreneurial theoretical advances. Since his early writings, he stressed the importance of information in explaining the “*entrepreneurial phenomenon*”. He proposed that economical problems were mainly caused by the lack of adaptation towards rapid change. Rapid changes occur because of the contradictory and fragmentary dispersion of information. The information’s role, in his view, is to enhance the efficient use of resources. Entrepreneurs distinguish themselves through the skills they possess in using information in innovative ways thus creating wealth.

Nowadays, the scholars working on innovation converge concerning the entrepreneur’s capabilities to collect and exploit information in order to detect opportunities (Kirzner 1979; Vesper 1989; Herron and Sapienza 1992; Chandler and Jansen 1992; Baum 1995). The entrepreneur also has specific competences in information management (Bayad *et al.* 2007), both within the enterprise by means of developing internal communication (Laviolette and Loue 2006) and outside of the organization by collecting information and knowledge of his industry.

Later on, another economist, Kirzner (1973), criticized the assumptions of classical economics that considers markets where the different agents have access to infinite information. Kirzner (1973) stressed the information asymmetry. Moreover, this author introduced the notion of the “*pure entrepreneur*” by proposing that there are two distinct ways in which this notion enters the analysis of the market process. The first way of entering is by means of contrast with classic economics, entrepreneurs exist once with information asymmetry, and the second way is through the alertness state characterizing entrepreneurs. The pure entrepreneur is “*a decision-maker, whose entire role arises out of his alertness to hitherto unnoticed opportunities*” (Kirzner 1979, p. 38-39). He suggested that the entrepreneurial capability of detecting opportunities comes along once with the experience. Busenitz (1996) joined Kirzner’s (1973) view with respect to the expression of the entrepreneurial alertness through the capabilities entrepreneurs own in terms of information processing.

Drucker (1985) mainly stressed the innovation capacity but also risk-taking propulsion as the main features that characterize entrepreneurs. Drucker (1985) highlighted the importance of pro-actively scanning for change information sources within the environment. Ray (1991) suggested that the search for opportunities is supported by the knowledge of the industry the firm is operating in. The explanation of how entrepreneurs detect opportunities is a subject of contradictions. There are many propositions within the literature that include the experience and entrepreneurial alertness (Kirzner 1979), the extent to which the environment is scanned

(Drucker 1985), and the non-verbal means of communication as the non-traditional information sources - an example being the contacts made by traveling abroad (Kaish and Gilad 1991). Note that these non-traditional information sources mentioned by Kaish and Gilad (1991) are close to Granovetter's (1973) conception of weak ties, which apparently have no value at a first glimpse, but in the end deliver rich information pieces.

In conclusion, according to entrepreneurial theoretical advances, enterprises need to develop capabilities for managing information by either scanning the environment or by developing the knowledge of the industry they operate in and using the "ties" they have in the industry. Information is an important input for innovation and innovation is essential for achieving both an organization's competitiveness and profitability that are seen as proof of organizational performance. Even though it is not explicitly stated, it seems that the link between information and performance is rather indirect through the development of innovation and opportunities detection. The entrepreneur's profile, in regards to his capabilities, influences the way he seizes the opportunity content of information and it is also a determinant in explaining innovation.

Figure 4. Synthesizing the effect of information upon organizational performance according to the entrepreneurial theoretical advances

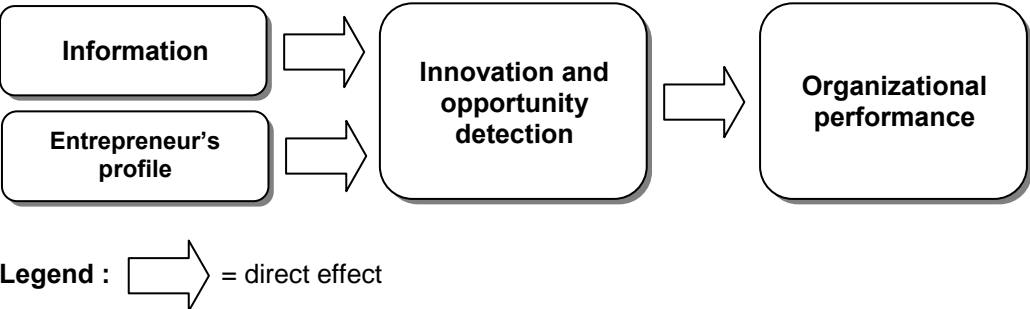

Figure 4 resumes only the main propositions advanced within the entrepreneurial theoretical field with respect to the relationship existing between information and organizational performance.

## II.2.5 Organizational learning theory

The main concern of the organizational learning theory is learning and knowledge development processes. Organizational learning was defined by Argyris and Schoen (1978) as the response that organizations implement to internal and external shifts in the environment. The organizations can respond by detecting and correcting errors and integrating the results of these investigations within the organizational shared mental models. Two elements are central to organizational learning theory. The first element is the environment perceived or interpreted by organizations and the second is the action deployed, proactively or not, based on the acquired information (DeGeus 1988).

The learning theory represents a heterogeneous research field. Three main research streams can be distinguished when dealing with organizational learning which are: (1) the behaviorist theory (Cyert and March 1963; Morvan 1972), (2) the social cognition research stream, and (3) the evolutionist theory of the firm (Nelson and Winter 1982; Teece *et al.* 1997). Each of these research streams point at several aspects of the learning process relative to information processing, social representations or organizational behavior.

Organizational learning scholars see organizations as information processing systems (e.g. Argyris 1976, 1993; Huber 1991; Nonaka 1994). Several other learning scholars approach organizational learning specifically under an “*informational*” perspective (e.g. Argyris 1976, 1993; Huber 1991; Nonaka 1994; Cohen and Levinthal 1990; 1994) stressing the key role played by information within the learning theory. The emphasis is put on information and information management as well as the organizational mechanisms meant to improve information processing efficiency. Information plays a key role in organizational learning. The access to information, its processing and diffusion constitute the main entrants of organizational learning. The impact of learning capacities on organizational performance is widely recognized by the literature. An organization’s failure is associated with the lack of learning (Levinthal and March 1993). Performance differences between enterprises are a function of an organization’s learning capacity (Prahalad and Hamel 1990; Henderson and Cockburn 1994; McGrath *et al.* 1995). Learning is translated through the development of capabilities, meaning knowledge and know-how, necessary to react and/or to efficiently anticipate environmental changes and thus enhancing performance (Kolb 1976; Argyris 1976, 1993; Levitt and March 1988; Huber 1991; Cohen and Levinthal 1990, 1994). If information represents an input for knowledge creation, then the question of what information should be

like in order to enhance learning and knowledge creation arises. Argyris (1976, 1993) suggested that learning efficiency depends on the accessibility, clarity, precision, and consistence of information. Argyris (1993) also proposed that successful learning organizations distinguish themselves by their capabilities to detect and correct errors by means of learning. In a similar vein, Huber (1991) proposed that in order to learn effectively, an organization needs to consider the inputs given by information. Additionally, they need to adjust their organizational structure in order to ease information processing. Huber's (1991) perspective is similar to the one of Argyris. Argyris (1993) suggested that in order to learn effectively, organizations need to adjust their behaviors according to the inputs given by information processing within the organization. To Huber (1991), processing information means acquiring, exploiting, interpreting, and diffusing information. The search and diffusion of information are the organizational actions that favor knowledge acquisition.

Experiential learning theories highlight the role of experience in the learning process (Kolb 1984). According to Kolb (1984), knowledge is created through the transformation of experience. Experience helps enterprises react more efficiently to similar information. However, the experience is not sufficient for learning to take place (Senge 1991). Considering the role of experience in learning contrasts with the current assumption that not all learning effects are positive. For instance, Day (1994b) explains that learning results from a continuum of experiences and experimentation. Organizations retain the practices that work and reject the ones that fail. The author explains that experience contributes to learning when the sanctions of our actions are immediate.

Cohen and Levinthal (1990) propose a more integrative perspective upon how information can be absorbed by means of learning within the enterprise. According to them, information needs to be acquired but its absorption will depend on the level of related knowledge and experience. The level of absorption also depends on the organizational mechanisms of coordination and communication favoring information processing. Cohen and Levinthal's (1989, 1990, 1994) and Levinthal's (1992) research on the absorptive capacity represent what may be the most important contribution to organizational learning theories over the last years. The fundamental hypothesis advanced by these scholars is that the learning and innovation capacity of organizations are driven by their capacity to absorb new and external information. The scholars suggested that the capacity of absorbing information in a specific field depends on the related knowledge that organizations possess in the specific area. They noticed that there are also external knowledge sources such as suppliers, clients, and universities. The given information sources improve information absorptive capacity.

In conclusion, information is at the very heart of the organizational learning theory and organizations are seen as information processing systems. The relationship between information and performance seems to be rather indirect. Performance is driven by learning and knowledge creation, information can be thought of as a key “*ingredient*” for learning. The learning process helps enterprises efficiently adapt and respond to environmental constraints. In order for information to be converted easily into knowledge or enhance learning, the information has to be accessible, clear, precise, consistent, and congruent with the organization’s objectives.

Cohen and Levinthal’s (1990) research on absorptive capacity provides the most integrative and complete framework explaining the role of information in learning. Efficient learning and information absorption depends on the relationship between the existing knowledge, experience, and information base to the new acquired information. Information absorption is also enhanced by the communication and coordination mechanisms implemented by organizations.

The main relationships between organizational information activities and business performance are synthesized in Figure 5 hereafter. Figure 5 resumes only the main propositions advanced within the organizational learning theory with respect to the relationship existing between information and organizational performance.

Figure 5. Synthesizing the effect of information upon organizational performance according to organizational learning theory

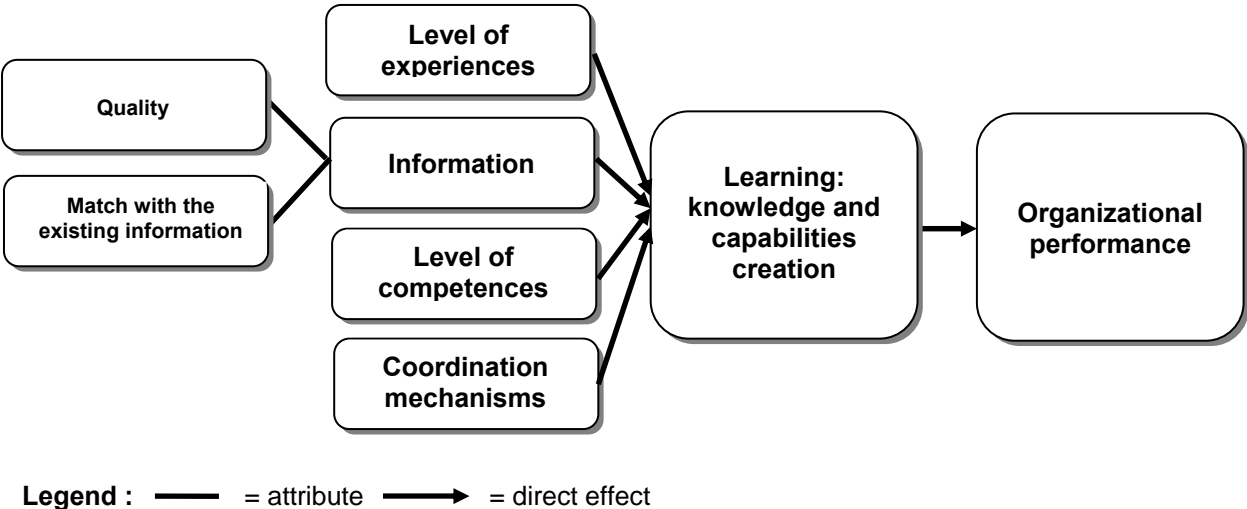

## II.2.6 Market orientation theoretical advances

With the recent emerging realization of the relevance of organizational learning to firm competitiveness there has been managerial and scholarly interest on the subject of learning in a market-based context (e.g. Day 1994; Sinkula 1994; Moorman 1995; Slater and Narver 1995; Sinkula *et al.* 1997). Even though conceptual contributions to organizational learning literature over the past four decades has been extensive (e.g. Cangelosi and Dill 1965; Argyris and Schon 1978; Hedberg 1981; Fiol and Lyles 1985; Huber 1991), the market-based view of learning is under-employed (Baker and Sinkula 1999).

Market Orientation (MO) literature cannot be regarded as a theory in any formal sense but rather can be seen as a set of ideas highlighting the key role of information activities in attaining organizational performance. For this reason, it is included in the present chapter. The market orientation concept will be first explained and then the advancement of the MO field towards the organizational learning theory will be exposed. Finally, MO contributions with respect to the explanation of the relationship existing between information and organizational performance will be presented.

### *II.2.6.1 The two conceptualizations of organizational market orientation*

Beginning with Kohli and Jaworski (1990), and Narver and Slater (1990), the MO literature has evolved over the last years towards the integration within the organizational learning field (Slater and Narver 1995). Two different approaches of the MO (behavioral and cultural) concept were developed at the same time and exist in the literature since 1990.

The behavioral perspective concentrates on organizational activities that are related to the generation and dissemination of information, market intelligence and the responsiveness firms implement to palliate foreign markets shifts. The behavioral perspective was developed by Kohli and Jaworski (1990, 1993). Accordingly, MO represents the development of market intelligence by the organizations with respect to the current and future needs of clients, the distribution of the acquired information along the organization and the action taken consequently. Market orientation is a set of actions undertaken by the organizations in order to respond to environmental shifts. Information is essential since it gives the inputs necessary to respond to environmental shifts. The information acquisition is mainly based on clients, which are considered the most important information source.



The cultural perspective focuses on organizational norms and values encouraging behaviors that are consistent with MO (Narver and Slater 1990; Deshpandé *et al.* 1993; Kirca *et al.* 2005) and it roots in Narver and Slater’s (1990) seminal work. Accordingly, MO is seen more as a set of values related to the corporate culture, which is market-based (Deshpandé *et al.* 1993; Day 1994). These values are oriented towards the valorization of clients and competitors’ knowledge so therefore the privileged information sources are the clients and competitors. Even though MO literature was not regarded since the beginning as related to the organizational learning theory, Slater and Narver (1994, 1995) realized the articulation between MO and the organizational learning theory.

Figure 6. The two approaches of market orientation

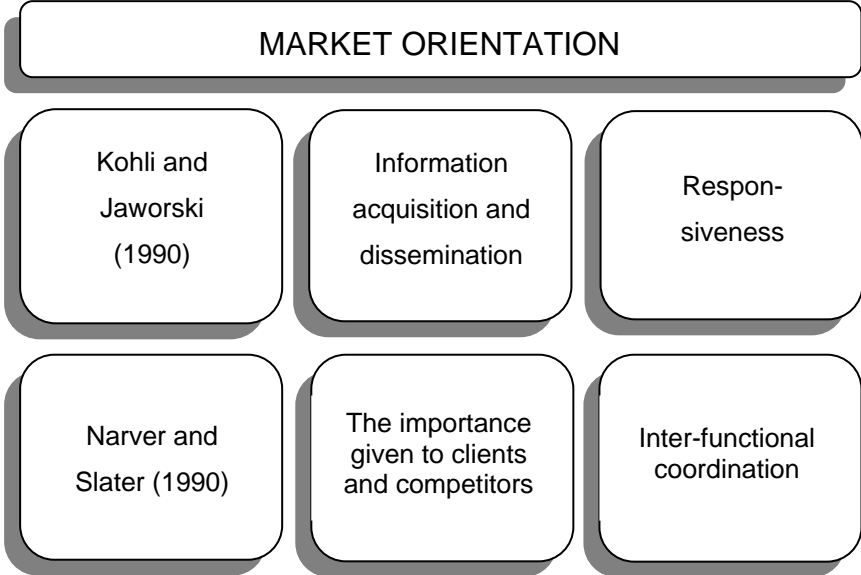

***II.2.6.2 From market orientation to market-based learning***

Later on, Slater and Narver (1994, 1995) further articulated the MO and organizational learning theory. The authors were inspired by the learning model of Fiol and Lyles (1985) that highlighted the knowledge development process and the actions taken by the firm to respond to environmental shifts as outputs of the organizational learning process. According to Fiol and Lyles (1985), two dimensions underline the organizational learning process, the cognitive and the behavioral developments. The two dimensions are liable to the environmental shifts and variations. An organization’s environmental alignment implies actions undertaken by firms and translates the evolution of the cognitive representations of the organization’s members. The behavioral development is similar to single-loop or adaptive learning.

Meanwhile, the evolution of the representations translates the existence of double-loop learning.

Market-based learning is translated by incremental adaptations, in other words actions implemented by the organization, and evolutions of its market knowledge. This view converges with Deshpandé *et al.*'s (1993) position. Accordingly, MO is an adaptation or alignment of the organization to the environment by means of responding to relevant market-related information.

Figure 7. The process of organizational learning according to Slater and Narver (1995)

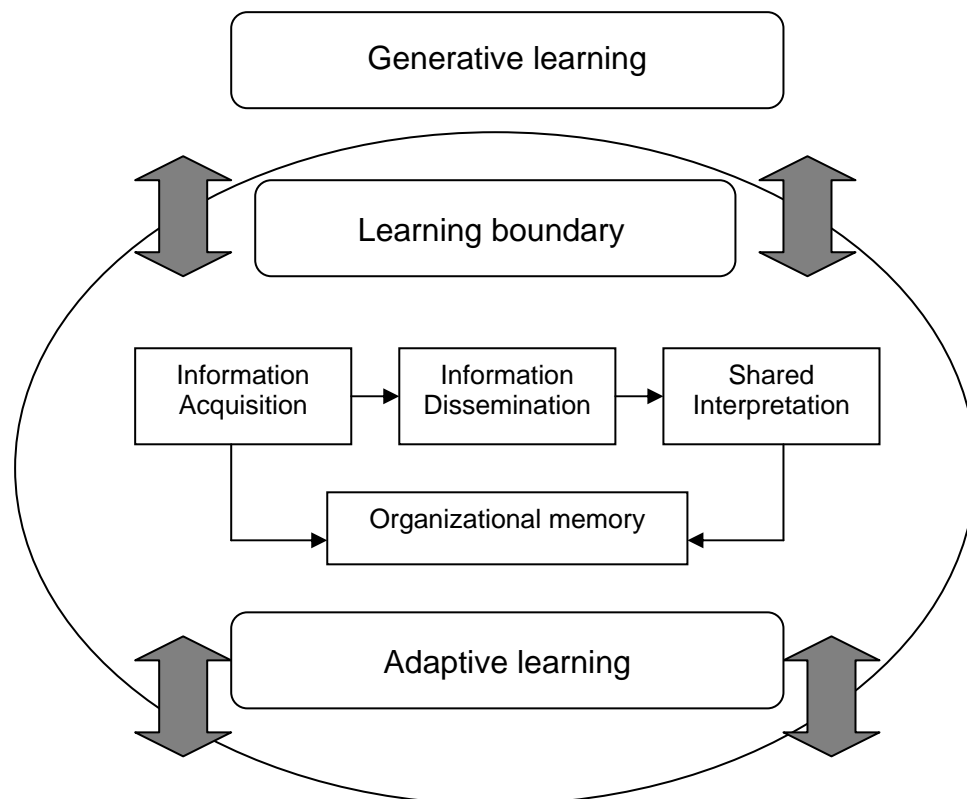

Source: Slater and Narver (1995, p. 5)

Some scholars, like Baker and Sinkula (1999), consider that it is assumed that market orientation is at the origin of information processing and that it does not necessarily lead to double-loop organizational learning since the MO dimension of responsiveness translates rather an adaptation, therefore single loop learning. These authors also highlight the “*power dimension*” of information that can be used in order to confirm the knowledge and policies already existing within the organization. Therefore, they argue that being market-oriented does not necessarily imply that learning process takes place. Nevertheless, adaptive learning should not be underestimated because many scholars defend its richness and complexity of experience and environment based learning (e.g. Kolb 1984; Tyre and Von Hippel 1997).

Additionally, March (1981) and the organizational evolutionist theory scholars (Nelson and Winter 1982; Marengo 1995; Teece *et al.* 1997) suggest that most of the changes within an organization are incremental and rooted in their relationship to the environment. Radical change characterizes exceptional crises. For instance, in a small firm, the loss of a main customer might lead the enterprise to try to expand on foreign markets in order to ensure its survival. As a result, organizational MO translates the learning process through the behavioral aspect: undertaking corrective action based on the incoming information. This basic idea was further exploited within Sinkula *et al.*'s (1997) research work on market-based learning further expanding on the key role of information within the market-based learning process. The market-based learning process of Sinkula *et al.* (1997) is made up of three dimensions: (1) learning orientation, (2) information processing, and (3) the changes undertaken within the marketing programs. The first dimension, the Learning Orientation (LO) is a cultural dimension. Sinkula *et al.* (1997) defined the learning orientation as values of an organization that influence its tendency to create and utilize knowledge. The LO encompasses three dimensions: (1) Shared vision: all the members in the organization are characterized by common beliefs and have a clear and comprehensive vision that places customers' interests first, (2) Commitment to learning: a belief in the fundamental premise that learning about customers is valued by the organization, (3) Open-mindedness: a belief in the value of questioning deeply held assumptions about customers and markets. In Sinkula *et al.*'s (1997) perspective, the commitment to learning, open-mindedness and a shared vision are necessary conditions to learn. The three dimensions of LO favor the market information generation and dissemination, which in turn, directly affects the degree to which an organization makes changes in its marketing strategies and the expression of learning (see Figure 8 for an illustration). As one can see, Sinkula *et al.* (1997) adopted a process view of market-based learning. The LO is an input favoring information acquisition and dissemination that in turn favor the changes firms implement as a response to information in their marketing programs. Sinkula *et al.* (1997) highlights the fact that the changes made by the organizations in the marketing strategies as a response to information can be seen as an output of learning but also as a method of enhancing learning. The authors conclude that within the marketing context, the implementation of changes within the marketing strategies represents the most appropriate measure for capturing organizational learning outputs.

In conclusion, the main interest of Sinkula *et al.*'s (1997) work and generally that of the MO literature is the operationalization of the learning process and the empirical evidence it brings regarding the role of information in the market based learning process. Organizational

learning literature frequently lacks operationalization instruments for capturing the constructs relative to the learning process. Consequently, organizational learning literature lacks sufficient empirical evidence (Machat 2003) and the evolution of the organizational learning literature in the marketing field is heterogeneous.

Figure 8. Sinkula *et al.*'s (1997) market-based learning model

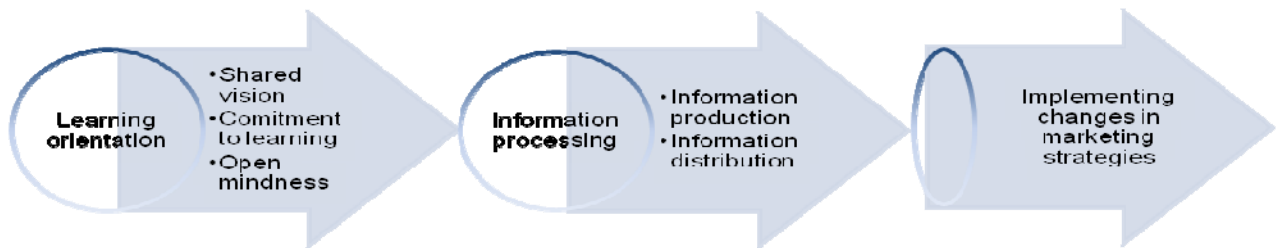

Source: Sinkula *et al.* (1997, p. 307)

### II.2.6.3 Market orientation theoretical advances

The MO research stream does not represent a formal theory. It can be seen as an evolving and heterogeneous research stream closely related to the organizational learning process under a market(ing) perspective. Market information is one of the key elements that guide organizational action and MO literature proposes several advances relative to the role of information in achieving business performance. For this reason, it is interesting to present MO theoretical advances within this chapter. The emphasis in MO literature is put on intelligence generation, “*The starting point of market orientation is intelligence generation*” (Kohli and Jaworski 1990, p. 4). According to the authors, intelligence generation is rooted in acquiring market related information.

Organizations are seen as information processors. An organization’s main role is to acquire, disseminate, process and apply information for driving responsive actions in order to satisfy costumers’ demands (Jaworski and Kohli 1993). The clients and the competitors are considered the most important information sources within the MO literature (Kohli and Jaworski 1990; Narver and Slater 1990). It is important to note that within the original conception of Kohli and Jaworski (1990), information acquisition activities were enlarged beyond clients and competitors to other information sources such as informal meetings, collecting primary or secondary data, and analyzing sales reports, customer databases, or formal market research as attitude surveys. The information is considered to be the most important strategic resource within the MO literature. Information is at the origin of the

development of innovation (Day *et al.* 1994) and it drives competitive advantage (Li and Calantone 1998). Information provides the inputs necessary to respond to environmental shifts (Kohli and Jaworski 1990; Jaworski and Kohli 1993) and in this way ensures a firm's performance. The strategic marketing literature posits that MO provides a firm with market-sensing and customer-linking capabilities that lead to superior organizational performance (Day *et al.* 1994; Hult and Ketchen 2001). Nonetheless, the relationship between MO and business performance is still a debated subject (Ellis 2005).

Drawing from other sections of this chapter, one can notice that the role of information in innovation is mainly stemming from the entrepreneurial theoretical developments. Information as a strategic resource driving competitive advantage stems from the RBV of the firm and the response capacity to environmental shifts steams from both contingency and learning theories. In conclusion, MO literature appears as a heterogeneous research field integrating ideas from several firm's theories. Heterogeneity roots partially from the initial conception of the MO concept under a behavioral and cultural perspective (Homburg and Pflesser 2000; Kirca *et al.* 2005). To resume, irrespectively of the emphasis put on either organizational behaviors or more culturally oriented norms, both conceptions of the MO highlight the role of information dissemination through the organization or the organizational mechanisms needed to improve information efficiency. The role of information dissemination mechanisms is extensively emphasized by the MO literature. Accordingly, organizations need to develop exchange, coordinate, share information and then debate it in order to value and use it.

The recent meta-analysis of the MO empirical studies conducted by Kirka *et al.* (2005) shows that the interdepartmental connectedness has the strongest impact on MO. Top management emphasis, market-based reward systems are also important antecedents of MO. Centralization and formalization practices are not significantly related to MO. These non-significant findings are consistent with Kohli and Jaworski's (1993) observation that the nature of formalized rules and centralized decision-making can also be designed to enhance MO.

When the contributions of the MO literature are summarized, one can conclude that organizations are intelligence generators. Market information plays a key role within the process of intelligence generation. The most useful information sources are clients and competitors. Based on the information they acquire, firms have a better response to their environment, they can innovate and create market-sensing capabilities. The latter of the outcomes drive organizations to success. The relationship with organizational performance stays ambiguous.

Figure 9. Synthesizing the effect of information upon organizational performance according to the market orientation literature

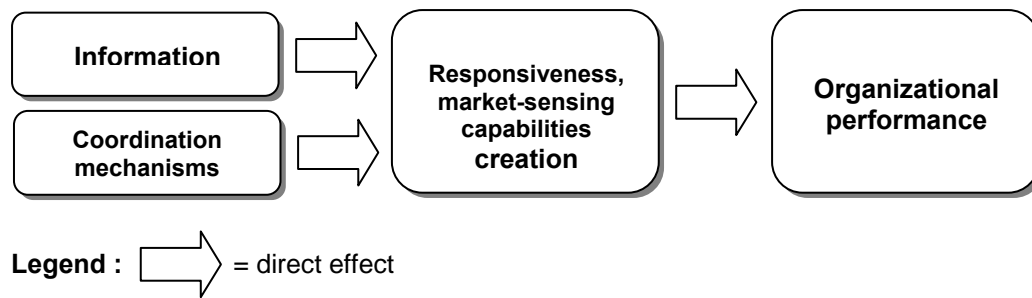

Figure 9 summarizes the main propositions issued from the MO literature with respect to the relationship existing between firms' information activities and business performance.

### II.3 Critical analysis of the theoretical frameworks explaining the link between information and organizational performance

The main theoretical frameworks that explain the link between information and performance synthesized and exposed within this section include the contingency theory, the decision-making theory, the Resource Based View (RBV) of the firm, the theoretical advances from the entrepreneurial field, organizational learning theory, and Market Orientation (MO) theoretical advances. All these theoretical frameworks emit different assumptions in regards to the way they conceptualize organizations and performance as well as the link between information and performance. Nonetheless, all except the MO theoretical advances<sup>18</sup>, underline the importance of information characteristics (value, richness) and the organizational mechanisms needed to enhance information use within organizations.

Thus, in the first point (II.3.1), the points of convergence of the six theoretical frameworks analyzed are presented. In the second point (II.3.2), the points of divergence of the six theoretical frameworks are underlined. Finally, in the third part (II.3.3), the framework to be used for theory building in the current research is discussed.

<sup>18</sup> MO theoretical advances only mention the preference for clients and competitors as information sources.

### II.3.1 Converging aspects of the theoretical frameworks reviewed

A recurrent assumption within all the reviewed theoretical frameworks is that in order for information to be valuable, it should present certain characteristics and qualities. The second common assumption of the reviewed theoretical frameworks is that organizations need to implement efficient organizational mechanisms that ensure information exploitation within the firm.

#### *II.3.1.1 Information quality or richness*

The contingency theory highlights the clarity, opportunity, reliability, validity, and adequacy of the content of information (Wilensky 1967). According to decision-making theory, information should be pertinent in respect to the problem at hand. Moreover, it should have the potential for opportunity detection and should be reliable and accessible for decision-makers (O'Reilly 1983). Argyris (1976) suggested that efficient decision-making should be based on valid and rich information. In order to be considered as a strategic resource within the RBV of the firm, information and its sources should benefit from the VRIN attributes (Amit and Shoemaker 1993); information should be valuable, rare, inimitable and non-transferable. Theoretical advances of the entrepreneurial field stressed the opportunity content of information. In organizational learning theory, a well-informed organization accesses clear and precise information that is consistent and congruent with the results of its actions (Argyris 1976, 1992). MO literature only stresses the strategic content of information (Li and Calantone 1998). However, to the best of knowledge, MO literature does not refer to aspects related to information richness.

In conclusion, even though the six theoretical frameworks are diverging concerning the way they see the relationship between information and business performance and their "*raison d'être*", they assume that information should be characterized by specific qualities in order to be valuable for organizations. Information qualities, such as value or richness, were also highlighted in other application fields and theories other than the six theoretical frameworks reviewed in this chapter. Information quality has been the focus of several studies within the marketing field (e.g. Menon and Varadarajan 1992; Maltz and Kohli 1996) or the international marketing field (Ramangalahy 2001; Toften and Olsen 2003). Zmud (1978) or Carlson and Zmud (1994) from communication science also addressed information qualities. Daft and Lengel (1984, 1986) developed the theory of media richness. The authors suggest

that information richness refers mainly to the learning potential of information, enhanced by several qualities information sources or the medias possess, such as contact facility or the instructive potential. To conclude, the spread of the research work on information richness and quality suggests that information richness and quality are important points to consider when analyzing the impact of information activities upon organizational performance.

### *II.3.1.2 The organizational mechanisms necessary to improve information dissemination within organizations*

The second common point of the six theoretical frameworks reviewed is the crucial role of organizational structure adjustment or the adoption of organizational mechanisms necessary to make better use of information. For instance, the contingency theory stresses the key role of information in helping organizations adjust their structure in response to environmental shifts. To that end, organizations need to implement mechanisms and adjust their internal structure to assure efficient information exploitation (Ansoff 1965; Andrews 1971; Ghoshal and Kim 1986; Baumard 1991). Scott (1992) stressed the role of rules, hierarchy, and decentralization as mechanisms that determine the information-processing capacity of organizations. To cope with internal and external constraints, organizations have to create specialized subunits with different structural features. Examples of such structural features are the different levels of formalization, centralization, or planning horizons (Lawrence and Lorsch 1967). Furthermore, the more different the structure, the more difficult it will be to coordinate the activities of the subunits and more resources will be needed to be applied for improving coordination. Nonetheless, there is no “*best way*” to manage organizations in order to be effective (Galbraith 1973). Planning, organizing, leading, and controlling must be tailored to the particular circumstances faced by the given organizations (Scott 1992).

The generic assumption of the decision-making theory is that decision-making in organizations is structured by procedures and rules that specify roles, methods and norms, which are learned from experience and guide action. The coordination of actions ensures efficient information use in organizations (Choo 1997) and leads to efficient decision-making. Decision-making and information use in organizations are limited by the bounded rationality of decision-makers (Simon 1945). Simon (1945) proposed four organizational mechanisms for overcoming the limits of the bounded rationality. They are: (1) authority decentralization, (2) efficient communication and coordination mechanisms, (3) training programs for employees, and (4) promotion and development of the employee’s loyalty towards the organization. According to Cyert and March (1963), organizational decision-making



efficiency relies upon the information that organizations dispose of, the organizational capabilities to scan environments, the retrieval and processing of information, and the efficiency of the communication and diffusion of information structures in the given organization. Therefore, managers should maintain a fluid information exchange system that will trigger the efficient mobilization and coordination of efforts (Barnard 1968; O'Reilly 1983). Barnard (1968) and O'Reilly (1983) suggest that organizations are more informed if they dispose of rich information and they communicate and integrate information efficiently within the company.

The RBV of the firm also highlighted the key role of managerial practices and organizational mechanisms as strategic resources. Barney and Zahac (1994) referred specifically to the importance of information processing behaviors as strategic resources of firms in enhancing information flows and use within organizations. Wernerfelt (1984) highlighted the importance of procedures. Barney (1991) stressed the importance of a formalized structure, planning, control and coordination systems, and internal and external communication channels. Finally, Grant (1991) underlined the importance of the coordination mechanisms, strategy, and leadership.

The entrepreneurial theoretical advances make less reference to the organizational mechanisms needed to enhance information use at the organizational level. Nonetheless, the capacity of coordinating and communicating information is one of the key characteristics of entrepreneurs (Bayad *et al.* 2007) and entrepreneurial organizations that proactively seek for information and continuously innovate on its basis.

Regarding the learning theory for effectively learning, organizations need to change their behaviors according to the inputs given by information processing within the organization and adjust their structure for improving information exploit and learning. Huber (1991) stressed the importance of acquiring, exploiting, interpreting, and diffusing information within organizations. The search for and the diffusing of information are the organizational actions that favor knowledge acquisition. Cohen and Levinthal (1990) stressed the utmost importance of communication and coordination practices for easing information flows within organizations.

Market Orientation (MO) theoretical advancements also highlight the importance of the organizational mechanisms such as formalization, centralization or coordination and communication in enhancing information exploitation within firms (Jaworski and Kohli 1993). The main contribution of MO literature is the utilization of all these procedures within a measurement scale named "*information dissemination*" (Kohli *et al.* 1993).

To conclude, all theoretical frameworks reviewed refer to the adjustment of the organizational structure or the organizational mechanisms necessary to improve information flows. The importance of communication and coordination practices is stressed in each of the six theoretical frameworks reviewed. Furthermore, with some variances in the specifics, the importance of rules, hierarchy, and decentralization such as determinant for the information-processing success of organizations are mentioned within most of the six frameworks under review. As a result, scholars should grant specific attention to the importance of organizational mechanisms in enhancing information use in organizations and to the importance of information quality. With exception to these two common points of the reviewed theories, the five theories differ in regards to their focus and the way they view organizations and the proposition they make in respect to the relationship between information activities and organizational performance.

### **II.3.2 Diverging aspects of the five theoretical frameworks reviewed**

The six theoretical frameworks reviewed propose different conceptualizations of the way they view organizations, their focus, and the sources of performance. These elements are presented in point II.3.2.1. The theoretical frameworks reviewed also differ in the way they link information activities to organizational performance. In point II.3.2.2, the main thesis they advance with in this respect is synthesized.

#### ***II.3.2.1 Main focus, organization's conceptualization and organizational performance sources***

Contingency theory suggests that uncertainty reduction and the adaptation towards the environment are the fundamental problems of organizations. Organizations are open systems or a sub-set of systems continuously confronted with uncertainty. Organizations have to adapt their mechanisms to the surrounding environment in order to survive and perform.

According to the decision-making theory, organizations are entities confronted with problems, which are solved by decision-making. Decision-making efficiency is the main input for organizational performance.

The RBV of the firm views organizations as bundles of tangible and intangible resources. Strategic resources, those that benefit from VRIN attributes, are the main inputs of organizational competitive advantage that in turn drives organizational performance.

Entrepreneurial theoretical advancements propose that organizations are innovation agents. An organization's main role is to innovate and its innovation capacity drives organizational performance expressed in terms of profitability and competitiveness.

According to learning theories, organizations are information-processing systems. The emphasis is put on information and its management and the organizational supports necessary for information processing. Performance is driven by the learning capacity of the organization and the creation of new knowledge.

Finally the MO perspective, especially the one stemming from Kohli and Jaworski's (1993) seminal work, approaches organizations as information processors and users. The emphasis is put on information acquisition, dissemination and use within firms. The role of information is to enhance the adequacy of the response actions that firms implement for responding to environmental changes. Most MO scholars believe that a firm's performance is driven by its capacity to adapt to environmental shifts. Nevertheless, the link with business performance is still under discussion in MO literature (Ellis 2005).

### *II.3.2.2 The different theses proposed on the relationship between information and organizational performance*

One can observe that different theses have been advanced in regards to the impact of information upon international performance by the reviewed theoretical frameworks. The theoretical frameworks reviewed can be seen as more complementary rather than exclusive although they all have their strengths.

According to the contingency theory, the role of information is to reduce uncertainty (Galbraith 1973) and to help enterprises respond to environmental shifts (Lawrence and Lorsch 1967). The theoreticians of contingency theories did not explain exactly how information impacts performance. Nevertheless, it can be deduced that the link between information and performance is rather indirect. "Good quality" of information (Lawrence and Lorsch 1967; Wilensky 1967), in sufficient quantity (Galbraith 1973), which is essential to its environment (Porter 1986), enhances both environmental responsiveness and uncertainty reduction, which in turn impact organizational performance. Organizations need to implement communication and coordination mechanisms in order to ease information flows within the

organization (Aguilar 1967; Thompson 1967; Baumard 1991). The organizational mechanisms can then be seen as mediators of the relationship between information, environmental responsiveness and uncertainty reduction.

The decision-making theory considers information to be an important input of the decision-making process (Simon 1945; Cyert and March 1963; Barnard 1968; Feldman and March 1991; March 1991). The access to information improves decision-making efficiency, which improves organizational performance. Again, similar to contingency theory, the scholars do not specifically explain the link between information and performance. Nonetheless, it can be assumed that information improves decision-making, which then drives organizational performance. Decision-making theory emphasizes the following aspects: the manager's profile and capabilities (Kolb 1976; Levinthal and March 1993; Nonaka 1994), the management of informational processing inside the organization in terms maintaining an open information exchange system (Barnard 1968), managerial practices as decentralization, communication and coordination, as well as training and promotion programs (Simon 1945). All of the elements mentioned above can also be seen as moderators of the relationship between information and performance.

The link between information and performance is finally explicitly described within the RBV of the firm. According to the RBV, information is a strategic resource. Strategic resources indirectly impact the organizational performance, the relation being mediated by competitive advantage. The strategic resources drive the competitive advantage of organizations, which in turn determines performance. Information elements and information sources are viewed as strategic resources in the same level as the capabilities, the experiences and some of the managerial practices or enterprises' assets (e.g. Wernerfelt 1984; Barney 1991; Mahoney and Pandian 1992; Amit and Shoemaker 1993).

The entrepreneurial theoretical advancements propose that organizations and entrepreneurs need to effectively scan the environment (Drucker 1985) for valuable information that mainly comes from non-traditional sources (Kaish and Gilad 1991) in order to seize opportunities and innovate. Information plays an important role in innovation and it helps enterprises encounter new opportunities. The importance of the entrepreneur's profile and capabilities to seize and exploit information are highlighted (e.g. Hayeck 1937, 1945; Kirzner 1979) as a catalyst of the relationship between information and innovation intensity.

Organizational learning theory proposes that information enhances learning and that effective learning drives organizations successful (Levinthal and March 1993; Henderson and Cockburn 1994; McGrath *et al.* 1995). Again, the link is not directly explained by learning

theory scholars. The emphasis is put on information management, on the capabilities and organizational mechanisms needed to improve information processing. It seems that the impact of information on learning efficiency also depends upon several factors namely the capabilities and experiences level, and the organizational mechanisms and practices aimed at effectively absorbing information (Cohen and Levinthal 1990, 1992, 1994). These factors might also be seen as moderators of the relationship existing between information and learning.

The MO research stream stresses the role of information in enhancing the adequacy of the response actions that firms implement in response to environmental changes. Most of the MO scholars agree that the performance of a firm is driven by its capacity to adapt to environmental shifts. Nevertheless, the link between business performance and companies' levels of market orientation is still under discussion in MO literature (Ellis 2005).

### **II.3.3 Critical analysis of the theoretical frameworks reviewed**

Within the current chapter, six different theoretical frameworks were exposed explaining the existing link between information and business performance. The converging and diverging aspects of the six theoretical frameworks were also highlighted. Furthermore, in point III.3.3.1, the pertinence of using the previously analyzed theoretical frameworks within the current research will be discussed. In point III.3.3.2, the existing perspectives for looking at the relationship existing between information and organizational performance are exposed and analyzed.

#### ***II.3.3.1 Towards an integrative theoretical framework over the impact of information activities on organizational performance***

*"In an economy where the only certainty is uncertainty, the one source of competitive advantage is knowledge. When markets shift, technologies proliferate, competitors multiply, and products become obsolete almost over night, successful companies are those that constantly create new knowledge". (Nonaka and Takeuchi 2004, p. 29)*

In the light of points II.1 and II.2, it can be concluded that the theoretical frameworks presented seem to converge concerning the importance of information richness and the organizational mechanisms needed to improve information processing at the organizational level. Nevertheless, they all propose different pathways concerning the impact of information

on organizational performance. They also differ in the way organizations are conceptualized and in the explanation of the way firms attain higher performance levels.

Among the six theoretical frameworks, the one providing the most powerful framework for explaining organizational performance is the RBV of the firm. The RBV explains in a very explicit manner the link between information and performance; it is the only theoretical framework that does so (Ramangalahy 2001). However, the RBV has a main limit; it is deterministic, static, and bounded by time (e.g. Kylaehaiko 1998; Kuivalainen and Bell 2004; Freiling *et al.* 2008; Locket *et al.* 2008). Accordingly, information is one among other organizational strategic resources that drives competitive advantage at a certain moment in time. The RBV does not provide any complementary information concerning the process and the dynamics of information evolution within organizations. The lack of information is contradictory to the dynamic character of information itself. Information is a flow (Nonaka 1994) that continuously enters organizations; it is further considered for decision-making and can be ignored or rejected (Souchon and Diamantopoulos 1997). Furthermore, there is empirical evidence that shows that a firm's competitive strategy impacts the information search practices that firms adopt and the market-related information these firms acquire (Beal 2000). Thus, it seems that RBV postulate that information is a strategic resource enhancing competitive advantage (Li and Calantone 1998) is in reality not uni-directional. In conclusion, the RBV of the firm fails to capture a part of the process and the dynamics associated with information processing in organizations. With this regard, organizational learning theories seem to best gap RBV's shortcomings when it comes to information processing related dynamics. If within the RBV information is one among other strategic resources the enterprises own, information is central within organizational (informational) learning theory in that they focus on information processing within organizations. Cohen and Levinthal's (1989, 1990, 1994) information Absorptive Capacity (AC) concept develops a very complete and interesting framework for explaining how information can be effectively exploited within organizations (Ramangalahy 2001) by means of learning. Accordingly, the successful absorption of information depends on the capabilities and the experiences organizations have in a given field that relates to information. Successfully absorbing information also depends upon the organizational mechanisms that make information exploitation easier. The information AC enhances learning that is expressed in terms of knowledge creation. While learning theories provide very strong indications on the pathways of information processing, they are less explicit when it comes to the link between information and performance. The link has not been clearly established by organizational learning scholars. Nevertheless, it can

be supposed that the link is rather indirect because information enhances the efficiency of learning and effective learning enhances performance. The main limit of the field of learning theories is the scarcity in terms of empirical quantitative research and measurement instruments for corroborating learning theory postulates (Slater and Narver 1999). Moreover, until now, what efficient learning represents is still an unanswered question.

A common idea supported not only by organizational learning and by contingency theories but also the MO literature is the organizational liability to its environment. According to the learning theories, through the learning process, enterprises react and anticipate environmental shifts (Argyris 1976; Kolb 1976; Cohen and Levinthal 1990; Huber 1991). According to the contingency theory, efficiently addressing environmental shifts leads to efficient performance (Lawrence and Lorsch 1967; Wilensky 1967; Scott 1995). Finally, the MO research stream also stresses that a firm's capacity to respond to environmental shifts drives them to be more competitive (Jaworski and Kohli 1993) and therefore more successful. It is worth to note that contingency, MO and organizational learning theoretical frameworks bridge the RBV's limits in regards to the inner orientation of this theory, towards the inside of the organization and its resources. The RBV of the firm ignores the environment and its structuring power to a certain extent.

By aiming to construct an organizational performance model in the current research, the most appropriate level of analysis is the firm. The main reason for doing so is that organizational performance is by definition an organizational level construct. For this defining reason, the decision-making theory or entrepreneurial theoretical advances are less adapted to address this research subject. Within both theoretical frameworks, the accent is put either on the decision-maker or on the entrepreneur's profile. Thus, both theories emphasize the personal level of analysis, which prevails over the organization's level of analysis.

The decision-making theory highlights the decision-maker's profile, his competences and capabilities that enable him to take the right decisions (Kolb 1976; Levinthal and March 1993; Nonaka 1994). However, it is very difficult to judge the decision-making's efficiency. Decision-makers are rationally bounded and it is impossible to calculate and evaluate all the decisions possible and their outcomes.

Entrepreneurial theoretical advances highlight the entrepreneur's profile and his capacity to grasp and seize opportunities from the surrounding environment (Hayeck 1937, 1945; Kirzner 1979). The entrepreneur has a superior capacity of using information innovatively and innovation capacity drives organizations successful. Resuming, as in the case of the decision-

making theory, the individual level of analysis prevails when mobilizing entrepreneurial theoretical advances.

Concluding, among the reviewed theoretical frameworks, the organizational learning theory and the RBV seem to provide the most interesting elements for studying the relationship between information and performance. They each bring interesting elements into the analysis. The organizational learning theories provide important insights concerning the environmental factors, the responsiveness companies need to implement in order to face environmental shifts, and information processing dynamics within organizations such as the learning and knowledge creating process. The RBV of the firm represents the most powerful framework for explaining the link between information and performance.

Therefore, it can be concluded that choosing only one theory would capture the relationship between information and performance in a limited manner. The two theories, organizational learning theory and the RBV of the firm, are complementary rather than mutually exclusive. Thus, it would be interesting to use elements from each in order to capture the influence a firm's information state on organizational performance in the most exhaustive way possible. As a result, within the current research, the dynamic dimension of information in the organizational learning process will be stressed. With this in mind, as shown in point II.3.3.2, the integrative character of the AC framework (Cohen and Levinthal 1989; 1990; 1994) makes it an appealing framework for studying the role of information in the learning process. Elements will also be incorporated from the RBV of the firm, which is the most powerful framework for explaining the existing relationship between information activities and organizational performance (Ramangalahy 2001; Julien and Ramangalahy 2003).

Over the last decade, a new theoretical framework has been under development, namely the Knowledge-Based View (KBV) perspective. The emerging KBV is not a theory of the firm in any formal sense. It can be seen more like a set of ideas about the existence and nature of the firm that emphasize the role of knowledge and its creation. The KBV emerged over the past decade from the seminal work of Grant (1996) and has some features that are particularly appealing for the current research. The main point of interest of the KBV resides in its integrative character. The KBV takes the interplay between action, cognition and a shared identity or organizational members into account stemming from the behaviorally oriented firm theories (Kogut and Zander 1996; Kuivalainen and Bell 2004). Moreover, KBV acknowledges the strategic value of a firm's resources and competences enhancing competitive advantage stemming from the RBV of the firm (Mahoney 1995; Christensen 1995; Barney 1996) while it also takes into account the environmental influences that stem



from contingency and learning theories. Traditionally, most scholars see KBV as an extension of the RBV of the firm, drawing on the outmost strategic value of intangible assets enabling competitive advantage (e.g. Christensen 1995; Mahoney 1995; Barney 1996).

Recall that among the six theoretical frameworks reviewed in this chapter, the RBV of the firm appeared as the most powerful framework for explaining the existing relationship between a firm's information activities and business performance. However, the RBV has been criticized mainly because of its fundamentally static character (Kylaehaiko 1998), describing a reality of strategic resources and competitive advantage state at a given moment in time. The KBV perspective brings along a dynamic perspective on resource evolution. All by accepting much of the content of the RBV, the KBV "*pays more attention to the process or path by which specific capabilities evolve and develop over time*" (Kuivalainen and Bell 2004, p. 2). The evolutionary character is interesting in the case of the current research work because of the dynamic nature of information. Information is a flux (Nonaka 1994) conveying a meaning and continuously entering organizations. Information provides insights into the activities that should be undertaken to match market conditions (Kohly and Jaworski 1993; Day *et al.* 1994; Slater and Narver 1995). Thus, in the most of the cases information is processed and furthermore exploited for commercial ends within firms.

To resume, the dynamics associated with firms' information activities cannot be captured by the RBV and respectfully the KBV is more appropriate in the current research. The dynamic character of the KBV is mainly explained by the importance that KBV grants to the learning process (Spender 1999) that is ongoing and continuously evolving. "*La raison d'être*" of firms within the KBV is knowledge creation and learning. According to the KBV, organizations can be seen as repositories of knowledge. The learning process is central to the KBV and it represents the ultimate source of long-lasting competitive advantage and superior performance for firms (Kogut and Zander 1993; Teece *et al.* 1997; Kylaehaiko 1998; Spender 1999). Since information is the key input for learning, according to numerous learning scholars (e.g. Argyris 1976, 1993; Huber 1991; Nonaka 1994; Cohen and Levinthal 1989, 1990, 1994), the focus KBV has on the learning process is another appealing feature in the case of the current research. Learning occurs through partially replicating processes and creating knowledge through integration and transferring mechanisms specific to the firm.

According to the KBV perspective, managers have to create the necessary conditions to enhance the knowledge development that can be managed at the firm level (Camus and Cova 2002). Indeed, the favored level of analysis within the KBV is the organization. With this regard, the KBV presents another advantage in the case of the current research since the

chosen level of analysis is the firm. Nonetheless, the KBV emphasizes the interaction among individuals and groups for sharing and creating knowledge and the implications of such interactions over competitive advantage (Grant 1996; Szulanski 1996). The role of individual knowledge and learning is not denied within the KBV perspective. The learning and knowledge creation process exists at different levels within organizations (Brown and Duguid 1991; Kogut and Zander 1996). They can take place at the individual level (Nonaka 1994; Matusik and Hill 1998) as well as at the firm's level. However, according to the KBV, knowledge development and learning can be managed and enhanced at the firm level (Camus and Cova 2002). Firm level learning is seen as more powerful for explaining the firms' levels of performance.

Resuming, the KBV presents numerous advantages for the study of how a firm's information processing impacts organizational performance. First, due to its integrative character, the KBV associates the dynamics of information evolution within the firm by means of the learning process that is central to the KBV. Second, it also takes into account the environmental influence on a firm's structural constitution stemming from learning theories. Third, it can draw on the strategic nature of firms' resources, which highlights the utmost importance of intangible resources such as information. Fourth, the firm is the favored level of analysis.

In conclusion, the KBV represents the most satisfactory theoretical framework for capturing the study of the dynamics associated with information within firms and their impact upon business performance. Nevertheless, the KBV presents several limits as well. The first limit is that the link with the organizational performance is still under discussion within the KBV. It might be the reason why the theoretical advancements of the KBV are not recognized as a "real" organizational theory for the moment. According to the RBV of the firm, the competitive advantage of firms is actually based on positioning and a single product. Under the KBV perspective, a sustainable competitive advantage is based on "*resources, capabilities, especially organizational skills and practices learnt and evolving over time*" (Kuivalainen and Bell 2004, p. 4). Firms are more able to perform if they develop superior knowledge and capabilities in comparison to competitors (Grant 1996).

The exporting literature stresses the critical role of international capabilities as significant determinants of success for most small firms (Kuivalainen and Bell 2004). In such dynamic, changing, and turbulent environments as international markets, knowledge-based capabilities are often seen to contribute the most to performance (Grant 1996; Miller and Shamsie 1996) by building efficient environmental responsiveness (Teece *et al.* 1997). Recently, the idea of

achieving positional advantage in terms of core competences seems to have become more accepted as the source of long lasting organizational performance within the KBV (Kuivalainen and Bell 2004; Kodama 2005).

The second limit in choosing the KBV as a theoretical framework in the case of the current research is that KBV denies the role of information in the organizational learning process over the role of knowledge. Even though the KBV perspective focuses upon intangible resources like information and the learning process is at the center of the KBV perspective (Kogut and Zander 1993; Teece *et al.* 1997; Kylaheiko 1998; Kuivalainen and Bell 2004), the role of information in the learning process has been neglected. KBV scholars favor the role of knowledge in learning over the role of information. This favoritism can be explained by the fact that the KBV has shifted the learning theories' visions of firms as information processors to firms as knowledge processors. Please recall that it is not always easy to draw a clear line between knowledge and information when trying to define them. Nevertheless, empirical evidence strongly supports the key role of information in learning and the knowledge creation process (Sinkula *et al.* 1997; Celuch *et al.* 2002). Information can be seen as a “*key ingredient*” in knowledge creation since information brings along insights on which actions should be undertaken depending on market conditions (Jaworski and Kohli 1993). Therefore, the contribution of information to the learning process should be integrated within the KBV (Morgan *et al.* 2004). It can be concluded that accepting the additional role of information within the learning and knowledge creation process can still be seen as a missing link within the KBV to a certain extent. The concept that links a firm's information-related activities and the KBV is the Absorptive Capacity (AC) of information. Initially defined by Cohen and Levinthal (1989) in terms of information absorption, the AC concept was further reiterated by Zahra and George (2002), as a dynamic capability reinforcing the firm's competences and capabilities based in key areas. As it follows the AC concept will be presented.

### *II.3.3.2 Absorptive capacity, a suitable perspective for looking at the relationship between information activities and organizational performance*

Six major theoretical frameworks were reviewed to capture the relationship between information and organizational performance. Among the six frameworks, four perspectives can be highlighted to look at the information-related aspects within organizations including quantitative, qualitative, psychological and managerial perspective (Ramangalahy 2001).

The first perspective for looking at a firm's information activities is "*quantitative*" by nature. It stems from the Galbraithian conception of the uncertainty reduction. Galbraith (1973) defined the uncertainty as the difference between the amount of available information and the information needed in organizations. The less organizations are confronted with uncertainty, the better they will adjust organizational structure to match environmental changes. Even though this perspective has frequently been applied within the literature, it is characterized by several limits. For instance, if it is accepted that managers are rationally bounded (Simon 1945) and limited in terms of calculation and analysis capacity, then it is accepted that they cannot take into consideration all the possible developments or evolution scenarios when making decisions. In addition, some authors suggest that managers are psychologically different. They all do not have the same capacity to exploit information and seize the opportunity character of information (Kirzner 1973). Moreover, they all do not dispose of the same cognitive capacities for exploiting information (Simon 1945).

The second perspective for looking at a firm's information activities is "*qualitative*" by nature. This perspective underlines the importance of information qualities and attributes. One of the main authors pertaining to this stream is Wilensky (1976). Wilensky stresses that decision-making's efficiency depends on the clearness, opportunity content, reliability, validity, adequacy, and diversity of the available information. Argyris (1976) stresses the importance of the validity content of information for making decisions. Lawrence and Lorsch (1976) defend the same thesis of the validity content of information organizations need in order to adapt their structure to environmental shifts. Again, this "*qualitative*" perspective for approaching information can be criticized in the light of Simon's (1945) bounded rationality theory that proposes a cognitive explanation of the managerial capacity to exploit information. Accordingly, different managers confronted with the same information can take different decisions because they do not have the same cognitive pathways of processing information.

The same observation can be highlighted as far as the third "*psychological*" perspective is concerned. This perspective stems from entrepreneurial theories that highlight the superior

capacity of the entrepreneurs to exploit information to innovative ends and detect opportunities (Kirzner 1973). In the meanwhile, entrepreneurial theories emphasize the individual capacity to exploit information and do not explain the organizational capacity to exploit information much. Simon's perspective (1945) proposing a cognitive or managerial interpretation of the information activities of an organization is also nonetheless limited at the individual level. Accordingly, managers do not all have the same cognitive capacity to process information.

Finally, the only perspective that allows an organizational evaluation in terms of information-based activities is the absorptive capacity (AC). Cohen and Levinthal (1989, 1990, 1992, 1994) developed the AC perspective. Like Simon's perspective, this perspective can be characterized as a cognitive or managerial perspective. The main difference with the cognitive perspective is that AC refers to firm and not individual ability in regards to the valorization, assimilation, and use of new, external information to commercial ends (Cohen and Levinthal 1990).

In their recent literature review of the 289 papers published on AC, Lane *et al.* (2006) analyze the different operationalizations of the concept and observe that the dominant practice was to measure AC by the capital invested in R&D. They confirm Jansen *et al.*'s (2005, p. 999) observation that *"despite the growing interest in absorptive capacity, few (studies) have captured the richness and multi-dimensionality of the concept"*.

Much of the literature has identified AC as a knowledge base or the extent of prior (related) knowledge in the firm (Mowery *et al.* 1996; Kim 1997; Ahuja and Katila 2001). Indeed, Cohen and Levinthal (1990) stressed the contextuality of information within the process of information absorption and learning, suggesting that *"the ability to assimilate information is a function of the richness of preexisting knowledge structure, learning is cumulative, and learning performance is greatest when the object of learning is related to what is already known"* (Cohen and Levinthal 1990, p. 131). Drawing on this observation, AC has been operationalized with variables considered proxies for prior knowledge base such as R&D intensity (Mowery *et al.* 1996; Meeus *et al.* 2001; Tsai 2001) and patents (Mowery *et al.* 1996; Aluja and Katila 2001). The appropriateness and validity of these measures for capturing the AC construct are questionable given the inconsistency of the empirical evidence (Lane *et al.* 2006). A firm's knowledge base represents only one aspect or dimension of the firm's AC. While reviewing a lecture of Cohen and Levinthal's conception of AC (1989, 1990, 1992, 1994), Ramangalahy (2001) distinguished five dimensions of the AC construct

which include a cognitive, knowledge, experience, information and managerial practices dimensions.

By following Cohen and Levinthal's (1994) direction, scholars frequently attempt to approach the AC through its cognitive dimension, the firm's capacity to take advantage of the emerging opportunities before rivals can recognize them, by collecting and exploiting market information (e.g. Chiesa and Manzini 1998; Davenport *et al.* 1998; Dyer and Singh 1998; Nahapiet and Ghoshal 1998). Note that the cognitive dimension is similar to the psychological and cognitive perspectives referring to the entrepreneur's or manager's capacity to exploit information. To a certain extent, the cognitive dimension of the AC extends the individual level conception stemming from entrepreneurial theories or Simon's (1945) bounded rationality theory at the firm level.

Secondly, the know-how and capabilities basis of the organizations, the knowledge dimension of the AC concept, helps firms to better scan their environment. Cohen and Levinthal (1990) deem that absorbing new information is based on previous related experience, capabilities, and knowledge. AC itself is often referred to as the knowledge base of firms, more specifically as the extent of prior knowledge in the firm (Mowery *et al.* 1996; Kim 1997; Aluja and Katila 2001; Lane *et al.* 2006). Alange *et al.* (1998) and Schilling (1998) interpret AC in terms of organizations' competence base.

The third dimension of the AC concept is the experiential dimension. Allange *et al.* (1998), as well as Schiling (1998) and Chang (1995), mention the role of previous experiences related to the new information content in regards to explaining AC. Proxies such as age (Sorensen and Stuart 2000; Rao and Drazin 2002) have been used to argue that older firms are more likely to have accumulated knowledge, developed routines and processes that facilitate assimilation and innovation (Lane *et al.* 2006).

The fourth dimension of the AC concept is the informational dimension. The internal and external communication networks of enterprises with the environment help them evaluate the capacities and knowledge existing outside of the company. In this way, the AC is reinforced "*to the extent that an organization develops a broad and active network of internal and external relationships, individual's awareness of others' capabilities and knowledge will be strengthened*" (Cohen and Levinthal 1990, p. 134). Cohen and Levinthal stressed that not all information sources necessarily develop AC. For example, they identify the personnel, suppliers, clients, competitors, universities and the government among important technological information sources. Cohen and Levinthal (1990) stress the importance of accessing new and external information in terms of innovation. Brown and Eisenhardt (1995),

and Levinson and Minoru (1995) emphasize the internal and external communication dimensions. Ramangalahy (2001) stresses the access to rich information sources on foreign markets as a dimension of the AC of SMEs. Leonard-Barton (1995) also highlights the access to external information and its internal diffusion within the organization. Chang (1995) mainly emphasized experience and information networks. O'Neil *et al.* (1998) underlined the importance of internal and external networks for accessing information. Matusik and Heeley (2005) highlight in a more general manner a firm's relationship with the external environment. At the inter-organizational level of analysis, the researchers have identified the importance of "*strong ties*" (Shenkar and Li 1999; Dyer and Nabeoka 2000) in acquiring external knowledge. This informational dimension encloses both "*quantitative*" and "*qualitative*" perspectives of approaching information by highlighting the preference for certain information sources that provide more valid and quantitatively significant information to the firm.

The last dimension of the AC construct refers to the routines and processes firms develop in order to analyze, process, interpret, and understand the information and knowledge obtained from external sources (Szulansky 1996; Kim 1997; Chou 2005; Matusik and Heeley 2005). Ramangalahy (2001) initially called it the "*managerial practices dimension*". The name of assimilation dimension is adopted here because it is a more widely used denomination for this dimension within the AC literature. Cohen and Levinthal (1990) stress the role of the organizational structure in facilitating information transfer and absorption by means of both formal and informal communication and coordination practices. A relatively limited number of studies have operationalized AC under a more behavioral angle in terms of compensation policies, dominant logic, and knowledge sharing routines or motivation (Szulanski 1996; Lane and Lubatkin 1998; Lane *et al.* 2001; Meeus *et al.* 2001). Dyer and Singh (1998) highlighted the managerial practices enhancing exchange among the members of organizations. Similarly, some authors stressed the importance of the familiarity of informal exchange through inter-organizational relationships and the feeling of belonging to a community, feeling a connection, and socializing (Meyer-Krahmer and Meyer-Krahmer 1998; Beise and Stahl 1999; Jansen *et al.* 2005). Acknowledging the organizational structure importance to the AC construct, some researchers underline the importance of the level of centralization (Gupta and Govindarajan 2000; Lane *et al.* 2001; Jansen *et al.* 2005), flexibility (Lane *et al.* 2001), cross-functional teams (Meeus *et al.* 2001) or the presence of more formalized integration mechanism such as task forces (Gupta and Govindarajan 2000; Meeus *et al.* 2001).

Please note that several elements related to the assimilation dimension, for example cross-functional interfaces and job rotation to name a few, have also been conceptualized as antecedents rather than constitutive parts of the AC (e.g. Jansen *et al.* 2005). The study of Jansen *et al.* (2005) has the merit of being one of the few studies bringing empirical evidence seen upon the AC as a process. Also within the study of Van den Bosch *et al.* (1999), the level of prior knowledge or the knowledge dimension, the organizational structure, and the combinative capabilities such as coordination, socialization, and system capabilities were seen as antecedents of the AC. This study is one of the few existing studies providing a review of the AC construct. By acknowledging the contributions of the study of Van den Bosch *et al.* (1999) and the study of Jansen *et al.* (2005), it is believed that assimilation practices, prior knowledge and capabilities represent dimensions of the AC in accordance with Cohen and Levinthal's initial conception and Ramangalahy's (2001) interpretation.

To resume, the AC concept appears as a multi-dimensional construct made up of five dimensions that include cognitive, information, knowledge or capabilities, experiential and assimilation dimensions. AC represents an integrative perspective drawing elements from the quantitative, qualitative, and psychological perspectives at the firm level. Moreover, the AC is the only perspective approaching firms' information activities under a managerial perspective describing the informational processing and impact at the firm level. In conclusion, among the four perspectives for approaching information, AC constitutes the most satisfying framework for the current research. Moreover, Zahra and George (2002) have linked the AC construct to business performance as a dynamic capability that enhances a firm's organizational performance. The AC is an especially interesting feature in the case of the current research since it allows the capturing of the dynamics associated with the firms' information activities and at the same time, links the AC construct to business performance under a knowledge based perspective. Zahra and George's conceptualization (2002) of AC for describing the relationship existing between firms' information absorption activities and organizational performance will be further analyzed.



## II.4 Absorptive capacity: a dynamic capability enhancing organizational performance

Over the last years, absorptive capacity (AC) has mainly been conceptualized as a dynamic and evolving process or capability (e.g. Van den Bosch *et al.* 1999; Zahra and George 2002; Jansen *et al.* 2005; Lane *et al.* 2006). Nevertheless, in the past, much of the literature has tended to identify the AC in a static manner such as a knowledge base or the extension of prior related knowledge in the firm (e.g. Mowery *et al.* 1996; Kim 1997; Aluja and Katila 2001; Ramangalahy 2001). The tendency can be explained by the consolidation of the RBV over the last years. Thus, scholars have been attracted to conceptualize AC as one set of a firm's resources that potentially explain differences in the firm's competitive advantage.

The acknowledgement of the process view of AC was mainly developed because of the emergence of the KBV over the last years (Lane *et al.* 2006). As a result, several authors like Zahra and George (2002) have embraced the dynamic and process-like view of AC. Zahra and George (2002) re-conceptualized AC as a set of organizational routines and processes by which firms acquire, assimilate, transform, and exploit knowledge. These authors view AC as a dynamic capability (DC) that influences a firm's ability to create and deploy knowledge necessary to build, modify or renew organizational capabilities in line with shifting market conditions.

DCs are strategic by nature and are the determinants for a firm's future development (Teece *et al.* 1997) and performance achievement (Wang and Pervaiz 2007). Most of the existing definitions of DC contain similar features to Teece *et al.*'s (1997, p. 116) definition of DC being a "*firm's ability to integrate, build, and reconfigure internal and external competences to address rapidly changing environments.*" DC literature mainly draws elements from the evolutionist view of the firm (Nelson and Winter 1982) that highlights the key role played by organizational routines in designing a firm's evolutionary path. DC literature also incorporates ideas from previous research work on distinctive (Learned *et al.* 1969) and core competences (Prahalad and Hamel 1990), core capabilities and rigidities (Leonard-Barton 1992), combinative capability (Kogut and Zander 1992), and architectural knowledge (Henderson and Clark 1990) or architectural competence (Henderson and Cockburn 1994). The diverse origins of DC literature explain the researchers' tendencies to identify DC as a wide range of resources, processes, and capabilities, and to use different terms to name very similar constructs (Thomas and Pollock 1999). In spite of the existing disparities within this

literature field, most of the scholars agree that DC can be seen as the organizational process of coordination, utilization, and enrichment of a firm's routines and processes in line with the competitive environment (e.g. Sanchez and Heene 1997; Teece *et al.* 1997; Wang and Pervaiz 2007). The idea of aligning a firm's processes, resources and competences to fit environmental evolutions and shifts is a leitmotiv within the DC literature (e.g. Sainy 2001; Zott 2003; Augier and Teece 2008).

While most of the definitions of the DC mainly have a generalist character (Wang and Pervaiz 2007), Zahra and George's (2002) definition has the merit of being operational and refers to the development of capabilities in key organizational functions such as marketing, distribution and production. Zahra and George's (2002) research suggest that four types of organizational capabilities exist that include knowledge acquisition, dissemination, transformation, and exploitation. They build on each other for yielding AC, defined as "*a dynamic capability that influences the firm's ability to create and deploy the knowledge necessary to build other organizational capabilities (e.g. marketing, distribution, and production)*" (Zahra and George 2002, p.188). Another notable contribution of Zahra and George's (2002) conceptualization is the explanation of the existing relationship between AC and organizational performance (Volberda *et al.* 2005). To resume, Zahra and George's (2002) re-conceptualization of AC is especially appealing for the current research. It not only has the merit of reinforcing the dynamic process view of the AC as a dynamic capability and being more operational in regards to the definition of AC as a DC, but it also explains the link between AC and organizational performance.

#### **II.4.1 Potential and realized absorptive capacity and their link to organizational performance**

Within the article written by Zahra and George (2002), they proposed a reconceptualization of the AC as a DC that drives knowledge creation and utilization, therefore enhancing organizational performance. As a DC, a firm's AC is embedded within organizational processes and routines and influences the path by which firms evolve and change (Zott 2001). These processes or capabilities allow firms to change and respond to shifting market conditions in order to perform (Zahra and George 2002).

Zahra and George (2002) differentiate two sub-sets of AC, Potential Absorptive Capacity (PACAP) and Realized Absorptive Capacity (RACAP). PACAP consists of acquisition and

assimilation of knowledge, and RACAP consists of the transformation and exploitation of knowledge. These four dimensions or capabilities are combinative by nature and build on each other for yielding an organizational DC. They influence firms' abilities to create other organizational capabilities (e.g. marketing, distribution or production) and finally enhance a firm's levels of performance (Zahra and George 2002).

It is worth to note that the distinction Zahra and George (2002) made between information and knowledge is rather ambiguous. For instance, when they referred to knowledge transformation dimension (RACAP) they defined it in terms of information exploitation by means of the bissociation process of combining information into innovative ways. Thus, they explicitly assumed that knowledge exploitation is at least very closely related to information exploitation. Therefore, it seems that they identified information to explicit knowledge as several scholars did before (e.g. Kogut and Zander 1992; Morgan *et al.* 2004). For this reason, it is suggested that this framework can be applied within the case of market information.

The acquisition dimension of PACAP refers to the firm's capabilities to identify and acquire external knowledge and information that is critical to its operations. The assimilation dimension of PACAP refers to a firm's processes and routines enhancing the analysis, as well as the interpretation and understanding of the information coming from external sources. The assimilation dimension of PACAP helps firms to process and internalize externally generated information.

The transformation dimension of RACAP refers to a firm's ability to develop and refine existing routines that facilitate the combination of existing knowledge with newly acquired and previously assimilated information. Zahra and George's (2002) conceptualization seem to highlight two aspects of the transformation dimension. The first aspect refers to a rather psychological capability arising from the association process characterizing entrepreneurial mindsets and enhancing the successful exploit of two apparently incongruent pieces of information (McGrath and Mac Millan 2000). The second aspect is rather behavioral and refers to the development and refinement of existing routines and processes, and also the expression of the entrepreneurial action that materializes the mental transformation of information.

Finally, the exploitation dimension of RACAP emphasizes the application of knowledge. Exploitation reflects a firm's propensity to refine, create and apply new incoming knowledge into the firm's operations. "*Exploitation is evident, for example, in new ventures that capture knowledge from their market and competition and customer and then in which knowledge is used to create new competences*" (Zahra and George 2002, p. 190). Resuming, exploitation is

materialized by the creation of competences in a key area of development for the firm like marketing, and distribution or production to name a few. Figure 10 describes the main relationships existing between the dimensions of AC according to Zahra and George’s (2002) model.

Figure 10. The relationships between PACAP, RACAP and organizational performance

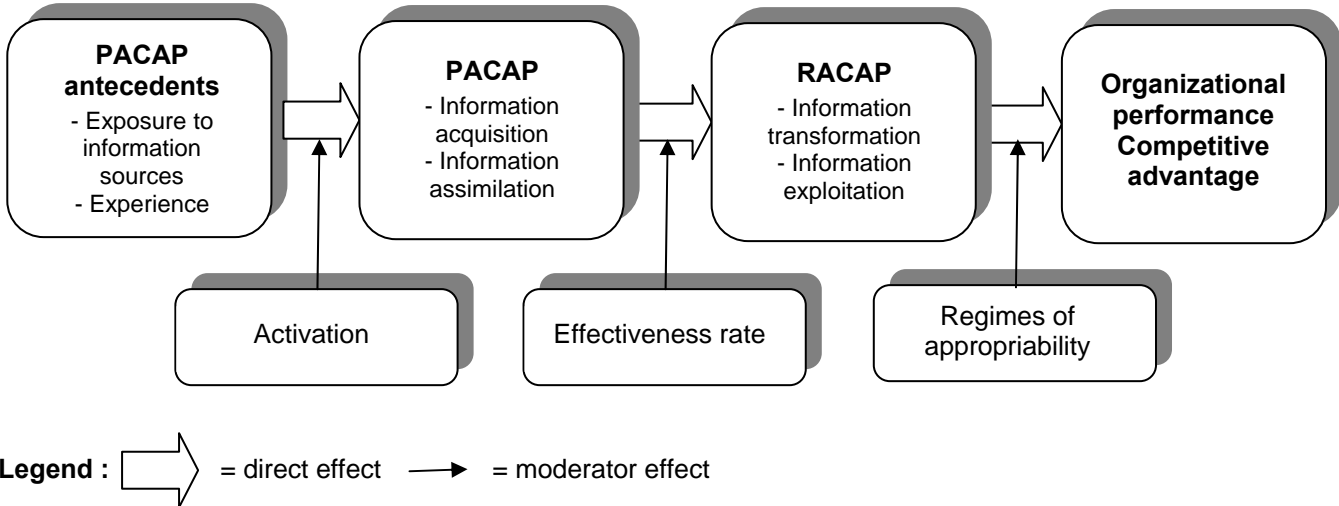

Note that Zahra and George (2002) addressed only two of the five dimensions previously described to constitute PACAP, namely the acquisition and assimilation dimensions. Nevertheless, within Zahra and George’s (2002) framework, the exposure to knowledge sources and their complementarities and organizational experiences are seen as antecedents but not as dimensions of PACAP. Within their AC organizational performance model, the authors base the assumption on the fact that previous studies suggest that a firm’s exposure to information, knowledge and their experiences are determinants of the efficiency of a firm’s knowledge acquisition and assimilation practices. Zahra and George (2002) suggest that a firm’s exposure to information sources within their environment influences their future development. Information sources that firms access should be diverse, complementary and related to the already existing knowledge base of the firm. A strong similarity between Zahra and George’s (2002) conceptualization of the quality of a firm’s exposure to information sources and the concept of information richness exists and has been highlighted by many organizational scholars (see point II.3.1.1). In conclusion, generally scholars suggest that a firm’s exposure to rich information sources will condition the levels of information acquisition and assimilation (PACAP) that characterize the firms.

The experience also plays a key role in fostering PACAP. Experience resumes the previous environmental scanning practices, collaborations with other firms (Lane and Lubatkin 1988), experiences of interactions with customers (Nonaka and Takeuchi 1995), and the accumulation of learning by doing (Levitt and March 1988). It also represents a memory deposit of firms (Walsh and Ungson 1991) and reflects knowledge accumulation. According to Eriksson *et al.* (2000, 2004), the international experiences of firms reflect the general internationalization knowledge of firms. Previous experience, which is embedded in a firm's processes and routines, fosters the path of information search practices and the way knowledge is acquired and assimilated within firms.

Several factors that Zahra and George (2002) called "*activation triggers*", moderate the effect of exposure to knowledge sources and experience on PACAP. The activation triggers can be either internal or external to the firm. Internal triggers may be an internal crisis that obliges the firm to redefine strategy or stimulate learning (Winter 2000). External triggers could be radical changes within the industry, radical innovations, and changes in institution-related regulations or technical shifts. Zahra and George (2002) suggest that these types of events, whether internal or external to the firm, have an influence on the way firms acquire and assimilate information based on their previous experience and their exposure to export information sources.

Zahra and George (2002) suggested that PACAP represents a necessary condition for achieving organizational performance, although indirectly, through determining RACAP. Only RACAP has a direct effect on organizational performance. Zahra and George (2002) suggest that firms vary in their capacity to combine their newly acquired knowledge with the existing knowledge to create new knowledge. The authors define the effectiveness rate or efficiency factor as the ratio of the real transformation of PACAP to RACAP. Firms with high efficiency factors are more skilled in developing and using knowledge or designing RACAP, these firms ultimately achieve higher levels of organizational performance. The effectiveness rate depends upon the social integration factors affecting the efficiency of knowledge incorporation within a firm's processes. Several scholars have suggested that organizations do not always efficiently integrate external information. Information sharing and integration depend on a wide range of formal and informal coordination procedures (Jaworski and Kohli 1993; Belich and Dubinsky 1999). Coordination procedures allow organizations to optimize information flows (Sheremata 2000) and favor information exploitation and transformation (Chaudhuri and Tabrizi 1999).

Zahra and George (2002) suggest that AC enhances knowledge creation within firms and requires learning capabilities. The authors suggest that the acquisition dimension partially reflects the speed and the quality of learning while the assimilation component of the AC conditions an organization's learning capacities. RACAP, the transformation and exploitation of information through improvement and innovation in product, process, capabilities or competences are sources of intra-industry variations of a firm's performance. The impact of RACAP on performance depends on the regimes of appropriability governing the industry under observation. The regimes of appropriability refer to the regulative and industry specific features affecting the firm's capacity to protect and benefit from the advantages in terms of products and processes. Regimes of appropriability can constitute barriers for the imitation of product and processes and preserve a firm's competitive advantage.

To recapitulate, the main research propositions advanced by Zahra and George (2002) within their AC model are the following:

- PI: PACAP antecedents, the previous experience and exposure to information sources, positively impact a firm's success in developing PACAP.**
- PII: A firm's PACAP levels, the information acquisition and assimilation, positively impact RACAP which is the transformation and exploitation of information development.**
- PIII: RACAP levels positively impact a firm's degree of organizational performance.**

The activation triggers, the firms' integration mechanisms and the regimes of appropriability that characterize the industry respectively moderate the strength of these relationships.

To summarize, Zahra and George's (2002) AC model represents an appealing framework for studying the impact of the information state of a firm upon the level of organizational performance. First, the model stresses the dynamics associated with information evolution within organizations because AC is viewed as a dynamic capability. Second, the link to international performance is explained by distinguishing between PACAP and RACAP as the two constituting parts of a firm's AC. PACAP represents a necessary condition for RACAP to be improved. In other words, the future transformation and exploitation of new external information depends on the quality of information acquisition and assimilation within organizations. Thirdly, if scholars have neglected AC's outputs in the past, Zahra and George's (2002) framework highlights the outputs of AC and also its antecedents.

Concluding, based on this framework and the three main research propositions resumed in Zahra and George's (2002) AC model, integrating insights from the SMEs' international management and marketing literature, the research model of the current study is built in this

next chapter by taking into account the exporting SMEs' specificities in terms of the AC associated processes.

### **Conclusion of Chapter II**

In the second chapter, the aim was to define information and analyze and discuss the theoretical frameworks and perspectives explaining the link between information and organizational performance. Similarities and differences among the theoretical frameworks are discussed along with the analysis of the application of different research frameworks and perspectives for best capturing the relationship under study between a firm's informational process and organizational performance.

It was concluded that one single theory would only partially capture the dynamics associated with a firm's information activities and business performance. As a result, the KBV perspective appeared to be the most appropriate framework for supporting the relationship between a firm's information activities and business performance. The results of this analysis also indicate that the most suitable perspective for looking at a firm's informational process and its impact upon business performance is the AC of the firm.

The generalized research model was developed in point II.4.) based on Zahra and George's (2002) conceptualization of the AC that combines insights from the two main theoretical frameworks of interest, namely AC and the KBV perspective. Zahra and George (2002) view AC as a dynamic capability enhancing firms' organizational performance. In chapter III, this generalized research model will be adapted in the case of exporting SMEs.

## CHAPTER III. THE RESEARCH MODEL DEVELOPMENT

### **Introduction to Chapter III**

In the third Chapter, the research model will be developed based on Zahra and George's (2002) generalized AC model. Their model is adapted under a KBV perspective in the specific case of exporting SMEs. Their specificities in terms of export information activities and structure will be taken into account.

The multi-dimensionality of the concepts and their relative reliance led to the division of the presentation of the research model into three parts for reasons of simplification that account for the three main groups of influence relationships existing in Zahra and George's (2002) model.

In the first section, the first group of research propositions related to the impact of PACAP's antecedents on PACAP is presented along with the conceptualization of PACAP and PACAP's antecedents in the specific case of exporting SMEs.

In a second section, the second group of research propositions related to the impact of PACAP on RACAP is presented along with the proposition of the conceptualization of RACAP specifically in the case of exporting SMEs.

Third, the last group of research propositions concerning the impact of RACAP upon SMEs' international performance levels is presented.

The KBV and AC have generated increasing academic interest over the last decade. Despite this growing scholarly interest, the theoretical and empirical efforts in the two research streams have focused mainly on technology-intensive firms and industries. Consequently, most KBV and AC writings have emphasized the importance of technical and R&D knowledge. As a result, the KBV and AC scholars have mostly ignored the knowledge and information related to a firm's market environment (Sinkula 1994; Lord and Ranft 2000; Liao *et al.* 2003).

The role of export information activities, learning, and more recently AC in SMEs' international development has been widely acknowledged by scholars as important resources (e.g. Ramangalahy 2001; Julien and Ramangalahy 2003; Andersen 2006). Surprisingly, they have not been extensively integrated within a KBV framework to study how foreign market information is combined with an organization's knowledge base and then transformed and exploited within small firms for ensuring their international performance levels.

Another point is that while the KBV and AC frameworks have been applied within the context of multinational and international joint ventures knowledge transfer, the SMEs' exporting field has been largely neglected compared to the empirical evidence showing the



knowledge based assets' importance for exporting small firms. As a result, this dissertation proposes a comprehensive empirical analysis of the knowledge creation chain while explaining the role played by several organizational factors in the overall process of SMEs' foreign market-based information absorption under a KBV perspective. A comprehensive beginning-to-end model of the foreign market-related information transformation process within SMEs is presented and tested by adapting the general AC model elaborated by Zahra and George (2002) in the specific case of exporting SMEs.

The main assertions advanced by Zahra and George (2002) for explaining the impact of AC upon business performance are briefly recalled. These authors see AC as a dynamic capability, which exists as two subsets of potential (PACAP) and realized AC (RACAP). PACAP is driven by the previous experience of the firm and the quality of the exposure to information sources within its external environment. While PACAP (information acquisition and assimilation) is a "*sine qua non*" condition for building RACAP, supposedly only RACAP by means of information transformation and exploitation has a direct impact upon organizational performance levels. Recapitulating, the main research propositions advanced by Zahra and George (2002) within their AC model are the following:

**PI: PACAP's antecedents, the previous experience and exposure to information sources, positively impact an organization's success in developing PACAP.**

**PII: A firm's PACAP levels, the information acquisition and assimilation, positively impact RACAP, the development of the transformation and exploitation of information.**

**PIII: RACAP levels positively impact an organization's degree of business performance.**

Schematically, Figure 11 recalls the main groups of research propositions that capture the main influence relationships within Zahra and George's (2002) research model.

Based on the three main research propositions, the research model is elaborated by adapting Zahra and George's (2002) framework under a KBV perspective in the specific case of exporting SMEs. First, the initial group of research propositions that relate to the impact of PACAP's antecedents on PACAP is presented along with the conceptualization for PACAP and its antecedents in the specific case of exporting SMEs. Secondly, the following group of research propositions in relation to the impact of PACAP on RACAP is presented along with the conceptualization proposition for RACAP, specifically in the case of exporting SMEs. Finally, the third and last group of research propositions concerning the impact of RACAP upon SMEs international performance levels is unveiled.

Figure 11. The main relationships between PACAP, RACAP and organizational performance

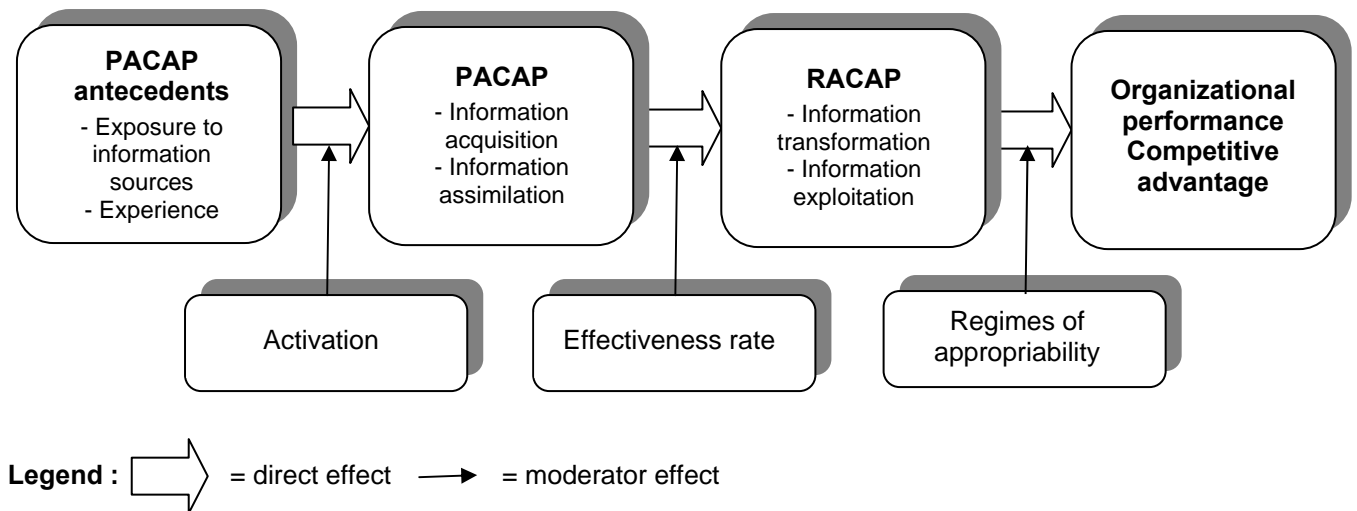

### III.1 The impact of PACAP's antecedents on the Potential Absorptive CAPacity (PACAP)

Within the KBV perspective, the accent is put on the evolution potential of intangible resources and knowledge creation, which is a path-dependent process. Drawing elements from the evolution theory, KBV posits that a firm's previous experiences influence the way knowledge is acquired and assimilated (DeNisi *et al.* 2003). The exposure to external knowledge sources also constitutes a pillar for knowledge development within firms.

Zahra and George's (2002) conceptualization of AC relies on the ideas exposed above. The authors identify two types of PACAP antecedents that include the exposure to information sources and a firm's previous experience levels. PACAP antecedents influence the way firms acquire and assimilate external information (PACAP). In the first section (III.1.1), the potential conceptualization of PACAP antecedents and PACAP in the case of exporting SMEs will be discussed. Furthermore, the impact of PACAP antecedents upon PACAP is presented within a second section (III.1.2) by taking into account SMEs specificities. Overall, section III.1 details and explains the first main research proposition in Zahra and George's (2002) AC model, namely:

**PI: PACAP antecedents, previous experience and exposure to information sources, positively and significantly impact a firm's success in developing PACAP.**

### III.1.1 The conceptualization of PACAP's antecedents and PACAP

Zahra and George (2002) identified the exposure to information sources and a firm's level of previous experience as antecedents of PACAP. However, according to the original writings of Cohen and Levinthal (1989, 1990, 1992), the previous experience and the exposure to export information sources were identified as dimensions of AC. Even though Zahra and George (2002) did not conceptualize them as dimensions of the AC construct, they acknowledged their importance and stressed their impact on PACAP (information acquisition and assimilation) under the name of antecedents of firms' PACAP.

#### *III.1.1.1 PACAP's antecedents conceptualization*

Hereafter, the conceptualization propositions for capturing PACAP's antecedents is presented in the specific case of exporting SMEs.

##### III.1.1.1.1 The exposure to rich export information sources

The internal and external information sources of enterprises help them evaluate the capacities and knowledge existing outside of the company and within the surrounding environment. Scholars like Brown and Eisenhardt (1995) and Levinson and Minoru (1995) emphasized a firm's internal and external communication dimensions. Cohen and Levinthal (1990) mainly pointed out the importance of accessing new and external information in terms of innovation. However, Cohen and Levinthal (1990) stressed that not all information sources necessarily develop a firm's AC. They identified among the important technological information sources the personnel, suppliers, clients, competitors, universities, and the government. Zahra and George (2002) also stressed that information sources should dispose of certain qualities in order to be valuable for an organization. The authors emphasized information sources that firms access in their surrounding environment should be complementary and diverse. Their conceptualization is close to the information richness conceptualization, sustained by numerous organizational scholars (see point II.3.1.1). Thus, it appears that not all information sources have the same strategic value for organizations. After reviewing the literature dealing with the empirical link between export information sources and elements and SMEs' international performance in chapter I, it can reasonably suggested that SMEs' managers

express a strong preference towards more personal information sources such as clients or distributor agents. Moreover, their preferences seem to determine their use of export information sources (Katsikeas and Leonidou 1996). Therefore, it does not make sense to consider the role of all possible information sources when studying SMEs' levels of AC. If the managers of SMEs do not perceive information sources as useful and important, they will not use them. Accordingly, the unused information cannot have an impact on a firm's information AC process. As a result, export information sources that are perceived as useful and used by SMEs' managers on an on-going basis should be considered for study purposes.

As suggested in chapter I, multi-dimensional qualitative aspects such as the richness of export information sources (Ramangalahy 2001; Julien and Ramangalahy 2003) or information quality (Toften and Olsen 2003) should be taken into account instead of uni-dimensional measures such as the perceived usefulness or importance for capturing export information activities of SMEs. The export information richness perspective is also in line with the AC framework that highlights the quality of the exposure to information sources of firms in their environment (e.g. Cohen and Levinthal 1990; Zahra and George 2002). Therefore, it is believed that the most appropriate perspective for capturing the exposure to export information sources for SMEs is the richness perspective.

#### III.1.1.1.2 The previous international experiences of the firm

Several scholars like Allange *et al.* (1998), Schiling (1998) and Chang (1995) highlighted the role of previous experiences in developing a firm's AC. The authors suggest that when the content of information is related to domains where firms have previously accumulated experience, it is easier for the firms to absorb the new incoming information. Proxies, such as age (Sorensen and Stuart 2000; Rao and Drazin 2002) have been used to argue that older firms are more likely to have accumulated knowledge and developed routines and processes that facilitate information assimilation and innovation (Lane *et al.* 2006).

In the international context, the role of international experience is widely acknowledged as fostering a firm's foreign market expansion. As firms acquire more experience in operating in foreign markets, they also accumulate more international-related knowledge and develop routines and processes that enhance the foreign market learning process. At the firm level, the international experience refers to the learning that enterprises have accumulated by doing business in a given market (Cavusgil and Zou 1994). The role of experiences as a basis for explaining SMEs' export performance was largely documented in the literature. Most scholars

agree that developing foreign activities is a process of learning and experience accumulation that helps firms better exploit export market information and opportunities and therefore perform better in international settings (Johanson and Wiedersheim Paul 1975; Johanson and Vahlne 1993; Welch and Luostarinen 1993; Denis and Depelteau 1985). Moreover, international experience has also been seen as a form of knowledge called general “*internationalization-related knowledge*” by authors like Eriksson *et al.* (2000, 2004).

The international experience concept was approached by previous studies in three levels of analysis made up of (1) the managerial level, (2) the management team level, and (3) the firm level. However, the first and third levels of analysis prevail in terms of conceptualization in past studies. Table 7 recapitulates most of the international experience operationalizations previously used by the literature in the field.

The SMEs’ exporting literature extensively documented the role of the owner or manager’s exposure to foreign markets in regards to a firm’s internationalization behaviors (Mayer and Flynn 1973; Simpson and Kujawa 1974; Brooks and Rosson 1982; Garnier 1982; Ogram 1982; Angelmar and Pras 1984; Karafakioglu 1986). Characteristics that have been found to be of utmost importance in exporting include the extent to which the manager has engaged in foreign travel, the number of languages spoken by the manager and if the export decision-maker was born abroad and whether he lived or worked abroad (e.g. Bilkey and Tesar 1977; Reid 1981; Misenbock 1988).

The emphasis on the top management level of analysis roots in Hambrick and Mason’s (1984) “*upper echelons*” perspective on organizational outcomes (Reuber and Fischer 1997). In SMEs, the founding team plays a much more extensive and dominant role than in large firms (e.g. Feeser and Willard 1990; Bell *et al.* 1992; Chandler and Hanks 1993; Reuber and Fischer 1997). Therefore, it is expected that the role of top management experience would be more pronounced in SMEs. For instance McDougall *et al.* (1994) and Oviatt and McDougall (1994) found that a team of individuals with international experience generally founds firms that are “*born global*” (international from inception). In addition, the findings of Bloodgood *et al.* (1996) showed that the international experience of the top management team was related to the internationalization extent of the firm’s activities. Ramangalahy (2001) approached the international experience of SMEs through the richness angle. According to him, the definition of top management international experience richness is a multi-dimensional concept. Several of its dimensions are the length of the experiences, number of foreign projects or clients, the complexity of the challenges, the diversity of contexts and their impact on the managerial team know-how.

Table 7. Different conceptualizations of international experience according to the level of analysis

Level of analysis	Conceptualization and references
Managerial level	<ul style="list-style-type: none"> <li>▪ Number of foreign languages spoken by the manager (Bilkey and Tesar 1977; Reid 1981; Misenbock 1988)</li> <li>▪ Number of years spent abroad (Reid 1981; Misenbock 1988; Shambharya 1996)</li> <li>▪ Number of years working within the enterprise and in exporting (Serिंगhaus 1987)</li> <li>▪ Number of years of international experience (Ramaswamy <i>et al.</i> 1996; Sullivan 1996)</li> <li>▪ Homogeneity of international experiences (Shambharya 1996)</li> <li>▪ Possession of experience with international selling (Ficher and Reuber 1996)</li> <li>▪ Degree of satisfaction with international activities development (Abdel-Malek 1974)</li> </ul>
Managerial team level	<ul style="list-style-type: none"> <li>▪ Proportion of top management members already having international experience (Shambharya 1996)</li> <li>▪ Previous international experience of the current management team with selling products abroad (Reuber and Fischer 1997)</li> <li>▪ Sum of the international experience, in years, of all employees working on international activities for more than half of their working time (Bijmolt and Zwart 1994)</li> <li>▪ Number of employees working on international activities for more than half of their working time (Bijmolt and Zwart 1994)</li> <li>▪ Richness of international experiences (Ramangalahy 2001)</li> </ul>
Firm level	<ul style="list-style-type: none"> <li>▪ Number of years of international experience (Ogbuehi and Longfellow 1994; Hart <i>et al.</i> 1994, Cavusgil and Zou 1994)</li> <li>▪ Number of years since the enterprise created an export department (Souchon <i>et al.</i> 2003; Walliser and Mogos-Descotes 2004)</li> <li>▪ Number of exporting markets (Hart <i>et al.</i> 1994; Cavusgil and Zou 1994)</li> <li>▪ Real number of export markets, meaning the difference between the total number of exporting country and the number of border countries among the exporting countries (Kuivalainen et Bell 2004)</li> <li>▪ Evolution of the exporting percentage over the last five years (Cavusgil and Zou 1994)</li> <li>▪ Diversity of foreign market entry modes used by firms (Kuivalainen and Bell 2004)</li> <li>▪ Number of continents where the firm exports to (Kuivalainen and Bell 2004)</li> <li>▪ Number of years the firm operated domestically before having foreign sales (Reuber and Fischer 1997)</li> </ul>

Numerous studies on the SMEs' internationalization highlight the key role of a firm's international experience. The most widely used indicators in capturing a firm's level of international experience are the number of years the company has been exporting (e.g. Cavusgil and Zou 1994; Hart *et al.* 1994; Ogbuehi and Longfellow 1994) or the number of exporting markets (e.g. Cavusgil and Zou 1994; Hart *et al.* 1994). Recently, Kuivalainen and Bell (2004) suggested that it would be more appropriate to assess the real number of export markets as the difference between the total numbers of exporting countries minus the number of border countries (among the exporting countries). The main reason for this new assessment is that with the absence of export barriers in the European Union (E.U.), firms sell their products in bordering countries almost as easily as they do in domestic markets. Some other proxies used for assessing SMEs' level of international experience are the evolution of the

exporting percentage over the last five years (Cavusgil and Zou 1994), the diversity of foreign market entry modes used by firms (Kuivalainen and Bell 2004), the number of continents where the firm exports (Kuivalainen and Bell 2004), and the number of years the firm operated domestically before having any foreign sales (Reuber and Fischer 1997).

Cohen and Levinthal (1990) have stressed the importance of the extent, complementarities and diversity of experiences in building higher levels of AC and learning. Notice that they favored the richness attributes of experiences (level, complementarities, and the diversity of experiences) over the length. Therefore, it is considered more appropriate to conceptualize SMEs' international experience under the richness angle, as Ramangalahy (2001) did in his Canadian study on exporting SMEs.

Nevertheless, the critical importance of the length of international experiences of SMEs in their internationalization process has been highlighted by an important number of studies (e.g. (Cavusgil and Zou 1994; Hart *et al.* 1994; Ogbuehi and Longfellow 1994; Souchon *et al.* 2003). Thus, a second international experience length-based conceptualization will be retained nonetheless.

### ***III.1.1.2 PACAP conceptualization***

According to Zahra and George (2002), two sub-dimensions, information acquisition and assimilation make up PACAP. As it follows, their conceptualization in the case of exporting SMEs will be discussed.

#### **III.1.1.2.1 Export information acquisition dimension**

Zahra and George (2002) refer to a firm's information acquisition capabilities in terms of identifying and acquiring externally generated information that is crucial to business operations. They highlight the intensity, the speed, and the direction of a firm's efforts to identify and acquire information from the external environment. To the best of our knowledge, no such conceptualizations have been reported within the SMEs' exporting literature. As a result, the possibility to conceptualize information acquisition dimension could be the assessment of the levels of export market-related informativity that characterizes SMEs. The underlying reasoning is that it can be logically assumed that the more efficient information acquisition there is, the more firms will be informed concerning foreign markets.

Several foreign market information taxonomies were proposed by the internationalization literature (e.g. Johanson and Vahlne 1977; Keegan 1980; Seringhaus 1987; Ervigen *et al.* 1993; Hart *et al.* 1994; Cafferata and Mensi 1995; Morgan *et al.* 2003). Even though the proposals rely on different parameters that leverage their definitions, these taxonomies are characterized by many comparable elements. The acquisition of foreign market-related information has been a matter of concern since the beginning of the study of the internationalization process. The exploratory research undertaken in 1977 by Johanson and Vahlne addressed the information needs of international enterprises. They identified several knowledge types an enterprise needs in order to develop activities abroad which include knowledge about culture and customs, social values, general way of life, users or consumers of products, distribution systems, competitors, language, and general information about the country.

In the specific case of SMEs, three main taxonomies were developed. They were already presented in detail in chapter I, section I.2.3.2.3 and therefore will only be briefly mentioned in this section. The taxonomy developed by Hart *et al.* (1994) distinguished three main classes of foreign market information that SMEs acquire on foreign markets. The classes are: (1) market feasibility information, (2) adaptation information and (3) background information. Julien and Ramangalahy's taxonomy (2003) highlights five classes of export information that SMEs collect on export markets that include information related to: (1) the export markets, (2) competition, (3) norms, (4) opportunities, and (5) export operations. Ramangalahy (2001) proposed what could be the most integrative framework, in terms of information types, through six underlying categories of foreign market information needs of SMEs relative to: (1) foreign clients or market, (2) competitors, (3) products, (4) prices, (5) communication and distribution, and finally, (6) the legal environment. Because of its integrative character, it is thought to be the most appropriate framework for capturing an export informativity degree of SMEs concerning foreign markets.



### III.1.1.2.2 Export information assimilation dimension

Zahra and George (2002) defined the assimilation dimension as “*firms’ routines and processes that allow it to analyze, process and interpret, and understand the information obtained from external sources*” (p. 189). They refer to the basic mechanisms by which information is processed at both an individual and organizational level. At the organizational level, information must be disseminated or shared between individuals for learning and efficient information exploitation to take place in addition to its prior acquisition (e.g. Brown and Duguid 1991; Nonaka 1994; Hurley and Hult 1998). The dissemination of information can be seen as a bi-directional flow between individuals and organizations that is materialized through the efficient transfer and integration of information within the organization by means of coordination procedures. According to Cadogan *et al.* (1999), the conceptual domain of coordination refers to several interrelated organizational mechanisms such as communication, common understanding, organizational culture, cooperation, a lack of conflicts between the organization’s members or departments, and shared values and vision. These mechanisms can foster joint action for attaining common goals at the organizational level. All these mechanisms allow fluid information diffusion within firms and create favorable conditions for efficient information exploitation and learning to take place (Agyris 1976, 1992; Huber 1991). Cohen and Levinthal (1990) mainly emphasized the role of coordination and communication practices as catalysts of external information absorption. Furthermore, some other scholars suggested the same organizational process as catalysts of external information assimilation in organizations (e.g. Jaworski and Kohli 1993; Sinkula *et al.* 1997; Belich and Dubinsky 1999; Ramangalahy 2001).

Based on the literature in the field of organizational information exploitation, several organizational mechanisms that enhance information assimilation within SMEs were recognized and included: (1) efficient coordination and (2) communication, (3) collaboration, (4) centralization, (5) formalization, (6) work teams, (7) shared vision concerning the strategic goal achievement, and (8) the efficiency of knowledge transfer and integration. Hereafter, the importance of these eight mechanisms in the case of exporting SMEs is discussed.

(1) Organizations can be viewed as systems made up of different departments. The role of coordination is to articulate the action of the different departments characterized by different functions and responsibilities (Stata 1989; Leonard-Barton 1992; Kofman and Senge 1993; Nevis *et al.* 1995). The importance of the coordination practices has been increasingly highlighted within the fields of management, production and marketing. Recently, more and

more studies suggest that departmental dynamics and coordination are vital drivers of business performance (Lascu *et al.* 2006; Guenzi and Troilo 2006; DeGroot and Brownlee 2006; Spillan and Parnell 2006). Moreover, the role of coordination is of utmost importance for efficiently exploiting information in SMEs (e.g. Belich and Dubinsky 1999; Souchon *et al.* 2003). In conclusion, the efficiency of coordination procedures of SMEs shall be retained as one of the information assimilation practices potentially enhancing export information exploitation in SMEs.

(2) Communication can occur through several formal and informal organizational practices such as sales reporting systems and company newsletters, informal conversations and social events hosted by the company (Daft and Huber 1987; Matusik and Hill 1998). Huber (1991) and Nonaka (1994) stressed the critical importance of communication. The two authors suggest that informational exchange and interaction between members of an organization influence the extent of organizational learning and information exploitation. Moreover, Daft and Lengel (1984) observed that informal communication practices facilitate the access to information sources by favoring the speed of exchanging information. SMEs' literature in the field suggests that communication is generally effective and barely formalized (Julien 1998; Torrès 2004). The SMEs mainly employ informal communication mechanisms and are usually mentored by the manager (Brusch 1992; Raymond and Lesca 1995).

Note that the efficiency of coordination relies on other organizational mechanisms that include communication and inter-departmental collaboration (Jaworski and Kohli 1993). As a result, communication problems across the different departments (Ruekart and Walker 1987), hampering coordination efficiency. It seems that if communication flows within an organization are efficient, it is reflected through their coordination capacity. Thus, assessing whether coordination in SMEs is efficient reflects to a great extent efficiency in communication. Therefore, communication efficiency will not be retained as a parameter in this analysis.

(3) The collaboration between the different compartments of the enterprise is a key feature that enhances coordination (Jaworski and Kohli 1993). The collaboration is hindered by the conflicts existing between different parties in the firms (Jaworski and Kohli 1993; Gattlin *et al.* 2002; Rashkis 2004). These statements hold true especially for large enterprises where communication and coordination gaps between the different departments are more prevalent. Departmentalization is not a common feature in SMEs because of their size and their low level of labor specialization (Marchesnay 1991; Mahé de Boisandelle 1996; Machat 2003). The low labor specialization implies that the manager and the members of the managerial

team assure several functions at the same time such as production, marketing, and exporting. To conclude this third point, in SMEs, the coordination mainly depends on the capacity that managerial team's members have to coordinate their activities and collaborate. Thus, the collaboration efficiency will not be retained in the future of this analysis.

(4) Several scholars believe that centralization inhibits a firm's information dissemination and utilization (Jaworski and Kohli 1993; Sinkula 1994; Matsuno *et al.* 2002). Nevertheless, some other scholars such as Kohli and Jaworski (1993) suggested that centralization in terms of decision-making could be beneficial for information dissemination since centralized decision-making could speed up information exploitation. This belief has been supported by Kirka *et al.*'s (2005) literature review on market orientation's (MO) antecedents and outcomes. The authors concluded that MO, regarding implicit information dissemination efficiency, is not significantly related to the degree of formalization or centralization practices implemented by companies. SMEs' literature suggests that they are generally characterized by high decision-making centralization degrees that gravitate around the manager or the managerial team (Julien 1993, 1994; Brouthers *et al.* 1998; Torrès 1999). To conclude this point, centralization generally characterizes SMEs and Kirka *et al.*'s (2005) literature review suggests that centralization is not significantly related to the efficiency of information dissemination activities. As a result, the centralization degree of SMEs as an organizational structure feature will not be retained within this analysis.

(5) Formalization refers to the definition of roles and authority through formalized rules in organizations. Several scholars suggest formalization inhibits the use firms get out of information and thus, the development of effective responses to changes in the marketplace (Jaworski and Kohli 1993; Kirca *et al.* 2005). However, Kohli and Jaworski (1993) suggest that the nature of formalized rules may very well be designed to enhance market information acquisition and dissemination throughout the organization. Nevertheless, Kirca *et al.*'s (2005) literature review on MO's antecedents and outcomes suggests formalization is not significantly related to the efficiency of information acquisition and dissemination activities. SMEs are generally characterized by low formalization levels (Julien 1994; D'Amboise 1995; Torrès 2000; Gueguen 2001; Torrès 2003) and this seems to be one of the features playing in their advantage for effectively exploiting information. Concluding this fifth point, the formalization degree of SMEs will not be retained in this analysis for two reasons. The first reason is that it seems that formalization does not significantly influence information dissemination in organizations (see Kirka *et al.*'s 2005 study). The second reason is that SMEs are generally low formalized structures.

(6) Creating work-teams for the management of important projects enhances open discussion and ideas sharing through dialogue and debate around the newly acquired market information (Stata 1989; Garvin 1993; Nonaka 1994; Slater and Narver 1995; Lei *et al.* 1999). Team learning allows the transfer, interpretation, and integration of the information acquired individually at the organizational level (Senge 1990; Hult and Ferrell 1997). These assertions hold especially true for large organizations where inter-departmental and hierarchical distance hamper information dissemination (Youndt *et al.* 1996). Palmer and Andrews (1997) explored the role of teamwork in four case studies in English SMEs. They found no clear link between an organization's use of teams and success in environmental management. In the case of SMEs, work teams are frequently synonymous to top management team members working together (Irani *et al.* 1997). Therefore, in the case of SMEs, it does not make much sense to consider teamwork.

(7) A shared vision requires bringing employees together to have a common identity in organizations (Senge 1990; Sinkula 1994). Sharing the managerial vision about a firm's objectives enhances the clear understanding of the organization's strategic goals and facilitates the employees' comprehension of how they can help to attain these goals (Hult and Ferrell 1997; Lei *et al.* 1999). A shared vision also favors joint action based on the will of attaining main goals. Thus, organizations can act as unified systems in which every individual action is directed towards the achievement of the firm's global objectives.

Exporting SMEs' managers have a tendency of concealing information as well as the reasons for making decisions and the implementation ideas about the future development (Julien 1998). The sharing of visions is beneficial to SMEs since it enhances the understanding of employees in how they can contribute to reach the firm's strategic objectives (Schmidt and Bayad 2002). Thus, the employees can identify themselves as a constitutive part of the organization and this helps them join their actions towards attaining common objectives. If a shared vision exists in the firm, when new external information is acquired on export markets, employees can judge more easily whether the new incoming information is relevant to the organization's objectives and whether it is worth to consider it. Nonetheless, it can be argued that a shared vision can be seen at the same title as communication as catalysts of coordination in organizations. For this reason, an efficient coordination may be considered to also partially reflect the extent to which a shared vision about the firm's objectives characterizes organizations.

(8) Knowledge transfer and integration refer to two closely linked processes. Some scholars believe that these two processes take place simultaneously rather than successively (Jerez-

Gomez *et al.* 2005). The effectiveness of information transfer implies internal spreading at the organizational level of the newly acquired information, mainly through conversations and interactions among individuals (Brown and Duguid 1991; Kofman and Senge 1993; Nicolini and Mezner 1995). Information and knowledge have to be further integrated in order to create a collective corpus of knowledge that keeps track of the work processes, routines and knowledge acquired in the past (Huber 1991; Walsh and Ungson 1991). Thus, knowledge can be subsequently recovered and applied to different situations in spite of the natural rotation of its members (Levitt and March 1988; Simon 1991).

The knowledge transfer and integration in SMEs is mainly a task of the managerial team members whom frequently assume more functions at the same time. In the case of the departure of a member of the managerial team, SMEs will generally also lose an important part of knowledge and know-how because of the multiple tasks developed by the management team's member gone. Thus, it is very likely that SMEs would benefit from organized methods that keep track of the information concerning the way the management teams' members were accomplishing their work in the past. Therefore, the efficiency of the knowledge transfer and integration procedures in SMEs will be retained within this analysis.

Resuming the above discussion concerning the importance of the eight main organizational mechanisms that enhance information assimilation in SMEs, the practices that seem to mostly affect their export information absorption activities are the coordination capacity and the efficiency of information, knowledge transfer and integration practices. Concluding, the information assimilation dimension of PACAP will be conceptualized through the efficiency of coordination, knowledge transfer and integration practices implemented in SMEs.

### **III.1.3 The impact of PACAP's antecedents upon PACAP development**

According to Zahra and George (2002), a firm's levels of experience and its exposure to export information sources within their market environment determine the development of their PACAP (information acquisition and assimilation) related capabilities. These relationships have not yet been specifically explored in the exporting SMEs literature. Thus, not much empirical evidence exists in this respect. Nevertheless, the organizational learning, KBV, AC or SMEs internationalization literature bring insights into this area. Accounting for the empirical and theoretical evidence, the relative reliance existing between PACAP's antecedents and PACAP will be explored.

The exposure to rich export information sources is considered to be an antecedent of SMEs' PACAP in terms of export information acquisition and assimilation. The export information acquisition dimension of PACAP has been conceptualized in terms of the information acquisition process efficiency by considering the level of informativity of SMEs concerning foreign markets. The export information assimilation dimension of PACAP was conceptualized in the specific case of SMEs as their propensity in terms of coordination, information transfer and integration practices.

While it was possible to retain internationally related constructs for the conceptualization of PACAP's antecedents and the acquisition dimension of PACAP, in the case of exporting SMEs, for the assimilation dimension of PACAP only domestic based operationalizations were available in the literature. As a result, it is difficult to emit propositions in respect to the effect of PACAP's antecedents upon SMEs' practices in terms of knowledge transfer, integration and coordination. For this reason, no research proposition will be emitted in this respect. Thus, the influence of the exposure to rich information sources and a firm's international experience upon the export information acquisition dimension of PACAP will only be explored.

According to Zahra and George (2002), several factors called activation triggers moderate the effect of PACAP's antecedents on PACAP. The activation triggers can be internal or external to the firm. Internal triggers may be an internal crisis that obliges firms to redefine their strategy or stimulate learning (Winter 2000). External triggers could be radical changes within the industry such as radical innovations, changes in institution-related regulations or even technical shifts. Zahra and George (2002) suggest that these events, whether internal or external, have an influence on the way firms acquire and assimilate information based on previous experience and exposure to export information sources in their environment. The conceptualization of Zahra and George (2002) of the activation triggers is very wide. Concerning internal crisis, they could result from very different events in SMEs, which could include the loss of a main client, furnisher or the departure of a key employee, etc. The same thing can be said about external triggers. Within the current research, companies from a single industry in the French context were considered - which represent a relatively homogeneous group of enterprises. Therefore, it is very likely that the external environment of these enterprises would be highly similar. As a result, it does not make much sense to test the moderator effect of the environmental factors on the relationship between PACAP's antecedents and PACAP within the context of the current research. Environmental effect

would be seemingly higher if the study would be directed towards companies from different industries.

### *III.1.3.1 The impact of SMEs' exposure to rich export information sources on export information acquisition*

According to the KBV perspective, the way a firm accesses information from the environment has an impact on the informational knowledge development inside the company (e.g. Spender 1998; DeNisi *et al.* 2003). The level of informativity of SMEs in respect to foreign markets can be seen as tacit, explicit or informational knowledge as Morgan *et al.* (2004) have considered it. Thus, the richness of information sources that SMEs access in their foreign environment represents an important stepping-stone in the development of their levels of informativity concerning key elements of foreign markets.

The existing reliance between the information sources used and the information elements acquired on foreign information in export markets has been underlined by several studies. For instance, Julien and Ramangalahy's (2003) study specifically explored the link between the types of export information that SMEs acquire in foreign markets and the frequency of use of several export information sources. They concluded that the export information elements SMEs acquire on foreign markets are correlated to the perceived quality of export information sources. Similar findings have also been underlined within the study of Leonidou and Katsikeas (1997). In summary, it seems that the use of information sources conditions the type and quantity of export information acquired by SMEs in foreign markets.

In the current study, the information sources richness perspective was retained for the study of export information sources. Information sources richness perspective was inspired by the research undertaken by Ramangalahy (2001) that is rooted in the theory of media richness developed by Daft and Lengel (1984). Accordingly, rich information sources allow: (1) the collection of important amounts of information and aspects regarding a specific subject, (2) the interaction and exchange of points of views with information sources thus allowing the adjustment of diverging view points, (3) verbal and non-verbal communication in ways that favor the speed of communication, (4) communication with different interfaces like density that provide diverse indications and (5) easy access to reliable information. As a result, by definition, a rich foreign market information source provides SMEs with important quantities of reliable information concerning the export markets' features. Therefore, it can be assumed

that accessing rich information sources in foreign markets will influence the level informativity of SMEs concerning export markets:

**P1: The richness of foreign market information sources has a positive and significant impact on the efficiency of export information acquisition in small firms.**

### *III.1.3.2 The impact of SMEs' international experiences richness on export information acquisition*

In the KBV perspective, the accent is put on organizational knowledge creation and consolidation. Drawing elements from the evolution theory of firms by Nelson and Winter (1982), the KBV suggests that knowledge development is a path-dependent process where previous experience is essential and represents the driving factor of the future development (Kuivalainen and Bell 2004; Kodama 2005).

The relationships between the international experience of SMEs and their practices in terms of export information have been explored in several empirical studies (e.g. Leonidou and Katsikeas 1997; Belich and Dubinsky 1999; Souchon *et al.* 2003). Several studies in the field revealed that older firms acquire less intensively information on export markets (Katsikeas 1997; Souchon *et al.* 2003). Nevertheless, strong theoretical and empirical evidence suggests that as SMEs acquire more international experience, they also progress in terms of foreign market-related knowledge (e.g. Fletcher 2007). The exporting SMEs' literature brings empirical support to the influence of several export specific factors such as the international experience of the firms and the export information-related activities of SMEs. Firms with little or lacking export experience are likely to have greater information needs in order to deal with export matters (Gronhaug and Graham 1987; Seringhaus 1993) because they cannot rely on past knowledge or internal expertise. The richness measures of export experiences selected within this study also refer to the length of the international experiences along with their variety and complementarity. As a result, it is logical to believe that the more rich export experiences of SMEs are, the more SMEs will have facilities in terms of export information acquisition. Based on previous "rich" international experience, sometimes viewed as a form of general internationalization-related knowledge (e.g. Eriksson 2000; Eriksson *et al.* 2004), firms can more easily enhance the consolidation of export market knowledge. Beginning with the first theories of internationalization, most scholars suggest that the diversification and accumulation of international experiences of firms is an indicator of their



progression in terms of foreign market-related knowledge. As a result, the following is proposed:

**P2: The richness of international experiences of export employees has a positive and significant impact on the efficiency of export information acquisition in small firms.**

A second conceptualization retained to capture SMEs' international experiences richness is the real export experience of the company, which captures internationalization length-related aspects. It has been assessed as the sum of exporting years a firm has spent by using a specific foreign market presence mode. The choice of entry modes influences the transfer of knowledge within the organization and the access to foreign market information (Kogut and Zander 1993; Kuivalainen and Bell 2004). For instance, if firm A owns a subsidiary abroad, it will have easier access to foreign market information than firm B whom distributes its products by using a local distributor in the same country. In addition, firm A can more easily check the reliability of information concerning the specific market where the subsidy is implemented than firm B. Subsequently, it is logical to believe that firms that have used several entry modes over the same period of time than other firms that have only been selling their products abroad by means of a single basic entry mode have accumulated international experience that is more diverse and rich. As a result, it is suggested that:

**P3: The real export experience of SMEs has a positive and significant impact on the efficiency of export information acquisition in small firms.**

Hereafter, Figure 12 recapitulates the research propositions emitted within this section describing the influence of PACAP determinants on PACAP development within the specific case of exporting SMEs.

Figure 12. The influence of PACAP's antecedents on PACAP

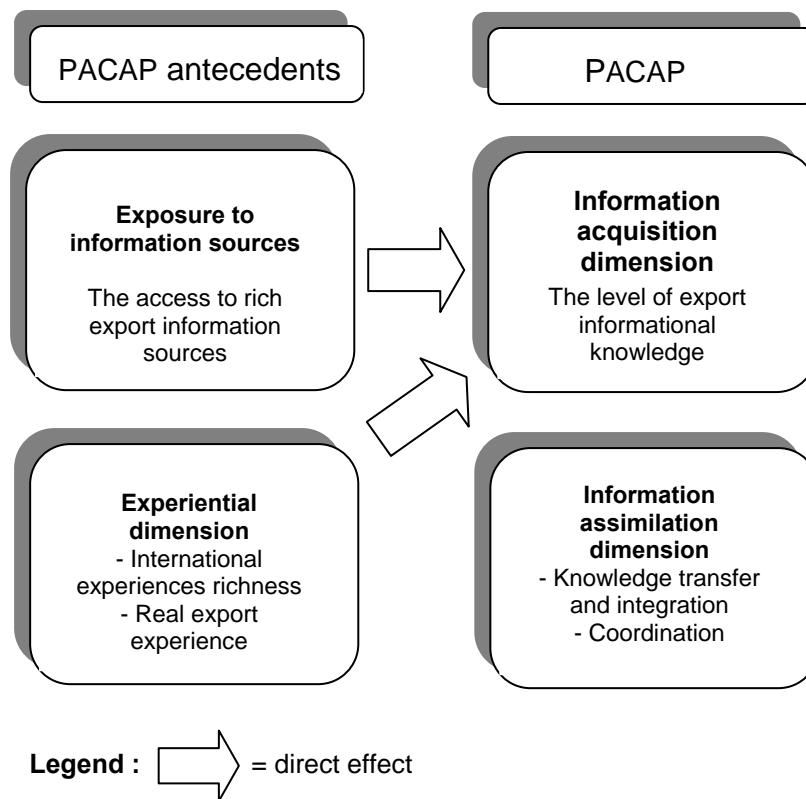

### III.2 The impact of PACAP on RACAP (Realized Absorptive CAPacity) development

According to Zahra and George's (2002) conceptualization, PACAP's dimensions are a necessary condition for building RACAP. Information acquisition and assimilation conditions the future possibility of transforming and exploiting the information to commercial ends.

Within this section, RACAP's dimensions in the specific case of export information absorption by SMEs will be conceptualized. Second, the influence of PACAP's dimensions, namely information acquisition and assimilation, on RACAP, information transformation and exploitation, will be exposed. Third, the factors potentially moderating the influence of PACAP on RACAP in the case of exporting SMEs will be discussed.

### III.2.1 RACAP conceptualization

RACAP refers to the transformation and exploitation of information to commercial ends.

As it follows, a possible conceptualization for the two sub-dimensions of RACAP, information transformation and exploitation in the case of exporting SMEs is proposed.

#### *III.2.1.1 Conceptualization of the transformation dimension of RACAP: the export responsiveness of SMEs*

According to Zahra and George (2002), the transformation dimension is related to the incorporation and conversion of the acquired and transformed knowledge into firms' operations. The authors refer to the transformation dimension as having two main functions. The first function is psychological by nature. The transformation dimension reflects the cognitive process of combining two different pieces of information to arrive at a new scheme of transformation capability. The second function is factual by nature. It reflects the incorporation of the new insights, brought into the firm by information, into a firm's processes and routines that solidify action (Zahra and George 2002).

The informational learning scholars also stress the factual aspect. They deem that organizations learn if based on the new incoming information processing their behaviors are modified (e.g. Argyris 1976; Argyris and Schoen 1978; Fiol and Lyles 1985; Levitt and March 1988; Senge 1990; Garvin 1993; Sinkula *et al.* 1997; Machat 2003). Behavioral adjustments translate changes from the conceptual level in concrete use (Sinkula *et al.* 1997). Zahra and George (2002) acknowledge the fact that developing AC requires learning capabilities that are needed within the process of knowledge creation. The transformation dimension of RACAP appears to be fundamentally important within the process of knowledge creation since it “denotes a firm's capability to develop and refine the routines that facilitate combining existing knowledge and the newly acquired and assimilated knowledge.” (Zahra and George 2002, p. 190). The meaning of the transformation dimension is close to the conceptualization of “*knowledge in action*”, which refers to the factual incorporation of the new insights that are carried out by the incoming information within firms' processes and actions (Fahey and Prusak 1998; Alvesson and Kärreman 2001). Lately, knowledge in action has been extensively viewed as the most suitable way of capturing the complex nature of

knowledge and the knowledge creation constructs (e.g. Fahey and Prusak 1998; Alvesson and Kärreman 2001; Cazal and Dietrich 2003).

Kohli *et al.* (1993) and Sinkula *et al.* (1997) have developed operational conceptualizations of “*knowledge in action*” in the marketing field for capturing response actions and processes firms implement when confronted to new incoming market-related information. Sinkula *et al.* (1997) defined the marketing dynamism as the degree to which organizations apply information to modify marketing programs and decisions. In a similar vein, Kohli *et al.* (1993) conceptualized responsiveness as the action taken in response to the relevant information generated and subsequently filtered. The response capacity of the firms to face environmental change was conceptualized by Kohli and Jaworski (1990) as a sub-dimension of the Market Orientation (MO) construct. Responsiveness can be seen as the direct result of the transformation of information into action (Kohli *et al.* 1993). Responsiveness also translates the speed and coordination with which the actions are implemented and periodically reviewed in firms. It also refers to evaluating goal achievements and accordingly correcting actions based on information through inter-departmental cooperation and coordination (Kohli *et al.* 1993).

Cadogan *et al.* (1999) adapted the MO construct to the international market context. In an international context, the export responsiveness relates to the action taken in response to the relevant export information generated and subsequently filtered. Export responsiveness reflects the speed and coordination with which the export-related actions are implemented and periodically reviewed. Export actions and decisions are based on the close observation of foreign clients by responding systematically to their wishes and complaints. It also refers to the evaluation of over or under-fulfillment of export goals for correcting accordingly and the export objective achievement.

Compared to Sinkula *et al.*'s (1997) conceptualization of the marketing dynamism, responsiveness is a wider concept that also incorporates elements such as goal achievement, coordination for strategy implementation, and a timely review of past actions in addition to marketing programs' modification. Responsiveness also translates the change more widely in the routines and processes implemented by the firm in order to keep up with market changes.

The market dynamism concept, as conceptualized by Sinkula *et al.* (1997), was developed in the case of more elaborate organizational structures and requires an important degree of formalization of the marketing activities within the firm. SMEs' marketing strategies are generally hardly formalized and on going. They rarely have a marketing department that designs marketing programs (Hermann 1995; Machat 2003) and the way they implement

marketing strategy is rather holistic. As a result, compared to responsiveness, market dynamism conceptualization appears to be less suitable for SMEs. Moreover, Cadogan *et al.* (1999) have adapted the responsiveness concept of Kohli and Jaworski (1993) in the case of foreign market-related activities as export responsiveness. Concluding, it is firmly believed that export responsiveness is the conceptualization that best captures the transformation dimension of RACAP in the specific case of exporting SMEs.

### *III.2.2.2 Conceptualization of the exploitation dimension of RACAP: the competitive advantage in terms of international marketing competences of SMEs*

The exploitation dimension, compared to the transformation dimension of RACAP, represents a further step in converting knowledge in the firm. The exploitation dimension translates the learning that has been achieved by the firm through competences' development in key organizational areas like production, marketing or distribution (Zahra and George 2002).

Dosi and Marengo (1995) define competences as contextualized sets of problem resolutions at the organizational level. Consequently, the competence is a combination of various factors specific to organizations. For example, a firm organizes formal meetings when it encounters difficulties to find clients in a foreign country. Meetings constitute specific ways of solving problems that might not be used in other firms. Thus, any time organizations encounter problems they elaborate a certain procedure for solving it, an explicit competence, which is objective, scientific and independent by nature (Baumard 1996). The way organizations solve problems cannot always be completely transmitted by word of mouth because problems are solved by engaging tacit knowledge and previous experience (Nonaka 1994). For this reason, competences cannot be completely observed and it is difficult to imitate competence. Competences cannot be verbally communicated as they have an important collective and experiential content. Competences are transferred by means of experience through action (DeNisi *et al.* 2003). For these reasons, competences constitute strategic assets for the firm (Barney 1991) and drive organizational performance. The competences are essentially developed by reproducing similar response activities and by repeating certain tasks that produce the expected results in similar situations. Firms naturally upgrade their capabilities and competences in response to changes in their market and technological environment (Kodama 2005). In light of Zahra and George's (2002) article, the finality of the AC process is to continuously renew the capabilities and competences in the bases of organizations. Zahra

and George (2002) suggested that RACAP's dimensions have a direct influence on business performance.

In accordance with the KBV perspective, the process of creating competences encloses a dynamic dimension and is believed to ensure the long-term competitive advantage (DeNisi *et al.* 2003; Kuivalainen and Bell 2004; Kodama 2005; Freiling *et al.* 2008) and thereby nurture organizational success over time. Therefore, operationalizing competence development as the exploitation dimension of RACAP is congruent with Zahra and George's (2002) widened understanding of the AC construct that ultimately influences the creation or the consolidation of organizational competences and capabilities. According to the KBV, performance differences between firms are grounded and translated in their learning capacity that leads to the development of distinctive competences (Prahalad and Hamel 1990; Henderson and Cockburn 1994; McGrath *et al.* 1995) or core competences as suggested later on by Hamel and Prahalad (1999). Thus, only the fact of achieving superior competences compared to the competitors in key organizational areas ultimately drive organizational performance.

Zahra and George (2002) stressed the role of AC as a dynamic capability in leveraging the development of new competences in core areas such as marketing and production. The SMEs' literature furnishes rich support when it comes to the key importance of marketing competences for manufacturing firms. For this reason, it is reasonable to conceptualize the exploitation dimension of RACAP in the case of exporting SMEs, in terms of development of their international marketing competences.

Authors for international marketing competences have used different appellations. Kedia and Chokar (1986) use the notion of capabilities and exporting know-how to indicate the international competences firms detain in planning marketing, financial, and technical processes in firms. Seringhaus (1993) used the notion of marketing expertise for designing the know-how related to the export market information acquisition, such as the identification of information sources, and the knowledge related to international operations such as language skills and international business practices. Belich and Dubinsky (1995) highlight the importance of international competences in segmentation and marketing mix strategies. Cavusgil and Knight (1997) refer to the importance of international marketing skills that include planning, control, evaluation, segmentation and the marketing mix. Ramangalahy (2001) highlights the importance of several groups of marketing competences for SMEs' international development such as information management, relational competences, segmentation competences, and finally the marketing mix related competences, which include price, product, communication, and distribution.

Table 8. The international marketing competences of exporting SMEs

Competences field	Related competences and references
International networking	<ul style="list-style-type: none"> <li>▪ Identification of information sources (Seringhaus 1993)</li> <li>▪ Contacts' identification and development (DeNoble <i>et al.</i> 1989; Seringhaus 1993)</li> <li>▪ Knowledge and understanding of business practices (Seringhaus 1993)</li> <li>▪ Foreign language knowledge (Pavord and Bogart 1975; Seringhaus 1993)</li> </ul>
Marketing management	<ul style="list-style-type: none"> <li>▪ Marketing planning (Cavusgil and Knight 1997)</li> <li>▪ Marketing strategy development (DeNoble <i>et al.</i> 1989)</li> <li>▪ Thoroughness of the marketing planning processes (Vorhies and Morgan 2005; Morgan <i>et al.</i> 2003) <ul style="list-style-type: none"> <li>▪ Undertaking marketing studies and research (Keng and Juan 1989; Seringhaus 1993)</li> <li>▪ Marketing information acquisition (Seringhaus 1993)</li> <li>▪ First sales development (Howard and Herremans 1989)</li> <li>▪ Control and evaluation of marketing costs (Keng and Juan 1989; Cavusgil and Knight 1997)</li> </ul> </li> <li>▪ Reaction to opportunities (Cavusgil and Knight 1997)</li> <li>▪ The use of marketing tools (Cavusgil and Knight 1997)</li> </ul>
Marketing segmentation	<ul style="list-style-type: none"> <li>▪ Opportunity seeking (Seringhaus 1993)</li> <li>▪ Identification and the development of new markets ( De Noble <i>et al.</i> 1989)</li> <li>▪ Segmentation and the target of new markets (Cavusgil and Knight 1997)</li> </ul>
Product strategy	<ul style="list-style-type: none"> <li>▪ Providing services (DeNoble <i>et al.</i> 1989)</li> <li>▪ Research, development, and the adaptation of marketing programs (Cavusgil and Knight 1997) <ul style="list-style-type: none"> <li>▪ Product packaging (Keng and Juan 1989)</li> <li>▪ Ability to develop new products (Zou <i>et al.</i> 2003)</li> <li>▪ Product modification and new product development (Cooper and Kleinschmidt 1985; Calantone <i>et al.</i> 1996; Morgan <i>et al.</i> 2003)</li> </ul> </li> </ul>
Price strategy	<ul style="list-style-type: none"> <li>▪ Price establishment (Keng and Juan 1989; Cavusgil and Knight 1997)</li> <li>▪ Account recovering (Howard and Herremans 1989)</li> <li>▪ Ability to extract optimal revenue from firms' costumers (Dutta <i>et al.</i> 2003)</li> </ul>
Communication strategy	<ul style="list-style-type: none"> <li>▪ Sales and product promotion (Howard and Herremans 1989; Keng and Juan 1989; Cavusgil and Knight 1997)</li> <li>▪ Enterprise image development (Cavusgil and Knight 1997)</li> <li>▪ Marketing communication skills and processes (Zou <i>et al.</i> 2003)</li> <li>▪ Effective managing of marketing communication programs (Zou <i>et al.</i> 2003)</li> </ul>
Distribution strategy	<ul style="list-style-type: none"> <li>▪ Selection of distributor agents (DeNoble <i>et al.</i> 1989; Howard and Herremans 1989; Keng and Juan 1989)</li> <li>▪ Training of sales personnel (DeNoble <i>et al.</i> 1989; Keng and Juan 1989)</li> <li>▪ Collaboration with distributor agents and relations entertainment (Howard and Herremans 1989; Cavusgil and Knight 1997)</li> <li>▪ Localization of selling points (Cavusgil and Knight 1997)</li> </ul>
Market information management	<ul style="list-style-type: none"> <li>▪ Gather information about costumers and competitors (Vorhies and Morgan 2005) <ul style="list-style-type: none"> <li>▪ Track customer wants and needs (Vorhies and Morgan 2005)</li> <li>▪ Analyze market research information (Vorhies and Morgan 2005)</li> </ul> </li> </ul>
Marketing implementation	<ul style="list-style-type: none"> <li>▪ Allocate marketing resources effectively (Morgan <i>et al.</i> 2003)</li> <li>▪ Organize the delivery of marketing programs effectively (Morgan <i>et al.</i> 2003) <ul style="list-style-type: none"> <li>▪ Translation of marketing strategies into action (Morgan <i>et al.</i> 2003)</li> <li>▪ Rapid execution of marketing strategies (Morgan <i>et al.</i> 2003)</li> </ul> </li> </ul>

A series of studies considering international competences of SMEs are resumed in Table 8.

### III.2.2 The influence of PACAP on RACAP

According to the KBV, the creation of knowledge by means of learning is the mechanism leading firms towards sustaining competitive advantage and business success (e.g. DeNisi *et al.* 2003; Patriotta 2004; Warnier 2005). KBV proponents suggest that the primary concern of the firm is to create and apply knowledge (DeCarolis and Deeds 1999; Kuivalainen and Bell 2004) to commercial ends. In the case of exporting SMEs, knowledge creation and incorporation in a firm's actions is an especially vital subject of concern since they frequently lack knowledge based capabilities for successfully developing international activities (e.g. Kuivalainen and Bell 2004; Fletcher 2007).

Within this section, the roles of the two sub-dimensions of PACAP, information acquisition and assimilation, are examined in fostering action by implementing foreign market responsiveness and further achieving positional advantage in terms of international foreign market-based competences development. In other words, the influence exerted by PACAP on RACAP is described. This section refers to the second main research proposition of this study, namely:

<b>PII: Organizations' levels of PACAP have a positive and significant impact on RACAP's development.</b>
---

To begin with, in point III.2.2.1, the impact of PACAP on the transformation dimension in the specific case of exporting SMEs is presented. As far as the impact of PACAP on the exploitation dimension of RACAP is concerned, several observations are to be made. Recall that competences are experience-based and action-related (DeNisi *et al.* 2003). The influence of information acquisition and assimilation dimensions on the exploitation dimension of RACAP can be seen as rather indirect when enhancing a firm's response capacity (Kodama 2005). In the meanwhile, a direct effect on the transformation dimension exerted by the international experiences of SMEs, one of the PACAP's antecedents, and the transformation dimension of PACAP, SMEs export responsiveness capacity, can be expected. These paths of influence will be discussed and argued in point III.2.2.2.



### *III.2.2.1 The impact of PACAP on the transformation dimension of RACAP*

Hereafter, the impact of the information acquisition dimension will be presented first and then the impact of the information assimilation dimension on the transformation dimension of RACAP.

Zahra and George (2002) defined the effectiveness rate or the efficiency factor as the ratio of the real transformation of PACAP into RACAP. Firms with high efficiency factors are more skilled in developing and using knowledge. In the end, these firms achieve higher levels of organizational performance. The effectiveness rate depends upon the social integration factors affecting the efficiency of knowledge incorporation in a firm's processes. All by acknowledging the utmost importance of the social integration factors and their catalyzing role that enhances information transformation and exploitation in small firms, to the best of knowledge, no specific conceptualization regarding export information transformation has yet been developed. Thus, in the current research, the moderator role of social integration factors will not be tested. The current analysis will be limited to the direct influence of PACAP's dimensions on RACAP development.

#### **III.2.2.1.1 The impact of the export information acquisition on the export responsiveness of SMEs**

Responsiveness refers to the action taken in response to the relevant information acquired and subsequently disseminated (Kohli *et al.* 1993). Thus, by definition, information plays a determinant role in fostering responsive action.

The access to rich information sources provides firms with information according to their needs and the possibility of exchanging points of views with information sources related to foreign markets. As a result, the access to rich information sources enhances the development of a firm's informational knowledge base. SMEs acquire export information relevant to their needs by accessing rich information sources in their international markets (Ramangalahy 2001). The pre-existing stocks of related informational knowledge that firms dispose of help the firms to make sense out of the new external information entering organizations (Cohen and Levinthal 1990). In this way, the conversion of information into informational knowledge can be operated more efficiently and guide response actions.

For example, a small firm aims to sell its products in market A, a developing market where the sales of its products have been growing increasingly over the last years, that is previous knowledge. The firm finds that products need to be technologically improved in order to

correspond to the tastes of the customers in market A, this is the new information. Accordingly, the firm should improve the product technologically. A decision will be made concerning the firm's expansion in market A and action will be undertaken. Thus, it is proposed that the effect of consulting rich information sources in foreign markets on international responsiveness capacity is indirect and is mediated by the development of informational knowledge. In other words, information has a meaning and guides action when related to a certain context.

KBV scholars suggest that information and knowledge have to be converted into action allowing the firms to successfully adapt to their environments and learn (e.g. Kogut and Zander 1992; Nonaka 1994; Morgan *et al.* 2003). Learning is the main mechanism by which knowledge is developed and maintained at the individual and firm level (Huber 1991; March 1991). New incoming foreign market information nurtures and renews a firm's informational knowledge base.

Cohen and Levinthal (1990, 1992, 1994) stressed that the interpretation and use of new external information depends on the already existing related knowledge base. The degree of informativity with regard to foreign markets drives the implementation of marketing actions through response actions to foreign markets shifts (Kohli and Jaworski 1990; Kohli *et al.* 1993; Sinkula *et al.* 1997; Baker and Sinkula 1999).

According to the KBV, a firm's knowledge base guides effective action (Kuivalainen and Bell 2004; Kodama 2005; Spender 2007). Therefore, the more SMEs own high levels of informational knowledge about export markets, the more they will be able to implement effective responsive action (Kuivalainen and Bell 2004). The impact of information acquisition upon the responsiveness capacity has been empirically confirmed by the study of Liao *et al.* (2003). Therefore, the following is proposed:

**P4: SMEs' export informational knowledge levels have a positive and significant impact upon their export responsiveness capacity.**

#### III.2.2.1.2 The impact of the information assimilation on the export responsiveness of SMEs

Efficient transfer and integration of information plays an important role in information exploitation within firms. Information integration refers to the perenisation of information within databases or files. Information sharing and integration in organizations depend on a wide range of formal and informal coordination procedures (Jaworski and Kohli 1993; Belich and Dubinsky 1999). Information transfer and integration are basic mechanisms through

which firms internalize and transform information to commercial ends (Zahra and George 2002). Successfully transferring information implies significant and efficient information flows that ensure that information reaches the right person in the firm who needs it for undertaking responsive action. Thus, the following is proposed:

**P5: Efficient information transfer and integration has a positive and significant impact on the export responsiveness capacity of SMEs.**

Efficient communication and the possibility of quickly accessing the right information needed for decision-making are key elements for the adoption of responsive action (Kohli *et al.* 1993). Coordination procedures allow organizations to optimize information flows (Sheremata 2000) and favor information exploitation and transformation (Choudhuri and Tabrizi 1999). As a result, it is proposed that:

**P6: Efficient coordination in SMEs has a positive and significant impact on the export responsiveness capacity of SMEs.**

### *III.2.2.2 The impact of SMEs' international experiences and export responsiveness on the exploitation dimension of RACAP*

In point III.2.2, it was concluded that the most suitable conceptualization of the exploitation dimension in the case of exporting SMEs is the level of development in terms of international marketing competences. Competences represent forms of tacit knowledge and are related and driven by the past actions and experiences of firms (DeNisi *et al.* 2003). Competences are path dependent and they are conditioned and fostered by the past problems encountered by firms and the responsive actions they have adopted for resolution. As a result, it can be assumed that the previous levels of international experiences of SMEs and their export responsiveness capacity impact their levels of international marketing competences. These relationships of influence were not present in Zahra and George's (2002) model and they are the result of the conceptualizations chosen for the AC related dimensions specifically in the case of SMEs. As it follows, the influence exerted by the international experience of SMEs upon their levels of international marketing competences will first be discussed. Thereafter, the effect of the export responsiveness of SMEs upon their levels of international marketing competences will be analyzed.

### III.2.2.2.1 The impact of the international experiences of SMEs

As firms accumulate international experience, they develop routines, rules, and action procedures that help them solve problems based on previous foreign experience (Laghzaoui 2007). Even more, the international experience refers to the learning enterprises have acquired by doing business in a given market (e.g. Cavusgil and Zou 1994; Basly 2007; Nguyen 2007). The role of experience as a basis for explaining the SMEs' export performance is largely documented by the literature. Based on experience, firms better exploit export-market information and opportunities, improve the consolidation of foreign knowledge-related capabilities and better perform in international settings (e.g. Johanson and Wiedersheim Paul 1975; Denis and Depelteau 1985; Johanson and Vahlne 1993; Welch and Luostarinen 1993). Within the current research, the creation or consolidation of international marketing competences of SMEs is specifically addressed. The international marketing competences can be defined as the development of specific procedures for solving foreign market-related problems based on the actions and experiences accumulated in the past. Based on Cohen and Levinthal's (1990; 1992) work, the richness of international experiences over their length was considered. One of the experience indicators used is the real export experience, which is calculated by summing up the number of years SMEs spent developing international activities by means of a certain presence mode. Woisetschläger and Evanschitzky (2005) stressed the fact that the choice of entering a new market is of greater concern for SMEs than large firms since they face these decisions in early phases of their internationalization process. On one hand, the entry modes reflect a choice in terms of resources and control deployment. On the other hand, entry modes affect the transfer of knowledge, the creation of value within the organization, and the diversity of know-how related to export markets (Kogut and Zander 1993; Kuivalainen and Bell 2004). For instance, firm A created a joint venture with a Chinese firm for selling its products in China besides also selling them through indirect exporting. Firm B sells its products only through indirect exporting in China. When information is needed concerning the determination of the pricing strategy for example, firm A might access the necessary information which includes negotiating and fixing the price and the payment delays, responsiveness in terms of pricing to market change, fixing the margins, and evaluation of the credit risks more easily and faster, in comparison to firm B, from the Chinese partner. Furthermore, firm A could put the pricing strategy into practice faster and better in comparison to firm B. In order to review the pricing strategy, firm B in comparison to firm A, would need additional time primarily for obtaining the information and then for

verifying its validity. Thus, the learning cycle would be longer for firm B and the knowledge and market-related competence accumulation would take more time compared to firm A. Therefore, it is proposed that:

**P7: The real export experience of SMEs has a significant and positive impact on their positional advantage in terms of international marketing competences.**

Several scholars suggested that studying the role of the international experience of small firms in foreign market-based learning process by using length measures somehow represents a limited choice (Kuivalainen and Bell 2004). Richness-related experience measures appear to be more appropriate.

Keogh and Stewart (2000) studied the learning process of 60 innovative technology-based Scottish SMEs and found that these companies were moving through a learning cycle, similar to the one developed by Kolb (1984), by reviewing and acting on past learning experiences. However, there are considerable differences in the time invested in this processes and it appears some of them learn faster. Moreover, today's learning internationalization cycles are reduced by the availability of information on the Internet and on-going globalization (Kuivalainen 2004). For these reasons, it seems more appropriate to consider the role of international experience richness instead of considering length-related aspects. Cohen and Levinthal (1990) highlighted the importance of the complementarity and variety of experiences within the learning process. By undertaking analogies with their previous "*rich*" experiences, firms could more easily acquire and/or improve their competences level. Therefore, it is proposed that:

**P8: International experiences richness has a significant and positive impact on SMEs' positional advantage in terms of international marketing competences.**

### III.2.2.2.2 The impact of the export responsiveness of SMEs

Undertaking responsive action for palliating foreign market shifts equivoques to continuously adjusting the export strategy according to the foreign clients' demands and foreign market related constrains. Responsiveness in terms of behavioral change within the market strategies translates learning into action (e.g. Sinkula *et al.* 1997; Baker and Sinkula 1999; Machat 2003). Thus, it can be seen as a form of learning by means of experiencing. Recall that according to the KBV perspective, learning is the most vital mechanism leading firms to higher performance levels (Spender 1999; Kuivalainen and Bell 2004) and superior economic rent creation (Curado 2006).

The role of experience and experiencing in the learning process is widely acknowledged by scholars (e.g. Kolb 1976; Huber 1991; Koenig 1994; Machat 2003). Moreover, it is frequently associated with single loop learning. Strong empirical evidence exists proving that single loop experiential learning allows SMEs to do things better as they acquire experience on export markets (Minguzzi and Passaro 1997; Fletcher 2007).

Sinkula *et al.* (1997) suggest that by undertaking corrective actions, firms create and improve their competence level over time. Therefore, it is logical to believe that by being confronted to undertake corrective and responsive actions in order to improve the match between the product targeted toward exporting markets and the strategy they adopt, firms improve their international marketing competences over time. Competences' development is a path-dependent process. The more experience small firms gain in foreign markets, the more they improve their international knowledge levels. Johanson and Vahlne (1977) emphasized the importance of learning as a determinant for a firm's internationalization in the Uppsala model. Accordingly, internationalization is seen as an incremental path-dependent and responsive process. As firms acquire market knowledge through experience, they use more advanced entry modes and progress to more markets. Other internationalization process models largely support the stages approach (e.g. Luostarinen 1980; Reid 1981). Johanson and Vahlne (2003) "*renewed*" the Uppsala model to include business relationship learning and commitment and recently rejected the "*establishment chain*" aspects. This renewed model suggests that firms progressively undergo developing direct and indirect exporting activities to the establishment of manufacturing subsidiaries (Johanson and Vahlne 2006). The main limit of behaviorist internationalization models is of course the path dependency and their deterministic character (Reid 1984). It is therefore arguable that except in a crisis situation, there are exceptional

firms evaluating mainly in an incremental manner by means of learning (Nelson and Winter 1982; Dosi and Marengo 1995; Machat 2003).

Concluding, the more small firms gain experience in foreign markets by means of implementing responsive actions, the more they improve their international knowledge and competence levels (Johanson and Vahlne 2006). By proactively scanning and responding to environmental changes, firms build market-based competences (Machat 2003). Even though it cannot be confirmed that responsive actions constantly lead to achieving a positional advantage in terms of international competences, it certainly contributes to their enhancement, renewal, and creation. Responsiveness actions that small firms undertake to respond to foreign market change can be seen as engines in maintaining or achieving positional advantage in terms of core competences as the international marketing competences are for international small firms. Thus, it is proposed that:

**P9: SMEs' export responsiveness capacity has a positive and significant impact upon their positional advantage in terms of international marketing competences.**

If firms characterized by high levels of export responsiveness are more likely to build more important stocks of international marketing competences over time, according to the KBV, firms' competences help enterprises to adapt or respond to environmental constrains. Within the KBV, the strategic process, the actions firms decide to undertake, are rather built on the basis of specific capabilities firms own (Castanias and Helfat 2001) than on the basis of resources difficult to develop or access in competitive, unfriendly environments (Tarondeau 1998). These processes constitute engines of the strategic change within the firm (Chandler and Hanks 1993; Sanchez *et al.* 1996), guiding actions, and strategic response in order to integrate and manage environmental change.

Regardless of the actions firms decide to take for developing their strategy, they are not always directed towards adaptation. The organizational responsiveness measure reflects the speed and coordination with which actions are implemented and periodically reviewed. Responsiveness also refers to the evaluation of the over or under-fulfilling of goals and the subsequent corrective actions (Kohli *et al.* 1993). Adopting a responsive attitude towards export markets shifts mainly translates continuously adapting export strategy according to the foreign clients' demands and foreign market constrains (Cadogan *et al.* 1999). However, it is believed that owning a positional advantage in terms of international marketing competences does not necessarily lead SMEs to adopting a rather “*adaptive*” export strategy. The ownership of a positional advantage leads to adopting the “*right*” actions and decisions

(Eriksson 2004) in accordance with the market-product-strategy couples that are not always adaptations to clients' demands. For instance, sometimes enterprises can attain high levels of international performance by adopting a standardization strategy. The efficiency of the adoption of an adaptation or standardization export strategy by SMEs is still an ongoing debate (Lages and Montgomery 2004). Moreover, adaptability generally appears as a feature characterizing most of the cases in small firms (Liao *et al.* 2003). Pelham (2000) suggests that strategy adoption in the case of SMEs should be a match between the couple of product-market, which does not necessarily mean adaptation strategy. To conclude, one cannot posit that attaining a positional advantage in terms of international marketing competences will push enterprises to adopt a highly responsive or adaptive attitude or strategy towards foreign markets. While adopting a responsive attitude towards exporting markets may be viewed as a form of experiential learning, according to the KBV, learning remains a path-dependent process. Even though learning cycles seem to shorten in the increasingly globalized business context, past experience influences the way firms learn. Concluding, the development of positional advantage in terms of international marketing competences is conditioned by the past experience firms have accumulated in foreign markets. The development is accelerated by the ongoing globalization and the growing availability of information on the Internet.

Resuming, the role of experience in the learning process (Kolb 1984; Machat 2003) and competences' development is acknowledged. It would be logical to propose that small firms crystallize responsive action into competence creation or renewal more easily if they are implemented over longer periods of time. In the meanwhile, the current study is a punctual study capturing managerial perceptions at a certain point in time. Thus, competences' evolution over time cannot be observed. In other words, if managers state in the current study that they are highly export responsive, it cannot be assumed that they have been highly responsive since the beginning of their internationalization process. Therefore, it cannot be assumed that the international experiences of small firms play a moderator role on the impact of export responsiveness on positional advantage development in terms of international marketing competences. This moderator role of the international experiences of SMEs could be more appropriately captured through a longitudinal research.

Within this section, several research propositions were emitted with respect to the impact of PACAP on RACAP and concerning the determinants of RACAP's transformation dimension, the previous international experience and the export responsiveness capacity of SMEs. In Figure 13, the research propositions emitted in this section III.2.2 are schematically resumed.



Figure 13. The influence of the determinants of the PACAP on RACAP

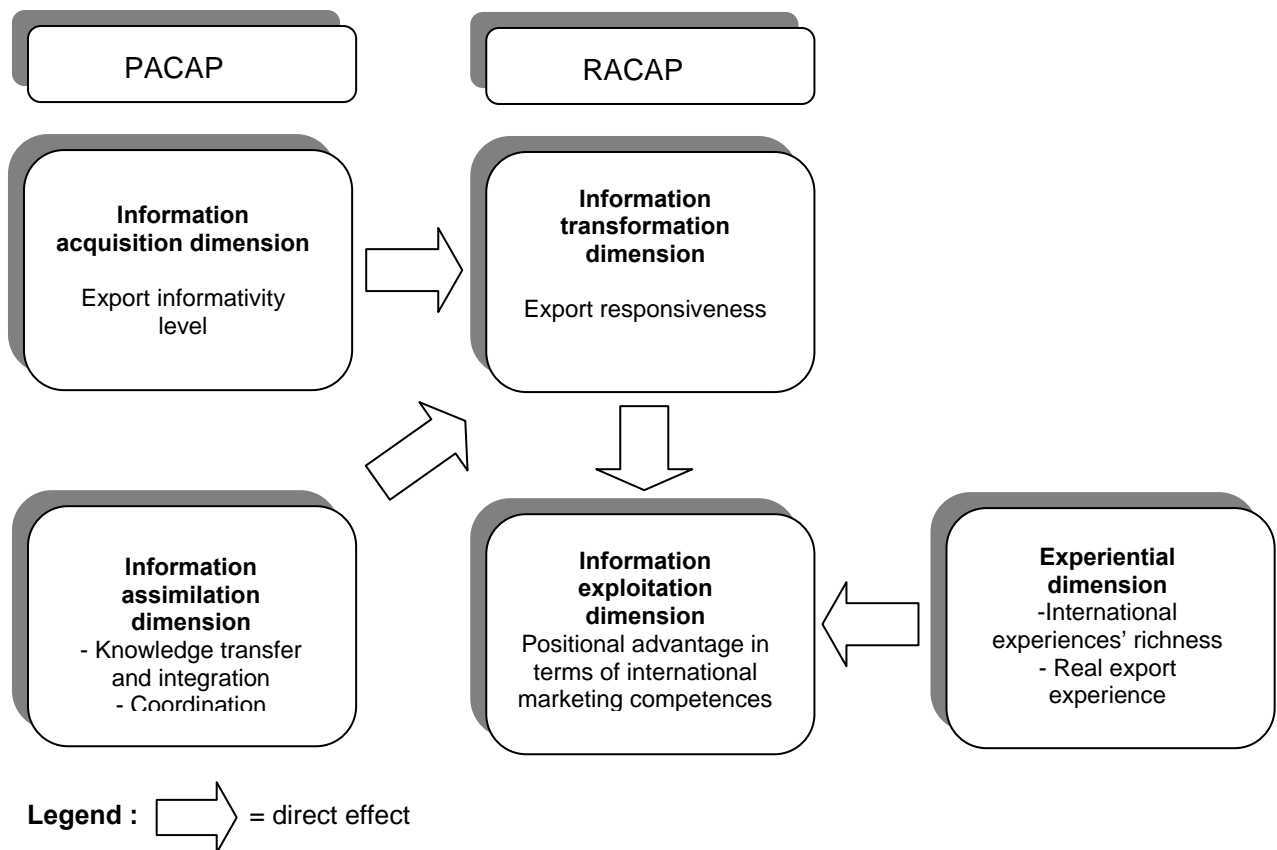

### III.3 The impact of RACAP on the international performance of SMEs

In this third part of chapter III, the relationships existing between RACAP and the levels of international performance of SMEs are resumed. These relationships correspond to the third main research proposition of the current study:

**PIII: RACAP development has a positive and significant impact on organizational performance.**

RACAP was conceptualized in the specific case of exporting SMEs in terms of export responsiveness, the transformation dimension, and the positional advantage of SMEs in terms of international marketing competences, the exploitation dimension. The transformation and exploitation of information through products, processes, capabilities, or competences' improvement and innovation constitute sources of intra-industry variations of a firm's performance (Zahra and George 2002).

Within the KBV literature, both elements of responsiveness and positional advantage in terms of competences development are seen as prerequisites of business performance (e.g. Grant 1996; Tarondeau 1999). In sections III.3.1 and III.3.2, the way the two sub-dimensions composing RACAP influence the degree of SMEs' international performance is explained in further detail.

Zahra and George (2002) suggested that the impact of RACAP on business performance depends on the regimes of appropriability governing the industry under observation. The regimes of appropriability refer to the regulative and industry specific features affecting the firm's capacity to protect and benefit from the advantages in terms of product and processes. They can constitute barriers for the imitation of products and processes and preserve the firm's competitive advantage. Since small firms from the same industrial sector, namely the steel industry, are exclusively targeted in this study, it is suggested that the regimes of appropriability shall be quite similar for these enterprises. Since little variance is expected to occur when it comes to the regimes of appropriability among the firms interviewed, their moderator effect within the current study will not be tested.

### III.3.1 The impact of RACAP's transformation dimension

The generic theme of organizational responsiveness has frequently been believed to impact an organization's level of performance. Several grounded theories sustain the positive impact of the organizational responsiveness efficiency upon a firm's performance. Learning theories posit that an organization's success is a function of the efficiency of the organizational adaptation's power to face environmental shifts (e.g. Kolb 1976; Argyris 1976, 1993; Levitt and March 1988; Huber 1991). Learning increases an *“organization's capacity to take effective action”* (Kim 1993, p. 43). Contingency theories also posit that effective organizations are *“loosely coupled”* with their environments (Pfeffer and Salancik 1978; Weick 1979). The efficiency of the adjustment to the surrounding environment is a determinant for organizational success (e.g. Barnard 1938; March and Olsen 1976; Duncan and Weiss 1979). Finally, the KBV perspective partly draws elements from the contingency and organizational learning theories. It asserts that the responsiveness that firms implement drives them to be more successful (Teece *et al.* 1997; Patriotta 2004). A *“firm's performance depends on the ability... to interpret correctly and respond to the messages they receive from their working environment”* (Patriotta 2004, p. 30).

Concluding, organizational responsiveness is a feature generally hypothesized as a determinant for organizational success. There are two observations that should be made with this respect. The first observation is that the field of organizational responsiveness, until recently, was a prerogative of study for large organizations. The question of the responsiveness' role in SMEs remains mainly unanswered. SMEs are often considered as more innovative, more customer-oriented, more flexible and as having quick response times when it comes to implementing changes and thus more responsive (Liao *et al.* 2003). Therefore, it is possible that responsive capacity is a feature generally characterizing small firms and does not necessarily directly affect their levels of business performance. The second observation that one should note is that the efficiency of the responsiveness firms implement appears as a key element for a firm's success. To the best of knowledge, no such operationalization that captures the efficiency of the organizational responsiveness exists. A firm's responsiveness capacity was conceptualized by Kohli and Jaworski (1990, 1993) and adapted in the case of export activities by Cadogan *et al.* (1999) as one of the dimensions of the export market-orientation construct. It refers to the speed and coordination with which actions are implemented and periodically reviewed in accordance with clients' demands, the over or under-fulfilling of goals and the subsequent corrective actions (Kohli *et al.* 1993). Adopting a responsive attitude towards export market shifts mainly translates continuously adaptive export strategies according to the foreign clients' demands and foreign market constraints (Cadogan *et al.* 1999). Nevertheless, adopting a responsive attitude towards foreign market shifts does not necessarily imply making the "right" decisions concerning export strategies. Slater and Narver (1995) stress the fact that there is a buffer between organizations and the environment that enables them to avoid a reactionary response to every event. One firm may frequently examine clients' demands and systematically review the over or under-fulfillment of export goals without necessarily making the "*right*" decisions. Making the "*right*" decisions in SMEs is a contingency choice depending on the couple product-market-assets (Pelham 2000). According to the KBV perspective, the efficiency in terms of deciding which responsive actions should be undertaken relies mainly on the firm's level of domain-related knowledge and capabilities which ultimately determine the firms' performance levels (e.g. Grant 1996; Kuivalainen and Bell 2004; De Nisi *et al.* 2005). Several learning scholars suggest that implementing responsive action in terms of marketing strategies translates learning into action, and thus represents a form of learning (e.g. Sinkula *et al.* 1997; Baker and Sinkula 1999; Machat 2003).

When it comes to the impact of responsiveness on business performance, Sinkula *et al.* (1997) suggest that marketing dynamism, a very close concept to responsiveness, enhances organizational performance on the short run or that the impact is indirect. The authors suggest that in the long run, responsive action helps organizations build marketing-related competences and capabilities, ultimately determining their levels of business success.

At the empirical level, the relationship between responsiveness and business performance was mainly studied within the market orientation (MO) literature. MO proponents suggest that being market oriented is beneficial for organizations. Moreover, companies have to increase their levels of MO in order to become and remain competitive. The stream of MO research brings empirical support concerning the impact of MO on business performance in different national settings (e.g. Jaworski and Kohli 1993; Pitt *et al.* 1996; Homburg and Pflessor 2000; Harris and Ogbonna 2001; Shoham and Rose 2001). Furthermore, some studies document the weak or non-significant effect of MO upon business performance (Greenley 1995; Chan and Ellis 1998; Gray *et al.* 1998; Harris 2001; Langerak 2003).

Several hypotheses were emitted for explaining the variations of the results concerning the impact of firms' MO on business performance. For instance, some of the scholars highlight the role of several moderators of the relationship between MO and business performance such as the competitive intensity (Jaworski and Kohli 1993; Homburg and Pflessor 2000) and the technological turbulence (Greenley 1995). According to some other authors, the relationship might be stronger according to the size of the home market or the level of development in the market and is mainly valuable within the US market (Ellis 2005, 2006). Pros and cons also exist that either support or not supporting these relationships. Regardless, definitive conclusions on all points are still lacking (Ellis 2005).

The studies of Cadogan and Diamantopoulos (1995) and Diamantopoulos and Cadogan (1996) suggest that the application of the MO construct to foreign markets is more complex. Moreover, the application of the MO construct to small firms is believed to be specific (Pelham and Wilson 1996; Remaud 2006). Nonetheless, Pelham and Wilson (1996) showed that SMEs could be just as MO as large companies are. Scholars that specifically address the question of the MO in small firms generally deem that the application of the market-orientation is specific and suggests that the link between market-orientation and its levels of international performance is indirect (e.g. Pelham and Wilson 1996; Remaud 2006). The results of the studies in the field are disparate. Pelham (1997) suggested that the link between MO and business performance is indirect. Remaud's (2006) study on SMEs operating in the wine industry from Australia, New Zealand and France brought empirical support on the

indirect effect of the MO upon their levels of international performance. MO exerts a direct influence upon the competitive advantage of small firms, which ultimately directly and positively influences their levels of international performance. Verhees and Meulenburg (2004) also supported the indirect influence of MO on the performance of SMEs through innovation development. Beaujanot *et al.* (2006) suggested that the market-oriented SMEs were more likely to develop more efficient strategic relationships with their main strategic export distributors. Nonetheless, several studies, such as the ones of Pelham (1999; 2000) or Keskin (2006), brought empirical evidence of the direct effect of SMEs' MO on their levels of business performance.

In regards to the above statements, definitive conclusions are lacking concerning the influence of the organizational responsiveness of SMEs on business performance (Ellis 2005). It is worth noting that responsiveness can be a quite general feature characterizing small firms (Liao *et al.* 2003) and that the responsiveness operational measure chosen does not tell anything about the efficiency of the responsive actions SMEs undertake to respond to foreign markets shifts. Within the current research, it is suggested that responsiveness influences the international performance of SMEs rather indirectly. In addition, as suggested by Sinkula *et al.* (1997), in the long run responsiveness enhances learning by consolidating or enhancing the development of market-based foreign competences by means of hands-on experimentation. Even more, much of the learning in SMEs has been found to be experiential (Deakins and Freel 1998), adaptive and relational (Minguzzi and Passaro 1997), from “*trial and error*” decision making processes (Matlay 2000), and learning by doing (Gibb 1997).

Sinkula *et al.* (1997) suggested that the marketing responsiveness action firms implement to respond to foreign market shifts indirectly impacts firms' performance levels through the development of the marketing competences. Accordingly, it is proposed that by means of being actively responsive in international markets, SMEs will gradually build superior foreign market-related competences and capabilities and by this mean, indirectly influence the levels of foreign market-related performance.

### III.3.2 The impact of RACAP's exploitation dimension

The marketing function in SMEs can be characterized as instinctive and informal, and marketing planning activities are conducted in almost the same manner (Carson and Cromie 1989; Machat 2003). However, prior research on exporting suggests that firms with superior marketing competences are likely to be more successful in export markets (e.g. Leonidou and Katsikeas 1996; Sousa 2004; Morgan *et al.* 2003; Zou *et al.* 2003). In a study of the characteristics of successful export ventures in the U.K., Piercy *et al.* (1998) found that high export performers in comparison to competitors exhibited significantly higher achievements than low export performers on several dimensions that may be identified as marketing competences though not grouped or labeled as such by the authors. These marketing competences include: (1) product development skills, (2) product quality, (3) technical support or after-sales service, (4) product line, (5) cost or price competitiveness, and (6) customer relationship skills among others. Cavusgil and Zou (1994) found that the performance of export ventures increases with the level of marketing support for distributors and the degree of product adaptation. Other studies indicate that export managers perceive marketing competences to be important export success factors (e.g. Katsikeas *et al.* 1997).

More generally, organizational level competences increase organizational flexibility and reactivity through better resources allocation and the development and sharing of knowledge. Moreover, competences drive enterprises to build new rules for competitors by imposing their own technical and commercial solutions (Hamel and Prahalad 1999). The emergence of the competence field in strategy marks a distinction from the traditional manner of approaching competitive advantage. If a firm's competitive positioning at a certain moment in time does not provide any information about the future development of the company, competences are dynamic by nature and can be deployed in new situations. Thus, according to the KBV, competitive positioning in terms of core competences is believed to ensure the long-term competitive advantage of companies (Kuivalainen and Bell 2004; Kodama 2005; Freiling *et al.* 2008) and superior economic rent creation (Curado 2006).

In dynamic, changing and turbulent environments, knowledge-based assets and especially tacit knowledge-based assets as competences are seen to most contribute to performance (Grant 1996; Miller and Shamsie 1996; DeNisi *et al.* 2003; Patriotta 2004; Spender 2007). The KBV defends the key role of positional advantage in terms of competences in ensuring

long-term performance, know-how in terms of process development can also be applied in the future for problem-solving.

Within the manufacturing SMEs' internationalization process, strong empirical support exists on the impact of international marketing competences of SMEs on international performance (e.g. Miesenbock 1988; Ford and Leonidou 1991; Holzmueller and Kasper 1991; Axinn *et al.* 1996; Cavusgil and Zou 1994; Ramangalahy 2001; Julien and Ramangalahy 2003). Resuming, under a KBV perspective, the positional advantage of SMEs in terms of international marketing competences determines their levels of international performance. As a result, it is suggested that:

**P10: SMEs' positional advantage in terms of international marketing competences has a positive and significant impact upon the international performance of SMEs.**

Several scholars suggested that the choice and the implementation of strategies, translating marketing competences into successful export performance, depend on several firm characteristics (Porter 1980; Cavusgil and Zou 1994). Such elements may be firms' resources available for export development (Terpstra and Sarathy 2000), their international experience (Douglas and Craig 1989), the managerial commitment towards exporting (Cavusgil and Nevin 1981; Cavusgil 1984a; Aaby and Slater 1989; Leonidou *et al.* 1998), or firm's size (Calof 1994; Katsikeas *et al.* 1997).

There is a general belief that a firm's size translates resource availability in SMEs. However, the results of empirical studies investigating the influence of firm size on export behavior and performance are mixed. Several empirical studies found a significant relationship between firm size and export performance (e.g. Burton and Schlegelmilch 1987; Calof 1994), while some others reveal a non-significant influence of the size (Czinkota and Johnston 1983; Diamantopoulos and Inglis 1988). Concerning the non-conclusive results on the effect of firm size on export behavior and performance, it is suggested that one should control the firm's size influence when measuring the impact of the marketing competences positional advantage on SMEs' export performance (Zou *et al.* 2003).

Export marketing studies also suggested that organizational capabilities that may significantly influence a firm's ability to turn its marketing competences into export success, which include managerial commitment as expressed in terms of interest in and willingness to allocate sufficient resources (marketing, financial, personnel, production, and related) to exporting (Cavusgil and Nevin 1981; Cavusgil and Zou 1994; Leonidou *et al.* 1998). The export orientation translates a company's willingness to allocate resources for exporting and extend

foreign-market activities (Cadogan *et al.* 2001). Again, as was the case for the size of SMEs, it is suggested that one should control for the effect of the export orientation of SMEs in order to better capture the real effect of the positional advantage of SMEs in terms of export-marketing competences on their level of international performance (Zou *et al.* 2003). Resuming, the effects of firm size and export orientation of SMEs will be isolated in order to assess the “*real*” impact of the positional advantage of SMEs in terms of international marketing competences. Hereafter, Figure 14 exposes the research propositions emitted with respect to the influence of RACAP on SMEs’ international performance.

Figure 14. The influence of RACAP on SMEs’ international performance

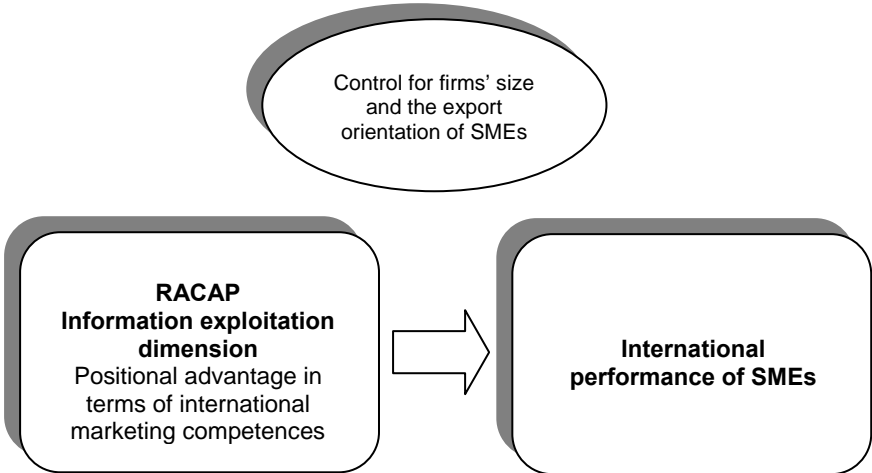
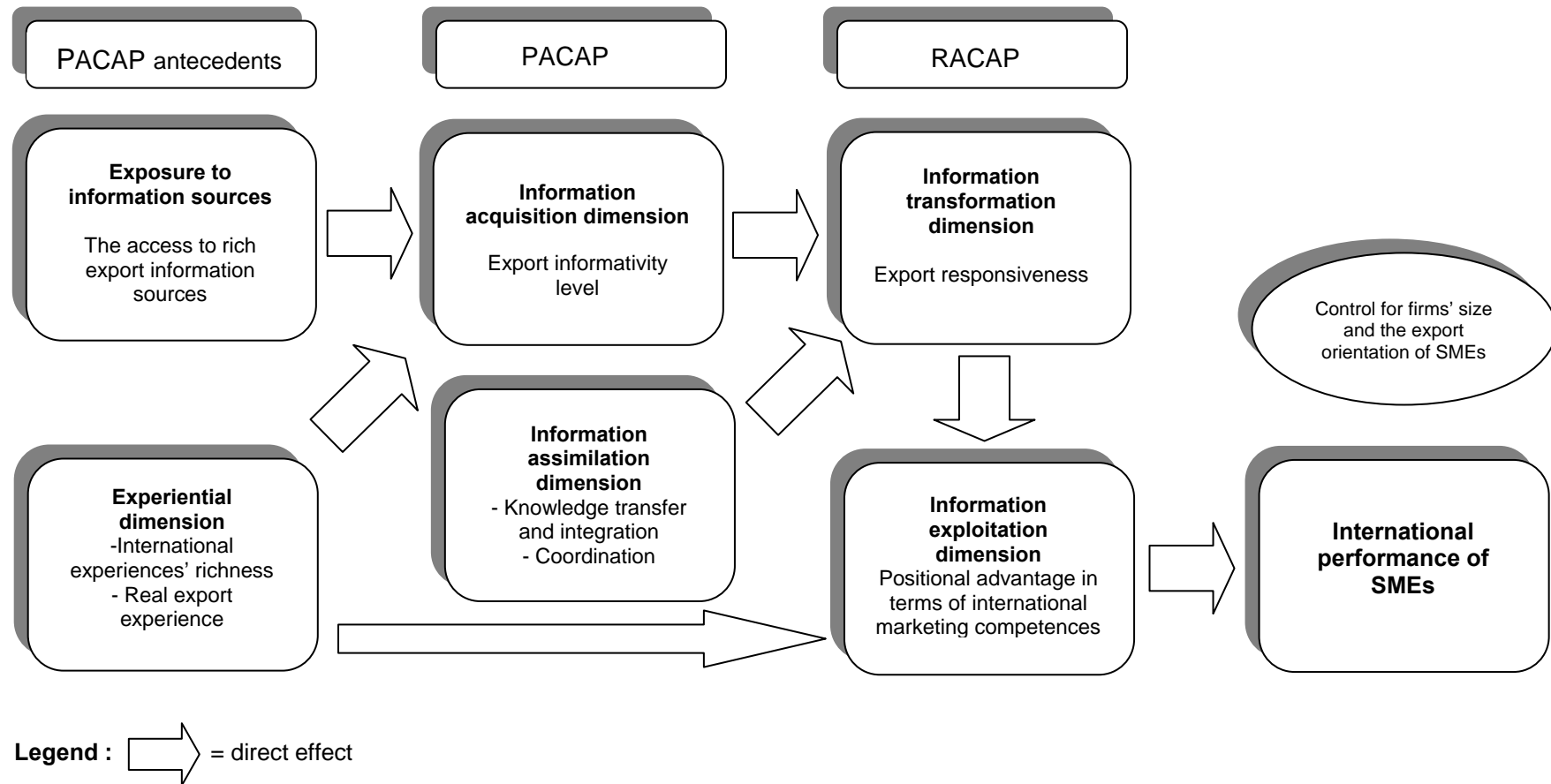

Figure 15 on the next page resumes the whole research model developed in this third chapter.



Figure 15. The research model



### **Conclusion of Chapter III**

Within this third chapter, based on the generalized AC model of Zahra and George (2002), the research model was developed. The research model was adapted under a KBV perspective in the specific case of exporting SMEs.

The SMEs' structural specificities and their particularities in terms of export information activities development and foreign market-behaviors have been taken into account in order to conceptualize AC dimensions and emit the research propositions. It should be noted that in terms of the conceptualization possibilities for the AC assimilation dimension, to the best of knowledge, only domestic based operationalizations have been developed until now. This fact subsequently led to the adaptation of several research propositions that differ from the original model of Zahra and George (2002). The presentation of the research propositions has been organized in three parts.

The first group of research propositions related to the impact of PACAP's antecedents on PACAP was presented, along with the proposition of the conceptualization of the PACAP and its antecedents, in the specific case of exporting SMEs. Due to the domestic based conceptualization of the assimilation dimension, research propositions were not emitted with respect to the impact of the two PACAP's antecedents that were SMEs' experience richness and the richness of export information sources on the assimilation dimension of PACAP.

The second group of research propositions presented was related to the impact of PACAP on RACAP along with the proposition of the conceptualization of RACAP specifically in the case of exporting SMEs. RACAP's transformation dimension was conceptualized as the export responsiveness capacity of SMEs. The exploitation dimension of RACAP was assessed in terms of the positional advantage SMEs detain in terms of international marketing competences.

While both sub-dimensions of PACAP (export information acquisition and assimilation) have a direct impact upon firms' responsiveness capacity, their influence upon the exploitation dimension of RACAP is indirect. Competences are action and experience related. As a result, two additional research propositions that were added to Zahra and George's (2002) model, relative to the influence of the richness of international experiences of SMEs and their levels of export responsiveness upon their levels of positional advantage they achieve in terms of international marketing competences. The last group of research propositions concerning the impact of RACAP upon SMEs' international performance levels was developed.

Concerning the moderator factors that strengthen the three main groups of relationships exposed above, Zahra and George (2002) mentioned the activation triggers, and the regimes of appropriability mentioned as moderators of the relationships between PACAP antecedents, PACAP and RACAP, and business performance. Their influence within the current research model was not tested due to the broadness of the conceptualization of these concepts and because they mainly refer to external institutional or industry related influences. Since French exporting SMEs from the steel industry were examined, it is expected that the external institutional and regulatory industry related influence factors would be similar; this was the main reason for their exclusion from the research model.

## CHAPTER IV. CONSTRUCTS OPERATIONALIZATION

### **Introduction to Chapter IV**

Five groups of constructs make up the research model: the antecedents of PACAP, PACAP, RACAP, the international performance of exporting SMEs, and the control variables. In the fourth chapter, the measures chosen for their operationalization are exposed.

First, the measures used to capture the antecedents of the PACAP are presented. Then the measures used to capture PACAP's dimensions, information acquisition and assimilation, are introduced. Third, the measures used to capture RACAP's dimensions, namely export information transformation and exploitation, are then exposed. Fourth, the measures chosen to capture the dependant construct in this research, the international performance of small firms, are reviewed. Finally, the operationalization chosen to capture the control variables used in order to assess the real impact of the positional advantage in terms of international marketing competences on the international performance of SMEs are presented. In the end, a synthetic recapitulative table of all the measures used for assessing the constructs used within the research model is presented.

### **IV.1 The antecedents of PACAP**

Two groups of antecedents of the PACAP were highlighted within Zahra and George's (2002) study, namely the previous experience and the exposure to information sources within the surrounding environment.

#### **IV.1.1 Operationalization of the exposure to information sources**

As concluded in section III.1.1.1.1, it does not make sense to take export information sources that are not used or considered as useful by SMEs' managers into consideration. In order to select the information sources considered as important by the exporting SMEs' managers, an exploratory study undertaken in 2002 by Walliser and Mogos-Descotes on 44 French SMEs from the steel industry, located in the East of France has been used as point of departure. This study allowed for a first glimpse of SMEs' perceptions of the importance of nine information sources presented in Table 9.

Even though the information sources investigated within this study are far from being exhaustive, it allows for capturing the perceived importance of export information sources as

viewed by French SMEs in the steel industry, which is the industry under study. One can notice a marked preference of SMEs from the steel industry for personal contacts and clients as foreign market-information vehicles. The agents or distributors and participation at trade fairs are also moderately appreciated by SME managers. As far as more formalized market research techniques are concerned, they are not very popular among these enterprises.

Table 9. The perceived importance of information sources of French SMEs from the steel industry

<b>... How important do you consider the following information sources? Items : (Likert scale, ranging from 1 = "not important at all" to 5 = "very important")</b>	<b>Mean</b>	<b>Standard deviation</b>
▪ Visits to customers	3,91	1,15
▪ Visits to distributors or agents	2,81	1,40
▪ Participation at trade fares / exhibitions	2,95	1,36
▪ Competitor visits	2,42	1,11
▪ Personal contacts	4,00	0,94
▪ Test marketing	1,88	1,21
▪ Mail surveys	1,80	1,05
▪ Telephone interviews	2,66	1,26
▪ Information seminars	1,86	0,96

Furthermore, during the qualitative phase of the current study, 24 SMEs' managers were interviewed concerning the importance granted to export information sources and the reasons why they consider the respective information sources as being important. The most appreciated and used sources of foreign information by SMEs' managers from the steel and textile industry were, in order of importance, the clients and competitors, the agents or distributors, and participation at trade fairs and trade missions abroad. The Internet was also widely recognized as an important export information source. Among the more formalized information sources, French SMEs moderately assert the role played by the Chambers of Commerce and Industry (CCI) and export marketing research.

To resume, based on the literature, the exploratory quantitative study undertaken in France specifically on SMEs from the steel industry and on the qualitative research undertaken with SMEs' export managers, it is concluded that seven export information sources appear to be the most used and useful for SMEs managers. The seven export information sources are the clients, competitors, distributors or agents, participation at trade fairs, CCI, marketing research providers and the Internet. As a result, these are the export information sources investigated within the current dissertation under the angle of their richness as suggested by

Cohen and Levinthal (1990) or Zahra and George (2002). As suggested within chapter I, multi-dimensional qualitative aspects such as the richness of information sources (Daft and Lengel 1984; Ramangalahy 2001; Julien and Ramangalahy 2003) or information quality (Toften and Olsen 2003) should be considered instead of uni-dimensional measures such as the perceived usefulness or importance. As a result of the qualitative preliminary study undertaken with 24 exporting enterprises managers, it was concluded that the information sources richness perspective is the most appropriate for the study of exporting SMEs' access to foreign information sources. Therefore, the multi-dimensional information sources richness perspective, inspired by Ramangalahy's (2001) study on Canadian exporters is retained for capturing SMEs' exposure to information on their foreign markets. The measure used in order to assess export information sources richness is schematically presented in Table 10.

Table 10. The operationalization of the richness of export information sources

Information sources considered	Richness attributes	Measurement scale	Reference
<ul style="list-style-type: none"> <li>▪ Clients</li> <li>▪ Competitors</li> <li>▪ Distributors or agents</li> <li>▪ Participation at trade fairs</li> <li>▪ CCI</li> <li>▪ Marketing research providers</li> <li>▪ Internet<sup>19</sup></li> </ul>	<ul style="list-style-type: none"> <li>▪ Information quantity provided by the information source</li> <li>▪ Interactivity in terms of the possibility to rapidly exchange points of view with information sources, thus allowing the adjustment of diverging points of view</li> <li>▪ Contact facility allows for the possibility to communicate in many different ways, verbally or non-verbally, that favor the speed of communication</li> <li>▪ Contact density means communicating with different interfaces (density) and providing diverse indications</li> <li>▪ Information reliability provides an easy access to reliable information</li> </ul>	5-point- scale ranging from 1="very limited" to 5= "very extended"	Inspired from Ramangalahy (2001)

<sup>19</sup> These export information sources have been considered as "rich" export information sources, as a result of the preliminary qualitative study (see chapter V, section V.2)

## IV.1.2 Operationalization of the experiential dimension

Older exporting firms can sometimes develop rigid routines that hamper foreign market related learning (Souchon *et al.* 2003). For this reason, it has been decided to rely rather on richness related measures in order to capture the international experience of small firms. Since the level of analysis retained in the case of the current research is the firm, focus is placed on the firm's related conceptualizations of international performance.

Examining Table 7 in section III.1.1.1.2, that recapitulates the export experience-related measures, one can observe that the measures related to the organizational level of analysis mainly capture rather "*quantitative*" and length related measures of the international performance such as the number of years of international performance of the firm or the number of years the enterprise has had an export department.

Lately, scholars suggest that more qualitative export experience measures should be privileged over quantitative ones (e.g. Ramangalahy 2001; Kuivalainen and Bell 2004). A qualitative export experience measure is, for instance, the number of entry modes such as direct exporting, indirect exporting, subsidiaries, associative modes, license or franchising, among other modes. The use of a certain entry mode conditions a firm's access to knowledge and information in foreign markets. It can be used as a proxy for capturing a firm's diversity of international experiences (Kuivalainen and Bell 2004). Moreover, if the numbers of years spent by companies with developing international activities under different foreign presence modes are added, a more accurate measure of the "*real*" length of the international experiences of firms is obtained.

Another measure appearing to be especially appealing for the current research was the international experiences' richness. Ramangalahy (2001) assessed this measure at the managerial team level of analysis. Within the current research, the firm level of analysis is privileged; as a result, the experiences' richness measure of Ramangalahy (2001) will be adapted at the firm level of analysis. Respondents will be asked whether the firm has already sold abroad by means of direct exporting, indirect exporting, subsidiary, associative modes, license, franchising, or other modes. Afterwards, respondents will be asked to characterize each of the foreign presence modes in terms of the length of the experience, number of projects or clients, challenge complexity, diversity of context and the impact upon a firm's international know-how on a 5-point-Likert scale ranging from 1="very limited" to 5="very

extended”. Table 11 recapitulates the measures retained for assessing SMEs’ international experiences richness.

Table 11. International experiences’ richness operationalization

Experience richness measures	Richness attributes	Measurement scale	Reference
The richness of SMEs international experiences by selling abroad through : <ul style="list-style-type: none"> <li>▪ Direct exporting</li> <li>▪ Indirect export modes (joint-ventures, strategic alliances, etc.)</li> <li>▪ Franchising</li> <li>▪ Licensing</li> <li>▪ Subsidiaries</li> <li>▪ Internet</li> <li>▪ Other</li> </ul>	<ul style="list-style-type: none"> <li>▪ Length of experiences</li> <li>▪ Number of projects, clients or contracts the firm had to deal with in this specific mode of foreign presence</li> <li>▪ Challenge complexity in terms of problems the firm needs to solve</li> <li>▪ Context diversity, the social, cultural, economic environment aspects that characterize the environments the firm has worked in</li> <li>▪ Impact on the know-how in terms of how much the firm has learned through this experience</li> </ul>	<p>“How would you characterize the following foreign presence modes in terms of (the richness attributes)”</p> <p>measured on a 5-point scale ranging from 1=“very limited” to 5= “very extended”</p>	Adapted from Ramangalahy (2001) and Kuivalainen and Bell (2004)
Real export experience	Sum of the years the firm has been developing exporting activities by using a certain foreign presence mode among including: direct exporting, indirect exporting, associative modes franchising, licensing, subsidiary, Internet, among others	Number of years	Adapted from Kuivalainen and Bell (2004)

## IV.2 PACAP dimensions

PACAP is composed by two sub-dimensions, namely export information acquisition and assimilation. Their operationalization is developed hereafter.

## IV.2.1 Operationalization of the information acquisition dimension

Concluded in section III.1.1.2.1 is that the best way to capture the efficiency of the export information acquisition in SMEs is to assess the level of informativity of small firms regarding export markets compared to their main competitors.

Several possible information acquisition taxonomies were developed in the literature. They have been presented in section III.1.1.2.1. Among them, since it was developed in the specific case of SMEs in a francophone context and because of its integrative character, it was decided to operationalize the information acquisition dimension by using the taxonomy of Ramangalahy (2001). The six categories of foreign market-related information suggested by Ramangalahy have been considered and additionally a supplementary dimension relative to the way of developing business in foreign markets has been added. During the interviews undertaken with the 24 SMEs' managers, they frequently pointed out the importance of the knowledge of the way of developing business in foreign markets. Managers generally thought that the elements related to the way of developing business in foreign markets such as customs and cultural elements can help them to better manage their relationships with their foreign clients. This supplementary dimension was drawn from the study of Johanson and Vahlne (1977). Since exporting SMEs mainly learn about foreign markets in a relational way (e.g. Minguzzi and Passaro 1997), the knowledge of the countries' customs and specificities in terms of approaching foreign clients may be decisive in building relationships with foreign market actors.

Ramangalahy (2001) used a 5-point scale ranging from 1 = "not useful at all" to 5 = "very useful" in order to capture the perceived usefulness of the information types acquired in foreign markets. As discussed previously in chapter I, perceived usefulness measures are limited by the fact that there are differences between what managers think and do. For example, they could appreciate that acquiring information about product adaptation is very useful, and in reality, it could be that they would not gather information relative to this issue. Another problem associated with this measure is that it does not highlight the information level of the company. For example, within the SMEs' export information literature, it has been shown that SMEs acquire more information within the initial phases of the internationalization process (Souchon *et al.* 2003). Afterwards, as they gain experience and knowledge in foreign markets, they acquire less information than younger exporters do, this does not however mean that they are less informed. During the years they have been



exporting, these “*older*” international firms have accumulated information and knowledge about foreign markets, and therefore might be less active in searching information on a current basis.

Table 12. Export information acquisition dimension operationalization

Export information types	Measurement scale	Reference
<ul style="list-style-type: none"> <li>▪ General foreign markets environment: economic, social, political environment, barriers to exporting, legislation</li> <li>▪ Potential clients: characteristics, needs, demand, preferences, mentalities, buying behaviors, new niches, potential partners</li> <li>▪ Competitors: main actors on the market, general situation, strategies they deploy, forces and strengths</li> <li>▪ Products: characteristics, technical norms, adaptation needs, packaging, innovation cycles</li> <li>▪ Price and payment practices: level, tendencies, margins and commissions, credit policies, mode and delay of payment</li> <li>▪ Communication practices: available media, methods employed, type of message, costs</li> <li>▪ Distribution practices: channels, costs, selling points, transport and deposit infrastructure, payment delays, intermediaries efficiency</li> </ul>	<p><i>“Compared to your main competitors on foreign market you consider being informed considering the following information elements characterizing foreign markets” : (7 point differential scale ranging from) -3 = “much less informed than competitors” to +3 = “much better than competitors”</i></p>	<p>Adapted from Ramangalahy (2001)</p>

In order to assess the “*real*” level of informativity of SMEs regarding foreign markets, a measure mainly used within the knowledge management literature for capturing knowledge-related constructs was adapted. SMEs’ managers were asked whether they consider to be more or less informed than their main competitors in foreign markets concerning foreign clients, competitors, distribution, prices, communication practices, products, general market environment and business management related practices on a 7-point-differential scale, ranging from -3 = “much less than competitors” to +3 = “much more than competitors”. This question is believed to more likely reflect the information level of SMEs than the perceived usefulness of information sources of the perceived frequency of acquisition. Even more, the measure employed allows for establishing whether the “*informational*” knowledge SMEs detain has a strategic character. More precisely, the measure assesses whether the SMEs’ foreign market information level is superior to that of competitors.

## IV.2.2 Operationalization of the information assimilation dimension

Two main organizational mechanisms were selected in order to best capture the assimilation dimension, namely coordination and knowledge transfer and integration.

Perhaps the most widely used measure of coordination is the measure designed by Kohli and Jaworski (1993). In spite of its wide utilization and validation across different studies, Kohli and Jaworski's (1993) scale was initially designed for large firms. Cadogan *et al.* (1999) further adapted it to international market contexts in order to design the coordination capacity of firms between the export department and the rest of the organization. Even though its international adaptation seems appealing for the current study, SMEs rarely dispose of an export department. Thus, the applicability of this measure in small organizations can be questioned. Ramangalahy (2001) proposed a measure for SMEs' coordination practices that was designed and tested within the Canadian context. Because the scale already exists in the French language and does not need back and forward translations and the scale proved psychometrically sound, it was preferred for assessing the efficiency of coordination. The scale is composed by six items assessed on a 5-point scale ranging from 1 = "very imprecise" to 5 = "very precise". The six items are related to: (1) sharing and understanding a managerial vision, (2) leadership efficiency, (3) closeness of the coordination between managers, (4) informal exchange practices, (5) internal collaboration facility, and (6) the use of work teams for important projects. It worth to note that after analyzing the literature review in the field of SMEs, it was concluded that it does not make much sense to study the use of work teams, the formalization of exchange practices, and the internal collaboration facility among departments. As a result, the fourth, fifth and sixth items are not relatable to the case of the current research.

Knowledge transfer and integration efficiency was assessed by Jerez-Gomez *et al.*'s (2005) measure. Respondents were asked to provide their agreement degree measured on a 7-point scale ranging from "completely disagree" to "completely agree" with four statements related to the discussions that were: 1) around errors and failures, 2) new idea and activities as well as their usefulness for the firm, 3) teamwork, and 4) the instruments (manuals, databases, files, organizational routines, etc.) that allow what has been learned in past situations to remain valid even when employees change. Since in the case of SMEs, work teams are frequently synonymous to top management team members working together (Irani *et al.* 1997), it was

concluded that teamwork does not apply much in the case of SMEs. As a result, the third item has not been considered.

Table 13. Information assimilation operationalization

Assimilation practices considered	Items	Measurement scale	Reference
Coordination	<ul style="list-style-type: none"> <li>▪ The senior management's strategic objectives are well known and accepted.</li> <li>▪ The leadership employed by the direction is efficient.</li> <li>▪ The members of the management team closely coordinate their activities.</li> </ul>	<p>"The agreement degree with the following statements", measured on a 5 point ordinal scale ranging from 1="very imprecise" to 5="very precise"</p>	Ramangalahy (2001)
Knowledge transfer and integration	<ul style="list-style-type: none"> <li>▪ The mistakes and failures are always discussed in this enterprise, at all levels.</li> <li>▪ The employees have the chance to discuss among them about new ideas, projects and activities that could be useful to the enterprise.</li> <li>▪ The firm has instruments (manuals databases, files, organizational routines, etc.) that allow what has been learnt in the past situations to remain valid.</li> </ul>	<p>7 point ordinal scale ranging from 1="completely disagree" to 7="completely agree"</p>	Jerez-Gomez <i>et al.</i> (2005)

### IV.3 RACAP dimensions

RACAP is composed of two sub-dimensions, namely information transformation and information implementation. Their operationalization is exposed hereafter.

#### IV.3.1 Operationalization of the transformation dimension of RACAP

In section III.2.1.1, it is concluded that the most suitable conceptualization for the transformation dimension of RACAP in the case of exporting SMEs is the export responsiveness construct of Cadogan *et al.* (1999). The measure is composed of 17 items relating to the responsive actions firms implement in order to manage changes taking place in the foreign business environment. They were assessed on a 7-point-Likert scale ranging from

1 = “totally disagree” to 7 = “totally agree” by asking the respondents whether they agreed with the 17 related statements, presented hereafter in Table 14.

Table 14. RACAP’s transformation dimension operationalization: the export responsiveness capacity of SMEs

Items	Measurement scale	Reference
<ul style="list-style-type: none"> <li>▪ It takes us forever to decide how to respond to price changes in our export markets.</li> <li>▪ For one reason or another, we tend to ignore changes in our foreign customers’ product or service needs.</li> <li>▪ We periodically review our product development efforts to ensure that they are in line with what foreign customers want.</li> <li>▪ Our strategy for standardizing or adapting our export product offerings is based on detailed customer observation.</li> <li>▪ Several ‘departments’ get together periodically to plan a response to changes taking place in our foreign business environment (e.g. regulation, technology, etc.).</li> <li>▪ The choice of the product we sell to foreign markets depends more on internal politics than real market needs.</li> <li>▪ If a major competitor were to launch an intensive campaign targeted to our foreign costumers, we would implement a response immediately.</li> <li>▪ Foreign costumer complaints fall on deaf ears in this company.</li> <li>▪ We are quick to respond to significant changes in our competitors’ price structures in foreign markets.</li> <li>▪ When we find out that export customers are unhappy with the quality of our service, we take corrective action immediately.</li> <li>▪ We are quick to respond to important changes in our business environment (e.g. regulatory, technology, economy, etc.).</li> <li>▪ All ‘departments’ in our firm are involved in implementing our export market strategies.</li> <li>▪ Our export business strategies are driven by our beliefs about how we can create greater value for export customers.</li> <li>▪ We give close attention to after-sales service for our foreign customers.</li> <li>▪ Our export business objectives are driven primarily by costumer satisfaction.</li> <li>▪ We rapidly respond to competitive actions that threaten us in our export markets.</li> <li>▪ Our export strategy for competitive advantage is based on our understanding of export costumer needs.</li> </ul>	<p>“... the agreement degree with the following statements” measured on a 7-point-ordinal scale ranging from 1=“completely disagree” to 7=“completely agree”</p>	<p>Cadogan <i>et al.</i> (1999)</p>

### IV.3.2 Operationalization of the exploitation dimension of RACAP

It was decided that the best possible conceptualization of the exploitation dimension of RACAP is SMEs' positional advantage in terms of international marketing competences. A specific measure for this construct has not yet been developed. Nevertheless, the positional advantage translates the advantage in terms of international marketing competences characterizing SMEs over their competitors. Morgan and Vorhies (2005) developed an appealing marketing competences scale in a national context. For this study, the scale has been adapted to the international context. The scale developed by Morgan and Vorhies (2005) is composed by seven groups of marketing competences related to: (1) the market information management, (2) the communication strategy, (3) distribution strategy, (4) price strategy, (5) product strategy, (6) marketing management strategy, and (7) the networking competences.

Table 15. RACAP's exploitation dimension operationalization: the positional advantage of SMEs in terms of international marketing competences

Export information types	Measurement scale	Reference
<ul style="list-style-type: none"> <li>▪ Networking: identifying contacts abroad, entertaining developing relationships with the contacts abroad, knowledge and understanding of business practices, foreign languages skill</li> <li>▪ International marketing management: setting marketing goals, formulating creative marketing strategies, translating marketing strategies into action, control and evaluation of marketing costs</li> <li>▪ Foreign markets segmentation: opportunity seeking, studying foreign markets characteristics, targeting and penetrating foreign markets, identification potential clients/markets</li> <li>▪ Product strategy: R&amp;D of new products or services, products and service adaptation, packaging, successfully launching of new products or services</li> <li>▪ Price strategy: negotiating and fixing price and payment delays, responsiveness in terms of pricing to market change, fixing margins, and evaluation of credit risk</li> <li>▪ Communication strategy: promoting sales, products, developing enterprise image and reputation, managing communication programs</li> <li>▪ Distribution strategy: selecting the distributor agents and sale force, entertaining the relations and collaborations with distributor agents, choosing the localization of the selling and distribution points, and training sales personnel</li> <li>▪ Information management: identification of information sources, collecting information on clients and competitors, tracking customers wants and needs, collecting and analyzing market information</li> </ul>	<p>“How do you rate yourself compared to your main competitors on foreign markets in terms of the development of the following marketing competences”</p> <p>measured on a 7-point-differential scale ranging from -3 = “much worse than competitors” to +3 = “much better than competitors”</p>	<p>Adapted from Morgan and Vorhies (2005)</p>

The positional advantage in terms of marketing competences was conceptualized as a formative construct summing up the competences SMEs dispose of in the seven marketing fields described above on a 7-point differential scale ranging from -3 = “much less than the competitors” to +3 = “much more than the competitors.” Table 15 displays this aforementioned measure.

#### IV.4 The dependent construct: the international performance of SMEs

The measurement of the international performance construct is an on-going subject of debate. International performance measures generally vary from one study to another, making the comparison of the findings of different studies difficult. According to the nature of the indicators used to capture the international performance construct, one can distinguish between objective and subjective measures. Objective measures include indicators such as the export sales ratio and export sales ratio growth. Subjective measures include the perceived export development, the general satisfaction with exporting activities, the perceived achievement of strategic exporting goals and more.

Nowadays, some scholars support the use of subjective over objective indicators (e.g. Katsikeas *et al.* 1997; Robertson and Chetty 2000). Scholars argue this preference by the fact that firms are extremely reluctant in providing the researcher with objective data (Francis and Collins-Dodd 2000; Leonidou *et al.* 2002), that objective data is not publicly available, and thus it is impossible to check the accuracy the reported financial performance figures (Robertson and Chetty 2000) and because decision-makers are guided by their subjective perceptions (Madsen 1989). However, the general agreement among researchers is that both types of measures are equally important and should be used given the advantages of both approaches and their complementary nature (e.g. Shoham 1998; Sousa 2004).

International performance measures can also be classified into financial, strategic, and perceived satisfaction-related measures (Cavusgil and Zou 1994; Zou *et al.* 1998). Financial measures include the percentage of export profits or their growth over a period. Strategic measures capture aspects referring to the strategic position of the firm in export markets, for example, whether the firm is a leader or follower and whether it is a major or minor supplier in export markets. Finally, satisfaction-related measures capture aspects such as the perception of the overall development of the exporting activities in the company. Again,

scholars suggest that the three types of measures shall be combined in order to best capture the international performance construct (Diamantopoulos 1999). Such a measure that combines subjective versus objective measures as well as strategic, financial and satisfaction related measures is the measure used by Souchon and Durden (2002), which was inspired by the widely used measure of Zou *et al.* (1998). It includes two objective measures, namely export profit growth and export sales growth as well as several subjective measures. The subjective measures refer to the perceived competitiveness in terms of export sales, export profits, market share in the export markets, and the perceived satisfaction with the sales, profits, market share abroad, as well as domestic versus international sales profitability. The subjective measure also concerns the strategic position of the firm as a leader or follower or as a major or minor supplier within its export market. Besides the wide use of the measure of Zou *et al.* (1998) within export performance studies (Sousa 2004), this measure can also allow comparison with some of the most recent export information-related studies by Souchon and Durden (2002). Table 16 hereafter recapitulates the measures used to capture the international performance of SMEs.

Table 16. The operationalization of the SMEs' international performance

Measures used to capture the international performance construct by Souchon and Durden (2002), inspired from Zou <i>et al.</i> (1998)	Measurement scale
<b><i>Qualitative measures of the international performance construct</i></b>	
Perceived satisfaction with the development of international performance over the last three years with the foreign market share, the foreign sales profits, foreign sales volume, and the number of new foreign markets entered	7-point scale ranging from 1 = "not satisfied at all" to 7 = "very satisfied"
Perceived competitiveness in export markets over the last three years with the foreign market share, the foreign sales profits, foreign sales volume, and the number of new foreign markets entered	7-point scale ranging from 1 = "not competitive at all" to 7 = "very competitive"
Relative perceived competitiveness, compared to the main competitors, with the development of the export activities over the last three years with regard to the foreign market share, the foreign sales profits, foreign sales volume, and the number of new foreign markets entered	7-point scale ranging from 1 = "not competitive at all" to 7 = "very competitive"
Perceived profitability of export sales compared to domestic sales	7-point-Likert scale ranging from "completely disagree" to "completely agree"

Strategic position of the firm in export markets	Nominal scale with four response possibilities: major or minor supplier, and challenger or follower
<b>Quantitative measures of the international performance construct</b>	
Export sales growth over the last three years	The mean of the progression of export sales volume over the previous year
Export profits growth over the last three years	The mean of the progression of export profits over the previous year

## IV.5 Operationalization of the control variables

SMEs' export orientation and the firm's size were the two control variables considered in order to assess the "real" effect of the positional advantage of SMEs upon their levels of international performance. The export orientation of SMEs was assessed by using the scale employed by the study of Cadogan *et al.* (2001). Firm size was assessed by means of one question disclosed at the end of the questionnaire that assesses the number of employees in the company. Table 17 hereafter presents the operationalization chosen for assessing the control variables.

Table 17. Operationalization of the control variables

Construct	Items	Measurement scale	Reference
International orientation	<p><i>"The management team in our company":</i></p> <ul style="list-style-type: none"> <li>▪ Considers exporting activities to be important.</li> <li>▪ Intends to increase company's exporting activities.</li> <li>▪ Actively explores international market opportunities.</li> </ul>	<p><i>"The agreement degree with the following statements"</i> assessed on a 5-point-ordinal scale ranging from 1 = "completely disagree" to 5 = "completely agree"</p>	Cadogan <i>et al.</i> (2001)
Firm size		Number of employees in the firm	Multiple references



Finally, Table 18 hereafter summarizes the measures used to capture all of the four groups of constructs mobilized within the research model, which include PACAP's antecedents, PACAP, RACAP, and the international performance of SMEs.

Table 18. Operationalization of the main groups of constructs mobilized within the research model:  
PACAP's antecedents, PACAP, RACAP and the international performance of SMEs

Variable/Construct	Items and scales	References
<b>PACAP's ANTECEDENTS</b>		
<b>Export information sources richness</b>		
The richness of seven "rich" information sources	<p>Second order construct assessing the richness of the seven export information sources:</p> <ul style="list-style-type: none"> <li>▪ Clients</li> <li>▪ Competitors</li> <li>▪ Agents or distributors</li> <li>▪ Trade-fairs</li> <li>▪ Chambers of Commerce and Industry</li> <li>▪ Export market research</li> <li>▪ Internet</li> </ul> <p>Each source is assessed on a 5 point measurement scale ranging from 1 = "very limited" to 5 = "very good" on five dimensions which are:</p> <ul style="list-style-type: none"> <li>▪ Contacts facility</li> <li>▪ Contacts density</li> <li>▪ Interactivity</li> <li>▪ Information reliability</li> <li>▪ Information quantity</li> </ul>	Adapted from Ramangalahy (2001) and Kuivalainen and Bell (2004)
<b>International experiences richness</b>		
Real export experience	<p>Sum of the number of years of experience with using one of the following foreign presence modes:</p> <ul style="list-style-type: none"> <li>▪ direct exporting</li> <li>▪ indirect exporting</li> <li>▪ associative modes</li> <li>▪ franchising or licensing</li> <li>▪ subsidiary</li> <li>▪ Internet</li> <li>▪ Others</li> </ul>	Adapted from Kuivalainen and Bell (2004)
International experience richness	<p>Companies are asked whether they already sell abroad by means of direct exporting, indirect exporting, subsidiary, associative modes, license/franchising, or other modes.</p> <p>Each of the foreign presence modes was assessed by means of a 5-point-Likert scale, ranging from 1 = "very limited" to 5 = "very extended" on five dimensions:</p> <ul style="list-style-type: none"> <li>▪ Length of the experiences</li> <li>▪ Number of projects or clients</li> <li>▪ Challenge complexity,</li> <li>▪ Diversity of context</li> </ul> <p>Impact upon the firm's international know-how.</p>	Adapted from Ramangalahy (2001) and Kuivalainen and Bell (2004)

<b>PACAP POTENTIAL ABSORPTIVE CAPACITY</b>		
<b>Information acquisition</b>		
The level of export informational knowledge	Reflexive construct made up of seven items that include: <ul style="list-style-type: none"> <li>▪ General foreign market situation,</li> <li>▪ Foreign clients and competitors</li> <li>▪ Products</li> <li>▪ Prices and payment methods</li> <li>▪ Communication</li> <li>▪ Distribution practices</li> </ul> Items are measured on a 7-point scale ranging from -3 = "informed much less than the competitors" to +3 = "informed much more than competitors"	Adapted from Ramangalahy (2001)
<b>Information assimilation</b>		
Coordination	Reflexive construct made up of three items measured on a 5-point-Likert scale ranging from 1 = "very imprecise" to 5 = "very precise"	Ramangalahy (2001)
Integration and transfer of information and knowledge	Reflexive construct made up of three items measured on a 7-point-Likert scale ranging from 1= "completely disagree" to 7 = "completely agree"	Jerez-Gomez <i>et al.</i> (2005)
<b>RACAP – REALIZED ABSORPTIVE CAPACITY</b>		
<b>Transformation dimension</b>		
Export responsiveness	Reflexive construct made up of 17 items measured on a 7-point-Likert scale ranging from 1= "completely disagree" to 7 ="completely agree"	Cadogan <i>et al.</i> (1999)
<b>Exploitation dimension</b>		
Positional advantage in terms of international marketing competences	Formative construct made up of eight items including: <ul style="list-style-type: none"> <li>▪ Relational competences</li> <li>▪ International marketing management</li> <li>▪ Foreign market segmentation</li> <li>▪ Product strategy</li> <li>▪ Price strategy</li> <li>▪ Distribution strategy</li> <li>▪ Communication strategy</li> <li>▪ Information management competences</li> </ul> The items are measured on a 7-point-differential scale ranging from 1 = "much less than competitors" to 7 = "much more than competitors"	Inspired from Morgan and Vorhies (2005)
<b>SMEs INTERNATIONAL PERFORMANCE</b>		
<b>Qualitative measures of the international performance construct</b>		
Perceived satisfaction with the development of export strategic objectives over the last three years	<ul style="list-style-type: none"> <li>▪ Market share</li> <li>▪ Foreign sales profits</li> <li>▪ Foreign sales volume</li> <li>▪ Number of new foreign markets entered</li> </ul> The items are measured on a 7-point-Likert scale ranging from 1 = "not satisfied at all" to 7 = "very satisfied"	Souchon and Durden (2002), inspired from Zou <i>et al.</i> (1998)

Perceived competitiveness on export markets in terms of export strategic objectives over the last three years over the last three years	<ul style="list-style-type: none"> <li>▪ Market share</li> <li>▪ Foreign sales profits</li> <li>▪ Foreign sales volume</li> <li>▪ Number of new foreign markets entered</li> </ul> <p>The items are measured on a 7-point-Likert scale ranging from 1 = “not competitive at all” to 7 = “very competitive”</p>	Souchon and Durden (2002), inspired from Zou <i>et al.</i> (1998)
Relative perceived satisfaction, compared to the main competitors, with the development of the export strategic objectives over the last three years	<ul style="list-style-type: none"> <li>▪ Market share</li> <li>▪ Foreign sales profits</li> <li>▪ Foreign sales volume</li> <li>▪ Number of new foreign markets entered</li> </ul> <p>The items are measured on a 7-point-Likert scale ranging from 1 = “not satisfied at all” to 7 = “very satisfied”</p>	Souchon and Durden (2002), inspired from Souchon and Durden (2002), inspired from Zou <i>et al.</i> (1998)
Perceived profitability of export sales compared to domestic sales	1 item measured on a 7-point-Likert scale ranging from 1 = “completely disagree” to 7 = “completely agree”	Souchon and Durden (2002), inspired from Zou <i>et al.</i> (1998)
Strategic position of the firm on export markets	A nominal scale with four response possibilities: major or minor supplier, challenger or follower.	Souchon and Durden (2002), inspired from Zou <i>et al.</i> (1998)
<b>Quantitative measures of the international performance construct</b>		
Export sales growth over the last three years	The mean of the progression of export sales volume over the last years	Souchon and Durden (2002), inspired from Zou <i>et al.</i> (1998)
Export profits growth over the last three years	The mean of the progression of export profits over the last years	Souchon and Durden (2002), inspired from Zou <i>et al.</i> (1998)
<b>CONTROL VARIABLES</b>		
Export orientation	Reflexive construct made up of three items measured on a 7-point-Likert scale ranging from 1 = “completely disagree” to 7 = “completely agree”	Cadogan <i>et al.</i> (2001)
Firm size	Number of employees in the firm	Multiple references

#### **Conclusion of Chapter IV**

Within this fourth chapter the choices of the measures used to capture the constructs composing our research model were exposed and discussed. They include the measures used to capture the antecedents of PACAP, PACAP, RACAP, the international performance of exporting SMEs, and finally the control variables.

## PART II. RESEARCH METHODOLOGY, RESULTS, CONCLUSIONS

Part II is made up by three chapters. Chapter V details the main methodological choices that guided this research: the level of analysis, the choice of combining both qualitative and quantitative research. The results of the preliminary qualitative study and the questionnaire pre-test are also presented in this chapter. Chapter VI presents the questionnaire administration procedure, and the descriptive analysis of the results. Chapter VII presents the validation of the research propositions along with the discussion of the results, the conclusions, the main implications of the study, limits and future research avenues.

### CHAPTER V. RESEARCH METHODOLOGY

#### **Introduction to Chapter V**

In this fifth chapter, the choices in terms of the level of analysis and the methodological choices we made in order to address the research question will be explained.

Second, the results of the preliminary qualitative research are also presented. With this respect, 24 semi-directed interviews with Romanian and French exporting SMEs' managers were undertaken in order to get additional insights into the way export information related activities are conducted in SMEs. In Chapter IV, it was concluded that it does not worth including all export information sources in this study. It was aimed by means of the qualitative study, to identify the "*rich*" export information sources from the managerial point of view, and achieve a better understanding into the way SMEs manage export markets related information. More precisely, exporting SMEs' managers were interviewed concerning their export information acquisition and use practices, the factors and organizational mechanisms enhancing export information exploitation in SMEs.

Finally, the questionnaire pre-test is also presented in this chapter.

Within this chapter, it is aimed to explain and describe the methodological choices that guided this research. Inspired from Zahra and George (2002) conceptualization of AC, the research model developed in Chapter III is based on three main research propositions: (1) PACAP (potential absorptive capacity) antecedents determine PACAP levels; (2) PACAP of export information enhances RACAP (realized absorptive capacity development), and (3) RACAP directly impacts the international performance of exporting SMEs. By definition, it can be affirmed that this research pertains to the field of explicative, causal research frameworks. In this specific case, quantitative methodology appears to be the most suitable (e.g. Easterby-Smith *et al.* 1991; Hubermann and Miles 1991).

The study proposes a comprehensive framework for analyzing export information processing within exporting SMEs. Resuming, export information flows nurture the evolution and consolidation of export related knowledge about foreign markets, guides responsive actions, foreign market related competences building, and ultimately impacts the SMEs' export performance. While the research question is causal by nature, the intangible, dynamic, and complex nature of the main constructs mobilized within this research: information, knowledge, and competences, are arguments that could support the use of qualitative methodology. Moreover, the stepping-stones of this research are the KBV perspective and the AC framework, two emerging theoretical fields. As a result, a qualitative approach could explore the managerial perceptions' concordance with the theoretical assumptions drawn from the KBV and AC frameworks. For these reasons, the decision was made to use a preliminary qualitative research in order to gain further insight into the export information processing and transformation processes within exporting SMEs. The qualitative study also allowed us for checking whether the assumptions of the KBV and AC frameworks are consistent with exporting SMEs managers' testimonies. Moreover, it helped to select for (quantitative) study purposes, the export information sources judged as most important (rich) by SMEs' managers. Furthermore, based on the theoretical assumptions and the interviews, a questionnaire was conceived in order to test the validity of the research propositions that are causal by nature. The quantitative study was feasible since the literature review realized allowed for measuring the different AC dimensions: PACAP and RACAP, PACAP's antecedents as well as the international performance of SMEs. The choice in terms of level of analysis, conditioned the measures used in order to capture the constructs in the research model.

## V.1 The level of analysis: the firm

Several scholars like Cavusgil and Zou (1994), Zou *et al.* (1998) or Sousa (2004) stressed that the dominant research practice in export is to choose the firm as a level of analysis, and they also stressed the limits of this practice. According to them, this approach implies that the different products and foreign markets generate comparable gains for the firms and that is not always the case. Especially in foreign settings, firms do not propose the same products and mainly according to the level of development of the market in question, they do not generate the same financial gains. However, the overwhelming majority of export studies adopted the firm unit of analysis to assess export performance, focusing on a firm's total export sales. According to Katsikeas *et al.* (2000), there are three main arguments for this choice. First, most of past export related studies used the firm level of analysis. As a result, for comparability reasons, the firm level of analysis shall be privileged. Next, secondary database data generally refer to the corporate level performance. Third, managers are more willing to disclose information at the broad firm level (Matthyssens and Pauwels 1996).

More specifically, one of the main objectives of this research is to build an international performance model. Scholars such as Jacobson (1987) or Hofer (1983) stressed that export performance is mainly an organizational construct. Moreover, this view is sustained by the most of the existing internationalization theories (e.g. Buckley and Casson 1985; Rugman 1981). A quite common assumption of the internationalization theories is that in imperfect markets, firms should internalize the firm-specific advantages (tangible and intangible) in order to achieve superior profitability levels. Firm-specific advantages result not only from the development and the marketing of a particular product on a given export market; they are also the outcome of the learning process that takes place within the firm as a whole. For these reasons expressed above, the firm seems to be the most appropriate level for analyzing the relation between absorptive capacity of export information and SMEs international performance.

## V.2 The results of the preliminary qualitative research

This research combined both: qualitative and quantitative approaches. A first preliminary qualitative study has been undertaken in both countries considered initially in the study: France and Romania. While the theoretical assumptions issued from the KBV perspective and

AC literature concerning export information management appear as particularly appealing, it is essential to check whether they are consistent with the managerial perceptions. Moreover, the qualitative study helped to better understand SMEs managers' preferences in terms of export information sources and the reasons explaining this preference.

It is worth mentioning that one of the initial aims of our study was comparing the export information activities of SMEs from Romania and France in order to highlight the similarities and differences of firms from both countries in terms of export information practices. It was considered that understanding how export information management is conducted in companies from these countries with different development levels would be useful, especially in the nowadays European context, where companies within the E.U. are more and more confronted to working and collaborating with each other. It was also assumed that carrying out the preliminary research in two countries with quite diverse institutional conditions, namely France and Romania, could avoid ethnocentric tendencies. We used two countries with different development levels, since it is very likely that the institutional environments vary with the level of development. For example, we can assume that because of corruption, which is more strongly prevalent in many East European countries, Romanian companies will differ in terms of the perception of governmental aid programs of their Western counterparts. Another underlying reason for selecting those two countries was the good knowledge of both languages and the familiarity with both cultural and institutional contexts by the researchers. We combined emic with etic approaches, since previous research suggested they are complementary in undertaking cross national research. The emic oriented qualitative study allowed us to get additional insights into the way SMEs use export information in two highly different cultural contexts, namely France and Romania. Furthermore, based on the exploratory research, we subsequently followed an etic oriented approach and performed the quantitative study in the French context. The quantitative study finally led to broader conceptual as well as empirical basis ultimately allowing for more robust and generalizeable results (Ronen and Shenkar 1988).

The emic oriented study has been carried out in Romania between July and September 2004, by means of 16 semi-directed interviews with managers of exporting firms, operating in the textile and steel industry. Between March and May 2005, eight semi-directed interviews with French SMEs were also realized. The interviews had durations in-between 45 and 100 minutes. The selected firms were operating within the steel and the textile industry, had different sizes, and different levels of export involvement (percentage of export sales), and international experience. The qualitative research was carried out with companies from two

manufacturing industries, namely steel and textile industries were interviewed. This choice was driven by the fact that these were the industry branches comparable in terms of the number of exporting SMEs in Romania and France. However, manufactured exports account for the bulk of total world export trade (World Bank 2001). Thus, studying manufacturing industries is a judicious choice for study purposes.

The interview guide, initially developed in French, was back and forward translated into Romanian in order to ensure translation equivalence. Based on my knowledge of the two languages: French and Romanian, and of the knowledge of both cultural contexts, the interviews were undertaken respectively in Romanian with Romanian managers and in French with French managers. The interview guide is to be found in appendix 2.

In the beginning of the interview, managers were asked export information related questions in order to broadly see which were the information sources they were using in order to keep informed regarding foreign markets. Second, the questions sought to see which their favorite information sources were and why they prefer them. They were also asked about the kinds of information elements they aimed to specifically gather on export markets. Secondly, managers were asked how they use export information in the company. Then, they were asked what helps them to optimize export information use. Fourth, they were asked how efficient the procedures of information dissemination (e.g. coordination, communication, etc.) are in their firms. Some additional questions about interviewees' profiles were also asked, as well as their planning activities, the degree of centralization and formalization of the managerial decision-making, etc.

As it follows, this frame is used in order to present the description of the main results issues from the preliminary qualitative study undertaken in the French and Romanian contexts. Following, a short "*résumé*" will be exposed concerning the 16 interviews undertaken in Romania. Second, the results of the interviews undertaken with French SMEs' managers are revealed. Finally, third, explained are the general conclusions with respect to export information management practices developed in both cultural settings.



Table 19. Synthetic presentation of the Romanian interviewees and their enterprises

Interviewee	Activity sector/ Industry	Position of the interviewees within the company	Sex and Education	Number of employees	Number of exporting countries	The main export market	The percentage of sales abroad	International experience of the company
Interviewee 1	Textile	Technique Dr.	F/Tech20	800	22	Germany	80 %	More than 100 years (c) 21
Interviewee 2	Textile	General Dr.	M/Tech	250	8	Germany	80 %	40 years (c)
Interviewee 3	Textile	Technique Dr.	F/Tech	100	3	Italy	100 %	4 years
Interviewee 4	Textile	Dr. Technique	M/Tech	1 100	6	Germany	98 %	44 years (c)
Interviewee 5	Textile	Commercial Dr	M/Tech	360	6	Germany	60 %	30 years (c)
Interviewee 6	Textile	Commercial Dr	M/Com	1 500	3	Belgium	90 %	36 years
Interviewee 7	Steel	Marketing Dr.	M/T+C	900	23	France	70 %	44 years (c)
Interviewee 8	Steel	General Dr.	M/Tech	60	4	Holland	100 %	6 years
Interviewee 9	Steel	General Dr.	M/Tech	94	4	Holland	70 %	9 years
Interviewee 10	Steel	General Dr.	M/Tech	60	4	Germany	80 %	9 years
Interviewee 11	Steel	General Dr.	M/Tech	365	2	Netherlands	10 %	7 years
Interviewee 12	Steel	General Dr.	M/Tech	140	1	France	3-5 %	2 years
Interviewee 13	Steel	General Dr.	M/Tech	55	2	Serbia	5 %	3 years
Interviewee 14 (Intermediary enterprise)	Steel	Commercial Dr.	M/Com	4	3	Turkey	72 %	5 years
Interviewee 15 (Subsidiary)	Steel	General Dr.	F/Tech+Com	35	2	Holland	100 %	11 years
Interviewee 16 (Subsidiary)	Steel	Technique Dr. + General Dr.	M/M/Tech/Te ch	178	1	France	100 %	10 years

M = Masculine, F=Feminine, Tech=Engineer university studies , Com = Business university studies, Dr. = director  
(c) = "old international" enterprise

## V.2.1 Results of the interviews realized with the Romanian enterprises

Specifically, 16 in-depth interviews were conducted with managers from Romanian exporting firms of different sizes, operating in two predetermined industries: metal and textile, and having different levels of export involvement and experience (see Table 19).

The “*type profile*” of the Romanian international manager is a person about 40 years old, having at least senior student studies (with two exceptions who are engineers) and previous working experience in the industrial field. The interviewed executives who attempted commercial studies are more likely to be aware of the different techniques and sources of foreign market information, and especially the export assistance types.

Given the exploratory nature of this stage of the research, the small sample size was deemed suitable, not for the generalization of the results, but for gaining preliminary insights into the issues of interest (Hart 1987), namely export information management related aspects.

The main results of this research are explained in seven points related to (1) export information acquisition, (2) export information use, (3) the factors enhancing export information exploitation within firms, (4) the practices enhancing information use within firms, (5) a proposition of classification of international Romanian SMEs, (6) the internationalization reasons of companies, and several (7) other aspects related to the development of international activities of SMEs such as the organization of planning activities, the competitive edge they detain on foreign markets, etc.

### *V.2.1.1 Export information acquisition*

Several aspects related to export information activities were investigated. First, managers were asked which the information sources they consulted on foreign markets were. Afterwards, they were asked which information sources they preferred and why. Finally, asked was what kind of information they acquire on foreign markets.

#### V.2.1.1.1 Information sources consulted on foreign markets

During the interviews, the managers mentioned a variety of foreign market information sources which can easily be classified into export marketing research, export assistance and export market intelligence, and which are presented exhaustively in Table 20. Romanian

managers stated a strong preference for relational, market intelligence related information techniques. By far, the favorite information sources of Romanian managers are the foreign clients. This observation confirms previous studies undertaken in Western contexts. When asked why they prefer clients over other information sources, several arguments were advanced. The main idea, resulting out the interviews was the adequacy of the information foreign clients provide to managers:

*“I prefer clients because they can give me the right information at the right time.”*  
(Interviewee 3)

*“When I ask clients for information, they can give me the information I need, most of the times.”* (Interviewee 6)

*“It’s more interesting to ask clients for information since they can give us advice and additional information we did not think about... This is impossible when you read a written, generalized report.”* (Interviewee 9)

The underlying idea is that they can exchange around the information they need with clients. Some other testimonies highlighted the experiential character of clients as information sources and the importance or the quality of the information gathered from clients:

*“They give us information based on real experience, and this kind of information is very precious to us.”* (Interviewee 12)

Only one company (Interviewee 1) mentioned trade fairs and agents as their favored information source on foreign markets, and did not mention foreign clients. Two of the companies interviewed used agents as an information technique on foreign markets. They expressed their marked preference for this mode of acquiring foreign market information, besides foreign clients. The main reason cited was again the adequacy of the information furnished by their sales agents on foreign markets, in accordance with their needs, but also the possibility to exchange the given information with them:

*“Our agents know exactly what kind of information we need and search specifically for it.”*  
(Interviewee 7)

*“We ask them to look up information according to our needs and are always able to discuss things with them when we need to.”* (Interviewee 1)

Trade fairs are very praised by companies who participate at trade fairs:

*“Trade fairs allow us to directly access the information we need about clients, products and prices.”* (Interviewee 1)

This remark underlines as well the adequacy of the information to the problems at hand, which seems to be the quality of information sources most researched by SMEs’ managers.

They praise participations at international trade fairs, where companies “*face competitors and clients at once. Both, clients and competitors are the best market engines.*” (Interviewee 7) Participation at trade fairs is sometimes viewed by Interviewees as a surrogate of market research undertaken in an informal manner:

*“We could refer to them a kind of market research... We can interview our clients, competitors, furnishers and so on. Of course, it is not undertaken in a formal and structured way, but still they remain of utmost importance to us.”* (Interviewee 1)

They also explain that participating in international trade fairs is sometimes a first experience and contact that one could have with one specific market.

All interviewees consult industrial reviews in their field every month, with as an exception however. Interviewee 5 did not express a particular perceived usefulness towards this specific information collection mode. Two interviewees belong to formal business networks, which they consider a very precious source of information. One of the managers of these companies (Interviewee 7) explained that this type of information is vital to him as only a restrained group can access it, as one must be a member of the network.

To conclude, export market intelligence was the unanimously favored way of acquiring information. The reasons given for this preference were numerous: this information comes directly from the marketplace and, thus, is experiential in nature, it takes little time to get it (e.g. a phone call), and additionally, they can ask for advice from export market intelligence related sources. Another explanation for the use of business contacts was the context that when managers need to make decisions quickly and under pressure they need a specific answer in real time. It is also “*free*” information, and it tends to be trusted more than any other form. The trust in information providers has been mentioned as a reason for consulting information sources by one of the managers:

*“How can I explain? ... It comes form acquaintances... I mean, they are more than acquaintances, I see them more like friends. And that’s why I trust them.”* (Interviewee 9)

Based on the statements above, it appears SMEs’ managers seem to underline information sources richness related aspects, such as the adequacy of the furnished information, and the possibility to exchange with information sources around the information provided by export market intelligence related sources. As a result, it seems that studying export information sources under the richness perspective, as suggested by Ramangalahy (2001), represents an adequate choice with managers’ perspective.

Many reservations were voiced with regard to the information provided by export assistance bodies. Out of the 16 managers interviewed, four reported not acquiring such information,

mainly because of the corruption of governmental agencies. Sometimes a lack of awareness existed of what help these governmental bodies could provide to exporting firms. Other companies have made use of assistance bodies in the past but did not rely on them any longer due to the corruption or because government bodies were seen to provide information that is out of date. Assistance bodies were also perceived as supplying information that is too general to suit the specific needs of exporters. Among the export assistance information sources, the Chambers of Industry and Commerce are the most used and appreciated by the managers. The less appreciated are the governmental aid programs. The managers deem that most governmental employees are corrupted and the way they attribute these aids to enterprises is not fair. Only one of the enterprises interviewed benefited from a governmental aid for participating at trade fairs in Japan (Interviewee 1). Their manager's testimony was very positive. The manager considered that this type of aid should be provided to enterprises as they can have a first contact with one specific market. However, generally, enterprises do not use export assistance bodies on a general basis. They address them only if they have a particular need. Enterprises reproach the quality of information to export assistance bodies as it is not adapted to their needs enough, and in the same time, is somehow dated.

Only one of these 16 Romanian companies, the biggest one with 1500 employees, undertakes export marketing research – commissioned to a consulting firm. Market study was considered very reliable by this company because it *“gives specific answers to our very specific questions”* (Interviewee 6). Nonetheless, export marketing research was perceived as a very reliable information source by every enterprise interviewed, even though it was not necessarily used by the company, mainly for cost reasons. None of the enterprises interviewed has a research department and when market studies were mentioned during the interviews, enterprises spontaneously thought of consulting enterprises, the externally commissioned way of undertaking market studies.

All the enterprises interviewed mentioned Internet as a current and useful information source about foreign markets. Mainly two different ways of using Internet can be distinguished: as a relational informational technique, (e.g. asking for information to a contact established abroad), and as a possibility of identifying new customers or acquiring general information about foreign markets – which seems to replace the use of export assistance bodies. The interviewees explain that Internet is interesting mainly from the point of view of the quantity of information it provides.

*“Internet is a huge source of information... One can find plenty of information about the products, competitors, trade fairs and so forth on the Internet”* (Interviewee 4).

Competitors are also frequently cited by Romanian managers among the information sources they use on a current basis: *“We always keep an eye open on our competitors: sometimes for really exchanging information, and sometimes just for keeping track of what they’re doing.”* (Interviewee 12)

Table 20. Export information sources mentioned by the Romanian interviewees

Export information classification: data display		
Export marketing research	Export market intelligence	Export assistance
<ul style="list-style-type: none"> <li>▪ Consultancy groups</li> </ul>	<ul style="list-style-type: none"> <li>▪ Agents/distributors</li> <li>▪ Magazines/trade journals</li> <li>▪ Dealer network/suppliers</li> <li>▪ Competition</li> <li>▪ Contacts/networking/traveling</li> <li>▪ Customers/market</li> <li>▪ Exhibitions</li> <li>▪ Trade fairs</li> <li>▪ Internet</li> </ul>	<ul style="list-style-type: none"> <li>▪ Chambers of Commerce and Industry</li> <li>▪ Local embassy</li> <li>▪ International Commerce Ministry</li> <li>▪ Internet</li> </ul>

Another particularity of the information collection is the preference for oral, direct communication and coordination mechanisms and the use of mainly domestic export information sources.

V.2.1.1.2 Export information elements acquired on foreign markets

When asked what kind of information managers acquire about foreign markets, the interviewees mentioned several export information elements. They generally focus on clients and competitors, as their knowledge is essential in Romanian managers’ view to perform on foreign markets:

*“Both, clients and competitors are the best market engines.”* (Interviewee 2)

*“The most important thing is to know the clients and the competitors, and then you know if you can sell something in the country.”* (Interviewee 5)

*“First, we always try to see whether there would be clients in the market and then who the competitors are, how expensive their products are and how good they are from the qualitative point of view...”* (Interviewee 9)

Table 21. Overview of the export information state of Romanian enterprises interviewed

Interviewee	The favorite export information source and the main reasons for preference	Other export information sources they judge as useful and they use on a current basis	Export information elements they acquire on foreign markets
Interviewee 1	Trade fairs and agents: the direct access to foreign market information on clients and competitors	Clients, competitors, Internet, CCI, market research	Clients and competitors, marketing mix
Interviewee 2	Foreign clients : the adequacy of information	Competitors, trade fairs, Internet	Clients, competitors, marketing mix
Interviewee 3	Foreign clients: the adequacy of information, the experiential character	Competitors, Internet	Clients, competitors, marketing mix
Interviewee 4	Foreign clients: the adequacy of information, the possibility to interact with information sources around the provided information	Competitors, trade fairs, Internet	Clients, competitors, technology
Interviewee 5	Foreign clients : the adequacy of information, the trust	Competitors, trade fairs, Internet, journals	Clients, competitors, products
Interviewee 6	Foreign clients and agents : the adequacy of information, the interactivity with information sources	Internet, CCI, market research	Clients, competitors, technology
Interviewee 7	Foreign clients and agents: the adequacy of information, the experiential content	Trade fairs, Internet, CCI, market research	Clients, competitors, marketing mix, technology, norms
Interviewee 8	Foreign clients: availability, facility of contact, information quality	Internet	Clients, competitors, product
Interviewee 9	Foreign clients : availability, the adequacy of information	Internet, competitors	Clients, competitors
Interviewee 10	Foreign clients: availability	Internet, competitors	Clients, competitors, marketing mix
Interviewee 11	Foreign clients, trade fairs : direct access, adequacy, interaction possibility	Internet	Clients, competitors
Interviewee 12	Foreign clients: adequacy	Internet, competitors	Clients, competitors
Interviewee 13	Foreign clients: adequacy, quality	Internet	Clients, competitors, marketing mix
Interviewee 14	Foreign clients: quality, timeliness, adequacy	Internet, trade fairs	Clients, competitors, marketing mix
Interviewee 15	Mother company	Clients, competitors	No information search activity
Interviewee 16	Mother company	Clients, Internet	No information search activity

Worth noting is that all the companies interviewed, mentioned the importance of clients and competitors as information elements in foreign settings. One can observe that the market orientation literature assumptions concerning the key importance of information relative to clients and competitors, was sustained by the Romanian managers' vision of the importance of information elements on foreign markets. Most of the managers interviewed also referred to some marketing mix related aspects as well:

*“We need to know how our competitors sell products: the level of quality, the production procedures, the price....how do they contact clients...the norms.”* (Interviewee 7)

Only one of the managers interviewed (Interviewee 7) mentioned the general market background information. Namely, he referred to the norms necessary to implement in order to sell products in the E.U. Three interviewees also declared keeping informed about technological aspects of the products sold abroad is important.

#### ***V.2.1.2 Export information use***

Managers were asked in which way information is useful to them in general and in which purpose they use it. Specific questions were asked furthermore to test for the conceptual, symbolic and instrumental use of information (see chapter 1, section I.2.3.2.3) for a detailed explanation of the different types of export information use. Several ideas came out of the interviews concerning the export information use that takes different forms in the enterprises interviewed. For instance, export information seems to play an important role in managerial sense-making:

*“Sometimes information helps us to better understand things... For instance, sometimes a client tells us something and we understand where we made the wrong decision. For example, last time we realized that German clients did not want to order their T-shirts in our factory because our embroidery sub-supplier worked with another client of theirs and they were not happy with the quality of execution of the embroidery.”* (Interviewee 10)

*“Last time I went to a trade fare in Bucharest, I met a manager from Italy. He explained the tendencies in the Italian fashion for the next year to me. Then I understood why our competitors bought new cotton weaving machines...”* (Interviewee 14)

Another idea that frequently came out of the interviews was information's role in the decision-making process. This idea seemed to prevail in most of the enterprises:



*“When we need to make decision, export information is vital. We search for it in order to be able to make the right choice.”* (Interviewee 5)

*“If we have the right information at the right time, then we can make good decisions... For example, last time we had two offers from a German and an Italian client. We used the database KOMPASS to see which one was more solid financially and we chose the German client.”* (Interviewee 8)

At the same time, information plays an important role in the learning process of the firm:

*“For instance, the last time I was discussing with one of our clients he told me that our catalogue for products was different from the way they did them in Italy in terms of the presentation. The colors were too dark, the paper not shiny enough ... Consequently, I followed the advices and I guess I learned how it should be done in order to better sell our products in Italy. And it worked. Afterwards, our Italian clients told me our catalogue was very professional.”* (Interviewee 10)

*“One client tells me one thing, another something else.... In the end we put this together and know what we should do.... and we learn out of it... we do things better and better each time.”* (Interviewee 2)

The learning process appears mostly to be a trial-error, generative, simple loop learning process. When asked why they consider export information acquisition important, managers often gave similar answers suggesting that information gives guidance for future (responsive) action:

*“Export information acquisition is vital for us. The more we know about our foreign clients and competitors, the better we know what to do and how to do it. Then we get better and better once we acquire experience.”* (Interviewee 7)

*“Information offers guidance. Based on information we know how to act: we respond to clients demands, we align ourselves with our competitors.”* (Interviewee 6)

*“If we have the information we know how the wind blows.... I mean we know what happens and what we should do.”* (Interviewee 13)

An additional aim was to test the reliance between the decision-making types (instrumental/conceptual and symbolic use) and the export information acquisition vehicles (market intelligence, export assistance and market research) as suggested by Souchon and Diamantopoulos (1999). Regarding the instrumental/conceptual use of information, it was observed that after the first two interviews, managers distinguished two different situations : (1) the strategic decision-making (e.g. the choice of a new exportation country), decisions which encounter major changes within organization, and (2) less constraining decisions, as choosing a

new client for example. Furthermore, the interview guide was adapted by asking two more precise questions concerning the choice of new exporting countries. In the both cases, enterprises keep track of advice given by their social contacts. It seems that the social contacts network plays a critical role when it comes to decision making. For choosing a new client, managers might content themselves with asking a friend if they can trust this new client, but when it comes to strategic decision-making, they become much more cautious: they contact a maximum of potential sources as CCI (Chambers of Commerce and Industry), embassies, Internet, etc.

When asked how they choose to approach a new exporting country, most of managers try to first see macro-economic elements of information, such as the importance of their industry, the growth rate of GDP (gross domestic product), etc. They get this type of information on the Internet or from embassies. Furthermore, they act again in a relational manner by trying to see if they know someone in the particular country or thinking about participating in a trade fare in this specific country.

Concerning decision-making (instrumental use of information), the majority of enterprises explain that they partly base decisions on experience, intuition, hunch and factual information at the same time. They consider intuition and experience very important when making decisions. The majority of enterprises count that the information they get through industrial magazines, participations at conferences and trade fairs, helps them to broaden their general knowledge about foreign markets, an instant of conceptual use of information.

It was relatively difficult to test the symbolic use of export information. Face to an unknown person, managers tempt to give politically correct answers. Consequently, the use of direct questions relative to the symbolic use of information was not possible. It would therefore be useful for the future that researchers describe the way in which they test symbolic use of information during interviews. Managers were asked if they sometimes find retroactively information to support their previous “*bad*” or “*good*” decisions, if they present it to their employees. Most of them tried to avoid the question, while some answered, they do it, as it is a proof they were right. Table 22 hereafter resumes interviewees’ statements with respect to information use, but also relative to the factors enhancing export information use.

Table 22. Information use and factors enhancing information use in Romanian SMEs

Interviewee	Export information use	Factors enhancing export information use (managerial vision)	Other organizational procedures enhancing export information use within the organization : coordination, communication, information transfer and integration		
			Coordination	Communication	Information transfer and integration
Interviewee 1	Learning, decision making Conceptual/instrumental and symbolic use	Foreign markets experience and knowledge	Averagely efficient and formal	Averagely efficient and formal	Averagely efficient and informal, use of databases
Interviewee 2	Learning, decision making Conceptual/instrumental and symbolic use	Foreign markets experience	Efficient and informal	Efficient and informal	Averagely efficient
Interviewee 3	Learning Conceptual/instrumental and symbolic use	Foreign markets knowledge	Efficient and informal	Efficient and informal	Efficient and informal
Interviewee 4	Learning, decision making Conceptual/instrumental and symbolic use	Foreign markets experience, intelligence	Averagely efficient and formal	Averagely efficient and formal	Efficient and informal
Interviewee 5	Learning, decision making Conceptual/instrumental use	Foreign markets knowledge and experience	Efficient and informal	Efficient and informal	Averagely efficient and informal
Interviewee 6	Decision making, responsiveness	Foreign markets experience	Averagely efficient and formal	Averagely efficient and formal	Averagely efficient and formal
Interviewee 7	Decision making, sense making, responsiveness	Sense for business, foreign markets experience	Efficient and informal	Efficient and informal	Averagely efficient and informal
Interviewee 8	Decision making, learning	Foreign markets experience and knowledge	Efficient and informal	Efficient and informal	Averagely efficient and informal
Interviewee 9	Learning, responsiveness	Foreign market knowledge	Efficient and informal	Efficient and informal	Efficient and informal
Interviewee 10	Sense making, learning	Foreign markets experience	Efficient and informal	Efficient and informal	Efficient and informal
Interviewee 11	Learning, decision making	Foreign markets knowledge	Efficient and informal	Efficient and informal	Efficient and informal
Interviewee 12	Responsiveness, decision making	Foreign markets experience	Efficient and informal	Efficient and informal	Efficient and informal
Interviewee 13	Responsiveness, decision making	Foreign markets knowledge	Efficient and informal	Efficient and informal	Efficient and informal
Interviewee 14	Responsiveness, sense making	Foreign markets experience	Efficient and informal	Efficient and informal	Efficient and informal

\*\*\* Interviewees 15 and 16 declared not using foreign market information, since they implement the decisions coming from the mother company. Therefore, they do not figure in this table.

### *V.2.1.3 The factors enhancing export information exploitation (managerial perspective)*

When asked what helps them to maximize the use of new incoming export information, Romanian managers mainly mention their previous knowledge and experience:

*“It is finally our experience that helps us the most... we saw similar things before, so based on our experience we know how to act, and improve over time.”* (Interviewee 9)

*“It is the diversity of our export know-how and experience, which help us ultimately.”* (Interviewee 11)

*“We now have certain experiences with doing business abroad... they are complementary and long. This guides us when we consider new information.”* (Interviewee 4)

One can observe that managers stressed three main characteristics of the international experiences necessary to better use information: the variety, complementarities and length. Another idea resulting from the interviews is that a certain “*sense for business*” helps enterprises better exploit information to commercial ends:

*“It’s our business sense; I guess it is sometimes inborn. Some managers just know how to maintain relationships with business partners and get the information.”* (Interviewee 13)

*“You need to sense where there are business opportunities... not everybody has the same gut feeling for these matters.”* (Interviewee 15)

Interviewee 4 mentioned that a certain form of intelligence helps them to better exploit new incoming foreign markets related information.

### *V.2.1.4 The practices enhancing export information use within firms*

Interviewees were asked to which extent the communication around export information and also the coordination were efficient in their enterprises. Most of the interviewees stated that both coordination and communication are efficient in their company. They are undertaken by informal means. The managers of the bigger enterprises interviewed pointed out some communication and coordination problems. It seems though, coordination problems are somehow related to company’s size. In these companies, the coordination and communication are more formalized. Communication and coordination are ensured by both informal and formal means in these companies like written reports or formal meetings. A summary of the efficiency of the coordination and communication practices implemented in the companies interviewed can be found in Table 22.

Concerning the transfer and integration of export information within the firms, it appears that it is done in a rather informal manner by means of oral discussions. Formalized integration practices are not current in any of the firms interviewed. Also investigated was, the degree of centralization and formalization of the companies' interviewed. The results were homogeneous, in the sense that all companies interviewed are rather centralized, informal structures. Generally, the manager and the export/marketing managers of the firms undertake export information activities and decisions are made on a common agreement basis between the managers.

Interviews suggest that a limited number of employees in the firm undertake the acquisition and use of export information. It is dependent upon the size of the enterprise, and in the specific case of SMEs, these activities are frequently undertaken by the sales or the production managers, and/or the general manager. All the interviewees stated that they consult someone in the company when making decisions, which often are a compromise. During one of the interviews, the idea of compromise was entirely supported. Although the interview with Interviewee 16 was scheduled with just the sales director, the general director wanted to participate in the interview as well. Throughout the interview, both the sales director and the general manager answered the questions simultaneously. In conclusion, the majority of the questions given were different and often times debated between the two. They said decisions in the company are usually made the same way.

Teamwork seems to be the usual way of work of the companies interviewed for the simple reason that the managerial team works closely for the management of the main projects in the company. As a result, it appears that studying teamwork does not make much sense in SMEs. Managers interviewed also generally believe that employees understand company's main goals and the way they can be useful for their achievement. The only interviewee, who had a different testimony, is the manager of one of the biggest companies in our sample (Interviewee 6).

#### *V.2.1.5 Proposition of a classification of Romanian enterprises based on their international experience*

The interviews had with the Romanian enterprises, suggest that they can be classified into three main categories from the point of view of their internationalization:

(1) The old international enterprises - they were already developing international activities during the communist times. After the Romanian Revolution in 1989, they continued developing international activities by exploiting their contacts with the foreign customers and their relative international experience - as the international transactions could not take place in a free market economy during communist times.

(2) The new international enterprises - the enterprises created after the Romanian Revolution and which generally began their internationalization process without any previous foreign market experience.

(3) The hybrid international enterprises – created for example by people who worked in the international field during the communist times. After the Romanian Revolution, they founded their own private company, using their international contacts portfolio and “relative” international knowledge, acquired during the communist regime.

The relative international knowledge of the executives of the two hybrid international enterprises explains why they are both “*born global*” (international since inception). Their managers already had international skills and/or contacts abroad before starting the business.

Some of the present day international enterprises are smaller parts from older and bigger communist enterprises, who began developing international activities before the Romanian Revolution. They were privatized after 1989, and as their size was often too big (more than 1000 employees in most of the cases) they were drawn apart and sold. It is normal that today they still have as employees people who worked in communist international enterprises at the time. For this reason, these enterprises might constitute another form of hybrid international enterprises - a type of enterprise, which is not contained by our sample. Nevertheless, many enterprises of this kind exist on the Romanian market today.

#### *V.2.1.6 Other aspects*

Considering the planning activities, Romanian enterprises plan their international activities in the short term: from 3 to 6 months in the textile industry and from 6 month to one year in metal industry.

Their international presence abroad is mainly assured by indirect selling. Only big enterprises (superior to 800 employees) have distributor agents abroad. From the point of view of competitive strategy, Romanian enterprises mainly develop cost or quality differentiation. It is interesting to note that the only two enterprises developing niche strategy, both have marketing departments.

When asked what drives them to be successful on export markets, most of the Romanian managers mentioned several types of know-how and knowledge: technical, general market knowledge, production know-how, etc.

It is noteworthy that subsidiaries declared not deliberately acquiring export market information. The same thing happened with enterprises marginally exporting as they did not undertake export information search activities.

## V.2.2 Results of the interviews realized with the French enterprises

The same interview guide was used in order to gain preliminary insights into the information activities development within French SMEs from the textile and steel industry. Precisely, eight in-depth interviews were conducted with managers from French exporting SMEs from six to 250 employees (see Table 23), and having different levels of export involvement and experience. The “*type profile*” of a French international manager is a person averaging about 50 years of age and has at least a masters degree (most of them have a business background). Only one of the managers interviewed is a woman. Again, given the exploratory nature of this stage of the research, the small sample size was deemed suitable, not for the generalization of the results, but for gaining preliminary insights into the issues of interest (Hart 1987).

### V.2.2.1 Export information acquisition

#### V.2.2.1.1 Information sources consulted on foreign markets

As in the case of the Romanian enterprises interviewed, Souchon and Diamantopoulos’ (1998) threefold classification of export information sources into market intelligence, export marketing research and export assistance will be used for presenting the results of the interviews. Again, a marked preference of the enterprises interviewed for the export market intelligence:

“*Relational is what I call the most efficient information mode.*” (Interviewee 2)

“*Nothing is better than direct contact with business life and clients.*” (Interviewee 3)

Table 23. Synthetic presentation of the French interviewees and their enterprises

Interviewee	Activity sector/ Industry	Position of the interviewees within the company	Sex and Education	Number of employees	Number of exporting countries	The main export market	The percentage of sales abroad	International experience of the company
Interviewee 1	Textile	Commercial director	Feminine/ literature studies	100	6	Belgium	10%	10 years
Interviewee 2	Textile	C.E.O.	Masculine/ textile chemistry	120	3	Germany	5-10%	10 years
Interviewee 3	Textile	Financial director	Masculine/ business studies	284	45	Germany	45%	15 years
Interviewee 4	Textile	Export director	Masculine/ business studies	6	12	USA	55%	30 years
Interviewee 5	Steel	Commercial director	Masculine/ business studies	70	5	Germany	20%	12 years
Interviewee 6	Steel	Export director	Masculine/ business studies	120	65	USA	25%	25 years
Interviewee 7 (Subsidiary)	Steel	C.E.O.	Masculine/ business studies	32	10	Germany	45%	45 years
Interviewee 8	Steel	C.E.O.	Masculine/ business studies	150	75	Netherlands	25%	25 years



As in the case of Romanian enterprises, the favorite information sources of French managers are the clients. Again, when asked why they prefer clients, the main argument advanced is the adequacy of the information foreign clients provide to managers: *“Most of the times our clients give us the information we need.”* (Interviewee 1)

*“Clients are the best direct foreign market information source. They know the market and they can provide us with fresh and appropriate information with respect to our needs.”* (Interviewee 5)

Based on the statements above, it appears SMEs’ managers underline mainly the adequacy of the furnished information to their needs among the information sources richness related aspects.

French companies also appreciate participating in trade fairs. Two managers of the companies interviewed, mentioned a preference for trade fairs at the same level as foreign clients:

*“At trade fairs we link the useful contacts with potential clients or other actors in the business area which can help us further on. Even more, trade fairs generate turnover on an immediate basis”* (Interviewee 1).

*“When we participate in trade fares we acquire experience and knowledge about clients and competitors at the same time. And this is maybe the most important when doing business abroad.”* (Interviewee 3)

The contacts with the agents/distributors are also very much appreciated by the two companies, which use this form of foreign market presence:

*“They can tell us: this is ok and this is not... The contact with clients tells us a lot about the adequation between products and customers’ demands ...”* (Interviewee 3)

It is to note that compared to Romanian managers, French managers use the competitors as export information sources less extensively and express more mistrust towards them than Romanian managers did. One of the interviewees belongs to a formal business network (Interviewee 2). He believes networking represents a very precious information source as it allows the direct exchange with other *“people in the field”* and it also provides rare information, which can be acquired only by persons within the network. Almost all enterprises interviewed (7 out of 8) consult industrial reviews every month, which they consider *“fresh, pertinent market information”* (Interviewee 2). In the meanwhile, they did not express a marked preference for industrial reviews, and only mentioned them when they were asked to mention other export information sources they use or they might know in general.

Export market intelligence was the unanimously favored way of acquiring information. There are many reasons explaining this preference: the information comes directly from the

marketplace and thus, is experiential in nature; it can provide specific answers quickly and it is interactive:

*“I can exchange with my partners, ask for an advice. I cannot do that with a market research report.”* (Interviewee 4)

Some reservations were voiced by French managers with regard to the information provided by export assistance bodies:

*“We seldom use this assistance type information sources... It’s kind of unclear... I mean, it can be interesting, but still one has to know where to look for it and also have the necessary time to do it.”* (Interviewee 1)

The Chambers of Commerce generally have a favorable image among most of the French enterprises interviewed:

*“We know that in the Chambers of Commerce, there are also very competent people. Sometimes they can provide interesting information about the potential clients, suppliers or competition to us.”* (Interviewee 3)

Two of the enterprises interviewed attended trade missions abroad that they found particularly appealing. They stated that trade missions permit the direct access to potential clients and a direct approach of foreign markets, and thus, experience and knowledge. From this point of view, they are similar with the participations in trade fairs. Three of the managers interviewed reported not acquiring such information at all anymore. The reasons are the time necessary to get this type of information, the fact that they cannot always directly contact someone in the governmental assistance bodies when they need them, or the fact that information was too general and not very actualized. However, enterprises did not use the export assistance bodies on a general basis; they address them only if they have a particular need.

Export marketing research (EMR), undertaken externally by a consulting enterprise is used by two of the enterprises interviewed. The companies who used it, considered EMR reliable because it gives specific answers to their questions:

*“We have for example an intuition about the development of our business on a certain market... We’ll ask an consultant to develop our ideas... to do a market research for us, see how can we position our brand, how do the other brands share the market, which is the structure, the segmentation on that specific market... all this kind of stuff... Actually they prepare all the information we need, we do a briefing and further on, they find it.”* (Interviewee 1)

All the enterprises interviewed mentioned the Internet as a widely used source of information about foreign markets. They mainly stressed the importance of Internet from the point of view

of the quantity of information it provides. Mainly two different ways of using Internet can be distinguished: as a relational informational technique, (e.g. asking for information from a contact established abroad), and as a possibility of identifying new customers or acquiring general information about foreign markets, which seems to replace the use of export assistance bodies. Some of the enterprises doubt the reliability of some of the data on Internet: *“Internet... I would say is a partial information mode... I say partial as for example a distributor could have an excellent web site and partially distort the information he puts in it.”* (Interviewee 6)

All the information sources mentioned by the eight enterprises interviewed are computed in the Table 24 according to the classification proposed by Souchon and Diamantopoulos (1999). Internet was added as well.

Table 24. Export information sources mentioned by the French managers

Export information classification		
Export marketing research	Export market intelligence	Export assistance
Consultancy groups	<ul style="list-style-type: none"> <li>▪ Agents/distributors</li> <li>▪ Magazines/trade journals</li> <li>▪ Competition</li> <li>▪ Contacts/networking/traveling</li> <li>▪ Customers/market</li> <li>▪ Exhibitions</li> <li>▪ Trade fairs</li> <li>▪ Internet</li> </ul>	<ul style="list-style-type: none"> <li>▪ Chambers of Commerce</li> <li>▪ DREE</li> <li>▪ Business meetings organized by the CCI</li> <li>▪ Trade missions</li> <li>▪ Internet</li> </ul>

#### V.2.2.1.2 Export information elements acquired on foreign markets

When asked what kind of information elements they acquire on foreign markets, French managers also focused more specifically on clients and competitors:

*“Knowing the clients and the competitors means knowing the market.”* (Interviewee 3)

*“We generally look for competitors and clients. By knowing the competitors well you know if you have a chance for selling products in the market and you need to know the clients to sell efficiently.”* (Interviewee 5)

Table 25. Overview of the export information practices of French SMEs

<b>Interviewee</b>	<b>The favorite export information source and the main reasons for preference</b>	<b>Other export information sources they judge as useful and they use on a current basis</b>	<b>Main export information elements acquired on foreign markets</b>
Interviewee 1	Trade fairs and foreign clients: direct access to information, adequacy and quality	Clients, Internet, CCI, market research, agents	Clients and competitors, marketing mix, general market information
Interviewee 2	Foreign clients : the adequacy of information	Agents, trade fairs, Internet, competitors, formalized network	do not acquire information
Interviewee 3	Foreign clients and trade fairs : the adequacy of information, the direct access to information, the possibility to interact with information sources around the given information	Trade fairs, Internet, CCI, market research	Clients, competitors, marketing mix
Interviewee 4	Foreign clients: the adequacy of information, the experiential character	Internet, CCI	Clients and competitors, marketing mix , general market information
Interviewee 5	Foreign clients : the adequacy of information, the interactivity with information sources	Trade fairs, Internet	Clients and competitors, marketing mix
Interviewee 6	Foreign clients : the adequacy of information, the interactivity with information sources	Internet, CCI, market research	Clients and competitors, marketing mix
Interviewee 7	Foreign clients : the adequacy of information, the experiential content	Internet, CCI, market research	Clients and competitors
Interviewee 8	Foreign clients: availability, facility of contact, information quality	Internet	Clients and competitors, general market information

Again, clients and competitors were mentioned by all companies. This reinforces the market orientation literature assumptions concerning the key importance of information coming from clients and competitors. The managers interviewed also mentioned aspect related to the marketing mix:

*“We need to know whether our prices and products correspond to the clients needs. Sometimes in countries with lower levels of development it’s not that obvious.” (Interviewee 4)*

*“We try to see if the quality levels are the same. This is because we sell high quality and expensive products...” (Interviewee 7)*

Three of the managers interviewed (Interviewee 1, 4 and 8) mentioned the general market background information. Namely, the managers of two enterprises referred to the level of development of the countries they are exporting in, exchange rates and other specific business related practices in the country.

#### ***V.2.2.2 Export information use***

As in the case of Romanian enterprises, several ideas extracted from the interviews, are that information use in the enterprises interviewed takes different forms. The main role of export information within the French firms appears to be in the learning process. Again, French companies seem to learn in a generative, responsive way:

*“Information helps us to keep track of what’s new in our industry. We always have an eye open on our competitors, to see how they conduct their business. Sometimes we imitate their practices and sometimes we try to be ahead of them.... Sometimes it works, sometimes it doesn’t. But I always considered one can learn from their mistakes.” (Interviewee 4)*

*“If we keep informed we can seize the tendencies and follow them. It is the main input for taking action. If we had no information we would not know how to act.” (Interviewee 7)*

Information plays an important role within the decision-making process. Most of the firms interviewed explained information is a main input for decision-making:

*“Information is vital when we need to make a decision. Then it is vital to have information on time and we search for it. Sometimes I just hear things like in a certain country, there are some business opportunities or some new technological advances have been made in our industry”. (Interviewee 8)*

*“We need to make decisions every day that are more or less important. And with this respect, we always need information... This general principle applies to the export activities as well.”*

(Interviewee 3)

Another aim was to test the decision-making types suggested by Souchon and Diamantopoulos (1999), namely the dissociation between instrumental/conceptual use and the conceptual use of export information. Regarding the instrumental/conceptual use of information, French managers also distinguish between the different situations: (1) the strategic decision making (e.g. the choice of a new exportation country), decisions which encounter major changes within the organizations and (2) less constraining decisions, as choosing a new client for example. In both cases, enterprises are more likely to use informal information techniques. It seems that the social contacts network plays a critical role in regards to decision-making. For choosing new clients, managers usually try to check the reliability of the new client by more formal ways (COFACE for example).

When it comes to strategic decision-making, managers take the most of the possible cautions. Some of them contact a consultant to aid them in dealing with it or contact a maximum of potential sources as CCI, embassies, Internet, business contacts, etc. When asked how they choose to approach a new exporting country, most of the managers tried to first check if their products correspond to local tastes, if there is still place for them in that market, competitors positioning and prices, and some macro-economic elements of information.

Concerning the decision-making process (instrumental information use), the majority of managers explained they base their decisions partly on intuition, but mainly base their decisions on factual information. Their testimonies suggest that their decision-making is mainly rationalistic. Usually decision-making is quite centralized. C.E.O.s seem to have the last word, but they previously consult directors of exporting, commercial, financial or other departments. The majority of enterprises count that the information they acquire through their industrial magazines, Internet or export assistance means, helps them to increase their general knowledge about foreign markets, an instant of conceptual use of information.

It was again difficult to test the symbolic use of export information. Faced to an unknown person, managers tempt to give politically correct answers or even avoid giving certain answers. Consequently, direct questions could not have been asked relative to the symbolic use of information. Managers were asked if when they find retroactively information to support their previous “*bad*” or “*good*” decisions, they present it to their employees. The

majority of them avoided answering this question. As a result, it was difficult to test whether the managers of the enterprises interviewed used export information symbolically.

Interviewees suggest that the acquisition and use of export information is not done by only one person in the company. There are generally two persons who do it, frequently the sales or the technical director and/or the general manager. The enterprises, which employ agents abroad, use them to collect foreign market information. Moreover, when asked which use they make out of export information most frequently, some of them (with Interviewee 7 and 4 as exceptions) emphasized the role of international environment scanning for the success of their business:

*“Information is diffuse... one should always continuously scan for information. Information is everywhere. We have to always stay awake in order to identify opportunities.”* (Interviewee 2)

It seems they perceive that information plays an important role in opportunity detection. There are only two interviewees (Interviewee 7 and Interviewee 5) who do not engage any efforts in scanning and declared they do not use export information in any way. It worth to be noted that Interviewee 7 is the managers of a subsidiary. The manager interviewed declared that:

*“Our customers are sent by the mother company in Germany. We don’t really search for information.”* (Interviewee 7)

Interviewee 5 declared not being very interested in developing export activities: *“It is not really our aim. We concentrate on the French market and if there are some orders coming from abroad they are welcomed, but we don’t invest time or money in looking for them.”*

### ***V.2.2.3 The factors enhancing export information exploitation (managerial perception)***

When asked what helps them to maximize the use of new incoming export information, French managers mainly mentioned their previous knowledge and experience on foreign markets. Contrastly, they did not refer to the “sense” for doing business, which is similar to the entrepreneurial capacity of firms’ managers, as Romanian managers did.

*“It is finally a matter of experience. This helps us in most of the case when we are confronted to new situations.... We evaluate the new information based on what we did before.”*

(Interviewee 4)

*“The more we know, the better we evaluate new information and make the right decisions.”*

(Interviewee 1)

*“We develop international activities since quite a while now. With time, we learned a lot about foreign markets and clients. There is always a bit of surprise with every new contract, but nevertheless our experience guides us quite well.”* (Interviewee 6)

*“Finally it is our experience and knowledge which helps us to orient ourselves in foreign markets.”* (Interviewee 2)

#### ***V.2.2.4 The practices enhancing information use within firms***

French managers were asked to which extent the communication around export information and also the coordination practices were efficient in their enterprises. The managers interviewed all declared that there were any particular problems in terms of communication and coordination in their firms. The transfer of information in the firm is mainly informal:

*“We generally transfer information just by simply communicating with each other during lunch or any other time of the day.”* (Interviewee 4)

Concerning the integration of the acquired export information, three of the French enterprises interviewed seem to use databases for tracking their previous contracts with export firms. Only Interviewee 1 explained that after every contract they sign with a foreign client abroad they keep track of the positive and negative points they met in dealing with the client. Generally, it appears the organization structures are not very formalized concerning the transfer and the integration of information. A summary of the efficiency of the coordination and communication practices implemented in the companies interviewed can be found in Table 26.

Additionally, investigated was the degree of centralization and formalization of the companies interviewed. The results were entirely homogeneous, in the sense that all companies interviewed are rather centralized and informal structures. Generally, the manager and the export/marketing managers of the firm undertake export information activities and decisions are made on a common agreement basis between the two managers. The interviewees stated that they consult someone in the company when making decisions. In regards to the export information acquisition and use activities, it appears again that a relatively limited number of top management employees develop this kind of activities.

Teamwork seems to be the usual way of work of the companies interviewed for the simple reason that the managerial team works closely for the management of the main projects in the company. As a result, it appears that studying teamwork does not make much sense in SMEs.



Table 26. Information use and factors enhancing information use in French SMEs

Interviewee	Export information use	Factors enhancing export information use	Other aspects: coordination, communication, information transfer and integration		
			Coordination	Communication	Information transfer and integration
Interviewee 1	Responsiveness, decision making, Conceptual/instrumental use	Foreign market experience and knowledge	Efficient and informal	Efficient and informal	Averagely efficient and informal
Interviewee 2	Learning, decision making Conceptual/instrumental use	Foreign market experience	Efficient and informal	Efficient and informal	Averagely efficient
Interviewee 3	Learning, responsiveness, decision making Conceptual/instrumental use	Foreign market knowledge	Efficient, both formal and informal	Efficient and informal	Averagely efficient and mainly informal, use of databases
Interviewee 4	Learning, decision making, Conceptual/instrumental use	Foreign market experience, intelligence	Efficient and informal	Efficient and informal	Efficient and informal
Interviewee 5	Learning, responsiveness Conceptual/instrumental use	Foreign market knowledge and experience	Efficient and informal	Efficient and informal	Averagely efficient and informal
Interviewee 6	Decision making, responsiveness	Foreign market experience	Efficient and informal	Efficient and informal	Efficient and informal
Interviewee 7	Decision making, sense making, responsiveness	Sense for business, foreign market experience	Efficient and informal	Efficient and informal	Averagely efficient and informal
Interviewee 8	Decision making, learning	Foreign market experience and knowledge	Efficient and informal	Efficient and informal	Averagely efficient and informal

### *V.2.2.5 Other aspects*

French enterprises mainly plan their international activities at short and middle term (6 months – 1 year). Only two of them establish long-term plans. In addition, there are differences between the two industries; textile companies have shorter planning spans than enterprises from the steel industry.

Concerning the presence modes used for selling abroad, most of the enterprises interviewed used indirect exporting foreign presence modes, and only two enterprises used direct presence modes abroad as agents. Their internationalization presence form on foreign markets is generally quite basic as well as their organizational structure. Only two companies (the larger ones among the SMEs, Interviewee 3 and 6) have an export department. In the other companies, generally the commercial director and the general manager deal with exporting activities. The informal coordination mechanisms managers use for communicating and coordinating information within the organization are worth noting.

From the competitive advantage point of view, French enterprises follow innovation, niche or even brand strategy. It is important to note that the enterprise developing brand strategy has an export department (Interviewee 3). Additionally, when enterprises were asked what they have that differentiates them from their competitors, the majority answered either marketing, technological or production knowledge and international experience: *“Finally it is our experience and knowledge which help us to orient ourselves in foreign markets.”* (Interviewee 2)

## **V.2.3 General conclusions relative to the export information management by exporting companies from France and Romania. A comparative analysis**

The interviews undertaken with French and Romanian enterprises suggest that there are of course similarities and differences between the companies acting in the two countries settings. The results are discussed hereafter.

### *V.2.3.1 Export information acquisition*

Both, French and Romanian SMEs’ managers prefer informal to formal information techniques. Numerous studies undertaken in Western contexts have found similar results

before, acknowledging the marked preference of SMEs for informal export information vehicles (e.g. Hart *et al.* 1994; Leonidou and Katsikeas 1997; Hart and Tsokas 1999).

This exploratory research further explores the reasons as to why these information sources are preferred. The managers interviewed mentioned the experiential nature of these information sources, the trust they have in their providers, the ability to exchange and debate points of views with someone competent in the field (interactivity), the speed of obtaining the information as well as getting specific answers to their questions (the adequacy between information and their needs and context). The enterprises converge quite a lot on the reasons evoked for explaining the preferences in terms of information sources, independently of their nationality. Worth noting is that the most praised reason for explaining the preference for a certain information source is the adequacy of the information to their needs. Under time pressure and high uncertainty conditions, managers turn towards clients for acquiring the adequate information in accordance with their needs. Foreign clients represent by far the most popular export information source for both, French and Romanian managers. The marked preference for clients of the SMEs' managers has also been acknowledged by previous studies. Participation in trade fairs and the sales people/agents they use to manage their activities on foreign markets were also mentioned among the favored information sources on foreign markets. Even though they do not necessarily trust them, both Romanian and French managers believe it is important to keep in touch with competitors. The feeling of mistrust towards competitors seems to be more present for French than Romanian managers. It can be mentioned that competitors are more frequently mentioned among the favorite export information sources of Romanian managers compared to French counterparts.

Concerning the formal information techniques, French enterprises use them more extensively than the Romanians do. They seem to be more aware and use export assistance related information sources on a wider scale. The Chambers of Industry and Commerce have an especially good image in France. Reserves were expressed concerning the export assistance related information sources. The main reasons managers mentioned for not using export assistance related information sources are bureaucracy, the difficulty to get the right interlocutor to speak with, and the general and dated character of the information provided by governmental bodies. The main perception difference between Romanian and French enterprises is the fact that most Romanian enterprises accuse governmental bodies of corruption. This is an outcome of the institutional business environment in Romania, which is constantly changing since the Romanian Revolution in 1989. The domestic environment

situation might also explain the preference for informal information techniques, as there are studies, which prove that under unstable and changing environmental conditions, enterprises tend to just use rich information sources, mainly informal by nature (Beal 2000).

Among the export assistance information sources, the organization of trade missions abroad is also unanimously appreciated by Romanian and French enterprises as it provides them direct contact with customers and markets. In the meanwhile, only a limited number of enterprises attended trade mission programs and are not necessarily informed concerning the exporting aid programs.

The use of international marketing research is in the French context quite common thing. In the Romanian context, marketing research use is exceptional. From a perception point of view, Romanian enterprises consider it useful, but it is difficult to realize in which extent they understand what marketing research really is as marketing science was only developed about 15 years ago in Romania and most of the interviewees have a technical background. The French enterprises which use marketing research, consider it useful as it can provide specific answers to their questions, they trust the person who undertakes the study, and they can discuss certain aspects with this person in the marketing research. The only Romanian enterprise using marketing research had a similar testimony.

Resuming, the information sources that appeared to be most appreciated and used on a current basis by French and Romanian enterprises are the following: the clients, the competitors, participations at trade fairs, distributor/agents, Chambers of Commerce and Industry, export marketing research and the Internet. The analysis suggests that the use of a certain information source is made with respect to the attributes or qualities this certain information source provides to managers, such as the adequacy to their needs, reliability, timeliness or the possibility to exchange points of view about the acquired information. Thus, the qualitative research confirms that retaining information sources richness (Daft and Lengel 1984) as an angle for studying firms' export information related behaviors is consistent with the managerial view.

In relation to the information types they primarily get about foreign markets, both Romanian and French SMEs mainly acquire export information about foreign clients and competitors. These findings reinforce the market orientation perspective application in the case of small firms as well. An important number of SMEs' managers also search for information concerning the marketing mix for the product on export markets, and only several of them acquire generalized foreign market information. In the meantime, French managers are more

sensitive to general foreign market information concerning the degree of economical development, exchange rate fluctuation, etc. This specific interest can be explained by the fact that French SMEs export towards countries where the levels of development are lower. The Romanian companies interviewed however, export more in mature markets like the E.U. or the U.S.

### *V.2.3.2 Export information use*

Export information use in French and Romanian enterprises takes several forms. In the first place, it seems that information represents the main input for undertaking responsive action and decisions concerning foreign markets. Export information appears also as an input for the single loop, generative learning in small firms. As SMEs interviewed acquire foreign market experience, they learn by responding to the inputs given by the new acquired information. Romanian and French managers highlighted elements related to the managerial sense making, and on opportunities detection.

Considering the bi-dimensional classification of information use in instrumental/conceptual and symbolic use, all companies attest to conceptually use export information. When it comes to instrumental/conceptual use, materialized by the decision-making, French enterprises seem more rational, trying to often use more formalized information vehicles and also informing themselves more extensively concerning foreign markets parameters than Romanian enterprises. Romanian enterprises easily trust their social network and seem to take more risk than French enterprises. During one interview, one of the Romanian managers expressed: *“if we can do business in this jungle, we can do business everywhere”* (Interviewee 5). The changing Romanian business environment could be the reason for the risk taking propulsion and somehow more reduced uncertainty avoidance of Romanian managers compared to the French. The environment could also explain why Romanian enterprises use relational information sources more extensively than the French ones. Under more difficult environmental conditions, managers turn themselves towards personal information sources (Pelham 2000). Therefore, it would be interesting to consider the domestic versus international environmental perceptions of managers when comparing two country settings.

Concerning the symbolic use of information, it is not that easy to find an explanation as to why Romanian enterprises use it more extensively. Nevertheless, it was difficult to test the symbolic use of export information within the French context. Hofstede (1980) suggests that

in ex-communist countries, the power distance is higher and the study of Souchon *et al.* (2003) suggests that symbolical use of information is positively linked to power distance. This could explain why Romanian managers confess more easily using symbolically export information.

Furthermore, it seems that several theoretical frameworks would capture export information use within firms: decision-making theory, entrepreneurial framework, learning theory and market orientation perspectives. Concerning the learning process, small firms seemingly learn as a result of a trial-error process as information brings the necessary inputs for changes to occur within the firm. Enterprises react to information, and based on their experiences, they learn on an incremental basis. It is worth noting that these same ideas characterize the market orientation perspective. Regardless, the aim was not to specifically capture the foreign market based learning process; this finding is inherent from the interviews.

The general conclusion with respect to information use in firms is that only one theory would not necessarily and completely capture the complexity of information use in firms. It appears that rather a combination of elements from several theoretical frameworks would best capture the phenomenon. As a result, one can observe that the qualitative research supports the use of an integrative theoretical framework such as the KBV perspective, as it was already previously suggested within the theoretical part.

### *V.2.3.3 The factors enhancing export information exploitation (managerial perspective)*

With respect to the factors enhancing export information exploitation in small firms, it seems that both Romanian and French managers agree that international experience and knowledge enhance information exploitation. The managers interviewed state that the more they acquire foreign market related knowledge and experience, the better they feel they are able to exploit information. Romanian managers also mentioned that some people have a “*sense for business*,” for grasping the opportunities, which helps them to make use out of export information.

One can observe that as suggested within the AC framework, the previous firms experience seems to have an influence upon export information acquisition and assimilation capacities. The observation that the previous foreign market knowledge helps them to better make use out of the new incoming information also supports the idea that the new information adds to the previous existing knowledge stock, providing guidance for future action. Thus, the

conceptualization of Nonaka (1994) of information as a flow, continuously enhancing the knowledge stocks of firms, seems to hold true based on the managerial statements.

The “*sense for business*” mentioned by the managers, seems to be close to the cognitive capacity of exploiting information that is similar to the entrepreneurial orientation of firms and managers. The cognitive dimension of the AC construct, referring to firms’ capacity to exploit information to commercial ends (Cohen and Levinthal 1990), stems from the cognitive bi-association process of being able to combine and exploit two apparently unrelated pieces of information (Zahra and George 2002).

#### *V.2.3.4 The practices enhancing export information assimilation within firms*

Most of the Romanian and French managers interviewed suggest that both communication and coordination procedures in their companies are efficient and informal. Coordination and communication generally occur informally through “*water-cooler*” conversations, or company social events. These findings confirm the results of previous studies on SMEs, suggesting that communication in SMEs is efficient and barely formalized (Julien 1998; Torrès 2004). Huber (1991) and Nonaka (1994) stressed the critical importance of communication efficiency.

Nevertheless, coordination seems less efficient in bigger French SMEs and the two big Romanian enterprises interviewed. The results somehow suggest that coordination is more efficient in smaller firms.

Similar observations can be made in terms of the procedures used for transferring and integrating information in SMEs. More formalized information integration and transfer procedures as sales reporting systems, or company newsletters are widely missing in SMEs. Nevertheless, the use of such procedures has the advantage of keeping track of information, avoiding its distortion, and thus, favoring its future exploitation in organizations, in spite of the personnel’s fluctuations (Levitt and March 1988; Simon 1991). In both countries, the enterprises are characterized by high centralization levels in terms of decision-making. In addition, companies seem to be characterized by low levels of formalization.

The international decision-making process is quite centralized between the manager and other sub units’ managers within the company and with little exceptions, the acquisition and use of export information is mainly done by these same people. These results confirm findings of

previous studies on SMEs, which are generally characterized by decision-making centralization (Julien 1993, 1994; Brouthers *et al.* 1998; Torrès 1999).

Often times, it appears that the assimilation practices investigated: communication, coordination, information transfer and integration in SMEs are rather efficient and informal with several exceptions for the coordination and information transfer and integration practices in “*bigger SMEs*” and large firms. Companies interviewed are also generally centralized structures, where decisions incomb generally to the general managers of the company.

These findings confirm previous studies in the field, and the conclusions gathered within the literature review in the previous chapter suggested that little variations could be found when exploring communication efficiency in SMEs. Meanwhile, different levels of coordination capacity and formalization in terms of information transfer and integration procedures may characterize small firms.

The results suggest it does not make much sense to study the teamwork in SMEs. In SMEs, the managerial team constitutes an on-going teamwork for the management of all the activities of the company. The SMEs’ managers interviewed generally believe that the employees are informed concerning the strategic goals of their company and they know how they can be of use for enhancing the achievement of these goals.

#### *V.2.3.5 Other aspects*

Both Romanian and French enterprises mainly used indirect selling as an international presence mode. Some of the companies were subsidiaries of a bigger group and some of them used agents for selling their products abroad. Those using agents appreciate them as an excellent source of information on export markets. As far as subsidiaries are concerned, they usually do not proactively search for export market information, as the mother company performs this activity.

The organizational structures of SMEs in both countries are similar, with a few exceptions. French and Romanian enterprises do not have exporting departments within the company, and the management of the exporting activities is generally ensured by the owner/manager himself or the production or sales director of the company. Generally, the coordination and communication mechanisms within the enterprise are not formalized. Marketing or R&D departments are in both cases, not very common.



A clear distinction between Romanian and French enterprises is relative to their international experience. The biggest part of Romanian enterprises began developing international activities only after the Romanian Revolution. A part of them might have developed international activities (at the enterprise or managerial level) during communist times. This feature dealinates Romanian from French companies, which are generally more experienced internationally. It worth to note that the free market economy is a relatively new organization of the Romanian economy that was previously planified. These institutional differences explain, at least partly the differences of SMEs' export information behaviors, such as the differences of the perception of export marketing research and export assistance information sources between Romanian and French SMEs' managers.

#### *V.2.3.6 General conclusions impacting the research design*

The semi-directed interviews realized with French and Romanian enterprises represent a preliminary qualitative emic research aimed to obtain additional insight to the way Romanian and French enterprises manage export information. The results issued from the preliminary research help construct the questionnaire, but also partly bring empirical support for the research model built in chapter III.

For the questionnaire construction, the export information sources that have been judged as rich and are used on a current basis by SMEs' managers are the following: foreign clients and customers, agents, trade fairs, Chambers of Commerce and Industry, export market research and Internet. This study brought insights into the reasons evoked by SMEs' managers for explaining their preference for these export information sources, the experiential nature of these sources, the trust they have in their providers. The study also sheds light on the fact that through this mean they can exchange and debate points of views with someone competent in the field (interactivity), and that they can receive specific answers to their questions (feet between info and context). Managers interviewed, independently of their nationality, converge quite a lot on the reasons evoked for explaining the preference in terms of export information sources. However, the reasons evoked for explaining the preference for export information sources show that retaining the information sources' richness perspective for studying the perception of export information sources, as suggested by Ramangalahy (2001), is appropriate. This finding confirms the theoretical conclusion emitted at the end of chapter II after a critical analysis of the theoretical frameworks explaining the link between

information and performance. It was concluded that authors converged a lot concerning the importance of information richness perspective for studying export information sources.

When it comes to the use of export information, several ideas come from the interviews. Managers learn by means of responding to the acquired export information and they use information for making export decisions and for grasping opportunities in export markets. Concerning the learning process, it seems to rather follow the generative single loop path. Managers are sensitive to the information coming from their foreign clients or competitors, they react to it, and furthermore under a trial-error selection process, they select the practices that have worked best for them in the past for taking future action.

The information seems to also be primordial in the decision-making process. The managers interviewed explained that when it comes to decision-making, they prefer personal information sources, as they quite often seem to react under an important time pressure, and need the right information at the right time. The managers explained that formalized information sources are useful when there is necessary time to make decisions. Another aspect from the decision-making process is that all the managers interviewed suggested that they consult at least one person regarding decision-making. In most of the cases, this person is the exporting or production director in their enterprise. The managers interviewed also revealed the role of information in opportunity detection in terms of foreign business development. This idea represents a basic premise of the entrepreneurial research stream.

Generally, SMEs' managers mainly acquire export information concerning clients and competitors. This observation reinforces the initial empirical qualitative study on enterprises' market orientation, undertaken by Kohli and Jaworski (1990). The authors have emphasized the key importance of knowing clients and competitors and their use as information sources. Besides clients and competitors, on a less extended scale, enterprises access marketing mix related information parameters and rarely access general foreign market information.

In the light of the above results, it can be concluded that elements from multiple theoretical frameworks can explain export information use in SMEs, such as the organizational learning theory and the market orientation perspective, the entrepreneurial framework, or the decision-making theory. It worth to be noted that the conclusion drawn in chapter II concerning the fact that the complexity of the information state of organizations would be difficult to be captured by using a single theoretical framework seems to be confirmed on the empirical level.

The factors enhancing export information use according to the managerial vision were also investigated. The results show that previous foreign market knowledge and export experience that firms have acquired helps them better exploit the new incoming export information. The results also confirm several theoretical assumptions emitted by the organizational learning scholars that view organizational learning through an informational perspective such as Cohen and Levinthal (1989, 1990, 1990) or Nonaka (1994). It seems that the information does indeed add to the existing organizational stock of knowledge as suggested by Nonaka (1994), by enlarging or modifying the previously existing stock of export knowledge in organizations. The access to information sources is also seen as an antecedent of the knowledge assimilation capacity of organizations within Zahra and George's (2002) AC framework. Within the same theoretical framework mobilized in this research, the previous experience appears as an antecedent of the export information assimilation capacity of organizations. This theoretical assumption seems to converge with the managerial vision as well. Managers stress three main aspects relative to the export experience qualities: the variety, the complementarity and the length. These aspects also seem to be necessary in order to efficiently make use out of export information. Recall that Cohen and Levinthal (1990) also highlighted these aspects in enhancing a firm's absorptive capacity.

Furthermore, the efficiency of several information assimilation procedures, such as the coordination, communication transfer, information transfer and integration practices were explored specifically. Additionally, the centralization and formalization degrees of organizations were explored. The empirical findings once again confirmed the literature review's assumptions concerning the high level of efficiency of the communication in SMEs, and the low formalization level. The coordination and the information transfer and integration procedures are barely formalized. In most of the SMEs interviewed, information integration procedures are almost non-existent. Coordination is sometimes not necessarily efficient and it seems that in bigger firms, coordination appears less efficient. Concluding, the theoretical analysis that conducted the selection of the coordination and information transfer and integration capacity of small firms in order to capture the information assimilation dimension of the absorptive capacity construct seems to be appropriate.

The results also showed that it does not make much sense to study teamwork in SMEs since the managerial team does on an on-going basis teamwork for broadly managing the company. Also, it does not make much sense to study the inter-departmental collaboration neither since the departmentalization does not really characterize the SMEs interviewed. Generally, the

management team accomplishes several tasks at the same time and no clear task definition exists in the companies. Another issue discussed in the interviews is planning. Only one of the enterprises interviewed used formalized procedures of planning. The rest of the enterprises interviewed argued that their agendas are basically used to organize the deadlines of their activities.

When asked what leads their company to achieve higher levels of success in export markets, both French and Romanian managers mainly mentioned their competences in terms of product development and more largely, the general export know-how. The managerial vision seems to be in accordance with the KBV perspective's proponents that firms, which detain higher tacit knowledge levels seem to perform better (e.g. Grant 1996; Kuivalainen and Bell 2004).

In the light of the above statements, the qualitative research seems to rather confirm the research model elaborated based on the AC framework in chapter III. More precisely, managers seem to support the idea that information flows nurture foreign market related informational knowledge levels. Managers also believe that the levels of export experience condition their capacities in terms of export information acquisition and exploitation. The findings confirm Zahra and George's (2002) assumptions that the access to information sources and the previous experience of firms are antecedents of their capacity to efficiently acquire and assimilate information.

Furthermore, the role of information in designing organization response was widely supported by the interviews. Moreover, several statements also show that the enterprises interviewed seem to learn on the basis of an ongoing responsiveness action implementation, and in this way build foreign markets competences that finally seem to enhance their levels of performance in foreign settings. Resuming, the results obtained through the qualitative phase also support the idea of the influence of PACAP's dimensions in regards to information acquisition and assimilation on RACAP; export information is used to respond to foreign markets shifts and build market related competences. Moreover, according to the managerial vision, finally their foreign market related know-how drives them to be competitive in terms of export success. The research proposition (emitted within the research model development in chapter III) concerning the impact of their foreign markets related competences on their degree of international performance seems to also be confirmed.

Concluding, it can be said that mostly, empirical results issued from the qualitative research, seem to support the research model build on the basis of the absorptive capacity perspective

in chapter III. However, the exploratory nature of the qualitative study cannot confirm or infirm the research propositions advanced in chapter III. Furthermore, based on the findings of the qualitative research and the literature review, the questionnaire aiming to test quantitatively our research model framework is elaborated. The questionnaire development and pre-test phase are presented in the next section of this chapter.

### V.3 Questionnaire development

Based on the literature review and the insights obtained by the qualitative research undertaken with French and Romanian SMEs, a first draft of questionnaire was elaborated (see Appendix 3). At this stage of the process, it was interesting to gather quantitative results in order to explore the generalization potential of the results. The structured postal questionnaire was used for collecting our data. The reason why this technique is used is because the population of our study is geographically dispersed all over the country (exporting SMEs from the steel industry). Even though a self-administered technique like the postal questionnaire does not allow the control of the way the questionnaire is filled out, it is a cost and time saving method. Moreover, structured questions are easy to tabulate and exploit, and standardized questions are designed so that all respondents reply to the same questions and have the same response options (Giannelloni and Vernet 2001).

The measurement scales employed to capture the constructs in the research model were all drawn from previous studies where they have been pre-tested for their psychometrical properties. Nevertheless, several of them have not been previously employed in French language-based studies. For example, the export responsiveness scale developed by Cadogan *et al.* (1999) has not been previously translated into French. For this reason, parallel translation procedures are used in order to make sure that the translation into French would be best performed. Two professional translators have realized the translation of the items from English to French and the two versions have been afterwards compared and adjusted when needed. The initial measurement scale of Cadogan *et al.* (1999) of the export responsiveness concept was made up of 17 items. Two items were very difficult to translate into French, namely “*It takes us forever to decide how to respond to price changes on our export markets*”, and “*Foreign customer complaints fall on deaf ears in this company*”. The two

parallel translations of these items are very different. For this reason, only the remaining 15 items are kept in order to capture the export responsiveness construct to ensure the most satisfying translation of the items composing it.

The initial version of the questionnaire has been subjected to a process of validation through pre-tests. The pre-test of a questionnaire shows how it performs under actual conditions of data collection. For this assessment, the questionnaire pre-test is vital. Several pre-tests are recommended according to Gilbert and Dawn (2005).

### V.3.1 The “qualitative” questionnaire pre-test

First, ten scholars were questioned for the questionnaire pre-test. All scholars have research background in marketing or research methodology. Three of the scholars are professors who are respectively specialized in marketing, strategy or research methodology. The remaining seven scholars are doctoral students who are also at least accustomed to research methodology. Second, 12 SMEs’ managers, responsible for the development of export activities in their companies were questioned for pre-test purposes. Among the 12 managers, six are Romanian and the other six are French. As suggested by Brislin (1981), back and forward translations of the questionnaire from French to Romanian were realized in order to ensure the questionnaire translation equivalence. I translated myself the questionnaire into Romanian, and the Romanian version was back-translated in French by a professional translator. Afterwards, the two French versions have been compared and adjusted when needed.

The questionnaire was pre-tested with six Romanian managers responsible for the export activities in their company. The pre-tests had lasted between 40 minutes and an hour and a half. They were realized between August and September 2005. Afterwards, between October 2005 and March 2006, the questionnaire was pre-tested with six French managers. Pre-tests had durations comprised between 40 minutes and an hour.

The second stage of the process of the questionnaire validation through the pre-test led to the reformulation of the questions considered ambiguous and to the withdrawal of the questions considered redundant. Several questions that could not be understood correctly by respondents were also discarded. As a result, several major modifications had to be made to the questionnaire. For example, several important adjustments had to be done in respect to the international performance construct. The managers interviewed encountered difficulties

concerning the questions about the growth or decline rate of the export sales abroad over the last three years, which is relative to the objective measures of the international performance. The managers interviewed not only did not remember exactly how much they sold abroad three years ago in terms of turnover or percentage of sales abroad but they also had difficulties in calculating a progression ratio of their sales over the last three years. As a result, all these objective measures of the international performance construct were finally aborted from the analysis. The general conclusion was that instead of getting objective data, a perceptual approximation of these numbers would have been obtained. As a result, the DIANE database was used to collect the financial international performance related data of the companies interviewed. More specifically, in DIANE database the average progression ratio of export sales and profits over the last three years are available. This alternative was considered as a viable way to make sure that data obtained is unbiased by human recall capacity and perception.

In the same vein, the managers explained that the questions concerning the perceived satisfaction, competitiveness, relative competitiveness (compared to the main competitors on export markets) with the evolution of the export sales, profits, and the progression of sales abroad over the last three years were difficult to answer. They stated they could not answer exactly how their business was progressing three years ago. Instead, the managers suggested an accurate answer concerning their satisfaction with the development of their export activities over the last year. By taking into account their observation, the respondents were finally asked to provide their satisfaction degree with the evolution of the export objectives only over the past year.

The strategic measure of the international performance of SMEs, assessing their competitive position in export markets had to be aborted as well. They were initially asked to allocate 100% among the following dimensions, capturing at best their position on foreign markets: (1) market leader; (2) second to market leader; (3) major supplier, and (4) minor supplier. The companies had difficulties answering this question. Some of them stated they did not understand the exact sense of the question. Some of them stated the situation might be different in every export market and that it is difficult to approximate at the global level. However, all the managers interviewed voiced hesitation in regards to answering this question. As a result, this strategic position measure was excluded from the initial analysis since the general conclusion was that they would have difficulties appropriately answering this question.

Another measure that had to be aborted is the measure of the export experiences' richness. Recall that Ramangalahy's (2001) measure of the experiences richness was adapted to the firm level of analysis in our study. Companies were asked if they have already sold products abroad by means of direct exporting, indirect exporting, subsidiaries, associative modes, license/franchising, or other modes. Each of the foreign presence modes were supposed to be assessed by means of 5-point Likert scales ranging from 1 = "very limited" to 5 = "very extended" on the five following dimensions: the length of the experiences, number of projects or clients, challenge complexity, diversity of contexts and the impact upon a firm's international know-how. The managers interviewed had difficulties in both understanding and rating their international presence modes according to the five dimensions explored. Each time, additional explanations were needed in order to clarify the meaning of each of the five dimensions explored. Since the chosen administration mode was the mail survey, because of the wide spread of the enterprises within the French territory, it was considered that they would have difficulties in answering this question on their own. Thus, it was decided to exclude this export experience measure from the analysis. In addition, another measure that is "qualitative" by nature was used. It is issued from the qualitative preliminary research and the literature review. This measure was assessed on a seven point Likert scale that ranges from 1 = "completely disagree" to 7 = "completely agree". The agreement degree of small firms with three statements concerning the variety, complementarity and length of export experiences of export employees (whom work more than 50% of their working time for the development of exporting activities) was assessed.

The measure used to capture information sources richness was assessed by Ramangalahy (2001) according to five dimensions: contact facility, interactivity, reliability, information quality and contact density on a 5-point Likert scale ranging from 1 = "very limited" to 5 = "very extended". Of the five dimensions, the contact density dimension was the dimension that was not easily understood by the managers interviewed. Several additional explanations were necessary to clarify the meaning of this dimension. Administrating the questionnaire through a mail survey (the method used by our research) would not allow additional explanations/clarifications of the meaning of the contacts' density dimension. As a result, it was excluded from the analysis. The four dimensions maintained in the current analysis for assessing the richness potential of the information sources included: contacts facility, interactivity, reliability and information quantity.



Moreover, for two of the seven information sources analyzed, namely market research and Internet, managers easily gave answers for the estimate of two dimensions of export information richness, which were information reliability and information quality. For the remaining two dimensions of the export information richness, contact facility and interactivity, they had difficulties in providing answers. Moreover, the managers suggested that two dimensions were not appropriate for analyzing Internet and export market research use by SMEs for collecting foreign market related information. Consequently, the use of Internet and export market research was finally assessed only according the two dimensions, namely information reliability and the quantity of export information obtained.

Another measure that was difficult to assess is the level of international marketing competences compared to the main competitors on export markets. The measure designed by Morgan and Vorhies (2005) was adapted to the international markets context. The measure assessed the level of foreign market competences of SMEs' managers concerning their networking skills, marketing mix elements (price, product, distribution, and communication), international market management, foreign market information management and foreign market segmentation. Each of the broad themes that pertain to the foreign markets marketing management has been detailed into several aspects. For instance, in order to assess competences in terms of product development in foreign markets, managers were asked how they rate themselves compared to their main competitors in terms of the competences they have for: (1) providing additional services to export clients, (2) ability to develop new export products or services, (3) developing new products or services in order to exploit R&D investment, (4) launching successful new product sales development, (5) insuring that product or service development efforts are responsive to a foreign customer's needs and (6) the technical development of the product. The managers interviewed suggested that they could not answer for each of the specific mentioned dimensions because sometimes they do not have the necessary information to do so. Instead, they suggested that they could assess their superiority or inferiority in comparison to the main competitors in export markets, in terms of foreign product strategy development in general. This remark was frequently acknowledged and advanced by SMEs' managers. As a result, the scale has been replaced. It was inspired from the scale used by Ramangalahy (2001). Finally, the managers interviewed were asked at the aggregate level how well their company is performing in terms of eight groups of foreign market related competences, which are: (1) international networking, (2) international marketing management, (3) foreign market segmentation, (4) product strategy, (5) price

strategy, (6) communication strategy, (7) distribution strategy, and (8) export information management. The items were assessed by means of a 7-point differential scale ranging from -3 = “much less than competitors” to + 3 = “much more than competitors”, as in the study of Morgan and Vorhies (2005). This measure, by definition, positions the companies interviewed in comparison to the main competitors on foreign markets. Thus, it was considered that it would best capture the idea of positional advantage in terms of international marketing competences and that is the construct that was aimed at to capture with this measure.

Another observation is that all the managers interviewed accused the high redundancy of the items composing the export responsiveness measure of Cadogan *et al.* (1999). Based on their remarks, seven more items were eliminated, the ones that were considered as the most redundant by the exporting SMEs’ managers interviewed. Counting the two items of the same scale dropped after the difficulties encountered with the parallel translations, only eight out of the 17 items for capturing the export responsiveness concept were finally used.

Difficulties were also encountered when managers were asked to evaluate inversed items, especially within the export responsiveness scale. They explained that it is somehow tiresome to read a statement again and then reconsider the measurement scale. As a result, one can observe that they provided answers rather close to the neutral opinion 4 on a 7-point Likert scale for these items. For methodological reasons, these inversed items are not excluded from the analysis since they are supposed to avoid mechanical answers in similar items. Nevertheless, based on the qualitative phase of the pre-test, it can be expected that the quantitative study will find similar response patterns again.

The managers interviewed also explained that they did not appreciate the use of several different measurement scales, especially the mixed use of differential and Likert scales. They suggested that one should not change the metrics of the scales employed since it requires additional attention and effort for understanding the meaning of the employed scales. As a result, within the questionnaire 7-point scales were used, excepting the export information richness measurement scale that was assessed by means of a 5-point Likert scale.

Resuming, the “qualitative” pre-test helped improve the questionnaire by sometimes reformulating several questions or even by just suppressing them in order to assure that the managers interviewed have the information and can answer the questionnaire as best possible. Table 27 synthesizes the modifications operated within the questionnaire after the qualitative pre-test phase. The “adjusted” questionnaire after this “qualitative” pre-test phase is presented in Appendix 4.

Table 27. Recapitulative table of the changes undertaken within the questionnaire after the “qualitative” pre-test

THE INITIAL MEASURES	MODIFICATIONS UNDERTAKEN AFTER THE PRE TEST
<b>PACAP ANTECEDENTS</b>	
<b>The access to export information : export information sources’ richness</b>	
<p>The richness of seven export information sources assessed in terms of five dimensions:</p> <ul style="list-style-type: none"> <li>▪ contacts facility</li> <li>▪ reliability, interactivity</li> <li>▪ information quantity</li> <li>▪ contacts density</li> </ul> <p>(Julien and Ramangalahy 2003)</p>	<p>The contacts density dimension for assessing the export information sources richness was dropped.</p> <p>The information sources richness of export market research and Internet was assessed on only two dimensions, information reliability and quality.</p>
<b>International experiences’ richness</b>	
<p>Export experience richness (Ramangalahy 2001) was assessed according to five dimensions:</p> <ul style="list-style-type: none"> <li>▪ the length of the experiences</li> <li>▪ number of projects or clients</li> <li>▪ challenge complexity</li> <li>▪ diversity of contexts</li> <li>▪ impact upon a firm’s international know-how.</li> </ul>	<p>This measure had to be dropped from the analysis because it was not understood correctly by SMEs managers.</p>
<p>The real export experience - inspired from Kuivalainen and Bell 2004.</p>	<p>Maintained.</p>
<p>The richness of export experiences of export employees in terms of variety, complementarity and length - 3 items, 7-point Likert scale ranging from 1 = “totally disagree” to 7 = “totally agree”.</p>	<p>Added for replacing a firm’s experience richness measure of Ramangalahy (2001)</p>
<b>PACAP</b>	
<b>Information assimilation</b>	
<p>Coordination (Ramangalahy 2001) 4 items, assessed on a 5-point Likert scale ranging from 1 = “totally disagree” to 5 = “totally agree”.</p>	<p>The measurement scale was modified, the items were assessed on a 7-point Likert scale, ranging from 1 = “totally disagree” to 7 = “totally agree”.</p>
<p>Knowledge transfer and integration (Jerez-Gomez <i>et al.</i> 2005) 4 items, assessed on a 7-point Likert scale ranging from 1 = “totally disagree” to 7 = “totally agree”.</p>	<p>Maintained.</p>
<b>Export information acquisition</b>	
<p>The level of export informational knowledge, adapted from Ramangalahy 2001, measured on a seven point differential scale ranging from -3 = “much less than competitors” to + 3 = “much more than competitors”.</p>	<p>The measurement scale was modified, the items were assessed on a 7-point Likert scale ranging from 1 = “much less than competitors” to 7 = “much more than competitors”.</p>
<b>RACAP</b>	
<b>Transformation dimension : export responsiveness</b>	
<p>Export responsiveness (Cadogan <i>et al.</i> 1999): 17 items measuring the agreement degree with 17 statements measured on a 7-point Likert scale ranging from 1 = “totally disagree” to 7 = “totally agree”.</p>	<p>3 items were excluded because of translation problems and the other 6 because of redundancy problems.</p>

<b>Exploitation dimension : achieving positional advantage in terms of international marketing competences</b>	
Positional advantage in terms of international marketing competences, scale adapted from Morgan and Vorhies 2005, measured on a 7-point differential scale ranging from -3 = "much less then competitors" to +3 = "much more then competitors".	Replaced with a scale inspired from Ramangalahy (2001). Respondents were asked to evaluate how companies perceive themselves, compared to their competitors on export markets, in terms of development of their international marketing competences (e.g. relational capabilities, international product, price, distribution, communication strategies, etc.) assessed on a 7-point scale ranging from -1 = "much less then competitors" to 7 = "much more then competitors"
<b>INTERNATIONAL PERFORMANCE</b>	
<i>Quantitative measures</i>	
The rate of export sales and export profits growth over the last 3 years.	Excluded from the questionnaire, instead objective data was drawn from DIANE database.
<i>Qualitative measures</i>	
Satisfaction degree, perceived competitiveness and the relative competitiveness with the evolution over the last 3 years of the market share on export markets, profits from export sales, volume of sales abroad, rate of new market entry .	Rate of new market entry replaced the number of new markets conquered over the last year. Since the managers interviewed stated that they cannot say how satisfied they were three years ago, we asked managers to evaluate their satisfaction degree, perceived competitiveness and the relative competitiveness with the evolution over the last year of the market share in export markets, profits from export sales, volume of sales abroad, rate of new market entry .
<i>Strategic measures</i>	
Competitive position on export markets is the 100% allocation among the following dimensions, that best capture their position on foreign markets as a: <ul style="list-style-type: none"> <li>▪ market leader</li> <li>▪ second to market leader</li> <li>▪ major supplier</li> <li>▪ minor supplier</li> </ul>	Measure excluded because of comprehension problems.
<b>CONTROL VARIABLES</b>	
Export orientation (Cadogan <i>et al.</i> 2001), 3 items assessed on a five point Likert scale ranging from 1 = "totally disagree" to 5 = "totally agree"	Modification of the measurement scale with a 7 point Likert scale ranging from 1 = "totally disagree" to 7 = "totally agree"
Company size	Number of employees

### V.3.2 The “quantitative” pre-test of the knowledge transfer and integration scale

The psychometrical qualities of the measurement scale employed to capture the knowledge transfer and integration concept have been pre-tested within the Romanian context. This scale was only designed and used in a study of reference within the Spanish context on a sample composed by companies of heterogeneous sizes and has never been applied in an export-based study (Jerez-Gomez *et al.* 2005). Thus, not much is known about the cross-cultural validity of this measurement scale. Moreover, one of the items composing this scale referred to the use of teamwork inside organizations. The literature review and the qualitative phase of the analysis suggested that teamwork does not make much sense in SMEs since the managerial team works on an on-going basis as teamwork for broadly managing SMEs' activities. Thus, this item has been aborted. As a result, the scale was pre-tested in December 2005, with a sample of 36 students striving to achieve MBA degrees designed for executives in Romania. Many students in the sample were working in international enterprises at the time (26 out of the 36 students). Taking into account that the scales were not specifically designed for exporting enterprises, their consistency was appropriately evaluated by using a convenience MBA students' sample since they were all currently working in organizations and the broad topics of coordination, knowledge transfer and integration apply in every organization. For exploratory purposes, the scale's dimensionality and internal consistency were tested by undertaking exploratory principal component analysis (PCA) with XLSTAT, which is generally considered by authors as appropriate for exploratory purposes.

The knowledge transfer and integration scale was also assessed on a Likert scale from 1 = “totally disagree” to 7 = “totally agree”. Generally, the three items that capture the knowledge transfer and integration construct reach general values above the middle point of 4. Results for individual items range between 4,68 and 5,02. A PCA of the three items composing the measure reveals a bi-dimensional character of the scale. In as such, the original scale dimensionality has not been confirmed. The first principal component explains 52,87% of the variance. Factor loadings are all superior to 0,7 on the both principal components extracted. It is to note that the communalities of the item composing the second principal component, namely “*The firm has instruments (manuals databases, files, organizational routines, etc.) that allow what has been learnt in the past situations to remain valid*” is particularly low (0,31), suggesting that the variance of the underlying latent construct is not well enough reflected through these item.

Table 28. Knowledge transfer and integration scale, PCA

The agreement degree with the following statements, assessed on a 7-point Likert scale ranging from 1="totally disagree" to 7="totally agree"	Mean	Standard deviation	PC 1	PC 2
▪ The mistakes and failures are always discussed in this enterprise, at all levels.	4,686	1,469	0,870	
▪ The employees have the chance to discuss among them about new ideas, projects and activities that could be useful to the enterprise.	4,833	1,363	0,729	
▪ The firm has instruments (manuals databases, files, organizational routines, etc.) that allow what has been learnt in the past situations to remain valid.	5,028	1,298		0,926
Percentage of variance explained: 71,79 %, Cronbach Alpha Factor 1 = 0,746				

Table 28 displays the results concerning the knowledge transfer and integration scale of Jerez-Gomez *et al.* (2005). A two-dimensional structure emerged after the exploratory principal component analysis explaining 71,79% of the variance. This result does not confirm the results obtained in the Spanish context by Jerez-Gomez *et al.* (2005). Moreover, the third item referring to the degree of formalization of the transfer and integration practices composes one principal component that by itself explains 25,49% of the total variance. The two remaining items instead captured the experiences and knowledge exchange facility in terms of discussing the causes of failures, and exchanging around new ideas or projects judged as useful for the enterprise. Even though the idea of transfer of knowledge and integration is highly captured by the two items, the idea of formal integration is missing. Therefore, the measurement scale of the construct is reconsidered by employing items drawn out of Calantone *et al.*'s (2002) measure of the knowledge transfer and integration construct relative to the knowledge transfer and integration dimension and Leonard-Barton's (1995) study. Concluding, the item *"In our company, we employ instruments (databases, files, organizational routines, etc.) which allow us to keep valid past learning."* was kept, and three more items were added, namely *"We attempt to keep our know-how acquired through past experiences even though employees might change."*, *"In this firm, we try to learn from past mistakes so that we will not reproduce the same mistakes in the future"*, and *"At all levels in this firm, we try to transmit the know-how as quickly as possible from old to new employees"*. The consistency of this scale proposition was further tested once with the data gathering in France. Table 29 hereafter recapitulates synthetically all the measures used to capture the constructs in our research model after the modifications undertaken as a result of the questionnaire pre- test.

Table 29. Constructs operationalization after the pre-test

Variable/Construct	Items and scales	References
<b>PACAP's ANTECEDENTS</b>		
<b>INFORMATIONAL DIMENSION</b>		
The richness information sources	Second order construct - the richness of seven export information sources (clients, competitors, agents/distributors, trade fairs, Chambers of Commerce and Industry, export market research, Internet) – assessed on four dimensions: contacts facility, interactivity, information reliability, and information quantity on a 5-point scale ranging from 1 = “very limited” to 5= “very good”	Adapted from Ramangalahy (2001)
<b>EXPERIENTIAL DIMENSION</b>		
Real export experience	Sum of the number of years the company used a certain foreign presence mode (direct, indirect exporting, associative modes, franchising/license, subsidiary, Internet, others)	Adapted from Kuivalainen and Bell (2004)
Export experience richness	Reflexive construct made up of three items relative to international experiences richness in terms of variety, complementarities and length, measured on a 7-point Likert scale ranging from 1 = “completely disagree” 7 = to “completely agree”	Derived from the dissertation work
<b>PACAP</b>		
<b>INFORMATION ACQUISITION</b>		
The level of export informational knowledge	Reflexive construct, seven items (informational knowledge related to the general foreign markets' situation, foreign clients and competitors, products, prices and payment methods, communication, distribution practices) measured on a 7-point Likert scale ranging from 1 = “informed much less than the competitors” to 7 = “informed much more than competitors“	Adapted from Ramangalahy (2001) and Morgan and Vorhies (2005)
<b>INFORMATION ASSIMILATION</b>		
Coordination	Reflexive construct made up of three items measured on a 7-point Likert scale ranging from 1 = “completely disagree” to 7 = “completely agree”	Adapted from Ramangalahy (2001)
Integration and transfer of information and knowledge	Reflexive construct made up of four items measured on a 7- point Likert scale ranging from 1 = “completely disagree” to 7 = “completely agree”	Derived from Jerez-Gomez <i>et al.</i> (2005), from Calantone <i>et al.</i> (2002) and Leonard-Barton (1995)

<b>RACAP – REALIZED ABSORPTIVE CAPACITY</b>		
<b>TRANSFORMATION DIMENSION</b>		
Export responsiveness	Reflexive construct made up of eight items measured on a 7-point Likert scale ranging from 1 = “completely disagree” to 7 = “completely agree”	Cadogan <i>et al.</i> (1999)
<b>EXPLOITATION DIMENSION</b>		
Positional advantage in terms of international marketing competences	Reflexive construct made up of 8 items (relational competences, international marketing management, foreign markets segmentation, product strategy, price strategy, distribution strategy, communication strategy, information management competences) measured on a 7-point Likert scale, ranging from 1 = “much less than competitors” to 7 = “much more than competitors”	Adapted from Ramangalahy (2001)
<b>SMEs INTERNATIONAL PERFORMANCE</b>		
<b><i>Qualitative measures of the international performance construct</i></b>		
Perceived satisfaction with the development of international performance over the last year	Perceived satisfaction with the progression over the last year of the market share, foreign sales profits, foreign sales volume, number of new foreign markets entered - measured on a 7-point Likert scale ranging from 1 = “not satisfied at all” to 7 = “very satisfied”	Adapted from Souchon and Durden (2002) and Zou <i>et al.</i> (1998)
Perceived competitiveness on export markets	Perceived competitiveness in terms of market share, foreign sales profits, foreign sales volume, number of new foreign markets entered over the last year - measured on a 7-point Likert scale ranging from 1 = “not competitive at all” to 7 = “very competitive”	Adapted from Souchon and Durden (2002) and Zou <i>et al.</i> (1998)
Relative perceived satisfaction (compared to the main competitors) with the development of the export activities over the last year	Perceived relative competitiveness in terms of market share, foreign sales profits, foreign sales volume, number of new foreign markets entered compared to the main competitors - measured on a 7-point Likert scale ranging from 1 = “not competitive at all” to 7 = “very competitive”	Adapted from Souchon and Durden (2002) and Zou <i>et al.</i> (1998)
Perceived profitability of export sales compared to domestic sales	Perceived profitability of the export sales compared to domestic sales over the last year, 1 item - measured on a 7-point Likert scale ranging from 1 = “completely disagree” to 7 = “completely agree”	Adapted from Souchon and Durden (2002) and Zou <i>et al.</i> (1998)
<b><i>Quantitative measures of the international performance construct</i></b>		
Export sales growth over the last 3 years	The mean of the progression of export sales volume over the last years	Adapted from Souchon and Durden (2002) and Zou <i>et al.</i> (1998)
Export profits growth over the last 3 years	The mean of the progression of export profits over the last years	Adapted from Souchon and Durden (2002) and Zou <i>et al.</i> (1998)



CONTROL VARIABLES		
Export orientation	Reflexive construct made up of three items measured on a 7-point-Likert scale ranging from 1 = "completely disagree" to 7 = "completely agree"	Cadogan <i>et al.</i> (2001)
Firm size	Number of employees in the firm	Multiple references

### **Conclusion of Chapter V**

Within this chapter, the main methodological choices that guided the development of this research were explained in regards to the level of analysis, the nature of this research, and the development of the research. It was concluded that the most appropriate level of analysis for the current research is the firm since the international performance is an organizational level construct.

Furthermore, it was explained that the quantitative methodology is the most appropriate in order to answer the research question of the impact of SMEs' export information behaviors upon their levels of international performance. At the same time, the multi-dimensional and complex nature of information would benefit more qualitative insights into the way firms perceive and deal with export information activities. As a result, a preliminary qualitative research with the managers of 24 Romanian and French SMEs has been undertaken in order to get additional insights into the main issues of interest in this research.

The results derived from the preliminary research helped construct the questionnaire but also brought some empirical support for the research model build in chapter III. For the questionnaire construction, the export information sources that have been judged as rich by export managers and are used on a current basis by SMEs' managers, namely foreign clients and customers, agents, trade fairs, Chambers of Commerce and Industry, export market research and Internet have been identified. Moreover, the preliminary study brought insights into the reasons evoked by SMEs managers for explaining their preference for these export information sources. The reasons evoked for explaining the preference for export information sources show that retaining the information sources richness for studying export information activities is appropriate.

Generally, the results of the qualitative research seem to rather confirm the research model elaborated in the previous section based on the AC framework in chapter III. More precisely, managers seem to support the idea that information flows nurture foreign market-related knowledge levels. They also believe that the levels of export experience condition their capacities in terms of export information acquisition and exploitation. Moreover, the role of export markets related information in determining export responsiveness was also extensively supported by SMEs managers' statements. The findings confirm Zahra and George's (2002) assumptions that the access to information sources and the previous experience of firms are antecedents of their capacity to acquire and assimilate information. However, the exploratory nature of the qualitative study cannot confirm the research propositions advanced in chapter III.

Furthermore, based on the findings of the qualitative research and the literature review the questionnaire aiming to quantitatively test the research model framework was elaborated. Questionnaire development and pre-test phase were also presented in this chapter. The pre-test undertaken with 12 Romanian and French managers proved to be especially helpful and revealed that managers had difficulties in answering several questions in the questionnaire. As a result, multiple modifications have been made to the questionnaire in regards to the measures used to capture the international experience richness, the positional advantage of SMEs in terms of international marketing competences, the knowledge transfer and integration and the international performance construct. The necessary modifications were made to ensure that managers would answer the questionnaire to best of their abilities.

# CHAPTER VI. QUESTIONNAIRE ADMINISTRATION AND DESCRIPTIVE RESULTS

## **Introduction to Chapter VI**

Chapter VI provides an overview of the descriptive analysis of the quantitative study.

First, the questionnaire administration procedure will be presented. The descriptive analysis of the quantitative data gathered is then exposed. The responding 107 enterprises are first described in terms of firm size and percentage of sales abroad compared to the population of the study. The SMEs interviewed are further pictured in terms of their levels of international experiences, the richness of the export information sources they access in foreign markets, their levels of informativity regarding foreign markets' evolution, the efficiency in terms of information assimilation practices, the response action they implement when confronted with foreign markets shifts, their levels of positional advantage in terms of international marketing competences, and the levels of international performance. Lastly, the measurement model evaluation will be exposed.

## **VI.1 Questionnaire administration**

The final questionnaire (see appendix 4) was administrated in France. In spite of the fact that the study was initially carried out in both France and Romania, data gathering for the quantitative phase was only done in France. The main reason for operating this way is that no equivalent databases between Romanian and French enterprises exist. Even though Van Dijk databases are extended to the European level through the AMADEUS database, the Romanian enterprises database in AMADEUS contains numerous limitations. Only about 500000 Romanian enterprises are recorded within the AMADEUS database and an important volume of data is missing. The European AMADEUS database includes the data available in the national French-based database DIANE (<http://www.bvdep.com/fr/DIANE.html>). DIANE represents the most exhaustive existing database for France. The DIANE database for France classifies all mandatory financial information requested from French companies. Resuming, in regards to French data, the AMADEUS database includes the DIANE database, which is the most exhaustive, existing database for French enterprises. That is not the case for the financial data of Romanian enterprises existing in AMADEUS and an important amount of

data is missing regarding Romanian firms. As a result, one of the preliminary conditions of the cross-cultural validity of market research, namely sampling equivalence (Müllbacher *et al.* 2006), would be violated. As a result, data gathering was only conducted in France.

Initially, the aim was to compare two different manufacturing industries, the textile industry and the steel industry. Finally, the analysis was directed exclusively towards the steel industry because major changes in the textile industry modified the international context parameters over the last years. In 2005, the Textile Agreement was signed between the European Union and China. As a result, the French textile industry was faced with an important decline of the export sales over the next years because of the Chinese competition. Moreover, during the preliminary qualitative research, French SMEs' managers from the textile industry suggested that in the future, the textile industry would be completely relocated abroad. The pessimistic expectations of French managers may condition the way they perceive their international performance levels. As a result, only companies from the steel industry were investigated in order to avoid possible bias in this respect. The parameters used for defining the enterprises pertaining to the population of the study were the following: (1) operation in the steel industry (NAF 28), (2) the size must be comprised of between 11 and 250 employees, (3) percentage of sales abroad must be more than 10% of their total turnover from foreign sales that was realized in the previous year and (4) enterprises must be independent (subsidiaries were excluded from the analysis). The choices operated in terms of criteria will be further explained in the following paragraphs.

(1) Choosing a single industry for undertaking this study certainly presents advantages as well as disadvantages. The advantage is represented by the fact that obtained results are applicable for a specific industry. The limits exist mainly in the external validity of the data; results cannot be extended for companies from other industries. Nevertheless, the concentration on a specific industry will facilitate the efforts necessary to ensure the best sample representativity.

(2) The choice of the steel industry was also motivated by the collaboration, at the time, with the Conseil Régional de la Lorraine whom is the local public authority and has partly financed this research due to its interest in this particular industry, more specifically, in regards to the decline in the exporting markets in Lorraine.

(3) As explained in chapter II, when SMEs were defined, micro-firms consisting of one to ten employees were not included in the analysis because previous studies in the field showed that they have specific characteristics (Bayad *et al.* 2007). Thus, micro-firms should be studied separately because the findings for this class of enterprises are very specific.

(4) Only enterprises that realized more than 10% of their turnover abroad were selected for sampling purposes because a previous study undertaken in France in 2002 on exporting SMEs from the East regions of France revealed that a large part of the non-respondents realized less than 10% of their turnover abroad. Moreover, when telephone calls were made to check for non-response bias, most of the SMEs that export less than 10% of their total turnover declared no interest in developing their foreign activities. These SMEs were contacted by foreign clients to sell their products abroad. For this reason, it was decided not to keep these companies in this analysis since no real efforts for gathering export information were deployed by the companies. The choice of excluding subsidiaries from the sample is due to the fact that they generally do not actively develop export information research activities. The qualitative analysis suggests that this activity involves the mother company.

Retaining the four selection criteria exposed above, a total population of 1194 enterprises was extracted out of the DIANE database (2005 edition). Several problems were encountered when realizing the extraction of enterprises' information from DIANE. When carefully examining the initially extracted data, several observations are worth to be mentioned. 139 enterprises were part of bigger groups, 288 had less than 11 employees or the size was unknown for the last year, and 130 enterprises exported less than 10% of their total turnover abroad or their percentage of sales was unknown for the previous year. After excluding these enterprises from the sample, a final population of 624 enterprises was obtained<sup>22</sup>. Since the population of the study can be qualified as rather small, we decided to address the questionnaire to all the population's elements.

In spite of the problems encountered with the extraction of the sample, the DIANE database has the main advantage of containing managing directors' names, and they were the specific respondents targeted within this research. The choice of directing the questionnaire towards the companies' managing directors was guided by the strong evidence of the key role that they play in fostering the international development of SMEs (e.g. Bijmolt and Zwart 1994; Halikias and Panayotopoulou 2003; Leonidou 2004).

The data for this research was gathered in four waves, in March, June and October of 2006, and in January of 2007. The questionnaire was accompanied by a short cover letter explaining the aim of the research, addressed nominally to the managing directors, and included a pre-paid response envelope. Despite follow-up efforts by phone and e-mail (on average 200

---

<sup>22</sup> The population of the SMEs may be bigger than 624 enterprises. Nonetheless as it follows when employing the term "population" we will make reference to those 624 enterprises.

randomly chosen enterprises were telephoned and 358 enterprises were reached by e-mail every time), the response rates were very low although comparable to similar recent studies in a French context. For instance, a recent study conducted on exporting SMEs by Favre-Bonté and Giannelloni (2007) realized a response rate of about 1% (with no follow-ups). Basly's (2006) study on family exporters had a response rate of 15,44% (using two follow-ups).

The four waves of questionnaires accompanied by follow-ups led to the collection of a total number of 80 questionnaires. By means of additional follow-ups by telephone, 126 questionnaires were finally gathered. Out of the 126 questionnaires, only 107 were usable. The remaining 19 questionnaires have not been fully fulfilled. If more than 10% of the items of interest were missing, we did not consider the questionnaires.

The numerous follow-ups allowed us to obtain information about the non-response reasons. Sometimes the SMEs interviewed no longer exported, they were under important time pressure, or company policy did not allow survey participation. None of the evoked reasons suggest that non-response behaviors reflect characteristics that could affect responses to the central issues of this research (Souchon and Diamantopoulos 1999). Concluding, no evidence of the presence of non-response bias was obtained.

Concerning the respondents, in spite of the fact that the questionnaire was specifically addressed nominally to the managing director of the company, out of the 107 usable questionnaires, only 86 have been fulfilled by the managing director. The rest of 21 questionnaires in the sample were fulfilled by the export directors of the companies (12 questionnaires), sales directors (6 questionnaires), two by production directors and one questionnaire by the company's accountant. Nonetheless, the overwhelming majority of the questionnaires were addressed to the targeted persons. Thus, the rest of the 21 questionnaires were seemingly directed towards the persons in the company who were considered the most appropriate to provide information concerning the organization of the exporting activities in the firm.

## **VI.2 Descriptive analysis of the results**

The descriptive analysis of the data gathered is presented in five main points that regroup the sample description including: the description of the export information AC of SMEs: PACAP's antecedents, PACAP, RACAP, and the description of the levels of international performance.

## VI.2.1 Sample description

The final sample is composed of 107 enterprises. Even though the sample size can be characterized as rather small, the final response rate obtained is considered satisfactory (19,2%). In terms of variables of interest comprised in this research model, 8,76% of missing data is to be reported. The percentage of missing data represents a rather normal percentage compared to similar studies in the field.

On average, the size of the 107 SMEs interviewed is of 86,38 employees (standard deviation = 69,65; median = 64; min = 10, max = 275). Table 30 compares the sample of 107 enterprises to the initial population of the study (624 enterprises) in terms of companies' size ranges. Even though initially companies comprised of between 11 and 250 employees were selected, two of the responding companies had 10 employees each and one company had 275 employees. The size difference can be explained by the fact that data from the DIANE database from 2005 was used and the data collection took place in 2006. However, since the size difference between these three enterprises and the initial range (11-250 employees) was not that important, they were kept for further analysis purposes. The two companies composed by 10 employees are enclosed in the range 11-50 employees and the one with 275 employees in the range 201-250 employees. By examining Table 30, it can be concluded that companies in this sample were slightly bigger than companies in the initial sample.

Table 30. Ranges of enterprise sizes in this sample compared to the population

Range of sizes of enterprises (number of employees)	Number of enterprises in the sample	Number of enterprises in the population	% of enterprises in the sample	% of enterprises in the population
11 – 50 employees	42	407	40,38 %	65,32 %
51 – 100 employees	27	120	25,96 %	19,26 %
101-150 employees	13	55	12,50 %	8,66 %
151 – 200 employees	11	22	10,57 %	3,53 %
201 -250 employees	11	20	10,57 %	3,21%
TOTAL	104	624	100%	100 %

On average, responding enterprises said that they export 40,49% of total turnover (std. deviation = 26,19; median = 35,00; min = 1; max = 97). Based on the data exposed in Table 31 hereafter, it can be concluded that responding SMEs present similar features from the perspective of the percentage of sales abroad with the companies extracted from the DIANE database. However, enterprises interviewed are slightly more engaged in export operations

than the companies in the sample extracted from the DIANE database. The higher ranges of export sales are more extensively represented in this sample.

Table 31. Ranges of export sales percentages in this sample compared to the population

Range of foreign sales percentage from the total turnover (percentage of sales abroad)	Number of enterprises in the sample	Number of enterprises in the population	% of enterprises in the sample	% of enterprises in the population
[0% - 20%)	26	198	24,29 %	31,78 %
[20% - 30%)	18	140	16,82 %	22,47 %
[30% - 40%)	15	96	14,01 %	15,40 %
[40% - 50%)	11	65	10,28 %	10,43 %
[50% - 60%)	7	38	6,54 %	5,93 %
[60% - 70%)	8	34	7,47 %	5,45 %
[70% - 80%)	8	23	7,47 %	3,68 %
[80% - 90%)	6	15	5,60 %	2,40 %
[90% - 100%)	8	15	7,47 %	2,40 %
TOTAL	107	624	100 %	100 %

Note that even though only companies that have realized over 10% of their total turnover from export sales in the previous year were selected, within this sample, 10 of the respondent companies declared having realized less than 10% of export sales abroad. Again, this difference may be explained by the fact that data was extracted from a 2005 DIANE database and the study had been carried out in 2006. Because of the difficulties encountered for gathering data for this study and also because the differences are subtle, these 10 companies that export slightly less than 10% of their turnover abroad were kept in the analysis.

If the sample composition is compared to the population of the study, one can notice that responding enterprises are slightly bigger and export slightly more than the enterprises composing the population of the study. However, the differences within the initial population cannot be judged as drastically marked. Nonetheless, these observations suggest that the results of the study cannot be entirely extrapolated to the whole population of exporting SMEs from the French steel industry.

## VI.2.2 PACAP's antecedents

Hereafter, the descriptive analysis of the levels of international experience of the companies in this sample is presented as well as their levels of richness in terms of export information sources.

### *VI.2.2.1 International experiences*

Concerning the international experience measures, more data than necessary for the research propositions test was gathered. Additional international experience aspects were explored through the questionnaire. Such aspects are the number of exporting countries, number of border countries, number of continents where companies were exporting, the existence of an export department and the number of years the firms have had an export department. Even though these variables are not included within the analysis, it is important to present these results since they allow for a better comprehension of the international experiences state of companies in the sample.

The companies in this sample have developed international activities for about 24,04 years on average (std. deviation = 15,66 ; median = 21,00; min = 1; max = 79,00). Many experienced international companies characterize this sample. Only 6,7% have been exporting for less than 5 years. More than half of the companies, 51,90% companies to be exact, began their exporting activities from 16 to 45 years ago, 21% have been exporting from 6 to 15 years ago, and 15,7% since more than 46 years ago.

The companies export their products in 19,12 foreign markets on average (std. deviation = 25,38; median = 12; min = 1; max = 180). Most of the companies export to 1 to 10 countries (44,4%), and 27,2% of the companies export to 11 to 20 countries. The rest, 28,4 %, export to more than 20 countries. All the companies in this sample sell their products to border countries. 71,6% of the companies interviewed export to one or two countries that border France and 18,8% export to more than five countries bordering France. It can be concluded that border countries are an important export destination for French SMEs. If the number of border countries is subtracted from the total number of exporting countries, the real number of export countries is obtained (Kuivalainen and Bell 2004). It worth to be noted that 11,8% of the companies in the sample export exclusively to border countries. This tendency can be explained by the fact that the northern border countries, Belgium and Luxembourg, speak the



same language. However, it can be supposed that sometimes exporting to neighboring countries can be easier in terms of logistics or psychological distance compared to exporting to the opposite side of France. For example, an Alsatian might have German clients that may be more similar than, for example, clients from the South of France in terms of psychological proximity.

Concerning the organizational structure that companies adopt for exporting, more than half of the companies interviewed have an export department (51,42%). 38,2% of these companies created the export department in the same year they began their exporting activities, which is a sign of international orientation. However, on average, enterprises create an export department 12,97 years after the beginning of their international activities. The results suggest that companies interviewed are more export engaged than an average company. Previous studies on SMEs suggest that most SMEs do not have a specific export department (e.g. Ramangalahy 2001) and that export activities are normally conducted by the managing director or another manager (e.g. marketing, production manager).

On average, companies interviewed use 2,14 modes of presence abroad (std. deviation = 1,04; median = 2; mode = 1; min = 1; max = 5). It is to note that most of the firms sell their products abroad by means of direct or indirect exporting (65,04%). Only about one-third of firms use more sophisticated foreign presence modes such as associative modes such as joint ventures, franchising or licensing, to name a few. It can be observed from the Table 32 that most of the companies use rather basic foreign presence modes such as direct exporting (97,17%) or indirect exporting (60,37%). Nonetheless, almost one-third of companies export by means of collaborative modes such as a strategic alliance of joint ventures (26,66%) or by owning a subsidiary abroad (33,96%).

The companies interviewed did not commonly conduct Internet sales and none of them organized sales abroad by means of franchising or licensing. By examining the means of the number of years since the companies use a specific foreign presence mode, one can observe that they have been using direct exporting for a longer time than indirect exporting, followed by collaborative modes, subsidiaries, and other modes. These results suggest that companies in the sample progressively began to employ more elaborate foreign presence modes once they got more used to developing foreign markets operations.

Recall that within this analysis, the real international experience of SMEs was calculated as the sum of the number of years that companies spent in developing foreign activities under a particular foreign presence mode. It was deemed reasonable to admit that companies using

different foreign presence modes would be characterized by higher levels of export experience compared to companies selling through only one basic foreign presence mode. The average real international experience of SMEs is of 39,27 years (std. deviation = 28,41 years; median = 30; min = 4; max = 129).

Table 32. Foreign presence modes used by the SMEs

Foreign presence modes analyzed	Frequency of responses: enterprises using the presence mode	Frequency of responses: enterprises not using the presence mode	Mean number of years using the respective presence mode	Standard deviation
▪ Indirect exporting	60,37 %	39,62 %	8,46	13,07
▪ Direct exporting	97,17 %	2,83 %	21,09	14,38
▪ Collaborative modes (strategic alliance, joint venture, etc.)	26,66 %	73,33 %	3,72	8,09
▪ Franchising, licensing	0,00 %	100 %	-	-
▪ Foreign subsidiary	33,96 %	66,03 %	3,72	8,05
▪ Selling on Internet	5,66 %	94,34 %	0,29	1,25
▪ Another mode (specify)	7,54 %	92,45 %	1,00	4,40

On average 5,19 employees (std. deviation = 5,93; median = 3, min = 0; max = 35) deal with the international activities of the company for more than 50% of their working time (called “export employees”). 88,8% of the enterprises in the sample allocate less than 10 employees for the organization of exporting activities.

Table 33. Export experience richness of the “export employees”

Items analyzed: Indicate your agreement with the following statements concerning the international experiences of your export employees (those working for more than 50% of their working time for the management of export activities)	Mean	Std. dev	Frequency of responses (%)						
			1 totally disagree	2	3	4	5	6	7 totally agree
▪ The international experiences of “export” employees are varied.	4,90	1,43	1,02 %	6,12 %	9,18 %	19,38 %	27,55 %	22,44 %	14,28 %
▪ The international experiences of “export” employees are complementary.	4,73	1,43	2,04 %	5,10 %	11,22 %	22,44 %	28,57 %	18,36 %	12,24 %
▪ The “export” employees’ international experiences are long lasting.	4,70	1,49	3,12 %	3,12 %	13,54 %	25,00 %	25,00 %	15,62 %	14,58 %

As far as the richness of the international experiences of the “*export employees*” is concerned, it seems that they are rather varied (mean = 4,90; std. deviation= 1,43; median = 5), complementary (mean = 4,74; std. variation = 1,43; median = 5) and long lasting (mean = 4,70; std. deviation = 1,49; median = 5). These variables were measured on a 7- point Likert scale ranging from 1 = “totally disagree” to 7 = “totally agree”. Table 33 displays the frequency of responses from the enterprises in the sample.

As can be observed in Table 33, SMEs that compose this sample are generally characterized by above-average levels of international experience richness. Systematically, more than 50% of enterprises in the sample exceed the average note of 4 when assessing the extent of the variety, complementarities or the length of their international experiences.

#### *VI.2.2.2 Export information sources richness*

The seven information sources retained for this analysis (the clients, competitors, distributors or agents, trade fairs, Chambers of Commerce and Industry, export market research and Internet) were approached under the richness angle. The richness of information sources has been assessed in most of the cases according to four dimensions: contact facility, interactivity, information reliability and information quantity. Internet and export market research were examined only according to two dimensions, namely information reliability and the quantity of information provided.

By examining Table 34, it can be observed that excepting competitors, Chambers of Commerce and Industry, and export market-research, the majority of the other selected information sources reach average values of over 3 (the middle point) for most of the four dimensions examined. Nonetheless, for all information sources excepting competitors, the four dimensions are rated over 3 (with 3, 4 or 5 on a 5-point scale) by more than 50% of the enterprises in the sample.

As far as competitors are concerned, only 38,83% of firms rated as average or above-average (with 3, 4 or 5) the facility of contacts with competitors and 27,45% rated above-average the interactivity possibility with the competitors. 30,39% of firms rated as average or above-average the quantity of export information coming from competitors, and 36,89% rated information reliability coming from competitors as above the average or average. In light of these results, it can be concluded that the competitors do not represent a rich export information source for French SMEs, and therefore, this information source will be excluded

from the analysis hereafter. Nonetheless, this finding is in line with the results of the qualitative research. Competitors appeared as an important information source in foreign markets for Romanian SMEs while French companies expressed reservation in this respect. The descriptive results confirm findings in previous studies and acknowledge the marked preference of SMEs' managers for clients and relational information sources such as trade fairs and distributors or agents. Nonetheless, it can be observed that most of the companies interviewed rate the Internet, market research and Chambers of Commerce and Industry as rich. These results are also in line with the preliminary qualitative research and with previous studies on SMEs' export information behavior (e.g. Leonidou and Katsikeas 1997; Hart and Tsokas 1999).

Table 34. Export information source richness

Export information sources analyzed	Mean	Std. dev	Frequency of responses (%)				
			1 Very limited	2 Limited	3 Moderated	4 Good	5 Very extended
Clients							
▪ contacts facility	4,03	0,82	0,96%	2,88%	17,30%	49,03%	29,80%
▪ interactivity	3,87	0,88	0,98%	4,90%	25,49%	43,13%	25,49%
▪ reliability	3,57	0,84	0,96%	9,61%	30,76%	48,07%	10,57%
▪ information quantity	3,54	0,84	1,94%	5,82%	39,80%	40,77%	11,65%
Competitors							
▪ contacts facility	2,36	1,07	23,30%	37,86%	19,41%	17,47%	1,94%
▪ interactivity	2,17	1,00	25,49%	47,05%	13,72%	11,76%	1,96%
▪ reliability	2,21	0,97	27,18%	35,92%	25,24%	11,65%	0,00%
▪ information quantity	2,08	1,04	36,27%	32,35%	18,62%	11,76%	0,98%
Distributors/Agents							
▪ contacts facility	3,59	1,12	7,92%	8,91%	17,82%	46,53%	18,81%
▪ interactivity	3,22	1,12	8,16%	17,34%	30,61%	31,63%	12,24%
▪ reliability	3,00	1,12	11,00%	22,00%	32,00%	26,00%	9,00%
▪ information quantity	2,75	1,21	19,19%	22,22%	31,31%	18,18%	9,09%
Trade fairs							
▪ contacts facility	3,60	1,02	7,61%	2,85%	26,66%	47,61%	15,23%
▪ interactivity	3,09	1,07	8,65%	20,19%	31,73%	31,73%	7,69%
▪ reliability	2,83	0,93	7,61%	28,57%	38,09%	23,81%	1,90%
▪ information quantity	3,01	1,10	11,53%	19,23%	31,73%	30,76%	6,73%
Chambers of Commerce and Industry							
▪ contacts facility	3,30	1,22	12,62%	9,70%	29,12%	32,03%	15,50%
▪ interactivity	2,89	1,14	15,68%	16,66%	38,23%	21,56%	7,84%
▪ reliability	2,74	1,08	14,56%	26,21%	20,38%	23,81%	4,85%
▪ information quantity	2,64	1,12	17,64%	27,45%	34,31%	13,72%	6,86%
Export market research							
▪ reliability	2,90	1,12	12,50%	22,91%	34,37%	21,87%	8,33%
▪ information quantity	2,77	1,18	14,73%	30,52%	25,26%	21,05%	8,42%
Internet							
▪ reliability	3,06	1,12	5,05%	13,13%	53,53%	27,27%	1,01%
▪ information quantity	3,77	1,18	4,12%	8,24%	22,68%	36,08%	28,86%

## VI.2.3 PACAP levels

The levels of PACAP of the exporting SMEs in the sample are exposed in terms of export information acquisition and assimilation.

### VI.2.3.1 Export information acquisition

As can be observed in the Table 35, generally, the SMEs interviewed are slightly above average in regards to how informed they are about foreign market elements compared to their main competitors.

Table 35. Export information acquisition levels

Variables analyzed	Mean	Std. dev	Frequency of responses (%)						
			1 Much worse than competitors	2	3	4 As well as the competitors	5	6	7 Much better than competitors
▪ General foreign market environment (economic, social, political environment, barriers to exporting, legislation).	4,16	1,22	0,93 %	7,47 %	18,69 %	39,25 %	15,88 %	15,88 %	1,86 %
▪ Potential clients (characteristics, needs, demand, preferences, mentalities, buying behavior, new niches, and potential partners).	4,57	1,12	0,00 %	4,67 %	9,34 %	33,64 %	33,64 %	14,09 %	4,67 %
▪ Competitors (main actors in the market, general situation, strategies they deploy, forces and strengths).	4,23	1,13	3,12 %	3,12 %	13,54 %	25,00 %	25,00 %	15,62 %	14,58 %
▪ Products (characteristics, technical norms, adaptation needs, packaging, innovation cycles).	4,63	1,27	1,86 %	2,80 %	17,75 %	40,18 %	25,23 %	9,34 %	2,84 %
▪ Price and payment practices (level, tendencies, margins and commissions, credit policies, mode and delay of payment).	4,32	1,15	0,93 %	2,80 %	16,82 %	42,99 %	18,69 %	14,01 %	3,73 %
▪ Communication practices (available media, methods employed, type of message, costs).	4,04	1,36	1,86 %	8,41 %	25,23 %	35,51 %	11,21 %	12,15 %	5,60 %
▪ Distribution practices (channels, costs, selling points, transport and deposit infrastructure, payment delays, intermediaries' efficiency).	4,15	1,19	0,93 %	5,60 %	19,62 %	44,86 %	12,15 %	14,01 %	2,80 %

SMEs seem to grant particular attention in order of importance to: clients (mean = 4,57; std. deviation = 1,12; median = 4 ; mode = 4), products (mean = 4,63; std. deviation = 1,27; median = 5 ; mode = 4), prices (mean = 4,32; std. deviation = 1,15; median = 4 ; mode = 4), competitors (mean = 4,23 ; std. deviation = 1,13; median = 4 ; mode = 4), general market information (mean = 4,16; std. deviation = 1,22; median = 4; mode = 4), distribution (mean = 4,15; std. deviation = 1,19; median = 4 ; mode = 4), and communication (mean = 4,04; std. deviation = 1,36; median = 4 ; mode = 4). The quantitative results seem to confirm the qualitative research, which has highlighted SMEs' high interests in client and product related information. Similar results have also been revealed in previous studies on SMEs' export information behaviors that were undertaken in different cultural contexts (e.g. Hart and Tsokas 1999; Ramangalahy 2001).

### *VI.2.3.2 Assimilation practices*

Two dimensions were retained for capturing the information assimilation dimension of PACAP, namely coordination and knowledge transfer and integration. It can be observed from Tables 36 and 37 hereafter that in general, the SMEs interviewed are characterized by above-average levels of efficiency of the assimilation practices. Moreover, the means of the items capturing coordination and knowledge transfer and integration efficiency are slightly higher than those used to capture the other dimensions of the AC construct.

Table 36. Coordination practices

Variables analyzed Indicate to what extent you agree or disagree with the following statements :	Mean	Std. dev	Frequency of responses (%)						
			1 Totally disa- gree	2	3	4	5	6	7 Totally agree
▪ The senior management strategic objectives are well known and accepted.	5,05	1,36	0,00 %	7,47 %	8,41 %	10,28 %	28,97 %	34,57 %	10,28 %
▪ The leadership employed by the direction is efficient.	5,31	0,98	0,00 %	0,00 %	4,71 %	14,15 %	35,84 %	35,84 %	9,43 %
▪ The members of the management team closely coordinate their activities.	5,48	1,02	0,00 %	0,97 %	3,88 %	7,76 %	34,95 %	37,86 %	14,56 %

The analysis of the items that capture the coordination dimension reveal that SMEs interviewed generally seem to communicate and reach acceptance from employees concerning the strategic objectives (mean = 5,05; std. deviation = 1,36; median = 6; mode = 6) to implement efficient leadership procedures (mean = 5,31; std. deviation = 0,98; median = 6; mode = 5) and that the members of the top management team closely coordinate their activities (mean = 5,48; std. deviation = 1,02; median = 6; mode = 6). These results converge to the ones of Ramagalahy (2001) who also revealed high coordination capabilities in the case of exporting Canadian SMEs.

In terms of knowledge transfer and integration practices, SMEs consider deploying efforts to keep the know-how acquired in the past in the firm despite personnel fluctuations (mean = 5,94; std. deviation = 0,93; median = 6; mode = 6). They use formalized instruments such as manuals, databases or files to keep previous learning (mean = 5,15; std. deviation = 1,53; median = 6; mode = 6) and so they can constructively learn from mistakes (mean = 5,86; std. deviation = 0,95; median = 6; mode = 6), and try to effectively transmit the know-how from older employees to new ones (mean = 5,65; std. deviation = 1,16; median = 6; mode = 6).

Table 37. Knowledge transfer and integration

Variables analyzed Indicate to what extent you agree or disagree with the following statements :	Mean	Std. dev	Frequency of responses (%)						
			1 Total- ly disa- gree	2	3	4	5	6	7 Total- ly agree
▪ We try to keep the know-how acquired by past experiences even though the employees are no longer the same.	5,94	0,93	0,94 %	0,00 %	0,00 %	2,83 %	23,58 %	44,34 %	28,30 %
▪ The firm has instruments (manuals databases, files, organizational routines, etc.) that allow what has been learnt in the past situations to remain valid.	5,15	1,53	1,86 %	5,60 %	11,21 %	6,54 %	24,29 %	31,77 %	18,69 %
▪ In this enterprise, we try to learn from our mistakes in order to avoid them in the future.	5,86	0,95	0,00 %	0,00 %	1,86 %	7,47 %	19,62 %	43,92 %	27,10 %
▪ At all levels, we try to communicate the know-how of older employees to newer ones as quickly as possible.	5,65	1,15	0,93 %	0,00 %	3,73 %	10,28 %	22,43 %	38,31 %	24,29 %

Resuming, Table 36 and 37 suggest that the SMEs interviewed score high in terms of assimilation capacity. Nonetheless, one should keep in mind that responding managers might have a higher appreciation of the coordination and knowledge transfer and integration in their

company since they are the ones, who normally manage the organizational design of these practices.

## VI.2.4 RACAP levels

The transformation dimension of the RACAP was conceptualized as the export responsiveness capacity of SMEs facing foreign market shifts and the exploitation dimension of RACAP as the level of international marketing competences. The descriptive analysis of the results that concern the two dimensions is presented hereafter.

### *VI.2.4.1 Export responsiveness*

Export responsiveness translates the capacity of SMEs to transform incoming export information into responsive action when new environmental constraints emerge in the surrounding environment.

Table 38 summarizes the export responsiveness levels of companies on this sample. Observe that SMEs interviewed register export responsiveness levels that are generally slightly above average. The customers occupy an important place in their business development patterns. Companies seem to take corrective actions immediately when they find that export customers are not happy with the quality of their services (mean = 5,56; std. deviation = 1,42; median = 5; mode = 6) and they adapt export product offerings based on detailed customer observation (mean = 4,80; std. deviation = 1,70; median = 5; mode = 6). Emphasis is placed on customer satisfaction when designing export business objectives (mean = 4,93; std. deviation = 1,78; median = 5; mode = 7) and they seem rather driven in designing their export strategies through the belief of creating greater value for export customers (mean = 4,82; std. deviation = 1,49; median = 5; mode = 5). SMEs interviewed appear to be slightly above the average in terms of responsive action they implement to competitive action threatening their export markets (mean = 5,02; std. deviation = 1,32; median = 5; mode = 5), responding to important changes in their environment (mean = 5,12; std. deviation = 1,39; median = 5; mode = 5), and in reaction to significant changes in the competitors' price structures on foreign markets (mean = 4,48; std. deviation = 1,53; median = 5; mode = 5).

8 out of the initial 17 items composing the initial measure of Cadogan *et al.* (1999) were retained after the questionnaire pre-test realized with 12 SMEs' managers. The qualitative



pre-test revealed that the managers interviewed had difficulties answering the reversed items that are the last two items in Table 38. Moreover, the questionnaire pre-test suggested that they answered to the questions as if they were not reversed or responded by providing answers close to the middle point of 4. Due to the response patterns for the reversed items in Table 38, it can be observed that managers provided responses very close to the middle point of 4. Therefore, it was concluded that measurement errors occurred when they answered the questionnaires and the two reversed items were excluded from the measurement model estimation analysis.

Table 38. Export responsiveness, descriptive analysis

Indicate to what extent you agree or disagree with the following statements :	Mean	Std. dev	Frequency of responses (%)						
			1 Totally disagree	2	3	4	5	6	7 Totally agree
▪ Our strategy for standardizing or adapting our export product offering is based on detailed customer observation.	4,80	1,70	7,61 %	4,76 %	8,57 %	15,23 %	19,04 %	32,38 %	12,38 %
▪ We are quick to respond to significant changes in our competitors' price structures in foreign markets.	4,48	1,53	2,83 %	9,43 %	15,09 %	18,86 %	25,47 %	19,81 %	8,49 %
▪ When we find that export customers are unhappy with the quality of our service, we take corrective action immediately.	5,56	1,42	0,00 %	3,73 %	9,34 %	7,47 %	16,82 %	31,77 %	30,84 %
▪ Our export business objectives are driven primarily by customer satisfaction.	4,93	1,78	2,80 %	9,34 %	14,01 %	11,21 %	15,88 %	21,49 %	25,23 %
▪ All 'departments' in our firm are involved in implementing our export market strategies.	5,04	1,57	1,86 %	8,41 %	4,67 %	16,82 %	26,16 %	20,56 %	21,49 %
▪ Our export business strategies are driven by our beliefs about how we can create greater values for export customers.	4,82	1,49	0,94 %	7,54 %	12,26 %	16,98 %	25,47 %	23,58 %	13,20 %
▪ We are quick to respond to important changes in our business environment (e.g. regulatory, technology, economy, etc.).	5,12	1,39	1,86 %	2,80 %	7,47 %	16,82 %	28,03 %	26,16 %	16,82 %
▪ We rapidly respond to competitive actions that threaten us in our export markets.	5,02	1,32	0,93 %	4,67 %	8,41 %	12,15 %	36,44 %	25,23 %	12,15 %
▪ For one reason or another we tend to ignore changes in our foreign customers' product or services needs.	4,02	1,12	0%	2,32 %	15,7 %	56,78 %	21,9 %	3,30 %	0%
▪ The choice of the product we sell to foreign markets depend more on internal politics than real markets needs.	3,98	1,08	0%	2,80 %	13,89 %	67,78 %	12,78 %	7,54 %	0%

#### *VI.2.4.2 The positional advantage in terms of international marketing competences*

Table 39 suggests that companies interviewed are generally characterized, in comparison to their main competitors in foreign markets, by slightly above average levels of international marketing competences.

They report the highest levels of competences (in order of importance) in terms of product strategy development (mean = 4,75; std. deviation = 1,21; median = 5, mode = 5), foreign networking (mean = 4,70; std. deviation = 1,28; median = 5, mode = 5), foreign pricing strategy (mean = 4,40; std. deviation = 1,09; median = 4, mode = 4), foreign markets segmentation (mean = 4,29; std. deviation = 1,29; median = 4, mode = 3), export information management (mean = 4,25; std. deviation = 1,21; median = 4, mode = 4), international communication strategy (mean = 4,12; std. deviation = 1,28; median = 4, mode = 4), international distribution strategy (mean = 4,06; std. deviation = 1,37; median = 4, mode = 4), and finally, international marketing management (mean = 3,90; std. deviation = 1,40; median = 4, mode = 4).

Table 40 recapitulates the descriptive analysis of the levels of positional advantage of SMEs interviewed in terms of international marketing competences. It can be observed that only one of the considered groups of foreign market-related competences is below average. More precisely, exporting SMEs seem to be less skilled in terms of international marketing management, more precisely in setting marketing goals, translating marketing strategies into action, control and evaluation of marketing costs. These actions generally relate to the planning procedures, and the qualitative analysis has already suggested that planning activities are poorly developed in SMEs.

It is interesting to note that with one exception, companies in the sample judge themselves as better than their main competitors concerning the development of their international marketing competences. Recall that the literature review highlighted the general lack of international competences in exporting SMEs. The sample description already suggested that companies interviewed are bigger and more internationally involved than the average. The results with regard to the development of international marketing competences of the companies interviewed also indicate that the companies in this sample seem to be rather successful exporters.

Table 39. Positional advantage in terms of international marketing competences

Variables analyzed	Mean	Std. dev	Frequency of responses (%)						
			1 Much worse than competitors	2	3	4 As much as the competitors	5	6	7 Much better than competitors
▪ Networking (e.g. identifying contacts abroad, entertaining developing relationships with the contacts abroad, knowledge and understanding of business practices, foreign languages skills)	4,70	1,66	0,94 %	1,88 %	16,03 %	25,47 %	25,47 %	22,64 %	7,54 %
▪ International marketing management (e.g. setting marketing goals, formulating creative marketing strategies, translating marketing strategies into action, control and evaluation of marketing costs)	3,90	1,97	2,87 %	15,23 %	21,90 %	24,76 %	21,90 %	10,47 %	2,85 %
▪ Foreign market segmentation (e.g. opportunity seeking, studying foreign markets characteristics, targeting and penetrating foreign markets, identification potential clients/markets)	4,29	1,67	1,88 %	2,83 %	28,30 %	20,75 %	26,41 %	16,98 %	2,83 %
▪ Product strategy (e.g. R&D of new products/services, products and service adaptation, packaging, launching successfully new products/ services)	4,75	1,46	1,88 %	1,88 %	9,43 %	22,64 %	41,50 %	15,09 %	7,54 %
▪ Price strategy (e.g. negotiating and fixing the price and the payment delays, responsiveness in terms of pricing to market change, fixing the margins, evaluation of the credit risks)	4,40	1,20	0,94 %	3,77 %	11,32 %	37,73 %	33,96 %	8,49 %	3,77 %
▪ Communication strategy (e.g. promoting sales, products, developing enterprise image and reputation, managing communication programs)	4,12	1,65	2,83 %	8,49 %	15,09 %	37,73 %	21,69 %	11,32 %	2,83 %
▪ Distribution strategy (e.g. selecting the distributor agents and the sale force, entertaining the relations/collaboration with distributor agents, choosing the localization of the selling/distribution points, training selling personnel)	4,07	1,89	3,81 %	7,61 %	22,85 %	28,57 %	20,00 %	14,28 %	2,85 %
▪ Information management (e.g. identification of information sources, collecting information on clients and competitors, tracking customers wants and needs, collecting and analyzing market information)	4,25	1,47	0,94 %	3,77 %	18,86 %	43,39 %	17,92 %	8,49 %	6,60 %

## VI.2.4 The levels of international performance

Recall that two main types of indicators, objective and subjective, were used in order to assess the levels of international performance of companies. Concerning the subjective indicators, enterprises are slightly above the average regarding the satisfaction with the evolution of the

export market-share (mean = 4,40; std. deviation = 1,61; median = 5; mode = 5), the export profits (mean = 4,67; std. deviation = 1,24; median = 5; mode = 5), the volume of export sales (mean = 4,62; std. deviation = 1,54; median = 5; mode = 6) and with the evolution of the number of export markets conquered over the last year (mean = 4,06; std. deviation = 1,69; median = 4; mode = 5). These results are displayed synthetically within the Table 40.

Table 40. The satisfaction with the evolution of the export objectives over the last year

Variables analyzed The degree of satisfaction with the evolution over the last year of the following export objectives:	Mean	Std. dev	Frequency of responses (%)						
			1 Much worse than competitors	2	3	4 As much as the competitors	5	6	7 Much better than competitors
▪ Market share abroad	4,40	1,61	0,94 %	13,08 %	17,75 %	14,95 %	27,10 %	13,08 %	12,15 %
▪ Profits obtained from international activities	4,67	1,24	0,93 %	5,60 %	7,47 %	28,03 %	32,71 %	19,62 %	5,60 %
▪ Sales volume in international markets	4,62	1,54	0,93 %	11,21 %	14,01 %	17,75 %	18,69 %	28,97 %	8,41 %
▪ Number of new foreign markets "conquered"	4,06	1,69	7,47 %	15,88 %	13,08 %	16,82 %	28,03 %	10,28 %	8,41 %

Responding managers also perceive their company as competitive slightly above average in terms of export market share (mean = 4,11; std. deviation = 1,59; median = 4; mode = 5), export profits (mean = 4,51; std. deviation = 1,23; median = 5; mode = 5), volume of export sales (mean = 4,39; std. deviation = 1,61; median = 5; mode = 5) and number of export markets conquered over the last year (mean = 4,00; std. deviation = 1,55; median = 4; mode = 5).

Table 41. Perceived competitiveness in terms of evolution of the export objectives over the last year

Variables analyzed The perceived competitiveness in terms of evolution over the last year of the following export objectives:	Mean	Std. dev	Frequency of responses (%)						
			1 Much worse than competitors	2	3	4 As much as the competitors	5	6	7 Much better than competitors
▪ Market share abroad	4,11	1,59	0,94 %	13,08 %	17,75 %	14,95 %	27,10 %	13,08 %	12,15 %
▪ Profits obtained from international activities	4,51	1,23	0,93 %	5,60 %	7,47 %	28,03 %	32,71 %	19,62 %	5,60 %
▪ Sales volume in international markets	4,39	1,61	0,93 %	11,21 %	14,01 %	17,75 %	18,69 %	28,97 %	8,41 %
▪ Number of new foreign markets "conquered"	4,00	1,55	7,47 %	15,88 %	13,08 %	16,82 %	28,03 %	10,28 %	8,41 %

Finally, compared to the main competitors in export markets, SMEs' managers are always satisfied at an average level with the evolution over the last year of the market share (mean = 4,29; std. deviation = 1,52; median = 4; mode = 4), the export profits (mean = 4,39; std. deviation = 1,23; median = 5; mode = 5), the volume of export sales (mean = 4,45; std. deviation = 1,49; median = 5; mode = 5) and the number of export markets conquered over the last year (mean = 4,00; std. deviation = 1,59; median = 4; mode = 5). Another qualitative indicator used to capture the international performance levels of the companies in the sample is the perceived profitability of the export sales compared to domestic sales. The companies perceive foreign sales generally as profitable as domestic sales (mean = 4, 04; std. deviation = 1,46; median = 4; mode = 4).

Table 42. Perceived relative competitiveness in terms of evolution of the export objectives over the last year

The perceived competitiveness, compared to the main competitors in export markets in terms of evolution over the last year of the following export objectives:	Mean	Std. dev	Frequency of responses (%)						
			1 Much worse than competitors	2	3	4 As much as the competitors	5	6	7 Much better than competitors
▪ Market share abroad	4,29	1,52	3,73 %	10,28 %	15,88 %	24,29 %	20,56 %	19,62 %	5,60 %
▪ Profits obtained from international activities	4,39	1,23	1,88 %	5,66 %	13,20 %	29,24 %	33,01 %	14,15 %	2,83 %
▪ Sales volume in international markets	4,45	1,49	3,73 %	8,41 %	14,01 %	18,69 %	28,03 %	21,49 %	5,60 %
▪ Number of new foreign markets "conquered"	4,00	1,59	5,60 %	15,88 %	16,82 %	19,62 %	21,49 %	16,82 %	3,73 %

Objective measures were drawn from the DIANE database for tracking export performance over time, namely the evolution of the export sales profits and export sales volume over the last three years. It can be observed once again that this sample is generally composed of rather highly successful companies. On average, their export sales increased 19,20 % over the last three years (std. deviation = 38,42; median = 13,80; min = -44,76; max = 209,86). In terms of the profits realized with sales abroad, the companies in the sample registered an increase of 17,24 % on average over the last three years (std. deviation = 35,28; median = 15,65; min = -37,65; max = 168,86).

## VI.2.5 The control variables

The level of international orientation of SMEs in the sample and their size was controlled in order to assess the real impact of the positional advantage in terms of international marketing competences upon the international performance of SMEs. The descriptive analysis of firms in terms of size was not detailed in this point since it was previously done in the sample description (point VI.2.1).

Table 43. The international orientation levels of SMEs in the sample

Please indicate the extent to which you agree with the following statements: “Senior management in our company...”	Mean	Std. dev	Frequency of responses (%)						
			1 Totally dis- agree	2	3	4	5	6	7 Totally agree
▪ considers our exporting activities to be important.	5,75	1,40	0,94 %	4,71 %	1,88 %	10,37 %	11,32 %	34,90 %	35,84 %
▪ intends to increase the company's exporting activities.	5,64	1,39	1,86 %	2,80 %	2,80 %	8,41 %	21,49 %	28,97 %	33,64 %
▪ actively explores international market opportunities.	5,48	1,50	1,88 %	0,94 %	11,32 %	12,26 %	10,37 %	33,01 %	30,18 %

In Table 43, it can be observed that high levels of international orientation characterize SMEs in this sample. The managers of the firms interviewed believe that their exporting activities are important (mean = 5,75; std. deviation = 1,40; median = 6; mode = 7), they highly intend to increase their international activities (mean = 5,66; std. deviation = 1,39; median = 6; mode = 7), and they seem to actively explore foreign market opportunities (mean = 5,48; std. deviation = 1,50; median = 6; mode = 6).

## VI.2.6 Synthesis of the descriptive analysis

The descriptive analysis allowed for a general overview of the absorptive capacity levels of companies in the sample as well as a description of their general characteristics, international performance and international orientation levels.

As far as the sample representativity is concerned, it can be observed that responding companies are generally bigger and more internationally involved than companies constituting the population of the study. Nevertheless, the differences with respect to the

percentage of sales realized abroad and a company's size cannot be judged as extremely marked.

The companies interviewed can generally be characterized as internationally experienced. Very few "*beginners*" in exporting are comprised in this sample. Most enterprises interviewed have an export department that highlights their engagement towards developing international activities. This feature is also supported by the results attesting that high levels of international orientation characterize the companies interviewed. They appear to be willing to extend their international activities and actively look for foreign market opportunities; they consider their international activities important.

Generally, an important number of employees are responsible for dealing with international activities for more than 50% of their time. The export experience of these employees can be judged as rather rich in terms of complementarity, variety, and length. Most of the enterprises in the sample export in a relatively important number of foreign countries. Border countries represent an important part of the export destinations. The companies interviewed mainly employ basic foreign presence modes to sell their products abroad such as direct and indirect exporting. Nevertheless, one-third of the companies use associative modes or have established subsidiaries abroad. The companies in this sample employ much less foreign presence modes such as licensing and internet sales.

The richness of information sources the companies use in order to inform themselves concerning foreign markets appear to be above average in terms of the relational information sources such as the clients, agents or distributors, and participation at trade fairs. Average levels of richness characterize Chambers of Commerce and Industry, export marketing research, and Internet. The only information source registering below average richness levels are foreign competitors. As a result, they cannot be considered as a rich information source and can no longer be included for the research propositions' test related analysis.

As far as the levels of potential absorptive capacity of companies in the sample are concerned, it can be observed that they appear to be highly developed. They coordinate efficiently and perform well in terms of knowledge transfer and integration.

The export information acquisition dimension appears to be less developed than the assimilation dimension. Nonetheless, companies interviewed are informed on a level that is above-average concerning foreign markets in comparison to their main competitors in foreign markets. The SMEs interviewed seem to give privilege to export information concerning foreign clients and product related information.

In terms of realized absorptive capacity, enterprises interviewed score quite highly above the average in terms of export responsiveness capacity (transformation dimension). SMEs perform generally slightly above average in terms of international marketing competences compared to their main competitors in foreign markets. They register the highest levels of competences in networking and product development, and the lowest performances in terms of international marketing management.

The descriptive results also allowed for an overview concerning the international performance levels that companies attain in foreign markets. Responding managers appear to be satisfied with the evolution of the main export objectives over the last year and they perceive themselves as rather competitive in comparison to their main competitors in foreign markets. They rate themselves as slightly superior in terms of reaching export objectives abroad. Their progression in terms of export sales and profits over the previous three years is also important (on average about 20%). Their foreign sales appear as profitable as the ones realized in the domestic market.

### VI.3 Measurement model validation

The Structural Equation Modeling (SEM) method was used for testing the research model. The advantage of SEM, compared to more classical approaches, is that SEM allows simultaneous testing for the psychometrical properties of measurement models and the relationships of influence among the constructs composing the research model, and at the same time, the evaluation of the overall quality of the research model.

Since the introduction of covariance-based SEM by Jöreskog in 1973, this classic technique has received considerable interest and has been widely used in empirical research. The predominance of LISREL is explained by the fact that co-variance-based SEM is also recognized as a very powerful statistical tool. The covariance-based approach “*attempts to minimize the difference between the sample co-variances and those predicted by the theoretical model. Therefore, the parameter estimation process attempts to reproduce the covariance matrix of the observed measures*” (Chin and Newsted 1999, p. 309).



PLS was first introduced by H. Wold (1975). This method attempts to maximize the variance of dependent variables explained by the independent ones instead of reproducing the empirical co-variance matrix (like co-variance based SEM does). Like co-variance based SEM, a PLS model consists of a structural part that reflects the relationships between the latent variables and a measurement model, which shows how the latent variables (LVs) and their indicators (manifest variables - MVs) are related. The PLS model has a third component, namely the weight relations, used to estimate the latent variables (Chin and Newsted 1999).

The two approaches of SEM present similarities and differences and they can be seen as alternative rather than concurrent approaches. While co-variance based SEM is to be employed only when research models are built on solid theoretical ground, variance based SEM is recommended in the case of emerging, “*soft*” theories that are under development (Falk and Miller 1992). Concerning this feature, it can be concluded that in the case of the current research, soft modeling is more appropriate. The KBV approach can be mobilized and can be seen as an emerging theoretical field (Lane *et al.* 2006) rather than a grounded theory. Another difference between the two approaches is that while the co-variance based SEM approach implies the use of substantial datasets, soft modeling works with a relatively small number of observations. From this point of view, soft modeling is also feasible in the case of the current research although the limited number of observations gathered (107 questionnaires) would not have allowed the use of a co-variance based SEM. Another observation is that co-variance based SEM requires data multi-normality, which is not a widely spread feature in the data gathered in human and social sciences; soft modeling does not require data multi-normality. While co-variance based SEM is a rather measure-oriented approach, PLS path modeling is actually a prediction-oriented approach. Monte-Carlo simulations have proved that very similar results are found by testing one research model with the two methods in terms of both measurement models and paths of influence (Tenenhaus 2008). However, co-variance based approaches appear to be more severe in terms of measurement model assessment, while PLS path modeling appears as more demanding in terms of predictive and causal relationships’ estimations. Resuming, it can be concluded that PLS path modeling appears as the most appropriate statistical technique for the estimation of this research model for several reasons including (1) the reduced number of observations composing this sample, (2) the use of formative indicators, (3) the high complexity of the research model, and (4) the soft theory employed by this research. Table 44 presents an overview of the differences existing between co-variance based and variance based SEM.

The PLS approach to SEM is used to cope with the non-normally distributed data (Falk and Miller 1992), large numbers of variables, and a relatively low number of observations compared to the number of parameters to be estimated (Fornell and Bookstein 1982). The main purpose of PLS SEM is to maximize prediction. This maximization is accomplished by using a series of multiple interdependent regressions aiming to minimize residual variance in structural equations. In the first estimation step, an estimate is made for each LV as a linear combination of its indicators. In the second step, the estimates are treated as variables that are directly observed. They are then re-estimated according to a path-weighting scheme for maximizing the correlation between constructs (Lohmöller 1984). The resulting coefficients are interpreted as standardized partial regression coefficients. The significance of the parameters is assessed using bootstrap and blindfolding estimations. Estimations of construct reliability and validity is undertaken as in ordinary co-variance based structural SEM (Fornell and Larcker 1981).

Table 44. Comparison of the co-variance and variance-based SEM

Criteria	Variance based SEM (PLS)	Co-Variance based SEM (LISREL)
Main aim	Prediction oriented	Parameter estimation orientated
Method	Variance based	Co-variance based
Acceptance	Prediction specifications	Multi-normality and independency of observations
Parameters estimation	Consistency at large (works better with high numbers of indicators for latent variables (LVs) and missing data)	Consistency
Latent variables	Weights are estimated	Weights indeterminate
Measurement model	Reflexive or formative	Reflexive
Theory specifications	Flexible	High
Model complexity	Highly complex models (e.g. 100 LVs 1000 items)	Limited
Samples	Appropriate for small samples as well	Big samples (200 and more observation)
Implications	Optimal for prediction estimation	Optimal for parameter estimations

Source: Bliemel et al. (2005), *Handbuch PLS-Pfadmodellierung*, p. 11.

No statistical test of model fit is provided to compare the predictive relevance of different models. Recently, Tenenhaus *et al.* (2005) developed a goodness of fit index for the PLS Path modeling based on the quality of the measurement models and the predictive quality of the structural relationships. A PLS path model is composed as a co-variance based path model by a measurement model relating manifest variables to latent constructs and a structural model

relating endogenous to exogenous latent variables. The measurement model is also called the outer model, while the structural model is also known as the inner model.

The psychometrical properties of the outer and inner models will be presented in the following sections. The outer model assessment will be exposed and afterwards, in chapter VII, the test of the research proposition also known as the causal analysis will be presented. The first step, the outer model assessment, is necessary in order to prepare the data for the estimation of the causal relationships in the research models. As most of the concepts mobilized in the research model developed in chapter III cannot be directly measured (they are latent constructs) it is necessary to first ensure that they are psychometrically sound. The formative and reflexive measurement models were mobilized within this research. The two types of measurement models differ in the way the manifest variables relate to the latent construct. In the reflective way, latent variables are indirectly observable through a set of manifest variables. Each one of the manifest variables is related to the latent variable by simple regressions. Most of the constructs within this research model are reflexive. In the formative way, the LV is calculated by linear regressions of its own MVs. The international performance of SMEs is the dependent variable, and it is also the single formative construct in this research model.

As it follows, the psychometrical properties of the measures employed in this research model are presented. The measurement model quality for assessing the dependent variable (the international performance of SMEs) in the model will first be presented. The reason for proceeding in this manner is that international performance is a formative construct made up of six indicators, three reflexive latent constructs and three manifest variables. As a result, it was necessary to first ensure that the reflexive constructs present satisfying psychometrical properties in order to be able to compute the formative construct.

In order to estimate the research model, the following parameters were employed: the estimation of missing data by means of the Lohmöller method, the treatment of MVs' and the LVs' scores was completed in standardized values, the internal estimation method employed in the centroid scheme and the OLS regression was used to assess the predictive paths of influence. One hundred re-samplings were used for the bootstrap estimation and 30 were used for the blindfolding procedure.

### VI.3.1 The psychometrical properties of the dependent variable: the international performance of SMEs

In line with recent studies in the field, the international performance of SMEs was conceptualized as a formative index made up of six indicators that are qualitative and quantitative by nature. Three of the indicators are reflexive constructs which capture qualitative strategic aspects of the international performance construct related to the development in the past year with the following export objectives: the market share in export markets, the export profits, the volume of export sales, and the number of export markets conquered abroad. The fourth indicator used to capture international performance is also qualitative by nature. It is measured by a single manifest variable that assesses the perceived profitability of export activities compared to domestic activities. The two remaining indicators that capture the international performance construct are quantitative and financial by nature. They capture the average evolution of the export sales and export profits over the last three years. They were extracted from the DIANE database.

The measurement validity of the international performance construct was assessed in two steps. First of all, the dimensionality and the internal consistency of the three reflexive constructs that compose the formative international performance constructs were assessed. Since it is impossible to specifically estimate measurement models among constructs that are correlated among each other and do not present influential relationships among each other with PLS path modeling, classical covariance based SEM was used to evaluate the psychometrical properties of the three reflexive constructs. Secondly, an estimate was made with PLS path modeling for assessing the psychometrical properties of the formative international performance construct.

The psychometric properties of the three reflexive scales that are the perceived satisfaction, the competitiveness, and the relative competitiveness with the evolution of the export objectives over the last year were subsequently assessed using established statistical measurement development procedures (e.g. Churchill 1979; DeVellis 1991; Nunnally and Bernstein 1994). A Confirmatory Factor Analysis (CFA) was performed with LISREL 8.54 to test the scales (convergent and discriminant) validity. The main limit of the assessment of the validity of convergence and discrimination by means of a CFA performed with LISREL is that the discriminant validity of the three reflexive scales cannot be assessed in comparison

with all the measurement models comprised in this research model (at the same time). Using covariance based SEM for evaluating all the measurement models comprised in our study at the same time is limited by the number of observations we dispose of. As a result, in spite of the limitation of the chosen method, performing a CFA on the items composing the three reflexive scales of interest represents the most suitable solution since the three reflective constructs (the perceived satisfaction, the perceived competitiveness, and the relative perceived competitiveness with the evolution of the export objectives over the last year) are expected to be correlated and reflexive relationships of influence cannot be tested with PLS path modeling. Moreover, generally scholars agree that co-variance based SEM are more accurate for assessing measurement models than variance based SEM (e.g. Bliemel *et al.* 2005).

The results of CFA are displayed in Figure 16 and they suggest that the measurement model does not efficiently fit the observed data:  $\chi^2=340,43$ ,  $df=51$ ,  $p<0,001$ ,  $RMSEA=0,23$ ,  $CFI=0,90$ ,  $SRMR=0,07$ ,  $GFI=0,65$ ,  $AGFI=0,47$ ,  $NFI=0,88$ . However, all items have quite substantial and significant loadings on their respective factor, which indicates the convergent validity of the items (Steenkamp and Van Trejp 1991). The Average Extracted Variance values for each dimension, greater than 0,7, are well above the recommended threshold of 0,5 (Fornell and Larcker 1981), thus supporting the convergent validity of the three dimensions.

While the conditions for the convergent validity are fulfilled, the discriminant validity of the three scales was not supported. There are significant positive relationships between the three reflexive constructs examined, and the size of the relevant correlations appears to be extremely high at above 0,9. These results indicate that the three latent constructs measure very close, almost identical concepts. Moreover, the squared correlation of the latent variables is higher than the AVE (average extracted variance). Concluding, the conditions necessary for discriminant validity of scales are not fulfilled.

Furthermore, based on the results of the CFA, Jöreskog's Rhô was calculated in order to assess the reliability of scales. This coefficient is considered less sensitive to the number of items used for capturing a reflective construct and more adapted to SEM than Cronbach's Alpha (Roussel *et al.* 2002). The internal consistency measures (Cronbach's Alpha and Jöreskog's Rhô) as well as the convergent and discriminant validity measures are presented in Table 45. One can notice that the reliability of the scales was supported by the results; Cronbach Alphas and Jöreskog's Rhôs are fairly high at above 0,8.

Table 45. Scales validity and reliability, convergent and discriminant validity

Factors	Reliability		Convergent validity	Discriminant validity		
	$\alpha$ Cronbach	Rh $\hat{o}$ Jöreskog	AVE	Correlation between factors		
RC	0.89	0.93	0.75	RC	PC	S
PC	0.88	0.92	0.74	1	1	
S	0.86	0.91	0.72	0.96	0.92	1

**Legend:** RC= relative competitiveness with the evolution of export objectives, PC = perceived competitiveness with the evolution of export objectives, S = satisfaction with the evolution of export objectives

Figure 16. CFA of the three reflexive constructs measuring the perceived satisfaction, competitiveness and relative competitiveness of SMEs

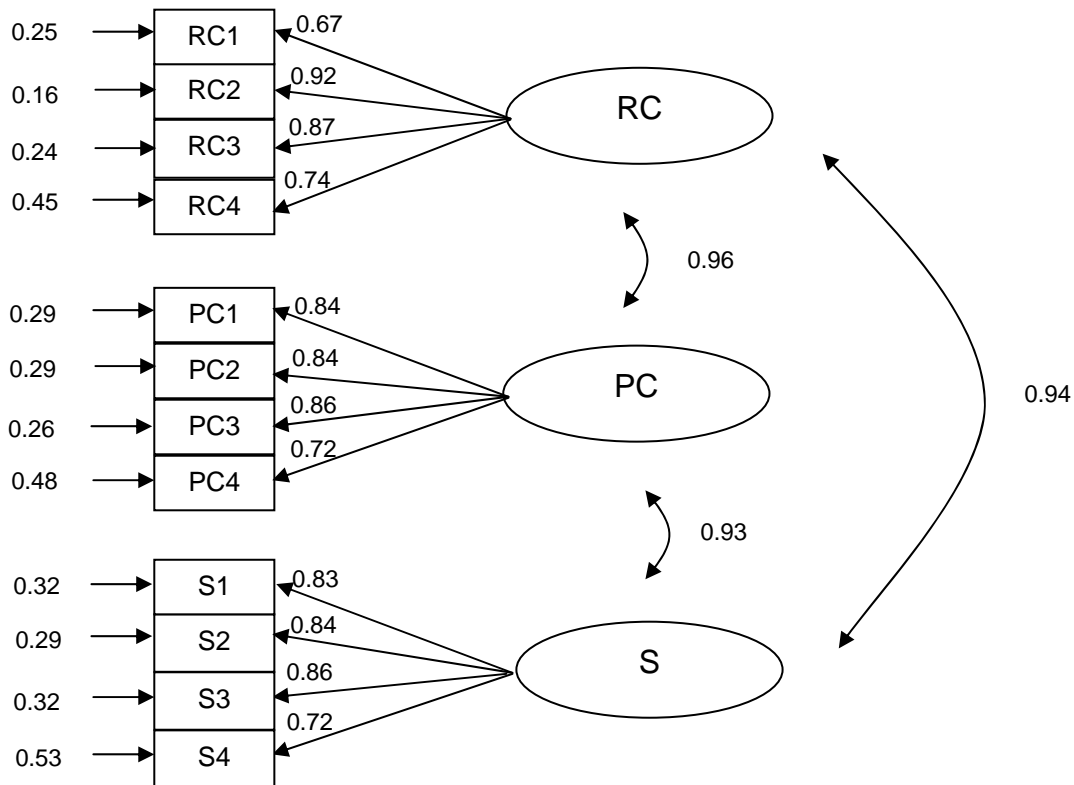

All parameters are significant at the level of 0.05.  
All parameters are completely standardized solutions.

**Legend:** RC= relative competitiveness with the evolution of export objectives; RC1 = relative competitiveness in terms of foreign market share, RC2 = relative competitiveness in terms of export sales volume; RC3 = relative competitiveness in terms of number of new foreign markets entered; RC4 = relative competitiveness in terms of foreign profits; PC = perceived competitiveness, PC1 = perceived competitiveness in terms of foreign market share, PC2 = perceived competitiveness in terms of export sales volume; PC3 = perceived competitiveness in terms of number of new foreign markets entered; PC4 = perceived competitiveness in terms of foreign profits; S = satisfaction with the evolution of export objectives; S1 = satisfaction with the evolution of the foreign market share, S2 = satisfaction with the evolution of the export sales volume; S3 = satisfaction with the evolution of the number of new foreign markets entered; S4 = satisfaction with the evolution of the foreign profits.

Concluding, the CFA results suggest that the proposed scales are not psychometrically sound instruments. The GoF indexes suggest the data does not fit well the measurement model. Moreover, the discriminant validity condition is not fulfilled. Resuming, the initial three-fold factorial structure was not confirmed in the case of the present research. Instead, a bi-dimensional structure emerged when exploring scales' dimensionality through a Principal Component Analysis (PCA) with a Vari-Max rotation on all the items composing the three reflexive constructs. Hereafter in Table 46, the results of the exploratory PCA are exposed. The PCA did not reveal a three-dimensional structure as expected. Instead, a bi-dimensional structure emerged explaining 77,01% of the total variance. The first component explains 68,40% of the variance while the second principal component explains only 6,80% of the total variance. The first component is composed of all the items except three, namely the ones referring to the satisfaction, the perceived competitiveness and the relative competitiveness of small firms in terms of profits obtained from export sales over the past year that compose the second principal component. The first principal components' internal consistency is very high (Cronbach Alpha = 0,95 for PC1; Cronbach Alpha = 0,90 for PC2).

Table 46. Exploratory PCA of international performance construct (on the items composing the LVs)

Construct	Items	Loadings on PC1	Loadings on PC2
Perceived satisfaction with the evolution of the export objectives over the last year	S1	0,79	
	S2	0,81	
	S3	0,83	
	S4	0,73	0,48
Perceived competitiveness in terms of the evolution of the export objectives over the last year	PC1	0,82	
	PC2	0,83	
	PC3	0,85	
	PC4	0,78	0,48
Relative perceived competitiveness in terms of the evolution of the export objectives over the last year	RC1	0,87	
	RC2	0,90	
	RC3	0,88	
	RC4	0,77	0,50
<i>Percentage of variance explained: 77,01% (68,40% for PC1 and 6,80% for PC2), Cronbach Alpha PC1 = 0,95, Cronbach Alpha PC2 = 0,90</i>			

**Legend:** ibidem Figure 16

Nevertheless, it is possible to observe that the three items composing the second principal component score higher on the first component extracted with loadings higher than 0,73, while they score quite low under the minimum value of 0,5 on the second principal component. For this reason and also because of the relative low value of the percentage of the variance explained (6,80%), the items composing the second principal component were dropped from the analysis.

It is not easy to explain the differences between the factorial structure obtained in this study and the one found in the study of Souchon and Durden (2002). However, a possible explanation of the emerging factorial structure might come from the preliminary qualitative study. Managers stated that their foreign profits diminished over the previous years because they had to keep the pace to a certain extent with the competitors from the Eastern countries, which had much lower costs. The companies interviewed might have progressed in terms of new markets entered abroad, sales volume and market share abroad, but not necessarily in terms of profits generated by means of their export sales. This finding might explain the fact that export profit related items did form another specific principal component in this analysis.

The results indicate that according to French managers' perceptions, satisfaction, perceived and relative competitiveness with the development of several export objectives - such as the number of foreign countries they entered over the last year, the export sales volume and the market-share they attain in foreign markets - are very closely related concepts and they formed a single principal component. The construct that results out of the PCA will be called "*the perceived strategic international performance of SMEs*" since it regroups the perceptive and qualitative variables used for assessing the perceived satisfaction with the evolution of the main export strategic objectives over the previous year.

In order to assess the convergent and discriminant validity of this construct issued out of the exploratory PCA, the research model was estimated with XLSTAT by using "*the perceived strategic international performance of SMEs*" as an explained, dependent variable (see appendix 6 for the detail of the results). LISREL and co-variance based SEM were no longer employed because the variance-based SEM also allows for the verification of the convergent and divergent validity of measures. Moreover, using variance-based SEM has the advantage of evaluating the discriminant validity of the construct by comparing the latent construct "*perceived strategic international performance of SMEs*" to all the other measures of the latent constructs in this research model. In addition, the test of the nomological validity of this scale was also possible through the use of the PLS path modeling. Checking for the



nomological validity of the scales should be done by linking the scales to other theoretically relevant constructs uncovered via a literature review (Peter 1981). Based on the literature review, we can expect that the positional advantage of SMEs in terms of international marketing competences would have a positive and significant effect on the international performance. As a result, we can expect that the positional advantage of SMEs in terms of international marketing competences would significantly and positively impact the “*perceived strategic international performance of SMEs*”.

In order to estimate the research model, the following parameters were employed: the estimation of missing data by means of the Lohmöller method, the treatment of MVs’ and the LVs’ scores was completed in standardized values, the internal estimation method employed in the centroid scheme and the OLS regression was used to assess the predictive path of influence. One hundred re-samplings were used for the bootstrap estimation and 30 were used for the blindfolding procedure.

The reflexive measurement models in PLS path modeling are assessed as is the case for the co-variance-based SEM in terms of dimensionality, items (manifest variables), reliability, internal consistency, convergence, divergence and nomological validity. The dimensionality of constructs is ensured if the results of the principal components analysis (PCA) on the Manifest Variables (MV) composing a certain latent variable (LV) reveal the same number of significant principal components with eigen values superior to the critical value of 1, also known as the Keiser criteria, as in the theoretical model. For the “*perceived strategic international performance of SMEs*”, a single principal component with an eigen value superior to one was extracted. Thus, it can be concluded that the construct is single-dimensional.

Item reliability for reflective indicators is tested by examining the loadings and the weights with their respective construct. The rule of thumb is that loadings should reach values of 0,70 or above, but in practice, it is common to find loadings below this threshold particularly when new items or new scales are employed (Hulland 1999). All the loadings are superior to 0,7 for the “*perceived strategic international performance of SMEs*” construct.

As far as the weights are concerned, they should reach positive values. Moreover, the MVs that compose the LVs should have similar contributions to the latent construct. That is the case for the items composing the LV “*perceived strategic international performance of SMEs*”. The stability of the predictions of the loadings and weights of the MVs on the underlying LVs are estimated in PLS path modeling by the bootstrap procedure. The

bootstrap procedure consists of assessing the stability of the prediction of the loadings and weights on one hundred randomly generated samples. The bootstrap estimation for the loadings and weights suggests that the LV “*perceived strategic international performance of SMEs*” is a stable measure.

Communality shows how much of the variance of one LV is reflected through the MVs. The communalities of the MVs generally should exceed the critical value of 0,5. For the “*perceived strategic international performance of SMEs*” all communalities of the MVs exceed 0,5.

For assessing construct reliability, two measures are available, namely Cronbach’s Alpha and Dillon Goldstein’s  $\rho$ . The critical values for accepting the reliability of the measures employed are that Cronbach’s Alpha should be superior to 0,6 and Dillon Goldstein’s  $\rho$  should exceed 0,8 (Ringle and Spreen 2006). The construct reliability criteria have been highly met for our latent construct of interest, the “*perceived strategic international performance of SMEs*”.

The convergent validity of reflexive measures can be established if the Average Variance Extracted (AVE) of the LVs exceeds the critical value of 0,5 (e.g. Fornell and Larcker 1992; Ringle and Spreen 2006). The convergent validity criteria has also been met for the “*perceived strategic international performance of SMEs*”.

The criteria retained for evaluating the discriminant validity of the reflexive constructs are the comparison of the AVE to the squared correlation of LVs and the examination of cross-loadings. The AVE of each LV should be superior to the squared correlation of two LVs (Fornell and Larcker’s criteria), which indicates that more variance is shared between the LV and its block of indicators (MV) than with another LV representing another block of indicators (Fornell and Larcker 1992). The two criteria for judging the discriminant validity of latent constructs have been met by the “*perceived strategic international performance of SMEs*”.

Another estimation method implemented in PLS is the blindfolding procedure which “*feels PLS like a glove*” (Chin 1998, p. 265). Blindfolding consists of estimating parameters by means of repeated omission for all data points of a part in the data matrix, and then reconstructing the omitted part by the estimated parameters (Esposito-Vinzi 2007). This procedure results in a generalized cross-validated measure that should be positive.

Communality shows how much of the variance of one LV is reflected through the MVs. Redundancy gives indications about how much of the LVs and MVs are explained by the

measurement model, and the quality of influence relationships composing the inner model. For the “*perceived strategic international performance of SMEs*”, redundancy and communalities estimations are positively defined.

The nomological validity condition was also fulfilled. As expected, the positional advantage of SMEs in terms of international marketing competences has a significant and positive impact on the “*perceived strategic international performance of SMEs*”<sup>23</sup>. The relationship is significant at the 99% level ( $\beta = 0,46$ ;  $p < 0,001$ ; critical ratio = 5,37).

Resuming, the results suggest that the “*perceived strategic international performance of SMEs*” is a psychometrically sound instrument. As a result, the score estimated for the LV “*perceived strategic international performance of SMEs*” through the PLS path modeling estimation with XLSTAT, was further used to assess the psychometrical properties of the (formative) construct, the international performance of SMEs. Using the score prediction and the other three indicators used to assess the international performance construct, namely the perceived profitability of export sales versus domestic sales, the average evolution over the last three years of the foreign sales and profits, the formative indicator international performance was computed and tested again with PLS path modeling.

Table 47. The main psychometrical properties of the LV “ *the perceived strategic international performance of SMEs*”

Latent Construct:	Items	Loadings	Communalities	Weights (on information richness)	Cronbach Alpha	Dillon-Goldstein Rhô	AVE
International strategic performance	S1	0,81	0,65	0,11	0,95	0,96	0,73
	S2	0,82	0,67	0,11			
	S3	0,85	0,72	0,12			
	PC1	0,84	0,72	0,15			
	PC2	0,89	0,79	0,15			
	PC3	0,85	0,73	0,14			
	RC1	0,85	0,73	0,10			
	RC2	0,88	0,78	0,12			
	RC3	0,89	0,80	0,13			

**Legend:** RC1 = relative competitiveness in terms of foreign market share, RC2 = relative competitiveness in terms of export sales volume; RC3 = relative competitiveness in terms of number of new foreign markets entered; PC1 = perceived competitiveness in terms of foreign market share, PC2 = perceived competitiveness in terms of export sales volume; PC3 = perceived competitiveness in terms of number of new foreign markets entered; S1 = satisfaction with the evolution of the foreign market share, S2 = satisfaction with the evolution of the export sales volume; S3 = satisfaction with the evolution of the number of new foreign markets entered.

<sup>23</sup> 41,30% of the variance of the “*perceived strategic international performance of SMEs*”.

In order to estimate the research model, the following parameters were employed: the estimation of missing data by means of the Lohmöller method, the treatment of MVs' and the LVs' scores was completed in standardized values, the internal estimation method employed in the centroid scheme and the OLS regression was used to assess the predictive path of influence. One hundred re-samplings were used for the bootstrap estimation and 30 were used for the blindfolding procedure.

Following the guidelines indicated by Diamantopoulos and Winklhofer (2001), the potential multi-collinearity existing among the four MVs composing the international performance latent construct was checked. The Value Inflation Factor (VIF) was inferior to the critical value of five. Therefore, it was concluded that no notable multi-collinearity problem could arise when computing international performance by using the formative pattern.

For assessing the measurement quality for formative constructs the only conditions that should be met are that the estimated weights of the MVs should be positively defined, and the Critical Ratio (CR) should be superior to the critical value of 1,96 (Arbuckle *et al.* 1997). Table 48 hereafter resumes these statistics for the construct of interest, namely the international performance of SMEs. It can be observed that even though the weights of the underlying MVs are positive, the CRs do not exceed the critical value of 1,96 for none of the indicators capturing the international performance of SMEs. Based on these results, it can be concluded that estimating the international performance construct as a formative index does not appear to be consistent in the case of the current research.

Table 48. Psychometrical properties of SMEs international performance (formative) construct

The manifest variables composing the formative construct international performance	Outer weights (normalized)	CR (critical ratio)
▪ Perceived international strategic performance (score)	0,75	1,06
▪ Perceived foreign sales profitability versus domestic sales profitability	0,10	0,41
▪ Mean of the progression of export sales over the last 3 years	0,06	0,97
▪ Mean of the progression of export profits over the last 3 years	0,23	0,77

Several reasons could explain this fact. While the two qualitative international performance indicators, “*the perceived strategic international performance*” and the perceived profitability of foreign sales, compared to domestic sales are indicators drawn from the questionnaire (primary data), the two financial international performance indicators are drawn from the

DIANE database (secondary data). Another main difference is that while the perceptive international indicators refer to the development of the export objectives over the last year, the two financial indicators are longitudinal data - the average evolution of the export sales volume and profitability over the last three years.

The main implication of these results is that the international performance construct cannot be measured according to the way it was initially aimed to, as a formative construct. As a result, in order to reduce the number of dependent variables aimed to capture the international performance construct, a PCA was operated on the four indicators – previously used to capture the international performance as a formative construct. Hereafter, the results of the PCA are presented in Table 49.

A single-dimensional structure emerged explaining 62,47% of the total variance. The MVs' loadings are exceeding the critical ratio of 0,7 (Nunnally 1988) with the exception of the item relative to the perceived profitability of export sales versus domestic sales. The small loading (0,46) and the small communality (0,22) obtained for this item suggest that this indicator does not reflect the underlying latent construct well. As a result, this item was withdrawn from the analysis. Also recall that the three perceived profitability indicators (perceived satisfaction, perceived competitiveness and relative competitiveness in terms of export profits) had to be previously withdrawn from the PCA undertaken on the twelve items aimed to measure the perceived satisfaction, competitiveness and relative competitiveness in terms of the evolution of export objectives over the last year. Based on the qualitative research, French managers suggested that they had to diminish margins in order to be able to face competition from Eastern Europe. As a result, it is possible that the results with respect to the assessment of the export profitability could be conditioned by the industry under study, and partially explains the results obtained.

Table 49. Exploratory PCA on the international performance indicators

<b>International performance indicators (MVs)</b>	<b>Loadings on PC1</b>	<b>Communality</b>
▪ Perceived international strategic performance (score)	0,818	0,669
▪ Perceived foreign sales profitability versus domestic sales profitability	0,469	0,220
▪ Mean of the progression of export sales over the last 3 years	0,855	0,732
▪ Mean of the progression of export profits over the last 3 years	0,947	0,879
<i>Percentage of variance explained: 62,47%, Cronbach Alpha PC1 = 0,78</i>		

After the item relative to the perceived foreign sales profitability versus domestic sales profitability was dropped from the analysis, a single-dimensional structure emerged again, explaining 78,49% of the total variance. The loadings and the communalities of the three international performance indicators are highly satisfying and the Cronbach Alpha (0,86) suggests that the underlying latent construct is solid in terms of internal consistency.

The results suggest that the new latent construct obtained presents satisfying properties in terms of dimensionality and internal consistency. Resuming, the results of the PCA suggest the three international performance indicators, namely the “*perceived international strategic performance*”, the means of the progression of the export sales and export profits over the last three years can be synthesized in a single reflexive construct that is called international performance in this study.

Table 50. Exploratory PCA on the international performance indicators

International performance indicators (MVs)	Loadings on PC1	Communality
▪ Perceived international strategic performance (score)	0,833	0,694
▪ Mean of the progression of export sales over the last 3 years	0,885	0,783
▪ Mean of the progression of export profits over the last 3 years	0,952	0,906
<i>Percentage of variance explained: 78,49%, Cronbach Alpha PC1 = 0,86</i>		

The advantage of this construct is that while it regroups at the same time more subjective or qualitative aspects - as the levels of satisfaction with the progression of strategic export objectives, it also regroups financial or objective data – such as the means of progression over the last three years of export sales and profits. Moreover, it encloses at the same time “static” measures - the perceived levels of satisfaction, competitiveness and relative competitiveness in terms of the progression over the previous year of strategic export objectives, namely the volume of export sales, the rate of new market entry and the levels of export market shares - and “dynamic” measures - the mean of the progression over the last three years of the export sales and profits. Nonetheless, it combines both secondary and primary data. While the means of the progressions of export sales and profits are issued from the DIANE database, the qualitative perceived importance measures are issued from the survey questionnaire in this study. Concluding, the international performance measure that emerged on an exploratory basis from this research covers most of the scholars’ recommendations concerning the measure of international performance (Sousa 2004), namely the combination of both objective

and subjective measures and the combination of static with dynamic data. The criteria of convergent and divergent validity of the international performance construct emerging from this research will be tested as follows within the outer model estimation for all the constructs composing the research model.

The nomological validity assessment is equivalent to the test of the tenth research proposition (see point VII.3.1) – assuming the positive and significant impact of the positional advantage SMEs detain in terms of international marketing competences on their levels of international performance. Recall that checking for the nomological validity of the scales should be done by linking the scales to other theoretically relevant constructs uncovered via a literature review (Peter 1981).

### **VI.3.2 Outer model estimation**

Within this section the quality of the psychometrical properties of the constructs composing the research model will be evaluated. The variables composing the research model can be regrouped into four classes: (1) the antecedents of PACAP, (2) PACAP dimensions, (3) RACAP dimensions, (4) international performance and (5) control variables. Hereafter, the way the variables have been assessed in the current research are briefly recalled.

(1) PACAP antecedents are export information richness sources and the international experience richness of SMEs. The export information sources richness construct was assessed as a second order construct made up of the reflexive constructs capturing export information sources richness of the six rich information sources considered for the final analysis: the foreign clients, agents, participations at trade fairs, Chambers of Commerce and Industry, export market research and Internet. The measure has been inspired by Ramangalahy's study (2001). It should be noted that within his study, Ramangalahy (2001) did not assess information sources richness as a second order construct. The author used factorial analysis to calculate scores for the richness attributes of each export information source group. Furthermore, he realized a new factorial analysis on the scores calculated for each group of export information sources and he synthesized once more the information comprised in these scores by calculating a new score reflecting the export information sources construct. The same method was not applied within the current research. The richness of export information sources was computed as a second order construct. The advantage of using this method is that

it allowed the estimation of the LV the richness of (the six) export information sources by being able to take into account the variance of each of the underlying richness attributes (underlying MVs) characterizing export information source richness (LVs) and at the same time the interactions between the LVs and their respective MVs, and also among the LVs composing the second order construct. For this reason, it seemed as if it would be more appropriate to estimate export information sources as a second order construct for this research case.

The export experience of SMEs has been captured by means of two constructs. The first one, the real international experience of SMEs, is obtained by adding the number of years firms have been selling their products abroad through a specific foreign presence mode. The second construct is reflexive; it is the richness of the international experience of the export employees. This construct is made up of three items assessing the agreement degree of SMEs with three statements concerning the degrees of variety, complementarity and length of the international experiences of export employees that spend more than 50% of their working time in the development of international activities.

(2) PACAP dimensions, specifically export information acquisition and assimilation, have been conceptualized respectively by the level of export market-related informativity of SMEs and the efficiency of the coordination and knowledge transfer integration practices in SMEs. Export information acquisition has been conceptualized as a reflexive construct relative to the state of export informativity levels of SMEs with respect to the general information, clients, competitors, products, prices, communication, and distribution practices in foreign markets. The export information assimilation of SMEs has been captured by two reflexive constructs, namely their coordination capacity and their ability to transfer and integrate knowledge inside the firm.

(3) The two dimensions of the RACAP have been conceptualized by means of two reflexive measures, which is the export responsiveness for the transformation dimension, and the positional advantage in terms of international marketing competences, that is for capturing the implementation dimension of RACAP. The export information transformation dimension has been conceptualized as SMEs export responsiveness capacity. The construct has been assessed by asking managers to provide their agreement degree with six statements relative to the response actions SMEs implement in order to face foreign market shifts. The export information transformation dimension of RACAP has been conceptualized in line with the study of Ramangalahy (2001) as a reflexive construct. The dimension captures the level of



international marketing competences of SMEs in terms of international networking competences, the competences associated with the management of the international marketing activities with foreign market segmentation, the strategy in international product development, foreign market pricing strategy, the international communication strategy, international distribution strategy, and the competences associated with the management of foreign market information.

(4) The international performance of SMEs has been captured through three items: (1) the mean of the progression of the percentage of export sales volume over the last three years, (2) the mean of the progression of the export profits over the last three years and (2) the perceived strategic international performance.

(5) Two control variables were used in order to assess the impact of the positional advantage in terms of international marketing competences more accurately on the level of the international performance of SMEs, namely a firm's size and the level of international orientation. The level of international orientation of small firms has been captured by asking the managers interviewed about their agreement degree with three statements concerning the SMEs' senior management opinions concerning the importance of exporting activities, the intention to increase the exporting activities of firms, and the active exploration of market opportunities.

Table 51 hereafter recapitulates the measurement models as well as the abbreviations of the MVs and LVs used to present the results.

Table 51. Abbreviations used for the MVs used to capture the LVs in the research model

Latent Construct:	Measurement scale	Items and abbreviations
Foreign clients richness	5 point Likert scale ranging from 1 = "very limited" to 5 = "very extended"	▪ Contacts facility (clients1)
		▪ Interactivity (clients2)
		▪ Reliability (clients3)
		▪ Information quantity (clients4)
Distributors/ Agents richness	Ibidem	▪ Contacts facility (agents1)
		▪ Interactivity (agents2)
		▪ Reliability (agents3)
		▪ Information quantity (agents4)
Trade fairs richness	Ibidem	▪ Contacts facility (trade fairs1)
		▪ Interactivity (trade fairs2)
		▪ Reliability (trade fairs3)
		▪ Information quantity (trade fairs4)
Chambers of Commerce and Industry richness	Ibidem	▪ Contacts facility (cci1)
		▪ Interactivity (cci2)
		▪ Reliability (cci3)
		▪ Information quantity (cci4)

Export market research	Ibidem	<ul style="list-style-type: none"> <li>▪ Reliability (emr1)</li> <li>▪ Information quantity (emr2)</li> </ul>
Internet	Ibidem	<ul style="list-style-type: none"> <li>▪ Reliability (internet1)</li> <li>▪ Information quantity (internet2)</li> </ul>
The richness of the international experiences of export employees	The agreement degree with the following statements, measured on a 7 point Likert scale ranging from 1="completely disagree" to 7="completely agree"	<ul style="list-style-type: none"> <li>▪ The international experiences of the export employees are varied. (rich_exp1)</li> </ul>
		<ul style="list-style-type: none"> <li>▪ The international experiences of the export employees are complementary. (rich_exp2)</li> </ul>
		<ul style="list-style-type: none"> <li>▪ The international experiences of the export employees are long lasting. (rich_exp3)</li> </ul>
Coordination	The agreement degree with the following statements, measured on a 7 point Likert scale ranging from 1="completely disagree" to 7="completely agree"	<ul style="list-style-type: none"> <li>▪ The senior management strategic objectives are well known and accepted. (coord1)</li> </ul>
		<ul style="list-style-type: none"> <li>▪ The leadership employed by the direction is efficient. (coord2)</li> </ul>
		<ul style="list-style-type: none"> <li>▪ The members of the management team coordinate closely their activities. (coord3)</li> </ul>
Knowledge transfer and integration	The agreement degree with the following statements, measured on a 7 point Likert scale ranging from 1="completely disagree" to 7="completely agree"	<ul style="list-style-type: none"> <li>▪ We try to keep the know-how acquired by past experiences even though the employees are no longer the same. (kti1)</li> </ul>
		<ul style="list-style-type: none"> <li>▪ The firm has instruments (manuals databases, files, organizational routines, etc.) that allow what has been learnt in the past situations to remain valid. (kti2)</li> </ul>
		<ul style="list-style-type: none"> <li>▪ In this enterprise we try to learn from our mistakes in order to avoid them in the future. (kti3)</li> </ul>
		<ul style="list-style-type: none"> <li>▪ At all levels, we try to send as fast as possible the know how of older employees to newer ones. (kti4)</li> </ul>
The informativity degree of SMEs concerning foreign markets' state	Compared to your main competitors on export markets regarding the following elements on your export markets measured on a seven point scale ranging from 1 = "much less informed than the competitors" to 7 = "much more informed than the competitors":	<ul style="list-style-type: none"> <li>▪ General foreign markets environment (economic, social, political environment, barriers to exporting, legislation) (infok1)</li> </ul>
		<ul style="list-style-type: none"> <li>▪ The potential clients (characteristics, needs, demand, preferences, mentalities, buying behavior, new niches, potential partners) (infok2)</li> </ul>
		<ul style="list-style-type: none"> <li>▪ Competitors (main actors on the market, general situation, strategies they deploy, forces and strengths) (infok3)</li> </ul>
		<ul style="list-style-type: none"> <li>▪ Products (characteristics, technical norms, adaptation needs, packaging, innovation cycles) (infok4)</li> </ul>
		<ul style="list-style-type: none"> <li>▪ Price and payment practices (level, tendencies, margins and commissions, credit policies, mode and delay of payment) (infok5)</li> </ul>
		<ul style="list-style-type: none"> <li>▪ Communication practices (available media, methods employed, type of message, costs) (infok6)</li> </ul>
		<ul style="list-style-type: none"> <li>▪ Distribution practices (channels, costs, selling points, transport and deposit infrastructure, payment delays, intermediaries efficiency) (infok7)</li> </ul>
Export responsiveness	The agreement degree with the following statements, measured on a 7 point Likert scale ranging from 1="completely disagree" to 7="completely agree"	<ul style="list-style-type: none"> <li>▪ When we find out that export customers are unhappy with the quality of our service, we take corrective action immediately. (resp1)</li> </ul>
		<ul style="list-style-type: none"> <li>▪ Our export business objectives are driven primarily by customer satisfaction. (resp2)</li> </ul>
		<ul style="list-style-type: none"> <li>▪ Our export business strategies are driven by our beliefs about how we can create greater values for export customers. (resp3)</li> </ul>
		<ul style="list-style-type: none"> <li>▪ Our export strategy for competitive advantage is based on our understanding of export customer needs. (resp4)</li> </ul>
		<ul style="list-style-type: none"> <li>▪ We are quick to respond to important changes in our business environment (e.g. regulatory, technology, economy, etc.). (resp5)</li> </ul>
		<ul style="list-style-type: none"> <li>▪ We rapidly respond to competitive actions that threaten us in our export markets. (resp6)</li> </ul>

<p>The positional advantage of SMEs in terms of international marketing competences</p>	<p>By comparing yourself to your main competitors on export markets indicate to which extent your enterprise owns international competencies in the fields listed here below ;, measured on a seven point scale ranging from 1 = “much worse than competitors” to 7 = “much better than competitors”:</p>	<ul style="list-style-type: none"> <li>▪ Networking (e.g. identifying contacts abroad, entertaining developing relationships with the contacts abroad, knowledge and understanding of business practices, foreign languages skills) (comp1)</li> <li>▪ International marketing management (e.g. setting marketing goals, formulating creative marketing strategies, translating marketing strategies into action, control and evaluation of marketing costs) (comp2)</li> <li>▪ Foreign markets segmentation (e.g. opportunity seeking, studying foreign markets characteristics, targeting and penetrating foreign markets, identification potential clients/markets) (comp3)</li> <li>▪ Product strategy (e.g. R&amp;D of new products/services, products and service adaptation, packaging, launching successfully new products/services) (comp4)</li> <li>▪ Price strategy (e.g. negotiating and fixing the price and the payment delays, responsiveness in terms of pricing to market change, fixing the margins, evaluation of the credit risks) (comp5)</li> <li>▪ Communication strategy (e.g. promoting sales, products, developing enterprise image and reputation, managing communication programs) (comp6)</li> <li>▪ Distribution strategy (e.g. selecting the distributor agents and the sale force, entertaining the relations/collaboration with distributor agents, choosing the localization of the selling/distribution points, training selling personnel) (comp7)</li> <li>▪ Information management (e.g. identification of information sources, collecting information on clients and competitors, tracking customers wants and needs, collecting and analyzing market information) (comp8)</li> </ul>
<p>The international performance of SMEs</p>		<ul style="list-style-type: none"> <li>▪ The mean of the progression of the percentage of export sales volume over the last three years (IPfin1)</li> <li>▪ The mean of the progression of the export profits over the last three years (IPfin2)</li> <li>▪ The perceived strategic performance of SMEs with the development of the strategic export objectives over the last year (IPstrat)</li> </ul>
<p>The international orientation of SMEs</p>	<p>Agreement degree with the following statements: “Senior management in our company...” measured on a 7 point Likert scale ranging from 1=“completely disagree” to 7=“completely agree”</p>	<ul style="list-style-type: none"> <li>▪ Considers our exporting activities to be important. (io1)</li> <li>▪ Intends to increase the company’s exporting activities. (io2)</li> <li>▪ Actively explores international market opportunities. (io3)</li> </ul>

In order to estimate the research model, the following parameters were employed: the estimation of missing data by means of the Lohmöller method, the treatment of MVs’ and the LVs’ scores was completed in standardized values, the internal estimation method employed in the centroid scheme and the OLS regression was used to assess the predictive path of influence. One hundred re-samplings were used for the bootstrap estimation and 30 were used for the blindfolding procedure.

All the constructs comprised in the research model are reflexive by nature. Recall that the reflexive measurement models in PLS path modeling are assessed, as is the case for the covariance based SEM, in terms of dimensionality, item reliability, internal consistency, convergent, divergent and nomological validity. The main psychometrical properties of the LVs in this research model are resumed in Table 52.

Constructs' dimensionality is ensured with the XLSTAT software that was used if the results of the Principal Components Analysis on the items composing a certain latent construct reveal the same number of significant principal components with eigen values superior to the critical value of 1 as in the theoretical model. The dimensionality condition has been fulfilled for all the constructs that compose this research model that are all also single-dimensional.

Item reliability for reflective indicators is tested by examining the loadings and the weights with their respective construct. The rule of thumb is that loadings should reach values of 0,70 or above, but in practice, it is common to find some loadings below this threshold particularly when new items or new scales are employed (Hulland 1999). Note that some authors accept loadings superior to 0,5 (Fillon 1996) when assessing the indicators' reliability. As far as the weights are concerned, they should reach positive values. Moreover, the MVs that compose the LVs should have similar contributions to the latent construct. Most of the loadings of the MVs on their underlying LVs exceed 0,7. Some of the loadings, however, are slightly under the value of 0,7 but they are higher than 0,5. As a result, they are still considered acceptable.

Communality shows how much of the variance of one LV is reflected through the MV. The communalities of the MV generally exceed the value of 0,5. Nevertheless, in some of the cases, communalities are slightly under 0,5. However, taking into account that for each LV the overall measurement quality criteria was met, the items with lower communalities were not excluded from the analysis.

The weights may be considered as balanced in most of the cases. The CR obtained should exceed the critical value of 1,96 (Arbuckle 1997). Concluding bootstrap estimations are satisfying and they all exceed the critical value of 1,96.

The stability of the predictions of the loadings and weights of the MVs on their underlying LVs are estimated in the PLS path modeling by the bootstrap procedure. The bootstrap procedure consists of assessing the stability of the prediction of the loadings and weights on one hundred randomly generated samples. It is worth to note that the bootstrap interval estimations for the items assessing contact facilities with the Chambers of Commerce and Industry, foreign clients, and the reliability of information gathered from foreign clients are

not significantly different from zero. For these items, lower bounds' values are slightly below zero. The lowest value in the model for the lower bound of the bootstrap estimation of the weight of the item assessing the reliability of export information gathered from foreign clients is -0,043 while the upper bound = 0,335. While the lower bound values of the bootstrap intervals of the three items cited above are slightly below zero, all CRs exceed the critical value of 1,96. The CR is the absolute indicator of the bootstrap estimation (Arbuckle 1997) that allows for the validation of the accuracy of the prediction of structural relationships. As a result, the three items can be maintained within the analysis and it can be concluded that the estimation of the measurement model for export information sources richness is satisfying.

The critical values for accepting the reliability of the measures employed are that Cronbach's Alpha should be superior to 0,6 and Dillon-Goldstein's  $\rho$  should exceed 0,8 (Ringle and Spreen 2006). The construct reliability conditions have been fulfilled for all the latent constructs in the research model with one exception. The Cronbach Alpha of the richness of the Internet as an export information source reached a value of 0,53 and a Dillon-Goldstein  $\rho$  of 0,81. It worth to note that the richness of Internet has been captured only through two items, namely information sources reliability and information quantity. It worth to be noted that Cronbach's Alpha is an internal consistency indicator sensitive to the number of items (Roussel *et al.* 2002). Thus, based on the high value of the Dillon Goldstein's  $\rho$ , it can be concluded that the internal consistency condition is satisfying for this measure.

The convergent validity of reflexive measures is established if the AVE of the latent construct exceeds the critical value of 0,5 (e.g. Fornell and Larcker 1992; Ringle and Spreen 2006). In other words, when AVE exceeds the critical value of 0,5, the latent construct captures more than 50% of the variance of the underlying MVs composing it. All the latent constructs in the AVE model have exceeded the critical value of 0,5. The two criteria retained for evaluating the discriminant validity of the reflexive constructs are the comparison of the AVE to the squared correlation of latent variables and the examination of cross-loadings. The AVE of each latent variable should be superior to the squared correlation of two latent variables (Fornell and Larcker's criteria), which indicates that more variance is shared between the LV and its block of indicators (MV) than with another LV that represents another block of indicators (Fornell and Larcker 1992). The two criteria for judging the discriminant validity of latent constructs have been met for all the constructs in this research model. The AVE of each latent variable is superior to the squared correlations of two other latent variables comprised in the research model (see Table 54). More variance is shared between the LV and its block of

indicators (MVs) than with another LV representing another block of indicators (see Appendix 8). Another estimation method implemented in PLS is the blindfolding procedure. Blindfolding consists of estimating parameters by means of repeated omission for all data points, of a part of the data matrix, and then reconstructing the omitted part by the estimated parameters (Esposito-Vinzi 2007). This procedure results in a generalized cross-validated measure of the communalities and redundancies of the LVs in the model that should be positive. While communality shows how much of the variance of one LV is reflected through the MVs, redundancy gives indications about how much of the LVs and MVs are explained by the measurement model and the quality of influence relationships composing the inner model. As a result, redundancy estimations are sensitive to the complexity of the structural relationships in the research model. For all the constructs in the model, redundancy and communalities estimations are positively defined with one exception. The blindfolding estimation of the item relative to the competences with international pricing strategy development, which is one of the items composing the scale assessing the SMEs' positional advantage in terms of international marketing competences, is slightly negative (-0,013). This result suggests that the variance of this item is not explained well enough by the structural equations in the research model. Nonetheless, the value is slightly below zero and accounting for the high complexity of the research model, the item has not been removed from the analysis. Table 52, hereafter, recapitulates the main psychometrical properties of the measurement model estimation (outer model).

Table 52. Recapitulative table of the main psychometrical properties of the reflexive LVs in our research model

Latent Variables	Items	Loadings	Communalities	Weights (on information richness)	Cronbach Alpha	Dillon-Goldstein Rhô	AVE
Foreign clients richness	clients1	0,84	0,70	0,29	0,84	0,89	0,67
	clients2	0,87	0,76	0,37			
	clients3	0,76	0,57	0,23			
	clients4	0,81	0,66	0,30			
Distributors/ Agents richness	agents1	0,83	0,69	0,25	0,92	0,94	0,80
	agents2	0,93	0,86	0,29			
	agents3	0,91	0,84	0,27			
	agents4	0,91	0,82	0,29			
Trade fairs richness	trade fairs1	0,82	0,68	0,28	0,86	0,91	0,71
	trade fairs2	0,85	0,72	0,27			
	trade fairs3	0,84	0,71	0,30			
	trade fairs4	0,86	0,74	0,31			

Chambers of Commerce and Industry richness	cci1	0,77	0,60	0,19	0,88	0,92	0,74
	cci2	0,88	0,78	0,26			
	cci3	0,89	0,80	0,35			
	cci4	0,88	0,77	0,33			
Export market research	emr1	0,95	0,91	0,54	0,89	0,95	0,90
	emr2	0,95	0,90	0,50			
Internet	internet1	0,74	0,54	0,46	0,53	0,81	0,68
	internet2	0,90	0,81	0,72			
Export experiences richness	rich_exp1	0,81	0,66	0,41	0,64	0,81	0,59
	rich_exp2	0,84	0,71	0,53			
	rich_exp3	0,63	0,40	0,33			
Coordination	coord1	0,77	0,59	0,50	0,67	0,82	0,60
	coord2	0,83	0,69	0,43			
	coord3	0,71	0,51	0,35			
Knowledge transfer and integration	kti1	0,77	0,60	0,30	0,76	0,84	0,58
	kti2	0,71	0,50	0,38			
	kti3	0,79	0,63	0,32			
	kti4	0,75	0,57	0,30			
Export information acquisition	infok1	0,66	0,44	0,14	0,85	0,88	0,53
	infok2	0,76	0,58	0,21			
	infok3	0,57	0,33	0,12			
	infok4	0,74	0,55	0,20			
	infok5	0,71	0,50	0,19			
	infok6	0,82	0,67	0,23			
	infok7	0,78	0,60	0,22			
Export responsiveness	resp1	0,74	0,56	0,21	0,80	0,86	0,51
	resp2	0,70	0,49	0,20			
	resp3	0,73	0,53	0,25			
	resp4	0,70	0,50	0,24			
	resp5	0,76	0,58	0,24			
	resp6	0,62	0,39	0,23			
The positional advantage of SMEs in terms of international marketing competences	comp1	0,79	0,63	0,18	0,88	0,91	0,55
	comp2	0,82	0,67	0,18			
	comp3	0,81	0,67	0,19			
	comp4	0,62	0,38	0,12			
	comp5	0,68	0,46	0,13			
	comp6	0,73	0,53	0,15			
	comp7	0,70	0,50	0,17			
	comp8	0,77	0,60	0,18			
International orientation	io1	0,81	0,66	0,44	0,78	0,87	0,68
	io2	0,75	0,57	0,23			
	io3	0,90	0,82	0,50			
International performance	IPfin1	0,85	0,72	0,30	0,86	0,91	0,78
	IPfin2	0,93	0,86	0,37			
	IP strat	0,86	0,74	0,44			

The export information sources richness construct has been assessed as a second order construct. It is made up of the reflexive constructs capturing export information source richness of the six “rich” information sources considered for the final analysis which are: the foreign clients, agents, participation at trade fairs, Chambers of Commerce and Industry, export market research and the Internet.

In order to assess the reliability of the second order constructs, the guidelines indicated by Wilson and Henseler (2007) and Tenenhaus and Hanafi (2008) were followed. The first condition is the assessment of the quality of the measurement models used for capturing the first order constructs that may be reflexive or formative (Tenenhaus and Hanafi 2008). Second, the authors suggest that for building second order constructs the measurement scales should be homogeneous and the p-values associated with the path coefficients of the latent variables composing the second order constructs should be significant. Moreover, the weights of the manifest variables should be all positive. All weights of the manifest variables are positive. Table 53 recapitulates the p-values associated with the path coefficients of the latent variables composing the second order constructs and the T statistics as well as the bootstrap estimation of the accuracy of the predictive relationship.

Table 53. Psychometrical properties of the second order construct the richness of export information sources

Latent variable (1st order construct)	T	Pr >  t	Critical ratio (CR)
▪ Foreign clients	47,83	p< 0,001	5,30
▪ Agents	66,30	p< 0,001	12,47
▪ Trade fairs	58,99	p< 0,001	9,19
▪ Chambers of Commerce and Industry	43,23	p< 0,001	5,34
▪ Export Marketing Research	37,48	p< 0,001	10,70
▪ Internet	28,26	p< 0,001	7,93

All p-values are significant at the 99% level and the CRs exceed all the critical value of 1,96. As a result, it can be concluded that the second order construct, the richness of export information sources, is psychometrically sound.

Resuming the whole outer mode estimation, it can be concluded that the measures used to capture the LVs in the research model proofed to be all psychometrically sound with one exception: the international performance construct. Nonetheless, on an exploratory basis, a psychometrically sound reflexive construct fore measuring the international performance construct emerged and was furthermore employed for the research propositions' test in chapter VII.



Table 54. Discriminant and convergent validity assessment

Squared correlation of LVs	Clients	Agents	Trade fairs	CCI	EMR	Internet	IER	EIA	COORD	KT&I	RESP	PA	IO	IP	AVE
Clients	1	0,07	0,06	0,00	0,04	0,02	0,02	0,08	0,03	0,00	0,00	0,12	0,04	0,08	0,67
Agents	0,07	1	0,17	0,02	0,17	0,11	0,04	0,17	0,08	0,00	0,04	0,19	0,07	0,10	0,80
Trade fairs	0,06	0,17	1	0,04	0,19	0,21	0,01	0,11	0,02	0,00	0,01	0,07	0,15	0,10	0,71
CCI	0,00	0,02	0,04	1	0,10	0,12	0,01	0,00	0,00	0,03	0,03	0,00	0,01	0,00	0,74
EMR	0,04	0,17	0,19	0,10	1	0,22	0,03	0,15	0,04	0,01	0,03	0,15	0,02	0,04	0,90
Internet	0,02	0,11	0,21	0,12	0,22	1	0,01	0,05	0,00	0,00	0,00	0,04	0,02	0,10	0,68
IER	0,02	0,04	0,01	0,01	0,03	0,01	1	0,16	0,11	0,10	0,34	0,19	0,15	0,14	0,59
EIA	0,08	0,17	0,11	0,00	0,15	0,05	0,16	1	0,16	0,04	0,25	0,50	0,17	0,23	0,53
COORD	0,03	0,08	0,02	0,00	0,04	0,00	0,11	0,16	1	0,28	0,38	0,23	0,22	0,16	0,60
KT&I	0,00	0,00	0,00	0,03	0,01	0,00	0,10	0,04	0,28	1	0,37	0,06	0,02	0,01	0,58
RESP	0,00	0,04	0,01	0,03	0,03	0,00	0,34	0,25	0,38	0,37	1	0,30	0,18	0,21	0,51
PA	0,12	0,19	0,07	0,00	0,15	0,04	0,19	0,50	0,23	0,06	0,30	1	0,23	0,41	0,55
IO	0,04	0,07	0,15	0,01	0,02	0,02	0,15	0,17	0,22	0,02	0,18	0,23	1	0,19	0,68
IP	0,08	0,10	0,10	0,00	0,04	0,10	0,14	0,23	0,16	0,01	0,21	0,41	0,19	1	0,78
AVE	0,67	0,80	0,71	0,74	0,90	0,68	0,59	0,53	0,60	0,58	0,51	0,55	0,68	0,78	0

**Legend:** AVE = average variance extracted; CCI = chambers of commerce and industry; EMR=export market research; IER = international experiences richness; EIA= export information acquisition; KT&I= knowledge transfer and integration: RESP = export responsiveness; PA=positional advantage in terms of international marketing competences; IO=international orientation; IP= international performance

**Note:** Where the squared correlation of two LVs is assessed with the value 0,00 in Table 54, it means that the squared correlation is lower than 0,0001.

## **Conclusion of Chapter VI**

Chapter VI provided an overview of the questionnaire administration procedure, the descriptive analysis of the enterprises interviewed and the validation of the measurement models.

The descriptive analysis revealed that the responding enterprises are generally bigger and rather highly export involved compared to the initial sample of the study (extracted from DIANE database). They are generally willing to actively develop their international activities in the future. The SMEs interviewed are rather internationally experienced and the richness of the export information sources they access on foreign markets is slightly above the average. Their potential levels of absorptive capacity are pretty developed. Compared to their main competitors, their levels of informativity regarding foreign markets' evolution are slightly above the average, and they are characterized by developed levels of efficiency in terms of information assimilation practices. In terms of realized absorptive capacity, SMEs interviewed are highly responsive to foreign markets shifts and they rate themselves as average or slightly above the average in terms of levels of positional advantage in terms of international marketing competences. Their levels of international performance of the companies interviewed are pretty developed as well. Resuming, the descriptive analysis suggests that SMEs interviewed are generally characterized by important levels of absorptive capacity and they seem to be rather successful in developing their international activities in foreign settings.

In terms of measurement models, with one exception, the international performance construct, all the constructs in the model appear to be psychometrically sound. Nonetheless, by means of the exploratory PCA, a psychometrically sound indicator for the international performance construct emerged.

## CHAPTER VII. RESEARCH PROPOSITIONS' TEST, CONCLUSIONS, LIMITATIONS, IMPLICATIONS AND FUTURE RESEARCH AVENUES

### Introduction to Chapter VII

In Chapter VII is organized in two points.

In point VII.1, the validation of our research propositions along with the discussion of the results is presented. First, the test of the research propositions relative to the impact of PACAP antecedents upon PACAP is exposed. Second, the impact of PACAP on RACAP is detailed and discussed. Third, the impact of RACAP upon SMEs' levels of international performance is developed. Fourth, the global evaluation of the measurement model proposed by our research is exposed.

Point VII.2 details the conclusions, limits, research contributions and the future research avenues for the current research. First, the main objectives of the research are recalled along with the main theoretical and methodological choices undertaken for carrying out this research. Second, we synthesize the main results and conclusions of the present research. Third, the implications and contributions of the current study are announced, and finally fourth, the main limits and future research avenues are detailed.

### VII.1 Research propositions' test, results, discussion

Recall that the three main groups of research propositions constituting Zahra and George's (2002) absorptive capacity (AC) model have been declined in ten underlying research propositions in chapter III. They are briefly recalled hereafter.

The first main research proposition postulated that the antecedents of the export information potential absorptive capacity, namely the access to rich export information sources within the external environment and the previous export experience, impact the levels of PACAP that characterize small firms (export information acquisition and assimilation). The second main research proposition posits that the higher the levels of PACAP of SMEs are, the more they are likely to convert them into realized absorptive capacity (RACAP), thus, the more they will transform and exploit information. Finally, the third main research proposition asserted the impact of RACAP upon SMEs' levels of international performance.

A first observation is that it is impossible to test these three main research propositions since conceptually the three constructs, namely the antecedents of PACAP, PACAP and RACAP do not exist in as such within this research model. The three constructs are multi-dimensional and their multi-dimensionality lead us to decline the three main research propositions into ten underlying research propositions when adapting Zahra and George's model in the case of exporting SMEs. The validation of these ten research propositions is exposed hereafter, regrouping them every time in three points, by following the three main research propositions enounced above.

### VII.1.1 The impact of PACAP's antecedents on PACAP

The first main group of research propositions postulated a positive and direct impact of the PACAP's antecedents (SMEs' real export experience, the richness of the international experiences of "export employees" and the access they have to rich export information sources) upon PACAP, the acquisition and the assimilation of export market information.

Due to operationalization limits, the assimilation dimension of PACAP was defined in terms of coordination and knowledge transfer and integration efficiency; both measures are domestic based. Since PACAP's antecedents have both been defined in terms of international based measures, no research proposition has been emitted with respect to PACAP's antecedents upon PACAP. Therefore, only the impact of PACAP's antecedents on the export information acquisition has been empirically tested within this study.

#### *VII.1.1.1 The impact of the richness of export information sources upon export information acquisition*

The first research proposition emitted in the current research was the following:

**P1: The richness of foreign market information sources has a positive and significant impact on the efficiency of export information acquisition in small firms.**

In order to validate this research proposition, the richness of six export information sources, namely the foreign clients, agents or distributors, trade fairs, Chambers of Commerce and Industry, export market research and the Internet was considered. It was postulated that the more SMEs would exploit these information sources in terms of contact facility, interactivity, information reliability and quantity, the more they will be likely to acquire export market

information efficiently. The export information acquisition dimension has been defined in terms of the level of informativity of SMEs (export informational knowledge), compared to their main competitors in foreign markets regarding the general foreign markets' situation, foreign clients and competitors, and marketing mix elements in foreign markets.

The impact of the richness of export information sources upon the export information acquisition dimension of PACAP appears to be highly significant at the 99% level. Table 55 recapitulates the p-value, standardized regression coefficient, the T-value associated with the test of the first research proposition and the critical ratio (CR) attesting the quality of the prediction of the structural relationship.

Table 55. The impact of the richness of export information sources on export information acquisition

Structural relationship	Path coefficient	T-value	Pr >  t	CR Bootstrap estimation
P1 : Export information sources richness → Export information acquisition	0,38	4,61	p<0,001	4,94

In light of the above results, it can be concluded that the first research proposition has been validated. The richness of export information sources seems to be a factor that enhances the efficiency of export information acquisition in small firms. The influence is highly significant at the 99% level.

It worth to note that it is possible to look at the richness of export information sources as a capability that companies build in exploiting export information sources, and not as a constitutive characteristic of export information sources. Concluding, the way exporting SMEs' managers develop capabilities in terms of accessing reliable information in enough quantity, the interactivity with foreign business contacts, and the contact facility with export information sources seem to be determinant factors in explaining the efficiency of export information acquisition in SMEs.

### VII.1.1.2 The impact of the international experiences of SMEs upon export information acquisition

The second research proposition postulated that the more SMEs are characterized by higher levels of international experience, the more they will be efficient in terms of export information acquisition. Two different measures were considered for assessing international experiences richness, more specifically, the real international experience and the richness of the international experiences of “*export employees*” (those working for more than 50% of their working time for the development of international activities). As a result, two research propositions concerning the positive and significant impact of export experiences on export information’s acquisition success in SMEs were emitted. The research propositions are the following:

**P2: The richness of international experiences of “export employees” has a positive and significant impact on the efficiency of export information acquisition in small firms.**

**P3: The real export experience of SMEs has a positive and significant impact on the efficiency of export information acquisition in small firms.**

The real international experience of SMEs was computed as the sum of the years companies have employed a specific foreign presence mode for selling their products abroad. The other measure considered in this research for assessing international experience is the international experience richness of “*export employees*”. This measure reflects the perceived complementarity, variety and length characterizing the international experiences of “*export employees*”. The export information acquisition has been conceptualized as the level of informativity of SMEs compared to their main competitors in foreign markets regarding the general foreign markets situation, foreign clients and competitors, and marketing mix elements.

Table 56. The impact of the real international experience on export information acquisition

Structural relationship	Path coefficient	T-value	Pr >  t	CR Boots-rap estimation
P2: Real international experience of SMEs → Export information acquisition	0,20	2,49	p<0,05	2,12

Table 56 recapitulates the statistics associated with the influence of the real international experience of SMEs on the efficiency of export information acquisition. The real export experience of SMEs positively and significantly impacts the efficiency of export information acquisition. The T and p-values are significant, the CR of the bootstrap estimation exceeds the critical value of 1,96.

Table 57. The impact of the international experiences richness of “export employees” on export information acquisition

Structural relationship	Path coefficient	T-value	Pr >  t	CR Boots-rap estimation
P3 : International experiences richness → Export information acquisition	0,28	3,50	p<0,001	3,00

Table 57 recapitulates the p-value, standardized regression coefficient, the T-value and the CR associated with the structural path of influence of the international experiences richness of export employees in regards to their levels of export information acquisition. The impact of the richness of export information sources upon export information dimension of PACAP appears to be highly significant at the 99% level.

*VII.1.1.3 Synthesis of the results of the research propositions concerning the impact of PACAP’s antecedents upon PACAP levels of SMEs*

Three research propositions with respect to the impact of PACAP antecedents upon PACAP were emitted. The first research proposition was relative to the impact of the richness of export information sources upon the efficiency of export information acquisition in SMEs. The second research proposition postulates that an SME would acquire export information more efficiently when it is also characterized by high levels of real international experience. The third research proposition postulated that the richer the international experiences of “export employees” are, the more efficiently they will acquire export information in their foreign markets.

Observe that the two PACAP antecedents, the richness of export information sources and the international experiences of SMEs, explain about 36,20% of the variance of the efficiency of

export information acquisition. To the best of knowledge, no previous study has explored these paths of influence. Therefore, it is difficult to estimate whether the R<sup>2</sup> is fairly high or not.

Table 58. Recapitulative table of the structural paths of influence of the impact of PACAP's antecedents upon export information acquisition

Structural relationship	Path coefficient	T-value	Pr >  t	CR Bootstrap estimation	Contribution the explained R <sup>2</sup> (%)
P1: Export information sources richness → Export information acquisition	0,38	4,61	p<0,001	4,94	50,45%
P2 : Real international experience of SMEs → Export information acquisition	0,20	2,49	p<0,05	2,24	17,44%
P3 : International experiences richness → Export information acquisition	0,28	3,508	p<0,001	3,008	32,10%
Percentage of the variance explained for the export information acquisition : 36,20 %					

The richness of export information sources accounts for about half of the explained variance of the efficiency of export information acquisition. The richness of the international experiences of the “*export employees*” explains only about 17% of the explained variance of the export information acquisition, while the real international experience of SMEs about 32%. Resuming, about half of the explained variance of the efficiency of export information acquisition is determined by the richness of export information sources, the other half is explained by the international experiences of SMEs. When comparing the impact of the two international experience measures, it can be observed that the richness of the export experiences of export employees explains twice more variance than the real length of firms’ international experiences. The implication is that in order to achieve better levels of informativity concerning foreign markets, SMEs can somehow overcome their “*youth*” in terms of the length of their export experiences by employing people with varied and complementary international experiences.

Recall that half of the explained variance of the export information acquisition is due to export information sources richness. As a result, it seems that the quality of the exposure to export information sources in foreign markets is the major determinant of firms’ levels of



informativity in foreign markets. As a result, managers should privilege the management of export information sources for achieving higher export informativity levels compared to their main competitors in international settings.

### **VII.1.2 The impact of PACAP on RACAP**

A second group of research propositions were emitted with respect to the influence of PACAP dimensions, the acquisition and the assimilation of export information, upon RACAP (the transformation and the implementation of export information).

For conceptualization reasons, in chapter III it was explained that direct influence relationships from PACAP upon the information transformation dimension of RACAP are expected. In the meanwhile, no direct influence of PACAP upon the exploitation dimension of RACAP is expected to occur. Nonetheless, the exploitation dimension of RACAP (the positional advantage of SMEs in terms of international marketing competences) is expected to be directly influenced by firms' levels of international experience and their export responsiveness capacity. Thus, the research propositions' test of the influence of the determinants of the export information transformation dimension of RACAP is first presented. Second, the impact of the determinants of the implementation dimension of RACAP is tested.

#### ***VII.1.2.1 The impact of the determinants of the transformation dimension of RACAP (SMEs' export responsiveness capacity)***

In accordance with Zahra and George's (2002) framework, two research propositions were emitted concerning the impact of export information acquisition and assimilation upon export information transformation dimension (export responsiveness) of RACAP.

##### **VII.1.2.1.1 The impact of export information acquisition**

To test this research proposition, it is proposed that the efficiency of export information acquisition, conceptualized as the degree of informativity (export informational knowledge) of SMEs, compared to the main competitors in export markets, will enhance their capacity to efficiently adapt and respond to foreign market shifts:

**P4: SMEs’ export informational knowledge levels have a positive and significant impact upon their export responsiveness capacity.**

The impact of export information acquisition upon the responsiveness capacity of SMEs is highly significant at the 99% level. Table 59 recapitulates the p-value, standardized regression coefficient, the T-value and the CR associated with the influence of export information acquisition on SMEs’ export responsiveness capacity.

Table 59. The impact of export information acquisition on SMEs’ export responsiveness

Structural relationship	Path coefficient	T-value	Pr >  t	CR Bootstrap estimation
P 4: Export information acquisition → Export responsiveness	0,31	4,41	p<0,001	5,30

In light of the above results, it can be concluded that the fourth research proposition has been validated. The superiority in terms of export informativity levels of SMEs leads them to superior levels of responsiveness to foreign market shifts. If this relationship of influence received empirical support within the study of Liao *et al.* (2003) in a domestic context, when exploring the influence of intelligence generation upon responsiveness (two dimensions of the market orientation construct), this study brought support for this path of influence within an international context.

**VII.1.2.1.2 The impact of export information assimilation**

The influence of the efficiency of SMEs’ assimilation dimension on the export responsiveness has been detailed in two research propositions. The first proposition ascertained that the better firms integrate and transfer knowledge, the more they will be able to efficiently respond to foreign market shifts.

**P5: Efficient information transfer and integration has a positive and significant impact on the export responsiveness capacity of SMEs.**

The second proposition postulated that the coordination capacity of small firms would allow them to more efficiently respond to foreign market shifts.

**P6: Efficient coordination in SMEs has a positive and significant impact on the export responsiveness capacity of SMEs.**

The impact of coordination and knowledge transfer and integration procedures upon the responsiveness capacity of SMEs is highly significant at the 99% level. Table 60 and Table 61 recapitulate the p-values, standardized regression coefficients, the T-values and the CRs associated with the influence of the efficiency of SMEs' coordination and knowledge transfer and integration practices upon the export responsiveness capacity of small firms.

Table 60. The influence of knowledge transfer and integration on SMEs export responsiveness

<b>Structural relationship</b>	<b>Path coefficient</b>	<b>T-value</b>	<b>Pr &gt;  t </b>	<b>CR Bootsrap estimation</b>
P5: Knowledge transfer and integration → Export responsiveness	0,40	5,33	p<0,001	5,19

Table 61. The influence of the coordination efficiency on SMEs' export responsiveness

<b>Structural relationship</b>	<b>Path coefficient</b>	<b>T-value</b>	<b>Pr &gt;  t </b>	<b>CR Bootsrap estimation</b>
P6: Coordination → Export responsiveness	0,27	3,33	p<0,001	3,83

The results suggest that the more efficient SMEs are in terms of coordination and knowledge transfer and integration, the more they are able to formulate response actions to face foreign market shifts. The relationships of influence are highly significant at the 99% level. Resuming, the statistical tests bring empirical support for the validation of the fifth and sixth research propositions.

### VII.1.2.1.3 Synthesis of the results of the research propositions concerning the impact of PACAP upon RACAP's transformation dimension

Three research propositions were emitted with respect to the impact of PACAP on RACAP. The first proposition was relative to the impact of the efficiency of export information acquisition upon the export responsiveness capacity of SMEs (P4). The second and the third propositions refer to the impact of assimilation practices on the responsiveness capacity of firms (P5 and P6). The three research propositions found empirical support. The structural paths of influence are highly significant at the 99% level.

Table 62 recapitulates the statistics associated with the research propositions' test concerning the impact of PACAP dimensions on RACAP's transformation dimension. The efficiency of export information acquisition and assimilation in small firms explains 57,50% of the variance of the SMEs' export responsiveness. In order of importance, the efficiency in terms of knowledge transfer and integration explains 43,35% of the explained variance of the export responsiveness phenomenon, followed by coordination (29,20%) and export information acquisition (27,44%). The results suggest that even though export information acquisition is an important input of the export responsiveness, firms need to efficiently transfer and integrate knowledge and coordinate in order to design effective response to foreign market shifts; information assimilation practices explain more than two thirds of the explained variance of export responsiveness capacity. The results lead to the idea that information needs to be valorized in small firms through efficient assimilation practices in order to be further exploited.

Table 62. Recapitulative table of the structural paths of influence of the impact of PACAP on RACAP's transformation dimension

Structural relationship	Path coefficient	T-value	Pr >  t	CR Bootsrap estimation	Contribution to the R2 (%)
P 4: Export information acquisition → Export responsiveness	0,31	4,41	p<0,001	5,30	27,44%
P5: Knowledge transfer and integration → Export responsiveness	0,40	5,33	p<0,001	5,19	43,35%
P6: Coordination → Export responsiveness	0,27	3,33	p<0,001	3,83	29,20%
Percentage of explained variance of SMEs' export responsiveness : 57,50%					

*VII.1.2.2 The impact of the determinants of the exploitation dimension of RACAP (the positional advantage in terms of international marketing competences of SMEs)*

While three research propositions were emitted concerning the influence of the PACAP's sub-dimensions on RACAP's transformation dimension, no direct pattern of influence has been proposed from PACAP on RACAP's exploitation dimension - the positional advantage of SMEs in terms of international marketing competences. Nonetheless, two research propositions have been emitted with respect to the impact of SMEs' responsiveness capacity and international experiences upon the positional advantage SMEs achieve in terms of international marketing competences. The test of these two research propositions is exposed hereafter.

**VII.1.2.2.1 The impact of the SMEs' international experiences**

The research proposition that the higher is the real number of years firms have been exporting, the more they are likely to achieve higher levels of positional advantage in terms of foreign markets related marketing competences was emitted.

**P7: The real export experience of SMEs has a significant and positive impact on their positional advantage in terms of international marketing competences.**

Table 63 recapitulates the p-value, the standardized regression coefficient, the T-value and CR associated with the influence exerted by the real number of exporting years on the levels of positional advantage in terms of international marketing competences of SMEs.

Table 63. The impact of the real number of exporting years on SMEs' positional advantage in terms of international marketing competences

Structural relationship	Path coefficient	T-value	Pr >  t	CR Bootsrap estimation
P 7: Real number of exporting years → Positional advantage in terms of international marketing competences	0,20	2,57	p<0,05	2,35

P7 has been supported. The influence of the real number of exporting years on the levels of positional advantage in term of international marketing competences is significant at the 95%

level. It seems though that the real length of SMEs' international experiences plays an important role in fostering firms' competences in managing foreign markets' operations.

The richness of the international experiences of the “*export employees*” has also been proposed to influence SMEs' levels of positional advantage in terms of international marketing competences:

**P8: International experiences richness of “export employees” has a significant and positive impact on SMEs' positional advantage in terms of international marketing competences.**

This research proposition has not been validated. As we can see in Table 64, the p-value associated with the influence of the richness of export experiences of “*export employees*” upon the positional advantage of SMEs in terms of international marketing competences is non significant. Moreover, the CR obtained through the bootstrap estimation does not reach the critical value of 1,96.

Table 64. The influence of the richness of the international experiences of “export employees” upon the positional advantage of SMEs in terms of international marketing competences

Structural relationship	Path coefficient	T-value	Pr >  t	CR Boots-rap estimation
P8: The richness of export experiences → Positional advantage in terms of international marketing competences	0,14	1,51	0,15	1,66

#### VII.1.2.2.2 The impact of the SMEs' responsiveness capacity

We emitted the research proposition that the more SMEs are export responsive, the more they are likely to achieve positional advantage in terms of foreign markets related marketing competences compared to their competitors:

**P9: SMEs' export responsiveness capacity has a positive and significant impact upon their positional advantage in terms of international marketing competences.**

Table 65 hereafter recapitulates the p-value, standardized regression coefficient, the T value and the bootstrap estimation of the critical ratio (CR) associated with the influence relationship described above.

Table 65. The influence of export responsiveness of SMEs upon their positional advantage in terms of international marketing competences

Structural relationship	Path coefficient	T-value	Pr >  t	CR Bootstrap estimation
P9: Export responsiveness → Positional advantage in terms of international marketing competences	0,44	4,65	p<0,001	4,16

The impact of SMEs' export responsiveness upon the positional advantage in terms of international marketing competences is highly significant (at the 99% level). The result suggests that by means of experiencing and pro-actively responding to foreign markets shifts, SMEs build superior levels of international marketing competences necessary for efficiently manage their foreign markets' operations.

#### VII.1.2.2.3 Synthesis of the results of the impact of the determinants of RACAP's exploitation dimension

We emitted three research propositions with respect to the impact of the determinants of RACAP's exploitation dimension. The first one referred to the impact of the real international experience of SMEs upon their levels of international marketing competences. The second one referred to the impact of the richness of international experiences of "export employees" on their levels of positional advantage in terms of international marketing competences. The third one was relative to the impact of the efficiency of export responsiveness of SMEs on the levels of positional advantage they attain compared to the main competitors on foreign markets in terms of international marketing competences.

Two of them were validated. The export responsiveness and the real export experience of SMEs impact positively and significantly the positional advantage in terms of international marketing competences. The impact of the richness of the international experiences of export "export employees" on the positional advantage of SMEs in terms of international marketing competences is non significant. It seems that the real length of experiences and the intensity of the reactivity and propulsion of SMEs to take effective actions face to foreign markets changes help them to better consolidate their levels of international marketing competences.

The research proposition that has not been validated proposed that the richness of the international experiences of the “*export employees*” would reinforce their positional advantage in terms of international markets related competences. A possible explanation for this result might be that while all the constructs in the research model were conceptualized at the firm level of analysis, the richness of the international experiences of export employees refers to the group level of analysis. Previous studies suggested that conceptualization differences in terms of levels of analysis conduct to contradictory results (Ramangalahy 2001).

Table 66 recapitulates the p-values, the standardized regression coefficients, the T-values and the CRs associated with the influence exerted by the real number of exporting years, the richness of international experiences of exporting employees and the SMEs’ export responsiveness capacity on their positional advantage in terms of international marketing competences.

Table 66. Recapitulative of the structural paths of influence of the determinants of RACAP’s exploitation dimension

Structural relationship	Path coefficient	T-value	Pr >  t	CR Bootsrap estimation	Contribution to the R2 (%)
P7: Real number of exporting years → Positional advantage in terms of international marketing competences	0,20	2,57	p<0,001	2,35	14,56%
P8: The richness of export experiences → Positional advantage in terms of international marketing competences	0,14	1,51	0,133	1,66	17,79%
P9: Export responsiveness → Positional advantage in terms of international marketing competences	0,44	4,65	p<0,001	4,16	67,63%
Percentage of the variance explained for the positional advantage in terms of international marketing competence: 37,10%					

37,10% of the explained variance of the positional advantage of SMEs in terms of international marketing competences has been explained by the levels of export experience and the export responsiveness capacity of SMEs. We can observe that export responsiveness accounts for 67,63% of the explained variance of the positional advantage of SMEs in terms of international marketing competences, three times more than the real number of exporting years, which accounts for 14,56% of the explained variance.



The implication of this result is that even though companies might not use several foreign presence modes for selling their products abroad, or they might not be characterized by long lasting international experiences, they could efficiently build foreign markets competences by implementing appropriate responsive action face to foreign markets shifts. It appears that in the highly competitive nowadays international business environment the ability to efficiently respond to foreign markets shifts prevails over the length of SMEs' international experiences in building superior levels of international marketing competences.

### VII.1.3 The impact of RACAP on SMEs' international performance

In line with the KBV perspective, we emitted a last research proposition concerning the impact of the positional advantage in terms of international marketing competences upon the international performance of SMEs:

**P10: SMEs' positional advantage in terms of international marketing competences has a positive and significant impact upon the international performance of SMEs.**

We also suggested that one should control for the influence of SMEs' international orientation and firm's size in order to correctly assess the strength of this relationship.

Indeed, the main KBV assertion is statistically validated by the present research. SMEs' levels of international marketing competences impact positively and significantly (at the 99% level) the degree of international performance of SMEs. Firm size does not play a determinant role in predicting the levels of international performance of SMEs; its impact is non-significant. This result is not particularly surprising. As already suggested within the third chapter of this dissertation, the results of previous studies ascertaining the impact of the size on the international performance levels are rather mixed (e.g. Zou *et al.* 2003).

The effect of the international orientation of SMEs upon their levels of international performance is weak, at the 90% level. One can see from the Table 67 that the international orientation of SMEs explains about 15% of the explained variance of the international performance construct. In the meanwhile, about 82%, the overwhelming majority of the explained variance of the international performance is explained by SMEs' positional advantage in terms of international marketing competences. 43,30 % of the international performance construct is explained by our research model. In line with Sousa's (2004) study, we can conclude that this represents a fairly high percentage of explained variance, attesting

the importance of SMEs' international marketing competences for the development of their international activities.

Table 67. The influence of the positional advantage of SMEs in terms of international marketing competences upon their international performance

Structural relationship	Path coefficient	T-value	Pr >  t	CR Bootsrap estimation	Contribution to the R2 (%)
P10: Positional advantage in terms of international marketing competences → international performance of SMEs	0,56	6,56	p < 0,001	6,55	82,50%
Control for the effect of firm size	0,04	0,63	0,74	0,82	2,05%
Control for the effect of the international orientation of SMEs	0,15	1,77	0,07	1,85	15,44%
Percentage of the variance explained of the international performance of SMEs: 43,30%					

#### VII.1.4 Global evaluation of the research model

We have emitted ten main research propositions in this research. The research propositions' test brought empirical support for nine out of the ten research propositions we have emitted in chapter III. Their validation is synthesized in Table 68 hereafter.

Table 68. Recapitulative of the validation of the research propositions

Research propositions	Validation	Level of significance
P1: Export information sources richness → Export information acquisition	Yes	p < 0,001
P2 : The richness of international experience → Export information acquisition	Yes	p < 0,001
P3: Real international experience → Export information acquisition	Yes	p < 0,05
P4: Export information acquisition → Export responsiveness	Yes	p < 0,001
P5 : Knowledge transfer and integration → Export responsiveness	Yes	p < 0,001
P6 : Coordination capacity → Export responsiveness	Yes	p < 0,001
P7 : Real international experience → Positional advantage in terms of international marketing competences	Yes	p < 0,05
P8 : The richness of international experience → Positional advantage in terms of international marketing competences	No	n.s.
P9 : Export responsiveness → Positional advantage in terms of international marketing competences	Yes	p < 0,001
P10: Positional advantage in terms of international marketing competences → SMEs international performance	Yes	p < 0,001

**Legend:** → = positive and significant impact, n.s. = non-significant relationship, p < 0,001 = research proposition validated at the 99% significance level; p < 0,05 = research proposition validated at the 95% significance level.

The impact of PACAP's antecedents on PACAP is entirely supported. The richness of export information sources, the real export experience of SMEs, and the richness of the international experiences of "*export employees*" positively and significantly influence the efficiency of export information acquisition in small firms. It worth to be noted that the richness of export information sources explains about 50% of the (explained) variance of the export information acquisition efficiency. If the contribution of the two international experience measures in explaining export information acquisition is examined, one can observe that the richness of the international experiences of "*export employees*" explains twice more variance than the real length of firms' international experience. The main implication is that in order to achieve better levels of informativity concerning foreign markets, SMEs can somehow overcome their lack of experience by employing people with varied, and complementary international experiences.

Recall half of the explained variance of the export information acquisition is due to export information sources richness. Thus, it seems that the quality of the exposure to export information sources on foreign markets is the major determinant of firms' levels of informativity on foreign markets. As a result, managers should privilege the management of export information sources for achieving higher export informativity levels compared to their main competitors on foreign markets.

Concerning the impact of PACAP upon RACAP, we can observe that all the research propositions emitted in this respect have been validated. Export information acquisition, as well as the assimilation practices, namely knowledge transfer and integration and coordination efficiency determine the export responsiveness of SMEs. In order of importance, the main determinant of the SMEs' export responsiveness capacity is the efficiency of knowledge transfer and integration practices, followed by the coordination capacity of small firms, and the richness of the export information sources they use to keep informed concerning foreign markets. The results suggest that export information acquisition efficiency is a "*sine qua non*" condition for staying responsive to foreign markets shifts, but it needs to be valorized since the assimilation practices have a (cumulative) stronger explanatory power.

Concerning the determinant factors of the SMEs' positional advantage in terms of international marketing competences, we can observe a strong impact of the export responsiveness capacity of small firms. The results suggest that by means of responding and taking corrective action in order to better manager foreign markets shifts, SMEs seem to build superior foreign market related competences compared to their competitors. The real international experience of small firms also significantly and positively impacts the degree of

positional advantage in terms of international marketing competences of SMEs. Surprisingly, the richness of the export experiences of “*export employees*” does not have a significant influence upon the positional advantage in terms of international marketing competences.

Resuming, it seems that the different dimensions of the international experiences of small firms do not have the same impact on the process of information absorption in small firms. If both, the richness of export experiences and their real length, help SMEs to attain higher levels of informativity concerning export markets, it is finally only the real length of their international experience who determines their levels of international marketing competences. The levels of informativity of SMEs regarding foreign markets can be regarded as a form of explicit knowledge (Morgan *et al.* 2003), while the competences are forms of tacit knowledge (e.g. Dosi and Marengo 1995; Nonaka 1994; Ingham 1997; DeNisi *et al.* 2003). The implication of our result is that while both richness and length related aspects of experience play a determinant role in the consolidation of foreign markets’ related explicit knowledge in SMEs, the tacit knowledge creation relies rather on the length of the international experiences of the firm.

Finally, the impact of RACAP on the international performance of SMEs is highly significant. Detaining a positional advantage in terms of foreign markets related marketing competences drives firms more successful in international settings. This result suggests that the main KBV assumption is strongly validated by the current study. Firms attain high levels of international performance if they achieve superior levels of positional advantage in terms of international marketing competences compared to their competitors.

We controlled for the influence of the international orientation and firm’s size when assessing the impact of the positional advantage of SMEs in terms of international marketing competences on international performance. The effect of firms’ size was non significant, and the impact of firms’ degree of international orientation is weak (it is only significant at the 90% level). Regardless of their size, SMEs from the steel industry seem to be able to achieve high levels of international performance.

Table 69 resumes the main characteristics of the inner (structural relationships of influence) and outer models (measurement model) - namely the amount of the variance explained by the structural influence relationships ( $R^2$  and adjusted  $R^2$ ), the average of the variance extracted for the latent constructs in the model (AVE) and the internal reliability of the latent construct in the model (Dillon-Goldstein rhôs).

Table 69. Recapitulative table of the main characteristics of the international performance model assessment

Latent variable	R <sup>2</sup> explained	Adjusted R <sup>2</sup>	AVE	D.G. rho
▪ Clients' richness			0,678	0,894
▪ Agents' richness			0,809	0,944
▪ Trade fairs' richness			0,718	0,911
▪ Chambers of Commerce and Industry' richness			0,804	0,925
▪ Export market research's richness			0,908	0,952
▪ Internet's richness			0,681	0,809
▪ Export information sources' richness	0,998	0,998	0,327	0,898
▪ International experiences' richness			0,593	0,812
▪ Export informativity levels of SMEs	0,364	0,352	0,530	0,886
▪ Coordination			0,601	0,818
▪ Knowledge transfer and integration			0,582	0,848
▪ Export responsiveness	0,575	0,566	0,512	0,862
▪ Positional advantage in terms of international marketing competences	0,391	0,380	0,578	0,905
▪ International orientation			0,691	0,870
▪ International performance	0,369	0,356	0,792	0,920
<b>Mean</b>	<b>0,539</b>		<b>0,565</b>	

Model quality assessment in PLS is based on the evaluation of the quality of the predictive relationships in the model (the explained and adjusted R<sup>2</sup>) and the quality of the measurement model, which is mainly reflected by the average variance extracted for LVs and redundancy estimation. Four GoF (goodness of fit) indexes were developed in PLS path modeling to assess the quality of the research model (Esposito-Vinzi 2007). The first GoF index called Outer Model GoF index evaluates the quality of the measurement model, mainly based on the communalities of the LVs (AVEs in PLS path modeling). The critical value for this index is 0,9. A second GoF index, called the Inner Model GoF index, assesses the quality of the predictions in the research model based on the R<sup>2</sup> of the endogenous latent variables (performance of the structural model). The critical value for this index is also 0,9. The Relative GoF index is obtained by dividing the absolute value by its maximum value achievable for the analyzed dataset through bootstrap estimations. The critical value for this index is also 0,9. The absolute GoF index reflects the overall quality of both measurement and prediction models. It is calculated as the product of the Outer Model GoF index and the Inner Model GoF index. The Absolute GoF index is the most widely used GoF index, based on the publications of Amato *et al.* (2004) and Tenenhaus *et al.* (2005). The critical value for this

index is 0,5. Table 70 presents the GoF indexes for the research model and their corresponding critical ratios.

Table 70. GoF indexes for the research model

GoF index	GoF	Critical ratio (CR)
Absolute	0,55	22,32
Relative	0,89	32,88
Outer model	0,99	416,98
Inner model	0,90	33,59

Observe that all the GoF indexes reach the critical values for the model with the exception of the Relative GoF index. Nonetheless, the 0,89 value is considered to be very close to the critical value of 0,9. Moreover, the CRs are highly significant. Thus, it can be concluded that the four GoF indexes for the research model are overall satisfying.

Finally, because we have collected the data by means of a single method, the survey questionnaire, we checked for the common method variance (CMV), which may inflate the estimated relationships in the model. We used the approach of Lindell and Whitney (2001). They posit that the smallest correlation with a theoretically unrelated variable should provide a judicious estimate of CMV. Lindell and Brandt (2000) and Lindell and Whitney (2001) suggested the one should partial out the smallest correlation from all the bivariate correlations in the model in order to remove this effect. Since our survey did not contain unrelated variables, we considered the smallest correlation among the latent variables. Since the smallest correlation is very close to zero (see Table 54), we can conclude that for our survey the effects of the CMV are negligible.

## **VII. 2 Conclusions, limits, research contributions and avenues for future research**

Point VII.2 is organized into four sections. First, the main objectives of the current dissertation are briefly recalled, as well as the theoretical and methodological choices that guided this research. Second, the results and conclusions referring to the characteristics of the sampled companies and the test of the research propositions are summarized. Third, the contributions and the implications of this research are exposed. Fourth, the limits of the current dissertation and the avenues for future research are discussed.

### **VII.2.1 The main objectives, main theoretical and methodological choices of the current research**

The main goal of the research was to better understand the impact of the export information processing by SMEs on their levels of international performance. This dissertation may be more generally inscribed within the wide theme of internationalization literature of SMEs. The point of departure of this research was the general belief relative to the critical importance of firms' capabilities and skills to manage foreign-market related information in order to better perform and compete in international settings. As a result, it is implicitly postulated that the more SMEs are skilled in terms of export information exploitation, the more they will achieve higher levels of international performance in foreign market settings.

In order to answer this research question, three underlying research questions had to be addressed that were relative to: (1) the conceptualization and the operationalization of the process of export information exploitation in SMEs, (2) the conceptualization and the operationalization of the international performance construct, and (3) the modelisation of the influence exerted by the process of export information exploitation in SMEs upon their levels of international performance.

The analysis of the relevant literature in the field led to the conclusion that the Absorptive Capacity (AC) perspective best captures the process of information exploitation at the firm level of analysis. As a result, the main assumption guiding this research was that the

efficiency of SMEs in terms of export information exploitation is reflected through their levels of absorptive capacity of export information.

In order to best describe the relationship between firms' information activities and organizational performance, the analysis of the literature review led to the identification of six main theoretical frameworks approaching the relationship existing between information and organizational performance. It was concluded that the KBV perspective represents the most appealing framework for studying the impact of a firm's capacity to absorb export information on their levels of organizational performance. The main reason leading to this conclusion is the integrative power of the KBV perspective. The KBV draws elements from the RBV of the firm that is well known for the high explanative power of organizational performance level, and at the same time, elements from the more behaviorally oriented firm theories capturing the evolution potential of strategic firms' resources. The integration of the dynamic process of evolution of firms' intangible resources such as information has been considered as particularly appealing in the case of the current research.

In order to link the AC concept to firms' organizational performance levels under a KBV perspective, Zahra and George's (2002) framework was used; it describes the impact of firms' AC levels on their levels of business performance. Zahra and George's (2002) AC framework was judged as especially appropriate in the case of the current study for three main reasons. The first reason is that the AC is viewed as a dynamically evolving beginning-to-end process capturing information processing at the firm level of analysis. The accent is put, as in the KBV perspective, on the evolution potential of information as a strategic resource. The second reason is that Zahra and George's (2002) AC model represents the only existing theoretical framework linking the AC concept to organizational performance. The third reason is that Zahra and George (2002) conceptualized AC as a multi-dimensional construct, accounting at the same time for the dynamics existing between AC's dimensions.

Zahra and George (2002) conceptualized AC as a dynamic capability that exists as two subsets of potential and realized AC. The potential absorptive capacity of firms is driven by the previous experience of the firm and the quality of the exposure to information sources within its external environment, the two constitutive dimensions of PACAP's antecedents. While PACAP (information acquisition and assimilation) is a "*sine qua non*" condition for building RACAP, only RACAP (information transformation and exploitation) has a direct impact on organizational performance. To recapitulate, the three main research propositions advanced by Zahra and George (2002) that have also represented the stepping-stones of this research model were the following:



**PI: PACAP's antecedents, the previous experience and the exposure to information sources, positively and significantly impact a firm's success in developing PACAP.**

**PII: A firm's PACAP levels, information acquisition and assimilation capacity, positively and significantly impact RACAP's development (information transformation and exploitation).**

**PIII: RACAP development levels positively and significantly impact a firm's degree of organizational performance.**

After having operationalized PACAP's antecedents, PACAP and RACAP in the specific case of exporting SMEs, these three main research propositions were declined into ten underlying research propositions that build our research model, describing the influence of the AC of export information of SMEs upon their levels of international performance.

The causal nature of the research question led to the retention of quantitative methodology. Nonetheless, taking into account the preponderant qualitative and multi-dimensional nature of information, qualitative preliminary research has also been undertaken aiming to provide additional insights into the way SMEs manage export information activities. A questionnaire was developed based on the literature review and the preliminary qualitative investigation. Furthermore, the questionnaire has been pre-tested with ten scholars and 12 SMEs' managers in order to make sure the questions were well understood by potential respondents. The final survey instrument, modified after the pre-test, was sent to exporting SMEs from the steel industry. Data gathered was exploited by means of descriptive analysis, allowing for a general overview of the characteristics of companies in the sample in terms of AC and international performance levels. Furthermore, the PLS path modeling method has been retained to test the propositions of this research, and subsequently the quality of the measurement instruments used to capture the constructs in this research model.

## VII.2.2 Synthesis of the results

Recall that qualitative and quantitative approaches were used in order to answer the research question. The preliminary qualitative research aimed to get additional insights in the way Romanian and French SMEs manage export information and check whether the theoretical assumptions driven from the KBV and AC frameworks are consistent with the perceptions of exporting SMEs' managers. An additional aim was the identification of the export information sources perceived as "*rich*" by SMEs' managers and used on a current basis by the latter. The qualitative study mainly suggested that the foreign clients, customers, agents,

trade fairs, Chambers of Commerce and Industry, export-market research and Internet are the main export information sources considered “*rich*” by SMEs’ managers. Recall that in the light of the literature review in chapter III, it was concluded that it does not make sense to consider, for the purposes of this study, export information sources that are not considered “*rich*” by SMEs’ managers. As a result, the qualitative study allowed for the election of the “*rich*” export information sources according to the managerial perspective. Thus, the seven information sources declared above have been further investigated in the questionnaire.

The preliminary qualitative study brought insight into the reasons evoked by SMEs’ managers for explaining their preference for export information sources. The experiential nature of information sources, the exchange and debate of points of views with information providers - considered competent and experienced in the field, the fact that managers consider they get specific answers to their questions and reliable information by using certain information sources were the main reasons advanced by the interviewees for explaining their preference in terms of export information sources use.

The interviewees converge quite a lot concerning the reasons for explaining their preference in terms of export information sources independently of their nationality. It is worth to note that the reasons evoked suggest that retaining the information sources richness perspective for exploring SMEs’ export information sources perception is appropriate. When explaining their preference in terms of export-information sources use, SMEs’ managers mainly mention information sources richness attributes such as information reliability, contact facility, and the interactivity with information sources among others.

When it comes to the use of export information, several ideas rise from the interviews; managers learn by means of responding to the acquired export information, they use information for undertaking export decisions and grasping new business opportunities in export markets. Concerning the learning process, it seems to follow a rather generative, single loop path. Managers are sensitive to the information coming from their foreign clients or competitors, they react to it and through a trial-and-error process, they select the best practices that have worked best for them in the past for building future action. The information also seems to be crucial in the decision-making process. The managers interviewed explained that when it comes to decision-making, they prefer more personal information sources since they have to react while under time pressure and therefore need to have “*the right information at the right time*”.

Interviewees explained that formalized information sources are useful when one has the necessary time to make decisions. Another aspect relative to the decision-making process

discovered in the interviews was that all the managers interviewed testify that they systematically consult at least one person when making decisions. In most cases, this person is the exporting or the production manager of the firm. The interviews have also revealed the role of information in opportunity detection in terms of foreign business development; this idea being one of the stepping stones of the entrepreneurial theoretical framework. In light of these findings, it can be concluded that elements from multiple theoretical frameworks can explain export information processing in SMEs. It seems that the conclusion drawn in chapter II concerning the fact that the complexity of the information state of organizations would be difficult to capture by using a single theoretical framework found empirical support within the qualitative study.

Generally, SMEs' managers mainly acquire export information concerning clients and competitors. This observation reinforces the initial empirical qualitative study on the market-orientation undertaken by Kohl and Jaworski (1990). The authors have emphasized the key importance of knowing clients and competitors in their study and their use as information sources. Besides clients and competitors, on a less extended scale, enterprises access marketing mix related information and rarely general foreign market-related information.

The factors that enhance export information use according to the managerial vision were also investigated. The managers interviewed state that, generally, their previous foreign market knowledge and export experience helps them better exploit the new incoming export information. Managers stressed three main aspects relative to the export experience qualities; they are the variety, the complementarity and the length. These characteristics seem to be necessary in order to efficiently make use out of export information. Recall that Cohen and Levinthal (1990) also highlighted similar experience related attributes (complementarity and variety) as enhancing a firm's absorptive capacity.

The results of the qualitative research seem to bring support to the fact that new information adds to the previously existing organizational stock of knowledge, as suggested by Nonaka (1994), by enlarging or modifying the previously existing stock of export knowledge in organizations. The access to information sources is also seen as an antecedent of the knowledge assimilation capacity of organizations within Zahra and George's (2002) AC framework. Within the same theoretical framework mobilized in this research, the previous experience appears as an antecedent of the export information assimilation capacity of organizations. This theoretical assumption seems to converge with the managerial vision as well.

Furthermore, the efficiency of several information assimilation procedures, such as the coordination, communication and information transfer and integration were specifically explored. Additionally, the centralization and formalization degree of organizations was explored. The empirical findings once again confirmed the literature review assumptions emitted in chapter III concerning the high level of efficiency of the communication in SMEs and their low formalization level. The coordination and information transfer and integration procedures appear as barely formalized in SMEs. Most of the managers interviewed state that formal information integration procedures are almost non-existent in SMEs. Coordination efficiency does not appear as a generic feature characterizing the SMEs interviewed. This study suggests that in “*bigger*” SMEs, coordination is less efficient. The results of the qualitative research also suggested that it does not make much sense to consider teamwork in SMEs. The managerial team in SMEs does teamwork on an on-going basis for the broad management of the company’s activities. It does not make much sense neither considering interdepartmental collaboration in SMEs, since departmentalization does not seem to characterize them in most of the cases. Interviewees also have the feeling that every employee in their company knows which the company’s main objectives are and how he can be of help in their attainment (shared vision). Concluding, the results suggest that in terms of assimilation practices most of the variance among SMEs appears in terms of coordination and information transfer and integration. The results suggest that SMEs appear as rather homogeneous in terms of centralization, formalization and communication, the way they approach teamwork and the way they perceive the efficiency of the existence of a shared vision in their company. These five organizational practices seem to be rather efficient in light of the qualitative research. Nonetheless, one should note that the interviewees are members of the managerial team in SMEs. Thus, they are normally in charge of the design and development of the assimilation practices in their firm and this might bias their statements with this respect.

Recall that based on the analysis of the literature review, the coordination and information transfer and integration capacity of small firms were judged as the most appropriate organizational practices for capturing the information assimilation dimension of the absorptive capacity construct. This theoretical assumption also seems to be approved in the preliminary qualitative study.

Another issue discussed in the interviews was planning. Only one of the enterprises interviewed seemed to use formalized planning. The rest of the enterprises interviewed argued that they mainly use their agendas for organizing their activities. When asked what drives

them more competitive in export markets, both French and Romanian managers mentioned their competences in terms of product development and the generalized export know-how. The managerial vision seems to be in accordance with the KBV proponents that firms that detain higher tacit knowledge levels seem to perform better and achieve higher levels of business performance (e.g. Grant 1996; Kuivalainen and Bell 2004).

Overall, the findings of the qualitative research confirm the theoretical assumptions mobilized for building the research model in chapter III. More precisely, managers seem to support the idea that information flows nurture foreign market-related knowledge levels. They also believe that their levels of export experience determine their efficiency in terms of export information acquisition and exploit. These empirical results are in line with Zahra and George's (2002) assumptions that the access to information sources and the previous experience of firms are antecedents of their capacity to acquire and assimilate information.

Furthermore, the role of information in designing organizational response was widely supported by the interviews. Moreover, several managerial statements also show that firms seem to learn on the ongoing responsiveness action implemented to face environmental shifts. In this way, they build foreign market related competences, which finally enhance their levels of performance in international settings. Resuming, the results obtained through the qualitative research also support the idea of the influence of PACAP's dimensions on RACAP - in relation to information transformation into action when responding to foreign market shifts and further into competences' building. Moreover, according to the managerial vision, it is finally the foreign market-related know-how that drives firms competitive in foreign settings. As a result, the research proposition emitted concerning the impact of the company's positional advantage in terms of foreign market-related competences on their degree of international performance seems to also be supported.

Concluding, it can be suggested that the empirical results issued from the qualitative phase seem to support the research model built on the basis of the AC perspective in chapter III. However, the exploratory nature of the qualitative study cannot confirm or reject the research propositions advanced in chapter III, and the results of the qualitative study can be regarded as suggestive rather than conclusive.

The research propositions' test has been realized by means of the quantitative research that has been further carried out. 107 usable questionnaires were obtained from exporting SMEs that operate in the steel industry.

The quantitative study allowed for a descriptive basis and a general overview of the AC characteristics of companies in this sample and their international performance levels.

Moreover, this research allowed for the testing of a comprehensive international performance model, shedding more light on the dynamics associated with export information management and its impact on the levels of the international performance of SMEs.

On a descriptive level, the companies interviewed can be generally judged as rather internationally experienced. Very few “*beginners*” to exporting take part in this sample. Most of the enterprises interviewed have an export department, testifying to their engagement to the development of international activities in their company. This feature is also supported by the results attesting that companies interviewed register high levels of international orientation. They appear to be willing to extend their international activities, to actively look for foreign market opportunities, and they consider their international activities to be important.

Generally, an important number of employees are dealing with the development of their firm’s international activities for more than 50% of their working time. The export experience of these employees, called “*export employees*”, can be judged as rather “*rich*” in terms of complementarity, variety and length. Most of enterprises in the sample operate in a relatively important number of foreign countries. Border countries represent an important part of the export country destinations.

Most of the companies mainly employ basic foreign presence modes to sell their products abroad such as direct and indirect exporting. Nevertheless, one third of the companies use associative modes or have established subsidiaries abroad for exporting their products. The other foreign presence modes (e.g. licensing, subsidiaries, joint ventures) are much less employed by the companies that composing sample.

The richness of information sources the companies use in order to inform themselves concerning foreign markets appears to be slightly above-average concerning most of the relational information sources such as the clients, agents or distributors, and participation at trade fairs. Average levels of richness characterize Chambers of Commerce and Industry, export marketing research, and the Internet. The only information source that registers below-average richness levels is the competitors. As a result, it is concluded that competitors cannot be considered as a rich export information source and they have not been further included in the research propositions’ test-related analysis.

As far as the levels of potential absorptive capacity of companies in the sample is concerned, they appear to be highly developed in terms of assimilation practices; they coordinate efficiently and perform well in terms of knowledge transfer and integration. The export information acquisition dimension appears to be less developed than the assimilation dimension. Companies interviewed are only slightly above-average more informed

concerning foreign markets, compared to their main competitors. The companies seem to privilege export information concerning foreign clients and product related information.

In terms of realized absorptive capacity, the SMEs interviewed scored quite highly above the average in terms of export responsiveness capacity (information transformation dimension). They perform generally slightly above the average in terms of international marketing competences compared to their main competitors in foreign markets. They register higher levels of positional advantage in terms of foreign networking competences and international product development, and the lowest levels of positional advantage for the international marketing management-related competences.

The descriptive results also allowed for an overview concerning the international performance levels that companies attain in foreign markets. Responding managers appear to be rather satisfied with the evolution of the main export objectives over the last year, they perceive themselves as rather competitive in comparison to the main competitors in foreign markets. The managers also rate themselves as slightly superior in term of attaining export objectives abroad. Their progressions in terms of export sales and profits over the past three years are quite important as well (an average about 20%). Managers interviewed perceive their foreign sales to be as profitable as their domestic sales.

The estimation of the causal relationships in this research model led to the validation of nine out of the ten research propositions emitted in chapter III. The results suggest that the AC perspective is an appealing and efficient framework for exploring the dynamics associated with export information processing in small firms. Concluding, Zahra and George's (2002) AC framework seems to be appropriate in explaining the export information exploitation process and its impact upon SMEs' international performance levels.

The three research propositions emitted with respect to the influence of PACAP's antecedents on PACAP development were validated. The richness of export information sources, the real export experience of SMEs, and the richness of the international experiences of "*export employees*" positively and significantly influence the efficiency of export information acquisition in small firms. It is worth to note that the richness of export information sources explains about half of the explained variance of the export information acquisition efficiency. If the contribution of the two international experience measures in explaining export information acquisition efficiency is examined, one can observe that the richness of the export experiences of "*export employees*" explains twice more variance than the real length of firms' international experience. The main implication is that in order to achieve better levels of informativity concerning foreign markets, SMEs can somehow overcome their "*youth*" in

terms of the length of their export experiences by employing people with varied and complementary international experiences. Recall that half of the explained variance of the export information acquisition is due to export information sources richness. As a result, it seems that the quality of the exposure to export information sources in foreign markets is the major determinant of firms' levels of informativity in foreign markets. Even though the international experiences are important factors, explaining about half of the variance of SMEs' informativity levels concerning foreign markets, the explanation power of the richness of export information sources is higher. Thus, managers should enhance the management of export information sources for achieving higher export informativity levels compared to their main competitors in foreign markets.

Concerning the impact of PACAP upon RACAP, it can be observed that all the research propositions emitted with this respect have been validated. Export information acquisition as well as the assimilation practices, namely knowledge transfer and integration, and coordination efficiency determine the export responsiveness capacity of SMEs. In order of importance, the main determinant of the SMEs' export responsiveness capacity is the efficiency of knowledge transfer and integration practices, followed by the coordination capacity of small firms and the richness of the export information sources they use to keep informed concerning foreign markets. The results suggest that export information is a "*sine qua non*" condition for staying responsive to foreign market shifts but it needs to be valorized through the implementation of efficient information assimilation practices. It is worth to note that Liao *et al.* (2003) have previously examined the reliance of market orientation dimensions under an absorptive capacity perspective and they found similar results. Their study brought empirical support that information acquisition and dissemination influence firms' responsiveness capacity in domestic markets. This study seems to confirm similar relationships of influence in the case of exporting SMEs.

Concerning the impact of the determinants of the positional advantage of SMEs in terms of international marketing competences, a strong impact of the export responsiveness capacity of small firms can be observed. The results suggest that by means of responding and taking corrective action in order to better manage foreign market shifts, firms appear to build superior levels of positional advantage in terms of foreign market-related competences when compared to their competitors. The real international experience of small firms also significantly and positively impacts the degree of positional advantage in terms of international marketing competences that SMEs achieve in export markets. Surprisingly, the



richness of the export experiences of export employees does not have a significant influence upon the positional advantage in terms of international marketing competences.

The results suggest that for small firms, the different dimensions of the international experience do not have the same impact at different stages of the process of export information absorption. Both, the richness of export experiences of the “*export employees*” and the real length of the international experience of SMEs, help them to stay informed about export markets. Nonetheless, it is finally the real length of their international experience that ultimately determines their levels of international marketing competences. The results suggest that while the variety and complementarities of the international experiences of “*export employees*” determine SMEs’ foreign market-related informativity levels, they do not have a direct influence on the building of higher levels of competences related to foreign operations’ management. It is finally the length of the international experiences of SMEs that impacts the levels of international marketing competences. Thus, achieving higher levels of positional advantage in terms of international marketing competences appears to be a path dependent process.

Finally, the impact of RACAP on the international performance of SMEs is highly significant. Detaining a positional advantage in terms of foreign market-related marketing competences drives SMEs to be more successful in international settings. This result suggests that the main KBV assumption is strongly validated by the current study. Firms attain high levels of international performance if they achieve superior levels of positional advantage in terms of international marketing competences compared to their competitors. The influences of the international orientation and firms’ size were controlled when assessing this effect. The impact of a firm’s size on the level of international performance is non-significant. Regardless of their size, French SMEs from the steel industry can achieve high levels of international performance. The impact of the international orientation of small firms upon their levels of their international performance is weak.

Concluding, the results suggest that export information management in small firms is a complex process. The export information acquisition efficiency depends on the export information sources richness and the export experiences of SMEs. Furthermore, export information has to be efficiently acquired and assimilated within organizations in order to best respond to foreign market shifts. Export market responsiveness determines the level of international marketing competences, which ultimately impacts an SME’s level of international performance. The main implication of the study with respect to the research question is that the impact of the export information processing of SMEs on their levels of

international performance is indirect and it depends on the efficiency of the whole organizational process of export information absorption. Overall, the results suggest that export information activities are important inputs when taking action and responding to foreign markets' shifts, indirectly sustaining the positional advantage in terms of foreign marketing competences. The impact on the international levels of performance of small firms appears as rather indirect. This finding is in line with the results and the recommendations of previous studies in the field (e.g. Ramangalahy 2001; Souchon and Durden 2002; Julien and Ramangalahy 2003). After reviewing the main results of this research, the research contributions and implications are presented hereafter.

### **VII.2.3 Research contributions and implications**

The implications and the contributions of the current research are presented together since they are usually related. They are exposed in four points referring to the implications and contributions from the theoretical and methodological points of views, and the contributions and implications for managers and policy-makers.

#### ***VII.2.3.1 Theoretical contributions and implications***

From a theoretical point of view, this dissertation provides several advancements. The first theoretical contribution of this research is the fact that this dissertation presents a detailed literature review of the research work undertaken over the last 26 years, aiming to capture the impact of firms' behaviors in terms of export information on the degree of the international performance of firms. A detailed analysis of the results of these studies in terms of (a) fieldwork characteristics, (b) sampling and data collection, (c) statistical analysis, (d) theoretical considerations (the use of a grounded theory research hypothesis or propositions), (e) export performance measures employed in the literature, and finally, (f) the findings of the studies with respect to the relationship existing between export information behaviors and international performance has been realized. To the best of knowledge, no such similar study has been previously undertaken.

A second theoretical contribution is represented by the detailed analysis of the different perspectives and theoretical frameworks explaining the link between information and

organizational performance. Furthermore, the main directions of the AC literature are presented and discussed. In the end, a relatively intuitive and simple framework capturing the impact of the AC of information on the levels of organizational performance is presented and used further in chapter III as a basis for developing the research model of the current study.

A third theoretical contribution is the abandonment of studying the export information activities of firms under a static perspective. Recall that previous studies have mainly captured managerial perceptions relative to the perceived importance or frequency of use of export information sources or export information types (Ramangalahy 2001) at a certain moment in time. The innovation brought by the current research is the study of the process of evolution of the information state of SMEs at the firm level of analysis, under a dynamic perspective. Previously, scholars like Ramangalahy (2001) and Julien and Ramangalahy (2003) have already pointed out the necessity to study the organizational state of information, including the process of information acquisition as well as the organizational mechanisms favoring information internalization. Nonetheless, the export information state of SMEs has previously been approached under a static perspective, namely the resource based view (RBV) of the firm (Ramangalahy 2001; Julien and Ramangalahy 2001); the RBV pictures the information state of firms at a certain moment in time. Since most of the scholars agree upon the dynamic nature of information, dynamic theoretical perspectives should be used in the future. They would allow a better understanding of the way the evolution of the export information state of SMEs impacts their international performance. The results in this research indicate the validity of the use of a processual perspective for capturing the export information evolution in small firms.

The fourth theoretical contribution is related to the one explained above. It refers to the use of more “*dynamic*” theoretical perspectives. In the current research, the KBV perspective has been used for capturing the evolution and transformation process associated with the exploitation of export information to commercial ends in small firms. Within the KBV, the accent is put on the evolution potential of resources and the dynamics associated with the learning process of firms. By combining insights from the KBV, the aim was to capture export information dynamics’ in small firms under a more systemic and dynamic perspective. Thus, the factors that determine effective export information acquisition, the efficiency of the organizational mechanisms that allow for better information exploitation in small firms, and finally the transformation of export information into responsive action have been taken into account.

The dynamics associated with export information gathering and transformation within organization is the focus of the research model. Moreover, the KBV shifts the main assumption of the RBV that competitive advantage determines performance levels; the KBV asserts that business performance is a matter of achieving a positional advantage in terms of competences in key organizational areas. The main difference is that if the competitive advantage characterizes companies at a certain moment in time, the positional advantage in terms of key competences provides insights concerning the future development and sustainability of performance levels; competences can be further deployed in different manners in order to ensure a firm's growth (Kuivalainen and Bell 2004).

The fifth contribution of the current research is also related to the dynamic perspective embraced for describing the relationship existing between SMEs' information state and their levels of performance in foreign settings. It consists of approaching the export information state of organizations through the Absorptive Capacity (AC) angle as a dynamic process or capability in accordance with the framework proposed by Zahra and George (2002). Cohen and Levinthal (1992) originally designed the AC concept for explaining technology-based innovation and learning in technology-intensive and dynamic industries by means of information absorption. More recent research has focused on and applied the concept of AC to knowledge management, emphasizing its role in the intra-organizational transfer of knowledge (Szulanski 1996; Gupta and Govindarajan 2000), inter-organizational learning (Lyles and Salk 1996; Lane and Lubatkin 1998; Lane *et al.* 2000) and also in explaining innovation (Tsai 2001). The study of Ramangalahy (2001) is the only study that has used the AC concept in order to study the export information behaviors in small firms. Meanwhile, Ramangalahy (2001) used the AC framework under the static perspective, the RBV of the firm.

The main theoretical implications of the third, fourth and fifth theoretical contributions of the current study are that scholars should abandon studying disparate information behaviors of SMEs in foreign settings. In exchange, the study of the evolution process of the state of export information characterizing SMEs should be privileged by means of using more dynamic theoretical frameworks.

The integration of insights from the KBV, AC and MO perspectives for capturing export information dynamics in small firms under a more systematic and dynamic perspective represents another theoretical contribution of the current research. To the best of knowledge, the three theoretical frameworks have not been previously combined into a single study for capturing the impact of the export information state of SMEs upon their levels of international

performance. As was suggested at the end of chapter II, the use of a single theoretical framework for assessing export information dynamics in small firms represents a limited choice. This theoretical conclusion found strong empirical support in both qualitative and quantitative studies. The empirical results revealed that a single theoretical framework cannot entirely capture the dynamics and complexity associated with the impact of information on business performance. Managers stated that they use information mainly to respond to changes in their surrounding international environment, to detect new business opportunities, and to make decisions. The implication is that several theoretical perspectives shall be combined, depending on the aim of the research and on the level of analysis, in order to best describe the impact of firms' export information dynamics on their levels of international performance.

Another theoretical contribution gained from this research is the ability to get a deeper understanding of the reasons of use of export information sources by SMEs' managers. Within the preliminary qualitative research, the accent was put on the understanding of the reasons why SMEs' managers use certain export information sources over others through the preliminary qualitative study. To the best of knowledge, previous studies in the field have not specifically addressed this matter. The results of this empirical investigation suggest that both French and Romanian managers stated that they prefer the use of certain export information sources because of the attributes or qualities information sources provide to managers. Some of the attributes mentioned by the interviewees are the adequacy of the information to their needs, reliability, timeliness or the possibility of exchanging points of view about the acquired information. Thus, the qualitative research implies that retaining information sources richness, a multi-dimensional perspective (Daft and Lengel 1984), as an angle for studying firms' export information-related perceptions is consistent with the managerial view.

An additional implication also issued from the qualitative investigation is the confirmation of several of the market orientation literature premises with respect to the key importance of clients and competitors and the use of information for responding to environmental shifts. Generally, SMEs' managers mainly acquire export information concerning clients and competitors. This observation reinforces the initial empirical qualitative study on the market orientation undertaken by Kohli and Jaworsky (1990). The authors have emphasized the key importance of knowing clients and competitors and their use as information sources. Moreover, managers frequently state using export information for responding to environmental shifts in their own environment. This is also one of the basic postulates of the MO perspective, finding extensive echo within our empirical investigation.

### *VII.2.3.2 Methodological contributions and implications*

From the methodological point of view, this research combined qualitative with quantitative methodology. Past research in the domain has mainly been quantitative by nature. There is no doubt that the research question is causal by nature, thereby justifying the use of quantitative methodology. Even though quantitative methodology use is justified by the causal nature of the research question, when studying complex and multi-dimensional concepts like information, quantitative research cannot alone gain a deeper explanation of the phenomenon under study. Thus, the use of an additional qualitative approach can complete or enrich the findings supported by the quantitative study. Indeed, the qualitative fieldwork used in this study brought general empirical support for the validation of the theoretical model and the research propositions' test. The preliminary qualitative study had the merit to answer several questions needed in order to construct the questionnaire such as "*Which are the 'richest' export information sources according to the managerial perspective?*" and "*Why do managers specifically use certain information sources over others?*". The qualitative study also supported the use of an integrative theoretical perspective for capturing the relationship between export information and international performance. Moreover, the qualitative study first brought an intuitive validation of the theoretical choices undertaken in terms of AC dimensions' operationalization and of the pertinence of the research propositions. The results imply that the combination of the qualitative with quantitative methodologies leads to a better comprehension of the export information process in small firms.

A second methodological contribution of the current study is the proposition and validation of several possible operationalizations of the AC dimensions and antecedents for Zahra and George's (2002) AC model, in the case of exporting SMEs. As a result, the study provides a set of measurement tools used to evaluate the export information AC dynamics in SMEs. In as such, the AC of export information can be assessed in future studies in the field by using the existing measurement tools and by improving them further.

A third methodological contribution is the development of a psychometrically sound measure used for capturing the richness of the international experiences of "*export employees*". The measure was issued from the preliminary qualitative study and was proven to be psychometrically sound. To the best of knowledge, no such measure has been previously developed. Moreover, numerous limits in terms of assessing the international experiences of companies characterize the exporting SMEs' literature (e.g. Kuivalainen and Bell 2004; Nguyen 2007). With this in mind, this research proposes a valid measurement instrument,

capturing more qualitative aspects of SMEs' international experiences such as the perceived variety or complementarity of the international experiences of "*export employees*".

A fourth methodological contribution and implication is represented by the fact that it appeared as appropriate to assess export information sources richness as a second order construct. Statistical results ascertained the satisfying psychometrical properties of the measurement of information sources richness through second order constructs.

Another methodological implication is of practical order. The questionnaire pre-test was a critical phase in the development of the questionnaire. In the case of the current research, the questionnaire pre-test showed that measurement scales used and pre-tested in studies undertaken in other cultural settings would not be correctly understood by managers interviewed from other countries. Important changes had to be made in order to make sure that the managers interviewed correctly understood the questions in the questionnaire. The measures used to capture international performance, export information sources richness, export experiences' richness, export responsiveness and the positional advantage of SMEs in terms of international marketing competences had to be adapted or replaced. All in all, the measures had to be at least slightly modified after the pre-test.

### *VII.2.3.3 Research contributions and implications for managers*

This study offers guidance for SMEs' managers in improving the management of export information activities and for achieving higher levels of foreign market-related performance. A detailed description and directions concerning the efficient acquisition, assimilation, transformation and exploitation of export information in small firms can be formulated based on the empirical findings of this research. Both qualitative and quantitative investigations provide interesting and complementary results that might be of use to exporting SMEs' managers. For instance, SMEs' managers can gain additional insights through the qualitative study concerning the way Romanian and French enterprises manage export information, the way they do business abroad, why they prefer some export information sources over others, and how they conceive the improvement and sustainability of their international activities.

The qualitative study sheds some knowledge into the reasons that motivate SMEs' managers to use export information sources. Regardless of their nationality, the managers interviewed expressed a marked preference for informal information sources. Moreover, they converge a lot concerning the reasons evoked for explaining their preference in terms of export information sources. They mainly explained the prevalent use of informal information

vehicles by mentioning the experiential nature of these sources, the fact that through this mean they can exchange and debate points of views with someone competent in the field, they can receive specific answers to their questions, and the fact that most of the time they trust the information providers. Based on these findings, SME managers could compare themselves to their competitors concerning the motivations pushing them towards the use of certain export information sources over others and into the value added provided by potentially using other information sources. For instance, based on the results of the qualitative studies, the companies not currently participating at trade fairs might achieve a deeper understanding into the way participation at trade fairs is useful to their competitors.

The results of the preliminary qualitative research revealed that SMEs' managers mainly acquire export information about clients and competitors. On a less extended scale, enterprises access marketing mix-related information and they rarely access general foreign market information. The findings suggest that clients and competitors represent strong market engines that should be closely watched in order to be successful in foreign settings. The implication for SMEs' managers is that they should continuously collect and closely watch foreign clients and competitors in order to ensure their foreign business development.

Managers can also better comprehend how their competitors use export information through the qualitative study. The recurrent outcome of the interviews is that SMEs learn by means of responding to the acquired export information. In addition, export information is used for decision-making and for grasping new business opportunities abroad. The prevalent mode of use of export information is to formulate response action. Furthermore, under a trial and error selection process, they select the practices that have worked best for them in the past for designing future action. The export information also seems to be primordial in the decision-making process. Regarding decision-making, all the managers interviewed suggested that they consult at least one person for decision-making. Most of the times, this person is the exporting or production director in their enterprise. They all agree that consulting someone else for decision-making is very useful to them because it allows for the exchange of points of view and multiple possibilities can be taken into account through creative problem-solving. Based on these findings, managers could compare themselves to their competitors regarding information use patterns in their firm and inspire themselves from the practices that seem to bear interesting fruits for their counterparts. For example, managers can consult several people for decision-making in order to exchange opinions and design efficient and creative responses to problems that need to be solved.



In addition, the results of the interviews realized can provide SMEs' managers with information concerning the factors enhancing export information use in their competitors' vision. Generally, interviewees believe that the previous foreign market knowledge and export experience help them to better exploit the new incoming export information. The variety, complementarity and length of export experiences determine the efficient use of export information.

Furthermore, based on the results of the qualitative study, SMEs' managers can achieve an overview on the efficiency of several information assimilation procedures such as for instance the coordination, communication, and information transfer and integration practices. The empirical findings revealed that high levels of efficiency of communication and low formalization levels characterize the SMEs interviewed. The coordination and the information transfer and integration procedures are barely formalized. In most of the SMEs interviewed, information integration procedures are almost non-existent. Coordination is sometimes not necessarily efficient and it seems that in bigger firms, coordination appears less efficient. These results could help SMEs' managers assess whether their company has a similar profile in terms of assimilation procedures compared to competitors and try to improve mechanisms in which they seemingly under-perform compared to the competition.

When asked what leads their company to achieve higher levels of success in export markets, both French and Romanian managers mainly mentioned their competences in terms of product development and more largely, the general export know-how. The findings suggest that managers should favor the development of their foreign market-related competences in order to achieve high levels of success in international settings.

Beyond the generalist insights referring to exporting SMEs' export information acquisition and use, and the factors enhancing information use throughout the organization, the preliminary qualitative study also provides SMEs' managers with information concerning the export information practices of their Romanian competitors. Within the growing E.U. context, the knowledge of the foreign business partners and competitors in the European market becomes of key importance. It is worth noting that regardless of their nationality, Romanian and French managers prefer informal information techniques to formal ones. In regards to the reasons evoked for explaining this preference, the managers also provide similar testimonies. Nonetheless, one can remark that Romanian managers make even more extensive use of personal export information sources. Another particularity is that Romanian managers have more ease when using their competitors as export information sources. However, Romanian and French managers believe it is important to keep in touch with competitors even if they do

not necessarily trust their competitors. The feeling of mistrust towards competitors seems to characterize more the French managers than the Romanian managers.

Concerning the formal information techniques, they are used more extensively by French firms. French SMEs' managers seem to use more extensively and be more aware of export assistance-related information sources on a wider scale. The Chambers of Industry and Commerce have an especially favorable image in France. However, reservation was expressed concerning the export assistance-related information sources. The main reasons that French managers mentioned for not using export assistance-related information sources are bureaucracy, the difficulty of getting the right interlocutor to speak with, and the general and out-dated character of the information provided by governmental bodies. The main difference in perception between Romanian and French enterprises is the fact that most Romanian enterprises accuse governmental bodies of corruption. This is an outcome of the institutional business environment in Romania that has been constantly changing since the Romanian Revolution in 1989. The domestic environment situation might also explain the preference for informal information techniques, as there are studies that prove that under unstable and changing environmental conditions, enterprises tend to use informal information sources (Beal 2000).

The use of international marketing research is a quite common thing in the French context. In the Romanian context, export marketing research use is exceptional. The French enterprises that use export marketing research consider it useful since it can provide specific answers to their questions, they trust the person who undertakes the study, and they can discuss certain aspects with this person in the marketing research. The only Romanian enterprise using marketing research had a similar testimony. Nonetheless, from a perception point of view, Romanian enterprises consider export-marketing research useful. In the meanwhile, it is difficult to see to what extent Romanian enterprises understand what marketing research really is; the marketing science was only developed about 15 years ago in Romania and most of the interviewees have a technical background. This might be as well one of the reasons that could explain the fact that Romanian companies do not use on a regular basis export marketing research.

In relation to the information types primarily collected on foreign markets, both Romanian and French SMEs mainly acquire export information about foreign clients and competitors. Romanian managers use export information as French managers do, for decision-making and responding to foreign market shifts. It is notable that the Romanian managers make decisions based on intuition much more extensively than French managers.

The testimonies of Romanian and French managers converge concerning the factors enhancing export information use in small firms. They generally believe their previous experience and knowledge primarily help them to better make use of export information. Nonetheless, Romanian managers state that they have a certain sense for business and that creative intuition is necessary to grasp opportunities in the business environment.

Furthermore, as far as the assimilation practices are concerned, Romanian enterprises are very similar to French enterprises. Romanian and French enterprises are efficient in terms of communication, being characterized by low levels of formalization, planning activities, and knowledge transfer and integration practices. Coordination is sometimes less efficient in bigger firms. Decision-making is centralized. They mainly count on their low prices and product quality for ensuring competitive advantage in foreign settings.

Based on the afore-mentioned generalist description of Romanian enterprises, French SMEs can achieve a better understanding of the weak and strong points of their Romanian competitors. In addition, the description of Romanian enterprises could help the French managers better manage business exchange relationships with Romanian firms since the qualitative study provides information concerning the reasons of use of certain business contacts over others. For example, if French enterprises would become the clients of a Romanian company, they should try to establish a trust-based relationship, to interact frequently and exchange points of view with the Romanian firm, and try to provide them with adequate information specific to their needs. Resuming, the qualitative study provides SMEs' managers with insights into the way their domestic and Romanian competitors manage their export information-related activities. Some insights include why they prefer certain information sources over others, which are the favored information sources in foreign markets, what kind of information is primarily collected about foreign markets, why and how they use export information. While the qualitative research provides a rich base of information, the results of the preliminary qualitative inquiry are suggestive rather than conclusive for small firms' managers.

In order to fill the gap of the qualitative study and provide more generalized results for SMEs' managers, a quantitative inquiry was further undertaken on a sample of 107 enterprises. By drawing on the descriptive results of the quantitative study, SMEs' managers could compare themselves to their competitors in terms of export information absorptive capacity. The study draws a detailed picture of the export information absorptive capacity of French SMEs and their levels of export performance. However, one can see that the companies in this sample are generally bigger, more internationally involved and more successful. Thus, based on the

results of this study, SMEs' managers can compare themselves to the average of the more successful SMEs from the steel industry.

The findings of this study allow for the characterization of the SMEs in the sample in terms of international experiences, export information sources richness, levels of informativity concerning foreign markets, export information assimilation practices, levels of international marketing competences and levels of export performance, export responsiveness, and export orientation.

The results relative to the international experiences of companies interviewed allow SMEs' managers to compare themselves to domestic competitors regarding different aspects of export experiences in their own company. Such aspects are the numbers of years the company has been exporting, the number of export employees, the richness of their international experiences, the number of export countries, and the foreign presence modes employed.

The quantitative results also describe the levels of richness of export information sources characterizing SMEs in the sample. Comparing themselves to the average of these results, SMEs' managers can assess their levels of richness of the use of export information sources. Additionally, they can try to improve the aspects of information sources richness, less developed in their company compared to the average of competitors, such as the facility of contacts or the quantity of information they get from export information sources.

As far as the levels of potential absorptive capacity of companies in the sample are concerned, they appear to be highly developed in terms of assimilation practices; the companies interviewed coordinate efficiently and they perform well in terms of knowledge transfer and integration. Again, by means of comparison to these findings, SMEs' managers can assess how they perform compared to the average of the enterprises in the sample.

The export information acquisition dimension appears to be less developed than the assimilation dimension. Companies interviewed are only slightly above-the-average more informed concerning the foreign markets in comparison to their main competitors. Based on these findings, managers can compare themselves to the average of the companies in the sample and try to raise their informativity level regarding the information elements that they perceive as less developed when compared to their competitors.

The SMEs interviewed score quite high above the average in terms of export responsiveness capacity, the information transformation dimension. They generally perform slightly above the average in terms of international marketing competences compared to their main competitors in foreign markets. By means of comparison to the average of the companies in the sample, SMEs' managers can evaluate their potential in terms of international marketing

competences and responsive action with respect to foreign market shifts. Moreover, they can try to improve the domains of export competence for which they under-perform.

The descriptive results allowed for an overview concerning the international performance levels companies attain in foreign markets. Responding managers appear to be satisfied with the evolution of the main export objectives over the last year, they perceive themselves as rather competitive. When compared to the main competitors in foreign markets, managers rate themselves as slightly superior in terms of attaining export objectives such as the foreign market share, the new number of foreign markets conquered abroad, the export sales volume and the profits issued from their foreign sales. Their progression in terms of export sales and profits over the last years is important as well. Their foreign sales appear as profitable as their domestic sales. Moreover, companies interviewed appear to be willing to extend their international activities, to actively look for foreign market opportunities, and they consider their international activities to be important. With regard to these results, SMEs' managers can compare themselves to the average of companies in the sample concerning their levels of international performance and export orientation.

The research propositions' test brought into light for SMEs' managers several implications of practical order. The results suggest that the more SMEs access rich information sources in foreign markets, the higher levels of informativity relative to foreign market development are attained. As a result, their level of informativity relative to foreign market development depends on the way they manage the relationships with export information sources in terms of contact facility development, and the interactivity of the relationship as well as the quantity and reliability of the information they get from foreign information sources.

On a less extended measure, the richness of the "*export employees*" international experiences also influences the levels of informativity of SMEs concerning foreign markets. The results also show that the real number of exporting years of SMEs impacts their levels of informativity relative to foreign markets. An interesting implication of this result is that they should do their best in order to try to constitute an exporting team made up of employees with varied, complementary and long export experiences. The results imply that the degree of informativity they attain in foreign markets depends on both the richness of the international experiences of the "*export employees*", but also on the aggregate levels of international experiences at the firm level. Nonetheless, the impact exerted by the richness of the international experiences of the "*export employees*" is stronger. This finding suggests that companies characterized by less developed levels of real export experience at the firm level

can, to some extent, overcome their lack of experience with this respect by hiring export employees with varied and complementary international experiences.

The analysis also underlines the role played by export information in providing small firms with guidance for future action. SMEs attaining higher levels of foreign market-related informational knowledge implement more efficient response actions when facing foreign market shifts. However, the aggregate impact of the assimilation practices, coordination and knowledge transfer and integration efficiency upon the export responsiveness levels of SMEs is significantly higher. To resume, while it is important for SMEs to efficiently acquire export information-related to foreign markets, the efficiency of the response actions they implement when facing foreign market shifts will depend on the efficiency of the assimilation practices in place in the organization to an important extent. Thus, export information shall be valorized in SMEs through the design of efficient information assimilation practices.

The results also suggest that export responsiveness appears as the main entrant of the positional advantage SMEs attain in foreign markets in terms of international marketing competences. It was also postulated that the levels of international experiences of SMEs would impact the levels of positional advantage in terms of international marketing competences they attain in foreign markets. Only the real number of exporting years has been found to exert a significant impact on their positional advantage levels. It is important to note that about two thirds of the variance of the levels of international marketing competences is explained by the export responsiveness capacity. This result suggests that nowadays international learning cycles have shortened and that companies seem to develop foreign market-related competences rather on a responsiveness basis than over time. Finally, SMEs' managers should aim at the development of their levels of international marketing competences since ultimately they are the key determinants of the levels of the international performance of small firms.

Resuming, the implications for SMEs' managers is that the successful managing of export information is a beginning-to-end and on-going process that should be carefully considered step-by-step in order to obtain rich satisfying results in terms of international performance. International performance is considered by managers as a tool that boosts corporate growth, strengthens competitive edge and ensures a company's survival and success in the marketplace (Samiee and Walters 1990; Terpstra and Sarathy 2000). This research proposes such a model. At the aggregate level, SMEs' managers should keep in mind that the impact of export information acquisition on business performance seems to be rather indirect. Export information provides firms with additional insights into which value-adding activities should

be undertaken in order to effectively respond to foreign markets' shifts. Export responsiveness in turn impacts the levels of positional advantage in terms of international marketing competences attained in foreign market settings. Finally, the positional advantage SMEs achieve in terms of international marketing competences' development directly impacts their level of international performance.

#### *VII.2.3.4 Research contributions and implications for policy makers*

This research provides also implications for public policy-makers. Nowadays, all governments in the world aims to increase exports in order to improve the commercial balance and sustain economic growth and development. As a result, most governments in the world create development support programs for SMEs at the national and regional level to enhance training, and to provide information or financial aid supporting a firm's exporting activities (Gencturk and Kotabe 2001). Based on this study, policy-makers can gain insights into the factors determining SMEs' international performance in order to further design more suitable support programs for enhancing knowledge and information management within SMEs.

The results of the qualitative study provide interesting insights for policy-makers. For instance, direct implications for policy-makers can be formulated based on the perception of a SME's manager of export assistance-related information sources. Only the Chambers of Commerce and Industry are popular among small firms' managers. For the remaining export assistance-based bodies, the managers interviewed had doubts with regard to the bureaucracy, the difficulty in getting the right interlocutor to speak with, and the general and dated character of the information provided by governmental bodies. Based on these findings, policy-makers can take corrective actions in order to improve the image of public export policies. For instance, they could facilitate the access to aid programs and try to decrease bureaucracy, and further personalize the communication with SMEs' managers and more frequently update the content of the export information provided.

Since the qualitative analysis compared the perceptions of SMEs' managers concerning export assistance bodies in France and Romania, directions for Romanian policy-makers can also be formulated. Most of the Romanian managers interviewed accuse governmental bodies of corruption. This finding suggests that public policy-makers in Romania should undertake corrective action in order to improve their image in the eyes of Romanian managers.

The study provides a broad measurement tool aimed at the evaluation of the export information absorptive capacity development in SMEs. By means of using the research questionnaire, policy-makers could, for instance, evaluate the levels of the absorptive capacity of export information of SMEs from specific industries and implement aid programs where needed. Policy-makers can also draw conclusions from the quantitative results with respect to the appreciation of the Chambers of Commerce and Industry (CCI). Overall, SMEs' managers interviewed rate CCIs rather averagely. In terms of contacts with the information sources, CCIs achieve ratings that are below average. The quantitative study confirms the qualitative study; it seems that the weakness of CCIs resides in the quality of the contact with SMEs' managers. Based on this finding, policy-makers can design programs to further personalize the contact with exporting SMEs' managers.

The descriptive analysis of the data gathered also suggests that the enterprises interviewed are not highly informed concerning foreign markets. Thus, more efficient and personalized aid programs concerning key information elements in export markets should be developed for the small firms operating in the steel industry. The government could organize information seminars and programs aimed to inform small firms about key information elements in their export markets.

The descriptive analysis suggested that SMEs are characterized by competences that are slightly below the average concerning specifically the international marketing management. As a result, aid programs aimed at developing SMEs' managers skills in terms of export marketing planning, formulating creative export marketing strategies, translating marketing strategies into action, and the control and evaluation of marketing costs in a foreign setting would be a great aid for the development of the levels of international performance of SMEs. Moreover, the causal analysis revealed the key role played by the international marketing competences of small firms in driving exporting firms to success in foreign settings. As a result, particular attention should be directed towards the design and implementation of aid programs for small exporters that are aimed at developing international marketing skills.

However, an important implication mainly issued from the qualitative study is the fact that in order to attract SMEs towards the use of public aid programs, policy-makers should develop the quality of the contact with SMEs. The SMEs value contact facility, the interactivity with information sources, the reliability of the information provided and information quantity. As a result, while designing appropriate public aid programs for SMEs, public policy makers should keep in mind that important communication and guidance efforts are needed in order to attract small companies to effectively use them.



## VII.2.4 Limits and future research avenues

The limits and the future research avenues of this research work are analyzed from the theoretical, methodological point of view, and also in terms of results obtained. Since the future research avenues in most of the cases are meant to overcome the limits of the research, they are presented in the same section.

### *VII.2.4.1 Theoretical limits and prolongations*

The theoretical limits of this research can be classified into the following four groups: the use of the KBV as a perspective for approaching the export information activities, the mobilization of the Absorptive Capacity (AC) concept as a perspective for capturing information activities in small firms, the use of the richness perspective for capturing the exposure to export information sources and the international experiences of SMEs, and the limitation of the study to exporting SMEs.

Using the KBV as a perspective for approaching the impact of export information activities in small firms upon their levels of international performance presents two main limitations. The first limitation refers to the fact that the KBV is not a real grounded theory. It can be better viewed as a set of ideas about the existence and the nature of the firm that emphasizes the role of knowledge, knowledge creation and the resource evolution potential. Traditionally, more scholars see KBV as an extension of the RBV of the firm, drawing on the strategic value of intangible assets enabling competitive advantage (e.g. Christensen 1995; Mahoney 1995; Barney 1996). By accepting much of the content of the RBV, the KBV “*pays more attention to the process or path by which specific capabilities evolve and develop over time*” (Kuivalainen and Bell 2004, p.2). This evolving character was judged to very appealing in the case of the current research work because of the dynamic nature of information.

The main limit associated with the mobilization of the KBV in the current research is the explanation of the business performance (e.g. DeNisi *et al.* 2003; Patriotta 2004; Kodama 2005). No agreement has yet been reached among scholars concerning the way firms achieve higher levels of business performance according to the KBV. However, Kuivalainen and Bell (2004) or Kodama (2005) suggested that KBV brings along a paradigm shift with respect to the RBV. If within the RBV of the firm, competitive advantage drives business performance,

this position has been criticized within the KBV. For instance, Khyvaleiko (1998) suggested that the competitive advantage of firms describes a reality at a certain moment in time but it does not tell much about the future development potential. As a result, Kuivalainen and Bell (2004) have suggested that firms should develop a competitive advantage in terms of competences development in key organizational areas; competences can be deployed and renewed over time when confronted with new situations, and thus will be able to predict future development. Within the current research, this assumption has been tested and received high empirical support. It was proposed that the positional advantage small firms achieve in terms of international marketing competences impacts the degree of international performance of SMEs. This research proposition has been validated and the relationship was highly significant. Meanwhile, the validity of this KBV assumption has yet to be validated by future studies in the field.

The other main limit associated with the use of the KBV in the case of the current research is that the KBV perspective does not accept the role of information. The paradigm shifts within the KBV from firms as information processors to firms as knowledge processors (Grant 1996). In the meanwhile, information was conceptualized as a flux (Nonaka 1994), conveying a meaning and continuously entering organizations and enhancing knowledge stocks. It was postulated that information provides insights into the activities that should be undertaken to match market conditions (Kohli and Jaworski 1993; Day *et al.* 1994; Slater and Narver 1995) in line with the market orientation literature. Again, these propositions have received empirical support but their external validity needs to be further confirmed by other studies.

In the light of the literature review, it has been concluded that the AC represents a satisfactory perspective in approaching the export information processing. The AC research stream is also a controversial literature. Nevertheless, the two main agreement points reached by scholars are the multidimensional nature of AC construct and most recently, its dynamic nature. However, these observations did not receive much empirical support. Research in the AC field is still mainly theory-driven (Zahra and George 2002; Lane *et al.* 2006). AC as a multi-dimensional construct was conceptualized according to Zahra and George's (2002) conceptualization. Accordingly, AC is made up two sub-sets of AC, potential and realized AC. They also mention the AC antecedents, namely the previous experience and exposure to information sources in the environment that influence the development of PACAP.

The two sub-dimensions that make up PACAP are information acquisition and assimilation. Transposed in the case of exporting SMEs, it was conceptualized as export information acquisition and assimilation. While available measurement instruments exist for the export

information acquisition dimension, they do not exist for export information assimilation practices in SMEs. The assimilation dimension was captured by means of SMEs' efficiency in terms of coordination and knowledge transfer and integration, which are domestic-based measures. As a result, the research proposition suggested by Zahra and George (2002) concerning the impact of PACAP antecedents on the assimilation dimension of PACAP could not be tested. The reason for not testing it is that it is not easy to establish a causal relationship between international experiences of small firms, the access to rich export information sources and the coordination and knowledge transfer and integration practices, which are domestic-based measures. Future research should be directed towards specific measures capturing the export information assimilation practices in SMEs in order to test the influence of PACAP's antecedents upon PACAP.

RACAP is made up of the two dimensions, information transformation and exploitation. The export information transformation dimension was conceptualized as the export responsiveness capacity of small firms and the exploitation dimension as firms' levels of international marketing competences necessary to operate in foreign markets.

This model explained about 43% of the variance of the positional advantage that SMEs attained in foreign markets in terms of international marketing competences. The implication is that other factors not taken into account in the current study influence the development levels of positional advantage in terms of international marketing competences. However, it worth to note that this research was not directed towards the explanation of the positional advantage SMEs attain in foreign settings in terms of international marketing competences. Due to the highly significant impact of the levels of positional advantage of SMEs on foreign markets in terms of international marketing competences on the international performance of SMEs, future studies should obtain deeper insights into the way companies can improve their levels of international marketing competences.

It is also worth to note that Zahra and George (2002) did not explicitly refer to the cognitive dimension of AC, firm's capacity to take advantage of the emerging opportunities before rivals can recognize them by collecting and exploiting market information (e.g. Chiesa and Manzini 1998; Davenport *et al.* 1998; Nahapiet and Ghoshal 1998). The cognitive dimension is the most prevalent dimension of the AC construct. As a result, it was not taken into account in the case of the current research. Moreover, to the best of knowledge, no operational definition of this dimension has yet been proposed by the literature. Further studies should also be directed towards the operationalization of this dimension.

Other concepts present in Zahra and George's (2002) framework have not yet been specifically empirically operationalized in the case of exporting SMEs, and thus it was not possible to test their influence. It is the case of the concepts called by Zahra and George (2002) "*activation triggers*", "*effectiveness rate*" and "*regimes of appropriability*". No specific operational definitions for these concepts exist in the case of exporting SMEs. Therefore, their moderator effect upon the influence of PACAP antecedents on PACAP, PACAP on RACAP, and RACAP on business performance has not been evaluated in this research work. Future studies should gain deeper insights into their operationalization and test these relationships.

Another observation is that by using Zahra and George's (2002) framework, the dynamic and processual nature of AC has been implicitly assumed. Recently, scholars seem to agree that AC is rather a process than a static resource (e.g. Jansen *et al.* 2005; Lane *et al.* 2006). This study empirically supported the approach of AC as a process. Zahra and George's (2002) AC framework was mobilized for describing the relationship between AC and business performance. The applicability of his framework in the case of export information absorption by SMEs has been supported by the empirical study. Nonetheless, the study of a process would have been better captured through a longitudinal study, allowing the observation of the evolution of the AC state of small firms over time. Thus, in the future, longitudinal studies on the topic should be envisaged.

In the light of the analysis of the literature review and also based on this qualitative preliminary study, it was concluded that the most appropriate perspective for looking at a firm's export information sources use is the richness perspective. In a similar vein, also based on the literature review on AC, Boutary's (1998) and Ramangalahy's studies (2001) and the preliminary qualitative study, the richness perspective was retained for capturing the international experiences of SMEs.

While the richness concept was conceptually appealing, during the questionnaire pre-test it was observed that managers did not correctly understand the questions relative to the richness of international experiences as conceptualized by Ramangalahy (2001). As a result, the measure initially considered had to be dropped after the pre-test. The reason was because SMEs' managers could not precisely understand the sense of the five dimensions retained to capture international experiences richness, namely (1) the length of experiences, (2) the number of projects, clients or contracts companies had to deal while using a specific foreign presence mode, (3) the challenge complexity in terms of problems that companies need to solve, (4) the context diversity that characterizes the environments companies have worked in

(social, cultural, and economic environment), and (5) the impact on the know-how development as well as how much the company learned through this experience. Instead of this afore-mentioned measure of international experiences' richness, based on the preliminary qualitative research, another international experience richness measure, capturing the diversity, complementarity and length of international experiences of export employees, was proposed and employed. The measure was proven to be psychometrically sound. Nevertheless, the measure issued from the qualitative research work did not refer to the firm level of analysis and therefore constitutes another limit in the assessment of the international experiences of SMEs. Further research should attempt to improve the terms of international experiences richness assessment at the firm level of analysis.

SMEs' managers also encountered difficulties in understanding the sense of one of the information sources richness attributes, namely the contacts density. As a result, the contacts' density dimension had to be dropped from the analysis. The remaining four dimensions are information quantity, interactivity with information sources, contact facility and information reliability; they have been used for capturing export information sources richness. For the export market research and Internet information sources, the pre-test indicated that only the information quantity and reliability dimensions were appropriate to capture the richness of these information sources. SMEs' managers have suggested that interactivity and contact facility did not apply to characterizing these two information sources.

Finally, another theoretical limit is represented by the fact that this analysis focused on exporting SMEs. This choice was driven by the fact that exporting represents the main foreign presence mode employed by SMEs in order to sell their products abroad. With this respect, several scholars pointed out that a growing number of SMEs are using alternative foreign presence modes such as joint ventures and subsidiaries to sell their products abroad (e.g. Bell *et al.* 1992; Cavusgil and Knight 1997; Kuivalainen and Bell 2004). Consequently, it would be more appropriate to study the notions of international or global SMEs that further reveal the diversity of foreign presence modes used by SMEs. Although this perspective is appealing, using several foreign presence modes reflects different degrees of internationalization of SMEs that are characterized by different degrees of control, resources' deployment and risk-taking for small firms. Under these conditions, the underlying question that could arise is whether the assessment of the international performance construct for a company selling the products abroad by means of indirect exporting or by creating a subsidiary has the same meaning. To the best of knowledge, the SMEs' internationalization literature does not yet provide an answer to this question (Ramangalahy 2001).

Exporting SME, in line with previous studies in the field, is defined as a company selling products outside of national borders (e.g. Bartlett and Ghoshal 1989; Dunning 1980; Johanson and Valhne 1993). Nevertheless, the difficulties to differentiate between national and international markets were acknowledged. This remark holds true, especially in the European context, where border regions are sometimes more similar to the cultural profiles of bordering countries. For instance, an Alsatian company might at least as easily sell products in Germany as in the South of France because of the equivalent knowledge of languages and the cultural and institutional similarity of the contexts in both countries.

#### *VII.2.4.2 Methodological limits and prolongations*

From the methodological point of view, this research presents limits in terms of the choice of research methodology, method selected for the research propositions' test and the level of analysis retained. Because of the causal nature of the research question, the quantitative methodology, which has been suggested as the most appropriate for answering causal research questions by several scholars (e.g. Huberman et Miles 1984; Eisenhardt 1989; Easterby-Smith *et al.* 1991) was adopted. Nonetheless, the subjective and multi-dimensional character of information led to the undertaking of a preliminary qualitative study in order to obtain additional insights into the management of export information activities in small firms. One of the aims of the qualitative research was also to balance the reductive character of quantitative methodology when studying “*qualitative*”, multi-faceted constructs as information, knowledge and competences.

Another major limit of the current research is that the process of export information absorption by SMEs has been studied by means of a punctual quantitative study. A longitudinal research would have certainly been more appropriate to capture a firm's evolution in terms of absorptive capacity over time but time and material limitations did not allow the materialization of a longitudinal study in the current research. Nevertheless, this is a research avenue seriously envisaged as a prolongation of this research.

Since one of the main aims of the research was to explain the international performance of SMEs, which is by definition an organizational level construct, it was concluded that the most appropriate level of analysis is the firm. This choice can be criticized since export information is generally collected at the individual level, and it is further transmitted among firms' employees at the organizational level. However, the use of several levels of analysis has been also identified as a limited choice when conducting research (e.g. Klein *et al.* 1994;

Ramangalahy 2001). Differences in terms of levels of analysis induce confusion regarding results' interpretation. As a result, limiting this investigation to the firm level of analysis appears to be the most judicious choice for the current research, all by accepting the importance of the interplay between the individual and the organizational level of analysis is limited. Nevertheless, future research should address this matter, possibly through means of qualitative research that could be more appropriate in the explanation of the interplay between the individual, group, and organizational levels of analysis.

All constructs in this research model are assessed at the firm level of analysis with two exceptions. The international experiences richness has been assessed at the group level of analysis while the international orientation of SMEs has been assessed at the managerial team level of analysis. These choices can be easily explained. Previous research in the field has suggested that the existence of an export department translates a propensity in terms of export information acquisition and use in SMEs (e.g. Ramangalahy 2001; Souchon *et al.* 2003). Note that SMEs do not always have a specific department that deals with the management of export operations; frequently the production or the marketing managers deal with exporting activities in small firms (Souchon and Diamantopoulos 1999). As a result, it is sometimes more appropriate to consider the number of employees dealing with the development of international activities in small firms (Reuber and Fischer 1997). Nonetheless, considering the “*export employees*” experiences richness was a contingency choice. Initially, the international experiences' richness was considered at the firm level of analysis, which had to be aborted after the pre-test; instead the “*export employees*” experience richness was considered.

When assessing the international orientation construct, the measure of Cadogan *et al.* (2001) was employed in the current research. This measure has been designed at the managerial team level of analysis. Several studies highlight the importance of the managerial team in SMEs (e.g. Bijmolt and Zwart 1994; Shambharya 1996; Reuber and Fischer 1997). In SMEs, the founding team plays a much more extensive and dominant role in the export strategic decision-making in large firms (e.g. Feeser and Willard 1990; Bell *et al.* 1992; Chandler and Hanks 1993; Reuber and Fischer 1997). For this reason, the role of the top management experience is expected to be more pronounced in SMEs. Thus, it is considered appropriate to consider senior management's will in terms of export activity development for assessing the degree of international orientation of SMEs.

Another observation is that the PLS approach was retained for the research propositions' test. The PLS path modeling appears to be the most appropriate method in the case of the current research for three main reasons. The first reason is that “*soft*” theoretical assumptions were

used when building this research model. Insights from the KBV and AC literature were mainly mobilized and are rapidly developing theoretical fields although they cannot be regarded as grounded theories. Consequently, this research can be viewed as an initial step in terms of theory advancement and development. In this case, PLS path modeling appears as the most appropriate methodological approach to be used in the initial stages of theory development (Fornell 1992; Fornell and Larcker 1992). The second reason is the relatively small sample size obtained, and the third reason is the violation of the data multi-normality conditions that are necessary in order to use a more co-variance based SEM. The data in this research was not normally distributed and the smallness of the sample size would not have permitted the use of more robust and advanced approaches like co-variance based SEM.

#### *VII.2.4.2 Limits and prolongations related to the results of the research*

The limits encountered in terms of results mainly refer to the sample representativity and the fact that the chosen international performance measure initially employed did not prove to be psychometrically sound. In terms of sample representativity, two remarks deserve to be made. The first remark is that in the end, the response rate in this study can be considered satisfying (19,10%), when compared to similar studies undertaken on the topic of export performance, reporting average response rates comprised between 15 and 20% (Sousa 2002). Moreover, the response rate appears as satisfying when conducted to recent studies undertaken in France, such as the study of Basly (2006) study on exporting family business (15,44% response rate) or Giannelloni and Fabvre-Bonté's (2007) study (about 1% response rate). It worth to note that many difficulties were encountered in terms of data gathering. The data gathering was realized in four different waves over the course of one year and substantive time gaps separated the different steps of data collection. The second observation is that companies in the sample are bigger, more internationally involved and have higher percentages of sales abroad than the companies composing the population of the study. As a result, it would be difficult to extrapolate the results of this research to the whole population of the exporting SMEs from the steel industry. Further studies should test the external validity of this research propositions on bigger and more representative samples as well as companies operating in different industries.

Another limitation of the current research is the international performance measure. It was impossible to use the international performance measures initially considered. After the pre-test, several modifications had to be undertaken. The items capturing the strategic position of



SMEs on foreign markets such as major supplier, minor supplier, market leader, and the second to market leader had to be dropped. Moreover, the managers interviewed were not able to precisely calculate the average rate of growth of foreign sales and profits over the last three years. Consequently, secondary data was used and extracted from the DIANE database in order to assess the financial situation evolution of SMEs over the last three years in terms of foreign sales and export profits. In addition, managers interviewed declared they could not remember exactly how much they progressed over the past three years in terms of market share abroad, rate of new market entry, export sales and export profits. They suggested that they recall with precision what happened the last year and that they would need secondary data in order to have a better appreciation of the progression. As a result, one can observe that after the pre-test drastic changes had to be undertaken concerning the international performance assessment. Finally, within the final quantitative study, the estimation of the international performance indicator as a formative index was not psychometrically solid. The numerous modifications undertaken in terms of international performance assessment could be the cause. The simultaneous use of perceptive versus objective measures, secondary and primary data and the use of static versus longitudinal measures of the international performance construct might explain this incongruity. As a result, data reduction methods were used for reducing the number of indicators capturing the international performance construct. A reflexive indicator capturing the international performance construct had emerged on an exploratory basis. However, the international performance measure obtained proved to be highly satisfying from a psychometrical point of view. It also has the advantage of enclosing the subjective, objective, financial and strategic measures of the international performance at the same time. Nevertheless, the international performance measure obtained has never been used by previous studies, and its use limits the comparison of the results to other studies in the field.

## **Conclusion of Chapter VII**

Chapter VII was organized in two parts. The first part detailed the validation of the research propositions along with the discussion of the results. The estimation of the causal relationships in this research model led to the validation of nine out of the ten research propositions emitted in chapter III. The results suggest that the AC perspective is an appealing and efficient framework for exploring the dynamics associated with export information processing in small firms. Concluding, Zahra and George's (2002) AC framework seems to be appropriate when explaining the export information exploitation process and its impact upon SMEs' international performance levels. The three research propositions emitted with respect to the influence of PACAP's antecedents on PACAP development were validated. The quality of the exposure to export information sources assessed as the richness of export information sources consulted in foreign markets, the richness of the previous international experiences of SMEs assessed in terms of variety, complementarity and length, and the real international experience of SMEs are strong determinants of SMEs' capacity to efficiently acquire export information. Concerning the impact of PACAP upon RACAP, all the research propositions emitted with this respect have been validated. Export information acquisition, as well as the assimilation practices determine the export responsiveness capacity of SMEs. In order of importance, the main determinant of the SMEs' export responsiveness capacity is the efficiency of knowledge transfer and integration practices followed by the coordination capacity of small firms and the richness of the export information sources they use to keep informed concerning foreign markets.

Regarding the impact of the determinants of the SMEs' positional advantage in terms of international marketing competences, a strong impact of the export responsiveness capacity of small firms can be observed. The results suggest that by means of responding and taking corrective action in order to better manage foreign market shifts, firms appear to build superior levels of positional advantage in terms of foreign market-related competences compared to their competitors. The real international experience of small firms also significantly and positively impacts the degree of positional advantage in terms of the international marketing competences that SMEs achieve in export markets. Surprisingly, the richness of the export experiences of export employees does not have a significant influence upon the positional advantage in terms of international marketing competences.

Finally, the impact of RACAP on the international performance of SMEs is highly significant. Detaining a positional advantage in terms of foreign market-related marketing competences drives firms to be more successful in international settings. This result suggests that the main KBV assumption is strongly validated by the current study. Firms attain high levels of international performance if they achieve superior levels of positional advantage in terms of international marketing competences compared to their competitors.

In the second part of chapter VII, the main conclusions, limits, research contributions and the future research avenues for the current research were exposed. First, the main objectives of the research are recalled along with the main theoretical and methodological choices undertaken for carrying out this research, namely the combination of both qualitative and quantitative methodology and the use of soft modeling when testing the research model. Second, the main results and conclusions of the

preliminary qualitative study and the quantitative research were synthesized. Third, the implications and contributions of the current study were enounced, distinguishing between the theoretical and methodological implications and contributions of the present study and the implications for managers and policy-makers. The main theoretical implications of the current research relate to the abandon of the classical approach of studying disparate information activities' perceptions of SMEs' managers. Instead, a dynamic perspective of the process of evolution of the information state of SMEs was embraced in the case of the current research by integrating insights from the KBV, MO and AC frameworks. As far as managers are concerned, the study provided multiple directions for the successful management of export information activities for achieving higher levels of export performance in small firms. For policy-makers, several implications can be formulated in terms of the design of public aid programs for small firms aimed to help them improve their export information and international marketing competence levels. Moreover, suggestions about the way aid programs should be implemented were formulated. Finally, in the forth point of the second part of the chapter VII, the main limits and future avenues for the current research were exposed. The main limit of the current research consists in the fact that the process of the evolution of SMEs' export information state was assessed by means of a punctual study. Future research in the field should employ a longitudinal methodology for capturing the evolution over time of the export information state of SMEs.

## BIBLIOGRAPHY

- Aaby N. E. and S. F. Slater (1989), Management influences on export performance: a review of the empirical literature 1978-88, *International Marketing Review*, 6(4), 7-26.
- Abdel-Malek T. (1974), *Managerial export-orientation, a Canadian study*, School of Business Administration, University of Ontario.
- Ackoff R. A. (1970), *A concept of corporate planning*, New York, Wiley.
- Aguilar F. J. (1967), *Scanning the business environment*, New York, MacMillan, Wiley.
- Ahuja G. and R. Katila (2001), Technological acquisitions and the innovation performance of acquiring firms: a longitudinal study, *Strategic Management Journal*, 22, 197-220.
- Akyol A. and G. Akehurst (2003), An investigation of export performance variations related to corporate export market orientation, *European Business Review*, 15(1), 5-19.
- Allange S., Jacobsson S. and A. Jarnehammar (1998), Some aspects of an analytical framework for the diffusion of organizational innovations, *Technology Analysis and Strategic Management*, 10(1), 3-21.
- Alavi M. and D. E. Leidner (2001), Review: knowledge management and knowledge management systems: conceptual foundations and research issues, *MIS Quarterly*, 25(1), 107-136.
- Aldrich H. (1999), *Organizations Evolving*, Thousand Oaks, CA, Sage.
- Alvarez R. (2004), Sources of export success in small and medium-sized enterprises: the impact of public programs, *International Business Review*, 13, 383-400.
- Alvesson M. and D. Kärreman (2001), Odd couple: making sense of the curious concept of knowledge management, *Journal of Management Studies*, 38(7), 995-1018.
- Amit R. and P. J. H. Schoemaker (1993), Strategic assets and organizational rent, *Strategic Management Journal*, 14, 33-46.
- Amato S., Esposito Vinzi V. and M. Tenenhaus (2004), A global goodness-of-fit index for PLS structural equation modeling, Oral Communication to PLS Club, HEC School of Management, France, March 24.
- Andersen P. H. (2006), Listening to the global grapevine: SME' export managers as a vehicle for export information generation, *Journal of World Business*, 41, 81-96.
- Andrews K. J (1971), *The concept of corporate strategy*, Irwin.
- Angelmar R. and B. Pras (1984), Product acceptance by middlemen in export channels, *American Journal of Small Business*, 3(1), 25-34.

- Ansoff H. I. (1965), *Corporate strategy*, New York, MacGraw Hill.
- Ansoff H. I. (1970), Toward a Strategic Theory of the Firm, in R. Lamb, *Competitive Strategic Management*, Englewood Cliffs, New Jersey, Prentice-Hall.
- Arbuckle J. (1997), *Amos Users' Guide Version 3.6*, Chicago IL: Smallwaters Corporation.
- Argyris C. (1976), Single-loop and double-loop models in research on decision making, *Administrative Science Quarterly*, 21(3), 363-375.
- Argyris C. (1993), *On organizational learning*, Cambridge Massachusetts, Blackwell Publishers.
- Argyris C. and D. Schön (1978), *Organizational learning: a theory of action perspective*, New York, McGraw-Hill.
- Augier M. and D. J. Teece (2008), Strategy as evolution with design: the foundations of dynamic capabilities and the role of managers in the economic system, *Organization Studies*, 8-9, 1187-1209.
- Auvolat M. (1999), Les artisans en milieu rural, une force entravée, *Economie Rurale*, 238, 5-24.
- Axinn C.N., Noordewier T. and J. M. Sinkula (1996), Export strategies and export performance: an empirical investigation of a products/markets typology, *Advances in International Marketing*, 8, 31-54.
- Baker W. E. and J. M. Sinkula (1999), The synergistic effect of market orientation and learning orientation on organizational performance, *Journal of the Academy of Marketing Science*, 27(4), 411-427.
- Barnard C. (1968), *Functions of the executive*, Boston, Massachusetts, Harvard University Press.
- Barney J. B. (1991), Firm resources and sustained competitive advantage, *Journal of Management*, 17(1), 99-120.
- Barney J. B. and E. J. Zajac (1994), Competitive organizational behavior: toward an organizationally-based theory of competitive advantage, *Strategic Management Journal*, 15, 5-9.
- Barney J. (1996), The resource-based theory of the firm, *Organization Science*, 7(5), 477-501.
- Bartlett C. A. and S. Ghoshal (1989), *Managing across borders, the transnational solution*, Boston, MA Harvard Business School Press.
- Basly S. (2006), L'internationalisation de la PME familiale: apprentissage organisationnel et développement de la connaissance, XVème Conférence Internationale de Management Stratégique, Annecy / Genève, 13-16 June.

- Basly S. (2007), Processus d'internationalisation de la firme: une relecture à la lumière des approches fondées sur la connaissance, XVème Conférence Internationale de Management Stratégique, Montréal, 6-9 June.
- Baum R. (1995), The relation of traits, competences, motivation, strategy, and structure to venture growth, *Frontiers of Entrepreneurship Research*, Babson College.
- Baumard P. (1991), *Stratégie et surveillance des environnements concurrentiels*, Paris, Masson.
- Baumard P. (1996), La recherche en gestion et le non-exprimé: premières bases d'une méthode d'exploration du tacite, in A. Noël, *Perspectives en management stratégique*, Paris, Economica, 10-37.
- Bawden D. (2001), Information and digital literacy, a review of concepts, *Journal of Documentation*, 57(2), 218-259.
- Bayad M., Boughattas Y. and C. Schmitt (2007), Démarche d'identification et évaluation: approche par référentiel compétences, 5ème Congrès International de l'Académie de l'Entrepreneuriat.
- Beal R. M. (2000), Competing effectively: environmental scanning, competitive strategy, and organizational performance in small manufacturing firms, *Journal of Small Business Management*, 38, 27-47.
- Beaujanot A. Q., Lockshin L. and P. Quester (2006), Delivering value: market orientation and distributor selection in export markets, in C.A. Solberg, *Advances in International Marketing*, Elsevier, 107-134.
- Beise-Zee M. and H. Stahl (1999), Public research and industrial innovation in Germany, *Research Policy*, 28, 397-422.
- Belich T. J. and A. J. Dubinsky (1995), Factors related to information acquisition in exporting organizations, *Journal of Business Research*, 33, 1-11.
- Belich T. J. and A. J. Dubinsky (1999), Information processing among exporters: an empirical examination of small firms, *Journal of Marketing Theory and Practice*, 7(4), 45-58.
- Bell J., Murray M. and K. Madden (1992), Developing expertise: an Irish perspective, *International Small Business Journal*, 10(2), 37-53.
- Bell J. (1995), The internationalization of small computer software firms: a further challenge to stage theories, *European Journal of Marketing*, 29(8), 60-75.
- Bijmolt T. H. A. and P. S. Zwart (1994), The impact of internal factors on the export success of Dutch small and medium-sized firms, *Journal of Small Business Management*, 32(2), 69-83.

- Bilkey W. J. and G. Tesar (1977), The export behavior of smaller-sized Wisconsin manufacturing firms, *Journal of International Business Studies*, 8, 93-98.
- Bliemel F., Eggert A., Fassot G. and J. Henseler (2005), *Handbuch PLS-Pfadmodellierung. Methode, Anwendung, Praxisbeispiele*, Schaeffer-Poeschel Verlag Stuttgart.
- Blili S. and L. Raymond (1993), Information technology: threats and opportunities for small and medium-sized enterprises, *International Journal of Information Management*, 13(6), 439-448.
- Bloodgood J. M., H. J. Sapienza and J. G. Almeida (1996), The internationalization of New High-Potential U.S. Ventures: Antecedents and Outcomes, *Entrepreneurship, Theory and Practice*, 20(4), 61-77.
- Boutary M. (1998), PME, gestion internationale et systèmes d'information marketing: au delà des évidences technologiques, PhD dissertation, University of Toulouse, France.
- Boutary M. (2000), PME, gestion internationale et systèmes d'information marketing: au-delà des évidences technologiques, *Revue Internationale des PME*, 13(3-4), 9-36.
- Boutary M. (2001), Les TIC au secours de l'activité internationale des PME, Colloque International de Management des Réseaux, Sfax, Tunisia, 24-25 October.
- Boutary M. and M. C. Monnoyer (2005), TIC et PME exportatrices: entre éloignement et gestion de proximité, *Revue Economie Méridionale*, 52(207), 193-207.
- Boutary M. (2007), Technologies de l'information et activités internationales des PME, in Filion L. J., *Direction et gestion des PME*, Édition internationale France/Québec, Pearson France/ERPI Québec, 55-78.
- Bower G. H. (1970), Imagery as a relational organizer in associative learning, *Journal of Verbal Learning and Verbal Behavior*, 9, 529-533.
- Brislin R. (1981), *Cross-cultural Encounters: Face-to-face Interaction*, New York, Pergamon.
- Brooks M. R. and P. Rosson (1982), A study of the export behavior of small and medium sized manufacturing firms in three Canadian provinces, in Czinkota M. R. and G. Tesar, *Export Management: An International Context*, New York, 39-54.
- Brouthers K. D., Andriessen F. and I. Nicolaes (1998), Diversification posture and top management team characteristics, *Journal of Management*, 32(5), 673 - 720.
- Brown J. S. and P. Duguid (1991), Organizational learning and communities-of-practice: forward a unified view of marketing, learning and innovation, *Organisation Science*, 2(1), 40-57.

- Brown S. L. and K. Eisenhardt (1995), Product development: past research, present findings and future, *Academy of Management Review*, 20(2), 343-378.
- Brush C. G. (1992), Marketplace information scanning activities of new manufacturing ventures, *Journal of Small Business Management*, 30(4), 41-53.
- Buckley P. J. and M. Casson (1985), *The economic theory of multinational enterprise*, New York, St-Martin's Press.
- Bull I. and G. E. Willard (1993), Towards a theory of entrepreneurship, in I. Bull, Thomas H. and G. Willard, *Entrepreneurship, perspectives on theory building*, Pergamon, 1-17.
- Burton F. N. and B. B. Schlegelmilch (1987), Profit analysis of non-exporters versus exporters grouped by export involvement, *International Management Review*, 27(1), 38-49.
- Busenitz L. W. (1996), Research on entrepreneurial alertness, *Journal of Small Business Management*, 34(4), 35-44.
- Busenitz L., Gomez C. and J. W. Spencer (2000), Country institutional profiles: unlocking entrepreneurial phenomena, *Academy of Management Journal*, 43(5), 996-1007.
- Bygrave W. D. and C. W. Hofer (1991), Theorizing about entrepreneurship, *Entrepreneurship, Theory and Practice*, 16(2), 13-21.
- Cadogan J. and A. Diamantopoulos (1995), Narver and Slater, Kohli and Jaworski and the market orientation construct: integration and internationalization, *Journal of Strategic Marketing*, 3, 41-60.
- Cadogan J. W., Diamantopoulos A. and C. P. De Mortanges (1999), A measure of export market orientation: scale development and cross-cultural validation, *Journal of International Business Studies*, 30(4), 689-707.
- Cadogan J. W., Nicola J. P., Salminen R. T., Puumalainen K. and S. Sundqvist (2001), Key antecedents to "export" market-oriented behaviors: a cross-national empirical examination, *International Journal of Research in Marketing*, 19(3), 261-282.
- Cadogan J. W., Diamantopoulos A. and J. A. Siguaw (2002), Export market-oriented activities: their antecedents and performance consequences, *Journal of International Business Studies*, 33(3), 615-626.
- Cadogan J. W. and C. H. Cui (2004), Chinese export agent's adoption of export market-oriented behaviours: measurement and performance relationship, *Journal of Asia Pacific Marketing*, 3(2), 21-37.
- Cafferata R. and R. Mensi (1995), The role of information in the internationalization of SMEs: a typological approach, *International Small Business Journal*, 13(3), 36-46.



Calantone R. J., Schmidt J. B. and X. M. Song (1996), Controllable factors of new product success: a cross-national comparison, *Marketing Science*, 15(4), 341-358.

Calantone R. J., Cavusgil S. T. and Y. Zhao (2002), Learning orientation, firm innovation capability, and firm performance, *Industrial Marketing Management*, 31(6), 515-524.

Calof J. L. (1994), The relationship between firm size and export behavior revisited, *Journal of International Business Studies*, 25(2), 367-387.

Camus B. and B. Cova (2002), Gérer le savoir commercial, *Décisions Marketing*, 26, 17-28.

Cangelosi V. E. and W. R. Dill (1965), Organizational learning: observations toward a theory, *Administrative Science Quarterly*, 10(2), 75-203.

Carlson J. R. and R. W. Zmud (1994), Channel expansion theory: a dynamic view of media and information richness perceptions, *Proceedings of the Academy of Management*, 280-284.

Carlson J. R. and R. W. Zmud (1999), Channel Expansion Theory and the Experiential Nature of Media Richness Perceptions, *Academy of Management Journal*, 42(2), 153-170.

Carson D. and S. Cromie (1989), Marketing Planning in Small Enterprises: A Model and Some Empirical Evidence, *Journal of Marketing Management*, 5(1), 33-50.

Castagnons J. and H. Lesca (2000), Signaux faibles et méthode cible. Quelques retours d'expérience, proceedings of IXème Conférence de l'AIMS, Montpellier, France, 24-26 May.

Castanias R. P. and C. E. Helfat (2001), The managerial rents model: theory and empirical analysis, *Journal of Management*, 27, 661-678.

Cavusgil S. T. (1984a), Organizational characteristics associated with export activity, *Journal of Management Studies*, 21(1), 3-22.

Cavusgil S. T. (1984b), Differences among exporting firms based on their degree of internationalization, *Journal of Business Research*, 12(2), 195-208.

Cavusgil S. T. and V. H. Kirpalani (1993), Introducing products into export markets: success factors, *Journal of Business Research*, 27, 1-15.

Cavusgil S. T. and G. A. Knight (1997), Explaining an emerging phenomenon for international marketing: global orientation and the born-global firm, Center for International Business Education and Research, Michigan State University.

Cavusgil S. T. and J. Nevin (1981), Internal determinants of export marketing behavior: an empirical investigation, *Journal of Marketing Research*, 18(1), 114-119.

Cavusgil T.S. and S. Zou (1994), Marketing strategy-performance relationship: an investigation of the empirical link in export market ventures, *Journal of Marketing*, 58(1), 1-21.

Cavusgil S. T., Zou S. and G. M. Naidu (1993), Product and promotion adaptation in export ventures: An empirical investigation, *Journal of International Business Studies*, 24(3), 479-506.

Cazal D. and A. Dietrich (2003), Compétences et savoirs: quels concepts pour quelles instrumentations, in A. Klarsfeld and E. Oiry, *Gérer les compétences: des instruments aux processus*, Paris, Vuibert, 241-262.

Celuch K. G., Kasouf C. J. and V. Peruvemba (2002), The effects of perceived market and learning orientation on assessed organizational capabilities, *Industrial Marketing Management*, 31, 545-554.

Chan H. N. and P. Ellis (1998), Market orientation and business performance: some evidence from Hong Kong, *International Marketing Review*, 15(2), 119-139.

Chandler G. N. and S. H. Hanks (1993), Resources based capabilities, strategy, and venture performance, in Churchill N. C. *et al.*, *Frontiers of Entrepreneurship Research*, Babson College, 31-42.

Chandler G. N. and E. J. Jansen (1992), Founders' self assessed competence and venture performance, *Journal of Business Venturing*, 7(3), 223-236.

Chang S. J. (1995), International expansion strategy of Japanese firms: capabilities, *Academy of Management Journal*, 38(2), 383-407.

Chapellier P. (1995), Données comptables et système d'information du dirigeant de PME, proceedings of IIème Congrès International Francophone PME (CIFPME), Paris, 405-422.

Chetty S. K. and D. B. Holm (2000), Internationalization of Small to Medium-sized Manufacturing firms: A Network Approach, *International Business Review*, 9(8), 77-93.

Chi T. (1994), Trading in strategic resources: necessary conditions, transaction cost problems and choice of exchange structure, *Strategic Management Journal*, 15, 271-290.

Chiesa V. and R. Manzini (1998), Toward a framework for dynamic technology strategy, *Technology Analysis and Strategic Management*, 10(1), 111-129.

Chin W. W. (1998), The Partial Least Squares approach to structural equation modeling, in Marcoulides G.A., *Modern methods in business research*, Earlbaum: Hillsdale, 295-336.

Chin W.W. and P. R. Newsted (1999), Structural Equation Modeling analysis with small samples using Partial Least Squares, in R.H. Hoyle, *Statistical strategies for small sample research*, Sage, Thousand Oaks, 307-341.

Choo C. W. (1997), IT2000: Singapore's vision of an intelligent island, in P. Droege, *Intelligent environments: spatial aspects of the information revolution*, Amsterdam, Netherlands: North-Holland.

- Choo C. W. (1999), The art of scanning the environment, *Bulletin of the American Society for Information Science*, 25(3), 13-19.
- Choo C. W. (2005), Environmental scanning as information seeking and organisational learning, in E. Maceviciute and T. Wilson, *Introducing information management: an information research reader*, London, UK Facet Publishing, 55-84.
- Chaudhuri S. and B. Tabrizi (1999), Capturing the real value in high-tech acquisitions, *Harvard Business Review*, 75(5), 123-130.
- Christensen J. F. (1995), Asset profiles for technological innovation, *Research Policy*, 24(5), 727-745.
- Churchill G. A. (1979), A paradigm for developing better measures of marketing constructs, *Journal of Marketing Research*, 16(1), 64-73.
- Cohen W. M. and D. A. Levinthal (1989), Innovation and learning: the two faces of R&D, *The Economic Journal*, 99, 569-596.
- Cohen W. M. and D. A. Levinthal (1990), Absorptive capacity: a new perspective on learning and innovation, *Administrative Science Quarterly*, 35(1), 128-152.
- Cohen W. M. and D. A. Levinthal (1994), Fortune favors the prepared firm, *Management Science*, 40(2), 227-251.
- Conant J. S., M. P. Mokwa and P. R. Varadarajan (1990), Strategic types, distinctive marketing competencies and organizational performance: a multiple measures-based study, *Strategic Management Journal*, 11(5), 365-383.
- Cooper R. G. and E. J. Kleinschmidt (1985), The impact of export strategy on export sales performance, *Journal of International Business Studies*, 16, 37-57.
- Coviello N. E. and A. McAuley (1999), Internationalization and the smaller firm: a review of contemporary empirical research, *Management International Review*, 39(3), 223-256.
- Coviello N. and H. Munro (1997), Network relationships and the internationalization process of small software firms, *International Business Review*, 6(4), 361-386.
- Crick D., Jones M. and S. J. Hart (1994), International marketing research activities of UK exporters: an exploratory study, *Journal of Euromarketing*, 3(2), 7-26.
- Curado C. (2006), The knowledge based view of the firm. From theoretical origins to future implications, (working paper),  
[http://www.iseg.utl.pt/departamentos/gestao/wp/N1\\_2006.pdf](http://www.iseg.utl.pt/departamentos/gestao/wp/N1_2006.pdf).
- Cyert R. M. and J. G. March (1963), *A behavioral theory of the firm*, New Jersey, Prentice Hall.

- Czinkota M. R. (2000), International information cross-fertilization in marketing, *European Journal of Marketing*, 34(11/12), 1305-1314.
- Czinkota M. R. and W. J. Johnston (1983), Exporting: does sales volume make a difference?, *Journal of International Business Studies*, 14, 147-153.
- D'Amboise G. (1985), A survey of strategic planning models for small business, *Journal of Small Business and Entrepreneurship*, 3(3), 6-17.
- Daft R. L. and G. P. Huber (1987), How organizations learn: a communication framework, *Research in the Sociology of Organizations*, 5, 1-36.
- Daft R. L. and R. H. Lengel (1984), Information richness: a new approach to managerial behavior in organization design, *Research in Organizational Behavior*, 6, 191-233.
- Daft R. L. and R. H. Lengel (1986), Organizational information requirements, media richness and structural design, *Management Science*, 32(5), 554-571.
- Daft R. L., J. Sormunen and D. Parks (1988), Chief executive scanning, environmental characteristics and company performance: an empirical study, *Strategic Management Journal*, 9, 123-139.
- Danjou I. (2004), *Entreprendre- la passion d'accomplir ensemble*, L'Harmattan.
- Davenport T. H. and L. Prusak (1998), *Working knowledge: how organizations manage what they know*, Boston: Harvard Business School Press, MA.
- Davenport S., Grimes C. and J. Davies (1998), Research collaboration and behavioral additionality: a New Zealand case study, *Technology analysis and strategic management*, 10(1), 55-67.
- Day G. S., Gold B. and T. D. Kuczmarski (1994), Significant issues for the future of product innovation, *Journal of Product Innovation Management*, 11(1), 69-75.
- De Luz M. (1993), Relationship between export strategy variables and export performance of Brazil-based manufacturers, *Journal of Global Marketing*, 7(1), 87-110.
- DeNisi A., Hitt M. and S. Jackson (2003), The knowledge-based approach to sustainable competitive advantage, in Jackson S., Hitt M. and A. DeNisi, *Managing knowledge for sustained competitive advantage*, San Francisco, Jossey-Bass, 3-33.
- DeNoble A. F., R. M. Castaldi and D. M. Moliver (1989), Export intermediaries: small business perceptions of services and performance, *Journal of Small Business Management*, 27(2), 33-41.
- Deakins D. and M. Freel (1998), Entrepreneurial learning and the growth process in SMEs, *The Learning Organisation*, 5(3), 144-55

DeCarolis D. M. and D. L. Deeds (1999), The impact of stocks and flows of organizational knowledge on firm performance: an empirical investigation of the biotechnology industry, *Strategic Management Journal*, 20, 953-968.

De Geus A. (1988), Planning as learning, *Harvard Business Review*, March-April, 70-74.

DeGroot T. and A. L. Brownlee (2006), Effect of department structure on the organizational citizenship behavior–department effectiveness relationship, *Journal of Business Research*, 59(10-11), 1116-1123.

Denis J. E. and D. Depelteau (1985), Market knowledge, diversification and export expansion, *Journal of International Business Studies*, 7, 77-89.

Deshpande R., Farley J. U. and F. E. Webster (1993), Corporate culture, customer orientation and innovativeness in Japanese firms: a quadrature analysis, *Journal of Marketing*, 57(1), 23-38.

DeVellis R. F. (1991), *Scale development: theory and applications*, Newbury Park, CA Sage.

Diamantopoulos A., Schlegelmilch B. B. and C. Allpress (1990), Export marketing research in practice: a comparison of users and non users, *Journal of Marketing Management*, 6(3), 257–273.

Diamantopoulos A. and K. Inglis (1988), Identifying differences between high- and low-involvement exporters, *International Marketing Review*, 5(2), 52-60.

Diamantopoulos A. and J. W. Cadogan (1996), Internationalizing the market orientation construct: an in-depth interview approach, *Journal of Strategic Marketing*, 4(1), 23-52.

Diamantopoulos A. and A. L. Souchon (1999), Measuring export information use: scale development and validation, *Journal of Business Research*, 46(1), 1-14.

Diamantopoulos A. (1999), Viewpoint, export performance measurement: reflective versus formative indicators, *International Marketing Review*, 16(6), 444-457.

Diamantopoulos A. and H. Winklhofer (2001), Index construction with formative indicators: an alternative to scale development, *Journal of Marketing Research*, 38(2), 269-277.

Dicht E., M. Leibold, H. G. Koglmayr and S. Muller (1984), The export-decision of small and medium-sized firms: a review, *Management International Review*, 24(2), 49-60.

Dominguez L. V. and C. G. Sequeira (1993), Determinants of LDC exporters' performance: a cross-national study, *Journal of International Business Studies*, 24(1), 19-40.

Donthu N. and S. H. Kim (1993), Implications of firm controllable factors on export growth, *Journal of Global Marketing*, 7(1), 47-63.

Doole I. and R. Lowe (2004), *International Marketing Strategy*, 4<sup>th</sup> edition, Thomson.

- Dosi G. and L. Marengo (1995), Toward a theory of organizational competences, in England R.W., *Evolutionary concepts in contemporary economics*, Michigan University Press, 157-178.
- Douglas S.P. and C. S. Craig (1983), *International marketing research*, Englewood Cliffs, New Jersey, Prentice-Hall.
- Dretske F. (1981), *Knowledge and the flow of information*, Basil Blackwell, Oxford.
- Drucker P. (1985), *Les entrepreneurs*, Paris, L'Expansion, Hachette.
- Drucker P. F. (1993), *Post Capitalist Society*, Harper Business, New York, USA.
- Duncan R. and A. Weiss (1979), Organizational learning: implications for organizational design, *Research in Organizational Behavior*, 1, 75-123.
- Dunning J. H. (1980), Toward an eclectic theory of international production: Some empirical tests, *Journal of International Business Studies*, 11(1), 9-31.
- Shantanu D., M. J. Zbaracki and M. Bergen (2003), Pricing process as a capability: a resource-based perspective, *Strategic Management Journal*, 24, 615–630.
- Dyer J. H. and H. Singh (1998), The relational view: cooperative strategy and sources of inter-organizational competitive advantage, *Academy of Management Review*, 23(4), 660-679.
- Dyer J. H. and K. Nobeoka (2000), Creating and managing high performance knowledge-sharing networks: the Toyota case, *Strategic Management Journal*, 21, 345-367.
- Easterby-Smith M., R. Thorpe and A. Lowe (1991), *Management Research: an introduction*, London, Sage Publications.
- Eisenhardt K. M. (1989), Building theories from case study research, *Academy of Management Review*, 14(4), 532-550.
- Ellis P. D. (2005), Market orientation and marketing practice in a developing economy, *European Journal of Marketing*, 39(5/6), 629–645.
- Ellis P. D. (2006), Market orientation and performance: a meta-analysis and cross-national comparisons, *Journal of Management Studies*, 43(5), 1089-1107.
- Eriksson K., Majkgård A. and D. Sharma (2000), Path dependence and knowledge development in the internationalization process, *Management International Review*, 40(4), 307-328.
- Eriksson K., Hohenthal J. and J. Lindbergh (2004), Cultural diversity and culture specific experience effect on development of institutional experiential knowledge in SMEs, *Journal of International Entrepreneurship*, 1(1), 100-120.
- Evirgen C., Bodur M. and S. T. Cavusgil (1993), Information needs of exporters: an empirical study of Turkish exporters, *Marketing Intelligence and Planning*, 11(2), 28-36.

- Esposito Vinzi V., Tenenhaus M., Chatelin Y. and C. Lauro (2005), PLS Path Modeling, *Computational Statistics and Data Analysis*, 48(1), 159-205.
- Esposito Vinzi V. (2007), General requirement courses for ESSEC PH.D program 2007/2008, Trimester 1, Quantitative Research Methods in Management 2, PLS Path Modeling.
- Evangelista F. U. (1994), Export performance and its determinants: some empirical evidence from Australian manufacturing firms, in S. T. Cavusgil and C. Axinn, *Advances in International Marketing*, Vol. 6, Greenwich, CT JAI Press, 207-229.
- Fahey L. and L. Prusak (1988), The eleven deadliest sins of knowledge management, *California Management Review*, 40(3), 265-276.
- Falk R. F. and N. B. Miller (1994), *A primer for soft Modeling*, The University of Akron Press, Ohio.
- Fallery B. (1983), Un système d'information du dirigeant pour les PME, *Revue Française de Gestion*, 46, 70-76.
- Fann G. L. and L. R. Smeltzer (1989), The use of information about competitors in small business management, *Entrepreneurship, Theory and Practice*, 13(4), 35-46.
- Favre-Bonté V. and J.-L. Giannelloni (2007), L'influence des caractéristiques de personnalité du dirigeant de PME sur la performance à l'export, XVIème Conférence Internationale de Management Stratégique (AIMS), Montréal, France, 6-9 June.
- Fayolle A. (2004), *Entrepreneuriat: Apprendre à entreprendre*, Dunod.
- Fayolle A. and T. Verstratete (2005), Paradigmes et entrepreneuriat, *Revue de l'entrepreneuriat*, 4(1), 33-52.
- Feeser H. and G. Willard (1990), Founding strategy and performance: a comparison of high and low growth high tech firms, *Strategic Management Journal*, 11(2), 87-98.
- Feldmann M.S. and G. J. March G. (1981), L'information dans les organisations : un signal et un symbole, *Administration Science Quarterly*, 26, 171-186.
- Fischer E. and A. R. Reuber (1996), *The impact of top management group on the internationalization of small and medium-sized software firms*, Babson College, Seattle.
- Filion L. J. (1990), Free Trade: the need for a definition of small business, *Journal of Small Business and Entrepreneurship*, 7(3), 33-46.
- Filion L. J. (1997), Le champ de l'entrepreneuriat : historique, évolution, *tendances*, Cahier de recherche 97.01, HEC Montréal.
- Fiol C. M. and M. A. Lyles (1985), Organizational learning, *Academy of Management Review*, 10(4), 803-813.

- Fletcher M., Jones M. and L. Casulli (2007), Exploring external and experiential knowledge in the internationalization of SMEs. A typology of knowledge types and sources, ICSB 2007 World Conference, Turku, Finland, 13-15 June.
- Ford I. D. and L. C. Leonidou (1991), Research developments in international marketing: an European perspective, in S. J. Paliwoda, *New perspectives on international marketing*, London, Routledge, 3-32.
- Ford I. D. and P. J. Rosson (1982), The relationships between export manufacturers and their overseas distributors, in Czinkota M.R. and G. Tesar, *Export management: an international context*, Praeger, New York, 257-75.
- Fornell C. (1992), A national customer satisfaction barometer: the Swedish experience, *Journal of Marketing*, 56, 6–21.
- Fornell C. and F. Bookstein (1982), Two structural equation models: LISREL and PLS applied to consumer exit-voice theory, *Journal of Marketing Research*, 19(4), 440-452.
- Fornell C. and D. F. Larcker (1981), Evaluating structural equation models with unobserved variables and measurement error, *Journal of Marketing Research*, 18(1), 39-50.
- Fourcade C. and O. Torres (2001), Proximité et stratégies d'internationalisation des PME: le rôle des milieux internationalisants, 3èmes Journées de la Proximité – “Nouvelles croissances et territoires”, Paris, France, 13-14 December.
- Francis J. and C. Collins-Dodd (2000), The impact of firms' export orientation on the export performance of high-tech SMEs, *Journal of International Marketing*, 8(3), 84-103.
- Freiling J., Gersch M. and C. Goeke (2008), On the path towards a competence-based theory of the firm, *Organization Studies*, 8-9, 1143-1164.
- Froelicher T. (1999), *Les liens sociaux entre dirigeants et le déclenchement de la coopération interentreprises*, *Revue Finance, Contrôle, Stratégie*, 1, 99-124.
- Fyol C. M. and M. A. Lyles (1985), Organizational learning, *Academy of Management Review*, 10(4), 803–813.
- Galbraith J. (1973), *Designing complex organizations*, Massachusetts, Addison-Wesley Publishing Company.
- Garnier G. (1982), Comparative export behavior of small firms in printing and electric industries, in Czinkota M. and G. Tesar, *Export management: an international context*, Praeger, New York.
- Garvin D. A. (1993), Building a learning organization, *Harvard Business Review*, July-August, 78-91.



- Genturk E. F. and P. S. Aulakh (1995), The use of process and output controls in foreign markets, *Journal of International Business Studies*, 26(4), 25-36.
- Gencturk E. F. and M. Kotabe (2001), The effect of export assistance program usage on export performance: a contingency explanation, *Journal of International Marketing*, 9(2), 51-72.
- Ghoshal S. and S.K. Kim (1986), Building effective intelligence systems for competitive advantage, *Sloan Management Review*, 28(1), 49-58.
- Giannelloni J.-L. and E. Verneffe (2001), *Etudes des marchés*, Vuibert.
- Gibb A. A. (1997), Small firms' training and competitiveness. Building upon the small business as a learning organization, *International Small Business Journal*, 14(3), 13-29.
- Churchill G. A. and D. Iacobucci (2005), *Marketing Research, Methodological Foundations*, 9<sup>th</sup> Edition, Thomson Learning.
- Glazer R. (1991), Marketing in information-intensive environment: strategic implications of knowledge as asset, *Journal of Marketing*, 55(4), 1-19.
- Granovetter M. S. (1973), The strength of weak ties, *American Journal of Sociology*, 78(6), 1360-1380.
- Grant R. M. (1991), The resource-based theory of competitive advantage: implications for strategy formulation, *California Management Review*, 33(3), 114-134.
- Grant R. (1996), Toward a knowledge-based theory of the firm, *Strategic Management Journal*, 17(winter special issue), 109-122.
- Gray B., Matea S., Boshoff C. and P. Matheson (1998), Developing a better measure of market orientation, *European Journal of Marketing*, 32(9/10), 884-903.
- Greenley G. E. (1995), Market orientation and company performance: empirical evidence from UK companies, *British Journal of Management*, 6(2/3), 1-13.
- Gronhaug K. and J. Graham (1987), International marketing research revisited, in Cavusgil S. T., *Advances in International Marketing*, JAI Press, New York.
- Gueguen G. (2001), Environnement et management stratégique des PME: le cas du secteur Internet, PhD dissertation, Université Montpellier 1, France.
- Guenzi P. and G. Troilo (2006), Developing marketing capabilities for customer value creation through marketing-sales integration, *Industrial Marketing Management*, 35(8), 974-988.
- Guilhon A. (1998), Pour une définition de la PME à partir du concept de contrôlabilité, in O. Torrès, *De nouvelles approches pour comprendre la PME*, Economica, 26-38.

Gundolf K. (2004), Construction territoriale et proximités des acteurs, *Revue de l'économie méridionale*, 52(208), 315-335.

Gupta A. K. and V. Govindarajan (2000), Knowledge flows within multinational corporations, *Strategic Management Journal*, 21(4), 473-496.

Halikias J. and L. Panayotopoulou (2003), Chief executive personality and export involvement, *Management Decision*, 41(4), 340-349.

Hamel G. and C. K. Prahalad (1994), Competing for the future, *Harvard Business Review*, 72(4), 122-129.

Harris L. C. (2001), Market orientation and performance: objective and subjective empirical evidence from UK companies, *Journal of Management Studies*, 38(1), 17-43.

Harris L. and E. Ogbonna (2001), Leadership style and market orientation: an empirical study, *European Journal of Marketing*, 35(5-6), 744-764.

Hart S. (1987), The use of the survey in industrial marketing research, *Journal of Marketing Management*, 3(1), 25-38.

Hart S. J. and N. Tzokas (1999), The impact of marketing research activity on SME export performance: evidence from UK, *Journal of Small Business Management*, 37(2), 63-75.

Hart S. J., Webb J. R. and M. V. Jones (1994), Export marketing research and effect of export experience in industrial SMEs, *International Marketing Review*, 11(6), 4-22.

Hartman E. A., Tower C. B. and T. C. Sebor (1994), Information sources and their relationship to organizational innovation in small businesses, *Journal of Small Business Management*, 32(1), 36-46.

Hayek F. A. (1937), *Economics and knowledge*, vol. 4, *Economica*.

Hayek F. A. (1945), The use of knowledge in society, *American Economic Review*, 35, 519-530.

Hedberg B. (1981), How organizations learn and unlearn, in Nystrom P. and W. Starbuck, *Handbook of Organizational Design*, vol. 1, Oxford: Oxford University Press, 3-27.

Henderson R. and I. Cockburn (1994), Measuring competence: exploring from effects in pharmaceutical research, *Strategic Management Journal*, 15, 63-84.

Herron L. and H. J. Sapienza (1992), The Entrepreneur and the Initiation of New Venture Launch Activities, *Entrepreneurship Theory and Practice*, 17(1), 49-55.

Hodkinson A. and McPhee P. (2002), SME information sourcing for innovation and export market development: from local or external environments?, International Conference on SMEs in a Global Economy: Sustaining SME innovation, competitiveness and development in the global economy.

- Hofstede G. (1980), *Culture's consequences: International differences in work-related values*, Beverly Hills, CA Sage.
- Hofer C. W. (1983), ROVA: A new measure for assessing organizational performance, in Lamb R., *Advances in strategic management*, vol. 2, New York, JAI Press, 43-55.
- Holmlund M. and S. Kock (1998), Relationships and the internationalization of Finnish small and medium sized companies, *International Small Business Journal*, 16(4), 46-63.
- Holzmuller H. and H. Kasper (1991), On a theory of export performance: personal and organizational determinants of export trade activities observed in small and medium-sized firms, *Management International Review*, 31, 45-70.
- Homburg C. and C. Pflesser (2000), A multiple layer model of market-oriented organizational culture: measurement issues and performance outcomes, *Journal of Marketing Research*, 37(4), 449-462.
- Howard D. G. and I. M. Herremans (1988), Sources of assistance for small business exporters: advice from successful firms, *Journal of Small Business Management*, 26(3), 48-54.
- Huber G. P. (1991), Organizational learning: the contributing processes and the literature, *Organization Science*, 2, 88-115.
- Huberman A. M. and M. B. Miles (1984), *Innovation up close: how school improvement works*, New York, Plenum.
- Huberman A. M. and M. B. Miles (1991), *Analyse des données qualitatives - recueil de nouvelles méthodes*, De Boeck Université.
- Hulland J. S. (1999), Use of Partial Least Squares (PLS) in strategic management research: a review of four recent studies, *Strategic Management Journal*, 20(2), 195-204.
- Hult G. T. M. and O. C. Ferrell (1997), A global organizational learning structure and market information processing, *Journal of Business Research*, 40(2), 155-66.
- Hult G. T. M. and D. J. Ketchen (jr.) (2001), Does market orientation matter?: A test of the relationship between positional advantage and performance, *Strategic Management Journal*, 22(9), 899-906.
- Hunt S. D. and R. M. Morgan (1995), The comparative advantage theory of competition, *Journal of Marketing*, 59(2), 1-15.
- Hurley R. F. and G. T. M. Hult (1998), Innovation, market orientation and organizational learning: an integration and empirical examination, *Journal of Marketing*, 62, 42-54.
- Inkpen A. (1996), Creating knowledge through collaboration, *California Management Review*, 39(1), 123-140.

- International Monetary Fund (2001), <http://www.imf.org/external/am/2001/o/index.htm>.
- Irani Z., Ezingard J.-N. and R. J. Grieve (1997), Integrating the costs of a manufacturing IT/IS infrastructure into the investment decision-making process, *Technovation*, 17(11-12), 695-706.
- Jacobson R. (1987), The validity of ROI as a measure of business performance, *American Economic Review*, 77(3), 470-478.
- Jansen J. J. P., Van den Bosch F. A. J. and H. W. Volberda (2005), Managing potential and realized absorptive capacity: how do organizational antecedents matter?, *Academy of Management Journal*, 48(6), 999-1015.
- Jaworski B. J. and A. K. Kohli (1993), Market orientation: antecedents and consequences, *Journal of Marketing*, 57(3), 53-70.
- Jerez-Gomez P., Cespedes-Lorente J. and R. Valle-Cabrera (2005), Organizational learning capability: a proposal of measurement, *Journal of Business Research*, 58(6), 715– 725.
- Johanisson B. (1994), Building a “glocal” strategy - internationalizing small firms through local networking, proceedings of the 39<sup>th</sup> ICSB World Conference, Strasbourg, France, 27<sup>th</sup> of June, p. 127-135.
- Johanson J. and F. Wiedersheim-Paul (1975), The internationalization of the firm, four Swedish cases, *Journal of Management Studies*, 12(3), 305-322.
- Johanson J. and J. E. Vahlne (1977), The Internationalization of the firm. A model of knowledge development and increasing foreign market commitment, *Journal of International Business Studies*, 8(1), 23-32.
- Johanson J. and J. E. Vahlne (1990), The mechanism of internationalization, *International Marketing Review*, 7(4), 11-24.
- Johanson J. and J. E. Vahlne (1993), The internationalization process of the firm: a model knowledge development and increasing foreign market commitments, in Buckley P.J. and P. Ghauri, *The internationalization of the firm: a reader*, London, Academic Press Ltd., 65-89.
- Johanson J. and J. E. Vahlne (2003), Business relationship learning and commitment in the internationalization process, *Journal of International Entrepreneurship*, 1, 83–101.
- Johanson J. and J. E. Vahlne (2006), Commitment and opportunity development in the internationalization process: a note on the Uppsala internationalization process model, *Management International Review*, 46(2), 165-178.
- Johnson J. L. and R. Kuehn (1987), The small business owner/manager’s search for external information, *Journal of Small Business Management*, 25 (3), 53-60.

Journal Officiel de l'Union Européenne (2003), <http://eur-lex.europa.eu/LexUriServ/LexUriServ.do?uri=OJ:L:2003:298:0029:0033:FR:PDF>

Julien P. A. (1993), Small business as a research subject: some reflections on knowledge of small business and its effects on economic theory, *Small Business Economics*, 5(2), 157-166.

Julien P. A. (1994), *Les PME, bilan et perspectives*, Economica, Paris.

Julien P. A. (1996), Le contrôle de l'information "riche" par des réseaux : clef du dynamisme des PME, proceedings of the 3<sup>rd</sup> Congrès International Francophone de la PME (CIFPME): Stratégie et croissance des PME, Université Québec Trois- Rivières, Canada, 23-25 October, 1139-1151.

Julien P. A. (1998), *The state of the art in small business and entrepreneurship*, Ashgate, Aldershot.

Julien P. A., Joyal A., Deshaies L. and C. Ramangalahy (1997), A typology of strategic behavior among small and medium-sized exporting businesses: a case study, *International Small Business Journal*, 15(2), 31-48.

Julien P. A., Raymond L., Jacob R. and C. Ramangalahy (1999), Types of technological scanning in manufacturing SMEs: an empirical analysis of patterns and determinants, *Entrepreneurship and Regional Development*, 11(4), 281-300.

Julien P. A. and C. Ramangalahy (2003), Competitive strategy and performance of exporting SMEs: an empirical investigation of the impact of their export information search and competencies, *Entrepreneurship, Theory and Practice*, 27(3), 227- 245.

Kaish S. and B. Gilad (1991), Characteristics of opportunities search of entrepreneurs versus executives: sources, interest, and general alertness, *Journal of Business Venturing*, 6(1), 45-61.

Karafakioglu M. (1986). Export activities of Turkish manufacturers, *International Marketing Review*, 3(4), 34-43.

Katsikeas C. S. and L. C. Leonidou (1996), Export marketing expansion strategy: Differences between market concentration and market spreading, *Journal of Marketing Management*, 12(1-3), 113-134.

Katsikeas C.S., L.C. Leonidou and N.A. Morgan (2000), Firm-level export performance assessment: review, evaluation and development, *Journal of the Academy of Marketing Science*, 28(4), 493-511.

Kedia B. L. and Chhokar J. (1985), Factors inhibiting export performance of firms: an empirical investigation, *Management International Review*, 26(4), 33-43.

Keegan W. J. (1974), Multinational scanning: a study of the information sources utilized by headquarters executives in multinational companies. *Administrative Science Quarterly*, 19(3), 411-421.

Keegan W. J. (1980), *Multinational marketing management*, 2<sup>nd</sup> edition, New Jersey, Prentice-Hall.

Keng K.A. and T.S. Jiuan (1989), Differences between small and medium sized exporting and non-exporting firms: nature and nurture, *International Marketing Review*, 6(4), 27-40.

Keogh W. and V. Stewart (2000), Science and technology based SMEs: learning from the market place, *International Journal of Entrepreneurial Behavior and Research*, 6(4), 187 – 203.

Keskin H. (2006), Market orientation, learning orientation, and innovation capabilities in SMEs: an extended model, *European Journal of Innovation*, 9(4), 396 - 417.

Kim D. H. (1993), The link between individual and organizational learning, *Sloan Management Review*, 35(1), 37-50.

Kim L. (1997), *From imitation to innovation: the dynamics of Korea's technological learning*, Cambridge, MA: Harvard Business School Press.

Kirca A. H., J. Satish and W. O. Bearden (2005), Market orientation: a meta-analytic review and assessment of its antecedents and impact on performance, *Journal of Marketing*, 69(2), 24-41.

Kirzner I. (1973), *Competition and entrepreneurship*, Illinois, Chicago University Press.

Kirzner I. (1979), *Perception, opportunity and profit*, Chicago: University of Chicago Press.

Klein K. J., Dansereau F. and R. J. Hall (1994), Levels issues in theory development, data collection, and analysis, *Academy of Management Review*, 19(2), 195- 229.

Kleinschmidt E. J. and R. E. Ross (1986), Export performance and foreign market information: relations for small high-technology firms, *Journal of Small Business and Entrepreneurship*, 4(1), 14-25.

Knight G. and S. T. Cavusgil (1996), The born global firm: a challenge to traditional internationalization theory, *Advances in International Marketing*, 8, 11-26.

Knight G. and P. Liesch (2002), Information internationalization in internationalizing the firm, *Journal of Business Research*, 55(12), 981-995.

Knorr K. D. (1977), Policy makers' use of social science knowledge: symbolic or instrumental?, in C. H. Weiss, *Using Social Research in Public Policy Making*, Lexington, MA: Lexington Books, 165-182.

- Kodama M. (2005), New knowledge creation through leadership-based strategic community - a case of new product development in IT and multimedia business fields, *Technovation*, 25(8), 895-908.
- Koenig G. (1994), Apprentissage organisationnel: repérage des lieux, *Revue Française de Gestion*, 97, 76-83.
- Kofman F. and P. M. Senge (1993), Communities of commitment: the heart of learning organizations, *Organizational Dynamics*, 5-23.
- Kogut B. and I. Zander (1993), Knowledge of the firm and the evolutionary theory of the multinational corporation, *Journal of International Business Studies*, 24(4), 625-645.
- Kogut B. and I. Zander (1996), What do firms do? Coordination, identity, and learning, *Organization Science*, 7, 502-518.
- Koh A. C. (1991), An evaluation of international marketing research planning in United States export firms, *Journal of Global Marketing*, 4(3), 7-25.
- Kohli A. and B. Jaworski (1990), Market orientation: the construct, research propositions and managerial implications, *Journal of Marketing*, 54(2), 1-18.
- Kohli A., Jaworski B. and A. Kumar (1993), MARKOR: a measure of market orientation, *Journal of Marketing Research*, 30(4), 467-477.
- Kolb D. A. (1976), *Learning-style inventory*, Boston, MA: McBer and Company.
- Kolb D. A. (1984), *Experiential learning: experience as the source of learning and development*, Upper Saddle River, New Jersey, Prentice Hall.
- Kotey B. and G. G. Meredith (1997), Relationships among owner/manager personal values, business strategies, and enterprise performance, *Journal of Small Business Management*, 35(2), 37-64.
- Kuivalainen O. and J. Bell (2004), Knowledge-based view of the firm and small firm internationalization, proceedings of the 4<sup>th</sup> Biennial McGill Conference on International Entrepreneurship, September 17-20, Montréal, Canada (CD-ROM).
- Kylaehaiko K. (1998), Making sense of technology: towards synthesis between neoclassical and evolutionary approaches, *International Journal of Production Economics*, 56-57, 319-332.
- Lages L. P. and D. B. Montgomery (2004), Directions for advancing export marketing theory in the Asia Pacific region: what can we learn from research in other regions of the world?, *Journal of Asia Pacific Marketing*, 3(2-3), 69-83.

- Laghzaoui S. (2007), Ressources et compétences: une nouvelle grille de lecture de l'internationalisation des PME, XVIème Conférence Internationale de Management Stratégique, Montréal, 6-9 June.
- Lainée F. (1991), *La veille technologique: de l'amateurisme au professionnalisme*, Paris, Editions Eyrolles.
- Lane P. J. and M. Lubatkin (1998), Relative absorptive capacity and inter-organizational learning, *Strategic Management Journal*, 19, 461-477.
- Lane P. J., Koka B. R. and S. Pathak (2006), The reiteration of absorptive capacity: a critical review and rejuvenation of the construct, *Academy of Management Review*, 31(4), 833-863.
- Lang J. R., R. J. Calantone and D. Gudmundson (1997), Small firms information seeking as a response to environmental threats and opportunities, *Journal of Small Business Management*, 35(1), 11-23.
- Langerak F. (2003), The effect of market orientation on positional advantage and organizational performance, *Journal of Strategic Marketing*, 11, 93-115.
- Lascu D. N., Manrai L. A., Manrai A. K. and R. Kleczek (2006), Interfunctional dynamics and firm performance: a comparison between firms in Poland and the United States, *International Business Review*, 15(6), 641-659.
- Lawrence P. R. and J. W. Lorsch (1967), *Organization and environment*, Massachusetts, Harvard Business School, Boston.
- Leboulch J. L. and P. Le Floch (1993), Les paradoxes de l'information: réflexion sur les problèmes d'appropriation et de circulation de l'information technologique, in Bes M. P. and J. L. Leboulch, *L'information face au changement technique: une approche multidisciplinaire*, Paris, Éditions L'Harmattan, 56-74.
- Lei D., Slocum J. W. and R. A. Pitts (1999), Designing organizations for competitive advantage: the power of unlearning and learning, *Organizational Science*, 2, 78-91.
- Leonard-Barton D. (1992), The factory as a learning laboratory, *Sloan Management Review*, 34(1), 23-38.
- Leonard-Barton D. (1995), *Wellspring of knowledge: building and sustaining the source of innovation*, Boston, Harvard Business School Press.
- Leonidou L. C. (1995), Empirical research on export barriers: review, assessment and synthesis, *Journal of International Marketing*, 3(1), 29-43.
- Leonidou L. C. and C. S. Katsikeas (1996), The export development process: an integrative review of empirical models, *Journal of International Business Studies*, 27(3), 517-551.



- Leonidou L. C. and C. S. Katsikeas (1997), Export information sources: the role of organizational and internationalization influences, *Journal of Strategic Marketing*, 3(2), 1-23.
- Leonidou L. C. and A. S. Florou-Adams (1999), Types and sources of export information: insights from small business, *International Small Business Journal*, 17(3), 32-50.
- Leonidou L. C., Katsikeas C. S. and N. F. Piercy (1998), Identifying managerial influences on exporting: past research and future directions, *Journal of International Marketing*, 6(2), 74-102.
- Leonidou L. C., Katsikeas C. S. and S. Samiee (2002), Marketing strategy determinants of export performance: a meta-analysis, *Journal of Business Research*, 55(1), 51-67.
- Leonidou L. C. (2004), An analysis of the barriers hindering small business export development, *Journal of Small Business Management*, 24(3), 279-302.
- Lesca H. and E. Lesca (1995), *Gestion de l'information: qualité de l'information et performance de l'entreprise*, Paris, Litec.
- Lesca H. (2001), Veille stratégique : passage de la notion de signal faible à la notion de signe d'alerte précoce, proceedings of Colloque VSST 2001, Barcelona, October, vol. 1, 98-105.
- Lesca H. and S. Blanco (2002), Contribution à la capacité d'anticipation des entreprises par la sensibilisation aux signaux faibles, proceedings of 6ème Congrès International Francophone sur la PME (CIFPME), HEC Montréal (Québec), 30 October-1 September.
- Levinson N. and A. Minoru (1995), Cross-national alliances and inter-organizational learning, *Organizational Dynamics*, 24(2), 50-62.
- Levinthal D. A. (1992), Wisdom from Wharton: R&D as investment in learning, *Chief-Executive*, 81, 62-64.
- Levinthal D. A. and J. G. March (1993), The myopia of learning, *Strategic Management Journal*, 4, 95-112.
- Levitt B. and J. G. March (1988), Organizational learning, *Annual Review of Sociology*, 14, 319-340.
- Leyronas C. and O. Torrès (1996), Stratégie de mondialisation et PME: l'instruction d'un paradoxe, 3ème Congrès International Francophone de la PME (CIFPME), Trois-Rivières, Québec, 23-25 October.
- Li T. and R. Calantone (1998), The impact of market knowledge competence on new product advantage: conceptualization and empirical examination, *Journal of Marketing*, 62(4), 13-29.
- Liao J., Welch H. and M. Stoica (2003), Organizational absorptive capacity and responsiveness: an empirical investigation of growth-oriented SMEs, *Entrepreneurship, Theory and Practice*, 28(1), 63-86.

- Lindell M. K. and C. J. Brandt (2000), Climate quality and climate consensus as mediators of the relationship between organizational antecedents and outcomes, *Journal of Applied Psychology*, 85, 331-348.
- Lindell M. K. and D. J. Whitney (2001), Accounting for common method variance in cross-sectional research designs, *Journal of Applied Psychology*, 86, 114-121.
- Lohmöller J.-B. (1984), *LVPLS program manual: latent variables path analysis with Partial Least-Squares estimation*, Köln: Zentralarchiv für empirische Sozialforschung.
- Lockett A., O'Shea R. P. and M. Wright (2008), The development of the resource-based view: reflections from Birger Wernerfelt, *Organization Studies*, 8-9, 1125-1142.
- Lord M. D. and A. L. Ranft (2000), Organizational learning about new international markets: exploring the international transfer of local market knowledge, *Journal of International Business Studies*, 31(4), 573-589.
- Luostarinen R. (1980), *Internationalization of the firm*, Helsinki School of Economics: Helsinki, Finland.
- Lyles M. (1987), Common mistakes of joint venture experienced firms, *Columbia Journal of World Business*, 22(2), 79-85.
- Lyles M. A. and I. I. Mitroff (1980), Organizational problem formulation: an empirical study, *Administrative Science Quarterly*, 25(1), 102-119.
- Lyles M. A. and J. E. Salk (1996), Knowledge acquisition from foreign parents in international joint ventures: an empirical examination in the Hungarian context, *Journal of International Business Studies*, 27(5), 877-903.
- MacPherson A. (2000), The role of international design orientation and market intelligence in the export performance of US machine tool companies, *R&D Management*, 30(2), 167-176.
- Machat K. (2003), Market-based learning in SME. Findings from a national survey of French food industry, Academy of Marketing / AMA 8th annual Symposium on the Marketing - Entrepreneurship Interface, Gloucestershire Business School, UK, 8-10 January.
- Madsen T. K. (1989), Successful export marketing management: some empirical evidence, *International Marketing Review*, 6(4), 41-57.
- Mahé de Boislandelle H. (1996), L'effet de microcosme en PME, proceedings of 3ème Congrès International Francophone PME (CIFPME), Trois Rivières, Québec, 101-115.
- Mahoney J. T. (1995), The management of resources and the resource of management, *Journal of Business Research*, 33(2), 91-101.
- Mahoney J. T. and J. R. Pandian (1992), The resource-based view within the conversation of strategic management, *Strategic Management Journal*, 13(5), 363-380.

- Makrikadis S. (1996), Reply to comments on “Forecasting: its role and value for planning and strategy”, *International Journal of Forecasting*, 12(4), 555-557.
- Machlup F. (1979), Uses, value and benefits of knowledge, *Knowledge: creation, diffusion, utilization*, 1(1), 62-81
- Maltz E. and A. Kohli (1996), Marketing intelligence and dissemination across functional boundaries, *Journal of Marketing Research*, 33(1), 47-61.
- March J. G. (1991), Les systèmes d’information et prise de décision: des liens ambigus, in J. J. March, *Décisions et organisations*, Paris, Organisation, p. 56-78.
- March J. G. and J. P. Olsen (1986), Garbage can models of decision making in organizations, in J.G. March and R. Weissinger-Baylon, *Ambiguity and Command*. Marshfield, MA Pitman, 11-35.
- Marchesnay M. (1991), De l’hypofirme à l’hypogroupe: naissance, connaissance et reconnaissance, Cahiers du LERASS, 23, 26- 41.
- Matusik S. F. and C. W. L. Hill (1998), The utilization of contingent work, knowledge creation, and competitive advantage, *Academy of Management Review*, 23(4), 680-687.
- Marengo L. (1995), Apprentissage, compétences et coordination dans les organisations, in N. Lazaric and J.-M. Monnier, *Coordination économique et apprentissage des firmes*, Economica, Paris, 3-22.
- Matlay H. (2000), Vocational education and training in small businesses: setting a research agenda for the twenty-first century, *Education and Training*, 44(8-9), 357-369.
- Matsuno K., Mentzer J.T. and A. Ozsomer (2002), The effects of entrepreneurial proclivity and market orientation on business performance, *Journal of Marketing*, 66, 18-32.
- Matthyssens P. and P. Pauwels (1996), Assessing export performance measurement, in S. T. Cavusgil and T. K. Madsen, *Advances in International Marketing*, New York, JAI Press, 85-114.
- Matusik S. F. and M. B. Heeley (2005), Absorptive capacity in the software industry: identifying factors that affect knowledge and knowledge creation, *Journal of Management*, 31, 549-572.
- Matusik S. F. and C. W. L. Hill (1998), The utilization of contingent work, knowledge creation and competitive advantage, *Academy of Management Review*, 23(1), 680-697.
- Mayer C. and J. Flynn (1973), Canadian small business abroad: opportunities, aids and experience, *The Business Quarterly*, 38, 33-47.
- McAuley A. (1993), The perceived usefulness of export information sources, *European Journal of Marketing*, 27(10), 52-64.

- McDougall P., Covin J., Robinson R. and L. Herron (1994), The effects of industry growth and strategic breadth on new venture performance and strategy content, *Strategic Management Journal*, 15(7), 537-554.
- McGrath R.G., MacMillan I.C. and S. Venkataraman (1995), Defining and developing competence: a strategic process paradigm, *Strategic Management Journal*, 16, 251-275.
- McGrath R. G. and I. C. MacMillan (2000), Assessing technology projects using real options reasoning, *Research, Technology Management*, 43(4), 35-49.
- Meeus M. T., Oerlemans L. A. and J. Hage (2001), Patterns of interactive learning in a high-tech region, *Organization Studies*, 22, 145-172.
- Meltsner A. J. (1976), *Policy analysts in the bureaucracy*, Berkeley, University of California Press.
- Menon A. and R. Varadarajan (1992), A model of marketing knowledge use within firms, *Journal of Marketing*, 56(4), 53-71.
- Meyer-Krahmer F. and F. Meyer-Krahmer (1998), Science-based technologies: university-industry interactions in four fields, *Research Policy*, 27, 835-851.
- Miesenbock K. J. (1988), Small businesses and exporting: a literature review, *International Small Business Journal*, 6(2), 42-61.
- Miller D. and J. Shamsie (1996), The resource-based view of the firm in two environments: the Hollywood film studios from 1935 to 1965, *Academy of Management Journal*, 39(3), 519-543.
- Minguzzi A. and R. Passaro (1997), Apprentissage et culture d'entreprise dans les PME: une analyse explorative intersectorielle, *Revue Internationale des PME*, 10(2), 45-79.
- Mintzberg H. (1994), *The rise and fall of strategic planning*, Free Press and Prentice-Hall International.
- Mogos Descotes R. and B. Walliser (2004), An exploratory inquiry into the acquisition and use of export information by French SMEs and its relationship to international performance, *FACEF PRESQUISA*, 7(1), 97-107.
- Moini A. H. (1995), An inquiry into successful exporting: an empirical investigation using a three-stage model, *Journal of Small Business Management*, 33(3), 9-25.
- Moorman C. (1995), Organizational market information processes: cultural antecedents and new product outcomes, *Journal of Marketing Research*, 32(3), 318-335.
- Morgan N. A. and D. W. Vorhies (2005), Benchmarking marketing capabilities for sustainable competitive advantage, *Journal of Marketing*, 69(1), 80-94.

- Morgan N. A., Zou S., Vorhies D. W. and C. S. Katikeas (2003), Experiential and informational knowledge, architectural marketing capabilities, and the adaptive performance of export ventures, *Decision Sciences*, 34(2), 287-321.
- Morgan N. A., Kaleka A. and C. S. Katsikeas (2004), Antecedents of export venture performance: a theoretical model and empirical assessment, *Journal of Marketing*, 68(1), 90–108.
- Morvan Y. (1972), *L'expérience et la vie des firmes*, Repères, Paris.
- Mowery D. C., Oxley J. E. and B. S. Silverman (1996), Strategic alliances and interfirm knowledge transfer, *Strategic Management Journal*, 17, 77-92.
- Mulbacher H., H. Leihls and L. Dahringer (2006), *International marketing, a global perspective*, Thompson.
- Nahapiet J. and B. Ghoshal (1998), Social capital, intellectual capital and the organizational advantage, *Academy of Management Review*, 23(2), 242-266.
- Narver J. and S. Slater (1990), The effect of a market orientation on business profitability, *Journal of Marketing*, 54, 20-35.
- Nelson R. R. and S. G. Winter (1982), *An evolutionary theory of economic change*, Cambridge: Belknap Press.
- Nelson R. R. and S. G. Winter (1982), *An Evolutionary Theory of Economic Change*, Bellknap Press Cambridge Mass.
- Nevis E. C., DiBella A. J. and J. M. Gould (1995), Understanding organizations as learning systems, *Sloan Management Review*, 36(2), 73-85.
- Nguyen P. H. S. (2007), Un modèle intégrateur des effets de l'internationalisation sur la performance de l'entreprise, XVIème Conférence Internationale de Management Stratégique, Montréal, Canada, 6-9 June.
- Nicolini D. and M. Meznar (1995), The social construction of organizational learning, *Human Relation*, 48(7), 727-746.
- Nonaka I. (1991), Managing the firm as an information creation process, *Advances in Information Processing in Organizations*, 4, 239-275.
- Nonaka I. (1994), A dynamic theory of organizational knowledge creation, *Organization Science*, 5, 14-36.
- Nonaka I. and H. Takeuchi (1995), *The knowledge creating company: How Japanese companies create the dynamics of innovation*, London: Oxford University Press.

- Nonaka I. and H. Takeuchi (2004), Theory of organizational knowledge creation, in Nonaka I. and H. Takeuchi, *Hitotsubashi on knowledge management*, John Wiley and Sons, Singapore, 47-91.
- Nunnally J. and I. Bernstein (1994), *Psychometric Theory*, 3<sup>rd</sup> edition, New York: McGraw-Hill.
- O'Reilly C. A. (1983), The use of information in organizational decision making: a model and some propositions, in Cummings L. L. and B. M. Shaw, *Research in Organizational Behavior*, vol. 5, Greenwich, Conn: JAI Press, 103-139.
- OECD (2001), [www.oecd.org](http://www.oecd.org).
- Ogbuebi A. O. and T. A. Longfellow (1994), Perceptions of US manufacturing SMEs concerning exporting: a comparison based on export experience, *Journal of Small Business Management*, 32(4), 37-47.
- Ogram E. W. (jr.) (1982), Exporters and non-exporters: a profile of small manufacturing firm in Georgia, in Czinkota M. R. and G. Tesar, *Export management: an international context*, New York: Praeger Publishers, 70-84.
- Ogunmokun G. O. and S. Ng (1999), Environmental scanning practices and export performance in international marketing: a study of Australian exporters, *International Journal of Management*, 16(1), 9-20.
- Oviatt B. M. and P. P. McDougall (1994), Toward a theory of international new ventures, *Journal of International Business Studies*, 25(1), 45-64.
- Palmer J. and L. Andrews (1997), Team-work to green small and medium-size enterprise?, *Team Performance Management*, 3(3), 193-205.
- Pant P. N. and W. H. Starbuck (1990), Innocents in the forest: forecasting and research methods, *Journal of Management*, 16(2), 433-460.
- Patriotta G. (2004), *Organizational knowledge in the making: How firms create, use and institutionalize knowledge*, Oxford, UK, Oxford University Press.
- Pelham A. M. and D. T. Wilson (1996), A longitudinal study of the impact of market structure, firm structure, strategy, and market orientation culture on dimensions of small-firm performance, *Journal of the Academy of Marketing Science*, 24(1), 27-43.
- Pelham A. M. (1997), Mediating influences on the relationship between market orientation and profitability in small industrial firms, *Journal of Marketing Theory and Practice*, 5, 5-76.
- Pelham A. M. (1999), Influence of environment, strategy, and market orientation on performance in small manufacturing firms, *Journal of Business Research*, 45(1), 33-46.

Pelham A. M. (2000), Market orientation and other potential influences on performance in small and medium-sized manufacturing firms, *Journal of Small Business Management*, 38(1), 48-67.

Peltz D. C. (1978), Some expanded perspectives on use of social science in public policy, in J. M. Yinger and J. Cutler, *Major social issues: a multidisciplinary view*, New York, Free Press, 346-357.

Pfeffer J. and G. R. Salancik (1978), *The external control of organizations: a resource dependence perspective*, New York, NY, Harper and Row.

Piercy N. F., Kaleka A. and C. S. Katsikeas (1998), Sources of competitive advantage in high performing exporting companies, *Journal of World Business*, 33(4), 378-393.

Pitt L., Caruana A. and P. R. Berthon (1996), Market orientation and business performance: some European evidence, *International Marketing Review*, 13(1), 5-18.

Polanyi M. (1966), *The Tacit Dimension*, Routledge and Kegan Paul: London, UK.

Porter M. E. (1980), *Competitive Strategy*, The Free Press, New York.

Porter M. E. (1986), *L'avantage concurrentiel: comment devancer ses concurrents et maintenir son avance*, Paris, Inter éditions.

Porter M. E. (1990), *The competitive advantage of nations*, New York, The Free Press.

Porter M. E. and V. E. Millar (1985), *How information gives you competitive advantage*, *Harvard Business Review*, July-August, 149-160.

Prahalad C. K. and G. Hamel (1990), The core competence of the corporation, *Harvard Business Review*, May-June, 79-91.

Ramangamahy C. (2001), Capacité d'absorption de l'information, compétitivité et performance des PME exportatrices: une étude empirique, PhD dissertation, Université de Montréal, Canada.

Ramaswamy K., K. G. Kroeck and W. Renforth (1996), Measuring the degree of internalization of a firm: a comment, *Journal of International Business Studies*, 27, 167-177.

Rao H. and R. Drazin (2002), Overcoming resource constraints by recruiting talent from rivals: a study of recruitment and product innovation in the mutual fund industry 1986-1994, *Academy of Management Journal*, 45(3), 609-619.

Rashkis C. (2004), Workplace conflict and the importance of resolving it early, [rashkis.com/documents/pdf/articles/workplace\\_conflict\\_resolution.pdf](http://rashkis.com/documents/pdf/articles/workplace_conflict_resolution.pdf).

Ray D. M. (1991), International opportunity identification in small Canadian exporting firms, *Frontiers of Entrepreneurship Research*, 159-173.

- Raymond L. and H. Lesca (1995), Evaluation and guidance of environmental scanning in SMEs: an expert systems approach, proceedings of The Annual Meeting of the Academy of Business Management, 539-546.
- Reid S. D. (1981), The decision-maker and export entry and expansion, *Journal of International Business Studies*, 12(2), 101-111.
- Reid S. D. (1984), Information acquisition and export entry decisions in small firms, *Journal of Business Research*, 12, 141-157.
- Remaud H. (2006), L'influence de l'orientation marché sur la compétitivité export des petites entreprises, 8ème CIFPME (Congrès International Francophone en Entrepreneuriat et PME, Friburg, Switzerland, 26-28 October.
- Reuber A. R. and E. Fischer (1997), The influence of the management team's international experience on the internationalization behaviors of SMEs, *Journal of International Business Studies*, 28(4), 807-825.
- Rich R. F. (1977), Measuring knowledge utilization: processes and outcomes. knowledge and policy, *The International Journal of Knowledge Transfer and Utilization*, 10(3), 11-24.
- Riddle L. A. and K. Gillespie (2003), Information sources for new ventures in the Turkish clothing export industry, *Small Business Economics*, 20(1), 105-120.
- Ringle C. M. and F. Spreen (2007), Beurteilung von ergebnissen einer PLS-pfadanalyse, in *Das Wirtschaftsstudium (WISU)*, Heft 2, 211-216.
- Robertson C. and S. K. Chetty (2000), A contingency-based approach to understanding export performance, *International Business Review*, 9, 211-235.
- Roussel P., Durrieu F., Campoy E. and A. El Akremy (2002), *Méthodes d'équations structurelles : recherche et applications en gestion*, Recherche en Gestion, Economica, Paris.
- Ruekert R.W. and O. C. Walker (1987), Marketing's interaction with other functional units: a conceptual framework and empirical evidence, *Journal of Marketing*, 51(1), 1-19.
- Salancik G. R. and J. Pfeffer (1978), A social information processing approach to job attitudes and task design, *Administrative Science Quarterly*, 23, 224-253.
- Samiee S. and P. Anckar (1998), Currency choice in industrial pricing: a cross-national evaluation, *Journal of Marketing*, 62(3), 112-128.
- Samiee S. and P. G. P. Walters (1990), Influence of firm size on export planning and performance, *Journal of Business Research*, 20(3), 235-248 .
- Sanchez R. and A. Heene (1997), Competence-based strategic management, in Heene A. and R. Sanchez, *Competence-based Strategic Management*, Chichester, Wiley, 3-42.



- Sanchez R., Heene A. and H. Thomas (1996), Towards the theory and practice of competence-based competition, in Sanchez R., Heene A. and H. Thomas, *Dynamics of competence-based competition*, Elsevier Pergamon, 1-36.
- Schilling M. A. (1998), Technical lockout: an integrative model of the economic and strategic factors driving technology success and failure, *Academy of Management Review*, 23(2), 267-284.
- Schmitt C. and M. Bayad (2002), Valeur et performance en PME: de l'importance de la vision à partager, 6ème Congrès International Francophone sur l'Entrepreneuriat et la PME, Montréal.
- Scott R. W. (1992), *Organizations: rational, natural, open systems*, Englewood Cliffs, New Jersey, Prentice Hall.
- Scott R. W. (1995), *Institutions and Organizations*, Thousands Oaks, CA: Sage publications.
- Senge P. M. (1990), *The fifth discipline: art and practice of the learning organization*, New York: Doubleday.
- Senge P. M. (1991), Learning organizations, *Executive Excellence*, 8(9), 7-8.
- Seringhaus R. F. H. (1985), How do major industrial countries support firms' international efforts?, proceedings of ASAC Conference, Université du Québec à Montréal, p. 112-129.
- Seringhaus R. (1987), The role of information assistance in the small firm's export involvement, *International Small Business Journal*, 5(2), 26-36.
- Seringhaus R. (1993), Comparative marketing behavior of Canadian and Austrian high-tech exporters, *Management International Review*, 33(3), 247-269.
- Sambharya R. B. (1996), Foreign experience of top management teams and international diversification strategies of US multinational corporations, *Strategic Management Journal*, 17(9), 739-746.
- Shane S. and S. Venktaraman (2000), The promise of entrepreneurship as a field of research, *Academy of Management Review*, 25(1), 217-226.
- Shannon C. E. and W. Weaver (1949), *A mathematical theory of communication*, Urbana, University of Illinois Press.
- Sharma P. and J. J. Chrisman (1999), Toward a reconciliation of the definitional issues in the field of corporate entrepreneurship, *Entrepreneurship, Theory and Practice*, 23(3), 11-27.
- Shenkar O. and J. T. Li (1999), Skill possession and search among prospective partners in international cooperative ventures, *Organization Science*, 10(2), 134-143.
- Sheremata W. A. (2000), Centrifugal and centripetal forces in radical new product development under time pressure, *Academy of Management Review*, 25(2), 389-408.

- Shoham A. (1998), Export performance: A conceptualization and empirical assessment, *Journal of International Marketing*, 6(3), 59-81.
- Shoham A., Rose G. M. and F. Kropp (2005), Market orientation and performance: a meta-analysis, *Marketing Intelligence and Planning*, 23(4-5), 435-54.
- Simon H. T. (1945), *Administrative behavior*, New York, The Free Press.
- Simon H. A. (1991), Organizations and markets, *Journal of Economic Perspectives*, 5(2), 25-44.
- Simpson C. L. and D. Kujawa (1974), The export decision process: an empirical enquiry, *Journal of International Business Studies*, 5(1), 107-118.
- Sinkula J. M. (1994), Market information processing and organizational Learning, *Journal of Marketing*, 58, 35-45
- Sinkula J. M., Baker W. E. and T. Noordewier (1997), A framework for market-based organizational learning: linking values, knowledge and behavior, *Journal of the Academy of Marketing Science*, 25(4), 305–318.
- Slater F. S. and J. C. Narver (1995), Market orientation and the learning organization, *Journal of Marketing*, 59, 63-74.
- Slater S. F. and J. C. Narver (1999), Market oriented is more than being customer-led, *Strategic Management Journal*, 20(12), 1165-118.
- Smeltzer L. R., Fann G. L. and V. N. Nikolaisen (1988), Environmental scanning practices in small business, *Journal of Small Business Management*, 26(3), 55-62.
- Sorensen J. B. and T. E. Stuart (2000), Aging, obsolescence and organizational Innovation, *Administrative Science Quarterly*, 45, 81-112.
- Souchon A. L. and A. Diamantopoulos (1996), A conceptual framework of export marketing information use: key issues and research propositions, *Journal of International Marketing*, 4(3), 49-71.
- Souchon A. L. and A. Diamantopoulos (1997), Use and non-use of export information: some preliminary insights into antecedents and impact on export performance, *Journal of Marketing Management*, 13, 135-151.
- Souchon A. L. and A. Diamantopoulos (1999), Export information acquisition modes: measure development and validation, *International Marketing Review*, 16(2), 143-168.
- Souchon A. L., Diamantopoulos A., Holz Müller H. H., Axinn C. N., Sinkula J. M., Simmet H. and G. R. Durden (2003), Export information use: a five-country investigation of key determinants, *Journal of International Marketing*, 11(3), 106-127.

Souchon A. L. and G. R. Durden (2002), Making the most out of export information: an exploratory study of UK and New Zealand exporters, *Journal of Euromarketing*, 11(4), 65-86.

Sousa C. M. P. (2004), Export performance measurement: an evaluation of the empirical research in the literature, *Academy of Marketing Science Review*, 4(9), 35-58.

Sousa C. M. and B. A. Alserhan (2002), An investigation into the antecedents of the export performance literature, proceedings of the 28<sup>th</sup> European International Business Academy Conference, Athens, Greece, December 2002.

Spence M. M. (2003), Evaluating export promotion programs: U. K. overseas trade missions and export performance, *Small Business Economics*, 20(1), 83-103.

Spender J. C. (1998), Pluralist epistemology and the knowledge-based theory of the firm, *Organization*, 5(2), 233-256.

Spender J. C. (1999), Organizational knowledge, collective practice and Penrose rents, in M. H. Zack, *Knowledge and Strategy*, Boston, Massachusetts: Butterworth-Heinemann, 117-132.

Spender J. C. (2007), Data, meaning and practice: how the knowledge-based view can clarify technology's relationship with organizations, *International Journal of Technology Management*, 38(1-2), 178-196.

Spillan J. and J. Parnell (2006), Marketing resources and firm performance among SMEs, *European Management Journal*, 24(2-3), 236-245.

Stata R. (1989), Organizational learning: the key to management innovation, *Sloan Management Review*, 30(3), 63-74.

Steenkamp J. B. and H. C. Van Trijp (1991), The use of LISREL in validating marketing constructs, *International Journal of Research in Marketing*, 8(4), 283-299.

Stehr N. (1994), *Knowledge societies*, London, Sage.

Sullivan D. (1996), Measuring the degree of internationalization of a firm: a reply, *Journal of International Business Studies*, 27 (1), 179-192.

Szulanski G. (1996), Exploring internal stickiness: impediments to the transfer of best practice within the firm, *Strategic Management Journal*, 17, 27-43.

Stoica M., Liao J. and H. Welch (2004), Organizational culture and patterns of information processing: the case of small and medium-sized enterprises, *Journal of Developmental Entrepreneurship*, 9(3), 251-266.

Tarondeau J. C. (1998), *Le management des savoirs*, Paris, PUF.

Tarondeau J. C. (1999), Approches et formes de la flexibilité, *Revue Française de Gestion*, 66-71.

- Teece D. J., Pisano G. and A. Shuen (1997), Dynamic capabilities and strategic management, *Strategic Management Journal*, 18(17), 509-533.
- Tenenhaus M. and M. Hanafi (2008), A bridge between PLS path modelling and multi-block data analysis, in V. Esposito Vinzi *et al.*, *Handbook of Partial Least Squares (PLS): concepts, methods and applications*, Volume II in the series of the Handbooks of Computational Statistics, Springer, upcoming.
- Tenenhaus M., V. Esposito Vinzi, Y. M. Chatelin and C. Lauro (2005), PLS path modelling, *Computational Statistics and Data Analysis*, 48(1), 159-205.
- Terpstra V. and R. Sarathy (2000), *International Marketing*, Dryden Press, Fortworth.
- Thomas H. and T. Pollock (1999), From I-O economics' S-C-P paradigm through strategic groups to competence-based competition: reflections on the puzzle of competitive strategy, *British Journal of Management*, Chichester, 10(2), 127-140.
- Thornton P. H. (1999), The sociology of entrepreneurship, *Annual Review of Sociology*, 25, 19-46.
- Toften K. and S. O. Olsen (2003), Export market information use, organizational knowledge, and firm performance: A conceptual framework, *International Marketing Review*, 20(1), 95 – 110.
- Torres O. (1998), *PME : De nouvelles approches*, Economica, Paris, Collection Recherche en Gestion.
- Torres O. (1999), *Les PME*, Flammarion, Paris, Collection Dominos.
- Torres O. (2000), Du rôle et de l'importance de la proximité dans la spécificité de gestion des PME, 5ème Congrès International Francophone PME (CIFPME), Lille, 5-7 October.
- Torres O. (2003), Petitesse des entreprises et grossissement des effets de proximité, *Revue Française de Gestion*, 144, 119-138.
- Torres O. (2004), The SME concept of Pierre-André Julien: analysis in terms of proximity, *Small Business*, 17(2), 51-62.
- Torres O. et J. M. Plane (2003), Le recours au conseil est-il dénaturant pour les PME ?, *La Revue du Financier*, 140, 38-46.
- Tsai W. (2001), Knowledge transfer in intra-organizational networks: effects of network position and absorptive capacity on business unit innovation and performance, *Academy of Management Journal*, 44(5), 996-1004.
- Tuomi I. (1999), Data is more than knowledge: implications of the reversed knowledge hierarchy to knowledge management and organizational memory, Proceedings of the 32nd Hawaii International Conference on Systems Sciences, IEEE Computer Society Press.

- Türker M. and L. Kavut (2004), Small and medium sized enterprises and the role of the accountancy profession In Turkey, 4<sup>th</sup> FCM Conference, “The Globalization of Small and Medium-sized Enterprises and the Role of the Accountancy Profession”, Capri, Italy, 3-4 May.
- Tyler B. B. (1991), Strategic decision models: integrating different perspectives, *Strategic Management Journal*, 12 (5), 327-351.
- Tyre M. J. and Von Hippel E. (1997), The situated nature of adaptive learning in organizations, *Organization Science*, 8(1), 71-83.
- Uskali M. (2005): models are experiments, experiments are like models, *Journal of Economic Methodology*, 12(2), 303-315.
- Uzzi B. (1999), Embeddedness in the making of financial capital: How social relations and networks benefit firms seeking financing, *American Sociological Review*, 64(4), 481–505.
- Van den Bosch F. A. J., Volberda H. W., Henk W. and M. DeBoer (1999), Coevolution of firm absorptive capacity and knowledge environment: organizational forms and combinative capabilities, *Organization Science*, 10(5), 551-568.
- Vance M. (1997), Use the Web to manage your network, *Datamation*, 43(1), 128-133.
- Verhees F. J. H. M and M. T. G. Meulenbergh (2004), Market Orientation, innovativeness, product innovation and performance in small firms, *Journal of Small Business Management*, 42 (2), 134-154.
- Vesper K. H. (1989), *New venture strategies*, Englewoods Cliffs: Prentice Hall.
- Vidal P. (2003), Les PME face à l’information : Attention !!! , in D. Phanel, *L’Intelligence Economique dans les PME-PMI*, Economica.
- Voerman L. (2003), The export performance of European SMEs, PhD dissertation, Rijksuniversiteit Groningen, Netherlands, Labyrinth Publication.
- Walliser B. (2002), Marketing International,  
[http://www.numilog.com/fiche\\_livre.asp?id\\_livre=24858&id\\_theme=&format=3&id\\_collec=&rubzone=STD&srcNws=1&idNwsltr=128](http://www.numilog.com/fiche_livre.asp?id_livre=24858&id_theme=&format=3&id_collec=&rubzone=STD&srcNws=1&idNwsltr=128)
- Walliser B. and R. Mogos Descotes (2004), An exploratory inquiry into the acquisition and use of export information by French SMEs and its relationship to international performance, *FACEF PRESQUISA*, 7(1), 97-107.
- Walsh J. and R. Ungson (1991), Organizational memory, *The Academy of Management Review*, 16(1), 57-91.

Wang C. and P. K. Ahmed (2007), Dynamic capabilities: a review and research agenda, *International Journal of Management Reviews*, 9(1), 31-51.

Warnier V. (2005), La constitution des compétences stratégiques: le cas de l'industrie de la dentelle haut de gamme, PhD dissertation, University of Lille, France.

Weaver K. M., Berkowitz D. and L. Davies (1998), Increasing the efficiency of national export promotion programs: the case of Norwegian exporters, *Journal of Small Business Management*, 36(4), 1-11.

Webster collegiate dictionary, <http://www.merriam-webster.com/>

Weick K. E. (1979), *The social psychology of organizing*, 2nd edition, Reading, MA, Addison-Wesley.

Weiss C. H. (1979), The many meanings of research utilization, *Public Administration Review*, 39(5), 426-431.

Wiener N. (1948), *Cybernetics or control and communication in the animal and the machine*, John Wiley.

Welch L.S. and R. Luostarinen (1993), Internationalization: evolution of a concept, in Buckley P.J. and P. Ghauri, *The internationalization of the firm: a reader*, London, Academic Press Ltd.

Welsch H. P. and J. F. Young (1982), The information source of selection decision: the role of entrepreneurial characteristics, *Journal of Small Business Management*, 20(4), 49-57.

Wernefelt B. (1984), A resource-based view of the firm, *Strategic Management Journal*, 5, 171-180.

Wikström S. and R. Norman (1994), *Knowledge and value*, Routledge, London.

Wilensky H. L. (1967), *Organizational intelligence: knowledge and policy in government and industry*, New York, Basic Books Inc. Publishers.

Wilkinson T. and L. E. Brouthers (2006), Trade promotion and SME export performance, *International Business Review*, 15(3), 233-252.

Wilson B. and J. Henseler (2007), Modeling reflective higher-order constructs using three approaches with PLS Path Modeling: a Monte Carlo comparison, proceeding of ANZMAC conference, University of Otago, Australia, 28-30 November.

Winter S. G. (2000), The satisfying principle in capability learning, *Strategic Management Journal*, 21(10-11), 981-996.

Woisetschläger D. M. and H. Evanschitzky (2005), Entry predictors and export market selection of German SMEs, Proceedings of the Academy of Marketing Science - World Marketing Congress, Münster, Germany.

World Bank, <http://www.worldbank.org/>

Yeoh P. L. (2000), Information acquisition activities: a study of global start-up exporting companies, *Journal of International Marketing*, 8(3), 36-60.

Young S. J., Hamil C., Wheeler C. and J. R. Davis (1989), *International market entry and development: strategies and management*, Prentice Hall.

Youndt M. A., Snell S. A., Dean J. W. and D. P. Lepak (1996), Human resource management, manufacturing strategy, and firm performance, *Academy of Management Journal*, 39(4), 836-866.

Zahra S. A. and G. George (2002), Absorptive capacity: a review, reconceptualization and extension, *Academy of Management Review*, 27(2), 185-203.

Zmud R. (1978), An empirical investigation of dimensionality of the concept of information, *Decision Sciences*, 9(2), 187-195.

Zott C. (2003), Dynamic capabilities and the emergence of intra-industry differential firm performance: insights from a simulation study, *Strategic Management Journal*, 24, 97-125.

Zou S., Taylor C. R. and G. E. Osland (1998), The EXPERF scale: a cross-national export performance measure, *Journal of International Marketing*, 6(3), 37-58.

Zou S., Fang E. and S. Zhao (2003), The effect of export marketing capabilities on export performance: an investigation of Chinese exporters, *Journal of International Marketing*, 11(4), 32-55.