



HAL
open science

Effects of elevated atmospheric CO₂ concentrations on carbon and nitrogen fluxes in a grazed pasture

Vincent Allard

► **To cite this version:**

Vincent Allard. Effects of elevated atmospheric CO₂ concentrations on carbon and nitrogen fluxes in a grazed pasture. *Biologie végétale*. Institut National Polytechnique de Lorraine, 2004. Français. NNT : 2003INPL013N . tel-01749757

HAL Id: tel-01749757

<https://hal.univ-lorraine.fr/tel-01749757v1>

Submitted on 29 Mar 2018

HAL is a multi-disciplinary open access archive for the deposit and dissemination of scientific research documents, whether they are published or not. The documents may come from teaching and research institutions in France or abroad, or from public or private research centers.

L'archive ouverte pluridisciplinaire **HAL**, est destinée au dépôt et à la diffusion de documents scientifiques de niveau recherche, publiés ou non, émanant des établissements d'enseignement et de recherche français ou étrangers, des laboratoires publics ou privés.



AVERTISSEMENT

Ce document est le fruit d'un long travail approuvé par le jury de soutenance et mis à disposition de l'ensemble de la communauté universitaire élargie.

Il est soumis à la propriété intellectuelle de l'auteur. Ceci implique une obligation de citation et de référencement lors de l'utilisation de ce document.

D'autre part, toute contrefaçon, plagiat, reproduction illicite encourt une poursuite pénale.

Contact : ddoc-theses-contact@univ-lorraine.fr

LIENS

Code de la Propriété Intellectuelle. articles L 122. 4

Code de la Propriété Intellectuelle. articles L 335.2- L 335.10

http://www.cfcopies.com/V2/leg/leg_droi.php

<http://www.culture.gouv.fr/culture/infos-pratiques/droits/protection.htm>

(M) 2003 ALLARD, V.

Massey University

Institut National Polytechnique de Lorraine

A thesis presented in partial fulfilment of the requirements for the degree of Ph D in Plant Science at Massey University and the degree of "Docteur en Sciences", speciality "Sciences Agronomiques" at the Institut National Polytechnique de Lorraine

Vincent Allard, 2003



**Effects of Elevated Atmospheric CO₂
Concentrations on Carbon and
Nitrogen Fluxes in a Grazed Pasture**

**Effets de l'Élévation de la
Concentration en CO₂ Atmosphérique
sur les Flux de Carbone et d'Azote en
Prairie Pâturée**

PhD supervisors:

Paul Newton
Cory Matthew
Jean-Francois Soussana
Philippe Grieu

“Je suis le luxe des civilisations occidentales”

Guillaume Clémentine (1999), *Le Petit Malheureux*
éditions “Le serpent à plumes”

Abstract

Predicting the response of grazed grasslands to elevated CO₂ is of central importance in global change research as grasslands represent 20% of the world's land area and grassland soils are a major sink for carbon (C). Grasslands responses to elevated CO₂ are strongly controlled by the availability of other nutrients and nitrogen (N) in particular. There have been many previous studies of N cycling in grasslands exposed to elevated CO₂ but none of these experiments were grazed. In this thesis I present data on CO₂ effects on N cycling from an experimental system (FACE: Free Air Carbon dioxide Enrichment) that enabled grazing to be included. The thesis focuses on the effects of elevated CO₂ on the different processes involved in organic matter (OM) returns from the plant to the soil and the consequences for N availability. In Chapter 1, it was shown that elevated CO₂ modified N returns by grazing animals by altering the partitioning of N between faeces and urine creating a potential for enhanced N losses at elevated CO₂. Plant litter decomposition rates were, at the ecosystem scale, not affected by elevated CO₂ (Chapter 3), but a marked increase in the organic matter fluxes, from roots, led to an accumulation of coarse OM in the soil (Chapter 4). In Chapter 5, using ¹⁴C and ¹⁵N labelling, I compared short-term (plant mediated) and long-term (soil mediated) effects of elevated CO₂ on soil OM dynamics and concluded that soil OM accumulation under elevated CO₂ was not caused by C or N limitation but probably by the availability of other nutrients. The thesis demonstrates that the inclusion of grazing animals can strongly modify N cycling under elevated CO₂. As most grasslands are grazed, the prediction of grassland responses to elevated CO₂ must be derived from systems in which animals are an integral part.

Résumé

Prédire la réponse des prairies pâturées à une élévation de la concentration en CO₂ revêt une importance majeure dans la mesure où cet écosystème représente environ 20% de la surface terrestre non immergée mais aussi, parce que les sols prairiaux représentent un puit majeur de carbone (C). La réponse des prairies à un enrichissement en CO₂ est fortement contrôlée par la disponibilité des autres nutriments et en particulier l'azote (N). De nombreuses expériences ont par le passé étudié le cycle de l'azote en prairie sous CO₂ enrichi mais aucunes de ces études n'a inclus le pâturage. Dans le cadre de cette thèse, je présente des données concernant les effets du CO₂ sur le cycle de l'N provenant d'un système expérimental (FACE: enrichissement en dioxyde de carbone à l'air libre) permettant d'inclure des ruminants. Cette thèse est dédiée à l'étude des effets de l'élévation en CO₂ sur les différents processus impliqués dans les retours de matière organique (MO) de la plante vers le sol et leurs conséquences pour la disponibilité en N. Dans le Chapitre 1, il a été montré que le CO₂ pouvait modifier les retours d'N par les ruminants en affectant la partition d'N entre l'urine et les faeces, ce qui induisait des pertes d'N potentiellement accrues. La décomposition de la litière végétale, considérée à l'échelle de l'écosystème, n'a pas été affectée par le CO₂ (Chapitre 3) mais une forte augmentation du volume de MO retournant au sol depuis les racines a induit une accumulation de MO grossière dans le sol (Chapitre 4). Au cours du Chapitre 5, à l'aide d'un double marquage isotopique ¹⁴C et ¹⁵N, nous avons comparé les effets court terme (transmis par la plante) et long terme (transmis par le sol) du CO₂ sur la dynamique de la MO du sol et il a été conclu que l'accumulation de MO n'était pas causée par une limitation en C ou en N mais probablement par la disponibilité en autres nutriments. Cette thèse démontre que l'inclusion des ruminants peut fortement modifier la réponse des prairies au CO₂. Dans la mesure où ce mode d'utilisation des pâtures est largement majoritaire, prédire les réponses des pâtures à un enrichissement en CO₂ doit provenir de systèmes où les ruminants sont partie intégrante.

Acknowledgements

First, I would like to thank my four supervisors, Paul Newton, Cory Matthew, Jean-Francois Soussana and Philippe Grieu. All of them provided me help from the start of this work, made excellent facilities available to me both in New Zealand and France and provided ideas, comments and criticisms all through these three years.

I am also grateful to Armand Guckert and Gilles Lemaire who gave me the opportunity to come and work in New Zealand by initiating this co-tutorial PhD.

The Massey University Doctoral Committee, the « département Agronomie et Environnement » of INRA and the « Service Culturel, Scientifique et de Coopération » of the French embassy in New Zealand are gratefully thanked for their financial support.

Many people participated to this work by giving technical assistance and time for useful discussions:

In Nancy, thanks are due to Christophe Robin for his tremendous help and supervision during my stay in the “Laboratoire Agronomie et Environnement”. We will surely remember the 2002 football world cup final we nearly missed due to ¹⁴C labelling. Patrice Marchal is also thanked for his huge help with chemical analysis. Patrick Gross is thanked for the management of the CO₂-controlled glasshouse. Pierre Montpied and Erwin Dreyer are also thanked for giving me full access to their lab and facilities and for the brief and intense “photosynthesis for dummies” lecture they gave me. All the students and staff from the LAE are thanked for providing help with plant sampling, even during summer weekends, and thanks also for the good time we had. Special mention to Frederic Henry for the numerous useless discussions we had; both our theses would have been finished six month ago if we had stayed both in our respective offices.

In Clermont-Ferrand I would like to thank Pierre Loiseau for his constant input of ideas, Roger Delpy for his help with organic matter fractionation and all the staff from the Agronomy department. Special thanks to Eric, Sloan, Florence and Emmanuelle.

In Agresearch, thanks are due to Mark Lieffering for his constant help, to Tony Parsons, Harry Clark, Andrew Carran and Phil Theobald for giving me time for useful discussions. None of the field work in the FACE would have been possible without the help of several people, in particular Yvonne Gray, Shona Brock, Sheinach Dunn, Erin Lawrence and Tore Rayner.

Thanks are also due to Des Ross, Gregor Yeates and Pascal Niklaus from Landcare Research who all helped me at various stages of this work.

Finally, I am greatly indebted to Paul Newton and Mark Lieffering for their constant criticisms, corrections and stimulation, in particular during this last year during the writing process. If they did not tell me “it will be good once rewritten” one million times, they did not tell it once.

Structure of the thesis

This thesis is based on a series of papers. Chapter 2 has been accepted for publication in *Global Change Biology*. Chapters 3 and 4 have been prepared for submission in *Global Change Biology and Plant and Soil* respectively. A decision on submission of Chapter 5 for publication is pending. The references relevant to individual chapters are at the end of each chapter.

Table of contents

Abstract	iii
Résumé	iv
Acknowledgements	v
Structure of the thesis	vi
Table of contents	vii
List of tables	xi
List of figures	xiii
List of plates	xvi

Chapter 1: Carbon and Nitrogen Interaction in Grazed Pastures under Elevated CO₂- Background and Objectives 1

1.1. Introduction	2
1.2. Plant response to elevated CO₂	3
1.2.1. <i>Photosynthesis stimulation</i>	3
1.2.2. <i>Plant growth responses to elevated CO₂</i>	5
1.2.3. <i>Nutrient dependency of plant response to elevated CO₂</i>	6
1.3. The difficulty in predicting ecosystem responses to elevated CO₂	8
1.3.1. <i>CO₂ effects in multispecific systems</i>	8
1.3.2. <i>Duration of the CO₂ enrichment</i>	10
1.3.3. <i>The step increase issue</i>	11
1.3.4. <i>The need for large spatio-temporal studies to assess C-N interactions in grasslands under elevated CO₂</i>	12
1.4. The New Zealand grazed pasture FACE experiment	14
1.4.1. <i>Free air CO₂ enrichment (FACE) experiments</i>	14
1.4.1. <i>Specifications of the New Zealand FACE</i>	14
1.4.2. <i>Description of the facility</i>	16
1.4.3. <i>Objectives of the work</i>	17
1.5. References	19

Chapter 2: Nitrogen Cycling in Grazed Pastures at Elevated CO₂: N Returns by Ruminants 28

2.1. Summary	29
2.2. Introduction	30
2.3. Materials and methods	31
2.3.1. <i>Experimental site</i>	31
2.3.2. <i>Sheep grazing procedure</i>	32
2.3.3. <i>Collection and analysis of faeces</i>	33
2.3.4. <i>Herbage analysis</i>	33
2.3.5. <i>Determination of the N budget</i>	34
2.3.6. <i>Statistical analysis</i>	35
2.4. Results	36
2.4.1 <i>Botanical composition</i>	36
2.4.2. <i>Single species chemical composition</i>	36

2.4.3. <i>Chemical composition of the offered diet</i>	37
2.4.4. <i>Nitrogen partitioning in the excreta</i>	38
2.5. Discussion	39
2.5.1. <i>CO₂ effects on chemical composition of single species</i>	39
2.5.2. <i>Effects of elevated CO₂ on botanical composition</i>	41
2.5.3. <i>Integration of direct and indirect effects of elevated CO₂ on herbage quality</i>	41
2.5.4. <i>Implications of a modified forage quality for nutrient cycling through ruminants</i>	42
2.6. Conclusion	44
2.7. Acknowledgements	44
2.8. References	45

Chapter 3: Elevated CO₂ Effects on Decomposition Processes in a Grazed Grassland **50**

3.1. Abstract	51
3.2. Introduction	52
3.3. Materials and Methods	53
3.3.1. <i>Experimental site</i>	53
3.3.2. <i>Sheep faeces collection and decomposition</i>	54
3.3.3. <i>Plant leaf and litter collection and decomposition</i>	55
3.3.4. <i>Plant root collection and decomposition</i>	56
3.3.5. <i>Relative N loss by decomposing material</i>	57
3.3.6. <i>Summary scenarios</i>	57
3.3.7. <i>Statistical analysis</i>	58
3.4. Results	58
3.4.1. <i>Initial chemical composition</i>	58
3.4.2. <i>Decomposition rates</i>	59
3.4.3. <i>N release during decomposition</i>	60
3.5. Discussion	61
3.5.1. <i>Effects of species changes under elevated CO₂ on leaf litter decomposition</i>	61
3.5.2. <i>Effects of CO₂ -induced shift in biomass allocation on decomposition rates</i>	62
3.5.3. <i>Effects of elevated CO₂ on ruminant faeces decomposition</i>	64
3.6. Conclusion	65
3.7. Acknowledgements	65
3.8. References	66

Chapter 4: Increased Quantity and Quality of Coarse Soil Organic Matter Fraction at Elevated CO₂ in a Grazed Grassland are a Consequence of Enhanced Root Growth and Turnover **70**

4.1. Abstract	71
4.2. Introduction	72
4.3. Materials and methods	74
4.3.1. <i>Experimental site</i>	74
4.3.2. <i>Experimental areas</i>	74

4.3.3. <i>Root measurements</i>	75
4.3.4. <i>Aboveground measurements</i>	76
4.3.5. <i>Soil compartments analysis</i>	76
4.3.6. <i>Soil water content</i>	78
4.3.7. <i>Statistical analysis</i>	78
4.4. Results	78
4.4.1. <i>Climate and soil moisture</i>	78
4.4.2. <i>Aboveground biomass and litter deposition</i>	79
4.4.3. <i>Root standing biomass, growth rate and turnover</i>	79
4.4.4. <i>Soil C and N</i>	80
4.4.5. <i>Soil microbial biomass (MBM) and Extractable Organic Matter (EOM)</i>	80
4.5. Discussion	80
4.5.1. <i>Plant organic matter fluxes</i>	80
4.5.2. <i>Soil organic matter</i>	82
4.5.3. <i>Microbial biomass and dynamic</i>	84
4.6. Conclusion	84
4.7. Acknowledgements	85
4.8. References	85
Chapter 5: Direct and Indirect Effects of Elevated CO₂ on <i>Lolium Perenne</i> Carbon Allocation and Nitrogen Yield	90
5.1. Abstract	91
5.2. Introduction	92
5.3. Materials and methods	93
5.3.1. <i>Soil, plant and growth conditions</i>	93
5.3.2. <i>Plant management</i>	94
5.3.3. <i>¹⁴C plant labelling</i>	94
5.3.4. <i>Plant and soil sampling</i>	95
5.3.5. <i>¹⁴C analysis</i>	96
5.3.6. <i>¹⁵N analysis and calculations</i>	97
5.3.7. <i>Statistical analysis</i>	97
5.4. Results	98
5.4.1. <i>Dry matter production</i>	98
5.4.2. <i>N yield and concentration</i>	98
5.4.3. <i>Origin of plant N</i>	99
5.4.4. <i>¹⁴C allocation within the plant-soil system</i>	99
5.5. Discussion	100
5.5.1. <i>Elevated atmospheric CO₂ increases root exudation</i>	100
5.5.2. <i>Increased availability of easily decomposable C induced higher microbial growth</i>	101
5.5.3. <i>Effects on native soil organic matter decomposition; occurrence of a priming effect</i>	102
5.5.4. <i>Did the increased SOM mineralisation affected N availability for plants?</i>	103
5.5.5. <i>Long-term CO₂ effect: origin of the soil</i>	104
5.6. Conclusion	104
5.7. Acknowledgements	105
5.8. References	105

Chapter 6: General Discussion	109
6.1. Introduction	110
6.2. Effects of elevated CO₂ on plant-soil organic matter fluxes and organic matter accumulation in the soil	111
6.2.1. <i>Rates of organic matter decomposition</i>	111
6.2.2. <i>Fluxes of organic matter under elevated CO₂</i>	112
6.2.3. <i>Exudation under elevated CO₂</i>	113
6.2.4. <i>Accumulation of soil organic matter under elevated CO₂</i>	115
6.3. An exploration of the possible impacts of grazing on N cycling in a pasture exposed to elevated CO₂	116
6.3.1. <i>Description of the model</i>	117
6.3.2. <i>Effects of grazing intensity on N cycling in a pasture</i>	118
6.3.3. <i>Possible interactions with elevated CO₂</i>	119
6.4. References	121
Appendix	124
Appendix 1	125
Appendix 2	126
Appendix 3	129
Appendix 4	131

List of tables

Chapter 1

Table 1.1: Summary of the main experiments assessing the effects of elevated CO ₂ on grasslands.	15
---	----

Chapter 2

Table 2.1: Aboveground biomass prior to grazing events in two years and the contribution of different plant functional groups to the biomass taken from pre-grazing cuts from pastures exposed to ambient or elevated CO ₂ .	35
Table 2.2: Some leaf chemical characteristics of plant species growing under ambient or elevated CO ₂ in two years, 2000 and 2001.	36
Table 2.3: Nitrogen budget for sheep, grazing pastures exposed to ambient or elevated CO ₂ .	39

Chapter 3

Table 3.1: Effects of elevated CO ₂ on N concentration (%) and C/N ratio prior to incubation of green leaf material and leaf litter from four species, root material and faeces.	57
Table 3.2: P-values from the analysis of variance of the effects of CO ₂ , species and their interaction on the N concentration and C/N ratio of green leaf material and leaf litter prior to the decomposition and P-values from the analysis of variance of the effects of CO ₂ on the N concentration and C/N ratio of root material and faeces material.	58
Table 3.3: Simulation of the effect of elevated CO ₂ on the mass loss rates and N release rates at the pasture scale under different scenarios.	61

Chapter 4

Table 4.1: Mean leaf litter standing biomass, deposition rate and residence time under ambient and elevated CO ₂ .	78
Table 4.2: Root standing biomass, growth and residence time under ambient and elevated CO ₂ .	79
Table 4.3: Microbial carbon, nitrogen and C/N ratio and extractible organic carbon and C/N ratio under ambient and elevated CO ₂ .	81

Chapter 5

Table 5.1: Effects of the treatments on the nitrogen derived from fertiliser, nitrogen derived from soil and real recovery of the fertiliser.	99
Table 5.2: Effects of the treatments on the fraction of total radioactivity recovered per pot in each compartment and relative specific activity of each compartment.	100
Table 5.3: Effects of the treatments on microbial carbon biomass, C/N ratio of the microbial biomass and soil respiration.	101

List of figures

Chapter 1

- Figure 1.1: Rise of the atmospheric CO₂ concentration between 1958 and 2002 2
- Figure 1.2: Estimates of terrestrial carbon stocks for the main biomes 3
- Figure 1.3: CO₂ dependency of photosynthesis 4
- Figure 1.4: Plant response to elevated CO₂ 6
- Figure 1.5: Climatic conditions at the experimental site 17

Chapter 2

- Figure 2.1: Effects of elevated CO₂ on the chemical composition of the herbage. 37
- Figure 2.2: Correlation between herbage water soluble carbohydrates content and herbage *in vitro* organic matter digestibility for samples taken from pasture growing at ambient or elevated (475 ppm) CO₂. 38
- Figure 2.3: Correlation between the proportion of legumes in herbage (% of total dry matter) and the proportion of dietary N excreted as urine by animals grazing pastures exposed to ambient or elevated (475 ppm) CO₂ during spring of 2000 and 2001. 38

Chapter 3

- Figure 3.1: Decomposition of green leaf material, leaf litter and roots of various plant species. 58
- Figure 3.2: Effects of the CO₂ concentration during the production of the material and during decomposition on the relative N loss after 120 days of decomposition of green leaves and leaf litter of various species. 59
- Figure 3.3: Effects of the CO₂ concentration during the production of the material and during decomposition on the mass loss of faeces. 60
- Figure 3.4: Effects of the CO₂ concentration during the production of the material and during decomposition on the relative N loss of faeces. 60

Chapter 4

Figure 4.1: Schematic representation of the ingrowth core PVC pipes	75
Figure 4.2: Maximum and minimum air temperature and weekly rainfall at the experimental site over the course of the experiment.	77
Figure 4.3: Volumetric soil water content in the experimental plots under ambient and elevated CO ₂ over the course of the experiment.	77
Figure 4.4: Aboveground biomass under ambient and elevated CO ₂ at the 4 successive sampling dates.	78
Figure 4.5: Root growth rate under ambient and elevated CO ₂ for the 2 measurement periods.	79
Figure 4.6: Mass, C and N concentration, C and N pools and C/N ratio in organic matter fractions and total soil under ambient and elevated CO ₂ .	80
Figure 4.7: Effect of atmospheric CO ₂ concentration on the C/N ratio of the organic matter fractions and total soil.	81

Chapter 5

Figure 5.1: CO ₂ concentrations and daily average air temperature in the ambient and elevated CO ₂ glasshouse over the course of the experiment.	94
Figure 5.2: Schematic view of a plant before ¹⁴ C labelling.	95
Figure 5.3: Effects of the treatments on root, sheath and lamina and plant dry matter.	97
Figure 5.4: Effects of the treatments on root, sheath and lamina N concentration and total plant N content.	98

Chapter 6

Figure 6.1: Possible pathways through which elevated CO ₂ may affect plant-soil organic matter fluxes.	111
Figure 6.2: The effect of the intensity of grazing on the major physiological components of herbage growth and utilisation.	116
Figure 6.3: Relative N fluxes from herbage to litter and animal utilisation in a grazed pasture.	117

Figure 6.4: Relative C fluxes from herbage to litter and animal utilisation in a grazed pasture.	117
Figure 6.5: Effect of an increasing herbage utilisation on the average C/N ratio of the organic matter returns, the total N recycled and lost from the pasture and the proportion of cycling N lost from the pasture.	118
Figure 6.6: Impacts of various value of partitioning of ingested N between urine and faeces on total N losses from the pasture, the proportion of recycled N lost from the pasture.	119
Figure 6.7: Impacts of various leaf N resorption rates on a) the total amount of N recycled in the pasture and b) the C/N ratio of the organic matter returns	120

List of Plates

Plate 1.1: General view of an elevated CO ₂ ring at the New Zealand pasture FACE.	15
Plate 1.2: Examples of ecosystems studied with FACE systems	15
Plate 2.1: General view of an elevated CO ₂ FACE ring during grazing by adult sheep wearing faeces collection bags	28
Plate 3.1: Litter incubation bags in the field. Leaf material is placed at the soil surface and root material is buried.	50
Plate 4.1: View of an “ingrowth core” pipe buried in the field with a 45° angle	70
Plate 5.1: <i>Lolium perenne</i> plants in the assimilation chamber during ¹⁴ C labelling	90

**Chapter 1: Carbon and Nitrogen Interactions in
Grazed Pastures under Elevated CO₂- Background
and Objectives**

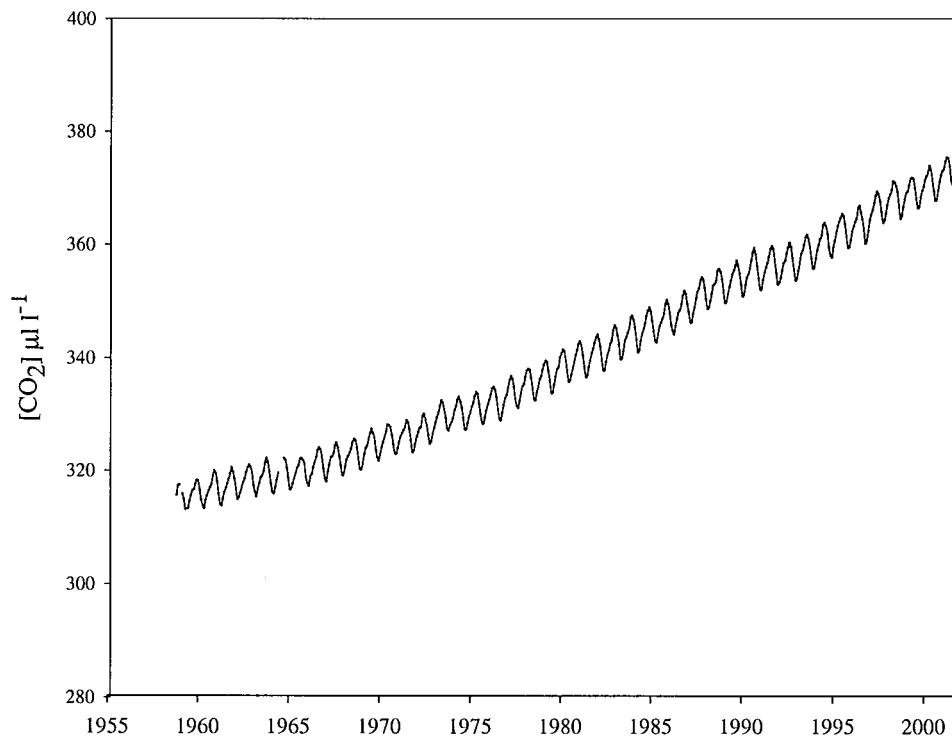

Figure 1.1: Rise of the atmospheric CO₂ concentration between 1958 and 2002. Measured at Mauna Loa, Hawaii, USA. Data from Keeling and Whorf, 2003.

Chapter 1: Carbon and Nitrogen Interactions in Grazed Pastures under Elevated CO₂- Background and Objectives

1.1. Introduction

Since the beginning of the industrial revolution, the intensive use of fossil energy sources (coal, oil and natural gas) and the continuing conversion of forests into agricultural land, has profoundly affected the chemical composition of our atmosphere by simultaneously increasing the sources and decreasing the sinks of biospheric carbon (C). This has led to an exponential increase of the atmospheric CO₂ concentration from a pre-industrial value of 280 $\mu\text{l l}^{-1}$ to about 373 $\mu\text{l l}^{-1}$ today (Fig. 1.1; Keeling and Whorf, 2003). Should this trend continue, CO₂ concentrations by the end of the 21st century are expected to be between 540 and 970 $\mu\text{l l}^{-1}$ (IPCC, 2001).

The increase in atmospheric CO₂ concentration has two major implications for the terrestrial ecosystems that should be considered separately. As a greenhouse gas, the rise in atmospheric CO₂ concentration could lead to an increase of global average air temperature and consequently strongly modify the functioning of the climate. It is estimated that surface temperatures have increased by 0.6°C since 1860 and that temperatures will be between 0.6 and 6°C warmer in 2100; this will have major implications for global and local climatic patterns, as well as for terrestrial ecosystem processes (IPCC, 2001). This thesis will not address the indirect effects of an increase in atmospheric CO₂ on air temperature and its numerous implications for plants but will focus on its direct effects on ecosystem functioning that occurs both at the single plant and community scales because CO₂ is the primary C substrate of photosynthesis.

In this context, the question of the response of grasslands to an increase in atmospheric CO₂ is of particular importance. Grasslands (temperate and savannas) account for more than 20% of the terrestrial surface and therefore predicting their response to elevated CO₂ has both major economic and ecological relevance. In addition, grasslands have a particular place in the total terrestrial C budget. Compared

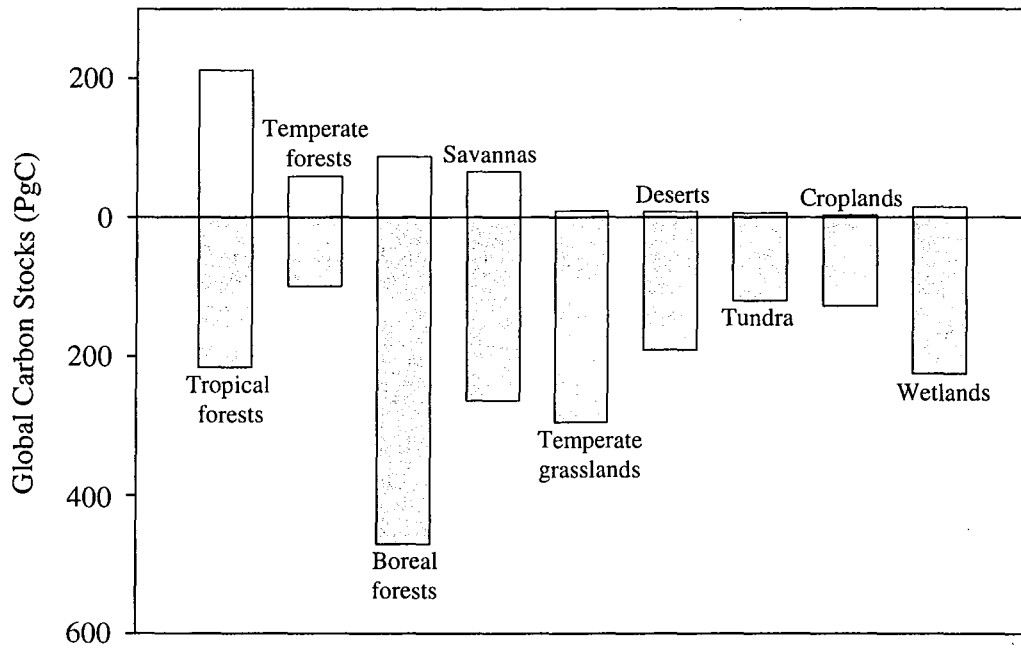

Figure 1.2: Estimates of terrestrial carbon stocks for the main biomes above (open bar) and belowground (full bar). Data from IPCC (2001).

to tropical forests, the C contained in grassland biomass is relatively limited, but when soils are taken into account their importance is dramatically increased (Fig. 1.2). Grasslands soils have been shown to sequester large amount of atmospheric C (Kim *et al.*, 1992; Franck *et al.*, 2000), a phenomenon that could contribute to buffer the increase in atmospheric CO₂.

Both grassland plant response to elevated CO₂ and sequestration of atmospheric CO₂ may be controlled by the availability of other nutrients and nitrogen (N) in particular. This thesis focuses on the C-N interactions in a grazed temperate grassland with an emphasis on how organic matter returns may affect soil N availability and organic matter content. In the following literature review I present results from previous studies about the effects of elevated CO₂ on single plant growth and show the difficulty of extrapolating these results to the ecosystem scale. I then give a brief description of the experimental site used in this work and show the advantages of the techniques used for understanding ecosystem responses to elevated CO₂.

1.2. Plant response to elevated CO₂

Because CO₂ concentration at its current level limits the rate of photosynthesis and hence C inputs into plants, elevated CO₂ has numerous effects on plant physiology. In this first part, I discuss the direct effects of elevated CO₂ on plant photosynthesis and growth. Attention is placed on the numerous controls affecting plant growth responses to elevated CO₂.

1.2.1. Photosynthesis stimulation

Increased photosynthetic activity at the leaf level under elevated CO₂ has been observed in a wide range of plants; including trees such as *Pinus sylvestris* (Jach and Ceulemans, 2000) and *Populus tremuloides* (Curtis *et al.*, 2000); crop species such as *Triticum aestivum* (Brooks *et al.*, 2000) and *Glycine max* (Ziska *et al.*, 2001); and

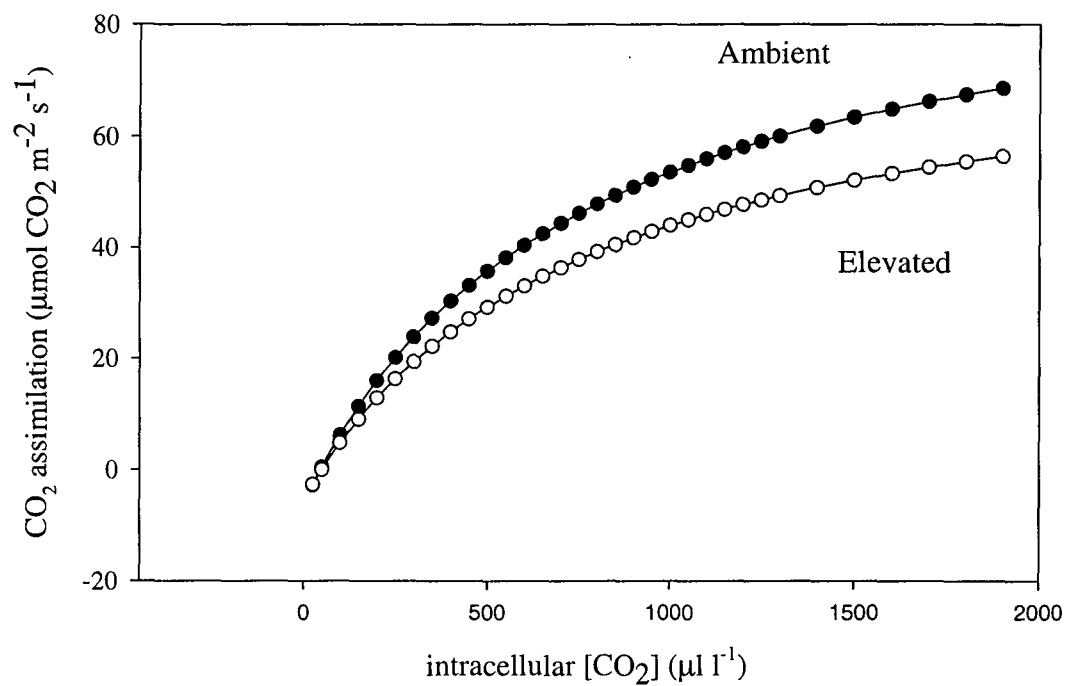

Figure 1.3: CO₂ dependency of photosynthesis of ryegrass (*Lolium perenne*) plants grown under ambient (full circles) or elevated (open circles) CO₂ for 3 months. The negative photosynthetic acclimation of plants grown under elevated CO₂ causes their lower assimilation rate.

pasture species like *Lolium perenne* (Rogers *et al.*, 1998) and *Trifolium repens* (Greer *et al.*, 2000).

As described by Farquhar (1980), C₃ photosynthesis, over the range of CO₂ concentrations occurring over a geological time scale (150-600 $\mu\text{l l}^{-1}$), is mainly limited by two phenomena; (i) the C fixation rate, which depends on the activity of ribulose 1,5-bisphosphate carboxylase-oxygenase (Rubisco) and (ii) on the regeneration of ribulose 1,5-bisphosphate (RuBP), which ultimately is limited by the availability of energy rich-compounds (ATP and NADPH). Under the current ambient CO₂ concentration Rubisco activity is unsaturated and therefore its activity increases with higher atmospheric levels of CO₂. In addition, because Rubisco has a double function (catalysing simultaneously RuBP carboxylation and oxygenation) the increase in the CO₂ concentration not only stimulates Rubisco activity but also limits photorespiration by displacing the competitive equilibrium between CO₂ and O₂ more towards carboxylation, hence reducing the amount of assimilated C immediately lost through this process.

The primary stimulation of photosynthetic rates under elevated CO₂ is partially buffered by a reduction of the photosynthetic capacity upon long-term exposure to high levels of CO₂ (Fig. 1.3), which is associated with reduced levels of Rubisco and organic N per unit leaf area (Long *et al.*, 1993). This down regulation or *acclimation* of photosynthesis usually increases with the duration of elevated CO₂ exposure and is most pronounced in plants grown under low nutrient supply (Sage, 1994). The causes of photosynthetic acclimation are both direct CO₂ control over photosynthesis and/or indirect CO₂ effects on plant N nutritional status (see review by Stitt and Krapp, 1999). Regardless of the main driver of acclimation and its physiological meaning, it is clear that the accumulation of non-structural carbohydrates usually observed under elevated CO₂ (see later) acts as a negative feedback on the synthesis of photosynthetic enzymes (Stitt, 1991).

Despite the acclimation phenomenon, plants growing under elevated CO₂ concentration usually maintain a higher photosynthetic rate per unit leaf area than plants growing under ambient CO₂ conditions, when they are studied in their respective growth environments. For example, recent data has shown that *Lolium*

perenne swards from a grass/legume mixture grown under elevated CO₂ for ten years sustained photosynthetic rates per unit leaf area about 40% higher than ambient plants, and with very little variation over the course of the experiment (Ainsworth *et al.*, 2003). In order to determine whether this increase in C assimilation per unit leaf area under elevated CO₂ is totally or only partially translated into more biomass, it is necessary to discuss the possible physiological controls over photosynthesis under elevated CO₂.

1.2.2. Plant growth responses to elevated CO₂

Although photosynthesis and growth are intricately linked, it does not mean that the CO₂ dependence of plant growth can be simply derived from the CO₂ dependence of photosynthesis (Lloyd and Farquhar, 1996). In a compilation of 14 long-term ecosystem-scale CO₂ studies, Körner (1996) clearly pointed out there was a missing link between the CO₂-induced stimulation of leaf photosynthesis and the amount of C in the biomass. In this compilation, 13 of the 14 experiments exhibited a disproportional increase in photosynthesis compared to biomass production when exposed to elevated CO₂. In a calcareous grassland, Leadley and Körner (1996) observed an increase in CO₂ assimilation under elevated CO₂ but this resulted in no above- or belowground biomass stimulation. Using a modelling approach to study this phenomenon, Luo *et al.* (1997) predicted that the observed increase of 70% in leaf photosynthesis in a Californian grassland community grown under elevated CO₂ should translate into an increase of 97% in plant biomass if no physiological adjustments in the plants occurred. This certainly did not match the observed 5, 13 and 40% biomass increases during the 3 years of the experiment.

The most likely reason for the discrepancy between growth and photosynthesis enhancement is that plants exhibit increased photosynthesis to the extent that they cannot fully incorporate the newly fixed C into additional growth. Firstly any supplementary photosynthetic C acquisition must be accompanied by increased maintenance respiratory costs (Lloyd and Farquhar, 2000). Secondly, plants grown under elevated CO₂ tend to accumulate non-structural carbohydrates in the leaves (Stitt, 1991; Casella and Soussana, 1997; Poorter *et al.*, 1997), usually taken as a sign

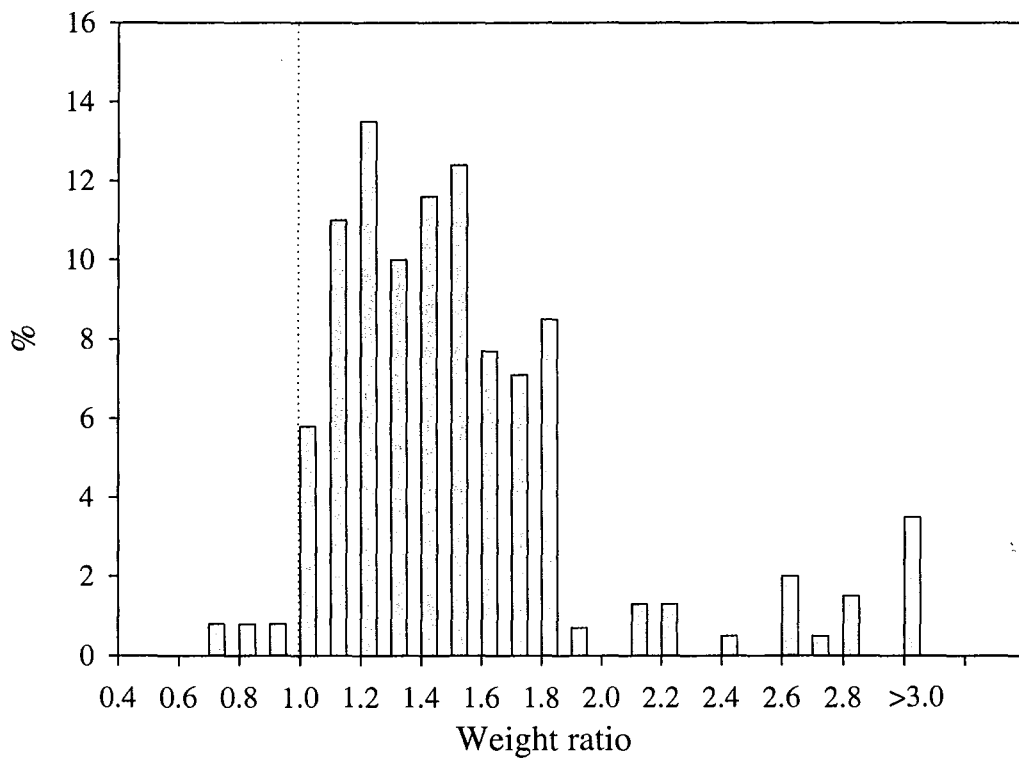

Figure 1.4: Plant response to elevated CO₂; distribution of the weight ratio (plant biomass_{elevated} / plant biomass_{ambient}). Data from Poorter (1993) after compilation of the literature (total number of species is 156). The vertical dotted line indicates a weight ratio of 1, i.e. no biomass response to elevated CO₂.

that the plant is unable to convert all the newly fixed C into structural biomass. Thirdly, due to this accumulation of non-structural carbohydrates, a decrease in plant specific leaf area (SLA) is one of the major adjustments found upon prolonged exposure to elevated CO₂ (Lambers *et al.*, 1998). By having more biomass in a given leaf area, the photosynthetic increase is partially buffered by having less light capture per unit biomass. Consequently growth stimulation is less than the photosynthetic stimulation per unit area (Evans and Poorter, 2001).

Despite these adjustments, single plant growth is usually greater under elevated CO₂. Poorter (1993), in a compilation of literature sources based on 156 different species found an average 37% stimulation of plant biomass (Fig. 1.4). Poorter also identified some functional traits, strongly linked with plant strategy, which were correlated with plant response to elevated CO₂. For example, species with a high relative growth rate (i.e. fast-growing species) were found to exhibit a higher response to elevated CO₂. This was supported by other studies also based on plant strategies (Hunt *et al.*, 1991). More generally, the plant response to elevated CO₂ might depend on the capacity to functionally use the newly fixed C (i.e. plants with strong C sinks) through: (i) greater accumulation of C in storage organs (Diaz, 1995), (ii) increased C allocation towards symbiotic microorganisms, for example mycorrhizal infection (Rillig *et al.*, 1998), or (iii) enhanced allocation belowground through higher root growth, turnover or exudation (Paterson *et al.*, 1996). Based on this information, it is intuitive that the fate of the extra C fixed under elevated CO₂ not only depends on a plants inherent capacity to use it, but also on the availability of other nutrients.

1.2.3. Nutrient dependency of plant response to elevated CO₂

CO₂ is just one of the many inorganic substrates that are required by plants to grow. Their response to elevated CO₂ will thus depend on the availability of other nutrients and the way they are utilised by the plant. Bazzaz (1990) stated that nutrient-limited plants respond less to increases in atmospheric CO₂ than plants grown at high nutrient availability. Under elevated CO₂, the higher rates of growth create a higher demand for other nutrients relative to C; these become relatively more limiting for

plant growth. In an experiment assessing the CO₂ response of a grass (*L. perenne*) under different soil nitrogen regimes, the CO₂-induced photosynthetic response was 3-fold greater with high N availability (Casella and Soussana, 1997). More generally, meta-analyses compiling numerous studies to assess the interactions between CO₂ and nutrient availability tend to show that on average, whole plant biomass stimulation under elevated CO₂ is less at low nutrient levels (Poorter, 1998; Poorter and Pérez-Soba, 2001). One reason for this positive relationship between CO₂ and N availability relies on the fact that, regardless of the elevated CO₂ issue, low-nutrient plants consistently show an accumulation of non-structural carbohydrates in the leaves (Chapin, 1980). This might therefore accentuate the photosynthesis acclimation phenomenon, which is partially induced by non-structural carbohydrates. Photosynthetic acclimation has indeed often been seen to be stronger under low N supply (Sage, 1994; Bowler and Press, 1996).

Nevertheless, plant C and N metabolic processes are in close interrelation and therefore there are numerous feedbacks between them (Stitt and Krapp, 1999). In particular thinking that an increased C availability simply increases the relative need for N or other nutrients would be over-simplistic, because elevated CO₂ might also affect the use of the existing nutrients. For example, a classic outcome of CO₂ studies is increased N use efficiency (NUE) i.e. the rate of growth per unit N taken up increases under elevated CO₂ (Davey *et al.*, 1999; Midgley *et al.*, 1999; Osborne *et al.*, 1998). Because under elevated CO₂ a given rate of C assimilation can be achieved with lower activities of Rubisco or other photosynthetic enzymes (Stitt, 1991; Rogers *et al.*, 1996), this allows the reinvestment of photosynthetic N into more limiting processes (Stitt and Krapp, 1999). When these complex physiological controls between C and N metabolisms are taken into account, the relationship between plant CO₂ response and N supply is not clear-cut and this may explain the results of certain studies where there were higher responses to CO₂ under low N supply (see for example Wong *et al.* 1992; Hocking and Meyer, 1991). Lloyd and Farquhar (1996), using an approach based on photosynthetic models, predicted that there was no simple relationship between N and CO₂ because of the variability of plant nutritional status and/or strategy of nutrient economy.

The issue of N control over the plant response to CO₂ assumes another dimension when the possible effects of CO₂ on soil N availability are taken into account: observed effects have been both positive (Zak *et al.*, 1993) and negative (Diaz *et al.*, 1993). This highlights two important needs in elevated CO₂ studies: the necessity of whole ecosystem studies to take into account possible feedbacks through soil processes, and the need for long-term experiments in order to allow these feedbacks to occur.

1.3. The difficulty in predicting ecosystem responses to elevated CO₂

When studying the effects of elevated CO₂ on complex ecosystems such as grasslands, interspecific competition and resource limitation become important (Körner, 1996). Prediction at the ecosystem scale based upon extrapolation of data obtained from a simpler system (typically at the single plant scale) has potential pitfalls. In particular it is important to consider spatial variability and possible time issues as these can profoundly alter system responses to elevated CO₂.

1.3.1. CO₂ effects in multispecific systems

A good example of the difficulty in extrapolating community responses to elevated CO₂ from single plant studies is the question of the relative response to elevated CO₂ of C₄ plants compared to C₃ plants. Early studies of this issue appeared to confirm the hypothesis that C₄ plants should not show significant growth responses to elevated CO₂ (Curtis *et al.*, 1989), due to the CO₂-concentrating mechanism in their bundle sheath cells. This mechanism increases the effective concentration of CO₂ at the carboxylation site, thereby masking photorespiration and apparently assuring the saturation of Rubisco at ambient CO₂ concentration. Therefore C₄ plants should not benefit from increased CO₂ concentration and may suffer reduced competitive abilities over C₃ species. However, in a meta-analysis of the response of C₄ and C₃ grass species to elevated CO₂, Wand *et al.* (1999) showed that this issue was not as clear-cut as previously thought. Both C₄ and C₃ species increased total biomass under elevated CO₂ by 33% and 44% respectively. When the two types of plants are in

competition, the problem of the relative response of C₃ and C₄ plants can even be more complex. An experiment comparing the response to elevated CO₂ of cotton (*Gossypium hirsutum*, C₃) and sorghum (*Sorghum bicolor*, C₄) showed that even though the C₃ plant had a greater response to CO₂ in monoculture, the C₄ was still a better competitor in the mixture (Derner *et al.*, 2003). Similar outcomes can be found in non-arable ecosystems: after 8 years of enrichment in a tallgrass prairie ecosystem, Owensby *et al.* (1999) observed little modification of the C₄-C₃ balance. This is particularly true under some sort of environmental stress situation (e.g. water limitation) in which case C₄ plants tend to maintain their CO₂-induced stimulation to a greater extent than C₃ plants. Predicting the response of multispecific systems to elevated CO₂ requires more than simple compilation of single-species studies and therefore, species diversity must be included within any experiments designed to obtain valid results on community scale responses to elevated CO₂.

In temperate grasslands, one of the strongest trends emerging from multispecific experiments concerns legume abundance. Numerous studies in a range of conditions have measured an increased legume abundance under elevated CO₂: e.g. permanent grasslands (Clark *et al.*, 1997; Teyssonneyre, 2002; Edwards *et al.*, 2001a); or *Lolium perenne* – *Trifolium repens* mixture (Lüscher *et al.*, 1996; Hebeisen *et al.*, 1997). The increased competitive ability of the legumes is generally attributed to their capacity to fix atmospheric N that allows them to meet the enhanced requirements for N induced by the CO₂ stimulation effect (Lüscher *et al.*, 2000). The CO₂-driven increase in legume abundance under elevated CO₂ is nevertheless not ubiquitous (Navas *et al.*, 1995; Leadley and Körner, 1996); this may be explained to some extent by phosphorus limitation, a nutrient that is often underestimated as a key driver of the legume CO₂ response (Stöcklin and Körner, 1999; Körner, 2000).

From the literature it appears that even two strongly deterministic physiological traits that are intuitively of primary importance in the plant CO₂-response process (photosynthetic type and N₂-fixing ability), cannot be used as universal predictors of the CO₂ effects at the community level. The difficulty in predicting community response to elevated CO₂ is even greater when temporal aspects are taken into account.

1.3.2. Duration of the CO₂ enrichment

Some of the processes discussed above (e.g. the acclimation phenomenon or the discrepancy between photosynthesis and biomass production responses to elevated CO₂) intuitively lead to the problem of *time* in elevated CO₂ experiments. CO₂ affects photosynthesis within seconds after CO₂ enrichment (the time for stomatal CO₂ concentration to adjust with the atmospheric concentration), while acclimation only occurs within days since it is (partly) controlled by an accumulation of non-structural carbohydrates in the leaves. The time problem is even more acute at higher levels of spatial complexity, increasing the number of possible feedbacks. Therefore the duration of the CO₂ enrichment applied to a given community can have a central importance when predicting its future functioning.

A valuable resource for assessing the differences between long-term and short-term plant responses to elevated CO₂ are natural CO₂ springs (Raschi *et al.*, 1997). They provide situations where both plants and soil have been exposed for long periods of time to high levels of CO₂ and therefore the system is likely to have adapted to this environment and to have reached a steady state. If such naturally CO₂-enriched sites have nearby a standard site with similar characteristics and ambient CO₂ concentration it is possible to compare short- and long-term responses to elevated CO₂. Using such a natural CO₂ source and a cross-over experiment (i.e. transplanting soil cores from enriched locations to ambient locations and *vice versa*), Newton *et al.* (2001a) clearly showed the discrepancy existing between transient and equilibrium responses to elevated CO₂, particularly because of the long-term alterations of soil substrate and/or decomposer communities.

Similarly, changes in botanical composition under elevated CO₂ may require the integration of numerous phenomena that can be affected by CO₂ at different time scales. As discussed previously, legume proportion usually increases in temperate grasslands under elevated CO₂. But long-term changes in community botanical composition not only occur through vegetative process but also through difference in the response of reproductive mechanisms to elevated CO₂. Edwards *et al.* (2001a, 2001b) clearly showed that seed production and seedling recruitment and performance were all affected by elevated CO₂ in a temperate grassland and that this effect was

species-specific. In particular, under elevated CO₂, *Trifolium repens*, a species exhibiting a strong response to elevated CO₂ in this particular system exhibited the following effects: (i) *T. repens* produced seeds with higher germination %, (ii) the resulting seedlings had a greater mass and (iii) seedlings grown from elevated CO₂ seeds had a higher survival rate when sown into the pasture. Consequently, changes in species composition not only reflect the effects of elevated CO₂ on the abundance of existing plants through vegetative competition, but also CO₂ effects on the recruitment of new plants from seeds. Because these processes do not affect the community at the same time scale and because they are inter-dependent, excluding one of them in a study by extrapolating short-term results to long-term community response may be seriously misleading.

1.3.3. The step increase issue

A second aspect of elevated CO₂ studies dealing with time relies on the methods used to simulate an increase in elevated CO₂, in particular the potential initial artefact caused by a step increase in CO₂. In the majority of CO₂ experiments, a single concentration step CO₂ increase is used to simulate future atmospheric CO₂ concentration. However, plants in the “real world” are not, and will not, be exposed to such an abrupt increase in CO₂ but rather to a gradually rising concentration at a rate of about 1.5 $\mu\text{mol mol}^{-1} \text{ year}^{-1}$ (IPCC, 2001). In response to a step increase in CO₂, photosynthetic rates usually dramatically increase (see above). The resulting large increment in photosynthetic C influx may exert different effects on the physiological processes compared to small increments in C influx observed with a gradual CO₂ increase (Luo, 2001). In an 80 day experiment comparing the effects of a step increase of elevated CO₂ (700 $\mu\text{mol mol}^{-1}$) with a gradual increase of 5 $\mu\text{mol mol}^{-1} \text{ day}^{-1}$ (reaching 700 $\mu\text{mol mol}^{-1}$ by the end of the experiment) on *Plantago lanceolata* photosynthesis and growth, Hui *et al.* (2002) showed that the step CO₂ increase resulted in an immediately higher leaf photosynthesis rate and induced a large N demand and stress that led to considerable down-regulation of photosynthesis. In comparison, the gradual increases stimulated photosynthesis gradually and created limited N stress. Nevertheless growth response under the two CO₂ treatments seemed

to converge at the end of the experiment showing a possible attenuation of the step-increase artefact with time.

Another aspect of the artefact created by a step-increase in elevated CO₂ relies on the fact that ecosystem responses to elevated CO₂ may depend on the concentration of the “elevated CO₂ treatment”. Indeed the response of some measured variables can be non-linearly related (i.e. not proportional) with the simulated increase of the CO₂ concentration. A good illustration of this phenomenon is given by studies using more than two CO₂ treatments (ambient and enriched), (e.g. Hunt *et al.*, 1991; Sims *et al.*, 1998, Clark *et al.*, 1997; Granados and Körner, 2002); or a gradient of concentrations from sub-ambient to super-ambient CO₂ concentrations (Gill *et al.*, 2002). For example Gill *et al.* (2002) showed that organic matter accumulation in a grassland soil was more sensitive to an increase from sub-ambient to ambient CO₂ concentration than to an increase from ambient to super-ambient CO₂ concentration. This implies the existence of specific thresholds that influence the magnitude of the change in some ecosystem processes. Granados and Körner (2002) also showed that the relative stimulation of growth by elevated CO₂ was larger at low as compared to higher ranges of CO₂ concentration. But in their experiment this phenomenon was species-specific with one species in particular expressing a negative effect of CO₂ at the highest CO₂ concentration used.

Predictive studies intrinsically require anticipation of future CO₂ conditions and therefore some sort of step-increase artefact is inevitable. But the examples given above clearly show that short-term plant responses to a step increase in CO₂ are far from being equilibrium responses. Therefore long-term studies should be preferred because they might allow systems to reach equilibrium, or at least show a reliable trajectory of response.

1.3.4. The need for large spatio-temporal studies to assess C-N interactions in grasslands under elevated CO₂

An important aspect of ecosystems response to elevated CO₂ dealing with both space and time are the numerous interactions existing between the C and N cycles.

We have seen so far that N is an important driver of both single plant response and community response to elevated CO₂ since the relative availability of C and N could induce feedbacks on photosynthesis at the plant scale but also shifts in botanical composition. The question of feedbacks in elevated CO₂ studies has already been described previously but let discuss more exhaustively how the CO₂-induced changes occurring at these different scales may induce feedback through soil N availability.

It has long been recognised that soil N availability could be a key driver of long-term plant responses to elevated CO₂ through increased immobilisation (Diaz *et al.*, 1993) or mineralisation (Zak *et al.*, 1993) of soil N under elevated CO₂. Various organic matter fluxes in the soil may alter organic matter dynamics under elevated CO₂: decreased quality of leaf litter (Strain and Bazzaz, 1983; Cotrufo and Ineson, 1996) and increased biomass allocation to roots (Cotrufo and Gorissen, 1997), both leading to lower decomposition rates and subsequently limit N availability for plant growth. In addition, increased root exudation of readily decomposable C (Paterson *et al.*, 1996) might stimulate the growth of soil microorganisms leading to higher N immobilisation. These processes will be reviewed more comprehensively later in this thesis but I will now set out why their existence requires a high level of integration. Firstly, as implied by many of the concepts discussed above, N cycling can be affected by elevated CO₂ both at the plant scale through a decrease in leaf N concentration (Cotrufo *et al.*, 1998), or at the community scale through an alteration of botanical composition. Secondly, soil N mineralisation not only depends on organic matter deposition through plant senescence (i.e. processes that can be affected in the relative short-term by elevated CO₂) but also by soil micro- and meso-fauna activity. Because soil organisms are further down in the chain of reactions through which elevated CO₂ affects ecosystem functioning, enough time is needed for them to reach a new equilibrium and for possible feedbacks to occur.

Table 1.1: Major elevated CO₂ experiments in grasslands.

Location	Vegetation type	Reference	Facility	[CO ₂]	Experimental duration	Past management	Defoliation
Colorado, USA	Shorthgrass steppe (C3-C4)	Morgan <i>et al.</i> , 2001	OTC	Amb-720	About 3 years	Low to moderate grazing by cattle	2 cuts per year
Kansas, USA	Tallgrass prairie (C3-C4)	Owensby <i>et al.</i> , 1999	OTC	Amb-twice amb	8 years	Winter grazing by cattle	1 cut per year
Texas, USA	Grassland (C3-C4)	Polley <i>et al.</i> , 2002	Tunnels	200-550 gradient	About 3 years	Grazed grassland	1 cut per year
California, USA	Annual grassland	Hungate <i>et al.</i> , 1997	OTC	Amb-Amb+350	4 years	n.a.	Single regrowth
California, USA	Sown annual grassland	Cardon <i>et al.</i> , 2001	OTC	Amb-Amb+350	Various	New	Single regrowth
California, USA	Annual grassland	Shaw <i>et al.</i> , 2002	Mini-Face	Amb-680	Since 1998	n.a.	Single regrowth
Minnesota, USA	Sown perennial grassland	Reich <i>et al.</i> , 2001	FACE	Amb-550	Various	New	
Clermont-Fd, France	Sown mixtures	Teyssonneyre <i>et al.</i> , 2002	Glasshouse	Amb-700	1 year	New	2 treatments : 3 or 6 cuts per year
Clermont-Fd, France	Sown ryegrass	Soussana <i>et al.</i> , 1996	Glasshouse	Amb-700	2 years	New	6 cuts per year
Clermont-Fd, France	Perennial grassland monoliths	Teyssonneyre, 2002	Mini-Face	Amb-600	about 4 years	Grazing by sheep	2 treatments : 4 or 8cuts per year
Basel, Switzerland	Calcareous grassland	Niklaus <i>et al.</i> , 2001	SACC (OTC)	Amb-600	5 years	Extensively grazing by cattle	2 cuts per year
Basel, Switzerland	Calcareous grassland monoliths	Stöcklin <i>et al.</i> , 1998	Glasshouse	Amb-600	2 years	Extensively grazing by cattle	2 cuts per year
Basel, Switzerland	Sown simulated grasslands	Stöcklin <i>et al.</i> , 1999	Glasshouse	Amb-600	2 years	new	2 cuts per year
Zurich, Switzerland	Lolium-Trifolium mixture	Glöser <i>et al.</i> , 2000	FACE	Amb-600	8 years	new	2 treatments : 4 or 8 cuts per year
Bulls, New Zealand	Perennial pasture turves	Newton <i>et al.</i> , 1994	Growth chamber	350-700	217 days	Grazed grassland	Cut every 3 weeks
Bulls, New Zealand	Perennial pasture turves	Clark <i>et al.</i> , 1997	Growth chamber	350-525-700	324 days	Grazed grassland	2 treatments: every 3 or 6 weeks
Bulls, New Zealand	Perennial grassland	Edwards <i>et al.</i> , 2001a	FACE	Amb-475	Since 1997	Grazed grassland	Grazed

1.4. The New Zealand grazed pasture FACE experiment

1.4.1. Free air CO₂ enrichment (FACE) experiments

In order to study the effects of elevated CO₂ on communities it is therefore essential to take into account the issue of time and scale discussed above. Free Air CO₂ Enrichment (FACE) experiments were developed to meet this need. This is a technology that delivers consistent CO₂ concentration, to large plots of an intact ecosystem without walls, and therefore without altering the microclimate or disturbing the soil (Allen, 1992; Hendrey *et al.*, 1993). In particular FACE does not modify environmental factors such as incident solar radiation, temperature, humidity and wind compared with methods that grow plants under elevated CO₂ in some sort of enclosure (i.e. glasshouses, tunnels and open-top chambers (OTC)). FACE systems release CO₂ to area of vegetation ranging from 1 to 27 m in diameter. Various technologies are used but all the systems control the CO₂ concentration in the target area using feedbacks that take into account of wind speed and direction and the CO₂ concentration (Plate 1.1). Enrichment may be to a set point or as a percentage addition to the ambient level (McLeod and Long, 1999). The FACE technique has been successfully used to grow a variety of vegetation types under elevated CO₂ (Plate 1.2): including rice (Okada *et al.*, 2001), pastures (Hebeisen *et al.*, 1997) and trees (Matamala and Schlesinger, 2000).

1.4.1. Specifications of the New Zealand FACE

Worldwide there have been numerous FACE experiments on grassland, which have together with smaller scale studies (Table 1.1) produced useful information at scales ranging from plant physiology to ecosystem ecology under elevated CO₂. Nevertheless none of these studies, often for practical limitations, have used grazing animals to achieve defoliation, whereas the majority of grassland ecosystems worldwide are grazed, at least to some extent, by wild or domestic animals. Table 1.1 highlights the fact that all existing experiment studying the effect of elevated CO₂ on grassland excluded grazing even when it was part of the normal management of the ecosystem.

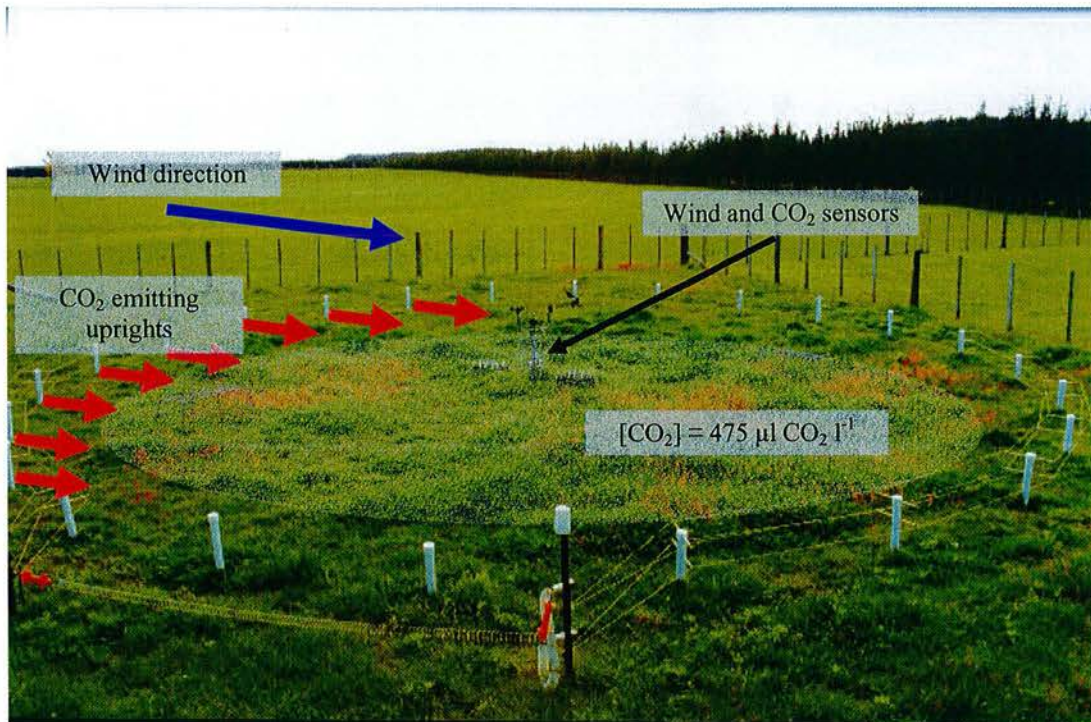

Plate 1.1: General view of an elevated CO₂ ring at the New Zealand pasture FACE. Depending on the wind direction measured in the centre of the ring, CO₂ enriched air is emitted by uprights encircling the ring that are in the wind. The CO₂ concentration is monitored by a CO₂ sensor at the centre of the ring.



Plate 1.2: FACE systems have been designed to simulate CO₂ enrichment on various ecosystems including (a) an Aspen forest (Wisconsin, USA), (b) a loblolly pine forest (North Carolina, USA), (c) a Mojave desert ecosystem (Nevada, USA) and (d) crops such as rice (Shizukuishi, Japan).

The New Zealand FACE experiment starts from the premise that the inclusion of grazers and ruminants in grassland studies may be of central importance for a number of reasons. First, concerning CO₂ effects on pasture botanical composition, the homogeneous removal of the vegetation by cutting does not take into account possible selective grazing by ruminants (Parsons *et al.*, 1994). Such a supplementary pressure on the selected species might be of importance in determining community response. More complex interactions between CO₂ and management (cutting or grazing) may also occur (Newton *et al.*, 2001b). Second, regarding the important question of N cycling under elevated CO₂, grazed grassland will differ significantly from cut grasslands both in terms of the amount of nutrient and the heterogeneity of these returns (Haynes and Williams, 1993), leading to the likelihood that these systems will differ in their response to elevated CO₂. Because, at a global scale, most of the grasslands are at least partially managed with domestic livestock, the prediction of grassland response to elevated CO₂ must at some stage include ruminants or other grazers in the scope of study. Compared to other grassland FACE experiments, the inclusion of grazing by sheep within the normal experimental management is the main distinguishing feature of the New Zealand pasture FACE.

1.4.2. Description of the facility

The New Zealand pasture FACE was set up in a pasture at Bulls, Manawatu, New Zealand (40°14'S, 175°16'E). The pasture had been under permanent grazing since the 1940s by cattle, sheep and goats with occasional hay cuts taken. An exhaustive botanical composition determination of the pasture in spring 1996 found 25 vascular plant species including the C₃ grasses *Agrostis capillaris* L., *Anthoxanthum odoratum* L., *Lolium perenne* L., the C₄ grasses *Paspalum dilatatum* Poir. and *Cynodon dactylon* (L.) Pers., the legumes *Trifolium repens* L., *Trifolium subterraneum* L. and *Trifolium dubium* L. and the herbs *Hypochaeris radicata* L. and *Leontodon saxatilis* Lam syn. L. taraxacoides. All the species found were non native. The soil at the site is a Pukepuke black sand (Mollic Psammaquent) with a 0.25-m black loamy, fine sand top horizon underlain by greyish-brown, fine sand textured

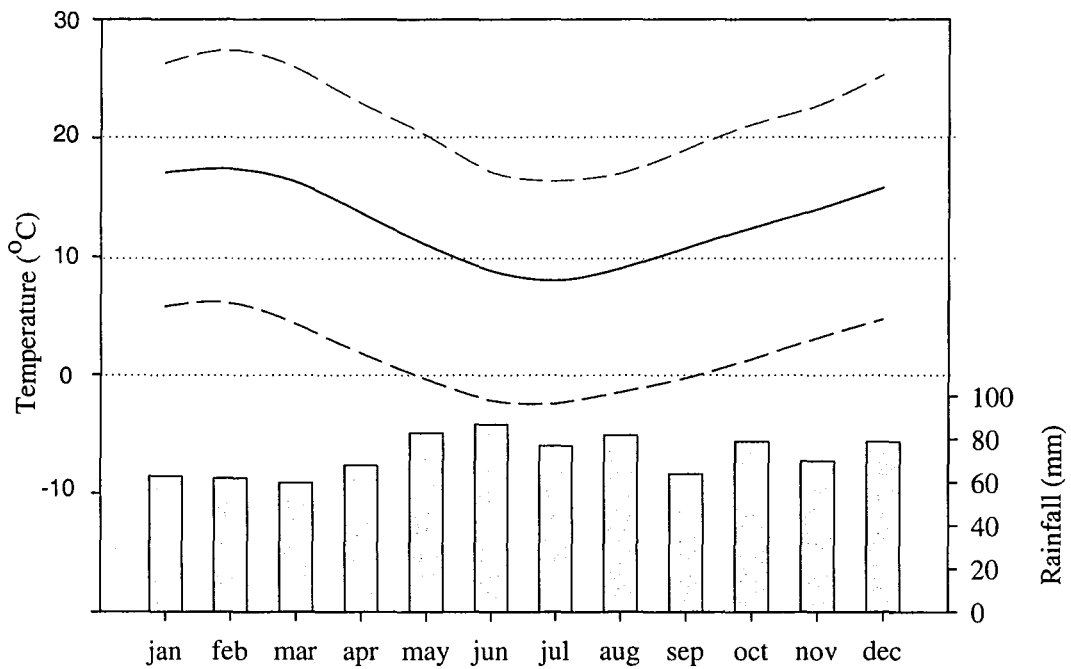

Figure 1.5: Twenty years temperature and rainfall average at the experimental site recorded from a nearby weather station (Flock House, Bulls). Average monthly temperature is indicated by the full line and maximum and minimum monthly average are also represented. Average monthly rainfall is indicated by the full bars.

horizons. Mean values of some physico-chemical characteristics of this soil in 1997 were: pH = 5.8, K=0.15 cM (+) kg soil⁻¹, P (phosphate) = 20 µg ml soil⁻¹ and S (sulphate) = 7 µg ml soil⁻¹ (data previously compiled by Edwards *et al.*, 2001b). Mean rainfall and air temperature at the experimental site are shown in Fig. 1.5.

The FACE facility consists of six rings, each 12 m in diameter. Three blocks of two rings were grouped based on initial botanical composition and soil properties. One ring in each block was selected to be enriched with CO₂, the other being left at ambient CO₂ concentration. Each ring was fenced off in order to control sheep access and the duration of the grazing events. The FACE system was installed during the first nine months of 1997 and enrichment began on 1 October 1997. The target CO₂ concentration for elevated CO₂ plots is 475 µl l⁻¹ CO₂ during the photoperiod. Enrichment takes place through 24 standpipes, each 0.05 m in diameter, located on the perimeter of each ring. Enriched air is blown across the ring from the up wind direction. The rings are intermittently grazed by sheep. Grazing begins when aboveground herbage biomass reach 1.8-2 t DM ha⁻¹ and continues until the residual biomass is about 0.5-0.7 t DM ha⁻¹. Standing dry matter and botanical composition of the rings is measured before and after each grazing event.

1.4.3. Objectives of the work

As discussed above, N cycling in grasslands submitted to elevated CO₂ is central to predict the response of this ecosystem to our changing climate. Elucidation of this forms the core objective of this thesis which is based on four separate experiments.

- As discussed previously, elevated CO₂ affects pasture both at the plant and the community scale. With regard to the question of N cycling, the decrease in leaf N concentration usually observed at the single plant scale under elevated CO₂ is accompanied, at the community scale, by an increase in legume proportion, possibly counterbalancing the leaf N concentration decrease. Because ruminants, through grazing, integrate both these effects of elevated CO₂ on pasture N status I

hypothesised that N returns by the ruminants grazing in a pasture under elevated CO₂ might be altered.

- A second pathway of organic matter and N return to the soil is litter decomposition. Though it is usually accepted that litter decomposition *per se* is not affected by elevated CO₂, there is still debate over the possibility that indirect effects of elevated CO₂ on botanical composition and shoot/root biomass partitioning might alter decomposition rates at the ecosystem scale. Therefore I compared *in situ* decomposition rates of leaf litter from different species, root material and faeces in order to integrate the different levels at which elevated CO₂ may act.
- The effects of elevated CO₂ on litter decomposition rates are not the only drivers of possible alterations of N availability and soil organic matter accumulation. The size of the litter fluxes returning to the soil is also of importance. Therefore I assessed the question of the quantity of plant material returning to the soil under elevated CO₂ and in particular, attention was paid to root growth and turnover, processes that are expected to be strongly enhanced under elevated CO₂. I hypothesised that if organic matter flux size was greater under elevated CO₂, it may lead to a detectable accumulation of young organic matter in the soil under elevated CO₂ and to a subsequent immobilisation of mineral N and accumulation of C in the soil.
- In order to test whether long-term feedbacks through the possible CO₂-driven changes in soil organic matter could affect plant response to elevated CO₂ a glasshouse experiment was set up. Soil from ambient and enriched rings were used in a cross-over design under ambient or enriched atmospheric CO₂ concentration and the growth and N yield of a model species, *Lolium perenne* was measured.

Finally, in a general discussion, some questions raised by the previous result chapters are developed and some perspectives about this work are discussed.

1.5. References

- Ainsworth EA, Davey PA, Hymus GJ, Osborne CP, Rogers A, Blum H, Nösberger J, Long SP (2003) Is stimulation of leaf photosynthesis by elevated carbon dioxide concentration maintained in the long term? A test with *Lolium perenne* grown for 10 years at two nitrogen fertilization levels under Free Air CO₂ Enrichment (FACE). *Plant, Cell and Environment*, **26**, 705-714.
- Allen LH (1992) Free-air CO₂ enrichment field experiments - an historical overview. *Critical Reviews in Plant Sciences*, **11**, 121-134.
- Bazzaz FA, Coleman JS, Morse SR (1990) Growth-responses of 7 major co-occurring tree species of the northeastern united-states to elevated CO₂. *Canadian Journal of Forest Research*, **20**, 1479-1484.
- Bowler JM, Press MC (1996) Effects of elevated CO₂, nitrogen form and concentration on growth and photosynthesis of a fast- and slow- growing grass. *New Phytologist*, **132**, 391-401.
- Brooks TJ, Wall GW, Pinter Jr. PJ, Kimball BA, LaMorte RL, Leavitt SW, Matthias AD, Adamsen FJ, Hunsaker DJ, Webber AN (2000) Acclimation response of spring wheat in a free-air CO₂ enrichment (FACE) atmosphere with variable soil nitrogen regimes. 3. Canopy architecture and gas exchange. *Photosynthesis Research*, **66**, 97-108.
- Cannell MGR, Thornley HM (1998) N-poor ecosystems may respond more to elevated (CO₂) than N-rich ones in the long term. A model analysis of grassland. *Global Change Biology*, **4**, 431-442.
- Cardon ZG, Hungate BA, Cambardella CA, Chapin III FS, Field CB, Holland EA, Mooney HA (2001) Contrasting effects of elevated CO₂ on old and new soil carbon pools. *Soil Biology and Biochemistry*, **33**, 365-373.
- Casella E, Soussana J-F (1997) Long-term effects of CO₂ enrichment and temperature increase on the carbon balance of a temperate grass sward. *Journal of Experimental Botany*, **48**, 1309-1321.
- Chapin FS (1980) The mineral nutrition of wild plants. *Annual Review of Ecology and Systematics*, **11**, 233-260.
- Clark H, Newton PCD, Bell CC, Glasgow EM (1997) Dry matter yield, leaf growth and population dynamics in *Lolium perenne* / *Trifolium repens* - dominated

- pasture turves exposed to two levels of elevated CO₂. *Journal of Applied Ecology*, **34**, 304-316.
- Cotrufo MF, Gorissen A (1997) Elevated CO₂ enhances below-ground C allocation in three perennial grass species at different levels of N availability. *New Phytologist*, **137**, 421-431.
- Cotrufo MF, Ineson P (1996) Elevated CO₂ reduces field decomposition rates of *Betula pendula* (Roth.) leaf litter. *Oecologia*, **106**, 525-530.
- Cotrufo MF, Ineson P, Scott A (1998) Elevated CO₂ reduces the nitrogen concentration of plant tissues. *Global Change Biology*, **4**, 43-54.
- Curtis PS, Drake BG, Whigham DF (1989) Nitrogen and carbon dynamics in C₃ and C₄ estuarine marsh plants grown under elevated CO₂ in situ. *Oecologia*, **78**, 297-301.
- Curtis PS, Vogel CS, Wang XZ, Pregitzer KS, Zak DR, Lussenhop J, Kubiske M, Teeri JA (2000) Gas exchange, leaf nitrogen, and growth efficiency of *Populus tremuloides* in a CO₂-enriched atmosphere. *Ecological Applications*, **10**, 3-17.
- Davey PA, Parsons AJ, Atkinson L, Wadge K, Long SP (1999) Does photosynthetic acclimation to elevated CO₂ increase photosynthetic nitrogen-use efficiency? A study of three native UK grassland species in open-top chambers. *Functional Ecology*, **13**, 21-28.
- Derner JD, Johnson HB, Kimball BA, Pinter Jr PJ, Polley HW, Tischler CR, Boutton TW, LaMorte RL, Wall GW, Adam NR, Leavitt SW, Ottman MJ, Matthias AD, Brooks TJ (2003) Above- and below-ground responses of C₃-C₄ species mixtures to elevated CO₂ and soil water availability. *Global Change Biology*, **9**, 452-460.
- Diaz S (1995) Elevated CO₂ responsiveness, interactions at the community level and plant functional types. *Journal of Biogeography*, **22**, 289-295.
- Diaz S, Grime JP, Harris J, McPherson E (1993) Evidence of a feedback mechanism limiting plant response to elevated carbon dioxide. *Nature*, **364**, 616-617.
- Edwards GR, Clark H, Newton PCD (2001a) The effects of elevated CO₂ on seed production and seedling recruitment in a sheep-grazed pasture. *Oecologia*, **127**, 383-394.
- Edwards GR, Newton PCD, Tilbrook JC, Clark H (2001b) Seedling performance of pasture species under elevated CO₂. *New Phytologist*, **150**, 359-369.

- Evans JR, Poorter H (2001) Photosynthetic acclimation of plants to growth irradiance: the relative importance of specific leaf area and nitrogen partitioning in maximizing carbon gain. *Plant, Cell and Environment*, **24**, 755-767.
- Farquhar GD, von Caemmerer S, Berry JA (1980) A biochemical model of photosynthetic CO₂ assimilation in leaves of C₃ species. *Planta*, **149**, 78-90.
- Frank AB, Sims PL, Bradford JA, Mielnick PC, Dugas WA, Mayeux HS (2000) Carbon dioxide fluxes over three Great Plains grasslands. In: *The Potential of U.S. Grazing Lands to Sequester Carbon and Mitigate the Greenhouse Effect* (eds Follett RF, Kimble JM, Lal R), pp. 167-187. Lewis Publishers, Boca Raton.
- Gill RA, Polley HW, Johnson HB, Anderson LJ, Maherali H, Jackson RB (2002) Nonlinear grassland responses to past and future atmospheric CO₂. *Nature*, **417**, 279-282.
- Glöser V, Frehner M, Lüscher A, Nösberger J, Hartwig UA (2002) Does the response of perennial ryegrass to elevated CO₂ concentration depend on the form of the supplied nitrogen? *Biologia Plantarum*, **45**, 51-58.
- Granados J, Körner C (2002) In deep shade, elevated CO₂ increases the vigor of tropical climbing plants. *Global Change Biology*, **8**, 1109-1117.
- Greer DH, Laing WA, Campbell BD, Halligan EA (2000) The effect of perturbations in temperature and photon flux density on the growth and photosynthetic responses of five pasture species. *Australian Journal of Plant Physiology*, **27**, 301-310.
- Haynes RJ, Williams PH (1993) Nutrient cycling and soil fertility in the grazed grassland ecosystem. *Advances in Agronomy*, **49**, 119-190.
- Hebeisen T, Lüscher A, Zanetti S, Fischer BU, Hartwig UA, Frehner M, Hendrey GR, Blum H, Nösberger J (1997) Growth response of *Trifolium repens* L. and *Lolium perenne* L. as monocultures and bi-species mixture to free air CO₂ enrichment and management. *Global Change Biology*, **3**, 149-160.
- Hendrey GR, Lewin KF, Nagy J (1993) Free air carbon-dioxide enrichment - development, progress, results. *Vegetatio*, **104**, 17-31.
- Hocking PJ, Meyer CP (1991) Effects of CO₂ enrichment and nitrogen stress on growth, and partitioning of dry-matter and nitrogen in wheat and maize. *Australian Journal of Plant Physiology*, **18**, 339-356.

- Hui DF, Sims DA, Johnson DW, Cheng WX, Luo YQ (2002) Effects of gradual versus step increases in carbon dioxide on *Plantago* photosynthesis and growth in a microcosm study. *Environmental and Experimental Botany*, **47**, 51-66.
- Hungate BA, Chapin FS III, Zhong H, Holland EA, Field CB (1997) Stimulation of grassland nitrogen cycling under carbon dioxide enrichment. *Oecologia*, **109**, 149-153.
- Hunt R, Hand DW, Hannah MA, Neal AM (1991) Response to CO₂ enrichment in 27 herbaceous species. *Functional Ecology*, **5**, 410-421.
- IPCC, 2001: *Climate Change 2001: The Scientific Basis. Contribution of Working Group I to the Third Assessment Report of the Intergovernmental Panel on Climate Change* (eds Houghton JT, Ding Y, Griggs DJ, Noguer M, van der Linden PJ, Dai X, Maskell K, Johnson CA), Cambridge University Press, Cambridge, 881 pp.
- Jach ME, Ceulemans R (2000) Effects of season, needle age and elevated atmospheric CO₂ on photosynthesis in Scots pine (*Pinus sylvestris* L.). *Tree Physiology*, **20**, 145-157.
- Keeling CD, Whorf TP (2003) Atmospheric CO₂ records from sites in the SIO air sampling network. In: *Trends: A Compendium of Data on Global Change*. Carbon Dioxide Information Analysis Center, Oak Ridge National Laboratory, U.S. Department of Energy, Oak Ridge.
- Kim JS, Verma B, Clement, RJ (1992) Carbon dioxide budget in a temperate grassland ecosystem. *Journal of Geophysical Research*, **97**, 6057-6063.
- Körner C (2000) Biosphere responses to CO₂ enrichment. *Ecological Applications*, **10**, 1590-1619.
- Körner C (1996) The response of complex multispecies systems to elevated CO₂. In: *Global Change and Terrestrial Ecosystems* (eds Walker B, Steffen W), pp. 21-42. Cambridge University Press, Cambridge.
- Lambers H, Chapin FS III, Pons TL (1998) *Plant Physiological Ecology*. Springer, New York, 540 pp.
- Leadley PW, Körner C (1996) Effects of elevated CO₂ on plant species dominance in a highly diverse calcareous grassland. In: *Carbon Dioxide, Population and Communities* (eds Körner C, Bazzaz FA), pp 159-175. Academic Press, San Diego.

- Lloyd J, Farquhar GD (1996) The CO₂ dependence of photosynthesis, plant growth responses to elevated atmospheric CO₂ concentrations and their interaction with soil nutrient status. I. General principles and forest ecosystems. *Functional Ecology*, **10**, 4-32.
- Lloyd J, Farquhar GD (2000) Do slow-growing species and nutrient-stressed plants consistently respond less to elevated CO₂? A clarification of some issues raised by Poorter (1998). *Global Change Biology*, **6**, 871-876.
- Long SP, Baker NR, Raines CA (1993) Analyzing the responses of photosynthetic CO₂ assimilation to long-term elevation of atmospheric CO₂ concentration. *Vegetatio*, **104**: 33-45.
- Luo Y, Wu L, Andrews JA, White L, Matamala R, Schafer KVR, Schlesinger WH (2001) Elevated CO₂ differentiates ecosystem carbon processes : deconvolution analysis of Duke forest data. *Ecological Monographs*, **71**, 357-376.
- Luo Y, Chen JL, Reynolds JF, Field CB, Mooney HA (1997) Disproportional increases in photosynthesis and plant biomass in a Californian grassland exposed to elevated CO₂: a simulation analysis. *Functional Ecology*, **11**, 696-704.
- Lüscher A, Hartwig UA, Suter D, Nösberger J (2000) Direct evidence that symbiotic N₂ fixation in fertile grassland is an important trait for a strong response of plants to elevated atmospheric CO₂. *Global Change Biology*, **6**, 655-662.
- Lüscher A, Hebeisen T, Zanetti S, Hartwig UA, Blum H, Hendrey GR, Nösberger J (1996) Differences between legumes and nonlegumes of permanent grassland in their responses to free-air carbon dioxide enrichment: its effect on competition in a multispecies mixture. In: *Carbon Dioxide, Population and Communities* (eds Körner C, Bazzaz FA), pp 159-175. Academic Press, San Diego.
- Matamala R, Schlesinger WH (2000) Effects of elevated atmospheric CO₂ on fine root production and activity in an intact temperate forest ecosystem. *Global Change Biology*, **6**, 967-979.
- McLeod AR, Long SP (1999) Free-air carbon dioxide enrichment (FACE) in global change research: a review. *Advances in Ecological Research*, **28**, 1-56.
- Midgley GF, Wand SJE, Pammenter NW (1999) Nutrient and genotypic effects on CO₂-responsiveness: photosynthetic regulation in *Leucadendron* species of a nutrient-poor environment. *Journal of Experimental Botany*, **50**, 533-542.

- Morgan JA, LeCain DR, Mosier AR, Milchunas DG (2001) Elevated CO₂ enhances water relations and productivity and affects gas exchange in C₃ and C₄ grasses of the Colorado shortgrass steppe. *Global Change Biology*, **7**, 451-466.
- Navas ML, Guillerm JL, Fabreguettes J, Roy J (1995) The influence of elevated CO₂ on community structure, biomass and carbon balance of mediterranean old-field microcosm. *Global Change Biology*, **1**, 325-335.
- Newton PCD, Clark H, Bell CC, Glasgow EM, Campbell BC. (1994) Effects of elevated CO₂ and simulated seasonal changes in temperature on the species composition and growth rates of pastures turves. *Annals of Botany*, **73**, 53-59.
- Newton PCD, Clark H, Edwards GR, Ross DJ (2001a) Experimental confirmation of ecosystem model predictions comparing transient and equilibrium plant responses to elevated atmospheric CO₂. *Ecology Letters*, **4**, 344-347.
- Newton PCD, Clark H, Edwards GE (2001b) The effects of elevated atmospheric CO₂ on grazed grasslands. In: *Structure and Function of Agroecosystem Design and Management* (eds M. Shiyomi & H. Koizumi), pp. 297-311. CRC Press, Boca Raton.
- Niklaus PA, Glockler E, Siegwolf R, Körner C (2001) Carbon allocation in calcareous grassland under elevated CO₂: a combined ¹³C pulse labelling/soil physical fractionation study. *Functional Ecology*, **15**, 43-50.
- Norby RJ, Kobayashi K, Kimball BK (2001) Rising CO₂ - future ecosystems. *New Phytologist*, **150**, 215-221.
- Okada M, Lieffering M, Nakamura H, Yoshimoto M, Kim HY, Kobayashi K (2001) Free-air CO₂ enrichment (FACE) using pure CO₂ injection: system description. *New Phytologist*, **150**, 251-260.
- Osborne CP, LaRoche J, Garcia RL, Kimball BA, Wall GW, Pinter PJ Jr., LaMorte RL, Hendrey GR, Long SP (1998) Does leaf position within a canopy affect acclimation of photosynthesis to elevated CO₂? Analysis of a wheat crop under free-air CO₂ enrichment. *Plant Physiology*, **117**, 1037-1045.
- Owensby CE, Ham JM, Knapp AK, Auen LM (1999) Biomass production and species composition change in a tallgrass prairie ecosystem after long-term exposure to elevated atmospheric CO₂. *Global Change Biology*, **5**, 497-506.
- Parsons AJ, Newman JA, Penning PD, Harvey A, Orr RJ (1994) Diet preference of sheep: effects of recent diet, physiological state and species abundance. *Journal of Animal Ecology*, **63**, 465-478.

- Paterson E, Rattray EAS, Killham K (1996) Effect of elevated atmospheric CO₂ concentration on C-partitioning and rhizosphere C-flow for three plant species. *Soil Biology and Biochemistry*, **28**, 195-201.
- Polley HW, Johnson HB, Derner JD (2002) Soil- and plant-water dynamics in a C₃/C₄ grassland exposed to a subambient to superambient CO₂ gradient. *Global Change Biology*, **8**, 1-12.
- Poorter H, VanBerkel Y, Baxter R, DenHertog J, Dijkstra P, Gifford R M, Griffin K L, Roumet C, Roy J and Wong SC (1997) The effect of elevated CO₂ on the chemical composition and construction costs of leaves of 27 C₃ species. *Plant, Cell and Environment*, **20**, 472-482.
- Poorter H (1993) Interspecific Variation in the growth response of plants to an elevated ambient CO₂ concentration. *Vegetatio*, **104-105**, 77-97.
- Poorter H (1998) Do slow-growing species and nutrient-stressed plants respond relatively strongly to elevated CO₂? *Global Change Biology*, **4**, 693-697.
- Poorter H, Pérez-Soba M (2001) The growth response of plants to elevated CO₂ under non-optimal environmental conditions. *Oecologia*, **129**, 1-20.
- Raschi A, Miglietta F, Tognetti R, van Gardingen PR (1997) *Plant Response to Elevated CO₂, Evidence from Natural Springs*, Cambridge University Press, Cambridge, 272 pp.
- Reich PB, Knops J, Tilman D, Craine J, Ellsworth D, Tjoelker M, Lee T, Wedin D, Naeem S, Bahaeddin D, Hendrey G, Jose S, Wrage K, Goth J, Bengston W (2001) Plant diversity enhances ecosystem responses to elevated CO₂ and nitrogen deposition. *Nature*, **410**, 809-812.
- Rillig MC, Allen MF, Klironomos JN, Field CB (1998) Arbuscular mycorrhizal percent root infection and infection intensity of *Bromus hordeaceus* grown in elevated atmospheric CO₂. *Mycologia*, **90**, 199-205.
- Rogers GS, Milham PJ, Thibaud MC, Conroy JP (1996) Interactions between rising CO₂ concentration and nitrogen supply in cotton. I. Growth and leaf nitrogen concentration. *Australian Journal of Plant Physiology*, **23**, 119-125.
- Rogers A, Fischer BU, Bryant J, Frehner M, Blum H, Raines CA, Long SP (1998) Acclimation of photosynthesis to elevated CO₂ under low-nitrogen nutrition is affected by the capacity for assimilate utilization. Perennial ryegrass under free-air CO₂ enrichment. *Plant Physiology*, **118**, 683-689.

- Sage RF (1994) Acclimation of photosynthesis to increasing atmospheric CO₂: The gas exchange perspective. *Photosynthesis Research*, **39**, 351-368.
- Shaw MR, Zavaleta ES, Chiariello NR, Cleland EE, Mooney HA, Field CB (2002) Grassland responses to global environmental changes suppressed by elevated CO₂. *Science*, **298**, 1987-1990.
- Sims DA, Luo Y, Seeman Jr. (1998) Comparison of photosynthetic acclimation to elevated CO₂ and limited nitrogen supply in soybean. *Plant, Cell and Environment*, **21**, 945-952.
- Soussana J-F, Casella E, Loiseau P (1996) Long-term effect of CO₂ enrichment and temperature increase on a temperate grass sward. II. Plant nitrogen budgets and root fraction. *Plant and Soil*, **182**, 101-114.
- Stitt M, Krapp A (1999) The interaction between elevated carbon dioxide and nitrogen nutrition: the physiological and molecular background. *Plant, Cell and Environment*, **22**, 583-621.
- Stitt M (1991) Rising CO₂ levels and their potential significance for carbon flow in photosynthetic cells. *Plant, Cell and Environment*, **14**, 741-762.
- Stöcklin J, Schweizer K, Körner C (1998) Effects of elevated CO₂ and phosphorus addition on productivity and community composition of intact monoliths from calcareous grassland. *Oecologia*, **116**, 50-56.
- Stöcklin J, Körner C (1999) Interactive effects of elevated CO₂, P availability and legume presence on calcareous grassland: results of a glasshouse experiment. *Functional Ecology*, **13**, 200-209.
- Strain BR, Bazzaz FA (1983) Terrestrial plant communities. In: *CO₂ and Plants* (ed Lemon ER), pp. 177-222. Westview Press, Boulder.
- Teyssonneyre F, Picon-Cochard C, Falcimagne R, Soussana J-F (2002) Effects of elevated CO₂ and cutting frequency on plant community structure in a temperate grassland. *Global Change Biology*, **8**, 1034-1046.
- Teyssonneyre F (2003) *Effet d'une augmentation de la concentration atmosphérique en CO₂ sur la prairie permanente et sur la compétition entre espèces prairiales associées*. PhD thesis, Université Paris XI, Orsay, 144pp.
- Wand SJE, Midgley GF, Jones MH, Curtis PS (1999) Responses of wild C₄ and C₃ grass (Poaceae) species to elevated atmospheric CO₂ concentration: a meta-analytic test of current theories and perceptions. *Global Change Biology*, **5**, 723-741.

- Wong SC, Kriedemann PE, Farquhar GD (1992) CO₂ × nitrogen interaction on seedling growth of 4 species of eucalypt. *Australian Journal of Botany*, **40**, 457-472.
- Zak DR, Pregitzer KS, Curtis PS, Teeri JA, Fogel R, Randlett DL (1993) Elevated atmospheric CO₂ and feedback between carbon and nitrogen cycles. *Plant and Soil*, **151**, 105-117.
- Ziska LH, Bunce JA, Caulfield FA (2001) Rising atmospheric carbon dioxide and seed yields of soybean genotypes. *Crop Science*, **41**, 385-391.



Plate 2.1: General view of an elevated CO₂ FACE ring during grazing by adult sheep wearing faeces collection bags.

Chapter 2: Nitrogen Cycling in Grazed Pastures at Elevated CO₂: N Returns by Ruminants

Chapter 2: Nitrogen Cycling in Grazed Pastures at Elevated CO₂: N Returns by Ruminants

Allard V, Newton PCD, Lieffering M, Clark H, Matthew C, Soussana JF, Gray YS.

2.1. Abstract

In pastures grazed by large herbivores, nutrients cycle both through litter and animal excreta. We compared nitrogen (N) returns from sheep grazing a temperate pasture exposed to ambient or elevated CO₂ (475 μmol mol⁻¹) in a FACE (Free Air CO₂ Enrichment) experiment established in the spring of 1997. In the spring of 2000 and 2001 we measured the chemical composition of the diet, sheep faeces and of individual plant species before grazing to characterise feed intake and to compare the intake of N to the N produced in faeces. In both years under elevated CO₂, leaves of the individual species exhibited lower N concentrations and higher water soluble carbohydrate (WSC) concentrations. There was a significantly greater proportion of legume in the diet at elevated CO₂ but, together with the changes in chemical composition of individual species, this resulted in diets that had similar N but higher WSC and digestibility for both ambient and elevated CO₂. We calculated that a greater proportion of dietary N was partitioned to urine at elevated CO₂, probably because of the higher proportion of legume N in the diet, with possible differences in protein quality. A potentially significant consequence of this change in partitioning is greater N loss through volatilisation at higher CO₂ levels.

2.2. Introduction

Grasslands cover a fifth of the terrestrial surface of the world (Hadley 1993) and most of this area is grazed by domestic livestock. The response of these grasslands to the predicted continuing increase in atmospheric CO₂ (Keeling *et al.*, 1995) is potentially important, first because of their economic significance and, second, because grasslands soils are a major sink for carbon (C) (Thornley *et al.*, 1995). The response of grasslands to elevated CO₂ depends, in the long-term, partly on how elevated CO₂ modifies nutrient cycling. It has been proposed that the fertilisation effect of elevated CO₂ on plant communities (Newton 1991) could be constrained by a relative decrease in the availability of other nutrients, in particular nitrogen (N) (Diaz *et al.*, 1993). One of the major mechanisms implicated in this negative feedback is a reduction in litter quality (i.e. increased C/N ratio) resulting from reduced N concentrations in plant tissues at elevated CO₂ (Poorter *et al.*, 1997; Cotrufo *et al.*, 1998) and, therefore, reduced N mineralisation rates in soils (Strain and Bazzaz 1983; Norby *et al.*, 1986; van Ginkel and Gorissen 1998). However, it has become apparent that the observed decrease in N concentration in green leaves at elevated CO₂ (Cotrufo *et al.*, 1998) is not, or is only partially, reflected in the senescing tissues; consequently only small changes in litter quality (Hirshel *et al.*, 1997; Hartwig *et al.*, 2000; Norby *et al.*, 2001) and decomposition rates (Dilustro *et al.*, 2001; Van Vuuren *et al.*, 2000) appear as a result of elevated CO₂. Thus, in ecosystems in which nutrient cycling depends heavily on shoot litter decomposition it seems unlikely that any feedback on N availability will occur (Norby and Cotrufo 1998).

However, in grasslands grazed by large herbivores only part of the nutrient cycling occurs through litter decomposition and this fraction decreases with higher herbage utilisation rates. In a well managed temperate grassland the optimum herbage utilization is about 50% of aboveground biomass production (Parsons and Chapman 2000). In this situation, due to the lower N concentration of senescing leaf material compared to green herbage and the poor N utilization by ruminants (Jarvis 2000), about 75% of the N returned to the soil occurs through the dung and urine of the grazers. In terms of potential CO₂ effects on these N cycling pathways it is important to note that grazers eat primarily live plant material and, therefore, any CO₂-induced

changes in green tissue composition may influence nutrient returns. In contrast, the litter pathway is sensitive to the chemical composition of dead/senescing material.

The literature indicates that changes in the chemical composition of ruminant diet at elevated CO₂ may arise from two sources: 1) a change in the chemical composition of individual species, especially the well documented reduction in N concentration of leaves (Poorter *et al.*, 1997; Cotrufo *et al.*, 1998), and 2) a change in plant species composition in the pasture, in particular, a shift to a higher content of N-rich legumes (Hebeisen *et al.*, 1997; Jongen and Jones 1998; Teyssonneyre *et al.*, 2002). Through the grazing process, grazers integrate the CO₂ effects that occur at these different scales (plant and community levels). Although most grasslands are grazed, our current understanding of nutrient cycling at elevated CO₂ is based exclusively on cut grasslands i.e. in which animals are excluded. There is good reason to expect that cycling under these conditions will differ significantly from grazed grasslands both in terms of the amount of nutrients returned and the heterogeneity of these returns (Haynes and Williams 1993) leading to the likelihood of cut and grazed systems responding very differently to elevated CO₂ (Newton *et al.*, 2001). In this paper we present data on N returns by sheep grazing a pasture exposed to elevated CO₂.

2.3. Materials and methods

2.3.1. Experimental site

The study was carried out in November 2000 and November 2001 (spring in the Southern Hemisphere) in a temperate pasture on the west coast of the North Island of New Zealand (40°14'S, 175°16'E). The pasture had been under permanent grazing by sheep, cattle and goats since at least 1940. The mean annual rainfall at the site is 875 mm and average air temperature at a nearby weather recording station ranges from 8.0°C in July to 17.4°C in February. More details about the site botanical and physical characteristics can be found in Edwards *et al.*, (2001). The experimental facility consisted of six FACE (Free Air CO₂ Enrichment) rings (McLeod and Long 1999), each 12 m in diameter; the rings were paired into three blocks based on initial

soil and the botanical characteristics. In each block, one ring was enriched with CO₂ at a target value of 475 µl l⁻¹ CO₂ (elevated CO₂) during the photoperiod, the second being left at ambient atmospheric CO₂ concentration (ambient CO₂). Enrichment began on 1 October 1997. Enriched rings were labelled R1, R2 and R3 (in blocks 1, 2 and 3 respectively) and ambient rings R4, R5 and R6 (blocks 1, 2 and 3). Each ring was fenced off individually in order to control sheep access and the duration and intensity of each grazing event.

2.3.2. Sheep grazing procedure

The usual grazing procedure throughout the experiment was intermittent grazing by adult sheep. Grazing started when the average aboveground biomass reached 1.8-2 t dry matter (DM) ha⁻¹ and continued until the residual aboveground biomass was reduced to approximately 0.5-0.7 t DM ha⁻¹. Details of the grazing methodology used for the two spring grazings reported here are given below.

November 2000

During the first grazing event, a single set of five mature wethers grazed all the rings sequentially; in this case individual sheep were used as replicates for the CO₂ treatment. The sheep were held indoors and starved for 24 h prior to grazing in order to remove the effects of their previous uncontrolled diet on dung composition, the average transit time of feed in the animals being 24 to 48 h (Haynes and Williams 1993). The sheep then grazed sequentially the three ambient rings (R4, R5 and R6) followed by the three enriched rings (R1, R2 and R3). Sheep were allowed to stay in each ring for 24 h and moved each morning. This sequential grazing began in R4 on 20 November and finished in R3 on 25 November 2000.

November 2001

In the second grazing event, adult wethers were contained within the same ring for the duration of grazing. Rings were taken as the replicate unit for analysis of CO₂ effects. The sheep were starved for 48 h prior to grazing in a devegetated pen. Since the initial aboveground biomass varied greatly between blocks, different numbers of animals were allocated to each block (2, 3 and 5 sheep per ring, in block

1, 2 and 3 respectively). Sheep were placed in the rings on 10 November and the experiment itself started on 11 November to minimize possible artefacts due to the 48 h starving period. Two sheep per ring were randomly selected for faecal collection (see below).

2.3.3. Collection and analysis of faeces

The five sheep in November 2000 and the two selected sheep per ring in November 2001 were equipped with harnesses and dung bags to allow total faecal collection. Sheep were trained with this equipment for at least 48 h during the week prior to the beginning of each grazing sequence to avoid excessive stress and any induced behaviour modification. Dung bags were fitted before sheep were allowed to enter in the rings and were emptied every 24 h. In 2000, sheep wore dung bags for six days, in 2001 for two days. All faecal samples were weighed and a sub-sample was taken and oven dried (60°C, to constant mass) for dry matter determination. This sub-sample was then ground to a fine powder and the C and N contents were determined at Lincoln University (New Zealand) with a mass spectrometer (PDZ Europa, UK).

2.3.4. Herbage analysis

Two randomly placed 1 m × 0.078 m quadrats were cut to 2 cm above ground level with powered hand shears from each compass quarter of each ring (total of eight per ring) on the day prior to and on the day after each grazing. The samples were bulked to give one sample per ring, and a sub-sample was immediately taken, placed briefly in a microwave oven (2 minutes at 600W) to arrest metabolism (Popp *et al.*, 1996) in order to later determine the chemical composition of the mixed herbage. The dry mass of this sub-sample was later added to the dry mass of the bulked sample for biomass calculations. A sub-sample from the bulked herbage was sorted into species; these were oven dried separately (60°C, 48h). The remainder of the bulked sample was also dried, thus allowing calculation of species composition of the total biomass. To determine single species chemical composition, green leaves of the most abundant species of different functional groups - *Lolium perenne* L., *Agrostis capillaris* Sibth.,

Anthoxanthum odoratum L. (all C3 grasses), *Trifolium subterraneum* L. and *T. repens* L. (both legumes), *Paspalum dilatatum* Poir. (C4 grass) and *Hypochoeris radicata* L. (forb) - were sampled randomly in each ring on the day prior to grazing, dried on site in a microwave oven as above and transferred to the lab to be oven dried (60°C, 48h).

Herbage chemical composition relevant to ruminant diets was measured by NIRS (Near Infrared Reflectance Spectroscopy) with the feedTECH system (Corson *et al.*, 1999). The components measured were: nitrogen (N), acid detergent fibre (ADF), neutral detergent fibre (NDF), water soluble carbohydrates (WSC) and *in vitro* organic matter digestibility (OMD). NIRS results had been previously calibrated against wet chemistry analysis with herbage samples from the same site. The same calibration curves were used for both CO₂ treatments since no effect of elevated CO₂ could be found in previous experiments on correlations between wet chemistry and NIRS values.

2.3.5. Determination of the N budget

In both years, herbage data were measured in each ring so rings were used as the replicate to estimate CO₂ effects. In 2000 a single group of sheep grazed the six rings sequentially and, for this grazing, we considered that the best estimates of faecal production and composition were those measured once the sheep had grazed for 48 h in the same CO₂ treatment and were still in a ring of the same treatment. Thus we used faeces collected on the last day of sheep presence in a given CO₂ treatment (respectively in R6 and R3 for ambient and enriched treatments) and sheep were used as replicates to test the CO₂ effects on these variables. For this grazing we calculated intake quality as the average of the diet on offer in all three rings in each treatment. In 2001 we used faecal samples collected on the second day of grazing in the rings to measure faeces production and N excretion and rings were used as replicates after averaging data by ring for the two selected sheep. The diet quality values were in this case extracted from each ring separately. The use of the quality of herbage on offer as a measure of the sheep diet may not represent the actual diet if there is strong species selection, in particular positive selection for legumes (Parsons *et al.*, 1994). In 2000, despite the relatively high clover content in the pasture, no positive selection for

Table 2.1: Aboveground biomass prior to grazing events in two years and the contribution of different plant functional groups to this biomass (%) taken from pre-grazing cuts from pastures exposed to ambient or elevated (475 ppm) CO₂. Values are mean of three replicates± standard deviation. Data analysed as ANOVA using a split-plot model with CO₂ as the main plot and year as a subplot. P values shown when p<0.05 and n.s. when p>0.05.

	2000		2001		Effects		
	Ambient	Elevated	Ambient	Elevated	CO ₂	Year	CO ₂ *Year
Biomass (g.m⁻²)	184.6±63.2	171.7±58.7	199.1±54.2	201.3±37.6	n.s.	n.s.	n.s.
Proportion (%)							
C3-grass	71.7±9.2	61.5±1.8	87.1±3.9	78±8.1	0.018	0.006	n.s.
Legume	21.7±7.4	34.1±3.8	5±2.7	10.7±6.3	0.019	0.006	n.s.
Forbs	3.5±4.3	2.7±1.2	3.3±2.5	6.1±2.9	n.s.	n.s.	n.s.
C4-grass	3.1±3.2	1.7±2.2	4.6±1.2	5.3±1.4	n.s.	n.s.	n.s.

legumes was measured. Indeed, a comparison of pre- and post-grazing botanical composition showed no difference in clover content ($p=0.138$) in the ambient or elevated CO_2 treatments. In addition the N concentration of the diet on offer before grazing was not different to the herbage remaining after grazing ($p=0.524$) showing that the animals did not preferentially remove N-rich species, legumes in particular. It was therefore considered that the apparent lack of diet selection enabled us to use diet on offer as an estimate of the ingested diet for 2000. In 2001 the very low legume content of the herbage on offer did not allow for intense sheep selection for clover, thus the quality of the pasture was again considered as a good estimate of the actual diet.

Sheep intake over 24 h was calculated from faecal production and the OMD values of the herbage:

$$\text{Intake (g DM sheep}^{-1} \text{ day}^{-1}) = \text{Faeces (g DM sheep}^{-1} \text{ day}^{-1}) / (1-\text{OMD})$$

Nitrogen intake was calculated from daily herbage intake and diet N concentration. N excreted in faeces was determined from individual daily faeces production and faeces N concentration. We calculated N excreted in urine as the difference between ingested N and N excreted in faeces assuming a fixed 5 % N retention; this value was used because N retention in animals is low on a yearly basis (Lambert *et al.*, 1982), particularly in adult sheep (Ball, 1982). The potential for differences in N retention between treatments is discussed later.

2.3.6. Statistical analysis

Analysis of variance was used to analyse CO_2 effects on diet chemical composition in this randomised block design ($n=3$). For botanical composition, year was used as a sub-plot within CO_2 across both grazing events ($n=3$). A split-plot in time was appropriate since no covariance symmetry problems could arise as there were only two dates in the experiment. A split plot design was used to analyse single species chemical composition with CO_2 as a main plot ($n=3$) and species as a subplot and linear contrasts were used to compare functional groups. N partitioning data were analysed by ANOVA using sheep as replicates for the CO_2 treatment in 2000 ($n=5$) and in 2001 using rings as replicate for CO_2 and sheep as a blocking factor ($n=3$).

Table 2.2: Some leaf chemical characteristics (nitrogen (N), acid detergent fibre (ADF), neutral detergent fibre (NDF), water soluble carbohydrates (WSC) and organic matter *in vitro* digestibility (OMD)) of plant species growing under ambient or elevated (475 ppm) CO₂ (values are mean of three replicates in % of total dry matter) in two years, 2000 and 2001. Species were combined into functional groups for linear contrasts: grasses = *Paspalum dilatatum*, *Agrostis capillaris*, *Anthoxanthum odoratum*, *Lolium perenne*; legumes = *Trifolium repens*, *Trifolium subterraneum*; forb = *Hypochaeris radicata*. Data analysed as ANOVA using a split-plot model with CO₂ as the main plot and species as a subplot. Linear contrast comparing functional groups are also shown for 2000 data.

	N (%)		ADF (%)		NDF (%)		WSC (%)		OMD (%)	
	Ambient	Elevated	Ambient	Elevated	Ambient	Elevated	Ambient	Elevated	Ambient	Elevated
2000										
<i>Agrostis capillaris</i>	4.2	3.9	18.2	18.4	41.3	42.7	19.9	21.0	79.4	80.6
<i>Anthoxanthum odoratum</i>	3.8	3.5	14.4	14.7	34.5	36.6	24.7	24.3	87.7	88.9
<i>Lolium perenne</i>	3.1	2.5	15.4	16.3	35.9	37.9	25.7	26.5	90.5	88.5
<i>Hypochaeris radicata</i>	3.5	3.3	13.3	12.6	26.8	24.6	21.7	23.1	82.8	83.7
<i>Paspalum dilatatum</i>	3.3	3.6	27.4	26.0	52.8	49.9	12.4	14.1	67.9	70.8
<i>Trifolium repens</i>	5.4	4.6	14.0	13.3	23.8	24.4	21.9	24.1	90.2	91.1
<i>Trifolium subterraneum</i>	5.0	4.3	15.6	15.2	26.9	27.1	20.4	22.5	86.8	85.8
Origin of variance (p values)										
CO ₂	0.089		0.588		0.761		0.055		0.753	
Species	< 0.001		< 0.001		< 0.001		< 0.001		< 0.001	
Contrast grass/legumes	< 0.001		< 0.001		< 0.001		0.113		< 0.001	
Contrast grass/forb	0.483		< 0.001		< 0.001		0.154		0.109	
Contrast legume/forb	< 0.001		0.019		0.908		0.858		< 0.001	
2001										
<i>Anthoxanthum odoratum</i>	3.4	3.6	17.5	15.9	33.5	33.7	22.2	22.6	85.8	89.0
<i>Hypochaeris radicata</i>	3.5	3.3	15.8	15.9	29.8	27.1	18.1	19.1	83.5	83.4
<i>Paspalum dilatatum</i>	3.4	3.4	26.2	26.5	48.6	47.8	12.5	12.5	71.1	70.3
<i>Trifolium subterraneum</i>	4.1	3.0	19.7	22.0	33.2	32.5	14.5	16.3	81.0	81.1
Origin of variance (p values)										
CO ₂	0.469		0.699		0.674		0.150		0.729	
Species	0.912		< 0.001		< 0.001		< 0.001		< 0.001	

Linear regression was used to describe the relationship between diet WSC and digestibility and between legumes content and proportion of N excreted in faeces. Genstat v 6.1 (Genstat, 2002) was used for all analysis.

2.4. Results

2.4.1 Botanical composition

The total pre-grazing aboveground biomass did not differ between treatments or years but the composition of this biomass was different (Table 2.1). Across both years legume content was significantly greater at elevated CO₂ (57% in 2000 and 114% in 2001); although much lower in absolute terms in 2001. The very low legume content in 2001 was primarily due to a very low presence of *T. repens* during the period in which it usually makes the major contribution to the legume pool (data not shown).

2.4.2. Single species chemical composition

In 2000 we examined the effect of atmospheric CO₂ concentration on the leaf chemical composition of seven species; comparisons were also made between functional groups by combining single species data (Table 2.2). N concentration was dependent on species ($p < 0.001$) (Table 2.2) and tended to be lower under elevated CO₂ (9.2% less on average) but this was only a trend ($p = 0.089$). If considered in terms of functional groups, the legume N concentration was about 40% higher than that of the grasses ($p < 0.001$) and 42% higher than that of the forbs ($p < 0.001$).

Across all species WSC concentration tended to increase under elevated CO₂ ($p = 0.055$) by 6.8% (Table 2.2). WSC concentration differed between species ($p < 0.001$) but the changes were similar between functional groups (Table 2.2).

ADF and NDF concentrations of the different species were not significantly affected by elevated CO₂ but differed markedly between species. The linear contrasts

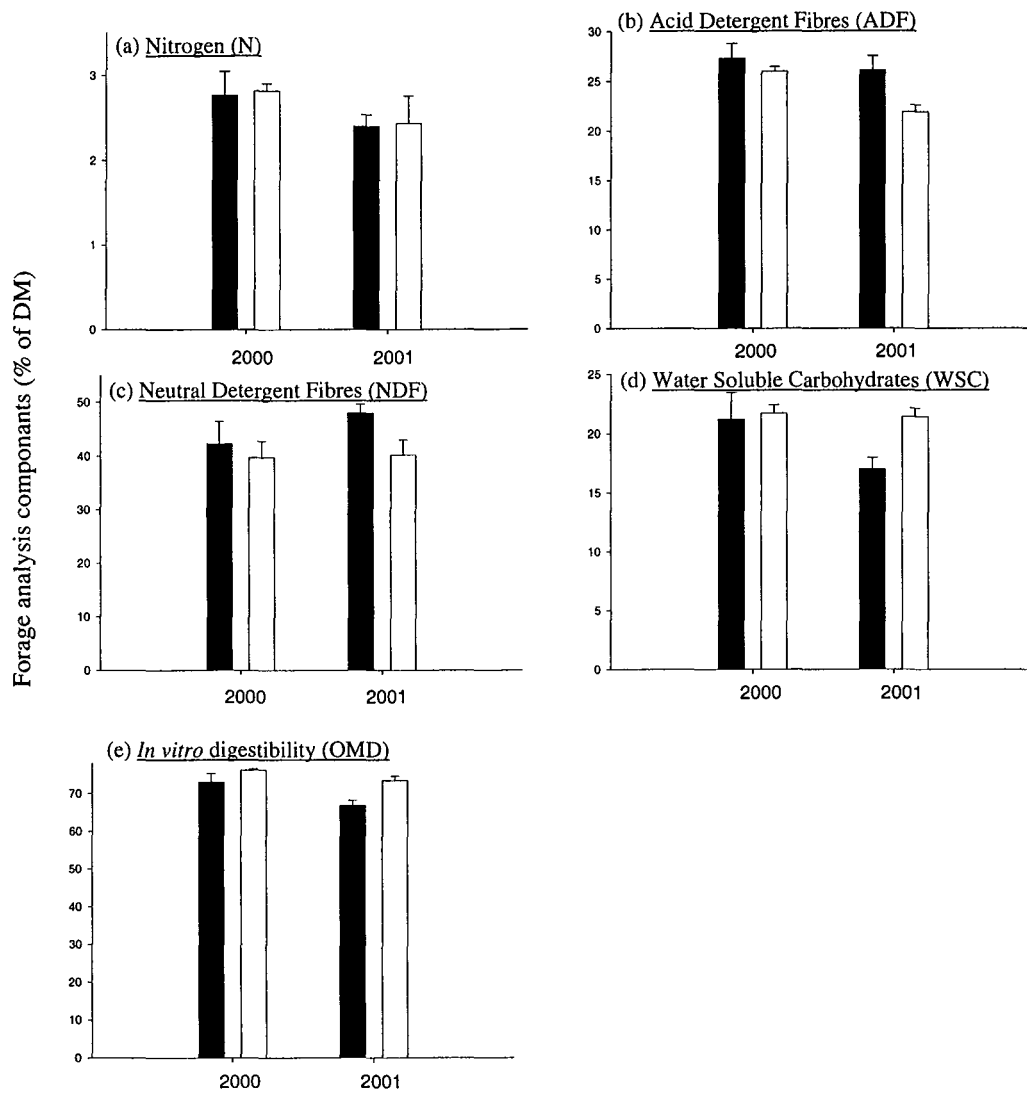

Figure 2.1: Effects of elevated CO₂ on the concentration (% dry matter) of a) nitrogen, b) acid detergent fibres, c) neutral detergent fibres, d) water soluble carbohydrates and e) *in vitro* organic matter digestibility. Values are mean of three replicates \pm standard deviation. Black bars: ambient CO₂, open bars: elevated CO₂.

showed lower fibre concentrations of forbs and particularly of legumes compared to the grasses.

OMD was unaffected by elevated CO₂, and ranged from 70% for *P. dilatatum* to about 90% for the highly digestible species *L. perenne* and *T. repens*. The analysis by functional groups highlighted the significantly higher digestibility of legumes compared to the other two groups (Table 2.2).

In 2001 only four species (*A. odoratum*, *H. radicata*, *P. dilatatum* and *T. subterraneum*) could be sampled individually due to the very low abundance of *T. repens* in all rings and of *A. capillaris* and *L. perenne* in one ring. For this reason data were not analysed on the basis of functional groups as in 2000. The trend showing a decrease in N concentration at elevated CO₂ observed in 2000 was not evident in 2001 (Table 2.2). The average reduction in N concentration for all four species was 7.2% but this decrease was almost entirely attributable to the reduction in *T. subterraneum* N concentration. The N concentration in *T. subterraneum* was much lower in 2001 than in 2000 in both treatments but of a similar magnitude in the other species. WSC concentration under elevated CO₂ showed a trend consistent with results from 2000 (4.8% greater under elevated CO₂) but the difference was not statistically significant. Other chemical composition parameters were not affected by elevated CO₂. Interspecific variations were consistent with those observed in 2000, in particular the high fibre concentration of *P. dilatatum* and its low digestibility.

2.4.3. Chemical composition of the offered diet

When examined as a mixture i.e. integrating both changes in individual leaf chemical composition and species presence and representing the average diet offered to the sheep, the average N concentration of the herbage was unaffected by elevated CO₂ (Fig. 2.1) in either year but was lower in 2001 (2.4%) than in 2000 (2.8%).

In 2001 both NDF and ADF concentrations of the herbage were significantly reduced by elevated CO₂ (16% (p<0.01) and 16.2% (p<0.01) respectively (Fig. 2.1). In 2000 no statistically significant difference was detected between treatments but a similar trend occurred for both ADF and NDF. In both years WSC and OMD were

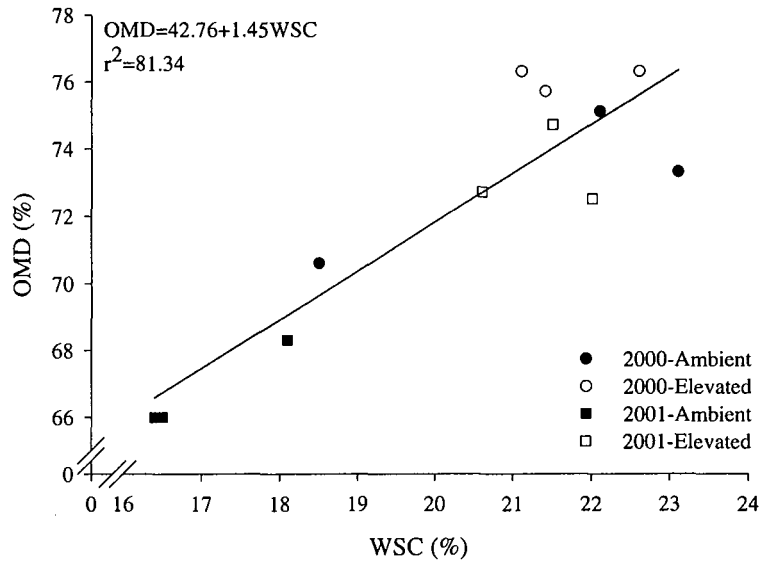

Figure 2.2: Correlation between herbage water soluble carbohydrates (WSC) content (in % dry matter) and herbage *in vitro* organic matter digestibility (OMD) (in % dry matter) for samples taken from pasture growing at ambient or elevated (475 ppm) CO₂. Fitted linear regression line, its equation and regression coefficient are shown.

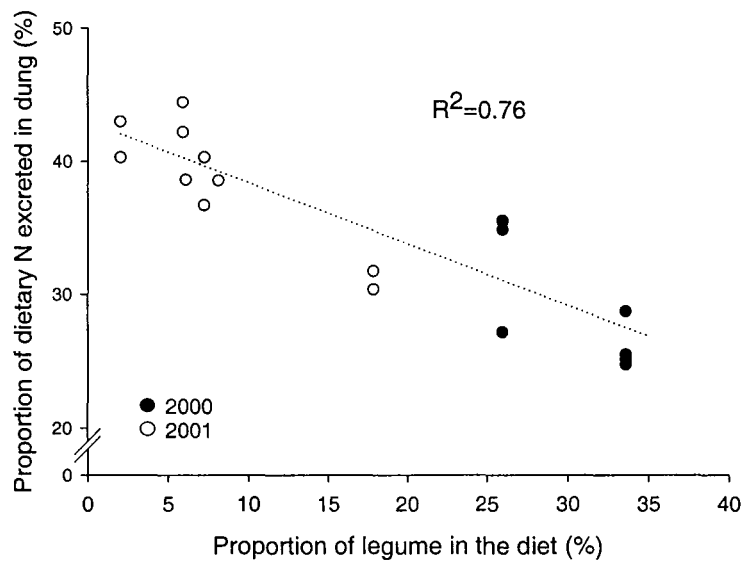

Figure 2.3: Correlation between the proportion of legumes in herbage (% of total dry matter) and the proportion of dietary N excreted as urine by animals grazing pastures exposed to ambient or elevated (475 ppm) CO₂ during spring of 2000 and 2001. Fitted linear regression line and its regression coefficient are shown.

higher at elevated CO₂ but the difference was only significant in 2001. Digestibility data from both years were well correlated with WSC concentration ($r^2=81.3$, $p<0.001$) (Fig. 2.2).

2.4.4. Nitrogen partitioning in the excreta

Herbage intake was calculated from the *in vitro* digestibility of the diet and faecal production. In both years the mass of faeces produced was lower under elevated CO₂ (by 21 and 5% in 2000 and 2001 respectively) but this difference was significant only in 2000 ($p=0.008$) (Table 2.3). Since OMD was higher under elevated CO₂, as described above, the calculated intake was unaffected by the CO₂ treatment but was about 40% lower in 2001 than in 2000. Because of the similar N concentration of the feed on offer regardless of the CO₂ level, the assumed dietary N was also similar for CO₂ treatments but again was lower in 2001. Faecal N output was calculated from daily faecal production and faecal N concentration. No statistically significant difference was observed between the CO₂ treatments in term of N concentration in the faeces despite a clear trend in 2000 ($p=0.051$) showing a N decrease under elevated CO₂. As a result, faecal N output was significantly lower under elevated CO₂ in 2000 (33%, $p=0.006$) but was unaffected in 2001 (Table 2.3). Faecal N output expressed as a proportion of ingested N was clearly lower under elevated CO₂. In 2000 the proportion of ingested N excreted in faeces dropped from 33.6% under ambient CO₂ to 24.4% under elevated CO₂. In 2001, the shift was of a similar magnitude (41.2% and 34.5% under ambient and elevated CO₂ respectively) but was only a trend ($p=0.07$). As shown in Fig. 2.3, the proportion of N excreted in faeces was strongly related to the proportion of legumes in the diet. These two variables were negatively correlated ($r^2=0.76$, $p<0.001$). Since the proportion of N excreted in urine was calculated by difference (see Materials and Methods section) it exhibited the opposite response to faeces and was higher under elevated CO₂.

Table 2.3: Nitrogen budget for sheep grazing pastures exposed to ambient or elevated (475 ppm) CO₂. Values are means with n=3 for digestibility and N content of the herbage, n=5 for other data in 2000 and n=6 for other data in 2001. Data analysed as ANOVA (see Materials and Methods section for information on the models).

	Ambient CO ₂	Elevated CO ₂	CO ₂ effect
2000			
Number of sheep	5	5	
Intake			
In-vitro digestibility of herbage(%)	73	76.1	p=0.07
Calculated intake (g DM.sheep ⁻¹ .day ⁻¹)	1528	1408	p=0.13
N% in herbage	2.8	2.8	p=0.8
Dietary N (gN.sheep ⁻¹ .day ⁻¹)	42.8	39.4	p=0.126
Faeces output			
Mass excreted (g.sheep ⁻¹ .day ⁻¹)	412.4	325.4	p=0.008
N% in faeces	3.5	3.1	p=0.051
Faecal N (gN.sheep ⁻¹ .day ⁻¹)	14.4	9.6	p=0.006
Faecal N (% of ingested N)	33.6	24.4	p=0.001
Urine output			
N retention (% of ingested N)	5	5	
Calculated urine-N (% of ingested N)	61.4	70.6	p=0.001 ^a
2001			
Number of sheep	6	6	
Intake			
In-vitro digestibility of herbage (%)	66.8	73.3	p=0.003
Calculated intake (g DM.sheep ⁻¹ .day ⁻¹)	836	985	p=0.42
N% in herbage	2.4	2.4	p=0.92
Dietary N (gN.sheep ⁻¹ .day ⁻¹)	20.3	24	p=0.39
Faeces output			
Mass excreted (g.sheep ⁻¹ .day ⁻¹)	277	263.2	p=0.83
N% in faeces	3	3.1	p=0.55
Faecal N (gN.sheep ⁻¹ .day ⁻¹)	8.3	8.3	p=0.99
Faecal N (% of ingested N)	41.2	34.5	p=0.07
Urine output			
N retention (% of ingested N)	5	5	
Calculated urine-N (% of ingested N)	53.8	60.5	p=0.07 ^a

^a Urine-N was calculated by difference from faecal N therefore p values for CO₂ effect are identical for the two variables.

2.5. Discussion

The main objective of this study was to assess if elevated CO₂ effects on pasture chemical and botanical composition would affect nitrogen cycling through ruminants. We showed that N partitioning between faeces and urine returns was affected by elevated CO₂ and this has possible implications for increased N losses. We used data from two non consecutive grazing events, the first in 2000 and the second in 2001. In order to discuss overall patterns observed during these two grazing, a brief summary of the inter-annual differences is required. Despite the fact that both grazing events took place in spring under similar climatic conditions, the pasture in 2001 was still expressing a carry over of an extreme spring drought that occurred 2 months before our experiment. The total rainfall in September 2001 was 3 mm while the 20 years average for this month is 60 mm. *Trifolium repens* is particularly vulnerable to spring drought (Brock 1988) and this was reflected in the extremely low legume abundance in 2001 compared to 2000. A second difference between years was the lower apparent feed intake observed in 2001; we are unable to identify the cause of this difference but intake rates can vary for many reasons (e.g. environmental, feed or animal related) (McDonald *et al.*, 1981). If the cause was a difference in the physiological state of the animals this could potentially influence N retention; however, as mature wethers were used in both years we do not consider this to be relevant to our results.

2.5.1. CO₂ effects on chemical composition of single species

In a survey of 27 C₃ species, Poorter *et al.*, (1997) found that the main changes in leaf chemical composition in plants grown under elevated CO₂ were an increase in non-structural carbohydrates and a decrease in leaf N concentration. While the increase in non-structural carbohydrates under elevated CO₂ was large (49% on average), there was high interspecific variability with responses ranging from almost zero to over 100%. The decrease in N concentration of these plants was 15% at elevated CO₂, again with high variability between species. In a survey of 67 species Cotrufo *et al.*, (1998) calculated a 14% decrease in N concentration at elevated CO₂ averaged over different experimental conditions, plant type and tissues. In our

experiment, averaged across species leaf N concentration dropped by 9% and 8% and the soluble sugars increased by 6% and 5% in 2000 and 2001 respectively (Table 2.2). These differences were not significant but reflect similar significant differences measured on this pasture (von Caemmerer *et al.*, 2001) and in other temperate grassland studies e.g. for *L. perenne* (Soussana *et al.*, 1996) and *T. repens* (Hartwig *et al.*, 2000). These data therefore support the view that leaf N and soluble sugar concentrations are the leaf chemistry parameters that exhibit the strongest response to elevated CO₂.

Nitrogen decrease in tissues, especially leaves, exposed to elevated CO₂ may occur through a combination of effects (Cotrufo *et al.*, 1998); two of the most likely mechanisms being: 1) a metabolic down-regulation of enzymes involved in photosynthesis as a regulatory response to the CO₂-stimulated photosynthesis rate, and 2) a dilution effect with N concentration reduced by an accumulation of non-structural carbohydrates (Gifford *et al.*, 2000). However, if the N concentration of single species in our experiment is recalculated on a soluble sugars-free basis then N was still lower at elevated CO₂ (8.3% in 2000 and 7.8% in 2001). This suggests that the elevated-CO₂ plants had lower N concentration due to a reduction in the amount of photosynthetic enzymes. In support of this view, data from the same experimental site has shown a strong photosynthetic acclimation to elevated CO₂ by both legumes and grasses (von Caemmerer *et al.*, 2001).

Other leaf chemistry responses to elevated CO₂ that might alter forage quality are increases in the synthesis of secondary products, in particular lignin (Gifford *et al.*, 2000). Although we did not directly assess the question of lignin concentration, the fact that both the ADF and NDF concentration were not affected under elevated CO₂ conditions allows us to hypothesise that highly recalcitrant compound like lignin were not significantly increased under elevated CO₂ in our experiment (Fig. 2.1). Moreover, OMD of individual species was not affected by elevated CO₂, showing that at the species scale, no major modification of tissue quality (from the ruminant perspective) occurred. The elevated CO₂-induced changes in WSC and N concentration reported here would have opposite effects on digestibility if taken alone. A decrease in the herbage N concentration usually leads to a limitation of microbial development in the rumen and thus a reduced capacity to digest compounds

like cellulose and hemicellulose. On the other hand, increases in highly digestible soluble sugars in the diet increase digestibility. Here, the CO₂ driven changes observed to both N and WSC seem to counterbalance each other, leaving the digestibility of individual species unaffected (Table 2.2).

2.5.2. *Effects of elevated CO₂ on botanical composition*

We observed a significant increase in the proportion of legumes in the pasture at elevated CO₂ (Table 2.1) as shown in many other studies and systems e.g. sown bispecific mixture (Hebeisen *et al.*, 1997; Soussana and Hartwig 1996) and multispecific complex pasture ecosystems (Newton *et al.*, 1994; Teyssonneyre *et al.*, 2002). Although a positive response of legumes to elevated CO₂ is frequently observed, it is not an invariable response (Leadley *et al.*, 1999), since the legume response can be modified by other factors such as phosphorus availability (Stöcklin and Körner 1999), temperature (Newton *et al.*, 1994), cutting frequency and N fertilisation (Hebeisen *et al.*, 1997). A potentially important modifying factor in our experiment was the presence of large herbivores that are known to express a positive preference for legumes (Parsons *et al.*, 1994). No active selection could be measured in this short term experiment (see Materials and Methods section) but is clearly an issue on a yearly basis and raises the possibility of differences arising in composition between grazed and cut swards, and, indeed, data from this site confirms the expectation of lower legume content under grazing (Newton *et al.*, 2001). Moreover, it appears that the relative clover suppression by grazing allows for greater expression of the CO₂ response as the difference between treatments in legume proportion was much greater under grazing than cutting (Newton *et al.*, 2001).

2.5.3. *Integration of direct and indirect effects of elevated CO₂ on herbage quality*

One important characteristic of large herbivores feeding in a pasture exposed to elevated CO₂ is their ability to integrate, through grazing, CO₂ effects that occur both at the plant and community levels. In this instance, the shift in the botanical composition towards a higher proportion of legumes counterbalanced the N decrease

observed at the single species scale, resulting in an N concentration of the overall diet that was unaffected by elevated CO₂ (Fig. 2.1). A similar phenomenon was observed in a cut grassland FACE experiment where a grass (*L. perenne*) and a legume (*T. repens*) were grown alone or in mixture (Hartwig *et al.*, 2000).

In contrast to N, changes at the species level and at the sward level appeared to combine additively in relation to WSC. As there was a significant correlation between WSC and digestibility (as previously observed by Dent and Aldrich, 1963; Humphreys, 1989), there was also an increase in digestibility of the high CO₂ forage. This result matches that found in a Mini-FACE experiment under cutting (Teyssonneyre 2002; Picon-Cochard *et al.*, 2003); here digestibility also increased in response to CO₂ despite reduced crude protein concentration. These data, and the strong relationship between soluble sugars (rather than N) and digestibility (Fig. 2.2) suggest that the widespread response to CO₂ of increased soluble sugars might lead to an increase in forage digestibility.

2.5.4. Implications of a modified forage quality for nutrient cycling through ruminants

Our data shows that despite having diets containing similar N concentrations, sheep grazing the elevated CO₂ pasture excreted proportionally less N in their dung and more in their urine. Because these sheep were mature they could be considered at maintenance i.e. had no significant N sink, we calculated urinary N as the difference between ingested and faecal N assuming a low N retention (5%). For this shift in N partitioning to be buffered by an increased N retention under elevated CO₂, it would require retention rates of about 14% and 12% in 2000 and 2001 respectively under elevated CO₂ conditions; i.e. a 2-3 fold increase in N retention under elevated CO₂. Given that N retention in non-pregnant, non-lactating animals is mainly driven by animal physiological needs, such an increase does not seem reasonable and our calculations probably reflect a real shift in N partitioning under elevated CO₂.

In general, the proportion of N excreted in the urine is positively correlated to N concentration of the diet (Jarvis 2000); however, in our case no difference in

dietary N concentration was apparent and we need to look elsewhere for an explanation for the change in partitioning. One strong candidate is the higher proportion of legumes ingested by the sheep on the elevated CO₂ pasture, particularly in 2000. A number of studies on a range of animals have shown increased allocation of N to urine as the proportion of clover in the diet increases even though the total N in the diet remains unchanged. For example MacRae and Ulyatt (1974), in a study of fresh forage digestion by sheep, measured a higher proportion of ingested N excreted in urine when sheep were fed with white clover (*T. repens*) (77.7%) compared to perennial (*L. perenne*) (68.2%) or annual ryegrass (*Lolium multiflorum* L.) (59%), despite a similar amount of ingested N in the three diets. The same trend was observed on ewes fed with pure ryegrass or ryegrass/ white clover mixed swards by Orr *et al.*, (1995). Again, data in Hutton *et al.*, (1967) show that variation in the N concentration of dairy cows' urine throughout a milking season was strongly correlated with the proportion of clover in the diet but not with the N concentration of the diet.

The reason for the enhancement of urinary N output for a given amount of ingested N is still unclear. It has been hypothesised that a legume increase would create an imbalance between protein intake and rapidly fermentable energy, thereby altering the efficiency of N use in the rumen (Beever 1993) and enhancing the production of ammonia that will eventually be excreted in the rumen (Evans *et al.*, 1996). This does not fit with our data since the diet WSC concentration slightly increased under elevated CO₂ (Fig. 2.1). We may thus hypothesise that N partitioning within the ruminant is affected by the type of N offered in the diet, a variable that is possibly affected by elevated CO₂ beyond the shift in botanical composition. This would explain the results obtained in 2001 with a low legume content. It is known that N use efficiency in the rumen can be affected by the degree of protein protection, by tannins for example (Waghorn 1985) or the amount of nitrate-N in the diet (Marais 1980). In a recent paper, Kebreab *et al.*, (2001) discussed the complex interactions between energy source and protein digestibility, both of which being potentially affected by elevated CO₂, on N partitioning in dairy cows. This highlights the need for more comprehensive experiments to elucidate the basis of the CO₂ effect reported here and whether this effect is purely driven by the increase in legumes in the herbage.

2.6. Conclusion

In this study we have shown that elevated CO₂ affects forage quality, both through changes in single species chemical composition and through altering the balance of plant species in the pasture in favour of legumes. Taken together, this leads to bulk forage with a slightly higher digestibility and similar N intake. Importantly, in relation to nutrient cycling, we estimated an increased proportion of excreted N in the urine relative to the faeces at elevated CO₂. N losses from urine through leaching and volatilisation can reach nearly 30% and 20% respectively of deposited N, making grazed pastures far from closed systems with respect to N (Ball *et al.*, 1979). In contrast, N losses from faeces are small (Haynes and Williams 1993) due to a low proportion of water-soluble N. Therefore we anticipate less efficient N cycling under grazing at elevated CO₂. The pathway of N loss is strongly soil dependent and in our pasture losses occur most readily through ammonia volatilisation, reaching approximately 20 kg N ha⁻¹ year⁻¹ under ambient CO₂ i.e. 15-20% of the N cycled through the animals (RA Carran, personal communication). Given the 15% increase in N partitioning towards urine shown here at elevated CO₂ and leaving aside any potential concentration dependant increase in volatilisation, an extra 3 kg N ha⁻¹ year⁻¹ of ammonia-N would be volatilised at high CO₂. As about 20% of the terrestrial biosphere is grazed by livestock and as between 40 and 75% of N cycles through animals rather than leaf litter, we suggest that this is a potentially important global response to elevated CO₂.

2.7. Acknowledgements

Financial support from the New Zealand Foundation for Research, Science and Technology (Contract C10X205) is gratefully acknowledged. V. Allard was funded by a Massey University Doctoral Scholarship. His stay in New Zealand was also supported by a grant from the Scientific and Cultural service of the French Embassy in New Zealand. We want to thank S. Brock, S. Dunn, E. Lawrence, T. Rayner for their technical assistance, F. Potter for statistical advice, G. Waghorn for advice on animal physiology, D. Corson for NIRs analysis and R. Cresswell for C-N

analysis. We also want to thank S. Ledgard, J. Crush, H. Jones and three anonymous referees for useful comments on the manuscript.

2.8. References

- Ball PR (1982) Nitrogen balances in intensively managed pasture systems. In: *Proceedings of a workshop on nitrogen balances in terrestrial ecosystems in New Zealand, Palmerston North, N.Z., May 1980*.
- Ball PR, Keeney DR, Theobald PW, Nes P (1979) Nitrogen balance in urine-affected areas of a New Zealand pasture. *Agronomy Journal*, **71**, 309-314.
- Beever DE (1993) Ruminant animal production from forages: present position and future opportunities. In: *Proceedings of the XVII International Grassland Congress 1993*, pp. 535-542. New Zealand Grassland Association.
- Brock JL (1988) Evaluation of New Zealand bred white clover cultivars under rotational grazing and set stocking with sheep. *Proceedings of the New Zealand Grassland Association*, **49**, 203-206.
- Corson DC, Waghorn GC, Ulyatt MJ, Lee J (1999) NIRS: Forage analysis and livestock feeding. In: *Proceedings of the New Zealand Grassland Association*, **61**, 127-132.
- Cotrufo MF, Ineson P, Scott A (1998) Elevated CO₂ reduces the nitrogen concentration of plant tissues. *Global Change Biology*, **4**, 43-54.
- Dent JW, Aldrich DTA (1963) The inter-relationships between heading date, yield, chemical composition and digestibility in varieties of perennial ryegrass, timothy, cooksfoot and meadow fescue. *Journal of the National Institute of Agricultural Botany*, **9**, 261-281.
- Diaz S, Grime JP, Harris J, McPherson E (1993) Evidence of a feedback mechanism limiting plant response to elevated carbon dioxide. *Nature*, **364**, 616-617.
- Dilustro JJ, Day FP, Drake BG (2001) Effects of elevated atmospheric CO₂ on root decomposition in a scrub oak ecosystem. *Global Change Biology*, **7**, 581-589.
- Edwards GR, Newton PCD, Tilbrook JC, Clark H (2001) Seedling performance of pasture species under elevated CO₂. *New Phytologist*, **150**, 359-369.

- Evans DR, Humphreys MO, Williams TA (1996) Forage yield and quality interaction between white clover and contrasting ryegrass varieties in grazed swards. *Journal of Agricultural Science*, **126**, 295-299.
- Genstat (2002) Genstat 6, Release 1.0.20. Lawes Agriculture Trust, IACR, Rothamsted.
- Gifford RM, Barrett DJ, Lutze JL (2000) The effects of elevated [CO₂] on the C:N and C:P mass ratios of plant tissues. *Plant and Soil*, **224**, 1-14.
- Hadley M (1993) Grasslands for sustainable ecosystems. In: *Proceedings of the XVII International Grassland Congress 1993*, pp. 21-28. New Zealand Grassland Association.
- Hartwig UA, Lüscher A, Daepf M, Blum H, Soussana JF, Nösberger J (2000) Due to symbiotic N₂ fixation, five years of elevated atmospheric pCO₂ had no effect on the N concentration of plant litter in fertile, mixed grassland. *Plant and Soil*, **224**, 43-50.
- Haynes RJ, Williams PH (1993) Nutrient cycling and soil fertility in the grazed grassland ecosystem. *Advances in Agronomy*, **49**, 119-190.
- Hebeisen T, Lüscher A, Zanetti S, Fischer BU, Hartwig UA, Frehner M, Hendrey GR, Blum H, Nösberger J (1997) Growth response of *Trifolium repens* L. and *Lolium perenne* L. as monocultures and bi-species mixture to free air CO₂ enrichment and management. *Global Change Biology*, **3**, 149-160.
- Hirschel G, Körner C, Arnone JA III (1997) Will rising atmospheric CO₂ affect leaf litter quality and *in situ* decomposition rates in native plant communities? *Oecologia*, **110**, 387-392.
- Humphreys MO (1989) Water-soluble carbohydrates in perennial ryegrass breeding. III. Relationships with herbage production, digestibility and crude protein content. *Grass and Forage Science*, **44**, 423-430.
- Hutton JB, Jury KE, Davies EB (1967) Studies of the nutritive value of New Zealand dairy pastures. V. The intake and utilisation of potassium, sodium, calcium, phosphorus, and nitrogen in pasture herbage by lactating dairy cattle. *New Zealand Journal of Agricultural Research*, **10**, 367-388.
- Jarvis SC (2000) Soil-plant-animal interactions and impact on nitrogen and phosphorus cycling and recycling in grazed pastures. In: *Grassland Ecophysiology and Grazing Ecology* (eds Lemaire G, Hodgson J, de Moraes A, Nabinger C, de F Carvalho PC), pp 317-337. CAB International, Wallingford.

- Jongen M, Jones MB (1998) Effects of elevated carbon dioxide on plant biomass production and competition in a simulated neutral grassland community. *Annals of Botany*, **82**, 111-123.
- Kebreab E, France J, Beever DE, Castillo AR (2001) Nitrogen pollution by dairy cows and its mitigation by dietary manipulation. *Nutrient Cycling in Agroecosystems*, **60**, 275-285.
- Keeling CD, Whorf TP, Wahlen M, Vanderpligt J (1995) Interannual extremes in the rate of rise of atmospheric carbon dioxide since 1980. *Nature*, **375**, 666-670.
- Lambert MG, Renton SW, Grant DA (1982) Nitrogen balance studies in some North Island hill pastures. In: *Proceedings of a workshop on nitrogen balances in terrestrial ecosystems in New Zealand, Palmerston North, N.Z., May 1980*.
- Leadley PW, Nicklaus PA, Stöcker R, Körner C (1999) A field study of the effects of elevated CO₂ on the plant biomass and community structure in a calcareous grassland. *Oecologia*, **118**, 39-49.
- McLeod AR, Long SP (1999) Free-air Carbon Dioxide Enrichment (FACE) in global change research: a review. *Advances in Ecological Research*, **28**, 1-56.
- Marais JP (1980) Effect of nitrate and non-protein organic nitrogen levels in kikuyu (*Pennisetum clandestinum*) pastures on digestibility in vitro. *Agroanimalia*, **12**, 7-11.
- MacRae JC, Ulyatt MJ (1974) Quantitative digestion of fresh herbage by sheep. II. The sites of digestion of some nitrogenous constituents. *Journal of Agricultural Science Cambridge*, **82**, 309-319.
- McDonald P, Edwards RA, Greenhalgh JFD (1981) *Animal Nutrition* (3rd edition). Longman, Harlow, 479 pp.
- Newton PCD (1991) Direct effects of increasing carbon-dioxide on pasture plants and communities. *New Zealand Journal of Agricultural Research*, **34**, 1-24.
- Newton PCD, Clark H, Edwards GR (2001) The effect of climate change on grazed grasslands. In: *Structure and Function of Agroecosystem Design and Management* (eds Shiyomi M, Koizumi H) pp. 297-311, CRC Press, Boca Raton.
- Newton PCD, Clark H, Bell CC, Glasgow EM, Campbell BD (1994) Effects of elevated CO₂ and simulated seasonal changes in temperature on the species composition and growth rates of pastures turves. *Annals of Botany*, **73**, 53-59.
- Norby RJ, Cotrufo MF (1998) A question of litter quality. *Nature*, **396**, 17-18.

- Norby RJ, Cotrufo M F, Ineson P, O'Neill EG, Canadell JG (2001) Elevated CO₂, litter chemistry, and decomposition: a synthesis. *Oecologia*, **127**, 153-165.
- Norby RJ, Pastor J, Melillo JM (1986) Carbon-nitrogen interactions in CO₂-enriched white oak: physiological and long-term perspective. *Tree Physiology*, **2**, 233-241.
- Orr RJ, Penning PD, Parsons AJ, Champion RA (1995) Herbage intake and N excretion by sheep grazing monocultures or a mixture of grass and white clover. *Grass and Forage Science*, **50**, 31-40.
- Owensby CE, Cochran RM, Auen LM. (1996). Effects of Elevated Carbon Dioxide on Forage Quality for Ruminants. In: *Carbon Dioxide, Populations, and Communities* (eds Körner C, Bazzaz F), pp. 363-371. Academic Press, London.
- Parsons AJ, Newman JA, Penning PD, Harvey A, Orr RJ (1994) Diet preference of sheep: effects of recent diet, physiological state and species abundance. *Journal of Animal Ecology*, **63**, 465-478.
- Parsons AJ, Chapman DF (2000) The principles of pasture growth and utilisation. In: *Grass* (ed Hopkins A), pp. 31-89. Blackwell, London.
- Picon-Cochard C, Teyssonneyre F, Besle JM, Soussana JF (2003) Effects of elevated CO₂ and cutting frequency on the productivity and herbage quality of a semi-natural grassland. *European Journal of Agronomy*, in press.
- Poorter H, VanBerkel Y, Baxter R, DenHertog J, Dijkstra P, Gifford RM, Griffin KL, Roumet C, Roy J, Wong SC (1997) The effect of elevated CO₂ on the chemical composition and construction costs of leaves of 27 C₃ species. *Plant, Cell and Environment*, **20**, 472-482.
- Popp M, Lied W, Meyer AJ, Richter A, Schiller P, Schwitte H (1996) Sample preservation for determination of organic compounds – microwave versus freeze-drying. *Journal of Experimental Botany*, **47**, 1469-1473.
- Soussana JF, Hartwig UA (1996) The effects of elevated CO₂ on symbiotic N₂ fixation: a link between the carbon and nitrogen cycles in grassland ecosystems. *Plant and Soil*, **187**, 321-332.
- Soussana JF, Casella E, Loiseau P (1996) Long-term effect of CO₂ enrichment and temperature increase on a temperate grass sward. II. Plant nitrogen budgets and root fraction. *Plant and Soil*, **182**, 101-114.
- Stöcklin J, Körner C, (1999) Interactive effects of CO₂, P availability and legume presence on calcareous grassland: results of a glasshouse experiment. *Functional Ecology*, **13**, 200-209.

- Strain BR, Bazzaz FA (1983) Terrestrial plant communities. In: *CO₂ and Plants: The Response of Plants to Rising Levels of Carbon Dioxide* (ed Lemon E), pp. 177-222. American Association for the Advancement of Science, Washington, DC.
- Teyssonneyre F (2002) *Effet d'une augmentation de la concentration atmosphérique en CO₂ sur la prairie permanente et sur la compétition entre espèces prairiales associées*. PhD thesis, Orsay, Paris XI, France.
- Teyssonneyre F, Picon-Cochard C, Falcimagne R, Soussana JF (2002) Effects of elevated CO₂ and cutting frequency on plant community structure in a temperate grassland. *Global Change Biology*, **8**, 1-13.
- Thornley JHM, Fowler D, Rogers HH (1995) Terrestrial carbon storage resulting from CO₂ and nitrogen fertilization in temperate grasslands. *Plant, Cell and Environment*, **14**, 1007-1011.
- van Ginkel JH, Gorissen A (1998) *In situ* decomposition of grass roots as affected by elevated atmospheric carbon dioxide. *Soil Science Society of America Journal*, **62**, 951-958.
- van Vuuren MMI, Robinson D, Scrimgeour CM, Raven JA, Fitter AH (2000) Decomposition of ¹³C-labelled wheat root systems following growth at different CO₂ concentrations. *Soil Biology and Biochemistry*, **32**, 403-413.
- von Caemmerer S, Ghannoum O, Conroy JP, Clark H, Newton PCD (2001) Photosynthetic responses of temperate species to free air CO₂ enrichment (FACE) in a grazed New Zealand pasture. *Australian Journal of Plant Physiology*, **28**, 439-450.
- Waghorn GG (1985) Effects of tannin on the digestion of *Lotus corniculatus* by sheep. In: *Recent advances in animal nutrition in Australia 1985. Proceedings of a symposium at the University of New England, November 24-27*.



Plate 3.1: Litter incubation bags in the field. Leaf material is placed at the soil surface and root material is buried.

Chapter 3: Elevated CO₂ Effects on Decomposition Processes in a Grazed Grassland

Chapter 3: Elevated CO₂ Effects on Decomposition Processes in a Grazed Grassland

Allard V, Newton PCD, Lieffering M, Matthew C

3.1. Abstract

In situ decomposition of plant litter and animal faecal material was studied, over two years, in the New Zealand Free Air CO₂ Enrichment (FACE) facility. As expected, elevated CO₂ did not affect decomposition rates of plant litter because quality of the litter at the species scale was not altered. Nevertheless, indirect effects of elevated CO₂ on the pasture botanical composition and biomass allocation were found and these effects tended to increase decomposition rates at the ecosystem scale. Decomposition of faecal material was slower under elevated CO₂ during a summer experiment but not during winter. This highlights the complex relationships between animal returns and other ecosystem components in the context of elevated CO₂ and also the importance of taking grazers into account when predicting effect of elevated CO₂ in grasslands. When direct and indirect effects of elevated CO₂ were taken into account, the two counterbalanced each other, and average organic matter decomposition rate in this ecosystem was not appreciatively altered by elevated CO₂.

3.2. Introduction

Understanding the response of organic matter (OM) decomposition to the rise in atmospheric CO₂ (Keeling *et al.*, 1995) is central to prediction of ecosystem functioning under our ongoing changing climate. In grasslands, carbon (C) sequestration occurs mostly belowground and because grasslands cover about 20% of the land surface, grassland soils are major C sinks (Thornley *et al.*, 1991). Thus, increased C stocks in grassland soils could potentially buffer the atmospheric CO₂ increase, but this process is largely dependent on the capacity of OM to retain C during decomposition. In addition, the nitrogen (N) immobilization-mineralisation balance during OM decomposition is a key process determining ecosystem functioning and may act as a feedback to the ecosystem response to elevated CO₂ (Diaz *et al.*, 1993; Zak *et al.*, 1993).

Decreased quality of litter at the individual species level under elevated CO₂ has long been considered the major mechanism altering litter decomposition (Strain and Bazzaz, 1983; Coûteau *et al.*, 1996; Cotrufo *et al.*, 1995). However, this hypothesis has now been discarded because the reduction in plant quality observed in green material (Cotrufo *et al.*, 1998) is only partially reflected in senescing tissue (Norby and Cotrufo, 1998). Therefore no changes, or at most only small changes in individual species litter decomposition rates have been observed under elevated CO₂ (Hirschel *et al.*, 1997; Van Vuuren *et al.*, 2000). Litter decomposition at the ecosystem scale might nevertheless be strongly altered if possible indirect effects of elevated CO₂ on botanical composition and biomass partitioning between shoots and roots are taken into account. Indeed, it was concluded that CO₂ driven shifts in species composition could change average decomposition rates in a C₃-C₄ grassland due the relative difference in degradability of these functional groups (Kemp *et al.*, 1994). Similar findings were obtained from a natural CO₂ spring (Ross *et al.*, 2002). In addition, belowground biomass allocation is usually increased under elevated CO₂ as shown by lower shoot: root ratios (Cotrufo and Gorissen, 1997; van Ginkel *et al.*, 1997) and increased root turnover (Canadell *et al.*, 1996; Fitter *et al.*, 1996). This might alter decomposition rate at the system scale if root decomposition is slower than leaf litter decomposition (Gorissen and Cotrufo, 2000).

The current understanding of organic matter decomposition processes in grasslands under elevated CO₂ is exclusively based on data for simulated cut grasslands (Newton *et al.*, 2001) in spite of the infrequent use of this management at a global scale. In the presence of herbivores a major part of organic matter returns to the soil occurs through faeces and urine (Parsons *et al.*, 1991; Orr *et al.*, 1995), therefore faeces decomposition may also be of importance in the context of elevated CO₂. Indeed herbivores feed mainly on green tissue, material that exhibits stronger effects of elevated CO₂ than senescing material and in addition grazing animals also integrate CO₂ effects at the community level in particular possible changes in botanical composition (Chapter 2).

This study compares elevated CO₂ effects on decomposition rates of the different material that contribute to organic matter input to a grassland soil and their capacity to release N during decomposition. To this end, the results of three different decomposition experiments that took place in the New Zealand pasture FACE experiment between 2000 and 2002 are presented. In particular, attention is focussed on the possible effects of CO₂-induced shifts in botanical composition and shoot:root biomass partitioning that might significantly alter decomposition rate at the ecosystem scale. In addition, to assess an important process in grazed grassland, the question of potential effects of elevated CO₂ on animal returns through changes in plant chemical composition and botanical composition will be addressed. We then bring these fluxes together to compare their relative importance and the net outcome in term of decomposition rate and N release.

3.3. Materials and Methods

3.3.1. Experimental site

The study was carried out in a temperate pasture on the west coast of the North Island of New Zealand (40°14'S, 175°16'E). The pasture had been under permanent grazing by sheep, cattle and goats since at least 1940. The mean annual rainfall at the site was 875 mm and average air temperature at a nearby recording station ranges from 8°C in July (minimum) to 17.4°C in February (maximum).

Species diversity in this pasture is high; more than 20 vascular species were found during an inspection of the vegetation in 1996. The pasture is dominated by the C3 grasses *Lolium perenne* L., *Agrostis capillaris* L. and *Anthoxanthum odoratum* L., the C4 grass *Paspalum dilatatum*, the legumes *Trifolium repens* L. and *Trifolium subterraneum* L., and the forbs *Hypochaeris radicata* L. and *Leontodon saxatilis* L. The experimental facility consisted of six FACE (Free Air CO₂ Enrichment) rings (McLeod and Long 1999), each 12 m in diameter; which had been paired based on initial soil and botanical characteristics. In each pair (or block), one ring was fumigated with CO₂ at a target value of 475 $\mu\text{l l}^{-1}$ CO₂ (enriched treatment) during the photoperiod, and the second was left at atmospheric CO₂ concentration (ambient treatment) with enrichment beginning on 1 October 1997.

3.3.2. Sheep faeces collection and decomposition

Two separate faeces decomposition experiments were set up in 2000 and 2001. Because the first experiment took place under a relatively extreme drought, a second was set up under more common climatic conditions. Methodology details for these two experiments are given below.

In November 2000 a single group of five sheep grazed all the rings sequentially. In this case, individual animals were used as replicates for the CO₂ treatments. The sheep were held indoors and starved for 24 h prior to the grazing in order to remove the effect of their previous diet on faeces composition. The sheep first sequentially grazed the three enriched rings followed by the three ambient rings. They were allowed to stay in each ring for 24 h and moved each morning to the next ring. Throughout this grazing, sheep wore harnesses and faecal collection bags. The bags were emptied every 24 h. For this experiment, we collected faeces after the sheep had grazed for 48 h in the same CO₂ treatment (i.e. were still in a ring of the same treatment). We thus collected five replicates samples of faecal material from both CO₂ treatments. Hence, individual animals were used as replicates for the CO₂ treatments.

A sub-sample of the faeces was taken and oven-dried (60°C, to constant mass) to determine dry matter content, and then finely ground before analysis of initial C and N concentration at Lincoln University with a mass spectrometer (PDZ Europa, UK). The remaining material was kept in a cold room (4°C) until preparation of the incubation bags. The incubation bags (5 cm × 5 cm) were made of polyethylene mesh (mesh size = 1mm) and filled with a known weight of fresh faecal material (approximately 5 g fresh weight). A cross-over design was used to compare the effects of the CO₂ concentration where the faeces originated from (CO₂ origin) and the CO₂ concentration during incubation (CO₂ incubation). In addition, enough bags were set up to allow for four retrieval dates (2, 4, 6 and 16 weeks of incubation). Therefore 40 incubation bags (2 CO₂ origin × 4 dates × 5 sheep) were placed in each ring. A nail was used to keep each incubation bag in close contact with the soil surface. The vegetation was cut to about 1 cm prior to the bag placement in December 2000. At each of the four sampling, the remaining faecal material was separated from adhering soil and newly grown vegetal material, oven dried (60°C, until constant mass), weighed and ground prior to C and N concentration determination.

In June 2001 sheep were kept in the same ring for the duration of grazing. Thus, in this instance, rings were the replicate units for detection of the CO₂ effect. Two sheep were allocated to the rings of the first block and three sheep per ring in the second and third blocks. This methodology was used because pre-grazing herbage biomass varied between blocks. In this second collection, animals did not wear faeces collection bags. Instead, after three days of grazing in the rings, fresh faecal samples were collected directly from the ground. These samples were then processed and placed in incubation bags, 40 per ring (2 CO₂ origin × 4 dates × 5 samples), as described above using the same experimental design. There four retrieval dates with sampling taking place after 4, 6, 8 and 12 weeks of incubation.

3.3.3 Plant leaf and litter collection and decomposition

A third experiment was set up to study vegetal material decomposition. This experiment dealt mainly with senesced leaf litter and root decomposition but green

leaf material was also included in the study in order to highlight how the resorbition processes during leaf senescence modified decomposition characteristics. Furthermore, green material decomposition was considered to be a good standard for comparison with faeces decomposition. In November 2001, green leaves of four species belonging to different functional groups– *Agrostis capillaris* (C₃ grass), *Trifolium subterraneum* (legume), *Hypochaeris radicata* (forbs) and *Paspalum dilatatum* (C₄ grass) – were sampled in each ring. These species were chosen from diverse functional groups in order to assess possible species effects on decomposition. In addition, leaf litter of the same species was collected. The methodology used to collect litter varied according to species. From patches where *P. dilatatum* and *A. capillaris* were highly dominant, newly fallen dead leaves were collected. However, attached dead leaves of *T. subterraneum* and *H. radicata* were collected as the litter sample, since no loose dead leaves originating from those plants were found at the soil surface. All plant samples were oven dried (60°C, to constant mass) and were kept in a cold room (4°C) until preparation of the incubation bags. To facilitate sampling, sets of 16 incubation bags (2 CO₂ origin × 4 species × green or litter) were made from a single piece of polyethylene mesh (30 cm × 30 cm, mesh size = 1 mm). Individual bags within each group were sealed with a soldering iron and filled with a known weight of approximately 0.35 g dry matter (DM) of material. A sufficient number of bags were set up to enable four retrieval dates. Litter bags were nailed in contact with the soil at the end of January 2001, and retrieval was every two months thereafter. After removal, samples were processed as described above for faecal samples and C and N content was analysed in INRA (France) with an elemental analyser (Carlo Erba, Italy).

3.3.4. Plant root collection and decomposition

Root material was collected from another experiment (Chapter 4) investigating the effect of elevated CO₂ on root growth using the “ingrowth core” method between January and October 2001. The root material used was thus derived from newly grown roots (maximum 2 months old) and did not include dead roots. The potential implications of this are discussed later. Due to the high botanical diversity in the

Table 3.1: Effects of elevated CO₂ on N concentration (%) and C/N ratio prior to incubation of green leaf material and leaf litter from *Trifolium subterraneum* (Tri), *Hypochaeris radicata* (Hya) and *Paspalum dilatatum* (Pasp) and *Anthoxantum odoratum* (Anth), root material and faeces from the summer experiment and the winter experiment. Values are mean of 3 replicates \pm s.d. Effects of the treatments are presented in table 3. 2.

[CO ₂] Origin	N		C/N	
	Ambient	Elevated	Ambient	Elevated
Material				
Green Anth	2.8 \pm 0.1	3 \pm 0.5	15 \pm 0.7	14.3 \pm 2.6
Green Hya	2.6 \pm 0.3	2.5 \pm 0.4	15.5 \pm 1.8	16.2 \pm 2.2
Green Pasp	3.1 \pm 0.2	3.1 \pm 0.4	14.2 \pm 1.2	14.3 \pm 2.1
Green Tri	3.5 \pm 0.3	3 \pm 0.4	12.5 \pm 0.9	14.3 \pm 1.7
Litter Anth	1.2 \pm 0.2	1.3 \pm 0.2	34.7 \pm 5.8	31.8 \pm 5.3
Litter Hya	1.2 \pm 0.1	1.2 \pm 0.2	29 \pm 3	30.2 \pm 4.6
Litter Pasp	1.2 \pm 0.1	1.1 \pm 0.2	34.8 \pm 4.3	37.3 \pm 8.6
Litter Tri	2.5 \pm 0.1	2.1 \pm 0.2	17.9 \pm 0.6	20.4 \pm 1.9
Roots	1.1 \pm 0.2	1.1 \pm 0.04	31.6 \pm 5.4	29.3 \pm 4.2
Faeces Summer	3.48 \pm 0.37	3.1 \pm 0.22	13.27 \pm 1.49	14.7 \pm 1.01
Faeces winter	2.48 \pm 0.47	2.39 \pm 0.29	16.66 \pm 2.83	16.79 \pm 1.85

rings, root material from particular plant species could not be collected separately. Six pseudo-replicates per ring were nevertheless sampled to take into account the botanical variability. The incubation bags were placed in groups of 12 (2 CO₂ origin × 6 samples), using a technique similar to that described above for dung samples, but with bags buried vertically with the upper edge 2 cm below the soil surface. As with the leaf material, incubation began at the end of January 2001 and a set of bags was retrieved after 2, 4, 6 and 8 months of incubation, except that bags for the third sampling date (6 months of incubation) were removed from the study because of problems during sampling.

3.3.5. *Relative N loss by decomposing material*

In order to assess the rate of N release by the different types of decomposing material the relative N loss was calculated as follow:

$$\text{Relative N loss} = (N_i - N_t) / (DM_i - DM_t)$$

Where N_i and N_t are the amount of N in the material before incubation and after sampling respectively and DM_i and DM_t the mass of the material at the same dates. The relative N loss was only calculated for one retrieval date for each type of material: after four months of incubation for plant material and 16 and 6 weeks for faecal material in the summer and winter experiment respectively.

3.3.6. *Summary scenarios*

To discuss the overall effect of elevated CO₂ on litter decomposition at the ecosystem scale, different scenarios based on data from this experimental site were used. The effect of a doubled proportion of dicots in the pasture under elevated CO₂ (scenario 1) was inspired by a results obtained in October 2000 (Chapter 2). The second scenario (scenario 2) assesses the effects of an enhanced biomass allocation to roots under elevated CO₂ on decomposition rate based on data obtained in chapter 4. Scenario 3 is a combination of scenarios 1 and 2 and simulates what might be the overall decomposition rate in a pasture under elevated CO₂ without considering any

Table 3.2: P-values from the analysis of variance of the effects of CO₂, species (*Trifolium subterraneum*, *Hypochaeris radicata*, *Paspalum dilatatum* and *Anthoxanthum odoratum*) and their interaction, on the N concentration and C/N ratio of green leaf material and leaf litter prior to the decomposition. P-values from the analysis of variance of the effects of CO₂ on the N concentration and C/N ratio of root material and faeces material from the summer and winter experiment prior to the decomposition, are mentioned.

Material		CO ₂	Species	CO ₂ *species
Green	N	0.727	0.025*	0.341
	C/N	0.743	0.142	0.575
Litter	N	0.334	<0.001***	0.759
	C/N	0.718	<0.001***	0.759
Roots	N	0.875	/	/
	C/N	0.688	/	/
Faeces summer	N	0.0870	/	/
	C/N	0.112	/	/
Faeces winter	N	0.781	/	/
	C/N	0.945	/	/

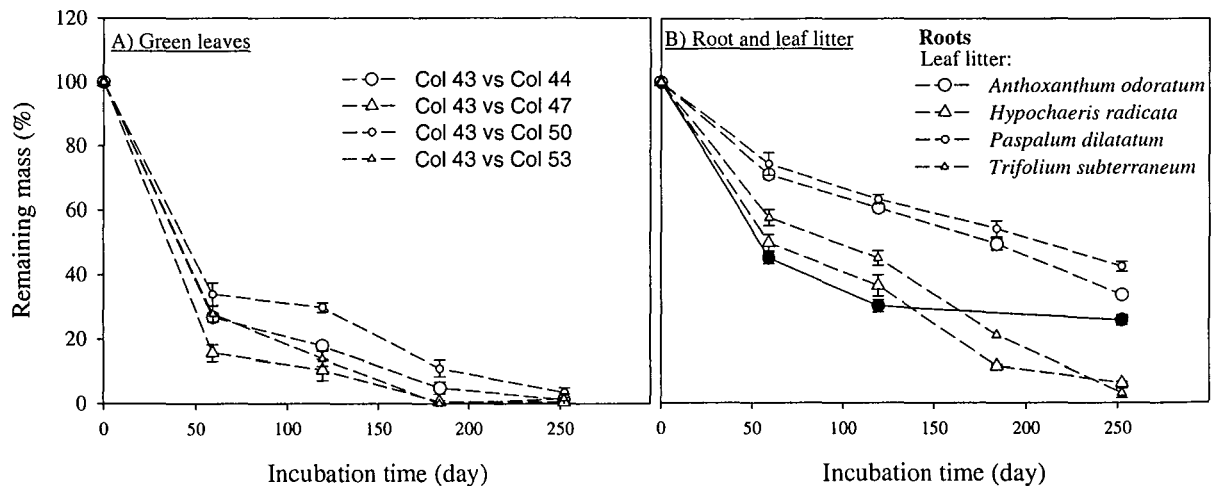

Figure 3.1: Disappearance rate (% of initial DM remaining) of (A) green leaf material and (B) leaf litter and roots of four plant species. Values are averaged over CO₂ treatments and are mean of 6 replicates ± s.e.

organic matter returns by grazers. Scenario 4 includes a possible decrease in faeces decomposition rate under elevated CO₂ based on the results observed in this study. To finish with scenario 5 combines scenarios 1, 2 and 4 and simulates overall decomposition rates in a grazed pasture under elevated CO₂. The decomposition rates used in the above scenarios were obtained by fitting average decomposition curves obtained in this experiment to an exponential decay model ($y = y_0E^{-kt}$, with k is the decomposition rate).

3.3.7. Statistical analysis

The mass of green material and leaf litter remaining was analysed at each date by analysis of variance (ANOVA) using a split-split-plot model using the following hierarchy: CO₂ incubation as main plot, CO₂ origin as sub-plot and species as sub-sub-plot. The relative N loss of these two materials was analysed with the same model but at a single date. The model for the analysis of root material remaining mass and the root relative N loss was a split-plot with CO₂ incubation as main plot and CO₂ origin as sub-plot. The mass of faeces remaining at each sampling date and the relative N loss, in 2001, were analysed as the root material and sheep were used as replicates in 2000. All analyses were performed in Genstat v 6.1 (Genstat 2002).

3.4. Results

3.4.1. Initial chemical composition

The initial chemical composition of green leaf, litter and root material used in this study did not differ between CO₂ treatments but species strongly affected N concentration of leaf green material and litter (Table 3.1). Green leaves of *P. dilatatum* and *T. subterraneum* had higher N concentration than *A. odoratum* and *H. radicata* but the absolute difference was marginal. Initial leaf litter initial chemical composition was also strongly affected by species type ($p < 0.001$, Table 3.2) with *T. subterraneum* litter having a 2-fold greater N concentration compared to the three other species. *Trifolium subterraneum* litter C/N ratio was also significantly lower

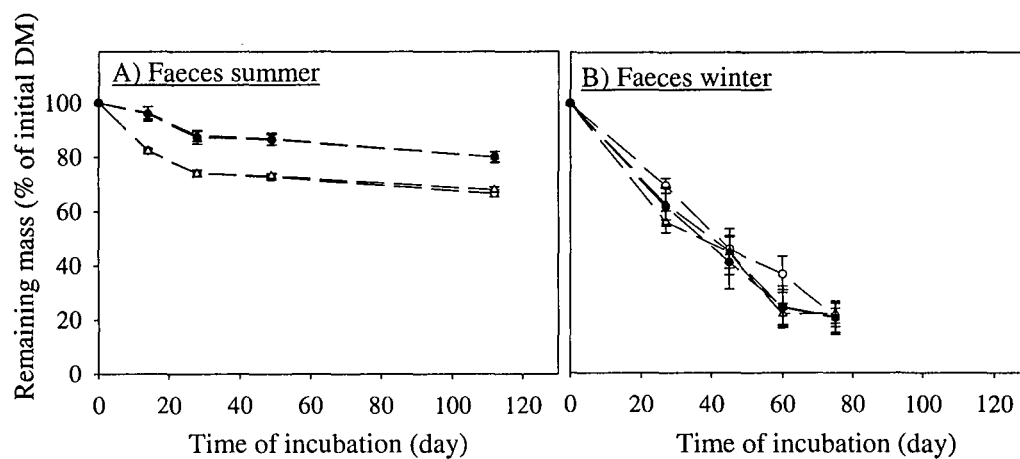

Figure 3.2: Effects of the CO₂ concentration during the production of the material (open shape: ambient and black bars: elevated) and during decomposition (circle: ambient and triangle: elevated) on the mass loss (% of remaining mass) of (A) faeces during summer and (B) during winter. Values are means of 3 replicates \pm s.e.

compared to the other species. The average N concentration of the faeces used in the summer experiment tended to be lower under elevated CO₂ (-11%, $p=0.087$) and the non significance of this result was due to one sheep ($p=0.005$ when it is excluded). In contrast, the average N concentration of the faeces samples used in the winter experiment was unaffected by elevated CO₂, though it was about 30% lower than in the first experiment.

3.4.2. Decomposition rates

Decomposition rates of green leaf material and litter, as measured by DM loss from the incubation bags, were not significantly affected by the CO₂ origin treatment, or by the CO₂ incubation treatment. Decomposition rates of both green material and leaf litter were affected by species, however. At all sampling dates, the species effect on remaining mass was extremely significant for both types of material. After 6 months of incubation, *T. subterraneum* and *H. radicata* green leaves were nearly totally decomposed while about 5% of *A. odoratum* and 11% of *P. dilatatum* material remained (Fig. 3.1a). Litter material exhibited a similar species effect with *H. radicata* and *T. subterraneum* having the smallest remaining mass after 6 months of incubation (11% and 21% respectively) while about 50% of the grass litter still remained (Fig. 3.1b).

Although roots could not be separated into plant species, it was still of interest to compare rates of root and green or dead leaf decomposition. Again, neither the CO₂ origin treatment, nor the CO₂ incubation treatment altered root decomposition rates. However, decomposition of root material and green or dead leaf material followed different time courses (Fig. 3.1b). Decomposition rate of root material was initially similar to that of the litter of the fast decomposing species *T. subterraneum* and *H. radicata*, but little change was observed over the last 4 months of incubation. About 25% of the initial root mass remained after 8 months, compared with 4% for dicot species litter and 40% for grass species litter.

The two measurements of faeces decomposition took place under contrasting climatic conditions. In the first experiment, conditions were dry, with volumetric soil

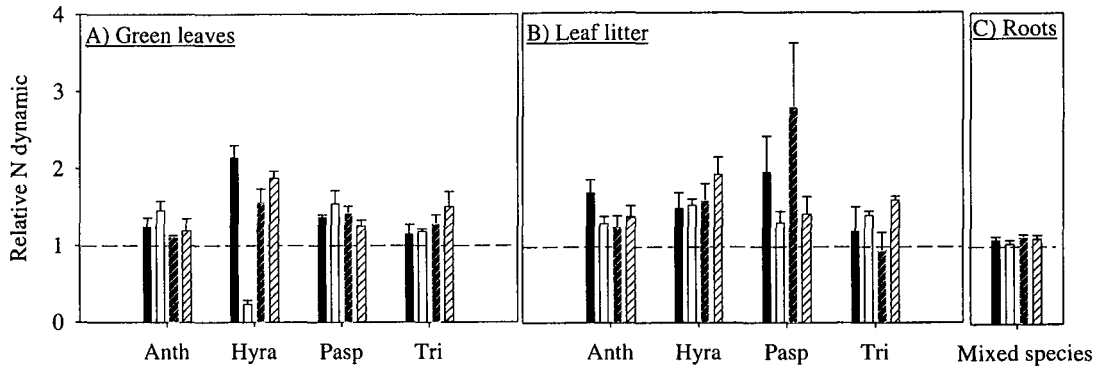

Figure 3.3: Effects of the CO₂ concentration during the production of the material (black bars: ambient and open bars: elevated) and during decomposition (empty bar: ambient and lined bar: elevated) on the relative N loss (remaining N / remaining mass) after 120 days of incubation of (A) green leaves and (B) leaf litter of four species (*Trifolium subterraneum* (Tri), *Hypochaeris radicata* (Hyra) and *Paspalum dilatatum* (Pasp) and *Anthoxantum odorantum* (Anth)) and (C) root material. Values are mean of three replicates \pm s.e

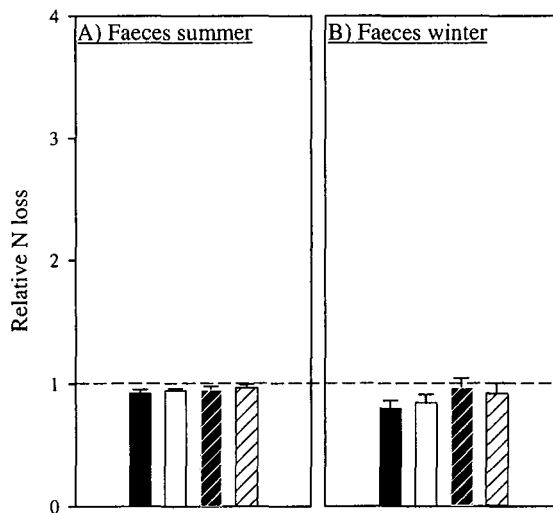

Figure 3.4: Effects of the CO₂ concentration during the production of the material (black bars: ambient and open bars: elevated) and during decomposition (empty bar: ambient and lined bar: elevated) on the relative N loss (remaining N / remaining mass) after 50 days of (A) faeces during summer and (B) faeces during winter.

moisture content to 15 cm depth averaging about 10%. In the second experiment, conducted in winter, soil moisture content averaged about 25%. Under the dry summer conditions remaining mass after 16 weeks was about 70% of the initial mass; during winter remaining mass was only 20% of the initial after 12 weeks (Fig. 3.2). In summer, the CO₂ origin dramatically altered decomposition rate ($p < 0.001$ at all dates). Faeces produced under elevated CO₂ decomposed more slowly; with about 20% more of the initial mass remaining at a given sampling date (Fig. 3.2). Conversely, CO₂ concentration during incubation did not affect decomposition rates. In winter faeces decomposition rates were unaltered by any of the treatments (Fig 3.2).

3.4.3. N release during decomposition

The relative N loss of the different plant materials was calculated for the second retrieval date, after 4 months of incubation; no significant effect of the CO₂ origin or CO₂ incubation treatments was evident (Fig. 3.3). However, relative N loss of root material was about 1.1 indicating similar DM and N decomposition pattern whereas relative N loss for leaf litter of some species exceeded 1.5 at the same date (Fig. 3.3), indicating relatively slower N release during leaf litter decomposition.

Relative N loss for faecal material of the first experiment was calculated after 16 weeks, and after 6 weeks in the second experiment, since with faster decomposition rates in the second experiment, insufficient material remained at the last sampling date for analysis. In contrast to plant green material or litter, relative N loss of faecal material was lower than 1 (Fig. 3.4), being 0.95 and 0.88 for the summer and the winter experiments, respectively.

Table 3.3: Simulation of the effect of elevated CO₂ on the mass loss rates and N release rates at the pasture scale under different scenarios. Mass loss values are derived from individual material decomposition curves after fitting to an exponential decay model and averaged to take into account the relative importance of the different materials. N release values are calculated from mass loss values and relative N release values measured in this study. Scenario 1 simulates an increase in dicots in the pasture; scenario 2 simulates increase in root production and scenario 4 a decrease in faeces decomposition; scenarios 3 and 5 are combination of the latter.

Scenario	[CO ₂]	Average mass loss		Average N release rate	
		Ambient	Elevated	Ambient	Elevated
1) Change in botanical composition ¹		5.50 10 ⁻³	6.10 10 ⁻³	4.20 10 ⁻³	4.70 10 ⁻³
2) Change in allocation to root growth ²		5.50 10 ⁻³	5.70 10 ⁻³	4.20 10 ⁻³	4.40 10 ⁻³
3) Cut grassland ^{1,2}		5.50 10 ⁻³	6.30 10 ⁻³	4.20 10 ⁻³	4.90 10 ⁻³
4) Decrease in faeces decomposition rates ³		6.90 10 ⁻³	6.80 10 ⁻³	7.30 10 ⁻³	6.90 10 ⁻³
5) Grazed grassland ^{1,2,3}		6.90 10 ⁻³	7.20 10 ⁻³	7.30 10 ⁻³	7.10 10 ⁻³

¹Dicots participation to herbage biomass is 15% and 30% under ambient and elevated CO₂, respectively.

²Root production is 30 and 50% of the herbage under ambient and elevated CO₂, respectively.

³Herbage utilisation rate is 50% of above ground production and herbage digestibility is 0.74.

3.5. Discussion

3.5.1. Effects of species changes under elevated CO₂ on leaf litter decomposition

Our results confirm earlier findings that elevated CO₂ does not alter the C/N ratio or decomposition rates of plant litter from individual species (Norby and Cotrufo, 1998; Ross *et al.*, 2002). These previous studies concluded that indirect CO₂ effects on botanical composition and shifts in biomass allocation may be of greater importance with regards to the litter decomposition at the ecosystem scale. This view is consistent with our results. None of the three vegetal materials (green leaf, litter and root) used in this experiment exhibited higher C/N ratio or lower decomposition rates when produced under elevated CO₂ but species-specific differences were observed. Leaf litter from *T. subterraneum* and *H. radicata* decomposed more than two times faster than the litter of the two grasses included in this study. Cornelissen (1996) also showed significantly greater decomposition rates of dicots compared to grasses. In view of the substantial increase in the proportion of legumes and forbs under elevated CO₂ at this site (Edwards *et al.*, 2001), it is clear from these results that elevated CO₂ must be associated with an overall increase in the decomposition rate of leaf litter at the pasture scale at this FACE site. Quantitatively, under the assumption of a 2-fold increase in the proportion of dicots under elevated CO₂ (Scenario 1), which is consistent with long term data from this site (P. Newton, unpublished data), the leaf litter mass loss and N release rates would increase by 10% at the sward scale (Table 3.3). Such an increase in decomposition rates driven by CO₂-induced shifts in botanical composition is probably not specific to this site. In temperate grassland an increasing abundance of dicots and legumes in particular, is a common response to elevated CO₂ and has been observed under a wide range of management conditions: in ryegrass/clover associations (Hebeisen *et al.*, 1997; Jongen and Jones, 1998), natural grassland (Teyssonneyre *et al.*, 2002) and in grazed temperate grassland (Newton *et al.*, 2001; Edwards *et al.*, 2001). In addition, not only does a high legume content induce a higher proportion of more rapidly decomposing litter but may also increase the average N concentration of the non-legume species and thus contribute to a faster decomposition of the latter (Hartwig *et al.*, 2000).

The observed increase in the proportion of “fast-decomposing species” under elevated CO₂ leads to the question of whether the decomposition rate is a functional trait directly or indirectly selected for under elevated CO₂. Regardless of the response to elevated CO₂, low litter decomposability is linked with low leaf palatability (Cornelissen and Thomson, 1997; Moretto *et al.*, 2001). Plants exhibiting low leaf palatability, a strategy used to limit or avoid defoliation by potential grazers, require large C investments in defence compounds. This decreases the amount of C able to be allocated in photosynthetically active tissues and therefore palatability is negatively correlated with growth rate (Coley, 1988). When the plant response to elevated CO₂ is considered, there is much evidence that fast growing species (i.e. with a high growth rate) show stronger growth response to elevated CO₂ than slow growing species (Poorter, 1993; Poorter *et al.*, 1996; Poorter and Navas, 2003). This leads to the conclusion that elevated CO₂ may be a selective agent for species with high decomposition rates. Berendse (1994) highlighted the importance of decomposition rates as a functional trait, suggesting that litter decomposition and the subsequent capacity to release nutrients was an active component of plant fitness. Indeed, plants appear to affect soil fertility in such a way that with time the substrate becomes more favourable for growth (Van Breemen, 1993). Under elevated CO₂, fast nutrient cycling may be an interesting feature because the higher C availability increases the relative need for other nutrients. Nevertheless, more comprehensive studies are needed to draw general conclusions about the importance of litter decomposition rate as an important trait determining species response to elevated CO₂.

3.5.2. *Effects of CO₂-induced shift in biomass allocation on decomposition rates*

Another level at which elevated CO₂ may alter decomposition rates at the ecosystem scale is through changes in biomass allocation and in particular a proportionally greater biomass allocation belowground. In another experiment on the same site it was shown that root growth and turnover were greatly increased under elevated CO₂ in summer and spring (Chapter 4) whereas aboveground herbage production was not affected. Strong CO₂ stimulation of root turnover in grasslands has been found elsewhere (Canadell *et al.*, 1996; Fitter *et al.*, 1996). In this study root decomposition was not found to differ greatly from leaf litter decomposition, at least

during the first phase of decomposition (accounting for about two thirds of the initial mass). Our results suggest that roots might have a more recalcitrant fraction which induces low decomposition rates in the later stages of the process but it still seems that overall root decomposition is not intrinsically slower than leaf litter decomposition.

This contrasts with other studies reporting much slower root decomposition when compared to aboveground material. For example Gorissen and Cotrufo (2000) observed that roots of three grass species exhibited between 25% and 50% less mass loss than aboveground material after about 7 months of incubation under laboratory conditions. Nevertheless we consider that this overestimates dramatically the differences in decomposition rates between the two types of material for two reasons. Firstly the use of green leaves in this decomposition experiment artificially increases the contrast with root decomposition rate since green material decomposes much faster than true leaf litter (Fig. 3.1). In comparison, decomposition rates of live and dead root material may differ less than those of live and dead leaves because rather less translocation of substrates from roots occurs during root senescence (Gordon and Jackson, 2000). Secondly, previous studies clearly demonstrated the effects of litter position on decomposition rates. Dukes and Field (2000) showed that leaf litter decomposes faster when buried rather than placed at the soil surface. Therefore the comparison of leaf and root material decomposition under standard conditions does not answer the central question of the relative decomposition rate of root and leaf litter decomposition *in situ*, i.e. aboveground for leaf litter and belowground for senesced roots. Again using a simulation scenario based on data from this site, a CO₂-driven shift towards an increased proportion of root litter in the total litter return will not lead to decreased decomposition rates at the ecosystem scale (Scenario 2). On the contrary, we calculate it would lead to a small increase (about 4%) in the average decomposition rate (Table 3.3). In addition, given the low N immobilisation potential of decomposing root material compared to leaf litter (Fig. 3.2; Seastedt, 1992), there should be a further increase soil N availability (6.5%). Combining the CO₂ effects on botanical composition and shoot:root allocation from Scenario 3 we calculate that at elevated CO₂ there will be a 15% increase in mass loss and 17% increase in N mineralisation rate from litter (Table 3.3).

3.5.3. Effects of elevated CO₂ on ruminant faeces decomposition

In well managed grazed grasslands, up to 50% of the aboveground herbage production is ingested by herbivores (Parsons and Chapman, 2000) therefore an important part of the organic matter cycling occurs through urine and faeces returns (Parsons *et al.*, 1991; Orr *et al.*, 1995). In this study sheep faeces decomposition exhibited a strong negative CO₂ effect during the first of the two decomposition experiments (Fig. 3.2). Because animals eat green leaves and not senescing material, and because CO₂ effects on leaf chemical composition are frequently observed in green material, it might be anticipated that herbivore diets may be altered under elevated CO₂. Furthermore, through the grazing process, ruminants integrate both the CO₂-driven decrease in N concentration observed at the single plant scale and the changes in botanical composition; in this case a higher proportion of legumes and forbs. In a previous experiment, we observed that these two processes were counterbalanced, leading to a similar N intake by animals under ambient and elevated CO₂ (Chapter 2). Nevertheless elevated CO₂ altered the partitioning of N return between urine and faeces, resulting in a decrease in N in animal faeces, attributable to the increased digestibility and higher proportion of legumes under elevated CO₂ conditions (Chapter 2).

Nevertheless, the decrease in faeces decomposition rate was only observed in the summer experiment. Under dry conditions, a thick crust forms over the surface of excreted faeces (Holter, 1979) that dramatically limits potential exchanges with the soil surface. Furthermore, under these dry conditions the soil fauna, in particular the earthworm population that plays a major role in dung decomposition (Hirschberger and Bauer, 1994), is mainly inactive, at least in the top soil (Yeates, 1976). The two most common earthworm species in New Zealand pastures are *Allobophora calliginosa* and *Lumbricus rubellus* and both of them develop inactive forms during the dry season. Decomposition that does occur in drier summer conditions is most likely to be caused by microbial and/or fungal activity and thus could be expected to be affected by variation in the initial C/N ratio of the material. By contrast, during winter, constant rainfall facilitates physical breakdown of the faeces and a fully active invertebrate population leads to fast decomposition. It seems likely that under these conditions, decomposition rate would be less dependent on initial quality of the

material. In a model ecosystem where dung decomposition is assumed to be the only process affected by elevated CO₂ (Scenario 4) both the ecosystem decomposition rate and the N mineralisation rate would be slightly decreased (by 2 and 5% respectively, Table 3.3). When all possible effects of elevated CO₂ are combined (Scenario 5) overall average decomposition rates are not altered by elevated CO₂ (Table 3.3).

3.6. Conclusion

This study confirmed that direct effects of elevated CO₂ on litter quality at the single plant scale could be discounted as a potential mechanism affecting organic matter decomposition in grasslands. However, secondary effects of elevated CO₂ at the community level through an increase in proportion of the legumes and other dicots, tended to increase litter decomposition rate. When organic matter return through herbivore faeces is not considered, these indirect CO₂ effects would lead to an increase of about 15% in decomposition rates. Under grazing, elevated CO₂ did not affect estimated decomposition rate. But importantly, grazing increased decomposition rates by more than 15% and N release rates by 60% when compared with grasslands without animal returns, probably enhancing potential N losses in particular under elevated CO₂ (Chapter 2). As a consequence, it appears that the effects of elevated CO₂ on decomposition processes in grazed grasslands act at different ecosystem scales that need to be included in future studies in order to predict more accurately the organic matter in grassland soils will accumulate or not under increasing levels of atmospheric CO₂.

3.7. Acknowledgements

The authors are grateful to Y. Gray, E. Lawrence, S. Brock, and D. Dewar for technical assistance with the decomposition experiment. We also want to thank S. Dunn and H. Clark for the maintenance of the FACE facility. V Allard was funded by a doctoral scholarship from Massey University and a grant from the Cultural and Scientific Service of the French Embassy in New Zealand.

3.8. References

- Berendse F (1994) Litter decomposability - a neglected component of plant fitness. *Journal of Ecology*, **82**, 187-190.
- Canadell JG, Pitelka LF, Ingram JSI (1996) The effects of elevated CO₂ on plant-soil carbon below-ground: A summary and synthesis. *Plant and Soil*, **187**, 391-400.
- Coley PD (1988) Effects of plant growth rate and leaf lifetime on the amount and type of anti-herbivore defence. *Oecologia*, **74**, 531-536.
- Cornelissen JHC (1996) An experimental comparison of leaf decomposition rates in a wide range of temperate plant species and types. *Journal of Ecology*, **84**, 573-582.
- Cornelissen JHC, Thomson K (1997) Functional leaf attributes predict litter decomposition rate in herbaceous plants. *New Phytologist*, **135**, 109-114.
- Cotrufo MF, Gorissen A (1997) Elevated CO₂ enhances below-ground C allocation in three perennial grass species at different levels of N availability. *New Phytologist*, **137**, 421-431.
- Cotrufo MF, Ineson P, Rowland AP (1995) Decomposition of birch leaf litters with varying C-to-N ratios. *Soil Biology and Biochemistry*, **27**, 1219-1221.
- Cotrufo MF, Ineson P, Scott A (1998) Elevated CO₂ reduces the nitrogen concentration of plant tissues. *Global Change Biology*, **4**, 43-54.
- Coûteaux MM, Monrozier LJ, Bottner P (1996) Increased atmospheric CO₂: chemical changes in decomposing sweet chestnut (*Castanea sativa*) leaf litter incubated in microcosms under increasing food web complexity. *Oikos*, **76**, 553-563.
- Diaz S, Grime JP, Harris J, McPherson E (1993) Evidence of a feedback mechanism limiting plant response to elevated carbon dioxide. *Nature*, **364**, 616-617.
- Dukes JS, Field CB (2000) Diverse mechanisms for CO₂ effects on grassland litter decomposition. *Global Change Biology*, **6**, 145-154.
- Edwards GR, Clark H, Newton PCD (2001) The effects of elevated CO₂ on seed production and seedling recruitment in a sheep-grazed pasture. *Oecologia*, **127**, 383-394.
- Fitter AH, Self GK, Wolfenden J, van Vuuren MMI, Brown TK, Williamson L, Graves JD, Robinson D (1996) Root production and mortality under elevated atmospheric carbon dioxide. *Plant and Soil*, **187**, 299-306.
- Genstat (2002) Genstat 6, release 1.0.20. Lawes Agriculture trust, IACR, Rothamsted.

- Gordon WS, Jackson RB (2000) Nutrient concentrations in fine roots. *Ecology*, **81**, 275-280.
- Gorissen A, Cotrufo MF (2000) Decomposition of leaf and root tissue of three perennial grass species grown at two levels of atmospheric CO₂ and N supply. *Plant and Soil*, **224**, 75-84.
- Hartwig UA, Lüscher A, Daepf M, Blum H, Soussana JF, Nosberger J (2000) Due to symbiotic N₂ fixation, five years of elevated atmospheric pCO₂ had no effect on the N concentration of plant litter in fertile, mixed grassland. *Plant and Soil*, **224**, 43-50.
- Hebeisen T, Lüscher A, Zanetti S, Fischer BU, Hartwig UA, Frehner M, Hendrey G R, Blum H, Nösberger J (1997) Growth response of *Trifolium repens* L. and *Lolium perenne* L. as monocultures and bi-species mixture to free air CO₂ enrichment and management. *Global Change Biology*, **3**, 149-160.
- Hirschberger P, Bauer T (1994) Influence of earthworms on the disappearance of sheep dung. *Pedobiologia*, **38**, 475-480.
- Hirschel G, Körner C, Arnone III JA (1997) Will rising atmospheric CO₂ affect leaf litter quality and situ decomposition rates in native plant communities. *Oecologia*, **110**, 387-392.
- Holter P (1979) Effect of dung beetles (*Aphodius* spp.) and earthworms on the disappearance of cattle dung. *Oikos*, **32**, 393-402.
- Jongen M, Jones MB (1998) Effects of elevated carbon dioxide on plant biomass production and competition in a simulated neutral grassland community. *Annals of Botany*, **82**, 111-123.
- Keeling CD, Whorf TP, Wahlen M, Vanderpligt J (1995) Interannual extremes in the rate of rise of atmospheric carbon dioxide since 1980. *Nature*, **375**, 666-670.
- Kemp PR, Waldecker DG, Owensky CE, Reynolds JF, Virginia RA (1994) Effects of elevated CO₂ and nitrogen fertilization pretreatments on decomposition on tallgrass prairie leaf litter. *Plant and Soil*, **165**, 115-127.
- McLeod AR, Long SP (1999) Free-air Carbon Dioxide Enrichment (FACE) in global change research: a review. *Advances in Ecological Research*, **28**, 1-56.
- Moretto AS, Distel RA, Didoné NG (2001) Decomposition and nutrient dynamic of litter and roots from palatable and unpalatable grasses in a semi-arid grassland. *Applied Soil Ecology*, **18**, 31-37.

- Newton PCD, Clark H, Edwards GE (2001) The effects of elevated atmospheric CO₂ on grazed grasslands. In: *Structure and Function of Agroecosystem Design and Management* (eds Shiyomi M, Koizumi H), pp. 297-311. CRC Press, Boca Raton.
- Norby RJ, Cotrufo MF (1998) A question of litter quality. *Nature*, **396**, 17-18.
- Orr RJ, Penning PD, Parsons AJ, Champion RA (1995) Herbage intake and N excretion by sheep grazing monocultures or a mixture of grass and white clover. *Grass and Forage Science*, **50**, 31-40.
- Parsons AJ, Orr RJ, Penning PD, Lockyer DR, Ryden JC (1991) Uptake, cycling and fate of nitrogen in grass-clover swards continuously grazed by sheep. *Journal of Agricultural Science, Cambridge*, **116**, 47-61.
- Parsons AJ, Chapman DF (2000) The principles of pasture growth and utilisation. In: *Grass* (ed Hopkins A), pp. 31-89. Blackwell, London.
- Poorter H (1993) Interspecific Variation in the growth response of Plants to an elevated ambient CO₂ concentration. *Vegetatio*, **104-105**, 77-97.
- Poorter H, Roumet C, Campbell BD (1996) Interspecific variation in the growth response of plants to elevated CO₂: A search for functional types. In: *Carbon dioxide, Populations and Communities* (eds Körner C, Bazzaz FA), pp. 375-410. Academic Press, New York.
- Poorter H, Navas ML (2003) Plant growth and competition at elevated CO₂: on winners, losers and functional groups. *New Phytologist*, **157**, 175-198.
- Ross DJ, Tate KR, Newton, PCD, Clark H (2002) Decomposability of C₃ and C₄ grass litter under different concentrations of atmospheric carbon dioxide at a natural CO₂ spring. *Plant and Soil*, **240**, 275-286.
- Seastedt TR, Parton WJ, Ojima D S (1992) Mass loss and nitrogen dynamics of decaying litter of grasslands: the apparent low nitrogen immobilization potential of root detritus. *Canadian Journal of Botany*, **70**, 384-391.
- Strain BR, Bazzaz FA (1983) Terrestrial plant communities. In: *CO₂ and Plants* (ed Lemon ER), pp. 177-222. Westview, Boulder.
- Teyssonneyre F, Picon-Cochard C, Falcimagne R, Soussana JF (2002) Effects of elevated CO₂ and cutting frequency on plant community structure in a temperate grassland. *Global Change Biology*, **8**, 1034-1046.

- Thornley JHM, Fowler D, Cannell GR (1991) Terrestrial carbon storage resulting from CO₂ and nitrogen fertilization in temperate grasslands. *Plant, Cell and Environment*, **14**, 1007-1011.
- van Breemen N (1993) Soils as biotic constructs favouring net primary productivity. *Geoderma*, **57**, 183-212.
- van Ginkel JH, Gorissen A, van Veen JA (1997) Carbon and nitrogen allocation in *Lolium perenne* in response to elevated atmospheric CO₂ with emphasis on soil carbon dynamics. *Plant and Soil*, **188**, 299-308.
- van Vuuren MMI, Robinson D, Scrimgeour CM, Raven JA, Fitter AH (2000) Decomposition of ¹³C-labelled wheat root systems following growth at different CO₂ concentrations. *Soil Biology and Biochemistry*, **32**, 403-413.
- Yeates G (1976) Earthworm population of a pasture spray-irrigated with dairy shed effluent. *New Zealand Journal of Agricultural Research*, **19**, 387-391.
- Zak DR, Pregitzer KS, Curtis PS, Teeri JA, Fogel R, Randlett DL (1993) Elevated atmospheric CO₂ and feedback between carbon and nitrogen cycles. *Plant and Soil*, **151**, 105-117.



Plate 4.1: View of an “ingrowth core” pipe buried in the field with a 45° angle

**Chapter 4: Increased Quantity and Quality of Coarse
Soil Organic Matter Fraction at Elevated CO₂ in a
Grazed Grassland Are a Consequence of Enhanced
Root Growth and Turnover**

Chapter 4: Increased Quantity and Quality of Coarse Soil Organic Matter Fraction at Elevated CO₂ in a Grazed Grassland are a Consequence of Enhanced Root Growth and Turnover

Allard V, Newton PCD, Soussana, J-F., Carran, RA, Matthew C, Lieffering M.

4.1. Abstract

The aims of this study were, firstly to determine whether elevated atmospheric CO₂ modified plant organic matter (OM) fluxes to the soil and secondly to assess whether any changes in the fluxes affected OM accumulation in the soil. A grazed temperate grassland was exposed for four years to elevated atmospheric CO₂ (475 µl l⁻¹) using a Free Air CO₂ Enrichment (FACE) facility. Neither aboveground herbage biomass nor leaf litter production were affected by elevated CO₂. In comparison, roots growth rate and turnover were clearly stimulated by elevated CO₂ in particular under relatively dry soil conditions. Consequently, significantly more plant material was returned to the soil under elevated CO₂. This was translated into an accumulation of coarse (> 1 mm) particulate organic matter (POM) under elevated CO₂ but not of finer POM fractions. In addition, the accumulating POM exhibited a lower C/N ratio, which was attributed to the higher proportion of legumes in the pasture under elevated CO₂. Only small changes were detected in the size and activity of the soil microbial biomass in response to the POM accumulation, suggesting that higher organic substrate availability did not stimulate microbial growth and activity despite the apparent higher quality of accumulating POM. As a result, elevated CO₂ may well lead to an accumulation of OM in grazed grassland soil in the long term.

4.2. Introduction

As the concentration of CO₂ in the atmosphere increases (Keeling *et al.*, 1995), attention has focused on the possibility to increase carbon (C) storage capacity on land. In this context, grassland responses to elevated CO₂ are of particular importance since grasslands account for 25% of the terrestrial land surface and 10% of global C stores (Schimel, 1995). Unlike tropical forests, where vegetation is the primary source of C storage, most of the grassland C stocks are in the soil. Therefore possible accumulation of OM in grasslands soils under elevated CO₂ may be of central importance in mitigating atmospheric CO₂ increase (Scurlock and Hall, 1998).

At least three processes have been identified as mechanisms that could lead to increased grasslands soil C storage under elevated CO₂. First, much attention has been paid to the potential alteration of litter decomposition rates that were expected to be lower under elevated CO₂ (Strain and Bazzaz, 1983). Nitrogen (N) concentration often decreases in plants that have been grown under elevated CO₂ (Cotrufo *et al.*, 1998; Chapter 3), but due to resorption processes during senescence, a decrease in N concentration is generally not observed in plant litter (Norby and Cotrufo, 1998). Consequently, litter quality and hence litter decomposition *per se* are commonly unaffected by elevated CO₂ (Hirschel *et al.*, 1997; van Vuuren *et al.*, 2000).

Second, increased root exudation of easily decomposable C has often been reported in elevated CO₂ studies (Paterson *et al.*, 1996; van Ginkel *et al.*, 2000). Exudation is difficult to quantify but estimates range from 10 to 40% of net assimilated C in annual crops (Whipps, 1984; van Veen *et al.*, 1991). Because the highly fermentable C of root exudates generates a high microbial activity in the rhizosphere (Hale and Moore, 1979), even small increases in root exudate quantity may alter soil OM dynamics through changes in microbial trophic preferences. It has been suggested (Lekkerkerk *et al.*, 1990) that microorganisms may turn to using more easily fermentable C substrate from roots exudates when this is available, rather than more recalcitrant old OM (Cardon *et al.*, 2001; van Veen *et al.*, 1991).

Third, in addition to potential modifications of OM quality, elevated CO₂ may also induce greater C fluxes from the growing plants to the soil through leaf (Navas *et*

al., 1995; Niklaus *et al.*, 2001) and root litter deposition in particular. Belowground plant-soil fluxes have indeed been observed to exhibit stronger responses to elevated CO₂ as shown by lower shoot:root ratio (Cotrufo and Gorissen, 1997; van Ginkel *et al.*, 1997) and increased root turnover (Canadell *et al.*, 1996; Fitter *et al.*, 1996) although these results are not ubiquitous (Niklaus *et al.*, 2001).

Because of the large background levels of organic C in grassland soils, changes in the size of soil C compartments are difficult to detect through direct measurements (Ross *et al.*, 1996). The coarse particulate POM compartment (>1 mm) represents the first stage in a continuum of decomposition in grassland ecosystems that culminates in stabilised soil OM (Mellilo *et al.*, 1989) consequently we might expect to see any changes in response to elevated CO₂ in short term experiments (relative to the duration of the complete decomposition process) expressed in the coarse POM pool. A method for separating newly deposited OM compartments is therefore needed to study belowground OM accumulation under elevated CO₂.

In this study we evaluate changes in POM pools and their possible origin by measuring aboveground herbage biomass, leaf litter and root C fluxes in a grassland grazed by large ruminants and exposed to elevated CO₂ (475 µl l⁻¹) for about four years. We are not aware of other studies that have measured the effects of elevated CO₂ on these fluxes under grazing despite the fact that grazing is the most common management for grasslands globally and that there is an expectation that grazed systems will respond differently to elevated CO₂ from those managed by infrequent cutting (Newton *et al.*, 2001). In particular, the frequent removal of herbage aboveground biomass by the ruminants may affect leaf litter production and its interactions with elevated CO₂ as well as root growth and turnover (Matthew *et al.*, 1991).

4.3. Materials and methods

4.3.1. Experimental site

The study was carried out between December 2000 and November 2001 in a temperate pasture on the west coast of the North Island of New Zealand (40°14'S, 175°16'E). The pasture had been under permanent grazing by sheep, cattle and goats since at least 1940. The mean annual rainfall at the site was 875 mm. More details about the site botanical and physical characteristics can be found in Edwards *et al.* (2001). The experimental facility consisted of six FACE (Free Air CO₂ Enrichment) rings (McLeod and Long, 1999) each 12 m in diameter; the rings were paired into three blocks based on initial soil and botanical characteristics. In each block, one ring was fumigated with CO₂ to a target value of 475 µl l⁻¹ CO₂ (elevated CO₂ treatment) during the photoperiod, the second being left at ambient atmospheric CO₂ concentration (ambient CO₂ treatment). Enrichment began on 1 October 1997.

4.3.2. Experimental areas

All plant measurements were made during two separate periods of four months in 2000-2001. The first period started in December 2000 and ended in May 2001 (summer-autumn) and the second period extended between July and November 2001 (winter-spring). In December 2000, 12 (2 × 6 species) circular areas (Ø=200 mm) were selected in each ring based on the dominance of each of these six plant species: *Lolium perenne* L., *Agrostis capillaris* L., *Anthoxanthum odoratum* L. (all C₃ grasses), *Trifolium repens* L. (legume), *Paspalum dilatatum* Poir. (C₄ grass) and *Hypochoeris radicata* L. (forb). New circular areas were selected in the ambient and elevated CO₂ rings in June 2001 for the second period. Because *T. repens* was absent from the rings in the second period the selected legume was *Trifolium subterraneum* but all the other species remained the same. For both experiments, the selection of the experimental areas was immediately followed by a grazing of the rings by adult sheep over a period of three days. Similarly, two months after the beginning of each experiment, the rings were grazed again. During both periods the botanical

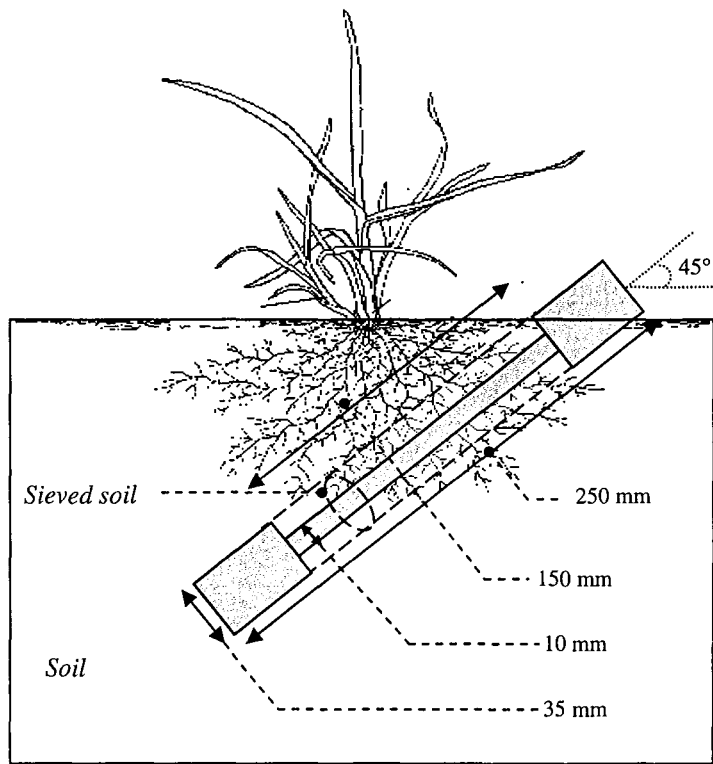

Figure 4.1: Schematic representation of an “ingrowth core” pipe

composition of some of the sampling areas changed over time. No species effect could thus be tested for and the botanical composition in the sampled areas was considered to be broadly representative of the entire rings. Indeed no significant differences were observed between the botanical composition of the whole rings and of the combined area made of the 12 experimental areas (data not shown).

4.3.3. Root measurements

In both experiments, after the initial grazing, soil cores ($\varnothing=35$ mm, length=250 mm), were taken at a 45° angle from the periphery of each sample area towards its centre. Roots were removed from the cores by sieving (mesh size=1 mm), oven dried (60°C , to constant mass) and weighed to provide an estimate of the root standing biomass at the beginning of the experiment. Root growth rate was assessed using an ingrowth core technique. In each hole resulting from the initial soil coring, a PVC pipe ($\varnothing=35$ mm, length=250 mm) was installed. Windows allowing roots penetration were made by removing 150 mm longitudinal sections of PVC from the middle of each pipe leaving only two 1cm wide PVC strips to preserve the structure (Fig. 4.1). This design was used to allow precise re-positioning during the following samplings and to facilitate core removal. The pipes were then filled immediately with sieved soil originating from the same ring and from which roots and debris had been removed using a 1 mm sieve. Soil compaction during refilling was standardized by applying the same filling methods at all samplings. At harvest times (experiment 1: 25 January, 20 February, 27 March and 1 May 2001; experiment 2: 3 August, 30 August, 5 October and 5 November 2001.), the PVC pipes and the soil they contained were removed with a metal tube with a diameter slightly larger than the PVC pipes. Soil and roots were extracted and the pipe was immediately replaced and refilled with soil free of roots. The root samples were cleaned on a sieve (mesh size = 1mm), oven dried (60°C , to constant mass) and weighed to give the value of root growth during the burial period. Root turnover was estimated by dividing the initial standing root biomass by the average of root production over the period (four successive samplings). We are aware that this estimate is strongly dependant of the initial standing root biomass value that could vary over the four months of the experiment.

Therefore this estimate of turnover should be regarded as a tool to compare the CO₂ treatments and the actual values should be considered with care.

4.3.4. Aboveground measurements

After two and four months of the root growth measurement period, aboveground biomass in the same areas than these used for root growth, was cut to 2 cm above ground level with powered hand shears. A sub-sample was taken for dissection into plant species and dry weights of these components and of the total sample were taken after drying to constant mass at 60°C. During the summer-autumn measurement period, dead leaf material deposited on the soil surface was regularly removed in the selected 200 mm diameter areas using a vacuum cleaner. Material stuck in dense vegetation patches was removed by hand. The first litter sampling occurred on 1 March then on four occasions at intervals of 15 days. The material removed was separated from adherent soil, oven dried (60°C, to constant mass) and weighed. The first sampling was used as an estimate of standing litter biomass and the subsequent samplings used to calculate the average leaf litter deposition rate.

4.3.5. Soil compartments analysis

In November 2001, at the end of the second measurement period, six soil cores (Ø=90 mm, depth=250 mm) were sampled from each FACE ring. Aboveground vegetation and litter were removed and the cores were shipped to France (INRA Clermont-Ferrand, Agronomy Unit) and kept in a cool room (4°C) before further analysis. In January 2002, the soil cores were cut longitudinally into equal quarters. One of these quarters was sieved (mesh size=1mm) and remaining roots and coarse litter fractions carefully removed. Sieved soil was used for microbial biomass (MBM) and extractible organic matter (EOM) measurements (see below) and total soil C and N concentrations. From the remaining three quarters of undisturbed soil, two POM fractions ("coarse": >1mm and "fine": 0.2-1mm) were obtained by wet sieving. The soil samples (about 1kg) were rotationally shaken in water in a plastic cylinder

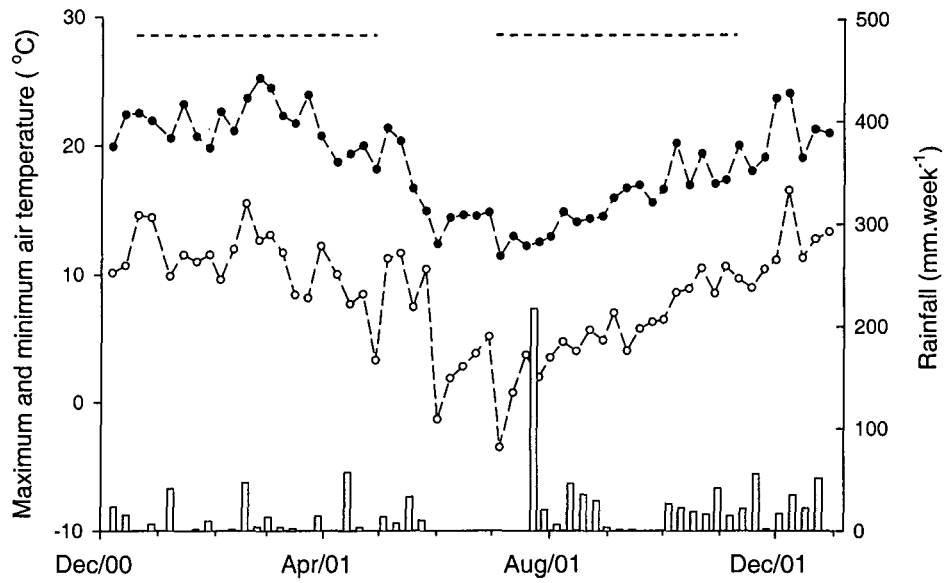

Figure 4.2: Maximum and minimum air temperature ($^{\circ}\text{C}$) (dotted lines) and weekly rainfall (mm week^{-1}) (bars) at the experimental site over the course of the experiment. The two horizontal dotted lines figure the two periods of root growth measurements.

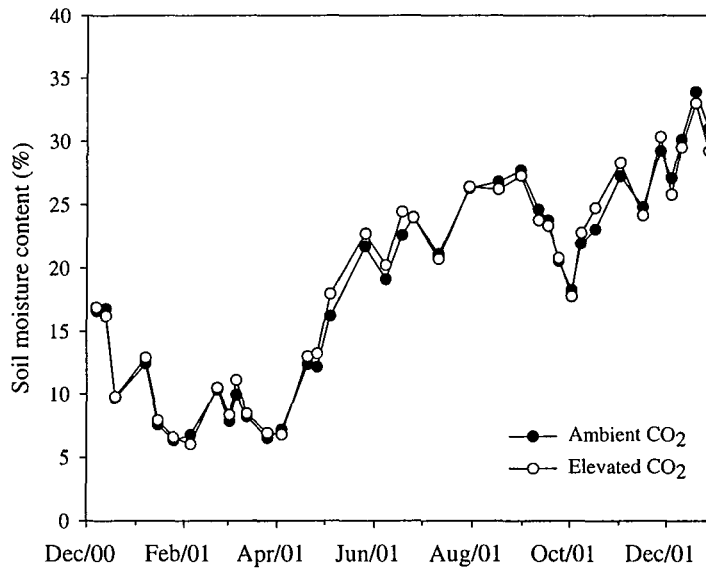

Figure 4.3: Volumetric soil water content in the experimental plots (% moisture) under ambient (solid circles) and elevated CO_2 (open circles) over the course of the experiment. Data are mean of three replicates per treatment.

($\varnothing=210$ mm, length =250 mm). After stirring for 30 min, the samples were sieved through mesh sizes of 1, 0.2 and 0.05 mm. The residues over 1mm were collected on the first sieve and dispersed in water to eliminate any adherent soil. The finer part of the POM (0.2-1mm) collected on the second sieve was separated from sand particles by densimetry in water. The smallest POM fraction (0.05-0.2mm) was also separated from dense particles in water but the difficulty of distinguishing between POM and the pure mineral fraction forced us to exclude this compartment from the study. The POM fractions were then oven dried (75°C, to constant mass) and finely ground using a ball mill (Retsch, Germany). The elemental C and N concentration of the two POM fractions and of total soil were determined using an elemental analyser (Carlo Erba, Italy) in INRA-Nancy, France.

Microbial biomass was extracted following the fumigation-extraction procedure described by Vance *et al.* (1987). Four replicates per soil sample were fumigated and two were unfumigated to compensate for the higher variability of C and N contents in fumigated extracts (G. Alvarez, personal communication). Organic C and N in the extracts were analysed with an automated TOC/TN analyser (Skalar Formacs, Netherlands). Microbial C biomass was calculated as $C_{mic} = (C_{fumigated} - C_{unfumigated}) / k_{EC}$, where k_{EC} is the extraction yield for microbial C ($k_{EC} = 0.42$, Ross and Tate, 1993). Microbial N biomass was calculated as $N_{mic} = (N_{fumigated} - N_{unfumigated}) / k_{EN}$, where k_{EN} is the extraction yield for microbial N ($k_{EN} = 0.45$). These coefficients are not affected by elevated CO_2 (Ross *et al.*, 1993). EOM was extracted from the soil samples by autoclaving the equivalent of 10 g dry soil using a modification of the method described in Lemaitre *et al.* (1995) (P. Loiseau, personal communication). The soil was first mixed with 40 ml distilled water for 1 min and then autoclaved (120°C, 2h). The extracts were filtered (Whatman No. 42 paper) before being analysed for organic C and N with an automated TOC/TN analyser (Skalar Formacs, Netherlands).

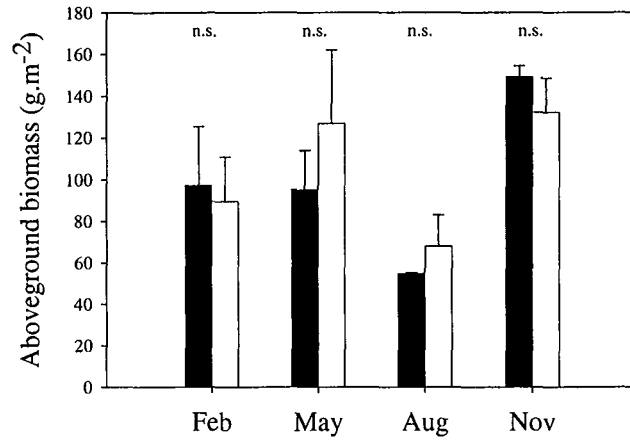

Figure 4.4: Aboveground biomass (g DM m⁻²) under ambient (solid bars) and elevated CO₂ (open bars) at the 4 successive sampling dates. Results are mean of three replicates per treatment ± standard deviation.

Table 4.1: Mean leaf litter standing biomass, deposition rate and residence time under ambient and elevated CO₂. Leaf litter deposition rates are means of 4 successive sampling times. Standard deviations are indicated.

	Ambient CO ₂	Elevated CO ₂	CO ₂ effect
Leaf litter standing biomass (g m ⁻²)	154.2±28.3	126.6±8.3	<i>p</i> =0.508
Leaf litter deposition rate (g m ⁻² day ⁻¹)	3±0.4	2.1±0.2	<i>p</i> = 0.116
Residence time (day) (standing biomass / deposition rate)	49.8±3.2	61±9.1	<i>p</i> = 0.42

4.3.6. Soil water content

Volumetric soil water content in the rings was measured weekly by time domain reflectometry (TDR) (Trase System, Soil Moisture Equipment Corporation, Santa Barbara California) using 15 cm probes. Mean values were calculated from 16 measurements taken in each FACE ring using a stratified random sampling method with four readings taken in each quadrant.

4.3.7. Statistical analysis

Analysis of variance (ANOVA) in Genstat (Genstat, 2002) was used to compare CO₂ effects on the different measured variables. The model used was a randomized block with three replicates (rings) per CO₂ treatment. Sub-samples within each ring were averaged prior to analysis. Root growth data were analysed using a repeated measures model using the four successive sampling of each experiment as repeated measures. Similarly, soil water content was analysed as repeated measures. Data that did not satisfy the homogeneity of variances assumption required for an ANOVA were log transformed prior to the analysis.

4.4. Results

4.4.1. Climate and soil moisture

The first period of root growth measurements (18 December-1 May) was characterised by typical weather for this part of the year with 210 mm of rainfall over the 4 months of study and an average daily maximum temperature of 21.5°C (Fig. 4.2). The second experimental period (2 July- 5 November) had an average daily maximum temperature of 15.3°C and total rainfall over the period was 488 mm (Fig. 4.2) which was considerably higher than the long-term (50 years) average of 372 mm. Volumetric soil moisture content was measured weekly in the rings (Fig. 4.3) and was not affected by elevated CO₂ ($p=0.507$). The first part of the root growth experiment

Table 4.2: Root standing biomass, growth and residence time under ambient and elevated CO₂ for the two measurement periods. Results are means of three replicates per treatment ± standard deviation except for root growth results that are mean of 4 successive sampling and three replicates per sampling. P values are indicated.

	Period 1 (19 Dec - 1 May)			Period 2 (2 Jul - 5 Nov)		
	Ambient CO ₂	Elevated CO ₂	CO ₂ effect	Ambient CO ₂	Elevated CO ₂	CO ₂ effect
Root standing biomass (g m ⁻²)	122.1±17.5	81.4±23.5	<i>p</i> =0.063	46.3±14.6	36.9±6.2	<i>p</i> =0.269
Root growth rate (g m ⁻² day ⁻¹)	0.9±0.2	1.4±0.1	<i>p</i> =0.026	1.2±0.2	1.4±0.1	<i>p</i> =0.440
Root residence time (day) (standing biomass/ growth)	173.6±20.4	62.5±18.7	<i>p</i> <0.001	39.3±13.9	30.2±9.8	<i>p</i> =0.250

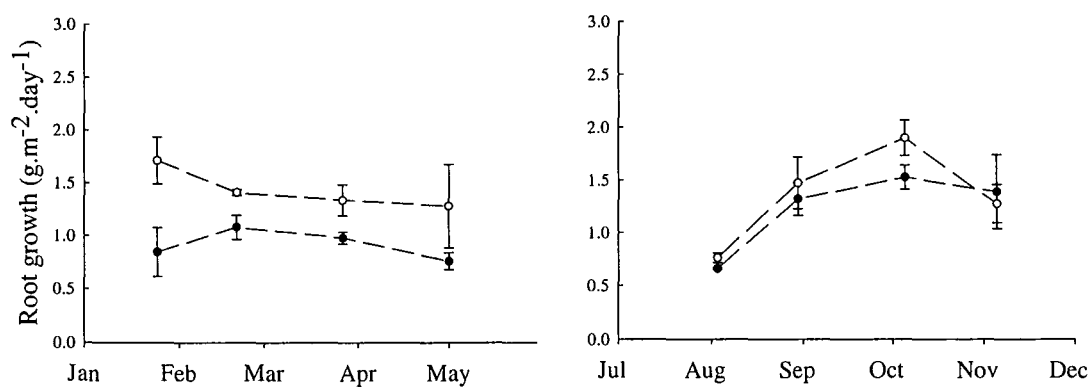

Figure 4.5: Root growth rate (g DM m⁻² day⁻¹) under ambient (solid circle) and elevated CO₂ (open circle) for the 2 measurement periods. Values are mean of three replicates pre treatment ± standard deviation.

(December-May) took place under low soil water content (9.1% on average) and the second part under relatively high soil water content (25.1% on average) (Fig. 4.3).

4.4.2. Aboveground biomass and litter deposition

Elevated CO₂ did not significantly affect the herbage biomass at any of the four harvests (Fig. 4.4). Leaf litter standing biomass was not significantly different between CO₂ treatments, the average mass of litter being 140 g dry matter (DM) m⁻² (Table 4.1). Also, neither the mean rate of litter deposition nor the estimate of the residence time of the litter was significantly altered by the CO₂ treatment (Table 4.1).

4.4.3. Root standing biomass, growth rate and turnover

Mean root standing biomass tended to be lower under elevated CO₂ at the December 2000 harvest (-33.6%, $p=0.06$) (Table 4.2) and showed a similar trend in July 2001 (-20.3%) but again it was not statistically significant. The difference between seasons in root standing biomass was very marked, with the average biomass measured in winter-spring being less than half of that measured in summer-autumn. Root growth rate was significantly enhanced by elevated CO₂ during the summer-autumn experiment (Fig. 4.5) ($p=0.026$) with a consistent CO₂ stimulation averaging 56.8%. During the winter-spring period there was no consistent effect of elevated CO₂; on average, root growth was 10.5% greater over this period, largely due to significantly higher growth in October (Fig. 4.5). As a result of the lower root standing biomass and the higher root growth under elevated CO₂, root residence time was significantly lower under elevated CO₂ during the summer-autumn period (-64%, $p<0.001$). A similar trend occurred during the winter-spring period (-23%) but this trend was not significant.

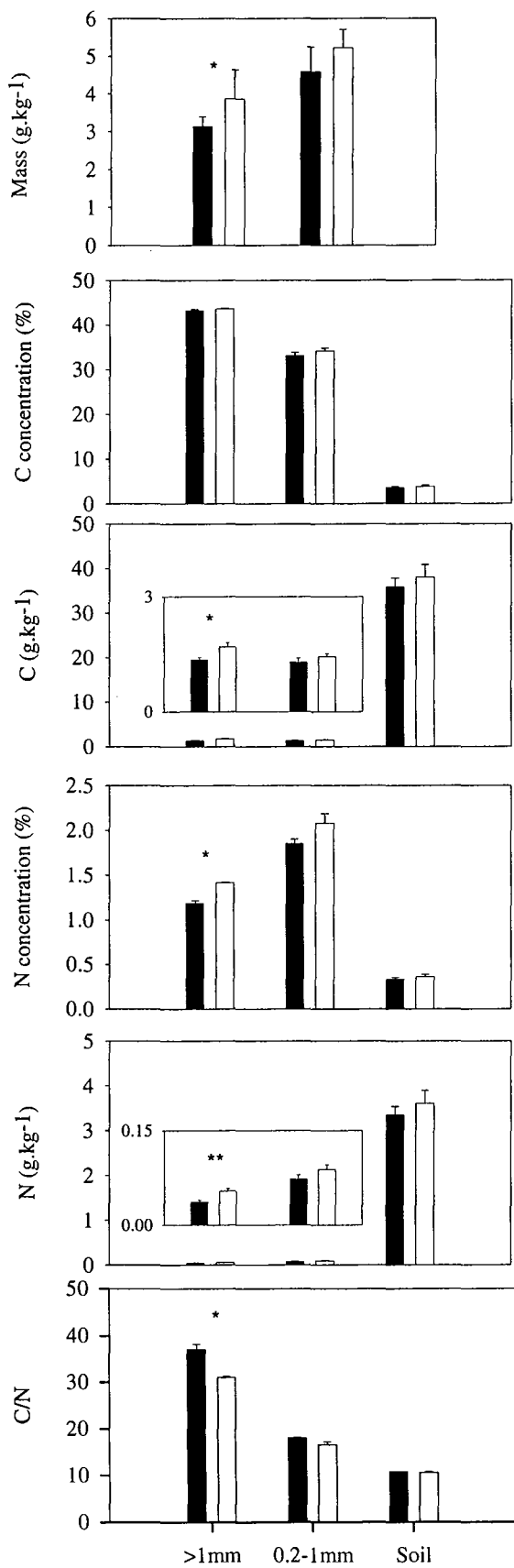

Figure 4.6: Mass, C and N concentration, C and N pools per kg of soil and C/N ratio in organic matter fractions and total soil under ambient (solid bars) and elevated CO₂ (open bars). Values are mean of three replicates per treatment \pm standard deviation. * and ** denote significant CO₂ effect at the 0.05 and 0.01 levels respectively.

4.4.4. Soil C and N

The mass of the coarser POM fraction (> 1 mm) isolated by OM fractionation was 24.5% ($p=0.024$) greater under elevated CO_2 (from 3.1 to 3.9 g DM kg^{-1} soil) (Fig. 4.6). This fraction had a similar increase in C mass ($p=0.031$) since the C concentration was not affected by elevated CO_2 (Fig. 4.6). On the other hand the mean N mass increase under elevated CO_2 in this pool was more marked (+45%, $p=0.009$) due to the 20% greater mean N concentration ($p=0.026$). Consequently the C/N ratio of the >1mm POM fraction dropped significantly from 37 to 31 g C g^{-1} N ($p=0.033$), on average. The smaller POM fraction (0.2-1mm) exhibited similar trends (Fig. 4.6) but none of these were statistically significant. Under elevated CO_2 , on average, the mass of this smaller fraction was 14% higher and the C/N ratio 7.9% lower. Total soil C and N was not significantly different under elevated CO_2 although there were trends consistent with the differences in POM pools i.e. increased C mass (+7%) and decreased C/N ratio (-1.7%). The C/N ratios of the soil OM fractions decreased with fraction size (Fig. 4.7).

4.4.5. Soil microbial biomass (MBM) and Extractable Organic Matter (EOM)

Soil microbial C and N were not affected by elevated CO_2 (Table 4.3). Nevertheless a trend showing a slightly lower MBM C/N ratio was observed under elevated CO_2 ($p=0.055$). Extractable organic C exhibited a significant increase under elevated CO_2 but of limited amplitude (about 3%). Extractable organic N and C/N were not affected by the elevated CO_2 treatment (Table 4.3).

4.5. Discussion

4.5.1. Plant organic matter fluxes

As shown by the lack of a CO_2 effect on herbage biomass and leaf litter deposition four years after the beginning of the CO_2 enrichment (Table 4.1), aboveground OM inputs to the soil were not affected by elevated CO_2 in our study.

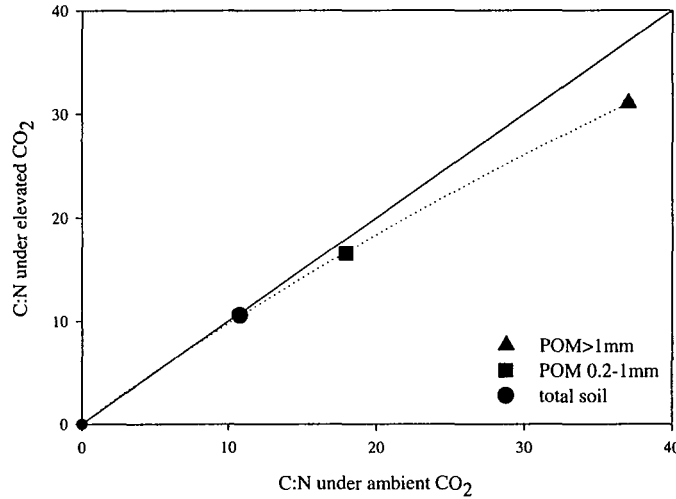

Figure 4.7: Effect of atmospheric CO₂ concentration on the C/N ratio of the organic matter fractions and total soil.

Table 4.3: Microbial carbon (MBM-C) nitrogen (MBM-N) and C/N ratio (MBM-C/N) and extractible organic C (EOM-C), N (EOM-N) content and C/N ratio (EOM-C/N) in the top soil (0-25 cm) under ambient and elevated CO₂. Values are means of three replicates per treatment \pm standard deviation. P values are indicated.

	Ambient CO ₂	Elevated CO ₂	CO ₂ effect
MBM-C (mg kg ⁻¹ soil)	492.2 \pm 52.2	483.4 \pm 74.3	<i>p</i> =0.868.
MBM-N (mg kg ⁻¹ soil)	75.1 \pm 9.4	82.1 \pm 15.1	<i>p</i> =0.346
MBM-C/N (gC g ⁻¹ N)	6.8 \pm 0.7	6.2 \pm 0.6	<i>p</i> =0.055
EOM-C (mg kg ⁻¹ soil)	5322.9 \pm 265.3	5491.8 \pm 240.6	<i>p</i> =0.046
EOM-N (mg kg ⁻¹ soil)	637.8 \pm 35.7	665.3 \pm 28	<i>p</i> =0.220
EOM-C/N (g C g ⁻¹ N)	8.4 \pm 0.3	8.2 \pm 0.2	<i>p</i> =0.435

Long-term measurements of aboveground biomass on this experimental site are consistent with this result and show no consistent increase of herbage production under elevated CO₂ (Edwards *et al.*, 2001). Furthermore, no difference in tissue turnover (leaf birth and death rates) under elevated CO₂ was measured in growth rooms on turves of the same soil type (Clark *et al.*, 1995) and in the FACE rings (H. Clark, unpublished data) under elevated CO₂. Elevated CO₂ effects on aboveground production in grasslands vary greatly between studies reporting both positive and negative effects (Owensby *et al.*, 1999; Morgan *et al.*, 2001; Shaw *et al.*, 2002) and increases in litter production usually exceeds any increase in standing biomass (Niklaus *et al.*, 2001; Navas *et al.*, 1995). Nevertheless, these previous experiments reporting an increase in leaf litter production under elevated CO₂ are based on grasslands with very lenient defoliation regime. The pasture used in the study presented here is submitted to a relatively high utilisation by ruminants and therefore, this probably minimises the potential for litter accumulation.

In contrast to the lack of response of aboveground OM fluxes under elevated CO₂, we observed a strong positive response of belowground fluxes under elevated CO₂. There have been several descriptions of increased root standing mass in grasslands under elevated CO₂ (Casella and Soussana, 1997; Loiseau and Soussana, 1999; Newton *et al.*, 1996) but it is not ubiquitous (Navas *et al.*, 1995; Stöcklin *et al.*, 1998). Larger root standing biomass however, does not necessarily tell us much about the flux of C belowground (Canadell *et al.*, 1996) as it is root turnover that is the major mechanism of C transfer to the soil (van Veen *et al.*, 1991). There are few data on root turnover in grassland soils in the literature and these again do not show a consistent CO₂ response. Fitter *et al.* (1996) observed concomitant higher root birth rates and shorter root longevity under elevated CO₂. Fitter *et al.* (1997) found similar results but only for one of the two soil types included in their study. However, Arnone *et al.* (2000) reported no detectable change in root production, mortality and root length density under elevated CO₂. In our study we observed both a higher root production rate as measured with ingrowth cores (Fig. 4.5) and a lower standing root biomass under elevated CO₂ (Table 4.2). Consequently, the estimate of root residence time was dramatically decreased, at least during the summer period of the experiment, implying a markedly higher flux of OM to the soil pool from roots under elevated CO₂ (Table 4.2). As stated in the Materials and Methods section the actual values of

root turnover estimates should be considered with care since the standing root biomass value was only measured once and was very probably not representative of root standing biomass all over the course of the experiment.

Arnone *et al.* (2000) hypothesised that growth conditions may interfere with belowground plant response since high response systems were mostly identified in glasshouse or growth chambers whereas in field studies it was difficult to detect any consistent increase in root system size under elevated CO₂. This was clearly not the case here. Increased root production under elevated CO₂ has also been linked with enhanced soil moisture content (Leadley *et al.*, 1999) but this was not the case in our experiment. We found increased growth at elevated CO₂ during the period of low soil moisture but no difference in moisture content between the CO₂ treatments (Fig. 4.3). This effect has been observed previously in turves of the same soil type growing in growth rooms; in this case, root length density was significantly greater under elevated CO₂ when the turves were grown in periods of low soil moisture (Newton *et al.*, 1996). In that study, C assimilation was sustained longer into the moisture deficit period at elevated CO₂ with a clear trend showing increased biomass allocation belowground rather than aboveground (Newton *et al.*, 1996). Other indirect CO₂ effects may be relevant to the increased root turnover observed under elevated CO₂. In particular, Yeates *et al.* (submitted) have measured significantly greater abundance (4.3-fold) of the root-feeding nematode *Longidorus elongatus* in the elevated CO₂ soil of the same experiment and the possibility of interactions between elevated CO₂, root herbivory and root turnover need further investigation.

4.5.2. Soil organic matter

After fractionation of the soil OM, we observed a significant increase in the coarser POM fraction at elevated CO₂ and a similar but non-significant trend in the 0.2-1mm fraction (Fig. 4.6). I suggest that the greater POM is due to the increased fluxes of OM from the plant root pool. In this study, root turnover has been identified in our system as the flux that exhibited the strongest response to elevated CO₂, and consequently, we suggest that the accumulation of soil POM is in large part a direct consequence of increased root turnover. Greater amounts of POM under elevated CO₂

have been reported by Loiseau and Soussana (1999) who found a 40% increase in macro-organic matter in ryegrass swards exposed to two and a half years of CO₂ enrichment and by Gill *et al.* (2002) who found a positive relationship between POM and CO₂ concentration (over a gradient from 200 to 550 ppm) after three years of enrichment. In contrast, Niklaus *et al.* (2001) did not observe any change in the POM fraction in a 6 years open-top chamber experiment in a calcareous grassland under elevated CO₂.

Regardless of the CO₂ treatment, the C/N ratio declined with decreasing OM fraction size. This is a general feature in grassland soil (Guggenberger *et al.*, 1994) due to a release of CO₂ during the stabilisation of the soil OM. Of particular note was the decrease in the C/N ratio of the POM we observed under elevated CO₂ (Fig. 4.6). This result is in contradiction with the findings of Loiseau and Soussana (1999) and Gill *et al.* (2002) who both showed increased C/N ratios at elevated CO₂. We suggest that the reason for this difference in results lies in the multispecific composition of the sward and the potential this provides for secondary effects to occur through changes in botanical composition. In particular, the higher proportion of legumes under elevated CO₂ (Newton *et al.*, 2001) may explain the higher quality of the recent soil POM pools through a higher N content of legume root material compared to non-legume species. The original idea was to study decomposition rates of single species but root material could not be sampled individually, thus this hypothesis could not be explicitly tested.

The CO₂-induced difference in POM C/N ratios was significant in the coarser fraction (>1mm) but not in the small OM fraction (0.2-1mm) and the total soil (Fig. 4.7). That can be expected since the latter is made of older OM and thus probably contains more material produced before the beginning of the CO₂ fumigation. Therefore, over time, we might expect the ratio to decrease further and the CO₂ effects to be transmitted in the smaller fractions as shown in (Fig. 4.7).

4.5.3. Microbial biomass and dynamic

In spite of the higher POM availability, microbial biomass did not increase under elevated CO₂ (Table 4.3). It confirms results from a long-term study on the same site (Ross *et al.* submitted) showing no CO₂ effect on microbial biomass since the beginning of the CO₂ fumigation. Extractible organic matter (EOM), a compartment that is supposed to integrate microbial dynamics over a relatively long period (Lemaitre *et al.*, 1995) was only slightly increased under elevated CO₂. The lack of a significant response in terms of microbial biomass to the increased availability of substrate for microbial growth under elevated CO₂ suggests that under these experimental conditions, C is not a major limitation to microbial growth. However the C/N ratio of the microbial biomass decreased significantly under elevated CO₂ suggesting possible modifications of the relative abundance of microbial communities in response to altered POM quality and/or quantity.

4.6. Conclusion

Despite a relatively low level of CO₂ enrichment compared to other elevated CO₂ studies (i.e. 475 µl l⁻¹), an accumulation of OM was observed in the coarser POM fraction and it appears that finer pools may likely express similar changes in the longer term. We suggest that the accumulation of coarse POM was a consequence of increased root turnover at elevated CO₂. It is unclear whether the increase in root turnover was a direct effect of elevated CO₂ on plant functioning or an indirect effect of elevated CO₂ on soil processes such as root herbivory by nematodes. The POM at elevated CO₂ had a lower C/N ratio which I suggest was due to a CO₂-induced effect on botanical composition.

Our results differ from some other published studies e.g. the lack of a soil moisture effect and no difference in the amount of leaf litter input. In most cases these differences might be expected given the experimental system; in particular, that our experiment was grazed by herbivores and that defoliation was at frequent intervals through the year rather than infrequent as done in several other studies. Another major difference from other studies is the lower C/N ratio of the accumulating POM under

elevated CO₂. A higher C/N ratio of newly deposited OM under elevated CO₂ was hypothesised to be responsible for shifts in microbial trophic preferences towards metabolisation of older soil OM in order to fulfil their nutritional requirements (Cardon *et al.*, 2001). Consequently organic C storage under elevated CO₂ was relatively small since the increase in POM-C storage was buffered by the decrease in older organic C (Gill *et al.*, 2002). Our results suggest that in grazed pastures with high plant species diversity we might expect extra C sequestration in soil OM mainly through an increase of C input rather than decreasing quality of accumulating OM.

4.7. Acknowledgements

Financial support from the New Zealand Foundation for Research, Science and Technology (Contract C10X205) is gratefully acknowledged. V. Allard was funded by a Massey University Doctoral Scholarship. His stay in New Zealand was also supported by a grant from the Scientific and Cultural service of the French Embassy in New Zealand. We thank Y. Gray, S. Brock, S. Dunn, E. Lawrence and T. Rayner for their technical assistance during field work and R. Delpy for his skilful help with OM fractionation. We also want to thank P. Loiseau for useful discussions and H. Clark for comments on the manuscript.

4.8. References

- Arnone JA, Zaller JG, Spehn EM, Niklaus PA, Wells CE, Körner C (2000) Dynamics of root systems in native grasslands: effects of elevated atmospheric CO₂. *New Phytologist*, **147**, 73-85.
- Canadell JG, Pitelka LF, Ingram JSI (1996) The effects of elevated CO₂ on plant-soil carbon below-ground: A summary and synthesis. *Plant and Soil*, **187**, 391-400.
- Cardon ZG, Hungate BA, Cambardella CA, Chapin FS, Field CB, Holland EA, Mooney HA (2001) Contrasting effects of elevated CO₂ on old and new soil carbon pools. *Soil Biology and Biochemistry*, **33**, 365-373.

- Casella E, Soussana JF (1997) Long-term effects of CO₂ enrichment and temperature increase on the carbon balance of a temperate grass sward. *Journal of Experimental Botany*, **48**, 1309-1321.
- Clark H, Newton PCD, Bell CC, Glasgow EM (1995) The influence of elevated CO₂ and simulated seasonal-changes in temperature on tissue turnover in pasture turves dominated by perennial ryegrass (*Lolium perenne*) and white clover (*Trifolium repens*). *Journal of Applied Ecology*, **32**, 128-136.
- Cotrufo MF, Gorissen A (1997) Elevated CO₂ enhances below-ground C allocation in three perennial grass species at different levels of N availability. *New Phytologist*, **137**, 421-431.
- Cotrufo MF, Ineson P, Scott A (1998) Elevated CO₂ reduces the nitrogen concentration of plant tissues. *Global Change Biology*, **4**, 43-54.
- Edwards GR, Clark H, Newton PCD (2001) The effects of elevated CO₂ on seed production and seedling recruitment in a sheep-grazed pasture. *Oecologia*, **127**, 383-394.
- Fitter AH, Graves JD, Wolfenden J, Self GK, Brown TK, Bogie D, Mansfield TA (1997) Root production and turnover and carbon budgets of two contrasting grasslands under ambient and elevated atmospheric carbon dioxide concentrations. *New Phytologist*, **137**, 247-255.
- Fitter AH, Self GK, Wolfenden J, van Vuuren MMI, Brown TK, Williamson L, Graves JD, Robinson D (1996) Root production and mortality under elevated atmospheric carbon dioxide. *Plant and Soil*, **187**, 299-306.
- Genstat (2002) Genstat 6, Release 1.0.20. Lawes Agriculture Trust, IACR, Rothamsted.
- Gill RA, Polley HW, Johnson HB, Anderson LJ, Maherali H, Jackson RB (2002) Nonlinear grassland responses to past and future atmospheric CO₂. *Nature* **417**, 279-282.
- Guggenberger G, Christensen BT, Zech W (1994) Land-use effect on the composition of organic matter in particle-size separates of soils. 1. Lignin and carbohydrate signature. *European Journal of Soil Science*, **45**, 459-468.
- Hale MG, Moore LD (1979) Factors affecting root exudation. II: 1970-1978. *Advances in Agronomy*, **31**, 93-124.

- Hirschel G, Körner C, Arnone JA (1997) Will rising atmospheric CO₂ affect leaf litter quality and *in situ* decomposition rates in native plant communities? *Oecologia*, **110**, 387-392.
- Keeling CD, Whorf TP, Wahlen M, Vanderpligt J (1995) Interannual extremes in the rate of rise of atmospheric carbon dioxide since 1980. *Nature*, **375**, 666-670.
- Leadley PW, Niklaus PA, Stocker R and Körner C (1999) A field study of the effects of elevated CO₂ on plant biomass and community structure in a calcareous grassland. *Oecologia*, **118**, 39-49.
- Lekkerkerk LJA, van de Geijn SC, van Veen JA (1990) Effects of elevated atmospheric CO₂ levels on the carbon economy of a soil planted with wheat. In: *Soils and the Greenhouse Effect* (ed Bouwman AF), pp. 423-429. John Wiley and Sons, Chichester.
- Lemaitre A, Chaussod R, Tavant Y, Bruckert S (1995) An attempt to determine a pool of labile organic matter associated with the soil microbial biomass. *European Journal of Soil Biology*, **31**, 121-125.
- Loiseau P, Soussana JF (1999) Elevated [CO₂], temperature increase and N supply effects on the accumulation of below-ground carbon in a temperate grassland ecosystem. *Plant and Soil*, **210**, 233-247.
- Matthew C, Xia JX, Chu ACP, Mackay AD, Hodgson J (1991) Relationship between root production and tiller appearance rates in perennial ryegrass (*Lolium perenne* L.). In: *Plant root growth: an ecological perspective* (ed Atkinson D), pp. 281-290. Blackwell, London.
- Mellilo JM, Aber JD, Linkins AE, Ricca A, Fry B, Nadelhoffer KJ (1989) Carbon and nitrogen dynamics along the decay continuum: plant litter to soil organic matter. *Plant and Soil*, **115**, 189-198.
- McLeod AR, Long SP (1999) Free-air Carbon Dioxide Enrichment (FACE) in global change research: a review. *Advances in Ecological Research*, **28**, 1-56.
- Morgan JA, LeCain DR, Mosier AR, Milchunas DG (2001) Elevated CO₂ enhances water relations and productivity and affects gas exchange in C₃ and C₄ grasses of the Colorado shortgrass steppe. *Global Change Biology*, **7**, 451-466.
- Navas ML, Guillerm JL, Fabreguettes J, Roy J (1995) The influence of elevated CO₂ on community structure, biomass and carbon balance of Mediterranean old-field microcosm. *Global Change Biology*, **1**, 325-335.

- Newton PCD, Clark H, Bell CC, Glasgow EM (1996) Interaction of soil moisture and elevated CO₂ on the above-ground growth rate, root length density and gas exchange of turves from temperate pasture. *Journal of Experimental Botany*, **47**, 771-779.
- Newton PCD, Clark H, Edwards GR (2001) The effect of climate change on grazed grasslands. In: *Structure and Function of Agroecosystem Design and Management* (eds Shiyomi M, Koizumi H), pp. 297-311, CRC Press, Boca Raton.
- Niklaus PA, Wohlfender M, Siegwolf R, Körner C (2001) Effects of six years atmospheric CO₂ enrichment on plant, soil and soil microbial C of a calcareous grassland. *Plant and Soil*, **233**, 189-202.
- Norby RJ, Cotrufo MF (1998) A question of litter quality. *Nature*, **396**, 17-18.
- Owensby CE, Ham JM, Knapp AK, Auen LM (1999) Biomass production and species composition change in a tallgrass prairie ecosystem after long-term exposure to elevated atmospheric CO₂. *Global Change Biology*, **5**, 497-506.
- Parsons AJ, Chapman DF (2000) The principles of pasture growth and utilisation. In: *Grass* (ed Hopkins A) pp. 31-89. Blackwell, London.
- Paterson E, Rattray EAS, Killham K (1996) Effect of elevated atmospheric CO₂ concentration on C-partitioning and rhizosphere C-flow for three plant species. *Soil Biology and Biochemistry*, **28**, 195-201.
- Ross DJ, Tate KR (1993) Microbial C and N in litter and soil of a southern beech (*Nothofagus*) forest: comparison of measurement procedures. *Soil Biology and Biochemistry*, **25**, 467-475.
- Ross DJ, Saggart S, Tate KR, Feltham CW, Newton PCD (1996) Elevated CO₂ effects on carbon and nitrogen cycling in grass/clover turves of a Psammaquent soil. *Plant and Soil*, **182**, 185-198.
- Schimel DS (1995) Terrestrial ecosystems and the carbon-cycle. *Global Change Biology*, **1**, 77-91.
- Scurlock JMO, Hall DO (1998) The global carbon sink: a grassland perspective. *Global Change Biology*, **4**, 229-233.
- Shaw MR, Zavaleta ES, Chiariello NR, Cleland EE, Mooney HA, Field CB (2002) Grassland responses to global environmental changes suppressed by elevated CO₂. *Science*, **298**, 1987-1990.
- Strain BR, Bazzaz FA (1983) Terrestrial plant communities. In: *CO₂ and Plants* (ed. Lemon ER), pp. 177-222. Westview Press, Boulder, Colorado.

- Stöcklin J, Schweizer K, Körner C (1998) Effects of elevated CO₂ and phosphorus addition on productivity and community composition of intact monoliths from calcareous grassland. *Oecologia*, **116**, 50-56.
- van Ginkel JH, Gorissen A, Polci D (2000) Elevated atmospheric carbon dioxide concentration: effects of increased carbon input in a *Lolium perenne* soil on microorganisms and decomposition. *Soil Biology and Biochemistry*, **32**, 449-456.
- van Ginkel JH, Gorissen A, van Veen JA (1997) Carbon and nitrogen allocation in *Lolium perenne* in response to elevated atmospheric CO₂ with emphasis on soil carbon dynamics. *Plant and Soil*, **188**, 299-308.
- van Veen JA, Liljeroth E, Lekkerkerk LJA, van de Geijn SC (1991) Carbon fluxes in plant-soil systems at elevated atmospheric CO₂ levels. *Ecological Applications*, **1**, 175-181.
- van Vuuren MMI, Robinson D, Scrimgeour CM, Raven JA, Fitter AH (2000). Decomposition of ¹³C-labelled wheat root systems following growth at different CO₂ concentrations. *Soil Biology and Biochemistry*, **32**, 403-413.
- Vance ED, Brookes PC, Jenkinson DS (1987) An extraction method for measuring soil microbial biomass C. *Soil Biology and Biochemistry*, **19**, 703-707.
- Whipps JM (1984) Environmental factors affecting the loss of carbon from the roots of wheat and barley seedlings. *Journal of Experimental Botany*, **35**, 767-773.
- Yeates GW, Newton PCD, Ross DJ (2003) Significant changes in soil microfauna in grazed pasture under elevated carbon dioxide. *Biology and Fertility of Soils*, **38**, 319-326.



Plate 5.1: *Lolium perenne* plants in the assimilation chamber during ^{14}C labelling.

**Chapter 5: Direct and Indirect Effects of Elevated
 CO_2 on *Lolium Perenne* Carbon Allocation and
Nitrogen Yield**

Chapter 5: Direct and Indirect Effects of Elevated CO₂ on *Lolium perenne* Carbon Allocation and Nitrogen Yield.

Allard V, Robin C, Soussana J-F, Newton PCD

5.1. Abstract

It is still unclear whether elevated CO₂ increases plant root exudation and affects soil microbial biomass by providing a greater quantity of readily decomposable carbon (C). Also the effects of elevated CO₂ on the C and nitrogen (N) contained in old soil organic matter pools is unresolved. In this study we compared the short- and long-term effects of elevated CO₂ on C and N pool and fluxes by growing ryegrass (*Lolium perenne*) plants on soil monoliths originating from the New Zealand FACE site (ambient and enriched soil) and under low and elevated concentration of atmospheric CO₂ in a glasshouse. Using ¹⁴CO₂ pulse labelling, we studied the effects of elevated CO₂ on C allocation within the plant-soil system. The results showed that under elevated CO₂ more root-derived C was found in the soil and in the microbial biomass. The increased availability of substrate enhanced soil microbial growth and acted as a “priming effect”, enhancing native soil organic matter decomposition regardless of the mineral N supply. Despite indications of faster N cycling in soil under elevated CO₂, N availability stayed unchanged. Soil from elevated CO₂ rings exhibited higher N cycling rates but again it did not affect plant N uptake. Although there are difficulties in extrapolating glasshouse experiment results to the field, we conclude that the accumulation of coarse organic matter observed in the field under elevated CO₂ was probably not created by an imbalance between C and N but was likely to be due to more complex phenomena involving soil mesofauna and/or other nutrients limitations.

5.2. Introduction

Plant-soil interactions in the context of elevated atmospheric CO₂ concentration (Keeling *et al.*, 1995) have received much attention during the past decade for two main reasons. First is the question of whether the initial fertilisation response that most ecosystems express under elevated CO₂ in the short-term, is sustainable in the long-term or whether other nutrients and N in particular will limit plant response to increased C availability (Diaz *et al.*, 1993). Second is the question of whether the direct effects of elevated CO₂ on plants will alter soil C stocks and thus exacerbate or buffer the increase in atmospheric CO₂ (Smith *et al.*, 2000). As C and N dynamics are strongly linked in soils through soil organic matter decomposition, both questions depend on potential changes in organic matter fluxes from plants under elevated CO₂ and on the fate of old organic matter pools. There have been numerous studies assessing CO₂ effects on plant litter production and decomposition both directly through changes in litter quality at the species scale (Cotrufo *et al.*, 1994; Hirschel *et al.*, 1997) or indirectly through modification of botanical composition (Kemp *et al.*, 1994; Chapter 3) and biomass allocation (Gorissen and Cotrufo, 2000; Chapter 3). In the particular context of grasslands, a large proportion of organic matter returns from plant to soil occurs through animal faeces and urine and this “pathway” can also be affected by elevated CO₂ (Chapter 2).

Root exudation of easily decomposable C is a third pathway of transferring organic matter from plant to soil. Although exudation is probably minor compared to other fluxes (for details about the methodological difficulties involved in exudation quantification see Todorovic *et al.*, 2001), its chemical nature may be more important for ecosystem functioning than its volume (Cardon, 1996). Indeed, the C contained in root exudates is more easily accessible than polymerised C of old organic matter and has the potential to enhance the growth of soils microorganisms that are usually C limited (Smith and Paul, 1990). In relation to elevated CO₂, both the frequently observed increase in root biomass (Rogers *et al.*, 1994; Chapter 4) and the potential increase in the amount of C exuded *per se* (Lekkerkerk *et al.*, 1990; Cheng and Johnson, 1998) might enhance microbial activity in soils and subsequently modify N availability for plants.

Prior to this study, we observed that elevated CO₂ altered some organic matter fluxes from plant to soil in a grazed pasture Free Air CO₂ Experiment (FACE), in particular, we measured a significant increase in the amount of root material entering the soil organic matter pool. After five years of CO₂ enrichment, this led to an accumulation of coarse organic matter in the soil (Chapter 4). The main objective of this study was to study the potential interactions between altered soil organic matter pools in enriched soil and the short-term effect of elevated CO₂ on plant root exudation on soil N availability. We tested whether elevated CO₂ increased C exudation by ryegrass roots and if the effect of these short-term CO₂ effects on soil microbial activity and old soil organic matter decomposition altered N availability. A cross-over design between soil, from ambient or enriched FACE rings, and atmosphere (plants grown under ambient or enriched CO₂ concentration) allowed us to study potential interactions between altered exudation processes and the changes in organic matter content observed in the field.

5.3. Materials and methods

5.3.1. Soil, plant and growth conditions

In November 2001, 48 soil monoliths (9 cm in diameter, 25 cm deep) were taken from the New Zealand grazed pasture FACE facility and kept in individual PVC cylinders. More details about the FACE site characteristics and management can be found in Chapter 1. Eight monoliths were taken from each ambient and elevated CO₂ (475 $\mu\text{l CO}_2 \text{ l}^{-1}$) ring. Monoliths originating from ambient rings and elevated CO₂ rings are hereafter referred to as S- and S+ respectively. All aboveground vegetation was removed manually before the monoliths were sent by air to France where they were kept in a cold room (4°C) until utilisation. In order to allow good water drainage, 5 cm of soil was removed from the bottom of each monolith and replaced with gravel held in place with plastic mesh.

In April 2002, the soil monoliths were placed in two glasshouses at INRA (Champenoux, France) in which the CO₂ level was controlled. One glasshouse had

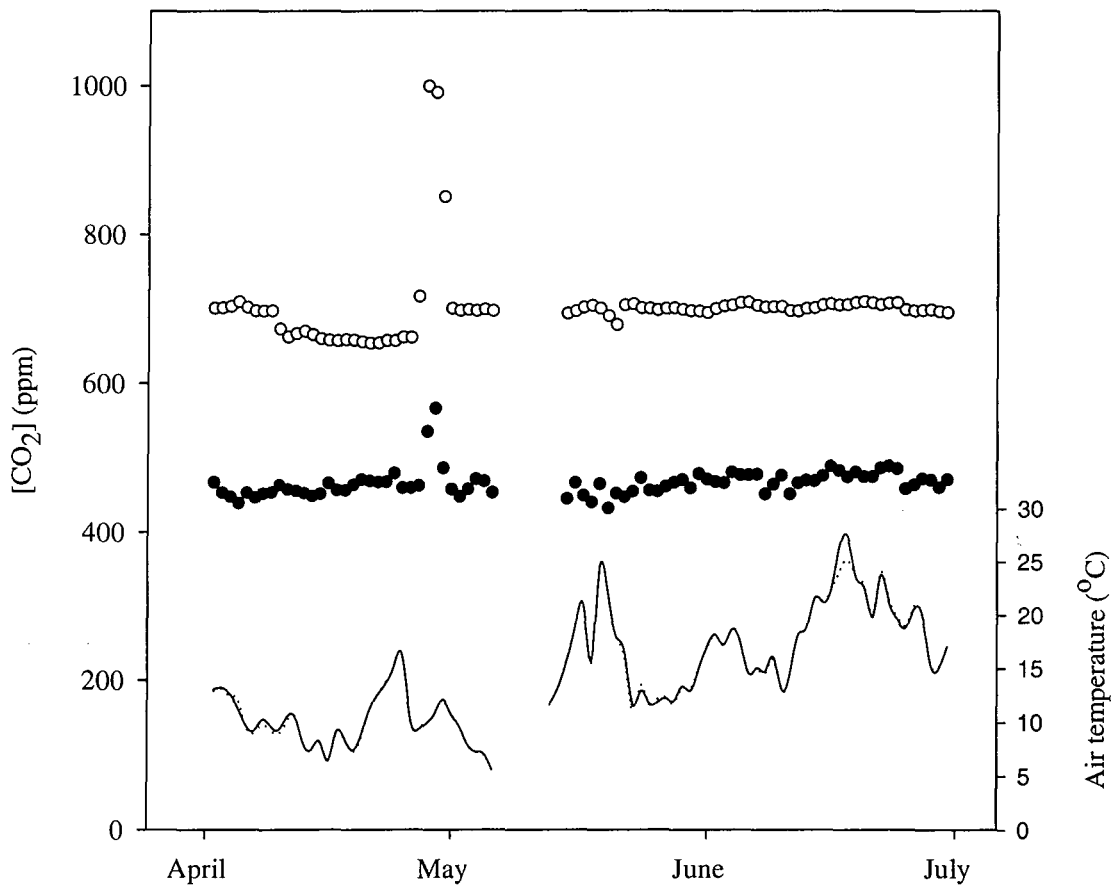

Figure 5.1: CO₂ concentrations (ambient: black circles and elevated: open circles) and daily average air temperature in the ambient and elevated CO₂ glasshouse over the course of the experiment. The data recording device was out of order during the second week of May but the CO₂ concentration was still regulated at that time.

elevated CO₂ levels (target = 700 ppm), the other was kept at ambient CO₂ concentration. Due to a minor air leak between the two glasshouses the CO₂ level in the ambient chamber was higher than ambient air (460 µl l⁻¹). Nevertheless the difference between the two chambers was steady and on average 230 µl l⁻¹ (Fig. 5.1).

One half of the monoliths were placed in the ambient glasshouse (hereafter referred as A-) and the remaining placed in the enriched glasshouse (A+). In order to exclude any potential ring effect for the soil treatment, care was taken to allocate a similar number of monoliths originating from a given FACE ring to each glasshouse. Three seedlings of *Lolium perenne* (cv. Aragon, Cebeco Handelsraad, NL) were transplanted into each monolith (April 1) and after three weeks (most plants at the three leaf stage). The plants were thinned to leave the most vigorous plant.

5.3.2. Plant management

One half of the monoliths of each of the soil-atmosphere combinations was fertilised with 100 kg N ha⁻¹ (N+) and the other half with 5 kgN ha⁻¹ (N-) in order to simulate plant growth without N fertilisation but nevertheless allowing ¹⁵N labelling. The fertiliser was supplied as ¹⁵NH₄¹⁵NO₃ at 5 and 19 atom% ¹⁵N excess for N+ and N- treatments respectively in three split applications: 25% at the removal of the extra seedlings (May 7) and then 37.5% after 2 weeks (May 23) and 5 weeks (June 18) of growth. All plants were irrigated to provide non-limiting amounts of water. They were watered from the top of the monolith according to the climatic conditions and plant size (twice weekly at the beginning of the experiment and twice daily during the last two weeks) in order to keep the soil surface moist and water present at the bottom of the monoliths. The temperature in the chambers was constantly monitored and no difference was measured between the two chambers (Fig. 5.1).

5.3.3. ¹⁴C plant labelling

The day before labelling the plants were removed from the CO₂ controlled glasshouse and brought to ENSAIA, Nancy where the ¹⁴C labelling facility was

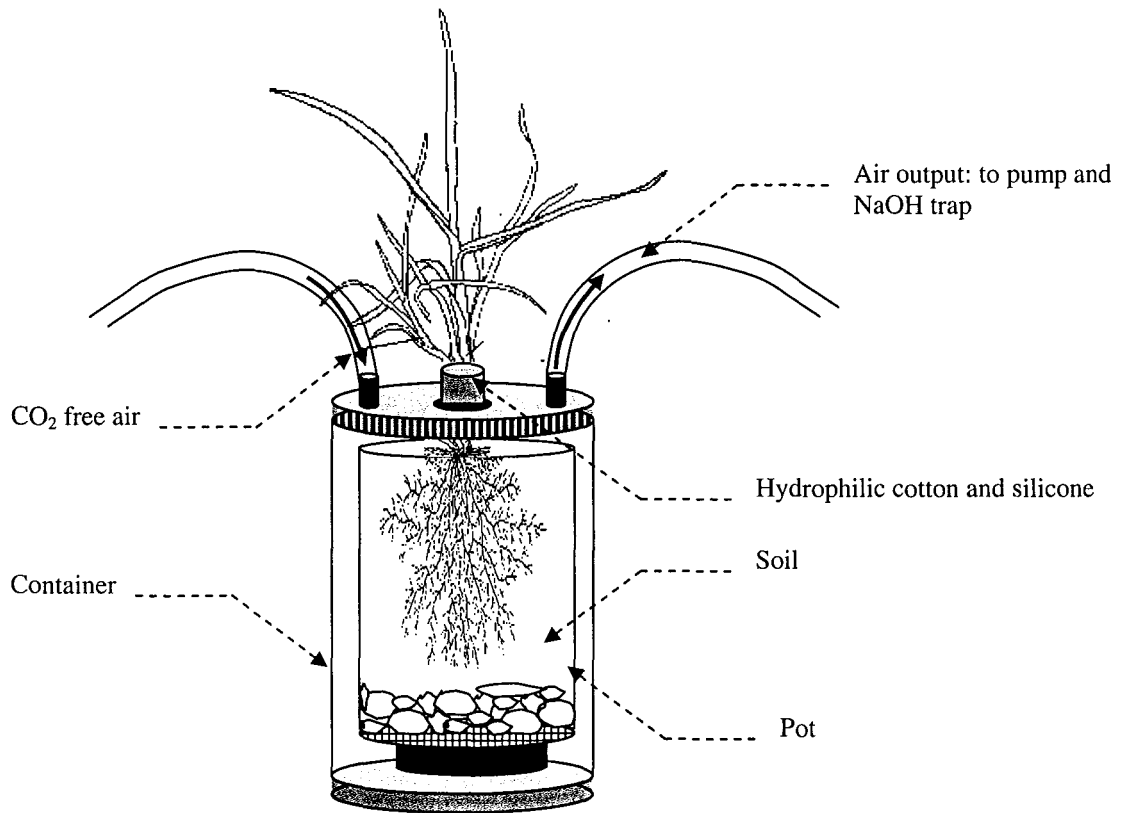

Figure 5.2: Schematic view of a plant before ¹⁴C labelling. The plant in its PVC pot is placed within a PVC container closed with a PVC lip. The space between the lip central hole and plant stems was filled with hydrophilic cotton and air tightness was insured by silicone.

installed. Fig. 5.2 describes the preparation of the labelling containers: a plastic tube (3 cm diameter, 4 cm length) was installed at the base of the plant and was filled with liquid silicone (RTV 585, Rhône Poulenc, France) to ensure an airtight seal between the shoot and the root-soil compartment. Each plant with its pot was then placed inside a PVC cylindrical container (12 cm diameter, 40 cm length) with a PVC lip that was screwed at the top of the container. The space between the plastic tube surrounding the base of the plant and the lip was filled with silicone as above. The air tightness of the containers was checked by immersion in water. Because the labelling had to take place under an atmospheric CO₂ concentration similar to the one during plant growth in order not to disturb the A treatment, A+ and A- plants could not be labelled simultaneously. The labelling of the plants took place on June 27 (A-) and July 1 (A+). The day before the labelling, the 24 plants from each of the CO₂ treatments with their containers were put in the assimilation chamber where temperature and light were controlled. Labelling began six hours after the beginning of the photoperiod. For labelling, the ¹⁴CO₂ was generated in a flask outside of the chamber by addition of acid to NaH¹⁴CO₃; respectively 780 and 1410 μCi of ¹⁴C were assimilated during the A- and A+ labelling. After two hours of exposure to the labelled CO₂, the remaining ¹⁴C was removed from the chamber and the plants were kept in the chamber for a further 48 hours. During this period the soil compartment of each pot was constantly flushed with CO₂ free air and the output air was trapped in NaOH (2M, 200 ml) traps in order to quantify rhizomicrobial respiration.

5.3.4. Plant and soil sampling

Plants were sampled 48 hours after the beginning of the ¹⁴C labelling. Aboveground tissues were separated into laminae and sheaths and were immediately dipped into liquid N and stored at -30°C until freeze drying. After removal from the PVC pot, the soil core was carefully broken and all the soil that was not adhering to the root system was considered as bulk soil. The root system was gently shaken and the soil that was still adhering was considered as rhizospheric soil. Sub-samples of both soil types were carefully cleaned from remaining fine roots prior to further analysis. Roots were processed as the other plant tissues (see above) before analysis.

Plant tissues and a sub-sample of soil fractions were dried (freeze dried for plant tissues), weighed and ground with a rotational ball mill (Retsch, Germany) before being analysed for C and N concentration with an elemental C-N-S analyser (Carlo Erba, Italy).

Microbial biomass was determined in the two soil compartments by fumigation-extraction (Vance *et al.*, 1987) using fresh soil (equivalent to 10g of dry soil) and 40 ml of 0.1M K₂SO₄ for the extraction. Both fumigated and non fumigated samples were replicated twice and the values averaged prior to statistical analyses. C and N concentration in the extracts were measured by combustion with a total organic C (TOC) and total N analyser (Shimadzu, Japan) and microbial biomass C and N were calculated as a difference between fumigated and non fumigated samples using extraction factors of $k_{EC}=0.42$ and $k_{EN}=0.45$ for C and N respectively (Ross and Tate, 1993). Total soil and root respiration during the 48 hours of the chasing period were measured by quantifying inorganic C in the NaOH traps with the TOC analyser.

5.3.5. ¹⁴C analysis

¹⁴C in plant material was determined with a ¹⁴C analyser (Radiomatic series A 500, Packard, USA) which was installed in series following the elemental C-N-S analyser. Soil ¹⁴C activity was too low to be analysed with the previous method; consequently a sample oxidizer (Packard, USA) was used and the CO₂ contained in the combustion products was trapped in a liquid scintillation cocktail (Carbosorb and Permafluor, Packard, USA) and counted with a Packard Tricarb liquid scintillation spectrometer. Liquid samples were counted for ¹⁴C with the liquid scintillation spectrometer in different scintillation cocktails: radioactivity of the NaOH traps was analysed in Ultima Gold whereas extracts from fumigation extractions were analysed in Ultima Flo (Packard, USA) to eliminate error caused by a precipitate occurring in the extract/ Ultima gold mixture with the concentrated K₂SO₄ solution.

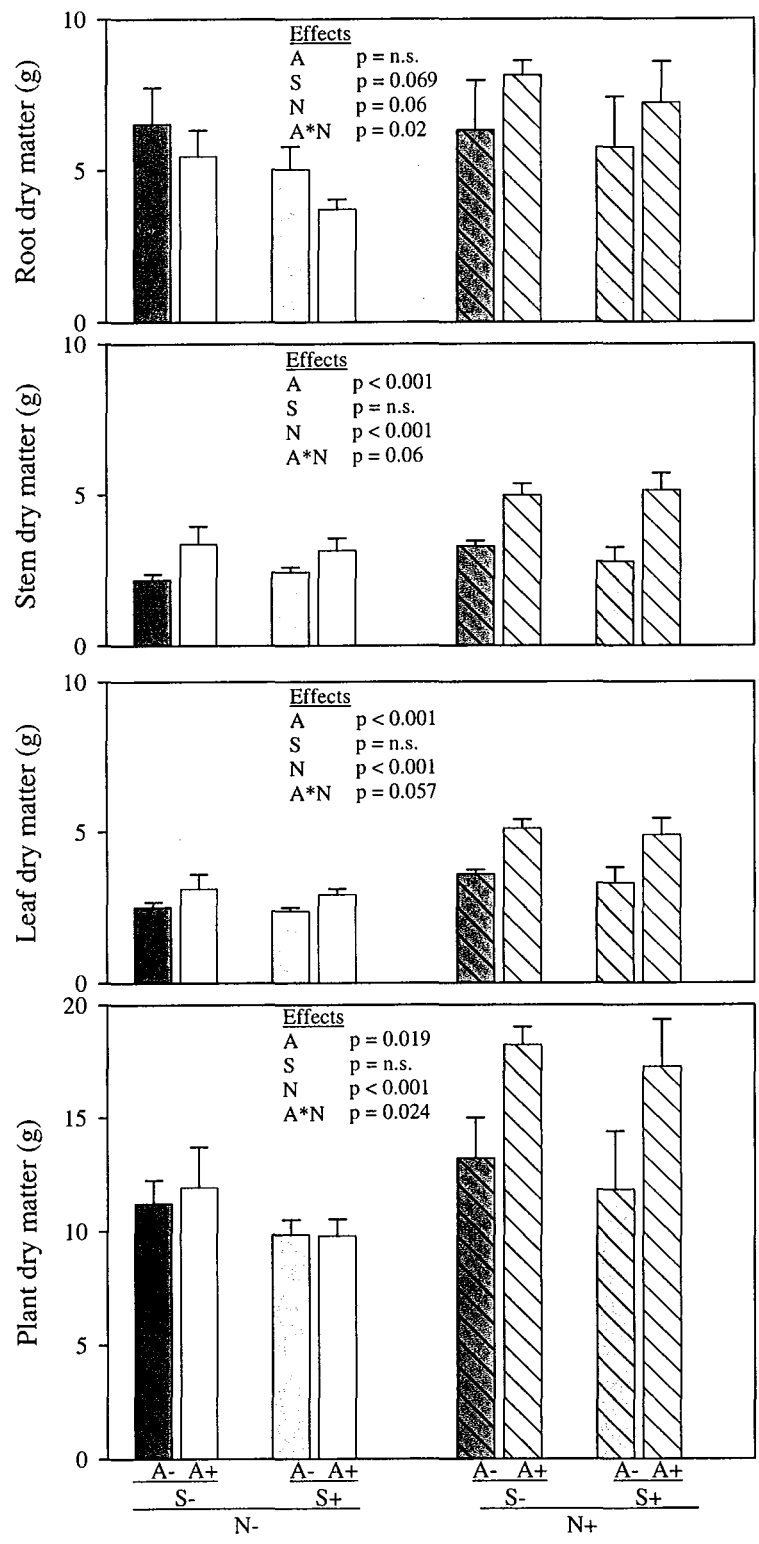

Figure 5.3: Effects of the treatment on root, stem, leaf and plant dry matter (g DM plant⁻¹). Values are average of 6 replicates \pm SE. Bars are grouped by fertiliser N (N- or N+), soil type (ambient soil, S- or enriched soil, S+) and atmospheric CO₂ concentration (ambient, A- or enriched, A+).

5.3.6. ^{15}N analysis and calculations

Plant and soil samples analysed for ^{15}N isotopic excess were processed in Nancy and sent to the University of California, Davis isotope laboratory to be analysed with a mass spectrometer (PDZ Europa, UK).

^{15}N results are presented using notations derived from Loiseau and Soussana (2000). The N derived from fertiliser (NF) in plant was calculated after sampling as:

$$\text{NF}_{\text{plant}} = (\text{E}^{15}\text{N}_{\text{plant}} / \text{E}^{15}\text{N}_{\text{fert}}) \text{N}_{\text{plant}}$$

where $\text{E}^{15}\text{N}_{\text{plant}}$ and $\text{E}^{15}\text{N}_{\text{fert}}$ are isotopic ^{15}N excess in the plant and the fertiliser respectively and N_{plant} is the total amount of N in the plant. The N derived from soil (NS) in the plant was calculated as the difference between total N and NDFP:

$$\text{NS}_{\text{plant}} = \text{N}_{\text{plant}} - \text{NF}_{\text{plant}}$$

And the real recovery (RR) of the fertiliser was calculated as:

$$\text{RR}_{\text{plant}} = \text{NF}_{\text{plant}} / \text{N}_{\text{fert}}$$

where N_{fert} is the amount of N in the fertiliser.

5.3.7. Statistical analysis

All the measured variables were analysed by analysis of variance (ANOVA) as a totally randomized factorial ANOVA ($A \times S \times N$) with 6 replicates. Pots were considered to be the experimental units though we are aware that the A treatment (CO_2 concentration of the atmosphere of growth) was not replicated *sensu stricto* due to the use of two glasshouses only. Because these glasshouses differed only by their CO_2 concentration it was considered that pots inside each glasshouse could be used as replicates. When the measure of a given variable was duplicated for experimental reasons (for example microbial biomass), the values were averaged per pot prior to analysis. All analyses were done with Genstat v 6.1 (Genstat, 2002).

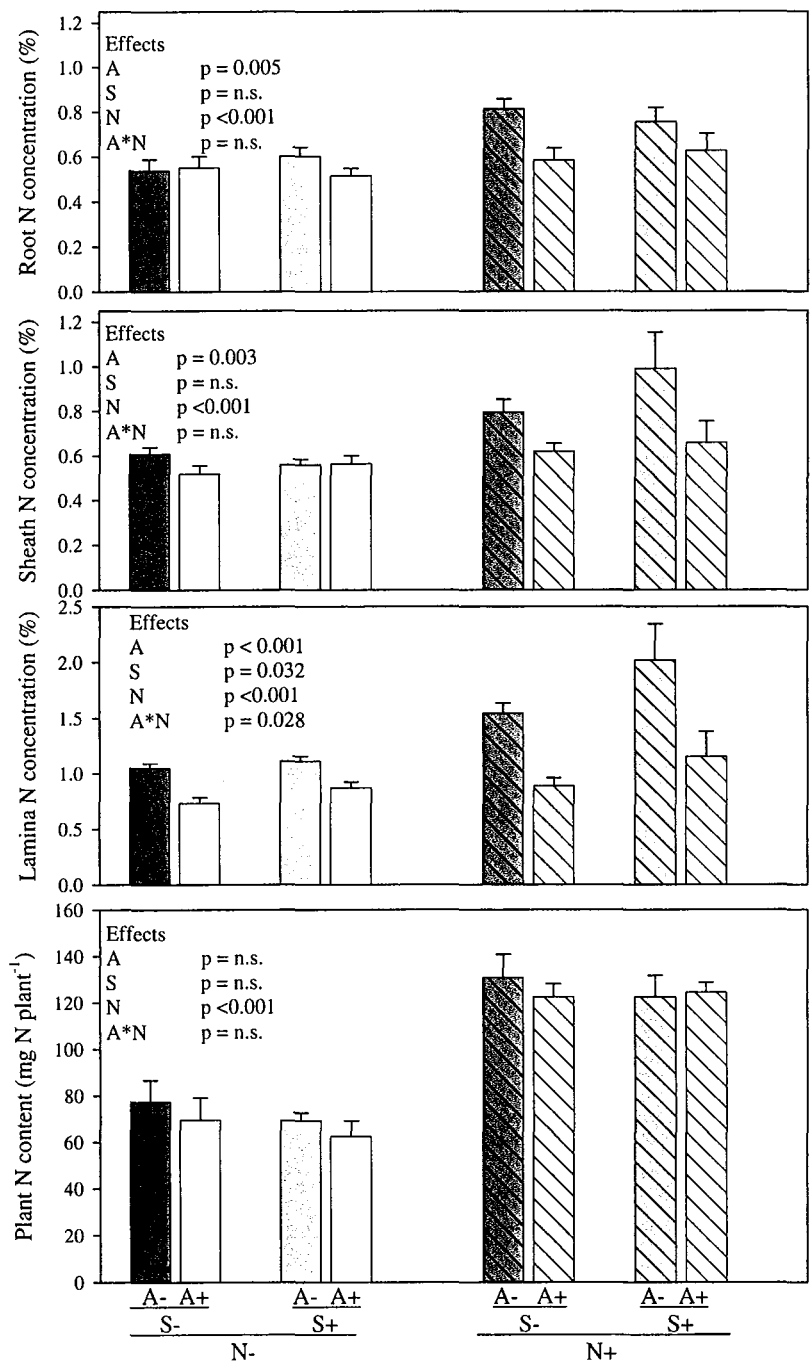

Figure 5.4: Effects of the treatment on root, stem and leaf N concentration (%) and total plant N content (mg N plant⁻¹). Values are average of 6 replicates \pm SE. Bars are grouped by fertiliser N (low, N- or high, N+), soil type (ambient soil, S- or enriched soil, S+) and atmospheric CO₂ concentration (ambient, A- or enriched, A+). P values are given for the main effects

5.4. Results

5.4.1. Dry matter production

Elevated CO₂ concentration during plant growth strongly increased total plant biomass at the end of the experiment. A+ plants had on average 24% more total biomass than A- plants (Fig. 5.3). This positive CO₂ effect mainly affected plants that were supplied with high N fertilisation as shown by the significant interaction between A and N treatment ($p=0.02$) on total plant biomass. Under N+, elevated atmospheric CO₂ induced a 42% increase in plant biomass whereas this increase was only about 3% under low N supply. Soil origin had no significant effect on total plant biomass despite a trend showing a negative effect of S+ soil (-10%).

When individual tissues were considered, the increased biomass under elevated atmospheric CO₂ only affected sheaths (+55%) and laminae (+36%) while root biomass increased under N+ but not under N- (Fig. 5.3). Similarly the enhanced biomass under high N fertilisation affected aboveground tissues more than roots. Again, the biomass response of laminae and sheaths to elevated atmospheric CO₂ was stronger under high N. Root biomass response to elevated CO₂ was even negative under low N whereas it was enhanced under high N.

5.4.2. N yield and concentration

Elevated atmospheric CO₂ had no significant effect on the total amount of N in plant biomass but it strongly modified N concentration in plant tissues: N concentration decreased by 16, 20 and 36% in root, sheaths and laminae respectively when plants were grown under elevated CO₂ (Fig. 5.4). Laminae N concentration was more reduced by elevated CO₂ under high N fertilisation. The origin of the soil only affected laminae N concentration but did not affect total plant N yield. Plants grown in soil originating from FACE rings exhibited a 22% higher lamina N concentration than plants grown in soil from ambient rings ($p=0.032$). High N fertilisation significantly increased N concentration in plant tissues by 26%, 36% and 49% in root, sheaths and laminae respectively. Coupled with the N driven increases in plant

Table 5.1: Nitrogen derived from fertiliser (NF in mg N plant⁻¹), nitrogen derived from soil (NS mg N plant⁻¹) and real recovery of the fertiliser (RR in %) under ambient (A-) and elevated (A+) atmospheric CO₂ concentration, on soil originating from ambient (S-) and elevated (S+) FACE rings and under low (N-) or high (N+) nitrogen fertilisation. Values are mean of six replicates \pm s.d. P values of the main effects are given at the 5% level. There was no significant interaction between main effects.

N	Atm	Soil	NF	NS	RR
N-	A-	S-	2.9 \pm 0.5	74.5 \pm 22.5	96.2 \pm 16.5
		S+	2.4 \pm 0.2	66.9 \pm 8	79.8 \pm 6.1
	A+	S-	2.3 \pm 0.3	67.2 \pm 23.2	77.8 \pm 9.6
		S+	2 \pm 0.2	60.4 \pm 16.2	67.8 \pm 5.1
N+	A-	S-	64 \pm 11.2	66.8 \pm 14.7	100.1 \pm 17.6
		S+	56.4 \pm 7.1	66.1 \pm 17.7	88.3 \pm 11.2
	A+	S-	60.1 \pm 5.7	62.4 \pm 8.1	94.1 \pm 9
		S+	54.1 \pm 3.5	70.4 \pm 10.4	84.7 \pm 5.5
Effects					
	N		p<0.001	n.s.	p<0.001
	A		p=0.002	n.s.	p=0.003
	S		p<0.001	n.s.	p<0.001

biomass described above, this resulted in an 80% increase in total plant N uptake for N+ plants ($p < 0.001$).

5.4.3. *Origin of plant N*

Elevated atmospheric CO₂ significantly decreased the amount of plant N derived from fertiliser (NF) by about 6% ($p = 0.002$) but this decrease was stronger at low N (-17%) than at high N (-5%) as shown by the significant interaction between N and CO₂ ($p = 0.047$) (Table 5.1). Plant N derived from soil (NS) was not affected by elevated CO₂ despite a trend showing an apparent decrease. The proportion of plant N deriving from fertiliser (% NF) was not affected by elevated CO₂. Soil from FACE rings also decreased plant NF (-11 %, $p < 0.001$) and left NS unaffected. Consequently, %NF significantly decreased when plant were grown on FACE soil (-8%). Obviously high N fertilisation increased plant NF and %NF dramatically. Interestingly NS was not affected by N fertilisation.

5.4.4. *¹⁴C allocation within the plant-soil system*

¹⁴C allocation within the plant was clearly affected by the treatments (Table 5.2). Elevated atmospheric CO₂ increased by 15% the percentage of assimilated CO₂ found in the sheath compartment and concomitantly decreased ¹⁴C allocation to the laminae. The origin of the soil had similar effects on ¹⁴C at the plant scale with S+ soil increasing allocation to sheaths and decreasing allocation to laminae by respectively 9 and 17%. On the other hand N fertilisation significantly increased allocation to laminae with N+ plants showing a 30% increase in the fraction of assimilated ¹⁴C found in laminae. Most of the assimilated ¹⁴C remained in the plant 48 hours after the labelling (about 85%) and this was not affected significantly by the treatments. The proportion of ¹⁴C that was respired by the roots and soil microbial biomass during the 48h chasing period was about 10% of the assimilated ¹⁴C and stayed unaffected by the treatments. High N fertilisation decreased the amount of ¹⁴C present in the soil (-31%, $p = 0.009$) and a strong trend showed a similar effect on the proportion of ¹⁴C found in the microbial biomass (-30%, $p = 0.051$). Elevated

Table 5.2: Fraction of total radioactivity recovered per pot in each compartment and relative specific activity of each compartment under ambient (A-) and elevated (A+) atmospheric CO₂ concentration, on soil originating from ambient (S-) and elevated (S+) FACE rings and under low (N-) or high (N+) nitrogen fertilisation. Values are mean of six replicates ± s.d. P values of the main effects are given at the 5% level. Values in italics are significant at the 10% level only. Only the statistically significant interactions are presented here.

Fertilisation	N-				N+				Treatments effects			
	A-		A+		A-		A+		N	A	S	N*A
	S-	S+	S-	S+	S-	S+	S-	S+				
% of total radioactivity recovered												
<i>Plant</i>	84.8±6.3	83.1±2.8	83.8±7.7	79.7±4.1	85.2±2.9	85.3±2.9	86.6±1.8	83.9±4.3	<i>0.061</i>	n.s.	n.s.	n.s.
Laminae	10.9±4.3	10.7±2.4	10.9±4	13.1±2.9	15.4±4	15.8±3.1	12.6±2.6	14.2±3.4	0.003	n.s.	n.s.	n.s.
Sheaths	33±11.7	33.8±4.7	35.5±6.9	43.5±3.8	36.4±5.2	35.7±6.6	38.2±9.5	42.3±5.2	n.s.	0.002	0.018	n.s.
Roots	40.8±17.9	38.5±6.9	37.5±7.7	23.1±5.1	33.3±10.2	33.8±5.8	35.8±10.5	27.3±8.3	n.s.	0.002	0.002	0.038
Rhiz. respiration	11.1±4.6	11.9±2.8	11±7	13.9±2.6	11.8±1.6	11.4±2.6	10.2±1.6	11.4±3.4	n.s.	n.s.	n.s.	n.s.
Soil	4.1±1.8	5±1.4	5.1±3.3	6.4±2.4	3.1±1.6	3.3±0.9	3.3±0.5	4.7±2.4	0.009	<i>0.081</i>	n.s.	n.s.
Microbial BM	0.4±0.3	0.6±0.2	0.7±0.4	0.8±0.4	0.3±0.1	0.3±0.1	0.5±0.1	0.6±0.1	<i>0.051</i>	0.001	<i>0.067</i>	n.s.
Relative Specific Activity												
<i>Plant</i>	48.5±1.4	47.2±0.9	50.5±2.5	49.4±1.3	41.6±1.6	52.9±3.4	31±0.5	35±1.8	0.011	0.073	n.s.	0.017
Laminae	26.9±1.7	25.2±0.8	24.6±1.6	26.9±1.2	26.1±1.5	33.9±2.9	15.7±0.7	20.2±0.9	n.s.	0.031	n.s.	0.042
Sheaths	94.5±2.3	79.9±1.8	83.8±5.1	86±1.9	69.5±2.9	89.5±4.9	50.7±1.7	58.4±3.1	<0.001	0.006	n.s.	0.029
Roots	39.7±2.9	43.6±1.5	50.6±4.6	38.1±1.9	35.8±1.2	47±3.6	29.2±1.4	28.2±1.4	<i>0.056</i>	n.s.	n.s.	<i>0.079</i>
Rhiz. respiration	211.4±16	208.4±9.6	196.4±24.9	216.9±8.7	145.7±7.5	211.1±13.7	137.9±3.8	149.7±8.1	0.044	n.s.	n.s.	n.s.
Soil	0.3±0.02	0.3±0.02	0.3±0.04	0.4±0.03	0.2±0.02	0.2±0.01	0.2±0.01	0.3±0.03	0.023	<i>0.088</i>	<i>0.052</i>	n.s.
Microbial BM	3±0.2	3.5±0.1	4.4±0.4	4.5±0.3	2.1±0.2	3±0.1	3.1±0.2	3.4±0.2	0.021	0.02	n.s.	n.s.

atmospheric CO₂ operated in the opposite direction with an increased proportion of ¹⁴C found in the soil compartments, in particular in the microbial biomass (+62%, p=0.001). The origin of the soil did not affect significantly ¹⁴C recovery within these compartments but there was a strong trend for increased allocation of ¹⁴C towards the microbial biomass in S+ soil (+20%, p=0.067).

When ¹⁴C distribution is considered in terms of relative specific activity (RSA), it takes into account both the size of the compartment and its metabolic activity. High N fertilisation decreased RSA of all compartments (Table 5.2) although the effect on laminae and root were not statistically significant. Elevated atmospheric CO₂ decreased RSA in the plant compartment but strongly increased RSA in soil (+29%) and microbial biomass (+33%). There was a 24% increase in soil RSA when plants were grown in S+ soil but this difference was non-significant.

5.5. Discussion

5.5.1. Elevated atmospheric CO₂ increases root exudation

Numerous studies have shown that increases in plant aboveground biomass under elevated CO₂ are often smaller than expected based on the stimulation of C assimilation (Chapter 1). It was therefore hypothesised that a great part of the extra C was allocated belowground. Previous studies in the New Zealand pasture FACE have shown greater C allocation towards roots and soil. Despite a greater photosynthetic activity (von Caemmerer *et al.*, 2001) in some abundant species herbage production stayed unaffected by elevated CO₂ (Newton *et al.*, 2001). However, in this thesis it has been shown that root production and turnover are greatly stimulated under FACE conditions (Chapter 4). In addition, both mycorrhizal infection rate (Rillig, M. personal communication) and nematode abundance (Yeates *et al.*, 2003) were enhanced under elevated CO₂ showing that other soil C sinks were also greater under elevated CO₂. In the present study the greater proportion of assimilated ¹⁴C found in the soil and the microbial biomass when *L. perenne* plants were submitted to elevated CO₂ gives a clear indication of enhanced root exudation. This is a common observation (Cheng and Johnson, 1998; van Ginkel *et al.*, 2000 but see Hodge and

Table 5.3: Microbial carbon biomass (MB-C in mg C g⁻¹soil), C/N ratio of the microbial biomass (MB-C/N) and rhizomicrobial respiration (mg C day⁻¹ pot⁻¹) under ambient (A-) and elevated (A+) atmospheric CO₂ concentration, on soil originating from ambient (S-) and elevated (S+) FACE rings and under low (N-) or high (N+) nitrogen fertilisation. Values are mean of six replicates ± s.d. P values of the main effects are given at the 5% level. Values in italic are significant at the 10% level only. No interactions between treatments were measured.

N	Atm	Soil	MB-C (mgC g ⁻¹ soil)	MB-C/N	Respiration (mgC day ⁻¹ pot ⁻¹)
N-	A-	S-	339.7+7.6	7.6±1.8	68.25±10.5
		S+	346.7+6	6±5.2	67.45±19.9
	A+	S-	369.1+7.4	7.4±0.9	81.9±33.6
		S+	409.4+7.4	7.4±2.7	82.3±36.75
N+	A-	S-	344.7+8.6	8.6±1.5	102.75±19.7
		S+	295.9+7.6	7.6±2.3	70.9±15.3
	A+	S-	438.1+7.9	7.9±3	98.95±26
		S+	446.1+11.2	11.2±5.2	112.15±49.45
Effects					
	N		n.s.	<i>p=0.065</i>	p=0.015
	A		p=0.003	n.s.	<i>p=0.057</i>
	S		n.s.	n.s.	n.s.

Millard, 1998) but the causes of this CO₂ driven increase in root exudation are still unclear. Is this phenomenon primarily caused by a proportional growth response of roots (van Ginkel *et al.*, 2000; Mikan *et al.*, 2000) or is exudation per unit root area also increased (Lekkerkerk *et al.*, 1990; Cheng and Johnson, 1998)? The results presented here support the second hypothesis since the apparent increased exudation under elevated CO₂ occurred without any change in root biomass (Fig. 5.3). This implies that exudation *per se* was affected by elevated CO₂, but extrapolation of this to what would happen under field conditions would be dangerous. There are good indications that root growth was at least partially limited by pot size. Previous studies describing a relative lower stimulation of root growth compared to shoot growth under elevated CO₂ are rare in the literature hence it can be suspected that belowground growth was constrained in one way or another. We do not know to what extent this may have affected the root exudation process but because C acquisition by roots is controlled simultaneously by leaves' capacity to assimilate C and by the roots' demand for C (Farrar and Jones, 2000), it seems intuitively reasonable to expect that an experimental artefact limiting the sink strength for C may have modified the exudation process.

5.5.2. Increased availability of easily decomposable C induced higher microbial growth

Whether the CO₂ stimulation of exudation is greater or proportional to the plant biomass increase is nevertheless only of relative importance here. Indeed, the main question remains whether a greater availability of easily decomposable C will or will not affect soil microbial biomass that is usually C limited. Several studies have observed a strong enhancement of root derived C allocation towards microbial biomass under elevated CO₂ (Mikan *et al.*, 2000; van Ginkel *et al.*, 2000) and a stimulation of microbial biomass due to an increase in available C substrate (Zak *et al.*, 1993; Cotrufo and Gorissen, 1997). In our study, the fraction of assimilated ¹⁴C and the RSA in the microbial biomass significantly increased under elevated CO₂. Not only did the increased availability of C substrate under elevated CO₂ stimulate the size and activity of the microbial biomass pool but there was also an increase in the

apparent preference of soil microorganisms for exudates (as shown by the higher RSA, Table 5.2).

5.5.3. Effects on native soil organic matter decomposition; occurrence of a priming effect

Belowground respiration (i.e. by soil microorganisms and roots) was increased under elevated CO₂ whereas root biomass was not affected. In consequence, it is reasonable to consider that the enhancement of belowground respiration was mainly caused by an increase in soil respiration. As described in Cheng and Johnson (1998) two mechanisms could be the cause of this phenomenon. First, as observed in this study, root exudation was higher under elevated CO₂ and the subsequent metabolisation of this material by soil microorganisms would lead to an increase in soil respiration. If this process was quantitatively important, it should increase the intensity of ¹⁴C labelling of soil CO₂; this was not the case here (Table 5.2). This implies that exudates use by soil microorganisms only represented a small part of the observed increase in soil respiration and that mineralisation of native soil organic matter was increased: this is the so called “priming effect” (Bingeman et al., 1953).

Past studies describing the effect of increased exudation on SOM decomposition have shown both stimulatory (Zak *et al.*, 1993) or suppressive (Cardon *et al.*, 2001) effects of root derived exudates on SOM decomposition. An hypothesis (Lekkerkerk *et al.*, 1990; Cardon, 1996) identifying N as a main driver of the response of microorganisms to increased exudates predicts that under sufficient N availability, soil microorganisms will preferentially metabolize root exudates that have a high C:N ratio, but that are easily available, instead of decomposing N-rich native SOM in which the C is less accessible. However, several studies have contradicted this prediction by showing an opposite effect; the CO₂-induced “priming effect” being stronger under high N (Hungate *et al.*, 1997; Cheng and Johnson, 1998). In our study the absence of interaction between N and atmospheric CO₂ on rhizosphere respiration (Table 5.3) suggests that the “priming effect” was independent of N availability. Fontaine *et al.* (2003) recently proposed a conceptual model in which the “priming effect” resulted from the competition for energy and nutrient acquisition between two

groups of microorganisms: those feeding on mainly easily accessible C and those specialized in metabolising native SOM. Under this assumption, the “priming effect” might well be dependent on complex controls, in particular if the structure of microbial populations is modified by elevated CO₂ (Montealegre *et al.*, 2002) or if soil mesofauna feeding on soil microbes are also affected by elevated CO₂ (Yeates *et al.*, 2003). Therefore a simple model considering soil microorganisms as a single entity responding to C and N availability is probably over-simplistic and can lead to the apparent contradictions described above.

5.5.4. Did the increased SOM mineralisation affected N availability for plants?

The occurrence of a “priming effect” caused by a CO₂-induced enhancement of the microbial biomass could potentially affect N availability in two opposite ways. Firstly, increased microbial growth under elevated CO₂ could increase microbial need for N; at a given moment in time more N would therefore be immobilised and not accessible by plants (Diaz *et al.*, 1993). Secondly, the increased metabolisation of native SOM due to the “priming effect” described above could increase soil mineral N (Zak *et al.*, 1993) since stabilised SOM is usually richer in N. Our results give no evidence that N availability for the plants was modified under elevated atmospheric CO₂ (Fig. 5.4). Although N concentration of the different plant organs was lower under elevated CO₂, in particular in laminae, total plant N yield was the same. Nevertheless an unaltered plants N yield gives no indication of the origin of the N and potential effects of the treatments on N dynamics in the soil. ¹⁵N data gives clear indications of altered N cycling. NF was clearly decreased by elevated atmospheric CO₂ while NS stayed unaltered (Table 5.1). Similarly, the concomitant decrease of fertiliser recovery rate (RR) and unaltered plant N yield under elevated CO₂, shows that for a given amount of N uptake by plants, a greater proportion originated from soil rather than from the fertiliser. Under the assumption that both fertiliser and soil mineral N are perfectly mixed in the soil (e.g. plants do not preferentially take up one or another), this indicates an increased dilution of fertiliser N by soil N because of the enhanced native SOM decomposition. Therefore microbial N immobilization and SOM N mineralisation seems to counterbalance each other leaving N availability unchanged for plant growth.

5.5.5. Long-term CO₂ effect: origin of the soil

In a previous experiment in the New Zealand pasture FACE site (Chapter 4) we have shown that soil originating from elevated CO₂ gave clear indications of accumulating particulate organic matter (POM) and that this accumulating POM had a lower C/N ratio than the POM in the ambient soil. We attributed the accumulation of POM mainly to an increase in root growth and turnover under elevated CO₂ (Chapter 4) and the decrease in C/N ratio to the increased proportion of legumes in the pasture (Edwards *et al.*, 2001). On this basis, we hypothesised that such a modification of the SOM quantity and quality could potentially alter plant N nutrition and control the short term effects of elevated CO₂ on soil dynamics that occurs through increased exudation. As expected, due to the lower C/N ratio of the POM, soil coming from FACE rings provided more N for a given amount of mineralized soil organic matter as shown by the higher dilution of fertiliser N by soil N (Table 5.1). But the origin of the soil had no significant effect on plant N yield showing that N availability stayed most probably unaltered. Because we did not observe a significant increase of the microbial biomass nor any change in its C/N ratio, we can assume that there was no increase in the gross microbial N immobilisation. Then why did the hypothesised increase in gross N mineralisation from SOM not induce an increase in mineral N availability? In this study we did not measure ¹⁵N in soil organic matter compartments. Loiseau and Soussana (2000) using a similar labelling technique have shown that a significant amount of fertiliser N was immobilised in soil organic matter pools shortly after fertilisation, thus limiting transfers of ¹⁵N through litter decomposition. In our study the greater amount of SOM in FACE soil might well have created a greater sink for soil N. Therefore the greater gross N mineralisation observed may have been counterbalanced by a greater gross N immobilisation by SOM.

5.6. Conclusion

Our results give clear indications that elevated CO₂ effects on root exudation have a negative effect on C sequestration due to the existence of a priming effect on native SOM decomposition. This phenomenon also explains the faster soil N turnover that allows a sustained N availability for increased plant growth. It also appears that

the accumulation of organic matter observed in the field in elevated CO₂ rings does not induce slower N cycling under the conditions of our experiment. This strongly suggests that the observed accumulation of SOM under elevated CO₂ is not driven by simple C and N limitations.

5.7. Acknowledgements

I thank P. Gross for the glasshouse maintenance, P. Marchal for help with the analysis and the numerous students and staff who helped with plant sampling after the ¹⁴C labelling.

5.8. References

- Bingeman CW, Varner JE, Martin WP (1953) The effect of the addition of organic matter materials on the decomposition of an organic soil. *Soil Science Society America Proceedings*, **29**, 692-696.
- Cardon ZG (1996) Influence of rhizodeposition under elevated CO₂ on plant nutrition and soil organic matter. *Plant and Soil*, **187**, 277-288.
- Cardon ZG, Hungate BA, Cambardella CA, Chapin III FS, Field CB, Holland EA, Mooney HA (2001) Contrasting effects of elevated CO₂ on old and new soil carbon pools. *Soil Biology and Biochemistry*, **33**, 365-373.
- Cheng W, Johnson DW (1998) Elevated CO₂, rhizosphere processes, and soil organic matter decomposition. *Plant and Soil*, **202**, 167-174.
- Cotrufo MF, Gorissen A (1997) Elevated CO₂ enhances below-ground C allocation in three perennial grass species at different levels of N availability. *New Phytologist*, **137**, 421-431.
- Cotrufo MF, Ineson P, Rowland AP (1994) Decomposition of tree leaf litters grown under elevated CO₂ - effect of litter quality. *Plant and Soil*, **163**, 121-130.
- Diaz S, Grime JP, Harris J, McPherson E (1993) Evidence of a feedback mechanism limiting plant response to elevated carbon dioxide. *Nature*, **364**, 616-617.

- Edwards GR, Clark H, Newton PCD (2001) The effects of elevated CO₂ on seed production and seedling recruitment in a sheep-grazed pasture. *Oecologia*, **127**, 383-394.
- Farrar JF, Jones DL (2000) The control of carbon acquisition by roots. *New Phytologist*, **147**, 43-53.
- Fontaine S, Mariotti A, Abbadie L (2003) The priming effect of organic matter: a question of microbial competition? *Soil Biology and Biochemistry*, **35**, 837-843.
- Genstat (2002) Genstat 6, release 1.0.20. Lawes Agriculture trust, IACR, Rothamsted.
- Gorissen A, Cotrufo MF (2000) Decomposition of leaf and root tissue of three perennial grass species grown at two levels of atmospheric CO₂ and N supply. *Plant and Soil*, **224**, 75-84.
- Hirschel G, Körner C, Arnone III JA (1997) Will rising atmospheric CO₂ affect leaf litter quality and *in situ* decomposition rates in native plant communities. *Oecologia*, **110**, 387-392.
- Hodge A, Millard P (1998) Effect of elevated CO₂ on carbon partitioning and exudate release from *Plantago lanceolata* seedlings. *Physiologia Plantarum*, **103**, 280-286.
- Hungate BA, Chapin FS, III, Zhong H, Holland EA, Field CB (1997) Stimulation of grassland nitrogen cycling under carbon dioxide enrichment. *Oecologia*, **109**, 149-153.
- Keeling CD, Whorf TP, Wahlen M, Vanderpligt J (1995) Interannual extremes in the rate of rise of atmospheric carbon dioxide since 1980. *Nature*, **375**, 666-670.
- Kemp PR, Waldecker DG, Owensky CE, Reynolds JF, Virginia RA (1994) Effects of elevated CO₂ and nitrogen fertilization pretreatments on decomposition of tallgrass prairie leaf litter. *Plant and Soil*, **165**, 115-127.
- Lekkerkerk LJA, van de Geijn SC, van Veen JA (1990) Effects of elevated atmospheric CO₂ levels on the carbon economy of a soil planted with wheat. In: *Soils and the Greenhouse Effect* (ed Bouwman AF), pp. 423-429. John Wiley and Sons, Chichester.
- Loiseau P, Soussana JF (2000) Effects of elevated CO₂, temperature and N fertilization on nitrogen fluxes in a temperate grassland ecosystem. *Global Change Biology*, **6**, 953-965.

- Mikan CJ, Zak DR, Kubiske ME, Pregitzer KS (2000) Combined effects of atmospheric CO₂ and N availability on the belowground carbon and nitrogen dynamics of aspen mesocosms. *Oecologia*, **124**, 432-445.
- Montealegre CM, van Kessel C, Russelle MP, Sadowsky MJ (2002) Changes in microbial activity and composition in a pasture ecosystem exposed to elevated atmospheric carbon dioxide. *Plant and Soil*, **243**, 197-207.
- Newton PCD, Clark H and Edwards GR (2001) The effects of climate change on grazed grasslands. In: *Structure and Function of Agroecosystem Design and Management* (eds Shiyomi M, Koizumi H), pp 297-311. CRC Press, Boca Raton.
- Rogers HH, Runion GB, Krupa SV (1994) Plant-responses to atmospheric CO₂ enrichment with emphasis on roots and the rhizosphere. *Environmental Pollution*, **83**, 155-189.
- Ross DJ and Tate KR (1993) Microbial C and N in litter and soil of a southern beech (*Nothofagus*) forest: comparison of measurement procedures. *Soil Biology and Biochemistry*, **25**, 467-475.
- Smith JL and Paul EA (1990) The significance of soil microbial biomass estimations. In: *Soil Biochemistry* (eds Bollag J, Stotsky G), pp. 357-393. Marcel Dekker, New York.
- Smith P, Powlson DS, Smith JU, Falloon P, Coleman K (2000) Meeting Europe's climate change commitments: quantitative estimates of the potential for carbon mitigation by agriculture. *Global Change Biology*, **6**, 525-539.
- Todorovic C, Nguyen C, Robin C, Guckert A (2001) Root and microbial involvement in the kinetics of ¹⁴C-partitioning to rhizosphere respiration after a pulse labelling of maize assimilates. *Plant and Soil*, **228**, 179-189.
- van Ginkel JH, Gorissen A, Polci D (2000) Elevated atmospheric carbon dioxide concentration: effects of increased carbon input in a *Lolium perenne* soil on microorganisms and decomposition. *Soil Biology and Biochemistry*, **32**, 449-456.
- Vance ED, Brookes PC, Jenkinson DS (1987) An extraction method for measuring soil microbial biomass C. *Soil Biology and Biochemistry*, **19**, 703-707.
- von Caemmerer S, Ghannoum O, Conroy JP, Clark H and Newton PCD (2001) Photosynthetic responses of temperate species to free air CO₂ enrichment

(FACE) in a grazed New Zealand pasture. *Australian Journal of Plant Physiology*, **18**, 439-450.

Yeates GW, Newton PCD, Ross DJ (2003) Significant changes in soil microfauna in grazed pasture under elevated carbon dioxide. *Biology and Fertility of Soils*, **38**, 319-326.

Zak DR, Pregitzer KS, Curtis PS, Teeri JA, Fogel R, Randlett DL (1993) Elevated atmospheric CO₂ and feedback between carbon and nitrogen cycles. *Plant and Soil*, **151**, 105-117.

Chapter 6: General Discussion

Chapter 6: General Discussion

6.1. Introduction

In the conclusion of a recently published review, Körner (2000) emphasised that CO₂ experiments should avoid over-simplification, in other words should aim for realism in their design: *“By “realism” I mean accounting for the complexity of interactions in real life. Since there is no doubt that plant species respond in rather different ways depending on their age, neighbours, microbial partners, soil resources and atmospheric condition, the experimental negation of these interactions and dependencies is wasteful – or, even worse, creates a biased picture of the world.”* In elevated CO₂ experiments conducted in grassland to date, one source of such behavioural variation that has been overlooked is the potential influence of grazing and the need for information about elevated CO₂ effects on grazed grasslands was also noted by Newton *et al.* (2001), who wrote: *“...it is by no means certain that we can extrapolate the results of CO₂ enrichment experiments from cut to grazed situations. In fact, what is required is not only a greater understanding of how changes in pasture might alter animal performance at elevated CO₂ but also, more importantly, a clearer picture of the CO₂ response of ecosystems in which grazing animals are an integral part”*.

The overall objective of this thesis is derived from the concepts expressed in these two statements. To assess the effects of elevated CO₂ on organic matter fluxes in a grazed grassland and the possible influence of these fluxes on soil organic matter accumulation and N availability it was thus necessary not only to consider species diversity and their relative response to elevated CO₂, but also the ecosystem fauna both aboveground (i.e. sheep) and belowground. In this general discussion I will summarize the results described in the previous chapters and draw some general conclusions. The two main themes are organic matter accumulation in the soil under elevated CO₂ in relation to the organic matter fluxes and the implications of grazing on nitrogen (N) cycling.

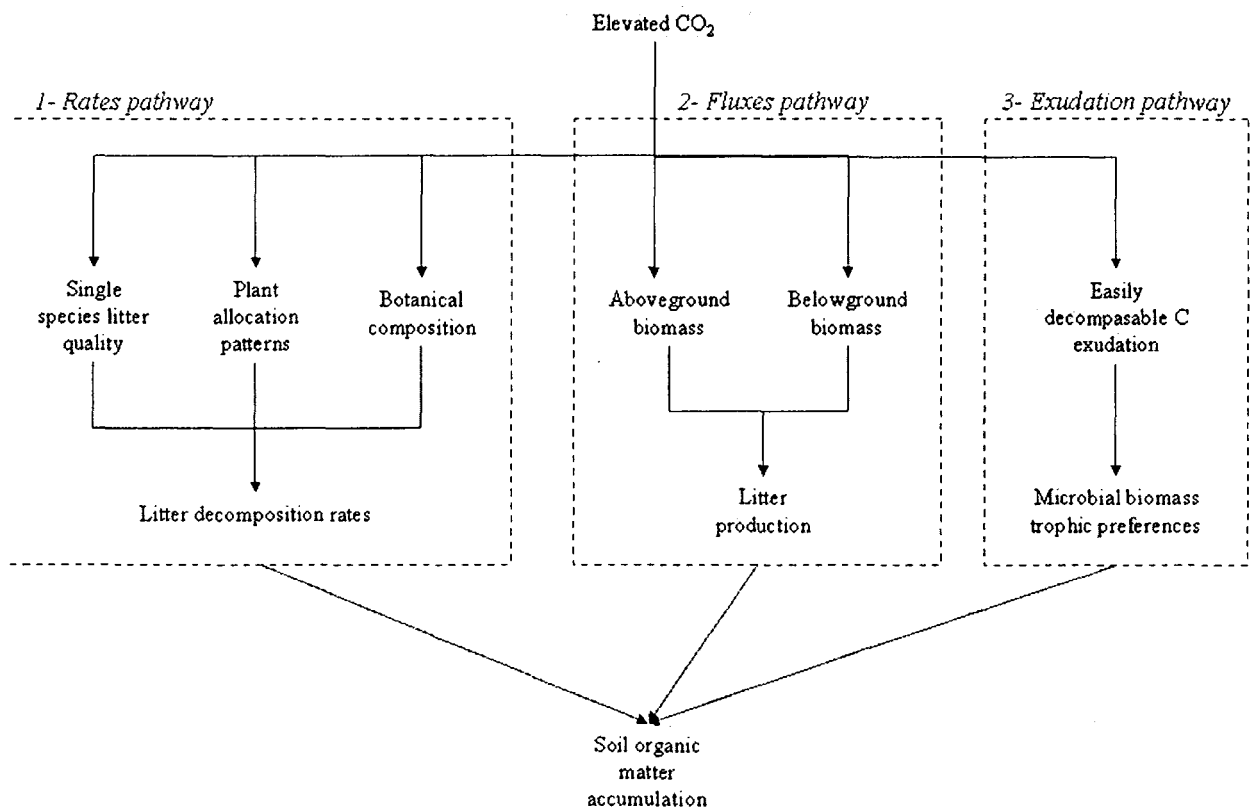

Figure 6.1: Possible pathways through which elevated CO₂ may affect plant-soil organic matter fluxes.

6.2. Effects of elevated CO₂ on plant-soil organic matter fluxes and organic matter accumulation in the soil

Classically, three main mechanisms are proposed in the elevated CO₂ literature as possible explanations for a modification of organic matter pools in soil under elevated CO₂ (Figure 6.1). Firstly, plant litter decomposition rates could be lower under elevated CO₂ both through direct effects of elevated CO₂ (decreased decomposability at the species scale arising from higher C:N ratio) or indirect effects (shifts in botanical composition or biomass allocation). Secondly, due to the increase in C assimilation under elevated CO₂ the size of the organic matter fluxes could be greater. Thirdly, increased root exudation of readily decomposable C under elevated CO₂ could modify the trophic preference of soil microorganisms and alter soil organic matter decomposition. I will now briefly review the results presented in the previous chapters about these three effects pathways.

6.2.1. Rates of organic matter decomposition

The data presented in Chapter 3 clearly showed leaf litter C:N ratio and decomposition rates, when considered at the single species level, were not affected by elevated CO₂. This result is now globally accepted (Norby and Cotrufo, 1998) after a long period of conflicting results showing both lower (Coûteau *et al.*, 1991; Cotrufo and Ineson, 1996) or unaltered litter decomposition rates under elevated CO₂ (Franck *et al.*, 1997; Dukes and Field, 2000). These divergences very probably have methodological origins. In particular due to the use of green leaves in decomposition experiments, instead of naturally senesced litter, can cause an experimental bias since green leaves usually exhibit a major change of their chemical composition under elevated CO₂ (Cotrufo *et al.*, 1998).

The rejection of the “litter hypothesis” (as formulated by Strain and Bazzaz, 1983) does not diminish the importance of indirect effects of elevated CO₂ at the community level that may affect overall decomposition rates. The results presented in Chapter 3, identify effects of elevated CO₂ on botanical composition as an important driver of decomposition processes. Two of the four species used in this experiment,

Trifolium subterraneum and *Hypochaeris radicata* exhibited greater decomposition rates than the two grasses. These two species with a higher decomposition rate are also two species that tend to increase in proportion in the pasture under elevated CO₂. It was therefore concluded that, overall, elevated CO₂ should lead to an increase in leaf litter decomposition rate at the study site. Another secondary effect of elevated CO₂ that affected decomposition rates was the increase in biomass allocation towards root growth and turnover (Chapter 4). Whereas above ground production was not changed by elevated CO₂, root growth was stimulated by nearly 60% in summer-autumn and about 10% in winter-spring. Root turnover was also greater under elevated CO₂ and the result of these effects was a large increase in the proportion of litter originating from roots under elevated CO₂. A more comprehensive study involving species-specific root litter material would be required to quantitatively define, at the pasture scale, the global implications of this shift in biomass allocation. Nevertheless, the results obtained in Chapter 3 where decomposition of mixed-species root material was tested, show that a greater proportion of roots litter in the total litter pool is not only unlikely to decrease the overall decomposition rate but probably leads to a slight increase. Overall, decomposition rates *per se* of plant litter at the study site were therefore increased under elevated CO₂. The only component of the plant-soil organic matter returns to the soil that showed a decrease in decomposition rate was ruminant faecal material under dry conditions.

6.2.2. Fluxes of organic matter under elevated CO₂

To determine if elevated CO₂ affects organic matter accumulation in soil the rates of decomposition must not be considered in isolation. Changes in flux sizes are also of importance. Leaf litter deposition was found to be unaltered under elevated CO₂ (Chapter 4) but root production and turnover were higher under elevated CO₂, hence root litter deposition was greatly increased. This has implications for the relative proportion of root litter relative to leaf litter as discussed above and also for the total return of organic matter to the soil. In this study there were clear indications that the total amount of plant organic matter returning to the soil is greatly increased under elevated CO₂. This result is not a consistent outcome reported in the literature and some discussion of the reasons for this is necessary. Even with the commonly

observed disparity between C assimilation and C accumulation (see Chapter 1) and the consequence that plants may dissipate extra C fixed under elevated CO₂ via enhanced root turnover (Stocker *et al.*, 1999), experimental evidence for such a phenomenon is elusive and some studies did not detect the expected “C overflow” from the roots to the soil (Arnone *et al.*, 2000). The latter authors, reviewing the existing literature, report that studies showing a large increase in root biomass under elevated CO₂ are mainly growth chambers experiments (see for example Newton *et al.*, 1994; Newton *et al.*, 1996; Fitter *et al.*, 1996; Fitter *et al.*, 1997) whereas field studies generally report lower or no CO₂-induced stimulation (Leadley *et al.*, 1999; Arnone *et al.*, 2000). They hypothesise that growth conditions might create an artefact by artificially increasing the growing period in growth chambers and therefore conclude that in “real life” root growth might not be significantly stimulated under elevated CO₂.

Arnone *et al.* (2000) in their own study assessed root standing biomass, growth and mortality and showed clearly that in their system elevated CO₂ did not affect the C flow from roots to the soil. Nevertheless some of the other *in situ* studies they use as example to draw their conclusions only report effects of elevated CO₂ on root standing biomass (Körner *et al.*, 1997; Sindhøj *et al.*, 2000). Our own results clearly show that root standing biomass and growth can respond very differently to elevated CO₂ (Chapter 4) so I believe that, based on these examples, it cannot be concluded that elevated CO₂ does not affect root C flux to the soil. It is possible, as Arnone *et al.* (2000) state, that growth chambers conditions artificially enhance the root system response to elevated CO₂ but it is equally probable that root standing biomass measurements, when taken alone in *in situ* studies, give an incomplete picture of the biomass flux and underestimate fluxes from the roots to the soil. Consequently, in my view, the existing literature tends to validate the results presented in Chapter 4.

6.2.3. Exudation under elevated CO₂

Root exudation of easily decomposable C compounds is the third pathway through which elevated CO₂ can potentially affect soil organic matter (Fig. 6.1). The

problem here is not to assess the changes in quality/quantity of plant litter returns but how the alteration of easily decomposable C by the roots may modify the fate of this litter by decreasing the mineralisation of complex soil organic matter (Lekkerkerk *et al.*, 1990) or in the other hand, by stimulating its mineralisation through a priming effect as suggested by the results of Zak *et al.* (1993).

Root exudation in this study was not measured *in situ* on a variety of plant species but assessed on individual *Lolium perenne* plants under glasshouse conditions (Chapter 5); therefore extrapolation of our results should be cautious. Nevertheless some interesting patterns emerged from this experiment. Firstly, it appeared that exudation was increased by elevated CO₂ since more ¹⁴C was recovered in the soil and from the microbial biomass under elevated CO₂ and this increase was independent of root biomass. Given the increase in root production at elevated CO₂ shown in Chapter 4, it suggests that an even larger increase in C exudation under elevated CO₂ might be occurring in the field. The enhanced availability of readily decomposable C drove an increase in the soil microbial biomass; this would be expected since microbial biomass is usually C limited (Smith and Paul, 1990). In this experiment, the results indicate that the enhanced microbial biomass led to a priming effect through a tendency to greater decomposition of polymerised organic matter. In other words, even if the microbial population partially changed its feeding source by metabolising more exuded-C (as shown by the higher relative specific activity of the microbial biomass, Chapter 5), the extent of the priming effect led to a situation that was not detrimental for organic matter decomposition. In our study, the priming effect was independent of N fertilisation. This shows the possible limits of the conceptual model proposed by Hungate and Chapin (1995, in Cardon, 1996). In their scheme, if mineral nutrients are abundant in the soil, microorganisms will utilise readily decomposable C and will immobilise mineral N leading to a suppression of organic matter decomposition. If, instead nutrients are scarce, microorganisms will use the exuded C as a C source but break down more organic matter in order to obtain nutrients. This leads to the question of whether the fate of soil organic matter in grassland under elevated CO₂ can be simply assessed based on C-N interactions or if a more complex model is required. This will be discussed in the following paragraphs.

6.2.4. Accumulation of soil organic matter under elevated CO₂

The results concerning the decomposability of the litter and the priming effect caused by enhanced exudation under elevated CO₂ should tend to create an equilibrium where soil organic matter does not accumulate, or even decreases. This raises the question: why is the increased flux of organic matter entering the soil, in particular in the form of dead roots, not totally processed by the microbial biomass? Results from Chapter 4 clearly indicate an increase in the coarser fraction of particulate organic matter under elevated CO₂ showing that the extra organic matter entering in the soil organic matter pool cannot be totally metabolised. In addition, this supplementary organic matter exhibits a lower C/N ratio suggesting together with long term results from the same site (Ross *et al.*, 2003) that lower N availability is not the driving factor of this accumulation under elevated CO₂. Clearly, there are one or more limiting processes in the soil leading to this organic matter accumulation. In particular, if an increase in microbial biomass was observed under laboratory conditions at elevated CO₂ (Chapter 5) this effect was not observed under field conditions (Chapter 4, Ross *et al.*, 2003) suggesting that the microbial population might be controlled by some processes we did not assess directly in our studies.

A possible answer to this question may be changes in soil fauna. A recent study based on the same experimental site (Yeates *et al.*, 2003) showed a dramatic increase in nematode abundance under elevated CO₂. In that study, however, the relative abundance of the different trophic groups (omnivorous, root-feeding, bacterial-feeding and fungal-feeding nematodes) was not affected by elevated CO₂ making it relatively unlikely that a specific soil function was depressed under elevated CO₂. Moreover, even an augmentation in bacterial or fungal-feeding nematodes does not induce a suppression of microbial activity but may rather be associated with an increase in microbial activity (G. Yeates, personal communication) and the subsequent decomposition of soil organic matter. Therefore in the sward studied here, the extra nematode abundance is more likely to be a sign of an enhanced overall soil activity that should be favourable to organic matter processing, though it should be kept in mind that the interactions among the various functional groups of below-ground microbes and microfauna are complex and, so far, largely unpredictable (Wardle *et al.*, 2001; Wardle, 2002).

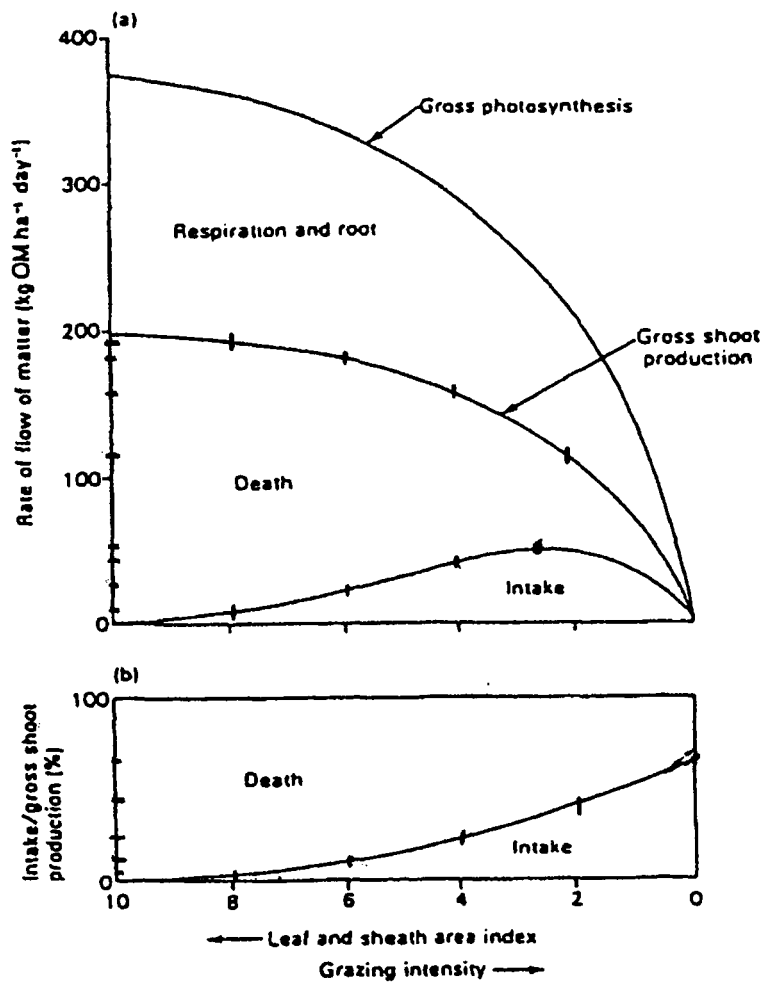

Figure 6.2: The effect of the intensity of grazing (the average leaf area index at which the sward is sustained) on the major physiological components of herbage growth and utilisation (from Parsons *et al.*, 1983).

A second possible answer to this accumulation of organic matter under elevated CO₂ would be to look further than possible C and N limitations. It is indeed likely that the availability of other macro-nutrients (P in particular) and possibly meso- and micro-nutrients can control ecosystem response to elevated CO₂ and more specifically microbial response to an increased organic matter supply. Studying the effects of elevated CO₂ on soil microbial biomass in a calcareous grassland, Niklaus (1998) concluded that microbial growth in their system under elevated CO₂ was limited by N but not by P availability. However, in this study, there was evidence that P might be a limiting factor, at least for aboveground plant growth. This leads to an interesting observation. In grasslands, such as this, containing a significant amount of legumes, the relative increase in N demand (compared to C) can be, at least partially counterbalanced by the increased proportion of legumes under elevated CO₂. Other nutrients however do not benefit from a similar mechanism and might become relatively scarce. This implies that future studies should widen their range of investigation by assessing the numerous controls that other nutrients can represent for ecosystem response to elevated CO₂. In addition there is probably also a strong need for a further integration of above and belowground processes. If, in relatively short-term experiments, including this one, ecosystem responses to elevated CO₂ are (apparently) mainly driven by plant and primary soil decomposers, it is probably hopeless to predict “real” ecosystem response to climate change without assessing indirect CO₂ effects on the multiple trophic levels of the soil food web.

6.3. An exploration of the possible impacts of grazing on N cycling in a pasture exposed to elevated CO₂

A second aspect of the results presented earlier that deserves further exploration is the implication for N cycling under elevated CO₂ of including the ruminants in the experimental system. In order to assess this, a simple conceptual model was developed to simulate the effects of an increasing herbage utilisation by ruminants on the amount, the form and fate of N returns in a pasture. This model has no quantitative objectives; its outcomes will only provide a basis for further discussion about possible interactions between grazing and elevated CO₂. In particular

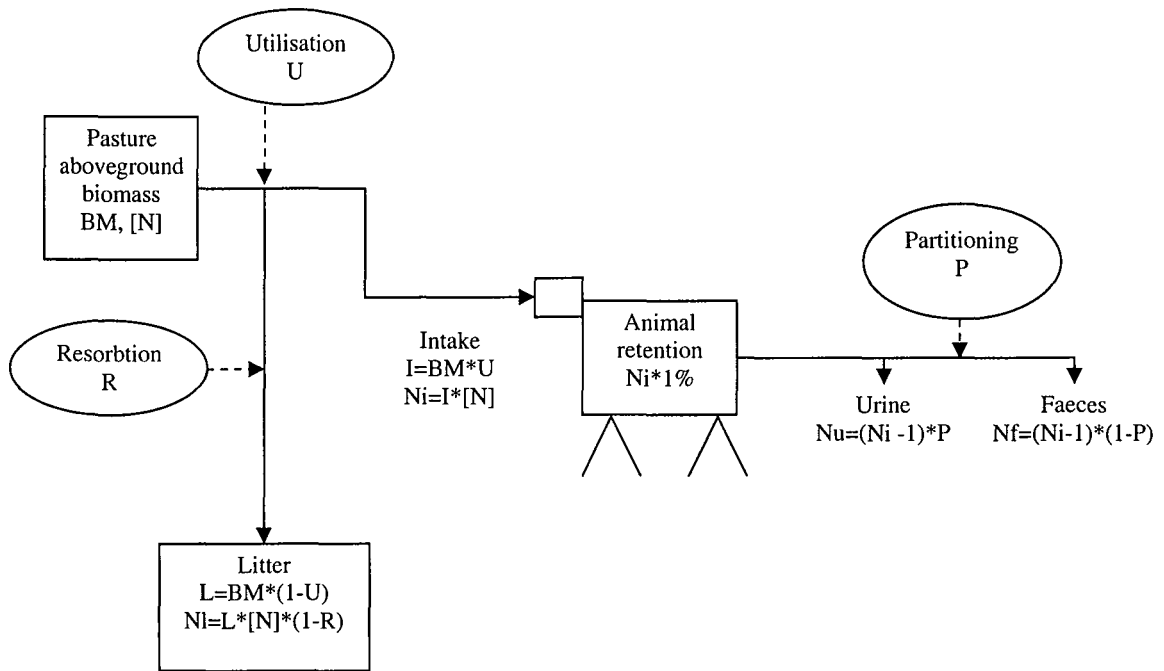

Figure 6.3: Relative N fluxes from herbage to litter and animal utilisation in a grazed pasture (modified from Thornley, 1998)

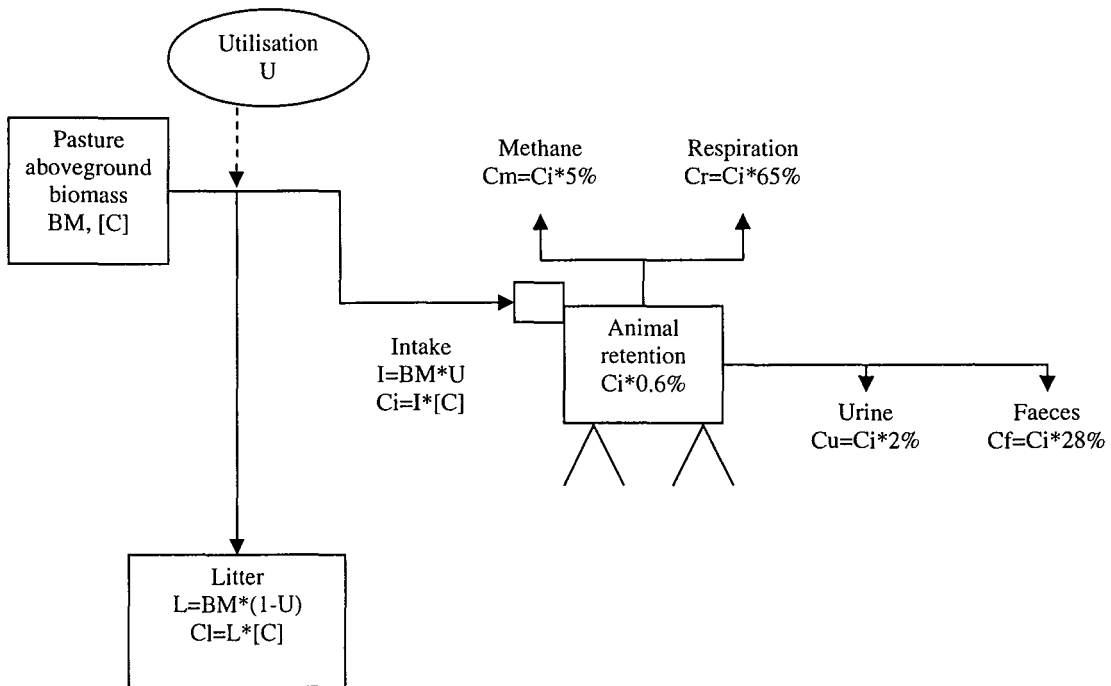

Figure 6.4: Relative C fluxes from herbage to litter and animal utilisation in a grazed pasture (modified from Thornley, 1998)

I will compare the relative and absolute N returns that occur through litter decomposition and faeces/urine deposition as a consequence of grazing intensity.

6.3.1. Description of the model

Grazing intensity can affect N cycling in a pasture through two main mechanisms. Firstly, the amount of N that is recycled is a function of the average biomass that is sustained in the pasture. Secondly, the amount of this biomass that is removed by animal grazing determines the proportion of N returned to the soil through leaf litter or animal excreta. The effects of grazing intensity on these two processes are described in Fig. 6.2. More specifically this figure taken from Parsons *et al.* (1983) describes the effects of the amount of leaf material that is sustained in the long-term in a pasture, on gross photosynthesis and on the balance between respiration and root growth, gross shoot production and intake by the grazers. In swards maintained on average at high leaf area index (LAI) (low grazing intensity, left side of the graph) canopy gross photosynthesis is close to a maximum, and the maximum amount of plant biomass is produced. To maintain the sward in this state however, only a small proportion of the leaves produced can be harvested and therefore most of the leaves produced die and return to the soil as litter. In swards maintained at lower LAI (right side of the graph), a greater proportion of plant material is grazed and the litter flux is therefore lower. In spite of a reduced gross photosynthesis induced by the lower LAI, this management achieve a better balance between photosynthesis, gross tissue production, death and intake. At even higher intensities of defoliation (extreme right of the graph), all components of production and utilisation are reduced: the sward is overgrazed. This figure gives us clear relationships between grazing intensity, amount of tissue production and the relative proportion of this production that is grazed or lost through litter decomposition. For the model presented here Parsons *et al.*' figure s provides a relationship between two variables: herbage biomass production (BM) and the proportion of this biomass that is grazed by the animal, the utilisation (U), in relation to grazing intensity.

Figure 6.3 (modified from Thornley, 1998) describes schematically the conceptual model and presents the three main processes that generate major

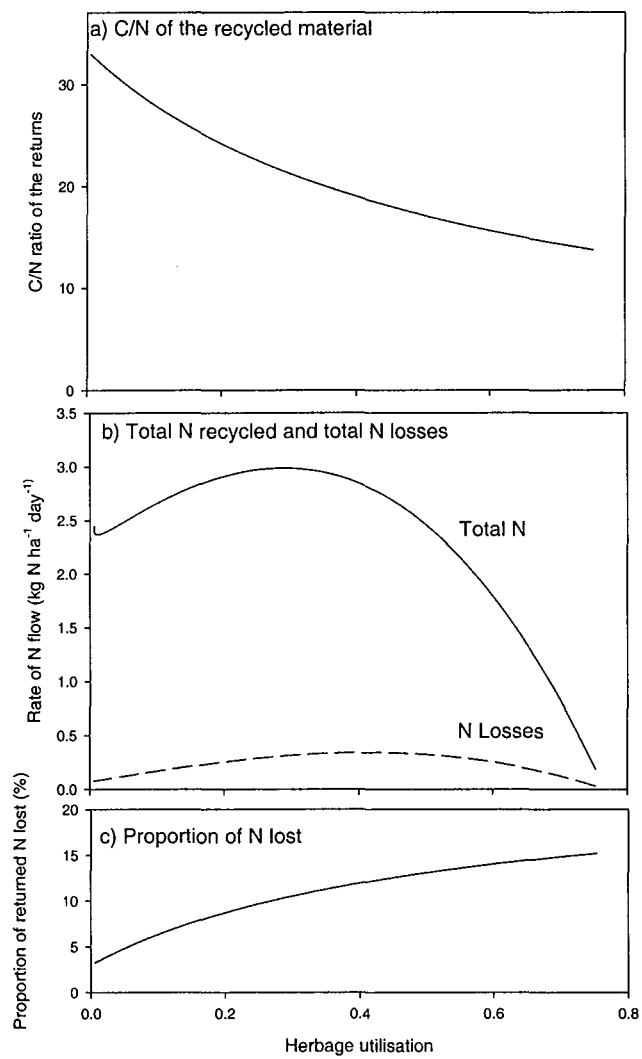

Figure 6.5: Effect of an increasing herbage utilisation by the grazers on a) the average C/N ratio of the organic matter returns, b) the total N recycled and lost from the pasture and c) the proportion of cycling N lost from the pasture.

discrepancies between grazed and ungrazed systems. Firstly, the herbage utilisation determines the relative volume of plant material returning to the soil as litter or through the grazing animals. Secondly, due to N resorption (R) during leaf senescence, the N concentration of the plant material deposited as litter is lower than the N concentration of the grazed material. Thirdly, because N is only marginally retained by grazing animals, nearly all of the ingested N is excreted in faeces or urine, their relative proportion depending on the N partitioning (P). Figure 1.4 presents a simple C cycle in a grazed pasture to highlight the fact that grazing animals “decouple” C and N cycles (compared to organic matter returns through litter) because most of the ingested C is not returned to the soil. This has major implications for the overall C/N ratio of the organic matter returned to the pasture.

6.3.2. Effects of grazing intensity on N cycling in a pasture

The most important effect of an increased grazing intensity on N cycling is to alter the form of the N returns by consistently decreasing their average C/N ratio (Fig 6.5 a). Under minimal grazing, all the N returns occur through litter deposition and therefore exhibit a maximum C/N ratio value (i.e. the one of the litter). When the proportion of grazed material increase, the overall C/N ratio of the returns continuously decreases for two reasons: the animals feed on material with higher N concentration (compared to the litter) and while most of the ingested N is returned to the soil, a great part of the ingested C is lost through respiration and methane production. Importantly, the total amount of N recycled is also greatly affected by grazing intensity. In referring to amount of N recycled, I mean all the N that is taken from the live plant pool and that is returned to the soil by whatever pathway. When going from low to intermediate herbage utilisation rates, the total amount of recycled N increases. Indeed the lower herbage biomass (and thus the smaller N pool in the herbage) induced by the lower LAI at higher utilisation rates, is more than counterbalanced by the fact that the grazed herbage pool has a higher N concentration than the herbage returning to the soil as litter. Nevertheless at even higher utilisation rates the total amount of N recycled decreases because the herbage standing biomass and associated fluxes are increasingly reduced, so limiting N cycling. Obviously, the greater the herbage utilisation by animals, the greater the proportion of cycling N that

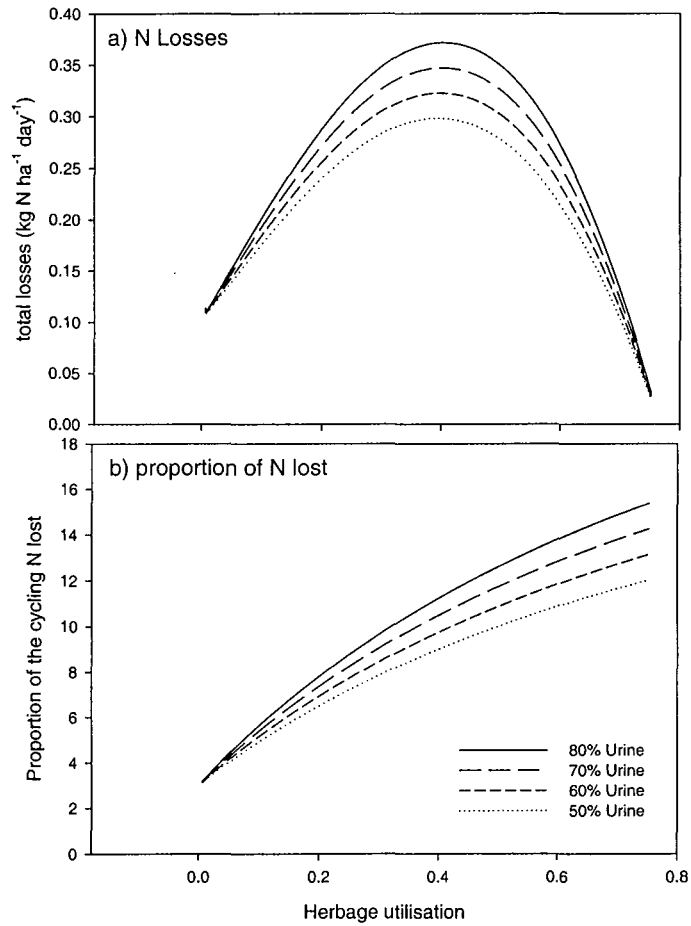

Figure 6.6: Impacts of various value of partitioning of ingested N between urine and faeces on a) total N losses from the pasture b) the proportion of recycled N lost from the pasture.

is potentially lost from the system, since animal returns, urine in particular, are highly susceptible to both volatilisation and leaching.

In summary, if we focus on the comparison between a well managed grazed grassland (with a herbage utilisation of about 0.3-0.4) and a “natural” grassland (with a very lenient defoliation management) which is the type of system used in most other CO₂ experiments (Owensby et al., 1999; Niklaus et al., 2001), it is obvious that there are numerous differences that may affect the response to elevated CO₂. The most of these are that the total amount of N cycling is greater and the overall C/N ratio of the material in which N is returned is dramatically lower. The compounding of these two processes maximises the potential for N losses from the system.

6.3.3. Possible interactions with elevated CO₂

Clearly this simple model cannot take into account the full range of effects of elevated CO₂ on N cycling. Nevertheless this tool allows me to explore some possible effects of elevated CO₂ that would not occur in an ungrazed system. In particular, Chapter 2 presented an unexpected effect of elevated CO₂: a shift in N partitioning between faeces and urine. Though this shift will leave the total amount of N cycling in the system unchanged, it will nevertheless affect the amount of N that remains in the system. Figure 6.6 indeed shows that an increased proportion of ingested N returning to the soil as urine creates greater potential for N losses, both in term of relative and absolute amounts. This is an outcome of the relatively lower potential N losses from dung than from urine (Haynes and Williams, 1993). Not only do greater N losses through volatilisation and/or leaching have a negative environmental impact, they also “unlock” the grassland N cycle under elevated CO₂ and contribute to a lower N availability for plant growth.

A second interesting outcome of this model is its response to changes in N resorption rate during senescence. It is generally accepted that elevated CO₂ does not directly affect N resorption in senescing leaves (Norby *et al.*, 2000) although a small decrease in resorption efficiency can occur in situations where the average proportion of leaf N resorbed during senescence is high (Arp *et al.*, 1997). However, changes in

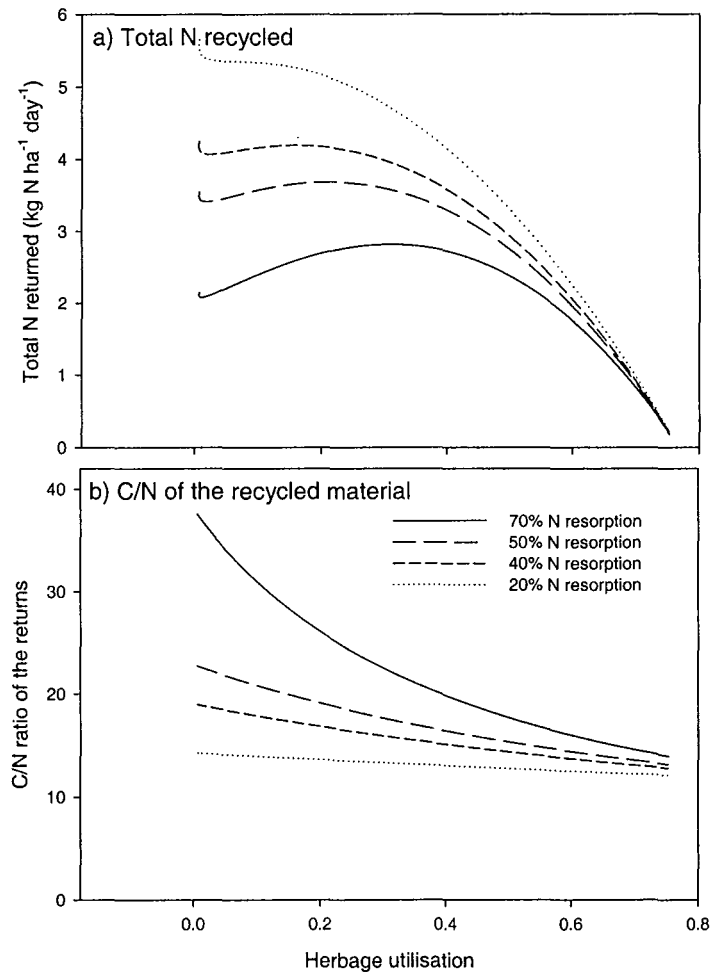

Figure 6.7: Impacts of various leaf N resorption rates on a) the total amount of N recycled in the pasture and b) the C/N ratio of the organic matter returns.

plant nutritional status or shifts in botanical composition can affect overall resorption efficiency since under low N availability plants tend to retain more N during senescence (Berendse and Aerts, 1987). Species-specific differences are also evident (Aerts, 1996). Data from Chapter 3, for example, tend to show that clover, a species that does not essentially rely on soil N availability, retains less N during senescence than grasses. Therefore an increase in the proportion of legumes under elevated CO₂ may lead to a lower resorption rate at the community scale. Fig. 6.7 shows that a lower resorption rate tends to offset the effect of increasing herbage utilisation on the C/N ratio of the returns. Indeed, with a low resorption rate the average N concentration in green herbage and litter are more similar. In relation to the total amount of N recycled, lower resorption rates increase the proportion of N that is recycled through litter and thus increase the total amount of N recycled. Nevertheless the shape of the curve defining the relationship between herbage utilisation and total N changes: at very low resorption rates total N is near maximum at a low utilisation rate and rapidly decreases driven by the negative effect of grazing pressure on herbage biomass.

Again, this conceptual model was not designed to be a predictive tool. Its only aim was to highlight the fact that N cycling (and other nutrients as well) under grazing is intrinsically different from N cycling in a cut grassland. Therefore this creates a real need for studies assessing the effects of elevated CO₂ specifically in grazed pastures. This thesis has provided a small contribution to this need but numerous key processes have not been studied. In particular the fact that animal N return is, unlike litter decomposition, a spatially heterogeneous process. Due to the deposition of faeces and urine, a pasture is a mosaic of patches ranging from very high to very low nutrient availability, creating potential for interactions not apparent when studying steady-state component processes. This possibility of complex interactions has major implications for herbage production, botanical composition and individual plant chemical composition. Because of its multiple influences on grassland processes, heterogeneity of nutrient availability is a characteristic that has a great potential to interact with elevated CO₂ (Newton *et al.*, 2001). Therefore, it seems to me that one of the great challenges of future studies dealing with elevated CO₂ and grasslands will be to understand the role of spatial heterogeneity if we are to predict more accurately the effects of elevated atmospheric CO₂ on grasslands.

6.4. References

- Aerts R (1996) Nutrient resorption from senescing leaves of perennials: are there general patterns? *Journal of Ecology*, **84**, 597-608.
- Arnone JA, Zaller JG, Spehn EM, Niklaus PA, Wells CE, Körner C (2000) Dynamics of root systems in native grasslands: effects of elevated atmospheric CO₂. *New Phytologist*, **147**, 73-85.
- Arp WJ, Kuikman PJ, Gorissen A, Cadisch G, Giller KE (1997) Climate change: the potential to affect ecosystem functions through changes in amount and quality of litter. In: *Driven by nature: plant litter quality and decomposition* (eds Cadisch G, Giller KE), pp. 187-200. CAB International, Wallingford.
- Berendse F, Aerts R (1987) Nitrogen-use-efficiency: a biologically meaningful definition? *Functional Ecology*, **1**, 293-296.
- Cardon ZG (1996) Influence of rhizodeposition under elevated CO₂ on plant nutrition and soil organic matter. *Plant and Soil*, **187**, 277-288.
- Cotrufo MF, Ineson P (1996) Elevated CO₂ reduces field decomposition rates of *Betula pendula* (Roth) leaf litter. *Oecologia*, **106**, 525-530.
- Cotrufo MF, Ineson P, Scott A (1998) Elevated CO₂ reduces the nitrogen concentration of plant tissues. *Global Change Biology*, **4**, 43-54.
- Couteaux MM, Mousseau M, Celerier ML, Bottner P (1991) Increased atmospheric CO₂ and litter quality - decomposition of sweet chestnut leaf litter with animal food webs of different complexities. *Oikos*, **61**, 54-64.
- Dukes JS, Field CB (2000) Diverse mechanisms for CO₂ effects on grassland litter decomposition. *Global Change Biology*, **6**, 145-154.
- Fitter AH, Graves JD, Wolfenden J, Self GK, Brown TK, Bogie D, Mansfield TA (1997) Root production and turnover and carbon budgets of two contrasting grasslands under ambient and elevated atmospheric carbon dioxide concentrations. *New Phytologist*, **137**, 247-255.
- Fitter AH, Self GK, Wolfenden J, van Vuuren MMI, Brown TK, Williamson L, Graves JD, Robinson D (1996) Root production and mortality under elevated atmospheric carbon dioxide. *Plant and Soil*, **187**, 299-306.
- Franck VM, Hungate BA, Chapin FS, Field CB (1997) Decomposition of litter produced under elevated CO₂ : dependence on plant species and nutrient supply. *Biogeochemistry*, **36**, 222-237.

- Haynes RJ, Williams PH (1993) Nutrient cycling and soil fertility in the grazed pasture ecosystem. *Advances in Agronomy*, **49**, 119-190.
- Körner C (2000) Biosphere responses to CO₂ enrichment. *Ecological Applications*, **10**, 1590-1619.
- Körner C, Diemer M, Schappi B, Niklaus P, Arnone J (1997) The responses of alpine grassland to four seasons of CO₂ enrichment: a synthesis. *Acta Oecologica-International Journal of Ecology*, **18**, 165-175.
- Leadley PW, Niklaus PA, Stocker R, Körner C (1999) A field study of the effects of elevated CO₂ on plant biomass and community structure in a calcareous grassland. *Oecologia*, **118**, 39-49.
- Lekkerkerk LJA, van de Geijn SC, van Veen JA (1990) Effects of elevated atmospheric CO₂ levels on the carbon economy of a soil planted with wheat. In: *Soils and the Greenhouse Effect* (ed Bouwman AF), pp. 423-429. John Wiley and Sons, Chichester.
- Newton PCD, Clark H, Edwards GE (2001) The effects of elevated atmospheric CO₂ on grazed grasslands. In: *Structure and Function of Agroecosystem Design and Management* (eds Shiyomi M, Koizumi H), pp. 297-311. CRC Press, Boca Raton..
- Newton PCD, Clark H, Bell CC, Glasgow EM (1996) Interaction of soil moisture and elevated CO₂ on the above-ground growth rate, root length density and gas exchange of turves from temperate pasture. *Journal of Experimental Botany*, **47**, 771-779.
- Newton PCD, Clark H, Bell CC, Glasgow EM, Campbell BD (1994) Effects of elevated CO₂ and simulated seasonal changes in temperature on the species composition and growth rates of pastures turves. *Annals of Botany*, **73**, 53-59.
- Niklaus PA (1998) Effects of elevated atmospheric CO₂ on soil microbiota in calcareous grassland. *Global Change Biology*, **4**, 451-458.
- Niklaus PA, Wohlfender M, Siegwolf R, Korner C (2001) Effects of six years atmospheric CO₂ enrichment on plant, soil and soil microbial C of a calcareous grassland. *Plant and Soil*, **233**, 189-202.
- Norby RJ, Cotrufo MF (1998) A question of litter quality. *Nature*, **396**, 17-18.
- Norby RJ, Long TM, Hartz Rubin JS, O'Neill EG (2000) Nitrogen resorption in senescing tree leaves in a warmer, CO₂ -enriched atmosphere. *Plant and Soil*, **224**, 15-29.

- Owensby CE, Ham JM, Knapp AK, Auen LM (1999) Biomass production and species composition change in a tallgrass prairie ecosystem after long-term exposure to elevated atmospheric CO₂. *Global Change Biology*, **5**, 497-506.
- Parsons AJ, Leafe EL, Collett B, Penning PD, Lewis J (1983) The physiology of grass production under grazing. II. Photosynthesis, crop growth and animal intake of continuously grazed swards. *Journal of Applied Ecology*, **20**, 127-139.
- Ross DJ, Newton PCD, Tate KR (2003) Elevated CO₂ effects on soil carbon and nitrogen pools and mineralization in a species-rich, grazed pasture on a seasonally dry sand. *Plant and Soil*, in press.
- Sindhøj E, Hansson AC, Andren O, Katterer T, Marissink M, Pettersson R (2000) Root dynamics in a semi-natural grassland in relation to atmospheric carbon dioxide enrichment, soil water and shoot biomass. *Plant and Soil*, **223**, 253-263.
- Smith JS, Paul EA (1990) The significance of soil microbial biomass estimations. In: *Soil Biochemistry, Volume 6* (eds Bollag M, Stotzky G), pp. 357-369. Marcel Dekker, New York.
- Stocker R, Körner C, Schmid B, Niklaus PA, Leadley PW (1999) A field study of the effects of elevated CO₂ and plant species diversity on ecosystem-level gas exchange in a planted calcareous grassland. *Global Change Biology*, **5**, 95-105.
- Strain BR, Bazzaz FA (1983) Terrestrial plant communities. In: *CO₂ and Plants* (ed Lemon ER), pp. 177-222. Westview, Boulder.
- Thornley JHM (1998) *Grassland Dynamics: an Ecosystem Simulation Model*. CAB International, Wallingford, 241pp.
- Wardle DA (2002) *Communities and ecosystems: linking the aboveground and belowground components*. Princeton University Press, Princeton, 400 pp.
- Wardle DA, Barker GM, Yeates GW, Bonner KI, Ghani A (2001) Introduced browsing mammals in natural New Zealand forests: aboveground and belowground consequences. *Ecological Monographs*, **71**, 587-614.
- Yeates G, Newton PCD, Ross DJ (2003) Significant changes in soil microfauna in grazed pasture under elevated carbon dioxide. *Biology and Fertility of Soils*, **38**, 319-326.
- Zak DR, Pregitzer KS, Curtis PS, Teeri JA, Fogel R, Randlett DL (1993) Elevated Atmospheric CO₂ and Feedback Between Carbon and Nitrogen Cycles. *Plant and Soil*, **151**, 105-117.

Appendix

Appendix 1: Abstract of the talk presented at the 2002 “Journées d’Ecologie Fonctionnelle” meeting, Gourdon, France. March 2002.

Stimulation de la croissance et du turnover racinaire d’espèces prairiales par l’augmentation de la [CO₂]

Allard, V. et Newton P.C.D.

Dans le contexte actuel de changement climatique et plus particulièrement de l’augmentation de la concentration en CO₂ atmosphérique ([CO₂]_a), une des questions centrales relatives à l’étude des écosystème terrestres sous [CO₂]_a enrichi, est leur capacité ou non à stocker dans les sols le flux de carbone supplémentaire créé par la stimulation de l’activité photosynthétique des couverts végétaux. En plus de leur importance économique majeure, les écosystèmes prairiaux ont la particularité d’associer dans leurs sols des stocks importants et un turnover rapide de matière organique ce qui en fait un système particulièrement sensible à un changement de quantité ou qualité de la matière organique entrant dans le système.

Afin de quantifier l’effet de l’élévation en [CO₂]_a sur ces flux de matière organique vers le sol, nous nous sommes concentrés sur l’étude de la croissance et du turnover racinaire d’espèces dominantes dans le système étudié, ce compartiment étant primordial quantitativement sous prairie pâturée mais aussi particulièrement sensible à l’élévation de la [CO₂]_a. Cette étude a été menée dans une prairie pâturée tempérée pourvue d’un système FACE (Free Air CO₂ Enrichment) à Palmerston North, Nouvelle-Zélande. Le dispositif consiste en 6 anneaux (Ø = 12 m), trois desquels étant enrichis en CO₂ (valeur cible 475 ppm), les trois autres laissés à concentration ambiante (≅ 370 ppm). La croissance racinaire mesurée par la méthode des « ingrowth cores » est stimulée de plus de 30% par l’élévation de la [CO₂]_a. De plus une estimation du temps de résidence des racines vivantes montre que celui-ci est diminué de près de 50 % par le CO₂. De ce fait, le flux de matière organique quittant le compartiment « racines vivantes » et rejoignant la matière organique du sol est stimulé de l’ordre de 80% ce qui représente un flux supplémentaire de matière sèche d’environ 1.1 t par hectare et par an. L’élévation de la [CO₂]_a crée donc une forte augmentation des entrées de matière organique dans les sols prairiaux, ce qui peut potentiellement modifier fortement les cycles du C et de l’N dans le sol. Des mesures concernant la qualité et la dégradabilité des racines sont en cours et sont nécessaires pour conclure à une éventuelle capacité de ces sols à stocker cet excès de C.

Appendix 2: Abstract of the talk presented at the 19th European Grassland Federation meeting, La Rochelle, France. June 2002.

Interactions between grazing by ruminants and elevated CO₂ on nutrient cycling in pastures.

V. Allard and P. C. D. Newton

Abstract

In a New Zealand temperate grazed pasture currently exposed to either ambient air or air enriched to 475 $\mu\text{l l}^{-1}$ CO₂ using a Free Air CO₂ Enrichment (FACE) technology, the pattern of nitrogen (N) return through sheep has been investigated. We show here that changes in the composition of the diet of ruminants at elevated CO₂ result in a different partitioning of N in the nutrient returned which could create a greater potential for N losses from grazed pasture in a high CO₂ world.

Keywords: elevated CO₂, N cycling, grazed pasture, faeces, urine

Introduction

It has often been hypothesised that the fertilisation effect of elevated CO₂ for plant communities may be buffered in the long term by a decrease in litter quality. It now seems that these changes are too small to consistently alter decomposition processes (Norby and Cotrufo, 1998). In grazed pastures about 40% of the N return to the system occurs through ruminant excreta so any CO₂-induced changes in faeces chemical composition and urine N concentration are likely to strongly affect N cycling at the pasture scale.

Materials and methods

This study was conducted during summer 2000 in a FACE experiment located in a temperate grazed pasture in Bulls, New Zealand. The facility consists of 6 experimental units (12 m diameter "rings"), three of them were enriched with CO₂ (475 $\mu\text{l l}^{-1}$) since October 1997 while the other three were kept at ambient CO₂ concentrations (see Edwards *et al.*, 2001 for details). Each ring is fenced off in order to control the timing and duration of the grazing by sheep. Five sheep were allowed to graze for 24 hours successively in each ring, firstly in the three ambient, then in three elevated ones. Dung was sampled using dung bags on the last day of grazing in each treatment (day 3 and 6). Dung subsamples were placed in nylon bags and returned to the rings to determine *in situ* decomposition rates. A crossover design was used to test potential direct CO₂ effects on decomposition. Prior to and after the grazing, the herbage was dissected for botanical composition determination and was analysed for chemical composition by NIR. Chemical composition of the dung samples was determined by wet chemistry analysis.

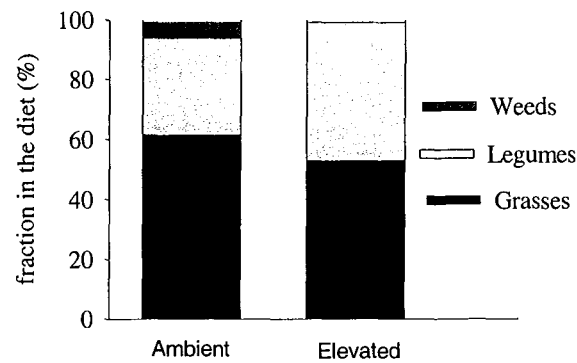

Figure 1: Contribution of three functional groups to the total dry matter intake by the sheep in ambient and elevated plots.

Results and discussion

The botanical composition of the grazed herbage was significantly different between the two treatments (Figure 1). At the single species scale, elevated CO_2 significantly decreased the leaf N concentration (Figure 2). This buffered the increase in legume content and as a result the N concentration of the ingested feed was similar in the two treatments (2.67% N in average). The digestibility of the herbage from the enriched plots was higher (76%) than from the ambient (74%), which is consistent with the higher proportion of legumes. The nitrogen content of the dung produced when sheep were grazing in high CO_2 rings was significantly lower (3.1%) than from the low CO_2 rings (3.5%) which induced a significant decrease in dung decomposition rate (Figure 3) during the first month of decomposition. The proportion of dietary N present in urine was higher when sheep were fed on high CO_2 herbage (72% against 66%). The same pattern was found in a subsequent experiment, which showed significantly greater N concentration in urine (+ 104%) from sheep grazing elevated CO_2 rings.

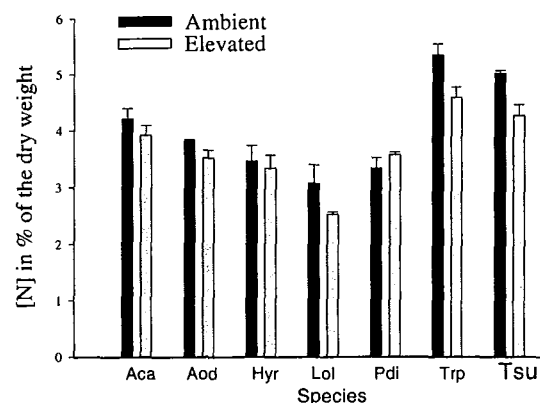

Figure 2: Leaf N concentration (in % of N in the dry matter) of seven dominant species in ambient and elevated plots.

Conclusion and perspectives

Under our experimental conditions, elevated CO_2 induced a modification of the dietary N partitioning between faeces and urine. Since the absolute N intake was unaltered by elevated CO_2 despite the botanical composition changes, this modification may be induced by complex interactions between herbage N digestibility (protein type) and carbon pools quality (Beever, 1993). This can potentially strongly affect N cycling at the pasture scale since a slower dung decomposition under elevated CO_2 would contribute to an increased N immobilisation in the soil organic

matter pool. In addition the increase in N concentration in the urine at elevated CO₂ might well result in greater N loss through volatilisation and leaching.

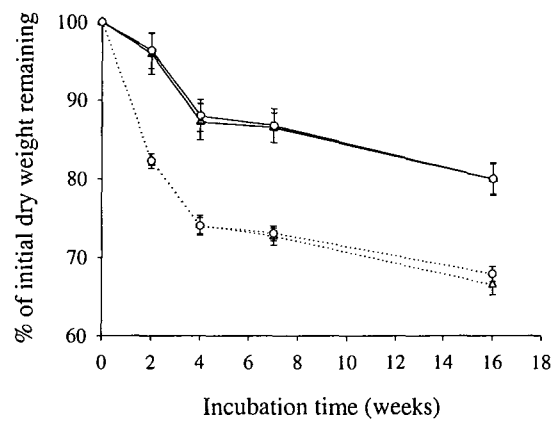

Figure 3: Decomposition (in % of the initial DW remaining) of faeces produced by sheep, which have been grazing in ambient (....) and enriched (—) submitted to either ambient (◻) or enriched (○) atmosphere during decomposition.

References

- Beever, D.E. (1993) Ruminant animal production from forages: present position and future opportunities. Proceedings of the XVII International Grassland Congress 535-542.
- Edwards, G.R., Newton, P.C.D., Tilbrook, J.C. and Clark, H. (2001) Seedling performance of pasture species under elevated CO₂. *New Phytologist* 150: 359-369.
- Norby, J. and Cotrufo, M.F. (1998) A question of litter quality. *Nature* 396: 17-18.

Appendix 3: Poster presented at the 2003 “Journées d’Ecologie Fonctionnelle” meeting, Nancy, France. March 2003. (*See next page*)

Allard V.¹, Montpied P.², Robin C.¹, Dreyer E.², Soussana J.-F.⁴, Grieu P.³ et Guckert A.¹

¹ U.M.R. INRA-INPL(ENSAIA) Agronomie et Environnement Nancy-Colmar, BP 172, 54505 Vandoeuvre lès Nancy cedex, France, e-mail: vincent.allard@ensaia.inpl-nancy.fr

² UMR INRA-UHP, Ecologie et ecophysiologie forestière 54 280 Champenoux

³ ENSAT - Avenue de l'Agrobiopole - BP 107 Auzville-Tolosane 31326 Castanet-Tolosan Cedex

⁴ INRA-Agronomie, Fonctionnement et Gestion de l'Ecosystème prairial 234 av. du Brezet, 63000 Clermont-Fd

Objectifs

Le CO₂ étant le substrat primaire de la photosynthèse chez les végétaux, son augmentation dans l'atmosphère du fait de la combustion d'énergies fossiles favorise l'assimilation de carbone par les plantes. Cependant les ressources en autres nutriments, en particulier en azote restant limitées, certaines plantes réduisent leur capacité photosynthétique en allouant leur nutriments vers d'autres compartiments métaboliques. On parle d'acclimation de la photosynthèse. Dans des écosystèmes naturels tels que des prairies, soumis à un enrichissement en CO₂ de longue durée, des rétroactions complexes peuvent aussi opérer si, par exemple, la disponibilité en minéraux du sol est affectée par l'élévation en CO₂. Notre objectif est donc de comparer les effets long-terme du CO₂ (via le sol) et court-terme (agissant directement sur la plante) sur l'activité photosynthétique des plantes afin de pouvoir prédire plus finement le comportement de ces dernières sous des climats futurs.

Méthodologie

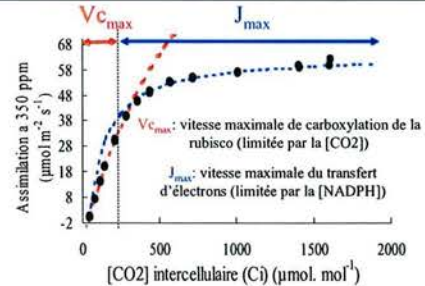
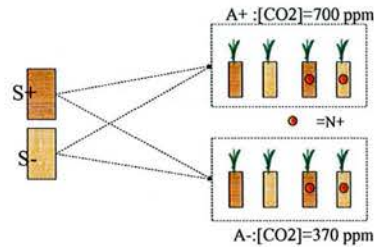

1) En Nouvelle-Zélande une prairie est soumise à un enrichissement en CO₂ depuis 5 ans. Du sol de parcelles ambiantes (S-) ou enrichies en CO₂ (S+) est prélevé.

2) Mise en culture du sol S+ ou S- avec une graminée (*Lolium perenne*) sous serre à atmosphère ambiante (A-) ou enrichie (A+) en CO₂. Deux niveaux de fertilisation azotée ont aussi été appliqués: 100 UN (N+) ou 5 UN (N-)

3) Après 3 mois de croissance, l'assimilation de CO₂ est mesurée pour une gamme de concentration en CO₂. Ces données sont ensuite ajustées au modèle photosynthétique de Farquhar qui fournit les variables V_cmax et J_{max}.

Résultats

	A-	A+
Assim à 350ppm (µmol.m ⁻² .s ⁻¹)	26.7	21.0
Vcmax (µmol.m ⁻² .s ⁻¹)	97.7	78.5
Jmax (µmol.m ⁻² .s ⁻¹)	220.9	170.8

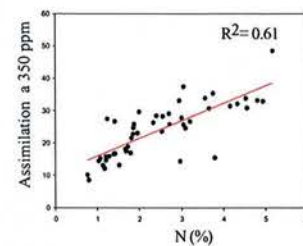
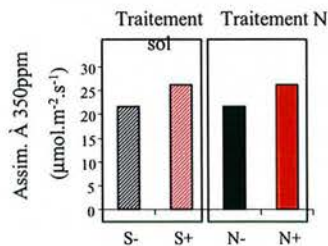

1) Les plantes ayant eu une croissance sous atmosphère enrichie en CO₂ expriment des paramètres photosynthétiques plus faibles. Notamment, l'assimilation à atmosphère ambiante est réduite de 20%. Il y a donc acclimation de la photosynthèse.

2) Cependant, l'effet «sol» que l'on assimile à un effet long terme du CO₂ induit une augmentation de l'assimilation mesurée sous atmosphère ambiante. Cette augmentation est de même ampleur que celle induite par la fertilisation azotée. Les traitements S+ et N+ gomment donc en partie l'acclimation induite par le traitement A+.

3) Tous traitements confondus, l'assimilation mesurée à atmosphère ambiante est corrélée fortement à la teneur en azote des feuilles. Nous faisons donc l'hypothèse que le traitement S+ favorise le maintien de la teneur en azote foliaire.

Conclusion

L'acclimation négative de la photosynthèse que l'on observe sur les plantes exposées à une atmosphère enrichie en CO₂ est tempérée sur sol ayant été lui-même exposé à un enrichissement en CO₂. Cet effet positif du sol enrichi semble être lié à une fourniture d'azote plus grande. Cette étude met donc l'accent sur la nécessité de travailler sur des systèmes couvert/sol si l'on veut prédire la réponse des écosystèmes terrestres au changement climatique.

Appendix 4: Poster presented by Gregor Yeates at British Ecological Society Annual Symposium “Biological Diversity and Function in Soils” March 2003, Lancaster University, England. (*See next page*)

Elevated carbon dioxide has marked effect on soil microfauna under grazed pasture on sand



Gregor W. Yeates
Landcare Research
yeatesg@landcareresearch.co.nz

Paul C. D. Newton
AgResearch
Paul.Newton@agresearch.co.nz

Vincent Allard
AgResearch
Vincent.Allard@agresearch.co.nz

Table 1. Mean abundance (m² in 0–10 cm soil) of soil microfauna under grazed pasture growing under ambient or elevated CO₂. (Quarterly sampling of three FACE rings per treatment)

Group	Ambient CO ₂	Elevated CO ₂	Ratio elevated: ambient	CO ₂ effect (ANOVA)
Nematodes	4 379 200	6 367 000	1.45	<0.0001
Enchytraeids	40 100	29 200	0.73	0.060
Rotifers	12 000	49 000	4.08	0.027

Table 2. Mean populations (m² in 0–10 cm soil) of various nematodes under grazed pasture growing under ambient or elevated CO₂

Group	Ambient CO ₂	Elevated CO ₂	Ratio elevated: ambient	CO ₂ effect (ANOVA)
<i>Tylenchus</i>	459 000	691 900	1.51	0.002
<i>Aphelenchus</i>	63 800	129 000	2.02	<0.0001
<i>Panagrolaimus</i>	223 600	373 000	1.67	0.023
<i>Cervidellus</i>	37 800	15 000	0.40	0.017
<i>Labronema</i>	30 300	117 500	3.88	0.005
<i>Aporcelaimus</i>	428 700	747 800	1.74	0.002
<i>Longidorus</i>	93 300	397 900	4.26	<0.0001
<i>Dorylaimellus</i>	139 100	295 800	2.13	0.007
<i>Tylencholaimus</i>	136 700	247 600	1.81	0.022
<i>Clarkus</i>	53 600	151 700	2.83	0.010
<i>Alaimus</i>	72 900	148 200	2.03	0.020
<i>Diphtherophora</i>	15 300	22 800	1.49	0.012

Table 3. Mean abundance of nematode feeding groups (m² in 0–10 cm soil) under grazed pasture growing under ambient or elevated CO₂

Group	Ambient CO ₂	Elevated CO ₂	Ratio elevated: ambient	CO ₂ effect (ANOVA)
Bacterial-feeding	1 520 000	1 930 000	1.27	0.0006
Fungal-feeding	303 000	477 000	1.57	0.002
Plant-feeding	990 000	1 307 000	1.32	0.016
Plant-associated	961 000	1 457 000	1.52	0.004
Omnivorous	515 000	1 013 000	1.97	0.0004
Predacious	91 000	186 100	2.05	0.046

Table 4. Root biomass, growth rates and residence times

Group	Period	Ambient CO ₂	Elevated CO ₂	CO ₂ effect (%)
Standing root biomass (g m ⁻²)	2 July	49.6	39.1	-21.2
Root growth (g day ⁻¹ m ⁻²)	2 Jul–30 Aug	0.849	1.037	22.1
	30 Aug–5 Nov	1.072	1.475	37.6
Residence time (day ⁻¹) (=standing biomass/growth)	2 Jul–30 Aug	58.4	37.7	-35.4
	30 Aug–5 Nov	46.3	26.5	-42.7

introduction

Increasing levels of atmospheric CO₂ affect plant tissue quality and its decomposition. To assess long-term implications we need to understand impacts of elevated CO₂ on soil processes. Free-air CO₂ enrichment (FACE) technology allows us to manipulate CO₂. A FACE array in a pasture permits alteration of most labile soil organic matter in a few years. Assessing the mechanisms underlying such changes is also critical in predicting responses in plant growth and below-ground carbon storage.

methods

- >30-year-old-pasture on Pukepuke black sand
- 6 rings, each 12 m in diameter
- 3 ambient controls (360 µl CO₂ l⁻¹)
- 3 enriched rings maintained at 475 µl CO₂ l⁻¹ (during photoperiod) since October 1997
- Baseline nematode samples collected from each ring in May 1997; 'equilibrated' samples collected May, August, November 2001, February 2002
- 5 samples per ring collected each time from 0–10 cm soil depth
- Soil nematodes extracted using the tray method
- Root growth measured in ingrowth cores

results

- We found significantly more (1.45×) nematodes in the elevated CO₂ pasture rings than in the ambient control rings after enrichment (Table 1). Rotifers also increased (4.08×) but enchytraeids were depressed
- Eleven of 21 abundant nematode taxa had significantly higher populations in rings under elevated CO₂ (Table 2). Only the bacterial-feeding *Cervidellus* had a lower abundance m⁻² under elevated CO₂
- The greatest nematode response to elevated CO₂ was by the root-feeding *Longidorus elongatus* (Figure 1). Its mean population increased from 87 to 372 per 100 g soil (4.26×) (Table 2)
- The greatest response of bacterial-feeding nematodes was a 2.03× increase in *Alaimus*. *Alaimus* was the only nematode to show a significant, positive response in related growth chamber experiments. It may feed on dissolved organic matter
- The abundance of each of the six nematode feeding groups showed a significant, positive response to elevated CO₂ (Table 3). These responses differ with trophic level
- Root mass was 21% lower under elevated CO₂ but root growth rate 22–37% greater. Thus root turnover was greater (i.e. residence time was lower) (Table 4)
- There was no consistent herbage response to elevated CO₂ [see Box A]
- Other responses to elevated CO₂ found in these FACE rings include
 - unchanged microbial biomass C and N contents
 - increased earthworm abundance and biomass [see Box A]

conclusions

- Increase of atmospheric CO₂ from ambient to 475 µl l⁻¹ was associated with significant changes in the soil fauna
- The 4.27× increase in the root-feeding nematode *Longidorus* was associated with increased root turnover under elevated CO₂. This suggests a significant increase in the partitioning of photosynthate below-ground
- The unchanged soil microbial biomass and doubling of populations of omnivorous and predacious nematodes suggest a multitrophic response in CO₂ and greater fluxes through soil biota
- Better understanding of plant-microbial-microfaunal interactions in soil is necessary. Until the processes are better understood, the impact of increasing atmospheric CO₂ levels on net plant productivity and carbon sequestration in soils cannot be evaluated

Acknowledgements – This work was funded by the New Zealand Foundation for Research, Science and Technology. We are grateful to Harry Clark and others who manage the FACE facility. Des Ross supplied soil microbial biomass data.

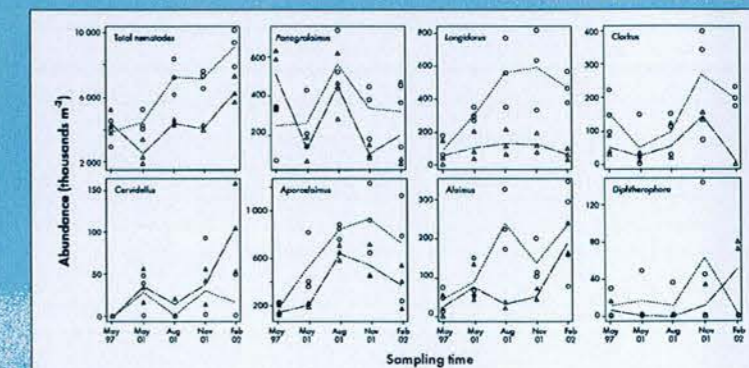
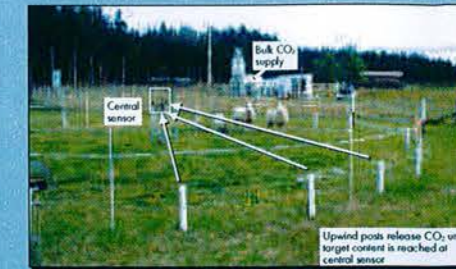

Figure 1. Abundance of total nematodes and selected genera in grazed pasture of FACE rings under ambient (Δ) and elevated (○) CO₂ regimes. The May 1997 samples are pre-treatment; the CO₂ treatment commenced in October 1997; values for individual rings as well as the treatment means are shown.

Properties of soil microbial biomass. Soil microbial C and N concentrations in 0–10 cm soil under ambient or elevated CO₂ (August 2001).

Property	Ambient	Elevated CO ₂
Microbial C (mg kg ⁻¹)	868	838
Microbial N (mg kg ⁻¹)	105	106

Populations of earthworms under grazed pasture growing under ambient or elevated CO₂ (September 2000).

	Ambient	Elevated CO ₂	
Total Lumbricidae	Individuals m ⁻²	463	615
	Biomass g m ⁻²	127	162
<i>Aporrectodea caliginosa</i>	Individuals m ⁻²	3.57	4.48
	Biomass g m ⁻²	94	106
<i>Lumbricus rubellus</i>	Individuals m ⁻²	106	167
	Biomass g m ⁻²	33	56

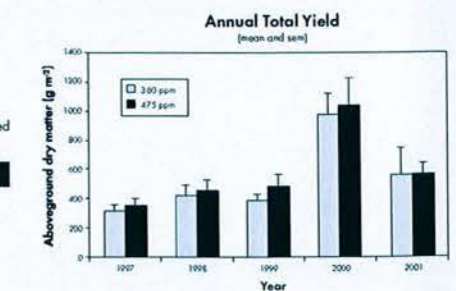

Service Commun de la Documentation
INPL
Nancy-Brabois

**AUTORISATION DE SOUTENANCE DE THESE
DU DOCTORAT DE L'INSTITUT NATIONAL
POLYTECHNIQUE DE LORRAINE**

000

VU LES RAPPORTS ETABLIS PAR

Monsieur Gilles LEMAIRE, Directeur de Recherche, INRA, Lusignan

Monsieur Tim CLOUGH, Directeur de Recherche, Université de Canterbury, Nouvelle-Zélande

Le Président de l'Institut National Polytechnique de Lorraine, autorise :

Monsieur ALLARD Vincent

à soutenir devant un jury de l'INSTITUT NATIONAL POLYTECHNIQUE DE LORRAINE,
une thèse intitulée :

**« Effets de l'élévation de la concentration en CO₂ atmosphérique sur les flux de carbone
et d'azote en prairie pâturée »**

en vue de l'obtention du titre de :

DOCTEUR DE L'INSTITUT NATIONAL POLYTECHNIQUE DE LORRAINE

Spécialité : **« Sciences agronomiques »**

Fait à Vandoeuvre, le 27 novembre 2008

Le Président de l'I.N.P.L.,

L. SCHUFFENECKER

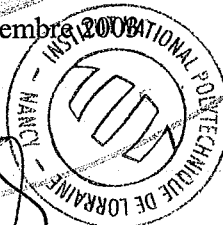

NANCY BRABOI
2, AVENUE DE L.
FORET-DE-HAY
BOITE POSTALE
F - 5450
VANDOEUVRE CEDE

Abstract: Predicting the response of grazed grasslands to elevated CO₂ is of central importance in global change research as grasslands represent 20% of the world's land area and grassland soils are a major sink for carbon (C). Grasslands responses to elevated CO₂ are strongly controlled by the availability of other nutrients and nitrogen (N) in particular. There have been many previous studies of N cycling in grasslands exposed to elevated CO₂ but none of these experiments were grazed. In this thesis I present data on CO₂ effects on N cycling from an experimental system (FACE: Free Air Carbon dioxide Enrichment) that enabled grazing to be included. The thesis focuses on the effects of elevated CO₂ on the different processes involved in organic matter (OM) returns from the plant to the soil and the consequences for N availability. In Chapter 1, it was shown that elevated CO₂ modified N returns by grazing animals by altering the partitioning of N between faeces and urine creating a potential for enhanced N losses at elevated CO₂. Plant litter decomposition rates were, at the ecosystem scale, not affected by elevated CO₂ (Chapter 3), but a marked increase in the organic matter fluxes, from roots, led to an accumulation of coarse OM in the soil (Chapter 4). In Chapter 5, using ¹⁴C and ¹⁵N labelling, I compared short-term (plant mediated) and long-term (soil mediated) effects of elevated CO₂ on soil OM dynamics and concluded that soil OM accumulation under elevated CO₂ was not caused by C or N limitation but probably by the availability of other nutrients. The thesis demonstrates that the inclusion of grazing animals can strongly modify N cycling under elevated CO₂. As most grasslands are grazed, the prediction of grassland responses to elevated CO₂ must be derived from systems in which animals are an integral part.

Résumé : Prédire la réponse des prairies pâturées à une élévation de la concentration en CO₂ revêt une importance majeure dans la mesure où cet écosystème représente environ 20% de la surface terrestre non immergée mais aussi, parce que les sols prairiaux représentent un puit majeur de carbone (C). La réponse des prairies à un enrichissement en CO₂ est fortement contrôlée par la disponibilité des autres nutriments et en particulier l'azote (N). De nombreuses expériences ont par le passé étudié le cycle de l'azote en prairie sous CO₂ enrichi mais aucune de ces études n'a inclus le pâturage. Dans le cadre de cette thèse, je présente des données concernant les effets du CO₂ sur le cycle de l'N provenant d'un système expérimental (FACE: enrichissement en dioxyde de carbone à l'air libre) permettant d'inclure des ruminants. Cette thèse est dédiée à l'étude des effets de l'élévation en CO₂ sur les différents processus impliqués dans les retours de matière organique (MO) de la plante vers le sol et leurs conséquences pour la disponibilité en N. Dans le Chapitre 1, il a été montré que le CO₂ pouvait modifier les retours d'N par les ruminants en affectant la partition d'N entre l'urine et les fèces, ce qui induisait des pertes d'N potentiellement accrues. La décomposition de la litière végétale, considérée à l'échelle de l'écosystème, n'a pas été affectée par le CO₂ (Chapitre 3) mais une forte augmentation du volume de MO retournant au sol depuis les racines a induit une accumulation de MO grossière dans le sol (Chapitre 4). Au cours du Chapitre 5, à l'aide d'un double marquage isotopique ¹⁴C et ¹⁵N, nous avons comparé les effets court terme (transmis par la plante) et long terme (transmis par le sol) du CO₂ sur la dynamique de la MO du sol et il a été conclu que l'accumulation de MO n'était pas causée par une limitation en C ou en N mais probablement par la disponibilité en autres nutriments. Cette thèse démontre que l'inclusion des ruminants peut fortement modifier la réponse des prairies au CO₂. Dans la mesure où ce mode d'utilisation des pâtures est largement majoritaire, prédire les réponses des pâtures à un enrichissement en CO₂ doit provenir de systèmes où les ruminants sont partie intégrante.