



**HAL**  
open science

# Combination of the biological and the photocatalytic methods in the process of municipal landfill leachate treatment :

Jaroslav Wiszniowski

► **To cite this version:**

Jaroslav Wiszniowski. Combination of the biological and the photocatalytic methods in the process of municipal landfill leachate treatment :. Autre. Université Paul Verlaine - Metz, 2004. Français. NNT : 2004METZ022S . tel-01750204

**HAL Id: tel-01750204**

**<https://hal.univ-lorraine.fr/tel-01750204v1>**

Submitted on 29 Mar 2018

**HAL** is a multi-disciplinary open access archive for the deposit and dissemination of scientific research documents, whether they are published or not. The documents may come from teaching and research institutions in France or abroad, or from public or private research centers.

L'archive ouverte pluridisciplinaire **HAL**, est destinée au dépôt et à la diffusion de documents scientifiques de niveau recherche, publiés ou non, émanant des établissements d'enseignement et de recherche français ou étrangers, des laboratoires publics ou privés.



## AVERTISSEMENT

Ce document est le fruit d'un long travail approuvé par le jury de soutenance et mis à disposition de l'ensemble de la communauté universitaire élargie.

Il est soumis à la propriété intellectuelle de l'auteur. Ceci implique une obligation de citation et de référencement lors de l'utilisation de ce document.

D'autre part, toute contrefaçon, plagiat, reproduction illicite encourt une poursuite pénale.

Contact : [ddoc-theses-contact@univ-lorraine.fr](mailto:ddoc-theses-contact@univ-lorraine.fr)

## LIENS

Code de la Propriété Intellectuelle. articles L 122. 4

Code de la Propriété Intellectuelle. articles L 335.2- L 335.10

[http://www.cfcopies.com/V2/leg/leg\\_droi.php](http://www.cfcopies.com/V2/leg/leg_droi.php)

<http://www.culture.gouv.fr/culture/infos-pratiques/droits/protection.htm>

**COMBINATION OF THE BIOLOGICAL AND THE  
PHOTOCATALYTIC METHODS IN THE PROCESS OF MUNICIPAL  
LANDFILL LEACHATE TREATMENT**

by

**Jarosław Wiszniowski**

Thesis submitted to:

University of Metz (France), UM

and

Silesian University of Technology (Poland), SUT

In fulfillment of the requirements for the degree of:

**DOCTOR OF PHILOSOPHY  
OF SILESIAN UNIVERSITY OF TECHNOLOGY  
AND  
UNIVERSITY OF METZ**

**Jury (examination board)**

Ph. D. D. Sc. Claire Richard (reviewer)

Prof. Ph. D., D. Sc. Michał Bodzek (reviewer)

Prof. Ph. D., D. Sc. Korneliusz Miksch (supervisor)

Prof. Ph. D., D. Sc. Jean-Victor Weber (supervisor)

Ph. D., D. Sc. Joanna Surmacz-Górska

Ph. D., D. Sc. Didier Robert

SUT, Gliwice 2004

BIBLIOTEKA UM -1027	
N° inv.	2004 0655
Octe	S/M <sub>3</sub> 04/22
Loc	

**ABSTRACT**

The research was devoted to the study and development approach of a new detoxification technique that combines photocatalytic and biological processes for the treatment of non-biodegradable organics as well as efficient N removal from the landfill effluents.

The humic acid was used as model compound of non-biodegradable organics present in mature and stabilised landfill leachates. One of the important issues in the photocatalytic process is the adsorption of the organic compound on the surface of the semiconductor. The effect of pH and inorganic salts such as  $\text{NaHCO}_3$ ,  $\text{NaCl}$ ,  $\text{Na}_2\text{SO}_4$ ,  $\text{Na}_2\text{HPO}_4$  (so-called inorganic matrix) commonly found in leachates on adsorption and photoreactivity of HAs were assessed.

The research were carried out at laboratory scale in Solar Box fitted with Xenon lamp (LCA –France) and confirmed at pilot scale using non-concentrating (CPC) collectors under solar radiation at Pataforma Solar de Almería (PSA) in Spain. The photocatalytic process ( $\text{UV}/\text{TiO}_2$ ) has proved to be effective for the decolourisation as well as mineralization of humic acids solution amounting to 100 ppm. The results obtained at both scales were very encouraging and the influence of the main parameters (such as catalyst concentration, pH, matrix effect) governing photocatalytic mineralization of humic acids was determined. It was suggested that the solar photocatalysis for HA- rich waters in good insolation region could become economically competitive for conventionally applied methods such as coagulation/flocculation/filtration, ionic exchange or membrane filtration. Moreover, it was found that biodegradability of refractory organic substances such as HAs increases with irradiation time, which is of great importance in the case of the application of physicochemical-biological coupled system to wastewater treatment.

In work, the efficiency of two different biological systems based on attached growth microorganisms used for biological oxidation treatment of organics as well as nitrogen removal from landfill leachate was reported. Both tested systems were efficient in degradation of a large fraction of the soluble organic matter from the leachate, but a significant amount of remaining COD, mainly humic like substance was present in effluent. Consequently, it was indicated that the removal of the residual COD fraction responsible for the specific yellow-brown colour is needed in order to meet discharge standards. The systems were successful in removing high nitrogen concentrations by means of nitrification/denitrification, but an external carbon source for enhancing denitrification was required.

The fifth chapter of the thesis refers to the study of photocatalytic degradation of refractory organic remaining in the biological pre-treated leachate. Two photocatalytic systems using different irradiation sources, i.e. Xe-lamp and Hg-medium pressure lamp, have been compared. The effect of inorganic matrix and catalyst dose on photocatalytic mineralization of organic and decolourization of leachate was determined.

At the same time it was observed that biodegradability (BOD/COD) increased in the leachate with reaction time. Moreover, the feasibility of post-biological treatment of organics remaining after photocatalytic stage was confirmed.

The last part of the thesis gives conclusions drawn from the present works. Additionally, it presents prospects for research including proposal of a combined photocatalytic/physical and biological method in the integrated system to treat stabilised leachate from municipal landfill.

## **ACKNOWLEDGMENTS**

The main part of the present work was carried out within the confines of the agreement n° 100/55 between Silesian University of Technology (Poland) and Technical University of Metz (France) concerning Ph.D. thesis prepared at both laboratories. I gratefully acknowledge the authority of both Universities for giving me this opportunity.

I am greatly indebted to the French Government for the scholarship “Cotutelle de Thèse“, which allowed me to become PhD student at the Technical University of Metz in 2001 and to carry out research in Laboratory of Chemistry and Applications (LCA) during my stay in France.

Throughout the years of thesis preparation, I have received much support from professors, family and colleagues...

I am fully aware of being unable to individually acknowledge all those who deserve it. In fact, many people were of help to me and somewhat contributed to the elaboration of the present dissertation.

My acknowledgments to the reviewers of the present thesis, namely Prof. Marian Bodzek and Dr. Claire Richard for accepting to read and evaluate my work and for providing precious remarks and comments.

I would like to thank my supervisors Prof. Korneliusz Mikschin Poland and Prof. Jean-Victor Weber in France for placing a lot of confidence in sense of my scientific intuition. They allowed me to develop my idea and were both always ready to help me in finding ways to overcome research problems.

I am profoundly grateful to Dr. Joanna Surmacz-Gorska and Dr. Didier Robert for invaluable support their help and guidance. During the preparation of the present work not only their precious suggestions but also their comments were of great importance to me. They helped me to skilfully manage the research without forgetting the ever essential human relations.

I would like to thank Dr. Andrzej Krzton from Polish Academy of Science in Gliwice, whom I consider a good friend and a mentor. I am grateful to him for his help to discover some “arcane” of FTIR analysis techniques. I appreciate his great sense of humour, unconditional and invaluable support, and his heartfelt help. We spend a lot of time in LCA (Saint-Avold) in France and he has always encouraged me and cheered me up during the difficult period of being away from home.

I also express my gratitude to the Polish and French colleagues for their support, help, and friendship. In particular, I thank Dr. Ewa Zablocka-Godlewska (EBD) and Dr. Gisèle Finqueneisel (LCA) for consultations concerning enumeration of denitrifying bacteria and HPLC analysis respectively.

I cannot forget the invaluable help provided by skilful technical staff in both laboratories (LCA and EBD). I acknowledge to Katarzyna Radziszewska, Marek Tarlowski and Philippe Lavalette.

Many thank to members of the laboratory who have contributed to make my stay very pleasant. I am particularly grateful to Ela Tarlowska and Chafia Mitsch, lab secretaries, in EBD and in LCA respectively for all their invaluable help, their friendliness and frequently taking care of my paperwork.

The work has been also carried out within the framework of the cooperation program i.e. bilateral project "Polonium" supported by the Ministère des Affaires Etrangères (France) and KBN (State Committee for Scientific Research) (Poland).

With colleagues from the University of Metz, we have gained access to the "Solar Plataforma de Almeria" (PSA) in Spain within the EU programme "Improving Human Potential", Action: 'Access to the Research Infrastructure' (contract n° HPRI-CT-1999-00013). I am gratefully acknowledging the support provided by this programme. Moreover, I wish to thank to Dr. Sixto Malato Rodrigéz and to the laboratory staff for precious hints and help provided during my stay at PSA.

Thanks to the authorities of local MWWTPs (Zabrze and Saint -Avoild) providing a seed of activated sludge used as inoculum for biological reactors as well as to authorities of landfills sites (Gliwice, Świętochłowice and Tétting) for the possibility of obtaining the samples of landfill leachates.

Finally, I would like to express my gratitude to my mother Grazyna and my grandparents Danuta and Bolesław who always believed in me and supported me in moments of doubt.

I am very grateful to my adorable wife Ewa for her affection and understanding. She relieved me of many daily round duties connected with house keeping and many others... which enable me to devote more time for developing my skills and doing my research.

At the same occasion I would like to apologize to my relatives for not spending enough time with them... for long months of separation during my stays in foreign countries within the confines of doctoral studies.

I am profoundly grateful to my cousin Magdalena and to Elodie Salé from the University of Metz for the time and effort spent proofreading the present work and for their valuable remarks.

## TABLE OF CONTENTS

<b>ABSTRACT</b>	<b>i</b>
<b>ACKNOWLEDGMENTS</b>	<b>iii</b>
<b>TABLE OF CONTENTS</b>	<b>v</b>
<b>LIST OF TABLES</b>	<b>ix</b>
<b>LIST OF FIGURES</b>	<b>x</b>
<b>GENERAL INTRODUCTION</b>	<b>xiv</b>
<b>CHAPTER I: BIBLIOGRAPHIC PART</b>	<b>1</b>
<b>I.1 Landfill leachates</b>	<b>2</b>
I.1.1 Introduction	2
I.1.2 Composition of landfill leachates	2
I.1.3. Humic substances	5
I.1.4 Environmental risk of landfill leachate	7
<b>I.2. Landfill leachate treatment methods</b>	<b>9</b>
I.2.1. Generalities on biological methods	9
I.2.1.1 <i>Biological treatment processes</i>	9
I.2.1.2 <i>Rotating Biological Contactors</i>	10
I.2.1.3 <i>Aerobic Activated Sludge</i>	10
I.2.1.4 <i>Process involving N removal: Nitrification /Denitrification/ Anammox</i>	12
I.2.1.5 <i>Natural Systems -treatment on Land and Lagoons and Wetlands</i>	16
I.2.1.6 <i>Anaerobic Systems</i>	17
I.2.1.7 <i>Aerobic Systems</i>	17
<b>I.2.2 Physico-chemical techniques</b>	<b>18</b>
I.2.2.1. <i>Coagulation-Flocculation</i>	18
I.2.2.2. <i>Adsorption</i>	19
I.2.2.3. <i>Membrane process</i>	19
I.2.2.4. <i>Chemical oxidation, AOP processes</i>	20
<b>I.2.3 Combined physico-chemical and biological methods – landfill leachate treatment plants case</b>	<b>23</b>
I.2.3.1 <i>Nitrification/denitrification-ozonation (+UV)-post-biological oxidation</i>	23
I.2.3.2 <i>Nitrification/denitrification-precipitation-ozonation</i>	24
I.2.3.3 <i>Chemical precipitation- membrane bioreactor (MBR)- revers osmosis (RO)</i>	24
I.2.3.4 <i>Coagulation -2 stages of revers osmosis (RO)-neutralization/sterilization</i>	25
<b>I.3. Generalities on heterogeneous photocatalysis</b>	<b>26</b>
I.3.1 Introduction	26
I.3.2 Heterogeneous photocatalysis	27
I.3.2.1 <i>Mechanism of TiO<sub>2</sub> heterogeneous photocatalysis</i>	30
I.3.3 Main parameters governing photocatalysis efficiency	32
I.3.3.1 <i>Catalyst loading</i>	32
I.3.3.2 <i>Substrate concentration</i>	34
I.3.3.3 <i>Influence of electron acceptor (oxygen, hydrogen peroxide)</i>	34
I.3.3.4 <i>Effect of pH and inorganic anion</i>	35
I.3.3.5 <i>Influence of physical parameters (radiation source, light intensity and temperature)</i>	38
I.3.4 Solar photocatalysis	39
I.3.4.1 <i>Solar spectrum</i>	39
I.3.4.2 <i>Solar photoreactors for water detoxification</i>	40



<i>I.3.4.3 Current commercial application systems</i>	44
<b>I.4 Formulation of thesis</b>	46
<i>I.4.1 Goals</i>	47
<b>CHAPTER II: EXPERIMENTAL PART</b>	<b>48</b>
<b>II.1 Part 1: Laboratory scale researches in France (LCA)</b>	<b>49</b>
<i>II.1.1. Products and analyses in LCA</i>	49
<i>II.1.1.1 Experimental set-up: Solar box ATLAS SUNTEST CPS+</i>	51
<i>II.1.2. Studies of adsorption of HAs on TiO<sub>2</sub></i>	52
<i>II.1.2.1. Determination of adsorption isotherm of HAs, pH influence</i>	52
<i>II.1.2.2. Evaluation of the adsorption by DRIFT spectroscopy</i>	53
<i>II.1.2.3. Evaluation of the influence of salts on adsorption of HAs on TiO<sub>2</sub></i>	53
<i>II.1.3. Photocatalytic degradation experiments (LCA)</i>	55
<i>II.1.3.1 Determination of pH and salts effect on photoreactivity of HAs</i>	56
<i>II.1.3.2 Evaluation of the influence of O<sub>2</sub> on photoreactivity of HAs</i>	57
<i>II.1.3.3 Assessment of bio-accessibility of HAs photocatalytic degradation products</i>	57
<b>II.2 Part 2 : Pilot Plant experiments in Spain (PSA)</b>	<b>57</b>
<i>II.2.1 Products and analysis in PSA experiments</i>	57
<i>II.2.1.1 Experimental conditions: CPCs reactors</i>	57
<i>II.2.1.2 The evaluation of solar UV radiation</i>	58
<i>II.2.2 Photocatalytic degradation experiments</i>	59
<i>II.2.2.1 Influence of catalyst loading and salts on photoreactivity of HAs</i>	59
<i>II.2.2.2 Evaluation of the influence of O<sub>2</sub> on photoreactivity of HAs</i>	60
<i>II.2.2.3 Assessment of bio-accessibility of HAs photocatalytic degradation products</i>	60
<b>II.3 Part 3: Laboratory scale researches in Poland (EBD)</b>	<b>61</b>
<i>II.3.1 Products and analysis in EBD experiments</i>	61
<i>II.3.1.1 Landfill leachate (Swietochlowice, Gliwice)</i>	61
<i>II.3.1.2 Experimental conditions: Activated sludge systems</i>	63
<i>II.3.1.2 a) Evaluation of short-term and long-terms effects of bentonite on sludge</i>	63
<i>II.3.1.3 Experimental conditions: Rotating Biological Contactors</i>	65
<i>II.3.1.3.a) Implementation of heterotrophic denitrification in aerobic RBC</i>	66
<i>II.3.1.4 Analytical methods- EBD study</i>	68
<i>II.3.1.5 Control of biological treatment efficiency in biological system</i>	69
<b>II.4 Part 4: Combined biological and photocatalytic systems for treatment of landfill leachate- laboratory scale research in France (LCA) and Poland (EBD)</b>	<b>74</b>
<i>II.4.2 Products and analysis</i>	74
<i>II.4.2.1 Landfill leachate (Teting) characterisation</i>	74
<i>II.4.2.2 Experimental conditions: procedure of landfill leachate combined process (LCA)</i>	75
<i>II.4.2.3 Experimental conditions: procedure of landfill leachate combined process (EBD)</i>	76
<i>II.4.2.4 The evaluation of irradiation time</i>	77
<i>II.4.2.5 Determination of bio-accessibility organics formed in the photocatalytic stage</i>	78

<b>CHAPTER III: STUDY OF PHOTOCATALYTIC DEGRADATION OF HAS WITH TiO<sub>2</sub> IN WATER</b>	<b>80</b>
<b>III.1. Introduction</b>	<b>81</b>
<b>III.2. Laboratory scale approach in France</b>	<b>81</b>
III.2.1 Adsorption studies: effect of different parameters	81
III.2.1.1 Adsorption Isotherm of HAS	82
III.2.1.2 pH effect on the adsorption of HAS	83
III.2.1.3 Effect of salts	87
III.2.2 Photocatalytic degradation of Aldrich HAS	90
III.2.2.1 Direct photolysis and photomineralization of HAS	91
III.2.2.2 Effect of catalyst loading	94
III.2.2.3 Influence of the pH	95
III.2.2.4 Effect of anions on the photocatalytic degradation of humic acids	96
III.2.2.4 a) Chloride (Cl <sup>-</sup> )	96
III.2.2.4 b) Sulphate (SO <sub>4</sub> <sup>2-</sup> )	98
III.2.2.4 c) Hydrogenocarbonate (HCO <sub>3</sub> <sup>-</sup> )	100
III.2.2.4 d) Hydrogenophosphate (HPO <sub>4</sub> <sup>2-</sup> )	101
III.2.2.4 e) Mixture of anions	102
III.2.2.5 Effect of electron acceptor	104
III.2.2.6 Evolution of biodegradability	105
<b>III.3. Pilot scale approach in Spain</b>	<b>106</b>
III.3.1 Solar photocatalytic degradation of HAS	107
III.3.1.1 Effect of initial TiO <sub>2</sub> concentration on HAS removal	107
III.3.1.2 Effect of anions on the photomineralization of HAS	108
III.3.1.2 a) Cl <sup>-</sup> and SO <sub>4</sub> <sup>2-</sup>	108
III.3.1.2 b) HCO <sub>3</sub> <sup>-</sup> and anions mixture	111
III.3.1.3 Effect of photoreactor volume and surface	115
III.3.1.4 Biodegradability changes during photocatalytic decomposition of HAS	116
<b>III.4. Conclusions</b>	<b>117</b>
III.4.1 Laboratory investigation (France)	117
III.4.2 Pilot plant and laboratory experiments (Spain)	119
<b>CHAPTER IV: STUDY OF BIOLOGICAL TREATMENT OF LANDFILL LEACHATE</b>	<b>120</b>
<b>IV.1 Introduction</b>	<b>121</b>
<b>IV.2. Activated sludge (AS)</b>	<b>122</b>
IV.2.1. Influence of bentonite on sludge settling properties-preliminary investigation (AS)	122
IV.2.2. Landfill leachate treatment –nitrification in AS	124
IV.2.3. Landfill leachate treatment –denitrification and COD removal in AS	126
IV.2.4. Discussion for AS	127
IV.2.5. Conclusions for AS	131
<b>IV.3. Rotating biological contactors (RBC)</b>	<b>132</b>
IV.3. 1 Landfill leachate treatment –nitrification in RBC	132
IV.3. 2 Landfill leachate treatment –denitrification and COD removal in RBC	135
IV.3. 3 Biofilm characterization	137
IV.3. 4 Discussion for RBC	137
IV.3.5. Conclusions for RBC	143
<b>IV.4 Conclusions-biological treatment of LL by RBC and AS</b>	<b>144</b>

<b>CHAPTER V: STUDY OF COMBINED BIOLOGICAL AND PHOTOCATALYTIC SYSTEMS FOR TREATMENT OF LANDFILL LEACHATE</b>	<b>145</b>
<b>V.1 Introduction</b>	<b>146</b>
<b>V.2. Photocatalytic treatment of biologically pre-treated landfill leachate (France)</b>	<b>147</b>
V.2.1 The effect of pH on photocatalytic oxidation of landfill leachate	147
V.2.2 Summary photocatalytic treatment of biologically pre-treated landfill leachate (France)	152
<b>V.3. Photocatalytic treatment of biologically pre-treated landfill leachate (Poland)</b>	<b>153</b>
V.3.1 Preliminary tests for UVC photocatalytic system - humic acids case	153
V.3.2 Direct photolysis and photomineralization of LL	155
V.3.3 Effect of catalyst loading	158
V.3.4 Biodegradability of by-products formed during the photocatalytic treatment	160
V.3.5 Post- biological oxidation by activated sludge	162
V.3.6 Summary of photocatalytic treatment of biologically pre-treated landfill leachate (Poland)	162
<b>V.4. Conclusions (Poland and France)</b>	<b>163</b>
<b>CHAPTER VI: GENERAL CONCLUSIONS AND PROSPECTS</b>	<b>165</b>
<b>6.1 General conclusions of the work</b>	<b>166</b>
<b>6.2 Overall treatment strategy for LL treatment and prospects</b>	<b>169</b>
<b>REFERENCES</b>	<b>171</b>
<b>CV</b>	<b>189</b>

## LIST OF TABLES

<b>Table 1.1</b>	<i>Composition of landfill leachate (adapted from Christensen et al. 2001)</i>	<b>3</b>
<b>Table 1.2</b>	<i>Evolution in landfill leachate composition along with landfill age (adopted from: Henry et la 1987, Amokrane et al. 1997, Christensen et al. 2001)</i>	<b>4</b>
<b>Table 1.3</b>	<i>Advantages and drawbacks of intensive approaches (Cartel internet site, Metcalf and Eddy 1991, Loukidou and Zouboulis 2001)</i>	<b>11</b>
<b>Table 1.4</b>	<i>Main advantages and drawbacks (Edeline 1987, Timur and Öztürk 1997)</i>	<b>17</b>
<b>Table 1.5</b>	<i>Main problems encountered in the AOPs treatment of landfill leachate</i>	<b>22</b>
<b>Table 1.6</b>	<i>Regulation criteria for direct discharge into surface water (adopted from Steensen 1997, Poitel et al. 1999, Ahn et al. 2002 and Polish standards 2002)</i>	<b>23</b>
<b>Table 1.7</b>	<i>Band positions of some common semiconductor photocatalysts in aqueous solution (Fox 1983)</i>	<b>29</b>
<b>Table 1.8</b>	<i>Advantages and disadvantages of PTCs technology.</i>	<b>41</b>
<b>Table 2.1</b>	<i>Operation conditions of CPCs devices.</i>	<b>58</b>
<b>Table 2.2</b>	<i>Characteristic of raw leachate from Swietochowice used in the period I, II and III</i>	<b>61</b>
<b>Table 2.3</b>	<i>Characteristic of raw leachate from Gliwice.</i>	<b>62</b>
<b>Table 2.4</b>	<i>Operating conditions for activated sludge system during the period I, II and III with LL from Swietochowice</i>	<b>65</b>
<b>Table 2.5</b>	<i>Operating conditions of RBC with the leachate from Gliwice.</i>	<b>67</b>
<b>Table 2.6</b>	<i>Composition of raw landfill leachate and treated leachate (04.2002-06.2003).</i>	<b>74</b>
<b>Table 2.7</b>	<i>Composition of biologically pre-treated landfill leachate from Gliwice ( 01-04.2004)</i>	<b>78</b>
<b>Table 3.1</b>	<i>Langmuir parameters determined by UV absorption and TOC analysis</i>	<b>83</b>
<b>Table 4.1</b>	<i>Comparison of reported C/N ratios</i>	<b>141</b>
<b>Table 5.1</b>	<i>Apparent first-order rate constants <math>k</math>, and liner regression coefficient of HAs</i>	<b>154</b>
<b>Table 5.2</b>	<i>Coefficient of degradation rate constant (<math>k</math>) by means of TOC, COD and colour for photolysis and photocatalysis of LL</i>	<b>157</b>

## LIST OF FIGURES

<b>Figure 1.1</b>	<i>Schematic illustration of the theoretical combination of photocatalytic-biological process for stabilized LL: 1- landfill site and leachate generation, 2- first biological stage (nitrification), 3- solar photocatalysis as a second stage, 4- post-biological stage (denitrification), 5- river</i>	<b>xv</b>
<b>Figure 1.2</b>	<i>Separation scheme for HS</i>	<b>5</b>
<b>Figure 1.3</b>	<i>State of the art structural concept of a humic acid (Adapted from Schulten and Schnitzer 1993)</i>	<b>6</b>
<b>Figure 1.4</b>	<i>Flux diagram of (a) partial nitrification/denitrification, (b) partial nitrification/anammox</i>	<b>15</b>
<b>Figure 1.5</b>	<i>Process flow diagram for a) the existing process and b) the retrofitted process (adapted from Ahn et al. 2002)</i>	<b>24</b>
<b>Figure 1.6</b>	<i>Flow diagram of leachate treatment system at Yachiyo Town (adapted from Ushikoshi et al 2002)</i>	<b>25</b>
<b>Figure 1.7</b>	<i>Photoexcitation of semiconductor by <math>h\nu \geq E_{BG}</math></i>	<b>28</b>
<b>Figure 1.8</b>	<i>Mechanism of TiO<sub>2</sub> heterogeneous photocatalysis. Figure depicts mechanisms of photodegradation taking place on an irradiated semiconductor particle.</i>	<b>31</b>
<b>Figure 1.9</b>	<i>Influence of different parameters on photodegradation rate. a) catalyst dose and initial concentration of substrate, b) wavelength, c) temperature, c) radiation flux</i>	<b>33</b>
<b>Figure 1.10</b>	<i>Solar Detoxification Facility two-axis PTCs (Helioman's collectors loop PSA, Spain)</i>	<b>41</b>
<b>Figure 1.11</b>	<i>Geometric profile of: a) parabolic trough reactor (PTR) and b) compound parabolic collecting reactor (CPC) (Alfano et al. 2000)</i>	<b>42</b>
<b>Figure 1.12</b>	<i>The thin-film fixed-bed reactor (TFFBR)</i>	<b>42</b>
<b>Figure 1.13</b>	<i>CPCs reactor in PSA, volume 190 l</i>	<b>43</b>
<b>Figure 1.14</b>	<i>a) R2000 Solar Oxidation (USA) based on solar irradiation and b) Photo-Cat® (Canada) operating under UV from Hg -low pressure lamps</i>	<b>45</b>
<b>Figure 1.15</b>	<i>Scheme of the Photo-Cat® Water Treatment Train</i>	<b>46</b>
<b>Figure 2.1</b>	<i>Adsorption spectra of humic acids in water pH 7.5; HAs concentration 100 mg/l (dilution 1:3)</i>	<b>49</b>
<b>Figure 2.2</b>	<i>Relationship between UV 254, UV 400 and DOC (TOC) analyses of HAs</i>	<b>50</b>
<b>Figure 2.3</b>	<i>Solar box ATLAS SUNTEST CPS+ set-up: 1- xenon lamp, 2-reflectance surface, 3- reactor (beaker), 4-programation panel Relationship between UV 254, UV 400 and DOC (TOC) analyses of HAs</i>	<b>52</b>
<b>Figure 2.4</b>	<i>Procedures for the adsorption evaluation</i>	<b>54</b>
<b>Figure 2.5</b>	<i>Procedures for the evaluation of Cl<sup>-</sup> effect</i>	<b>56</b>
<b>Figure 2.6</b>	<i>Picture of CPC<sub>35/39</sub> (left) and illustration-scheme of proceeding: 1-sampling valve, 2- thermocouple, 3- not-reacting tank, 4- pump (right)</i>	<b>58</b>
<b>Figure 2.7</b>	<i>The oxygen uptake rate recording set-up: 1- magnetic stirrer, 2-dissolved oxygen electrode, 3-vessel, 4-respirometer, 5- recorder</i>	<b>60</b>

<b>Figure 2.8</b>	<i>Schematic diagram of activated sludge unite with a useful volume of 2.0 l</i>	<b>63</b>
<b>Figure 2.9</b>	<i>Schematic diagram of activated sludge system with pre-denitrification: 1- raw leachate, 2- anoxic reactor, 3- secondary clarified , 4- external sludge, 5- aerobic reactor, 6-treated leachate</i>	<b>64</b>
<b>Figure 2.10</b>	<i>Schematic diagram (top) and picture a) nitrification zone I-VI discs (bottom left), b) denitrification zone VII-XII discs (bottom right) of RBC: 1- leachate influent, 2- discs, 3- external carbon source , 4- drive motor, 5- effluent</i>	<b>66</b>
<b>Figure 2.11</b>	<i>Diagram of lab scale combined process for landfill leachate treatment.</i>	<b>75</b>
<b>Figure 2.12</b>	<i>Schematic diagram (left) and picture of photocatalytic set-up (right): (1) Photoreactor; (2) UVC 400W (200W); (3) Cooling (jacket) loop (4) Non-reacting tank, (sampling point); (5) Recycle peristaltic pump (6) Aeration; (7) Magnetic stirrer; (8) Outlet of cooling liquid</i>	<b>77</b>
<b>Figure 3.1</b>	<i>Adsorption isotherms of HAs (pH 7.8) on TiO<sub>2</sub></i>	<b>82</b>
<b>Figure 3.2</b>	<i>Effect of pH and equilibrium time on adsorption of humic acids</i>	<b>84</b>
<b>Figure 3.3</b>	<i>Model HAs adsorption on TiO<sub>2</sub> according to pH</i>	<b>85</b>
<b>Figure 3.4</b>	<i>Schematic illustration of HAs adsorbed on different site of surface; loops, tails and trains conformation</i>	<b>86</b>
<b>Figure 3.5</b>	<i>DRIFT spectrum of adsorbed HAs on TiO<sub>2</sub> at different pH</i>	<b>87</b>
<b>Figure 3.6</b>	<i>Influence of ionic strength on affinity of HAs amounting to 100 mg/l to the catalyst surface. TiO<sub>2</sub> = 1.0 g/l and pH 7.5 (except the solution of HCO<sub>3</sub><sup>-</sup>)</i>	<b>88</b>
<b>Figure 3.7</b>	<i>Photolysis and photomineralization of HAs equalling to 110 mg/l with [TiO<sub>2</sub>] = 0.5 and 1.0 g/l</i>	<b>91</b>
<b>Figure 3.8</b>	<i>Evolution of the initial step (first domain) according to the TiO<sub>2</sub> amount</i>	<b>92</b>
<b>Figure 3.9</b>	<i>Chromatograms of photocatalytic degradation of humic acids intermediats with [TiO<sub>2</sub>]=0.5 g/l</i>	<b>93</b>
<b>Figure 3.10</b>	<i>Evolution of Area Peak (P1-peak 1, P2-peak 2 and P3-peak 3) and TOC versus irradiation time during degradation of HAs</i>	<b>93</b>
<b>Figure 3.11</b>	<i>Influence of catalyst concentration on the photomineralization of humic acids</i>	<b>94</b>
<b>Figure 3.12</b>	<i>Evolution of a)TOC and b)DOC during illumination of humic acids solution ([HA] = 100 mg/l) containing TiO<sub>2</sub>=1.0 g/l at different initial pH values (3.4, 7.8 and 11.5)</i>	<b>95</b>
<b>Figure 3.13</b>	<i>Effect of NaCl on photomineralization of HAs a) TOC disappearance b) removal of Abs at 254, S1 (NaCl preliminary equilibrated with TiO<sub>2</sub>, then HAs addition); S2 (NaCl added after equilibrating HAs with TiO<sub>2</sub>)</i>	<b>97</b>
<b>Figure 3.14</b>	<i>Effect of NaCl on photomineralization (TOC) of HAs at different initial pH values (5.0, 7.5 and 11.0)</i>	<b>98</b>
<b>Figure 3.15</b>	<i>Effect of NaSO<sub>4</sub> on photomineralization of HAs a) TOC disappearance b) removal of ABS at 254 nm</i>	<b>99</b>
<b>Figure 3.16</b>	<i>Influence of NaHCO<sub>3</sub> on photodegradation of HAs a) Abs at 254 nm disappearance b) Colour removal (Abs at 400 nm)</i>	<b>100</b>
<b>Figure 3.17</b>	<i>Effect of Na<sub>2</sub>HP0<sub>4</sub> on colour removal of HAs</i>	<b>101</b>
<b>Figure 3.18</b>	<i>Influence of Na<sub>2</sub>SO<sub>4</sub> and NaCl mixture on photomineralization (TOC) of HAs</i>	<b>102</b>

<b>Figure 3.19</b>	<i>Effect of the mixture [Na<sub>2</sub>SO<sub>4</sub>, NaCl and NaHCO<sub>3</sub>], so-called [mixture] and [Na<sub>2</sub>SO<sub>4</sub> and NaCl] on photodegradation of HAs a) Abs at 254 nm disappearance b) Colour removal (Abs at 400 nm)</i>	103
<b>Figure 3.20</b>	<i>Effect of Na<sub>2</sub>HPO<sub>4</sub> and air-flow on photomineralization of HAs</i>	104
<b>Figure 3.21</b>	<i>Evolution of BOD<sub>5</sub> and TOC during the irradiation of [HA] = 100 mg/l with [TiO<sub>2</sub>] = 1.0 g/l</i>	105
<b>Figure 3.22</b>	<i>Influence of catalyst concentration on mineralization efficiency a) and b) colour removal of HAs solution versus accumulated UV energy. (○) TiO<sub>2</sub>= 0.2 g/l; (◇) TiO<sub>2</sub>=0.3 g/l; (△) TiO<sub>2</sub>=0.5 g/l; (◻) TiO<sub>2</sub>=0.7 g/l; (◆) TiO<sub>2</sub>=1.0 g/l; (■) TiO<sub>2</sub>=1.2 g/l; (●) TiO<sub>2</sub>=2.0 g/l</i>	108
<b>Figure 3.23</b>	<i>Effect of inorganic anions on a) mineralization and b) colour removal of HA solution versus accumulated UV energy. TiO<sub>2</sub> = 0.2 g/l; (○) HA; (▲) HA + [Cl<sup>-</sup>] (4.5 g/l); (■) HA + [SO<sub>4</sub><sup>2-</sup>] (7.75 g/l) and (---) pH HA</i>	109
<b>Figure 3.24</b>	<i>Effect of carbonate ions (3.05 g/l) on: a) absorbance at 254 nm and b) colour removal of HA solution versus accumulated UV energy, TiO<sub>2</sub> = 0.7 g/l. (△) HA + [HCO<sub>3</sub><sup>-</sup>], (○) HA expressed as Abs/Abs<sub>0</sub> at 254 nm; (▲) HA + [HCO<sub>3</sub><sup>-</sup>], (●) HA expressed as at Abs/Abs<sub>0</sub> at 400 nm and (---) pH HA + [HCO<sub>3</sub><sup>-</sup>]</i>	111
<b>Figure 3.25</b>	<i>Effect of mixture of inorganic anions in HA solution on a) Abs/Abs<sub>0</sub> at 254 nm, b) Abs/Abs<sub>0</sub> at 400 nm (colour) and c) DOC removal versus accumulated UV energy; TiO<sub>2</sub> = 0.7 g/l; (△) HA + [HCO<sub>3</sub><sup>-</sup>+Cl<sup>-</sup>+SO<sub>4</sub><sup>2-</sup>]; (▲) HA + [HCO<sub>3</sub><sup>-</sup>]; (■) HA+[Cl<sup>-</sup>+SO<sub>4</sub><sup>2-</sup>] and (●) DOC of HA; (◻) DOC of HA + [Cl<sup>-</sup>+SO<sub>4</sub><sup>2-</sup>]</i>	113
<b>Figure 3.26</b>	<i>HAs mineralization a) and colour removal b) versus accumulated UV energy. Kinetics performed in two CPCs and catalyst concentration amounting to 0.7 g/l</i>	115
<b>Figure 3.27</b>	<i>Variation of DOC, BOD<sub>5</sub> and %OUR during photocatalytic decomposition of HAs solution versus accumulated UV energy. (●) BOD<sub>5</sub>; (●) DOC HA; (▲) %OUR</i>	116
<b>Figure 4.1</b>	<i>Sedimentation curves a) and MLSS, SVI evolution b)</i>	123
<b>Figure 4.2</b>	<i>Nitrogen forms concentrations and percentage of nitrogen removal in the system, period I</i>	124
<b>Figure 4.3</b>	<i>Ammonia nitrogen concentration in raw and treated leachate during period II and III</i>	125
<b>Figure 4.4</b>	<i>Nitrite and nitrate concentrations in aerobic chamber during period II and III</i>	125
<b>Figure 4.5</b>	<i>COD concentration in the raw and treated leachate period I</i>	126
<b>Figure 4.6</b>	<i>Percentage of nitrogen removal related to degree of recycle as well as BOD<sub>5</sub>/N ratio</i>	127
<b>Figure 4.7</b>	<i>Relationship between nitrification rate and ammonia and BOD<sub>5</sub> loading</i>	129
<b>Figure 4.8</b>	<i>Ammonia concentrations in influent and effluent from RBC and percentage of ammonia removal in the system</i>	132
<b>Figure 4.9</b>	<i>Ammonia concentrations in influent and effluent from RBC and ammonia loading rate</i>	133
<b>Figure 4.10</b>	<i>Nitrite and nitrate concentration in effluent from RBC</i>	134
<b>Figure 4.11</b>	<i>Percentage of N removal and bCOD/N ratio (biodegradable COD from CH<sub>3</sub>COOH/nitrite, nitrate and ammonia in influent) versus operating days</i>	135

<b>Figure 4.12</b>	<i>Profile of RBC at a) 167 operating day, bCOD/N= 2.9 and b) 240 operating day, bCOD/N= 7.0</i>	136
<b>Figure 4.13</b>	<i>Relationship between nitrogen removal efficiency and bCOD/N ratio</i>	142
<b>Figure 5.1</b>	<i>Effect of pH on photocatalytic degradation of landfill leachate amounting to COD= 210 mgO<sub>2</sub>/l, determined by a) normalised absorption at 254 nm and b) normalised adsorption at 400 nm (colour) evolutions</i>	148
<b>Figure 5.2</b>	<i>Effect of NaHCO<sub>3</sub> on photocatalytic degradation of model HAs at pH 8.8 and 11.0 determined by normalised absorption at 254 nm and normalised adsorption at 400 nm (colour)</i>	150
<b>Figure 5.3</b>	<i>Photocatalytic degradation of landfill leachate a) determined by of TOC and colour removal at 400 nm, pH 3.5; b) determined by COD and colour removal at 400 nm, pH 4.0</i>	151
<b>Figure 5.4</b>	<i>Evolution of the remaining normalized concentration of COD, photolysis and photocatalytic degradation of HAs (100 mg/l) with TiO<sub>2</sub> amounting to 0.5 and 1.0 g/l, initial COD =100 mg/l, pH = 7.8</i>	154
<b>Figure 5.5</b>	<i>Photolysis and photocatalytic degradation of landfill leachate determined by a) TOC and b) COD, pH 4.0</i>	156
<b>Figure 5.6</b>	<i>Photocatalytic degradation of landfill leachate determined by normalised absorption at 400 nm, pH 4.0</i>	157
<b>Figure 5.7</b>	<i>Effect of the photocatalyst (TiO<sub>2</sub>, P-25) concentration on the photodegradation rate of landfill leachate at pH 4; determined by a) TOC, b) COD and c) Colour</i>	159
<b>Figure 5.8</b>	<i>Evolution of COD, BOD<sub>5</sub> and %OUR during phototocatalytic decomposition of LL versus irradiation time</i>	161
<b>Figure 5.9</b>	<i>Microbial oxidation of COD in activated sludge reactor of photocatalytically pre-treated landfill leachate</i>	162
<b>Figure 6.1</b>	<i>Process flow diagram for the proposed "HYBIDETOX" process</i>	169



## **GENERAL INTRODUCTION**

Landfilling of municipal waste is still a very important issue of the waste management system in Europe and the rest of the world. Due to the stricter regulation of Polish law concerning landfilling (Statute of 27 April 2001 on Wastes) which follows European Council Directive (1999/31/EC, so-called Landfill Directive), the amount of deposited waste, in particular biodegradable one, must decrease. For instance, the biodegradable municipal waste is expected to be reduced to 75% by weight of 1995 levels by 2010.

Some alternative methods such as recycling, composting and incineration are nowadays very much encouraged but even incinerations create residue of approximately 10 to 20 % that must be ultimately landfilled. At present, modern landfills are highly engineered facilities designed to eliminate or minimize the adverse impact of the waste on the surrounding environment. However, the generation of contaminated leachate remains an inevitable consequence of the existing waste disposal practice and the future landfills. The leachate is made up of rain that passes through a landfill site and liquids that are generated by the breakdown of the waste within the landfill. The leachate is produced not only during exploitation of landfill, but also many years after the closure of the site.

Since the first European Directive in 1975 (Surface water 1975/440/EEC), much progress has been made in tracking contamination sources of aquatic ecosystem. Its aim is to better protect the environment from any adverse effects caused by discharge of urban and industrial wastewaters. Especially, "appropriate treatment" is imposed on some industrial effluents to improve and develop a new treatment method in order to meet the relevant quality standards and the relevant provisions. Consequently, landfill effluents need to be pre-treated on site to meet the standards for its discharge into the sewer or its direct disposal into surface water.

In the EU countries the problem of leachate treatment has been existed for some time now, but a universal solution has not been found. The leachates are a mixture of high concentration organic and inorganic contaminants including humic acids, ammonia nitrogen, heavy metals, xenobiotics and inorganic salts, and need to be removed due to their toxicity or unfavourable effect on the environment. The processes currently used often require combined techniques which are designed as modular or multistage units skilled in the treatment of contaminants which vary in concentration over the years.

The biological method of nitrification/denitrification is probably the most efficient and cheapest process to eliminate nitrogen from leachate. However, biological treatment is hampered by the specific toxic substances (such as PAHs- polyaromatic hydrocarbons, AOXs-adsorbable organic halogens, PCBs-polychlorinated biphenyls) and/or by the presence of bio-refractory organics (such as humic substance, or surfactants). The efficiency of denitrification is reduced due to the limited level of biodegradable organics, in particular in stabilised landfills. Conventional leachate treatment methods, such as air stripping,

coagulation, flocculation and settling, are often costly in terms of initial outlay of plant equipment, energy requirements and frequent use of additional chemicals. Other methods such as reverse osmosis, active carbon adsorption only transfer the pollution and do not solve the environmental problem. Advanced oxidation processes (AOP's) e.g. UV/FeII+ H<sub>2</sub>O<sub>2</sub>, UV/H<sub>2</sub>O<sub>2</sub>, UV /O<sub>3</sub>, UV/TiO<sub>2</sub> have been proposed in the recent years as an effective alternative for mineralization of recalcitrant organics in landfill leachate. However, these techniques in application for the treatment of large-scale effluents are not economically acceptable. A significant decrease of overall leachate treatment cost could be obtained by the combination of AOP's with a biological process but compatibility of these two processes should be proved.

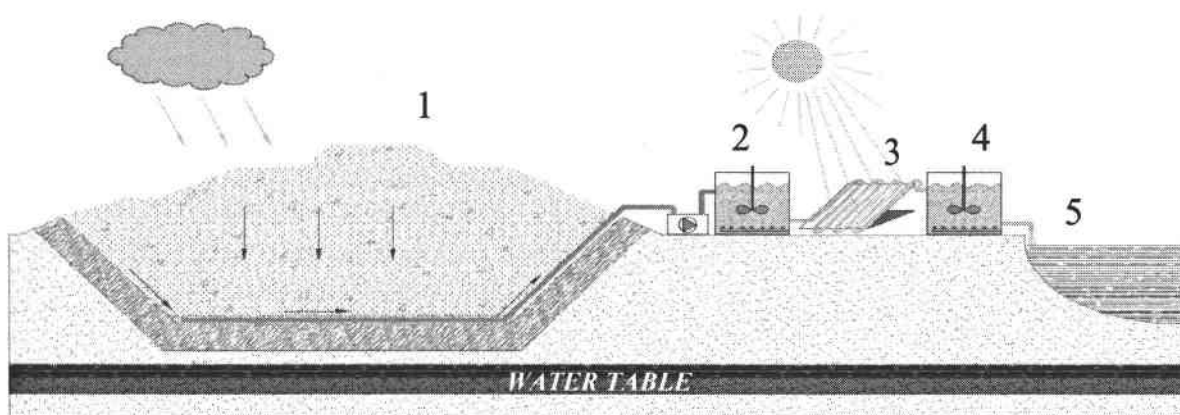

*Figure 1.1 Schematic illustration of the theoretical combination of photocatalytic-biological process for stabilized LL: 1- landfill site and leachate generation, 2- first biological stage (nitrification), 3- solar photocatalysis as a second stage, 4- post-biological stage (denitrification), 5- river*

However, photocatalysis (UV/TiO<sub>2</sub>) was not yet evaluated as an oxidation process (as a pre-treatment enhancing biological activity) of non-biodegradable organic compounds in the heterogeneous medium such as landfill leachate.

Especially profitable seems to be the idea to use the transformed organics in photocatalysis stage from biologically pre-nitrified leachate for biological nitrogen removal (denitrification) as a final stage of treatment. Moreover, a significant reduction of overall cost of combined process could be achieved by using solar energy as an irradiation source (solar photocatalysis) (Fig. 1.1).

# CHAPTER I

---

## *BIBLIOGRAPHIC PART*

---

---

---

## I.1 Landfill leachates

### I.1.1. Introduction

Because of economic issues landfills are the most attractive disposal route for municipal solid waste and it is still the most popular waste treatment in Poland and many countries in Europe and all over the world. Alternative methods to landfilling (incineration, composting) are considered as volume reduction process because they produce waste fraction (ashes, slag), which ultimately has to be landfilled (Calace et al. 2001).

Nowadays, in the modern landfills, waste is actually encapsulated and sealed off to prevent migration of pollutants and pathogens. However, the generation of contaminated leachate remains an inevitable consequence of the practice of waste disposal in landfills.

Leachate is formed when the refuse moisture content exceeds its field capacity, which is defined as the maximum moisture that is retained in a porous medium without producing downward percolation. Moisture retention is attributed primarily to the holding forces of surface tension and capillary pressure. Percolation occurs when the magnitude of the gravitational forces exceed the holding forces (El-Fadel et al. 2002). In other words, leachate is formed when water passes through the waste strata into the landfill cell due to the precipitation (rain, melted snow) or the liquid from the decomposition of waste material.

The bottom of modern sanitary landfills is lined with impermeable layers, and the leachate is captured by the leachate collection system. Next, the leachate is pumped into the collection tanks.

### I.1.2. Composition of landfill leachates

The leachates are a mixture of high strength organic and inorganic contaminants including among others humic acids, ammonia nitrogen, heavy metals and inorganic salts (Oman and Hynning 1993, Chen 1996). According to Chistensen and co-workers (2001) the landfill leachate can be characterised as waters containing four groups of pollutants:

- i) Dissolved organic carbon – expressed as general characterisation parameters such as: Chemical Oxygen Demand (COD), Total Organic Carbon (TOC), Biochemical Oxygen Demand (BOD) or  $\text{CH}_4$ , volatile fatty acids (in particular in acidogenic phase), more refractory compounds fulvic-like and humic-like substances.
- ii) Inorganic compounds – Ca, Mg, Na, K,  $\text{NH}_4^+$ , Fe, Mn, Cl<sup>-</sup>,  $\text{SO}_4^{2-}$  and  $\text{HCO}_3^-$
- iii) Heavy metals: Cd, Cr, Cu, Pb, Ni and Zn
- iv) Xenobiotic organic compounds - (XOCs) originating from household or industrial chemicals and present in relatively low concentrations in the leachate (usually less than 1.0

mg/l of individual compounds). These compounds include among others a variety of aromatic hydrocarbons, phenols and chlorinated aliphatic, halogenated hydrocarbons, pesticides.

The composition of leachate depends on many factors such as age of landfill, climate, nature of deposited wastes, the degree of waste compaction, and construction of the landfill (Harrington et al. 1986). Moreover, seasonal variation in leachate concentration and leachate flow has been observed. This phenomenon is usually connected with current precipitation. (Chan 1996, El-Fadel et al. 2002).

Municipal landfills are composed of diverse components of waste of varying age which are subjected to spatially and temporally changing biochemical reactions. The data given in Table 1.1 is based on sample of leachates from landfills less than 25 years old (Christensen et al. 2001).

Table 1.1 Composition of landfill leachate (adapted from Christensen et al. 2001)

Parameter	Range	Unit
pH	4.5–9	
Specific conductivity ( $\mu\text{S cm}^{-1}$ )	2500–35 000	
Total solids	2000–60 000	mg/l
<i>Organic matter</i>		
Total organic carbon (TOC)	30–29 000	} mg/l
Biological oxygen demand ( $\text{BOD}_5$ )	20–57 000	
Chemical oxygen demand (COD)	140–152 000	
$\text{BOD}_5/\text{COD}$ (ratio)	0.02–0.80	
Organic nitrogen	14–2500	mg/l
<i>Inorganic macrocomponents</i>		
Total phosphorous	0.1–23	} mg/l
Chloride	150–4500	
Sulphate	8–7750	
Hydrogencarbonate	610–7320	
Sodium	70–7700	
Potassium	50–3700	
Ammonium-N	50–2200	
Calcium	10–7200	
Magnesium	30–15 000	
Iron	3–5500	
Manganese	0.03–1400	
Silica	4–70 <sup>b</sup>	
<i>Inorganic trace elements</i>		
Arsenic	0.01–1	} mg/l
Cadmium	0.0001–0.4	
Chromium	0.02–1.5	
Cobalt	0.005–1.5	
Copper	0.005–10	
Lead	0.001–5	
Mercury	0.00005–0.16	
Nickel	0.015–13	
Zinc	0.03–1000	

Several parameters of leachate change dramatically along with landfill age, stabilization process occurring in the landfill deposit. As a “young landfill” it is considered a landfill, which is up to 3 - 5 years old (Tab. 1.2). During this initial phase (so-called acidogenic), the intensive anaerobic degradation of organic wastes occurs. Consequently, high concentrations of readily biodegradable organic is formed (mainly volatile fatty acids Harmsen 1983 - 95% of VFAs, Edeline 1987- 95%) and BOD/COD ratio reaches its maximal level (Tab. 1.2). At the same time, pH can considerably decrease. It is due to organic compounds hydrolysis and its fermentation to primarily volatile fatty acids, hydrogen, and carbon dioxide. In the second phase, there is a transition in which mainly hydrogenotrophic methanogens starts to proliferate. The decrease of hydrogen partial pressure allows acetogenic bacteria to convert the alcohols and fatty acids (produced during the first phase) to acetic acid, hydrogen, and carbon dioxide. By contrast, the concentration of ammonia does not decrease, and often constitutes a major long-term pollutant in leachate (Christensen et al. 2001).

Table 1.2. Evolution in landfill leachate composition along with landfill age (adopted from: Henry et al. 1987, Amokrane et al. 1997, and Christensen et al. 2001)

Type	Young	Mature	Old
Landfill « Age »	< 5 years	from 5 to 10 years	> 10 years
pH	<6.5	from 6.5 to 8.0	> 7.5
Biodegradability COD/BOD <sub>5</sub>	High (0.7)	Moderate (0.5->0.3)	Weak (0.1)
Volatile Fatty Acids (VFA)	VFA > 80%	5% < VFA < 30%	-
Fulvic Acids Humic Acids	Poor	Moderate	High

In the later methanogenic phase (in so-called “old landfill”), the CH<sub>4</sub> production is significant. Consequently, the amount of organics (TOC, COD, and BOD) drastically decreases and pH increases in the leachate. At the same time, BOD/COD ratio reflecting biodegradability of the organic sharply declines. Thus, with age and stabilization process of landfill deposit, the biodegradable fraction of organic compounds (VFA) in leachates disappears and refractory compounds like fulvic and humic acids take their place (Chian 1977AB, Chen 1996, Kang et al. 2002).

Many researchers consider (Castagnoli et al. 1990, Calace et al. 2001, Kong et al. 2002, Nanny and Rastasuk 2002) that an evolution of humic and fulvic acids concentrations in leachate, with the ageing of landfill can be a determinant of humification degree of disposed wastes.

### I.1.3. Humic substances

Humic substances (HS) are structurally complex macromolecules found in soils, sediments and natural waters. They arise as a consequence of the plant breakdown and animal decay residues by microbial activities as well as abiotic processes. HS are produced by abiotic chemical reaction including condensation, polymerization, oxidation and reduction, by which relatively low molecules weight compounds, such as proteins, carbohydrates and lignin, are linked to each other.

These macromolecules have a yellow to black appearance and are the most representative part of stable organic carbon in biosphere. Frequently they occur as a major fraction (60-70%) of soil organic matter and 30-90% of surface water organic matter (Stevenson 1985, Corin et al. 1996, Jones and Bryan 1998, Calace et al. 1999).

Humic substances are also reactive fraction of lignite coal and peat, well-known for their therapeutic properties already in Babylonia and Roman Empire times. They have some therapeutically relevant characteristics such as antiviral, anti-inflammatory, estrogenic pro-fibolytic and heavy metals-binding activates (Klöcking 1994). Nowadays, humic acids are used in soil for improvement of plant growth by: i) clay disaggregation (makes soil less dense and less compact encouraging plant rooting); ii) water penetration enabled, iii) micronutrient transference (improves micronutrient exchange and transference to the plant's circulation system), iv) water sequestration (slows water evaporation from soils) ([http://www.phelpstek.com/clients/humic\\_acid.html](http://www.phelpstek.com/clients/humic_acid.html)).

Despite much research, the structure of HS is still not well characterised due to their heterogeneity, both in terms of structure and size and to their tendency to association in solutions as their concentration increases. They cannot be classified as any other chemical classes of compounds but they are frequently defined according to their solubility. Generally, HS can be divided into three classes as illustrated in Figure 1.2.

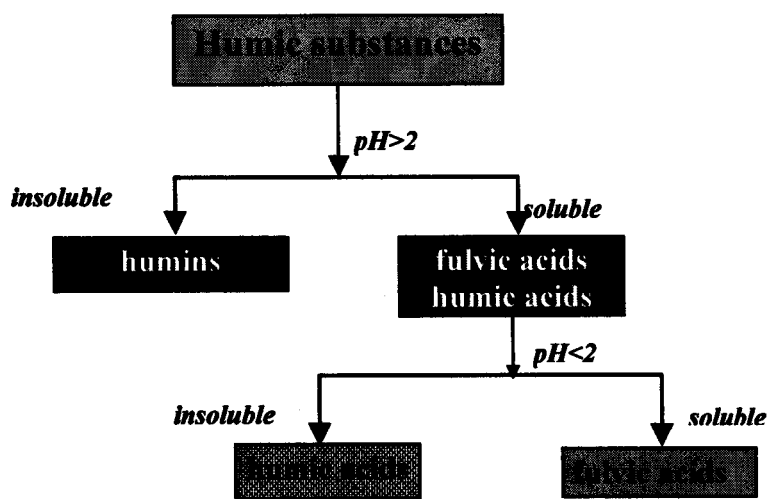

Figure 1.2 Separation scheme for HS

Fulvic acids (FAs) are materials soluble in water under all pH conditions. Humic acids (HAs) are soluble at  $\text{pH} > 2$  and humins are insoluble at all pHs. Thus, we will consider only fulvic and humic acids, which are dispersed or soluble in aqueous media. HS can also be classified according to molecular weight (Corine et al. 1996, Shin et al. 1999):

- FAs are lower than HA molecular-weight, usually amounting to above 2000 Da.
- HAs average molecular weight is 2000–5000 Da, (Alborzfar et al. 1998).

In literature can also be found a structure of humic substance proposed by Stevenson 1982 or Shulten and Schnitzer 1993 (Fig. 1.3). It was assumed that oxygen is present in different forms such as: carboxylic, phenolic and alcoholic hydroxyl; carboxylic ester and ethers, as well as nitrogen in heterocyclic structure and nitriles. It can be represented by an empirical formula of  $\text{C}_{308}\text{H}_{328}\text{O}_{90}\text{N}_5$  (Jones and Bryan 1998).

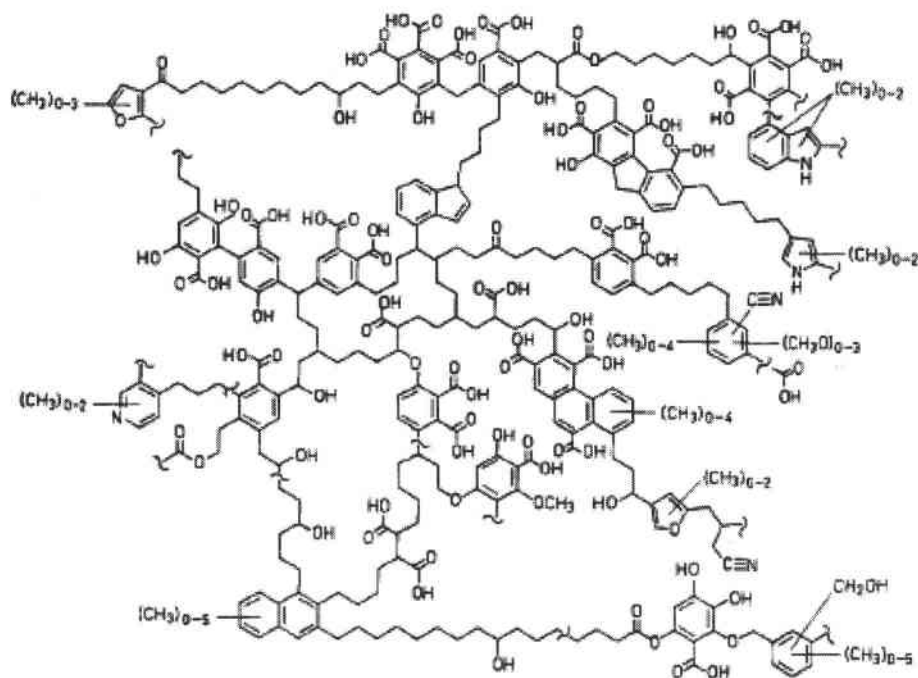

Figure 1.3 State of the art structural concept of a humic acid (Adapted from Schulten and Schnitzer 1993)

In the surface water there is relatively low concentration of HS (from few to dozens of ppm), but the role of these substances in water chemistry receives much attention in connection with water treatment. HS are known to be the precursors of mutagenic by-products (hazardous trihalomethanes) arising during chlorination of drinking water (Eggins et al. 1997, Wang et al. 2000A, Kim and Walker 2001). They also impart a brown/yellow colour to the water. For example, in Norway, as is reported by Ødegaard and colleges (1999), there are about 160 treatment plants designed specifically for removing humic substances from water.



As stated above humic substances remained in landfill leachate and their content depends on age of landfill. Nevertheless, the results concerning molecular weight distribution of these compounds are not unambiguous. For instance Artiola-Fortuny and Fuller (1982) reported that FAs are formed initially and HAs forms sequentially as the landfill is getting old. Authors reported that in methanogenic phase, 60% of the DOC content is humic-like material. On the other hand Kang and co-workers (2002) characterized different molecular weight fraction of HS present in landfill leachates with respect to age and they found higher content of smaller-molecular-weight fulvic acids in the samples from the oldest landfill. A similar result was obtained by Christensen and co-workers (1998). They characterized different fractions of leachate from "old landfill" and in the isolated fraction of DOC (83%) were found 60% of fulvic acids, 10 % of humic acids and 30 % of a hydrophilic fraction.

#### I.1.4. Environmental risk of landfill leachate

One of the most important features of humic substance HS is that their colloidal aggregates give rise to numerous potential binding sites for a wide range of materials (hazardous pollutants and biocides) which can be transported into the environment.

The molecular structure of HS sets both polar and nonpolar substituents, therefore these groups can interact both with water- soluble and insoluble compounds. It is well documented (Stevenson 1976, Smith et al.1991, Cezikova et al. 2001) that humic and fulvic acids extracted from soils, coals or concentrated from groundwater have a great capacity to bind metal cations. In these studies it was suggested that the primary metal binding sites are carboxylate, polyphenolic and nitrogen containing ligands. Referring to the studies performed by Cezikova et al. 2001 the affinity of HS to cations can be arranged in the order:  $Pb > Cu > Cd > Ba > Ni \approx Zn \approx Co \approx Mn > Mg > Ca$ . On the other hand, it has been shown that HS can complex organic pollutants such as benzopyren, pentachlorophenol (DePaolis and Kukkonen. 1997) pesticides/herbicides (Ertuç et al. 2002) and phenanthrene (Lassen and Carlsen 1997) as well as other PAHs (Lee al. 2003). Various binding mechanisms between organic contaminants and humic-like material were proposed. Hydrogen bonding, van der Waals forces, ligand exchange, and charge transfer complexes represent weak binding energies whereas covalent linkages represent chemically stable bonds.

Thus, the presence of humic substances can actually increase the toxicity of a system by inhibiting the precipitation or retention of hazardous contaminants (i.e. heavy metals, xenobiotics) and retaining it in solution. For the humic substances from landfill site this effect were studied with metals (Christensen et al. 1996, Jensen and Christensen 1999) and hydrophobic organic compounds (Bauer and Herrmann, 1998, Martinen et al. 2003).

Actually, the binding strength of HS is strictly associated with parameters such as ionic strength, pH and overall composition of the solution. Christensen and co-workers (1996,

2001) pointed out that potentially, the ability to form a complex of DOC in landfill leachate with heavy metals (Cd, Ni, Pb, Cr and Zn) may have different characteristics from humic and fulvic acid extracted from surface water or groundwater. The high ionic strength and high concentrations of competing cations, as found in leachate, may affect the ability of DOC to form complexes. Under methanogenic phase, anaerobic conditions, soluble metals precipitate as especially insoluble sulfides, but also carbonates, hydroxides and possibly phosphates in landfills.

Jensen and Christensen (1999) found a considerable but highly varying part of the heavy metals (Cd, Ni, Zn, Cu, Cr, Pb) associated favourably with the small colloidal fractions (0.001 and 0.40  $\mu\text{m}^1$ ). The highest affiliation for dissolved organic matter has Pb and Cu. Thus they can be potentially transported into the environment.

However, Christensen and co-workers (2001) support that heavy metals present in leachate do not consist a groundwater pollution problem because municipal leachate contain only modest heavy metal concentrations and the metals are subjected to strong attenuation by sorption and precipitation.

Many of the organic pollutants, such as phthalates and PAHs, in wastewaters are hydrophobic and thus are readily adsorbed on particles and in dissolved humic substances (Marttinen et al. 2003). On the other hand, Ertunc and co-workers (2002) suggested that in the mature stage of humification, the bound xenobiotic moieties become an integral part of the organic matter and accordingly they do not constitute an environmental risk for groundwater. Christensen et al. (2001) pointed out that more than 1000 organic XOCs have been identified and XOCs may constitute a very significant group of leachate contaminants, although they constitute only very little of the total DOC. Some of XOCs, such as PAHs are generally recalcitrant in strongly reducing conditions, others like chlorinated aliphatic carbon are susceptible to being degraded. However, XOCs fate and correlation with the other biogeochemical reactions in the plume is not yet fully understood.

It could be assumed that leachate from municipal landfills are susceptible of biological treatment. Surmacz-Górska (2001) reported no inhibitory effect of municipal landfill leachate collected in region of Upper Silesia (Poland) on non-acclimated activated sludge from WWMTPs<sup>2</sup>. The OUR (oxygen uptake rate) determined on the samples of leachate revealed an increase of activity of microorganisms in contact with the leachate sample. That result was confirmed by the dehydrogenase activity (metabolic activity of microorganisms).

The incising level of nitrite/nitrate nitrogen in groundwater due to leachate percolation from landfill leachates or discharges of negligently treated leachate has become a major concern, because of its health effect i.e. infant methaemoglobinemia and the possible formation of nitrosoamines, which could have carcinogenic effects (Aps 1991, Shrimali and

<sup>1</sup> These colloids would have been characterized as dissolved, if the filter used for sampling had been the commonly used filter separating at 0.45  $\mu\text{m}$

<sup>2</sup> WWMTPs – Wastewater Municipal Treatment Plants

Singh 2001). Moreover, environmental problems associated with excessive amounts of un-ionized ammonia ( $\text{NH}_3$ ), is potentially toxic to many aquatic and marine organisms. In addition, eutrophication of surface waters is frequently linked with elevated N concentrations, especially in coastal and estuarine environments.

## I.2. Landfill leachate treatment methods

The EU Landfill Directive (1999/31/EC) aims at improving standards of landfilling across Europe, through setting specific requirements for the design, operation and aftercare of landfills, and for the types of waste that can be accepted in landfills. The generated leachate is collected and must be appropriately treated before being discharged into the environment.

The options for treatment include recirculating the leachate back to the landfill, treating for sanitary sewer discharge, or treating for local surface water discharge. The treatment of landfill leachate together with municipal wastewater is not advised due to the accumulation of hazardous compounds, (XOCs, heavy metals) from the leachates in the activated sludge during the treatment process). It makes the use of this sludge as fertiliser in agriculture impossible (Welander et al. 1998, Marttinen et al. 2003).

Technologies meant for leachate treatment can be classified as follows i) biological methods, ii) chemical and physical methods. However, in order to meet strict quality standards for direct discharge of leachate into the surface water, a development of integrated methods of treatment, i.e. a combination of chemical, physical and biological steps, are required.

### I.2.1. Generalities on biological methods

#### *I.2.1.1 Biological treatment processes*

Regardless of the type of wastewaters, the biological treatment process consists in controlling the environment required for optimum growth of the microorganisms involved. The microorganisms are used to convert the colloidal, dissolved carbonaceous organic matter and inorganic element (such as N, P, S, K, Ca, Mg) into cell tissue or/and into the various gases.

Most biological treatment processes are made up of complex interrelated, mixed biological populations adapted to removal of individual pollutants. When designing or analyzing a biological treatment process, the engineer should think in terms of an ecosystem or community, and not in terms of a “black box” that contains mysterious microorganisms (Metcalf and Eddy 1991).

The control relationships parameters such as cell residence time (sludge age), food-microorganism ration (F/M), hydraulic retention time (HRT), sludge volume index (SVI) etc. allow to assess operating conditions of biological system (see *section II.3.1.5*).

The principal biological process presented below (*activated sludge and biological filter*) has been known quite well and is successfully applied for domestic wastewater. However, for industrial effluents or leachate, the conventional approach for treatment requires some modifications. Depending on the wastewater and the standards which they have to meet, different process design and/or operational control parameters must be considered. At first the laboratory scale approach is needed.

### ***1.2.1.2 Rotating Biological Contactors***

The *rotating biological contactor* is an example of biological filter (attached growth) technology. It consists of circular plastic discs mounted centrally on a common horizontal shaft. These discs are approximately 40 percent submerged in a tank containing wastewater and are slowly rotated by either a mechanical or a compressed air drive. Microorganisms from the wastewater adhere to the plastic disc surfaces and, within 1 to 4 weeks from start-up, form a biofilm ranging from 1-2 mm in thickness. This biological growth assimilates organics from the wastewater passing over the surface of the disc and is responsible for most of the treatment which occurs. When the disc rotates out of the wastewater, the biofilm becomes exposed to air and is oxygenated, thereby maintaining aerobic conditions. After reaching a critical thickness, portions of the biofilm slough off the discs.

The disc rotation serves many purposes, including providing contact between the biomass and wastewater, shearing of excess biomass, mixing of the mixed liquor, and aeration of the wastewater. For many case an optimal rotation speed is of about 2 rpm for a 3 m diameter disc. However, taking in to account power requirements (increasing exponentially with increases of in media velocity) a rotational speed of 1.5 to 2.0 rpm is considered a practical upper velocity limit to use, even when trading high strength waster (Bishop and Kinner 1986).

### ***1.2.1.3 Aerobic Activated Sludge***

The principle of activated sludge is that in a reactor a community of microorganisms is constantly supplied with organic matter and oxygen. The microorganisms consume the organic matter and transform it by means of aerobic metabolism, partly into new microbial biomass and partly into carbon dioxide, water, and minerals. The flow of the water brings about a constant wash-out of the microorganisms from the reactor to the settler. Here, the microorganisms, which grow in flocs and have acquired a density sufficient to decant, are

retained and then removed with the underflow. Part of this sludge is then recycled to provide biomass to treat the new influent. The surplus amount is discharged.

First, the active biological component comprises not a pure culture but an association of bacteria, yeast, fungi, protozoa, and higher organisms such as rotifers. These organisms grow on the incoming waste and interact with one another.

The reactions occurring in the activated sludge process can be summarized as follows:

1. Sorption of soluble, colloidal, and suspended organics in and on the sludge flocs.
2. Biodegradation (oxidation) of the organics resulting in the end-products ( $\text{CO}_2$ ,  $\text{H}_2\text{O}$ , minerals) and synthesis of new microbial biomass (Equation 1.1).

*Bacteria*

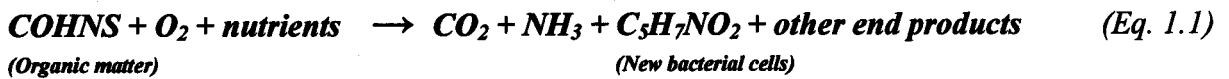

In aerobic treatment about half of the organic carbon is assimilated into the biomass while the other half is respired to form  $\text{CO}_2$  (Schönborn 1986, Verstraete and Vaerenbergh 1986)

3. Ingestion of bacteria and possibly of other suspended matter by protozoa or other predators.
4. Oxidation of ammonium to nitrite and further to nitrate by the nitrifying bacteria.
5. In moments of insufficient supply of energy (=waste): oxidation of cell reserves (internal and also external) resulting in sludge mineralization and lyses (Verstraete and Vaerenbergh 1986, Metcalf and Eddy 1991)

Advantages and disadvantages of both systems are summarized in Table 1.3

Table 1.3 Advantages and drawbacks of intensive approaches (Cartel internet site, Metcalf and Eddy 1991, Loukidou and Zouboulis 2001)

	Advantages	Drawbacks
- RBCs	<ul style="list-style-type: none"> <li>- low energy consumption;</li> <li>- simple operation requiring less maintenance and monitoring than the activated sludge technique;</li> <li>- good settling characteristics of the sludge;</li> <li>- lower sensitivity to load variations and toxins than activated sludge;</li> <li>- the effect of staging in this plug-flow system eliminates short circuiting and dampens shock loading</li> <li>- generally adapted to small communities;</li> <li>- resistance to cold (the discs are always protected by hoods or a small chamber).</li> </ul>	<ul style="list-style-type: none"> <li>- performance is generally lower than with an activated sludge technique. This is mostly due to former design practices.</li> <li>- A more realistic dimensioning should allow satisfactory quality of treated water to be reached;</li> <li>- rather high capital costs (can be greater by about 20% compared to activated sludge).</li> </ul>
Activated sludge	<ul style="list-style-type: none"> <li>- adapted to any size of community (except very small ones);</li> <li>- good elimination of all the pollution parameters (SS, COD, BOD<sub>5</sub>, N by nitrification and denitrification);</li> <li>- adapted to the protection of sensitive receiving areas;</li> <li>- partially-stabilised sludge;</li> <li>- easy to implement simultaneous dephosphatation.</li> </ul>	<ul style="list-style-type: none"> <li>- relatively high capital costs;</li> <li>- high energy consumption;</li> <li>- requires skilled personnel and regular monitoring;</li> <li>- sensitivity to hydraulic overload;</li> <li>- the settling property of sludge is not always easy to control;</li> <li>- high production of sludge that must be thickened.</li> </ul>

### 1.2.1.4 Process involving N removal: Nitrification /Denitrification/ Anammox

Three major biological processes directly involved with biological nitrogen removal in wastewater treatment are: *ammonification, nitrification/denitrification and anammox.*

*Ammonification* occurs when organic nitrogen is converted to ammonia. It is an important mechanism that ultimately allows organic nitrogen to be removed from wastewaters through hydrolysis to amino acids, which are broken down to produce ammonium or directly incorporated into biosynthetic pathways in support of bacterial growth.

*Nitrification.* Ammonia is oxidized to nitrate in the environment and in biological wastewater treatment by two groups of chemo-lithotrophic bacteria which operate in sequence. The first group of bacteria in this process of nitrification, represented principally by members of the genus *Nitrosomonas* (Equation 1.2), oxidize ammonia to nitrite which is then further oxidized to nitrate by the second group, usually represented by members of the genus *Nitrobacter* (Equation 1.3). These oxidations can be written as:



and overall

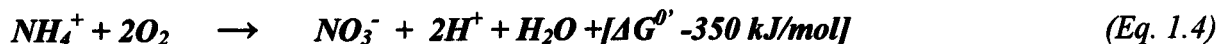

The energy released in this oxidation is used to synthesize cell material from hydrogen carbonate. As a consequence of the relatively low amount of energy released and the high amount of energy required for cell synthesis, the cell yield is quite low.

Two other important aspects of the process are the requirement for oxygen and the liberation of hydrogen ions.

a) *Oxygen demand* in nitrification is an important feature in treatment plant aeration system design and may also be important in water receiving effluents from treatment plants.

b) *Acid production* during nitrification may result in depression of the pH in poorly buffered wastewater and lead to loss of process stability. Approx. 8.64 mg HCO<sub>3</sub><sup>-</sup> (alkalinity) and 4.3 mgO<sub>2</sub> per mg of ammonia oxidation to nitrate is needed (Metcalf and Eddy 1991).

The general requirements for growth of the nitrifiers can be summarized as follows:

- pH range: 5.5-9.0<sup>3</sup>; at pH values below 7.0, optimum pH=7.5
- dissolved oxygen min 1.0 mg/l,
- temperature: 5-40°C,
- level of free ammonia and free nitrous acid (Verstraete and Vaerenbergh 1986).

During the aerobic treatment, only a minor part of ammonia is fixed in the newly formed microbial biomass. Therefore it is generally advisable to remove the NH<sub>4</sub><sup>+</sup> in the highly

<sup>3</sup> pH tolerance strictly depends on ammonia or/and nitrite concentrations in the treated wastewaters

contaminated wastewater in order to avoid toxicity to fish life ("free ammonia" is toxic to fish at a concentration of 1.0 mg/l) (Verstraete and Vaerenbergh 1986) or other adverse effects (see section I.1.4).

One of the main problems encountered during the treatment of wastewaters with high ammonia concentration such as landfill leachate (Shiskowski and Mavinic 1998, Im et al. 2001, Yalmaz and Öztürk 2001) or industrial effluent from fertilizer, urea plant (Gupta and Sharma 1996) or sludge reject water (Ghyoot et al. 1999) is related to the arising of free ammonia and free nitrous acid toxicity. Anthonisen and co-workers (1976) determined the levels of free ammonia and free nitrous acid that are inhibitory to *Nitrosomonas* and *Nitrobacter*. *Nitrosomonas* became inhibited at free ammonia levels of between 10 and 150 mg/l as N, while *Nitrobacter* became inhibited at free ammonia concentrations between 0.1 and 1.0 mg/l as N. Free nitrous acid (unionized nitrite) became inhibiting to *Nitrobacter* between 0.22 and 2.8 mg/l as N.

As the nitrifiers develop their adaptation ability, the loading rate can gradually be increased. Loadings up to 1.5 g  $\text{NH}_4^+$ -N per l per day are possible provided the pH is strictly controlled in the 7.0-7.5 region (Verstraete and Vaerenbergh 1986). The maximal efficiency of ammonia removal was reported by Campos and co-workers (2002) successful nitrification of 3300 mg/l (4 g  $\text{NH}_4^+$ -N/l\*d) of synthetic ammonia feed in activated sludge system.

However, in that case a long acclimation period amounting to 4.3 months was needed and the system was operated at stable pH equalled to 7.8 and DO was maintained above 2.0  $\text{mgO}_2/\text{l}$ . Moreover, extremely high biomass concentration equal to 20 g MLVSS/l would be difficult to maintain in the real installation due to mass transfer limitation and/or high expenses of pumping, recycling and halogenations of mixed liquor in the bio-reactor.

The experiments on the real leachate report successful ammonia oxidation from the influent of 800-1000  $\text{mgNH}_4^+$ -N/l in SBR (sequencing batch reactor) (Yalmaz and Öztürk 2001) or up to 1700  $\text{mgNH}_4^+$ -N/l, but at loading rate not exceeding 0.75 g  $\text{NH}_4^+$ -N/l\*d (Im et al. 2001). It should be noted that control of DO as well pH (provided by inserting of buffer  $\text{HCO}_3^-$ ) is crucial in order do not to fail nitrification process.

*Denitrification* is the second step in the removal of nitrogen by nitrification/denitrification process. This is a process by which nitrate functions as an acceptor of reducing equivalents and dissimilates to nitrogen gas: ( $\text{NO}_3^- \rightarrow \text{NO}_2^- \rightarrow \text{NO} \rightarrow \text{N}_2\text{O} \rightarrow \text{N}_2$  Nitrite /Nitrite oxide/nitrous oxide/ nitrogen gaze). The principal routes by which nitrate reaches surface water are domestic, industrial effluents, leaching and run-off from agricultural soils. Some industrial effluents such as fertilizer, explosive/propellant manufacture and synthetic fibres industry contain high concentrations of nitrate (Eckenfelder and Musterman 1995), while others (e.g. landfill leachate) generate nitrites by nitrification.

Denitrifiers are heterotrophs and use organics for synthesis and energy nitrate reduction.



The denitrification consumes approx. 3.7 g bCOD/g NO<sub>3</sub>-N reduced (Chiu and Chung 2003) and produces 0.45 g-new cell and 3.57g of alkalinity per g NO<sub>3</sub>-N reduced (Eckenfelder and Musterman 1995).

Denitrification is brought about by a great variety of bacteria. Some of the most important genera are *Pseudomonas*, *Alcaligenes*, *Acinetobacter*, *Hyphomicrobium*, and *Thiobacillus*, *Lactobacillus* and *Spirillum* (Metcalf and Eddy 1991). These bacteria are facultative aerobes. They utilize a respiratory cytochrome system and produce energy by electron transfer phosphorylation. When oxygen is present, they use it as electron acceptor. When it is absent, they modify the cytochrome system and utilize nitrate. They are not facultative anaerobes since they cannot use organic compounds as terminal electron acceptors or gain energy by substrate level phosphorylation (fermentation). The environmental factors governing denitrification are:

- temperature: range 5-60°C,
- pH: range 6-8, below 6 incomplete reduction can occur and the undesirable nitrite ion can accumulate.
- DO concentration: the supply of dissolved oxygen to the cells must be limited. Consequently, DO in biological reactor should be maintained below the value of 0.5 mgO<sub>2</sub>/l.
- availability of an appropriate electron donor. The most obvious source in the biodegradable waste material (bCOD) itself.
- availability of nitrate as electron acceptor (Verstraete and Vaerenbergh 1986)

The most important issue concerning N removal (in the system treated landfill leachate) is to ensure an appropriated C/N ratio. The biological process is especially efficient in treatment of young landfill leachates that are rich in volatile fatty acid. For instance, Im and co-workers (2001) obtained complete N removal from landfill leachate by means of simultaneous denitrification/metanogenesis in anaerobic reactor and nitrification. Then COD/N ration amounted to 14 and consequently organic present in raw leachate was used as a carbon source. On the other hand, when treating leachates characterized by high level of ammonia -N and low levels of biodegradable organics, a supplementary source of organic carbon is needed (Spengel and Dzombak 1991, Iliés and Mavinic 2001). For the stabilised leachate (BOD<sub>5</sub>/N) amounting to 0.2 Welander and co-workers (1998) and Loukidou and Zouboulis (2001) accomplished complete denitrification by using methanol and an external



carbon source in the dosage of 4 g COD per g of  $\text{N-NO}_3^-$ . Higher COD/N- $\text{NO}_x$  equalling to 5.9 ratios was reported by (Yalmaz and Öztürk 2001). Nevertheless, there were no studies demonstrating the possibility of use raw leachate as a carbon source for denitrification with respect to BOD/N ration evolution in leachate along maturing landfill.

In the past few years, the processes of *partial nitrification*, oxidation of wastewater ammonium to nitrite (but not to nitrate) arouse sciences and researcher's interest. To achieve partial nitrification, the subsequent oxidation of nitrite to nitrate must be prevented. Partial nitrification can be combined with the *anammox* process (Fig.1.4a, Equation 1.7) (Hellings et al. 1998), but even if it is combined with conventional denitrification (the so called "nitrite route"), already a significant benefit is achieved in terms of use of resources (Walender et al. 1998).

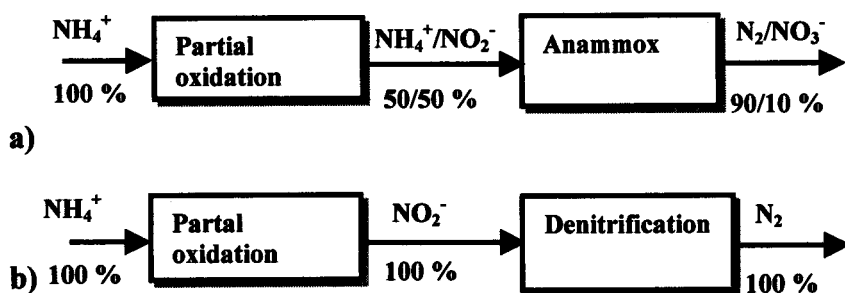

Figure 1.4 Flux diagram of (a) partial nitrification/denitrification, (b) partial nitrification/anammox

The process needs less aeration, the subsequent denitrification consumes less COD (chemical oxygen demand), since only nitrite and not nitrate has to be reduced to molecular nitrogen ( $\text{N}_2$ ). This is cost-effective if the low C/N ratio of the wastewater necessitates the addition of a synthetic electron donor, such as methanol, ethanol acetic acid (Turk and Mavinic 1989). In that case, the process also emits less  $\text{CO}_2$  to the atmosphere (Schmidt et al 2003). Bae et al. (1997) reported decrease of organic carbon requirement for denitrification via nitrite during N removal from landfill leachate.

*Anammox*. The *anaerobic ammonium oxidation* process is a novel, promising, low-cost alternative to conventional denitrification systems (Graaf et al. 1996, Strous et al. 1998). The process consists in the conversion of ammonia to dinitrogen gas with nitrite as an electron acceptor.



The physiology of the anaerobic ammonia oxidizer '*Candidatus Brocadia anammoxidans*' was studied in details (Strous et al. 1998). It has a very high affinity for the substrates ammonia and nitrite. The process is reversibly inhibited by oxygen and irreversibly by nitrite (at concentrations superior to 70 mg N g/l for several days) and phosphate (60 mg

>P for several days) (Hellings et al. 1998). *Candidatus Kuenenia stuttgartiensis* has a higher, but still low, tolerance to nitrite (180 mg N/l) and phosphate (600 mg P/l) (Egli et al 2001). Both bacteria have a similar temperature (37°C) and pH (8) optima.

The biochemistry of the anammox bacteria is not yet completely resolved. One of the main challenges of the anammox process is the long start-up time. Because the anammox planctomycetes grow so slowly, it takes between 100 and 150 days before an anammox reactor inoculated with activated sludge reaches full capacity (Strous et al. 1997).

The first full-scale anammox reactor is currently being built in Rotterdam, the Netherlands, as an addition to the SHARON (Single reactor High activity Ammonia Removal over Nitrite) reactor that is already in place (<http://www.anammox.com/application.html>). For simplicity, nitrification and denitrification are performed in one reactor, by switching the aeration on and off (Hellings et al. 1998). The reactor is estimated to have a return on investment of less than 7 years, because addition of methanol (currently used to sustain the denitrification) will no longer be required (Schmidt et al. 2003).

There are very few papers concerning anammox process for landfill leachate treatment. Helmer and Kunst (1998) found up to 90% nitrogen loss in RBC system during the treatment of stabilised leachate containing 250 mg/l of ammonia. Authors attributed that phenomenon to the occurrence of *Nitrosomonas europaea* which are able to denitrify in the presence of small amount of DO. Seigrist and co-workers (1998) ascribed nitrogen loss in RBC to anammox process.

#### ***1.2.1.5 Natural Systems -treatment on Land and Lagoons and Wetlands***

These techniques are based on the natural attenuation processes occurring in soils and water environments respectively. The leachates are sprayed over peat field, bogs (utilizes the natural capacity of the soil system to aerobically degrade, assimilate, and immobilize certain waste constituents). Otherwise, the leachate is introduced into the lagoons (shallow ponds) or wetlands where the natural capacity of the plant species and algae photosynthesis is utilized.

This kind of treatment is advised only as a polishing stage of landfill treatment after a main treatment process or for relatively low flows of weak (contaminated) leachate. The major advantage of the treatment is its low investment and operational cost, simplicity and the fact that no large operating staff is needed. The efficiency of treatment is highly connected with climate conditions, and for example in winter (at lower temperatures), the effects of purification significantly decrease. Moreover, these techniques require large areas for its operating (Harrington and Maris 1986, Rosik-Dulewska 1999, Heavey 2003)

### 1.2.1.6 Anaerobic Systems

Anaerobic digestion is the oldest process used in wastewater treatment (it has been used since the end of 19 century) (Schönborn 1986). The process involves biological decomposition of organic and inorganic matter in the absence of molecular oxygen. As a result of conversion a variety of end products including methanol (CH<sub>4</sub>) and carbon dioxide (CO<sub>2</sub>) is produced. Conventionally, an anaerobic reactor has mostly been installed in leachate treatment process for treating high-loading organic compounds discharged from young landfill site (Henry et al. 1987, Im et al. 2001). Then, leachate is characterised by values of BOD levelling to several thousands milligrams per litre, and the organics are in form of VFAs and low molecular simple aliphatic compounds vulnerable to fermentation. Different reactors can be used, such as AF (Anaerobic Filters) (Henry et al. 1987), ASBR (Anaerobic Sequencing Batch Reactor) or UASB (Up-flow Anaerobic Sludge Blanket) (Im et al. 2001). The main advantages and disadvantages of the system during the treatment of landfill leachate are given in Table 1.4

Table 1.4 Main advantages and drawbacks (Edeline 1987, Timur and Öztürk 1997)

Advantages	Drawbacks
<ul style="list-style-type: none"> <li>- high efficiency of concentrated substrate removal (&gt;90 % of BOD)</li> <li>- lower dose of P needed as a “growth factor” for anaerobic bacteria</li> <li>- low production of surplus sludge</li> <li>- low energy use</li> <li>- biogas production</li> </ul>	<ul style="list-style-type: none"> <li>- heavy metals can hamper digestion</li> <li>- ammonia toxicity</li> <li>- susceptible to pH and temperature changes</li> <li>- high ammonia remaining in effluent</li> </ul>

It should be noted that similar anaerobic processes occurred in the landfill deposit, including production of biogas (methanogenic phase). Consequently, a decrease of anaerobic treatment efficiency after the first 5 years of proceeding is observed, which means that for stabilised leachate this method is inefficient.

### 1.2.1.7 Aerobic Systems

As reported above, treatment of leachate can be performed in suspended growth microorganisms - activated sludge (*section 1.2.1.3*) as well as attached growth microorganisms (*section 1.2.1.2*). Both systems commonly applied for municipal wastewaters treatment are adapted to treat leachate from mature or stabilised landfills. The main advantages as well as disadvantages in respect to treated LL have already been illustrated above in Table 1.3.

For the suspended sludge system (activated sludge) a new approach has been proposed. It is well-known that the final performance of the activated sludge process depends mostly on

good solid- liquid separation between treated water and sludge in the final clarifier (Verstraete and Vaerenbergh 1986). It was reported that the insertion of additives such as talk (Rasmussen et al. 1996, Seka et al. 2001), plastic carriers (Welander et al. 1998, Roston et al. 2001) or granular activated carbon (Loukidou and Zouboulis 2001) into the AS reactor can improve settling sludge properties and allow to retain the microorganisms in the system. Nevertheless, bentonite as an additive into AS system has never been examined for the treatment of landfills leachate.

Apparently, microorganisms attached on suspended carrier possess some advantages over conventional activated sludge system such as fast removal of pollutants, and biological filter such as less negative effect of low temperature and toxic agents. Additionally, in the case of activated carbon, the porous material enhances adsorption of the substrate (which can also be used by attached growing microorganisms) (Loukidou and Zouboulis 2001). Increased activated carbon concentrations added to biological reactor resulted in more effective COD removals (Kargi and Pamukoglu 2003) which can be an opportunity for extra removing of refractory organic from the treated leachate. Nevertheless, taking into account the large amount of residue (sludge and activated carbon) which needs to be treated, the operational cost of leachate treatment will be significantly increased.

## 1.2.2 Physico-chemical techniques

Physico-chemical methods are used along with the biological methods mainly to improve treatment efficiency or make them possible when the biological oxidation process is hampered by the presence of bio-refractory materials. The techniques are applied for removing non-biodegradable (humic, fulvic acid) and/or undesirable compounds (heavy metals, AOXs, PCBs...) from the leachate.

### 1.2.2.1. Coagulation-Flocculation

Several studies reported on the examination of coagulation–flocculation for the treatment of landfill leachates, aiming at performance optimization, i.e. selection of the most appropriate coagulant, determination of experimental conditions, assessment of pH effect and investigation of flocculant addition. Aluminium sulphate (alum), ferrous sulphate, ferric chloride and ferric chloro-sulphate were commonly used as coagulants and addition of flocculants together with coagulants enhances the floc-settling rate (Ehrig 1984, Amokrane et al. 1997, Tatsi et al. 2003). Amokrane and co-workers (1997) indicated that the percentage of COD and TOC removal obtained by this process was generally 10-25% with young leachates, but it was highest (50-60%) for stabilised leachate (low BOD/COD ratio) in acidic medium.

Similarly, Tatsi and co-workers (2003) recently obtained a higher effectiveness of COD removal amounting to 75% for partially stabilised leachates than for young leachate (25–38%). However, it should be pointed out that the initial COD concentration were different and amounted on average 5350 mg COD/l and 70900 mg/l, for partially stabilised and young leachates respectively.

Lime milk and sodium hydroxide are well-known as precipitants for heavy metals, and can be used for pH control during coagulation with Al and Fe salts. However, lime is not advised if reverse osmosis is applied subsequently, due to the possible fouling effect of membrane by CaCO<sub>3</sub> (scaling) (Amokrane et al. 1997). The literature survey reports the attempts of using coagulation–photooxidation treatment process. It resulted in 64% of COD removal and 90% of colour removal from stabilised leachate.

#### ***1.2.2.2. Adsorption***

The adsorption process is used as a stage of integrated chemical–physical–biological process for landfill leachate treatment (Morawe et al. 1995, Geenens et al. 2001), or simultaneously with a biological process (Loukidou and Zouboulis 2001, Kargi and Pamukoglu 2003). The most frequently used adsorbent is granular or powdered activated carbon. Carbon adsorption permits 50-70% removal of both COD and ammonia nitrogen (Amokrane et al. 1997). Consequently, activated carbon adsorption aim is to i) ensure final polishing level by removing toxic heavy metals or organics i.e. AOXs, PCB, etc, ii) support microorganisms.

Other materials, tested as adsorbents, have given treatment performances close to those obtained with activated carbon. These are zeolite, vermiculite, illite, keolinite, activated alumina and municipal waste incinerator bottom ash (Chian and Dewalle 1976, Amokrane et al. 1997).

#### ***1.2.2.3. Membrane process***

The membrane processes consist in separating two solutions with different concentrations by a semi-permeable membrane. In this process, pressure is added to the more concentrated solution, forcing the water to flow from the higher concentration to the lower concentration. Microfiltration and ultrafiltration, operated singly or in combination with reverse osmosis and nanofiltration are membrane processes applied in landfill treatment (Bodzek 1997, Weber and Holz 1991, Trebouet et al. 2001).

Due to the high ability of modern high-rejection osmosis membranes (DT-Module) to retain both organic and inorganic contaminates, an efficiency levelling 98-99% can be achieved (Peters 1998).

One of the major disadvantages of these membrane processes is fouling or biofouling of the membrane, induced by deposits of inorganic, organic and microbiological substances on both the membrane surface and inside the membrane pores. Extensive membrane fouling leads to a pronounced decrease in permeate flux and can threaten the economic efficiency of the membrane plant (Schlichter 2003). Successful application of membrane technology for the treatment of the landfill leachate requires an efficient control of membrane fouling (Trebouet, et al. 2001 Bodzek 1997).

The removal of potential foulants including dissolved organic and inorganic substances, colloidal and suspended particles can be achieved by pH adjustment, pre-filtration and coagulation. Frequently, RO is preceded by biological pretreatment (Weber and Holz 1991), lime precipitation or coagulation-flocculation (Amokrane 1997) or hybrid systems combining biological and chemical oxidation treatment (Bohdziewicz et al. 2001).

It should be noted that using membrane techniques (in particularly RO, NF) for highly contaminated wastewater effluents, a problem of retentate production arise, which needs to be further treated. The neutralization (including evaporation, drying and incineration) of retentate has to be taken into account in the overall cost of the technology.

Nevertheless, the reverse osmosis techniques are considered as a well defined barrier. The purification process itself can be controlled continuously and with a high degree of security by simple and precise measurement. Membrane filtration has proved to be a justifiable and economic solution in the cases, even when the overall costs for the purification are comparable with other approaches for the treatment of landfill leachate (Peters 1998). Confirming this assertion, many real installations are operating all over the world based on the membrane techniques alone, as in Holland (Bodzek 1999), or as methods combined with other techniques: Germany (Weber and Holz 1991), France (Poitel et al. 1999), Korea (Ahn et al. 2002) or Japan (Ushikoshi et al. 2002). The efficiency of membrane as techniques incorporated in the multistage system will be further discussed in the following section.

#### ***1.2.2.4. Chemical oxidation, AOP processes***

Chemical oxidation is required for the treatment of wastewater containing soluble organic (which cannot be removed by physical separation), non-biodegradable and/or toxic substance (for biological oxidation) (Marco et al. 1997). As Amokrane and co-workers (1997) reviewed, commonly used oxidants such as chlorine, ozone, potassium permanganate and calcium hydrochloride for landfill leachate treatment resulted in COD removal of around 20-50%. The most processes based on direct reaction of oxidant ( $O_3$  -selective) with contaminates or *via* generated hydroxyl radicals ( $^{\circ}OH$ ). The hydroxyl radical is a second strongest oxidant (after flour) and non-specific oxidant (comparing to  $O_3$ ), and is therefore able to rapidly oxidise a large number of recalcitrant molecules.

Advanced oxidation processes (AOP's) have been proposed in recent years as an effective alternative for mineralization of recalcitrant organics in landfill leachate (Hand book on AOPs 1998). The main purpose of AOPs (Huang et al. 1993) is to enhance chemical oxidation efficiency by increasing generation of hydroxyl radicals. These processes include both:

*Non-photochemical* -methods generating hydroxyl radicals without light energy

- Ozonation (O<sub>3</sub>) at elevated pH (> 8.5)
- Ozone + hydrogen peroxide (O<sub>3</sub>/H<sub>2</sub>O<sub>2</sub>)
- Ozone + catalyst (O<sub>3</sub>/catalyst)
- Fenton process (H<sub>2</sub>O<sub>2</sub>/Fe<sup>2+</sup>)

*Photochemical methods*

- O<sub>3</sub>/UV
- H<sub>2</sub>O<sub>2</sub>/UV
- O<sub>3</sub>/H<sub>2</sub>O<sub>2</sub>/UV
- Photo-Fenton
- Photocatalysis (UV/TiO<sub>2</sub>)

For instance, decomposition of H<sub>2</sub>O<sub>2</sub>, using ferrous iron (Fe(II)) under acidic (pH=3) conditions yields °OH and is known as a Fenton reagent (Fenton 1884). The efficiency of COD removal by using a Fenton reagent varied from 60% (Lopez et al. 2004) to 75% (Kang and Hwang 2000, Surmacz-Górska 2001) for mature and biologically pre-treated leachate respectively. But generally, with increase of molecular weight of DOC fraction a percent of organic removal increases (Yoon et al. 1998).

The rate of removal of organic pollutants and the extent of mineralization using the Fe(II)/H<sub>2</sub>O<sub>2</sub> reagents are considerably improved by irradiation with near-UV radiation and visible light (Kim et al. 1997). For biologically pre-treated leachate Kim and co-workers (1997) achieved maximum degradation amounting to 80%.

Beyond global parameters such as COD or TOC a control of specific organic pollutants is needed in order to meet requirements for discharge. Wenzel and co-workers (1999) studied the efficiency of different systems, i.e. UV/O<sub>3</sub>, UV/H<sub>2</sub>O<sub>2</sub>, UV/H<sub>2</sub>O<sub>2</sub>/O<sub>3</sub> for biologically pre-treated leachate. Yet, the removal 51 %of TOC (from initially 430 mgC/l) in UV/O<sub>3</sub> system allowed to remove toxic micropollutants e.g. of approx. 100% of phenols and polycyclic hydrocarbon, 23 - 96% for polychlorinated biphenyls and 74 % of dioxins and furans (Wenzel et al. 1999).

The photocatalytic oxidation with UV/TiO<sub>2</sub> has seldom been investigated for landfill leachate so far. The rudimentary literature data indicate that this process allows to remove up to 80% COD in biologically pre-treated leachate ranging from 100 to 500 mgCOD/l in optimal pH conditions (Bekbolet et al. 1996, Cho et al. 2002B).

Despite the fact that the oxidation performance of the AOPs leads to the efficient removal of a number of organic compounds found in leachates, some problems encountered during operation have to be pointed out (Tab. 1.5).

Table.1.5 Main problems encountered in the AOPs treatment of landfill leachate

Process	Problems encountered
O <sub>3</sub> and O <sub>3</sub> /H <sub>2</sub> O <sub>2</sub>	- leachate should be nitrified to avoid oxidant consumption for ammonia oxidation, - better results require elevated pH (pH>8) and low alkalinity (from carbonate), - H <sub>2</sub> O <sub>2</sub> added after oxidation of highly reactive compounds with O <sub>3</sub> alone.
O <sub>3</sub> /UV and O <sub>3</sub> /UV/H <sub>2</sub> O <sub>2</sub>	-high energy consumption for UV lamps, -formation of deposit layer on UV lamps and in the pipes due to badly soluble oxalates (at high carbonate concentration), -poor UV light transmission into leachate, -concentration of carbonate ions (<1000 ppm is required), -pH<8.
UV/H <sub>2</sub> O <sub>2</sub>	-high energy consumption for UV lamps, -poor UV light transmission into leachate, acidic pH is required (2-3),
Fenton reagent	-sludge production, - high chloride or sulphates concentration remaining, - low pH (about 3) is needed.

The application of AOPs would allow to achieve two goals: i) the reduction of the COD content of wastewater up to the permitted level for discharge, i.e converted to simple final products, such as water and carbon dioxide (mineralization) and/or ii) the enhancement of the biodegradability of treated effluents with the aim of making their subsequent biological treatment possible.

It should be noted that complete degradation (mineralization) of the pollutants for the treatment of large-scale effluents is not economically acceptable (Scott and Ollis 1995, Karrer et al. 1997, Rivas et al. 2003, Koh et al. 2004). The combination with biological techniques would considerably decrease the overall treatment costs and ensure an effective removal of undesirable contaminates. For instance, recently Koh and co-workers (2004) successfully combined these two systems: biological nitrification/denitrification and UV/H<sub>2</sub>O<sub>2</sub> followed by biological oxidation stage. This solution permitted to decrease BOD<sub>5</sub>, COD as well as AOX concentrations below the threshold values for a direct discharge of wastewater according to the legal restriction (Tab. 1.6).

To my knowledge there are no studies reporting photocatalytic (UV/TiO<sub>2</sub>) pre-treatment enhancing biodegradability of refractory organic compounds in the complex medium such as landfill leachate. More details concerning principles and applications of heterogeneous photocatalysis will be found *in section 1.3*.



### 1.2.3 Combined physico-chemical and biological methods – landfill leachate treatment plants case

Taking in to account the changing nature and composition of leachates depending on age, season, climatic conditions as well as more stringent regulation criteria for leachate discharge, leachate treatment plants are forced to integrate chemical–physical and biological stages. Table 1.6 reviews some selected regulation criteria in different countries.

Table 1.6 Regulation criteria for direct discharge into surface water (adopted from Steensen 1997, Poitel et al. 1999, Ahn et al. 2002 and Polish standards 2002<sup>4</sup>)

Parameter	German (1997)	France (1999)	Korea (1997)	Poland (2002 <sup>4</sup> )
pH	6.5 -8.5	6.5 -8.5		6.5 -8.5
COD	200	150	400 or >90%	125
BOD <sub>5</sub>	20	30	50 or >95%	25
Ammonia nitrogen or TN*	50	-	50 or >95%	10 (30 <sup>*</sup> )
AOX	0.5	0.5	-	0.5
Pb/ Cu/ Ni/Cr <sub>total</sub> /Hg/Cd	-	1.0/1.0/1.0/1.0/0.05/0.2	-	0.5/0.5/0.5/1.0/0.05/0.2

TN\* - total nitrogen

Steensen (1997) reported the experiences of 100 purification pilots for the treatment of leachate operating in Germany. All use a combination of several individual processes. More than 60% of the plants have been provided with biological phase which represents the first stage of the treatment. In 15 plants, the process of chemical oxidation was chosen for further purification.

#### 1.2.3.1 Nitrification/denitrification-ozonation(+UV) - post-biological oxidation

Concerning the issue of commercialized AOPs based on O<sub>3</sub> technology, WEDECO Company (Germany) is well-known to provide systems for a variety of environmental and industrial solutions ([http://www.wedecouv.de/en/produkte/industriewasser\\_ozon.html](http://www.wedecouv.de/en/produkte/industriewasser_ozon.html), WEDECO 1998). An example of combined biological and chemical process is Treatment Plant in Singhöfen (Germany) operating since 1994 and treating 107.4 m<sup>3</sup>/d of landfill effluent. The system includes pre-denitrification and nitrification reactor with sedimentation tank and sand filter in a first stage of treatment. Next, there is ozonation-UV stage with sand filter followed by aerated packed bed as a post biological stage. During the first operating period, it was observed that the effectiveness of ozone used alone permitted to fulfil purification requirements without UV assistance. Moreover, the ozone treatment brings about a considerable increase of BOD fraction in leachate. This fraction was successfully removed in

<sup>4</sup> "Regulation of the Minister for the Environment" (Polish authority standards for discharge of wastewaters) Dz. U. 02.212.1799 z dnia 16 grudnia 2002r

The LLTPs train has been modified by implementation of membrane bioreactor and reverse osmosis (RO) stage instead of contact aeration reactor, RBC and GAC (Fig. 1.5). A submerged membrane reactor named KIMAS (Kolon Immersed Membrane Activated Sludge) allowed to improve organic matters and increase nitrification rate as well as ensured retention of biomass in biological reactor. Whereas RO process used a spiral wound membrane module (Filmtec, USA) and was installed to improve removal of non-biodegradable compounds and inorganic nitrogenous ions.

Finally, the global efficiency of MBR/RO process was more than 97% for COD and BOD<sub>5</sub>, which corresponded to concentrations of 6-72 mg/l and 1-7 mg/l for COD and BOD<sub>5</sub> respectively. Ammonia and nitrate were at level of 10-47 mg/l and 7-23 mg/l respectively. It indicated that the effluent quality met the enhanced regulation limits (Tab. 1.6). Similar performance of treatment in the MBR/RO system was obtained in LLTPs of Hersin-Coupigny landfill located in northern France. The plant has been operating since 1994 with maximal flow of treated leachate amounting to 40 m<sup>3</sup>/d (Poitel et al. 1999).

#### 1.2.3.4 Coagulation -2 stages of reverse osmosis (RO)-neutralization/sterilization

An example of installation operated without a biological treatment stage is located in Yachiyo Town (Japan) "Clean Park KINU". It should be mentioned that dumped wastes consist mainly of incinerated residue and incombustibles i.e. inert, non-biodegradable material. The capacity of the system is 70 m<sup>3</sup>/d, and it started operation in April 1999. Landfill leachate is collected in the equalization basin and transferred to the settling basin, followed by sand filters, micron filters and 1st stage DT-Module units. A permeate of the 1st stage units is fed to the 2<sup>nd</sup> stage DT-Module units for polishing and the permeate from the 2<sup>nd</sup> stage is neutralized and sterilized before disposal in the KINU River (Figure 1.6)

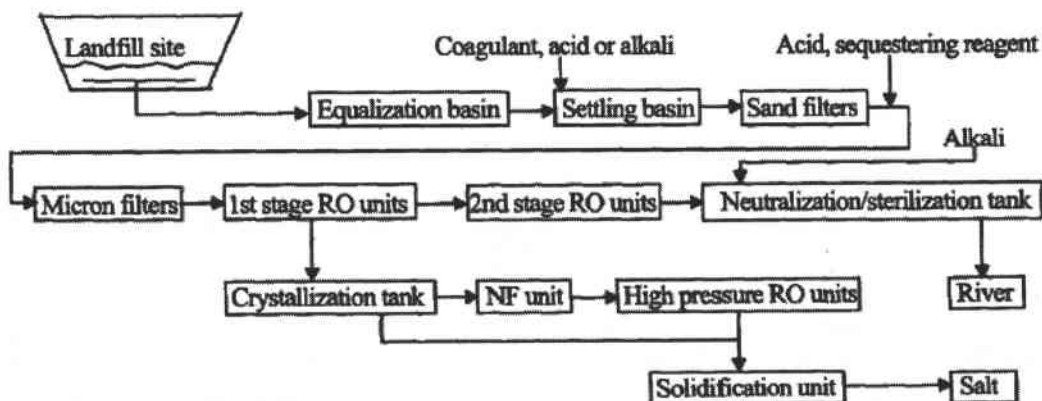

Figure 1.6 Flow diagram of leachate treatment system at Yachiyo Town (adapted from Ushikoshi et al 2002).

Moreover, retentat from the 1<sup>st</sup> stage DT- Module units is subsequently treated by nanofiltration (NF) unit, high-pressure DT-Module units and finally dried to salts that are packed in a flexible container.

Ushikoshi and co-workers (2002) reported that the operation (lasting two and a half years) of the DT- Module RO system for leachate with high salinity and very high scaling ions (such as CaCO<sub>3</sub>, CaSO<sub>4</sub>, SrSO<sub>4</sub>, BaSO<sub>4</sub> and SiO<sub>2</sub>), was successful. The satisfactory performance and a salt rejection rate higher than 99%, producing a potable level treated water in TDS, BOD<sub>5</sub>, COD<sub>Mn</sub><sup>5</sup> and TN less than 190, 5, 1 and 2 mg/l were obtained respectively.

### I.3. Generalities on heterogeneous photocatalysis

#### I.3.1. Introduction

The AOPs methods offer the advantage of destroying the pollutants, in comparison to conventional techniques such as activated carbon or air stripping that only transfers the contaminants from one phase to another. In AOPs, organic and inorganic compounds and even microorganisms are degraded or transformed into less harmful substances.

In the late 1970s, the initial stages of AOPs development were boosted by very attractive proposals concerning water splitting using solar UV energy. Expectations were not fulfilled and in the early 1980s, when the enthusiasm faded out, a new potential application appeared because it was found that photocatalytic reactions could have an important impact providing new technologies for processes of environmental remediation. Notwithstanding that several investigations in organic synthesis have been reported, the abatement of air and water pollution remains the most important target for applications and the main driving force for research and development studies (Fujishima et al. 2000, Cassano and Alfano 2000).

Photocatalytic reactions constitute one of the emerging technologies for chemical transformations of different kinds of refractory organics (Ollis and Ekabi 1993). Degradation by photocatalysis has been most investigated on monoaromatics and consequently, these pollutants appear as model compounds in dozens of scientific papers. Some of the monoaromatics investigated were benzene, dimethoxybenzenes, halobenzenes, nitrobenzene, chlorophenols, nitrophenols, benzamide, aniline, etc., most of which are recognised as priority pollutants by the U.S. Environmental Protection Agency. The wide review of removal of hazardous compounds *via* photocatalytic process can be found in the bibliography prepared by Blake (1994, 1995, 1997, 1999). However, there are still very few studies reporting attempt of landfill leachate treatment *via* photocatalytic process.

<sup>5</sup> COD<sub>Mn</sub> – COD determined by using potassium permanganate instead of potassium dichromate as an oxidant.

### I.3.2. Heterogeneous photocatalysis

Catalysis is usually defined as a process accelerating a specific chemical reaction towards equilibrium through the use of a substance, i.e. a catalyst that does not undergo any chemical change during the conversion of reactant to product. The former characteristic is associated with the extent to which the catalyst can facilitate the rate of conversion of reactant to product. It is important at this point to emphasize that some catalysts become active for a specific reaction in the presence of light, and these are referred to as photocatalysts (Schoonen et al. 1998).

Photocatalysis is defined as the catalysis of a reaction via a mechanism that only operates if the system is illuminated. Semiconductor particles can act as effective catalysts only in the presence of irradiated light of a *suitable wavelength* corresponding to their “band gap” (Nozik 1978, Fox 1988, Graetzel 1988, Cassano and Alfano 2000). Then it may be photoexcited to form electron donor sites (reducing sites) and electron acceptor sites (oxidising sites), providing great scope for these materials as effective redox reagents (Robertson 1996). Heterogeneous means that two different active phases are involved, i.e. solid and liquid or solid and gas.

A semiconductor (SC) is characterized by a specific electronic band structure. The highest occupied energy band (filled by an electron  $e^-$ ), called valence band (VB), and the lowest empty band, called conduction band (CB), are separated by a band gap, i.e. a region of forbidden energies in a perfect crystal (Fig. 1.7). When the catalyst particle is illuminated ( $h\nu$ ) with the energy higher or equal to the energy of band gap ( $h\nu > E_{bg}$ ), an electron ( $e^-$ ) is promoted from the VB to the CB and simultaneously a hole ( $h^+$ ) is generated in the valence band (Litter 1999). These charge carriers ( $h^+$ ,  $e^-$ ) can migrate to the catalyst surface in competition with an exothermic and normally fast recombination reaction. When they reach the semiconductor surface they may once more recombine, or participate in successive oxidation and reduction reactions (Cassano and Alfano 2000). The  $e^-_{CB}$  and  $h^+_{VB}$  trapped in surface states where they can react with donor (D) or acceptor (A) species adsorbed or close to the surface of the particle (Litter 1999).

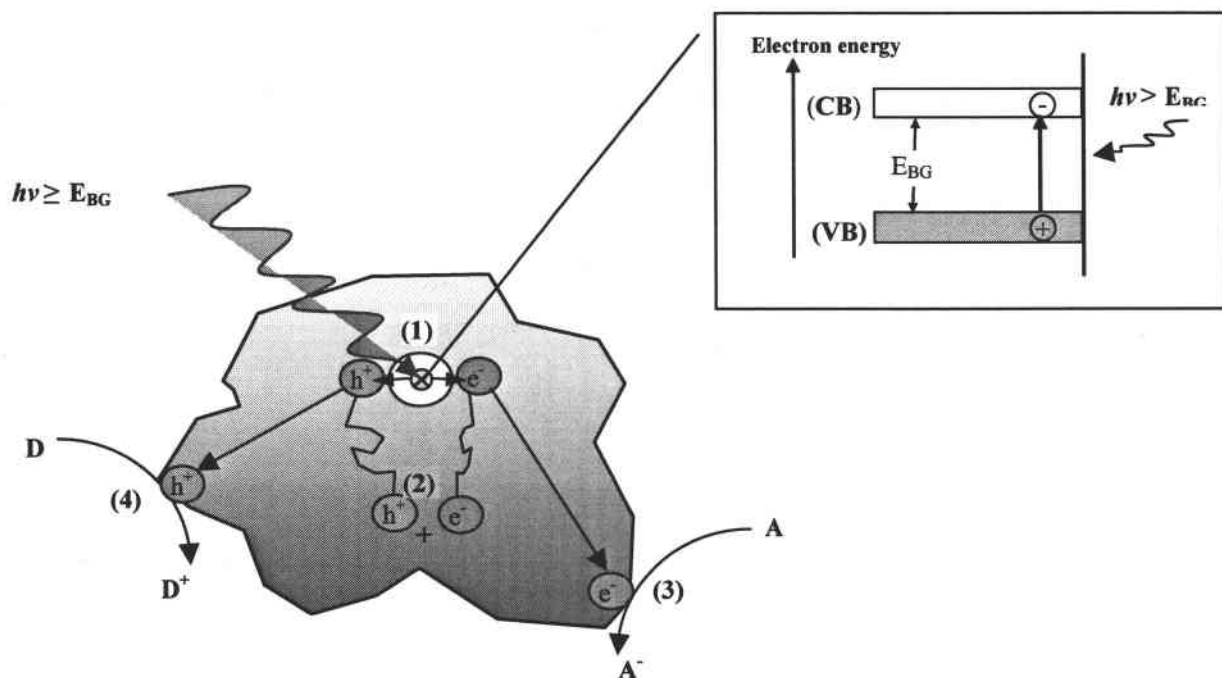
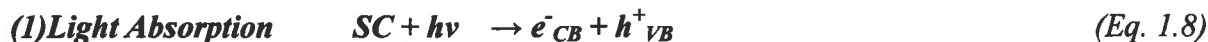

Figure 1.7 Photoexcitation of semiconductor by  $h\nu \geq E_{BG}$

The possible reactions on semiconductor (SC) can be summarised as follows:



Where: D -species being oxidised, A - species being reduced (Robertson 1996).

The critical step in this mechanism is the creation of a photoelectron/hole pair in the semiconductor. By contrast, no gap exists between populated and empty electronic levels in a metal. The illumination of metal results in the promotion of an electron to an unfilled level, but this is immediately followed by a vibrational relaxation (heat transfer) to the ground state (Equation 1.9). The rate of recombination of a photo electron/hole pair in a metal is so high that the chance for the photoelectron or hole to react with a sorbed species is minimal. In the case of insulators they are characterized by a large gap ( $>4$  eV) that makes excitation with UV or visible light impossible. Hence, insulators cannot act as photocatalysts (Schönborn et al. 1998).

As for classical heterogeneous catalysis, the overall process can be decomposed into five independent steps: i) transfer of the reactants in the fluid phase to the surface, ii) adsorption of at least one of the reactants, iii) reaction in the adsorbed phase, iv) desorption of the product(s), v) removal of the products from the interface region (Herrmann 1999).

A reaction between adsorbate and photoelectron/holes is feasible depending on the energy positions of  $E_{CB}$  and  $E_{VB}$  with respect to the frontier orbitals of the adsorbates. Thus, in order to photoreduce a chemical species, the conductance band of the semiconductor must be more negative than the reduction potential of the chemical species, to photo-oxidize a chemical species, the potential of the valence band of the semiconductor must be more positive than the oxidation potential of the chemical species. In-depth discussions of photochemical reactions can be found in (Nozik 1978 , Graetzel 1988, Schoonen et al. 1998). The redox potential of the VB and the CB for different semiconductors varies between +4.0 and -1.5 volts versus Normal Hydrogen Electrode (NHE) respectively. Therefore, by careful selection of the semiconductor photocatalyst, a wide range of species can be treated *via* these processes (Robertson 1996). Table 1.7 displays a list of semiconductor materials, which have been used for photocatalytic reaction together with the valence band and conductance band position. The last column in the table indicates the wavelength of radiation required to activate the catalysts. According to Planck's equation, the radiation able to produce this gap must be of a wavelength ( $\lambda$ ) equal to (Equation 1.12) or lower than that calculated by the following equation:

$$\lambda = \frac{hc}{E_G} \quad (\text{Eq. 1.12})$$

Where:  $E_G$  is the semiconductor band-gap energy,  $h$  is Planck's constant and  $c$  is the speed of light.

Table 1.7 Band positions of some common semiconductor photocatalysts in aqueous solution (Fox 1983)

Semiconductor	Valence Band (V vs NHE)	Conductance band (V vs NHE)	Band gap (eV)	Band gap wavelength (nm)
TiO <sub>2</sub>	+3.1	-0.1	3.2	387
SnO <sub>2</sub>	+4.1	+0.3	3.9	318
ZnO	+3.0	-0.2	3.2	387
ZnS	+ 1.4	-2.3	3.7	335
WO <sub>3</sub>	+ 3.0	+0.4	2.8	443
CdS	+ 2.1	-0.4	2.5	496
CdSe	+ 1.6	-0.1	2.5	729
GaAs	+ 1.0	-0.4	1.7	886
GaP	+ 1.3	-1.0	1.4	539

Different chalcogenides (oxides and sulphides) have been used: TiO<sub>2</sub>, ZnO, CeO<sub>2</sub>, CdS, ZnS, etc. Ideally, a semiconductor photocatalyst should be chemically and biologically inert, photocatalytically active, easy to produce and use, activated by sunlight and cheap (Herrmann 1999, Fujishima et al. 2000, Mills and Lee 2002).

Up to now, no semiconductor has met those requirements, but the  $\text{TiO}_2$  material is close to being an ideal photocatalyst. The main advantages  $\text{TiO}_2$  which makes the treatment technology very attractive can be listed:

- it is relatively inexpensive (1.5 EURO/kg),
- highly stable chemically in aqueous media and in large range of pH (0 pH 14),
- can be reused several times,
- no additives is required (only oxygen from the air),
- degradation of organic molecules, without addition of chemicals except the photocatalyst,
- great deposition capacity for noble metal recovery,
- total mineralization is achieved for many organic pollutants,
- efficiency of photocatalysis with halogenated compounds sometimes very toxic for bacteria in biological water treatment,
- low inhibition by ions generally present in water,
- possible combination with other decontamination methods (Herrmann 1999, Fujishima et al. 2000, Mills and Lee 2002).

Titanium dioxide exists in three main crystallographic forms: anatase, rutile and brookite. However in most cases, the anatase is to be more active photocatalytically than others forms (Mills and Le Hunte 1997, Litter 1999).

The most popular commercial form of  $\text{TiO}_2$  is produced by the German company Degussa under the name P-25, 99.5% pure, a finely divided material,  $50 \pm 15 \text{ m}^2/\text{g}$ , containing 70:30 ratio of anatase to rutile, and average particle diameter of 21 nm. It is important to note that 90% of the material does not exist as isolated particles, but rather as irreducible complex primary aggregates, typically of approximately  $0.1 \mu\text{m}$  in diameter.

The VB and CB positions for Degussa P-25 have been calculated as +2.9 and -0.3 V, respectively, at pH=0 (Martin et al. 1994).

This material is cheap, and extremely photoactive, and as a result has become almost the “gold standard” in semiconductor photochemistry research.

### ***1.3.2.1. Mechanism of $\text{TiO}_2$ heterogeneous photocatalysis***

As generally observed, the best photocatalytic performances with maximum efficiency are always obtained with titania (Herrmann 1999, Fujishima et al. 2000, Mills and Lee 2002). The photocatalytic detoxification process consists in the utilization of a wavelength shorter than 400 nm to promote a strong oxidation reaction. This reaction takes place when such UV radiation photoexcites a semiconductor catalyst in the presence of oxygen (as electron acceptor).

There is a fair degree of debate regarding the mechanism of destruction of pollutants under photocatalytic oxidation (Robertson 1996). Schematically, two mechanisms have been suggested (Chen et al. 1999) and are illustrated in Figure 1.8.

The first involves mainly free radicals. Due to the irradiation of  $\text{TiO}_2$  with an energy equal or superior to the band gap ( $>3.2$  eV) photoelectron/hole pair is generated (Equation 1.13). The recombination of electron/hole pair yields the heat release, and in this case from the point of view of phototreatment process the energy is lost.



During the successful charges separation, photogenerated electrons ( $e_{cb}^-$ ) reduce  $\text{O}_2$  to form superoxide anion radicals ( $\text{O}_2^{\circ-}$ ) or other radicals (Equation 1.14) while photogenerated holes ( $h_{vb}^+$ ) oxidize water to form  $^{\circ}\text{OH}$  radicals in solution (Equation 1.15).

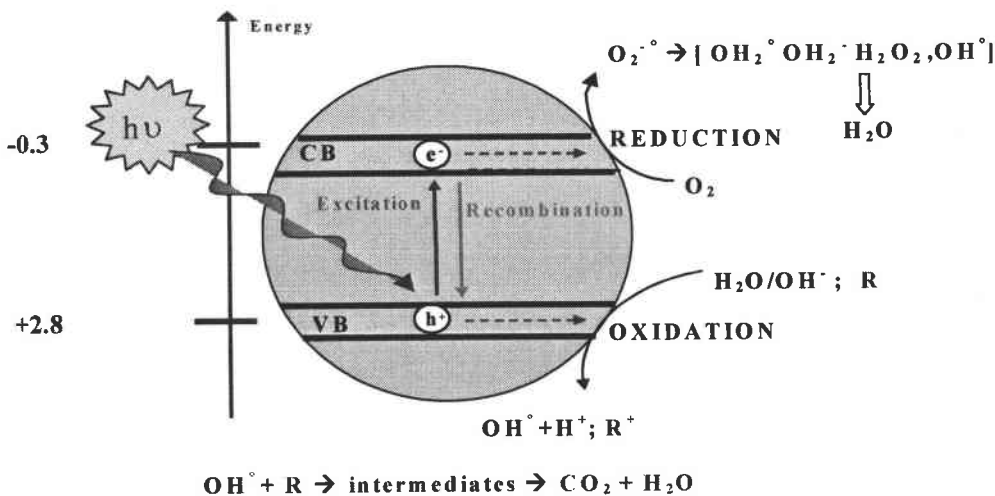
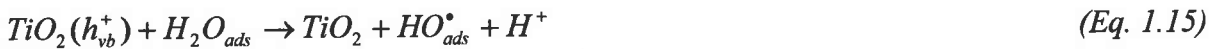
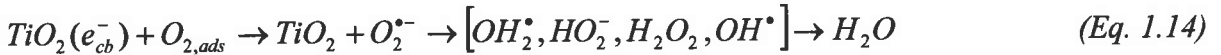

Figure 1.8 Mechanism of  $\text{TiO}_2$  heterogeneous photocatalysis. Figure depicts mechanisms of photodegradation taking place on an irradiated semiconductor particle.



Next, these radicals attack contaminants (R) in the solution to yield oxidation products and finally transforms to carbon dioxide, water and diluted mineral acids (Equation 1.16) (Kormann et al. 1991, Chen et al. 1999).



The other mechanism is also reported. The substrate is adsorbed onto catalyst surface then reacts directly with  $h^+$ ,  $e^-$  or  $^{\circ}OH$  radicals. The reaction of photoelectron with an adsorbate leads to the reduction of the adsorbate, while the reaction of a hole with an adsorbate leads to the oxidation of the adsorbate. In order for a semiconductor to act as a catalyst via this mechanism, the products must desorb so that the active sites are regenerated. (Chen et al. 1999)

Both of the proposed mechanisms are possible and are believed to occur in heterogeneous photocatalysis (Fig. 1.8).

### 1.3.3. Main parameters governing photocatalysis efficiency

#### 1.3.3.1. Catalyst loading

Either in bath test (static) in slurry or dynamic flow photoreactors, the initial reaction rates are directly proportional to the catalyst dose indicating a true heterogeneous catalytic regime. However, above a certain value of catalyst dose, the reaction rate levels off and becomes independent of catalyst concentration (Herrmann 1999) (Fig. 1.9a).

These limits correspond to the maximum amount of  $TiO_2$  in which the maximal surface of catalyst particles can be exposed to irradiation. It is well-known that a high catalyst concentration leads to excessive solution opacity and reduction of the system efficiency by the screening effect (Cunningham and Al-Sayyed 1990, Mills and Morris 1993, Cunningham and Sedlak 1996).

There are a large number of studies in literature on the influence of catalyst concentration on photocatalysis process efficiency. And the results are quite different as report Fernandez-Ibanez and co-workers (1999), but it may be deduced that incident radiation on the reactor and the length of path inside the reactor are fundamental in determining an appropriate catalyst concentration (Fernandez-Ibanez et al. 1999).

If the *lamp is inside* the reactor and coaxial with it and the path length is short (several mm), an optimal dose of  $TiO_2$  is very high (around several grams per litre). On the other hand, the amount of catalyst is low (hundreds of mg per litre) when several centimetres needs to be crossed. If the *lamp is outside*, but the path length is several centimetres long (a large diameter), as in a reactor illuminated by solar radiation, the appropriate catalyst concentration

is of several hundred milligrams per litre (Fernandez–Ibanez et al. 1999, Blanco and Malato UNESCO 2001).

For applications, this optimum dose of catalyst has to be chosen in order to: i) avoid an excess of catalyst and ii) to ensure a total absorption of efficient photons. Moreover, in the case of applying solar energy photocatalysis by using suspended semiconductor, it seems to be reasonable to extend the reaction time rather than overdosing the catalyst. After photocatalytical treatment the semiconductor particles required to be separated from the solution and to undergo to regeneration.

It could be concluded that appropriate catalyst concentration depends on the geometry of reactors, photocatalyst, working conditions (i. e. irradiation source) and target compounds and matrix to be treated.

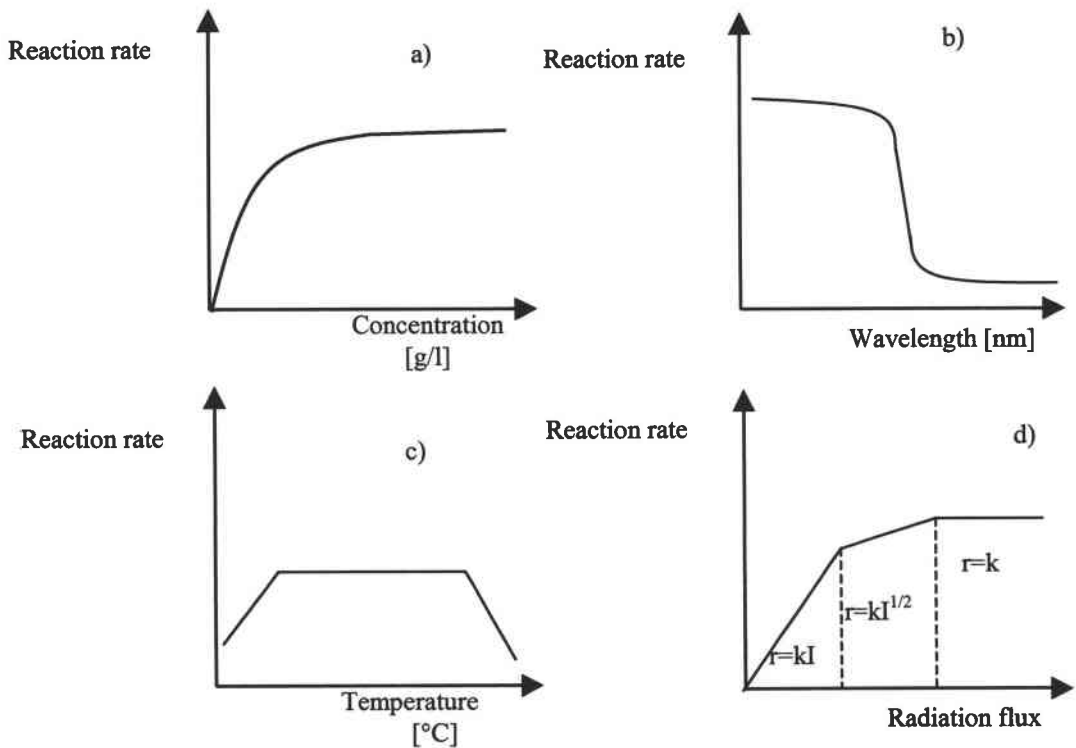

Figure 1.9. Influence of different parameters on photodegradation rate. a) catalyst dose and initial concentration of substrate, b) wavelength, c) temperature, c) radiation flux

the post-biological stage. It not only allowed to decrease overall treatment technology cost thanks to the reduction of ozone consumption but also ensured the final requirement for discharge (Tab. 1.6).

### 1.2.3.2 Nitrification/denitrification-precipitation-ozonation

The landfill leachate treatment plants (LLTPs) in Bord-Matin landfill, near Saint-Etienne (France) treats the stabilised leachate from the landfill effluent, and has been operated since 1972 (Poitel et al. 1999). The leachate quantity amounted to 12.5m<sup>3</sup>/d, contained 1750 mg/l and 850 mg/l of COD and ammonia respectively. The treatment plant system consists of a biological stage including nitrification and post-denitrification process followed by chemical precipitation with lime in a lamellar settling tank. The process ends with ozonation, which allows to reach a final discharge standard in respect to refractory COD. The solution allows to ensure the following parameters in effluent: COD = 130 mg/l, ammonia = 2 mg/l and nitrate=10 mg/l, which is in agreement with national authority standards (Tab. 1.6).

### 1.2.3.3 Chemical precipitation- membrane bioreactor (MBR) - reverse osmosis (RO)

Ahn and co-workers (2002) reported the experience from an exploitation of the LLTPs located at Chung-Nam Province in Korea that was retrofitted on April 2000. The existing state of LLTPs (Fig. 1.5a) had the capacity of 50 m<sup>3</sup>/d and the process was composed of contact aeration, rotating biological contactor (RBC) and granulated organic carbon (GAC) adsorption process. The leachate contained high concentration of ammonia (200-1400 mg/l), nitrate (28-251 mg/l) and organic COD (400-1500 mg/l) and BOD<sub>5</sub> (100-500 mg/l). Nevertheless, that system did not ensure stable removal of COD and TN in the light of new regulatory national standards (Tab. 1.6) in effluent. The system suffered the biomass washout and frequent replacements of activated carbon were needed.

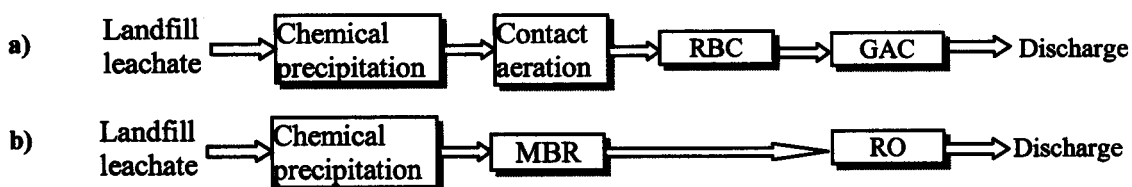

Figure 1.5 Process flow diagram for a) the existing process and b) the retrofitted process (adapted from Ahn et al. 2002)

### 1.3.3.2. Substrate concentration

The photocatalytic process can generally be expressed in a kinetic equation based on Langmuir monomolecular adsorption, which is normally used to model heterogeneous catalytic process on solid-gas interaction. Adapted equation so-called *Langmuir-Hinshelwood model* (L-H) is used to describe the degradation characteristic in many reports (Lu et al. 1993, Kumar and Davis 1997, Wang et al. 1998, Zang et al. 1998). The rate of reaction mechanism ( $r$ ) varies proportionally to the fraction of surface covered by the substrate ( $\Theta$ ) as follows:

$$r = k_r \cdot \Theta = k_r \left( \frac{KC_0}{1 + KC_0} \right) \quad (\text{Eq. 1.17})$$

Where:  $k_r$ , the specific reaction rate constant for oxidation of organic compound observed for L-H kinetics (mol/l \*min),  $K$  the equilibrium adsorption constant of organic compounds,  $C_0$  is the initial concentration of organic compounds (Chan et al. 2001). For diluted solutions ( $C < 10^{-3}$  M),  $KC$  becomes  $\ll 1$  and the reaction is of the apparent first order, whereas for concentrations  $> 5 \cdot 10^{-3}$  M, ( $KC \gg 1$ ), the reaction rate is maximum and the zero order can be noted (Fig. 1.9a) (Herrmann 1999). The classical saturation phenomenon of substrate is noted for catalyst. However, if the adsorption does not obey the Langmuir mode then the multi-site model should be considered (Robert et al. 2000).

### 1.3.3.3 Influence of electron acceptor (oxygen, hydrogen peroxide)

It was reported that oxygen is essential for photocatalytic degradation of organic compounds. It has been demonstrated that the initial reaction rates as well as the total mineralization of organic compounds depend on  $O_2$  concentration (Al-Ekabi et al. 1991; Schwarz et al. 1997, Wang and Hong 2000). Oxygen is known to be readily adsorbed onto the  $TiO_2$  surface and can be reduced by the photoinduced conduction-band electrons during which superoxides and other reduced species are formed (Equation 1.8). Then, generated radicals oxidize organic chemicals. As electron acceptor, oxygen molecule can significantly reduce surface electron-hole recombination.

Herrmann (1999) suggested that if the oxygen is regularly supplied, it can be assumed that its coverage at the surface of titania is constant and can be integrated into the apparent rate constant ( $k_{app}$ ):

$$r = -\frac{dC}{dt} = k_r \cdot \Theta_c \Theta_{O_2} = k_{app} \Theta_c \quad (\text{Eq. 1.18})$$

Where: the apparent rate constant should be considered as a function of the power flux (exposed in  $mW/cm^2$ ) and of oxygen coverage ( $\Theta_{O_2}$ ). In other words, the oxygen pressure in the system should be kept constant to eliminate the effect of oxygen concentration on organic oxidation (Chen et al. 1999).

It has also been observed (Kormoran et al. 1988, Equation 1.19) that hydrogen peroxide can be used as an electron acceptor, and then enhances photocatalytic reaction:



Being an electron acceptor, hydrogen peroxide reacts with conduction band electrons to generate hydroxyl radicals, which are required for the photomineralization of organic pollutants.

It should be noted that the  $\text{H}_2\text{O}_2$  effect is beneficent in terms of prevention of electron/holes recombination and additional  $^\bullet\text{OH}$ , but on the other hand, the effect of  $\text{H}_2\text{O}_2$  is sometimes detrimental (Equation 1.20 and 1.21). In this case by i) scavenging of photoproducted holes and ii) reaction with hydroxyl radicals:



Thus, the optimal concentration of  $\text{H}_2\text{O}_2$  usually depends on  $\text{H}_2\text{O}_2$ /contaminant molar ratio (Malato et al. 2000A)

#### 1.3.3.4. Effect of pH and inorganic anion

The rate of photocatalytic removal of organic contaminants can be strongly influenced by solution matrix parameters such as pH and ionic strength i.e. dissolved ions, co-dissolved species, (Bekbolet et al. 1996, Schmelling et al. 1997, Epling and Lin 2002) which can be present in underground, ground and industrial wastewaters or landfill leachate.

It is well-known that the surface of  $\text{TiO}_2$  is promptly hydroxylated in aqueous solution due to dissociation of chemisorbed water. The hydrated  $\text{TiO}_2$  surface is amphoteric and has a pH-dependent ionic speciation (Equation 1.22, Wang et al. 1999). The pH at which the surface of an oxide is uncharged is defined as the Zero Point Charge ( $\text{pH}_{\text{zpc}}$ ), which for  $\text{TiO}_2$  is about pH 7 (6.3-6.6) (Bekbolet et al. 2002). Above this value the catalyst is negatively charged, and below, the catalyst surface becomes positively charged:



Generally, it is believed that adsorption plays a prominent role in photocatalytic degradation of organics. It has been reported that a strong adsorption of substances on the catalysts surface at low pH could enhance the reaction rate of photooxidation (Eggins et al. 1997, Wang et al. 2000B, Piscopo et al. 2001, Cho and Choi 2002A, Li et al. 2002). For instance, Guillard and co-workers (2003) recently found a high correlation between the amounts of adsorbed on TiO<sub>2</sub> dyes and their photocatalytic degradation. The lower pH favoured adsorption and mineralization of anionic dyes, and higher pH improved adsorption and degradation of cationic dyes as a result of enhanced adsorption increased also its photoreactivity.

By contrast Wang and co-workers (1999) demonstrated that dark adsorption of 2-Chlorobiphenyl (2-CB) is not affected by pH. Therefore, the higher TiO<sub>2</sub>-photocatalysis of 2-CB in acidic pH, was attributed to the change of Fermi level <sup>6</sup>(a decrease of band gap) of semiconductor. In this way, the generation of °OH radical on TiO<sub>2</sub> surface is enhanced. In general, the optimum pH for the most effective oxidation rate strongly depends on the character of the compound to be oxidized.

On the other hand, a presence of common inorganic anion in reacting medium can influence adsorption and photocatalysis of organic. Chen and co-workers (1997) found that adsorption of the ions was competitive with that of DCE (dichloroethane). Consequently, the inhibition oxidation rate provoked by individual anions were in the order: [NO<sub>3</sub><sup>-</sup>] < [Cl<sup>-</sup>] < [HCO<sub>3</sub><sup>-</sup>, CO<sub>3</sub><sup>2-</sup>] < [SO<sub>4</sub><sup>-</sup>] < [H<sub>2</sub>PO<sub>4</sub><sup>-</sup>, HPO<sub>4</sub><sup>2-</sup>]. Moreover, bicarbonate/carbonate species have a negative effect on photocatalytic oxidation rate due to the scavenging of photogenerated hydroxyl radicals (Bekbolet and Balcioglu 1996, Wang et al. 2000C).

The effect of inorganic anions is strictly correlated with pH of solution, the properties of organics being degraded and the acid/basic properties of TiO<sub>2</sub>. It was demonstrated that under acidic conditions (below pH<sub>pzc</sub>) a TiO<sub>2</sub> surface is positively charged and has a strong affinity to adsorb anions from the solution. Due to the competition between organics and anions, a degradation rate is inhibited (Wang et al. 1999, Wang et al. 2000B, Piscopo et al. 2001). On the contrary, in neutral and basic conditions, electrostatic repulsion does not favour adsorption of anions on negatively charged TiO<sub>2</sub> surface (above pH<sub>pzc</sub>) and photocatalytic degradation is not retarded (Wang et al. 2000B, Guillard et al. 2003). Besides, it was observed in several studies that the presence of some anions, i.e. SO<sub>4</sub><sup>2-</sup> can improve photocatalysis due to formation of radicals sulphide radicals (°SO<sub>4</sub><sup>-</sup>) (Abdullah et al 1990, Wang et al. 2000B).

The pH of the aqueous solution significantly affects TiO<sub>2</sub>, including the charge of the particle and the size of the aggregates it forms. Mean particle-size measurements have been found to be about 300 nm at pH far from 7 (Fernandez-Ibanez et al 2000). However, while the pH is equal to the point of zero charge (PZC), the particles aggregate and ensembles are larger, and medium "particles" size increases to 2-4 µm, and sediments easily (Fernández-

<sup>6</sup> Fermi level -The chemical potential of electrons in a solid (metal, semiconductors or insulators) or in an electrolyte solution (Serpone and Emeline (2002))

Ibáñez et al. 1999, Blanco and Malato 2001 UNESCO). It is of great importance in the case of the application of a powdered semiconductor, which is more effective than supported ones.

Therefore, the main difficulty connected with suspended  $\text{TiO}_2$  separation could be overcome. The studies of Fernandez-Ibanez and co-workers (2003) has shown that simple adjustment of pH to the isoelectric point leads to the fast and effective recovery of the catalyst and up to 97% of initial concentration can be recovered. Similarly, the addition of electrolyte (increase of ionic strength due to addition of e.g. NaCl) results in agglomeration of the particles and the weight of the clusters formed make them settle very fast (Fernandez-Ibanez et al. 2003).

The presence of dissolved metal ions is common in natural waters as well as in industrial wastes, and they can sensibly affect the rate and efficiency of photocatalytic reactions. Such an effect has been found in the removal of aromatic hydrocarbons, benzoic acids, phenols, aliphatic acids and other organic compounds in the presence of metallic ions, mainly  $\text{Cu}^{2+}$ ,  $\text{Fe}^{3+}$  and  $\text{Ag}^{2+}$  (Litter 1999).

The increase in photooxidation rates by addition of metal ions has been attributed, in the first instance, to the ability of ions to scavenge electrons on the catalyst surface thereby reducing the non-desired electron/hole recombination.

One of the most important parameters that affect the efficiency of the process is the standard redox potential of the involved metallic couple ( $\text{TiO}_2/\text{Me}^{\text{n+}}$ ), because only those species with reduction potentials much more positive than the conductive band edge can be photoreduced. However, according to Sykora (1997) the effect is strongly dependent on the type and concentration of the metal ion: both an increase in the photooxidation rate and a detrimental effect have been observed, with an optimal value in concentration that enhances the rate of the photocatalytic transformation. Thus, a convenient concentration of the metallic ions added should be carefully controlled to avoid inhibition of the process. It should be noted that from the standpoint of application on a large scale, this operation can be very expensive and is not convenient.

To sum up, co-dissolved species, both ionic and non-ionic, can seriously reduce photocatalytic degradation rate of a target compound through sorption onto the catalyst surface, thereby inactivating reactive sites, and/or scavenging oxidizing radicals both at the surface and in the solution. In the heterogeneous photocatalytic system, the characteristics of the solution matrix, such as the pH and the ionic strength, are critical in determining the speciation distribution of acidic and basic molecules and the magnitude of the solute-surface interactions in the solid oxide/solution interface, respectively. Consequently, these parameters can significantly affect the extent of adsorption or chemisorption of the solute on the semiconductor surface as well as the concentration of the key oxidizing species formed during the photocatalytic process. Therefore, these factors will be crucial in controlling the rates and mechanism of the degradation process.

### ***I.3.3.5. Influence of physical parameters (radiation source, light intensity and temperature)***

#### ***Radiation source***

The variation of the reaction rate as a function of the wavelength follows the absorption spectrum of the catalyst (Fig. 1.9b), with a threshold corresponding to its band gap energy. At lower wavelength the destruction of a molecule by electromagnetic radiation may occur by means of direct photolysis.

The light source is a very important factor because the performance of a photoreactor is strongly dependent on the irradiation source. Different types of lamps allow generation of radiation with different ranges of wavelengths. In general, in photocatalysis the arc and the fluorescence lamps are used. For arc lamps and in particular for mercury lamps, a classification based on the pressure of Hg is as follows:

- *Low-pressure Hg lamps.* This type of lamp contains Hg vapour at a pressure of about 0.1 Pa at 25°C, emitting mainly at 253.7 and 184.9 nm
- *Medium-pressure Hg lamps.* This type of lamp has a radiation source containing mercury vapour at pressures ranging from 100 to several hundred kPa. Emission is mostly from 310 to 1000 nm with most intense lines at 313, 366, 436, 576, and 578 nm.
- *High-pressure Hg lamps.* This type of lamp has a radiation source containing mercury vapour at pressure of 10 MPa or higher, which emits broad lines and a background continuous between about 200 and 1000 nm
- *Xenon and Hg- Xenon lamps.* In this type of lamps an intense source of ultraviolet, visible and near-IR radiation in the mixture of Hg and Xe vapours under high pressure is obtained. Xenon lamps are used to simulate the solar irradiating spectrum and the Hg vapour increases the radiation intensity in the UV region (Augugliaro et al. 1997)

Ultraviolet light is arbitrarily broken down into three bands:

UV-A (315-400 nm), which is the least harmful type of UV light, because it has the least energy is often called black light.

UV-B (280-315 nm) is typically the most destructive form of UV light, because it has enough energy to damage biological tissues, yet not quite enough to be completely absorbed by the atmosphere. Since the atmosphere blocks most of the extraterrestrial UV-B light, a small change in the ozone layer could dramatically increase the danger of skin cancer.

UV-C (100-280 nm) is almost completely absorbed in air within a few hundred meters. When UV-C photons collide with oxygen atoms, the energy exchange causes the formation of ozone. UV-C is never observed in nature, however, since it is absorbed so quickly. Germicidal UV-C lamps are often used to purify water because of their capability to kill bacteria.



### **Light intensity**

It was observed that the rate of reaction is proportional to the light intensity  $I^1$  (radiant flux) and it confirms the photo-induced power flux (expressed in  $\text{mW}/\text{cm}^2$ ) nature of the activation of the catalytic process, with the participation of photo-induced electrical charges (electrons and holes) to the reaction mechanism (Fig. 1.9d). Nevertheless, after reaching certain value, estimated to be ca.  $25 \text{ mW}/\text{cm}^2$  in laboratory experiments, the reaction rate becomes proportional to  $I^{1/2}$  (Herrmann 1999, Bouchy and Zahraa 2002).

Many experimental measurements on solar technology have confirmed that above a certain UV photon flux the reaction rate becomes independent on the radiation received. It is considered boarder value amounting from one to two suns, i.e.  $60\text{-}120 \mu\text{Einstein}/\text{m}^2 \text{ s}$ , i.e.  $22\text{-}44 \text{ W}_{\text{UV}}/\text{m}^2$  (Malato et al. 2002)

Thus the optimal light power application corresponds to the region where reaction rate is directly proportional to radiation flux (Romero et al. 1999, Chen et al. 2001).

### **Temperature**

By contrast to catalyst processes such as the catalytic converter on automobiles the photocatalytic systems do not require heat energy to be activated.

The apparent activation energy  $E_a$  is often very small (a few  $\text{kJ}/\text{mol}$ ) in the medium temperature range ( $20^\circ\text{C}$  to  $80^\circ\text{C}$ ) (Figure 1.3c) (Herrmann 1999). The operating at room temperature makes the photocatalytic reaction attractive treatment technology from the point of view of energy savings, in comparison to incineration for example (Ollis and Al-Ekabi 1993).

## **I.3.4. Solar photocatalysis**

### **I.3.4.1. Solar spectrum**

The sun can be considered as a huge reservoir of energy. All the energy coming to earth amounts to  $1.7 \times 10^{14} \text{ kW}$ , meaning  $1.5 \times 10^{18} \text{ kWh}$  per year, or approximately 28000 times the world consumption for one year. Radiation beyond the atmosphere has a wavelength of between  $0.2 \mu\text{m}$  and  $50 \mu\text{m}$ , which is reduced to between  $0.3 \mu\text{m}$  and  $3.0 \mu\text{m}$  when reaching the surface. It is due to the absorption of part of radiation by different atmospheric components (ozone, oxygen, carbon dioxide, aerosols, steam, and clouds).

The solar radiation that reaches the ground without being absorbed or scattered is called *direct radiation*; radiation that reaches the ground but has been dispersed is called *diffuse radiation*, and the sum of both is called *global radiation*. In general, the direct radiation of global radiation on cloudy days reaches its minimum and the diffuse component reaches its maximum. The opposite situation can be observed on clear days (Hulstrom et al. 1985).

As mentioned above, only a little part of solar spectrum coming onto to earth's surface is available for photocatalytic reaction with  $\text{TiO}_2$  as catalyst. A half of the UV arriving radiation is scattered even on a clear day. Near-UV wavelengths (from 285 to 390 nm) comprise only 2-3 % of the energy in direct sunlight, but they make up 4-6% of combined diffuse and direct sunlight. Finally, taking into account the solar efficiency of 70% and 1% for catalyst (Romero et al. 1999) it was assumed by Malato and co-workers (2000A) that 0.04% original solar photons is used in the detoxification process. This makes the process rather ineffective. Nevertheless, in spite of this disadvantage, solar technology is the most environmentally friendly method among the AOPs proposed, and its feasibility for mineralization of organic water pollutants in the industrial destruction of toxic organics in water as has been widely studied in recent years (Goswami 1997, Herrmann 1999, Piscopo et al.1999, Malato et al. 2000B, Blanco et al. 2000, Alfano et al. 2000).

#### ***1.3.4.2 Solar photoreactors for water detoxification***

Two of the major design issues for solar photoreactor systems are: i) whether to use a suspended or a supported photocatalyst and ii) whether to use concentrated or non-concentrated sunlight.

Until now, the majority of tests of solar photocatalytic reactors and treatment plants have been using small particles of the photocatalyst (usually  $\text{TiO}_2$ ) suspended in the contaminated water (Alfano et al. 2000, Malato et al. 2002). In particular, the main advantages of these slurry systems such as i) low pressure drop through the reactor; ii) better availability of the catalytic surface area for adsorption and reaction and iii) good mass transfer of the wastewater contaminants from the fluid to the photocatalyst. Therefore, this option should be preferred.

In fact, solar photocatalytic reactors (*concentrated or non-concentrated sunlight*) have much in common with those used for thermal applications. However, their designs begin to diverge, since:

- the fluid must be exposed to ultraviolet solar radiation, and, therefore, the absorber must be UV-transparent,
- temperature does not play a significant role in the photocatalytic process, so no insulation is required.

A good example of concentrated reactors for water detoxification is *parabolic-trough concentrators (PTC)*, logical extension of the historical emphasis on trough units for solar thermal applications. Figure 1.10 presents theirs modified type, two-axis PTCs, first engineering-scale solar photochemical facility for water detoxification in Europe developed by CIEMAT in 1990 (Almeria, Spain)(Blanco et al. 1991).

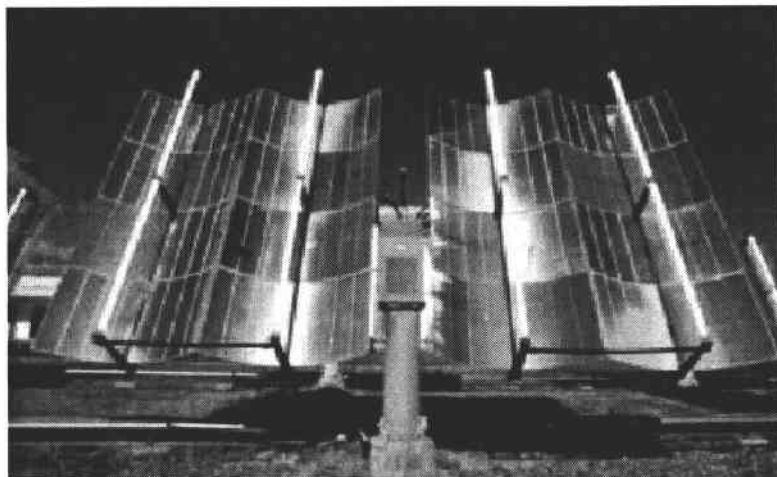

Figure 1.10 Solar Detoxification Facility two-axis PTCs (Helioman's collectors loop PSA, Spain)

Thanks to the moving part of “tracking system (azimuth and elevation)” the collector aperture plane is always perpendicular to the solar rays, which are reflected by the parabola onto the reactor tube (pyrex glass) (Fig. 1.11a). Table 1.8 demonstrate the main advantage and disadvantage of the PTCs reactors (Blanco and Malato 1993, Alfano et al. 2000, Malato et al. 2002).

Table 1.8 Advantages and disadvantages of PTCs technology.

Advantages	Disadvantages
<ul style="list-style-type: none"> <li>- direct solar radiation- thermal energy collected could be used in parallel for other applications</li> <li>- size and length - is small, receiving a large amount of energy per unit of volume</li> <li>-control of the liquid- is simple and cheap</li> <li>risk of leaks- low</li> </ul>	<ul style="list-style-type: none"> <li>- direct solar radiation- losses of optical efficiencies (up to 50%)</li> <li>- sensitive to losses of optical efficiencies by:               <ul style="list-style-type: none"> <li>* breakdown of reflectivity</li> <li>* breakdown of translucence</li> <li>* mechanic parts errors</li> <li>* ( tracking system)</li> </ul> </li> </ul>

This technology was successfully applied for degradation of phenol (Curco et al. 1996); pentachlorophenol (Minero et al. 1993), atrazine (Minero et al. 1996), some industrial effluent (Malato et al. 1996), and many other reported by Alfano and co-workers (2000). These pilot-plant experiments usually processed hundreds of litres of water with catalyst slurries dose of 200 mg/l ( $\text{TiO}_2$ ) and ten milligrams per litres of treated contaminants.

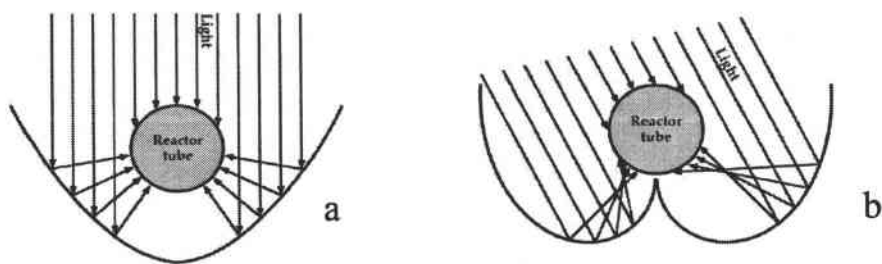

Figure 1.11 Geometric profile of: a) parabolic trough reactor (PTR) and b) compound parabolic collecting reactor (CPC) (adapted from Alfano et al. 2000)

*Non-concentrating* (one-sun) collectors are cheaper than PTCs as they have no moving parts or solar tracking devices, and require low capital investment. They do not concentrate radiation, so that efficiency is not reduced by factors associated with concentration and solar tracking. One-sun systems can use more sunlight as they are able to capture the diffuse UV light as well as direct solar beams.

On the other hand, non-concentrating systems, especially with supported catalyst ones, require significantly more photoreactor area than concentrating photoreactors (Alfano et al. 2000, Malato et al. 2002). In addition, flow in non-concentrating systems is usually laminar, which presents mass transfer problems and vaporization of reactants. A wide number of these types of reactors was proposed for example: the double-skin sheet reactor (DSSR), the thin-film fixed-bed reactor (TFFBR, Fig. 1.12), and different tubular reactors. These reactor types have been described in detail by Alfano and co-workers (2000).

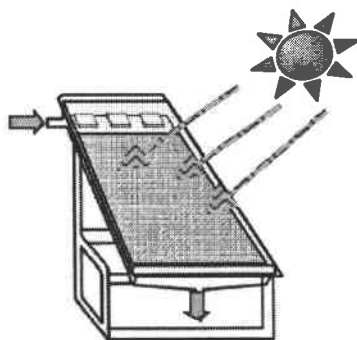

Figure 1.12 The thin-film fixed-bed reactor (TFFBR)

However, more attention should be paid to tubular photoreactors, in particular *compound parabolic concentrator* (CPC). The main advantage of these reactors relies on the inherent structural efficiency of tubes, which are available in a large range of materials and sizes and are a natural choice for pressured systems.

CPCs reactors are an interesting cross between trough concentrators and one-sun systems, and according to many researchers (Romero et al. 1999, Ajona and Vidal 2000, Blanco et al. 2000) it constitutes a good option for solar photochemical applications.

The shape of a CPC reflector usually consists of two half cylinders of parabolic profiles set side by side. The centre line (equivalent to a focal axis) is located closely above the connection of the two parabolic profiles (Fig. 1.11b). This geometry enables light entering from almost any direction to be reflected into the “focal” line of the CPC, i.e., most of the diffuse light entering the module can also be employed for the photocatalytic reaction. CPCs are designed with a concentration factor near one, thus having the advantages of both PTCs and one-sun collectors.

It has to be emphasized that in order to obtain maximum annual efficiency, the azimuth of the CPCs should be adjusted to the complementary angle of the geographical altitude and the pipes should be aligned to south (Fig. 1.13) (Alfano et al. 2000). For example, in Plataforma Solar de Almería (PSA), the tilt angle of facilities is  $37^\circ$  according to the local latitude.



Figure 1.13 CPCs reactor in PSA, volume 190 l

The CPC reactor has been successfully used in PSA for detoxification of various pollutants, such as pesticides (Malato 2000C), dyes (Augugliaro et al. 2002), benzamide (Robert et al. 1999), 4-chlorophenol (Herrmann et al 1999A), humic acids (Wiszniewski et al. 2003) as well as water disinfection (Vidal et al. 1999).

This technology is believed to be the best option for solar detoxification systems (Curco et al. 1996, Anjano and Vidal 2000, Malato et al. 2002) and according to Blanco and co-workers (1999), it is useful for treating wastewater containing even several hundreds of mg per litre of non-biodegradable contaminants.

The requirements for the photocatalytic reactor are similar to other advanced water or air oxidation processes, with the additional necessity of an illuminated photocatalyst. The photocatalytic reactor must contain the catalyst and be transparent to UV radiation providing good mass transfer of the contaminant from the fluid stream to an illuminated photocatalyst surface with minimal pressure drop across the system. Additionally, UV and chemical inertness are demanded.

Common materials that meet these requirements for *solar application* are:

- fluoropolymers (ETFE (ethylenetetrafluoroethylene), PTFE (polytetrafluoroethylene), ECTFE (ethylenechloridetetrafluoroethylene), PVDF (polyvinylidene fluoride), FEP (fluorinated ethylenepropylene), PFA and TFE (tetrafluoroethylene))
- acrylic polymers
- Several types of glass (i.e. borosilicate with cut-off 285 nm). Standard glass is not recommended because it absorbs a part of the UV radiation, due to its iron content.
- Quartz has excellent UV transmission and temperature and chemical resistance, but the slight advantage in transmission in the terrestrial solar spectrum over other materials does not justify its high cost, which makes it completely unfeasible for photocatalytic applications.

#### ***1.3.4.3 Current commercial application systems***

Over the last few years, photocatalysis has become more and more popular for recalcitrant organic carbon decomposition. Heterogeneous photocatalysis is now reaching the preindustrial level (Romero et al. 1999).

Several pilots and prototypes have been built in various countries. The solar photocatalytic treatment of pesticides used in agriculture and in the food industry being under study at Plataforma Solar de Almeria (Spain), is an excellent example of the development of solar water detoxification.

Attempts at commercial application of semiconductor photochemistry have already been done for water purification and wastewater treatment. Recently, there appeared on web-site the first commercially available systems for water purification, proposed by Clearwater Industries (USA) ([www.cwirfc.com](http://www.cwirfc.com)) or the modular design facilities Photo-Cat system from Canada ([info@purifics.com](mailto:info@purifics.com)). The systems are designed for a wide range of contaminants, i.e. dye, pesticides/herbicides, aromatics - including phenols and chlorinated phenols, carboxylic acids, chlorinated aliphatics, aliphatic alcohols, PCBs and heterocyclics, nitro-organics, cyanide etc. Unfortunately, there are very few details concerning principal parameters such as concentration of pollutants to be treated, or the efficiency of the systems.

However, it was reported that R2000 Solar Oxidation Facility (Clearwater Industries) uses a fixed photocatalyst bed reactor and solar energy as irradiation source (Fig. 1.14a). On the contrary, the modular design facilities Photo-Cat system (Canada) utilises artificial light as photoexcitation source (info@purifics.com). Moreover, there is emphasis on the low cost of the low pressure mercury lamps, i.e.  $\lambda_{\max}$  (emission) = 254 nm, which are extremely long lasting, with lifetimes >14,000 h.

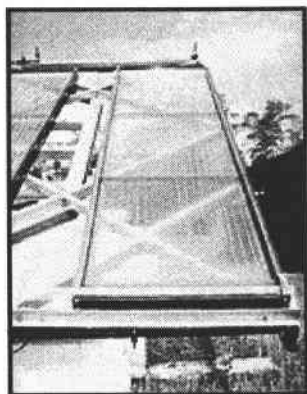

a

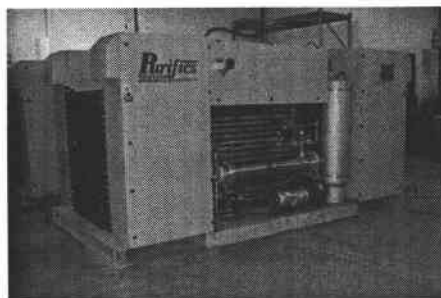

b

Figure 1.14. a) R2000 Solar Oxidation (USA) based on solar irradiation and b) Photo-Cat® (Canada) operating under UV from Hg-low pressure lamps

An efficient system, such as Photo-Cat, based on artificial light could be an interesting alternative for the country with significantly lower isolation. For example Poland (Latitude 49-54.50°), receives on average 1600 sunny hours per year (tp://www.ekoenergia.pl/pdf/slonce.htm), so it is three times less than in the Plataforma Solar de Almeria (Spain) which receives 4380 sunny hours per year (Latitude 37°50') (Malato et al. 2000C).

It was reported that (June 12, 2003) a 25 kW Photo-Cat® system has been installed at a US Superfund Site for the destruction of 1,4-dioxane in landfill leachate at a sustained rate of 105 m<sup>3</sup>/day (26,000gpd) (info@purifics.com).

Photo-Cat® systems are based on a patented closed-loop titanium dioxide photocatalyst slurry process. The turn key modular technology is a set of photocatalytic racks, each containing a number of individual cells. Depending on the concentration of the contaminants and the throughput required, the racks are linked together in a serial and/or parallel mode. For sustained single pass treatment, the TiO<sub>2</sub> slurry is contained inside a slurry loop and is continually recycled to the inlet stream. A key element of the patented technology is the continuous TiO<sub>2</sub> separation process which allows the catalyst to be separated out of the purified water and reintroduced into the inlet stream. This automated, ambient temperature process can treat water down to levels that exceed drinking water standards. It is essentially a solid state device that is very efficient and can operate unattended (Fig. 1. 15).

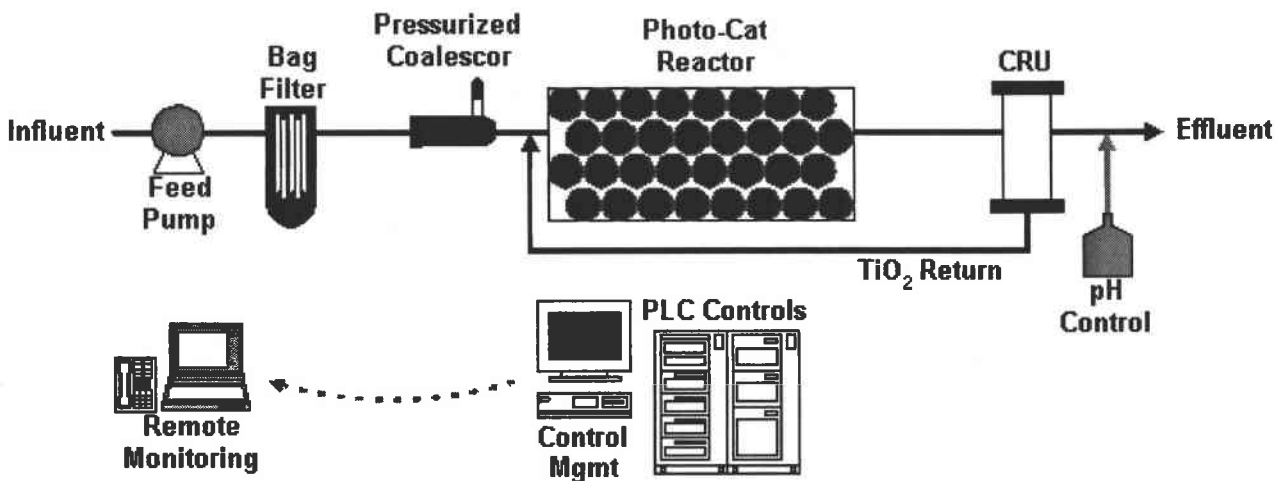

Figure 1.15 Scheme of the Photo-Cat® Water Treatment Train

## I.4 Formulation of thesis

The review presented above provides a critical analysis of literature most relevant to the thesis topic. It includes i) an assessment of environmental effect of discharged landfill leachate, ii) principles of biological methods in the context of leachate treatment iii) review of currently applied physical, chemical as well as combined techniques applied during leachate detoxification iv) theory of a new emerging AOPs process - photocatalytic oxidation (UV/ $\text{TiO}_2$ ) and its practical applications for water and wastewater purification.

Taking into account high expenditure for the system currently operating, which involves combined techniques, the development of new alternatives, economically attractive and environmentally acceptable solutions is needed. In particular, a considerable amount of thought should be given to the process capable to cope with the persistent organic contaminants present in landfill leachates.

As a consequence the following thesis has been proposed:

**THESIS I:** Combination of the biological and the photocatalytic methods permit to fulfil the present regulatory laws for direct discharge of municipal landfill leachate. This combined technology is directed to the mature or stabilised leachates containing high ammonia and refractory organic concentrations.

**THESIS IA:** In spite of high ammonia concentration as well as the presence of antimicrobial constituents (such as heavy metals, AOXs, and others) in the municipal leachate, it is feasible to effectively implement biological nitrogen removal by means of adequate control of operational parameters treatment.



THESIS IB: Photocatalytic processes can be an alternative solution for removing non-biodegradable organics remaining after biological treatment. Photocatalysis allows to mineralize the refractory organics present in leachates and/or to convert it into biodegradable, less toxic species. As a consequence, its degradation *via* biological metabolism would be possible.

### I.4.1 Goals

The final (major) goal of the PhD thesis is to evaluate the feasibility of coupling of the photocatalytic and the biological methods for improving a detoxification of municipal landfill leachate containing high ammonia and refractory organics.

More precisely the purposes can be divided into the three main stages:

- The first one involves study of photocatalytic degradation of model compounds simulating refractory organics present in landfill leachate,
  - characterisation of landfill leachate composition and selection of organics model for photocatalytic oxidation test as well as main inorganic continuants in solution matrix (i.e. inorganic anions),
  - study of photocatalytic degradation of non-biodegradable organic simulating compounds present in landfill leachate. Determination of parameters influencing photocatalytic removal of model organics (effect of pH, inorganic solution matrix) and optimisation of photocatalytic removal of refractory organics. Additionally the formation of biodegradable organic from refractory compounds has to be proved.
- Second part of the work is focused on application of biological processes for landfill leachate samples detoxification,
  - validation of biological process suitability for effective reduction of organic compounds and nitrogen forms from the leachates in the system with suspended microorganisms (activated sludge method) and rotating biological contactor was studied by:
    - a) control of operating parameters such as: biomass concentration, food-microorganism ration (F/M), hydraulic retention time (HRT), recirculation rate, concentration of dissolved oxygen in order to make the process more efficient.
    - b) improvement of nitrogen removal from high ammonia contaminated leachate by means of heterotrophic denitrification with the application of external carbon source.
- Part three of the work consists in combination of photocatalytic and biological process in integrated detoxification of leachate,
  - assessment of feasibility of solar photocatalysis for refractory organics,
  - optimization of photocatalytic degradation organics in real landfill leachate effluents and proposition of an overall strategy of combined biological and photocatalytic process

# CHAPTER II

---

---

## *EXPERIMENTAL PART*

---

---

---

## II.1 Part 1: Laboratory scale research in France (LCA)

The present Chapter reviews all chemicals used and analytical methods applied in the research. Moreover, this survey contains not only the specific description of experiment procedures but also schemes, photographs of devices used in the work.

### II.1.1. Products and analyses

Humic acids sodium salts were supplied by Sigma-Aldrich Company. Titanium dioxide P-25 obtained from Degussa Corporation (70% anatase, 30% rutile; 99.8% purity, average particle size 20 nm and specific surface of 50 m<sup>2</sup>/g) was used.

The chemicals purchased to assist in HPLC analysis were obtained from Fluka. Milli-Q water was used throughout for the preparation of aqueous solutions or as a component of the mixed water-acetonitrile-phosphoric acid mobile phase.

#### *Humic acids characterisation - Spectroscopic properties (UV-VIS)*

The spectroscopic properties of commercial humic acids (Aldrich –Sigma) were determined. It should be noted that the electronic absorption spectra had no apparent absorption peaks (deflection point) but exhibited continuous increase of absorption with decreasing wavelengths (Fig. 2.1). For this reason, based on the previous findings (Bekbolet et al. 1996) the general parameters such as absorbance at 254 nm and absorbance at 400 nm (colour) were used for characterisation of HAs in the UV-VIS region. Figure 2.2 shows the correlations between absorbance, measured at 254 nm, 400 nm. Thus, the concentrations were measured by UV-VIS absorption spectroscopy analysis using Shimadzu spectrophotometer.

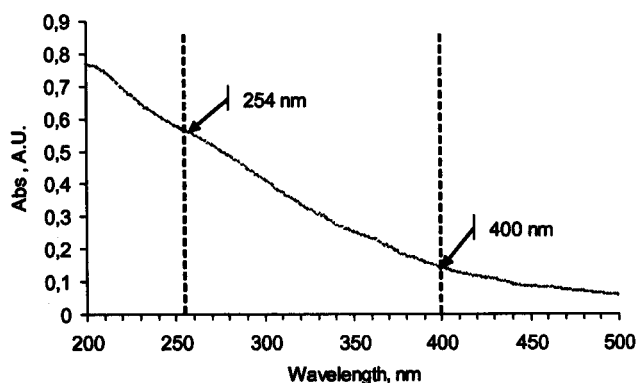

Figure 2.1 Adsorption spectra of humic acids in water pH 7.5; HAs concentration 100 mg/l (dilution 1:3)

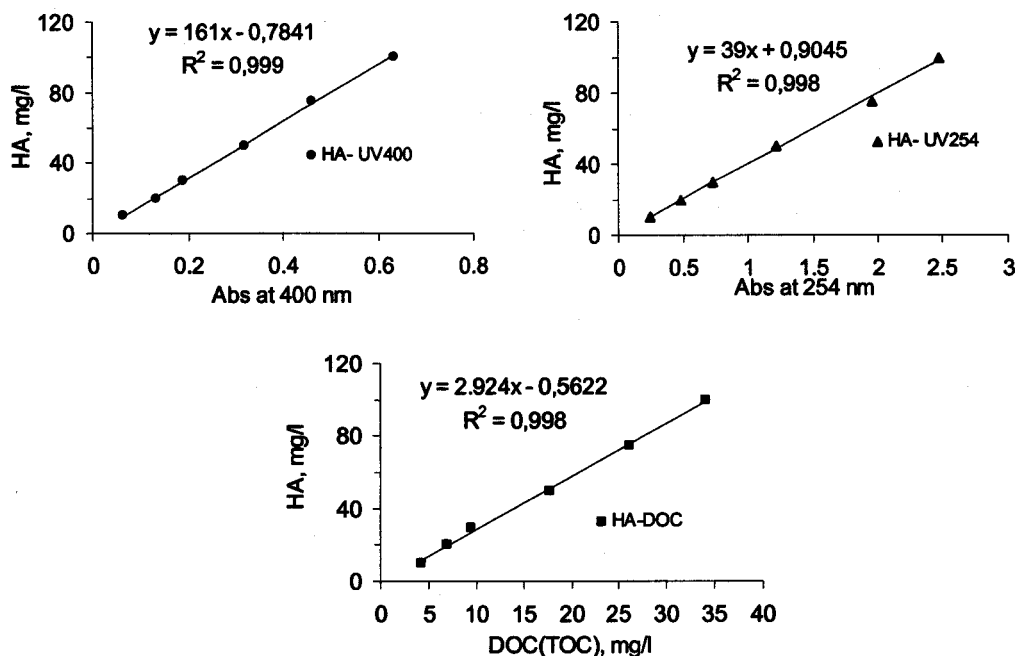

Figure 2.2 Relationship between  $UV_{254}$ ,  $UV_{400}$  and DOC (TOC) analyses of HAs

### Total Organic Carbon (TOC)

The TOC values at different irradiation times were determined with Shimadzu TOC Analyzer, TOC-5050-A. The samples taken to analyses were with  $TiO_2$  so-called Total Organic Carbon (TOC) or/and filtrated by  $0.45 \mu m$  Whatman or Sarius Cellulose Nitrate Membrane filters and so-called Dissolved Organic Carbon (DOC) (Fig. 2.2). It should be noted that for samples contained hydrogen carbonate (*see section II.1.3. and II.2.1.1*) the HAs was measured only by UV spectroscopy, because the high difference between the amount of inorganic carbon (thousands of ppm) and organic carbon from HA (dozens of ppm) contained in the samples prevented good detection in TOC Analyser

### Diffuse Reflectance Infrared Fourier Transform (DRIFT)

*DRIFT* technique was adopted to determine the types of function between the surface of catalyst and the adsorbed molecules. Samples were loaded without stress into 10 mm diameter stainless cups and the top surfaces of powders were levelled. Spectra were recorded for infrared measurements from  $4000$  to  $700 \text{ cm}^{-1}$  and resolution of  $4 \text{ cm}^{-1}$  as single beam spectra. The measurements were carried out on a Digilab FTS-185 Fourier transform spectrometer by a liquid nitrogen cooled narrow-band mercury-cadmium-telluride (MCT) detector. The infrared spectra were recorded by diffuse reflectance Fourier Transform (DRIFT) technique using Graseby-Specac accessory.

The  $TiO_2$  samples were mixed with KBr in the ration 1:20.

The KBr single-beam spectrum was registered and used as reference for reconstruction of absorbance like working spectra. The arithmetic application was performed on the working spectra comprising subtraction between working spectra. Therefore, differential sub-spectra of the HA<sub>ads</sub>/TiO<sub>2</sub> were obtained by means of subtracting the working spectrum of TiO<sub>2</sub> blank sample from samples of working spectra HA<sub>ads</sub>\_TiO<sub>2</sub>.

### ***Chromatographic analysis (HPLC)***

The degradation of HAs as well as the formation and the disappearance of the oxidation products were analysed after filtration (0.45µm) by *high performance liquid chromatography* (HPLC Waters 600 pump and 996 photodiode array detector, SUPELCOGEL Carbohydrate column and acetonitrile (15%) water (84 %) phosphoric acid (1%) mixture as mobile phase). The UV spectra were measured from 200 to 400 nm. It needs to be mentioned that none of the separated products on the column showed a maximum of absorbence (no apparent absorption peaks). Thus, to best illustrate the evolution of forming products the wavelength of 206 nm was arbitrary selected.

### ***Biological Oxygen Demand (BOD<sub>5</sub>)***

Biodegradation studies were carried out in Aqualitic thermostated 20°C system with BOD sensor. All the samples (previously adjusted to pH about 7 if necessary) were placed in 465 ml bottles and inoculated by 2 ml or 1% (of samples volume) of seed from outlet of MWWT local plant and 1 ml of nutrients substances (P, N and trace elements) needed for the bacterial growth. Moreover, a “control” (blank sample) was made without any pollutant but containing seed and nutrients. Then the BOD<sub>5</sub> was calculated with the difference of oxygen consumption between the sample and the control.

#### ***II.1.1.1 Experimental set-up: Solar box ATLAS SUNTEST CPS+***

Photocatalysis experiments were carried out in a Solar box ATLAS SUNTEST CPS+ simulating natural radiation. The light source was a vapour Xenon lamp (300 nm < λ < 800 nm) and the maximal power amounting to 600 Watt/m<sup>2</sup> (Fig. 2.3). The beaker with humic acids water solution and TiO<sub>2</sub> is placed into the chamber. During the photocatalytic test the mixture was constantly mixed by magnetic stirrer.

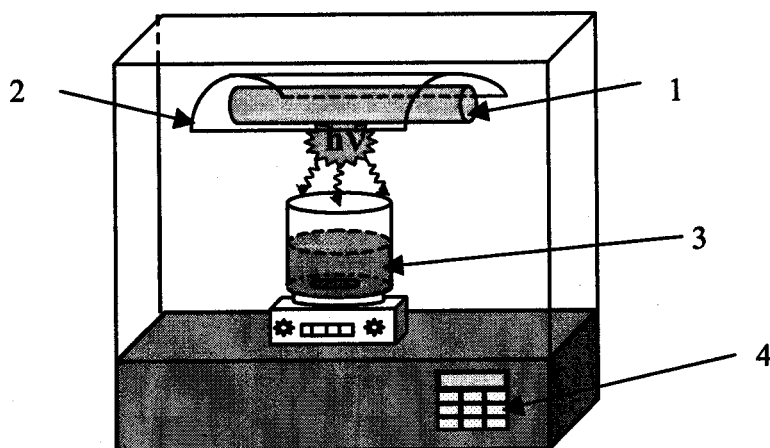

Figure 2.3 Solar box ATLAS SUNTEST CPS+ set-up: 1- xenon lamp, 2-reflectance surface, 3- reactor (beaker), 4-programation panel

## II.1.2. Studies of adsorption of HAs on $\text{TiO}_2$

### II.1.2.1. Determination of adsorption isotherm of HAs, pH influence

The affinity of humic acid to  $\text{TiO}_2$  was determined by batch equilibrium experiments in the dark. Research was carried out on suspension prepared by mixing 200-ml-solution of various HAs concentration at natural pH (7.3-7.8) and fixed amount of catalyst P-25 Degussa equal to 1.0 g/l.

In the studies of pH effect, three HAs solutions were prepared with the concentration of 100 mg/l but at various pHs (3.5; 7.5; 11.5). The volume of sample in that case was 500 ml.

The pH of HAs solution was adjusted with 1 M HCl or 1 M NaOH before added of  $\text{TiO}_2$ . The reaction slurry was continuously mixed using magnetic stirrer. Equilibration was achieved in approximately 30 min. The samples were taken after 0.5, 1.0 and 2 hours of reaction time.  $\text{TiO}_2$  was separated from solution by filtration 0.45  $\mu\text{m}$  filters.

The HAs solutions were prepared by adding an appropriate HAs salts dose, without any purification or pre-filtration, into distilled water and homogenised over night. To determine isotherms of adsorption, each solution (containing 10, 20, 30, 50 75 and 100 mg/l of HAs) were placed in Aqualitic thermostated (20°C) system and mixed using a magnetic stirrer.

Preliminary investigation proved that HAs adsorb quickly on to the  $\text{TiO}_2$  particles from aqueous solution (within 30 min). Nevertheless, 2 hours of equilibrium were ensured. Next, the samples of mixture were taken and filtrated. It was checked that about 15 % of humic acids remained on 0.45  $\mu\text{m}$  filters from raw (without  $\text{TiO}_2$ ) solution. Therefore, the blank samples were also prepared, i.e. the raw solutions of adequate humic acids concentration were filtrated (0.45  $\mu\text{m}$  filters). Blank samples obtained in this way were used for further

calculation of HA adsorption ( $HA_{filtered} - HA_{equilib} = HA_{ads}$ ). The concentrations were measured by UV-VIS absorption spectroscopy and TOC analysis.

The Langmuir (Langmuir 1915) model has been assumed. According to this model mono layer coverage and once the layer has been formed a saturation point is reached above which no further adsorption can occur (Equation 2.1).

$$[HA]_{ads} = [HA]_{ads\ max} \cdot \frac{K \cdot [HA]_{eq}}{1 + K \cdot [HA]_{eq}} \quad (Eq.2.1)$$

Hence, we calculated the maximum adsorption capacity  $[HA]_{ads\ max}$  by linearization Equation 2.2):

$$\frac{1}{[HA]_{ads}} = \frac{1}{[HA]_{eq}} \cdot \frac{1}{K \cdot [HA]_{ads\ max}} + \frac{1}{[HA]_{ads\ max}} \quad (Eq.2.2)$$

Where: K is the adsorption equilibrium constant;  $[HA]_{eq}$  – humic acids remaining in the solution ;  $[HA]_{ads}$  - humic acids adsorbed on  $TiO_2$ .

### II.1.2.2. Evaluation of the adsorption by DRIFT spectroscopy

The solutions of HA (100 mg/l) were preliminary filtered through Millipore filters (45  $\mu$ m diameter). The pH of HA solution was adjusted, before  $TiO_2$  addition, to pH 1.9 and 11.0 with appropriate quantity of 1.0 mol/l NaOH or HCl solutions. Simultaneously, a sample in natural pH (without pH adjustment) was prepared. Next, 1.0 g/l of catalyst was added into each sample.

After 2 hours of mixing by magnetic stirrer in the dark the suspension of  $TiO_2$  was separated from liquid by filtration through the 0.45  $\mu$ m Cellulose Nitrate Membrane Whatman filters. Next  $TiO_2$  samples were dried in the open air for 24 hours (at 25°C) and for 5 hours under vacuum (at 60 C°), still in the dark. Simultaneously, a blank sample ( $TiO_2$  treated with distilled water) was prepared. Next, it was treated by the DRIFT –technique as it was described above.

### II.1.2.3. Evaluation of the influence of salts on adsorption of HAs on $TiO_2$

The effects of some inorganic salts such as NaCl,  $Na_2SO_4$ ,  $NaHCO_3$  and  $Na_2HPO_4$  on the HAs adsorption were determined by batch equilibrium experiments in the dark at stable temperature 20°C using Aqualitic thermostated system. As was shown in previous experiments the adsorption equilibrium is reached within 20 min (Palmer et al. 2002), 30 min (Wiszniewski et al. 2002). In this work the equilibrium time was fixed at 120 min.

Experiments were carried out simultaneously in two vessels (beakers) (Fig. 2.4) on suspensions prepared by mixing a 500 ml solution containing 100 mg/l of HAs at natural pH and a fixed amount of catalyst P-25 Degussa. After 2 h of mixing the first samples were taken and filtered. Next, the dose of NaCl and Na<sub>2</sub>SO<sub>4</sub> were added in order to obtain concentration of 1.0 g/l of chlorine in vessel 1 and vessel 1.0 g/l of sulphate into vessel 2 respectively. After 2 h of mixing, the samples were taken and filtered. These actions were repeated twice, until the chlorine concentration rose to 4.5 g/l and the sulphate concentration rose to 7.75 g/l in vessel 1 and vessel 2 respectively.

Then, a dose of Na<sub>2</sub>SO<sub>4</sub> and NaHCO<sub>3</sub> were added into vessel 1 (which brought about an increase of sulphate and carbonate to the concentration of 7.75 g/l and 3.05 g/l respectively).

Simultaneously, a dose of NaCl was introduced into vessel 2 caused the increase of chlorine to the value 4.5 g/l. After another two hours of adsorption in the dark, the last samples were taken. A similar concentration of ions (sulphate, chloride and hydrogen carbonate) used in our experiments can be found in real leachate (Christensen et al. 2001).

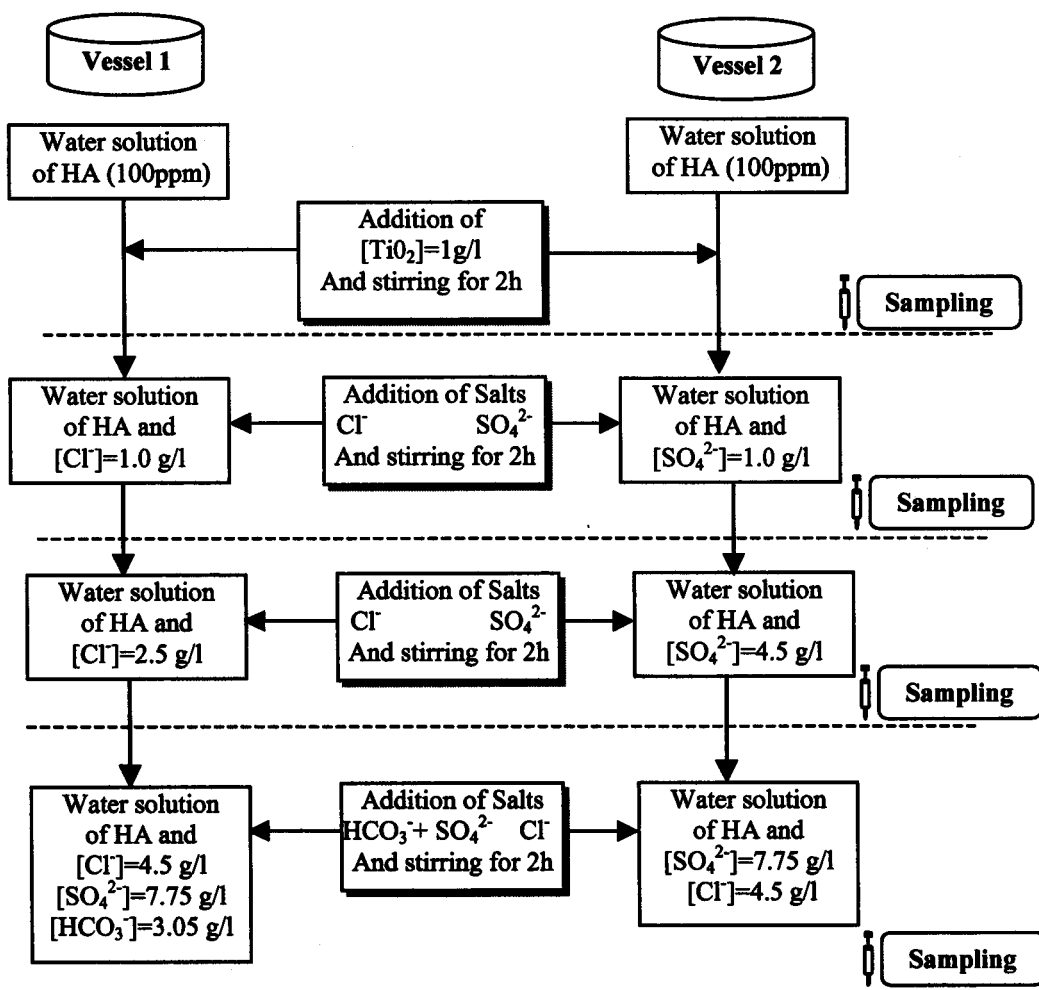

Figure 2.4 Procedures for the adsorption evaluation



It has been checked that between 15% and 19% (owing to the precipitation which occurs on change of ionic strength) of HAs remained on 0.45  $\mu\text{m}$  filters from the solution (without  $\text{TiO}_2$ ). Therefore, the blank samples were prepared i.e. the raw solutions of HAs as well as raw HAs solution containing appropriated ions concentration were filtered through the 0.45  $\mu\text{m}$  filters. Blank samples obtained in this way were used for further calculation of HAs adsorption. The concentrations were measured by UV-visible absorption spectroscopy analysis using Shimadzu spectrophotometer at 245 and 400 nm as well as TOC analyser (except mixture with  $\text{HCO}_3^-$  ions).

The effect of  $\text{Na}_2\text{HPO}_4$  was determined separately. Similarly to the previous experiments, after obtaining equilibration state of HAs, the dose of 50 mg  $\text{PO}_4^{3-}/\text{l}$  (from the salts  $\text{Na}_2\text{HPO}_4$ ) was added into the reacting mixture. Then, after 0.5 and 2 hours of reaction in the dark the samples were taken and filtered.

### II.1.3. Photocatalytic degradation experiments (LCA)

Photocatalysis experiments were carried out in a Solar box ATLAS SUNTEST CPS+ set-up (Fig. 2.3). To determine the photocatalytic mineralization kinetic, the initial concentration of humic acids was 100 mg/l (*one except HAs=110 mg/l*). Homogeneous mixing was provided by sonication of the slurry for 5 minutes with titanium dioxide. Next, the beaker with mixture was placed into the Solar Box chamber and was mixed for 30-60 minutes using magnetic stirrer in order to obtain equilibrium state. This operation was carried out in the dark and the time zero was the beginning of irradiation. For all experiments the photocatalyst concentration was 1.0 g/l except the study of the influence of  $\text{TiO}_2$  loading when catalyst amount varied from 0.1 to 2.0 g/l.

The volume of reaction solution was 300 ml and illuminated surface 80  $\text{cm}^2$  (*section, III.2.2.2*).

The volume of reaction solution was 500 ml and illuminated surface 130  $\text{cm}^2$  (*section III.2.2.1, biodegradability*).

The process was carried out at temperature of 20-30°C. The degradation of HAs as well as the formation and the disappearance of the oxidation products were analysed by HPLC, DOC, UV/VIS absorbance after filtration or without  $\text{TiO}_2$  separation expressed as TOC.

Generally, the data were recalculated (Equation. 2.1) and illustrated as an evolution of normalised concentration, i.e. normalised dissolved ( $\text{DOC}/\text{DOC}_0$ ) or total organic carbon ( $\text{TOC}/\text{TOC}_0$ ), and normalised absorbance ( $\text{ABS}/\text{ABS}_0$ ) at 254 nm or 400 nm (so-called colour).

$$\text{normalised concentration} = \frac{\text{concentration at different reaction time}}{\text{initial concentration}} \quad (\text{Eq.2.3})$$

### II.1.3.1 Determination of pH and salts effect on photoreactivity of HAs

The pH of HAs solution was adjusted with 1 M HCl or 1 M NaOH before addition of  $\text{TiO}_2$ . In order to obtain demand anion concentration, i.e.  $\text{Cl}^-$  [1.0 and 4.5 g/l],  $\text{SO}_4^{2-}$  [1.0 and 7.75 g/l],  $\text{HCO}_3^-$  [3.05 g/l],  $\text{HPO}_3^{2-}$  [0.05 g/l] the appropriate dose of salts: NaCl,  $\text{Na}_2\text{SO}_4$ ,  $\text{NaHCO}_3$  and  $\text{NaHPO}_4$  were respectively added into HAs solution.

The effect of salt (NaCl) on initial adsorption and photocatalysis of HAs was studied with respect to the order of chemicals added. “(Solution1)” corresponds to the experiment in which HAs were added after equilibration of chloride anion and  $\text{TiO}_2$ . “(Solution 2)” corresponds to the experiment in which the chlorine anions were added after equilibration of HAs and  $\text{TiO}_2$  (Figure 2.5).

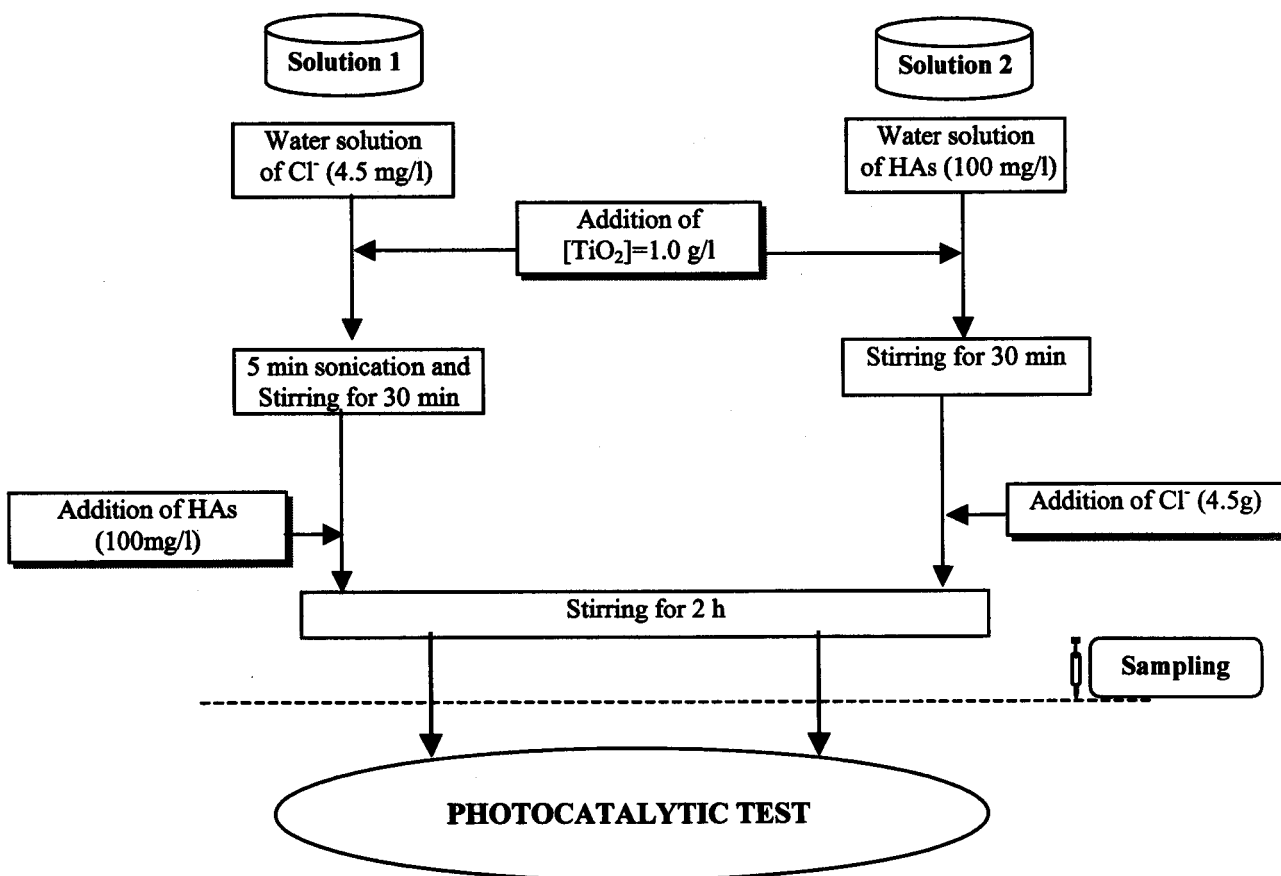

Figure 2.5 Procedures for the evaluation of  $\text{Cl}^-$  effect

### ***II.1.3.2 Evaluation of the influence of O<sub>2</sub> on photoreactivity of HAs***

Photocatalytic mineralization of HAs was performed in the presence of air-flow constantly supplied into the reacting mixture. The air-flow was fixed in order to prevent the solution medium from foaming. A pipette of Pasteur was used as the diffuser of air.

### ***II.1.3.3 Assessment of bio-accessibility of HAs photocatalytic degradation products***

In order to assume biodegradability of by-products the BOD<sub>5</sub> measurements were performed (*see section II.1.1.*). It was checked that a presence of TiO<sub>2</sub> in the dark conditions do not affect microorganism metabolism. Thus, the samples at different reaction times were analysed directly without TiO<sub>2</sub> separation.

## **II.2 Part 2: Pilot Plant experiments in Spain (PSA)**

### **II.2.1 Products and analysis in PSA experiments**

#### ***II.2.1.1 Experimental conditions: CPCs reactors***

The photocatalysis experiments at Plataforma Solar de Almeria were carried out in the compound parabolic collectors CPC<sub>35</sub> (Fig. 2.6) as well as CPC<sub>190</sub> systems. The CPCs systems are static collectors with an involute reflective surface around a cylindrical reactor tube. It consists of a plug flow reactor in total recirculation loop with a non-reacting tank, providing aeration and samples for analyses. The hydraulic circuit has been carefully designed with the highest volumetric efficiency and the nominal flow is turbulent (Reynolds number =  $10^4$ ) to avoid catalyst settlement. More detailed descriptions of this set-up can be found in literature (Malato et al. 2000B, Augugliaro et al. 2002, Malato et al. 2002, <http://www.psa.es/webeng/instalaciones/quimica.html>).

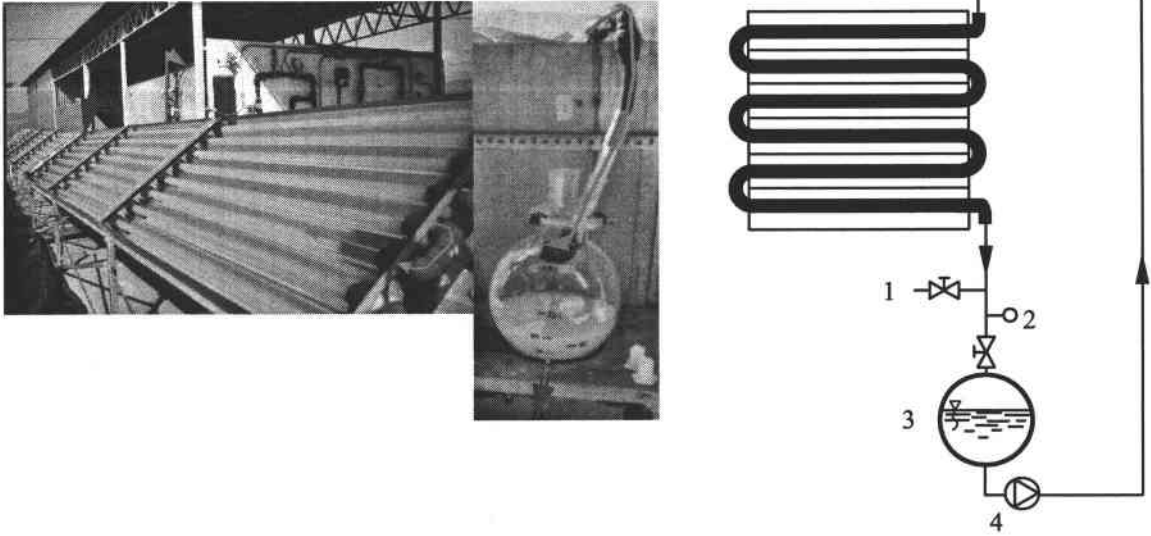

Figure 2.6 Picture of CPC<sub>35/39</sub> (left) and illustration-scheme of proceeding: 1-sampling valve, 2- thermocouple, 3- not-reacting tank, 4- pump (right)

Table 2.1 gives the general operating conditions for experiments.

Table 2.1 Operation conditions of CPCs devices

Parameters:	Units	CPC <sub>35</sub>	CPC <sub>190</sub>
Total volume of pilot-plant $V_t$	l	35.0/39.0	190.0
Irradiated volume $V_{ir}$	l	22	72
Irradiated surface $A_r$	m <sup>2</sup>	3.08	6.0
TiO <sub>2</sub> concentration	g/l	(0.2-2.0), 0.7	0.7

### II.2.1.2 The evaluation of solar UV radiation

The use of experimental time as the calculation unit in the case of pilot plants could lead to misinterpretation of the results because: i) the reactor consists of exposed and non-illuminated elements and ii) the intensity of solar radiation depends on the season, the time of day and the weather. Since it is not possible to work in conditions of constant illumination under sunlight, it is convenient to use a mathematical approach to process the data obtained in real solar experiments. In this work the relationship between experimental time ( $t_n$ ), plant volume ( $V_t$ ), collector surface ( $A_r$ ) and the radiant power density ( $UV_g = W_{uv}/m^2$ ) measured by the radiometer (KIPP & ZONEN, model CUV3) mounted on a platform at a fixed 37° angle (the same angle as the CPCs) was used. The data of incident  $UV_g$  provided by the radiometer were stored into computer and next used for the recalculation.

The kinetics of the outdoor experiments were determined by plotting the HAs concentration as a function of accumulated energy ( $Q_{uv,n}$ ) by photoreactor (instead of experimental time). According to Malato et al. (2000) the following Equations 2.4 and 2.5 were applied:

$$Q_{UV,n} = Q_{UV,n-1} + \Delta t \cdot UV_{G,n} \cdot \left(\frac{A_t}{V_t}\right) [J / l] \quad (\text{Eq. 2.4})$$

$$\Delta t = t_n - t_{n-1} [s] \quad (\text{Eq. 2.5})$$

## II.2.2 Photocatalytic degradation experiments

### II.2.2.1 Influence of catalyst loading and salts on photoreactivity of HAs

The initial concentration of HA was prepared using the appropriated amount of HA sodium salts. The solution of HA mixed overnight. The day of experiments, the aqueous solution of HA (100 mg/l) was circulated in the system without irradiation (the collectors were covered). Next, the  $TiO_2$  (P-25 from Degussa) was added to the non-reacting tank and the semiconductor slurry was mixed by recirculation. This operation was carried out in the dark.

After 30 to 60 min of processing, in order to evaluate the initial adsorption of HA, a sample was taken. Next, the collectors were uncovered and the photocatalytic process started.

In the experiments the photocatalyst concentration varied in the range 0.2 g/l to 2.0 g/l. However, in the tests for inorganic anion influence, only two catalyst doses of 0.2 and 0.7 gram per litre were chosen. The first one was referred to by previous studies in PSA (Fernandez et al. 1999, Malato et al 2002) and the second one was determined experimentally as an appropriate catalyst concentration in the preliminary (Wiszniewski et al. 2002) and in the present investigations (Wiszniewski et al. 2003).

The degradation of HA solution was followed after filtration on millipore filter- 0.2  $\mu m$  by global parameters, such as dissolved organic carbon (DOC) and UV/Vis absorption spectroscopy analysis. The DOC values at different irradiation times were determined by using Shimadzu TOC Analyser (TOC-5050-A). Based on the previous studies of Bekbolet and co-workers (1996) the general parameters such as absorbance at 254 nm and absorbance at 400 nm (colour) were used for characterisation of HA. The specific absorption was determined by using Dunicam spectrophotometer.

### II.1.3.3 Assessment of bio-accessibility of HAs photocatalytic degradation products

The biodegradability of the photocatalytic by-products was assessed by means of: i) biological oxygen demand (BOD<sub>5</sub>) and ii) oxygen uptake rate (OUR) measurements. The BOD<sub>5</sub> parameter was carried out in WTW thermostated 20°C system with BOD sensors. Samples were taken from CPC at different reaction times without TiO<sub>2</sub> separation. Also, with the samples containing TiO<sub>2</sub> the oxygen uptake rate (OUR) measurements were performed. The OUR test is a bioassay procedure in which living microbial consortia consume dissolved oxygen while using organic matter for energy and carbon source (Mao et al. 1995). The operating procedure was as follows: a conventional respirometer with a small reactor vessel completely covered (volume 100 ml) was used. The respirometer with an oxygen electrode was connected to a recorder (Fig. 2.7).

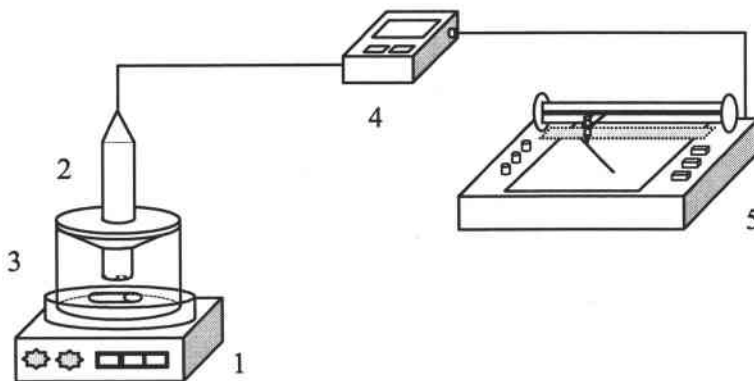

Figure 2.7 The oxygen uptake rate recording set-up: 1- magnetic stirrer, 2-dissolved oxygen electrode, 3-vessel, 4-respirometer, 5- recorder

First, mixed liquor (80 ml) of activated sludge (from local Municipal Wastewater Treatment Plant) sample was saturated with oxygen by shaking and was put into the vessel. Next, the vessel was filled with the sample (20 ml) taken from the photoreactor and carefully closed, with no air bubbles remaining in it. The magnetic stirrer mixed the sample during measurement. The OUR (OUR<sub>i</sub>) measurement of each sample at different irradiation times was compared to the value of OUR (OUR<sub>0</sub>) of HA sample taken at the beginning of photocatalysis. According to the following Equation 2.6 the % OUR was calculated:

$$\% \text{ OUR} = \frac{\text{OUR}_i - \text{OUR}_0}{\text{OUR}_0} \cdot 100 \% \quad (\text{Eq. 2.6})$$

The increase % OUR will correspond to the increases of amount of biodegradable organic. It should be noted that the temperature of individual samples in respirometer was constant.

## II.3 Part 3: Laboratory scale researches in Poland (EBD)

### II.3.1 Products and analysis in EBD experiments

#### II.3.1.1 Landfill leachate (Swietochlowice and Gliwice)

Raw leachate from *Świętochłowice* municipal landfill was used in the experiments in period I - April -June 1999, period II - December 1999 - February 2000 and period III - February - July 2000. The *Świętochłowice* landfill has been in operation since 1993. The composition of leachate suggested the methanogenic phase of landfill (Harrington i Maris, 1986; Henry et al. 1987; Bretschneider and Löcher 1993). The high pH amounting to 8.5, relatively low organic (COD and BOD<sub>5</sub>) and sulphate concentrations indicated that it was an “old landfill” (Tab. 2.2).

Table 2.2 Characteristic of raw leachate from Swietochlowice used in the period I, II and III

Parameters	Period I	Period II	Period III
pH	8.5	8.5	8.5
COD (mg O <sub>2</sub> /l) <sup>a</sup>	2680	2030	1020
BOD <sub>5</sub> (mg O <sub>2</sub> /l) <sup>b</sup>	1630	1140	340
BOD <sub>5</sub> /COD	0.6	0.5	0.3
TKN (mg N /l) <sup>c</sup>	421	890	619
Ammonia (mg NH <sub>4</sub> <sup>+</sup> -N /l)	402	841	569
Nitrogen (mg NO <sub>2</sub> <sup>-</sup> -N/l)	1.8	2.0	3.9
Nitrate (mg NO <sub>3</sub> <sup>-</sup> -N /l)	-	0.6	0.5
Sulphate (mg SO <sub>4</sub> <sup>2-</sup> /l)	217	247	302
HA (mg/l) <sup>d</sup>	***	60	85

<sup>a</sup>COD - chemical oxygen demand.

<sup>b</sup>BOD<sub>5</sub>- 5-day biochemical oxygen demand.

<sup>c</sup>TKN- total Kjeldahl nitrogen

<sup>d</sup>HA- humic acids

\*\*\*lack of data

Parameters	Range and average from period I, II and III	Range**
Arsenic (mgAs <sup>3+</sup> /l)	0.015-0.045 (0.021)	***
Chromium (mgCr <sup>3+</sup> /l)	0.041-0.25 (0.116)	>2.7
Copper (mgCu <sup>2+</sup> /l)	0.003-0.17 (0.024)	0.4-1
Lead (mgPb <sup>2+</sup> /l)	0.16-0.5 (0.156)	***
Mercury (mgHg <sup>2+</sup> /l)	0.002-0.044 (0.023)	0.2-0.7
Nickel (mgNi <sup>2+</sup> /l)	0.031-0.057 (0.040)	0.4-2.5
Zinc (mgZn <sup>2+</sup> /l)	0.079-0.33 (0.139)	***

\*\* Heavy metals tolerance of activated sludge systems according to Buraczewski 1994

Nevertheless, BOD<sub>5</sub>/COD ratio would point out to a young landfill. The reason for this phenomenon was that the storage reservoir collected the leachate from the older landfill cell as well as from the new one being operated since 1998. Actually, the younger leachate had a great importance on the leachate “cocktail”. Next, (period II and II) leachate contained decreasing quantity of biodegradable organic substances and high concentration of ammonia. The decrease of biodegradability proved that the stabilisation process occurred into the landfill deposit along the age of landfill. Simultaneously, increased concentrations of HS were also observed. The heavy metals detected in leachate from Swietochlowice did not differ from the border concentration occurred in other sanitary landfills and reported in literature (Harrington and Maris 1986, Christensen et al. 2001).

The leachate samples were also collected from a municipal landfill site, which had been operat since 1978, located in *Gliwice*. The leachate was withdrawn from the central collection points (well), which collected the percolates mainly from the closed cell being in the later methanogenic phase (“old landfill”) as well as a new cell which started its operation in 2000. Moreover, the stored leachate was diluted (especially during rainy weather) by the liquid coming from the perimeter trenches. The composition of leachate used in the study between October - 2001 and May- 2002 is given in Table 2.3.

Table 2.3 Characteristic of raw leachate from *Gliwice*

Parameters	Landfill leachate (average)
pH	7.8
COD (mg O <sub>2</sub> /l )	680
BOD <sub>5</sub> (mg O <sub>2</sub> /l)	138.
BOD <sub>5</sub> /COD	0.2
TKN (mg N /l)	326
Ammonia (mg NH <sub>4</sub> <sup>+</sup> -N /l)	305
Nitrogen (mg NO <sub>2</sub> <sup>-</sup> -N/l)	0.15
Nitrate (mg NO <sub>3</sub> <sup>-</sup> -N /l)	5.68
Phosphate (mgPO <sub>4</sub> <sup>3-</sup> /l)	6.5
Chlorine( mg/Cl)	800
Sulphate (mg SO <sub>4</sub> <sup>2-</sup> /l)	508.

The parameters detected in leachate correspond to composition of stabilised leachate. The leachates were characterised by low biodegradability, BOD<sub>5</sub>/COD ratio amounted to 0.2 and still high ammonia concentration levelling at 300 mg/l.



### II.3.1.2 Experimental conditions: Activated sludge systems

#### II.3.1.2 a) Evaluation of short-term and long-term effects of bentonite on sludge

Initially, the effect of bentonite on activated sludge sedimentary properties was investigated. These experiments were carried out in aerated reactor (Fig 2.8) with 2.0 l operating volume by using activated sludge originated from a local municipal wastewater treatment plant.

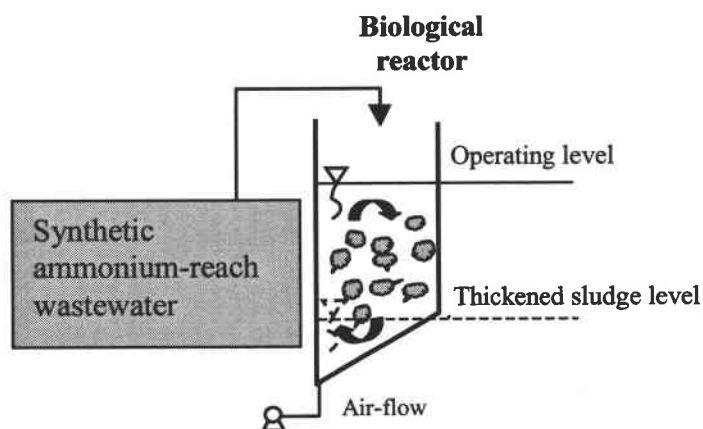

Figure 2.8 Schematic diagram of activated sludge unit with a useful volume of 2.0 l

Before starting experiments with additive, the sedimentary properties of activated sludge from the municipal wastewater treatment plant were determined. Next, a dosage of bentonite carrier (TERRANA 510 from Süd-Chemie) of inert surface  $60 \text{ m}^2/\text{g}$  and apparent bulk density of  $1000 \text{ mg/l}$  was introduced into the reactor. After about one hour of mixed liquor aeration *short-term effect* was determined by measuring SVI index. The initial bentonite: activated sludge ratio was 1:2.

In order to estimate the *long-term effect* of bentonite on activated sludge properties, the system was examined for 30 days. Daily, after decantation of sludge a 1.5 l of synthetic ammonium-rich wastewater (200-300 mg/l) was introduced into the reactor. The feed was obtained by dosage of salts:  $\text{NH}_4\text{Cl}$ ,  $\text{NaHCO}_3$ ,  $\text{MgSO}_4$ ,  $\text{KH}_2\text{PO}_4$  and other microelements into tap water. The conditions (without organic carbon source) were favourable to growth of nitrification (autotrophic) bacteria, which are known to be freely associated with the flocs and they have worse sedimentary properties than heterotrophs. Therefore, they could easily be washed out from the treatment system.

In the experiment with *landfill leachate* it was decided to decrease the initial bentonite:biomass ratio to 1:4. Composition of real landfill leachate used as a feed for biological set-up ensures the growth of mixed population of microorganisms, which should have better sedimentation properties than nitrifiers alone. Thus, heterotrophs might play a vital role in the total process stability by providing compact sludge flocs at which nitrifiers

may be retained. The other reason is that higher presence of bentonite in biomass entails at the same time much higher expense for treatment of residual sludge.

Repetitive doses of bentonite (1.0 g/l) were provided to the system in the interval of 30 days which corresponded more or less to generation time of mixed population of bacteria (sludge age). Figure 2.9 shows pre-denitrification set-up. The system consists of the anoxic reactor followed by the aerobic one and the secondary clarifier.

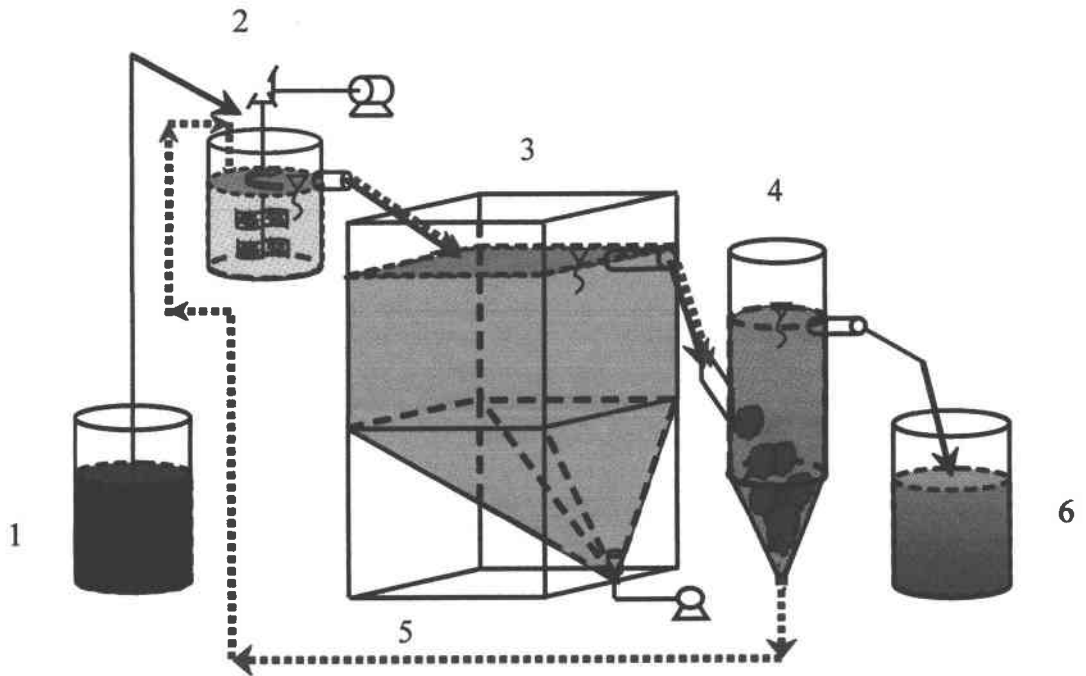

Figure 2.9 Schematic diagram of activated sludge system with pre-denitrification: 1- raw leachate, 2- anoxic reactor, 3- secondary clarified, 4- external sludge, 5- aerobic reactor, 6- treated leachate

Raw leachate was pumped into an anoxic reactor and mixed with biomass by stirrer. In this condition denitrification (reduction of nitrite and nitrate to molecular nitrogen) was accomplished. The internal recycle (aerobic-anoxic) was not applied. The external sludge recycle rate (from secondary clarified to anoxic reactor) provided the appropriate concentration of biomass in the reactors and supplied  $\text{NO}_x$  (nitrite and nitrate) for denitrification. Nitrification occurred under aerobic conditions in the second reactor. Dissolved oxygen was supplied by porous diffusers placed at the bottom of the reactor. The sludge was separated from the biologically treated effluent by sedimentation in the secondary clarifier. All reactors were operated at  $20^\circ\text{C} \pm 2^\circ\text{C}$ , and dissolved oxygen concentration was in the ranges 1.4-4.4 and 0.1-0.5  $\text{mg O}_2/\text{l}$  for aerobic and anoxic chamber respectively. Since the leachate has phosphorus deficiency (not appropriate to biosynthesis),  $\text{KH}_2\text{PO}_4$  was added to the feed to supply a BOD/P ratio 100:1 (Eckenfelder and Musterman 1995). Sodium

carbonate  $\text{NaHCO}_3$  was also provided to the feed in order to maintain proper alkalinity in the aeration reactor.

In the start-up period about 1 month before period I, the reactor was inoculated with Activated Sludge from municipal wastewater treatment plant and was fed with diluted raw leachate to provide nitrification-denitrification ability of biomass. Table 2.4 shows the general operating conditions for the adapted sludge determined for each period (period I, II and III) when the undiluted leachate was supplied into the system.

Table 2.4 Operating conditions for activated sludge system during the period I, II and III with LL from Swietochowice

Parameters	Period I	Period II and III
Aerobic reactor volume (l)	11.0	11.0
Anoxic reactor volume (l)	1.3 / 3.0	3.0
Flow rate (l/d)	10.8	6.0-13.0
Hydraulic retention time in system (d)	1.0	1.7 – 2.8
Hydraulic retention time in aerobic reactor (d)	0.12 / 0.3	1.0-1.8
Organic loading rate (g COD /g MLSS•d)	0.157-0.514	0.050-0.226
$\text{NH}_4^+$ -N loading rate (g $\text{NH}_4^+$ -N/ g MLSS•d)	0.022-0.112	0.035-0.116
Sludge recycle (% of influent)	52-450	100-540
Sludge concentration in anoxic reactor (g MLSS/l) <sup>a</sup>	7.6-12.4	5.1-10.0
Sludge concentration in aerobic reactor (g MLSS/ l) <sup>a</sup>	4.7-9.2	4.0-8.3
Sludge age (d)	12- 14	22- 43

<sup>a</sup>MLSS contained from 70 to 85% of MLVSS

### II.3.1.3 Experimental conditions: Rotating Biological Contactors

The rotating biological contactor (RBC) set-up consisted of 12 circular plastic discs (diameter = 21 cm) mounted centrally on a common horizontal shaft. A developed surface area for bio-film was provided by (home-made) discs with doormat (PE) fixed to it. The discs were approximately 41 percent submerged in a tank containing wastewater and were slowly rotated (rotational speed of 1.5 rpm) by either a mechanical drive (Fig. 2.10 top). The temperature was maintained at 19°C.

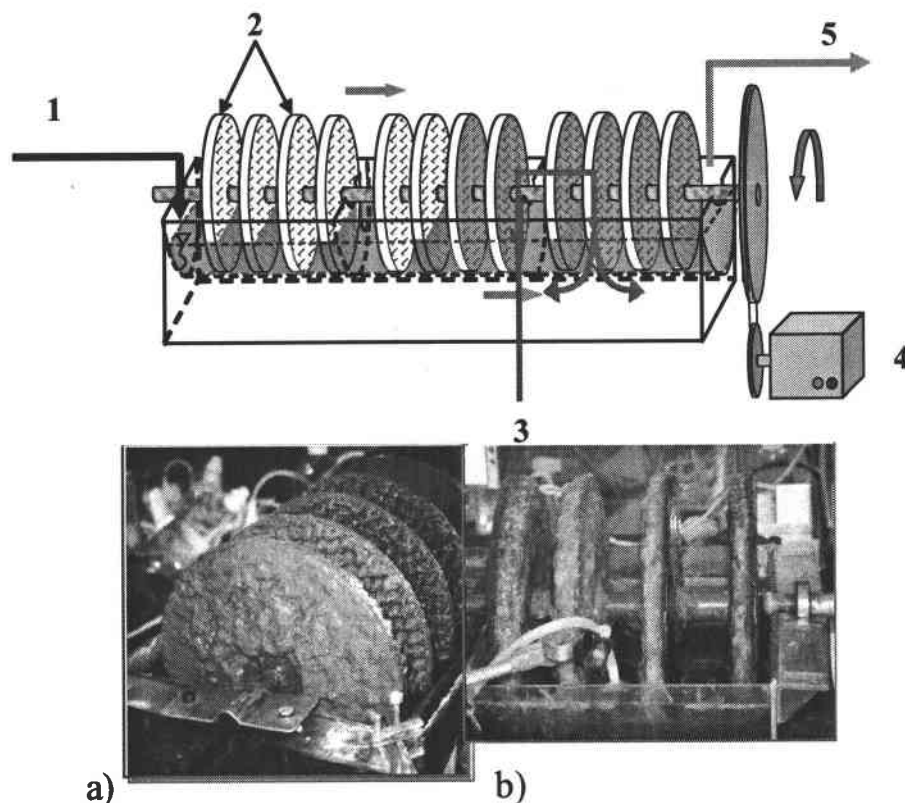

Figure 2.10 Schematic diagram (top) and picture a) nitrification zone I-VI discs (bottom left), b) denitrification zone VII-XII discs (bottom right) of RBC: 1- leachate influent, 2- discs, 3- external carbon source, 4- drive motor, 5- effluent

Attached-growth bio-film was formed during the contact of discs (support) with the treated medium (landfill leachate). When the disc rotates out of the wastewater, the biofilm becomes exposed to air and is oxygenated, thereby maintaining the aerobic conditions. After reaching a critical thickness, portions of the biofilm slough off the discs. The bio-film sloughed (detached layer) from the discs was periodically removed in order to prevent solids build up in the trough.

RBC is a plug-flow system i.e. as wastewater passes from chamber to chamber within a treatment train, it undergoes an increasing degree of treatment.

### II.3.1.3 a) Implementation of heterotrophic denitrification in aerobic RBC

The research in RBC system on landfill leachate from Gliwice were carried out between October 2001 and June 2002.

Before providing the leachate to the RBC, the samples were enriched with  $\text{KH}_2\text{PO}_4$  as a source of phosphorus enhancing biological growth. Next, the leachate was subjected to first stage of biological pre-treatment in the activated sludge (AS) reactor, the same as it was shown on Figure 2.12. The parameters governing biological process (such as hydraulic retention time amounting to 3.7 h, sludge loading rate amounting to  $0.777 \text{ gCOD/gMLSS}\cdot\text{d}$

was adjusted with the purpose of reducing BOD fraction but without abatement of ammonia from the leachate. The effluent of AS reactor was subsequently used as a feed for RBC.

It should be noted that in the previous study (Chromik 2001) microorganisms, which settled on RBC system had been acclimated to the high ammonia concentration amounting to about 800 mg/l in influent. Considering that the amount of ammonia in real leachate from Gliwice ranged from 200 to 300 mg/l, the concentration of ammonia in the leachate used as a feed for RBC was adjusted to about 800 mg/l by adding  $\text{NH}_4\text{Cl}$ . Additionally, an appropriated dose of sodium carbonate  $\text{NaHCO}_3$  was added in order to neutralize the acid produced during nitrification process (see equation 1.2 in section 1.2.1.3)

The study included three stages i) first; the efficiency of RBC system for complete nitrification of ammonia from landfill leachate was confirmed. Then, as a nitrification zone we consider all chambers of RBC ii) next, the microorganisms were acclimated to the stream of acetic acid used as an external carbon source for biological denitrification. The solution of acetic acid was introduced into the III chamber of RBC, but taking into account "backwater" of the new stream, it was considered that denitrification zone should start from disc VII of chamber II (Fig. 2.10). The amount of  $\text{CH}_3\text{COOH}$  was gradually increased (from 0.5 g/l to about 7.0 of COD per gram of N) in order to form a microbial community capable of reducing nitrite and nitrate concentration formed in nitrification zone of RBC; iii) finally, the dose ensuring steady conditions for biological denitrification was determined.

Table 2.5 shows the general operational conditions for RBC system determined for the period 26.10.2001 to 24.06.2002 when the leachate was supplied into the system.

Table 2.5 Operating conditions of RBC with the leachate from Gliwice.

Parameters	RBC
Disc submergence (%)	41
Number of chambers	3
Total discs number	12
Total surface area of discs ( $\text{m}^2$ )	0.912
Liquid volume (l)	14
Flow rate (l/d)	5.0
Hydraulic retention time in nitrification zone (d)	1.31
Hydraulic retention time in denitrification zone (d)	0.78
Organic loading rate (g COD / $\text{m}^2 \cdot \text{d}$ )*	3.0-5.8
Organic loading rate (g bCOD / $\text{m}^2 \cdot \text{d}$ )**	5.4-26.3
$\text{NH}_4^+$ -N loading rate (g $\text{NH}_4^+$ -N/ $\text{m}^2 \cdot \text{d}$ )***	8.5

\*loading from landfill leachate

\*\*loading from  $\text{CH}_3\text{COOH}$  (bCOD)-easily biodegradable organic

\*\*\* average since 80 operating day

### II. 3.1.4 Analytical methods- EBD study

The efficiency of biological treatment was followed in terms of general parameters such as: COD (Chemical Oxygen Demand- dichromate method), BOD<sub>5</sub> (5 day Biochemical Oxygen Demand - Oxi Top WTW system with BOD sensor), pH (pH-meter WTW), TKN (total Kjeldahl nitrogen) and ammonia (Kjeltec System 1026 Tecator), nitrite and nitrate, sulphates. Mohlman Index SVI (sludge volume index), mixed liquor volatile suspended solids (MLVSS), mixed liquor suspended solids (MLSS) and dissolved oxygen were also analysed. Additionally, according to Anthonisen's equation (1976), the free ammonia (mg NH<sub>3</sub> /l) and free nitrous acid (mg HNO<sub>2</sub> /l) concentrations were calculated for the experimental condition of pH 8.5 and temperature 20<sup>0</sup>C.

### *Humic substances characterisation in landfill leachates samples*

The procedure used for the determination of HS concentration in landfill leachate was based on a method described by Hermanowicz and co-workers (1976) and by using calibration prepared with model HAs (Aldrich-Sigma).

The samples of raw landfill leachate were initially filtered through a 1.2 µm filter to remove particulate matter. Next, the sample was diluted with distilled water in order to obtain suitable HS concentration i.e. in the range 0-5 mg/l. The 250 ml of diluted sample was placed in separatory funnel and 5 ml of H<sub>2</sub>SO<sub>4</sub> (p.a.). After mixing the sample, a 25 ml of extracting solvent (amyl alcohol CH<sub>3</sub>(CH<sub>2</sub>)<sub>3</sub>CH<sub>2</sub>OH) is added. Next, the two liquids are shaken together for 1 min. and are allowed to separate within 2 hours. Then, the denser water-phase is removed by the bottom. The remaining alcohol with interface impurities should be softly shaken and allowed to separate one more time. After a while, residual water is removed. Next, 25 ml of NaOH is added into the separatory funnel and shaken for about 10 s. After 10 min, the denser water-phase containing extracted HS withdrawn by the bottom. The first 4 ml of the liquid is rejected and next 10 ml of analyte is filtered (through fine filter paper) and analyzed.

Analyses of a samples were carried out in terms of visible adsorption spectroscopy at 420 nm and compared with a blank sample (distilled water) prepared through the same procedure. Calibration curves were prepared using HAs from Aldrich-Sigma sodium salts. The spectrophotometric method for the quantitative determination of HS levels in 0-5 ppm gives a normal linear calibration curve for which  $HA_{stand} = 29.2x$  and coefficient  $R^2 = 0.99$ .

### **Enumeration of denitrifying bacteria in RBC**

A part of the bio-film attached on disc I (chamber I) and X (Chamber II) was removed. The sampling point corresponded to two distinguishable zone of RBC i.e. nitrification and denitrification zone respectively. Each sample weighed about 10g.

For each biofilm a part of the sample was used to determine a dry mass. The other portion of the sample was inserted into an Erlenmeyer flask containing 90 ml of NaCl (0.85% v/v) medium and vigorously shaken using a rotary shaker for 15 min. Next, the sample was left aside in order to sediment the large particles for 2 min, and supernatant was taken for further treatment. The first preparation of the sample (according to the procedure stated above) was named *dilution*  $10^{-1}$ . The subsequent samples were prepared by dilution sample till *dilution*  $10^{-12}$  using NaCl solution.

Next, 1 ml of each *dilution* was taken and introduced into the liquid containing Giltay medium (PN-77/C-04615)<sup>1</sup>; Cell density of denitrifying bacteria was determined as a “*titre*” (the lowest dilution in which identification of isolated strain was detected).

Inoculated samples were incubated at stable temperature amounting to 26°C within 48 hours.

Next, from the samples which gave a “positive results” (colour change and gas production) 0.1 ml of *inoculum* (seed) was taken and transferred into nutrient agar plates with the aim of isolating pure culture of denitrifying bacteria. The plates were incubated at stable temperature amounting to 26°C for 48 hours.

In order to isolate the single strain of bacteria cultures, they were transferred on Petri plate containing nutrient agar. This operation was repeated several times for ensuring purity of isolated colonies.

Pure strains were used for inoculation liquid Giltay medium to check again their ability for denitrification. Then, their morphology, reductase and oxidase reaction were determined. All isolated strains were Gram-negative, oxidase-positive rods. A characterization was performed by commercial identification kits API 20 NE.

#### **II. 3.1.5 Control of biological treatment efficiency in biological system**

Characterisation of biological purification involves control of different parameters governing this process. The main parameters determined for activated sludge as well as in RBC systems are listed below.

<sup>1</sup> PN-77/C-04615 Polska norma., Water and wastewater Microbiological testings Determination of the denitrifying bacteria by the tube method.

**Activated sludge system and/ or Rotating Biological Contactors (RBC)****Hydraulic retention time for reactor, HRT :**

$$HRT = \frac{V}{Q} [d], \quad (\text{Eq. 2.7})$$

where:  $V$  – volume of biological reactor [ $m^3$ ];  $Q$  – flow [ $m^3/d$ ]**Recirculation ratio,  $R$  :**

$$R = \frac{Q}{Q_R}, \quad (\text{Eq. 2.8})$$

where:  $Q_R$  – recirculation flow [ $m^3/d$ ]**Sludge loading rate, F/M (food-microorganism ratio):**

$$F/M = \frac{C_o \cdot Q}{V \cdot X_r} [g/g \text{ MLSS} \cdot d] \quad (\text{Eq. 2.9})$$

where:  $C_o$  – substrate concentration in influent [ $g/m^3$ ];  $X_r$  – microorganism concentration in reactor (mixed liquor suspended solid) [ $gMLSS/m^3$ ].**Volumetric loading rate, F/V:**

$$F/V = \frac{C_o \times Q}{V} [g/m^3 \cdot d], \quad (\text{Eq. 2.10})$$

**Sludge Volume Index, SVI :**

$$ISV = \frac{V_o}{X_r} [cm^3/g \text{ sm}], \quad (\text{Eq. 2.11})$$

where:  $V_o$  - volume of thickened sludge after 30 min of sedimentation in Imhof funnel [ $cm^3/dm^3$ ], (SVI 40-60 ml/g ,means good settling sludge;  $X_r$  - microorganism concentration in reactor [ $MLSS/dm^3$ ].**Average growth rate in calculative period  $\Delta X$  :**

$$\Delta X = \frac{V \times X_{r2} - V \times X_{r1} + X_e \sum_{i=1}^n Q_e + X_w \sum_{i=1}^n Q_w}{n} [gMLSS/d], \quad (\text{Eq. 2.12})$$

where:  $X_{r1}$  - microorganism concentration in reactor at the beginning of calculative period [ $gMLSS/dm^3$ ];  $X_{r2}$  - microorganism concentration in reactor at the end of calculative period [ $gMLSS/dm^3$ ];  $X_e$  - average microorganism concentration in effluent from solids separation unite [ $gMLSS/dm^3$ ];  $Q_e$  - flowrate of liquid from the separation unite [ $dm^3/d$ ];  $Q_w$  - flowrate of liquid



containing the biological cells to be removed (wasted) from the system;  $[dm^3/d]$ ,  $X_w$  - average microorganism concentration removed (wasted) from the system  $[gMLSS/dm^3]$ ;

**Sludge age SA, (mean - cell retention time)**

$$SA = \frac{V(X_{r2} - X_{r1})}{2\Delta X} [d] \quad (\text{Eq. 2.13})$$

**Removal or treatment efficiency, E :**

$$E = \frac{C_o - C_e}{C_o} \cdot 100\% \quad (\text{Eq. 2.14})$$

where:  $C_e$  - substrate concentration in effluent  $[g/m^3]$ ;

**Ammonia oxidation rate,  $\rho_X^{amon}$  :**

$$\rho_X^{amon} = \frac{(C_N^{amon} - C_{Ne}^{amon}) \cdot Q}{V \cdot X_r} [gNH_4 - N / MLVSS \cdot d] \quad (\text{Eq. 2.15})$$

where:  $C_{Ne}^{amon}$  - ammonia concentration in effluent  $[g/m^3]$ ;  $C_N^{amon}$  - ammonia concentration in influent  $[g/m^3]$ ;

**Denitrification rate  $\rho_N^{denitr}$  :**

$$\rho_N^{denitr} = \frac{(C_{Ne}^{N-NO_x} - C_N^{N-NO_x}) \times Q}{V \cdot X_r} [g N / MLVSS \times d] \quad (\text{Eq. 2.16})$$

where:  $S_{Ne}^{N-NO_x}$  - concentration of  $NO_x$  ( $N-NO_2^- - N$  and  $N-NO_3^- - N$ ) in effluent of reactor

$[g N / m^3]$ ;  $S_N^{N-NO_x}$  - concentration of  $NO_x$  ( $N-NO_2^- - N$  and  $N-NO_3^- - N$ ) in influent of reactor  $[g N / m^3]$ .

**Hydraulic loading  $Oh_F$  :**

$$Oh_F = \frac{Q}{F} [m^3 / m^2 \cdot d] \quad (\text{Eq. 2.17})$$

where:  $F$  - total surface area of discs  $[m^2]$ .

**Substrate loading rate  $A_F$  :**

$$A_F = \frac{C_o \times Q}{F} [g O_2 / m^2 \times d],$$

where:  $C_o$  - substrate concentration  $[g O_2 / m^3]$ .

**Removal or Treatment efficiency,  $E$  :**

$$E = \frac{[(C_o \cdot Q)] - [C_e \cdot (Q + Q_{CH_3COOH})]}{[(C_o \cdot Q)]} \cdot 100 \% \quad (\text{Eq. 2.18})$$

where:  $Q_{CH_3COOH}$  - flow rate of acetic acid solution  $[dm^3 / d]$ .

**Treatment efficiency for COD (from landfill leachate,  $E_{CODLL}$  :**

$$E = \frac{(C_o - C_{CODVI}) \cdot Q}{(C_o \cdot Q)} \cdot 100 \%, \quad (\text{Eq. 2.19})$$

where:  $C_{CODVI}$  - concentration of COD after VI discs (in effluent from nitrification zone)  $[g O_2 / m^3]$ ,

**Treatment efficiency for bCOD (from  $CH_3COOH$ )**

$$E = \frac{C_{COD}^{CH_3COOH} \cdot Q_{CH_3COOH} - [(Q_{CH_3COOH} + Q) \cdot C_{CODeff} - Q \cdot C_{CODVI}]}{C_{COD}^{CH_3COOH} \cdot Q_{CH_3COOH}} \cdot 100 \% \quad (\text{Eq. 2.20})$$

where:  $C_{COD}^{CH_3COOH}$  -COD concentration in the solution of acetic acid  $[mg / dm^3]$ ,

$C_{CODeff}$  -COD concentration in effluent of RBC,  $C_{CODVI}$  -COD concentration after VI disc of RBC

**Ammonia oxidation rate in nitrification zone of RBC,  $\mathcal{G}_F^{amon}$  :**

$$\mathcal{G}_F^{amon} = \frac{[(C_{N}^{amon} - C_{NVI}^{amon}) \cdot Q]}{F_{nitr}} [g N - NH_4 / m^2 \times d], \quad (\text{Eq. 2.21})$$

where: -  $C_{NVI}^{NH_4^+-N}$  ammonia concentration in effluent from nitrification zone (after VI-disc)

$[g / m^3]$ ,  $F_{nitr}$  - total surface area of discs in nitrification zone  $[m^2]$ .

**Volumetric ammonia oxidation rate in nitrification zone of RBC,  $\mathcal{G}_F^{amon}$  :**

$$\mathcal{G}_F^{amon} = \frac{[(C_{N}^{amon} - C_{NVI}^{amon}) \times Q]}{V_{nitr}} [g N - NH_4 / m^2 \times d], \quad (\text{Eq. 2.22})$$

where: -  $V_{nitr}$  - total surface area of discs in nitrification zone  $[m^3]$ .

**Determination of bCOD/N ratio**

$$bCOD / N = \frac{C_{CH_3COOH} \cdot Q_{CH_3COOH}}{[Q] \cdot (C_o^{NOx-N} + C_o^{NH_4^+-N})} [g COD / gN] \quad (\text{Eq.2.23})$$

where:  $C_{CH_3COOH}$  - concentration of COD in the solution of acetic acid introduced in RBC (III chamber)  $[g COD / m^3]$ ;  $Q_{CH_3COOH}$  - flow rate of acetic acid solution  $[dm^3 / d]$ .  $C_o^{NOx-N}$ ,  $C_o^{NH_4^+-N}$  - nitrate, nitrite and ammonia concentration in influence or RBC system  $[dm^3 / d]$ .

**Calculation of free ammonia  $NH_3$  concentration (Anthonisen et al 1976):**

$$NH_3 = \frac{17}{14} \times \frac{C_N^{amon} \times 10^{pH}}{e^{\frac{6344}{273+T}} + 10^{pH}} \left[ g \text{ } NH_3 / m^3 \right], \quad (\text{Eq. 2.24})$$

where:  $pH$  - pH of liquid in reactor,

$T$  - temperature of treated medium [ $^{\circ}C$ ].

**Calculation of free nitrous acid concentration (Anthonisen et al 1976):**

$$HNO_2 = \frac{46}{14} \times \frac{C_N^{N-NO_2}}{e^{\frac{-2300}{273+T}} + 10^{pH}} \left[ g \text{ } HNO_2 / m^3 \right] \quad (\text{Eq. 2.25})$$

## II.4 Part 4: Combined biological and photocatalytic systems for treatment of landfill leachate - lab scale research in France (LCA) and Poland (EBD)

### II.4.2 Products and analysis

#### II.4.2.1 Landfill leachate (Teting) characterisation

Landfill leachate (LL) samples used in this research were obtained from a municipal landfill located in Tétang (10 km away from Saint-Avold, France). The characteristics of municipal landfill leachate are shown in Table 2.6.

Table 2.6. Composition of raw landfill leachate and treated leachate (04.2002-06.2003)

Parameters	Units	Raw leachate	Biologically treated*
COD	mgO <sub>2</sub> /dm <sup>3</sup>	4950- 6600	450-820*
BOD <sub>5</sub>	mgO <sub>2</sub> /dm <sup>3</sup>	1600-2550	10-20*
BOD <sub>5</sub> /COD	-	0.3-0.4	0.02-0.04*
Ammonia nitrogen	mg NH <sub>4</sub> <sup>+</sup> -N/dm <sup>3</sup>	1310 - 1720	35-60*
TKN	mg N/dm <sup>3</sup>	1400- 1770	***
Sulphate	mg SO <sub>4</sub> <sup>2-</sup> /dm <sup>3</sup>	350	***
Chlorine	mg Cl/dm <sup>3</sup>	1920- 3150	***
Phosphate	mg PO <sub>4</sub> <sup>3-</sup> /dm <sup>3</sup>	5-25	***
pH	-	8.0-8.6	6.1 -7.0*
Nitrate	mg NO <sub>3</sub> <sup>-</sup> -N/dm <sup>3</sup>	1-7	182-248*
Nitrite	mg NO <sub>2</sub> <sup>-</sup> -N/dm <sup>3</sup>	0-5	8-45*

\*Parameters determined in LCA

Parameters	Units	Raw leachate (average)	Range**
Chromium	mgCr <sup>3+</sup> /l	0.005-0.5 (0.283)	2.7
Copper	mgCu <sup>2+</sup> /l	0.01-0.212 (0.058)	0.4-1
Mercury	mgHg <sup>2+</sup> /l	0.001-0.005 (0.0025)	0.02-1
Nickel	mgNi <sup>2+</sup> /l	0.1-0.22 (0.1456)	0.4-2.5
Lead	mgPb <sup>2+</sup> /l	0.027-0.056 (0.0381)	***
Zinc	mgZn <sup>2+</sup> /l	0.04-1.02 (0.4312)	***

\*\* Heavy metals tolerance of activated sludge systems according to Buraczewski 1994

\*\*\* Lack of data

The BOD<sub>5</sub>/COD ratio amounting to 0.4 indicates that the landfill leachate contained some quantity of organic matter susceptible of biological degradation and a high concentration of ammonia. Moreover, the concentration of heavy metals present in landfill leachate was far from border range which caused inhibition of activated sludge systems. Table 2.6 depicts the composition of biologically treated landfill leachate.

### II.4.2.2 Experimental conditions: procedure of landfill leachate combined process (LCA)

In the initial experiments, a combined treatment process consisting of activated sludge process operated in continuous mode and photocatalytic oxidation treatment (Fig. 2.11) operated in non-continuous mode had been proposed.

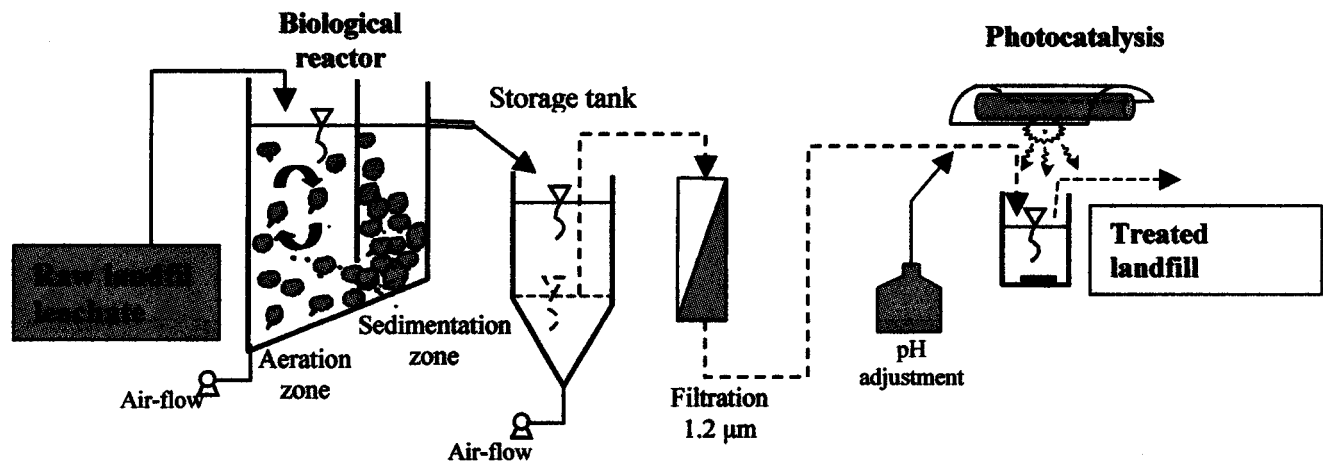

Figure 2.11 Diagram of lab scale combined process for landfill leachate treatment

First, the raw landfill leachate was preliminary diluted with tap water in the ratio of 1 to 4 and pumped at the flow 2.5 l/d to the “aeration zone” (volume 1.5 l) of biological reactor containing an activated sludge biomass. The aerobic conditions as well as appropriated mixing of the reactor contents were ensured by air-flow by porous diffusers placed at the bottom of the reactor. In this condition the nitrification (oxidation of ammonia to nitrite and nitrate) and biodegradable organics removal could be accomplished. Next, the activated sludge was separated from the treated effluent by sedimentation in a “sedimentation zone” (volume 1.0 l).

Activated sludge from the local Municipal Wastewater Treatment Plant (in Saint-Avoid) was used as an inoculum of biological reactor originated.

Second, the biologically treated effluent of landfill leachate was piped off to a “storage tank” (10 l). The liquid was constantly aerated to remove traces of easily degradable organic matter and to deactivate micro-organisms (*via* endogenic respiration). Periodically, after sedimentation of residual suspended matter in “storage tank” the sample containing mainly bio-recalcitrant was subjected to photocatalytic treatment.

Finally, before a photocatalytic test the samples were filtered though 1.2  $\mu\text{m}$ - filters to remove particulate matter (residual microorganisms) and pH of the solution was adjusted to the desired value by using HCl or NaOH.

The efficiency of biological treatment was followed in terms of general parameters such as: BOD<sub>5</sub> (5 day Biochemical Oxygen Demand - Oxi Top WTW system with BOD sensor), COD (Chemical Oxygen Demand- dichromate method), pH, ammonium nitrogen, nitrite and nitrate nitrogen; standard methods.

Photocatalysis experiments were carried out in a Solar box ATLAS SUNTEST CPS+ set-up (Fig. 2.3). Homogeneous mixture of LL sample and catalyst was provided by sonication for 5 minutes. Next, the beaker with mixture was placed into the Solar Box chamber and was mixed using magnetic stirrer still in the dark for 60 minutes in order to reach the equilibrium state. Time zero was the beginning of irradiation. For all experiments the photocatalyst concentration was 1.0 g/l.

The volume of solution reaction was 500 ml and illuminated surface 130 cm<sup>2</sup>.

The process was conducted at a temperature ranging between 20 and 30°C. The degradation of LL was analysed after filtration (0.45µm) by using, DOC (TOC or COD) and UV/VIS absorbance at 254 nm and 400 nm.

It should be noted that the concentrations of total organics present in real leachate were several times higher in comparison to the photocatalytic tests of HAs. Accordingly, a prolonged reaction time was needed. Taking into account a slow evaporation of the reacting solution during the experiment, the level of reacting mixture was systematically (every two hours) adjusted (completed) with distilled water.

#### ***II.4.2.3 Experimental conditions: procedure of landfill leachate combined process (EBD)***

Photocatalytic experiments at laboratory scale in Poland (EBD) were carried out in the UviLab P400 UV reactor provided by Vita Tec UV-System GmbH Company. The light source was a medium-pressure mercury lamp (with a broad radiation spectrum 200-280 nm) immersed in quartz-reactor. The maximal lamp power was 400W, but all research were done with 200W energy power.

Figure 2.12 depicts photocatalytic set-up. It consisted of the photoreactor (1) (350 ml volume) connected by a recirculation pipe with no-reacting tank (4) (750 dm<sup>3</sup> volume). The mixture of suspension catalyst and wastewater solution was continuously circulated by using peristaltic pump (5). The circulating flow rate was only 1.0 l/min but the homogenous mixing was provided by air-bubbling (using gas inlet placed in the bottom of photoreactor)(6) as well as magnetic stirring (7). Water pumped through the reactor jacket (3) ensured a constant temperature inside the reactor.

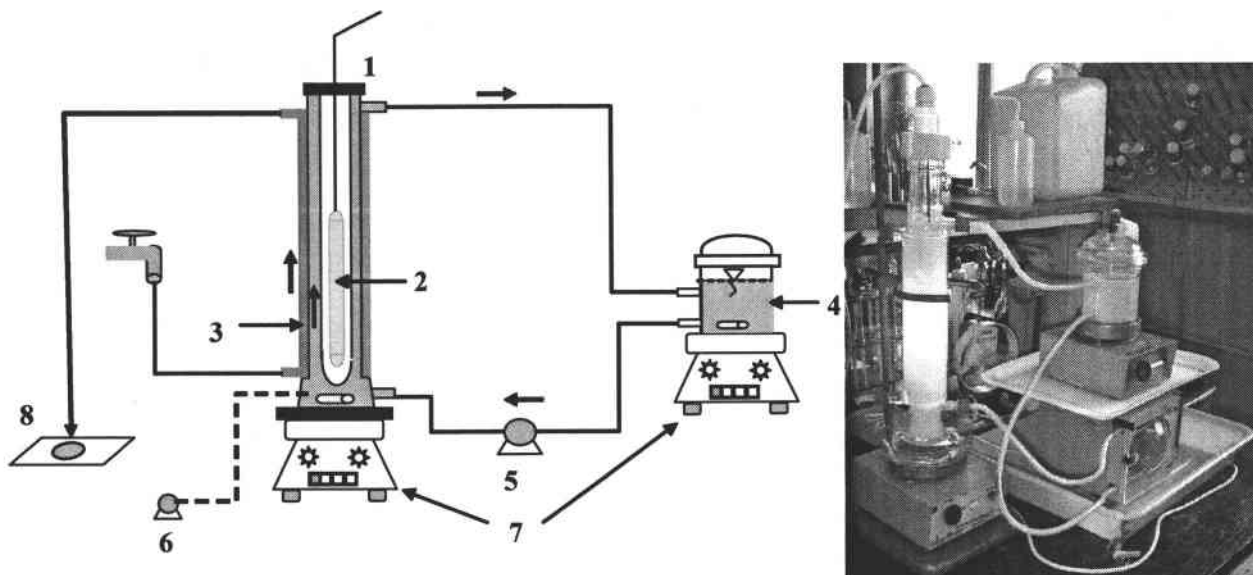

Figure 2.12 Schematic diagram (left) and picture of photocatalytic set-up (right): (1) Photoreactor ; (2) UVC 400W (200W); (3) Cooling (jacket) loop (4) Non-reacting tank, (sampling point); (5) Recycle peristaltic pump (6) Aeration; (7) Magnetic stirrer; (8) Outlet of cooling liquid

#### II.4.2.4 The evaluation of irradiation time

The kinetics of the experiments were determined by plotting the organics concentration as a function of illumination time ( $T_{irr}$ ) in photoreactor (instead of experimental time  $t_{ex}$ ). Illumination time could be calculated by the following equation:

$$T_{irr,n} = T_{irr,n-1} + \Delta t_{ex} \cdot \left( \frac{V_{irr}}{V_t - \sum V_s} \right) [\text{min}] \quad (\text{Eq. 2.26})$$

$$\Delta t_{ex} = t_{ex,n} - t_{ex,n-1} [\text{min}] \quad (\text{Eq. 2.27})$$

where:  $T_{irr}$  is the illumination time( so-called “irradiation time” and marked by “min r”),  $t_{ex}$  the experimental time,  $V_{irr}$  the illuminated volume (volume of photoreactor),  $V_t$  the total running volume (350 ml+ 750 ml) and  $V_s$  the sum of samples drown out from the set-up.

The Equation 2.26 was elaborated on the basis on procedure proposed by Cho and co-workers (2003). The modification consisted in taking into account the volume of samples taken for analysis. In the described case it was a very important value, because the total volume of sample taken for analysis during the experiment rose up to 730 ml, which constitute 2/3 of total running volume.

The initial leachate (Tab. 2.7) was adjusted to ca. 4 by HCl and was centrifuged at 3000 rpm within 10 min. Next, the supernatant was placed into the vessel with appropriate amount of catalyst ( $\text{TiO}_2$  P-25 Degussa) except the experiments with direct effect of photolysis. The mixture of catalyst and leachate was equilibrated in the dark within 60 min. Then, solution (1100 ml) was inserted into non-reacting tank (4) and was circulated between photo-reactor and no-reacting tank for 5 min. Time zero was the beginning of the irradiation.

In the experiments, the photocatalyst concentration varied from 0.5 g/l to 3.0 g/l.

Table 2.7 Composition of biologically pre-treated landfill leachate from Gliwice, January-April 2004.

Parameters	Unite	Biologically pre-treated LL
TOC	mgC/dm <sup>3</sup>	200-207
COD	mgO <sub>2</sub> /dm <sup>3</sup>	460-510
BOD <sub>5</sub>	mgO <sub>2</sub> /dm <sup>3</sup>	15-20
BOD <sub>5</sub> /COD	-	0.03
Ammonia nitrogen	mg NH <sub>4</sub> <sup>+</sup> -N/dm <sup>3</sup>	3.8-5.4
Chlorine	mg Cl/dm <sup>3</sup>	(2050)*
Phosphate	mg PO <sub>4</sub> <sup>3-</sup> /dm <sup>3</sup>	1.2
pH	-	8.5 (3.5-4.0)*
Nitrate	mg NO <sub>3</sub> <sup>-</sup> -N/dm <sup>3</sup>	175-215
Nitrite	mg NO <sub>2</sub> <sup>-</sup> -N/dm <sup>3</sup>	ndl
Humic acids	mg /dm <sup>3</sup>	25

ndl – not detectable

\*- after pH adjustment

The degradation of LL solution was followed by determination of general parameters, such as: COD (Chemical Oxygen Demand- dichromate method), TOC (Shimadzu Analyser TOC-V<sub>CSH</sub> with auto-sampler ASI-V), and spectroscopy absorption at 400 nm (colour).

At different irradiation times, samples of leachate were withdrawn from non-reacting tank and centrifuged at 3000 rpm for 10 min prior to DOC (TOC) analysis. The samples were additionally filtered (through the filter) prior to spectroscopy absorption at 400 nm and TOC analysis. The COD was measured without TiO<sub>2</sub> separation. It was proved that the presence of catalyst in the sample did not affect this measurement.

#### II.4.2.5 Determination of bio-accessibility organics formed in the photocatalytic stage

The biodegradability of the photocatalytic by-products was assessed by means of: i) biological oxygen demand (BOD<sub>5</sub>) and ii) oxygen uptake rate (OUR) measurements according to the procedure described in section II.1.3.3. The catalyst concentration used in the photocatalytic test amounted to 2.0 g/l. Before OUR determination, the samples were preliminary adjusted to pH 7 and some trace micro and macro elements were added.

The accessibility of photocatalytic oxidation products was determined in biological reactor with activated sludge. After 40 min of irradiation into photoreactor (Fig. 2.12), the reaction was stopped and TiO<sub>2</sub> was separated by centrifuged at 3000 rpm for 10 min. For ensuring an adequate condition for biological activity a supplementary amount of phosphorus (KH<sub>2</sub>PO<sub>4</sub>) was added into the leachate and pH was adjusted to about 7. Next, the sample of



The ratio of sample to thickened activated sludge was 10 to 1 (v/v). The evolution of organic carbon in reactor was followed in terms of COD. The operating volume of biological reactor was 1.0 l. Activated sludge used as an inoculum of biological reactor originated from the local Municipal Wastewater Treatment Plant (in Zabrze). The microbial biomass in reactor was 2.8 g MLSS/l.

## CHAPTER III

---

---

*STUDY OF PHOTOCATALYTIC  
DEGRADATION OF HAS WITH  $TiO_2$   
IN WATER*

---

---

---

## III.1. Introduction

The aim of the studies presented was to investigate the photocatalytic degradation of HAs present in high concentration in leachates from mature and old landfills. According to our research, biologically pre-treated leachates still contain up to one third of humic-like substances. Consequently, a similar concentration (100 mg/l) of commercially available HAs was taken as a model of refractory organics present in landfill leachate. The work consisted in the determination of key parameters influencing photocatalytic removal of HAs. In this work, the following phenomena were studied: i) the effect of inorganic ions such as sulphate, chloride, hydrogen carbonate and phosphate on adsorption and photodegradation of model HAs, ii) the effect of catalyst concentration, pH and oxygen on photodegradation of model HAs, iii) the evolution of biodegradable products formed during photocatalytic degradation of HAs.

Real leachate had maximal ion concentrations of 7.5 g/l of sulphate, 4.5 g/l of chloride or hydrogen carbonate-3.0 g/l, as reported by Christensen and co-workers (2001). On the other hand, it is well-known that the anions could have strong effects during the photocatalysis process. Schematically, inorganic anions can: i) modify the surface adsorption and consequently change the rate of photodegradation (Chen et al. 1997) ii) play the role of radical scavenger and then decrease the oxidation rate (Bekbolet and Balcioglu 1996, Bekbolet et al. 1998) or, on the contrary be oxidized into more oxidative species (Abdullah et al. 1990) and iii) impose pH conditions in general less favourable for degradation (Wang et al. 2000B).

Hence, the results obtained in Chapter III should be considered as an approach for real landfill leachate photocatalysis.

## III.2. Laboratory scale approach in France

### III.2.1 Adsorption studies: effect of different parameters

Heterogeneous photocatalysis using TiO<sub>2</sub> as catalyst has been widely investigated for environmental detoxification. A variety of reaction mechanisms incorporating both surface adsorbed and solution phase species have been proposed to describe the photodegradation of organic molecules onto TiO<sub>2</sub>. Adsorption could play a prominent role in catalytic photodegradation of organic molecules (Chen et al. 1997, Cunningham et al. 1999, Robert et al. 2000, Chun et al. 2001) and e.g. can explain selective oxidation in the case of mixtures treatment (Piscopo 2002). Most researchers applied Langmuir–Hinshelwood kinetic model to explain a photocatalytic disappearance of organic substrate. Consequently, bearing in mind

the L-H kinetics (Equation 1.17 in section I.3.3.2), (merely the substitution of photocatalytic degradation rate factor), the “Langmuir” adsorption model could be applied.

### III.2.1.1 Adsorption Isotherm of HAs

Therefore, HAs affinity towards catalyst surface (TiO<sub>2</sub>) was one of the issues of the study. The increasing HAs concentrations in the range 10 to 100 mg/l were tested. The measurements of HAs adsorption were carried out in terms of UV-light absorption at two wavelengths (250 and 400 nm) and by TOC analysis according to the procedure described in section II.1.2. It was found that adsorption kinetics is fast and adsorption equilibrium is reached within 30 min (Fig. 3.2). The adsorption isotherms for HAs are given in Figure 3.1, where  $[HA]_{ads}$  is the number of HAs milligrams adsorbed per gram of TiO<sub>2</sub> and  $[HA]_{eq}$  the equilibrium concentration.

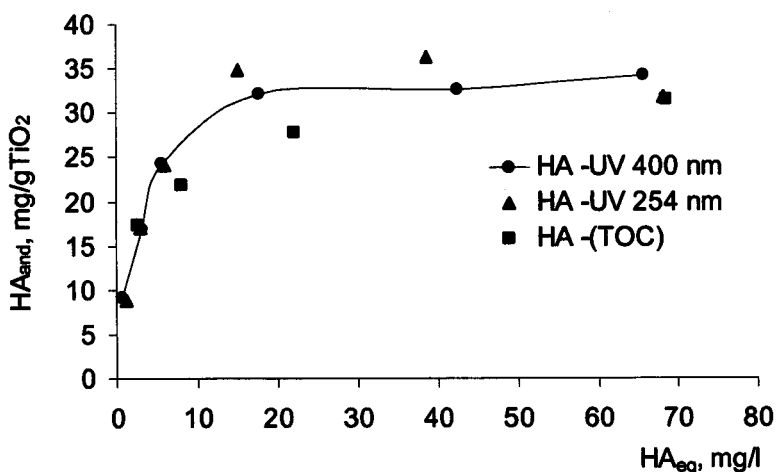

Figure 3.1 Adsorption isotherms of HAs (pH 7.8) on TiO<sub>2</sub>

It can be observed that the main effect of increasing concentration was to increase the amount of HAs adsorbed onto the semiconductor surface and the HAs values calculated by the UV method at different wavelengths and TOC method were quite similar. First, the classical adsorption model of Langmuir (Langmuir 1915), which has been applied in many studies to explain the adsorption phenomenon on semiconductor surface was applied in the present studies as well. The calculated Langmuir parameters according to Equation 2.1 and 2.2, section II.1.2 are reported in Table 3.1.

Table 3.1 Langmuir parameters determined by UV absorption and TOC analysis

Method of measurement	HA <sub>(400)</sub>	HA <sub>(254)</sub>	HA <sub>(TOC)</sub>
K (l/mg)	2.00	4.15	2.11
[HA] <sub>adsmax</sub> (mg /gTiO <sub>2</sub> l)	32.7	39.8	30.2

The affinity of HAs to the oxide surface has been studied by several authors (Au et al 1999, Kim et al 2001, Bekbolet et al 1998, 2002, Palmer et al 2002, Wiszniowski et al. 2002). However, there are some discrepancies between the different adsorption results. The main difficulties of HAs characterisation consist in their heterogeneity, in terms of structure, size and to their tendency to associate in solutions as their concentration increases. For example, Bekbolet et al. (1998, 2002) proposed to apply a Freundlich model rather than Langmuir model in the studies of HAs absorbance.

In spite of relative appropriateness of the present experimental data to “Langmuir model” (LM), it has been suggested that multilayer model of HAs adsorption should be seriously considered. Preliminary investigations (Wiszniowski et al. 2002) have shown that the (LM) does not give reproducible results in the case of HA adsorption on TiO<sub>2</sub> surface. Nevertheless, in the current study, the values of HAs adsorbed expressed as TOC and reaching the level of 9.8 -11.1 mgC/gTiO<sub>2</sub> for the range of HAs from 50 to 100 mg/l are close to the maximal value of adsorbed organic carbon (TOC) reported by Palmer and co-workers (2002) and amounted to 9.68 mg C/gTiO<sub>2</sub>.

### III.2.1.2 pH effect on the adsorption of HAs

PH is one of the major parameters which can influence both HAs and TiO<sub>2</sub> properties. The attraction of HAs molecules amounting to 100 mg/l to TiO<sub>2</sub> was determined under the different pH (3.5, 7.5 and 11.5). Figure 3.2 shows that humic acids adsorption onto TiO<sub>2</sub> is very fast at all pH and the equilibrium was achieved within about 30 min. At acidic medium (pH 3.5) HAs adsorption reached the highest level of 80% and of 90% for DOC (TOC) and UV<sub>254</sub>, UV<sub>400</sub> respectively. However, with increase of pH the quantity of HAs adsorbed on TiO<sub>2</sub> surface decreased. Hence, in natural pH (7.5) adsorbed HAs amount went down to 30% and under basic pH (pH = 11.5) adsorption dropped to 5-8%.

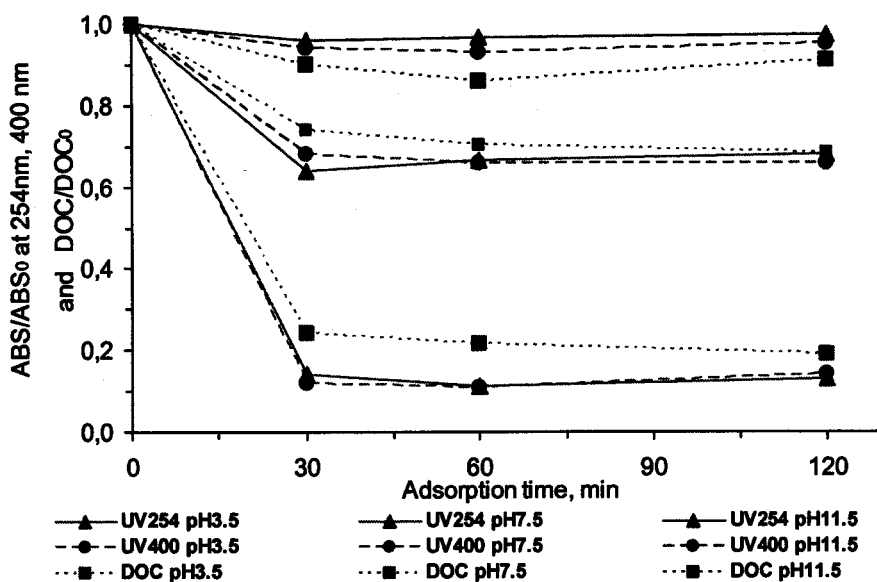

Figure 3.2 Effect of pH and equilibrium time on adsorption of humic acids

These results are not surprising owing to the properties of HAs and electrostatic surface charge model of TiO<sub>2</sub> (see section 1.3.3.4). The zero point charged (pH<sub>ZPC</sub>) for Degussa P-25 is known to be about pH 7 (Bekbolet et al. 2002, Fernández-Ibáñez et al. 1999). When the pH of solution is below pH<sub>ZPC</sub> (pH < pH<sub>ZPC</sub>), TiO<sub>2</sub> surface takes positive charge (Ti-OH<sub>2</sub><sup>+</sup>). Whereas HAs molecules have an anionic character and (especially in natural and basic conditions) are charged negatively due to deprotonation of carboxylic groups present in their chemical structure. In this case, the coulombic interactions are attractive and promote adsorption of HAs. According to Cho and Choi (2002A), adsorption occurs with multilayer formation and the model of HAs adsorption, as is shown in Figure 3.3.

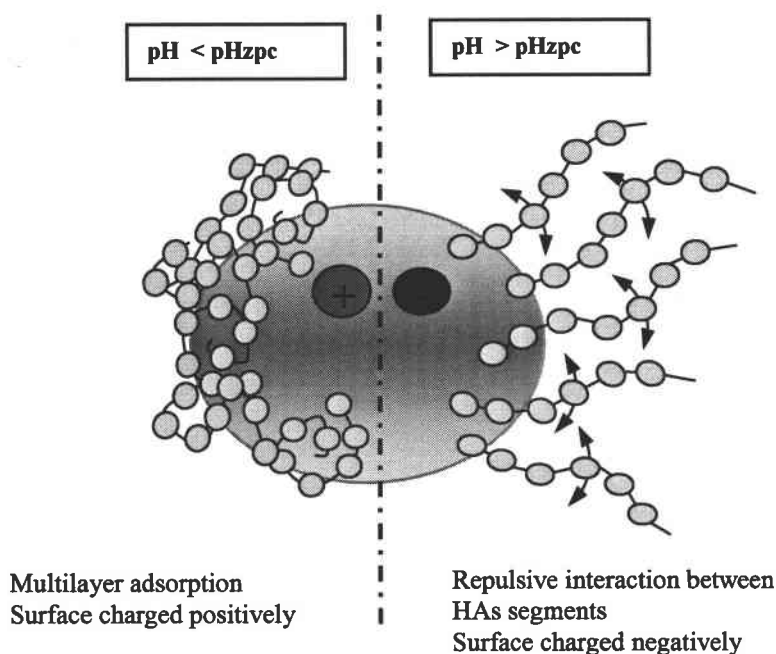

Figure 3.3 Model HAs adsorption on TiO<sub>2</sub> according to pH

Similarly, the adsorption of humic acids onto titanium dioxide decreased with increasing pH due to electrostatic interaction. With increasing pH, both the initial surface charge of TiO<sub>2</sub> (Ti-OH → Ti-O<sup>-</sup>) and the charge of HAs become more negative. In this case, the lateral repulsion among charged (ionized group of) HAs segments exists and adsorption of HAs on TiO<sub>2</sub> is not favourable. However, the adsorption of HA amounting to 30% (Figure 3.2) can be explained by coexistence of both positively (TiOH<sub>2</sub><sup>+</sup>) and negatively (Ti-O<sup>-</sup>) charged sites over a broad range of pH on oxide surface. Thus, an electrostatic attraction may exist between the positive sites of the surface and the carboxylic groups of the HAs (Figure 3.4). This assertion is in agreement with results presented by Boisvert and co-workers (2000), who worked on the model which presented a negatively charged polyelectrolyte and their ability to adsorb on a globally negative mineral surface such as TiO<sub>2</sub>.

At basic medium, the adsorption of HA can occur due to the specific (noncoulombic) interactions between HAs functional group surface sites (Au et al. 1999). The hydrophobic properties of HAs can promote adsorption in this case. It is conceivable that salicylate ions which are one major functional group of humic acid participate in binding mechanisms on the surface as suggested Bekbolet and co-workers (2002). Moreover, simple inorganic ions Na<sup>+</sup>, Ca<sup>2+</sup>, Cl<sup>-</sup> are radically hydrated and these facilitate the formation of hydrophobic mineral surface, which may also enhance HAs adsorption.

Generally, the polyelectrolyte can be adsorbed in flat conformation, in particular for low molecular weight polyelectrolyte (Dupot and Foissy 1996), or it can retain its conformation in solution leading to a tail, loop and train conformation, which is expected in case of HAs (Au et al 1999) (Figure 3.4). Furthermore, the pH of solution affects the conformation of HAs adsorbed in hydrodynamic layer. At  $\text{pH} > \text{pH}_{\text{ZPC}}$  the polyelectrolyte adsorbed layer becomes more extended from the surface as pH increases. Thus layers formed during adsorption process must extend in a direction normal to the surface (Fig.3.3).

Boisvert and co-workers (2000) suggested different possibilities of interactions between the polyelectrolyte and the surface: hydrogen bonds, acid-base interactions, complexation, hydrophobicity and electrostatic interactions.

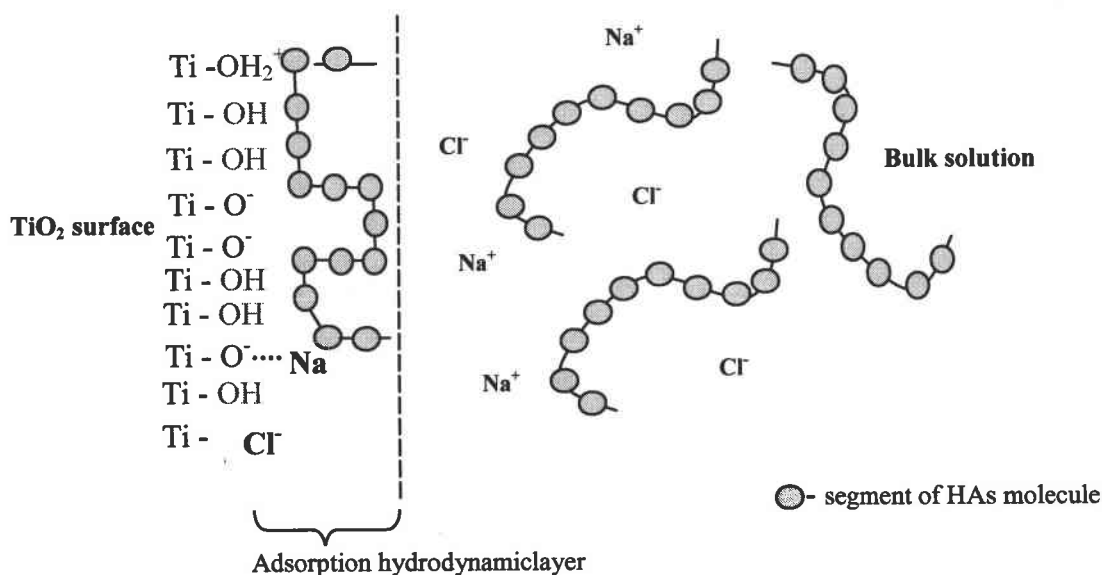

Figure 3.4 Schematic illustration of HAs adsorbed on different site of surface; loops, tails and trains conformation

In this case, infrared spectroscopy in diffuse reflectance mode (DRIFT) is particularly adapted for the study of surface complex (Palmisano et al. 1988, Robert et al. 2000, Bandara et al. 2001). The DRIFT spectroscopy allows studying adsorption in a qualitative way. This technique is well adapted to determine the types of functions between the surface of catalyst and the adsorbed molecule (see section II.1.2.2).

Two distinct peaks at  $2920$  and  $2850 \text{ cm}^{-1}$  are attributed to asymmetric and symmetric stretching vibration of C-H aliphatic groups, respectively (Bellamy 1975).

At  $\text{pH} = 1.9$  an intense band of  $\nu\text{C}=\text{O}$  vibration in carboxylic groups is present at  $1715 \text{ cm}^{-1}$ . The strong bands at  $1580$  and  $1390 \text{ cm}^{-1}$  can be attributed to asymmetric and symmetric stretching vibration of carboxylate  $\text{COO}^-$  groups (Giles et al. 1974). The strong and large bands between  $1410$  and  $1310 \text{ cm}^{-1}$  with shoulder about  $1200 \text{ cm}^{-1}$  can be attributed to OH deformation and C-OH stretching vibration of phenols and carboxylic acid.



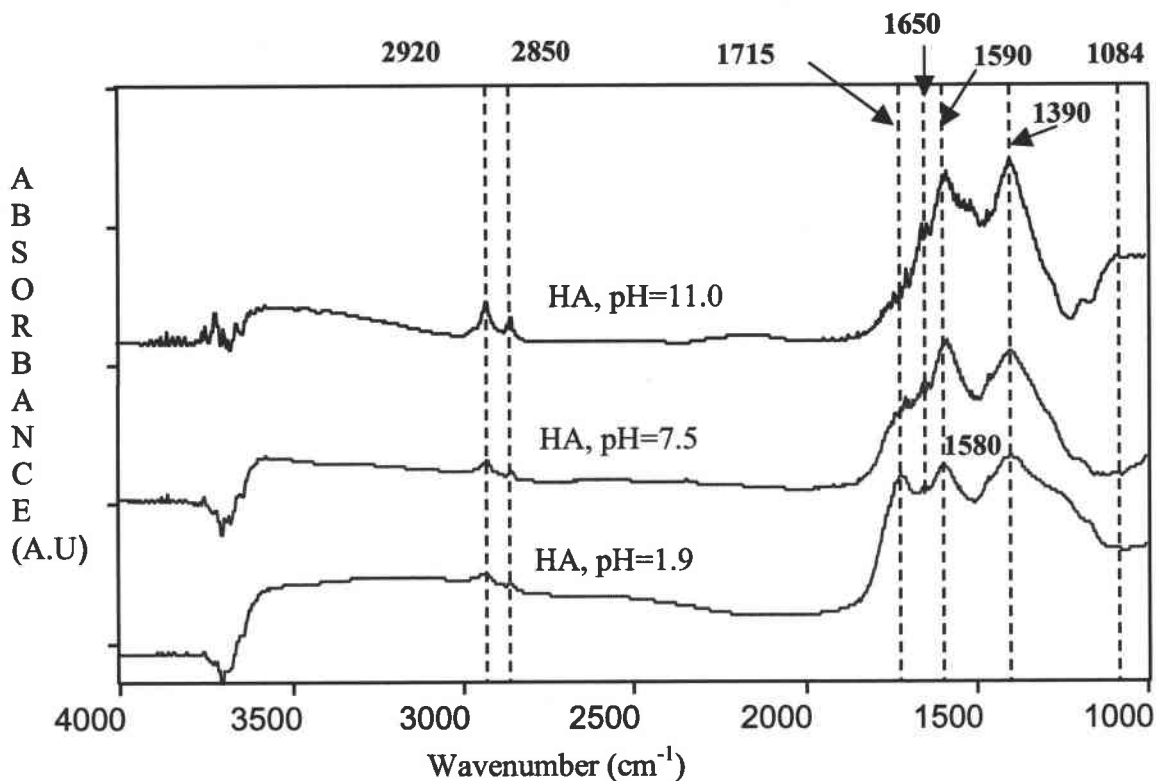

Figure 3.5 DRIFT spectrum of adsorbed HAs on TiO<sub>2</sub> at different pH

Due to pH changes (to 7.5 and 11.0) the increase of carboxylate bands COO<sup>-</sup> and disappearance of carboxylic band is logically found (Giles et al. 1974). The presence of both forms of the carboxyl groups, ionised and non-ionised can be deduced from the spectrum of the adsorbed HAs at acidic pH, and therefore the responsibility of carboxylate groups for the adsorption on TiO<sub>2</sub> is decisive (Fig. 3.5).

### III.2.1.3 Effect of salts

Batch equilibrium experiments (conducted in natural pH, amounting to 7.5) demonstrated that the adsorption of HAs increases with increasing concentration of NaCl (in the range 1.0 to 4.5 g/l). A similar trend was noted for NaSO<sub>4</sub> (Fig. 3.6a and 3.6b). In order to explain the phenomenon of HAs adsorption onto an oxide surface, both HAs and oxide properties change versus pH and ionic strength have to be considered.

Ghosh and Schnitzen (1980) proposed that both humic and fulvic acids are most densely coiled at high concentration, low pH, or raised ionic strength, and at low ionic strength, neutral pH and low concentration, the molecules behave like flexible linear colloids.

On the other hand, hydroxyl groups (TiOH), positive (TiOH<sub>2</sub><sup>+</sup>) and negative (TiO<sup>-</sup>) sites can also adsorb ions from the solution (from added salts). As a result, on the surface forms a complex species such as “TiOH<sub>2</sub><sup>+</sup> - Cl<sup>-</sup>” or “TiO<sup>-</sup> - Na<sup>+</sup>”.

When an electrostatic attraction exists between the HAs and the surface, it could be assumed that as the salt concentration increases (NaCl and Na<sub>2</sub>SO<sub>4</sub>), the repulsion between HAs segments decreases and adsorption is enhanced. The screening of the repulsion can also lead to a more compact HAs conformation leading to a tighten packing of adsorbed macromolecules on the oxide surface. This effect has been previously described, in the studies of HAs or other polyelectrolyte adsorption on ion oxide (Au et al. 1999, Kim and Walker 2001) and TiO<sub>2</sub> (Dupont and Foissy 1996, Boisvert et al. 2000) surface respectively.

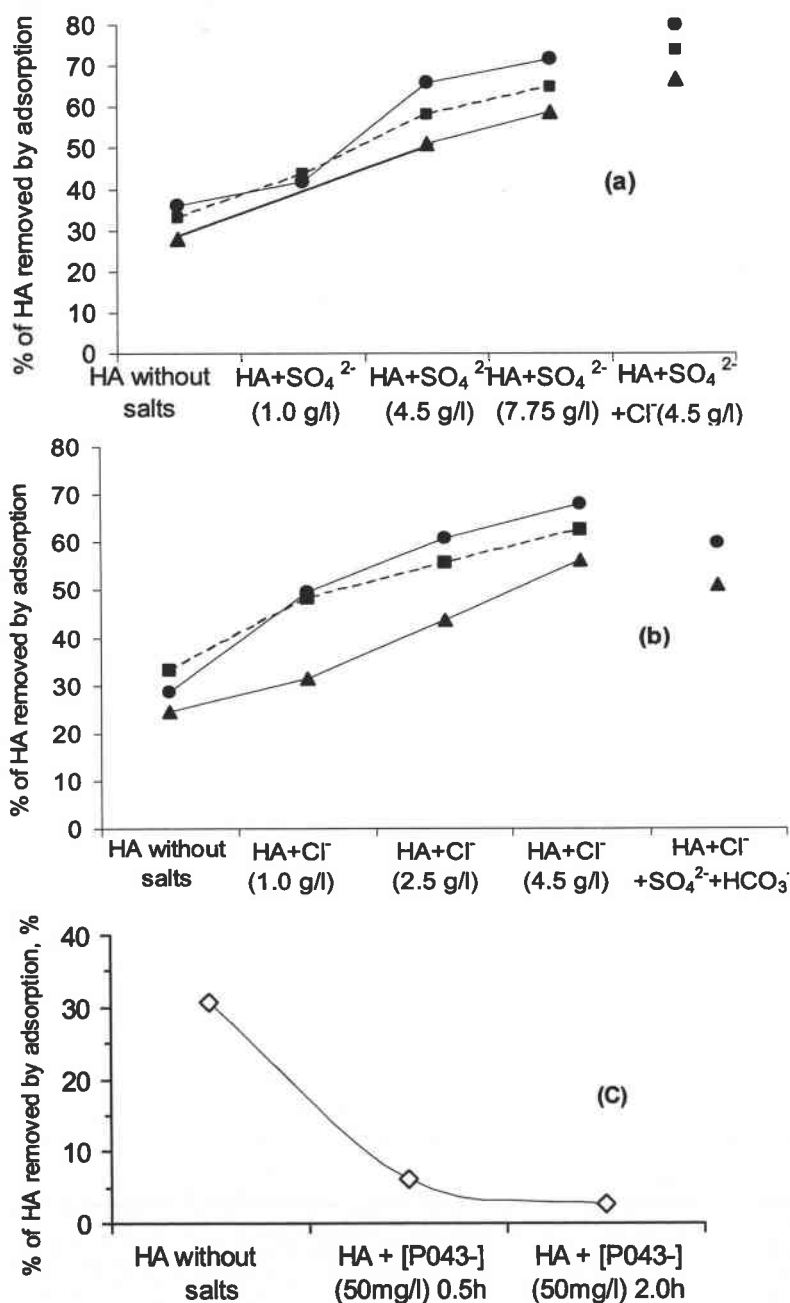

Fig. 3.6 Influence of ionic strength on affinity of HAs amounting to 100 mg/l to the catalyst surface. TiO<sub>2</sub> = 1.0 g/l and pH 7.5 (except the solution of HCO<sub>3</sub><sup>-</sup>)

Association of adsorbed HAs with some species present in solution can not be excluded. For instance Li and co-workers (2002) suggested that the calcium ion (Ca<sup>2+</sup>) can bridge HAs segments, thus improving HAs adsorption on TiO<sub>2</sub>.

The negative effect of HCO<sub>3</sub><sup>-</sup> on HA adsorption can be mainly attributed to pH. The nature of the anion depends on the pH (e.g. CO<sub>2</sub>/HCO<sub>3</sub><sup>-</sup>/CO<sub>3</sub><sup>2-</sup>); on the other hand the pH itself depends on the presence (addition) of the salts (Chen et al. 1997). Classically, hydrogen carbonate is an amphoteric species (Harvey 2000) and dissociation of NaHCO<sub>3</sub> in solution brings about an increase of pH to about 8.3. The addition of HCO<sub>3</sub><sup>-</sup> in reacting mixture resulted in shift of pH from about 7.5 to 8.4. In this case, HAs adsorption expressed as colour went down from 70% to about 60%. This behaviour can logically be explained by the decrease of affinity of HAs to the catalyst surface due to increasing pH above the pHPZC. Nevertheless, at that moment, the ionic strength of salts (NaCl, Na<sub>2</sub>SO<sub>4</sub>, and NaHCO<sub>3</sub>) present in the solution mixture impeded a HAs desorption, and the initial level of 30% HA adsorbed was not exceeded (Fig. 2.6b). This result is in agreement with Pina and co-workers (1999) findings. The authors reported that the behaviour and amount of polyelectrolyte adsorption depends on the range of salt concentration. At the lower salt (KNO<sub>3</sub>) concentration, range near 10<sup>-3</sup> M, the inhibitory effect was observed and the amount of polyelectrolyte adsorption decreases with increasing salt concentration. Nevertheless, whereas the concentration of salt was at level of 10<sup>-2</sup> M, opposite effect of ionic strength was noted. It should be noted that in the present studies the salt concentrations (NaCl, NaSO<sub>4</sub>, NaHCO<sub>3</sub>) were always above 10<sup>-2</sup> M, and this can be the reason why a competitive effect was not observed. The maximum adsorbed amount increases again with increasing ionic strength from NaCl and Na<sub>2</sub>SO<sub>4</sub> (Figure 2.6 a and b), but a slight inhibition of adsorption in the presence of HCO<sub>3</sub><sup>-</sup> can be noted (effect of pH increase).

Phosphate anions also imposed the pH of solution mixture resulting in increase of pH to 8.4 (with TiO<sub>2</sub>). Figure 2.6c demonstrates that phosphate anion has a high affinity to TiO<sub>2</sub> surface and brings about HAs adsorption. After 2 hours of equilibrium in the dark the amount of HAs adsorbed, detected as DOC, dropped from about 30% to 2%. This effect can mainly be attributed to the competition of phosphate with HAs. Both phosphate and organic compounds are known to interact with similar surface sites on hydrous metal oxide particle surfaces (Kreller et al. 2003).

An inhibitive effect can be expected due to competitive adsorption of inorganic anions with organic substrate as it was reported by Chen and co-workers (1997). However, this effect was most likely observed in low pH (pH < pHPZC) and e.g. Dionysiou and co-workers (2000) found a decrease of adsorption capacity onto the TiO<sub>2</sub> powder with increasing ionic strength (in pH = 3.0).

To summarise, the HAs adsorption onto TiO<sub>2</sub> catalyst in the presence of salts may be governed by the following processes:

- i) Electrostatic (coulombic) HAs interaction with discrete neutral, positive sites of TiO<sub>2</sub> ( $\text{pH} > \text{pH}_{\text{ZPC}}$ ), binding the HA adsorbed and remaining in the solution, screening negative sites of TiO<sub>2</sub>;
- ii) Nonelectrostatic interaction i.e. hydrophobic interaction between salicylate groups of HAs, enhanced by the screening of the repulsion;
- iii) Competition of the polyelectrolyte with the salt ions by the formation of a complex species such as “TiOH<sub>2</sub><sup>+</sup> - Cl<sup>-</sup>”;
- iv) Shift of pH by introduction of salts (NaHCO<sub>3</sub>, Na<sub>2</sub>HPO<sub>4</sub>)

### III.2.2. Photocatalytic degradation of Aldrich HAs

In many countries, humic acids are abated from water before chlorination by coagulation with aluminium sulphate and filtration. However, coagulation process brings two main disadvantages. The first is arisen of residual sludge with high aluminium content which needs to be treated. Second, treated water needs high quality monitoring of aluminium concentration. When water contains more than 0.2 mg/l it is not recommended for drinking (Eggins et al. 1997). Moreover, it should be mentioned that during this conventional treatment process only 10 to 50 % of the TOC are eliminated (Jacangelo et al. 1995). Ødegaard and co-workers (1999) reported that reduction of up to 90% of specific colour of humic substance is achieved in Norwegian plants.

Heterogeneous photocatalysis can be an effective alternative solution for the elimination of HAs from aqueous solution (Li et al. 2002, Bekbolet et al. 2002, Cho and Choi 2002A, Wiszniowski et al. 2002) even in waters containing high salt concentrations (Al-Rasheed and Cardin 2003). With this process it is possible to degrade the majority of the organic molecules, without adding more products than photocatalyst (titanium dioxide).

As reviewed in Chapter I, the photocatalytic treatment of organics from water solution is assumed to be affected by several factors including: catalyst loading ionic strength, pH and oxygen dissolved. Thus, these key parameters were investigated at laboratory scale in France.

### III.2.2.1. Direct photolysis and photomineralization of HAs

The effect of direct irradiation (without TiO<sub>2</sub>) on HAs degradation, which is believed to occur in natural aquatic medium (Corrin et al. 1996) has been studied. Figure 3.7 shows that the direct photolysis of HAs did not take place within 6 h of irradiation. Moreover, the low increase of the TOC is induced by the slow evaporation of the mixture during the experiment. Similarly, Al-Rasheed and Cardin (2003) observed only negligible decomposition of HAs even after prolonged irradiation. On the other hand, the evolution of TOC demonstrates the ability of TiO<sub>2</sub> to act as an efficient catalyst in the photodegradation of humic acids. In this case, more than 85% of total organic removal was achieved by using 1.0 g/l of tiania (Wiszniewski et al. 2002, 2003)

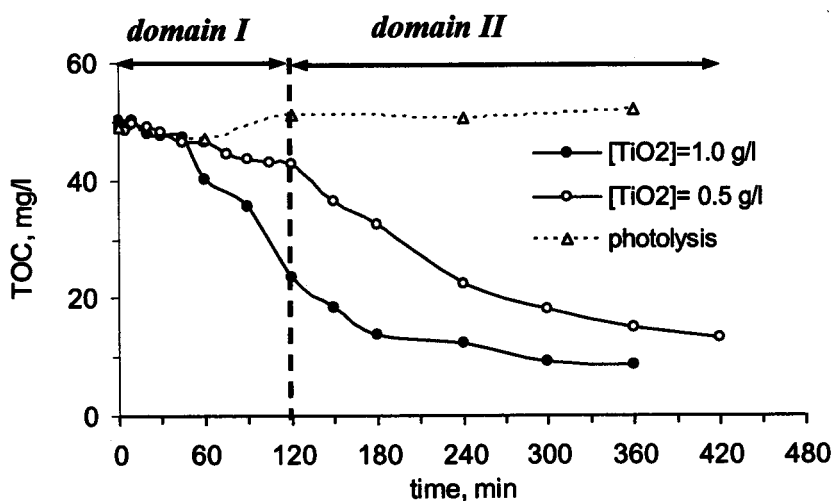

Figure 3.7 Photolysis and photomineralization of HAs equalling to 110 mg/l with [TiO<sub>2</sub>] = 0.5 and 1.0 g/l

The global evolution of the degradation shows two distinct domains. At the beginning of the reaction, the TOC value decreases slowly (domain I) and then pseudo first order is observed for the TOC decrease (domain II). The initial decrease is connected with the amount of TiO<sub>2</sub> in suspension: the lower the TiO<sub>2</sub> amount, the longer the duration of this initial step is (Fig. 3.8.). The classical saturation phenomenon is noted for TiO<sub>2</sub> amount which is higher than 1.0 g/l (Bahnemann 1999).

The slight decrease of TOC suggests that the mineralization of humic acid is rather limited in domain I (Fig. 3.7). It can be explained by surface reaction involving the groups of HAs such as carboxylate bound to the catalyst. It was proven that photodegradation can proceed in surface via oxidation by "hole" and this mechanism is favoured in case of adsorbed molecules (Bahnemann et al. 1994, Pichat 1997, Chen et al. 1999, Herrmann 1999). All these observations suggest that the surface degradation of adsorbed HAs via the carboxylate or

phenolate surface groups leads to photodepolymerization. HAs are progressively degraded by surface oxidative mechanism and as long as some macromolecules issued from HAs remain in solution this mechanism predominates. The slow decrease of TOC is certainly attributed to the CO<sub>2</sub> evolution from surface oxidation of adsorbed carboxylate or phenolate.

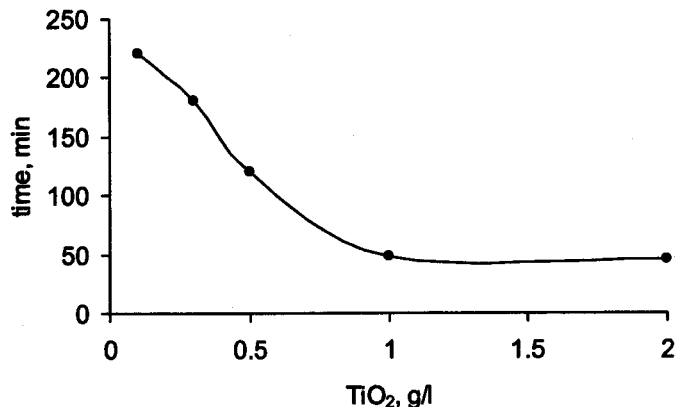

Figure 3.8 Evolution of the initial step (first domain) according to the TiO<sub>2</sub> amount

The photocatalytic degradation of HAs as well as the formation and disappearance of the by-products were followed by high performance liquid chromatography (HPLC) (see section II.1.1).

The UV-spectra of oxidation compounds were compared with some standard model registered spectra of low-molecular-weight organic carboxylic acids (4-hydroxybenzoic acid, oxalic, succinic, malonic acids) known as possible degradation products of HAs (Corin et al. 1996). Unfortunately HPLC analysis did not allow to identify individual oxidation intermediates of HAs and in this work, this aspect was not optimised. Nevertheless, the analysis permitted to trace a trend of the evolution of these complex compounds during photocatalytic process.

Figure 3.9 depicts the chromatograms obtained for different photocatalytic degradation times with TiO<sub>2</sub> dose amounting 0.5 g/l. Very similar chromatograms were received employing 1.0 and 2.0 of TiO<sub>2</sub> concentration. It was found that HAs solution (100 mg/l) at  $t = 0$  presents only one Peak (P1) with retention time of 3.0 min. Along with irradiation time two supplementary peaks appeared. Peak (P2) and peak (P3) at retention time 3.7 min and 5.3 min respectively can be distinguished. Moreover, the increased intensity of the first peak brought about a change of molar coefficient of absorption of the new compounds (up to 120 min of process) indicates that molecular structures of humic acids were rearranged. This time corresponds to the end of domain I.

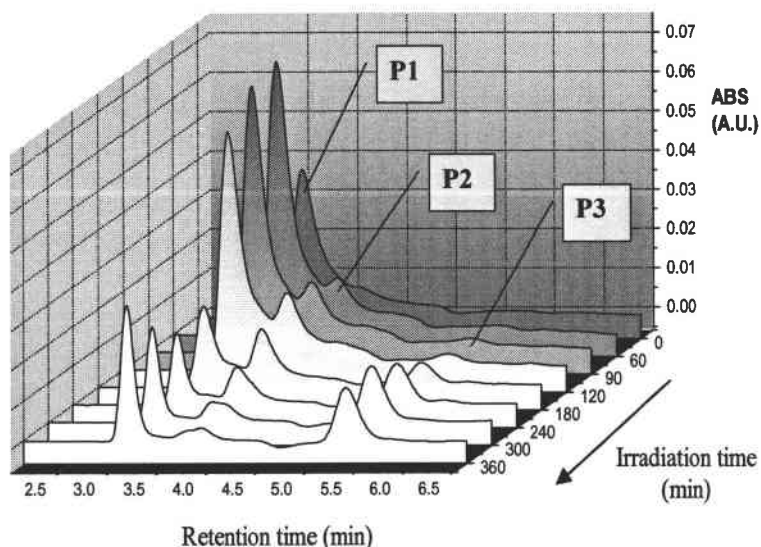

Figure 3.9 Chromatograms of photocatalytic degradation of humic acids intermediats with  $[TiO_2]=0.5g/l$

This could be explained by the formation of by-products. Then, during the photocatalytic reaction simultaneous decrease of P2 and increase of P3 was observed. Peak 3 seems to be associated with photoresistant products or nonadsorbed products. These products explain the level of the TOC after 6 hours of irradiation. Figure 3.10 also shows peaks area for the different reaction times.

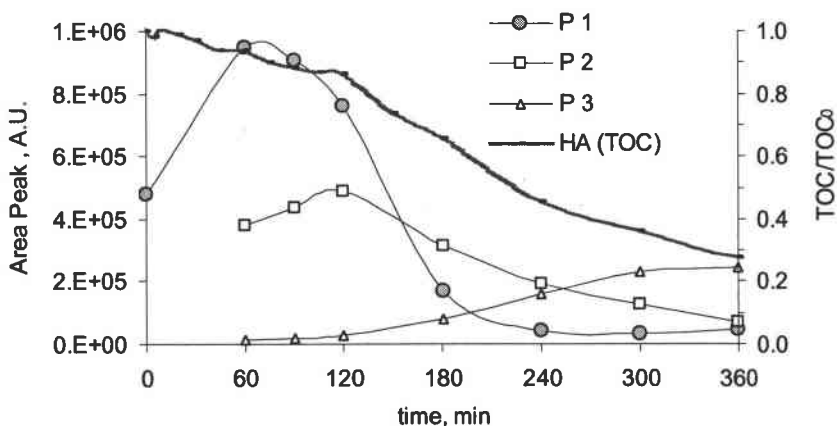

Figure 3.10 Evolution of Area Peak (P1-peak 1, P2-peak 2 and P3-peak 3) and TOC versus irradiation time during degradation of HAs

These results indicate that the photodegradation of HAs leads to the production of smaller molecules. Two kinds of molecules are generated i.e. easily photodegraded ones corresponded to P2 and photoresistant one corresponded to P3.

The chromatograms (Fig. 3.9) also show the evolution of the specific colour of HAs during the photocatalysis. The initial brown coloration of solution disappeared totally after 3 hours of irradiation.

### III.2.2.2. Effect of catalyst loading

The influence of photocatalyst concentration on mineralization kinetics of HAs has been investigated employing different concentrations of Degussa P25 varying from 0.1 to 2.0 g/l (see section II.1.3). Figure 3.11 demonstrates that the degradation of HAs was faster with increasing catalyst concentration, reaching the value 1.0 g/l. At higher concentrations of TiO<sub>2</sub>, the removal efficiencies decreased with increasing amount of TiO<sub>2</sub>. These results indicate that there is an optimum amount of TiO<sub>2</sub>. Above the concentration ranging between 0.5 and 1.0 g/l, the suspended particles of TiO<sub>2</sub> block UV-light passage and reduce the formation of electron/hole pairs and active sites (Cunningham and Al-Sayyed 1990). Most likely, the turbidity and colour of treated solution, along with the effect of TiO<sub>2</sub> blocking in solution, made the decomposition less effective.

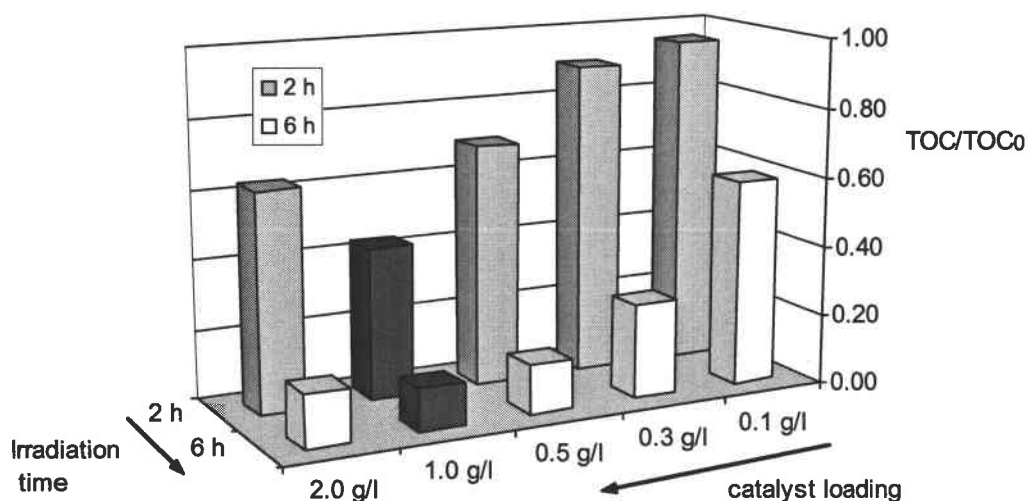

Figure 3.11 Influence of catalyst concentration on the photomineralization of humic acids

As reviewed in section I.3.3 an appropriate catalyst concentration depends on different parameters, particularly on the geometry of photoreactor, working conditions (i. e. irradiation source) and the target compounds and matrix to be treated. For example Bekbolet (1996) found a similar trend of increasing reaction efficiency with increasing catalyst loading in the range 0.1-1.0 g/l and decrease photoreactivity with catalyst amounting to 2.0 g/l. By contrast, higher optimum value of catalyst concentration for photodegradation of HAs were reported by Al-Rasheed and Cardin (2003) (2.5 g/l) or Li and co-workers (2002) (4.0 g/l).



### III.2.2.3 Influence of the pH

The photocatalytic mineralisation of HAs was carried out adjusted by HCl and NaOH to various initial pH values amounting to pH 3.4 and pH 11.5 respectively. It was found that the change of pH during photodegradation tests was not significant (0.5 units).

Figure 3.12 demonstrates the HAs mineralization with respect to TOC as well as dissolved organic fraction (DOC). It is clear that HAs degradation is strongly affected by pH and there is an optimal pH to improve the efficiency of this process. The lowest photocatalytic mineralization efficiency (TOC and DOC) of HAs was found in basic solution. The behaviour of HAs can be explained both by the evolution of adsorption (versus pH) and the change of the molecular form (according to the pH) (see section III.2.1.2). Bearing in mind the amphoteric character of  $\text{TiO}_2$ , in alkaline medium (pH 11.5),  $\text{pH} \gg \text{pH}_{\text{ZPC}}$ , the interactions between  $\text{TiO}_2$  ( $\text{Ti-O}^-$ ) and HAs (with ionised carboxylic groups) were strongly repulsive and acted to inhibit adsorption. Consequently, the mineralization rate was also affected by the decrease of efficiency in the direct reaction of photogenerated holes with HAs molecules and still 68% of HAs remained in solution after 5 hours of irradiation.

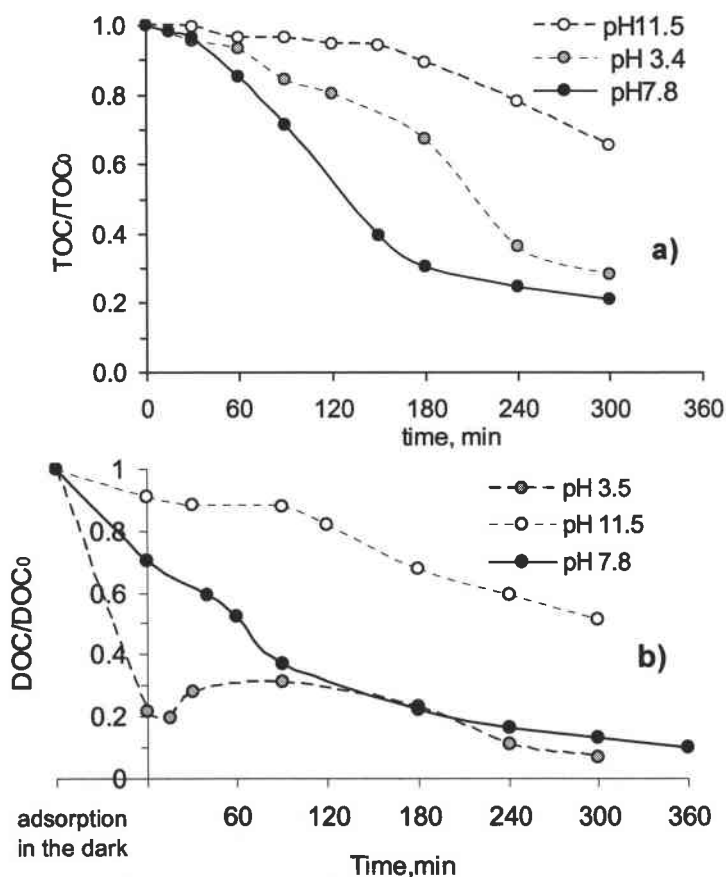

Figure 3.12 Evolution of a) TOC and b) DOC during illumination of humic acids solution ( $[\text{HA}] = 100 \text{ mg/l}$ ) containing  $\text{TiO}_2 = 1.0 \text{ g/l}$  at different initial pH values (3.4, 7.8 and 11.5)

A much larger quantity of HAs adsorbed on TiO<sub>2</sub> was observed in pH 3.5 than in pH 7.8 (Fig. 3.2). As a result, increase of TiO<sub>2</sub>-photoreactivity in those conditions was expected.

Nevertheless, the greatest TOC removal of HAs amounting to 80% was obtained in natural pH (7.8), rather than in acidic medium (Fig. 3.12a). This result is in agreement with the studies of Palmer et al. (2002), who observed the maximum mineralization rate at pH 7 (close to pH<sub>PZC</sub>). By contrast, Bekbolet (1996, 2002), Cho and Choi (2002) found that the highest HAs removal occurred under pH 3. Those authors consider that with increase of HAs initial adsorption onto TiO<sub>2</sub> surface, the probability of reaction between organic and photogenerated species (h<sup>+</sup>, °OH) rises.

Considering the efficiency of DOC (Fig. 3.12b) alone, it can be noted that higher removal from initial HAs concentration (93 %) occurred in acidic solution. This result is due to the physical separation of TiO<sub>2</sub> from the acidic solution. A higher portion of organics (photodegradation by-products of HAs) strongly adsorbed onto TiO<sub>2</sub> was removed than it occur in natural pH. Thus, from the standpoint of mineralization of organic pollution, natural pH is privileged.

The reason for the inhibition of photocatalytic mineralization in acidic pH is that multilayer adsorption of HAs as well as HAs conformation (densely coiled) act as filter interfering with light adsorption by TiO<sub>2</sub> (Fig. 3.3). On the other hand, Cunningham and co-workers (1999) have shown that strongly adsorbed organic, especially at high concentration can impend photocatalytic process. This is due to lower mass transfer process between TiO<sub>2</sub> surface and bulk solutions. In other words, the agglomeration of HAs onto TiO<sub>2</sub> brings about the impediment in desorption of photodegraded products (originated from break-down of HAs) and block the access of molecules remaining in solution to the activated site of TiO<sub>2</sub>. Similarly, Palmer and co-workers (2002) justified their results.

#### ***III.2.2.4 Effect of anions on the photocatalytic degradation of humic acids***

##### **III.2.2.4 a) Chloride (Cl)**

Figure 3.13 depicts the effect of chloride ion on the photodegradation of HAs expressed as TOC (with TiO<sub>2</sub>), and measured as absorbance at 254 nm in the solution at natural pH (7.5). The addition of NaCl (4.5 g Cl/l) showed no influence on the reaction. It can be stated that higher initial adsorption of HAs in the presence of chloride did not improve their final removal efficiency (Fig. 3.13.b). In the same studies, the effect of salt addition order was investigated (*section II.1.3.1, Fig. 2.5*). It was found that whatever was the sequence of added chemicals i.e. NaCl and TiO<sub>2</sub> next HAs (S1) or HAs and TiO<sub>2</sub> next NaCl (S2), the amount of HAs adsorbed on TiO<sub>2</sub> after 2 h of equilibrium in the dark was very similar and amounted to about 60%.

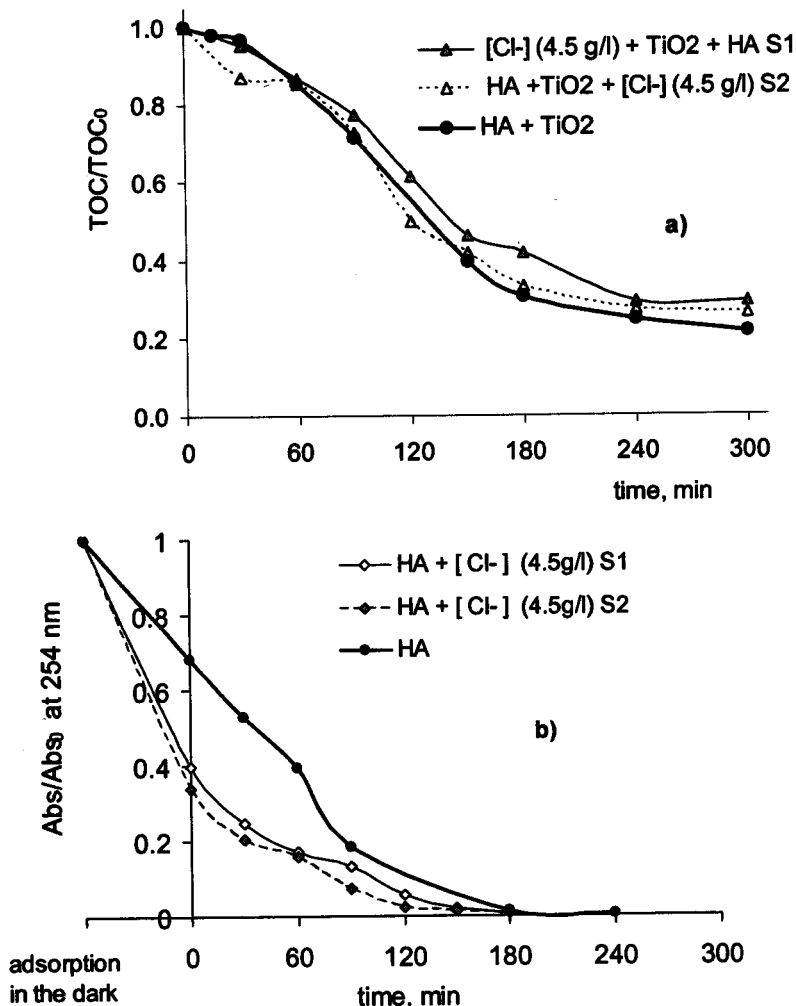

Figure 3.13 Effect of NaCl on photomineralization of HAs a) TOC disappearance b) removal of Abs at 254, S1 (NaCl preliminary equilibrated with  $\text{TiO}_2$ , then HAs addition); S2 (NaCl added after equilibrating HAs with  $\text{TiO}_2$ )

It was reported that the addition of chloride ions induces an inhibitive effect on the photocatalytic reaction (Wang et al. 1999, Wang et al. 2000B, Piscopo et al. 2001), but this effect is correlated with the pH of the aqueous solution. Wang and co-workers (1999) indicated that at low pH ( $\text{pH} < \text{pH}_{\text{ZPC}}$ ), the chloride ions are strongly adsorbed on the  $\text{TiO}_2$  surface and reduce the photodegradation rate. In neutral or alkaline conditions, the addition of chloride ions did not influence the reaction (Epling and Lin 2002). The authors report that the main explanation is the acid/base properties of  $\text{TiO}_2$ -P25 surface (adsorption with  $\text{TiOH}_2^+$  at low pH and repulsion of  $\text{Cl}^-$  by  $\text{TiO}^-$  at basic pH). These results are in agreement with the data obtained in the present studies. Figure 3.14 presents the effect of chloride ion (4.5 g per litre) introduced into the solution on photoreactivity of  $\text{TiO}_2$  at different pH, i.e. pH 5.0, pH 7.5 and pH 11.0. It is conceivable that in pH 5.0 the catalyst surface was positively charged ( $\text{pH} < \text{pH}_{\text{ZPC}}$ ) and enhanced chloride adsorption. Consequently, the competition for adsorption sites between  $\text{Cl}^-$  and HAs anions occurred. The lowering of photoreactivity of HAs in acidic

pH and the presence of salts should not only be ascribed to a decrease in the amount of HAs adsorbed, but also to the conformation of adsorbed HAs impeding mass transfer process between TiO<sub>2</sub> surface and bulk solutions (*see section III.2.1.2*). Similarly, a more significant retardation effect in the photocatalytic decay of HAs can be expected under acidic condition and in the presence of others anions, higher molecular weight than Cl<sup>-</sup>, such as SO<sub>4</sub><sup>2-</sup>, NO<sub>3</sub><sup>-</sup> or HPO<sub>4</sub><sup>2-</sup>.

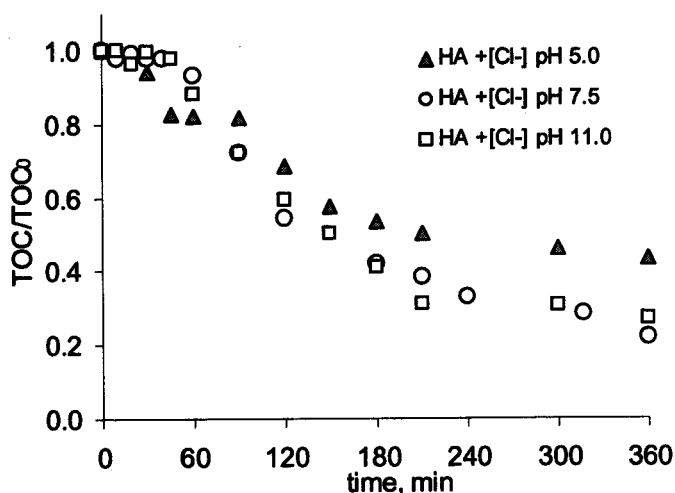

Figure 3.14 Effect of NaCl on photomineralization (TOC) of HAs at different initial pH values (5.0, 7.5 and 11.0)

On the contrary, no apparent retardation in TOC removal at neutral and basic conditions was observed. Moreover, comparing the kinetic of HAs removal in pH 11.0 and in the presence of NaCl (Fig. 3.14) with the kinetic in pH 11.5 and without NaCl (Fig 3.12) it can be noted that the ionic strength (from NaCl) added into the solution, in fact promoted photocatalytic degradation of humic acids. This phenomenon might be explained by enhancing of initial HAs adsorption on catalyst surface due to increase of ionic strength of solution in that conditions (*see section III.2.1.3*).

#### III.2.2.4 b) Sulphate (SO<sub>4</sub><sup>2-</sup>)

It can be seen in Figure 3.15 that the presence of sulphate amounting to 1.0 g/l modifies neither the kinetic of HAs mineralization (TOC), nor absorbance removal at 254 nm. However, for the higher SO<sub>4</sub><sup>2-</sup> equalling to 7.75 g/l, the mineralization rate is reduced during the first three hours (after 180 min. of irradiation only 30 % of the solution has been mineralized) while for [SO<sub>4</sub><sup>2-</sup>] = 1.0 g/l, there is 70% of mineralization.

As already described above (*section III.2.2.1*) the photomineralization of Aldrich humic acids was achieved in two stages.

Figure 3.15 demonstrates that the presence of the sulphate ions modifies the first stage of HAs degradation. However, after 300 min. of irradiation, the mineralization is the same as for the other tests. It was observed that the ionic strength enhanced adsorption of HAs onto TiO<sub>2</sub> (Fig. 3.15b). Additionally, at the same time, a stronger adsorption of SO<sub>4</sub><sup>2-</sup> (than for Cl<sup>-</sup> anion) on TiO<sub>2</sub> resulting competition with HAs molecules can not be excluded. On the other hand, the second stage of HAs photodegradation seems to be favoured. The possible reason for this phenomenon may be the enhanced rate of oxidation due to the sulphate radicals formed by the reaction of the sulphate ions with °OH radicals (Equation 3.1) or/and with h<sup>+</sup> (“holes”) (Equation 3.2) (Abdullah et al. 1990).



As a strong oxidizing agent, the sulphate radicals could accelerate the mineralization reaction (Equation 3.3). Zhu Hua and co-workers (1995) reported that the photocatalytic oxidation rate of *monocrotophos* was increased by increasing the sulphate ions concentration.

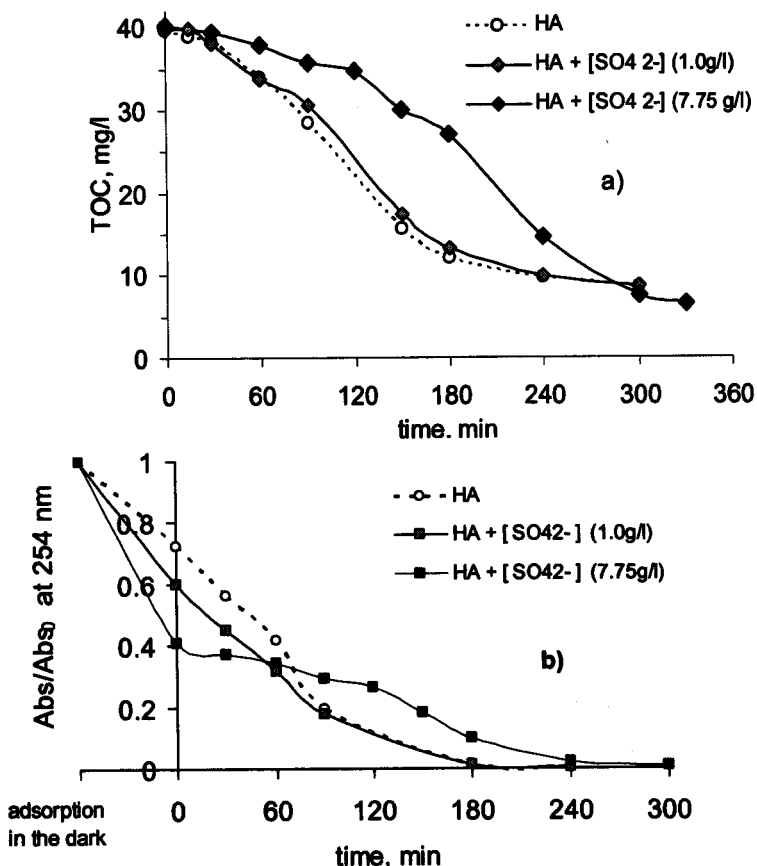

Figure 3.15 Effect of Na<sub>2</sub>SO<sub>4</sub> on photomineralization of HAs a) TOC disappearance b) removal of ABS at 254 nm

These results are not in accordance with those obtained by Bekbolet and co-workers (1998), who have observed that the presence of sulphite ions brings about the relevant inhibition of colour removal rate (about 35%). Nevertheless, these authors calculated the reaction rate according to the simple Langmuir–Hinshelwood kinetic model, which does not fit with presented data.

### III.2.2.4 c) Hydrogenocarbonate (HCO<sub>3</sub><sup>-</sup>)

Figure 3.16 shows that HCO<sub>3</sub><sup>-</sup> anions levelling at 3.05 g/l influence both the photocatalytic degradation as well as the initial adsorption of HAs. We observed that HAs removal represented by UV<sub>254</sub> absorbance were much more strongly inhibited than the colour removal. Then, after 240 min of irradiation, still about 35% and 5% of HAs remained in the solution for UV<sub>254</sub> and colour respectively.

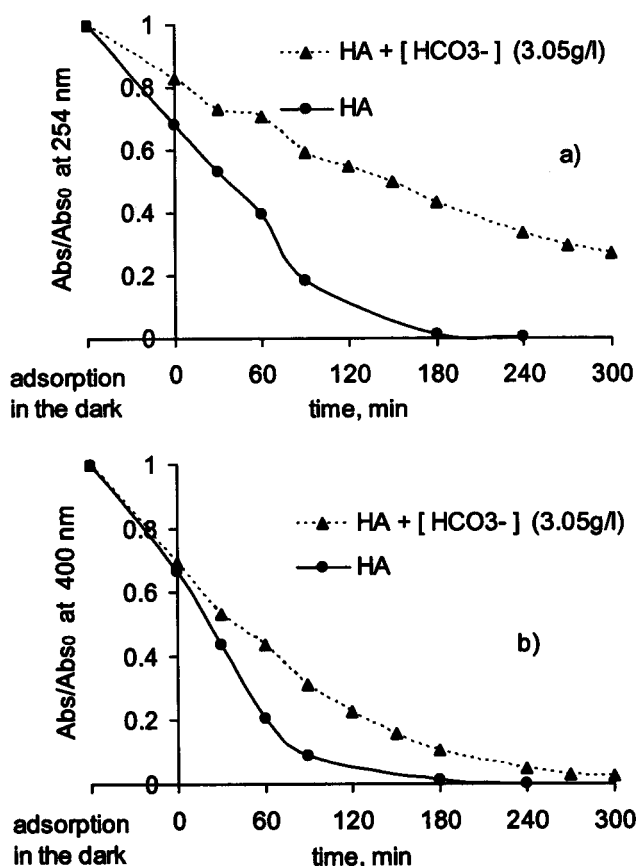

Figure 3.16 Influence of NaHCO<sub>3</sub> on photodegradation of HAs a) Abs at 254 nm disappearance b) Colour removal (Abs at 400 nm)

Kormann and co-workers (1991) found that hydrogen carbonate did not absorb strongly onto TiO<sub>2</sub> surfaces in alkaline pH. Thus, we believe that these ions would not compete significantly with HAs for adsorption site on catalyst surface in natural pH.

According to studies (Bekbolet and Balcioglu 1996, Chen et al 1997, Wang GS et al. 2000) the main negative effect of hydrogen carbonate is due to scavenging of the hydroxyl radicals anions (Equation 3.4) formed during the photocatalysis.



Moreover, the addition of bicarbonates brought about pH changes, which can affect affinity of HAs to TiO<sub>2</sub>.

#### III.2.2.4 d) Hydrogenophosphate (HPO<sub>4</sub><sup>2-</sup>)

The presence of a competitive ligand, such as phosphate, drastically reduces the adsorption of the organic species (Taborda et al. 2001). Confirming this assertion, it has already been demonstrated (*see section III.2.1.3*) that the HPO<sub>4</sub><sup>2-</sup> (present at a relatively low concentration of 0.05g/l) has a high ability to compete with HAs for activate site of TiO<sub>2</sub>. Data showed that at the beginning of reaction (t=0 min) the specific colour of HAs, detected as the absorbance at 400 nm remained almost totally in to the solution (Fig. 2.17).

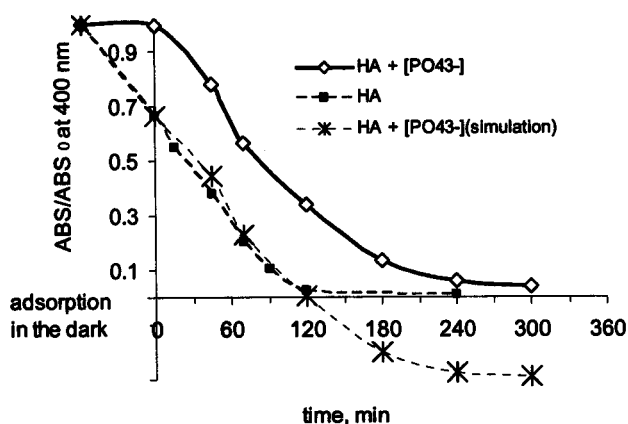

Figure 3.17 Effect of Na<sub>2</sub>HPO<sub>4</sub> on colour removal of HAs

The shortage of initial adsorption of HAs on catalyst surface could suggest the significant retardation in photocatalytic reaction due to decrease of the possibility of direct reaction between adsorbed species and generated “holes”. Accordingly, it can be noticed that after 120 min of reaction, still 34% of colour remained in the solution. Nevertheless, this result is not so unambiguous. If it is supposed that initial adsorption of HAs in the presence and absence of phosphate is the same, practically identical kinetics of HAs disappearance (the curve “simulation” drawn on Figure 2.17) will be obtained. It could be speculated that adsorption-desorption equilibrium is not an efficiency-limiting factor for HAs degradation, at least in our experimental conditions. Thus, the studies imply that the mechanism involving photogenerated free radicals is not affected.

The higher HAs removal in the absence of phosphate can most likely be attributed to the increase of initial adsorption of these species as well as adsorption of their by-products. Moreover, the presence of HPO<sub>4</sub><sup>2-</sup> seems to accelerate photocatalytic mineralization kinetic after 180 min of reaction (Fig. 2.20). More studies are needed to clarify the effect of phosphate.

The presented results are not in agreement with the studies of Bekbolet and co-workers (1998), who observed a drastic decrease of HAs degradation rate (measured in terms of colour evolution at 400 nm) in the presence of phosphate (380 mg/l). These authors consider that this effect is due to the extensive degree of blockage of the surface active site of catalyst.

However, no inhibition of phthalic acid degradation, even in acidic medium (pH 4.25), in the presence of phosphate concentration amounting to 100 mg/l was found by Taborda and co-workers (2001).

#### III.2.2.4 e) Mixture of anions

The effect of anion mixture on photocatalytic degradation of humic substances in waters has hardly ever been tested and, to my knowledge, there is only one recent study by Al-Rasheed and Cardin (2003) concerning this subject.

A photocatalytic oxidation test was carried out in the presence of [Cl<sup>-</sup>] = 4.5 g/l and [SO<sub>4</sub><sup>2-</sup>] = 7.75 g/l. Similarly to the results presented in section III.2.2.4, the presence of salts mixture (NaCl and NaSO<sub>4</sub>) affected only the first stage of photocatalytic mineralization (Fig. 3.18). In the second stage of the process (after 2h), the reaction was more rapid and still about 80% of TOC removal was achieved after 5 h of reaction.

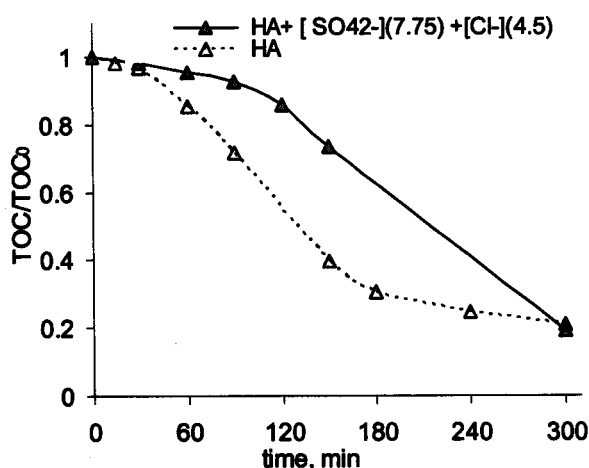

Figure 3.18 Influence of Na<sub>2</sub>SO<sub>4</sub> and NaCl mixture on photomineralization (TOC) of HAs



These results are confirmed by the studies of the dissolved fraction of HAs analysed in terms of  $\text{UV}_{254}$  and colour evolution (Fig. 3.19). It can be seen that with increase of ionic strength from  $\text{NaCl}$  and  $\text{NaSO}_4$  initial adsorption of HAs increases. Then, with the photooxidation process, the photodesorption process occurred simultaneously, affecting the first stage of HAs depolymerization (Fig. 3.19a).

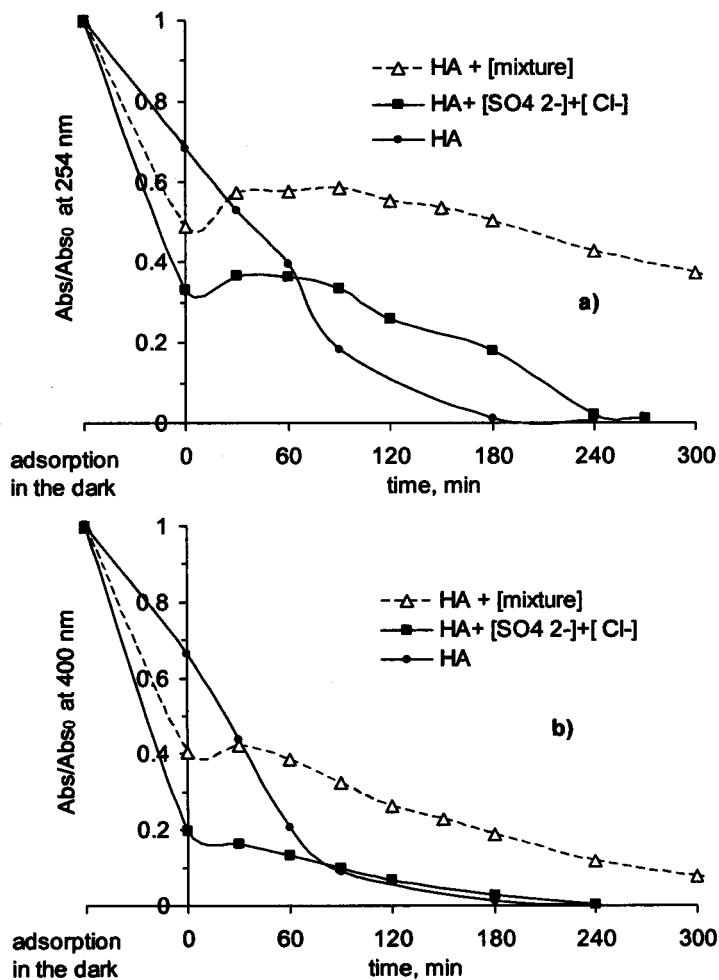

Figure 3.19 Effect of the mixture [ $\text{Na}_2\text{SO}_4$ ,  $\text{NaCl}$  and  $\text{NaHCO}_3$ ], so-called [mixture] and [ $\text{Na}_2\text{SO}_4$  and  $\text{NaCl}$ ] on photodegradation of HAs a) Abs at 254 nm disappearance b) Colour removal (Abs at 400 nm)

Moreover, it was observed that a mixture of three anions [ $\text{HCO}_3^- + \text{Cl}^- + \text{SO}_4^{2-}$ ], called a [mixture] is responsible for deterioration of HAs efficiency removal. Consequently, under these conditions still 43% and 13 % of HAs remaining into solution were detected by  $\text{UV}_{254}$  and  $\text{UV}_{400}$  respectively within the 240 min of reaction (Fig. 3.19 a and b). The inhibition effect can mainly be attributed to the occurrence of hydrogen carbonate in reacting mixture (Fig. 3.16). However, the presence of other anions such as sulphate competing in reaction should not be neglected.

The complex solution matrix [ $\text{HCO}_3^-$ ,  $\text{Cl}^-$ ,  $\text{SO}_4^{2-}$ ] strongly influenced the photoreactivity of HAs and the deterioration of reaction efficiency in this case suggests that a prolongation of irradiation is required.

It is clear that the simple L-H kinetics model cannot be applied to explain catalytic degradation of HAs in the presence of anions mixture. This assumption was recently confirmed by Al-Rasheed and Cardin (2003), who found a discrepancy of analytical data with L-H model.

### III.2.2.5 Effect of electron acceptor: O<sub>2</sub>

Photocatalytic degradation of HAs is expected to increase with air-flow, i.e. the oxygen dissolved in reacting mixture can act as an electron acceptor and consequently significantly reduce the surface electron-hole recombination (*see section I.3.3.3.*). Figure 3.20 shows that the oxygen supplied into the reactor did not enhance photocatalytic removal of HAs.

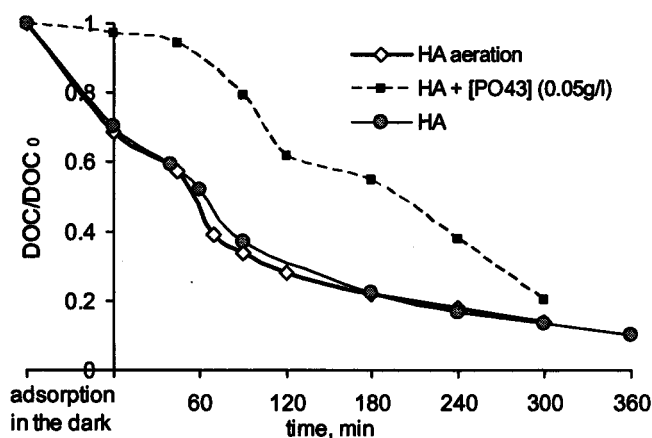

Figure 3.20 Effect of Na<sub>2</sub>HPO<sub>4</sub> and air-flow on photomineralization of HAs

This result can be explained by the fact that during the intensive mixing on magnetic stirrer (at 400 rpm) the adsorption of oxygen by the surface of solution was sufficient for photocatalytic oxidation. Thus, the oxygen saturation of reacting mixture was ensured and bubbling the air did not improve photoreactivity of HAs in this case.

Nevertheless, a positive effect of air-flow is retaining TiO<sub>2</sub> in suspension. As a result a homogenisation of mixed medium is ensured. Nevertheless, it should be noted that too high flow brings about a foaming of solution and then precludes operating efficiency of photocatalytic system. This kind of problem was reported by Al-Rahideed and Cardin (2003).

### III.2.2.6 Evolution of biodegradability

According to Corin and co-workers (1996), the direct photolysis of the HAs leads to formation of low-molecular-weight carboxylic acids (oxalic, succinic, formic, acetic...). On the other hand, Herrmann and co-workers (1999), or Vautier and co-workers (2001) indicated that the photocatalytic oxidation of poly-aromatic compounds (e.g. dyes) results in the formation of aliphatic fragments, especially formate and acetate ions. Moreover, these low-molecular weight compounds are rather stable, and remain in reacting mixture. All these low-molecular products are radically biodegradable, which makes their removal *via* biological process possible.

BOD measurement allows to follow the biodegradability of organic HAs intermediates products during irradiation time. Figure 3.21 shows that the raw HAs are refractory compounds ( $\text{BOD}_5$  of 100 mg/l HAs solution is 1.0  $\text{mgO}_2/\text{l}$ ). However, it was found that biodegradability (understood as amount of  $\text{BOD}_5$  in relation to TOC content of sample) of HA increased with irradiation time. The  $\text{BOD}_5/\text{TOC}$  ratio rose from 0.02 at  $t=0$  to 0.53 after 3.5 hours of photocatalysis.

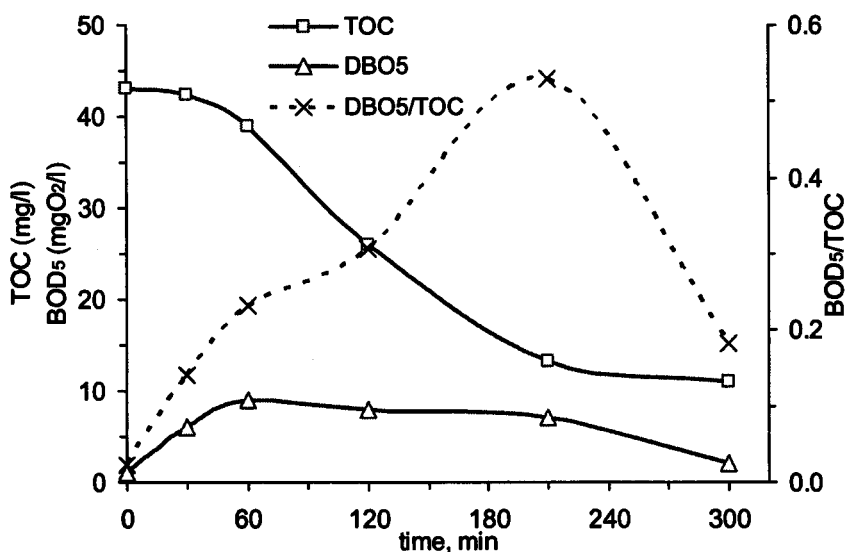

Figure 3.21 Evolution of  $\text{BOD}_5$  and TOC during the irradiation of  $[\text{HA}] = 100 \text{ mg/l}$  with  $[\text{TiO}_2] = 1.0 \text{ g/l}$

This indicates that photocatalysis process can break down or rearrange molecular structures of HA and convert the nonbiodegradable organics to more biodegradable forms. It is of great importance in the case of the application of physicochemical-biological coupled system to wastewater treatment (Pulgarin et al. 1999). If the wastewater contain a big amount of recalcitrant compounds, the preliminary photocatalytic treatment can transform these

organic compounds into easily biodegradable by-products. Finally, it allows to improve biological step efficiency and to reduce the cost of the treatment.

In our batch experiments only a slight increase in the BOD<sub>5</sub> (maximum 9.0 mg/l) was observed. It can be suggested that during photocatalysis process the HAs were mainly mineralised (converted to CO<sub>2</sub>) without forming large amounts of biodegradable species. In other words, macromolecules of HAs which were broken down to less aromatic, simple compounds, immediately transformed and removed from the system as CO<sub>2</sub> gas

### III.3. Pilot scale approach in Spain

The experiments presented in this part were carried out in the Solar Plataforma in Almeria (Spain 2002) within the EU programme “Improving Human Potential”, Action: ‘Access to the Research Infrastructure’ contract n° HPRI-CT-1999-00013.

This project concerns the solar photodegradation of Algrich-Sigma HA as a model of humic substances presents in landfill leachates by using the compound parabolic collectors (CPCs)-solar photoreactor. The investigations also include the evaluation of the possibility of combination photoreactor and biological process for the removal of refractory organics from leachate. Nowadays, CPCs technology is believed to be the best option for solar detoxification systems (*see section I.3.4*).

Solar photocatalytic detoxification can be an attractive, low cost, environmentally friendly technology for the removal of humic substance from drinking water. Particularly, it could be an effective alternative solution in countries having good annual insolation conditions.

Similarly to the previous studies at laboratory scale (*see section III.2*) two phenomena were investigated at pilot scale i.e. i) the effect of inorganic ions (inorganic matrix) on adsorption and photodegradation of model HA and ii) the evolution of biodegradability of photocatalytic by-products.

### III.3.1 Solar photocatalytic degradation of HAs

#### III.3.1.1 Effect of initial TiO<sub>2</sub> concentration on HAs removal

The influence of TiO<sub>2</sub> concentration on the photocatalytic degradation of organics in aqueous solution has already been studied in the literature (Fernandez-Ibanez et al 1999, Gimenez et al. 1999, Wiszniowski et al. 2002). The necessity to optimise this factor was pointed out. Moreover, it seems that each organic molecule has its own optimum concentration of TiO<sub>2</sub> to be degraded. The previous studies at laboratory scale (*see section III.2.2.2*) demonstrated that the optimum amount of TiO<sub>2</sub> for HAs degradation lay in the range 0.5 to 1.0 g/l. During the experiments in PSA, different TiO<sub>2</sub> amounts: 0.2, 0.3, 0.5, 0.7, 1.0, 1.2, 2.0 g/l were investigated. On the whole, it was observed that with the increase of TiO<sub>2</sub> concentration the amount of energy that had to be provided to the reactor for HAs removal decreased. A fall in the amount of DOC remaining in the solution at  $Q_{uv} = 0$  kJ/l corresponded to the quantity of HAs adsorbed by catalyst before the beginning of irradiation. It is well-known that a high catalyst concentration leads to excessive solution opacity and reduction of the system efficiency by the screening effect. In the tests this effect is not so easy to determine due to the high adsorption of HAs on the catalyst surface. Along with increasing TiO<sub>2</sub> concentration from 0.2 to 2.0g/l the amount HAs remaining in solution fell. However, the catalyst concentration amounting 0.7 g/l appeared to accelerate drastically the effect of DOC disappearance as well as UV<sub>400</sub> (Fig. 3.22). For example it was observed that 93 % of DOC reduction at  $Q_{uv} = 33$  kJ/l for 0.7g/l catalyst concentration as opposed to 86 % removed for the catalyst amounted to 0.2 g/l at  $Q_{uv} = 60$  kJ/l or 86 % for 0.3 and 0.5 TiO<sub>2</sub> dosage at  $Q_{uv} = 57$  kJ/l.

It was considered that a slight increase of efficiency of HAs removal for TiO<sub>2</sub> above 0.7 g/l (Fig. 3.22) might rather be attributed to the adsorption of HAs on catalyst surface and its separation (i.e. *via* filtration) from the solution than to the HAs degradation. The main goal of photocatalysis applied for detoxification of wastewaters is to destroy (mineralize) contaminants, not only to separate them from the solution. Bearing in mind the expenses of catalyst separation and its regeneration, it seems favourable to extent solar irradiation (reaction) time rather than overdose catalyst loading.

Nevertheless, in the case of HAs (or others organic being characterized by high affinity to the catalyst), in order to confirm the above assertion the simultaneous analysis of adsorbed organic during photocatalytic reaction should be done. A possible solution to overcome this inconvenience is to analyse the samples as TOC i.e. without TiO<sub>2</sub> separation (*see section III.2.2*). Moreover, it can be observed that the shapes of all curves for DOC disappearance are similar, with a characteristic point of inflection, for e.g. at  $Q_{uv}$  about 17 and 26 kJ/l for 0.7 and 0.2 g TiO<sub>2</sub>/l respectively. Hence the reaction of HAs mineralization is not expected to follow a simple model, as for example the first or zero order kinetics and overall reaction rate cannot

be calculated. This has already been pointed out in (section III.2.2) and will be discussed later.

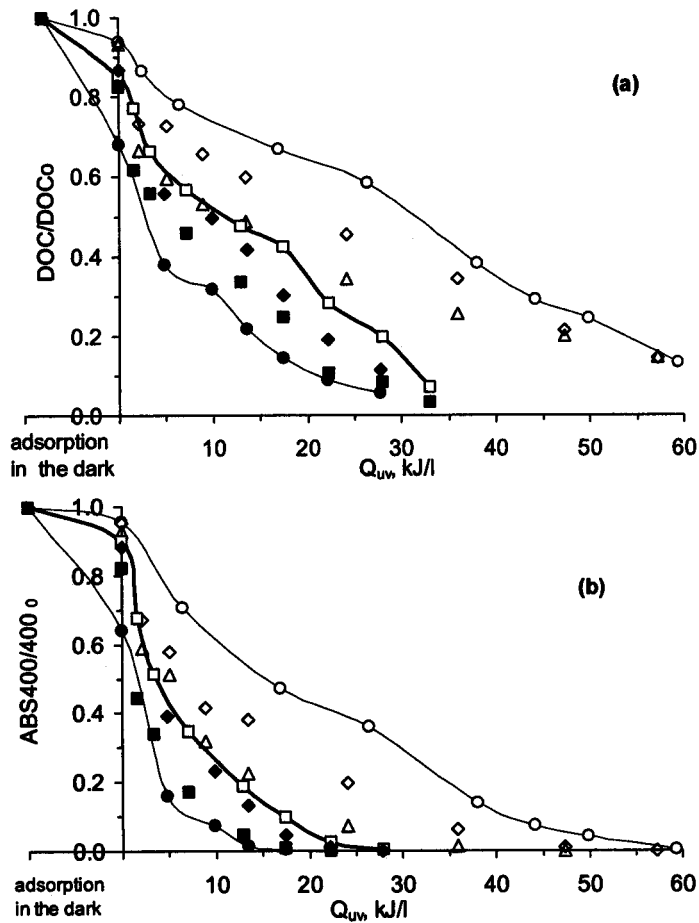

Figure 3.22 Influence of catalyst concentration on mineralization efficiency a) and b) colour removal of HAs solution versus accumulated UV energy. (○) TiO<sub>2</sub>=0.2 g/l; (◇) TiO<sub>2</sub>=0.3 g/l; (△) TiO<sub>2</sub>=0.5 g/l; (□) TiO<sub>2</sub>=0.7 g/l; (◆) TiO<sub>2</sub>=1.0 g/l; (■) TiO<sub>2</sub>=1.2 g/l; (●) TiO<sub>2</sub>=2.0 g/l

### III.3.1.2 Effect of anions on the photomineralization of HAs

#### III.3.1.2 a) Cl<sup>-</sup> and SO<sub>4</sub><sup>2-</sup>

The real landfill leachates contain a mixture of inorganic species, which could compete for the active site on TiO<sub>2</sub> surface, and could decrease the photooxidation rate of organic compounds (Herrmann 1999, Bekbolet et al. 1996). Guillard and Co-workers (2003) also reported a direct correlation between effect of inorganic anions (such as carbonate, phosphate, sulphate chloride, and nitrite) on the amount of initially adsorbed dyes and its photocatalytic efficiency removal.

In the present study, the photocatalytic degradation was carried out in the presence and absence of inorganic salts (NaCl and Na<sub>2</sub>SO<sub>4</sub>) and using 0.2 gTiO<sub>2</sub> g/l of catalyst loading (Fig. 3.23). In the test, initial pH of HAs solution was slightly basic (pH 7.8), consequently not as

favourable as in acidic medium. In these conditions the presence of chloride and sulphate at higher concentration (4.5 and 7.75 g/l respectively) did not inhibit a final efficiency of HAs removal followed in terms of DOC (Fig. 3.23a) and UV absorbance at 400 nm, so-called colour (Fig. 3.23b). Nevertheless, the following remarks of photocatalytic mineralization of HAs could be given

- i) The decrease of pH solution in the first part of the graph was probably due to the production of acidic molecules (The decrease of pH solution in the first part of the graph was probably due to the production of acidic molecules (Fig. 3.23a))
- ii) The overall mechanisms of humic acids degradation with catalyst were similar and two stages of different kinetic behaviour can be noticed (Fig. 3.23a). A first, a fast decrease of DOC below 7 kJ/l ( $Q_{UV}$ ). Next, the reaction rate slowed down and was characterised by quasi-zero order model (linear decrease). Finally, in the second stage, there was a decrease;
- iii) The first part of the graphs were similar till 30 kJ/l;
- iv) The decrease after 30 kJ/l was faster for HAs alone;
- v) The quasi complete mineralization of HAs occurs within similar irradiation time.

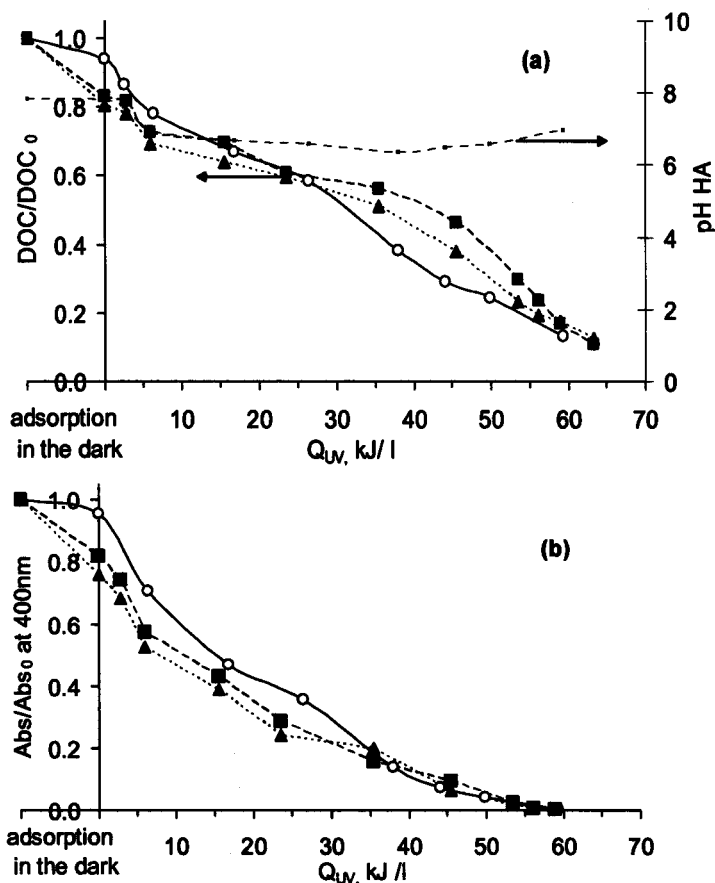

Figure 3.23 Effect of inorganic anions on a) mineralization and b) colour removal of HA solution versus accumulated UV energy.  $\text{TiO}_2 = 0.2$  g/l; (○) HA; (△) HA + [Cl<sup>-</sup>] (4.5 g/l); (□) HA + [SO<sub>4</sub><sup>2-</sup>] (7.75 g/l) and (—) pH HA

Referring to previous studies (Wiszniewski et al. 2002) the photomineralization of Aldrich humic acids is believed to occur in two stages. The first corresponded to the conversion of humic acids molecules into its component low molecular weight with a slower disappearance of organic carbon. It can be seen that in the domain ( $Q_{uv} < 10\text{-}20$  kJ/l) the reaction occurring on the catalyst surface is mainly the depolymerization of HAs (Fig. 3.23a). Next, in the second stage (above 30 kJ/l), the little molecules re-adsorb onto the TiO<sub>2</sub> surface and predominates the fast mineralization of HA's intermediate products.

The effect of ionic strength on photocatalytic degradation of HA can be noticed by in shift of the end of stage one (Fig. 3.23a). It resulted in retardation of HA removal, which was maximal at  $Q_{uv} = 45$  kJ/l and amounting to 13% and 24% caused by chlorine and sulphate were respectively. Nevertheless, the oxidation of HAs in the presence of chlorine and sulphide accelerated and 85% of the elimination in DOC was still reached at  $Q_{uv}$  equal to 63 kJ/l. It was previously reported that SO<sub>4</sub><sup>2-</sup> can promote the photocatalytic reaction of o-methylbenzoic acid (Wang KH et al. 2000) as well as HA (Bekbolet et al. 1998) removal. A possible explanation for this phenomenon is the formation of SO<sub>4</sub><sup>•-</sup> radicals due to reaction of SO<sub>4</sub><sup>2-</sup> with OH radicals (Abdullah et al. 1990). As an oxidant agent SO<sub>4</sub><sup>•-</sup> increase the oxidation of organic carbon in solution (Equation 3.3 in section III.2.2.4).

The specific brown colouration of HAs disappeared during reaction time and ionic strength seemed not affect this process. While  $Q_{uv}$  reached the level of 60 kJ/l, the specific colour (UV<sub>400</sub>) was completely removed (Fig. 3.23a). In addition the absorbance measured at 254 nm fell down about to 98%.

Evidently, the ionic strength from added salts enhanced initial HA adsorption on TiO<sub>2</sub> (Fig. 3.23a and Fig. 3.6 in section III.2.1) and improvement in photoreactivity might be expected (Li et al. 2002).

In the case of HAs, it is conceivable that the global increase of HAs adsorption was not exactly equivalent with the increase of HAs in active site onto the TiO<sub>2</sub> surface. An increase of initial HAs adsorption was most probably due to the screening effect of the negative HAs segments by the Na<sup>+</sup> counter-ions. In this case the HAs segments already adsorbed on the TiO<sub>2</sub> surface could bind the HAs remaining in the bulk (solution). It results in increasing of overall binding layer of HAs but, the amount of HAs effectively adsorbed on positively charged site of TiO<sub>2</sub> is not significantly increased. Thus, during the irradiation of catalyst, the direct reaction between adsorbed (in this way) macromolecules and electron/hole pair generated on TiO<sub>2</sub> surface did not occur. And this can be a reason for the lack of improvement in photoreactivity in present experimental conditions in spite of grater initial adsorption. On the other hand, an increase in ionic strength results in decreasing zeta-potential of TiO<sub>2</sub> due to compaction of the electrostatitic double layer at the particle surface. Consequently, the particles of catalyst aggregate and their medium particles' size increase (Fernandez-Ibanez et



al. 1999), which brings about a decrease of catalytic surface available for photocatalytic reaction of adsorbed organics compounds.

### III.3.1.2 b) HCO<sub>3</sub><sup>-</sup> and anions mixture

In order to shorten experimental time, 0.7 g/l of catalyst in the tests was applied. Figure 3.24 demonstrates that HCO<sub>3</sub><sup>-</sup> anions (3.05 g/l) caused a clear inhibition effect on photocatalytic rate. In particular, HAs removal represented by UV<sub>254</sub> absorbance was affected and at Q<sub>UV</sub> equal to 28 kJ/l still around 40% of HAs in the presence of HCO<sub>3</sub><sup>-</sup> remained (Fig. 3.24a). Colour removal (Fig. 3.24b) was retarded considerably less than UV<sub>254</sub> absorbance. The inhibitory effect of hydrogen carbonate on photocatalytic oxidation can be elucidated by the scavenging character of these anions on the OH<sup>•</sup> photogenerated radicals during the photocatalysis (Bekbolet and Balcioglu 1996, Wang et al. 1999). It was believed that hydrogen carbonate did not significantly compete with HAs for adsorption site on catalyst surface in the operating conditions; according to literature (Kormann et al. 1991) those ions did not absorb strongly onto TiO<sub>2</sub> surfaces in alkaline pH.

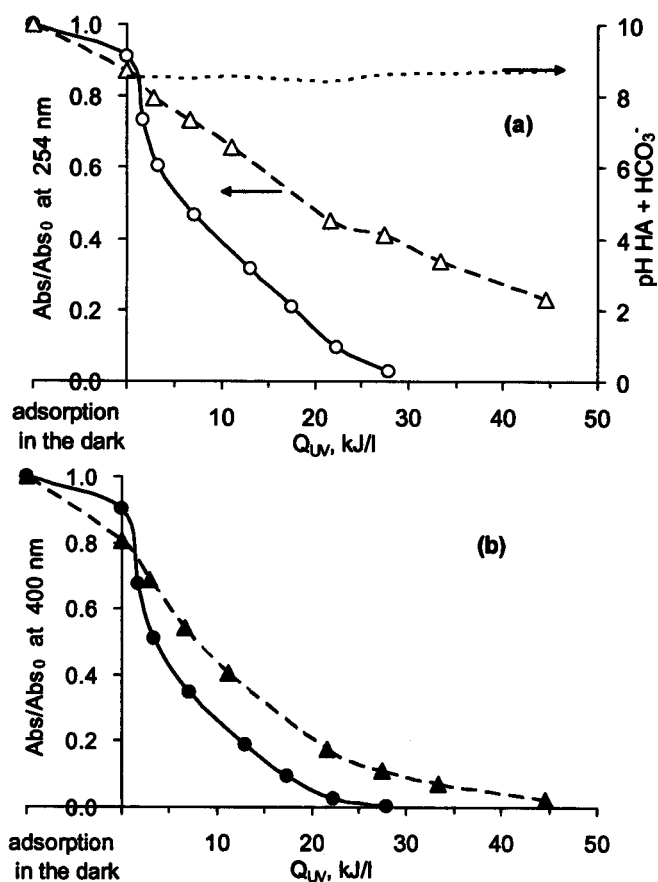

Figure 3.24 Effect of carbonate ions (3.05 g/l) on: a) absorbance at 254 nm and b) colour removal of HA solution versus accumulated UV energy, TiO<sub>2</sub> = 0.7 g/l. (—△—) HA + [HCO<sub>3</sub><sup>-</sup>], (—○—) HA expressed as Abs/Abs<sub>0</sub> at 254 nm; (—▲—) HA + [HCO<sub>3</sub><sup>-</sup>], (—●—) HA expressed as at Abs/Abs<sub>0</sub> at 400 nm and (---) pH HA + [HCO<sub>3</sub><sup>-</sup>]

As mentioned before, the pH itself can depend on the presence of the salts, as carbonic and phosphoric acids are not totally dissociated (Chen HY et al. 1997). In the tests with TiO<sub>2</sub> 0.7 g/l, the HCO<sub>3</sub><sup>-</sup> ions addition brought about pH changes. The pH of HAs solution in the presence of hydrogen carbonate was higher than the raw HA solution (pH 7.8) and during photocatalytic reaction even rose from 8.4 to 8.8 pH (Fig. 3.24a). The pH value is one of the major factors influencing photocatalytic process rate, and there is an optimal pH to improve efficiency of this process. Based on the previous finding (Palmer et al. 2002, Bekbolet et al. 2002) the photodegradation rate of HAs declined with the increase of pH above zero point charge of TiO<sub>2</sub> (about pH 7.0), and it could also be a phenomenon occurring in this case. Curiously, no deterioration in HAs adsorption was observed. On the contrary, in the presence of HCO<sub>3</sub><sup>-</sup> the HAs adsorption slightly increased even though the pH of the reaction medium also increased. It may well be that the ionic strength form NaHCO<sub>3</sub> in the solution impedes somehow desorption of HAs. The previous laboratory experiments (*see section III.2.1.3*) demonstrated that only 10% of HAs desorption was observed after addition of NaHCO<sub>3</sub> into the complex inorganic matrix [NaCl and Na<sub>2</sub>SO<sub>4</sub>].

A photocatalytic oxidation test was also performed in the presence of mixture of [HCO<sub>3</sub><sup>-</sup>] = 3.05 g/l, [Cl<sup>-</sup>] = 4.5 g/l and [SO<sub>4</sub><sup>2-</sup>] = 7.75 g/l and 0.7 g/l of catalyst loading. The mixture of NaCl and NaSO<sub>4</sub> [Cl<sup>-</sup> + SO<sub>4</sub><sup>2-</sup>] resulted in an increase of initial HAs adsorption onto the TiO<sub>2</sub>. This was demonstrated by the decrease of the HAs remaining in solution to 35% and 25% for UV<sub>254</sub> and UV<sub>400</sub> respectively (Fig. 3.25a and b) and it corresponded to the decline of DOC from 27 to 10 mg/l in solution (Fig. 3.25c). The results were in agreement with previous observation (*see section III.2.1.3*) and might be cleared by increase of ionic strength of inorganic solution matrix.

It can be estimated that the main depolymerization of HAs using 0.7 g/l occurred within Q<sub>uv</sub> amounting to 17 kJ/l (Fig. 3.25c). At the beginning of the process (up to 12 kJ/l) in the presence of [Cl<sup>-</sup> + SO<sub>4</sub><sup>2-</sup>], the DOC as well as absorbance UV<sub>254</sub> (Fig. 3.25a) gradually increased. Then, with the photooxidation process the photodesorption occurred simultaneously. At Q<sub>uv</sub> equal to 7 kJ/l, the maximal value of 40 % UV<sub>254</sub> remaining was detected.

The higher initial adsorption of HAs in the presence of [Cl<sup>-</sup> + SO<sub>4</sub><sup>2-</sup>] mixture did not influence the final photooxidation efficiency of the process. At Q<sub>uv</sub> equal to 34 kJ/l, the same level of HAs removal was obtained in either the presence or the absence of the mixture of Cl<sup>-</sup> and SO<sub>4</sub><sup>2-</sup> (Fig. 3.25c).

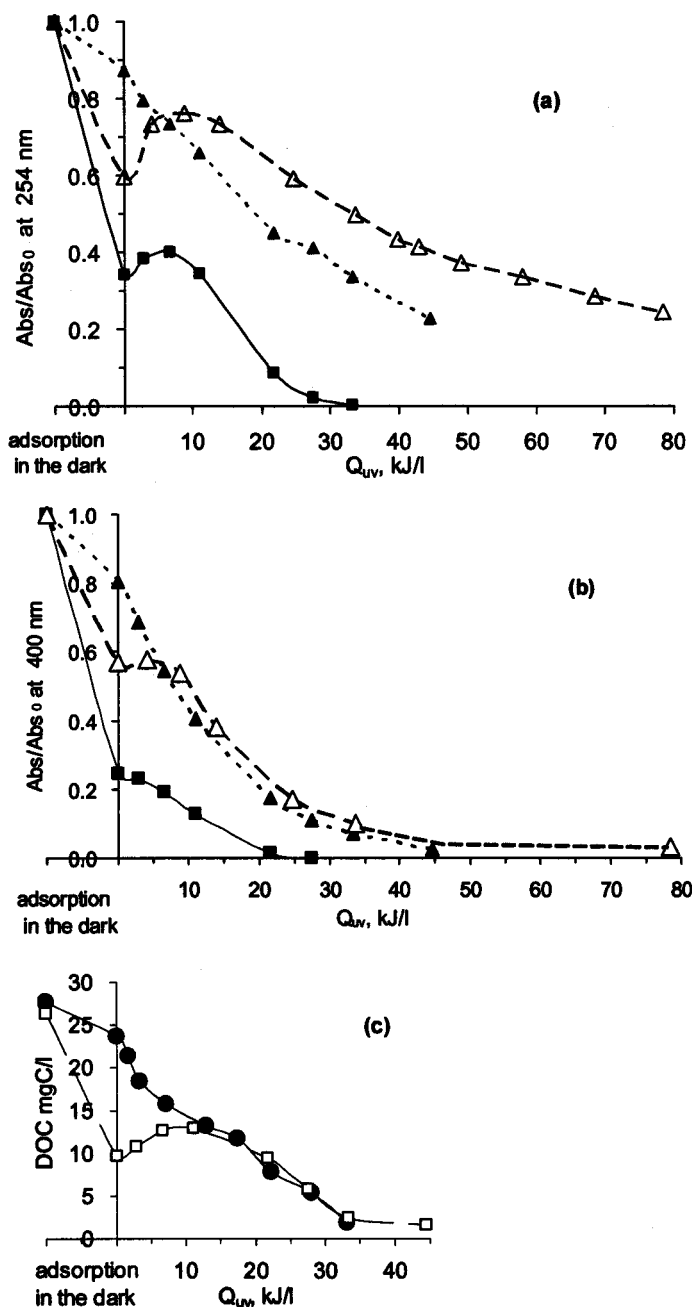

Fig. 3.25 Effect of mixture of inorganic anions in HA solution on a)  $\text{Abs}/\text{Abs}_0$  at 254 nm, b)  $\text{Abs}/\text{Abs}_0$  at 400 nm (colour) and c) DOC removal versus accumulated UV energy;  $\text{TiO}_2 = 0.7 \text{ g/l}$ ; ( $\triangle$ ) HA +  $[\text{HCO}_3^- + \text{Cl}^- + \text{SO}_4^{2-}]$ ; ( $\blacktriangle$ ) HA +  $[\text{HCO}_3^-]$ ; ( $\blacksquare$ ) HA +  $[\text{Cl}^- + \text{SO}_4^{2-}]$  and ( $\bullet$ ) DOC of HA; ( $\square$ ) DOC of HA +  $[\text{Cl}^- + \text{SO}_4^{2-}]$

The effect of solution matrix containing the mixture of three anions  $[\text{HCO}_3^-, \text{Cl}^-, \text{SO}_4^{2-}]$  was followed by  $\text{UV}_{254}$  (Fig. 3.25a) and colour removal (Fig. 3.25b) and the following observation can be given:

- 1) A change of initial adsorption of HA in the dark, i.e. an increase in comparison with  $\text{HCO}_3^-$  alone and a decrease in comparison with  $[\text{Cl}^-, \text{SO}_4^{2-}]$  mixture.
- 2) A photodesorption at the beginning of the process, as was noted for  $[\text{Cl}^-, \text{SO}_4^{2-}]$  mixture.

- 3) Delay of photocatalytic process and at  $Q_{uv}$  of 34 kJ l<sup>-1</sup>, and still 50% of HA measured by UV<sub>254</sub> absorbance left in solution (Fig. 3.25a);

On the basis of the above findings, it becomes clear that the decrease in the efficiency of the process is likely attributed to the presence of HCO<sub>3</sub><sup>-</sup>. Hydrogen carbonate acted as radical scavengers and effectively consumed °OH radicals.

Furthermore, the role of the ionic strength (from NaCl and Na<sub>2</sub>SO<sub>4</sub>) cannot be neglected. The complex matrix containing three salts (NaHCO<sub>3</sub>, NaCl and Na<sub>2</sub>SO<sub>4</sub>) inhibited much more degradation of HA detected as absorbance at 254 than in the matrix containing NaHCO<sub>3</sub> only (Fig. 3.25a). The differences of colour removal for inorganic matrix [HCO<sub>3</sub><sup>-</sup>, Cl<sup>-</sup>, SO<sub>4</sub><sup>2-</sup>] and [HCO<sub>3</sub><sup>-</sup>] were not important (Fig. 3.25b).

It is believed that the initial adsorption of organics enhanced photoreactivity due to the higher probability to the reaction between photogenerated active species (h<sup>+</sup>, °OH) and the molecules adsorbed on the catalyst surface. Moreover, an enhancement of HAs oxidation as a result of the sulphate radicals formation could be observed (Fig. 3.23).

Nevertheless, the high initial HAs adsorption actually can hamper the photocatalytic process. This is due to lower of mass transfer process between TiO<sub>2</sub> surface and bulk solutions (Cunningham et al. 1999). In other words, the agglomeration of HA onto TiO<sub>2</sub> bring about the impediment in desorption of photodegraded products (originated from breakdown of HAs) and the blockade the access of molecules remaining in solution to the activated site of TiO<sub>2</sub>. This phenomenon was observed in the first stage of HAs degradation to about 17 kJ/l of  $Q_{uv}$  (Fig. 3.25a). Moreover, an increase of ionic strength causes agglomeration of TiO<sub>2</sub> and blocking active parts of the catalyst surfaces for organic molecules.

The complex solution matrix [HCO<sub>3</sub><sup>-</sup>, Cl<sup>-</sup>, SO<sub>4</sub><sup>2-</sup>] strongly delayed the photoreactivity of HAs, but the future mineralization requires prolonged reaction time which might not be economically attractive for commercial application of the process (Fig. 3.25a and b). In particular it should be pointed out that if the photocatalysis is going to be applied for the treatment of wastewaters (in prospect for landfill leachate), a pH pre-adjustment will be needed for removing carbonate (alkalinity) from the solution matrix.

### III.3.1.3 Effect of photoreactor volume and surface

The photocatalytic degradation of HAs was performed in two CPCs systems which differed in the irradiated surface, the operating volume (*Table 2.1 in section II.2.1.1*) and the tube diameter. However, the same catalyst loading amounting to 0.7 g/l was applied. Moreover, a difference of two examined CPCs consist in alignment of collectors, i.e. it was vertical (from top to bottom) for CPC<sub>190</sub> (*Fig. 1.13 in section I.3.4.2.*) and horizontal for CPC<sub>35/39</sub> (*Fig. 2.6 in section II.2.1.1*). The materials used to build the photoreactor were different i.e. fluoropolymers and pyrex glass for CPC<sub>190</sub> and for CPC<sub>35/39</sub> respectively. In spite of these differences, a kinetic of HAs removal expressed as DOC or colour evolution was the same (*Fig. 3.26*).

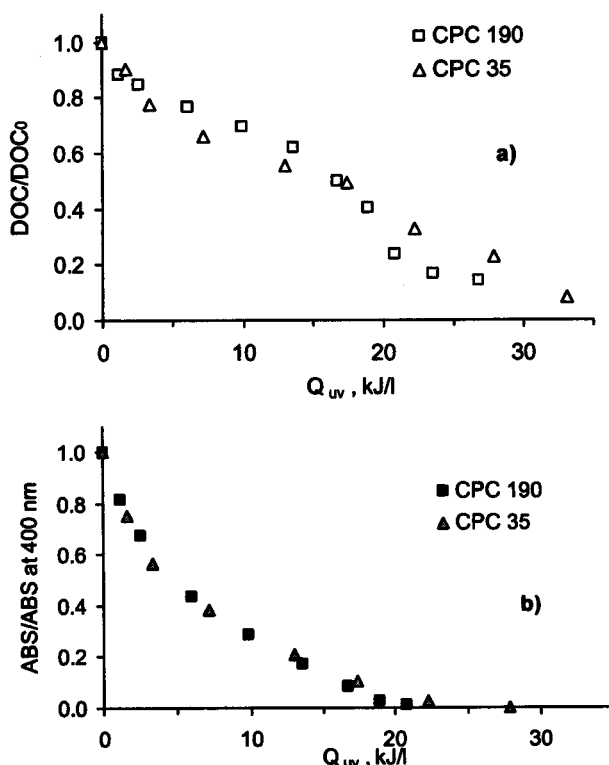

Figure 3.26 HAs mineralization a) and colour removal b) versus accumulated UV energy., Kinetics performed in two CPCs and catalyst concentration amounting to 0.7 g/l

This could suggest that the amount of energy accumulated per liter of photoreactor needed for the degradation of the specific contaminants (e.g. HAs) is the same. However, it does not mean that irradiation time (exposure time to solar radiation) for both facilities will also be the same. In fact, it was observed that in CPC<sub>35</sub>, degradation occurred much faster than in CPC<sub>190</sub>. It was found that for CPC<sub>35</sub>, the colour disappeared completely after 4.5 h of proceeding (with the average UV amounting to 21 W<sub>uv</sub>/m<sup>2</sup>) and for CPC<sub>190</sub> it required 8 h of proceeding (with the average UV amounting to 26 W<sub>uv</sub>/m<sup>2</sup>). This effect can be easily explained by the fact that the collector surface/total plant volume ( $A_r/V_t = 12$ ) ratio was much higher for CPC<sub>35</sub> than the ratio ( $A_r/V_t = 32$ ) for CPC<sub>190</sub>. According to Malato and co-workers

(2002), a solar photocatalytic degradation technology may be considered as linearly dependent on the energy flux and therefore on the collector surface. Thus, with increase of the collector's surface exposure ( $A_r$ ), the time required for detoxification decreased.

### III. 3.1.4 Biodegradability changes during photocatalytic decomposition of HAs

BOD and OUR measurements allowed to follow the biodegradability of organic HAs by-products along with photocatalysis. The OUR measured in the presence of individual samples taken from the photoreactor reflected the rate of oxygen consumption by microorganisms for the degradation of organic carbon contained in samples. Each time, the value of OUR was a response of heterotrophic organism activity to the amount of biodegradable species remaining in solution. In other words, with the increase of quantity of substrates accessible for microorganisms the rise of OUR was observed.

Figure 3.27 shows that the raw HAs are refractory compounds (BOD<sub>5</sub> of 100 mg/l HAs solution was 1.0 mg O<sub>2</sub>/l). In the first stage of the process,  $Q_{UV}$  changes from 0 to 37 kJ/l, the BOD<sub>5</sub> (biodegradable organic fraction) increased while DOC decreased. The same trend was observed for %OUR. Along with the mineralization process, with the rise of BOD<sub>5</sub> the OUR went up and with the decrease of BOD<sub>5</sub>, the OUR went down as well.

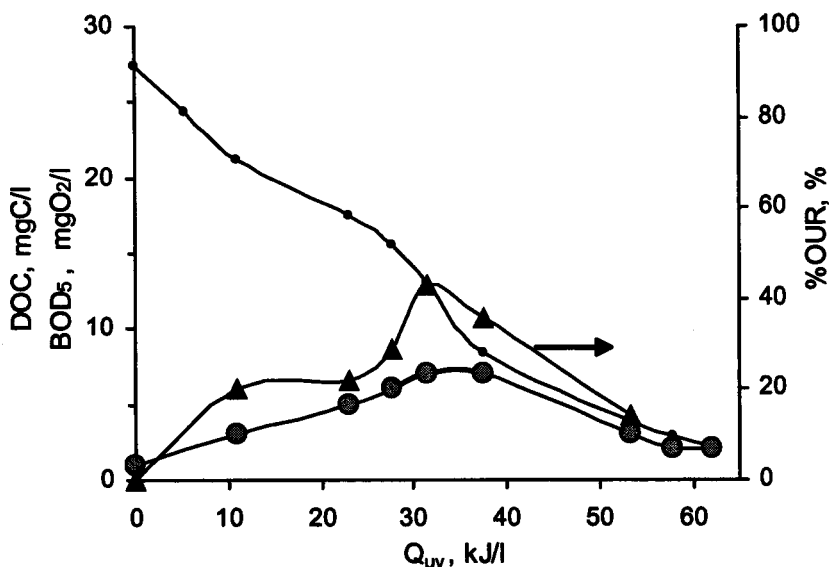

Figure 3.27 Variation of DOC, BOD<sub>5</sub> and %OUR during photocatalytic decomposition of HAs solution versus accumulated UV energy. (●) BOD<sub>5</sub>; (○) DOC HA; (▲) %OUR

It should be noted that maximum values of BOD<sub>5</sub> and OUR were obtained in the range of energy cumulated by reactor 27 - 37 kJ/l. Then, in the last stage of the process (Fig. 3.27), the mineralization rate was much slower, and with the decrease of DOC, both BOD<sub>5</sub> and OUR decreased. OUR as well as BOD<sub>5</sub> reached their maximum 40% and 7 mg/l respectively. This indicates that photocatalysis process can break down or rearrange molecular structures of HA

and convert the nonbiodegradable organic to more biodegradable forms. It is of great importance in the case of the application of a physicochemical–biological coupled system to wastewater treatment (Pulgarin et al. 1999).

Considering the economical aspects, the use of photocatalysis alone as a treatment procedure is not economic because degradation results in complete mineralization only with prolonged irradiation (reaction), which is not possible in commercial applications. If wastewater contains a large amount of recalcitrant compounds, the preliminary photocatalytic treatment can transform these organic compounds into biodegradable by-products. It allows to improve the efficiency of biological treatment and consequently to achieve reduction in the overall costs of combined methods.

### **III.4. Conclusions**

The photocatalytic process has proved to be effective for the decolourisation as well as mineralization of humic acids solution in laboratory scale experiments with artificial irradiation source as well as under solar radiation experiments conducted in Spain (PSA). The results obtained at both scales were very encouraging, and the influence of the major parameters governing photocatalytic mineralization of humic acids has been determined. The feasibility of solar photocatalysis for the elimination of humic substance from water has been proved, which could become economically competitive for conventional methods such as coagulation/flocculation/filtration, ionic exchange or membrane filtration. On the other hand, the research described above confirms the potential suitability of photocatalysis to remove bio-recalcitrant fractions from landfill leachate.

#### **III.4.1. Laboratory investigation (France)**

It was shown that adsorption plays an important role in photocatalytic degradation of organic molecules, but could not be considered as a single mechanism of photocatalytic oxidation of organics.

Study of the HA adsorption on the TiO<sub>2</sub> surface by DRIFT spectroscopy indicates that at acidic pH, HAs were adsorbed on TiO<sub>2</sub> mainly by carboxylate surface groups. DRIFT spectra also show presence of free carboxylic groups. It was shown that Langmuir model of adsorption can give relatively good results in the case of HAs, but only in natural or basic pH conditions (pH $\geq$ 7.3). The presence of inorganic salts and/or decrease of pH (acidic medium) in solution matrix, strongly influences the properties of HAs. Consequently, Langmuir model would not be applied.

The direct photolysis of HAs did not take place under the experimental conditions. Conversely, with “optimal” catalyst loading amounting to 1.0 g/l, more than 85% of TOC was achieved after 6h of irradiation. It was observed that the data did not often fit the Langmuir–Hinshelwood kinetic models due to the heterogeneity of humic acid and its large molecular size as well as its concentration. The global evolution of the photocatalytic degradation has shown two distinct domains. In the first step, a slow decrease of TOC probably due to “photodepolymerization” of adsorbed HAs on TiO<sub>2</sub> surface was observed. Then, photodegradation followed pseudo-first order kinetic and this behaviour is connected with mineralization of HA by-products.

Moreover, it was demonstrated that increase of initial adsorption of HAs (in the high ionic strength solution or acidic medium) did not guarantee improvement in oxidation efficiency. This has mainly been explained by HAs aggregation problem which leads to the impediment of mass transport between catalyst surface and solution bulk during the photocatalytic reaction. Additionally, in acidic medium (pH < pHzpc) both inorganic and organic (HAs) anions had strong affinity to the catalyst surface. As a result, competition between these two species causes a decrease of the reaction rate (the case studied - NaCl). Surprisingly, by the lack of initial adsorption of HAs in the presence phosphate in natural pH did not retard mineralization of HAs, which can suggest a predominant role of the mechanism involving photogenerated free hydroxyl radicals (<sup>o</sup>OH) and HPO<sub>4</sub><sup>o-</sup> for HAs degradation. On the other hand, we noticed that the bicarbonate hindered seriously the degradation of HAs, most likely by scavenging of (<sup>o</sup>OH).

The studies revealed that the oxygen needed for photocatalytic oxidation reaction can be easily supplied from the air. Furthermore, the O<sub>2</sub> saturation has already been ensured by an intensive agitation of reacting solution at least in the conditions of present studies.

It was found that biodegradability of refractory organic substances such as HAs increase with irradiation time. It is of great importance in the case of the application of physicochemical-biological coupled system to wastewater treatment. Photocatalysis process can break long organic molecules into smaller biodegradable compounds and remove them by biological treatment. In the end it may reduce the overall treatment cost. However it was indicated that during photocatalysis of HAs, mineralization process predominated without forming large amounts of easily biodegradable species.



### III.4.2. Pilot plant and laboratory experiments (Spain)

The fastest degradation of HAs in CPC system was found by using an “optimal” catalyst dose of 0.7 g TiO<sub>2</sub>/l. Nevertheless, a similar efficiency of HAs removal was obtained with the catalyst concentration amounting to 0.2 g/l, but in this case twice more accumulated energy ( $Q_{uv}$ ) was required. The tests carried out have confirmed that the presence of individual ions Cl<sup>-</sup>, SO<sub>4</sub><sup>2-</sup> even at concentration levels as high as 4.5 and 7.75 g/l for chloride and sulphate respectively, did not seriously affect the oxidation rates.

The inhibition effect of HCO<sub>3</sub><sup>-</sup> ions was observed. The mixture of Cl<sup>-</sup>, SO<sub>4</sub><sup>2-</sup>, and HCO<sub>3</sub><sup>-</sup> significantly delayed the degradation process. It was demonstrated that the mixture of the anions requires prolonged time of irradiation, and the presence of hydrogen carbonates is the most fatal factor influencing photocatalytic reaction.

Biodegradability changes during photocatalytic decomposition could be measured successfully with respirometric activity (OUR). This method is very fast (approximately 10 min per sample) compared to BOD<sub>5</sub> analysis (5 days) and gives good correlation with the amount of biodegradable species as determined by BOD<sub>5</sub>.

The present studies should be considered as an approach for real landfill leachate photocatalytic treatment. More accurate assessment of optimal catalyst concentration will be made in further investigations.

Finally, it was shown that conclusions drawn from laboratory scale experiments are valid for a pilot plant scale operation with solar radiation. Thus, the data obtained in the laboratory can be successfully used to predict behaviour for large scale treatment plants. Consequently a several operational control parameters of designed technology (landfill leachate treatment) might be determined in laboratory experiments.

# **CHAPTER IV**

---

---

## *STUDY OF BIOLOGICAL TREATMENT OF LANDFILL LEACHATE*

---

---

---

## IV.1 Introduction

Biological nitrification and denitrification is one of the most feasible, effective and economic methods of nitrogen removal from, not only municipal, but also from industrial discharge (Ilies and Mavinic 2001). Furthermore, the biodegradable organic compounds can be efficiently removed from leachate by biological process. The principle of this process has been known quite well and biological treatment technology is successfully applied for domestic wastewater. However, for industrial wastewater or leachate, the conventional approach for treatment requires some modifications. Depending on the wastewater and the standards that the effluents have to meet, different process design and/or operational control parameters must be considered (Eckenfelder and Grau 1992). First, laboratory scale research has to be carried out.

In this study, two different technologies based on *attached growth microorganisms* for landfill leachate treatment were evaluated.

Activated sludge method with microorganisms immobilized on suspended carrier have been chosen because they possess some advantages such as fast removal of pollutants, less negative effect of low temperature and improvement of sedimentary properties, which allow to apply very short retention time of the sludge in the secondary clarifier. The short retention time of sludge in secondary clarifier protects against the undesirable denitrification, which is very often observed during the treatment of wastewater with high concentration of nitrogen (Welander et al. 1997, Loukidou and Zouboulis 2001).

Rotating Biological Contactors (RBC) process appears to offer several advantages over the conventional activated sludge process. The primary advantage is that it is relatively easy for operation and maintenance, is a good solution for on-site leachate treatment, which often are in remote locations (Spengel and Dzombak 1991). RBC units are widely used in the treatment of wastewater because it is possible to obtain high performance in the removal of dissolved pollutants using less energy than activated-sludge systems (Friedman et al. 1979).

The aim of the study was:

- To determine the efficiency of biological removal of changeable, high ammonia concentrations from leachate by using pre-denitrification system with *activated sludge immobilized on suspended carrier*. The specific objects of study were: i) to evaluate a short and long-term effect of bentonite on sludge settling properties, ii) to determine optimal parameters ensuring full nitrification, iii) to assess the efficiency of denitrification stage with organic carbon source from landfill leachate.
- To determine the efficiency of biological removal of high ammonia concentrations and poorly biodegradable leachate by using RBC system. The specific objects of study were: iv) to determine optimal parameters ensuring stable nitrification in RBC, v) to optimise N removal with external carbon source (acetic acid).

## IV.2. Activated sludge (AS)

### IV.2.1. Influence of bentonite on sludge settling properties-preliminary investigation (AS)

This part of the research was conducted on the model of activated sludge unit (*Fig. 2.8 in section II.3.1.2*) by using synthetic ammonium-rich wastewater (200-300 mg/l) as a feed. A detailed description of procedure is contained in *section II.3.1.2.1*.

The SVI of activated sludge from the municipal wastewater treatment plant amounted to 172 ml/g, and sludge concentration was equal to 4.0 g MLSS/l. After having recorded one control sedimentation curve "reference", the 2.0 g/l of bentonite was added. A new initial sedimentation curve "0 d" was determined after about 1 hour of aeration of mixed liquor. It was seen that the addition of bentonite resulted in a reduction of sludge blanket height from 690 to 575 ml within 30 min (*Fig. 4.1a*). It corresponded to 44% decrease of SVI which amounted to 96 ml/g (*Fig. 4.1 b*). Similar instantaneous improvement of settling properties by addition of a polymer or a large amount of talc has already been reported by Rasmussen et al. (1996) or by Seka et al. (2001). Nevertheless, there are very few papers that refer to application of bentonite in the activated sludge system (Lee et al. 2002). However, the effect of sedimentary improvements of biomass by addition of bentonite was not well studied. Similarly to Rasmussen (1996) findings, in the present tests, short-term beneficial effect of bentonite (presented by "reference" and "0 d" curves) could be explained by increase of average density of the floc aggregations.

In the presented study a positive effect on the sludge settling properties was also observed in the long-term experiments (30 days). Initial settling velocity was calculated within the first 5 min of sedimentation process. The "lag phase", in which flocs form again after being disturbed by the turbulence during the filling of the graduated cylinders was passed over in the study. The decrease of initial settling velocity from 2.0 m/h to 0.8 m/h occurring over the first days was probably due to the shift of microbial population. The system was fed with synthetic wastewater containing high amount of ammonia. Due to a lack of organic carbon in inlet a disappearance of heterotrophic microorganisms was expected. It resulted in decline of MLSS in the reactor in this period from 6.0 to 4.5 g/l. However, unstable process of adaptation did not seriously affect SVI, which was around 100 ml/g and the height of sludge blanket had a tendency to decrease. After the 14<sup>th</sup> day of study, the process was stabilised and only a slight decrease in sludge concentration from 4.5 to 4.0 g/l after 30 days was observed.

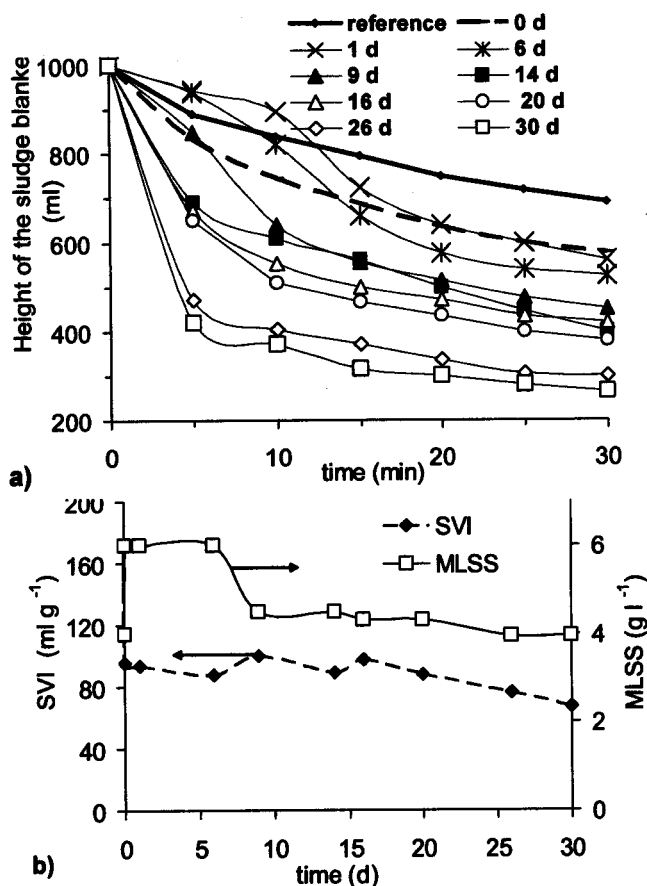

Figure 4.1 Sedimentation curves a) and MLSS, SVI evolution b)

Figure 4.1 shows the sedimentation curves. At the beginning, the sedimentation rate in the first 5 minutes was very fast (a “fairly linear settling period”) and then slowed down due to compression of the sludge blanket where all floc layers have physical contact with the underlying ones. Moreover, along with acclimation time, particularly in the last experimental period (between 14 and 30 d), the initial settling velocity went up sharply from about 3.7 m/h for curve “14 d” to 6.5 m/h for curve “30 d”. The explanation is that the interaction time between activated sludge and bentonite was long enough to give durable microbial structure. Actually the microscopy showed that bentonite had been incorporated into the floc structures. The microscopy confirmed the presence of large flocs that resembled rather typical heterotrophic sludge than autotrophic one. Accordingly, the properties of sludge were improved and SVI decreased to 67 ml/g. At the same time, full nitrification of 300 mg NH<sub>4</sub><sup>+</sup>-N/l was achieved.

## IV.2.2. Landfill leachate treatment –nitrification in AS

The experiments with landfill leachate (Table 2.2 in section II.3.1.1) were carried out using pre-denitrification system (Fig. 2.9) with activated sludge immobilized on suspended carrier (bentonite).

In the first experimental period almost complete ammonia oxidation was achieved in the system on the average 99% with the reference to the average concentration of 372 mg  $\text{NH}_4^+$ -N/l in the influent. It allowed to ensure low ammonia concentration in effluent, in the range of 1.5-5.4 mg  $\text{NH}_4^+$ -N/l (average 4.6 mg  $\text{NH}_4^+$ -N/l) (Fig. 4.2).

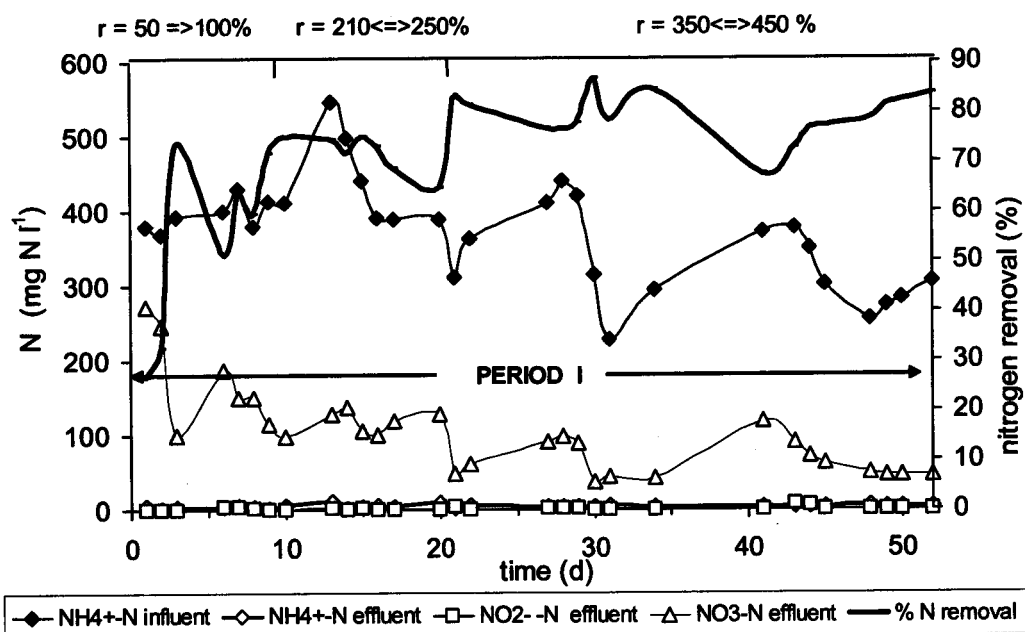

Figure 4.2 Nitrogen forms concentrations and percentage of nitrogen removal in the system, period I

The ammonia oxidation rate varied in this period from 0.03 to 0.08 g  $\text{NH}_4^+$ -N / g MLVSS \*d (average 0.06 g  $\text{NH}_4^+$ -N / gMLVSS \*d)

Nitrite concentrations in aeration chamber are kept at low range 0.0 to 5.1 mg  $\text{NO}_2^-$ /l and only twice these values were exceeded, reaching the values of 11.4 and 13.1 mg  $\text{NO}_2^-$ -N/l. The nitrate concentrations were much higher and varied from 11.8 to 166.7  $\text{NO}_3^-$ -N/l (Fig. 4.2). This phenomenon corresponds to classic nitrification, where the 2<sup>nd</sup> stage of nitrification rate (oxidation  $\text{NO}_2^- \Rightarrow \text{NO}_3^-$ ) is faster than the 1<sup>st</sup> stage of nitrification rate (oxidation  $\text{NH}_4^+ \Rightarrow \text{NO}_2^-$ ) for this reason nitrites build-up is not observed into the system.

In the periods II and III the system was fed with leachate containing 425-868 mg  $\text{NH}_4^+$ -N/l, on average 600 mg  $\text{NH}_4^+$ -N/l. It was about twice greater than in the previous period I. At first (period II), in spite of growing ammonia contents in the influent to 868 mg  $\text{NH}_4^+$ -N/l (maximum value) the average removal was still very high, amounting to 96% on average (71-99%). Consequently, ammonia concentration in the effluent varied in the range 5 to 248 mg

$\text{NH}_4^+\text{-N/l}$  (on average  $44 \text{ mg NH}_4^+\text{-N/l}$ ) (Fig. 4.3). The average ammonia oxidation rate for period II reached  $0.08 \text{ g NH}_4^+\text{-N/g MLVSS}\cdot\text{d}$  ( $0.04\text{-}0.12 \text{ g NH}_4^+\text{-N/ g MLVSS}\cdot\text{d}$ ) and was higher than the average oxidation rate for period I.

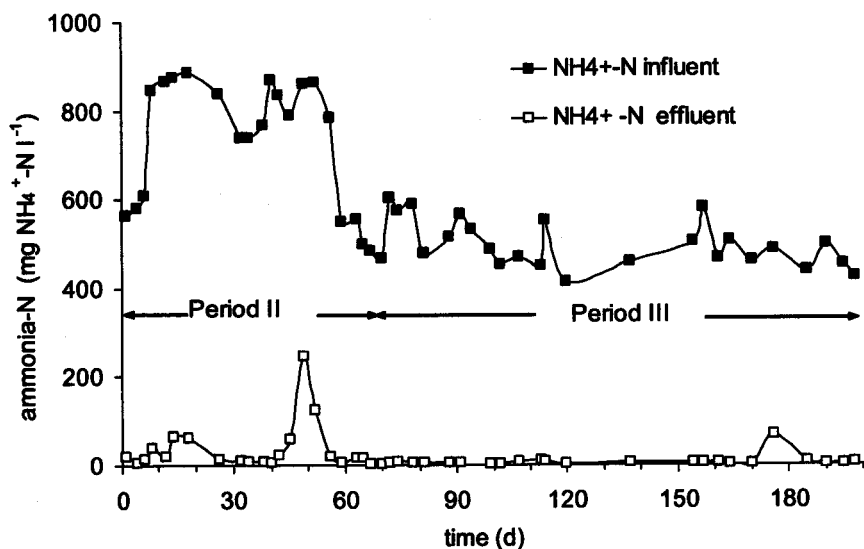

Figure 4.3 Ammonia nitrogen concentration in raw and treated leachate during period II and III

During period III the  $\text{NH}_4^+\text{-N}$  level was about  $500 \text{ mg/l}$  and average ammonia removal raised to 98%. The quality of effluent was improved ensuring low ammonia concentration. The ammonia oxidation rate decreased in this period to  $0.05 \text{ g NH}_4^+\text{-N g MLVSS}\cdot\text{d}$  ( $0.04\text{-}0.08 \text{ g NH}_4^+\text{-N/g MLVSS}\cdot\text{d}$ ).

For the first 65 days of operation (period II), nitrification process was characterised by changes of concentration of oxidised nitrogen forms. Nitrite varied from  $66$  to  $381 \text{ mg NO}_2^-\text{-N/l}$  and nitrate varied from  $45$  to  $381 \text{ mg NO}_3^-\text{-N/l}$  (Fig. 4.4). Periodically, in aerobic chamber an increase of nitrate concentration was accompanied by a decrease of nitrite concentration and on contrary with the increase of nitrite, the amount of nitrate decreased.

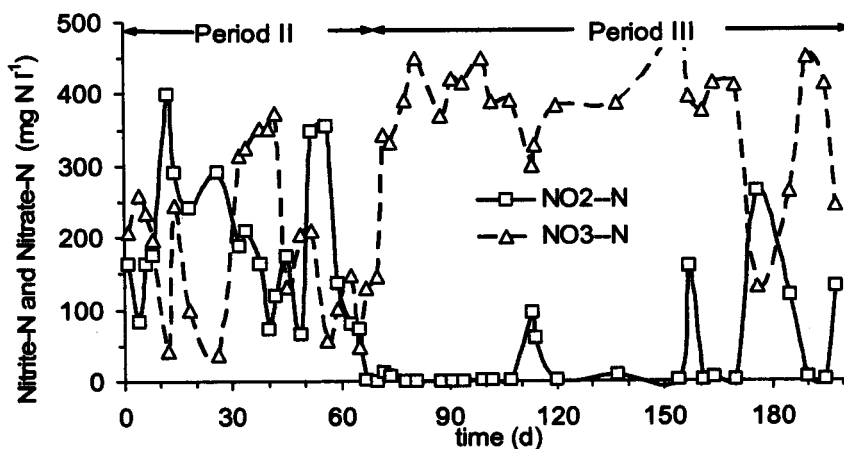

Figure 4.4 Nitrite and nitrate concentrations in aerobic chamber during period II and III

## IV.2.3. Landfill leachate treatment –denitrification and COD removal in AS

During the whole first experimental period the easy biodegradable organic fraction was in leachate at a very high, stable level, and BOD<sub>5</sub>/COD ratio equal to 0.6. COD elimination was significant and levelled at 85% in average. It allowed to reduce the concentration of organic compounds in treated effluent to the average level of 364 mg O<sub>2</sub> /l (Fig. 4.5).

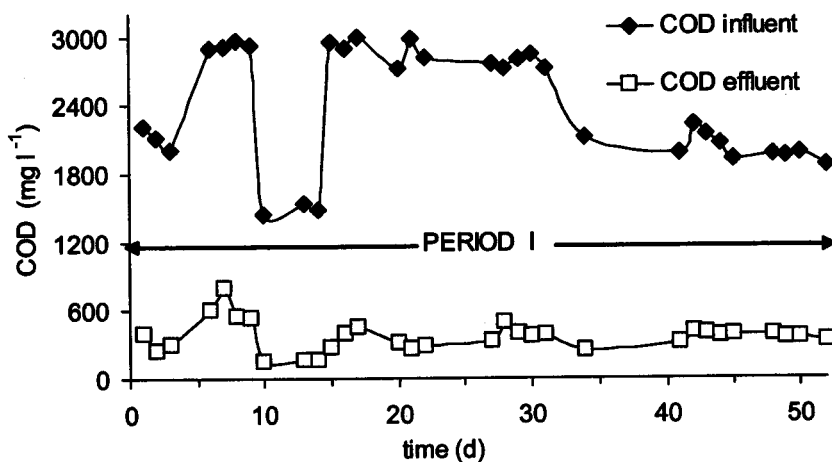

Figure 4.5 COD concentration in the raw and treated leachate period I

Raw leachate was used as an organic carbon source for denitrification process. The denitrification rate during this period was around 0.09 g N/g MLVSS\*d, and volumetric denitrification rate 21.0 g N/m<sup>3</sup>\*h. This high denitrification rate allowed to remove on average 72% of nitrogen from leachate. In the first period of study, the efficiency of nitrogen removal depended not only on the amount of easy biodegradable organic carbon but also on the sludge recycle flow ratio, which transported the load of oxidised nitrogen forms (NO<sub>x</sub>) to the anoxic chamber.

Initially, the sludge recycle flow ratio increased from 50 to 100%. It brought about an increase of nitrogen elimination from 27% to 73%. Next, when the recycle flow ratio degree was fixed at 210-250%, the stable nitrogen removal amounting to 65-75% was obtained. Higher recycle flow ratio levelled at 350-450% and improved even more the removal of nitrogen to 80%, which resulted in 25-148 mg NO<sub>3</sub><sup>-</sup>-N/l in the remaining effluent (Fig. 4.2). Thanks to bentonite applied as a biomass carrier the recycle flow ratio could be operating at such a high level without negative effect on secondary clarified, and the sludge index amounted to 52 ml /g during the period I.

During period II and period III the average removal of COD was similar and amounted 38% and 36% respectively.

The ratio of the biodegradable organic carbon to the nitrogen (BOD<sub>5</sub>/N) was not favourable to denitrify the whole amount of nitrogen in the leachate. In period II this ratio was at a level of 1.3 Then, the leachate contained relatively high quantity of bio-available organic



compounds and the denitrification rate amounted on average to  $0.07 \text{ g N /g MLVSS}\cdot\text{d}$ , and volumetric denitrification rate was  $12.3 \text{ g N m}^3 \cdot\text{h}$ . Consequently, 47% of nitrogen removal in the system was achieved. Also in this case, the percentage of nitrogen elimination depended on the sludge recycle flow ratio (Fig. 4.6). Subsequently, increasing recycle flow ratio from 100 to 280%, N removal raised from 30% to 75%.

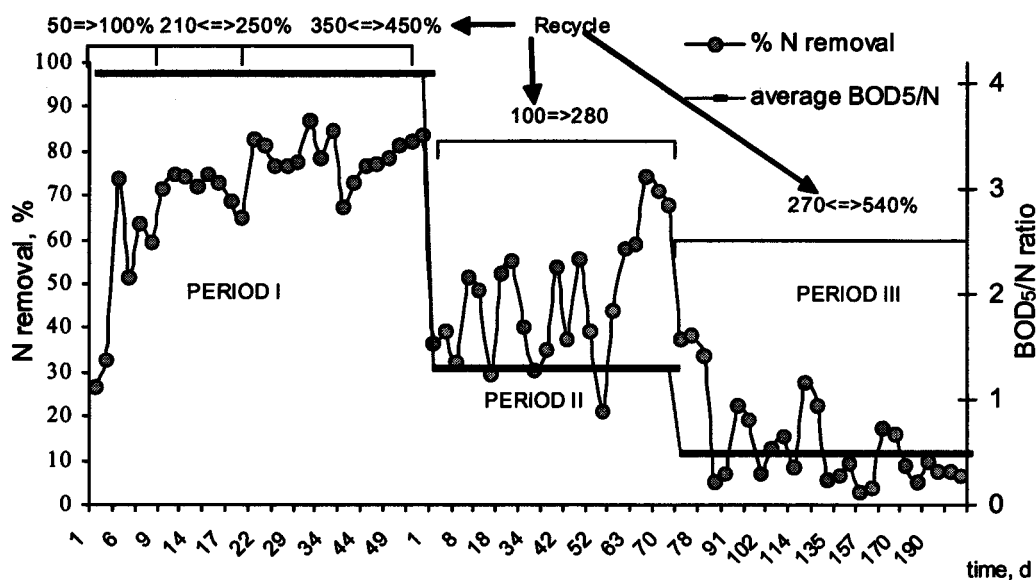

Figure 4.6 Percentage of nitrogen removal related to degree of recycle as well as  $BOD_5/N$  ratio

In period III, the average  $BOD_5/N$  ratio deteriorated to 0.5. Such a low level resulted in a decrease of denitrification rate to  $0.02 \text{ g N /g MLVSS}\cdot\text{d}$  ( $4.6 \text{ g N /m}^3 \cdot\text{h}$ ) after 120 days of operation of the system, the rate decreased even more to  $0.007 \text{ g N/gMLVSS d}$  ( $1.3 \text{ g N m}^3\cdot\text{h}$ ). The recycle flow ratio changes at a range of 270-540% during this period did not improve nitrogen removal, which fell down from 17 to 8% (Fig.4.6).

#### IV.2.4. Discussion for AS

The additives can improve settling properties of sludge (Rasmussen et al. 1996, Seka et al. 2001). The present results have shown that even a single dose of bentonite immediately improved sedimentary properties of biomass. It could be explained by ballasting performance of bentonite. Our preliminary investigation using mainly autotrophic population within 30 days (Fig. 4.1) confirmed the ability of bentonite to act as an effective support of microorganisms, which is conducive to high efficiency of nitrification as well as good separation of sludge and effluent in secondary clarifiers. In all experimental periods, in the laboratory-scale system, complete ammonia oxidation (over 95%) was obtained. As a result, low ammonia concentration in effluent, usually  $5.0 \text{ mg NH}_4^+ \cdot\text{N/l}$ , was ensured. Many authors have reported that nitrification process was significantly affected by free ammonia ( $\text{NH}_3$ ) and

free nitrous acid ( $\text{HNO}_2$ ) presence in activated sludge aerobic reactor (Anthonisen et al., 1976; Balmelle et al. 1992, Shiskowski and Mavinic 1998; Yalmaz and Öztürk 2001). Maintenance of both these nitrogen forms depends on pH, temperature and respectively on ammonia or nitrite nitrogen concentrations. Their negative influence on nitrification has been described by Anthonisen and co-workers (1976) and Balmelle and co-workers (1992). The results of period I study shown that population of nitrifiers (both *Nitrosomonas* and *Nitrobacter*) were well acclimated to high ammonia concentration in raw leachate. The amount of free ammonia in aeration reactor was at range 0.1 to 1.0 mg  $\text{NH}_3/\text{l}$  (on average 0.6 mg  $\text{NH}_3/\text{l}$ ), which is considered as a reason for inhibition of *Nitrobacter* bacteria, oxidising  $\text{NO}_2^-$  to  $\text{NO}_3^-$  (Anthonisen et al. 1976). Nevertheless, the nitrite average concentration in effluent amounting to 1.7 mg  $\text{NO}_2^-$ -N/l indicated that in whole period I of the study the activity of *Nitrobacter* was not slowed down.

The opposite situation was observed in period II. The fluctuation in nitrite and nitrate concentrations detected in aerobic reactor during period II of study proved that II stage of nitrification has been destabilised. At that moment the maximum ammonia concentration amounted to 850 mg  $\text{NH}_4^+$ -N/l was observed in influent. As a result, the high concentration of free ammonia (average 4.9 mg  $\text{NH}_3/\text{l}$ ) appeared and partially inhibited the growth of *Nitrobacter* bacteria. Nevertheless, this concentration was still below the range 10 to 150 mg  $\text{NH}_3/\text{l}$  which caused the inhibition of both *Nitrosomonas* and *Nitrobacter* (Anthonisen et al., 1976).

In period III, a stable nitrification can be observed. A likely explanation would be a stable pollutants loading, sludge age above 25 days and progressive acclimation of nitrifiers (within 2 months of system operating). Despite the fact that free ammonia concentration reached 1.1 mg  $\text{NH}_3/\text{l}$  exceeding slightly inhibition boundary acceptable by nitrifiers of II stage (*Nitrobacter*), the accumulation of nitrite in aerobic chamber did not take place.

From the standpoint of application of biological treatment process to the real leachate it is of great importance to show nitrification capacity as a function of nitrogen load. It allows to determine the upper limit of ammonia loading referring to the available biomass in the system. Consequently in the bioreactor with load variation it is possible to estimate an oxidising efficiency of the ammonia nitrogen. Muller et al. (1995) reported that maximal nitrification capacity is proportional to the nitrogen load except at the highest loaded as it was still increasing. Fig. 4.7 shows that nitrification capacities expressed as ammonia oxidation rate were proportional to the nitrogen load up to the value of 0.13 g  $\text{NH}_4^+$ -N/ gMLVSS\*d.

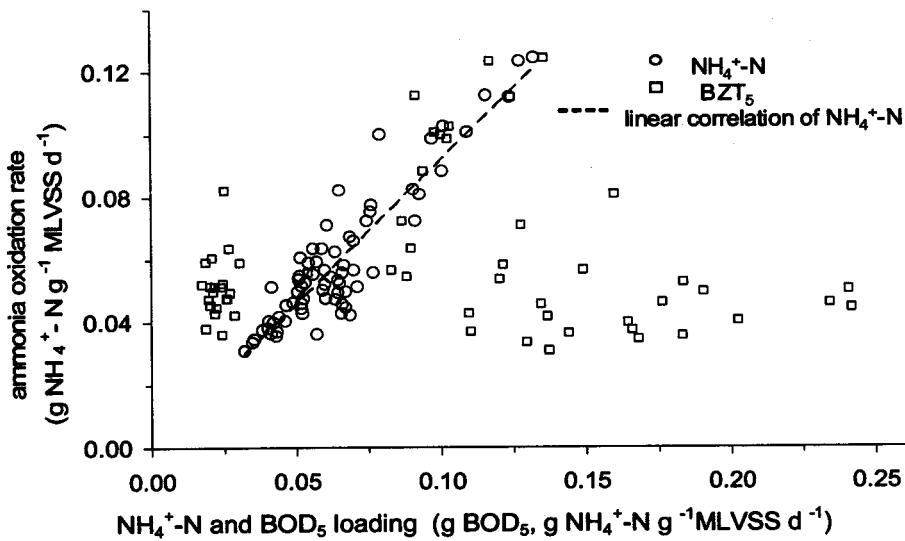

Figure 4.7 Relationship between nitrification rate and ammonia and BOD<sub>5</sub> loading

The stable and complete oxidation of ammonia (to nitrate) was ensured in period I and III while N-loading increased up to the value of 0.09 g NH<sub>4</sub><sup>+</sup>-N/gMLVSS\*d. Higher ammonia loading in period II up to 0.13 gNH<sub>4</sub><sup>+</sup>-N g/ MLVSS\*d (pH 8-8.5) entailed some inhibition problems of 2<sup>nd</sup> nitrification stage, but still almost all ammonia was oxidized. Yamaz and Öztürk (2001) found that capacities of nitrifiers could be developed to treat successfully N-load amounting to 0.13 gNH<sub>4</sub><sup>+</sup>-N/g MLVSS\*d, but it required more than 3 months of acclimation.

The other issue is connected with a solid retention time i.e. sludge age (SA) and hydraulic retention time (HRT) (Table 2.4, Ch. II) indispensable for retaining nitrifiers in the system. According to Gupta and Sharma (1996), the optimum SA and HRT for nitrification of mixture of urea and pharmaceutical wastewaters was found to be 30 d and 2 d respectively. Under these operating conditions, stable and complete oxidation of ammonia was ensured for N-load amounting to 0.16 g TKN/g MLVSS\*d. The results obtained in the present study showed that even at lower SA and higher HRT in period I, the system did not suffer from washing out of nitrifiers. It is conceivable that bentonite associated with flocs was favourable to autotrophic bacteria growing and their good retention in the system. Its use also allowed to shorten acclimation time required for successful nitrification.

Previously, Welander et al. (1997) reported that the acclimation periods of 2 months is required for steady state operating conditions in biological nitrification process. The volumetric nitrification rate achieved in present study at range amounting to 6.1-11.6 g NH<sub>4</sub><sup>+</sup>-N/ m<sup>3</sup>\*h was very close to the values 4.5-11.1 g NH<sub>4</sub><sup>+</sup>-N/m<sup>3</sup>\*h received by Welander et al. (1997) who used system with microorganisms immobilised on suspended carrier for treating leachate containing 460-600 NH<sub>4</sub><sup>+</sup>-N/l at temperature 20<sup>o</sup>C. However, in the described experiments the highest nitrification rates were reached during long acclimation to the high ammonia concentration.

High load of biodegradable organic matter ( $BOD_5$ ) present in wastewater provokes the favourable growth of heterotrophs in activated sludge biomass. Since nitrifiers have smaller growth rate than heterotrophs, their amount in activated sludge decreases and nitrification is inhibited (Hanaki et al., 1990). However, Fig. 4.7 shows that organic substrate loading up to value  $0.24 \text{ g } BOD_5 / \text{g MLVSS} \cdot \text{d}$  did not influence the nitrification rate. Similar values of ammonia oxidation rate -  $0.05 \text{ g } NH_4^+ - N / \text{gMLVSS} \cdot \text{d}$  were observed in period I and in period III, when organic loading has reached the maximum value  $0.24 \text{ g } BOD_5 / \text{g MLVSS} \cdot \text{d}$  and minimum value  $0.02 \text{ g } BOD_5 / \text{gMLVSS} \cdot \text{d}$  respectively. Hence, growing heterotrophs did not dominate in the competition for nitrogen, as it was observed in literature (Hanaki et al., 1990), nor the nature of organics present in leachate resulted in inhibition of nitrogen oxidation.

The removal of organic compounds (COD) was found to occur effectively and maximum value was obtained for period I when the raw leachate had the highest biodegradability ( $BOD_5 = 61\%$  of COD). In this period COD removal was 85%. More than 95% of COD removal was reported by Yalmaz and Öztürk (2001) in SBR at the same  $BOD_5/\text{COD}$  ratio. Comparable level of 90% of COD elimination from leachate ( $BOD_5/\text{COD} = 0.7$ ) using anaerobic filter was obtained by Henry et al. (1987). Curiously, a similar COD removal rate (about 38%) was observed in period II and III while the  $BOD_5/\text{COD}$  ratio amounted to 0.5 and 0.3 respectively. This phenomenon requires closer assessment in the future experiments.

The problem of nitrogen removal from leachates and wastewater containing high ammonia concentration has already been widely discussed in literature (Bae et al. 1997; Surmacz-Górska et al. 1997, Welander et al. 1998, Ilies and Mavinic 2001, Shiskowski and Mavinic 2001, Yalmaz and Öztürk 2001). The denitrification rate depends on the biodegradability and quantity of the organics in wastewater. In the studied system, removal of nitrogen occurred via nitrification and denitrification by using raw leachate as an organic carbon source. The highest denitrification rate amounting to  $0.09 \text{ g N } / \text{gMLVSS} \cdot \text{d}$  was achieved in the first period of the study and was higher than the value  $0.07 \text{ g N } / \text{gMLVSS} \cdot \text{d}$  ( $3 \text{ mg N/gMLVSS} \cdot \text{h}$ ) reported by Henze and co-workers (1977) for denitrification with raw municipal wastewater as a carbon source.

The denitrification rate of  $0.07 \text{ g N/gMLVSS} \cdot \text{d}$  was obtained in period II of the study. During period III, the treated leachate was characterised by low level of biodegradable organic compounds in the relation to nitrogen ( $BOD_5/N = 0.5$ ). Therefore it was unfavourable to heterotrophic denitrification. At this moment, the denitrification rate decreased 10 times to  $0.007 \text{ g N } / \text{gMLVSS} \cdot \text{d}$  and efficiency of N removal fell down.

Denitrification in secondary clarifiers is often observed during the treatment of wastewaters containing high concentration of nitrogen in activated sludge systems, and it is responsible for uncontrolled biomass removal from the systems. However, microorganisms immobilised on the bentonite carrier had very good sedimentary properties and SVI was not higher than  $55 \text{ ml/g}$  during the whole experiment. It allowed to shorten the retention time in

the secondary clarifier from 4.3 h at recycle flow ratio amounting to 100 % to 0.72 h at recycle flow ratio amounting to 540%. Thus, it prevented denitrification in the secondary clarifier starting with the recycle flow ratio amounting to 200%, corresponding to 2.1 h of retention time.

In order to provide an adequate N removal in the described system treating landfill leachate an external carbon source for denitrification should be ensured, which has already been applied (Ilies et al. 2001, Yalmaz and Öztürk 2001). For example Welander and co-workers (1998) achieved 90% of N reduction and the denitrification rate reached the value 55 g N/m<sup>3</sup> h for treatment of leachate with methanol as an external carbon source. Nevertheless, it should be mentioned that applying external carbon source such as methanol or acetic acid will entail higher operation costs. Conversely in the case of unfavourable BOD/N ratio it is justified and can be optimised. Many authors (Surmacz-Górska et al. 1997, Yalmaz and Öztürk 2001) have noticed that nitrite accumulation in the aerobic stage is not necessarily a problem, as long as the concentration does not reach a level that is toxic to nitrifiers. As a matter of fact, partial nitrification to nitrite followed by denitrification is an economically favourable process, as less oxygen (25%) is needed in the aerobic stage and less carbon source (40%) is required for the reduction of nitrites (Turk and Mavinic 1987). But from the point of view of operating control condition, a stable formation of nitrites is necessary. Moreover, extremely careful dosing of external carbon source is vital for avoiding its overdosing.

#### IV.2.5. Conclusions for AS

Bentonite proved to have beneficial long-term effect for settling properties of biomass due to change in flocs structure. Preliminary investigation confirmed that even for autotrophic sludge, which is known to be easily washed out from the systems a low SVI (67 ml/g) and complete nitrification was ensured.

Thanks to bentonite addition it was possible to shorten HRT in secondary clarifiers to 0.72 h. High recycle flow ratio from 200 up to 540 % from the secondary clarifier to the anoxic reactor replaced successfully the internal recycle flow ratio of nitrates from aerobic to anoxic reactor. And it protected the secondary clarifier against the undesirable denitrification, which is responsible for uncontrolled biomass removal from the system.

The biological process was able to remove most of biodegradable organic carbon (BOD<sub>5</sub>), together with the major fraction of COD. However it did not result in complete COD reduction from the leachate. The COD remaining in the effluent (250-500 mg/l) consisted of refractory organics, which should be removed *via* physical-chemical methods. The study of biological removal of high ammonia nitrogen concentration (300-850 mg NH<sub>4</sub><sup>+</sup>-N/l) from real

landfill leachate demonstrated the efficiency of the process and low concentration about 5 mg  $\text{NH}_4^+\text{-N/l}$  in effluent was fulfilled.

It was shown that when N-loading increased up to 0.09 g  $\text{NH}_4^+\text{-N /g MLVSS*d}$ , ammonia nitrogen had a preference for oxidising to nitrate. When ammonia concentration in raw leachate rose to maximum level amounted to 850 mg  $\text{NH}_4^+\text{-N/l}$  nitrite started to build-up in the system. At that time nitrogen loading reached a range of 0.1-13 g $\text{NH}_4^+\text{-N /g MLVSS*d}$ .

Organic matter in landfill leachate can be used as carbon source for denitrification and can allow even higher denitrification rate (0.09 g N /gMLVSS\*d) than organic compounds present in municipal wastewater (0.07 g N /g MLVSS\*d). However, organic substance amount and its biodegradability decrease in leachate with time, and then an external carbon source for denitrification is required, or other methods of nitrogen elimination should be applied.

### IV.3. Rotating biological contactors (RBC)

#### IV.3. 1 Landfill leachate treatment –nitrification in RBC

Before the start of research, the RBC system had been operating for 4 months on the landfill leachate from the municipal landfill in Gliwice (see Table 2.3 in II.3.1.3). In that period a biofilm of RBC was subjected to gradual increasing ammonia concentration from 180 to about 800 mg/l in influent. It corresponded to the increase of ammonia loading rate from 1.54 - 8.73 g  $\text{NH}_4^+/\text{m}^2*\text{d}$ .

The acclimation was successful and resulted in almost complete ammonia oxidation (95% on average) (Fig. 4.8).

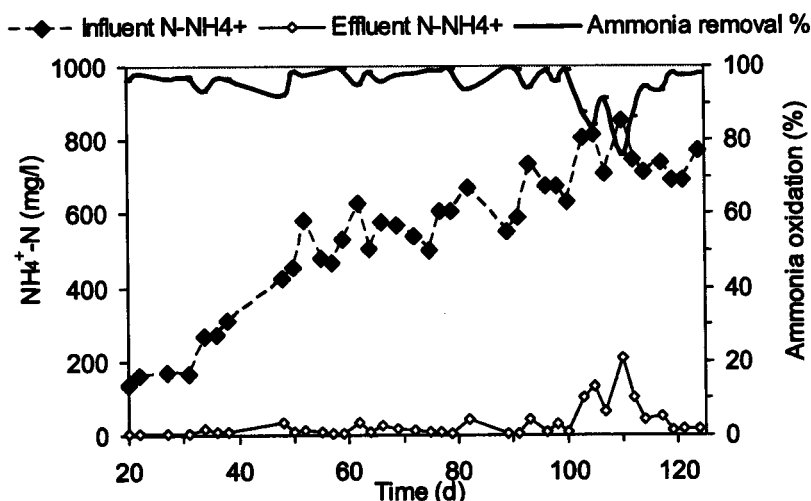

Figure 4.8 Ammonia concentrations in influent and effluent from RBC and percentage of ammonia removal in the system

As reviewed in section II.3.1, leachate used in the present studies as a feed for RBC corresponded to stabilised leachate with low biodegradability BOD<sub>5</sub>/COD ratio amounted to 0.2. Biological pre-treated leachate in activated sludge reactor contained: ammonia concentration levelling on average 790 mg NH<sub>4</sub>-N/l, nitrite 15 mg NO<sub>2</sub><sup>-</sup>-N/l and nitrate 70 mg NO<sub>3</sub><sup>-</sup>-N/l.

At the beginning of the study (up to 20 d) more than 90% of ammonia was nitrified in the system (Fig. 4.9), and the main form which appeared in effluent was the nitrate (Fig. 4.10). Then, the nitrite amount stayed at the low level of 8.0 mg NO<sub>2</sub><sup>-</sup>-N/l. This situation indicated that both species of nitrifying bacteria *Nitrosomonas* and *Nitrobacter* responsible for two steps of ammonia oxidation were active and acclimated to the feed.

During the next few days, the ammonia loading rate rapidly increased which corresponded to increase of ammonia in influent to 950 NH<sub>4</sub>-N/m<sup>2</sup>. At the same time, a new stream of organic carbon started to be introduced into the third chamber of RBC (Figure 2.10) in order to provide denitrification. Consequently, from that moment the first VI discs of RBC were considered as a "nitrification zone" and the following ones (from VII to XII) as a "denitrification zone"

It was observed that an increase of ammonia loading affected the second stage of nitrification (oxidation NO<sub>2</sub><sup>-</sup> ⇒ NO<sub>3</sub><sup>-</sup>) and with decrease of nitrate concentration a build-up of the nitrite appeared. Nevertheless, ammonia oxidation was still at a high level. The soaring inhibition of ammonia oxidation observed in 118 and 146 d could be correlated with two peaks of nitrogen loading rate amounting to 10.0 and 11.0 g N/m<sup>2</sup>\*d respectively (Fig. 4.9).

In that moment, maximal ammonia quantity of 185 and 176 mg/l appeared in effluent of RBC.

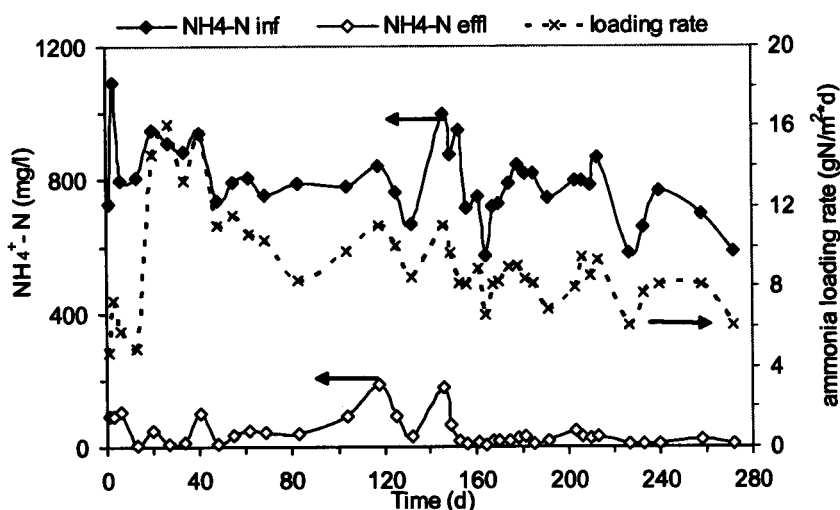

Figure 4.9 Ammonia concentrations in influent and effluent from RBC and ammonia loading rate

Next, (above 160 d) the process was stabilised. N loading rate amounted to about 8.0 g N/m<sup>2</sup>\*d. Ammonia in the treated leachate was at a stable low level, not exceeding concentration of 15 mg/l within that last part of study. The ammonia oxidation rate varied in this period from 6.0 to 8.6 g NH<sub>4</sub><sup>+</sup>-N /m<sup>2</sup> \*d (7.5 g NH<sub>4</sub><sup>+</sup>-N /m<sup>2</sup> \*d on average)

After 40 days of operation, the nitrite and nitrate concentrations fluctuated simultaneously in the broad range 0.1 to 300 mg/l, and its current quantity strictly related to the efficiency of denitrification process (Fig. 4.10).

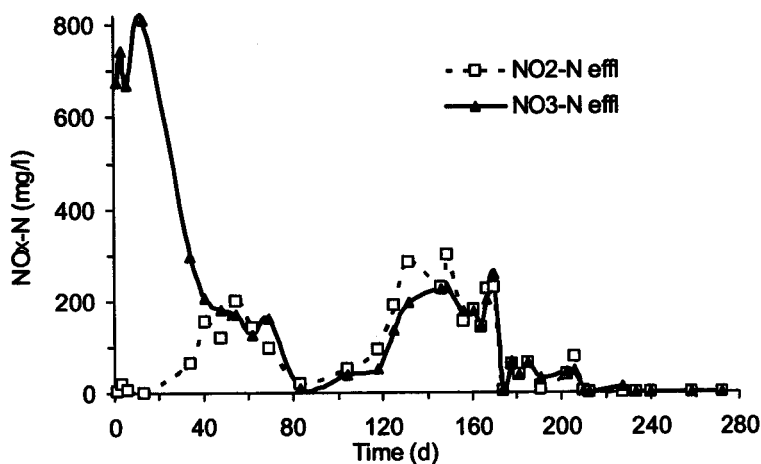

Figure 4.10 Nitrite and nitrate concentration in effluent from RBC

One of the parameters governing the efficiency of biological treatment in RBC consisted in the disc rotation speed control. The disc rotation speed was adjusted in order to ensure an appropriate condition of treatment in subsequent stages, i.e. aerobic in nitrification zone and anoxic in denitrification zone. Before starting dosing an external carbon source into chamber III (up to 20 d), the dissolved oxygen (DO) contents was as follows: 1.5, 2.5 and 3.0 mgO<sub>2</sub>/l for Chamber I, II and III respectively. From the standpoint of nitrification requirements, DO concentrations were along the whole RBC. It could be observed that DO consent corresponded to the rate of decreasing substrate loading (COD and/or NH<sub>4</sub>-N) in different chambers, i.e. the highest DO concentrations were associated with the lowest substrates loading.

After the acclimation phase to the acetic acid, above 160 operating days, the rotation speed was decreased somewhat. Consequently, the DO maintained at the level of 1.0 mg O<sub>2</sub>/l in the chamber I, 0.3 mg O<sub>2</sub>/l at chamber II and 0.1 at chamber III. The sharp oxygen depletion in chamber II and III corresponded to the loading of COD of acetic acids. These conditions were conducive to denitrification proceeding in the system.



## IV.3.2 Landfill leachate treatment –denitrification and COD removal in RBC

In the course of the study of the landfill leachate, the biodegradability of organics present in leachate was at very low level. Subsequently, it was assumed that the biodegradable fraction of organics from the leachate was removed in the first stage of treatment within VI (nitrification zone). The efficiency of COD reduction assessed in that manner levelled at 23 % in average. An average of COD remaining after VI disc was 550 mg/l and this value was considered as refractory organics which could not be reduced via biological methods. It became clear that leachate would not be used as an organic carbon source for efficient denitrification in that case. Thus, nitrogen removal was performed in post-denitrification mode (occurring mainly in III chamber) by using a supplementary biodegradable organics.

Figure 4.11 demonstrates that the effectiveness of nitrogen removal depended on the bCOD/N ratio, i.e. the correlation between the amounts of readily biodegradable organics (from acetic acid) and nitrogen forms (nitrite, nitrate and ammonia) in the provided leachate (Equation 2.23 in section II. 3.1.5).

When the bCOD/N ratio increased from 0.64 to 3.2 within the first 70 days of operation the N removal rose from 10 to 30%. Further increase of this ratio up to 4.0 brought about improvement in N reduction to about 82%. As a result,  $\text{NO}_x$  concentrations significantly decreased in effluent of RBC (Fig. 4.10).

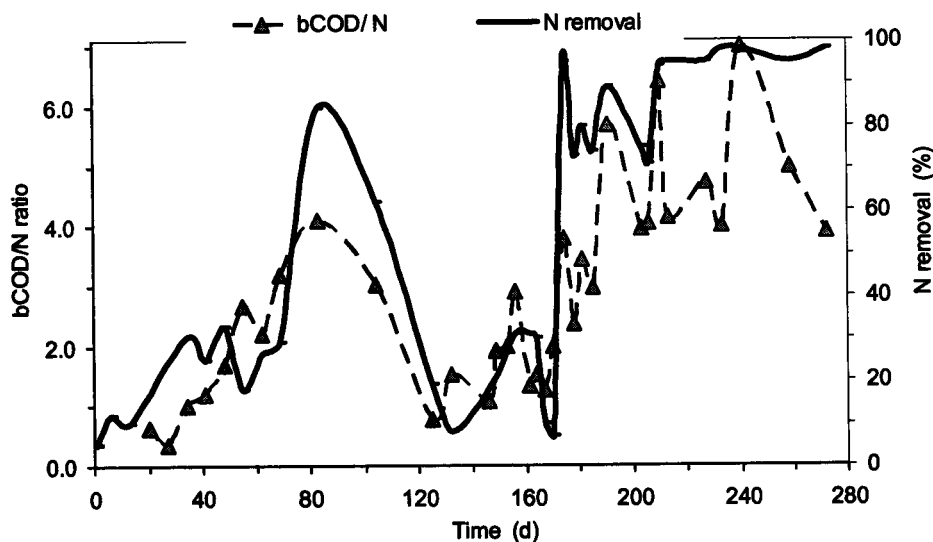

Figure 4.11 Percentage of N removal and bCOD/N ratio (biodegradable COD from  $\text{CH}_3\text{COOH}$ / nitrite, nitrate and ammonia in influent) versus operating days

Generally, it could be noticed that an increase of bCOD/N ratio was accompanied by an increase of N reduction and on contrary with the decrease bCOD/N ratio the amount of N reduction decreased in the system. It proved that acclimation of biofilm occurred successfully.

In the last phase of the study, after 210 to 272 operating days a stable nitrogen abatement reaching of 96 % on average (95-98%) was obtained. bCOD/N ratio then ranged 3.9 to 7.0. Consequently, the lowest average ammonia, nitrite and nitrate level amounting to 0.3 and 2.9 mg N/l concentration were respectively detected in effluent.

It was calculated (Equation 2.20 in section II. 3.15) that bCOD decay in the system was at the level of 90% on average. It indicated that about 10% of external carbon provided into chamber III was not metabolised by microorganisms. It brought about deterioration in quality of treated leachate with respect to organics in the effluent.

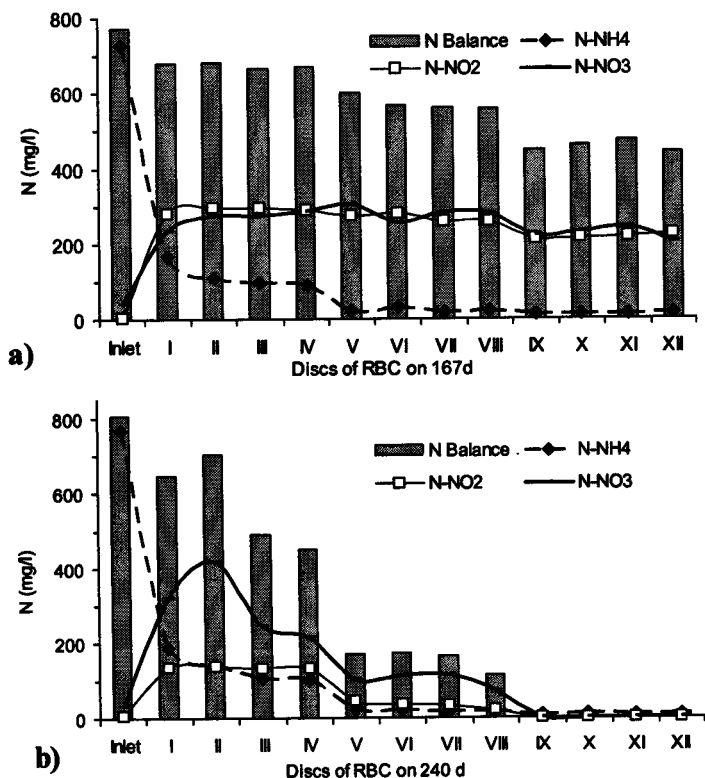

Figure 4.12 Profile of RBC at a) 167 operating day, bCOD/N= 2.9 and b) 240 operating day, bCOD/N= 7.0

From the point of view of denitrification performance an inserted supplementary organic carbon has to be controlled. An appropriated amount of bCOD should be dosed on the basis of  $\text{NO}_x$  loading rate of denitrification zone. As stated above, it was assumed that the denitrification zone starts at VII disc, but in fact,  $\text{NO}_x$  started to disappear at the beginning of chamber II (i.e. IV and V disc). This phenomenon is illustrated on Figure 4.12. Simultaneously, with nitrification process characterized by a decrease of ammonia content from 105 to 20 mg/l and denitrification occurred by decrease of  $\text{NO}_x$ -N from 346 to 95 mg/l (Fig. 4.12b). Moreover, it was conceivable that in chamber II dilution of nitrogen concentration occurred. It was due to the “backwater” of acetic acid stream from chamber III.

Taking into account these difficulties of reliability in determination of  $\text{NO}_x$  loading in

plug-flow reactor it was calculated as bCOD/N ratio instead of bCOD/N-NO<sub>x</sub> ratio. Additionally, the dilution of N forms in the system due to acetic acid stream was considered.

### IV.3.3 Biofilm characterization

The visual observation of the RBCs system confirmed that attached biofilm was developing successfully on the RBC discs being in contact with the treated medium. Moreover, some diversity in respect to appearance as well as bacterial culture was observed.

A thinner, uniform, brown biofilm layer developed on the discs in the first stage of RBC, nitrification zone (from I to VI discs) (Fig. 2.10a in section II.3.1.3). Additionally, a thickness of biofilm layer decreased along with direction of leachate flow in that zone.

In denitrification zone, particularly in chamber III (where external carbon source was inserted) the disc surfaces were completely covered with a white- pink and fluffy biofilm (Fig. 2.10b in section II.3.1.3). Such biological growth noticeably reached disc VI of chamber II. Moreover, bubbles of presumably nitrogen gas appeared in that zone.

The microbial analysis of denitrifying bacteria in both biofilms (API method) revealed the disparity as well. In the seed taken from disc I (nitrification zone) *Plesiomonas shigelloides* bacteria titer amounting to  $10^4$  was identified. In the biofilm responsible for denitrification, fed with acetic acid, the following denitrifying bacteria strains have been identified: *Plesiomonas shigelloides*, *Aeromonas sobria* and *Pseudomonas alcaligenes*. The titer of the bacteria determined in the seed from disc X levelled to  $10^{10}$ .

The results confirm the presence of *Pseudomonas* classically considered as a predominating species responsible for denitrification of wastewater in WWTPs. It is also in agreement with the results of Mohseni-Bandpi and Elliott (1998) who found *Pseudomonas stutzeri* as a representative of *Pseudomonas* species in biofilm of RBC feed by acetic acid.

### IV.3.4 Discussion for RBC

Nitrifiers grow slowly, and additionally, they are sensitive to environmental changes (pH, temperature, toxic and inhibitory compounds, etc.) (Verstraete and Vaerenbergh 1986, Henze 2001).

Therefore, the hydraulic retention time (HRT) of a biological nitrogen removal plant should be designed sufficiently long in order to secure the nitrification process. In the studied case in nitrification zone, HRT ranged 1.0 to 2.0 d (1.3 d in average), which corresponded to the fluctuation of ammonia loading from 16.0 to 6.0 gN/m<sup>2</sup>\*d. However, in the RBC with inserted denitrification stage a stable ammonia oxidation of more than 96% was obtained after 160 of operating days. Then, an average loading rate and HRT were 8.0 gN/m<sup>2</sup>\*d (21.8 gN/m<sup>3</sup>\*h) and 1.14 d respectively.

The volumetric nitrification rate achieved the average value of 20.5 g NH<sub>4</sub><sup>+</sup>-N /m<sup>3</sup>\*h and it was twice higher than observed in the studies on activated sludge system (see section

IV.2.4). It should be noted that RBC operating in that condition was not stable in producing nitrate as a final product of nitrification ( $\text{NH}_4^+ \Rightarrow \text{NO}_3^-$ ) as nitrite was also present. The nitrite concentration was usually at the same level as nitrate.

Apparently complete nitrification process was hampered by higher ammonia loading rate bringing about free ammonia (FA) toxicity generation in the reactor. According to Anthonisen and co-workers (1976) the concentration of FA that started to inhibit *Nitrosomonas* and *Nitrobacter* were 0.1-1.0 and 10-150 mg/l respectively. However, it has been reported that nitrifiers can acclimate to higher concentration of FA (Turk and Mavinic 1989, Gupta and Sharma 1996).

The previous study on activated sludge system (section IV.2.4.) demonstrated that microorganisms can be successfully adopted to treat FA concentration amounting to 1.1 mg/l without accumulation of  $\text{NO}_2^-$  (i.e. inhibition of *Nitrosomonas*).

RBC proceeded in plug-flow mode, thus a substrate loading decreased by stages within the flow of leachate. Hence, the most strongly loaded with ammonia was chamber I and the highest free ammonia concentrations were expected there. For instance, at day 167 and 240 (pH 8.5) the FA rose to the value of 18 mg  $\text{NH}_3\text{-N/l}$  on average (12-24 mg  $\text{NH}_3\text{-N}$  within first three discs). In spite of the fact that the free ammonia concentration reached its inhibiting level of 10-150 mg  $\text{NH}_3\text{/l}$  (Anthonisen et al. 1976) for *Nitrosomonas*, the ammonia oxidation was still levelling at 97 %. The increase of nitrate concentration in RBC suggested that the second stage of nitrification was partially hampered (Fig. 4.10). Nevertheless, it can be deduced that along with acclimation time, the biofilm population of *Nitrobacter* becomes more resistant to FA toxicity. For instance Helmer and Kunst (1998) obtained efficient ammonia conversion at maximal free ammonia concentration amounted to 27 mg  $\text{NH}_3\text{-N/l}$  without a build-up of nitrate in the RBC system. All of this confirmed a general assertion that attached microorganisms are less susceptible to antimicrobial agents than activated sludge system (Martienssen 2000). In the studied case, it was suggested that partial accumulation of nitrite after a long period of acclimation (above 160 d) would be attributed to the DO content. During this period DO concentration dropped in nitrification zone below 1.0 mg/l on average influencing the II step of nitrification. The nitrite occurrence can be advantageous from the point of view of biological denitrification and it will be discussed later.

It was noticed that in chamber I (discs I, II and III) about 100 mg/l of nitrogen has already been removed Fig. 4.11. It would only be partially attributed to the heterotrophic growth (assimilation into the growing cell) yielding N reduction with respect to the "rule of thumb" to assure adequate nutrient mass ratio 100:5:1 (BOD:N:P) in aerobic conditions (Eckenfelder and Musterman 1995). Nevertheless, it could not be a single pathway of N reduction in the chamber I. It was speculated that the loss of nitrogen was due to Anammox (Graaf et al. 1996) and/or simultaneous nitrification/denitrification. Both processes have

already been reported to occur during the treatment of landfill leachate in RBC system (Seigrist et al. 1998, Helmer and Kunst 1998).

According to the conventional engineering approach, simultaneous nitrification/denitrification (SN/D) within biofilms can occur only under the following conditions: (i) nitrifiers and denitrifiers must be present in the biofilm and (ii) suitable growth conditions for each of the responsible strains of bacteria must be created somewhere in the biofilm, i.e. oxic and anoxic microzone (Watanabe et al. 1995). Helmer and Kunst (1998) found that inorganic nitrogen decreases by 83% in the nitrification stage during the treatment of leachate containing low COD/N ratio equalling to 2. The authors suggested that nitrogen loss could not be explained by the traditional (heterotrophic) denitrification. They pointed out that it was due to the activity of autotrophic bacteria such as *Nitrosomonas* strains which are able to denitrify (use nitrite as an electron acceptor) in the conditions of limited oxygen concentration. Furthermore, Seigrist and co-workers (1998) supported a hypothesis of autotrophic denitrification allowing for nitrogen removal ranging 27 to 68%. The anammox process (anaerobic ammonia oxidation) in RBC system consists in denitrification into the anoxic biofilm layer of nitrite formed into aerobic biofilm layer with ammonia as an electron donor.

Some conditions were conducive to anammox occurrence in chamber I after 160 d of study, namely: (i) low oxygen concentration (ii) presence of nitrite and ammonia, (iii) long period of system operating, (iv) low content of biodegradable organics ( $BOD_5$ ). Even if the Anammox process occurred in RBC, it was assumed that it contributed insignificantly to the overall nitrogen removal (maximum in 10%).

Because essentially all of the bio-degradable carbonaceous substrate from the leachate was removed in nitrification zone of RBC, the solution of acetic acid was added into chamber III as the carbon source in order to ensure denitrification occurrence.

Figure 4.11b gives nitrogen balance as well as concentration of N forms across the RBC, while heterotrophic biofilm was successfully developed, and noticeably settled in the so-called "denitrification zone" (from disc VII to XII). Nevertheless, the results indicated that "denitrification zone" shifted to up disc IV. In consequence, chamber II would be considered as a "transitional zone" between nitrification and denitrification process in which ammonia oxidation and  $NO_x$  reduction could occur simultaneously. The nitrification occurred most likely in the outer side of the microbial films, which acted aerobically, and the denitrification occurred in the inner, side wherever anoxic zones were created. It is believed that the environmental conditions in this chamber meet growth requirements for nitrifiers, denitrifiers, and other heterotrophs and could coexist throughout the biofilm. Additionally, a reason for the high decrease of N concentration forms in chamber II could also be brought about dilution by the "backwater" of acetic acid stream from chamber III. The HRT in denitrification zone was almost twice lower than in nitrification zone and amounted to 0.7 d on average.

The phenomenon of simultaneous nitrification/denitrification in RBC system was reported by Bang and co-workers (1995). They found that the process occurred in the fully aerobic biofilm system treating the wastewaters containing PVA and demonstrated that nitrogen losses (denitrification) were observed even under high dissolved oxygen concentration of above 3 mg/l. However, such a high level of oxygen brings about the increase of organic carbon needed for complete denitrification because of the supplementary consumption of substrate due to aerobic oxidation. For instance, Watanabe and co-workers (1995) pointed out that the overall CPFS RBC (Combined Partially and Fully Submerged RBC) required lower C/N ratio for nitrogen removal than the partially submerged RBC alone because of the specialization of the biofilm for nitrification and denitrification. Another feature is that an excess in carbon results in oxygen limitation, which leads to a failure of the nitrification.

The success of the denitrification depended on providing an adequate carbon source and quantity for the denitrifying organism (Spengel and Dzombak 1991). The effect of different carbon source such as methanol, ethanol and acetic acid on denitrification in RBC system has been tested by Mohseni-Bandpi and co-workers (1998). They reported that acetic acid was a more readily metabolised carbon source than methanol or ethanol and gave the highest efficiency of  $\text{NO}_3^-$  reduction from groundwater. It confirmed the suitability of the selected carbon source in the present tests for landfill leachate.

Furthermore, the removal of nitrogen depends on the bio-availability of COD (organic carbon) to the nitrogen ratio and it was shown in *section IV.2.3* that an unfavourable ratio in the leachate limited the nitrogen removal efficiency of activated sludge system. Chiu and Chung (2003) noticed that even similar biological systems may have different optimal C/N ratios if used to treat the various wastewaters under distinct environmental conditions. Therefore, the optimal C/N ratio for a biological denitrification system for treating a specific wastewater under special conditions must be determined experimentally.

Table 4.1 summarize C/N ratios determined for different systems during nitrogen removal and applying acetate or acetic acid as carbon source.

Table 4.1 Comparison of reported C/N ratios

Wastewater and C source	Methodology	% of N removal	C/N ratio	Author and year
Municipal wastewater $\text{CH}_3\text{COOH}$	MWWTP	Opt.	2.9-3.5 gCOD/gN 3.1-3.7 gSubstrate/gN	Henze et al. 2001
Sludge reject water $\text{NH}_4^+ \text{-N}$ (244 mg/l) $\text{CH}_3\text{COOH}$	Lab scale, Membrane – assisted bioreactor	90	4.1 gCOD/gN	Ghyoot et al.1999).
Synthetic feed simulating groundwater solution $\text{NO}_3^- \text{-N}$ (40-130mg/l) $\text{CH}_3\text{COOH}$	Pilot plant RBC completely submerging	99	4.6 gCOD/g $\text{NO}_3^- \text{-N}$ 4.3 gSubstrat/g $\text{NO}_3^- \text{-N}$	Mohseni-Bandpi et al. 1999
Synthetic wastewater $\text{NH}_4^+ \text{-N}$ (25-100 mg/l) $\text{CH}_3\text{COONa}$	Lab scale Combined Partially and Fully Submerged RBC, simultaneous nitrification/denitrification	90	8.0 g COD/g $\text{NO}_3^- \text{-N}$ 3.0 gC/gN	Watanabe et al. 1995
Synthetic wastewater $\text{NH}_4^+ \text{-N}$ (27.5 mg/l) $\text{CH}_3\text{COONa} \cdot 3\text{H}_2\text{O}$	Lab scale, RBC simultaneous nitrification/denitrification	44-64	9.1 gCOD/gN	Gupta and Gupta, 1999
Landfill leachate $\text{NO}_3^- \text{-N}$ (400-600mg/l) $\text{Ca}(\text{CH}_3\text{COO})_2$	Lab scale SBR , activated sludge	90	5.9 gCOD/g $\text{NO}_3^- \text{-N}$	Yalmaz, and Öztürk 2001
Synthetic feed $\text{NO}_3^- \text{-N}$ (50-200 mg/l) $\text{CH}_3\text{COONa}$	Activated sludge bench-scale reactor	Opt	2.6-5.5 gCOD/g $\text{NO}_3^- \text{-N}$	Chiu and Chung 2003
Landfill leachate N (600-900 mg/l) $\text{CH}_3\text{COOH}$	Lab scale, RBC nitrification and post-denitrification	>95	4-5 gCOD/gN	Present studies

Opt. - the optimal C/N ration ensuring max conversion of all N to  $\text{N}_2$

According to Hanaki and co-workers (1992) the C/N ratio within denitrification strongly affects the production of  $\text{N}_2\text{O}$  and  $\text{N}_2$  gas. Namely, higher carbon content in the influent is more conducive to production of inert nitrogen gas ( $\text{N}_2$ ) than to conversion into nitrous oxide. Bearing in mind that  $\text{N}_2\text{O}$  is one of the gases responsible for the greenhouse effect (Czepiel et al. 1996) the content of these denitrification products should be minimized. It is one of the features which should be taken in to account in future works.

In the present studies, the incorporation of denitrification unit as a post-denitrification mode in partially submerged RBC system was successful. It was assumed that the N reduction exceeding 95% in RBC allows to decrease nitrogen concentration in effluent to meet discharge requirements. This was fulfilled for bCOD/N ratio ranging from 4.0 to 5.0 (Fig. 4.13).

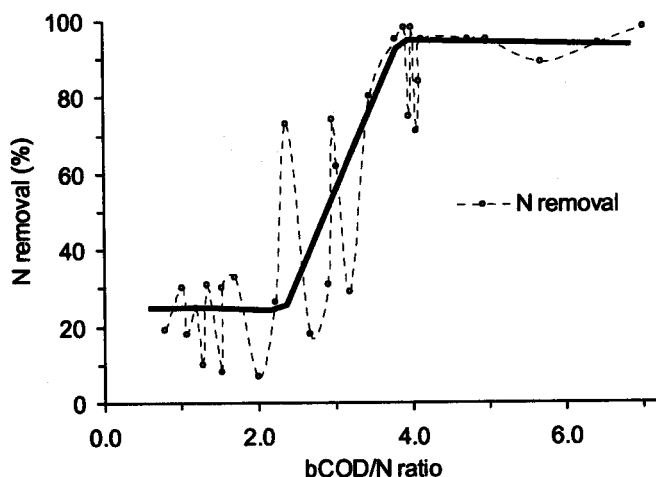

Figure 4.13 Relationship between nitrogen removal efficiency and bCOD/N ratio

However, overdosing in external carbon above the optimal bCOD/N ratio led to the increase of organic remaining in treated leachate. Consequently, an additional purification would be needed, which raises the cost of operating technology.

In the present studies, the nitrate build-up observed in the investigated system (Fig. 4.10) was not a drawback in respect to the overall cost reduction of nitrogen removal. Several authors (Turk and Mavinic 1987, Balmelle et al. 1992, Surmacz-Gorska et al. 1997, Schmidt et al. 2003) took note of the possibility of shortening nitrogen removal by means of partial nitrification (by inhibiting of activity and growth of *Nitobacter*) (see section I.2.1.4) and denitrification of nitrite to free nitrogen ( $N_2$ ). Consequently, it brings about reduction of energy consumption for oxygenation as well as carbon requirement for denitrification. For instance, Ghyoot and co-workers (1999) obtained lower C/N ratio using so-called “nitrite route” of denitrification (Table 4.11).

The optimal bCOD/N ratio determined in the present investigation was consistent with results achieved by Mohseni-Bandpi and co-workers (1999) (see Table 4.11) using completely submerged RBC system.

It suggests that readily biodegradable organic matter supplied into the system was efficiently used for denitrification process. This beneficial bCOD/N ratio may be explained as follows: i) low concentration of DO in denitrification zone, which reduced a competition from other heterotrophs (able to use  $O_2$  as an electron acceptor only), ii) discs area in denitrification zone was preferentially colonized by denitrifiers metabolized  $CH_3COOH$  as a carbon source, iii) denitrification via nitrite and nitrate (partially “nitrite route”)



### IV.3.5 Conclusions for RBC

The installation for landfill treatment must be characterized by reliability, simplicity in maintenance and low costs of operating. These requirements are fulfilled by the rotating biological contactors (RBC).

Rotating biological contactors proved to be a very effective treatment technology with high ammonia content. It was possible to find optimal trade-offs between different requirements for nitrification and denitrification using RBC. The ammonia concentrations at the level of 800 mg/l were successfully removed from nitrification zone of RBC. Due to a shortage of biodegradable organic in the stabilised leachate ( $BOD_5/N$  equalled to 0.2- in the case of LL in Gliwice) the acetic acid was applied as an external carbon source needed for biological denitrification.

The studies showed that the denitrification by nitrite and nitrate allowed to decrease organic requisite added into the denitrification zone in comparison to the denitrification via nitrate only. The optimal acetic acid expressed as  $bCOD/N$  was 4.0-5.0. It permitted to achieve nitrogen reduction of 95% and to minimise the excess acetic acid in effluent of RBC. Additionally, denitrification by "nitrite route" might decrease the cost of overall treatment process even more.

Microbial analysis of biofilm from denitrification zone confirmed the presence of *Pseudomonas alcaligenes* species considered as classic representative of denitrifiers. The COD remaining in the effluent (on average was 540 mg/l) consisted of bio-refractory organics and the minor quantity of biodegradable organic resulting from unused acetic acid. The analysis of RBC effluent indicated that nitrogen abatement in the system would meet the regulatory authority standards for direct discharge, but application of additional physico-chemical treatment seems to be important as a subsequent polishing step of effluent quality, ensuring lower effluent COD concentrations.

## IV.4 Conclusions-biological treatment of LL by RBC and AS

For mature landfill leachate or a mixture of young and mature leachate (case of LL in Swietochowice) containing relatively high COD/N ratio ( $BOD_5/N = 4.1$ ) it is useful to design pre-denitrification biological system. The main advantages of such solution consist in using of organics contaminates as a carbon source for biological reduction of N. It was shown that an adopted activated sludge system with pre-denitrification revealed a high performance in nitrogen removal reaching 80% and its efficiency was very close to meet discharge requirement for nitrogen forms. By contrast, when  $BOD_5/N$  ratio amounted to 0.5 the denitrification rate decreased dramatically. That is why at this moment the 12% N removal could be mainly ascribed to the N conversion into cell tissue of bacteria mainly.

For the stabilised landfill leachate in Gliwice the heterotrophic denitrification as a unit process in aerobic rotating biological contactor was successfully incorporated. By using optimal dose of external carbon source, a 95% of N was reached, thus meeting the regulatory standards for direct discharge into the environment.

The adopted microbial population resided in both systems (AS and RBC) and demonstrated its effectiveness in ammonia oxidation. Moreover, the systems seemed to be more resistant than conventional suspended microorganisms to environmental conditions e.g. free ammonia toxicity or other antimicrobial agents such as heavy metals, PAHs, PCB, AOX frequently detected in landfill effluents.

Both tested systems were successful in removing nitrogen species (by means of nitrification/denitrification) and a large fraction of the soluble organic matter from the leachate. However, a significant amount of non-degradable COD still remained after biological treatment. A large part of these organics consisted of humic and fulvic acids which were also responsible for the specific yellow-brown colour of the leachate.

Obviously, the removal of the residual COD fraction by physic-chemical methods would be needed in order to meet discharged standards. Basing on the experiences on photocatalytic oxidation of model humic acids (*see Chapter III*) we proposed a photocatalytic stage as an appropriate method for removal of bio-recalcitrant organic compounds from landfill leachate.

# **CHAPTER V**

---

---

*STUDY OF COMBINED BIOLOGICAL AND  
PHOTOCATALYTIC SYSTEM  
FOR  
TREATMENT OF LANDFILL LEACHATE*

---

---

---

## V.1 INTRODUCTION

The discharge of landfill leachate can lead to serious environmental problems, since the leachate contains a large amount of organic matter (both biodegradable and non-biodegradable carbon), ammonia-nitrogen, heavy metals, chlorinated organic and inorganic salts. Many researchers (Chian, 1977, Christensen et al. 1996, Jensen and Christensen 1999), Kang et al. 2002) indicate that humic-type substances (refractory compounds) in particular from the “old landfill” constitute an important group of leachate organic matter.

As it has been reviewed in *Chapter I*, the processes for landfill leachate treatment used today are often *combined techniques*. They are designed as modular or multistage units skilled in the treatment of contaminants, which vary in leachate concentration over the years. Frequently, the first step of plants is a biological process for ammonia, COD and BOD<sub>5</sub> removal.

There are very few papers reporting photocatalytic treatment (using TiO<sub>2</sub>) of organic components from landfill leachates (Bekbolet et al. 1996, Cho et al. 2002B, 2004) even at laboratory scale. Previously (*see Chapter III*), the feasibility of photocatalysis at laboratory as well as at pilot scale for degradation of commercial humic substances from water was proved. Thus, those promising research showed the feasibility of photocatalysis to remove the bio-recalcitrant organic fraction, such as humic substances present in the landfill leachate.

On the other hand, in *Chapter IV* the efficiency of two biological techniques (activated sludge and rotating biological contactors) applied for landfill leachate pre-treatment has been demonstrated. The results confirmed the possibility of effective decay of biodegradable fraction of organics as well as the total oxidation of high ammonia nitrogen. The same results showed the limitation of common biological processes with respect to bio-recalcitrant organic fraction.

The Advanced Oxidation Processes (AOPs) is a very promising method for remediation of such contaminants. However, the operational cost of these processes applied alone is very high. A significant decrease of overall leachate treatment cost could be obtained by using AOPs as a pre-treatment stage to enhance biodegradability of bio-recalcitrant organic, followed by biological oxidation. Recently, a first successful installation of combined biological and solar photocatalytical process (photo-Fenton) for model biorecalcitrant compound, (5-amino-6-methyl-2-benzimidazolone) at pilot plant in Spain (PSA) was reported by Pulgarin's group from Swiss Federal Institute of Technology (Sarria et al. 2003).

The objectives of this chapter are: i) to explore the feasibility of the photocatalytic (UV/TiO<sub>2</sub>) degradation method for the oxidation of bio-refractory organics remaining in the leachate after biological pre-treatment, ii) to study the accessibility for microbial oxidation of the photocatalytic degradation products formed from refractory compounds in treated leachate.

## V.2. Photocatalytic treatment of biologically pre-treated landfill leachate (France)

During the experimental period the easy biodegradable organic fraction of raw leachate from the landfill of Tétang (France) was at a relatively high level, which was reflected in BOD<sub>5</sub>/COD ratio amounting to 0.4 (Table 2.6 in section II.4.2.1). Consequently, the biological treatment allowed to remove nearly the totally of BOD<sub>5</sub> fraction ensuring its low concentration in effluent amounting to 10-20 mgO<sub>2</sub>/l. The BOD<sub>5</sub>/COD ratio decreased to 0.02 in biologically treated landfill leachate (LL). The COD elimination was also significant and levelled at 63% (on average).

In the same conditions, ammonia oxidation was achieved in the system 80 % (on average) from the initial concentration in influent amounting to 320 mg NH<sub>4</sub><sup>+</sup>-N/l (on average). As a result, their oxidized forms (nitrite and nitrate) appeared in effluent of biological reactor. Moreover, it can be observed that the nitrate concentrations were much higher than nitrite ones (Table 2.6 in section II.4.2.1).

It is apparent that the biological method did not result in complete COD or specific colour reduction from the leachate. The COD remaining in the effluent (450-820 mg/l) of solution consisted of refractory organics, which was subjected to the photocatalytic oxidation.

### V.2.1 The effect of pH on photocatalytic oxidation of landfill leachate

The photocatalytic degradations of biologically pre-treated LL adjusted to three different initial pH values are shown in Figure 5.1, as the decrease of normalised absorbance (Abs/Abs<sub>0</sub>) at 254 and 400 nm with reaction time. The pH value was chosen on the basis the preliminary results on model humic acids (*see Chapter III*).

In the present case, the experiments were performed on LL containing 210 mg/l of refractory COD. In the given experiments a catalyst concentration amounting to 1.0 gTiO<sub>2</sub>/l was applied.

It was demonstrated that photocatalytic degradation expressed as absorbance at 254 nm (UV<sub>254</sub>) is higher in acidic pH (pH=3.5), than in pH 7.8 and alkaline pH equal to 10.5. Consequently, the process allowed to remove 80 %, 42% and 31% of organics with respect to UV<sub>254</sub> absorbance after 16 hours of reaction (Fig. 5.1a). Colour decay was also strongly favoured in acidic medium and its almost complete removal was achieved at the end of irradiation. A very similar kinetic of colour removal was observed at pH 7.8 and pH 10.5 (Fig. 5.1b), but still about 20 % of UV<sub>400</sub> remained in the solution.

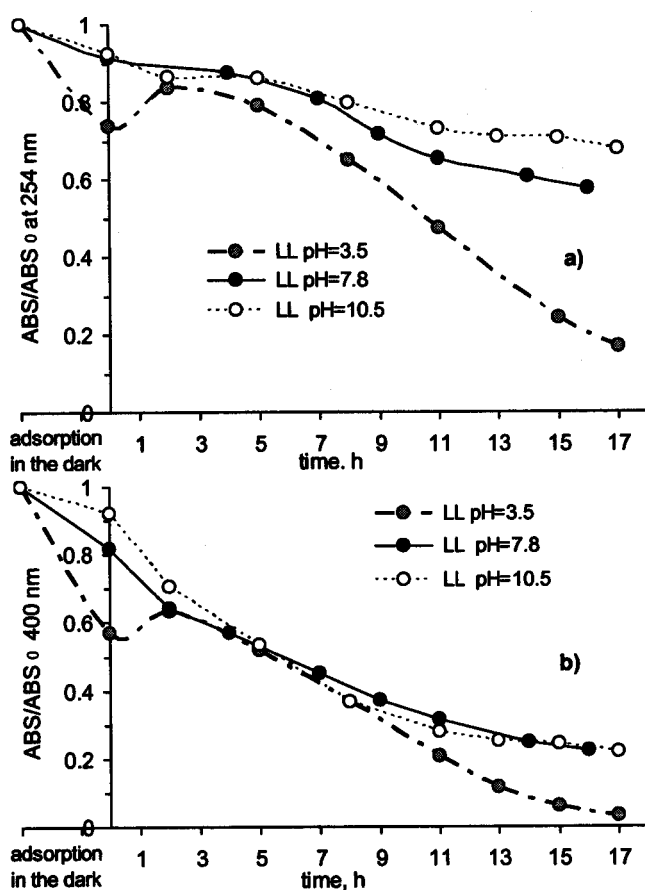

Figure 5.1 Effect of pH on photocatalytic degradation of landfill leachate amounting to COD= 210 mgO<sub>2</sub>/l, determined by a) normalised absorption at 254 nm and b) normalised adsorption at 400 nm (colour) evolutions

Another important feature of acidification is that at certain pH the humic substance starts to precipitate. The formation of a brownish gel in stabilised, acidified leachate to pH 3.2 was reported by Rivas and co-workers (2003). As a consequence, the authors noticed a rapid decrease of COD (dissolved organics) and absorbance in the solution. In the present study, it was suggested that this precipitated organics fraction (HAs) were also removed from the reacting mixture. First, after removal of the HAs preliminary adsorbed onto the catalyst, the HAs conglomerates were partially dissolved and re-adsorbed onto catalyst surface. Consequently, photocatalytic oxidation reaction could successfully proceed. This hypothesis is reasonable because within irradiation time a decolouration of overall solution mixture was observed without a visible brownish gel. Moreover, the eventual decrease of dissolved organics content due to the sample acidification was taken into account in the proposed procedure.

It can be expected that, at low pH ( $\text{pH} < \text{pH}_{\text{zpc}}$  of TiO<sub>2</sub>) the complex inorganic matrix of LL, i.e. inorganic anions (Cl<sup>-</sup>, SO<sub>4</sub><sup>2-</sup>, NO<sub>3</sub><sup>-</sup>, HPO<sub>4</sub><sup>2-</sup> and others) will be preferentially adsorbed on positively charged TiO<sub>2</sub> surface. As a result, photocatalytic reactivity can be decreased by these species due to the hindering of active site on TiO<sub>2</sub> and preventing the substrate adsorption. This phenomenon has already been studied with the example of chloride (*see*

III.2.2.4). On the other hand, it is evident that in acidic medium the initial adsorption of organics as well as adsorption of intermediate products are enhanced (Fig. 5.1). Subsequently, photocatalysis is improved due to the higher probability of the reaction between photogenerated active species ( $h^+$ ,  $^{\circ}\text{OH}$ ) and the molecules adsorbed on the catalyst surface.

Therefore, another important factor lowering reactivity in neutral or basic medium must exist. Thus, the decrease of degradation efficiency of organic in LL can be mainly attributed to the presence of inorganic carbon. The following carbonate equilibrium (Equation 5.1) can be given:

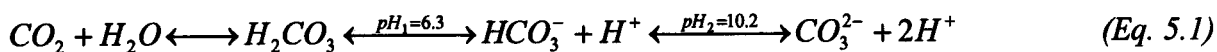

It can be expected that below pH 6.3,  $\text{H}_2\text{CO}_3$  is efficiently converted into carbon dioxide, which can be easily removed from the reacting mixture to air by simple volatilization. By contrast, the inorganic carbon remaining in the solution between  $6.3 < \text{pH} < 10.2$  is mainly present in the form of  $\text{HCO}_3^-$  and above pH 10.2 as  $\text{CO}_3^{2-}$  anion.

Moreover, Cho and co-workers (2002B) suggest that the inhibition of photocatalytic reaction in basic medium (pH 10) is due to the increase of inorganic carbons from the mineralization of organics ( $\text{organic} \rightarrow \text{CO}_2 + \text{H}_2\text{O}$ ). It is also due to the trapping and the dissolution of carbon dioxide from the atmosphere by basic solution during the intensive agitation of the reacting mixture.

On the other hand, it has been demonstrated in previous studies (Kormann et al. 1991, Bekbolet and Balcioglu 1996, Chen et al. 1997, Wang et al. 1999, Wang et al. 2000C, Cho et al. 2002B, 2004) as well as in the present investigation that  $\text{HCO}_3^-/\text{CO}_3^{2-}$  have an inhibiting effect on photocatalysis. It is widely accepted that (bi)/carbonate anions act as an effective radical scavengers for  $^{\circ}\text{OH}$  radicals.

In order to better understand the effect of inorganic carbon the results of real LL can be compared with the experiments performed on model compounds HAs (Aldrich-Sigma) at pH 8.8 and 11.0 and in the presence of  $\text{HCO}_3^-$  (3.05 g/l) (Fig. 5.2).

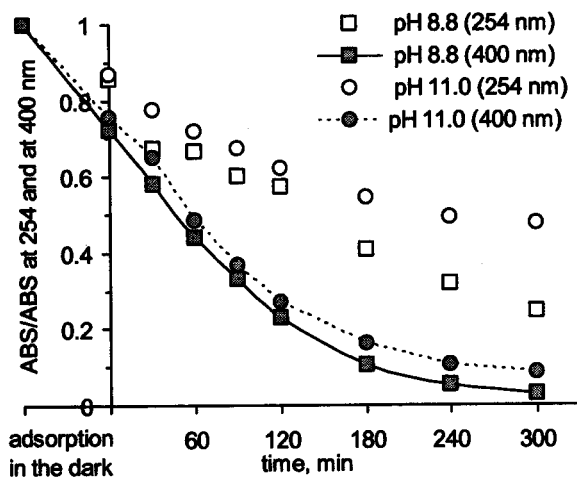

Figure 5.2 Effect of  $\text{NaHCO}_3$  on photocatalytic degradation of model HAs at pH 8.8 and 11.0 determined by normalised absorption at 254 nm and normalised adsorption at 400 nm (colour)

It can be seen that pH has little effect on the photocatalytic removal of colour both from HAs as well as LL solution. By contrast, the degradation of aromatic band expressed as  $\text{UV}_{254}$  absorption is much more affected by pH. It is apparent that the photocatalytic reaction rate of LL is limited by the presence of inorganic carbon. Thus, before the photocatalytic process the pH of the solution has to be adjusted.

The data are in agreement with the results obtained by Bekbolet and co-workers (1996) and recently by Cho and co-workers (2002B). The authors found the best photocatalytic rate for biologically pre-treated LL in acidic solution, but the “optimal” proceeding pH was different depending on the authors. For instance, Bekbolet and co-workers (1996) observed the highest photodegradation rate at pH 5, and Cho and co-workers (2002B) reported the greater photoreactivity at pH 4.

Further experiments were carried out in acidic medium. Photocatalytic mineralization of LL was followed in terms of COD (Fig. 5. 3b) or TOC (Fig. 5. 3a) and colour evolution (at 400 nm).



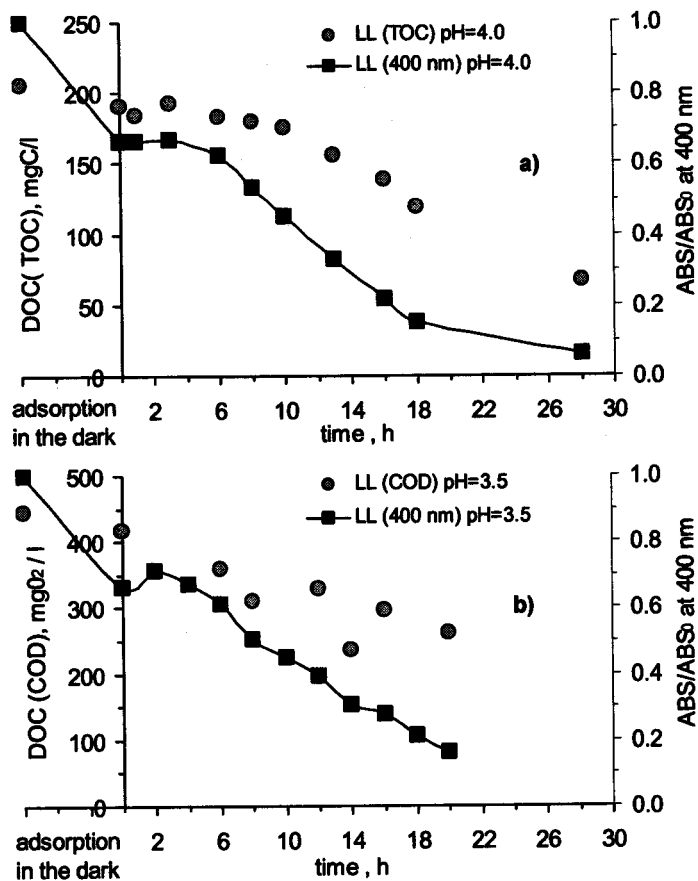

Figure 5.3 Photocatalytic degradation of landfill leachate a) determined by of TOC and colour removal at 400 nm, pH 4.0 b) determined by COD and colour removal at 400 nm, pH 3.5

It should be noted that the concentrations of total organic carbon present in real leachate were several times higher (from 4 to 5) than for the photocatalytic tests of HAs. Accordingly, a prolonged reaction time was needed.

Generally, it can be observed that photocatalytic removal of colour (UV<sub>400</sub>) is faster than photomineralization (Fig. 5.3). This behaviour may be explained by a difference of initial adsorption of organics on TiO<sub>2</sub>. The molecules responsible for the specific colour of LL have higher initial affinity (amounting to 33%) to the catalyst in comparison to the general amount of organics determined as COD (6.5% at pH 3.5) (Fig. 5.3b) or TOC (7.5% at pH 4.0) (Fig. 5.3a).

It should be noted that the landfill leachate contains a mixture of different organic and inorganic species and the total rate of photocatalytic degradation is not the sum of the individual rates. The most active substance is degraded faster, preventing the degradation of the others (Blanco et al. 1999). On the other hand, after degradation of organics responsible for specific colour, the intermediate products which appeared in solution were less susceptible to photocatalytic oxidation.

Moreover, relying on previous works as well as present findings, it can be observed that the mechanism of photodegradation of model –HAs (Wiszniewski et al. 2002) and organics present in bio-pre-treated LL is similar, and two major stages can be distinguished. By analogy to HAs, the first stage of “photodepolymerisation” of organics in LL is characterised by a more rapid decrease in  $UV_{400}$  absorption (the removal of colour) and much slower decline in  $UV_{254}$  absorption (aromatic band) (Fig 5.1). Figure 5.3a shows that in the first step of reaction the mineralization of organics is rather limited and only a weak evolution of TOC (after 10 hours) is observed. The second stage of reaction corresponds mainly to the mineralization of the fragments produced from macro-organics structure resulting in the evident disappearance of TOC or COD (Fig. 5.3 a, b).

### V.2.2 Summary: photocatalytic treatment of biologically pre-treated landfill leachate (France)

The experimental data suggested that the use of Aldrich - HAs as model compounds of landfill leachate was a good choice. The shapes of photocatalytic degradation curves for the model HAs in the presence of inorganic salts as well as for the real landfill leachate samples were similar. A good approach for real leachate was obtained.

A simple Langmuir–Hinshelwood kinetic model did not fit exactly with the data and this model was not applied to describe a photocatalytic degradation of real leachate.

The results confirmed that the pH has an important effect on photocatalysis. Therefore, if photocatalysis is going to be applied for LL, a pre-treatment involving pH adjustment is needed for removing of  $HCO_3^-/CO_3^{2-}$  anions, most inhibitory agents. It was proved that the degradation of LL was more efficient in acidic conditions and optimal pH was assumed to lie in the range of pH 4 to pH 5.

The solution matrix, particularly inorganic anions (such as chloride, sulphate, phosphate etc.) remaining in the leachate after pH acidification would affect photocatalytic reaction due to the competitive adsorption on the catalyst. However, the photocatalysis was not completely hampered and within 28 h of proceeding, a complete bleaching (loss of colour) as well as mineralization reaching 70 % were achieved. Studies performed in the solar box system (which simulates natural solar radiation) indicate that a high organics removal from landfill leachate can be obtained only after a prolonged time of irradiation. Therefore, it could be assumed that the same efficiency of leachate mineralization will involve few days of operation in the pilot plants in e.g. CPC reactors.

### V.3. Photocatalytic treatment of biologically pre-treated landfill leachate (Poland)

In this part of experiments, the leachate originated from Gliwice municipal landfill which was in the methanogenic phase ("mature landfill") (Table 2.2 in section II.3.1.1). The leachate samples were withdrawn from the central collection points (well) which collected all percolates through the waste but also liquid from the perimeter trenches. Consequently, the stored leachate was diluted with the precipitation water during the rainy weather and average concentration of COD and ammonia were relatively low, amounting to 630 mg O<sub>2</sub>/l and 310 mg N-NH<sub>4</sub><sup>+</sup>/l respectively.

First, landfill leachate was biologically pre-treated in RBC system (Fig. 2.11) described in the section II.3.1.3, without external carbon source into the system. The biological aerobic oxidation resulted in removal of biodegradable organic fraction present from the raw leachate as well as complete nitrification of ammonia (Table 2.7 in section II.4.2.4). However, the landfill leachate cannot be treated only by conventional biological treatment because a "refractory" COD persists, higher than 500 mg O<sub>2</sub>/l which is value almost four times too high for a direct discharge in the environment (see Table in section I.2.3).

This part of research was conducted by using new photoreactor: UviLab P400 UV (Fig. 2.13, section II.4.2.3) fitted with UVC lamp. The study consisted in: i) determination the UVC radiation effect on photolytic and photocatalytic oxidation of refractory organic compounds in leachate, ii) evaluation of the accessibility of photocatalytic degradation products formed from refractory organic in treated leachate for microbial oxidation.

#### V.3.1. Preliminary tests for UVC photocatalytic system - humic acids case

Before the start of the research on the photoreactivity of organics from real leachate using a new photoreactor, the degradation of model organics – humic acids (Sigma-Aldrich) was verified. The test was performed into the set-up proceeding in batch-flow mode. The humic acids solution amounting to 100 mg/l was irradiated in the presence and absence of catalyst, and kinetics was followed in terms of COD evolution (Fig. 5.4).

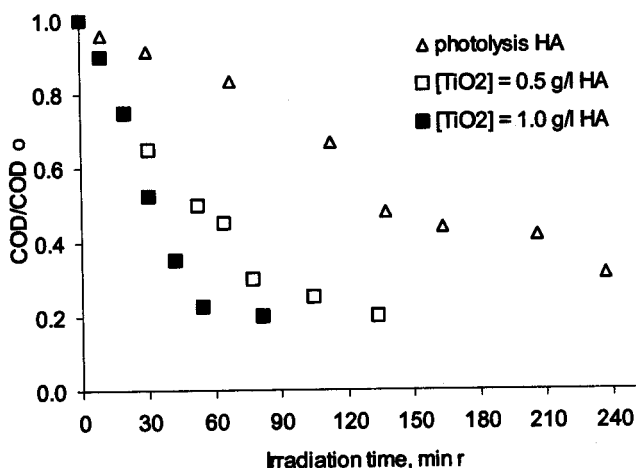

Figure 5.4 Evolution of the remaining normalized concentration of COD, photolysis and photocatalytic degradation of HAs (100 mg/l) with TiO<sub>2</sub> amounting to 0.5 and 1.0 g/l, initial COD = 100 mg/l, pH = 7.8

As can be observed, application of UV radiation alone, already led to the decay of HAs versus irradiation time. It was in opposition to the previous research where the direct illumination of HA's solution by using light of xenon lamp did not caused organic degradation (see section III.2.2.1.). That discrepancy was related to differences in reactor construction as well as radiation source. In the present study we used Hg -lamp which generated more energy wavelengths (UV-C) than less energy wavelengths (UV-A) Xenon lamp. Moreover, the experiments performed in a quartz photoreactor with immersed coaxial lamp in solution mixture provided effective penetration of excitation light into aqueous solution.

The cleavage of HAs was due to the direct photolysis by photons adsorption and/or by production of reactive intermediates in the presence of dissolved oxygen. Early investigation (Corin et al. 1996, Aguer et al. 2002) report that HA can act as precursor of reactive species such as oxygen singlet (<sup>1</sup>O), hydroxyl radicals (HO°), super oxide radical (O<sub>2</sub>°), peroxy radicals (ROO°) and reactive triplet state (<sup>3</sup>HS). However, this process involves mainly short waves UV-radiation ( $\lambda < 350$  nm) (Aguer et al. 1999), which was available in the system studied.

The simple Langmuir-Hinshelwood model (L-H) for HA degradation was assumed. The photocatalytic oxidation rate constants were calculated and listed in Table 5.1.

Table 5.1 Apparent first-order rate constants  $k$ , and linear regression coefficient of HAs

COD	$k$ , (1/min)	R <sup>2</sup>
photolysis HA	0.0049	0.978
TiO <sub>2</sub> [0.5 g/l] HA	0.0126	0.936
TiO <sub>2</sub> [1.0 g/l] HA	0.0226	0.965

The photolysis of HA resulted in 70 % of COD removal within 240 min of reaction. The combination of UV radiation with photocatalyst showed an increase of HAs degradation. It was observed that the reaction rate increased significantly with increasing catalyst dose. The catalyst concentration amounting to 1.0 g/l brought about 80% of COD removal within 82 min.

It should be emphasised that an improvement in COD decay was ascribed to the presence of a two parallel pathways: photolysis and photo-generation of activate specimen *via* catalyst excitation.

### V.3.2. Direct photolysis and photomineralization of LL

The biologically pre-treated leachate used in the tests contained relatively low concentration of organics (TOC approx. of 200 mgC/l, COD of approx. 500 mgO<sub>2</sub>/l) and humic acids of approx. 25 mg/l). Moreover, BOD<sub>5</sub>/COD ratio amounting to 0.03 indicated that organics present in leachate are bio-refractory and their removal should be performed by means of the physicochemical treatment.

On the basis of the previous findings (*section V.2.1*) as well as on literature data (Cho et al. 2004), it was postulated that the alkalinity of the leachate had to be removed for ensuring appropriate conditions of proceeding. Thus, acidified to pH = 4.0 and suspended free samples of leachate were subjected to photocatalytic stage.

First, the effect of direct irradiation (without TiO<sub>2</sub>) on LL degradation was studied. The dissolved oxygen is believed to be a precursor for transformation into the various oxygen species in homogeneous (Aguer et al. 1999) as well as heterogeneous photocatalysis (Al-Ekabi et al. 1991, Wang and Hong 2000). In the present studies, the system was operated under O<sub>2</sub> saturation provided by air-flow inserted through the gas inlet placed at the bottom of the photoreactor.

Apparently, organic compounds remaining in landfill leachate strongly absorbed UV radiation and a quantum yield in photoreactor was high enough to induce homogeneous oxidation of organic molecules. COD, TOC (Fig. 5.5) as well as specific colour (Fig. 5.6) of leachate were gradually removed versus irradiation time.

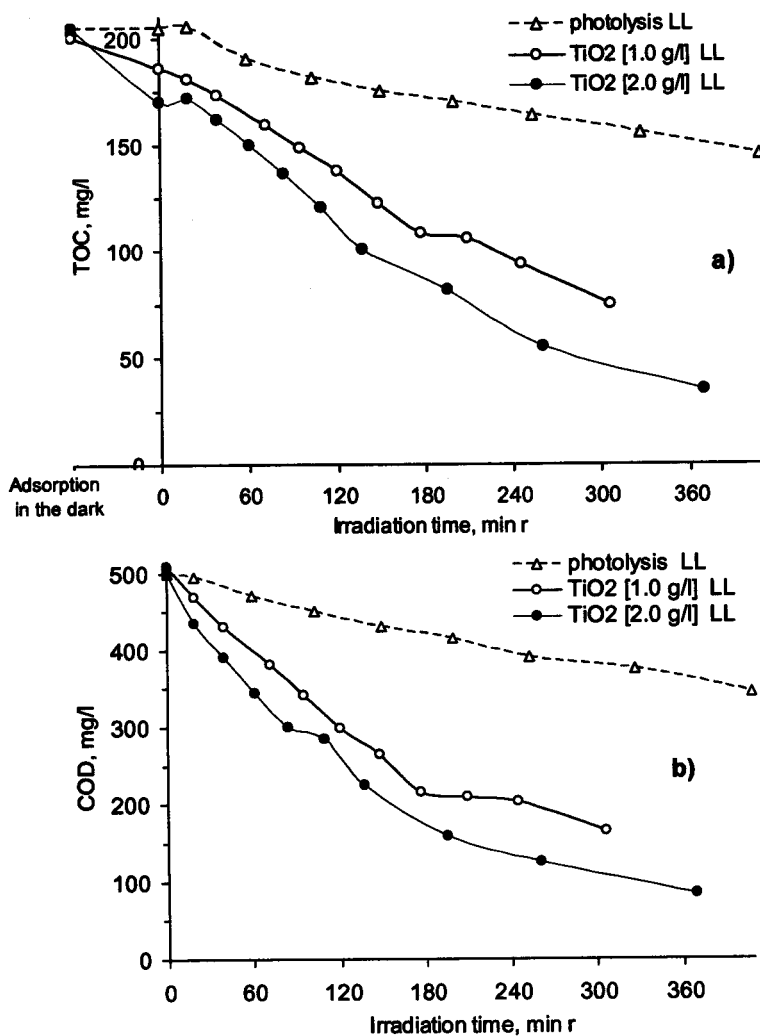

Figure 5.5 Photolysis and photocatalytic degradation of landfill leachate determined by a) TOC and b) COD (without TiO<sub>2</sub> separation), pH 4.0

Consequently, the specific brown-yellow colour (principally attributed to the humic substance fraction) was removed faster, and more than 70% reduction of absorbance at 400 nm was observed within 410 min. Nevertheless, mineralization was less effective and only 35 % reduction for TOC and COD was obtained. It corresponded to 145 and 345 mg/l concentrations remaining in the solution for TOC and COD respectively.

A considerable increase in organic removal efficiency was found (Fig. 5.5 and Fig. 5.6) after addition of catalyst into the solution. For instance, the catalyst dose equal to 2.0 g/l allowed to decrease organic (near 85%) to the value of 34 and 85 g/l for TOC and COD respectively after 370 min of proceeding.

The average amount removed in this way was 15.6 mg of TOC (ca. 7.5%) per gram of TiO<sub>2</sub> in pH 4 (Fig. 5.5). It was measured that adsorption was slightly higher for COD and equalled to 50 mg per gram of TiO<sub>2</sub>.

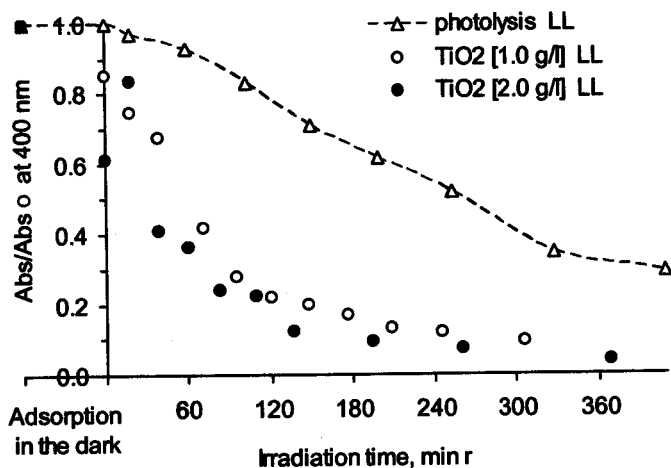

Figure 5.6 Photocatalytic degradation of landfill leachate determined by normalised absorption at 400 nm, pH 4.0

As opposed to the previous experiments with xenon-lamp, in the present study two domains (so-called: I-depolymerization and II-photomineralization) describing photocatalytic degradation of organic were hardly distinguishable. In the system fitted with UVC-Hg lamp a significant reduction of organic was governed by photolysis and photocatalysis occurring simultaneously. For simplification, it was assumed that results of degradation pathway of LL followed pseudo-first-order kinetics mode. As a proof of this assertion a good correlation  $R^2$  was obtained (Tab. 5.2). The photocatalysis of LL using  $TiO_2$  can improve the oxidation rate by 3.0 and 6.7 times respectively compared to that of direct photolysis (Fig. 5.7).

Table 5.2 Coefficient of degradation rate constant ( $k$ ) by means of TOC, COD and colour for photolysis and photocatalysis of LL

	$k$ , (1/min) (TOC)	$R^2$ (TOC)	$k$ , (1/min) (COD)	$R^2$ (DOC)	$k$ , (1/min) (400 nm)	$R^2$ (400 nm)
photolysis LL	0.0008	0.978	0.0009	0.994	0.0032	0.978
$TiO_2$ [0.5 g/l] LL	0.0028	0.993	0.0031	0.934	0.0065	0.867
$TiO_2$ [1.0 g/l] LL	0.0031	0.994	0.0038	0.966	0.0074	0.927
$TiO_2$ [2.0 g/l] LL	0.0046	0.990	0.0049	0.986	0.0079	0.953
$TiO_2$ [3.0 g/l] LL	0.0056	0.979	0.0057	0.982	0.0058	0.886

Aside from the reduction of organic contaminants, the treatment technology of leachate has to include a method for nitrogen removal as well. Its concentration in wastewaters discharged is limited due to potential adverse environmental impacts (i.e. eutrophication, infant methemoglobinemia disease). Some studies reported conversion of ammonia to  $NO_3$  and  $NO_2$  and/or to inert nitrogen gas  $N_2$  (some  $N_2O$ ) (Bonsen et al. 1997, Bems et al. 1999).

Hence, the evolution of mineral nitrogen forms (i.e. nitrite, nitrate and ammonia) was investigated during photocatalysis with 2.0 g/l of catalyst and pH 4. At the beginning of

reaction the main nitrogen form was nitrate (215 mg NO<sub>3</sub>-N/l), but ammonia amounting to 3.0 mg NH<sub>4</sub><sup>+</sup>-N/l was present in the solution as well. Nevertheless, nitrite forms equalled to 12 mg NO<sub>2</sub>-N/l in solution mixture has already been detected within 20 min of proceeding. Most likely it was due to the reduction of nitrate adsorbed on TiO<sub>2</sub> surface to nitrite (NO<sub>3</sub>→NO<sub>2</sub>). Periodically, an increase of nitrate concentration was accompanied by a decrease of nitrite concentration, and on the contrary with the increase of nitrite the amount of nitrate decreased. Finally, the nitrite increased to 22 mg/l, but taking into account the balance of N (sum of nitrogen forms), the total nitrogen concentration can be assumed as invariable.

The ammonia concentration was at a stable low level and its concentration slightly increased from the start 3 to 5 mg/l at the end of process. It is in agreement with results carried out by Cho and co-workers (2002B) who found negligible conversion of ammonia in acidic solution (pH 4).

### V.3.3 Effect of catalyst loading

As has already been discussed, an appropriate catalyst concentration depends on various parameters, particularly on the geometry of photoreactor (Fernández-Ibáñez et al. 1999) and the irradiation source. The earlier study on photocatalytic degradation of HA at pilot plant as well as at laboratory scale (LCA) pointed out that optimal catalyst concentration was about 1.0 g/l (see III.2.2.2.). Taking into account complex solution matrix of leachate, the possibility of inhibition of photocatalyst by heavy metals and the differences in photoreactor construction, the most accurate catalyst concentration needed to be determined.

Previously, the photocatalytic degradation of leachate was tested by Bekobolet and co-workers (1996) in batch reactor xenon-lamp emitting UV-light at wavelength above 320 nm. However, the authors applied catalyst (TiO<sub>2</sub>) concentration equal to 5.0 g/l without optimisation. In more recent study, Cho and co-workers (2002B) examined effect of catalyst concentration in the range 3.0 to 20 g/l in the photoreactor fit with UVC lamp (254 nm).

They found a catalyst dose amounting to 3.0 g/l as an optimal one. Additionally, Fernández-Ibáñez and co-workers (1999) reported that if the lamp is inside the reactor and coaxial with it and the path length (illuminated layer solution) is short, in present study case equalled to 0.5 cm, an optimal dose of TiO<sub>2</sub> can rise up to *several grams per litre*.

Nevertheless, we were interested in researching lower TiO<sub>2</sub> concentration (below 3.0 g/l) for reaction proceeding ensuring high photoreactivity for landfill leachate. Subsequently, the influence of the photocatalyst concentration on the degradation rate of LL has been investigated employing different concentrations of TiO<sub>2</sub> varying from 0.5 to 3.0 g/l (Fig. 5.7).



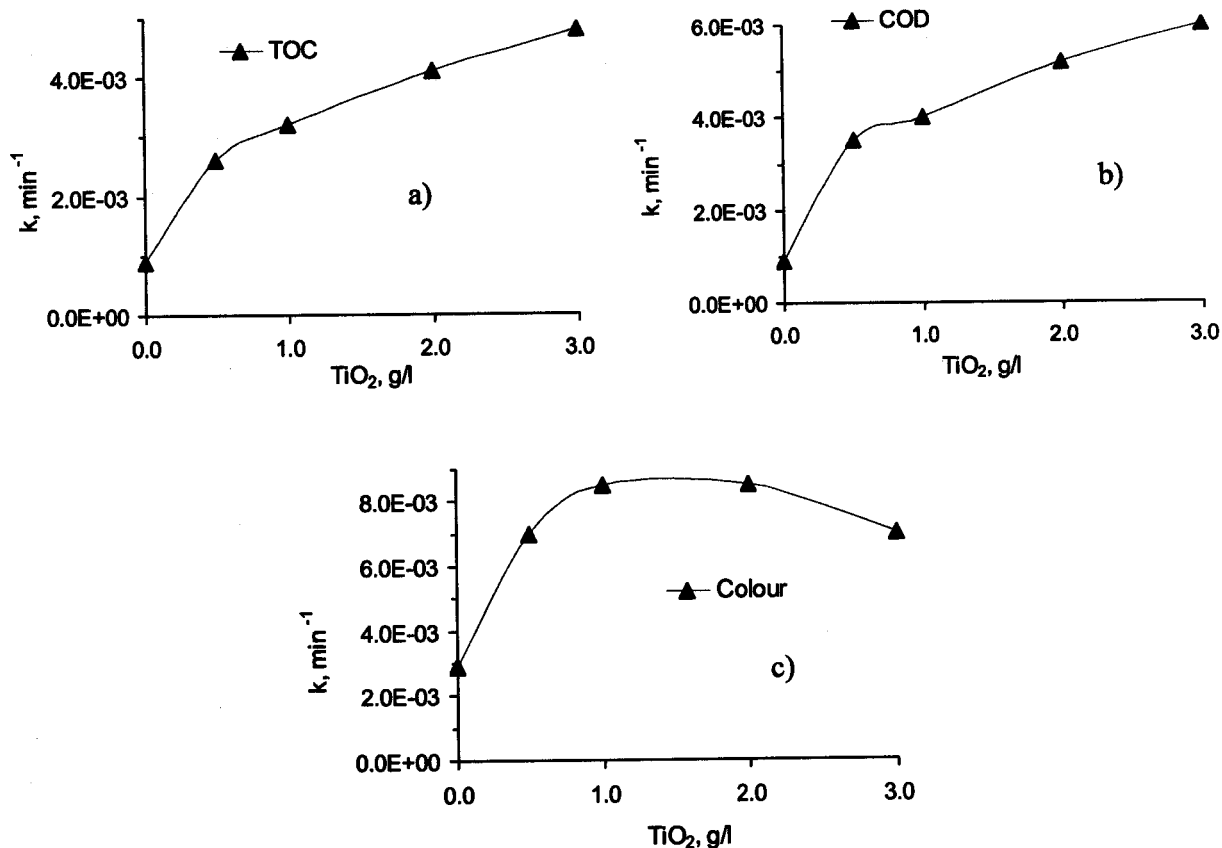

Figure 5.7 Effect of the photocatalyst (TiO<sub>2</sub>, P-25) concentration on the photodegradation rate of landfill leachate at pH 4; determined by a) TOC, b) COD and c) Colour

It was observed that the degradation rates for TOC and COD were increased with increasing photocatalyst concentration in the whole range. This could confirm the results obtained by Cho and co-workers (2002). However, a plateau for colour removal was reached at catalyst concentration amounting to 1.0 g/l and higher catalyst dose (above 2.0 g/l) resulted in decrease of reaction rate (Fig. 5.7c).

The appropriate catalyst concentration for photocatalytic treatment was strongly affected by inorganic matrix solution. Ionic strength in landfill leachate was at high level (already Cl<sup>-</sup> anions exceeded 2.0 g/l, range 10<sup>-2</sup> M). It could result in agglomeration of the particles due to screening of electrostatic repulsion between TiO<sub>2</sub> particles by adsorbed anions (Cl<sup>-</sup>, SO<sub>4</sub><sup>2-</sup>, PO<sub>4</sub><sup>3-</sup>, NO<sub>3</sub><sup>-</sup> etc.). The colloidal stability of the sample was diminished by decreasing zeta-potential (due to compaction of the electrostatic double layer at the particle surface) and larger clusters of TiO<sub>2</sub> would be formed. The weight of formed clusters makes them settle easily. It was a reason why in the real solution of leachate it was possible to remove TiO<sub>2</sub> completely by centrifuging, as opposed to the previous studies on model HAs when the solutions were prepared by using distilled water.

The high ionic strengths found in real leachate have a crucial effect on spontaneous sedimentation of  $\text{TiO}_2$ . Therefore, it may prove advantageous if  $\text{TiO}_2$  slurry is applied. The suspended catalyst forms are well-known to be more efficient than the supported one, but their separation from the treated solution after the photocatalytic oxidation process is needed. On the other hand, the catalyst agglomerations lead to the loss of photocatalytic activity by decrease of surface active site of aggregates and higher catalyst concentration needs to be applied.

#### V.3.4 Biodegradability of by-products formed during the photocatalytic treatment

The preliminary results on model HA (see section III.2.2.6 and III. 3.1.4) showed that photocatalysis can enhance biodegradability of refractory organic compounds, such as the ones present in stabilised landfill leachate. Some constituents of real leachate (AOXs humic substances, heavy metals etc.) can affect biological oxidation. On the other hand, oxidation products of photocatalytic process had to be examined, as sometimes the intermediates formed might be toxic for microorganisms. For instance, it was reported by Parra and co-workers (2002) that photodegradation product of isoproturon (herbicide) revealed a significant increase of toxicity at the beginning of the treatment in comparison to its parent compounds. Nonetheless, the same studies have shown that prolonged irradiation led to a considerable decrease of toxicity and visible increment of biodegradability  $\text{BOD}_5/\text{TOC}$  (up to 0.6).

The photocatalytic conversion viability of non-biodegradable organics was assessed in order to obtain significant improvement in biodegradability ( $\text{BOD}_5/\text{TOC}$ ,  $\text{BOD}_5/\text{COD}$  ratio). Moreover, specific oxygen uptake rate (OUR) was used to estimate the inhibitor's effect of formed by-products on the activated sludge microorganisms (Sher et al. 2000). Photocatalytic test was carried out (using 2.0 g/l of  $\text{TiO}_2$ ) on nitrified leachate containing bio-refractory organic compounds.

The low biodegradability of the biologically pre-treated leachate was confirmed by the extremely low  $\text{BOD}_5/\text{COD}$  and  $\text{BOD}_5/\text{TOC}$  ratio equal to 0.03 and 0.08 respectively. Figure 5.8 demonstrates that  $\text{BOD}_5$  of leachate increased within 20 min of irradiation from 15 to 53  $\text{mg O}_2/\text{l}$ . At the same time, TOC (Fig 5.5a) was not removed and only a slight decrease of COD was observed. It suggested that photocatalytic oxidation changed the structure and chemical properties of organic substances. The degradation of both aliphatic and aromatic groups of refractory organic could lead to the formation of smaller and more oxidized molecules, such as short carboxylic acids (formic, acetic and oxalic). Such biodegradable intermediates have been detected e.g. by Vulliet and co-workers (2002) during photocatalytic degradation of sulfonylurea herbicides.

Up to 120 min of illumination, along with decrease of COD and TOC, the BOD<sub>5</sub> fluctuated insignificantly in the range of 53 to 60 mg O<sub>2</sub>/l. Simultaneously, OUR rose to its maximum value (120%), which indicates that formed substrates become more and more readily accessible to bacteria. Next, all parameters gradually decreased, but still 40 mg/l of BOD remained in the solution within 260 min of reaction. Then, higher BOD<sub>5</sub>/COD and BOD<sub>5</sub>/TOC ratio amounting to 0.35 and 0.73 respectively were detected.

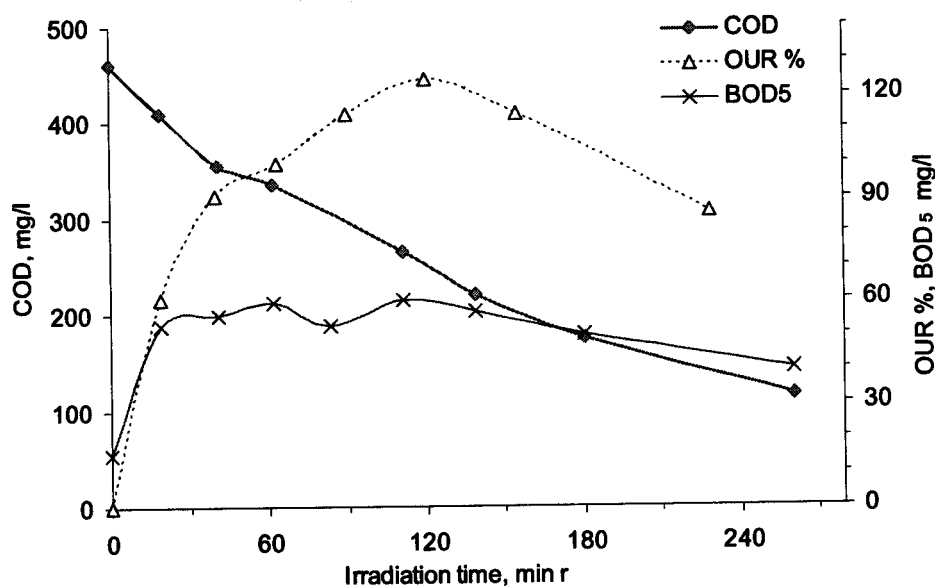

Figure 5.8 Evolution of COD, BOD<sub>5</sub> and %OUR during photocatalytic decomposition of LL versus irradiation time

As a reference, the biodegradability (BOD<sub>5</sub>/COD) of municipal wastewaters supplied to MWWTPs usually ranges from 0.4 (Metcalf and Eddy 1991) to 0.6 (Verstraete and Vaerenbergh 1986). It is clear that conversion of refractory organic to biodegradable fraction in the leachate would be improved in order to apply post-biological treatment in the combined system.

However, the present results were much better than was reported in earlier investigations by Bekbolet and co-workers (1996). The authors found only slight increase of biodegradable fraction (BOD<sub>5</sub>) up to the value 7 mg/l during the irradiation of LL samples. They suggested that low production of BOD in the system was due to the high catalyst concentration (5.0 g/l). Consequently, the substrate was mainly converted into CO<sub>2</sub> without forming a large amount of biodegradable intermediates.

The relatively low BOD<sub>5</sub>/COD (0.35) obtained in the studies can be caused by the fact that the biological measurements (BOD<sub>5</sub>, OUR) were performed by using unacclimated seed. The species formed during the photocatalytic oxidation of leachate might not be the same as that needed microbial population for digestion. We concluded that the further acclimation of

the activated sludge system to the photocatalytic intermediates can result in greater organic consumption than it was observed in the current studies.

### V.3.5 Post- biological oxidation by activated sludge

The accessibility of organics formed in photocatalytic stage was validated in the biological reactor with suspended biomass (Fig. 2.8 in section II.1.3.3). After roughly 40 min of proceeding in photoreactor and catalyst separation, the leachate was subjected to biological treatment. Figure 5.9 shows the evolution of organic matter within 12 h of reaction. It was observed that COD decreased as biological degradation proceeded

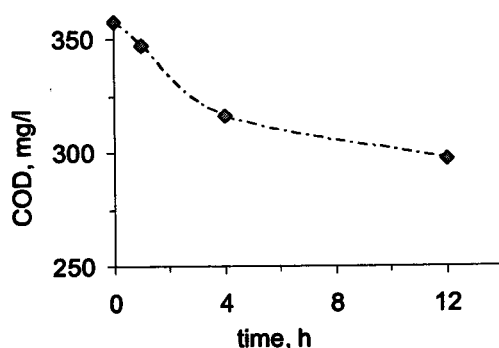

Figure 5.9 Microbial oxidation of COD in activated sludge reactor of photocatalytically pre-treated landfill leachate

Finally, 60 mg/l of COD was removed from the reactor. This effect can be ascribed to aerobic microbial metabolism, oxidation of BOD fraction to carbon dioxide and water fraction and/or immobilization of organic into cell biomass. A partial sorption of COD onto activated sludge flocs can not be excluded.

### V.3.6 Summary of photocatalytic treatment of biologically pre-treated landfill leachate (Poland)

The last part of this study was devoted to the assessment of the photocatalytic oxidation process efficiency as a post-treatment through the oxidation of a biologically pre-treated landfill leachate. The first stage of biological treatment resulted in nitrification (oxidation of ammonia to nitrite and nitrate) and removal of biodegradable organics from the leachate.

At the end of photocatalytic treatment a total decolouration was observed. COD and TOC significantly decreased ensuring its low concentration, below the threshold value for direct discharge of leachate according to the legal restrictions amounting to 125 mg O<sub>2</sub>/l and 30 mg C/l respectively. The optimal catalyst concentration for colour removal from LL should not be

higher than 2.0 g/l. Nevertheless, the greatest reaction rate for organics removal (mineralization) was obtained at catalyst dose equalled to 3.0 g/l.

Photocatalytic reaction conducted in acidic medium (pH 4) did not allow to nitrogen removal and merely insignificant conversion of nitrate toward nitrite was detected. Taking into account nitrogen concentration after photocatalytic reactor above 200 mgN/l could not be considered as suitable for direct discharge into the environment. According to the UE regulation directives (Nitrates Directive 91/676/EEC) the total nitrogen should not exceed 30 mg/l in effluent from wastewater treatment plants.

Photocatalysis brought about conversion of refractory organic from the LL into readily biodegradable species (BOD). It was proved that the BOD fraction formed in that way can be removed via aerobically biological oxidation. Similarly, the organic fraction (BOD) can be used by heterotrophes (denitrifiers) during the reduction of nitrite or nitrate to  $N_2$ . However, the amount of biodegradable species provided to denitrifiers bacteria from photocatalytic stage will allow to meet the standard in respect to N concentration. For instance the previous experiments indicated that about 4 g of  $BOD_5$  were needed for successful reduction of 1 g of  $NO_x$  from the leachate (see section IV.2.4).

#### V.4 Conclusions (Poland and France)

The photocatalytic oxidation was efficient in removal of biorefractory organics remaining after biological pre-treated leachate. It was confirmed that in order to ensure the photoreactivity of  $TiO_2$ , the inhibitory agent, i.e. (bi)carbonate has to be removed. Consequently, the adjustment to about pH 4 of the leachate and its purge from  $CO_2$  before the start of the process is required.

Much higher reaction efficiency was found in the system with UVC-lamp (EBD) than in the systems where UVA-VIS radiation (LCA) was used. Subsequently, 85 % reduction of COD and TOC were achieved within 6 hours of operating in comparison to 70% of COD and TOC reduction within 28 hours of operating, for UVC and UVA-VIS systems respectively.

The higher performance of UVC system was attributed to the combination of two possible degradation pathways i.e.: i) direct and/or indirect photolysis and ii) photocatalytic reaction with generated on  $TiO_2$  radicals ( $^{\circ}OH$ ,  $^{\circ}SO_4$ ) or direct oxidation of adsorbed organics by holes " $h^+$ ".

Another factor was also related to photoreactor geometry. The absorption of photon flux was more efficiently ensured in the UVC (EBD) reactor because of lower path layer of illuminated solution amounting to 0.5 cm as opposed to the UVA-VIS (LCA) system when the path layer of illuminated solution was of a few centimetres.

The optimal catalyst concentration determined for mineralization of refractory organics in LL was found to be 3.0 g $TiO_2$ /l in UVC system.

The studies at lower catalyst dose (equal 2.0 g/l) showed that conversion of refractory organics into biodegradable species has been generated at the beginning of reaction. Nevertheless, mineralization was the dominating process and the highest biodegradability (BOD<sub>5</sub>/COD) amounting to 0.35 was achieved when about 75% of organics was reduced.

The effectiveness of post-biological oxidation treatment was limited to the removal of COD biodegradable fraction formed in photocatalytic stage.

To summarize, the developed combination technology consisted of: first biological pre-treatment involving BOD removal and nitrification ⇒ then UV/TiO<sub>2</sub> treatment with Xenon (UVA) lamp or with Mercury (UVC) lamp systems for recalcitrant organics mineralization/conversion (COD⇒BOD) ⇒ finally biological post-treatment involving BOD removal (and denitrification). The last part of the studies concerning biological denitrification by using formed BOD in photocatalytic stage was not evaluated in the present work. This will be the subject of the future investigations.

The present results indicate that commercialisation of solar TiO<sub>2</sub>-photocatalytic technology used for treatment of highly contaminated landfill leachate containing a mixture of organic and inorganic compounds will not be practicable. Because of the fact that reaction involves high retention time in the system, a large area in the vicinity of the landfill site is needed for settling the solar detoxification system. That is why the implementation of this technology is difficult.

By contrast, a considerable improvement in photocatalysis efficiency can be expected in systems illuminated with artificial UVC lamps. The other advantage is that the compact, modules systems use low pressure mercury economic lamps which can operate 24 hours a day and are independent from external solar conditions. The system can become an alternative for European countries "less privileged" in insolation (like Poland and many others).

In the end, the combination of photocatalytic and biological process may result in the cheaper option for stabilised landfill leachate but it is necessary to optimize BOD formation in photocatalytic stage and increase the performance of biological post-treatment. In order to cope with these tasks, the following issues could be envisaged:

- i) Effect of pH increase after reduction of bi(carbonate) on TiO<sub>2</sub> photoreactivity.
- ii) Combination of the catalyst action with a low dose of oxidant at the beginning of photocatalytic stage to enhance conversion of refractory organics into the biodegradable molecules.
- iii) Effect of bacterial biomass acclimation on oxidation efficiency of organics remaining after photocatalytic stage.

# **CHAPTER VI**

---

---

## *GENERAL CONCLUSION AND PROSPECTS*

---

---

---

---

---

## 6.1 General conclusion of the work

Landfill operators are under increasing economic, regulatory and environmental pressures which force them to find appropriate, environmentally passive and inexpensive method of leachate detoxification.

The perspective of combining biological processes with photocatalysis method is an economically attractive option for landfill effluent treatment. It should be noted that the strategy of combined systems, is not necessarily a universal solution for all kinds of landfill effluents. For instance, (*see section I.2.3.4*) for the leachates from the disposal of inert, non-biodegradable materials, a more adequate solution seems to be an AOPs technology assisted with the physical techniques (membranes, activated carbon, coagulation etc. ).

The present studies showed combined biological and photocatalytic treatment process designed to cope with leachate from mature or stabilised sanitary landfills which are currently operating in Poland and many European countries.

Photocatalysis is a new emerging and promising technology for wastewater and air treatment. Especially interesting seems to be the use of solar photocatalysis in regions of good year-round insolation. Heterogeneous photocatalysis is now reaching the pre-industrial level. Several pilot plants and prototypes have been built in various countries. The solar photocatalytic treatment of pesticides used in agriculture and in food industry is being studied at Plataforma Solar de Almeria (PSA). PSA in Spain is an excellent example of the development of solar water detoxification in Europe. Recently, the first successful combined biological and photocatalytic process based on photo-Fenton reagents at PSA was also reported by Pulgarin's group from the Swiss Federal Institute of Technology (Sarria et al. 2003).

In this work, it was shown that the photocatalytic process is effective in degradation of humic acid solutions (amounting to 100 mg/l) used as a model of refractory organics present in real stabilized leachate. Mineralization of organics of more than 85% as well as complete removal of specific brown colouration was observed. The research was conducted at laboratory scale experiments (France, Poland) and confirmed under solar irradiation conditions at Plataforma Solar de Almería (PSA) in Spain.

The results obtained at both scales were very encouraging, and the influence of major parameters governing photocatalytic degradation of humic acids (such as pH, inorganic matrix, catalyst loading) was determined. Consequently, the feasibility of solar photocatalysis for the removal of humic substance from water was validated. This new method could become economically competitive with conventional methods such as coagulation/flocculation/filtration, ionic exchange or membrane filtration.



The same studies showed that the biodegradability of refractory organic substances such as HAs increases with irradiation time. It is of great importance in the case of the application of physicochemical-biological coupled system to wastewater treatment, but it was observed that during photocatalysis of HAs, mineralization process predominated without forming large amounts of easily biodegradable species (BOD). This fraction was estimated as 10% of initial TOC.

It has often been reported in literature that initial adsorption of organics on catalyst surface is a requirement for the photodegradation of organic compounds. Moreover, some studies showed a direct correlation between adsorption and photoreactivity. In the present research, humic acids adsorption was studied and correlated with their photocatalytic degradation. It was found that an enhancement of initial adsorption due to ionic strength or acidic pH did not bring about an increase of photocatalytic efficiency. This has mainly been explained by the properties of HAs which cause their aggregation and lead to the impediment of mass transport between catalyst surface and solution bulk during the photocatalytic reaction.

It was demonstrated that the inorganic matrix (mixture of added salts) affects photocatalytic oxidation efficiency of "target" compounds – HAs. The presence of inorganic anions mixture (frequently found in real leachates such as  $\text{Cl}^-$ ,  $\text{SO}_4^{2-}$  and  $\text{HCO}_3^-$ ) in the reacting mixture requires prolonged time of irradiation, and the presence of hydrogen carbonates is the most fatal factor influencing photocatalytic reaction.

In this work, two different biological systems based on attached growth microorganisms were optimized for landfill leachate detoxification. Both tested systems were efficient in degradation of large fraction of the soluble organic matter from the leachate, but a significant amount of no-degradable COD still remained after biological treatment. This part of organics consisted of humic and fulvic acids which were also responsible for the specific yellow-brown colour of the leachate. Consequently, it was indicated that the removal of the residual COD fraction by physico-chemical methods is needed in order to meet discharge standards.

Beside non-biodegradable organics, the leachate contains very high concentration of nitrogen compounds, mainly in ammonia form (from hundreds to thousands of mg per litre) which can cause an important problem in biological treatment. The operating parameters of biological system were controlled with the aim of avoiding inhibition of ammonia oxidation (nitrification). The systems were successful in removing nitrogen species by means of denitrification. However, due to unfavourable biodegradable organics/nitrogen ratio (C/N) in stabilised leachate, an external carbon source for denitrification was required.

Biological process involving nitrification can be used as a pre-treatment of landfill leachate before the photocatalytic stage in the combined system.

The research performed on real leachate confirmed that the presence of alkalinity in treated solution (i.e.  $\text{HCO}_3^-/\text{CO}_3^{2-}$ ) brings about the most deteriorating effects on photocatalysis. Therefore, if the photocatalysis is applied for LL, a pre-treatment involving pH adjustment will be needed.

The test performed in the system using Xenon lamp simulating natural (solar) radiation demonstrated that even at the optimal pH, the threshold value of organics removal (COD, TOC) in leachate for direct discharge is only achieved after a long (more than 28 h) reaction time. Therefore it was assumed that the application of solar photocatalysis would not be feasible for highly polluted, with both organic and inorganic contaminates, landfill leachate (*several hundred g per m<sup>3</sup> of TOC*). The full-scale detoxification systems (hundreds of square meters of collectors) might be designed to withstand the operating pressures anticipated for fluid circulation through a large field, which could not be possible in the vicinity of the landfill site. Moreover, bearing in mind that the amount of available solar irradiation in most European countries is relatively small in comparison to PSA (Spain), the solar-driven process is not justified.

By contrast, electric ultraviolet lamps are currently available on the market for a variety of applications and can also be used for photocatalytic degradation processes. The most suitable type of all the electric lamps available for UV-photon production is the low-pressure mercury fluorescent lamps, as they are the simplest, cheapest and long lasting lamps. The treatment in photocatalytic stage when using artificial light as an irradiation source needs to be optimized in order to decrease a high electricity consumption, which can represent the most important operating cost.

The experiments carried out in the system using Hg -lamp which generated more energy wavelengths (UV-C) than Xenon lamp, showed much higher efficiency of organic removal from biologically pre-treated leachate. Moreover, Hg-system had advantage over Xe-system consisted in the geometry of photoreactor (illuminated layer solution). As a result 85 % reduction of COD and TOC were received within 6 hours of reaction.

On the other hand, photocatalysis brought about conversion of refractory organics from the LL into readily biodegradable species (BOD). It was proved that the BOD fraction formed in that way can be removed in the subsequent biological stage. The same studies have shown that the amount of biodegradable organics (BOD) generated from landfill leachate will not be balanced for microbial N removal. A supplementary organics stream will still be needed for ensuring N effective denitrification.

Nevertheless, there is still a lot of work to be done in terms of optimization of the pre-treatment photocatalytic stage and its effect on the biological process, in particular use of the formed organics for denitrification.

## 6.2 Overall treatment strategy for LL treatment and prospects

The validation of combined biological and photocatalytic process was not possible within the framework of thesis preparation due to the extensive range of necessary experiments and lack of specialized equipment needed for photocatalytic stage at the mother Institute (EBD in Poland). Thus, this year I applied for Marie Curie: Intra-European Fellowships FP6-2002-Mobility-5, 18 February 2004, proposal number N° 515137. The submitted proposal is called "HYBRIDETOX" and it is a continuation of the research started within the PhD thesis.

([http://europa.eu.int/comm/research/fp6/mariecurie-actions/pdf/eif\\_proposals2004.pdf](http://europa.eu.int/comm/research/fp6/mariecurie-actions/pdf/eif_proposals2004.pdf)).

A combined process which enhances the biodegradability of persistent organic compounds in leachates by introducing photocatalytic degradation was proposed. This process can be effectively developed and investigated during Marie Curie scholarship on the basis of the acquired experience and scientific excellence of the hosting institution X.

Therefore, the research objectives of the proposal are directed towards development of the new, environmental friendly and economically attractive process of landfill leachate detoxification. The combined and more developed system will consist of three stages. The first stage will include a bio-membrane-reactor followed by a second photocatalytic stage with cross-flow microfiltration unit (CFM) and the final biological post-denitrification stage in sequencing bath reactor (SBR) (Figure 6.1).

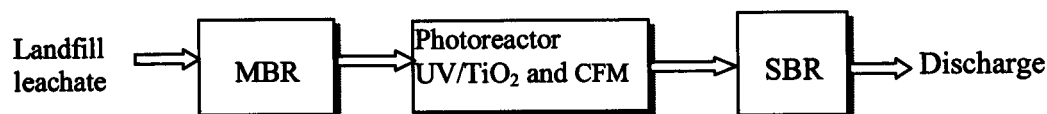

Figure 6.1 Process flow diagram for the proposed "HYBRIDETOX" process

Adopted by the EU Landfill directive (1999/31/EC) requires a general improvement not only in the standards of landfill construction but also in its operating, with the objective of preventing any negative effect on the environment caused by landfilling. This Directive imposes on landfill operators both water control and leachate management. It also includes the prevention of rainwater entering the site, the prevention of surface/groundwater entering the waste, and collection and treatment (to appropriate discharge standards) of contaminated water and leachate.

The proposal (HYBRIDETOX) addresses the problem of the "appropriate treatment" of contaminated landfill leachate before it is discharged in the environment. The concept of new, environmental friendly and economically attractive process will be the answer to the problem of

detoxification of persistent organics not only for leachate but also for other wastewaters (industrial) streams. The method will involve biological process of nitrogen removal (nitrification/denitrification), membrane filtration as well as photocatalytic degradation (UV/TiO<sub>2</sub>) stage.

At present most of the landfill leachate in Poland is still discharged directly into the sewage systems without or using only rudimentary pre-treatments. More stringent regulations from EU Directives will force not only Polish but also other European landfill site operators to introduce appropriate technologies for landfill leachate detoxification.

The proposal is based on the following main scientific objectives

(i) improvement of photocatalytic degradation of non-biodegradable organics and assessment of their conversion viability; (ii) evaluation of accessibility of transformed organics for microbial denitrification; (iii) optimization of combined system for nitrogen and non-biodegradable organics removal.

The proposed biological-photocatalytic system will be compared with a parallel system operating with another AOPs stage currently applied for landfill treated instead of photocatalytic stage (UV/TiO<sub>2</sub>). It is planned to optimize the formation of biodegradable organics in the photocatalytic stage by using "expert system".

Attempts of commercial application of semiconductor photochemistry have already been made for water purification. The first commercially available systems appeared recently. For instance, R2000 Solar Oxidation Facility (Clearwater Industries, USA) uses a fixed photocatalyst bed reactor, and solar energy as irradiation source. Next, a modular design facilities Photo-Cat system (Canada) operating under artificial light as photoexcitation source and a catalyst in suspended form has been proposed.

The competitiveness of HYBRIDETOX method developed in the proposal in comparison to the methods currently applied needs to be proved. In particular, the practical scale-up approach for photocatalytic stage including optimal concentration of catalyst and UV dose required to achieve a desirable effluent contaminants concentration has to be performed. Therefore, future study will involve the electrical operating cost associated with supplying UV energy, TiO<sub>2</sub> separation as well as other reactive cost estimations expressed in the units of kilowatt hour per cubic meter (kWh/m<sup>3</sup>) of treated leachate. The capital cost in a function of system size will also be evaluated.

## REFERENCES

- Abdullah M., Low G.K. and Matthews R.W. (1990). Effect of common inorganic anions on rate of photocatalytic oxidation of organic carbon over illuminated titanium dioxide, *J.Phys. Chem.* 94, 6820-6825.
- Aguer J.-P., Richard C. and Andreux F. (1999). Effect of light on humic substances: Production of reactive species. *Analisis* 27(5), 387-390
- Aguer J.-P., Richard C., Trubetskaya O., Trubetskoj O., Leveque J., and Andreux F. (2002). Photoinductive efficiency of soil extracted humic and fulvic acids *Chemosphere* 49, 259-262
- Ahn W.Y., Kang M.S., Yim S.K. and Choi K.H. (2002). Advanced landfill leachate treatment using an integrated membrane processes. *Desalination* 149, 109-114
- Ajona J.A. and Vidal A. (2000). The use of CPC collectors for detoxification of contaminated water: design, construction and preliminary results. *Solar Energy* 68 (1), 109-120.
- Alborzfar M., Jonsson G. and Grøn C., (1998). Removal of natural organic matter from two types of humic ground waters by nanofiltration, *Water Research* 32, 2983- 2994.
- Al-Ekabi H., Safarzadeh-Amiri A., Sifton W. and Story J., (1991). Advanced technology for water purification by heterogeneous photocatalysis. *Int. J. Environ. Pollut.* 1(12) 125-136.
- Al-Rasheed R. and Cardin D. J. (2003). Photocatalytic degradation of humic acid in saline waters. Part 1. Artificial seawater: influence of TiO<sub>2</sub>, temperature, pH, and air-flow. *Chemosphere* 51, 925-933.
- Alfano O.M., Bahnemann D., Cassano A.E., Dillert D. and Goslich R., (2000). Photocatalysis in water environments using artificial and solar light. *Catalysis Today* 58, 199-230.
- Amokrane A., Comel C. and Veron J. (1997). Landfill leachate pretreatment by coagulation-flocculation. *Water Research* 31, 2775-2782.
- Anthonisen A.C., Loehr R.C., Prakasam T.B.S. and Srinath E.G., (1976). Inhibition of nitrification by ammonia and nitrous acid. *Research Journal Water Pollution Control Fed* 48(5), 835 - 852.
- Aps T., (1991). Health hazards of nitrite in drinking water. *Water AS* 17, 1-77.
- Artiola-Fortuny J. and Fuller W.H. (1982). Humic substances in landfill leachates: I. Humic acid extraction and identification. *J. Environ. Qual.* 11, 663-668.
- Au K-K., Penisson A.C., Yang S. and O'Melia Ch., (1999). Natural organic matter at oxide/water interfaces: Complexation and conformation. *Geochemica et Cosmochimica Acta* 63 (19/20), 2903-2917.
- Augugliaro V., Loddo V. and Schiavello M. Heterogeneous Photocatalytic reactors: An Assessment of fundamental engineering aspects: In: *Heterogeneous photocatalysis*. Wiley (1997) series in photoscience and photoengineering 3(6), 169-189.

- Augugliaro V., Baiocchi C., Prevot A.B., E. Garcia-Lopez, Loddo V.; Malato S., Marci G., Palmisano L., Pazzi M. and Pramauro E. (2002). Azo-dyes photocatalytic degradation in aqueous suspension of TiO<sub>2</sub> under solar irradiation. *Chemosphere* 49, 1223-1230.
- Bae J-H., Kim S-K. and Chang H-S. (1997). Treatment of landfill leachate: ammonia removal via nitrification and denitrification and further COD reduction via Fenton's treatment followed by activated sludge. *Water Science and Technology* 36, 341-348
- Bandara J., Mielczarski J.A. and Kiwi J. (2001). Adsorption mechanism of chlorophenols on iron oxides, titanium oxide and aluminium oxide as detected by infrared spectroscopy. *Applied Catalysis B: Environmental* 34, 307-320.
- Bahnmann D. in *Handbook of Environmental Photochemistry*, P. Boule Ed., Springer Verlag, 1999, p 285.
- Bahnmann D., Cunningham J., Fox M.A., Pelizzetti E., Pichat P., Serpone N., in *Aquatic and Surface Photochemistry*, eds Helz G.R., Zepp R.G. and Crosby D.G., Lewis, Boca Raton, FL, 1994, p. 261.
- Bang D.-Y., Watanabe Y. and Noike T. (1995). An experimental study on aerobic denitrification with polyvinyl alcohol as PVA as a carbon source in biofilms. *Water Science and Technology* 32 (8), 235-242.
- Bae J-H., Kim S-K. and Chang H-S. (1997). Treatment of landfill leachates: ammonia removal via nitrification and denitrification and further COD reduction via Fenton's treatment followed by activated sludge. *Water Science and Technology* 36 (12), 341-348.
- Bauer M.J., and Herrmann R. (1998). Dissolved organic carbon as the main carrier of phthalic acid esters in municipal landfill leachates. *Waste Manage Research* 16, 446 -454.
- Balmelle, B., Nguyen, K.M., Capdeville, B., Cornier, J.C. and Deguin, A. (1992). Study of factors controlling nitrite build-up in biological processes for water nitrification. *Water Science and Technology* 26(5-6), 1017-1025.
- Bekbolet M., Lindner M., Weichgrebe D., and Bahnmann D.W. (1996). Photocatalytic detoxication with the thin-film fixed bed reactor (TFFBR): clean-up of highly polluted landfill effluents using a novel TiO<sub>2</sub> photocatalyst. *Solar Energy* 56, 455-469.
- Bekbolet M. (1996). Destructive removal of humic acids in aqueous media by photocatalytic oxidation with illuminated titanium dioxide. *J. Environ. Sci. Health A* 31(4), 845-858.
- Bekbolet M., and Balcioglu I. (1996). Photocatalytic degradation kinetics of humic acid in aqueous TiO<sub>2</sub> dispersions: influence of hydrogen peroxide and bicarbonate ion. *Water Science and Technology* 34 (9), 73-80.
- Bekbolet M., Boyacioglu Z. and Ozkaraova B. (1998). The influence of solution matrix on the photocatalytic removal of colour from natural waters. *Water Science and Technology* 38, 155-162.

- Bekbolet M., Suphandag A.S. and Uyguner C.S. (2002). An investigation of photocatalytic efficiencies of TiO<sub>2</sub> powders on the decolourisation of humic acids. *Journal of Photochemistry and Photobiology* 148, 121-128.
- Bems B., Jentoft F.C. and Schlogl R. (1999). Photoinduced decomposition of nitrate in drinking water in the presence of titania and humic acids. *Applied Catalysis B: Environmental* 20, 155-163
- Bellamy L.J. (1975) *The Infra-red Spectra of complex Molecules*, Ed. Chapman and Hall, London
- Bishop P.L. and Kinner N.E. (1986). Aerobic fixed-film processes, Chapter III in "Biotechnology" Vol. 8 ed. Schönborn W. Microbial degradation ed. Rehm H.-J. and Reed G., Weinheim; New York. VCH.
- Blanco J., Malato S., Sanchez M., Vidal A., Sánchez B., in: M.E. Arden, S.M.A. Burley, M. Coleman (Eds.), *Proceedings of the ISES Solar World Congress, Denver, USA*, Pergamon Press, Oxford, (1991) p. 2097.
- Blanco J. and Malato S., in: D. Ollis, H. Al-Ekabi (Eds.), *Photocatalytic Purification and Treatment of Water and Air*, Elsevier, Amsterdam, 1993, p. 639.
- Blanco J., Malato S., Fernandez P., Vidal A., Morales A., Trincado P., Oliveira J.C., Minero C., Musci M., Casalle C., Brunotte M., Tratzky S., Dischinger N., Funken K.-H., Sattler C., Vincent M., Collares-Pereira M., Mendes J.F., and Rangel C.M. (1999). Compound parabolic concentrator technology development to commercial solar detoxification applications. *Solar Energy* 67 (4-6), 317-330.
- Blanco J., Malato S., Fernandez P., Vidal A., Morales A., Trincado P., Oliveira J.C., Minero C., Musci M., Casalle C., Brunotte M., Tratzky S., Dischinger N., Funken K.H., Sattler C., Vincent M., Collares-Pereira M., Mendes J.F. and Rangel C.M. (2000). Compound parabolic concentrator technology development to commercial solar detoxification applications. *Solar Energy* 67(4-6), 317-330.
- Blanco J. and Malato S., (2001). *Solar Detoxification*. UNESCO, natural Sciences, World Solar Programme 1996-2005. Available from <<http://www.unesco.org/science/wsp>>.
- Blake D.M. *Bibliography of work on the photocatalytic removal of hazardous compounds from water and air*. Update Number To June 1995. Update Number 2 To October 1996. Update Number 3 January 1999. National Technical Information Service, US Dept of Commerce, Springfield, USA, 1994, 1995, 1997, 1999.
- Bodzek, M. (1999). Membrane techniques in wastewater treatment, In: *Water Management Purification and Conservation in Arid Climates* (Goosen, M.F.A. and Shayya, W.H. ed.), Technomic Publishing Company, Lancaster-Basel, pp.121-184.
- Bonsen E.M., Schroeter S., Jacobs H. and Broekaert (1997). Photocatalytic degradation of ammonia with TiO<sub>2</sub> as photocatalyst in the laboratory and under the use of solar radiation. *Chemosphere* 35, 1431.

- Boisvert J-Ph., Persello J., Foissy A., Castaing J-Ch. and Cabane B. (2000). Effect of surface charge on the adsorption mode of sodium poly(acrylate) on alumina-coated TiO<sub>2</sub> used as coating pigment, *Colloids Surface A: Physicochemical and Engineering Aspects* 168, 287–296.
- Bouchy M. and Zahraa O. "Photocatalytic reactors" 2<sup>o</sup> European Meeting on/ Solar-Chemistry and Photocatalysis/ Environmental Application Saint-Avold (France) May 29-31, 2002
- Buraczewski G., "Biotechnologia osadu czynnego" "Biotechnology of activated sludge" p. 79. PWN, Warszawa 1994 (*in Polish*)
- Calace N., Capolei M., Lucchese M., and Petronio B.M. (1999). The structural composition of humic compounds as indicator of organic carbon source. *Talanta* 49, 277-284.
- Calace N., Liberatori A., Petroni B.M. and Pietroletto M. (2001). Characteristics of different molecular weight fractions of organic matter in landfill leachate and their role in soil sorption of heavy metals. *Environmental Pollution* 113, 331-339.
- Cassano A. E. and Alfano O. M. (2000). Reaction engineering of suspended solid heterogeneous photocatalytic reactors. *Catalysis Today* 58, 167–197.
- Castagnoli O., Musmeci L., Zavattiero E., Chirio M. (1990). Humic substances and humification rate in a municipal refuse disposed of in a landfill. *Water Air Soil Pollut.* 53, 1–12
- Chan Yi-Ch., Chen J-N. and Lu M-Ch. (2001). Intermediat inhibition in the heterogenous UV-catalysis using a TiO<sub>2</sub> suspension system. *Chemosphere* 45; 29-35.
- Chen P.H. (1996) Assessment of leachates from sanitary landfills: Impact of age, rainfall and treatment. *Environment International* 22 (2), 225-237.
- Chen H.Y., Zahraa O., Bouchy M. (1997). Inhibition of the adsorption and photocatalytic degradation of an organic contaminant in an aqueous suspension of TiO<sub>2</sub> by inorganic ions *Journal of Photochemistry and Photobiology A: Chemistry* 108, 37–44.
- Chen J., Ollis D. F., Rulkens W. H. and Harry Brunking (1999). Kinetic processes of photocatalytic mineralization of alcohols on metallized titanium dioxide, *Water Research* 33 (5), 1173-1180.
- Chen D., Li F. and Ray A. (2001). External and internal mass transfer effect on photocatalytic degradation. *Catalysis Today.* 66, 475-485.
- Cezikova J., Kozler J., Madronova L., Novak J. and Janos P. (2001). Humic acids from coals of the North-Bohemian coal field II. Metal –biding capacity under statistic conditions. *Reactive and Functional Polymers* 47, 111-118.
- Chian E.S.K. and Dewalle F.B. (1976). Sanitary landfill leachate and their treatment. *J. Environ. Eng. Div.* 102, 411-431.
- Chian E.S.K. and DeWalle F.B., (1977). Characterization of soluble organic matter in leachate. *Environ. Sci. Technol.* 11, 158–163.



- Chian E.S.K. (1977). Stability of organic matter in landfill leachates. *Water Research* 11, 225-232.
- Chiu Y-C. and Chung M-S. (2003). Determination of optimal COD/nitrate ratio for biological denitrification. *International Biodeterioration and Biodegradation* 51, 43-49.
- Cho S. P. and Choi W. (2002A). Visible light-induced reactions of humic acids on TiO<sub>2</sub>. *Journal of Photochemistry and Photobiology* 148, 129-135.
- Cho S.P., Hong S.C. and Hong S-I. (2002B). Photocatalytic degradation of the landfill leachate containing refractory matters and nitrogen compounds. *Applied Catalysis B: Environmental* 39, 125-133.
- Cho S-P., Hong S-Ch. and Hong S-I. (2004). Study of the end point of photocatalytic degradation of landfill leachate containing refractory matter. *Chemical Engineering Journal* 98, 245-253.
- Corin N., Backlund P. and Kulovaara M. (1996). Degradation products formed during UV-Irradiation of humic waters. *Chemosphere* 33 (2), 245-255.
- Christensen J.B., Jensen D. L. and Chistensen T.H. (1996). Effect of dissolved organic carbon on the mobility of cadmium, nickel and zinc in leachate polluted groundwater. *Water Research* 30 (12), 3037-3049.
- Christensen J.B., Jensen D.L., Gron Ch., Filip Z. and Chistensen T.H. (1998). Characterisation of dissolved organic carbon in landfill leachat-polluted groundwater. *Water Research* 32 (1), 125-135.
- Christensen T.H., Kjeldsen P., Bjerg P.L., Jensen D. L., Chistensen J.B., Baun A., Albrechtsen H-J., Heron G. (2001) Biogeochemistry of landfill leachate plumes. *Applied Geochemistry* 16, 659-718.
- Chromik A. (2001). Removal of high ammonia concentrations from landfill leachate by using rotating biological contactors. Master Thesis, Silesian University of Technology Environmental Biotechnology Department, Gliwice (*in Polish*).
- Chun H., Yizhong W. and Hongxiao T. (2001). Influence of adsorption on the photodegradation of various dyes using surface bond-conjugated TiO<sub>2</sub>/SiO<sub>2</sub> photocatalyst *Applied Catalysis B: Environmental* 35, 95-105.
- Cunningham J. and Al-Sayyed G. (1990). Factors influencing efficiencies of TiO<sub>2</sub>-sensitised photodegradation. Part 1. Substituted benzoic acids: discrepancies with dark adsorption parameters. *J. Chem. Soc. Faraday Trans.* 86 (23), 3935-3941.
- Cunningham J. and Sedlak P. (1996). Kinetic studies of depollution process in TiO<sub>2</sub> slurries: interdependences of adsorption and UV-intensity. *Catalysis Today* 29, 309-315.
- Cunningham J., Al-Sayyed G., Sedlak P. and Caffrey J. (1999). Aerobic and anaerobic TiO<sub>2</sub>-photocatalysed purifications of waters containing organic pollutants. *Catalysis Today* 53, 145-158.

- Curco D., Malato S., Blanco J., Gimenez J. and Marco P. (1996a). Photocatalytic degradation of phenol: comparison between pilot plant scale and laboratory results. *Solar Energy* 56 (5), 387–400.
- Czepiel P., Douglas E., Harriss R. and Crill P. (1996). Measurements of N<sub>2</sub>O from composted organic wastes. *Environmental Science and Technology* 30, 2519–2525.
- DePaolis F. and Kukkonen J. (1997). Binding of organic pollutants to humic and fulvic acids: Influence of pH and the structure of humic material. *Chemosphere* 34 (8), 1693–1704.
- Dionysiou D.D, Suidan M. T., Bekou E., Baudin I. and Lainé J-M. (2000). Effect of ionic strength and hydrogen peroxide on the photocatalytic degradation of 4-chlorobenzoic acid in water. *Applied Catalysis B: Environmental* 26, 153–171.
- Dupont L., and Foissy A. (1996). Evolution of the adsorption trends of low molecular-weight polyelectrolyte with a site-binding model. *Colloids and Surface A: Physicochemical and Engineering Aspects* 110, 235–248.
- Eckenfelder, W.W., Grau, P. (1992). *Activated sludge process design and control: theory and practice*. Chap. 4. Technomic, Lancaster, Basel.
- Eckenfelder W.W., and Musterman J.L. (1995). *Activated sludge treatment of industrial wastewater*. Chap. 2. :Characterization and pretreatment of industrial wastewater. Technomic, Lancaster, Basel.
- Eckenfelder, W.W., Musterman, J.L. (1995). *Activated sludge treatment of industrial wastewater*. Chap. 15. Technomic, Lancaster, Basel.
- Edeline F. (1987). L'épuration des lixiviats de décharge. *Tribune de l'eau* 566(6), 57-65
- Egli K., Fanger, U., Alvarez P.J.J., Siegrist H., Van der Meer, J.R., and Zehnder, A.J.B. (2001). Enrichment and characterization of an anammox bacterium from a rotating biological contactor treating ammonium-rich leachate. *Arch. Microbiol.* 175, 198–207.
- Eggs B.R., Palmer F.I. and Byrne, J.A. (1997). Photocatalytic treatment of humic substances in drinking water. *Water Research* 31 (5), 1223–1226.
- El-Fadel M., E. Bou-Zeid, Chahine W. and Alayli B. (2002). Temporal variation of leachate quality from pre-sorted and baled municipal solid waste with high organic and moisture content. *Waste Management* 22, 269–282
- Epling G.A. and Lin Ch. (2002). Investigation of retardation effects on the titanium dioxide photodegradation system. *Chemosphere* 46, 937–944.
- Ertuğ T., Hartlieb N., Berns A., Klein W. and Schaeffer A. (2002). Investigations on the binding mechanism of the herbicide simazine to dissolved organic matter in leachates of compost. *Chemosphere* 49, 597–604.
- Fenton H. J. (1884). Oxidative properties of the H<sub>2</sub>O<sub>2</sub>/Fe<sup>2+</sup> system and its application. *Journal of the American Chemical Society* 65, 889–899.

- Fernández-Ibáñez P., Malato S. and de las Nieves F.J. (1999). Relationship between TiO<sub>2</sub> particle size and reactor diameter in solar photoreactors efficiency. *Catalysis Today* 54, 195–204.
- Fernández-Ibáñez P., de las Nieves F. J. and Malato S. (2000). Titanium Dioxide/Electrolyte Solution Interface: Electron Transfer Phenomena. *Journal of Colloid and Interface Science* 227, 510–516.
- Fernández-Ibáñez P., Blanco J., Malato S. and de las Nieves F.J. (2003). Application of the colloidal stability of TiO<sub>2</sub> particles for recovery and reuse in solar photocatalysis. *Water Research* 37, 3180–3188.
- Fujishima A., Rao T. N. and Tryk D.A. (2000). Titanium dioxide photocatalysis. *Journal of Photochemistry and Photobiology C: Photochemistry Reviews* 1, 1–21.
- Fox M.A. (1988). Photocatalytic oxidation of organic substrates. In: Schiavello, M. Ed. , *Photocatalysis and Environment*. Kluwer Academic Publishers, Dordrecht, pp. 445–467.
- Friedman A.A., Robbins L.E., Woods R.C. and Wauford, J.R. (1979). Effect of disk rotational speed on biological contactors efficiency. *J. Water Pollut. Control Fed.* 51, 2678–2690.
- Geenens D., Bixio B., and Thoeye C. (2001). Combined ozone-activated sludge treatment of landfill leachate. *Water Science and Technology* 44 (2-3), 359–365.
- Ghosh K. and Schnitzen M. (1980) Macromolecular structure of humic substances (1980). *Soil Science* 129 (5), 266-276.
- Giles C. H., D'Silva A. P., and Easton I. A. (1974). A general treatment and classification of the solute adsorption isotherm Part II. Experimental interpretation, *J. Colloid Interface. Sci.* 47, 766–778.
- Ghyoot W., Vandaele S. and Verstraete W. (1999). Nitrogen removal from sludge reject water with a membrane-assisted bioreactor. *Water Research* 33 (1), 23-32.
- Graaf Van de A.A., Mulder A., Bruijn P., de Jetten M.S.M. and Kuenen J.G. (1996). Anaerobic ammonium oxidation is a biologically mediated process. *Applied Environmental Microbiology* 61, 1246-1250.
- Graaf Van de, A.A., De Bruijn, P., Robertson, L.A., Jetten, M.S.M. and Kuenen, J.G. (1996) Autotrophic growth of anaerobic ammonium-oxidizing micro-organisms in a fluidized bed reactor. *Microbiology UK* 142, 2187-2196.
- Graetzel M. (1988). Photocatalysis with colloidal semiconductors and polycrystalline films. In: Schiavello, M. Ed., *Photocatalysis and Environment*. Kluwer Academic Publishers, Dordrecht, pp. 367–398.
- Goswami D.Y. (1997). A review of engineering developments of aqueous phase solar photocatalytic detoxification and disinfection processes. *J. Solar Energy Eng*, 101–107.
- Guillard Ch., Lachheb H., Houas A., Ksibi M., Elaloui E. and Herrmann J.-M. (2003). Influence of chemical structure of dyes, of pH and of inorganic salts on their photocatalytic

- degradation by TiO<sub>2</sub> comparison of the efficiency of powder and supported TiO<sub>2</sub>. *Journal of Photochemistry and Photobiology A: Chemistry* 158, 27–36.
- Gupta, S.K. and Sharma, R. (1996). Biological oxidation of high strength nitrogenous wastewater. *Water Research* 30 (3), 593-600.
- Gupta, A.B. and Gupta, S.K. (1999). Simultaneous carbon and nitrogen removal in a mixed culture aerobic RBC biofilm. *Water Research* 33 (2), 555–561.
- Hanaki, K., Wantawin C. and Ohgaki, S. (1990). Effects of the activity of heterotrophes on nitrification in suspended-growth reactor. *Water Research* 24 (3), 289-296.
- Hanaki K., Hong Z. and Matsuo T. (1992). Production of nitrous oxide gas during denitrification of wastewater. *Water Science and Technology* 26 (5–6), 1027–1036.
- Harmsen J. (1983). Identification of organic compounds in leachate from a waste tip. *Water Research* 17, 699-705.
- Harrington D.W. and Maris J.P. (1986). The treatment of leachate: a UK perspective. *Water Pollution Control* 45-56.
- Helmer Ch. and Kunst (1998). Simultaneous nitrification/denitrification in an aerobic biofilm system. *Water Science and Technology* 37(4-5), 183-187.
- Heavey M. (2003). Low-cost treatment of landfill leachate using peat. *Waste Management* 23, 447–454.
- Hellinga C., Schellen A.A.J.C., Mulder J.W., Van Loosdrecht M.C.M. and Heijnen J.J. (1998). The SHARON process: an innovative method for nitrogen removal from ammonium-rich waste water. *Water Science Technology* 37, 135-142.
- Helmer Ch. and Kunst (1998) Simultaneous nitrification/denitrification in an aerobic biofilm system. *Water Science and Technology* 37(4-5), 183-187.
- Henze M., Harremoës P., la Cour Jansen J., and Arvin E. *Wastewater Treatment: Biological and Chemical Processes*, Springer Verlag, (2001) translated by Żygadło M, and Bartkiewicz B. *Oczyszczanie ścieków. Procesy biologiczne i chemiczne* Politechnika Świętokrzyska, Kielce 2002, ISBN 83-88906-10-0, p.254.
- Henze, M. and Harremoës, P. (1977). Biological denitrification of sewage: A literature review. *Progress in Water Technology* 8 (6/7), 509-555.
- Henry J.G., Prasad D. and Young, H. (1987) Removal of organics from leachate by anaerobic filter. *Water Research* 21 (11), 1395-1399.
- Hermanowicz M., Dozanska W., Dojlido J. and Koziorkowski B. (1976). Physical and chemical water and wastewater examination, Arkady, Warszawa (*in Polish*)
- Herrmann J-M. (1999). Heterogeneous photocatalysis: fundamentals and applications to the removal of various types of aqueous pollutants *Catalysis Today* 53, 115–129.

- Herrmann J.M.; Matos J., Disdier J., Guillard Ch., Laine J., Malato S. and Blanco J. (1999A). Solar photocatalytic degradation of 4-chlorophenol using the synergistic effect between titania and activated carbon in aqueous suspension. *Catalysis Today* 54, 255-265.
- Huang C.P., Dong C. and Tang Z. (1993). Advanced chemical oxidation: its present role and potential future in hazardous waste treatment. *Waste Manage.* 13, 361-377.
- Hulstrom R., Bird R. and Riordan C. (1985) Spectral solar irradiance data sets for selected terrestrial conditions. *Solar Cells*, 15: p. 365-391.
- Ilies P., and Mavinic D.S. (2001). The effect of decreased ambient temperature on the biological nitrification and denitrification of a high ammonia landfill leachate. *Water Research* 35(8), 2065-2072.
- Im. J-H., Woo H-J., Choi M-W., Han K-B., and Kim Ch-W. (2001). Simultaneous organic and nitrogen removal from municipal landfill leachate using an anaerobic-aerobic system. *Water Research* 35(10) 2403-2410.
- Jacangelo J. G., DeMarco J., Owen D. M. and Randtke S. J. (1995). Selected processes for removing NOM. *J. AWWA* 87(1), 64-77.
- Jensen D. L. and Chistensen T.H. (1999). Colloidal and dissolved metals in leachates from four Danish landfills. *Water Research* 33 (9), 2139-2147.
- Jokela J.P.Y., Kettunen R.H., Sormunen K.M. and Rintala J.A. (2002). Biological nitrogen removal from municipal landfill leachate: low-cost nitrification in biofilters and laboratory scale in-situ denitrification. *Water Research* 36, 4079-4087.
- Jones M.N., Bryan N. D. (1998). Colloidal properties of humic substances. *Advances in Colloid and Interface Science* 78, 1 -48.
- Kang Y.H. and Hwang K-Y. (2000). Effects of reaction conditions on the oxidation efficiency in the Fenton process. *Water Research* 34(10), 2786-2790.
- Kang K-H, Shin H.S. and Park H. (2002). Characterization of humic substances present in landfill leachates with different landfill ages and its implications. *Water Research* 36, 4023-4032.
- Kargi F. and Pamukoglu M.Y. (2003). Simultaneous adsorption and biological treatment of pre-treated landfill leachate by fed-batch operation. *Process Biochemistry* 38, 1413-1420.
- Karrer N.J., Ryhiner G. and Heinzl E. (1997). Applicable test for combined biological-chemical treatment of wastewaters containing biorefractory compounds. *Water Research* 31(3), 1013-1020.
- Kim S.-M., Geissen S.-U. and Vogelpohl A. (1997). Landfill leachate treatment by a photoassisted Fenton reaction. *Water Science and Technology*. 35, 239-248.
- Kim K. E. and Walker W. (2001). Effect of cationic polymer additives on the adsorption of humic acid onto iron oxide particles. *Colloids and Surfaces A: Physicochemical and Engineering Aspects* 194, 123-131.

- Klöcking, R. In: Humic Substance in the Global Environment and Implications on Human Health, Senesi, M. and Miano T.M. Eds, Elsevier Science B.V., 1994, pp 1245-1257.
- Koh I-O., Chen-Hamacher X., Hicke K. and Thiemann W. (2004). Leachate treatment by the combination of photochemical oxidation with biological process *Journal of Photochemistry and Photobiology A: Chemistry* 162 261–271.
- Kormann C., Bahnemann D. and W and Hoffmann M. R. (1991). Photolysis of chloroform and other organic molecules in aqueous TiO<sub>2</sub> suspensions. *Environ. Sci. Technol* 25, 494-500.
- Kreller D.I., Gibson G., Novak W., Gary W., Van Loon J., and Horton H. (2003). Competitive adsorption of phosphate and carboxylate with natural organic matter on hydrous iron oxides as investigated by chemical force microscopy. *Colloids and Surfaces A: Physicochem. Eng. Aspects* 212, 249-264.
- Kumar S. and Davis A.P. (1997). Heterogenous photocatalytic oxidation of nitrotoluenes. *Water Environ. Res.* 69, 1238-1245.
- Langmuir I. (1915). Chemical reaction at low temperature. *Journal of the American Chemical Society* 37, 1139 – 1167.
- Lassen P. and Carlsen L. (1997). Solubilization of phenanthrene by Humic acids. *Chemospher* 34(4), 817-825.
- Lee, H.S., Park, S.J., and Yoon, I.T. (2002). Wastewater treatment in a hybrid biological reactor using powdered minerals: effect of organic loading rate on COD removal and nitrification. *Process Biochemistry* 38, 81-88.
- Lee Ch-L., Kuo L-J., Wang H-L., Hsieh P-Ch (2003). Effects of ionic strength on the binding of phenanthrene and pyrene to humic substances: three-stage variation model *Water Research* 37, 4250–4258.
- Legrini O., Oliveros E. and Braun A.M. (1993). Photochemical processes for water treatment *Chemical Reviews* 93, 671-98.
- Li X.Z., Fan C.M. and Sun Y.P. (2002). Enhancement of photocatalytic oxidation of humic acid in TiO<sub>2</sub> suspensions by increasing cation strength. *Chemosphere* 48, 453–460.
- Litter M. (1999). Heterogeneous photocatalysis Transition metal ions in photocatalytic systems *Applied Catalysis B: Environmental* 23, 89–114.
- Lopez A., Pagano M., Volpe A. and Di Pinto A. C. (2004). Fenton's pre-treatment of mature landfill leachate. *Chemosphere* 54, 1005–1010.
- Loukidou, M.X. and Zouboulis, A.I., (2001). Comparison of two biological treatment processes using attached-growth biomass for sanitary landfill leachate treatment. *Environmental Pollution* 111(2), 273-281.
- Lu M.C., Roam G.D. and Chen J.N. (1993). Factors affecting the photocatalytic degradation of dichlorovos over titanium-dioxides supported on glass. *J. Photochem. Potobiol: A*, 76, 103-110.

- Malato S., Blanco J., Richter C. and Vincent M. (1996). Photocatalytic degradation of industrial residual waters. *Solar Energy* 56(5), 401–410.
- Malato S., Blanco J., Maldonado M.I., Fernandez-Ibanez P. and Campos A. (2000A). Optimising solar photocatalysis mineralization of pesticides by adding inorganic oxidising species; application to the recycling of pesticide containers. *Environmental* 28 163-174.
- Malato S., Blanco J., Richter C. and Maldonado M. I. (2000B). Optimization of pre-industrial solar photocatalytic mineralization of commercial pesticides application to pesticide container recycling. *Applied Catalysis B: Environmental* 25, 31–38.
- Malato S., Blanco J., Richter C., Fernandez P. and Maldonado M.I. (2000C). Solar photocatalytic mineralization of commercial pesticides: oxamyl. *Solar Energy Mater Solar Cells* 64, 1–14.
- Malato S., Blanco J., Vidal A., and Richter Ch. (2002). Photocatalysis with solar energy at a pilot-plant scale: an overview *Applied Catalysis B: Environmental* 37 1–15.
- Marco A., Esplugas S. and Saum G. (1997). How and why combine chemical and biological processes for wastewater treatment. *Water Science and Technology* 35(4), 321-327.
- Martin S., Herrmann H. and Hoffmann M. (1994). Time-resolved microwave conductivity, Part 2. Quantum sized TiO<sub>2</sub> and the effect of adsorbates and light intensity on charge-carrier dynamics. *J. Chem. Soc. Faraday Trans.* 90(21), 3323-3330.
- Metcalf and Eddy, Inc. (1991). *Wastewater Engineering: Treatment, Disposal, and Reuse* McGraw-Hill, Inc., New York, NY. ISBN 0-07-100824-1
- Martienssen M. (2000). Simultaneous catalytic detoxification and biodegradation of organic peroxides during the biofilm process. *Water Research* 34 (16), 3917-3926.
- Martinen S.K., Kettunen R.H. and Rintala J.A. (2003). Occurrence and removal of organic pollutants in sewages and landfill leachates. *The Science of the Total Environment* 301, 1-12.
- Mills A. and Morris S. (1993). Photomineralization of 4-chlorophenol sensitized by titanium dioxide: a study of the initial kinetics of carbon dioxide photogeneration. *Journal of Photochemistry and Photobiology A: Chemistry* 71, 75-83.
- Mills A. and Le Hunte S. (1997). An overview of semiconductor photocatalysis *Journal of Photochemistry and Photobiology A: Chemistry* 108, 1-35.
- Mills A. and Lee S-K. (2002). A web-based overview of semiconductor photochemistry-based current commercial applications *Journal of Photochemistry and Photobiology A: Chemistry* 152 (2002) 233–247.
- Minero C., Pelizzetti E., Malato S. and Blanco J. (1993). Large solar plant photocatalytic water decontamination: degradation of pentachlorophenol. *Chemosphere* 26, 2103–2119.
- Minero C., Pelizzetti E., Malato S. and Blanco J. (1996). Large solar plant photocatalytic water decontamination: degradation of atrazine. *Solar Energy* 56(5), 411–419.

- Mohseni-Bandpi A. and Elliott D.J. (1999). Groundwater denitrification with alternative carbon sources. *Water Science and Technology* 38 (6), 237-243.
- Mohseni-Bandpi A., Elliott D.J. and Momeny -Mazdeh A. (1999). Denitrification of groundwater using acetic acid as a carbon source. *Water Science and Technology* 40 (2), 53-59.
- Morawe B., Ramteke D.S. and Vogelpohl A. (1995). Activated carbon column performance studies of biologically treated landfill leachate. *Chem. Eng. Process* 34, 299-303.
- Muller, E.B., Stouthamer, A.H., van Verseveld, H.W., (1995). A novel method to determine maximal nitrification rates by sewage sludge at a non-inhibitory nitrite concentration applied to determine maximal rates as function of the nitrogen loaded. *Water Research* 29(4), 1191-1197.
- Nanny M.A. and Ratasuk N. (2002). Characterization and comparison of hydrophobic neutral and hydrophobic acid dissolved organic carbon isolated from three municipal landfill leachates. *Water Research* 36, 1577-1584.
- Nozik A.J. (1978). Photoelectrochemistry: applications to solar energy conversion. *Annu. Rev. Phys. Chem.* 29, 189-222.
- Ødegaard H., Eikebrokk B. and Storhaug R. (1999) Processes for the removal of humic substances from water- an overview based on Norwegian experiences. *Water Science and Technology* 40(9), 37-46.
- Ollis D.F. (1991). Solar-assisted photocatalysis for water purification: issues, data, questions, in *Photochemical conversion and storage of solar energy*, Kluwer Academic Publishers. p. 593-622.
- Ollis D.F. and H.A. Ekabi, *Photocatalytic purification and treatment of water and air*, in: EDS, Elsevier, Amsterdam, 1993.
- Ollis D.F., Al-Ekabi H. (Eds.), *Photocatalytic Purification and Treatment of Water and Air*, Elsevier, Amsterdam, 1993
- Palmer F.L., Eggins B. R., and Coleman H.M. (2002). The effect of operational parameters on the photocatalytic degradation of humic acid. *Journal of Photochemistry and Photobiology A: Chemistry* 148, 137-143.
- Palmisano L., (1988) *New Journal of Chemistry* 12, 847-854.
- Parra S., Malato S. and Pulgarin C. (2002). New integrated photocatalytic-biological flow system using supported TiO<sub>2</sub> and fixed bacteria for the mineralization of isoproturon. *Applied Catalysis B: Environmental* 36, 131-144.
- Peters A. (1998). Purification of landfill leachate with reverse osmosis and nanofiltration. *Desalination* 119, 289-293.
- Pichat P., in *Handbook of heterogeneous photocatalysis*, eds. G. Ert, H. Knözinger and J. Weitkamp, VCH-Wiley, Weinheim, 1997, p. 2111



- Piscopo A., Robert D., Weber J.V. (2000). Influence de l'adsorption sur la cinétique de photodégradation de composés organiques. *Entropie* 28, 27-30.
- Piscopo A., Robert D. and Weber J.V. (2001). Influence of pH and chloride anion on the photocatalytic degradation of organic compounds Part I. Effect on the benzamide and *para*-hydroxybenzoic acid in TiO<sub>2</sub> aqueous solution *Applied Catalysis B: Environmental* 35, 117–124.
- Piscopo A. (2002). Chimie solaire et traitements photocatalytiques des eaux polluées : applications aux traitements sélectifs et exemples d'utilisation de catalyseurs supportés. PhD. Thesis, Université de Metz Laboratoire de Chimie et Applications à Saint-Avold (*in French*).
- Poitel D., Courant P., Primi C. and Mandin JM. (1999). Various leachate treatment plants in France. *Proceedings of The Seventh International Landfill Symposium, SARDINIA* pp. 135-142 , available on ([http://www.sb.ltu.se/at/Sardinia\\_99/S99%20P/Poitel.pdf](http://www.sb.ltu.se/at/Sardinia_99/S99%20P/Poitel.pdf)).
- Pulgarin C.; Invernizzi M., Parra S., Sarria V., Polania R. and Péringer P. (1999). Strategy for the coupling of photochemical and biological flow reactors useful in mineralization of biorecalcitrant industrial pollutants. *Catalysis Today* 54, 341–352.
- Rajeshwar K. (1995). Photoelectrochemistry and the environmental. *J. Appl. Electrochem.* 25, 1067.
- Rasmussen, M. R., Larsen, T., and Claus, F. (1996). Improving settling dynamics of activated sludge by adding talc powder. *Water Science and Technology*, 34, (5-6), 11-18.
- Rivas F. J., Beltran F., Gimeno O., Acedo B., and Carvalho F. (2003). Stabilized leachates: ozone-activated carbon treatment and kinetics. *Water Research* 37, 4823–4834.
- Robertson P. (1996). Semiconductor photocatalysis: an environmentally acceptable alternative production technique and effluent treatment process. *J. Cleaner Prod.* 4(3-4), 203-212.
- Robert D., Piscopo A., Heintz O. and Weber J.V. (1999). Photocatalytic detoxication with TiO<sub>2</sub> supported on glass-fibre by using artificial and natural light. *Catal. Today* 54 291-296
- Robert D., Parra S., Pulgarin C., Krzton A., and Weber J.V., (2000). Chemisorption of phenols and acids on TiO<sub>2</sub> surface. *Applied Surface Science* 167, 51- 58.
- Romero M., Blanco J., Sanchez B., Vidal A., Malato S., Cardona A. and Garcia E. (1999). Solar photocatalytic degradation of water and air pollutants: Challenges and perspectives. *Solar Energy* 66 (2), 169–182.
- Rosik-Dulewska Cz. (1999). „Principles of waste management” Eds: Ekoinżynieria, Lublin. Podstawy gospodarki odpadami. Wydawnictwo Ekoinżynieria, Lublin (*in Polish*)
- Roston W.D. Stuckey D. C. and Young A.A. (2001). Nitrification of high strength ammonia wastewaters/comparative study of immobilization media; *Water Research* 35(5), 1169-1178
- Sarria V., Kenfack S., Guillod O. and Pulgarin C. (2003). An innovative coupled solar-biological system at field pilot scale for the treatment of biorecalcitrant pollutants *Journal of Photochemistry and Photobiology A: Chemistry* 159, 89–99

- Scott J.P. and Ollis D.F. (1995). Integration of chemical and biological oxidation processes for water treatment. Review and recommendations. *Environmental Progress* 14, 88–110.
- Schlichter B., Mavrov V. and Chmiel H. (2003). Study of a hybrid process combining ozonation and membrane filtration - filtration of model solutions *Desalination* 156 257-265.
- Schmidt I., Sliemers O., Schmid M., Bock E., Fuerst J., Kuenen G.J., Jetten M.S.M., and Strous M. (2003). New concepts of microbial treatment processes for the nitrogen removal in wastewater. *FEMS Microbiology Reviews* 27, 481-492.
- Schönborn (1986) Historical developments and ecological fundamentals, Chapter 1 in "Biotechnology" Vol. 8 ed. Schönborn W. Microbial degradation ed Rehm H.-J. and Reed G., Weinheim; New York. VCH.
- Schönborn M.A.A., Yong Xu, Daniel R. Strongin A. (1998). An introduction to geocatalysis. *Journal of Geochemical Exploration* 62, 201–215.
- Schwarz P. F., Turro N. J., Bossmann S. H., Braun A. M., Abdel Wahab A.-M. and Duerr H. (1997). A new method to determine the generation of hydroxyl radicals in illuminated TiO<sub>2</sub> suspensions. *The Journal of Physical Chemistry: B* 101(36), 7127-7134.
- Siegrist H., Reithaar S., and Lais P., (1998). Nitrogen loss in nitrifying rotating contactor treating ammonium rich leachate without organic carbon. *Water Science and Technology* 37 (4-5), 589-591.
- Seka, A. M., von de Wiele, T., and Verstraete, W. (2001). Feasibility of a multi-component additive for efficient control of activated sludge filamentous bulking. *Water Research* 35 (12), 2995-3003.
- Serpone N., Sauvé G., Koch R., Tahiri S., Pichat P., Piccinni P., Pelizzetti E. and Hidaka H. (1996) Standardisation protocol of process efficiencies and activation parameters in heterogeneous photocatalysis: relative photonic efficiencies  $\zeta$ . *Journal of Photochemistry and Photobiology A: Chemistry*. 95, 191-203.
- Serpone N. (1997). Relative photonic efficiencies and quantum yields in heterogeneous photocatalysis *Journal of Photochemistry and Photobiology A: Chemistry* 104, 1-12.
- Serpone N. and Emeline A. V. (2002). Suggested terms and definitions in photocatalysis and radiocatalysis. *International Journal of Photoenergy* 4, 91-131.
- Sher M.I., Arbuckle W.B. and Shen Z. (2000). Oxygen uptake rate inhibition with PACT sludge. *Journal of Hazardous Materials B* 73, 129–142.
- Shin H-S., Monsallier J.M. and Choppin G.R. (1999). Spectroscopic and chemical characterization of molecular size fractionated humic acid. *Talanta* 50, 641-647.
- Shiskowski D.M. and Mavinic D.S. (1998). Biological treatment of a high ammonia leachate: influence of external carbon during initial start-up. *Water Research* 32 (8), 2533-2541.
- Shuval H. I. and Gruner N. (1977). Infant methaemoglobinaemia and other health effects of nitrates in drinking water. *Prog. Water Technol.* 8, 183-193.

- Smith B., Higgs J.J.W., Moody P., Davis J.R., Williams G.M. and Warwick P. (1991). Comparative study of humic substance in groundwater. The extraction of humic material from Drigg groundwater and a study of its ability to form complexes with cobalt and nickel. British Geological Survey. Nottingham, Technical Report WE/90/43.
- Spengel D.B. and Dzombak D.A. (1991). Treatment of landfill leachate with rotating biological contractors: beach-scale experiments. *Research Journal Water Pollution Control Fed* 63 (7), 971-981.
- Steensen M. (1997). Chemical oxidation for the treatment of leachate – process comparison and results from full-scale plants. *Water Science and Technology* 35, 249-256.
- Stevenson F.J. (1976) Stability constants of  $\text{Cu}^{2+}$ ,  $\text{Pb}^{2+}$ ,  $\text{Cd}^{2+}$  complexes with humic acids *Soil Sci. Soc. Am. J.* 40, 665-672.
- Stevenson F.J. (1982). *Humus Chemistry: Genesis, Composition, Reactions*. Wiley, New York.
- Stevenson F.J. Geochemistry of soil humic substances. In: Aiken GR, McKnight DM, Wershaw RL, MacCarthy P, editors. *Humic substances in soil, sediment and water*. New York: Wiley-Interscience, 1985. pp. 13– 52.
- Strous M., van Gerven E., Zheng P., Kuenen J.G. and Jetten M.S.M. (1997). Ammonium removal from concentrated waste streams with anaerobic ammonium oxidation (Anammox) process in different reactor configurations. *Water Research* 31 (8), 1995-1962.
- Strous M., Kuenen J.G. and Jetten M.S.M. (1999). Key physiology of anaerobic ammonium oxidation. *Appl. Environ. Microbiol.* 65, 3248-3250.
- Schulten H.R. and Schnitzer M., (1993). State of the art structural concept of a humic acid. *Naturwissenschaften* 80, 29-30.
- Surmacz-Górska, J., Cichoń, A. and Miksch, K. (1997). Nitrogen removal from wastewater high ammonia nitrogen concentration via shorter nitrification and denitrification in wastewater. *Water Science and Technology* 36 (10), 73-78.
- Surmacz-Górska, J., Miksch, K., Kita, T., Kita, M. (1999). Combined – chemical and biological treatment of landfill leachates. *Proceedings of the Third International Wastewater Conference*, pp. 123-129, Teplice.
- Surmacz-Gorska J. (2001). *Degradation of organic compounds in municipal landfill leachate*. Publishers of Environmental Engineering Committee of Polish Academy of Sciences, Lublin ISBN 83-915874-3-6 (*in Polish*).
- Sykora J. (1997). Photochemistry of copper complexes and their environmental aspects. *Coordination Chemistry Reviews* 159, 95-108.
- Taborda A.V., Brusa M.A. and Grela M.A. (2001). Photocatalytic degradation of phthalic acid on  $\text{TiO}_2$  nanoparticles. *Applied Catalysis A: General* 208, 419–426.
- Tatsi A.A., Zouboulis A.I., Matis K.A. and Samaras P. (2003). Coagulation–flocculation pre-treatment of sanitary landfill leachates. *Chemosphere* 53, 737–744.

- Thrumann E.M. and Malcolm R.L. (1981). Preparative isolation of aquatic humic substances. *Environment Science and Technology* 15, 463-466.
- Trebouet D., Schlumpf J.P., Jaouen P. and Quemeneur F. (2001). Stabilized landfill leachate treatment by combined physicochemical-nanofiltration processes. *Water Research* 35, 2935-2942.
- Turk O. and Mavinic D.S. (1987). Benefits of using selective inhibition to remove nitrogen from highly nitrogenous wastes. *Environmental Technology Letter* 8, 419-426.
- Turk O. and Mavinic D. S. (1989) Influence of process changes on maintaining nitrite build-up in activated sludge system acclimated to free ammonia. *Water Research* 23 (11), 1383-1388.
- Ushikoshi K., Kobayashi T., Uematsu K., Toji A., Kojima D. and Matsumo K. (2002). Leachate treatment by the reverse osmosis system *Desalination* 150, 121-129.
- Vautier M., Guillard Ch. and Herrmann J-M. (2001). Photocatalytic degradation of dyes in water: Case study of indigo and of indigo carmine. *Journal of Catalysis* 201, 46-59.
- Verstraete W. and van Vaerenbergh E. (1986). Aerobic Activated Sludge, Chapter 2 in "Biotechnology" Vol. 8 ed. Schönborn W. Microbial degradation ed Rehm H.-J. and Reed G., Weinheim; New York. VCH.
- Vidal A., D'Áz A.I., El Hraiki A., Romero M., Muguruza I., Senhaji F. and Gonzalez J. (1999). Solar photocatalysis for detoxification and disinfection of contaminated water: pilot plant studies. *Catalysis Today* 54, 183-290.
- Vulliet E., Emmelin C., Chovelon J-M., Guillard Ch, and Herrmann J-M, (2002) Photocatalytic degradation of sulfonylurea herbicides in aqueous TiO<sub>2</sub>. *Applied Catalysis B: Environmental* 38, 127-137.
- Wang K.H., Hsieh Y.H. and Chen L.J. (1998). The heterogenous photocatalytic degradation, intermediates and mineralization for the aqueous solution of cresols and nitrophenols. *J. Hazard. Mater.* 59, 251-260.
- Wang Y., Hong Ch-S. and Fang F. (1999). Effect of solution matrix on TiO<sub>2</sub> photocatalytic degradation of 2-Chlorobiphenyl. *Environmental Engineering Science* 16(6), 433-440.
- Wang Y., and Hong C.S. (2000A). TiO<sub>2</sub>-mediated photomineralization of 2-chlorobiphenyl : the role of O<sub>2</sub>. *Water Research*, 34(10), 2791-2797.
- Wang K-H., Hsieh Y-H, Wu Ch-H. and Chang Ch-Y. (2000B). The pH and anion effects on the heterogenous photocatalytic degradation of o-methylbenzoic acid in TiO<sub>2</sub> aqueous suspension. *Chemosphere* 40, 389-394.
- Wang G-S, Hsieh S-T., and Hong C-S., (2000C). Destruction of humic acid in water by UV light-catalyzed oxidation with hydrogen peroxide. *Water Research* 34 (15), 3882-3887.
- Wang Z-P., Zhang Z., Lin Y.-J., Deng N.-S., Tao T. and Zhuo K. (2002) Landfill leachate treatment by a coagulation-photooxidation process. *Journal of Hazardous Materials B* 95, 153-159

- Watanabe Y., Okabe S., Hirata K. and Masuda S. (1995). Simultaneous removal of organic materials and nitrogen by micro-aerobic biofilms. *Water Science and Technology* 31 (1), 195-203.
- WEDECO UV-Verfahrenstechnik (WEDECO). 1998. Letter Regarding Case Studies on WEDECO UV Oxidation Process. From Horst Sprengel. To Kumar Topudurti, Environmental Engineer, Tetra Tech EM Inc. April 21.
- Welander, U., Henrysson, T., and Welander, T. (1997). Nitrification of landfill leachate suspended-carrier biofilm technology. *Water Research* 31 (9), 2351-2355.
- Welander, U., Henrysson, T., and Welander, T. (1998). Biological nitrogen removal from municipal landfill leachate in a pilot scale suspended carrier biofilm. *Water Research* 32(5), 1564-1570.
- Weber B. and Holz F. (1991). Landfill leachate treatment by reverse osmosis, In *Effective Industrial Membrane Processes: Benefits and Opportunities* (Tuner, M.K., ed.), Elsevier Applied Science, London-New York, pp. 143-154.
- Wenzel A., Gahr A. and Niessner R. (1999). TOC-removal and degradation of pollutants in leachate using a thin-film photoreactor. *Water Research* 33, 937-946.
- Wiszniewski J., Robert D., Surmacz-Gorska J., Miksch K., Weber J-V. (2002). Photocatalytic decomposition of humic acids on TiO<sub>2</sub> Part I: Discussion of adsorption and mechanism. *Journal of Photochemistry and Photobiology A: Chemistry* 152, 267-273.
- Wiszniewski J., Robert D., Surmacz-Gorska J., Miksch K., Weber J-V. (2003). Photocatalytic mineralization of humic acids with TiO<sub>2</sub>: Effect of pH, sulphate and chloride anions. *International Journal of Photoenergy* 5, 69-73.
- Wiszniewski J., Robert D., Surmacz-Gorska J., Miksch K., Weber J-V. Photocatalysis of the organic compounds originated from landfill leachate – pilot plant experiments. Proceedings of the IHP Programme “Research results at “Plataforma Solar de Almeria” within the year 2002, Access Campaign”. Serie Ponencias, Ciemat, Madrid, 2003, pp. 43-50. ISBN: 84-7834-446-2
- Yalmaz G. and Öztürk I., (2001). Biological ammonia removal from anaerobically pre-treated landfill leachate in sequencing batch reactors (SBR). *Water Science and Technology* 43(3), 307-314.
- Yoon J., Cho S., Cho Y. and Kim, S. (1998). The characteristics of coagulation of Fenton reaction in the removal of landfill leachate organics. *Water Science and Technology* 38, 209-214.
- Zang F., Zhao J., Shen T., Pelizzeti E. and Serpone N. (1998). TiO<sub>2</sub>-assisted photodegradation of dye pollutants: II adsorption and degradation kinetics of eosin in TiO<sub>2</sub> dispersions under visible light irradiation. *Appl. Catal. B* 15, 156-174.
- Zhu H., Manping Z., Zongfeng X., and Low G.K.C, (1995). Titanium dioxide mediated photocatalytic degradation of monocrotophos. *Water Research*. 29, 2681-2688.

Zouboulisa A.I., Chaib X-L. and Katsoyiannis I.A. (2004). The application of bioflocculant for the removal of humic acids from stabilized landfill leachates. *Journal of Environmental Management* 70, 35–41.

#### Web site

[www.cwirfc.com](http://www.cwirfc.com) (*R2000 Solar Oxidation Facility*)

[info@purifics.com](mailto:info@purifics.com) (*Photo-Cat® system*)

<http://www.ekoenergia.pl/pdf/slonce.htm>

<http://www.oieau.fr/> (*service guide section- Cartel internet site*)

<http://www.anammox.com/references.html>

[http://www.wedecouv.de/en/produkte/industriewasser\\_ozon.htm](http://www.wedecouv.de/en/produkte/industriewasser_ozon.htm)

[http://www.phelpstek.com/clients/humic\\_acid.html](http://www.phelpstek.com/clients/humic_acid.html) (*Bio-Liquid Complex*)

<http://www.psa.es/webeng/instalaciones/quimica.html>)

#### Regulations concerning discharges from waste water

Water Framework Directive: the Drinking Water Directive 80/778/EEC safeguarding human health by establishing strict standards for the quality of water intended for human consumption;

Dangerous Substances Directive 76/464/EEC and its daughter Directives controlling pollution of surface waters with dangerous substances from industrial installations;

Integrated Pollution Prevention and Control Directive 96/61/EEC controlling pollution of surface water with dangerous substances from large industrial installations.

Urban Waste Water Treatment Directive 91/271/EEC controlling pollution, in particular, eutrophication of surface water with nutrients (particularly nitrogen and phosphorus) from urban waste water;

Nitrates Directive 91/676/EEC controlling nitrate pollution from agricultural sources, complementing the

Urban Waste Water Treatment Directive and the Bathing Water Directive 76/160/EEC safeguarding the health of bathers and maintaining the quality of bathing waters.

Regulatory Polish authority standards for discharge of wastewaters- „Rozporządzenie Ministra Środowiska” z dnia 29 listopada 2002 r. w sprawie warunków, jakie należy spełnić przy wprowadzaniu ścieków do wód lub do ziemi oraz w sprawie substancji szczególnie szkodliwych dla środowiska wodnego (Dz. U. 02.212.1799 z dnia 16 grudnia 2002 r.)

Statute of 27 April 2001 on Wastes - (Ustawa z dnia 27 kwietnia 2001 r o odpadach) Dz.U. 2001 no 62 item 628

1999/31/EC Council Directive of 26 April 1999 on the landfill of waste. Official Journal of the European Communities L 182(1), <http://europa.eu.int/>.

## CURRICULUM VITAE

### PERSONAL DATA

---

Name: Jarosław Wiszniowski  
 Born: January 11<sup>th</sup> 1975, Gliwice, Poland (29 years old)  
 Marital status: Married  
 Address: Nowy Swiat 14f/2, Gliwice, Poland  
 Fax: +48322372946  
 Telephone: +48322372896

### FORMAL HIGHER EDUCATION

---

- 1999-2004 (in October) Ph.D. in Environmental Biotechnology Department, Silesian University of Technology (Poland) and since 2001 in Laboratoire de Chimie et Applications "Procédés Propres et Environnement" of University of Metz (France)  
 Dissertation Title: "Combination of the biological and the photocatalytic methods in the process of municipal landfill leachate treatment".
- 1994-1999 M.S. in Environmental Biotechnology Department, Silesian University of Technology (Poland), M.Sc. Title: "Treatment of landfill leachate from municipal landfill using an activated sludge method".

### RESEARCH INTERESTS AND SKILLES

---

- Environmental biotechnology
- Biological nutrient removal from wastewaters
- Combined techniques for municipal and industrial wastewater treatment
- Landfill leachate treatment by biological and advanced oxidation processes (UV/TiO<sub>2</sub> photocatalysis)

Have a good knowledge of "wet" analysis in water and wastewater such as TKN, ammonium, nitrite and nitrate nitrogen, phosphate etc., COD, BOD<sub>5</sub>, OUR (*oxygen uptake rate*), respiratory activity tests (TTC, INT) in activated sludge; familiar with UV/Vis, FTIR (basic level), HPLC-UV (intermediate level), IC (basic level).

Languages: Polish (mother tongue), French (advanced level), and English (intermediate level)

### PUBLICATIONS

---

1. Wiszniowski J., Surmacz-Górska J., Miksch K. Variable composition of landfill leachate treated with biomass of activated sludge.– Proceedings of 7<sup>th</sup> Polish Symposium on „Environmental Biotechnology” in Wisła, December 4-7, (2001), Poland, pp.121-135. (*in Polish*)
2. Wiszniowski J.; Robert D. Preliminary experiments with photocatalytical decomposition of humic acids as a model of refractory compounds coming from landfill leachates”. 4-7 grudnia 2001. Proceedings of 7<sup>th</sup> Polish Symposium on „Environmental Biotechnology” in Wisła, December 4-7, (2001), Poland, pp. 149-160. (*in Polish*)
3. Wiszniowski J., Robert D., Surmacz-Gorska J., Miksch K., Weber J-V. Photocatalytic decomposition of humic acids on TiO<sub>2</sub> Part I: Discussion of adsorption and mechanism. *Journal of Photochemistry and Photobiology A: Chemistry* 152, (2002), 267-273.
4. Wiszniowski J., Robert D., Surmacz-Gorska J., Miksch K., Weber J-V. Photocatalytic mineralization of humic acids with TiO<sub>2</sub>: Effect of pH, sulphate and chloride anions. *International Journal of Photoenergy* 5, (2003), 69-73.

5. Wiszniowski J., Robert D., Surmacz-Gorska J., Miksch K., Weber J-V. Photocatalysis of the organic compounds originated from landfill leachate – pilot plant experiments. Proceedings of the IHP Programme “Research results at “Plataforma Solar de Almeria” within the year 2002, Access Campaign”. Serie Ponencias, Ciemat, Madrid, (2003), pp. 43-50. ISBN: 84-7834-446-2.
6. Wiszniowski J., Robert D., Surmacz-Gorska J., Miksch K., Malato S., and Weber J-V. Solar photocatalytic degradation of humic acids as a model of organic compounds of landfill leachate in pilot plant experiments: influence of inorganic salts. (*Accepted to Applied Catalysis: B Environmental* 2004).
7. Wiszniowski J., Robert D., Surmacz-Gorska J., Miksch K., Weber J-V. Variable composition of landfill leachates treated with immobilised biomass of activated sludge. (*Submitted to Chemosphere*).

### **ORAL PRESENTATIONS IN INTERNATIONAL CONFERENCES**

---

„Photocatalytic decomposition of humic acids with TiO<sub>2</sub> in aqueous solution” „2<sup>nd</sup> European Meeting on Environment Chemistry” in Dijon, 12-15 December 2001, France

„Formation of organic carbon source for the microbial denitrification of leachates by photocatalytic decomposition of humic acids” „2<sup>nd</sup> European Meeting on: „Solar –Chemistry and Photocatalysis: Environmental Applications” in Saint-Avoid, Mai 29-31, 2002, France.

“Treatment of wastewater containing humic acids by photocatalysis at laboratory and pilot-plant scales” 3<sup>rd</sup> European Meeting on Solar Chemistry and Photocatalysis: Environmental Applications, in Barcelona, 30 June and 1, 2 July 2004 (Spain)

#### **Co-author**

“Utilisation de la photocatalyse heterogene pour le traitement des lixivats de decharges municipales” “Journées scientifiques du Groupe PHOTOCHIMIE de la Société Française de Chimie. Paris 6-7 November 2003, France.

“Nitrogen removal from wastewater by means of heterotrophic denitrification assisted by nitrification or deamonification in rotating biological contactor”, Ecological Aspects of Denitrification, with Emphasis on Agliculture, 2<sup>nd</sup> Scientific Meeting Marburg March 25-28, 2004, Germany.

### **PARTICIPATION IN UE PROGRAMS, GRANTS**

---

Scholarship of French Government “Training stay” in Laboratory of Chemistry and Applications University of Metz (LCA) in France – 1 months in 1999

Bilateral project between Environmental Biotechnology Department and Laboratory of Chemistry and Applications University of Metz, within Programme Polonium 2001-2002 « Polonium » research project-“ Couplage des methods biologiques et photocatalytique dans les processus d’épuration des lixivitas de decharges municipales” - Ministère des Affaires Etrangères (France), KBN (State Committee for Scientific Research) (Poland) - 2 months in the year 2001.

Scholarship of French Government “Cotutelle de thèse” 2001-2004 in Laboratory of Chemistry and Applications University of Metz, - 15 months since 2001

“Improving Human Potential” Programme, (European Union Enhancing Access to Research Infrastructures) at “Plataforma Solar de Almeria” (Spain). The contract number: (HPRI – CT – 1999 – 00013) - 2 months in 2002



## CURRICULUM VITAE

### PERSONAL DATA

Name: Jarosław Wiszniowski  
 Born: January 11<sup>th</sup> 1975, Gliwice, Poland (29 years old)  
 Marital status: Married  
 Address: Nowy Swiat 14f/2, Gliwice, Poland  
 Fax: +48322372946  
 Telephone: +48322372896

### FORMAL HIGHER EDUCATION

- 1999-2004 (in October) Ph.D. in Environmental Biotechnology Department, Silesian University of Technology (Poland) and since 2001 in Laboratoire de Chimie et Applications "Procédés Propres et Environnement" of University of Metz (France)  
 Dissertation Title: "Combination of the biological and the photocatalytic methods in the process of municipal landfill leachate treatment".
- 1994-1999 M.S. in Environmental Biotechnology Department, Silesian University of Technology (Poland), M.Sc. Title: "Treatment of landfill leachate from municipal landfill using an activated sludge method".

### RESEARCH INTERESTS AND SKILLES

- Environmental biotechnology
- Biological nutrient removal from wastewaters
- Combined techniques for municipal and industrial wastewater treatment
- Landfill leachate treatment by biological and advanced oxidation processes (UV/TiO<sub>2</sub> photocatalysis)

Have a good knowledge of "wet" analysis in water and wastewater such as TKN, ammonium, nitrite and nitrate nitrogen, phosphate etc., COD, BOD<sub>5</sub>, OUR (*oxygen uptake rate*), respiratory activity tests (TTC, INT) in activated sludge; familiar with UV/Vis, FTIR (basic level), HPLC-UV (intermediate level), IC (basic level).

Languages: Polish (mother tongue), French (advanced level), and English (intermediate level)

### PUBLICATIONS

1. Wiszniowski J., Surmacz-Górska J., Miksch K. Variable composition of landfill leachate treated with biomass of activated sludge.– Proceedings of 7<sup>th</sup> Polish Symposium on „Environmental Biotechnology” in Wisła, December 4-7, (2001), Poland, pp.121-135. (*in Polish*)
2. Wiszniowski J.; Robert D. Preliminary experiments with photocatalytical decomposition of humic acids as a model of refractory compounds coming from landfill leachates”. 4-7 grudnia 2001. Proceedings of 7<sup>th</sup> Polish Symposium on „Environmental Biotechnology” in Wisła, December 4-7, (2001), Poland, pp. 149-160. (*in Polish*)
3. Wiszniowski J., Robert D., Surmacz-Gorska J., Miksch K., Weber J-V. Photocatalytic decomposition of humic acids on TiO<sub>2</sub> Part I: Discussion of adsorption and mechanism. *Journal of Photochemistry and Photobiology A: Chemistry* 152, (2002), 267-273.
4. Wiszniowski J., Robert D., Surmacz-Gorska J., Miksch K., Weber J-V. Photocatalytic mineralization of humic acids with TiO<sub>2</sub>: Effect of pH, sulphate and chloride anions. *International Journal of Photoenergy* 5, (2003), 69-73.

5. Wiszniewski J., Robert D., Surmacz-Gorska J., Miksch K., Weber J-V. Photocatalysis of the organic compounds originated from landfill leachate – pilot plant experiments. Proceedings of the IHP Programme “Research results at “Plataforma Solar de Almeria” within the year 2002, Access Campaign”. Serie Ponencias, Ciemat, Madrid, (2003), pp. 43-50. ISBN: 84-7834-446-2.
6. Wiszniewski J., Robert D., Surmacz-Gorska J., Miksch K., Malato S., and Weber J-V. Solar photocatalytic degradation of humic acids as a model of organic compounds of landfill leachate in pilot plant experiments: influence of inorganic salts. (*Accepted to Applied Catalysis: B Environmental* 2004).
7. Wiszniewski J., Robert D., Surmacz-Gorska J., Miksch K., Weber J-V. Variable composition of landfill leachates treated with immobilised biomass of activated sludge. (*Submitted to Chemosphere*).

### **ORAL PRESENTATIONS IN INTERNATIONAL CONFERENCES**

---

„Photocatalytic decomposition of humic acids with TiO<sub>2</sub> in aqueous solution” „2<sup>nd</sup> European Meeting on Environment Chemistry” in Dijon, 12-15 December 2001, France

„Formation of organic carbon source for the microbial denitrification of leachates by photocatalytic decomposition of humic acids” „2<sup>nd</sup> European Meeting on: „Solar –Chemistry and Photocatalysis: Environmental Applications” in Saint-Avold, Mai 29-31, 2002, France.

“Treatment of wastewater containing humic acids by photocatalysis at laboratory and pilot-plant scales” 3<sup>rd</sup> European Meeting on Solar Chemistry and Photocatalysis: Environmental Applications, in Barcelona, 30 June and 1, 2 July 2004 (Spain)

#### **Co-author**

“Utilisation de la photocatalyse heterogene pour le traitement des lixivats de decharges municipales” “Journées scientifiques du Groupe PHOTOCHIMIE de la Société Française de Chimie. Paris 6-7 November 2003, France.

“Nitrogen removal from wastewater by means of heterotrophic denitrification assisted by nitrification or deamonification in rotating biological contactor”, Ecological Aspects of Denitrification, with Emphasis on Agliculture, 2<sup>nd</sup> Scientific Meeting Marburg March 25-28, 2004, Germany.

### **PARTICIPATION IN UE PROGRAMS, GRANTS**

---

Scholarship of French Government “Training stay” in Laboratory of Chemistry and Applications University of Metz (LCA) in France – 1 months in 1999

Bilateral project between Environmental Biotechnology Department and Laboratory of Chemistry and Applications University of Metz, within Programme Polonium 2001-2002 « Polonium » research project-“ Couplage des methods biologiques et photocatalytique dans les processus d’épuration des lixivitas de decharges municipales” - Ministère des Affaires Etrangères (France), KBN (State Committee for Scientific Research) (Poland) - 2 months in the year 2001.

Scholarship of French Government “Cotutelle de thèse” 2001-2004 in Laboratory of Chemistry and Applications University of Metz, - 15 months since 2001

“Improving Human Potential” Programme, (European Union Enhancing Access to Research Infrastructures) at “Plataforma Solar de Almeria” (Spain). The contract number: (HPRI – CT – 1999 – 00013) - 2 months in 2002

## CURRICULUM VITAE

### PERSONAL DATA

---

Name: Jarosław Wiszniowski  
 Born: January 11<sup>th</sup> 1975, Gliwice, Poland (29 years old)  
 Marital status: Married  
 Address: Nowy Swiat 14f/2, Gliwice, Poland  
 Fax: +48322372946  
 Telephone: +48322372896

### FORMAL HIGHER EDUCATION

---

- 1999-2004 (in October) Ph.D. in Environmental Biotechnology Department, Silesian University of Technology (Poland) and since 2001 in Laboratoire de Chimie et Applications "Procédés Propres et Environnement" of University of Metz (France)  
 Dissertation Title: "Combination of the biological and the photocatalytic methods in the process of municipal landfill leachate treatment".
- 1994-1999 M.S. in Environmental Biotechnology Department, Silesian University of Technology (Poland), M.Sc. Title: "Treatment of landfill leachate from municipal landfill using an activated sludge method".

### RESEARCH INTERESTS AND SKILLES

---

- Environmental biotechnology
- Biological nutrient removal from wastewaters
- Combined techniques for municipal and industrial wastewater treatment
- Landfill leachate treatment by biological and advanced oxidation processes (UV/TiO<sub>2</sub> photocatalysis)

Have a good knowledge of "wet" analysis in water and wastewater such as TKN, ammonium, nitrite and nitrate nitrogen, phosphate etc., COD, BOD<sub>5</sub>, OUR (*oxygen uptake rate*), respiratory activity tests (TTC, INT) in activated sludge; familiar with UV/Vis, FTIR (basic level), HPLC-UV (intermediate level), IC (basic level).

Languages: Polish (mother tongue), French (advanced level), and English (intermediate level)

### PUBLICATIONS

---

1. Wiszniowski J., Surmacz-Górska J., Miksch K. Variable composition of landfill leachate treated with biomass of activated sludge.– Proceedings of 7<sup>th</sup> Polish Symposium on „Environmental Biotechnology” in Wisła, December 4-7, (2001), Poland, pp.121-135. (*in Polish*)
2. Wiszniowski J.; Robert D. Preliminary experiments with photocatalytical decomposition of humic acids as a model of refractory compounds coming from landfill leachates”. 4-7 grudnia 2001. Proceedings of 7<sup>th</sup> Polish Symposium on „Environmental Biotechnology” in Wisła, December 4-7, (2001), Poland, pp, 149-160. (*in Polish*)
3. Wiszniowski J., Robert D., Surmacz-Gorska J., Miksch K., Weber J-V. Photocatalytic decomposition of humic acids on TiO<sub>2</sub> Part I: Discussion of adsorption and mechanism. *Journal of Photochemistry and Photobiology A: Chemistry* 152, (2002), 267-273.
4. Wiszniowski J., Robert D., Surmacz-Gorska J., Miksch K., Weber J-V. Photocatalytic mineralization of humic acids with TiO<sub>2</sub>: Effect of pH, sulphate and chloride anions. *International Journal of Photoenergy* 5, (2003), 69-73.

5. Wiszniewski J., Robert D., Surmacz-Gorska J., Miksch K., Weber J-V. Photocatalysis of the organic compounds originated from landfill leachate – pilot plant experiments. Proceedings of the IHP Programme “Research results at “Plataforma Solar de Almeria” within the year 2002, Access Campaign”. Serie Ponencias, Ciemat, Madrid, (2003), pp. 43-50. ISBN: 84-7834-446-2.
6. Wiszniewski J., Robert D., Surmacz-Gorska J., Miksch K., Malato S., and Weber J-V. Solar photocatalytic degradation of humic acids as a model of organic compounds of landfill leachate in pilot plant experiments: influence of inorganic salts. (*Accepted to Applied Catalysis: B Environmental* 2004).
7. Wiszniewski J., Robert D., Surmacz-Gorska J., Miksch K., Weber J-V. Variable composition of landfill leachates treated with immobilised biomass of activated sludge. (*Submitted to Chemosphere*).

### **ORAL PRESENTATIONS IN INTERNATIONAL CONFERENCES**

---

„Photocatalytic decomposition of humic acids with TiO<sub>2</sub> in aqueous solution” „2<sup>nd</sup> European Meeting on Environment Chemistry” in Dijon, 12-15 December 2001, France

„Formation of organic carbon source for the microbial denitrification of leachates by photocatalytic decomposition of humic acids” „2<sup>nd</sup> European Meeting on: „Solar –Chemistry and Photocatalysis: Environmental Applications” in Saint-Avold, Mai 29-31, 2002, France.

“Treatment of wastewater containing humic acids by photocatalysis at laboratory and pilot-plant scales” 3<sup>rd</sup> European Meeting on Solar Chemistry and Photocatalysis: Environmental Applications, in Barcelona, 30 June and 1, 2 July 2004 (Spain)

#### **Co-author**

“Utilisation de la photocatalyse heterogene pour le traitement des lixivats de decharges municipales” “Journées scientifiques du Groupe PHOTOCHIMIE de la Société Française de Chimie. Paris 6-7 November 2003, France.

“Nitrogen removal from wastewater by means of heterotrophic denitrification assisted by nitrification or deamonification in rotating biological contactor”, Ecological Aspects of Denitrification, with Emphasis on Agliculture, 2<sup>nd</sup> Scientific Meeting Marburg March 25-28, 2004, Germany.

### **PARTICIPATION IN UE PROGRAMS, GRANTS**

---

Scholarship of French Government “Training stay” in Laboratory of Chemistry and Applications University of Metz (LCA) in France – 1 months in 1999

Bilateral project between Environmental Biotechnology Department and Laboratory of Chemistry and Applications University of Metz, within Programme Polonium 2001-2002 « Polonium » research project-“ Couplage des methods biologiques et photocatalytique dans les processus d’épuration des lixivitas de decharges municipales” - Ministère des Affaires Etrangères (France), KBN (State Committee for Scientific Research) (Poland) - 2 months in the year 2001.

Scholarship of French Government “Cotutelle de thèse” 2001-2004 in Laboratory of Chemistry and Applications University of Metz, - 15 months since 2001

“Improving Human Potential” Programme, (European Union Enhancing Access to Research Infrastructures) at “Plataforma Solar de Almeria” (Spain). The contract number: (HPRI – CT – 1999 – 00013) - 2 months in 2002