



**HAL**  
open science

# Measuring and modeling light, water and carbon budgets and net primary productivity in a coffee-based agroforestry system of Costa Rica

Fabien Charbonnier

► **To cite this version:**

Fabien Charbonnier. Measuring and modeling light, water and carbon budgets and net primary productivity in a coffee-based agroforestry system of Costa Rica. *Silviculture, forestry*. Université de Lorraine, 2013. English. NNT : 2013LORR0218 . tel-01750514

**HAL Id: tel-01750514**

**<https://hal.univ-lorraine.fr/tel-01750514>**

Submitted on 29 Mar 2018

**HAL** is a multi-disciplinary open access archive for the deposit and dissemination of scientific research documents, whether they are published or not. The documents may come from teaching and research institutions in France or abroad, or from public or private research centers.

L'archive ouverte pluridisciplinaire **HAL**, est destinée au dépôt et à la diffusion de documents scientifiques de niveau recherche, publiés ou non, émanant des établissements d'enseignement et de recherche français ou étrangers, des laboratoires publics ou privés.



## AVERTISSEMENT

Ce document est le fruit d'un long travail approuvé par le jury de soutenance et mis à disposition de l'ensemble de la communauté universitaire élargie.

Il est soumis à la propriété intellectuelle de l'auteur. Ceci implique une obligation de citation et de référencement lors de l'utilisation de ce document.

D'autre part, toute contrefaçon, plagiat, reproduction illicite encourt une poursuite pénale.

Contact : [ddoc-theses-contact@univ-lorraine.fr](mailto:ddoc-theses-contact@univ-lorraine.fr)

## LIENS

Code de la Propriété Intellectuelle. articles L 122. 4

Code de la Propriété Intellectuelle. articles L 335.2- L 335.10

[http://www.cfcopies.com/V2/leg/leg\\_droi.php](http://www.cfcopies.com/V2/leg/leg_droi.php)

<http://www.culture.gouv.fr/culture/infos-pratiques/droits/protection.htm>



Collegium Sciences & Technologies  
Ecole Doctorale Ressource Procédés, Produits, Environnement  
D.F.D Biologie Végétale Forestière

## Thèse

Présentée en vue de l'obtention du titre de  
Docteur de l'Université de Lorraine  
Spécialité : Biologie Végétale et Forestière

par **Fabien Charbonnier**

### **Mesure et modélisation des bilans de lumière, d'eau, de carbone et de productivité primaire nette dans un système agroforestier à base de caféier au Costa Rica**

### **Measuring and modeling light, water and carbon balance and net primary productivity in a coffee-based agroforestry system of Costa Rica**

Soutenance publique le 19 décembre 2013

Membres du Jury :

M. Daniel EPRON	Professeur	Université de Lorraine, Nancy	Président du jury
M. Denis LOUSTAU	Directeur de Recherches	INRA, Bordeaux	Rapporteur
M. Philippe TIXIER	Chercheur (HDR)	CIRAD, Montpellier	Rapporteur
Mme Belinda MEDLYN	Professeur	MacQuarie U. Sydney, Australia	Examinatrice
M. Christian Dupraz	Ingénieur de Recherches	INRA, Montpellier	Examinateur
M. Erwin DREYER	Directeur de Recherches	INRA/ Université de Lorraine, Nancy	Directeur de thèse
M. Olivier ROUPSARD	Chercheur (HDR)	CIRAD, Montpellier	Co-directeur de thèse

---

CIRAD-Persyst, UMR Ecologie Fonctionnelle and Biogéochimie des Sols et Agroécosystèmes, Montpellier.

UMR Ecologie et Ecophysiologie Forestières (EEF) INRA-Université de Lorraine F 54280 Champenoux

*A mes parents*

*A Nereyda et Julia*

---

# Preface

---

This manuscript presents the PhD work the author did within the *UMR Ecologie Fonctionnelle et Biogéochimie des Sols et Agroécosystèmes* team (CIRAD) based in the *Centro Agronómico Tropical de Investigación y Enseñanza* (CATIE) in Turrialba, Costa Rica. This work was funded by a CIRAD grant and supported by EU-CAFNET Project, SOERE F-ORE-T observatory network, ANR-Ecosfix project, ANR-MACACC project, PCP platform of CATIE, BID Fontagro Caf'Adapt project. Field experiments were done in a coffee based agroforestry system within the “Coffee-Flux” platform located in the “Finca Aquiares”.

This manuscript is a thesis by publication composed of 4 scientific papers, including one already published. The document begins with an extended abstract in French, the rest is written in English. **The first chapter is a synthesis** of current knowledge and scientific gaps in modeling above-ground interactions in agroforestry systems and a justification of the modeling choices we have done in this thesis. The **second chapter** is the study of the spatial and temporal variability of light interactions between coffee plants and shade trees, using MAESTRA/MAESPA (a 3D light interception model) parameterized and verified in our experimental setup (**Article A**). The **third chapter** studies the determinants of coffee plants net primary productivity using intensive field measurements together with modeled outputs as explanatory variables: shade tree transmittance and plant light budgets (**Article B**). The **fourth chapter** aims at verifying modeled carbon and water exchanges by MAESPA against plant and plot scale fluxes measurements in order to study the spatial variability of photosynthesis, transpiration, light use efficiency and transpiration efficiency (**Article C**). A **last annexed chapter** studies specifically the different functional roles of leaf area index in a coffee agroforestry watershed (**Article D**):

**Article A** : Charbonnier, F., le Maire, G., Dreyer, E., Casanoves, F., Christina, M., Dauzat, J., Eitel, J.U.H., Vaast, P., Vierling, L.A., Roupsard, O., 2013. Competition for light in heterogeneous canopies: Application of MAESTRA to a coffee (*Coffea arabica* L.) agroforestry system. *Agricultural and Forest Meteorology* 181, 152-169.

**Article B** : Charbonnier, F., Roupsard, O., Casanoves, F., le Maire, G., Lacoite, A., Clément-Vidal, A., Jourdan, C., Audebert, L., Defresnet, E., Cambou, A., Khac, E., Barquero, A., Leandro, P., Van den Meersche, K., Alline, C., Avelino, J., Saint-André, L., Vaast, P., Dreyer, E., Increased light use efficiency of coffee under shade trees compensates for ANPP but not for fruiting. To be submitted to *Journal of Experimental Botany*.

**Article C** : Charbonnier, F., Roupsard, O., Dreyer, E., Bonnefond, J.M., Christina, M., Jarri, L., Siles, P., Rapidel, B., Harmand, J.M., Vaast, P., Nouvellon, Y., Robelo, A., le Maire, G., Modeling the intra-plot variability of Light and Water Use efficiencies in a 2-layered heterogeneous coffee (*Coffea arabica* L.) agroforestry system. To be submitted to Plant, Cell & Environment.

**Article D** : Taugourdeau, S., Le Maire, G., Avelino, J., Jones, J.R., Ramirez, L.G., Jara Quesada, M., Charbonnier, F., Gomez Delgado, F., Harmand, J.M., Rapidel, B., Vaast, P., Roupsard, O., 2013. Leaf Area Index as an indicator of Ecosystem Services and management practices in coffee agroforestry. Agriculture, Ecosystem, Environment (under major revision, oct. 2013).

During his PhD work, the author made one oral presentation at an international conference:

**Charbonnier, F., Roupsard, O., Dreyer, E., Le Maire, G., 2012.** Using the MAESTRA model to simulate light interactions and photosynthesis in a heterogeneous agroforestry system, 30th AMS Conference on Agricultural and Forest Meteorology. American Meteorological Society, Boston, MA.Oral Presentation.

The author co-supervised the work of two MSc students:

Audebert, L., 2011. Productivité aérienne du café agroforestier: effets de l'ombrage et de l'âge des rejets, Biologie et Ecologie pour la Forêt, l'Agronomie et l'Environnement. Master II. UHP Nancy I, Nancy, France, 25 pp + Annexes.

Defrenet, E., 2012. Evaluation de la biomasse et de la productivité souterraines du caféier dans un système agroforestier au Costa Rica. Master II Productions Végétales option Ingénierie des Agrosystèmes. Agrocampus Ouest Rennes-France. 29 pp + Annexes

---

# Acknowledgements

---

First I wish to thank Olivier Roupsard, my thesis co-director, for welcoming me in the “Coffee-flux” team and sharing with me his passion and experience during a little bit more than 3 years. You have always been a very insightful thesis director and human person, and you stimulated me a lot through your high scientific expectations. I want to thank you for allowing me to be part of an outstanding field experiment that is quite unique in terms of measurement intensity and variety. I also want to express my gratitude to Muriel and you for being so friendly and helpful to my family and me.

The experience of Erwin Dreyer, my thesis director, was of inestimable importance especially regarding the didactic of scientific writing and more generally on the scientific approach. I learned a lot from your very efficient proof reading.

I want to extend my thanks to Dr Denis Loustau and Philippe Tixier for acting as *rapporteur* for this PhD work as well as to Dr Christian Dupraz and Dr Belinda Medlyn for participating in this jury as *examaniteurs*.

My gratitude goes above all to Guerric le Maire who patiently initiated me to MAESTRA, Matlab, and to the philosophy of modeling in general. Guerric has been one of the main pillars in this thesis, without his help, this work would have been really, really different... Thank you Guerric for your astounding support !

I want to thank especially Philippe Vaast who first believed in my scientific capacity and raised my interest in science: he initiated me to coffee ecophysiology, agroforestry and hydrological fluxes in India. Thank you Philippe !

I wish to thank the CIRAD for funding my PhD, UMR Eco & Sols for welcoming me and CATIE for the logistical support. Special thanks go to Jean-Michel Harmand and H el ene Guillemain for their help and support at the UMR Eco&Sols direction; as well as John Beer and Eduardo Somarriba at the agroforestry department in CATIE. The financial support for this thesis was provided by EU-CAFNET Project, SOERE F-ORE-T observatory network, ANR-Ecosfix project, ANR-MACACC project, PCP platform of CATIE and BID Fontagro Caf Adapt project.

I wish to thank my “thesis comity”: Anne Cl ement-Vidal, Christophe Jourdan, Andr e Lacointe, Guerric le Maire, Philippe Thaler, and Philippe Vaast. The two meetings we had were always very supportive and insightful.

I want to thank the international *Lee-Dare team* Jean Dauzat, Jan Eitel, Lee Vierling, Guerric and Olivier. During an intensive week, we compared different methods to assess LAI. For me, it has been one of most enthusiastic and effervescent moment of science blitz!

My gratitude goes to Fernando Casanoves who helped a lot for the statistical design of the experimental plot and for statistical analysis especially linear mixed models.

Thanks to the Aquiares farm for welcoming and supporting this experiment

Estoy muy agradecido a la familia Barquero. Además de ser amigos sinceros, hicieron un trabajo inmenso en el experimento “Coffee-Flux”. Álvaro Barquero Aguilar cuidó el dispositivo experimental con mucha dedicación. Alejandra Barquero Aguilar fue una piedra angular de este trabajo, muy poco hubiera sido hecho sin ella. *Muchas gracias Ale!* Mis pensamientos van a Doña Gladis que desapareció demasiado temprano.

Alejandra Barquero Aguilar, Jenny Barquero Aguilar, Cindy Rojas Aguillar, Mariella Jara Vargas, Carlos Calvo Barquero hicieron un trabajo paciente y increíblemente dedicado en la medición de la productividad de los cafetales. Gracias a Grace Granados para su dedicación en las mediciones de flujos de gases a la escala de la hoja.

Thank you to all the students I had the chance to work with: Louise Audebert & coffee plant NPP, Elsa Defrenet to look closer at the below-ground world, Laura Jarri & leaf gas exchanges, Ana Deffner & plant transpiration, Aurélie Cambou & non-structural carbohydrates, Junior Perez Molina & soil/root respiration, Manu Khac & coffee plant plasticity, Mathias Christina & MAESPA.

In CATIE, I want to thank Patricia Leandro for her help providing lab facilities.

Special thanks to the CIRAD members in Costa Rica for the discussions and their friendship. Clémentine Alline, Jacques Avelino, Bruno Rapidel, Philippe Tixier, Karel Van den Meersche. Thanks to the other PhD students in CATIE for mutual support and friendship: Louise Meylan, Carlos Cerdan, Laura Benegas, Federico Gomez-Delgado. Thanks to all CATIE students I met during those years.

I have a thought to Patrick Gallard who gave me very early the taste of tropical agronomy through his inspiring stories.

Plus que tout, je voudrais remercier mes parents d’avoir cru en moi et de m’avoir supporté toutes ces années. Sans vous, je n’aurais pas fait ni la moitié du chemin.

Gracias más que todo a mis dos amores, a mis dos fuentes de fuerza, Nereyda amor de mi vida et Julia ce merveilleux bébé qui a grandi si vite en deux ans. Gracias Nere por apoyarme, siempre. Julia j’espère que tu me pardonneras d’avoir été si souvent absent cette dernière année. De hecho, fue una tesis para los tres !

Finally, thanks to Karen not to turn into a tropical cyclone just above Yucatan peninsula while I was 1 month from delivering this manuscript.



---

# Résumé étendu

---

Les systèmes agroforestiers (SAF) sont appelés à prendre une place importante dans la transition d'une agriculture actuelle hautement consommatrice en intrants vers une agriculture s'inspirant des mécanismes écologiques. En effet, cette transition commence à être sérieusement comprise comme une nécessité au regard des pressions inégalées qui vont s'exercer sur l'agriculture de demain: nourrir une population mondiale de 9 milliards d'habitants en 2050 dans un contexte d'épuisement des ressources énergétiques abondantes et bon marché, et ce sous un climat globalement dérégulé.

Les avantages attendus pour les SAF par rapport aux monocultures sont i) leur capacité à mieux utiliser les ressources des systèmes (lumière, eau, nutriments) ; ii) leur capacité à tamponner les effets du climat sur la culture en améliorant le microclimat (par exemple, la température de l'air est lissée sous ombrage). Ces avantages sont généralement conceptuellement séparés en termes d'effets de **facilitation** (ex: arbres fixateurs d'azote, etc.) ou de **complémentarité** (ex : systèmes racinaires colonisant le sol en profondeur pour les arbres et en surface pour la culture). Dans le même temps, certains mécanismes de **compétitions** pour la ressource entre les arbres et les cultures peuvent contrebalancer de manière temporaire ou permanente les avantages de l'association. Pour évoquer cet équilibre entre interactions positives et négatives, on peut dire que la compétition entre les arbres d'ombrage et la culture pour l'acquisition d'une ressource peut être **plus ou moins compensée** par les effets de facilitation/complémentarité. Le concept de surface équivalente assolée sert à mesurer l'effet global de l'association agroforestière sur le rendement de la parcelle comparé au rendement de 2 parcelles en assolement (l'une avec la culture principale, l'autre avec la plantation forestière). Cette approche pertinente est néanmoins peu généralisable du fait de l'incommensurable diversité des SAF (en terme d'espèces, de structures, de conditions bioclimatiques, de gestion, etc.) et du fait de la nature lourde des dispositifs expérimentaux nécessaires à cette évaluation.

Des approches basées sur la modélisation ont été recommandées afin de formaliser les connaissances sur les interactions en jeu dans les SAF et leurs effets sur la productivité des systèmes. De plus, ces approches doivent permettre de simuler des conditions sortant des gammes généralement observées comme dans le cadre du changement climatique (ex : augmentation des températures, réduction de la disponibilité en eau, augmentation de concentration en CO<sub>2</sub> de l'atmosphère ou leurs combinaisons exprimées à des niveaux inhabituels).

Les interactions entre arbres et cultures dans les SAF sont par nature complexes du fait de la présence d'au minimum 2 couches de végétation. Il en résulte un microclimat particulier pour la culture de sous-étage: quantité de lumière réduite et dont le spectre est modifié, flux d'énergie réduits, profils de vent altérés. Ces modifications microclimatiques ont un effet certain sur les principaux processus

physiologiques de la culture à l'ombre : modification de la photosynthèse, de la respiration et de la transpiration. Cependant, les relations entre microclimat et processus physiologiques sont généralement non linéaires et résultent d'interaction entre les processus. Les conséquences du microclimat sur les processus physiologiques de la culture sont donc souvent contre-intuitifs. Leur compréhension nécessite l'utilisation de modèles mécanistes décrivant le plus finement possible les liens entre phénomènes physiques et biologiques. Les choix présidant au niveau de description de ces processus dépendent i) de la complexité du système (système homogène horizontalement vs. système en 3D) ; ii) du niveau de limitations de l'écosystème (un écosystème très humide ne nécessite pas *a priori* une modélisation fine de la disponibilité en eau du sol par exemple) et iii) de la généralité du modèle (qu'il s'adapte ou non dans des situations différentes).

Dans ce manuscrit, nous étudions les processus de capture de la lumière, d'acquisition du carbone, de transpiration et de productivité primaire nette aérienne (ANPP) d'un système agroforestier à base de caféier et d'*Erythrina poeppigiana* (Fabacées) dans la Vallée Centrale du Costa Rica où le climat est tropical humide sans saison sèche marquée. Le SAF est caractérisé par de grands arbres en croissance libre plantés à faible densité qui introduisent une variabilité intra-parcelle forte en termes de rayonnement et d'énergie transmis à la couche de caféiers. De plus, la couche de caféiers est elle-même caractérisée par une forte hétérogénéité spatiale du fait de la taille, une pratique culturale nécessaire pour le recépage de caféiers devenus trop grands et improductifs. Nous insistons ici sur l'importance de la prise en compte de la variabilité intra-parcelle des SAF, du point de vue du gestionnaire de la parcelle.

Nous avons choisi d'appliquer MAESPA, un modèle mécaniste (basé sur des processus) décrivant les couronnes des arbres et des caféiers en 3D comme des formes géométriques simplifiées. MAESPA simule l'interception de la lumière, la photosynthèse et la transpiration, et le bilan d'énergie entre le sol, les plantes et l'atmosphère. Bien que MAESPA simule aussi le bilan hydrique de la parcelle, celui-ci ne sera pas utilisé dans ce travail.

Les objectifs de cette thèse sont :

- de vérifier la capacité de MAESPA à simuler de manière satisfaisante la variabilité intra-parcelle de l'interception lumineuse, de la photosynthèse et de la transpiration de la couche de caféiers, ainsi l'efficacité d'utilisation de la lumière et l'efficacité de transpiration ;
- de décrire et d'identifier les déterminants de la variabilité spatiale/saisonnnière de la lumière disponible, de la photosynthèse et de la transpiration de l'efficacité d'utilisation de la lumière de la couche de la culture principale, le caféier ;
- de proposer une approche alliant expérimentation et modélisation pour identifier les déterminants de la variabilité spatiale de la NPP aérienne des caféiers.

### **Variabilité spatiale et saisonnière de la lumière disponible et implications agronomiques**

Une parcelle de caféier agroforestier de 2.7 ha a été décrite finement à partir d'inventaires de la plantation avant et après recépage afin de paramétrer MAESPA. L'évolution de l'indice de surface foliaire (LAI) des caféiers et arbres d'ombrage a été suivie de manière précise à partir d'estimations indirectes optiques. Des mesures plus précises d'un échantillon représentatif de caféiers et d'*Erythrina* ont été entreprises afin de caractériser la répartition des angles foliaires et de répartition des surfaces foliaires dans les couronnes. Un certain nombre de placettes positionnées à différentes distances des *Erythrina* ont été décrites assez finement et équipées de capteurs quantiques au-dessus et en dessous de la couche de caféier. De même des mesures de transmittance angulaire (3 angles zénithaux) ont été effectuées le long de transects dans la parcelle à différentes saisons (LAI contrastés) grâce à un analyseur de canopée (LAI2000, Li-COR).

La comparaison des simulations et des mesures de transmittance au-dessus et en-dessous des caféiers était satisfaisante (RRMSE<26%) ce qui indiquait que i) la représentation des *Erythrina* et des caféiers comme des couronnes de formes géométriques simplifiées était adéquate; ii) que les surfaces foliaires des caféiers et des *Erythrina* ont été correctement paramétrées et iii) que chacune des 2 couches était bien représentée. La comparaison satisfaisante (RRMSE=9%) des mesures de transmittance angulaires à différentes saisons a permis de mettre en évidence la simulation correcte par MAESPA i) des distributions des angles foliaires et des surfaces foliaires dans la couronne, ii) de la croissance progressive des couronnes et donc de la fermeture de la canopée au cours de la saison. Nous avons comparé la qualité de la prédiction de MAESPA avec des études similaires de la littérature, et nous avons montré que les adéquations entre mesures et prédictions pour des systèmes à une seule couche étaient assez similaires avec celles rapportées dans notre étude.

Une fois la paramétrisation correcte de MAESPA vérifiée, nous avons donc pu étudier la variabilité spatiale et saisonnière de la lumière absorbée par les différentes couches. Les *Erythrina* étaient plantées à une densité faible de 5.2 ha<sup>-1</sup> (pour un taux de couverture d'environ 10%) et absorbaient en moyenne sur l'année 14% de la lumière absorbée par le SAF. Néanmoins, pour des caféiers situés juste sous leurs couronnes, la lumière transmise par les *Erythrina* pouvait ne représenter localement que de 30 à 50% de la lumière incidente. Les simulations n'ont pas montré d'effets azimutaux marqués. MAESPA a montré un effet fort des arbres d'ombrage sur la modification de la qualité de la lumière : la proportion de lumière diffuse était augmentée de 33% sous leurs couronnes, indiquant un effet potentiellement positif sur l'efficacité photosynthétique des caféiers ombragés.

La couche de caféiers représentait un LAI moyen d'environ 3.5 pour une absorption d'environ 60% de la lumière incidente. L'hétérogénéité spatiale de la couche de caféier était cependant extrêmement forte due à la présence de caféiers de différents âges et tailles se côtoyant, et ce à cause de la pratique de recépage annuelle. La variabilité saisonnière de la lumière absorbée était elle aussi extrêmement

forte et principalement pilotée par les variations saisonnières de LAI. Comme attendu, c'est le recépage qui a été la plus forte source de variation saisonnière de la lumière absorbée par la plantation. Les variations de LAI des *Erythrina* (espèce décidue, localement au mois de mars) n'influençaient que de quelques pourcents le bilan de lumière absorbée de la parcelle entière.

Globalement, nous avons donc montré que la lumière non absorbée par ce SAF représentait à peu près 26% de la lumière incidente, dont la plupart était sans doute absorbée par le sol entre les lignes. Nous prétendons ici que dans un système non contraint par la ressource en eau, il y aurait la possibilité d'introduire une couverture végétale de type engrais-vert ou une légumineuse dans une stratégie d'amélioration de la capture de la ressource lumineuse et de réduction des apports de fertilisants.

Une simulation a montré que l'augmentation de la densité des arbres d'ombrage entraînait une diminution du bilan de lumière absorbée par la parcelle de caféiers qui suivait une loi de Beer-Lambert de coefficient d'extinction ( $k$ ) similaire à celui mesuré sous les *Erythrina*. Ceci soulignait la faible interaction entre les couronnes des arbres d'ombrage pour l'interception de la lumière.

Une autre simulation a montré qu'au cours d'une journée ensoleillée dans une plantation en plein soleil (sans arbres d'ombrage), la fraction de lumière absorbée était plus forte le matin et le soir alors que le midi, cette fraction était minimale. A l'opposé, dans une plantation agroforestière assez dense, cette cinétique journalière était totalement inversée : la fraction de lumière absorbée par la couche caféière à midi était plus forte qu'en début et en fin de journée, bien que beaucoup plus faible par rapport à son niveau en plein soleil. Cette propriété peut avoir un effet positif sur la photosynthèse du caféier qui est une espèce tolérant l'ombrage et dont la photosynthèse est rapidement saturée en réponse à la lumière incidente.

En conclusion, grâce à la modélisation, nous avons pu caractériser la variabilité spatiale et saisonnière de la ressource lumière dans un SAF caféier. Nous avons pu quantifier des phénomènes comme la modification de la fraction de lumière diffuse qui pourrait influencer de manière significative la photosynthèse des caféiers et compenser la diminution de la lumière absorbée par les plantes à l'ombre.

Finalement, nous argumentons sur les possibilités offertes par l'utilisation des sorties du modèle comme variables explicatives continues dans des expérimentations de terrain. Par exemple, nous pensons qu'une estimation précise de la lumière transmise à un point donné dans une plantation intégrée sur un pas de temps désiré (intégration de la variabilité du LAI du couvert, de la saisonnalité de la course du soleil, etc.) est beaucoup plus informative qu'une photographie hémisphérique prise ponctuellement. Nous avons identifié des applications potentielles telles que l'étude de la variabilité spatiale des maladies ou des attaques de ravageurs, l'effet de l'ombrage sur la plasticité des plantes ou sur leur productivité.

### **Déterminants de la variabilité de la productivité primaire**

La productivité primaire nette aérienne (ANPP) et ses déterminants, le bilan de lumière absorbée et l'efficacité de conversion de la lumière (LUE), ont été étudiés pendant deux années sur un échantillon de caféiers et d'*Erythrina* de notre SAF. Le suivi d'ANPP des caféiers de différentes classes d'âge et situés à différentes distances des arbres d'ombrage a été réalisé à partir de mesures biométriques, de récoltes de litières et de quantification des exportations (récolte de fruits). Les mesures biométriques ont été converties en biomasse en utilisant des relations allométriques développées spécifiquement sur notre site. La lumière absorbée par chacun des caféiers ainsi que la transmittance des *Erythrina* au dessus de chacun d'eux ont été simulés avec MAESPA. Pour les *Erythrina*, l'estimation d'ANPP s'est faite de manière simplifiée en suivant la croissance en diamètre du tronc et la production de litière.

Nous avons montré que ANPP des caféiers augmentait linéairement avec l'âge du caféier mais que sa partition entre les différents compartiments (bois, feuilles, fruits) variait selon l'âge et la charge en fruits. Les deux premières années, le caféier investissait à égalité entre le compartiment bois et feuille. C'est seulement à partir de sa troisième année que la productivité des fruits devenait significative, affectant négativement l'allocation vers le compartiment feuille, mais très peu l'allocation vers le compartiment bois. La productivité des fruits était fortement marquée par la bi-annualité : une année de forte productivité pour un caféier voyait automatiquement la productivité de l'année suivante chuter drastiquement. Nous confirmons ici ce phénomène largement décrit chez le caféier qu'est la grande force de puits des fruits, avec ses conséquences sur la bi-annualité : les assimilats sont alloués prioritairement aux fruits qui, s'ils sont trop nombreux concurrencent l'allocation vers les composantes végétatives, clefs du rendement de l'année suivante.

Nous avons également montré que l'allocation des assimilats vers les fruits était en général plus faible pour les caféiers sous ombrage en raison d'une initiation florale plus faible. Cependant, en moyenne et sur les 2 années de mesures, la productivité en fruits des caféiers n'était pas significativement différente à l'ombre et au soleil, ceci contrairement à beaucoup d'autres études.

ANPP des caféiers n'était pas affectée par la distance aux arbres d'ombrage. Or les simulations de MAESPA ont montré que le budget lumineux des caféiers était réduit de 50 à 70 % à l'ombre sous les couronnes des *Erythrina*. Nous avons donc analysé les déterminants de l'efficacité d'utilisation de la lumière (LUE), à savoir ANPP standardisé par la lumière absorbée par la plante modélisée. Nous avons démontré un pouvoir explicatif très fort de l'âge des caféiers et de la transmittance des arbres d'ombrage sur LUE : LUE était environ deux fois plus fort pour les caféiers à l'ombre ( $0.48 \text{ gC MJ}^{-1}$ ), ce qui permettait de compenser totalement la diminution du budget lumineux. Nous avons formulé plusieurs hypothèses dont les plus pertinentes semblent être i) une meilleure efficacité photosynthétique de la feuille à faible rayonnement incident, ii) une augmentation de la fraction de rayonnement diffus permettant une meilleure pénétration du rayonnement dans les couronnes et donc

une amélioration de la photosynthèse à l'échelle de la plante ; iii) une réduction des pertes de C due à la respiration grâce à des températures généralement plus fraîches à l'ombre. Nous n'avons pas pu démontrer d'adaptations anatomiques ou morphologiques entre les feuilles des caféiers d'ombre et de lumière qui auraient pu expliquer une meilleure efficacité photosynthétique. Enfin, des résultats préliminaires d'analyse de NPP souterraine (BNPP) ne permettaient pas de conclure à une allocation souterraine significativement plus importante pour les caféiers de plein-soleil, BNPP ne serait donc pas un bon candidat pour expliquer les variations de LUE

Grâce à l'échantillonnage représentatif de caféiers et à des inventaires en plein de la plantation, nous avons pu extrapoler la biomasse et ANPP des caféiers pour le compartiment bois. Pour les compartiments feuilles et fruits très variables à l'échelle plante, les mesures ont été directement faites à l'échelle parcelle : suivi du LAI par proxy-détection et pièges à litières pour le compartiment feuille, pesée de la récolte bords-champs et pièges à litière pour les compartiments fruits. Les stocks aériens de carbone (26-28 MgC ha<sup>-1</sup>) étaient pour 40% dus aux *Erythrina* alors que 60 % du stock de C des caféiers était contenu dans les souches et 10% dans les feuilles. ANPP des caféiers (6.5-7.1 MgC ha<sup>-1</sup> an<sup>-1</sup>) représentait 80% d'ANPP du système. La productivité des souches ne représentait plus que 15% d'ANPP des caféiers alors que NPP des feuilles représentait 35%. La production de fruit a été stable entre les deux années et représentait 20% d'ANPP des caféiers. La productivité des compartiments labiles des caféiers (durée de vie inférieure ou égale à 1 an) représentait donc entre 50 et 60% d'ANPP des caféiers.

En conclusion, nous avons utilisé ici une approche couplant mesures expérimentales et covariables dérivées de la modélisation. Par cette approche, nous avons pu quantifier un phénomène rarement démontré dans la littérature agroforestière, l'augmentation de LUE à l'ombre et nous soutenons ici qu'une telle démarche pourrait aider à démêler les effets complexes dans les expérimentations.

Le doublement de LUE entre des caféiers à l'ombre et au soleil est cependant un résultat inhabituel. Nous nous proposons pour la suite d'essayer de quantifier quelle est la part de l'augmentation de l'efficacité photosynthétique dans ce doublement de LUE afin de pouvoir donner du poids aux autres hypothèses développées plus haut.

### ***Variabilité spatiale de la photosynthèse et de l'efficacité d'utilisation de la lumière***

La variabilité spatiale de la photosynthèse, de la transpiration, des efficacités photosynthétiques d'utilisation de la lumière et de transpiration a été modélisée par MAESPA après une étape de comparaison aux flux de CO<sub>2</sub> et H<sub>2</sub>O mesurés à l'échelle de la plante puis à l'échelle de la parcelle.

Les paramètres physiologiques foliaires nécessaires à la paramétrisation de MAESPA ont été extraits de mesures d'échanges gazeux foliaires. La plantation utilisée était la même que celle utilisée précédemment. Pour permettre une vérification locale (échelle plante) de la photosynthèse et de la

transpiration, nous avons conçu une chambre plante-entière afin de mesurer la dynamique journalière de ces flux sur un échantillon varié de caféiers (différents âges et différentes distances aux arbres d'ombrage). Ces mêmes caféiers ainsi que leurs voisins les plus proches ont été décrits finement et paramétrés dans MAESPA. Les flux semi-horaires de photosynthèse et transpiration de chacun de ces caféiers échantillonnés ont donc été simulés dans MAESPA et comparés aux mesures.

Malgré une certaine variabilité entre le modèle et la mesure ( $R^2 \geq 0.76$ ), la photosynthèse et la transpiration ont été simulés de manière assez satisfaisante (pente proche de 1). Les décalages entre le modèle et les mesures pouvaient s'expliquer par de très nombreux points dont deux nous semblaient prépondérants : i) l'incertitude sur la lumière absorbée (RRMSE de 25% conformément à ce qui a été montré plus haut) ; ii) le décalage entre une mesure ponctuelle dans la chambre (1 mn toutes les 30 mn) et les données météorologiques utilisées dans MAESPA moyennées sur une demi-heure. Malgré ce décalage, les courbes de réponse de la photosynthèse à la lumière absorbée étaient assez similaires entre le modèle et la mesure. De même, nous avons montré une bonne adéquation entre mesures et modèle pour ce qui est de l'efficacité photosynthétique d'utilisation de la lumière et de l'efficacité de transpiration.

Les prédictions de MAESPA en termes de photosynthèse et de transpiration ont également été comparées à des mesures à l'échelle de la parcelle grâce à un instrument de mesure des corrélations turbulentes installé au-dessus des arbres d'ombrage (tour). La comparaison entre photosynthèse mesurée et simulée était assez satisfaisante ( $R^2=0.61$ ). Alors que la réponse de la photosynthèse simulée à la lumière absorbée était assez contrainte par le modèle, la variabilité des flux mesurés était beaucoup plus forte et ce lié notamment à la variabilité des conditions de vent faisant varier l'empreinte de la tour au cours de la journée. En intégrant la photosynthèse à une échelle journalière, MAESPA a eu tendance à surestimer systématiquement de 10-15% la photosynthèse mesurée. En revanche, MAESPA a été capable de reproduire de manière très satisfaisante la variabilité saisonnière de la photosynthèse. Surtout, la modélisation a permis de partitionner la photosynthèse entre caféiers et *Erythrina*. Les *Erythrina* ont contribué pour seulement 7% du LAI du SAF mais pour 30% de la photosynthèse. Cela a été expliqué par une vitesse maximale de carboxylation par la Rubisco deux fois plus importante que pour le caféier et une saturation de la photosynthèse à des lumières incidentes beaucoup plus élevées.

Si la simulation de la photosynthèse a été satisfaisante, la simulation des flux de transpiration s'est révélée sous-estimée par MAESPA, en particulier lorsque l'on s'attendait de fortes évapotranspirations. Plusieurs pistes ont été évoquées sans que le problème de la simulation de l'évapotranspiration n'ait pu être véritablement résolu : i) calculs du bilan d'énergie inadéquats dans MAESPA notamment liés à l'absence de prise en compte du sol dans notre simulation, ce problème ainsi que des problèmes de code ont déjà été évoqués dans la littérature; ii) simulation inadéquate du

microclimat dans MAESPA, notamment de la conductance aérodynamique ; iii) modèle de conductance stomatique qui aurait tendance à saturer pour de fortes valeurs de transpiration ; iv) incertitudes sur les mesures ; v) hypothèses de mesures trop simplifiées (notamment l'hypothèse d'absence d'évaporation du sol après une période de plus de 48H sans pluies).

Pour toutes ces raisons, nous avons choisi de laisser de côté les simulations de transpiration pour nous concentrer sur la variabilité spatiale de la photosynthèse et d'efficacité photosynthétique d'utilisation de la lumière.

La photosynthèse était extrêmement variable dans la parcelle due à la forte hétérogénéité au sein même de la strate de caféier. Cette variabilité intra-strate de la photosynthèse (de 1 à 3 kgC m<sub>sol</sub><sup>-2</sup> an<sup>-1</sup>) était au moins aussi forte que celle introduite par les *Erythrina*.

Nous avons isolé la perte de photosynthèse uniquement due à la présence des arbres d'ombrage en comparant les simulations de notre plantation actuelle avec une plantation théorique sans arbres d'ombrage. Plusieurs observations ont résulté de ce calcul : i) la réduction de la photosynthèse était légèrement moins importante que la réduction de la lumière incidente (réduction de 12% de la photosynthèse pour une réduction de 15% de la lumière absorbée) ; ii) une absence d'effet azimutal marqué et iii) un effet marqué des *Erythrina* sur la photosynthèse de la couche de caféier avec une empreinte beaucoup plus large que la projection de leurs couronnes.

L'efficacité photosynthétique d'utilisation de la lumière est environ 2.5 à 3 fois plus forte que LUE (mesurée à partir d'ANPP), ce qui veut dire qu'entre la photosynthèse et la production effective de biomasse, environ deux tiers sont perdus en respiration et en allocation vers les compartiments souterrains. La variabilité spatiale de l'efficacité photosynthétique d'utilisation de la lumière était fortement influencée par la présence des arbres d'ombrage ; en dehors de leurs couronnes, elle variait très peu. Celle-ci variait de 1 à 1.6 gC MJ<sub>PAR</sub><sup>-1</sup> entre caféiers de lumière et d'ombre ; soit une augmentation de 60% entre un caféier de plein soleil et un caféier poussant à l'ombre. Cette valeur représente un peu moins des 2/3 de l'augmentation attendue de LUE, ce qui signifie que les autres hypothèses (respiration réduite à l'ombre et allocation vers les racines privilégiée au soleil) expliqueraient un tiers de l'augmentation de LUE.

Pour conclure, MAESPA s'est révélé capable de simuler la photosynthèse et l'efficacité photosynthétique de conversion de la lumière de manière raisonnable que ce soit à une échelle intra-parcelle ou parcelle. En revanche, le modèle a montré ses limites pour la simulation de la transpiration, limités déjà soulignés dans la littérature. Ce problème de simulation pourrait fort bien être un problème de code, dans le sens où les formalismes utilisés par MAESPA ont été adoptés par de nombreux modèles et ont permis de simuler de manière satisfaisante ces flux. Nous recommandons ici



de sérieusement s'intéresser au code de MAESPA pour essayer de lever ce point de blocage récurrent depuis de nombreuses années déjà.

Dans ce manuscrit de thèse, nous avons tout d'abord réalisé un important travail de terrain pour l'acquisition de données de flux de carbone et d'eau pour les caféiers et les arbres d'ombrage ainsi que pour acquérir les paramètres du modèle. Pour la première fois, le modèle 3D MAESPA a été paramétré dans un SAF de manière à confronter simulations et données de terrain. Cette approche a permis dans un premier temps de vérifier si les hypothèses de ce modèle initialement forestier étaient adaptées pour un SAF : approche 3D, couronnes simplifiées, etc. Nous avons montré la capacité de MAESPA à simuler dans l'espace et dans le temps des processus physiologiques comme la photosynthèse résultant d'interactions complexes entre la culture et arbres d'ombrage. Ces simulations ont été réalisées dans des conditions où la lumière était le principal facteur limitant. Il faudrait désormais tester la capacité de MAESPA à simuler correctement des processus de photosynthèse dans un contexte où l'eau est un facteur limitant et où il existe une compétition inter-spécifique pour l'acquisition de cette ressource. De même, MAESPA est un modèle statique pour qui la taille des plantes et leurs surfaces foliaires sont des variables d'entrée. Pour avoir une vision plus complète du cycle du carbone dans les SAF, il faudrait coupler MAESPA avec un modèle de croissance et d'allocation de carbone.

Enfin, nous avons montré par un exemple le très fort intérêt d'utiliser des variables modélisées non directement mesurables afin de mieux expliquer des données expérimentales. Ces variables modélisées peuvent également servir à spatialiser des données mesurées ponctuellement. MAESPA est aussi capable de simuler les températures de couvert, une variable clef pour de nombreux phénomènes biologiques, et pourrait être utilisé pour mieux comprendre la dissémination d'insectes ravageurs ou de maladies. La capacité d'un modèle mécaniste comme MAESPA à simuler (en dehors des spectres pour lesquels il a été vérifié) des variations de données climatiques en fait un outil de premier plan pour étudier les réactions potentielles des systèmes au changement climatique.

---

# Table of contents - Synthesis

---

1.	Potential role of agroforestry in a new paradigm of agriculture.....	3
A.	Context .....	3
B.	Definition of agroforestry and historical aspects of agroforestry research.....	4
C.	Agroforestry and ecosystem services .....	6
i.	Hydrological services and soil erosion .....	7
ii.	Biodiversity conservation .....	8
iii.	Carbon sequestration.....	8
iv.	Primary productivity and resource use efficiency.....	9
v.	Mitigation of the effects of climate change .....	9
2.	Specificity of interactions in agroforestry systems .....	10
A.	Competition, Facilitation, Complementarity .....	10
B.	Seasonal interactions: phenology and synchronicity.....	12
C.	Highlight on the competition for light.....	13
D.	Effect of microclimate on processes.....	14
i.	Changes of heat fluxes .....	15
ii.	Effect of wind .....	17
3.	Why modeling canopy processes in AFS? .....	18
A.	Connecting processes and formalizing the biophysical understanding .....	18
B.	Bringing continuous variables into heterogeneous plots and helping experimental designs ....	19
C.	The importance of virtual simulation for the design of innovative AFS .....	19
D.	Modeling to assess the resilience of AFS.....	20
4.	How to model processes in AFS?.....	21
A.	Which processes to simplify? Which processes to ignore? .....	22
B.	How to model the AFS structure? .....	22
5.	Measuring and modeling processes in AFS .....	23

A.	Field measurements for parameterization and model verification .....	24
i.	Studying the structure heterogeneity of AFS .....	24
ii.	Measuring canopy processes.....	26
B.	Modeling strategies .....	28
i.	Static models .....	28
ii.	Dynamic models .....	30
iii.	Justifying our choice of MAESTRA/MAESPA .....	33
6.	Conclusions: our contribution to AFS understanding: modeling the effects of microclimate modifications on understorey fluxes .....	35
A.	Mapping the absorbed radiation in a plot with a plant resolution .....	35
B.	Using the absorbed radiation as a covariate for experimentation.....	36
C.	Intra-plot variability of photosynthesis and of LUE.....	37
7.	Perspectives .....	38
A.	Possible limitations of MAESTRA-MAESPA.....	38
B.	Our scientific strategy .....	38

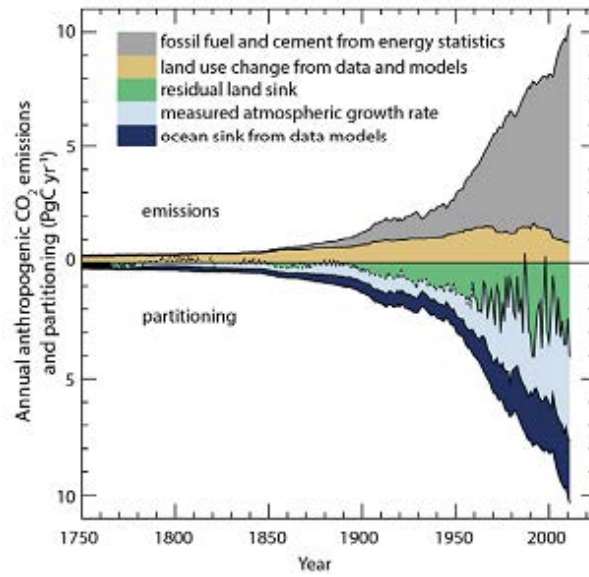

**Fig. 1** - Annual anthropogenic emissions of C and its partitioning between atmospheric CO<sub>2</sub> increase, modeled ocean sink. Residuals are considered as terrestrial ecosystem sink (IPCC, 2013).

---

# SYNTHESIS

---

## 1. Potential role of agroforestry in a new paradigm of agriculture

### A. Context

Agriculture will soon face one of its greatest challenges: feeding the **growing humanity** with **limited energy resources, disrupted climate and degrading ecosystems**.

The first major challenge for agriculture will be to face dramatic **decrease in available resources: agricultural land** (*i.e.* due to deforestation and urbanization mainly; *e.g.* Lambin and Meyfroidt, 2011) and especially **energetic resources** (Meadows *et al.*, 2004; Turner, 2012). “Peak oil” has already been reached in 2006 according to the International Energy Agency ([www.iea.org](http://www.iea.org)) and is illustrated by a 25% decrease of the oil production for the 5 major oil companies between 2004 and 2012 (<http://www.theoil Drum.com/node/9946>). Today, coal seems to be the most easy to reach available energy: it is globally the fastest-growing energy source and may overpass oil production in 2017 ([IEA](http://www.iea.org))! In this context, it becomes obvious that the paradigm of an agriculture highly demanding in energy input (fertilizer, machines, etc) will no longer work. Agriculture, like industry could face soon its “Limits to Growth”, due on one hand to the rising cost of resources, and on the other hand the obligation to pay for negative externalities (contamination of soil, air, water etc.), leaving little profit margin for growth (Meadows *et al.*, 2004).

The second major challenge for agriculture will be to **face predicted climate change**. Agriculture is a key contributor to climate change: 29% of CH<sub>4</sub> and 18% of N<sub>2</sub>O emissions in the atmosphere while Land Use Change (mainly deforestation) is responsible of 10-20% of total CO<sub>2</sub> emissions (Fig. 1) (IPCC, 2013). Note that fuel and electricity consumption by agriculture is not accounted for in this graph. On the other hand, climate change has already impacted agriculture, and is expected to impact further food production (FAO, 2013). The increase in mean temperature, changes in rain patterns and water table levels, increased salinity, increase in the occurrence of extreme events (storms...) may impact deeply agriculture (*e.g.* FAO, 2013; Thornton and Cramer, 2012).

Recently, diagnosis of the **failure of productive agriculture** and the **urgent necessity** for a global **shift to agroecological practices** started to be recognized at the political level in the United-Nations (De Schutter, 2011; UNCTAD, 2013), in North America (Rodale Institute, 2013), in Europe (Robin, 2012), and in France (Guillou *et al.*, 2013). In Latin America, negative impacts of the millions of hectare of cash-crop production (mostly to produce soya and biofuel) were extensively documented: land erosion, massive deforestation, contamination, loss of food sovereignty, etc (*e.g.* Fearnside, 2001;

Pengue, 2005). Indigenous movements, such as *Via Campesina*, empowered themselves against those politics. They developed alternative propositions, such as agroecology, seen as a way to rescue nature, ensure food safety and empower peasants (Altieri and Toledo, 2011). Nowadays, their vision is receiving a great political echo and alternative cropping systems such as *milpa* in Mexico and Central America gained a renewed interest (e.g. Moreno-Calles *et al.*, 2012).

Agroforestry is recognized among the **agroecological practices** in the sense that it can provide a “balanced environment, sustained yields, biologically mediated soil fertility and natural pest regulation through the design of diversified agroecosystems and the use of low-input technologies” (Altieri, 1989; FAO, 2013).

## **B. Definition of agroforestry and historical aspects of agroforestry research**

Agroforestry is a land-use system that involves **growing trees with crops** and sometimes animals that interact spatially and temporally (Nair, 1991; Nair, 2007). Torquebiau (2007) mimicked the definition of agriculture and defined agroforestry as the “valorization of soil through the sequential or simultaneous association of woody trees and crops or animals to bring goods and services to human beings”. Some definitions rely on the hypothesis of an overall **beneficial effect** on mixing trees and crops when compared to a sole crop (Dupraz and Liagre, 2008). This is illustrated by the statement : “the tree must acquire resources that the crop would not otherwise acquire” (Cannell *et al.*, 1996).

“Agroforestry is an old farming system but a new scientific interface”, according to Hallé (1986). Everywhere in the tropics, agroforestry has been largely used by farmers, based on the observation of the vertical stratification of plant canopies in natural ecosystems (Nair, 1991). Even in temperate regions, trees have traditionally been mixed in “bocages”, fruit orchards and fallows grazed by cattle and many other associations (Dupraz and Liagre, 2008).

Agroforestry was first defined at a meeting on deforestation in Canada in the mid-1970s (Torquebiau, 2007). A couple of years later only, in 1977, the World Agroforestry Center (ICRAF) was created, highlighting the enthusiasm around this new concept (Nair, 1991). First projects regarding agroforestry were mainly development projects, with little funding for research.

Agroforestry systems (AFS) are **complex systems by nature**, thus **difficult to characterize**: combinations of species composition, management practices and local conditions are potentially infinite. In the introduction of the first issue of *Agroforestry Systems* in 1982, the director of ICRAF mentioned the “**building-up of a systematic knowledge** on agroforestry technologies and **development of methods** on how to study them” as one of the main objectives of agroforestry research (Lundgren, 1982). In 1989, the first international scientific conference on agroforestry was

held at the University of Edinburgh. Paul Jarvis (1991), in an enthusiastic introductory speech, presented agroforestry as one of the most obvious means to restrain the impact of climate hazards on crops, reduce the degradation of agricultural lands and the deforestation, retrieve soil fertility, improve productivity and diversify revenues. A few years later, Sanchez (1995) reviewed very honestly the main failures and disillusion of the past 15 years of agroforestry experience (*i.e.* the failure of alley cropping). He advocated for the development of agroforestry as a new integrated science and proposed a set of 16 hypotheses to build the agroforestry research. He also raised the need to build biophysical models as tools to systematize agroforestry knowledge.

In the 1990s, the most outstanding ecophysiologicalists, participated in agroforestry research projects: Paul Jarvis worked at ICRISAT-Niamey (Niger) on energy and water fluxes in windbreaks (Smith and Jarvis, 1998; Smith *et al.*, 1997a, b; Smith *et al.*, 1997c), John Monteith worked at ICRISAT-Hyderabad (India) on microclimate in Millet-*Leucaena* alley cropping (Monteith, 1997; Monteith *et al.*, 1991). Melvin Cannell participated to the first generic process-based model for agroforestry systems created during The Agroforestry Modeling Project (AMP project led by the Institute of Terrestrial Ecology in Edinburgh). The Edinburgh team came out with the HyPAR model, a coupled physiologically-based forest model and an understorey crop model (Mobbs *et al.*, 1998a). It was designed for tropical crops, and used to explore the theoretical potential of agroforestry plots in a gradient of rainfall in Africa over years to decades (Cannell *et al.*, 1998). Its development was furthered by the Silvoarable Agroforestry For Europe project (SAFE) through the so-called Hi-SAFE model (Dupraz *et al.*, 2005). A few other generic biophysical models were published, among them the most accomplished was WaNulCas (Van Noordwijk and Lusiana, 1998). For coffee AFS, the first and unique complete biophysical model (CAF2007) was created during the CASCA project (Coffee Agroforestry Systems in Central America)(van Oijen *et al.*, 2010a, b).

In the meanwhile, numerous field research was conducted on agroforestry mostly under the tropics (by institutions like CATIE, CIRAD, ICRAF, CIFOR, University of Florida, U. of Bangor...) using methods mainly based on observation/experimentation with existing AFS. Only few long-term experimental monitoring sites were established. At CATIE (Costa Rica), coffee and cacao based AFS were monitored during long term experiments with various shade tree species and densities as well as nutrient availability (Alpizar *et al.*, 1985; Beer, 1988; Fassbender *et al.*, 1985; Fassbender *et al.*, 1991; Gomez-Delgado *et al.*, 2011; Hergoualc'h *et al.*, 2012; Heuveldop *et al.*, 1985; Kinoshita, 2012; Kinoshita *et al.*, 2013; Noponen *et al.*, 2013; Siles *et al.*, 2010; Soto-Pinto *et al.*, 2010). In Kenya, long-term experiments were handled at the ICRAF's Machakos Research Station on above and below ground interactions in water-limited agroforestry systems (Black and Ong, 2000; Lott *et al.*, 2000a, b; Lott *et al.*, 2009; Ong *et al.*, 2000; Ong and Leakey, 1999; Wallace *et al.*, 1999). In Europe, the

experimental farm of Restinclières (<http://www.agroof.net/PIRAT/>) was the first large scale AFS experimental site.

The number of scientific publications on agroforestry peaked in the 1990's and has been decreasing since the beginning of the years 2000 (database Web of Knowledge). 3230 scientific articles were published in high impact journals over the past 30 years<sup>1</sup>, of which 1830 articles were published in *Agroforestry Systems* and 43 000 in total over the same period. Since 2000, the number of scientific publications seems to stagnate while the number of citations is increasing exponentially. These crude bibliometric indexes confirm i) the limited number of researchers explicitly involved in agroforestry research, ii) a broad gain of interest for the agroforestry research as a topic, and likely iii) the persistence of major scientific frontiers that need to be addressed and solved in order to revive the scientific dynamics in AFS research. Indeed, the main stakes of AFS research remain to **develop generic tools** able to assess the capacity of the different AFS to improve lastingly agrosystems services.

### C. Agroforestry and ecosystem services

Millenium Ecosystem Assessment (2005) defined **Ecosystem Services** (ES) as the benefits people obtain from ecosystems. Ecosystems services are divided into 4 functions:

- **supporting** services: primary production, nutrient cycling, soil formation, etc. ;
- **provisioning** (or production) services: food, timber wood, fresh water, etc.;
- **regulating** services: carbon sequestration, soil protection against erosion, water purification, etc.;
- **cultural** services: aesthetical, educational, spiritual etc.

In anthropized ecosystems, strong **trade-offs between ES** are expected especially between productivity and supporting/regulating services (Meylan *et al.*, 2013). For example, high input production is expected to be antagonist to biodiversity conservation, carbon sequestration, soil microbiological diversity, etc. In such cases, the manager does not have economical short-term interest in favoring the supporting/regulating service. Because each ES can be quantified through biophysical estimates (*e.g.* the amount of carbon sequestrated) or indicators (*e.g.* indices of biodiversity), ES were

---

<sup>1</sup> Forest Ecology and Management (563); Agriculture, Ecosystem, Environment (294); Plant & Soil (223); Tree Physiology (82); Agricultural systems (77); J. of agricultural and food chemistry (44); Agricultural and Forest Meteorology (37); Annals of Botany (31); Ecological applications (30); Ecological modeling (27); J. of Experimental Botany (18); Trends in ecology and evolution (16); European J. of agronomy (15); Agronomy for sustainable development (10); Advances in agronomy (7); Science (5); Global Change Biology (5); Food Policy (4); Biogeoscience (4); Plant, Cell & Environment (1)



proposed as a framework to assess the externalities of human economy on ecosystems (also called the economical evaluation of ES)(Millenium Ecosystem Assessment, 2005). **Payments for ecosystem services** (PES) are mechanisms to remunerate the actors for good practices that favor ES (such as avoided deforestation, reduction of erosion, carbon sequestration, etc.) while **compensation markets** are another mechanism based on the “polluter pays” principle (*e.g.* Carbon emission trading) (Karsenty *et al.*, 2010).

Despite its wide international acceptance, the concept of ES and their economic valuation have been criticized from philosophical (*e.g.* anthropocentrism), ecological (*e.g.* trade-offs between services) and even economical (*e.g.* free rider problem) points of views (Karsenty *et al.*, 2010; Karsenty *et al.*, 2012; Maris, 2012).

However, we will keep this convenient framework to analyze how AFS may improve functional attributes of agrosystems. We will present few examples of ES that have been studied in the agroforestry literature and other that have to be addressed in a near future. We show that studies of ES in AFS were generally assessed empirically, thus most of the time insufficient for the purpose of generalization.

#### i. Hydrological services and soil erosion

Hydrological services and the control of soil erosion have certainly been the most remunerated ecosystem services for AFS (Nair, 2007). For example, the Costa Rican hydropower producer (ICE, *Instituto Costarricense de Electricidad*) is the major payer of environmental services (ES) in the country (Pagiola, 2008). It is hypothesized that AFS reduce surface run-off (higher leaf area index and leaf litter covering the soil) and favor water infiltration and drainage (*e.g.* for coffee see Benegas *et al.*, 2013; Cannavo *et al.*, 2011; Gómez-Delgado, 2010). The decrease of sediment deposition in the dams directly alleviates dam cleaning. The effects of different sedimentation rates on electricity costs are thus easily modeled by the hydropower companies; the benefits earned by the company may be partly redistributed to the farmers as incentive to plant more trees in their AFS.

However, links between land use and hydrology were seldom investigated quantitatively (Gómez-Delgado, 2010). Gómez-Delgado *et al.* (2011) investigated the partition of streamflow into evapotranspiration, throughfall, drainage, runoff in our coffee AFS watershed of Costa Rica through an experimentation/modeling approach. They found a modest runoff at the exit of the watershed, due to highly permeable soils (andosols; USDA-NRCS, 2005). They found that superficial runoff and sediment production in plots were 50% lower under shade trees when compared to areas with coffee monoculture. However, 95% of the sediments originated from outside the plots (river bed and road paths especially). This example emphasizes the need for field observation and experimentation, and model validation for the quantification of hydrological services in order to test erosion hypotheses at

various scales (here from plots to watershed). This example does not mean that the plantation of trees does not have other beneficial effects!

## ii. Biodiversity conservation

Studies on the effect of AFS on biodiversity are numerous (*e.g.* for coffee AFS: Boreux *et al.*, 2013 on pollinisation services; and meta-analyses by De Beenhouwer *et al.*, 2013; and Philpott *et al.*, 2008). Generally, biodiversity is positively correlated to the AFS complexity (number of tree species and number of strata) (Schroth *et al.*, 2004). Indeed, the number of ecological niches is expected to increase drastically between a system with one tree species (*e.g.* Coffee+*Erythrina* AFS in Costa Rica) and agroforests with more than 120 tree species (coffee agroforests in the Indian Western Ghâts; Garcia *et al.*, 2010).

AFS may play four major roles in conserving biodiversity (Jose, 2009; Schroth *et al.*, 2004): (1) they provide habitats for species that tolerate a certain level of disturbance; (2) they help reducing the rates of deforestation of natural habitats by providing a more productive, resilient alternative; (3) they provide connectivity, creating corridors between habitat remnants and may support their integrity; and (4) they help conserving biological diversity by providing other ecosystem services such as erosion control and water recharge, thereby preventing the degradation and loss of surrounding habitat.

## iii. Carbon sequestration

Carbon sequestration by AFS has been the focus of several studies (*e.g.* for coffee AFS see: Hergoualc'h *et al.*, 2012; Kinoshita, 2012; Kinoshita *et al.*, 2013; Noponen *et al.*, 2013; Siles *et al.*, 2010; Soto-Pinto *et al.*, 2010). Although the potential of C sequestration varies widely among the types of AFS, their potential is generally larger to sole crop lands but still largely below that of forests (Albrecht and Kandji, 2003; Montagnini and Nair, 2004). For example, a recent study compared carbon stocks and NPP of a tropical moist forest in Indonesia to a nearby 80 years old cocoa and *Gliricidia* AFS (Leuschner *et al.*, 2013). The total carbon stocks were 8 times lower in the AFS than in the forest, above-ground NPP was one third lower and C stocks in the soil were 50% lower. According to Hillel and Rosenzweig (2010), once the forest has been felled, the potential to restore C in vegetation and soils is normally limited to a few tens of % of the initial stock, even after strong measures to replant trees. Indeed, since the Clean Development Mechanisms of the Kyoto Protocol (1997), there has been a large interest on C sequestration issues, whereas the main problem of C balance and biodiversity of terrestrial ecosystems was Land Use Change, namely deforestation. Few researchers and some environmentalist NGO's started to warn about the over-emphasis on the C sequestration that they considered less effective to mitigate climate change than directly controlling deforestation and fossil fuel consumption (Powlson *et al.*, 2011). This raising concern is being addressed in REDD, REDD+ and REALU programmes.

Recently, FAO (2013) suggested that the actual incentives through the payment of ecosystem services (PES) (e.g. REDD+) should be used to facilitate the shift from unsustainable agricultural systems to agro-ecological systems that would consume less fossil oils, promote organic matter recycling, increase resource use efficiency, and be more resilient. Agroforestry was suggested as an adapted practice in a context of resource scarcity and climate disruptions (e.g. Climate Smart initiative: FAO, 2013).

#### iv. Primary productivity and resource use efficiency

AFS contain in their definition the expected increase of resource-use-efficiency. In other words, AFS should allow producing more primary products than a sole crop and expressed through the concept of land-equivalent ratio (LER; Mead and Willey, 1980). It represents the gain of productivity when comparing: 1/ crop and trees mixed in the same plot to 2/ the sum of the productivity of 2 plots planted with the sole crop (1<sup>st</sup> plot) and with the sole trees (2<sup>nd</sup> plot). LER above 1 indicates a net gain of efficiency for the agroforestry plot compared to the 2 sole plots (Malézieux *et al.*, 2009). This concept was used extensively and successfully used to communicate on agroforestry to farmers and politicians (Talbot, 2011). However, LER is in reality difficult to assess experimentally (Dupraz, 1999).

Resource-use-efficiency may also be assessed empirically by farmers after their conversion to AF practices. The farmer generally monitors the year-to-year evolution of yields, the decrease in quantities of applied fertilizers, the increase in soil organic matter content, the change in working hours spent in plot management, and hence assesses indirectly the effect of the conversion on resource use efficiency. Definitely, comparing conventional systems and AFS after conversion would take a long time, given that the constraints are multiple, vary between years and the systems are dynamic.

Given the weak extensibility of empirical or experimental estimations of LER to other systems, mechanistic modeling appears to be a straightforward method to produce long-term insights on LER and resource-use-efficiency by the system (Talbot, 2011).

#### v. Mitigation of the effects of climate change

Each cropping system is characterized by an optimum and a “coping range” of temperatures and resources (water, nutrients) beyond which it would no longer be viable or profitable and should be adapted or replaced (Crop and Land Suitability Assessment, FAO (1978-1981)). Depending on the pace and intensity of climate change, adaptation strategies could be (Thornton and Cramer, 2012):

- Short to medium term and incremental relying on the resilience and accommodation: rationalization of irrigation, traditional varieties or/and? GM crops, mixing crop, AF;
- Middle term and systemic: climate-adapted breeds, valorization of the variability of crop genetic resource, relocalization of food systems;

- Long-term and transformative: altering the balance between crops and livestock, changes in diet.

Agroforestry was proposed as an adaptation strategy to cope with mean temperature increase, more frequent drought episodes and extreme events (Nair and Garrity, 2012). Applying GCM (Global Circulation Models) to predict future temperature and rains in Nicaragua by 2050, Läderach *et al.* (2008) pointed to a potentially drastic reduction of suitable area to grow coffee (likewise in Brazil: Assad *et al.*, 2004; and in Ethiopia: Davis *et al.*, 2012). Indeed, Arabica coffee plant is originating from high plateaus of Eastern Africa (Ethiopia, Kenya, Tanzania), where it grows naturally in the understorey of forests and it is quite sensitive to high and to freezing temperatures. In a further study using the same dataset, they emphasize the different strategies of adaptation as a function of climate change intensity. In the case of a 2°C increase of mean air temperature (a rather conservative figure...), what could happen (Vermeulen *et al.*, 2013)?

- At higher altitudes, new land area could be converted into coffee plantations. However, shifting altitude increases competition with alternative land uses, *e.g.* forests or temperate crops (Feeley *et al.*, 2013);
- At medium altitudes, coffee plantations could keep growing provided planting of shade trees that would buffer highest temperatures;
- At low latitudes, the increase in temperature would make Arabica coffee production totally unsuitable and plantation should be converted into another crop, including possibly Robusta (*Canephora*) coffee or Cocoa.

We have described in this first section the potential functional advantages of AFS in terms of improvements of ecosystem services, resource efficiency and adaptation to climate change. Those advantages are due to typical interactions created by the introduction of shade trees with crops. Those interactions (for resource capture or microclimate modifications) affect biological processes, and thus all ecosystem functioning. If those interactions may be described individually, they are all interconnected and may result in counter-intuitive AFS properties.

## 2. Specificity of interactions in agroforestry systems

### A. Competition, Facilitation, Complementarity

Interactions in AFS for resource acquisition could be characterized as the following:

- **Competition** for resources between shade trees and crops, typically for light, water and nutrient captures. Competition for light is considered asymmetric due to the vertical

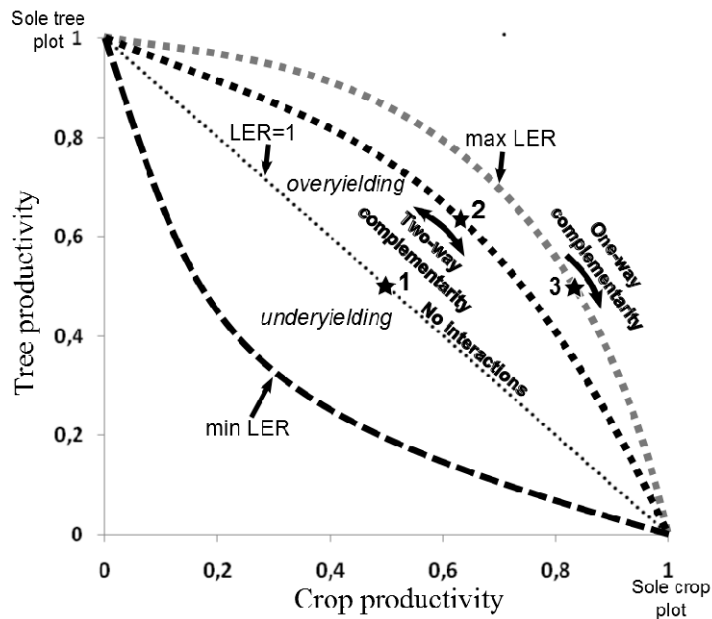

**Fig. 2** - Diagram representing the theoretical trade-offs between crop and shade tree productivity in an AFS. Productivity scale is relative and 1 corresponds to the maximal production that is recorded in the sole plot at optimal density. AFS is planted according to a substitutive design, i.e. at half density of the sole crop. LER is the Land-Equivalent Ratio (adapted from Garcia-Barrios and Ong, 2004; Ong et al., 1996).

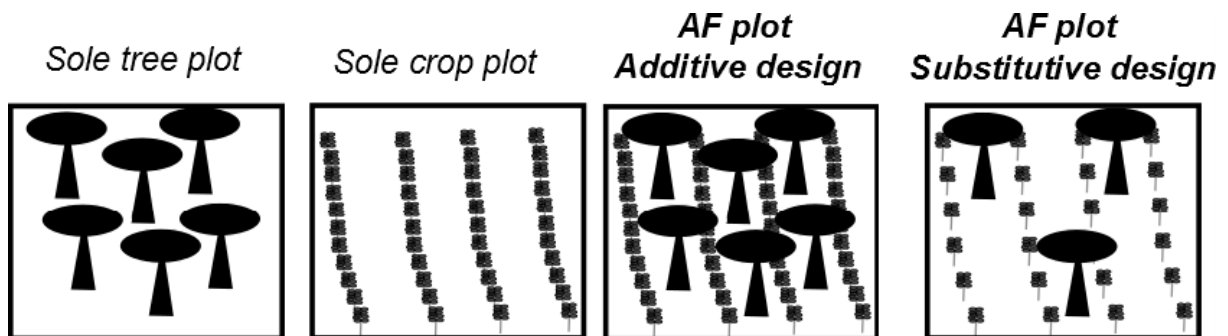

**Fig.3** - Statistical design for studying biophysical interactions (competition and facilitation) in AFS (adapted from Malézieux et al., 2009).

stratification (trees intercept light first) while competition for water and nutrient acquisition would be more symmetric;

- **Facilitation:** the presence of shade trees can favor the acquisition of resources for the main crop (Vandermeer, 1989). Typical examples are: hydraulic redistribution by shade trees to upper soil layers (*e.g.* Burgess *et al.*, 1998), increased bioavailability of phosphorus (*e.g.* Hall *et al.*, 2010), nitrogen-fixing species, microclimate more favorable to crop growth (*e.g.* Siles *et al.*, 2010), increased fraction of diffuse light more favorable for crop photosynthesis (Gu *et al.*, 2002), etc;
- **Complementarity:** the differences in ecological niche between crop and trees lead to an enhanced use of system resources. Typical examples are the complementarity in rooting zones and time lags in phenological stages (*e.g.* reverse phenology of *Faidherbia albida*: Rouspard *et al.*, 1999).

Effects of interactions in AFS were formalized by Ong *et al.* (1996) using a simple generalized equation:

$$I = (F + C) + Compet \quad (1)$$

where  $I$  is the interaction effect on crop yield between shade trees and crop (may be expressed in yield per unit of time and per unit of area),  $F$  and  $C$  are the facilitation and complementarity effects of shade trees on crop yield and  $Compet$  is the competitive effect of shade trees on crop yield (negative value). If  $I$  is negative, the association between shade trees and crop has a negative effect on crop yield. If  $I$  is positive, there is a **compensation** of the competition by the  $(F+C)$  term.  $(F+C)$  and  $Compet$  can be assessed using a factorial design with 4 treatments, for instance: crop yield of an AFS, crop yield of an AFS with the litter produced by trees removed, yield of sole crop and yield of sole crop with litter added from pruned trees. This equation was developed further by Cannell *et al.* (1996) and Rao *et al.* (1997) who introduced specific interaction terms such as microclimate effect, pest effect, allelopathy effect, which complicate to a large extent the experimental design.

Interaction effects between crop and shade trees were often represented as illustrated in Fig. 2 (Garcia-Barrios and Ong, 2004; Ong *et al.*, 1996). In this figure, AFS is planted with half the density of the 2 sole plots (planted at optimal density) according to a complete substitutive design (see Fig. 3). In theoretical case #1, no interactions occurred between trees and crop and the yield of both crop and trees is reduced by half. In case #2, the productivity of both tree and crop is enhanced equally thanks to interspecific complementarity/facilitation effects: this is the two-way complementarity. In case #3, crop productivity is enhanced by the presence of shade trees while tree productivity was not impacted by the presence of the crop: this is a one way complementarity.

However, this general framework displayed its limits (Dupraz, 1999; Garcia-Barrios and Ong, 2004; Talbot, 2011). Before being adapted to agroforestry, this approach was designed for intercropping of

annual crops that reached a steady-state of soil fertility with no time related changes in environment (Dupraz, 1999; Mead and Willey, 1980). Designs in AF are much more additive than substitutive (*i.e.* the crop density is only reduced in the rows where the trees are planted) and the system is mainly under transient state (evolution of soil organic matter and reduction of light availability with time; Dupraz, 1999).

Dupraz (1999) showed that both additive and substitutive designs were necessary to separate properly intraspecific from interspecific interactions. However, such designs with control plots may be limited to the most economically promising systems due to the high and long-term costs they require. One of the main advantage of this approach is its **demonstration capacity** towards policy makers and farmers. This experimental approach does not have any predictable or generalization capacity but they represent an inestimable value for **testing and verifying models**.

Indeed, only spatially explicit process-based models would allow an explicit quantification of the interactions involved in AFS (Dupraz, 1999). Models for instance enable the test of crop responses to varying shade tree densities, which can hardly be done experimentally. While crop/forest models have undergone an impressive development, during the last three decades with high degrees of mechanistic understanding, the implementation of spatially explicit, multispecies, process-based AF models remains an unachieved challenge due to the fact that upscaling from individual plant to the complex canopy is a mathematical and computational challenge.

## **B. Seasonal interactions: phenology and synchronicity**

In temperate countries, all crop varieties were selected for their performance under full irradiance; as a consequence, the impact of shade trees on system productivity is usually strongly negative (Dufour *et al.*, 2013). In the tropics, even though light is rarely the main limiting resource, introduction of shade trees may also decrease significantly crop performance, especially if the crop results from selection (varietal selection were mainly made in full irradiance conditions), which is the case for Arabica coffee. During the AFS design, a special care is taken in choosing trees and crops that do not have synchronous cycles or to plan tree pruning at critical crop phenological stages. However, that knowledge on phenology is mostly empirical. The effect of a reduction of light during the different phenological stages (*i.e.* critical stages such as blossoming or bean filling) remains to be assessed. Indeed, those aspects were generally ignored in traditional crop models (Dufour *et al.*, 2013).

Dufour *et al.* (2013) studied the effect of shade on wheat yield in an AFS planted with *Juglans* trees ( $\approx 20\text{-}30\%$  reduction of available irradiance for the crop). They evidenced the beneficial effect of a late budburst of walnut trees, when the max LAI of spring wheat is already reached. They found no difference between wheat yield in the sole plot and in the AFS. In the case of *Paulownia* that displays

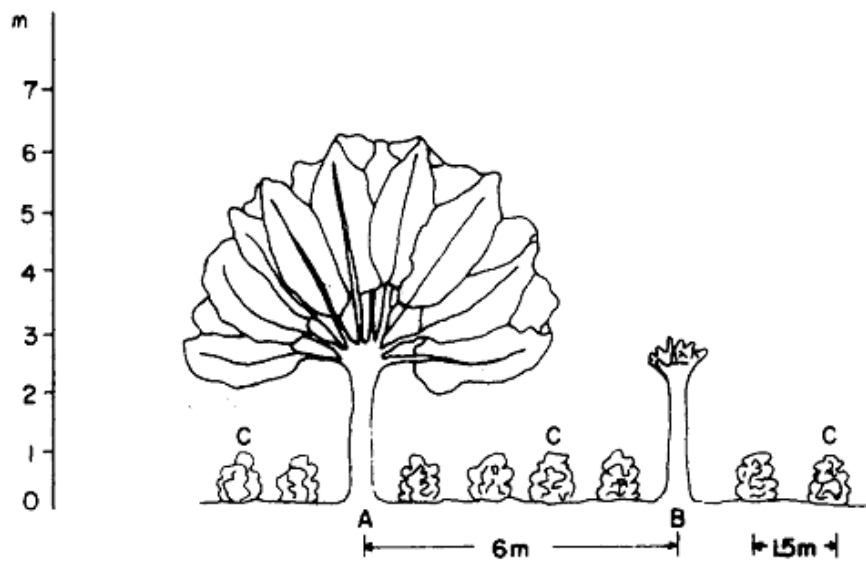

**Fig. 4** - Coffee and *Erythrina poeppigiana* AFS. (A) is an *Erythrina* not pruned for 6 months, (B) is an *Erythrina* recently pollarded and (C) are the coffee plants (Russo and Budowski, 1986).



bud-burst during wheat germination (50 % reduction in available irradiance), it led to a 50% reduction of wheat yield. Moreover, no below-ground competition between wheat and *Juglans* was evidenced under non-limiting nutrient and water conditions.

A famous example of complementary phenology in AFS is the reverse phenology of *Faidherbia albida* in Sudanese and Sahelian zones. *Faidherbia* is at maximum leaf area during the dry season and sheds leaves at the beginning of the rain season, providing nitrogen-rich leaf litter for crops. Additionally, mobilization of water and nutrients of *Faidherbia* does not compete with crop due to its deep rooting. The reverse phenology between *Faidherbia* and crop results in the absence of competition for light and water and probably facilitation effects through enhanced fertility (Roupsard *et al.*, 1999).

Sometimes, AFS do not display any natural advantageous lag in phenological stages, thus management practices such as pruning may help in handling satisfactorily the critical stages. For coffee AFS, the critical phenological stage is the blossoming. At this season, managers may prune the shade trees so that coffee plants receive a full irradiance favorable to fruiting. The shade trees are pruned every year or twice a year (they have a shape of pollarded trees) and provide shade during the rest of the year (Fig. 4). In this case, pruning also provides mulch to the crop.

### **C. Highlight on the competition for light**

Shade trees introduce a spatial and seasonal variability in light availability for the crop, light absorption being the first driver of plant productivity in non-limiting conditions (Monteith, 1972). Understanding this intra-plot variability is a critical and non trivial issue for:

- Farmers who need to adapt management practices that may vary spatially and seasonally: delayed harvest, different pruning strategies, etc;
- Technicians who need to build decision-making tools that can provide recommendations on tree density, row orientations in a certain context;
- Researchers who need to disentangle processes involved in tree-crop interactions.

Light absorption by the crop depends on: (1) variations of sun course (with latitude, season, obstacles, slope and azimuth); (2) hourly/daily variations of radiative forcing; (3) variations of nebulosity influencing radiation intensity and the ratio of direct to diffuse light, (4) tree density and spatial organization; (5) tree phenology and seasonal variations of tree LAI the modulate transmission to the crop and spectral composition of the transmitted light; (6) LAI and crop canopy properties (leaf angle distributions); (7) optical properties of the leaves (reflectance and transmittance).

In AFS research, the shading effect due to trees is generally poorly analyzed. Shading intensity is usually described with fuzzy indicators like “percentage of tree cover” or “shade density”. Methods most frequently used to assess shading intensity are, in decreasing order of use: visual estimation, densiometer, hemispherical photographs (HP), PAR sensors and plant canopy analyzer. Even though those tools do not quantify the same parameters they were often aggregated for the purpose of system comparison in papers: *e.g.* Soto-Pinto *et al.* (2000) compared gap-fraction estimates measured with HP in a coffee AFS to Muschler (2001) values of shade measured with a densiometer. Even though “shade” values measured using the different methods are probably correlated to some extent (Bellow and Nair, 2003), they are mostly not suited to provide: (1) absolute values of transmitted light; (2) time-integrated values of transmitted light; (3) spatial variability of transmitted light (unless planning a costly spatially and temporally intensive sampling). And they are not adapted at all to calculate actual interception by the crop. In AF research, experiments assessing the effect of shade on a particular crop trait (on disease, on productivity, etc.) were generally designed with shade as a discrete factor: shade vs. full sun with a punctual quantification of shade.

In order to estimate the spatial and seasonal variability of productivity in AFS, we postulate that only process-based models are able to estimate light budgets reliably. Indeed, computing adequately light budgets is a compulsory step to convert budgets into biomass.

#### **D. Effect of microclimate on processes**

The presence of shade trees in an AFS influences the microclimate experienced by the understorey crop: shade trees intercept irradiance, thus reduce the available light and the energy reaching the crop; they alter wind velocity and turbulence in the system. The purpose of this section is not to describe physically the phenomena; neither to explain how to model tree-crop interactions in AFS. The scaling up of microclimate (energy but especially turbulence) requires complex formalisms that are out of scope in this synthesis. The objective here is mostly to review the potential effects of shade trees on the three main crop canopy processes, *i.e.* heat, carbon and water exchange. We will emphasize the potential contradictory and counter-intuitive effects of microclimate on those fluxes through few examples taken from the literature. Through this approach, we wish to highlight the possible large impacts of microclimate and the need to use/develop appropriate modeling tools to quantify those effects.

Some large progresses have been obtained in the mathematical description of those processes for monoculture crops mostly, and partially in hedged agrosystems (de Parcevaux and Huber, 2007). However, agroforestry research did not investigate enough in this direction, which is highlighted by the quite small number of agroforestry publications in agro-meteorological journals.

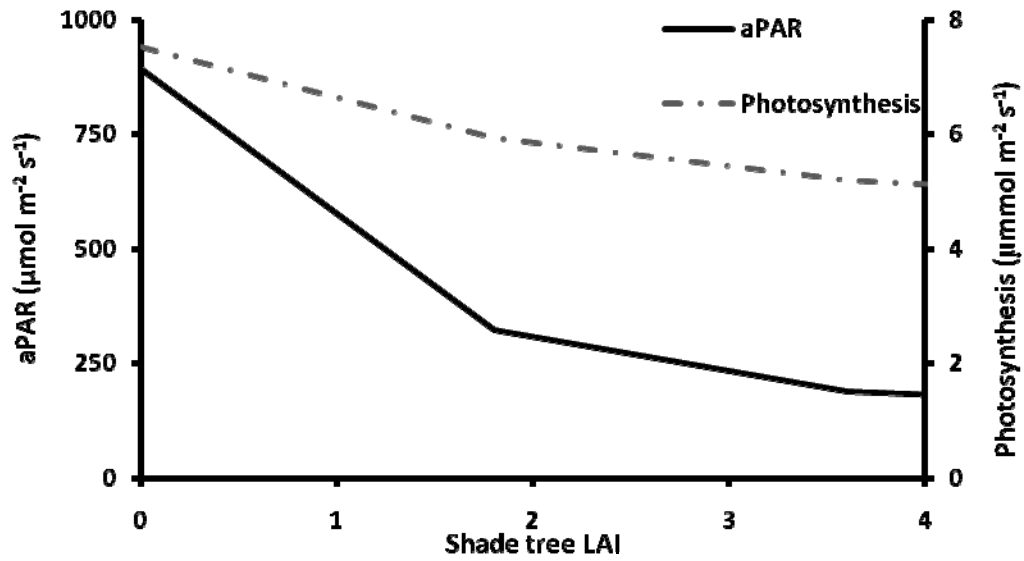

*Fig. 5 – Simulated midday absorbed radiation and photosynthesis of a coffee plant located under a shade tree of varying LAI (incident PAR=2000  $\mu\text{mol m}^{-2} \text{s}^{-1}$ ). Simulation was run with MAESPA model parameterized for coffee plant +Erythrina shade tree.*

### **i. Changes of heat fluxes**

The conversion of a monoculture into an AFS may considerably affect the energy balance of the system. For example the system taken as a whole may experience modifications similar to those described by Baldocchi and Ma (2013) in a mixed observation-modeling approach (comparison of a pasture with a savanna-pasture):

- A decreased albedo in the savanna-pasture due to higher LAI should increase system heat and light absorption. On the other hand, the air column above the system may have an increased albedo due to higher savanna transpiration.
- A possible increase in savanna ambient temperature i) due to a better radiation absorption by the system during the day (de Parcevaux and Huber, 2007) or ii) due to a rougher surface that may facilitate the transfer of extra absorbed energy as sensible heat into the atmosphere;

Baldocchi and Ma (2013) showed that those hypotheses varied seasonally (meteorology + phenology effects). In their study, canopy surface conductance plays a major role in controlling heat fluxes by organizing shifts between latent and sensible heat fluxes. They advocate that only the use of modeling helped explaining differences in heat fluxes between a one layer crop (pasture) and a 2-layered heterogeneous system (savanna+pasture).

When studying the energy fluxes of the under-crop only, the picture is quite different because understorey receives less energy than in a sole crop. The spatial variability of those fluxes is highly dependent on the arrangement of shade trees.

#### ***Available radiation***

Under shade tree crowns, crop receives fewer radiations than in the open, which is expected to decrease crop photosynthesis. At leaf scale, photosynthesis saturate at high levels of radiations and thus leaves under shade trees must display higher photosynthetic light use efficiencies (LUE) than in full sun. However, it is difficult to say *a priori* how this expected higher leaf LUE under shade varies when integrated over the entire canopy and larger time scales (Medlyn, 1998). As an example, Fig. 5 shows how a shade tree of varying LAI could affect the midday absorbed radiation (aPAR) and the subsequent photosynthesis of a coffee plant located under its crown (simulation with MAESPA, a 3D process-based model parameterized for coffee and *Erythrina* AFS; Duursma and Medlyn, 2012; Medlyn and Duursma, 2009). In this example, the coffee plant photosynthesis diminishes less rapidly than aPAR leading to higher photosynthetic LUE at high shade tree LAI. Integrated over an entire day or more, the difference of photosynthetic LUE between shaded and unshaded plant may be more or less buffered (Medlyn, 1998).

Shade trees are also expected to modify the proportion of diffuse radiation which is known to affect canopy photosynthesis (Gu *et al.*, 2002; Spitters *et al.*, 1986). Enhanced diffuse radiation is expected to increase LUE and to **compensate** to a certain extent for the decrease in photosynthesis due to the decrease in available radiation (Dapoigny *et al.*, 2000; Monteith *et al.*, 1991).

Additionally, shade trees are expected to modify the spectrum of radiation by depleting the amount of radiation in red wavelength which may affect leaf Specific Leaf Area (Kwesiga and Grace, 1986) with consequences on photosynthetic light compensation point, maximal carboxylation rate by Rubisco or quantum yield (Lambers *et al.*, 2008).

### ***Canopy temperature***

Canopy temperatures were reported to be buffered under shade trees (Lin, 2007; López-Bravo *et al.*, 2012; Siles *et al.*, 2010). For example, in a coffee AFS where shade trees reduced incident light by 50 to 75% of, Siles *et al.* (2010) reported **lower maximal canopy temperature** (- 1 to -7°C) and **higher minimal temperatures** (+1 to +2°C). However, authors used air temperature measured in the open as a reference, making difficult to separate the microclimatic effect of shade trees (reduced local air temperature) from the effect of different flux partitioning in the crop canopy (between sensible and latent heat). These modifications of temperature are expected to modify the photosynthesis efficiency (Rubisco activity is dependent on temperature) and respiration rates (related to the temperature through a Q10). Those temperature buffering are also expected to expand the ecological “coping range” of crops.

At identical shape and LAI, two shade tree species may have a totally different effect on local microclimate and thus crop canopy processes. Farmers empirically classify them as “fresh” and “hot trees” (Cerdán *et al.*, 2012). From a physiological point of view, it depends on the tree capacity to keep transpiring or not during the day.

### ***Latent heat fluxes***

It is really difficult to predict *a priori* the effects of shade trees on crop transpiration, because it depends on how stomata respond to the local micrometeorological conditions (crop dependent), changes in canopy surface conductance, and changes in heat fluxes. But overall, a decrease in crop transpiration under tree crowns is likely due to expected smaller VPD. The photosynthesis is non-linearly related to transpiration, photosynthesis saturating at high transpiration rates. It is thus expected that shade trees have a positive effect on crop water-use-efficiency (Wallace and Verhoef, 2000; Wallace, 2000).

Temperature and humidity modifications under shade trees thus depend on the shade tree species, LAI, phenology, radiation forcing, atmosphere temperature and humidity as well as water availability.

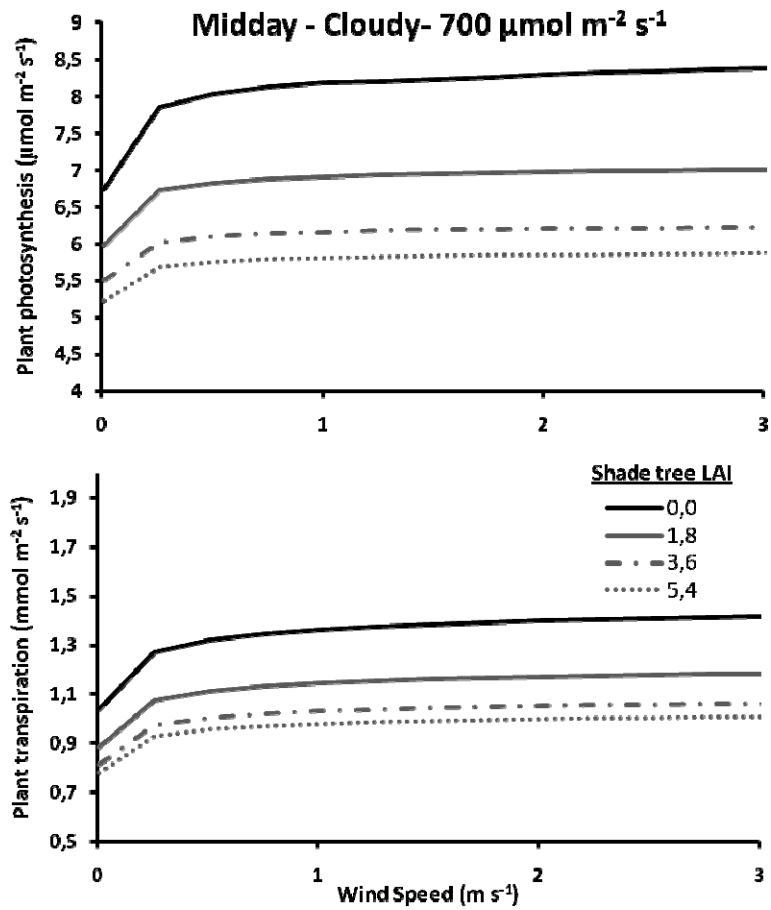

**Fig. 6** - Effect of wind speed on photosynthesis and transpiration at midday of a coffee plant located under shade tree (Simulated with MAESPA, wind speed is the value just above the coffee plant crown).

Some models were built specifically to simulate local variations of air temperature and humidity in sparse canopies (Shuttleworth and Wallace, 1985), multi-layer canopies (Choudhury and Monteith, 1988), mixed canopies (Wallace and Verhoef, 2000).

## ii. Effect of wind

Increased wind speed increase aerodynamic conductance. In return, aerodynamic conductance affects plant carbon and water fluxes in a complex way, depending on the couple stomatal conductance/leaf-to-air vapor pressure deficit. Generally, low aerodynamic conductance leads to lower transpiration rates. An example of simulation (Fig. 6) shows how increasing wind speed could affect the photosynthesis and transpiration of a coffee plant located under a shade tree (simulation with MAESPA). In MAESPA model, shade tree affects the available radiation for the coffee plant (negative effect of coffee plant midday photosynthesis and transpiration) but do not affect wind profile. Wind is considered maximum (input wind speed) above the crown of each simulated plant and the wind speed decreases with crown depth, plant LAI and leaf width following a logarithmic scale (Duursma and Medlyn, 2012). In this simulation, the photosynthesis and transpiration is decreased by 23 and 14%, respectively if the wind speed is null. More complex representations of within canopy wind profile can be modeled considering turbulent fluxes such as Lagrangian approaches (Raupach, 1992).

In agroforestry systems, shade trees may provide high disturbance in wind profiles. Trees have a rough surface, their spatial variability introduce wind shearing and spatially complex turbulence. To date and to our knowledge, there are no modeling tools adapted to agronomy that can take into account 3D variations of turbulence and their effect on aerodynamic conductance.

In some types of AFS such as windbreaks, trees are planted in hedgerows to protect the crop from the negative effects of advection. Advection is the evaporative capacity of the supply of energy provided by a wind blowing over a crop (*i.e.* evaporative capacity is expected higher for irrigated crop subjected to high wind). In some cases, advection term can even be higher than evapo-transpiration ( $\lambda E$ ) caused by net radiation ( $R_n$ ) (de Parcevaux and Huber, 2007). For specific AF applications regarding advection, the reader can refer to the complete set of studies by D. Smith, P. Jarvis and colleagues on Sahelian windbreaks (Smith and Jarvis, 1998; Smith *et al.*, 1997a, b; Smith *et al.*, 1997c).

### 3. Why modeling canopy processes in AFS?

#### A. Connecting processes and formalizing the biophysical understanding

The study of complex systems requires the formulation of hypothesis and the development of functions to describe quantitatively the processes. Modeling consists in the elaboration of the precise organization of those hypotheses (de Parcevaux and Huber, 2007). Modeling thus provides a holistic approach by connecting inter-dependent processes. Process-based models provide a mathematical framework to (1) produce research questions and hypothesis; (2) explain/decompose the variability in observed data, *i.e.* help summarize and interpret field data; (3) predict system behavior in unknown conditions; (4) down-scale or up-scale processes (D. Baldocchi, Adv. biometeorology course, UC. Berkeley; de Parcevaux and Huber, 2007). AFS typically require process-based models to further and systematize our understanding of the complex interactions involved, especially microclimatic.

Process-based models for monoculture stands (in the forestry or agronomic fields) are now simulating canopy processes with great accuracy (*e.g.* Brisson *et al.*, 2003 for crop models ; Hanson *et al.*, 2004 for a set of forest models). The most refined models embark detailed canopy processes including the complex effects of turbulence or the description of short and long wave radiations (Baldocchi and Harley, 1995). Those models generally deal with spatially averaged canopies virtually divided in one or multiple layers. Fluxes are represented in 1D. Those models helped solving a great number of ecophysiological/agronomical issues in those systems: effect of clumping, LAI and percentage of diffuse radiations on crop light use efficiency (Medlyn, 1998), linear relationship between aPAR and plot scale NPP (Monteith and Moss, 1977), etc. They also helped in finding key and emerging processes for up-scaling. For example, locally influent turbulence effect may be canceled at larger scales (de Parcevaux and Huber, 2007). Representing the canopy by a single layer separated into sun and shade leaves is sufficient to simulate satisfactorily light absorption and photosynthesis (De Pury and Farquhar, 1997; Roupsard *et al.*, 2008; Ryu *et al.*, 2011).

The coupling of 2 vertical canopy-layers (*i.e.* shade tree canopy + crop canopy) or multiple vertical layers systems create new interactions, such as microclimate feedback, that were not modeled by single canopy-layers models. Those models only describe vertical gradients of fluxes (*e.g.* Cannell *et al.*, 1998).

Spatially disaggregated (*e.g.* Mobbs *et al.*, 1998b) or explicit 3D (*e.g.* Wang and Jarvis, 1990a) models account for lateral fluxes. Those models consider uniquely the radiative transfer in 3D; in most cases energy, water and wind fluxes are still modeled according to a vertical gradient. The modeling of the 3D nature of those fluxes remains a huge challenge in AFS and heterogeneous systems in general.



Impact of those non-modeled lateral fluxes in certain AFS may be important (see the Sahelian windbreak example cited above) or perhaps may be neglected (*e.g.* humid climate).

## **B. Bringing continuous variables into heterogeneous plots and helping experimental designs**

AF research provided legions of articles trying to assess experimentally the effect of shade on productivity, pests and diseases incidence, crop quality, pollination (a simple google search allows to access the wide variety of studied effects of shade)... Those effects are generally weak, display a high variability and are sometimes contradictory between studies.

Spatially explicit models are expected to produce maps of processes that could not be easily inferred solely from measurements, for example a map of light available for the understorey, a map of canopy temperature, a map of photosynthesis, etc. Those maps may provide local values of processes integrated over user-defined time scale. Models are thus requested to produce explanatory variables for field experiments. We argue here that those continuous variables could help explaining much more variability than the usual full sun/ shade dichotomy used in AFS experimental designs. Meaningful covariates that could be mapped and used in experimental designs: *e.g.* total transmitted radiations to the crop, crop canopy temperature...

Models also provide a quantification of local (or plant scale) fluxes (integrated over time) that can be coupled to plant productivity measurements to produce significant ratios in plant physiology: biomass produced per unit of absorbed radiation (light use efficiency), of water transpired (water use efficiency) or of carbon assimilated by photosynthesis (carbon use efficiency). Studying the determinants of the variability of those ratios may give significant insights on the effect of shade trees on local canopy processes.

## **C. The importance of virtual simulation for the design of innovative AFS**

By definition, process-based models are expected to produce reliable predictions even outside their validation range, even if verification is recommended. They are thus suitable to predict the system behavior in after varying the physical constraints.

A typical question in AF research is related to the optimal density, arrangement and row orientation of shade trees, so that the crop production is only marginally affected. AF or forestry models were already used to optimize the absorbed radiations or photosynthesis (Grace, 1988). Such simulations were attempted by Talbot (2011) who simulated the effects of tree arrangements on the tree and crop yield using a 3D light interception model for trees coupled to a crop model (Hi-Safe; Dupraz *et al.*, 2005). In the simulation, the author compares the evolution of tree and crop yield compared to sole

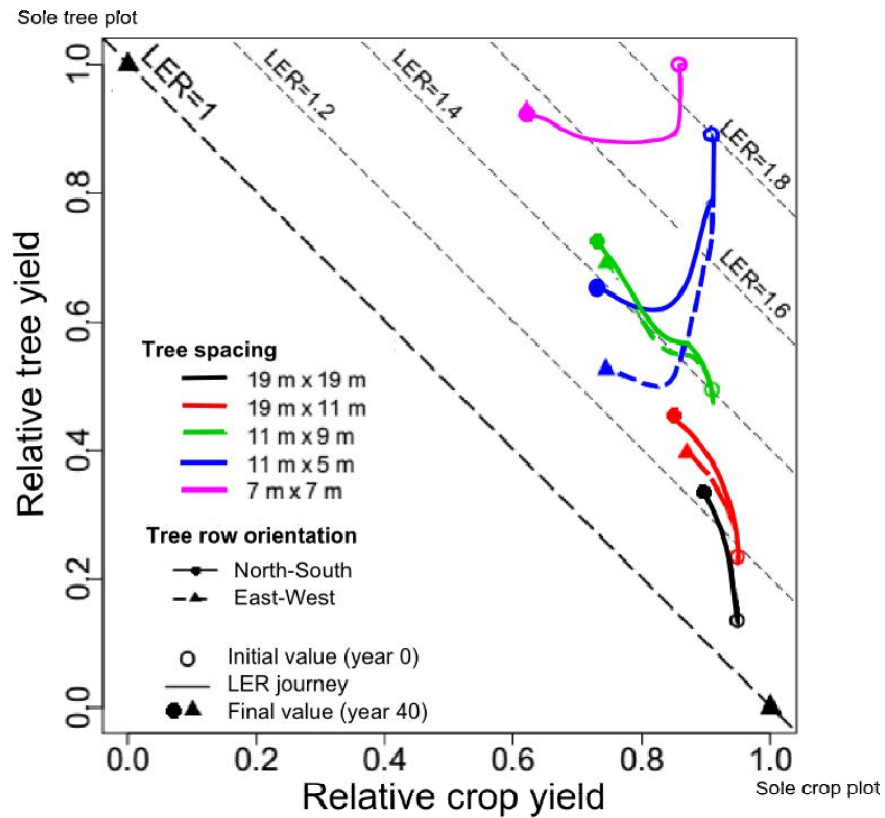

**Fig.7** – 40 years simulation of the evolution of Land-Equivalent ratio (LER) in a virtual wheat-walnut AF plot under varying shade tree density and line orientation (Talbot, 2011). Sole plots are planted at a standard optimal density, explaining that shade tree yield at the beginning of the run vary with plantation density.

plots during 40 years for various shade tree density and line orientations (Fig. 7). The author demonstrates that it is difficult even *a posteriori* to determine which variables influenced more the variations in crop productivity, because in a complex dynamic crop model nearly none of the explanatory variables were independent.

#### **D. Modeling to assess the resilience of AFS**

Given the spatial heterogeneity and species diversity, AFS are assumed to be intrinsically more resilient (i.e. the capacity of the system to recover production after a climate disruption such as a drought or an extended period with high temperatures) than a monoculture (Anderson and Sinclair, 1993). If we can easily state a large resilience of traditional agroforests that mimic the ecological functioning of rainforests (*e.g.* Michon *et al.*, 1983), the resilience of modern AFS with 2-3 species is not so obvious. Unlike undisturbed ecosystems, the resilience of AFS is intrinsically linked to management practices. An absence of adequate management in an AFS would rapidly lead to a loss of production. In practice, it would be interesting to separate an intrinsic AFS resilience (so-called “ecological resilience”) from a “global resilience” including economic and social factors (O. Roupsard, Pers. Comm.). Theoretically, the “ecological resilience” would be the inherent capacity of the system to absorb environmental stresses and recover stability. In practice, AFS is already a managed system receiving energetic inputs (fertilizers, pesticides, etc). Its intrinsic resilience would thus be biased by the absence of nutrient limitations. The system resilience should be a step by step assessment that would include: 1/ an AFS managed with realistic levels of fertilization (*i.e.* system recycling + fertilizers produced in the farm; context of organic farming); 2/ an AFS with generally admitted levels of oil-derived inputs; 3/ an AFS with economical and social constraints. Those 3 level resilience profiles should be established under various scenarios such as: climate projections scenarios locally downscaled, effect of strong disturbing climatic events (*e.g.* hurricanes or strong drought), effect of considered time scale, and effect of economic scenarios on the crop-value chain or on the price of raw materials such as oil prices...

The assessment of those resilience profiles is a huge scientific challenge in such complex context. Obviously, mechanistic models that couple biophysical and economic models would be needed. Environment, the management and the economic factors do impact the system. That's why models should be dynamic in order to account for feedback loops. Few attempts were made to couple biophysical and economical models: to our knowledge only the “Silvoarable AgroForestry for Europe” project (SAFE) developed an economic model (Graves *et al.*, 2011) coupled to a dynamic and simplified biophysical model designed for long term run (van der Werf *et al.*, 2007). However, the simplified biophysical model would not allow studying “ecological resilience” of systems. The same team is being developing a daily time step model to study the above and below ground intra-plot

biophysical interactions using 3D approach that would be able to make such study (Hi-Safe) (Dupraz *et al.*, 2005).

A recently accepted French project (ANR agrobiosphère MACACC) aims at studying resilience profiles of 3 perennial plantations, including coffee AFS to increased temperature, decreased precipitations and under nutrient constraints. They plan to study specifically the buffering capacity of shade trees in maintaining adequate microclimate (temperature) for the under-storey under different downscaled climate change scenarios and nutrient limitations. They plan to use a 3D soil-vegetation-atmosphere transfer model adapted to AFS (MAESPA; Duursma and Medlyn, 2012) coupled with a model of carbon allocation and growth (GO+: Loustau *et al.*, 2012) to model the 3 perennial plantations.

#### **4. How to model processes in AFS?**

As outlined in the first part of this manuscript, agroforestry systems appears difficult to model by nature due to their complexity. The effects of the multiple vertical / horizontal / temporal heterogeneities on AFS processes may lead to models of incredible complexities. On the other hand, the agroforestry model should have the aim to be adopted by other AF researchers teams working on different systems around the World. Degraded/simplified models should be implemented to be used as application-oriented tools with a coupling to economics at farm or regional scale (*e.g.* van der Werf *et al.*, 2007). Roupsard *et al.* (2008) argued that a process-model should be used for investigation and validation while simplified/degraded/empirical models should be used for coupling with economic model or for upscaling applications. The process-model should be the reference (they are expected to simulate more satisfactorily the processes) against which the simplified model should be compared. Moreover, they proposed that the process-model should be parsimonious regarding parameters: sensitivity studies should be performed with the model before designing the field experiment to identify what are the main parameters to document in the field and at what resolution, according to their impact on the model simulations and to their estimated variability in the field.

Typically for any type of AFS, the reference model should have an hourly time step to reproduce the effect of sun course on the daily time course of processes. For example, the effect of shade trees on the time course of the photosynthesis limitations (stomatal limitation or radiation limitation) can only be highlighted at this time scale. The model should be able to simulate one complete crop cycle (1 year). The spatial scale of a reference AFS model should be *ca.* the square meter (or the individual plant) until the plot scale which is the farmer management unit.

How complex should the reference model be? The main questions are related to which processes to simulate and how to represent the spatial structure of the AFS.

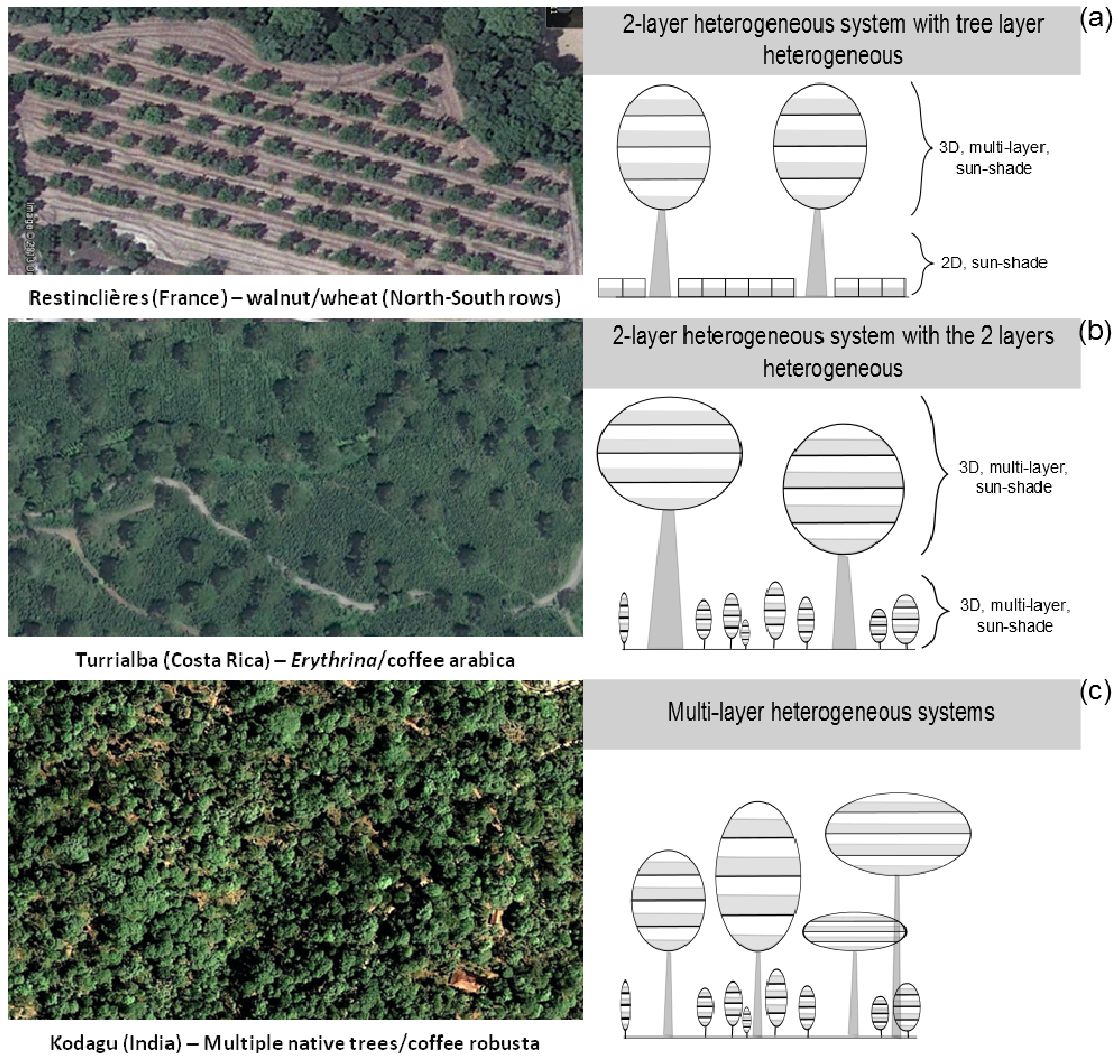

**Fig. 8** - Spatial heterogeneity of shade in AFS of France (a), Costa Rica (b) and India (c) and possible modeling representations to account for the variability of light availability.

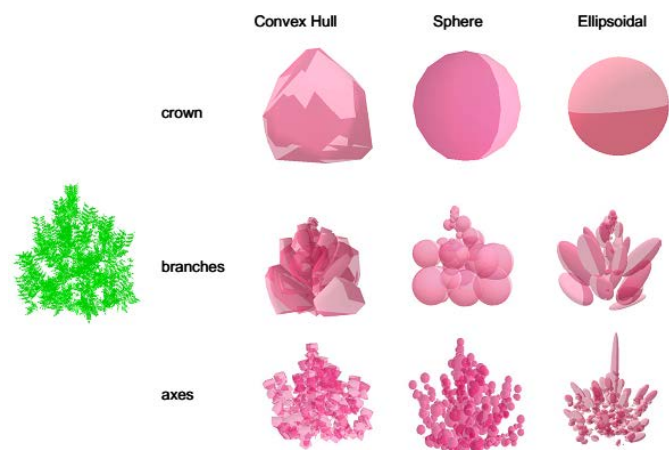

**Fig. 9** - Simplifying the tree crown representations - Many possible options.... (Dupraz et al., 2005)

### **A. Which processes to simplify? Which processes to ignore?**

The answers mainly depend on the AFS considered. For example, if the studied system experiences a drought during the year, it would be highly recommended to introduce a detailed soil water balance module to constrain modelled plant transpiration while transpiration may be modelled without water limitation in a humid system (D. Baldocchi, Adv. biometeorology course, UC. Berkeley). In the case of a Sahelian windbreak system, ignoring the advection in the modelling process would cause potential large biases in transpiration estimates (Smith and Jarvis, 1998). At this point, we argue that simulating canopy processes in humid climate where there is no limitation for water is ideal to start testing a new agroforestry model. On the other hand, humid climates typically display a high nebulosity; considering the partitioning of radiations into diffuse and direct beam would be highly relevant to get more accurate estimates of photosynthesis (Gu *et al.*, 2002).

Others could argue that the more generic the model is, the more it can be adapted to different systems and adopted by different research team. This is the case of WalNuCAS (Van Noordwijk and Lusiana, 1998) which is the first generic AF model that has been widely used in the tropics on different systems. The model represents numerous biophysical processes in a patchy 2D environment. The structure and the processes used in the model are generally largely simplified (such as light capture or carbon acquisition); they can hardly be used as a research tool. Dupraz (2002) suggested that it could be used as a base-line to compare with other models.

### **B. How to model the AFS structure?**

Choosing a representation of the AFS structure in the model is critical because it will condition model calculation times: a fine scale 3D calculation is obviously much time consuming! Representing AFS with 3D models is quite straightforward even though this assumption may be simplified in the case of nearly homogeneous shade tree or crop layer (Fig. 8). An AFS planted with an annual crop such as wheat or maize does not need a tree centered representation; the crop layer can be represented by a spatially discretized but horizontally homogeneous layer (Fig. 8a) (Dupraz *et al.*, 2005). In the case of the coffee AFS (Fig. 8b&c), the shade trees as well as the coffee layers are vertically and horizontally heterogeneous, so both layers may be represented in 3D.

When 3D canopy are selected for the modelling, the possibilities of crown representation are wide (Fig. 9). In this example, researches from the SAFE project compared simulations of absorbed light with reference models (architectural models) with different degraded options. Their final choice was based on trade-offs between canopy simplification, accuracy of absorbed light prediction and computational time (Dupraz *et al.*, 2005).

Other important choices in the structure representation are related to leaves: how to represent their spatial distribution within the crown, the leaf angle distributions and the intra-crown clumping? Those three factors may dramatically influence the simulated absorbed light (Wang and Jarvis, 1990b).

Many other challenges are raised by the AF modelling:

- How to manage and organize parameter and structure database for multiple species and systems?
- How to couple biophysical model with economic models?
- How to simplify the reference model?
- What are the pros and cons in implementing the model on a modelling platform with the possibility of adding and replacing modules?
- How to manage the huge quantity of outputs generated by the models?
- Etc.

For further insights, we recommend reading the reports of the SAFE project. Project members described their strategy, success and failures to create a generic agroforestry model Hi-Safe. Some failure in simulating satisfactorily the microclimate delayed model publication. Indeed, they planned to rely on the Shuttleworth and Wallace (1985) model to calculate microclimate: the water vapour fluxes due to soil evaporation and transpiration (of trees and crops) depend on the tree/crop canopy microclimate and which modify this microclimate as a feedback. This coupling between microclimate and fluxes implied iterative calculations. However the Hi-Safe approach relied on the coupling of two independent models (a 3D shade tree radiative transfer model and the crop model STICS) communicating through input/output datafiles, making the iterative calculations difficult (SAFE, 2<sup>nd</sup> year annual report [www1.montpellier.inra.fr/safe/](http://www1.montpellier.inra.fr/safe/)). This example shows that despite clear objectives, a near exhaustive modelling review of processes, a well planned strategy, they slaved in implementing a microclimate module (which was the most eagerly awaited module) in a multilayer system, due to choices in interface.

## **5. Measuring and modeling processes in AFS**

From now on, we will focus on canopy processes, namely heat, carbon and water fluxes assuming that we are working in non-limiting water and nutrient conditions.

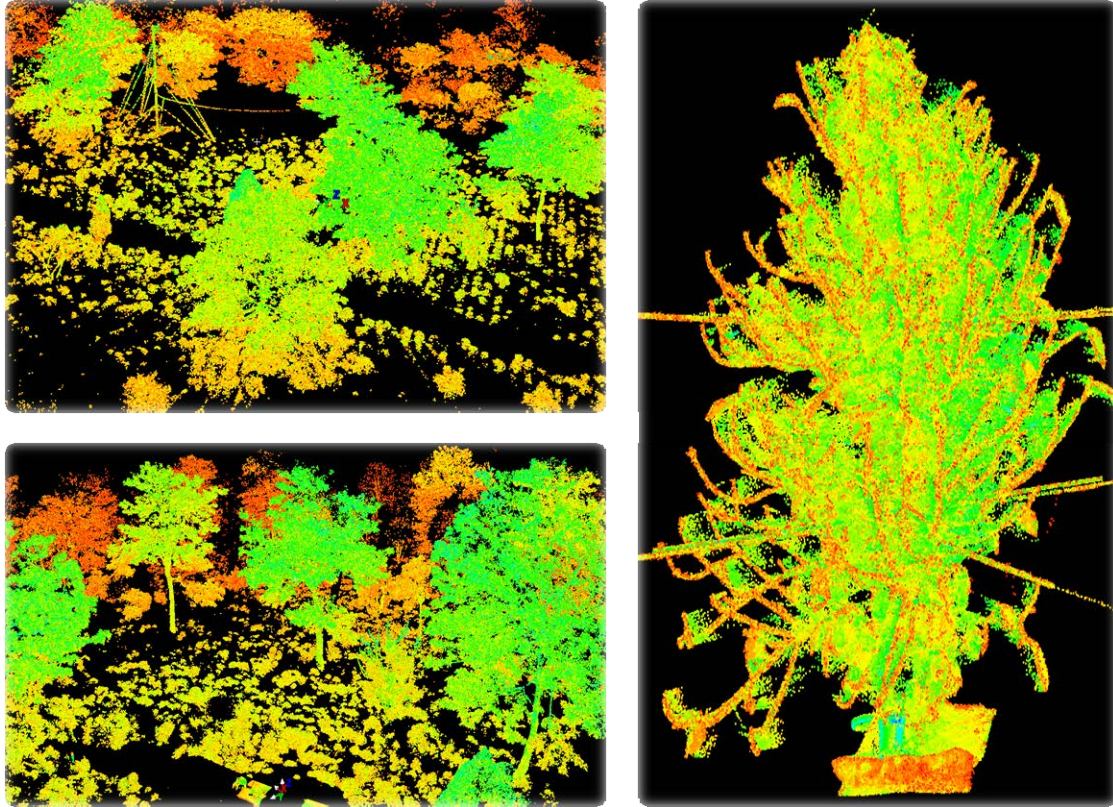

**Fig. 10** - LiDAR scans of a coffee and *Erythrina poeppigiana* AFS in Turrialba, Costa Rica (Left). Scan of an isolated coffee plant in the lab (horizontal lines are strings to delimit crown volumes). (<https://sites.google.com/site/laiworkshoppcp/project-definition>). Source: A courtesy of L. Vierling and J. Eitel.



## A. Field measurements for parameterization and model verification

### i. Studying the structure heterogeneity of AFS

#### *Spatial arrangement of plants*

In order to study canopy processes in AFS, it is mandatory to characterize the plot spatial heterogeneity and its evolution according to phenology (seasons) and management (*e.g.* pruning). A description of the plot structure is thus required in order to map the spatial arrangement of the different tree species and their canopy shape.

The most accessible technique to assess spatial variability is the inventory. This method is among the most precise; it does not require expensive instruments (a meter tape and a clinometer to assess tall tree heights are sufficient). Inventory of the AFS can then easily be geolocalized (*e.g.* using SPOTImage available from GoogleEarth) and the tree or crop line positions adjusted. However, the inventory is a time-consuming step which may need the work of several laborers depending on the area to inventory and the density of the plantation.

Very high spatial resolution satellites images combined with tree detection algorithm are able to detect projected canopy area of the shade trees in an AFS (le Maire *et al.*, 2012). Other parameters such as tree height or leaf area can be derived from this remote estimation using field based allometric relationships. Detection of the understorey would be possible if the crop size is within the precision of the image (down to 15 cm). However, the problem of occlusion of the understorey by the shade trees remains unresolved.

LiDAR (airborne or terrestrial) is potentially a promising way to characterize spatial heterogeneity in AFS. LiDAR send laser pulses and relies on their return speed and intensity to draw a 3D picture of elements. The 3D picture resolution depends mainly on the frequency of laser pulse and on the distance between the LiDAR and the scanned object. LiDAR was already used to characterize height (with a good precision), leaf/branch area index (with a much lower precision) of forest canopies (for a review, see Leeuwen and Nieuwenhuis, 2010) and even of orchards planted in rows (*e.g.* using ground-based LiDAR: Moorthy *et al.*, 2011). Fig. 10 shows the result of a single return LiDAR ground-based scan for our coffee AFS experimental plot and for a single coffee plant in the lab. Those pictures reveal 1/ the low resolution of single return LiDAR when scanning large areas; 2/ the non - visible elements do not appear: other scan from other directions would be needed; 3/ the coffee rows are well delineated and the coffee layer appears really heterogeneous; 4/ only the largest plants would appear, even after scans from other direction, leading inexorably to an underestimation of crop crown volume and leaf area index; 5/ leaves are not easy to delimit, most of the studies rely on the empirical correlation between leaf area and number of laser returns (Vierling *et al.*, 2012). Waveform LiDAR

were shown to return a smoother and more precise characterization of heterogeneous systems (Richardson *et al.*, 2009; Zhao *et al.*, 2011). Terrestrial LiDAR scanning were never applied to AFS to our knowledge, surely due to the high cost of those instruments. The development of cheapest instruments together with algorithms to transform cloud of points into object area is expected to make its use wider (Eitel *et al.*, 2013).

Airborne LiDAR allows a spatially integrated picture but do not solve the problem of occlusion of the crop by the shade trees (Tang *et al.*, 2012; Tang *et al.*, 2013). Until now, they remain out-of-reach for most of research team unless to be lucky enough to have its experimental plot on the flight of those airplanes...

Recently, coupled LiDAR (airborne or ground-based) and imaging spectrometry provided new possibilities of extracting spatial informations on chemical and spectral composition of canopies giving new possibilities for AFS description and model parameterization (*e.g.* Carnegie Airborne Observatory: Asner and Martin, 2008; Townsend and Asner, 2013).

When compared to the remote technics, the inventory remains the reference in terms of precision. The choice of the description technique will be first conditioned by the feasibility of using the remote technique (multistrata and dense systems would be excluded for instance). Then the choice of the technique will be a trade-off between the precision needed (depending on the complexity of the system) and the cost.

Management practices such as tree or crop pruning may produce or maintain a spatial heterogeneity in the AFS. They should be accounted for in the inventories.

### **Leaf area index**

Special care must be taken in measuring the spatial and seasonal variability of LAI. Indeed LAI is a key variable linking structure and function of ecosystems: LAI is the main variable explaining the absorbed light and the subsequent rate of photosynthesis. It is also involved in the hydrologic process such as rainfall interception and canopy transpiration (Ryu *et al.*, 2010). LAI values may be estimated directly from destructive sampling, from litterfall collections and from allometric relationships. It can be estimated indirectly using gap-fraction inversion technique using plant canopy analyzer (PCA; such as LAI2000, LiCOR) or hemispherical photographs. Pros, cons and methodologies for each of these methods were widely discussed in the literature (*e.g.* Bréda, 2003 provide a critical appraisal of existing field techniques; Ryu *et al.*, 2010 deal specifically with LAI in heterogeneous canopies). LAI can be detected using remote sensing thanks to its correlation (non linear) with Normalized Difference Vegetation Index (NDVI) calculated from satellites images. Recently, Pontauiller and Hymus (2003)

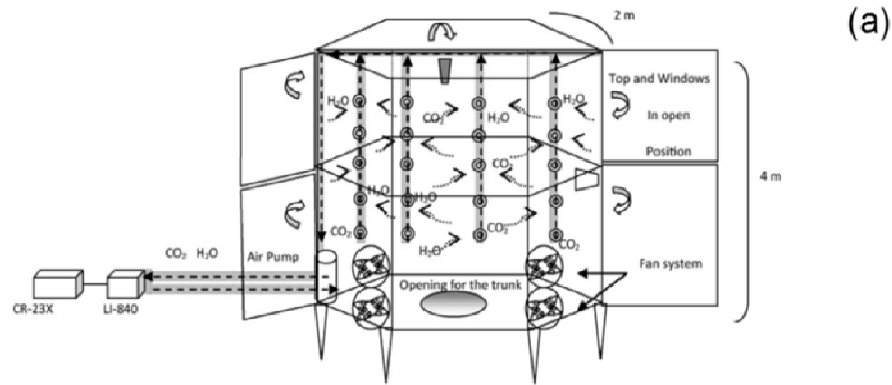
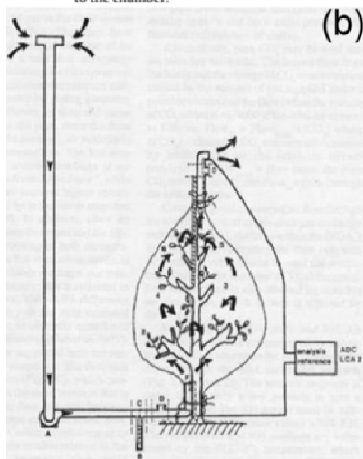
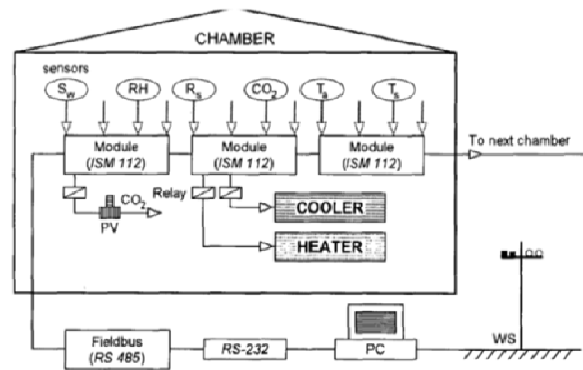

Fig. 1. Schematic drawing of the chamber, showing the opening windows and other components. The arrows indicate the air flow through the sampling circuit, and its return to the chamber.



(b)



(c)

Fig. 2. Schematic representation of the closed-top chamber exposure facility shown in Fig. 1, including the dispensing and monitoring systems. PV: CO<sub>2</sub> proportional valve, PC: personal computer, WS: weather station, S<sub>w</sub>, RH, R<sub>s</sub>, CO<sub>2</sub>, T<sub>a</sub> and T<sub>s</sub>: sensors for measuring volumetric soil water, relative humidity of the air, solar radiation, CO<sub>2</sub> concentration, and air and soil temperature, respectively.

**Fig. 11** – (a) Transient-state chamber that has to be closed to proceed to measurement (Pérez-Priego et al., 2010). (b) branch-bag type dynamic chamber (Corelli-Grappadelli and Magnanini, 1993). (c) Dynamic chamber with controlled environment (Kellomäki et al., 2000).

developed a proxy-detection NDVI sensor: fixed above the canopy the sensor is able to track daily variations of canopy LAI (Soudani *et al.*, 2012).

## ii. Measuring canopy processes

### *Intraplot variability of canopy processes*

In AFS, variability in crop canopy processes can be studied as a function of the distance to shade trees by implementing adequate experimental designs. A wide variety of measurements may be implemented after a careful characterization of the local environment (shade tree transmittance), crop architecture (LAI, leaf angle distributions), phenological stages and local meteorological data.

Energy budgets can be quantified locally using a complete set of instruments, compulsory to quantify each parameter of the energy balance equation: radiometers to measure the incoming radiation ( $R_n$ ) and sensible heat fluxes ( $H$  from soil and canopy), thermoradiometers or thermocouples to measure canopy or leaf temperature, sap-flow probes to estimate plant transpiration ( $T$ ). Additionally, anemometers coupled to shaded evaporimeters or heated leaf-replica can be used to assess aerodynamic conductance (Kainkwa and Stigter, 2000; Smith *et al.*, 1997a).

To characterize effects of shade trees on crop carbon and water fluxes, leaves or plants or group of plants have to be enclosed in chambers that may be dynamic or transient state (Livingston and Hutchinson, 1995):

- Leaf fluxes may be measured under standardized conditions using instruments such as Li-COR 6400 (Fig. 12a), and used to explore physiological modifications caused by shade trees.
- Among whole-plant chambers, the transient-state chamber (or closed chamber) is the simplest to design (Fig. 11a). During measurements, it consists in maintaining an air-flow in a closed-circuit that connects the chamber and an infrared gas analyzer (IRGA; to measure  $\text{CO}_2$  and  $\text{H}_2\text{O}$  concentration). Between measurement phases, the chamber is open. The flux (photosynthesis/respiration or transpiration) is calculated as the rate of gas concentration change ( $\text{CO}_2$  or  $\text{H}_2\text{O}$ ) within the circuit (Bethenod *et al.*, 1995). However, the gas concentration is never stable during the measurement phase; it is thus difficult to know if the measured flux corresponds to a steady-state (*i.e.* stable stomatal conductance; Bethenod *et al.*, 1995). This issue can be minimized by doing rapid measurements (Angell and Svejcar, 1999; Pérez-Priego *et al.*, 2010; Reicosky and Peters, 1977); combined with an efficient air mixing, it may reduce the temperature and relative humidity increase. Ideally, the undisturbed rate of gas exchange is the initial slope after the chamber closure (Pérez-Priego *et al.*, 2010; Wagner *et al.*, 1997).
- A small improvement can be made on the closed chamber system to avoid manual chamber opening (Fig. 12b). Between measurements, a blower can blow ambient air inside the chamber. At



**Fig. 12** - Leaf, plant and plot scale measurements of carbon and water exchanges in a coffee AFS in Turrialba, Costa Rica. Leaf gas exchange (a) parameters are used for model parameterization while whole-plant chamber (b) and eddy-covariance (c) are used respectively for intra-plot and plot verification of model predicted fluxes.

the moment of the measurement, the blower is turned off, entry and exit one-way valve close and the measurement can take place (Charbonnier *et al.*, in prep.-b). If automated, the closed chamber can acquire data night and days.

- The dynamic chamber (or open chamber) consists in measuring the difference of gas concentration of the airflow between the entry and the exit of the chamber (Fig. 11b&c)(Bethenod *et al.*, 1995). This system needs a very accurate measurement of the airflow. Then, there are two possibilities: either the air-flow has to be high enough to maintain the microclimate constant inside the chamber generating technical issues on airflow measurement and energy requirements (Fig. 11b)(branch-bag type: Corelli-Grapadelli and Magnanini, 1997); either the chamber microclimate has to be controlled which also need huge energy requirements and some complex automations (Fig. 11c)(Kellomäki *et al.*, 2000; Medhurst *et al.*, 2006).

Flux measurements should be associated with ancillary measurements to quantify the chamber effect on microclimatic modifications: incident net radiation, incident PAR, air and leaf temperature, air relative humidity....

Effect of shade trees on the variability of crop NPP can be assessed with repeated measurements of crop growth and harvest of litter production. Biometric measurements can be converted into biomass through site specific allometric equations (Clark *et al.*, 2001). Changes in the concentration of non-structural carbohydrates in plants are not accounted for in allometric relationships but may be important when looking at the NPP balance. Only destructive sampling or core sampling are able to assess quantitatively the NPP due to carbohydrate reserves (Mialet-Serra *et al.*, 2008).

All those processes are very sensitive to perturbations, the units involved are small thus susceptible to measurements uncertainties, time needed for experiments is large; such measurements cannot be replicated easily. For the same reasons, long term-measurements also seem practically difficult, given the high precision required. Moreover, meteorological conditions may change between replicates making comparisons even more difficult. The experimental technique alone rapidly appears inadequate to comprehend the spatial variability of canopy processes.

However, such local measurements made in carefully selected areas (*e.g.* a transect from an open area to a shade tree), appear to be very useful in the process of verifying the model capacity of predictions in contrasted environments.

### ***Plot scale and seasonal variability***

Eddy-covariance (EC) is a micrometeorological technique that provides a direct measure of net carbon, water and energy fluxes between the canopy and the atmosphere (Baldocchi *et al.*, 2001). EC typically allows estimating spatially integrated carbon and water fluxes (over a few hectares) with a

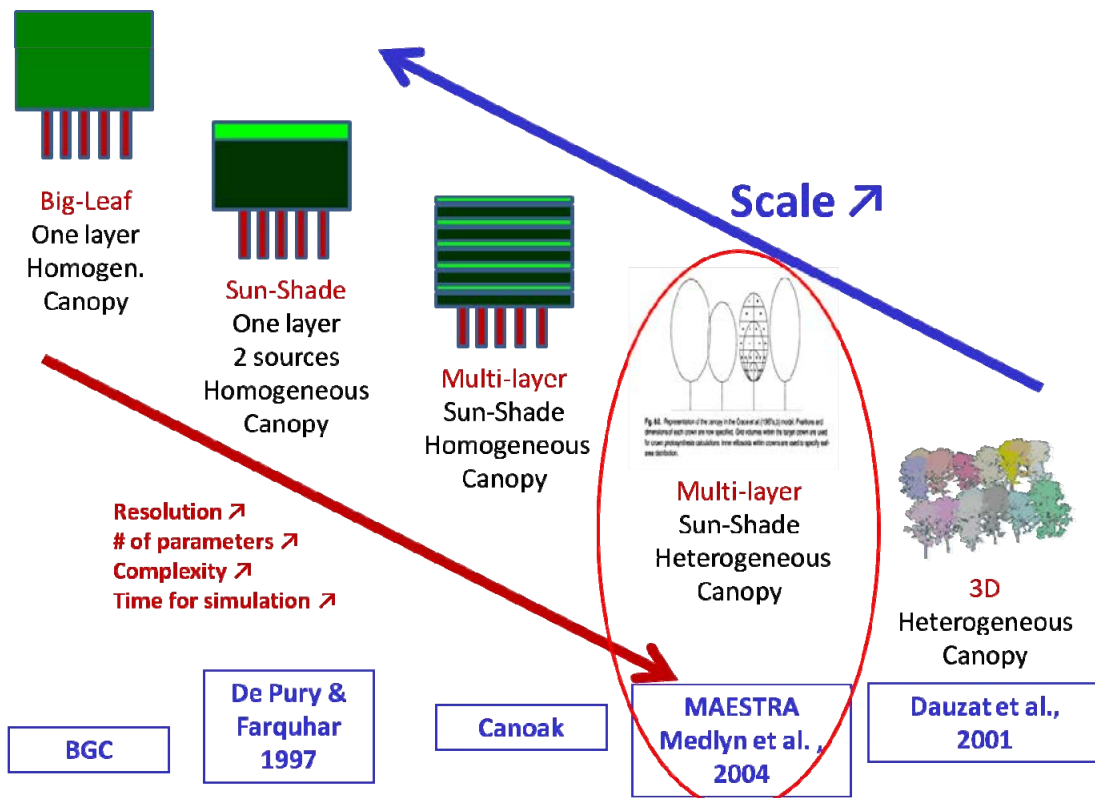

**Fig. 13** - The continuum of possible canopy representations in (S)VAT models, and some criteria for a choice (Roupsard et al., 2011).

fine temporal scale. EC technique is not able to separate easily fluxes from the different canopy layers. However, it relies on models to partition net ecosystem productivity (NEP) into gross primary productivity (GPP) and ecosystem respiration (Reco; Fig. 12c)(Lasslop *et al.*, 2010; Reichstein *et al.*, 2005).

Available field measurements techniques of canopy processes, at leaf, plant or plot scale, do not allow explaining the physical and physiological basis of heterogeneity introduced by shade trees. Only coupled process models would be able to do so. Nevertheless, those multi-scale measurements are more than recommended:

- standardized measure of leaf gas exchanges are used to parameterize leaf photosynthesis and stomatal conductance model parameters;
- plant and plot scale measurements of transpiration and photosynthesis are important and often scarce data for a process of model verification.

## **B. Modeling strategies**

### **i. Static models**

Static models describe processes for systems in steady-state. Momentum transfer models such as (Soil)-Vegetation-Atmosphere Transfer (SVAT) models or multiple regression models to predict variables such as yield are typically static models (de Parcevaux and Huber, 2007).

#### ***SVAT models***

SVAT models aim at representing radiation balance, transfers of heat, moisture and momentum (fluxes) occurring at the soil-atmosphere and canopy-atmosphere interfaces. They are the only models capable of explaining the soil-plant-atmosphere interactions by solving simultaneously the energy and mass balance (D. Baldocchi, Pers. Comm.). Most of them use the analogy of electrical systems to solve the energy balance. SVAT are the only mean to obtain fluxes predictions that do respect to the energy balance, thanks to their coupling with ecophysiological modules (*i.e.* coupled photosynthesis stomatal conductance model; *e.g.* Ball *et al.*, 1987; Cowan and Farquhar, 1977; Leuning, 1995). Most of SVAT models parameters should be measurable. SVAT may be classified according to the way they describe canopy layers and the number of energy sources they consider:

1D models: The simplest SVAT models consider modeling ideal canopies, that is to say horizontally and vertically homogeneous canopies. Those models are called “big-leaf”; soil contribution to energy balance is ignored due to high LAI’s (*e.g.* Penman-Monteith evapotranspiration model for closed canopies: Allen *et al.*, 1998)( Fig. 13; Fig. 14a).



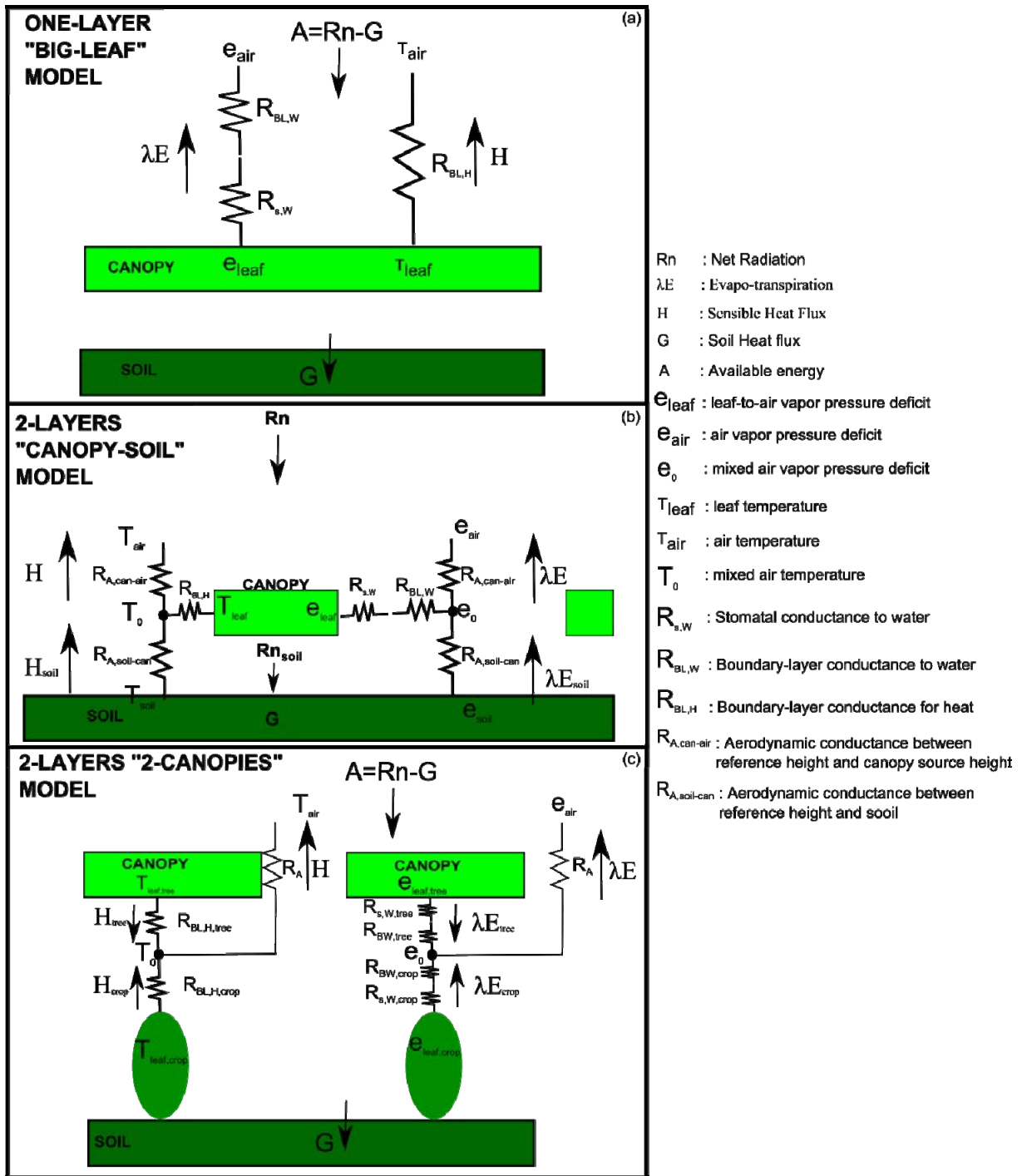

Fig. 14 – Schematic diagrams of energy partitions in single layer “big-leaf” models (a; Pennman-Monteith evapotranspiration model, Allen et al., 1998), in sparse crops+soil models (b; Shuttleworth and Wallace, 1985) and in 2 layers-2 sparse canopies models (c; Wallace, 1995).

The canopy layer may be separated in 2 sources: energy balance and photosynthesis are calculated separately for sunlit and shaded leaves (De Pury and Farquhar, 1997; Roupsard *et al.*, 2008; Ryu *et al.*, 2011). By integrating 2 types of relationships between photosynthesis and leaf exposition (2 types of non-linear relationships), “Sun-Shade” models were found to be much less susceptible to systematic biases than “big-leaf models” and thus to be tuning-free (Fig. 13).

The canopy layer may be separated from the soil layer leading to the 2-canopy layers in order to study the evapotranspiration of sparse canopies (*e.g.* Choudhury and Monteith, 1988; Shuttleworth and Wallace, 1985) (Fig. 12b). The soil layer may be replaced by an understorey, and thus the model may have a multi-layer application (Fig. 14c). This solution was formalized by Wallace (1995) and explored by Lawson *et al.* (1995) in an AF context. The latter study mentions some difficulties in defining resistance values and making converging calculations (calculation time issues).

Multi-layered systems separate the canopy in different vertical layers while keeping the horizontal homogeneity. Vertical layers are connected through the coupled micrometeorological and ecophysiological model. Multi-layered models can thus calculate energy exchanges (leaf and soil), radiative transfers, wind, flux transfers and **gradients** (or scalars) **of concentrations** profiles (temperature, CO<sub>2</sub>, water vapour, etc). Those vertical gradients may be inferred using the electric analogy paradigm (Fig. 14)(de Wit *et al.*, 1978; Goudriaan, 1977) or calculated using the modelling of turbulent diffusion transports (Baldocchi and Harley, 1995; Raupach, 1992).

1D models do not seem adapted to AF system that are horizontally and vertically heterogeneous. Indeed, many studies showed the huge over-estimation of absorbed light introduced by such simplifications (Fig. 15)(Mobbs *et al.*, 1998b).

However, multi-layer modellers developed powerful mechanistic approaches to cope with microclimate and vertical gradients. The extension of those approaches to spatially heterogeneous systems is actually among the biggest challenges of SVAT modelling (D. Baldocchi, Pers. Comm.).

### Three dimensional models:

3D models can represent different level of canopy complexities:

- plant rows simulated as 3D prisms or parallelepipoids (Palmer *et al.*, 1992): the crop row is simulated as a unique simplified entity. In this representation, rows are represented by their length, the mean height and width of plants in the rows. Empty space between rows is considered.

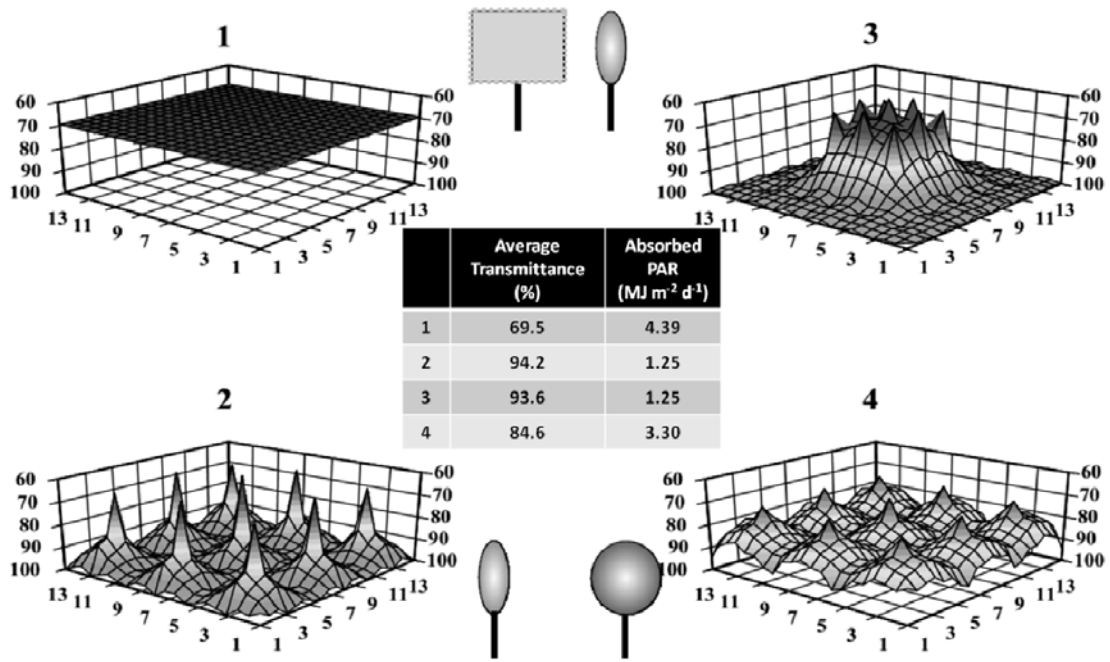

**Fig. 15** - Effect of HyPAR model disaggregation on shade tree transmittance and absorbed radiation (aPAR) by tree canopy. Canopy representations are: homogeneous canopy (1), spaced fastigate trees (2), clumped fastigate trees (3) and spaced ovate trees (4) (Mobbs et al., 1998b).

- Plant crowns simulated as 3D volumes (Norman and Welles, 1983; Wang and Jarvis, 1990a) with more or less simplified shapes (Fig. 13, Fig. 9): each plant crown has its own dimensions, each plant can be simulated individually.

The mapping of light and radiation availability gave the possibility of studying 3D variability of photosynthesis, transpiration and stomatal conductance. Today, few 3D models deal with the soil layer (Duursma and Medlyn, 2012). They nearly all use the electric analogy, excepted recently Kobayashi *et al.* (2012) who introduced 1D Lagrangian turbulence diffusion in its 3D model.

### ***Semi-empirical models: epsilon models***

Epsilon models (Monteith and Moss, 1977) use mechanistic estimates of absorbed radiation and a “tuning factor” called light use efficiency (also called “epsilon”) which quantifies the quantity of energy needed to produce a unit of biomass. This epsilon factor is empirical, adjusted to data and in certain cases assumed to vary with soil moisture (Zhao *et al.*, 2005) or phenological stages (Van Noordwijk and Lusiana, 1998). Those kinds of models have to be avoided for AFS modeling when researchers expect from the model to have an explanatory capacity.

## **ii. Dynamic models**

Dynamic models account for the evolution of phenomenon as a function of time; they are able to simulate growth, modification of development over long time periods (de Parcevaux and Huber, 2007). Simplified SVAT are generally used in crop growth models or forest growth models. SVAT may also be coupled to functional-structural plant models (FSPM)(Dauzat *et al.*, 2013; Godin and Sinoquet, 2005).

### ***Crop models and forest growth models***

Crop growth models are dynamic semi-mechanistic models adapted to agricultural crops. Their simulations are mainly made on a daily basis. The formalization of the soil-plant-atmosphere interactions for radiation, heat, carbon and water fluxes are generally simplified (Brisson *et al.*, 2003). Generally, formalism such as degree-days are used to describe phenological changes. They are able to simulate plant phenology, growth, yield formation, management practices, water/nitrogen/other nutrients balance, etc.

Crop/forest growth models are generally 1D or 2D, they generally do not deal with explicit spatial heterogeneity. Recently, crop models STICS was adapted to simulate intercropping through a geometrical approach based on prisms representing crop rows (Brisson *et al.*, 2004).

Carbon allocation rules depend on modelers choices and on the degree of comprehension of allocation mechanisms (Génard *et al.*, 2007):

- Empirical allocation coefficients, that can be modulated according to phenology (Van Noordwijk and Lusiana, 1998)
- Allometric allocation coefficients such as power functions: the growth of an organ can be expressed in terms of mass and growth rate of another organ (Génard *et al.*, 2007). Allometric relationships are integrative and are a simple way to avoid representing mechanic or hydraulic constraints (Dupraz *et al.*, 2005).
- Teleonomic approaches (approaches based on the goal-directedness of structures and functions) in which certain explicit goals are assumed such as: a functional balance between shoot and root or between conductive tissue and leaf area (pipe models)
- Based on the source-sink relationships: organs have a “sink strength” related to their growth rate potentials (that vary with phenological stage) adjusted to stress factors (Génard *et al.*, 2007; Lacoite, 2000). In this approach, C assimilated is allocated according to priorities among functions (respiration, growth, reproduction, carbohydrate pools, etc). This approach is perhaps more adapted to FSPM models because assimilates transport may depend strongly on architecture (Génard *et al.*, 2007).

For tropical crops, the flowering (and consequently the harvest) may be spread over the entire year or at least an entire season (*e.g.* coffee and banana). The spread of the flowering is complex and not well understood. Some authors developed cohort models directly inspired from population modeling in ecology (Rodríguez *et al.*, 2011; Tixier *et al.*, 2004). Those models rely on empirical distribution functions that describe the probability of flowering as a function of time. Then different cohorts evolve together at different phenological stages in the same plot (Tixier *et al.*, 2004). Rodríguez *et al.* (2011) used this approach in a complete coffee growth model (coffee in full sun only) to describe the multiple cohorts of coffee flowering.

### **FSPM models**

Functional-Structural Plant Modeling approaches aim at understanding the relations between plant architecture and the processes that drive the plant development (Godin and Sinoquet, 2005). FSPM imply to work with 3D plant architectural models (simple to the most sophisticated). They are able to study the effects of specific abiotic conditions on plant functioning, like growing under shade trees (*e.g.* Pearcy *et al.*, 2005) or effect of management (*e.g.* pruning) on plant development.

FSPMs rely on plant topology, plant geometry, carbon acquisition and carbon allocation modules that are intimately coupled. They yield to the most complex plant models. They need numerous parameters:

- Long term plant growth observations to define phyllochrone and growth rates for branches and leaves; define rules and rates of fruit initiation/development/senescence;

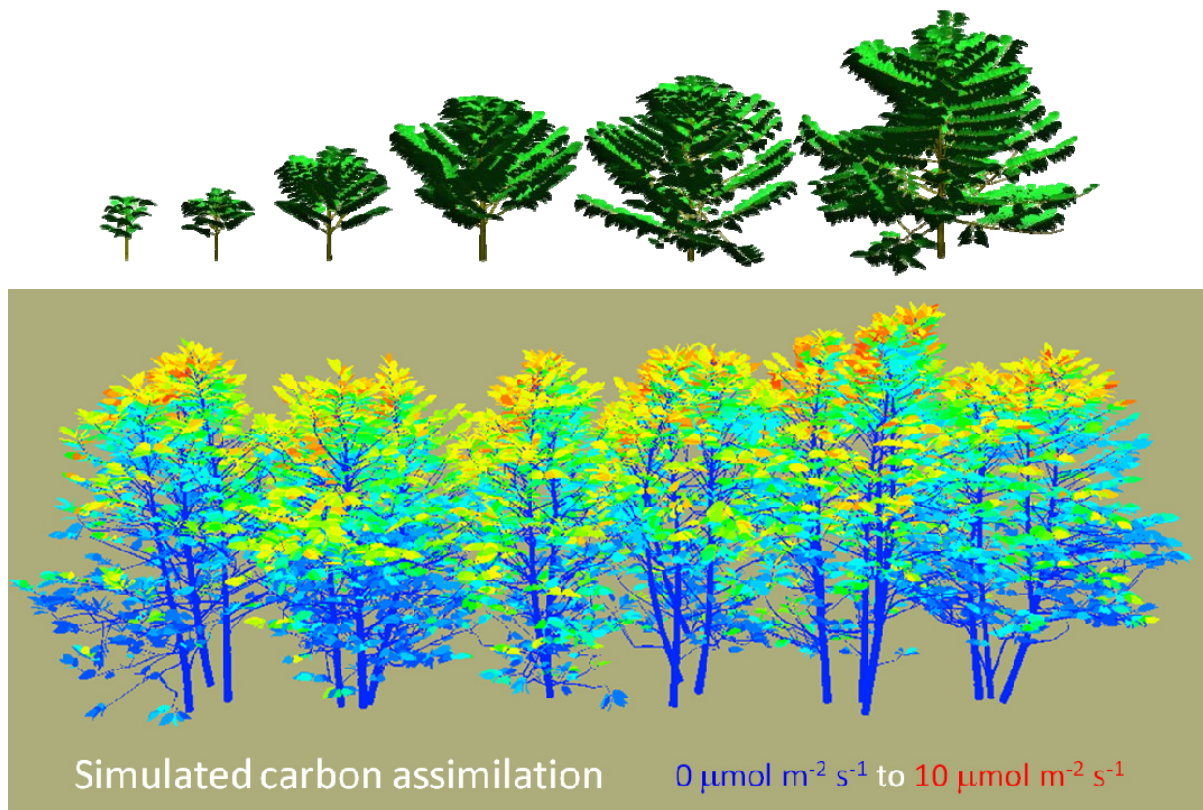

**Fig. 16** – FSPM of coffee plants. Plant architecture at different plant development stages simulated with the growth simulator AMAPSim (Top). 3D digitized coffee plant row and the spatial variability of photosynthesis simulated with Archimed (bottom; J. Dauzat, N. Franck, P. Vaast; [amapstudio.cirad.fr](http://amapstudio.cirad.fr)).

- Plant 3D digitalization to define geometrical rules and get real plants to work with;
- Leaf scale gas exchanges measurements in order to parameterize the ecophysiological models (Fig. 16).
- Long term observations of plant level carbon allocation (root:shoot, SLA, source-sink competitions, NPP per compartments);

FSPMs are so complex that a necessary step-by-step approach is required for model validation: validation of geometry by comparing modeled vs measured light transmission, validation of gas exchanges making comparisons with plant scale measurements, validation of modeled C allocation by comparing model output with destructive sampling.

Even though they do not seem adapted to plot scale simulations due to the amount of computer calculations involved, they appear as the most powerful tools to study crop-tree interactions in AFS. The parameterization of such models would require few years of work to have a complete and validated model for ... one specie; thus FSPMs are less prone to provide a generic and widely-used platform for AFS models.

Some platforms (*e.g.* AMAPSIM: Barczi *et al.*, 2008; OPENALEA: Pradal *et al.*, 2008) host a number of existing tools to simulate virtual plants, join them in a virtual plantation, simulate plant growth, etc.

### **Model coupling**

Here, we will present different approaches to couple SVAT model (*e.g.* 3D) and growth models (Dupraz, 2002).

- The 2 models may be merged in the same code... The main advantage is that there are no communication problems and that the new model is harmonized. However, the work of program rewriting may be tremendous
- The 2 models may work separately and communicate using output files from the model 1 as input files for model 2, and conversely. This approach may be consuming in computer calculations but it is surely the easiest way to implement for a non programmer using program such as Octave/Matlab for the management of data input and output.
- The 2 models may be integrated in an existing modeling platform such as CAPSIS (Dufour-Kowalski *et al.*, 2012) that already have computational-efficient tools to make the models communicate together.
- The SVAT model may be degraded to be directly used in a growth model using simpler approaches (*i.e.* “big-leaf”). “Big-leaf” model thus have to be calibrated against the SVAT model by adjusting tuning coefficients (*e.g.* Moreaux, 2012).

### iii. Justifying our choice of MAESTRA/MAESPA

We have shown that the only way to study the interactions occurring in an AFS (between shade tree and crop, soil and atmosphere) in a holistic way, was to study the canopy processes relying on physic laws (energy and mass transfers) that take into account the multiple non-linearities involved in the different processes (radiative, heat, water and carbon transfers). SVAT models are the only kind of models to provide such framework.

In vertically and horizontally heterogeneous systems, simplified 3D models appear as an ideal way of simulating plant to plot canopy processes when studying the intra-plot variability (or the local effects of shade trees). More sophisticated 3D models such as architectural models (*e.g.* Dauzat *et al.*, 2001; de Reffye *et al.*, 1995) beside their extremely complex parameterization, are until now hardly compliant to simulate plot scale or yearly scales fluxes (Fig. 13).

Half-hourly time scales are the only scale able to study microclimates effects introduced by shade trees on crop canopy processes, according to sun course, season and latitude and meteorological inputs. The model should be able to run a full year because it is the minimum time needed to have an overview on the whole system phenological cycle.

Farquhar *et al.* (1980) model is a widely accepted mechanistic description of photosynthesis. It is generally coupled to a stomatal conductance model (Ball *et al.*, 1987; Jarvis, 1978; Leuning, 1995; Medlyn *et al.*, 2011). The coupling between, stomatal conductance and photosynthesis is empiric, but to date there is no reliable and widely applicable mechanistic alternative. This couple photosynthesis – stomatal conductance approach has to be preferred to more empirical approaches.

MAESTRA is an array model with a long and prestigious development history that come back to the late 70s (for details see: Medlyn, 2004). It was one of the first spatially explicit model representing individual plants by simple geometrical shapes (Fig. 15a). MAESTRA is able to simulate intercepted radiations of individual plants in PAR, near infrared and thermal infrared wavelengths, in a crown divided in various vertical layer and various point per layer (for details see: Norman and Welles, 1983; Wang and Jarvis, 1990a). MAESTRA was the first array model to represent the vertical and horizontal spatial distribution of leaves within the crown and assess its importance (Wang *et al.*, 1990). MAESTRA is coupled to a photosynthesis stomatal conductance model, allowing balance closure for all fluxes (Ball *et al.*, 1987; Jarvis, 1978; Leuning, 1995; Medlyn *et al.*, 2011).

MAESTRA potentials to model AFS were highlighted when Dr Jennifer Grace used it to study the sensitivity of plant (and plot) absorbed light and photosynthesis to tree rows orientation and spatial arrangement (Grace, 1988; Grace, 1990). Lawson *et al.* (1995) used MAESTRA in its 1<sup>st</sup> explicit AF application during the Agroforestry Modeling Project. The authors showed the strong overestimation



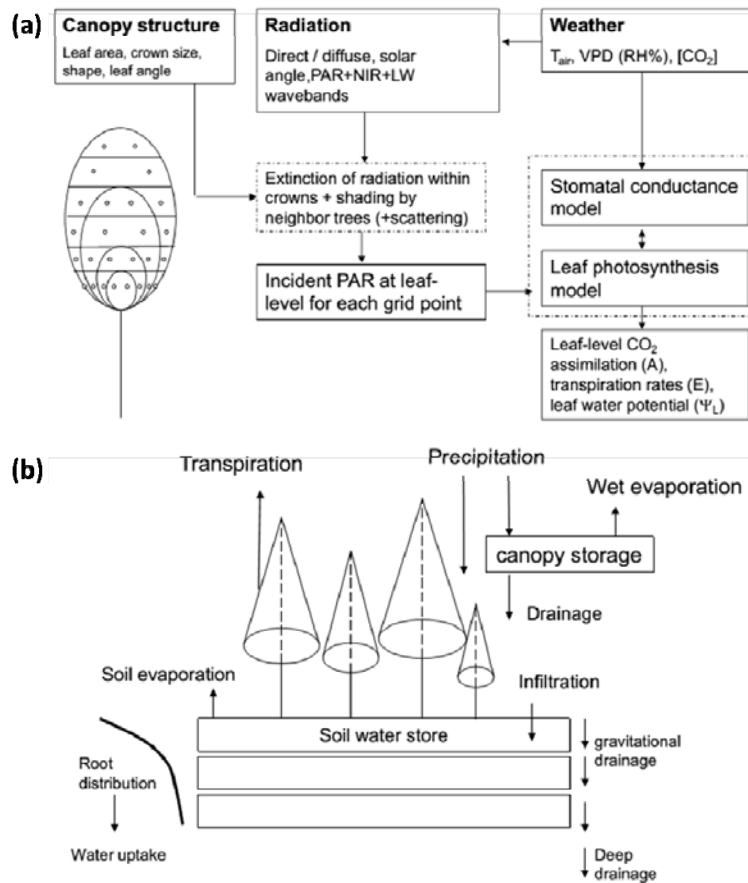

**Fig. 17** – Flowcharts of MAESTRA and MAESPA models (a). Radiative transfer is calculated by MAESTRA for each gridpoint within the crown, and drives the stomatal conductance and photosynthesis submodels. (b) inclusion of a water balance model in MAESPA (Duursma and Medlyn, 2012).

of light interception assuming homogeneous canopies when compared to spatialized crowns simulated with MAESTRA. MAESTRA was further abandoned for this trial due to 1/ the huge amount of time needed for calculations 2/ the inability of the model to account for water stress in a Sahelian environment.

MAESTRA was widely used since its publication in 1990s as displayed in the website (<http://bio.mq.edu.au/research/projects/maestra/bibliog.htm>). It was successfully validated for:

- Predicting light absorption in even-aged forests (Wang and Jarvis, 1990a), mixed forests (le Maire *et al.*, 2013) and heterogeneous canopies (Chen *et al.*, 2008) against light sensors;
- Predicting the photosynthesis of forest stands against eddy-covariance measurements in normal conditions (Ibrom *et al.*, 2006; Medlyn *et al.*, 2005) or in enhanced atmospheric CO<sub>2</sub> concentrations (Luo *et al.*, 2001);
- Predicting plant transpiration against sap-flow measurements (Medlyn *et al.*, 2007);

Recently MAESTRA was coupled to a water balance module SPA (Williams *et al.*, 2001), resulting in one of the first tree-centered SVAT model that could account for light and water limitations (Fig. 17).

Additionally, an important fact for us (as we did not have the resources to create a new model): MAESPA was one of the only available models that could account for multispecies. The MAESTRA/MAESPA website is regularly updated by Belinda Medlyn/Remko Duursma and the code is freely available and modifiable.

MAESPA being a static model, it does not integrate any growth module: growing plantation and changing LAI have to be modified by the user. We argue here that for a first complete AF application, it is important to check whether MAESPA is able to simulate correctly the effect of microclimate modifications introduced by the shade trees on crop canopy processes before addressing plant growth and below-ground interactions.

For this thesis, we ignored the sensitivity of crop canopy processes on few MAESPA assumptions that could be slightly inappropriate for AFS:

- Using only simple logarithmic wind profiles in a vertically and horizontally heterogeneous system may impede the simulated transpiration;
- air temperature and humidity, assumed homogeneous among the plot may affect the calculations of energy balance and thus transpiration and photosynthesis estimates, especially under shade tree crowns.
- ignoring woody elements may also affect the partition of the energy in the plot.

**Table 1** – Comparison of suitable models to study interactions in AFS. Light grey cells highlight the minimum desired characteristics for our objectives

Model name	HyPAR V1.0	HyPAR V2.0	Hi-Safe	CAF2007	WaNuLCAS	MAESPA	Canoak-Flies	TreeGrass	Archimed	RATP
Source	Mobbs <i>et al.</i> (1998a)	Mobbs <i>et al.</i> (1998b)	Dupraz <i>et al.</i> (2005)	van Oijen <i>et al.</i> (2010b)	Van Noordwijk and Lusiana (1998)	Duursma and Medlyn (2012)	Kobayashi <i>et al.</i> (2012)	Simioni <i>et al.</i> (2000)	Dauzat <i>et al.</i> (2001)	Sinoquet <i>et al.</i> (2001)
Model type	Models explicitly designed for AFS					Other models with 3D representations			Reference models	
Geometric representation	Tree	1D Multilayer	3D cubes	3D envelopes	1D Single Layer, 2 patches (with or without shade tree)	Simplified 3D envelopes (cones, ellipsoid, etc)	3D envelopes	Canopies formed by 3D cell grids	3D, resolution per organ	Canopies formed by 3D cell grids
	Crop	1D Single Layer	1D Single Layer	2D Geometrical forms representing lines	2D - Single Layer					
Leaf representation	Constant Leaf area density, spherical angle distrib.	Constant Leaf area density, spherical angle distrib.	Constant Leaf area density, explicit leaf angle distrib	Constant Leaf area density, spherical angle distrib.	Constant Leaf area density, spherical angle distrib.	Explicit Angle Distrib. Vertical and horizontal distribution in crown	Spherical angle distrib. Constant leaf area density	Explicit angle distrib. Constant leaf area density within each grid	explicit	Explicit angle distrib. Constant leaf area density within each grid
Light interception calculation	Tree	Radiative transfer	Radiative transfer	Radiative transfer	Beer's law	Radiative transfer	Radiative transfer, Monte-Carlo ray tracing	Radiative transfer	Radiative transfer, Monte-Carlo ray tracing	Radiative transfer
	Crop	Beer's law	Beer's law	Beer's law						
Woody elements?	No	No	Yes for trees	No	Yes for trees	No	Yes	No	Yes	Yes
Run timestep	Daily	Daily	Daily	Daily	Daily	Hourly	Hourly	Hourly	Hourly	Hourly
Energy balance	for trees	for trees	for trees	No	No	Simplified for NIR and Thermal IR	Detailed for NIR and TIR	Simplified for NIR and TIR	Simplified for NIR and TIR	Simplified for NIR and TIR
Turbulent Diffusion	No	No	1D Log wind attenuation	No	No	1D Log wind attenuation	1D Lagrangian	No	1D Log wind attenuation	Flexible
C assimilation	Tree	Farquhar day	Farquhar day	LUE	Mechanistic LUE	Farquhar	Farquhar	Farquhar	Farquhar	Farquhar
	Crop	LUE	LUE	LUE						
Water balance	Yes	Yes	Yes, spatial variation in soil water balance	Penman. 2 patches	No	Complete- No spatial variation in soil water balance	Plant only	Plant only	Plant only	Plant only
Carbon allocation	Coefficient adj. by stress & phenology	Coefficient adj. by stress & phenology	Structure-function balance / Allometric	Coefficient adj. for phenology	Empirical	No	No	No	No	No
Shade tree/ crop interactions	Water, Light, Heat & nutrients	Water, Light, Heat & nutrients	Water, Light, Heat & nutrients	Water & light	Water, light & nutrients	Water, Light & Heat	Light & Heat	Light & Heat	Light	Light & Heat
Microclimate interactions (T and RH)	No	Tried with Wallace (1995) model	Tried with Wallace (1995) model	Empirical adj. of temperature	No	No	No	No	No	No
Slopes	No	No	not implemented	for run-off cal	for run-off calc	in 2 directions	No	No	No	in 2 directions
Ease of parameterization	Easy	Medium	Difficult	Medium	Difficult	Difficult	Very difficult	Difficult	Very difficult	Difficult
Spatial Scale of use	Plot to region	Plot to region	Intra-plot to plot	Plot to region	Intra-plot to plot	Plant to plot	Plant to plot	Plant to plot	Intra-plant to multiplant	Intra-plant to multiplant
Temporal scale of use	day to decade	day to decade	day to decade	day to decade	day to decade	Intra-day to year	Intra-day to year	Intra-day to year	Intra-day to month	Intra-day to year

- Due to absence of spatial variation of soil water balance, belowground water balance cannot be compared below shade and in the open (this assumption is not examined in this work because we were working in non limiting conditions for water resource);

Comparisons of MAESPA main characteristics with other AFS or forest models may help in visualizing the comparative advantages of MAESPA (Table 1). We highlighted the minimum desired characteristics for the model in order to correspond to the desired objectives and MAESPA appeared to be among the best options.

## **6. Conclusions: our contribution to AFS understanding: modeling the effects of microclimate modifications on understorey fluxes**

### **A. Mapping the absorbed radiation in a plot with a plant resolution**

MAESTRA was fully parameterized for the first time in a 2-layered AFS with both layers heterogeneous in order to simulate the determinants of the spatial variability in light interactions (Article A: Charbonnier *et al.*, 2013). The experimental site was a coffee based AFS shaded by large and low density *Erythrina poeppigiana* (Fabaceae; Fig. 8b & Fig. 18). A virtual plantation was modeled based on intensive inventories (including pruning), monitoring of LAI and crown development for both coffee plants and shade trees. Plant structural parameters such as leaf angle distributions, leaf area distributions in the crown were thoroughly investigated. Those structural parameters for coffee plants and *Erythrina poeppigiana* represent a unique dataset that can be used to parameterize MAESTRA (or other models) in other coffee growing areas.

We proposed a two step approach to verify the model predictions of transmitted light using:

- a classical approach with quantum sensors to compare locally transmitted diffuse PAR above and below the coffee canopy at different distances from shade tree crowns.
- an approach based on an assessment of the angular transmittance following the methodology proposed by le Maire *et al.* (2013) which allowed to assess the good representation by the model of leaf angle distribution and inter-crown clumping (good representation of rows)

Once MAESTRA model and its parameterization were successfully verified, we were able to:

- Model and map the shade tree transmittance integrated over a desired time step (from the half-hour to the complete year) with a square-meter resolution. We could show that the impact of large shade trees on transmitted light was much larger than the projection of their shade tree crown. We could quantify the impact of shade trees on the modification of light geometry, *i.e.* a 20% increase in the fraction of diffuse radiation. Such type of mapping was already done in



**Fig. 18** – Evolution of the shade tree cover in our experimental site between 2001 and 2010. Shade trees were pruned as displayed in Fig. 4 until 2001, and then the farm managers let them grow freely without pruning.

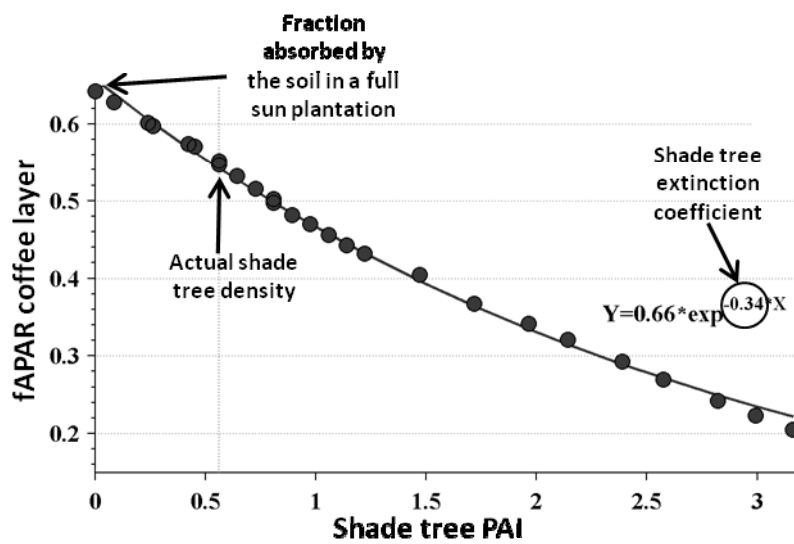

**Fig. 19** – Simulation of the fraction of absorbed PAR (fAPAR) of the coffee layer to an increased shade tree density simulated with MAESTRA.

other type of AF plantations: *e.g.* Leroy *et al.* (2009) and Lamanda *et al.* (2008) in coconut AFS using an explicit 3D model (ARCHIMED, see Dauzat *et al.*, 2001) or in Talbot (2011) PhD thesis using a daily time scale light interception model similar to MAESTRA (Talbot and Dupraz, 2012).

- Model and map the absorbed light in PAR of individual coffee plants integrated over a desired time step. The model was able to separate the direct beam from the diffuse absorbed PAR. To our knowledge, this was never done for the crop in the AFS at these resolutions, *i.e.* from plant to plot. The modeling of consistent plant light budgets according to plant size, leaf area, local competition and distance to shade tree open the straight-forward possibility to build crop models.
- Simulate the effect of an increasing shade tree density on the fraction of absorbed PAR by the coffee layer (fAPAR; Fig. 19). We started from a virtual open coffee plantation (illustrated in Fig. 16 top) to a very dense shade tree density (PAI>3). We could show that the decrease in fAPAR in response to shade tree PAI followed the negative exponential of the Beer's law (Fig. 17). The extinction coefficient of this formula was similar to the extinction coefficient of the shade tree. This simulation analysis also allowed quantifying the amount of energy reaching the soil (*ca.* 30% in the open), leading us to propose some advices on management practices to avoid such a loss of energy (*e.g.* planting of a cover crop, increasing coffee plant density, etc.)

## B. Using the absorbed radiation as a covariate for experimentation

Shade tree transmittance and plant light budgets simulated by MAESPA were used to assess the determinants of above-ground net primary productivity (ANPP).

ANPP of individual coffee plants (60 coffee resprouts, of various ages (0 to 5 years, after pruning), located below or far from the shade trees) was assessed during two years in the field from repeated biomass estimations (via branch scale allometry) and litter harvest (Article B: Charbonnier *et al.*, in prep.-a).

Surprisingly, coffee plants ANPP was not influenced by the presence of shade tree, despite large transmittance differences modeled just above them with MAESTRA. MAESTRA was also used to calculate yearly light budgets of the measured coffee plants. Light use efficiency (LUE) of coffee plants was calculated dividing their annual ANPP by plant absorbed PAR (aPAR).

MAESTRA showed that aPAR decreased severely for coffee plants located under shade tree crowns (down to 70%). However, we obtained a 2-fold increase in LUE for coffee plants located under shade trees, and a spatial gradient of LUE according to the distance to the shade tree. The analysis revealed

that the increase in LUE totally compensated the expected reduction of ANPP due to the reduction in aPAR. The main hypothesis explaining those strong variations in LUE are formulated in the paper.

In the AF literature, this observation was expected for shade tolerant plants such as coffee (Ong *et al.*, 1991). It was rarely quantified for annual crops and never for a perennial crop. Such approach combining experimental measurements with modeled variables allowed us to demonstrate a major compensation effect in AFS that was rarely showed before.

### C. Intra-plot variability of photosynthesis and of LUE

Upgraded MAESTRA, MAESPA was finally used to assess the determinants of the spatial variability of photosynthesis and photosynthetic LUE (Charbonnier *et al.*, in prep.-b). Leaf gas exchanges measured in the field were used to parameterize the photosynthesis and stomatal conductance sub-models in MAESPA.

We applied a two-scale verification of carbon and water fluxes: in a first time at plant level comparing MAESPA simulations with measurements with a whole plant chamber and in a 2<sup>nd</sup> time at plot level comparing simulations to eddy-covariance measurements. This approach was never used in the same study for a double upscaling: leaf-to-plant and plant-to-plot. This approach allowed gaining confidence in model simulations at the two resolutions, allowing us to discuss model/measurements sources of variability and to better highlight potential problems.

Intra-plot variability of photosynthesis was dominated by the intrinsic strong spatial heterogeneity in the coffee layer (plants of all sizes are mixed in the plot). The effect of shade trees on this variability could be assessed by comparing a virtual plantation without shade trees and an AFS plantation. It was shown that the strong effect of shade trees on coffee canopy photosynthesis (>20% reduction in photosynthesis) was not much larger than their canopy projection. We highlighted only a small azimuthal effect when looking at yearly integrated values of photosynthesis. Photosynthetic light use efficiency ( $LUE_{photo}$ , canopy photosynthesis/aPAR) variability was mainly influence by the shade trees: they allowed a 20-40% increase in  $LUE_{photo}$ ; thus explaining only partly the 2-fold increase in LUE discussed above, and suggesting that autotrophic respiration or C allocation could have been modified also for coffee plants below shade tree.

Such a fine spatial variation of photosynthesis and LUE was never assessed at the plant scale in an AFS with a 3D SVAT model. Comparison with chamber and eddy-covariance measurements allowed us to gain much confidence in those predictions. This successful model verification allows to study directly the response of the coffee layer photosynthesis to varying shade tree density or to test alternative tree arrangements, for example.

## 7. Perspectives

### A. Possible limitations of MAESTRA-MAESPA

In this work, we encountered discrepancies in the simulations of H<sub>2</sub>O fluxes and canopy temperature by MAESTRA-MAESPA. We realized that these problems had already been observed in other studies (Moreaux, 2012) and that MAESTRA-MAESPA was not used very often to simulate transpiration (Medlyn *et al.*, 2007). Moreaux (2012) also showed a strong saturation of transpiration at higher Rn values when comparing MAESTRA-MAESPA simulations with eddy-covariance measurements. She highlighted problems in the energy balance calculations, especially a saturation of modeled Rn at high irradiance input. We also isolated a problem in the partitioning between the sensible and latent heat flux, although their sum (H+LE) remained quite realistic, provided that the contribution of the soil would be added. Finally, we observed large delta between canopy temperature and air temperature in the field that were not reflected in the simulations of MAESPA, whatever the option for canopy temperature (iteration on or off).

Nevertheless, such problem of energy balance prevented us to progress any further on evapotranspiration and canopy temperature issues, or to assess the impact of some simplified modeling assumptions of MAESPA regarding intra-plot homogeneity of microclimate and 1D aerodynamic conductance profile.

Considering the realistic performances of MAESPA for absorbed PAR and for photosynthesis, as reflected in most articles from the literature, we believe that these remaining problems are just transient, likely the result of some hidden code errors that appear to be addressed.

### B. Our scientific strategy

In order to solve those problems, a strategy is proposed:

1) to parameterize the MAESPA **soil module** to have all the components of the energy balance equation. This will allow us to compare modeled soil evaporation with our assumptions when treating eddy-covariance  $\lambda E$  measurements.

2) after checking the correct energy balance closure simulated by MAESPA, some indepth work in the MAESPA program must be undertaken. This work would aim to disentangle some **potential calculation issues** from misrepresentations due to simplification assumptions. A particular look will be given on:

- **the sensitivity of transpiration calculations to simulated wind extinction profiles.** MAESPA considers that the wind entered as a meteorological input is maximum just above the canopy of the



simulated plant and decrease logarithmically in the crown. This assumption was proven reasonable in horizontal homogeneous plantations, but is surely inexact in an AFS with 2 heterogeneous layers;

- **the stomatal conductance model.** In our study, the leaf scale stomatal conductance model tended to underestimate higher values of measured conductance. This saturation was observed with all classical steady-state stomatal conductance models (Ball *et al.*, 1987; Leuning, 1995; Medlyn *et al.*, 2011). We could not see whether Moreaux (2012) had the same issue, because this data was not displayed in her manuscript. Anyway, we observed that measured leaf photosynthesis was related non-linearly with measured stomatal conductance whereas coupled models assume a nearly linear relationship. This difference between observed and modeled response has also been found on *Eucalyptus* plantations (M. Christina, Pers. Comm.).

---

# References

---

- Albrecht, A., Kandji, S.T., 2003. Carbon sequestration in tropical agroforestry systems. *Agriculture, Ecosystems & Environment* 99, 15-27.
- Allen, R., Pereira, L., Raes, D., Smith, M., 1998. Crop evapotranspiration. Guidelines for computing crop water requirements, FAO Irrigation and drainage paper 56. Available at <http://www.fao.org/docrep/X0490E/X0490E00.htm>, p. 301 pp.
- Alpizar, L., Fassbender, H.W., Heuvelink, J., Enriquez, G., Folster, H., 1985. Agroforestry Systems of Coffee (*Coffea arabica*) with Laurel (*Cordia alliodora*) and Poro (*Erythrina poeppigiana*) in Turrialba, Costa-Rica .1. Biomass and Nutrients. *Turrialba* 35, 233-242.
- Altieri, M.A., 1989. Agroecology: A new research and development paradigm for world agriculture. *Agriculture, Ecosystems & Environment* 27, 37-46.
- Altieri, M.A., Toledo, V.M., 2011. The agroecological revolution in Latin America: rescuing nature, ensuring food sovereignty and empowering peasants. *The Journal of Peasant Studies* 38, 587-612.
- Anderson, L.S., Sinclair, F.L., 1993. Ecological interactions in agroforestry systems. *Agroforestry Abstracts* 6, 35.
- Angell, R., Svejcar, T., 1999. A Chamber Design for Measuring Net CO<sub>2</sub> Exchange on Rangeland. *Journal of Range Management* 52, 27-31.
- Asner, G.P., Martin, R.E., 2008. Spectral and chemical analysis of tropical forests: Scaling from leaf to canopy levels. *Remote Sensing of Environment* 112, 3958-3970.
- Assad, E.D., Pinto, H.S., Zullo Junior, J., Ávila, A.M.H., 2004. Impacto das mudanças climáticas no zoneamento agroclimático do café no Brasil. *Pesqui. Agropecu. Bras.* 39, 1057-1064.
- Baldocchi, D., Falge, E., Gu, L., Olson, R., Hollinger, D., Running, S., Anthoni, P., Bernhofer, C., Davis, K., Evans, R., Fuentes, J., Goldstein, A., Katul, G., Law, B., Lee, X., Malhi, Y., Meyers, T., Munger, W., Oechel, W., Paw, K.T., Pilegaard, K., Schmid, H.P., Valentini, R., Verma, S., Vesala, T., Wilson, K., Wofsy, S., 2001. FLUXNET: A New Tool to Study the Temporal and Spatial Variability of Ecosystem-Scale Carbon Dioxide, Water Vapor, and Energy Flux Densities. *Bulletin of the American Meteorological Society* 82, 2415-2434.
- Baldocchi, D., Ma, S., 2013. How will land use affect air temperature in the surface boundary layer? Lessons learned from a comparative study on the energy balance of an oak savanna and annual grassland in California, USA. *Tellus B* 65.
- Baldocchi, D.D., Harley, P.C., 1995. Scaling carbon dioxide and water vapour exchange from leaf to canopy in a deciduous forest. II. Model testing and application. *Plant, Cell & Environment* 18, 1157-1173.
- Ball, J.T., Woodrow, I.E., Berry, J.A., 1987. A model predicting stomatal conductance and its contribution to the control of photosynthesis under different environmental conditions, in: Biggins, J. (Ed.), *Progress in Photosynthesis Research*, pp. 221-224.

- Barczi, J.-F., Rey, H., Caraglio, Y., de Reffye, P., Barthélémy, D., Dong, Q.X., Fourcaud, T., 2008. AmapSim: A Structural Whole-plant Simulator Based on Botanical Knowledge and Designed to Host External Functional Models. *Annals of Botany* 101, 1125-1138.
- Beer, J., 1988. Litter production and nutrient cycling in coffee (*Coffea arabica*) or cacao (*Theobroma cacao*) plantations with shade trees. *Agroforestry Systems* 7, 103-114.
- Bellow, J.G., Nair, P.K.R., 2003. Comparing common methods for assessing understory light availability in shaded-perennial agroforestry systems. *Agricultural and Forest Meteorology* 114, 197-211.
- Benegas, L., Ilstedt, U., Rounsard, O., Jones, J.R., Malmer, A., 2013. Effects of trees on infiltrability and preferential flow in two contrasting agroecosystems in Central America. *Agriculture Ecosystems & Environment* (under major revision oct. 2013).
- Bethenod, O., Daudet, F.-A., Castell, J.-F., Maillard, P., 1995. Hypothèses et principes de la représentation de la diffusion du CO<sub>2</sub> à différentes échelles, de la feuille au couvert., in: INRA, D.d.b. (Ed.), *Ecole chercheurs en bioclimatologie, Thiverval-Grignon*, pp. 129-153.
- Black, C., Ong, C., 2000. Utilisation of light and water in tropical agriculture. *Agricultural and Forest Meteorology* 104, 25-47.
- Boreux, V., Kushalappa, C.G., Vaast, P., Ghazoul, J., 2013. Interactive effects among ecosystem services and management practices on crop production: Pollination in coffee agroforestry systems. *Proceedings of the National Academy of Sciences* 110, 8387-8392.
- Bréda, N.J.J., 2003. Ground-based measurements of leaf area index: a review of methods, instruments and current controversies. *Journal of Experimental Botany* 54, 2403-2417.
- Brisson, N., Bussièrre, F., Ozier-Lafontaine, H., Tournebize, R., Sinoquet, H., 2004. Adaptation of the crop model STICS to intercropping. Theoretical basis and parameterisation. *Agronomie* 24, 409-421.
- Brisson, N., Gary, C., Justes, E., Roche, R., Mary, B., Ripoche, D., Zimmer, D., Sierra, J., Bertuzzi, P., Burger, P., Bussièrre, F., Cabidoche, Y.M., Cellier, P., Debaeke, P., Gaudillère, J.P., Hénault, C., Maraux, F., Seguin, B., Sinoquet, H., 2003. An overview of the crop model STICS. *European Journal of Agronomy* 18, 309-332.
- Burgess, S.S.O., Adams, M.A., Turner, N.C., Ong, C.K., 1998. The redistribution of soil water by tree root systems. *Oecologia* 115, 306-311.
- Cannavo, P., Sansoulet, J., Harmand, J.M., Siles, P., Dreyer, E., Vaast, P., 2011. Agroforestry associating coffee and *Inga densiflora* results in complementarity for water uptake and decreases deep drainage in Costa Rica. *Agriculture, Ecosystems & Environment* 140, 1-13.
- Cannell, M., Mobbs, D., Lawson, G., 1998. Complementarity of light and water use in tropical agroforests - II. Modelled theoretical tree production and potential crop yield in arid to humid climates. *For. Ecol. Manage.* 102, p.275-282.
- Cannell, M.G.R., Van Noordwijk, M., Ong, C., 1996. The central agroforestry hypothesis: the trees must acquire resources that the crop would not otherwise acquire. *Agroforestry Systems* 34, 27-31.

Cerdán, C.R., Rebolledo, M.C., Soto, G., Rapidel, B., Sinclair, F.L., 2012. Local knowledge of impacts of tree cover on ecosystem services in smallholder coffee production systems. *Agricultural Systems* 110, 119-130.

Charbonnier, F., le Maire, G., Dreyer, E., Casanoves, F., Christina, M., Dauzat, J., Eitel, J.U.H., Vaast, P., Vierling, L.A., Roupsard, O., 2013. Competition for light in heterogeneous canopies: Application of MAESTRA to a coffee (*Coffea arabica* L.) agroforestry system. *Agricultural and Forest Meteorology* 181, 152-169.

Charbonnier, F., Roupsard, O., Casanoves, F., Le Maire, G., Lacoïnte, A., Clément-Vidal, A., Jourdan, C., Audebert, L., Defresnet, E., Cambou, A., Khac, E., Barquero, A., Leandro, P., Van den Meersche, K., Alline, C., Avelino, J., Saint-André, L., Vaast, P., Dreyer, E., in prep.-a. Increased light use efficiency of coffee under shade trees compensates for ANPP but not for fruiting. To be submitted in *Journal of Experimental Botany*.

Charbonnier, F., Roupsard, O., Dreyer, E., Bonnefond, J.M., Christina, M., Jarri, L., Siles, P., Rapidel, B., Harmand, J.M., Vaast, P., Nouvellon, Y., Robelo, A., le Maire, G., in prep.-b. Modeling the intra-plot variability of Light and Water Use efficiencies in a 2-layered heterogeneous coffee (*Coffea arabica* L.) agroforestry system. To be submitted to *Plant, Cell & Environment*.

Chen, Q., Baldocchi, D., Gong, P., Dawson, T., 2008. Modeling radiation and photosynthesis of a heterogeneous savanna woodland landscape with a hierarchy of model complexities. *Agricultural and Forest Meteorology* 148, 1005-1020.

Choudhury, B.J., Monteith, J.L., 1988. A four-layer model for the heat budget of homogeneous land surfaces. *Quarterly Journal of the Royal Meteorological Society* 114, 373-398.

Clark, D.A., Brown, S., Kicklighter, D.W., Chambers, J.Q., Thomlinson, J.R., Ni, J., 2001. Measuring net primary production in forests: concepts and field methods. *Ecological Applications* 11, 356-370.

Corelli-Grapadelli, L., Magnanini, E., 1997. Whole-tree gas exchanges: can we do it cheaper? *Acta Horticulturae (ISHS)* 451, 279-286.

Cowan, I.R., Farquhar, G.D., 1977. Stomatal function in relation to leaf metabolism and environment, in: Jennings, D.H. (Ed.), *Integration of activity in the higher plant*. Society for Experimental Biology, Cambridge, UK.

Dapoigny, L., de Tourdonnet, S., Roger-Estrade, J., Jeuffroy, M.-H., Fleury, A., 2000. Effect of nitrogen nutrition on growth and nitrate accumulation in lettuce (*Lactuca sativa* L.), under various conditions of radiation and temperature. *Agronomie* 20, 843-855.

Dauzat, J., Griffon, S., Roupsard, O., Vaast, P., Rodrigues, G., 2013. Building the foundations of a *Coffea arabica* FSPM, in: Nikinmaa, E., Nygren, P., Sievänen, R., Godin, C., Lintunen, A. (Ed.), *Proceedings of the 7th International Conference on Functional Structural Plant Models*. Vantaa : Finnish Society of Forest Science, Saariselka, Finland, pp. 269-271.

Dauzat, J., Rapidel, B., Berger, A., 2001. Simulation of leaf transpiration and sap flow in virtual plants: model description and application to a coffee plantation in Costa Rica. *Agricultural and Forest Meteorology* 109, 143-160.

Davis, A.P., Gole, T.W., Baena, S., Moat, J., 2012. The Impact of Climate Change on Indigenous Arabica Coffee (*Coffea arabica*): Predicting Future Trends and Identifying Priorities. *PLoS ONE* 7, e47981.

De Beenhouwer, M., Aerts, R., Honnay, O., 2013. A global meta-analysis of the biodiversity and ecosystem service benefits of coffee and cacao agroforestry. *Agriculture, Ecosystems & Environment* 175, 1-7.

de Parcevaux, S., Huber, L., 2007. *Bioclimatologie, Concepts et Applications*. Editions Quae, Versailles, France.

De Pury, D.G.G., Farquhar, G.D., 1997. Simple scaling of photosynthesis from leaves to canopies without the errors of big-leaf models. *Plant, Cell & Environment* 20, 537-557.

de Reffye, P., Houllier, E., Blaise, F., Barthelemy, D., Dauzat, J., Auclair, D., 1995. A model simulating aboveground and belowground tree architecture with agroforestry applications. *Agroforestry Systems* 30, 175-197.

De Schutter, O., 2011. *Agroecology and the Right to Food*, Report presented at the 16th Session of the United Nations Human Rights Council [A/HRC/16/49].

de Wit, C.T., Goudriaan, J., Van Laar, H., Penning de Vries, F.W.T., Louwse, W., Sibma, L., de Jonge, C., 1978. Simulation of assimilation, respiration and transpiration of crops. The Netherlands, Pudoc, Wageningen.

Dufour-Kowalski, S., Courbaud, B., Dreyfus, P., Meredieu, C., Coligny, F., 2012. Capsis: an open software framework and community for forest growth modelling. *Annals of Forest Science* 69, 221-233.

Dufour, L., Metay, A., Talbot, G., Dupraz, C., 2013. Assessing Light Competition for Cereal Production in Temperate Agroforestry Systems using Experimentation and Crop Modelling. *Journal of Agronomy and Crop Science* 199, 217-227.

Dupraz, C., 1999. Adequate design of control treatments in long term agroforestry experiments with multiple objectives, in: Auclair, D., Dupraz, C. (Eds.), *Agroforestry for Sustainable Land-Use Fundamental Research and Modelling with Emphasis on Temperate and Mediterranean Applications*. Springer Netherlands, pp. 35-48.

Dupraz, C., 2002. Tree-crops interaction models - State of the art report, in: (SAFE), S.A.f.E. (Ed.), *Delivery 1.1*.

Dupraz, C., Burgess, P., Gavaland, A., Graves, A., Herzoll, F., Incoll, L.D., Jackson, N., Keesman, K., Lawson, G., Lecomte, L., Liagre, F., Mantzanas, K., Mayus, M., Moreno, G., Palma, J., Papanastasis, V., Paris, P., Pilbeam, D., Reisner, Y., Vincent, G., van der Werf, W., 2005. Synthesis of the Silvoarable Agroforestry For Europe project, in: INRA, U.S.E. (Ed.), *Montpellier*, p. 254 p.

Dupraz, C., Liagre, F., 2008. *Agroforesterie: Des arbres et des Cultures*, Paris.

Duursma, R., Medlyn, B.E., 2012. MAESPA: a model to study interactions between water limitation, environmental drivers and vegetation function at tree and stand levels, with an example application to [CO<sub>2</sub>] × drought interactions. *Geoscientific Model Development* 5, 919-940.

Eitel, J.U.H., Vierling, L.A., Magney, T.S., 2013. A lightweight, low cost autonomously operating terrestrial laser scanner for quantifying and monitoring ecosystem structural dynamics. *Agricultural and Forest Meteorology* 180, 86-96.

FAO, 2013. *Climate-smart agriculture sourcebook*. FAO.

- Farquhar, G.D., Caemmerer, S., Berry, J.A., 1980. A biochemical model of photosynthetic CO<sub>2</sub> assimilation in leaves of C<sub>3</sub> species. *Planta* 149, 78-90.
- Fassbender, H.W., Alpizar, L., Heuvelop, J., Enriquez, G., Folster, H., 1985. Agroforestry systems of coffee (*Coffea arabica*) with laurel (*Cordia alliodora*) and coffee with poro (*Erythrina poeppigiana*) in Turrialba, Costa Rica. 3. Models for organic matter and nutrients. *Turrialba* 35, 403-413.
- Fassbender, H.W., Beer, J., Heuvelop, J., Imbach, A., Enriquez, G., Bonnemann, A., 1991. Ten year balances of organic matter and nutrients in agroforestry systems at CATIE, Costa Rica. *For. Ecol. Manage.* 45, 173-183.
- Fearnside, P.M., 2001. Soybean cultivation as a threat to the environment in Brazil. *Environmental Conservation* 28, 23-38.
- Feeley, K.J., Hurtado, J., Saatchi, S., Silman, M.R., Clark, D.B., 2013. Compositional shifts in Costa Rican forests due to climate-driven species migrations. *Global Change Biology* 19, 3472-3480.
- Garcia-Barrios, L., Ong, C.K., 2004. Ecological interactions, management lessons and design tools in tropical agroforestry systems. *Agroforestry Systems* 61, 221-236.
- Garcia, C.A., Bhagwat, S.A., Ghazoul, J., Nath, C.D., Nanaya, K.M., Kushalappa, C.G., Raghuramulu, Y., Nasi, R., Vaast, P., 2010. Biodiversity Conservation in Agricultural Landscapes: Challenges and Opportunities of Coffee Agroforests in the Western Ghats, India. *Conservation Biology* 24, 479-488.
- Génard, M., Dauzat, J., Franck, N., Lescourret, F., Moitrier, N., Vaast, P., Vercambre, G., 2007. Carbon allocation in fruit trees: from theory to modelling. *Trees* 22, 269-282.
- Godin, C., Sinoquet, H., 2005. Functional–structural plant modelling. *New Phytologist* 166, 705-708.
- Gómez-Delgado, F., 2010. Hydrological, ecophysiological and sediment processes in a coffee agroforestry basin: combining experimental and modelling methods to assess hydrological environmental services. PhD thesis, Centre international d'études supérieures en sciences agronomiques -Montpellier Supagro; Ecole doctorale Systèmes Intégrés en Biologie, Agronomie, Géosciences, Hydrosiences, Environnement (SIBAGHE). Supagro, Montpellier, p. 254.
- Gomez-Delgado, F., Rouspard, O., le Maire, G., Taugourdeau, S., Perez, A., van Oijen, M., Vaast, P., Rapidel, B., Harmand, J.M., Voltz, M., Bonnefond, J.M., Imbach, P., Moussa, R., 2011. Modelling the hydrological behaviour of a coffee agroforestry basin in Costa Rica. *Hydrology and Earth System Sciences* 15, 369-392.
- Gómez-Delgado, F., Rouspard, O., Lemaire, G., Taugourdeau, S., Pérez, A., Van Oijen, M., Vaast, P., Rapidel, B., Voltz, M., Bonnefond, J.M., Imbach, P., Moussa, R., 2011. Modelling the hydrological behaviour of a coffee agroforestry basin in Costa Rica. *Hydrology and Earth System Sciences* 15.
- Goudriaan, J., 1977. *Crop micrometeorology : a simulation study*. Pudoc, Wageningen.
- Grace, J.C., 1988. Effect of tree arrangement on intercepted radiant energy and photosynthesis, in: Werger, M.J.A., van der Aart, P.J.M., During, H.J., Verhoeven, J.T.A. (Eds.), *Forest Growth Modelling and Prediction*. US Department of Agriculture Forest Service General Technical Report pp. 285-292.
- Grace, J.C., 1990. Process-level models for investigating alternative spacing patterns, in: James, R.N., Tarlton, G.L. (Eds.), *New Approaches to Spacing and Thinning in Plantation Forestry*. Ministry of Forestry, FRI Bulletin, pp. 229-232.

Graves, A.R., Burgess, P.J., Liagre, F., Terreaux, J.P., Borrel, T., Dupraz, C., Palma, J., Herzog, F., 2011. Farm-SAFE: the process of developing a plot- and farm-scale model of arable, forestry, and silvoarable economics. *Agroforestry Systems* 81, 93-108.

Gu, L., Baldocchi, D., Verma, S.B., Black, T.A., Vesala, T., Falge, E.M., Dowty, P.R., 2002. Advantages of diffuse radiation for terrestrial ecosystem productivity. *Journal of Geophysical Research* 107, 4050.

Guillou, M., Guyomard, H., Huyghe, C., Peyraud, J.-L., 2013. Propositions pour le ministre: Vers des agricultures doublement performantes pour concilier compétitivité et respect de l'environnement, in: Agreenium, INRA (Eds.).

Hall, H., Li, Y., Comerford, N., Gardini, E., Cernades, L., Baligar, V., Popenoe, H., 2010. Cover crops alter phosphorus soil fractions and organic matter accumulation in a Peruvian cacao agroforestry system. *Agroforestry Systems* 80, 447-455.

Hallé, F., 1986. Un système d'exploitation ancien, mais une interface scientifique nouvelle : l'agroforesterie dans les régions tropicales, in: Chatelin, Y., Riou, G. (Eds.), *Milieux et paysages*. Editions Masson, Paris.

Hanson, P.J., Amthor, J.S., Wullschleger, S.D., Wilson, K.B., Grant, R.F., Hartley, A., Hui, D., Hunt, J.E.R., Johnson, D.W., Kimball, J.S., King, A.W., Luo, Y., McNulty, S.G., Sun, G., Thornton, P.E., Wang, S., Williams, M., Baldocchi, D.D., Cushman, R.M., 2004. Oak forest carbon and water simulations: model intercomparisons and evaluations against independent data. *Ecological Monographs* 74, 443-489.

Hergoualc'h, K., Blanchart, E., Skiba, U., Henault, C., Harmand, J.-M., 2012. Changes in carbon stock and greenhouse gas balance in a coffee (*Coffea arabica*) monoculture versus an agroforestry system with *Inga densiflora*, in Costa Rica. *Agriculture Ecosystems & Environment* 148, 102-110.

Heuvelink, J., Alpizar, L., Fassbender, H.W., Enriquez, G., Folster, H., 1985. Agroforestry Systems of Coffee (*Coffea arabica*) with Laurel (*Cordia alliodora*) and Coffee with Poro (*Erythrina poeppigiana*) in Turrialba, Costa-Rica .2. Production, Wood and Residues. *Turrialba* 35, 347-355.

Hillel, D., Rosenzweig, C., 2010. *Handbook of Climate Change and Agroecosystems: Impacts, Adaptation and Mitigation*. Imperial College Press.

Ibrom, A., Jarvis, P.G., Clement, R., Morgenstern, K., Oltchev, A., Medlyn, B.E., Wang, Y.P., Wingate, L., Moncrieff, J.B., Gravenhorst, G., 2006. A comparative analysis of simulated and observed photosynthetic CO<sub>2</sub> uptake in two coniferous forest canopies. *Tree Physiology* 26, 845-864.

IPCC, W.G.I., 2013. *Climate Change 2013: The Physical Science Basis*.

Jarvis, P.G., 1978. The interpretation of the variations in leaf water potential and stomatal conductance found in canopies in the field. *Philosophical Transactions of the Royal Society of London. B, Biological Sciences* 273, 593-610.

Jarvis, P.G., 1991. Preface to special issue. *Agroforestry: Principles and Practice For. Ecol. Manage.* 45, 1-3.

Jose, S., 2009. Agroforestry for ecosystem services and environmental benefits: an overview. *Agroforestry Systems* 76, 1-10.

- Kainkwa, R.M.R., Stigter, C.J., 2000. Measuring wind gradients in agroforestry systems by shaded piche evaporimeters. I. validation of the square-root dependence on wind speed. *International Agrophysics* 14, 279-289.
- Karsenty, A., Sembres, T., Randrianarison, M., 2010. Paiements pour services environnementaux et biodiversité dans les pays du sud. *Revue Tiers Monde* 202, 57-74.
- Karsenty, A., Vogel, A., Ezzine de Blas, D., Fétiveau, J., 2012. La problématique des « droits sur le carbone » dans REDD+. *VertigO - la revue électronique en sciences de l'environnement [En ligne]*.
- Kellomäki, S., Wang, K.-Y., Lemettinen, M., 2000. Controlled Environment Chambers for Investigating Tree Response to Elevated CO<sub>2</sub> and Temperature Under Boreal Conditions. *Photosynthetica* 38, 69-81.
- Kinoshita, R., 2012. Strategies for soil quality assessment using VNIR hyperspectral spectroscopy. Cornell, USA. , New-York. Master Sc. 89pp.
- Kinoshita, R., Rouspard, O., Chevallier, T., Albrecht, A., Taugourdeau, S., Hively, W.D., van Hes, H.M., 2013. Using hyperspectral spectroscopy and geostatistics for assessing the spatial variability of soil C within landscape attributes in a Costa Rican coffee agroforestry system. To be submitted to *Geoderma*.
- Kobayashi, H., Baldocchi, D.D., Ryu, Y., Chen, Q., Ma, S., Osuna, J.L., Ustin, S.L., 2012. Modeling energy and carbon fluxes in a heterogeneous oak woodland: A three-dimensional approach. *Agricultural and Forest Meteorology* 152, 83-100.
- Kwesiga, F., Grace, J., 1986. The Role of the Red/Far-Red Ratio in the Response of Tropical Tree Seedlings to Shade. *Annals of Botany* 57, 283-290.
- Lacointe, A., 2000. Carbon allocation among tree organs: A review of basic processes and representation in functional-structural tree models. *Ann. For. Sci.* 57, 521-533.
- Läderach, P., Jarvis, A., Ramirez, J., Fisher, M.J., 2008. Predictions of land use changes under progressive climate change in coffee growing regions of the AdapCC project : Final report. Centro Internacional de Agricultura Tropical (CIAT), Cali (Colombia).
- Lamanda, N., Dauzat, J., Jourdan, C., Martin, P., Malezieux, E., 2008. Using 3D architectural models to assess light availability and root bulkiness in coconut agroforestry systems. *Agroforestry Systems* 72, 63-74.
- Lambers, H., Chapin III, F.S., Pons, T.L., 2008. *Plant Physiological Ecology*. Springer.
- Lambin, E.F., Meyfroidt, P., 2011. Global land use change, economic globalization, and the looming land scarcity. *Proceedings of the National Academy of Sciences* 108, 3465-3472.
- Lasslop, G., Reichstein, M., Papale, D., Richardson, A.D., Arneeth, A., Barr, A., Stoy, P., Wohlfahrt, G., 2010. Separation of net ecosystem exchange into assimilation and respiration using a light response curve approach: critical issues and global evaluation. *Global Change Biology* 16, 187-208.
- Lawson, G., Crout, N., Levy, P., Mobbs, D., Wallace, J., Cannell, M., Bradley, R., 1995. The Tree-Crop Interface - Representation by Coupling of Forest and Crop Process-Models. *Agroforestry Systems* 30, p.199-221.



le Maire, G., Nouvellon, Y., Christina, M., Ponzoni, F.J., Gonçalves, J.L.M., Bouillet, J.P., Laclau, J.P., 2013. Tree and stand light use efficiencies over a full rotation of single- and mixed-species *Eucalyptus grandis* and *Acacia mangium* plantations. *For. Ecol. Manage.* 288, 31-42.

le Maire, G., Nouvellon, Y., Rouspard, O., Christina, M., Charbonnier, F., Zhou, J., Ponzoni, F., Stape, J.-L., Dautat, J., Coutron, P., 2012. Very high resolution satellite images for parameterization of tree-scale forest process-based model, Geoscience and Remote Sensing Symposium (IGARSS), 2012 IEEE International. IEEE, pp. 6553-6556.

Leeuwen, M., Nieuwenhuis, M., 2010. Retrieval of forest structural parameters using LiDAR remote sensing. *European Journal of Forest Research* 129, 749-770.

Leroy, C., Sabatier, S., Wahyuni, N., Barczi, J.-F., Dautat, J., Laurans, M., Auclair, D., 2009. Virtual trees and light capture: a method for optimizing agroforestry stand design. *Agroforestry Systems* 77, 37-47.

Leuning, R., 1995. A critical appraisal of a combined stomatal-photosynthesis model for C3 plants. *Plant, Cell & Environment* 18, 339-355.

Leuschner, C., Moser, G., Hertel, D., Erasmi, S., Leitner, D., Culmsee, H., Schuldt, B., Schwendenmann, L., 2013. Conversion of tropical moist forest into cacao agroforest: consequences for carbon pools and annual C sequestration. *Agroforestry Systems* 87, 1173-1187.

Lin, B.B., 2007. Agroforestry management as an adaptive strategy against potential microclimate extremes in coffee agriculture. *Agricultural and Forest Meteorology* 144, 85-94.

Livingston, G.P., Hutchinson, G.L., 1995. Enclosure-based measurement of trace gas-exchange: applications and sources of error., in: Matson, P.A., Harris, R.C. (Eds.), *Biogenic Trace Gases: Measuring Emissions from Soil and Water*. Blackwell Scientific Publications, London, pp. 14-51.

López-Bravo, D.F., Virginio-Filho, E.d.M., Avelino, J., 2012. Shade is conducive to coffee rust as compared to full sun exposure under standardized fruit load conditions. *Crop Protection* 38, 21-29.

Lott, J.E., Howard, S.B., Ong, C.K., Black, C.R., 2000a. Long-term productivity of a *Grevillea robusta*-based overstorey agroforestry system in semi-arid Kenya: I. Tree growth. *For. Ecol. Manage.* 139, 175-186.

Lott, J.E., Howard, S.B., Ong, C.K., Black, C.R., 2000b. Long-term productivity of a *Grevillea robusta*-based overstorey agroforestry system in semi-arid Kenya: II. Crop growth and system performance. *For. Ecol. Manage.* 139, 187-201.

Lott, J.E., Ong, C.K., Black, C.R., 2009. Understorey microclimate and crop performance in a *Grevillea robusta*-based agroforestry system in semi-arid Kenya. *Agricultural and Forest Meteorology* 149, 1140-1151.

Loustau, D., Moreaux, V., Bosc, A., Trichet, P., Kumari, J., Rabemanantsoa, T., Balesdent, J., Jolivet, C., Medlyn, B., Cavaignac, S., Nguyen-The, N., 2012. A climate sensitive model of carbon transfer through atmosphere, vegetation and soil in managed forest ecosystems, AGU Annual Assembly, San Francisco, USA.

Lundgren, B., 1982. Introduction. *Agroforestry Systems* 1, 3-6.

- Luo, Y., Medlyn, B., Hui, D., Ellsworth, D., Reynolds, J., Katul, G., 2001. Gross primary productivity in Duke forest: modeling synthesis of CO<sub>2</sub> experiment and eddy-flux data. *Ecological Applications* 11, 239-252.
- Malézieux, E., Crozat, Y., Dupraz, C., Laurans, M., Makowski, D., Ozier-Lafontaine, H., Rapidel, B., Tourdonnet, S., Valantin-Morison, M., 2009. Mixing plant species in cropping systems: concepts, tools and models. A review. *Agron. Sustain. Dev.* 29, 43-62.
- Maris, V., 2012. De la nature aux services écosystémiques – Une commodification de la nature. *Ecorev* 38, 19-23.
- Mead, R., Willey, R.W., 1980. The Concept of a 'Land Equivalent Ratio' and Advantages in Yields from Intercropping. *Exp. Agric.* 16, 217-228.
- Meadows, D., Randers, J., Meadows, D., 2004. Limits to growth : the 30-year update. White River Junction, VT : Chelsea Green Pub. Co.
- Medhurst, J., Parsby, J.A.N., Linder, S., Wallin, G., Ceschia, E., Slaney, M., 2006. A whole-tree chamber system for examining tree-level physiological responses of field-grown trees to environmental variation and climate change. *Plant, Cell and Environment* 29, 1853-1869.
- Medlyn, B., 2004. A MAESTRO Retrospective, in: Mencuccini, M., Moncrieff, J., McNaughton, K., Grace, J. (Eds.), *Forests at the Land-Atmosphere Interface*. CABI Publishing.
- Medlyn, B., Berbigier, P., Clement, R., Grelle, A., Loustau, D., Linder, S., Wingate, L., Jarvis, P., Sigurdsson, B., McMurtrie, R., 2005. Carbon balance of coniferous forests growing in contrasting climates: Model-based analysis. *Agricultural and Forest Meteorology* 131, 97-124.
- Medlyn, B., Duursma, R., 2009. The MAESTRA Model. Macquarie University, Sydney.
- Medlyn, B.E., 1998. Physiological basis of the light use efficiency model. *Tree Physiology* 18, 167-176.
- Medlyn, B.E., Duursma, R.A., Eamus, D., Ellsworth, D.S., Prentice, I.C., Barton, C.V.M., Crous, K.Y., De Angelis, P., Freeman, M., Wingate, L., 2011. Reconciling the optimal and empirical approaches to modelling stomatal conductance. *Global Change Biology* 17, 2134-2144.
- Medlyn, B.E., Pepper, D.A., O'Grady, A.P., Keith, H., 2007. Linking leaf and tree water use with an individual-tree model. *Tree Physiology* 27, 1687-1699.
- Meylan, L., Merot, A., Gary, C., Rapidel, B., 2013. Combining a typology and a conceptual model of cropping system to explore the diversity of relationships between ecosystem services: The case of erosion control in coffee-based agroforestry systems in Costa Rica. *Agricultural Systems* 118, 52-64.
- Mialet-Serra, I., Clement-Vidal, A., Roupsard, O., Jourdan, C., Dingkuhn, M., 2008. Whole-plant adjustments in coconut (*Cocos nucifera*) in response to sink-source imbalance. *Tree Physiology* 28, 1199-1209.
- Michon, G., Bompard, J., Hecketsweiler, P., Ducatillion, C., 1983. Tropical forest architectural analysis as applied to agroforests in the humid tropics: The example of traditional village-agroforests in West Java. *Agroforestry Systems* 1, 117-129.
- Millenium Ecosystem Assessment, 2005. *Ecosystems and Human Well-being: Synthesis*. Island Press, Washington, DC.

- Mobbs, D., Cannell, M., Crout, N., Lawson, G., Friend, A., Arah, J., 1998a. Complementarity of light and water use in tropical agroforests - I. Theoretical model outline, performance and sensitivity. *For. Ecol. Manage.* 102, p.259-274.
- Mobbs, D.C., Crout, J.J., Lawson, G.J., Cannell, M.G.R., 1998b. Structure and applications of the HyPAR model. *Agroforestry Forum* 8, 10-13.
- Montagnini, F., Nair, P.K.R., 2004. Carbon sequestration: An underexploited environmental benefit of agroforestry systems. *Agroforestry Systems* 61, 281-295.
- Monteith, J.L., 1972. Solar Radiation and Productivity in Tropical Ecosystems. *Journal of Applied Ecology* 9, 747-766.
- Monteith, J.L., 1997. Agroforestry modelling: a view from the touchline. *Agroforestry Forum* 8, 52-54.
- Monteith, J.L., Moss, C.J., 1977. Climate and the Efficiency of Crop Production in Britain [and Discussion]. *Philosophical Transactions of the Royal Society of London. B, Biological Sciences* 281, 277-294.
- Monteith, J.L., Ong, C.K., Corlett, J.E., 1991. Microclimatic interactions in agroforestry systems. *For. Ecol. Manage.* 45, 31-44.
- Moorthy, I., Miller, J.R., Berni, J.A.J., Zarco-Tejada, P., Hu, B., Chen, J., 2011. Field characterization of olive (*Olea europaea* L.) tree crown architecture using terrestrial laser scanning data. *Agricultural and Forest Meteorology* 151, 204-214.
- Moreaux, V., 2012. Observation et modélisation des échanges d'énergie et de masse de jeunes peuplements forestiers du Sud-Ouest de la France, École doctorale Sciences et Environnements Bordeaux 1, Bordeaux, p. 282 p.
- Moreno-Calles, A., Casas, A., García-Frapolli, E., Torres-García, I., 2012. Traditional agroforestry systems of multi-crop "milpa" and "chichipera" cactus forest in the arid Tehuacán Valley, Mexico: their management and role in people's subsistence. *Agroforestry Systems* 84, 207-226.
- Muschler, R.G., 2001. Shade improves coffee quality in a sub-optimal coffee-zone of Costa Rica. *Agroforestry Systems* 51, 131-139.
- Nair, P.K.R., 1991. State-of-the-art of agroforestry systems. *For. Ecol. Manage.* 45, 5-29.
- Nair, P.K.R., 2007. The coming of age of agroforestry. *Journal of the Science of Food and Agriculture* 87, 1613-1619.
- Nair, P.K.R., Garrity, D., 2012. *Agroforestry - The Future of Global Land Use*. Springer.
- Nojonen, M.R.A., Healey, J.R., Soto, G., Hagggar, J.P., 2013. Sink or source—The potential of coffee agroforestry systems to sequester atmospheric CO<sub>2</sub> into soil organic carbon. *Agriculture, Ecosystems & Environment* 175, 60-68.
- Norman, J.M., Welles, J.M., 1983. Radiative Transfer in an Array of Canopies. *Agronomy Journal* 75, 481-488.

Ong, C., Black, C., Marshall, F.M., 1996. Principles of resource capture and utilisation of light and water, in: Huxley, P., Ong, C. (Eds.), *Tree-Crop Interaction, A Physiological Approach*. CAB International, Wallingford, UK, pp. 74-158.

Ong, C.K., Black, C.R., Wallace, J.S., Khan, A.A.H., Lott, J.E., Jackson, N.A., Howard, S.B., Smith, D.M., 2000. Productivity, microclimate and water use in *Grevillea robusta*-based agroforestry systems on hillslopes in semi-arid Kenya. *Agriculture, Ecosystems & Environment* 80, 121-141.

Ong, C.K., Corlett, J.E., Singh, R.P., Black, C.R., 1991. Above and below ground interactions in agroforestry systems. *For. Ecol. Manage.* 45, 45-57.

Ong, C.K., Leakey, R.R.B., 1999. Why tree-crop interactions in agroforestry appear at odds with tree-grass interactions in tropical savannahs. *Agroforestry Systems* 45, 109-129.

Pagiola, S., 2008. Payments for environmental services in Costa Rica, *Ecological Economics*, pp. 712-724.

Palmer, J.W., Avery, D.J., Wertheim, S.J., 1992. Effect of apple tree spacing and summer pruning on leaf area distribution and light interception. *Scientia Horticulturae* 52, 303-312.

Pearcy, R.W., Muraoka, H., Valladares, F., 2005. Crown architecture in sun and shade environments: assessing function and trade-offs with a three-dimensional simulation model. *New Phytologist* 166, 791-800.

Pengue, W.A., 2005. Transgenic Crops in Argentina: The Ecological and Social Debt. *Bulletin of Science, Technology & Society* 25, 314-322.

Pérez-Priego, O., Testi, L., Orgaz, F., Villalobos, F.J., 2010. A large closed canopy chamber for measuring CO<sub>2</sub> and water vapour exchange of whole trees. *Environmental and Experimental Botany* 68, 131-138.

Philpott, S.M., Arendt, W.J., Armbrecht, I., Bichier, P., Diestch, T.V., Gordon, C., Greenberg, R., Perfecto, I., Reynoso-Santos, R., Soto-Pinto, L., Tejeda-Cruz, C., Williams-Linera, G., Valenzuela, J., Zolotoff, J.M., 2008. Biodiversity Loss in Latin American Coffee Landscapes: Review of the Evidence on Ants, Birds, and Trees. *Conservation Biology* 22, 1093-1105.

Pontailier, J.-Y., Hymus, G., 2003. Estimation of leaf area index using ground-based remote sensed NDVI measurements: validation and comparison with two indirect techniques. *Canadian Journal of Remote Sensing* 29, 381-387.

Powlson, D.S., Whitmore, A.P., Goulding, K.W.T., 2011. Soil carbon sequestration to mitigate climate change: a critical re-examination to identify the true and the false. *European Journal of Soil Science* 62, 42-55.

Pradal, C., Dufour-Kowalski, S., Boudon, F., Fournier, C., Godin, C., 2008. OpenAlea: a visual programming and component-based software platform for plant modelling. *Functional Plant Biology* 35, 751-760.

Rao, M.R., Nair, P.K.R., Ong, C.K., 1997. Biophysical interactions in tropical agroforestry systems. *Agroforestry Systems* 38, 3-50.

Raupach, M.R., 1992. Drag and drag partition on rough surfaces. *Boundary-Layer Meteorol* 60, 375-395.

Reichstein, M., Falge, E., Baldocchi, D., Papale, D., Aubinet, M., Berbigier, P., Bernhofer, C., Buchmann, N., Gilmanov, T., Granier, A., Grünwald, T., Havránková, K., Ilvesniemi, H., Janous, D., Knohl, A., Laurila, T., Lohila, A., Loustau, D., Matteucci, G., Meyers, T., Miglietta, F., Ourcival, J.-M., Pumpanen, J., Rambal, S., Rotenberg, E., Sanz, M., Tenhunen, J., Seufert, G., Vaccari, F., Vesala, T., Yakir, D., Valentini, R., 2005. On the separation of net ecosystem exchange into assimilation and ecosystem respiration: review and improved algorithm. *Global Change Biology* 11, 1424-1439.

Reicosky, D.C., Peters, D.B., 1977. A Portable Chamber for Rapid Evapotranspiration Measurements on Field Plots. *Agron. J.* 69, 729-732.

Richardson, J.J., Moskal, L.M., Kim, S.-H., 2009. Modeling approaches to estimate effective leaf area index from aerial discrete-return LIDAR. *Agricultural and Forest Meteorology* 149, 1152-1160.

Robin, M.M., 2012. Les moissons du futur: Comment l'agroécologie peut nourrir le monde. *La Découverte*.

Rodale Institute, 2013. The Farming System Trial. Celebrating 30 years.

Rodríguez, D., Cure, J.R., Cotes, J.M., Gutierrez, A.P., Cantor, F., 2011. A coffee agroecosystem model: I. Growth and development of the coffee plant. *Ecological Modelling* 222, 3626-3639.

Roupsard, O., Dauzat, J., Nouvellon, Y., Deveau, A., Feintrenie, L., Saint-André, L., Mialet-Serra, I., Braconnier, S., Bonnefond, J.-M., Berbigier, P., Epron, D., Jourdan, C., Navarro, M., Bouillet, J.-P., 2008. Cross-validating Sun-shade and 3D models of light absorption by a tree-crop canopy. *Agricultural and Forest Meteorology* 148, 549-564.

Roupsard, O., Ferhi, A., Granier, A., Pallo, F., Depommier, D., Mallet, B., Joly, H.I., Dreyer, E., 1999. Reverse phenology and dry-season water uptake by *Faidherbia albida* (Del.) A. Chev. in an agroforestry parkland of Sudanese west Africa. *Functional Ecology* 13, 460-472.

Ryu, Y., Baldocchi, D.D., Kobayashi, H., van Ingen, C., Li, J., Black, T.A., Beringer, J., van Gorsel, E., Knohl, A., Law, B.E., Roupsard, O., 2011. Integration of MODIS land and atmosphere products with a coupled-process model to estimate gross primary productivity and evapotranspiration from 1 km to global scales. *Global Biogeochemical Cycles* 25.

Ryu, Y., Sonnentag, O., Nilson, T., Vargas, R., Kobayashi, H., Wenk, R., Baldocchi, D.D., 2010. How to quantify tree leaf area index in an open savanna ecosystem: A multi-instrument and multi-model approach, *Agricultural and Forest Meteorology*, pp. 63-76.

Sanchez, P.A., 1995. Science in agroforestry. *Agroforestry Systems* 30, 5-55.

Schroth, G., da Fonseca, G.A.B., Harvey, C.A., Gascon, C., Vasconcelos, H.L., Izac, A.M.N., 2004. *Agroforestry and Biodiversity Conservation in Tropical Landscapes*. Island Press.

Shuttleworth, W.J., Wallace, J.S., 1985. Evaporation from sparse crops-an energy combination theory. *Quarterly Journal of the Royal Meteorological Society* 111, 839-855.

Siles, P., Harmand, J.-M., Vaast, P., 2010. Effects of *Inga densiflora* on the microclimate of coffee (*Coffea arabica* L.) and overall biomass under optimal growing conditions in Costa Rica. *Agroforestry Systems* 78, 269-286.

Smith, D.M., Jarvis, P.G., 1998. Physiological and environmental control of transpiration by trees in windbreaks. *For. Ecol. Manage.* 105, 159-173.

- Smith, D.M., Jarvis, P.G., Odongo, J.C.W., 1997a. Aerodynamic conductances of trees in windbreaks. *Agricultural and Forest Meteorology* 86, 17-31.
- Smith, D.M., Jarvis, P.G., Odongo, J.C.W., 1997b. Energy budgets of windbreak canopies in the Sahel. *Agricultural and Forest Meteorology* 86, 33-49.
- Smith, D.M., Jarvis, P.G., Odongo, J.C.W., 1997c. Sources of water used by trees and millet in Sahelian windbreak systems. *Journal of Hydrology* 198, 140-153.
- Soto-Pinto, L., Anzueto, M., Mendoza, J., Ferrer, G., Jong, B., 2010. Carbon sequestration through agroforestry in indigenous communities of Chiapas, Mexico. *Agroforestry Systems* 78, 39-51.
- Soto-Pinto, L., Perfecto, I., Castillo-Hernandez, J., Caballero-Nieto, J., 2000. Shade effect on coffee production at the northern Tzeltal zone of the state of Chiapas, Mexico. *Agriculture Ecosystems & Environment* 80, 61-69.
- Soudani, K., Hmimina, G., Delpierre, N., Pontailier, J.Y., Aubinet, M., Bonal, D., Caquet, B., de Grandcourt, A., Burban, B., Flechard, C., Guyon, D., Granier, A., Gross, P., Heinesh, B., Longdoz, B., Loustau, D., Moureaux, C., Ourcival, J.M., Rambal, S., Saint André, L., Dufrêne, E., 2012. Ground-based Network of NDVI measurements for tracking temporal dynamics of canopy structure and vegetation phenology in different biomes. *Remote Sensing of Environment* 123, 234-245.
- Spitters, C.J.T., Toussaint, H.A.J.M., Goudriaan, J., 1986. Separating the diffuse and direct component of global radiation and its implications for modeling canopy photosynthesis Part I. Components of incoming radiation. *Agricultural and Forest Meteorology* 38, 217-229.
- Talbot, G., 2011. L'intégration spatiale et temporelle du partage des ressources dans un système agroforestier noyers-céréales : une clef pour en comprendre la productivité ? PhD thesis, ED SIBAGHE. Université Montpellier 2, Montpellier, p. 297.
- Talbot, G., Dupraz, C., 2012. Simple models for light competition within agroforestry discontinuous tree stands: are leaf clumpiness and light interception by woody parts relevant factors? *Agroforestry Systems* 84, 101-116.
- Tang, H., Dubayah, R., Swatantran, A., Hofton, M., Sheldon, S., Clark, D.B., Blair, B., 2012. Retrieval of vertical LAI profiles over tropical rain forests using waveform lidar at La Selva, Costa Rica. *Remote Sensing of Environment* 124, 242-250.
- Tang, S., Dong, P., Buckles, B.P., 2013. Three-dimensional surface reconstruction of tree canopy from lidar point clouds using a region-based level set method. *International Journal of Remote Sensing* 34, 1373-1385.
- Thornton, P., Cramer, L., 2012. Impacts of climate change on the agricultural and aquatic systems and natural resources within the CGIAR's mandate, CCAFS Working Paper. CGIAR Research Program on Climate Change, Agriculture and Food Security (CCAFS), Copenhagen, Denmark.
- Tixier, P., Malezieux, E., Dorel, M., 2004. SIMBA-POP: a cohort population model for long-term simulation of banana crop harvest. *Ecological Modelling* 180, 407-417.
- Torquebiau, E., 2007. L'Agroforesterie, des arbres et des champs. L'Harmattan, Paris.
- Townsend, A.R., Asner, G.P., 2013. Multiple dimensions of resource limitation in tropical forests. *Proceedings of the National Academy of Sciences* 110, 4864-4865.

Turner, G.M., 2012. On the Cusp of Global Collapse? Updated Comparison of "The Limits to Growth" with Historical Data. *GAIA - Ecological Perspectives for Science and Society* 21, 116-124.

UNCTAD, 2013. Trade and environment review 2013. United Nations.

USDA-NRCS, 2005. Global Soil Regions. USDA-NRCS, Soil Survey Division, World Soil Resources, Washington D.C.

van der Werf, W., Keesman, K., Burgess, P., Graves, A., Pilbeam, D., Incoll, L.D., Metselaar, K., Mayus, M., Stappers, R., van Keulen, H., Palma, J., Dupraz, C., 2007. Yield-SAFE: A parameter-sparse, process-based dynamic model for predicting resource capture, growth, and production in agroforestry systems. *Ecological Engineering* 29, 419-433.

Van Noordwijk, M., Lusiana, B., 1998. WaNuLCAS, a model of water, nutrient and light capture in agroforestry systems. *Agroforestry Systems* 43, 217-242.

van Oijen, M., Dauzat, J., Harmand, J.-M., Lawson, G., Vaast, P., 2010a. Coffee agroforestry systems in Central America: I. A review of quantitative information on physiological and ecological processes. *Agroforestry Systems* 80, 341-359.

van Oijen, M., Dauzat, J., Harmand, J.-M., Lawson, G., Vaast, P., 2010b. Coffee agroforestry systems in Central America: II. Development of a simple process-based model and preliminary results. *Agroforestry Systems* 80, 361-378.

Vandermeer, J., 1989. The ecology of intercropping. Cambridge University Press.

Vermeulen, S.J., Challinor, A.J., Thornton, P.K., Campbell, B.M., Eriyagama, N., Vervoort, J.M., Kinyangi, J., Jarvis, A., Läderach, P., Ramirez-Villegas, J., Nicklin, K.J., Hawkins, E., Smith, D.R., 2013. Addressing uncertainty in adaptation planning for agriculture. *Proceedings of the National Academy of Sciences* 110, 8357-8362.

Vierling, L.A., Xu, Y., Eitel, J.U.H., Oldow, J.S., 2012. Shrub characterization using terrestrial laser scanning and implications for airborne LiDAR assessment. *Canadian Journal of Remote Sensing* 38, 709-722.

Wagner, S.W., Reicosky, D.C., Alessi, R.S., 1997. Regression Models for Calculating Gas Fluxes Measured with a Closed Chamber. *Agron. J.* 89, 279-284.

Wallace, J., Verhoef, A., 2000. Modelling interactions in mixed-plant communities: light, water and carbon dioxide, in: Marshall, B., Roberts, J.A. (Eds.), Leaf development and canopy growth. Sheffield Academic Press, Sheffield, UK.

Wallace, J.S., 1995. Towards a coupled light partitioning and transpiration model for use in intercrops and agroforestry.

Wallace, J.S., 2000. Increasing agricultural water use efficiency to meet future food production. *Agriculture, Ecosystems & Environment* 82, 105-119.

Wallace, J.S., Jackson, N.A., Ong, C.K., 1999. Modelling soil evaporation in an agroforestry system in Kenya. *Agricultural and Forest Meteorology* 94, 189-202.

Wang, Y.P., Jarvis, P.G., 1990a. Description and validation of an array model -- MAESTRO. *Agricultural and Forest Meteorology* 51, 257-280.

Wang, Y.P., Jarvis, P.G., 1990b. Influence of crown structural properties on PAR absorption, photosynthesis, and transpiration in Sitka spruce: application of a model (MAESTRO). *Tree Physiology* 7, 297-316.

Wang, Y.P., Jarvis, P.G., Benson, M.L., 1990. Two-dimensional needle-area density distribution within the crowns of *Pinus radiata*. *For. Ecol. Manage.* 32, 217-237.

Williams, M., Bond, B., Ryan, M., 2001. Evaluating different soil and plant hydraulic constraints on tree function using a model and sap flow data from ponderosa pine. *Plant, Cell and Environment* 24, 679-690.

Zhao, F., Yang, X., Schull, M.A., Román-Colón, M.O., Yao, T., Wang, Z., Zhang, Q., Jupp, D.L.B., Lovell, J.L., Culvenor, D.S., Newnham, G.J., Richardson, A.D., Ni-Meister, W., Schaaf, C.L., Woodcock, C.E., Strahler, A.H., 2011. Measuring effective leaf area index, foliage profile, and stand height in New England forest stands using a full-waveform ground-based lidar. *Remote Sensing of Environment* 115, 2954-2964.

Zhao, M.S., Heinsch, F.A., Nemani, R.R., Running, S.W., 2005. Improvements of the MODIS terrestrial gross and net primary production global data set. *Remote Sensing of Environment* 95, 164-176.





Contents lists available at ScienceDirect

## Agricultural and Forest Meteorology

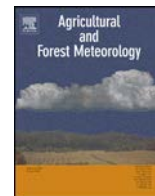
journal homepage: [www.elsevier.com/locate/agrformet](http://www.elsevier.com/locate/agrformet)

## Competition for light in heterogeneous canopies: Application of MAESTRA to a coffee (*Coffea arabica* L.) agroforestry system



Fabien Charbonnier<sup>a,b,c,d,\*</sup>, Gueric le Maire<sup>a</sup>, Erwin Dreyer<sup>b,c</sup>, Fernando Casanoves<sup>d</sup>, Mathias Christina<sup>a</sup>, Jean Dauzat<sup>e</sup>, Jan U.H. Eitel<sup>f,g</sup>, Philippe Vaast<sup>a,h</sup>, Lee A. Vierling<sup>f</sup>, Olivier Roupsard<sup>a,d</sup>

<sup>a</sup> CIRAD, UMR Eco&Sols (Ecologie Fonctionnelle & Biogéochimie des Sols et des Agro-écosystèmes), 34060 Montpellier Cedex 2, France

<sup>b</sup> Université de Lorraine, UMR 1137 "Ecologie et Ecophysiologie Forestières", F 54500 Vandœuvre, France

<sup>c</sup> INRA, UMR 1137 "Ecologie et Ecophysiologie Forestières", F54280 Champenoux, France

<sup>d</sup> CATIE (Centro Agronómico Tropical de Investigación y Enseñanza), 7170 Turrialba, Costa Rica

<sup>e</sup> CIRAD, UMR AMAP, 34000 Montpellier, France

<sup>f</sup> Dept. of Forest, Rangeland, and Fire Sciences, University of Idaho, Moscow, ID, United States

<sup>g</sup> McCall Outdoor Science School, University of Idaho, McCall, ID, United States

<sup>h</sup> ICRAF, United Nations Avenue, Gigiri, PO Box 30677-00100, Nairobi, Kenya

## ARTICLE INFO

## Article history:

Received 25 March 2013

Received in revised form 17 July 2013

Accepted 21 July 2013

## Keywords:

Agroforestry systems

3D light model

MAESTRA

Shade tree density/Coffee

## ABSTRACT

In agroforestry systems (AFS), quantifying the competition for light is a prerequisite toward understanding the impact of shade trees on the productivity of the under-crop. Models for homogeneous canopies and shade/full-sun approaches do not address the intra-plot heterogeneity, typical of AFS. For the first time, MAESTRA, a 3D light absorption model, was fully parameterized in a heterogeneous 2-canopy layers AFS. We quantified competition for photosynthetic photon flux density ( $Q$ ) between shade trees (*Erythrina poeppigiana*) and coffee (*Coffea arabica*), with a spatial resolution from the plant to the plot (2.7 ha) and a temporal resolution from half-hour to one full year. The predicted transmittance through the 2-canopy layers was verified against field measurements. The goodness of fit ( $R^2 > 0.75$ , RRMSE < 26%) was comparable to the predictions from 10 other studies using 3D light models and mostly verified in one-layered systems (mean  $R^2 = 0.89$  and mean RRMSE = 17%). Maps of absorbed  $Q$  showed that despite their low density in the plot (5.2 trees  $\text{ha}^{-1}$ ), the tall *Erythrina* trees reduced  $Q$  available for the coffee layer by 14% annually. Annual pruning of the oldest unproductive coffee resprouts maintained a large horizontal heterogeneity in coffee LAI, with direct impact on the  $Q$  absorption map. This management practice had a strong impact on seasonal variations of absorbed  $Q$  by the coffee canopy. We proposed also a simple approach to estimate  $Q$  absorbed yearly by the coffee plants in AFS of variable tree density, requiring only few measurements in the field. An extrapolation indicated that the amount of  $Q$  absorbed by the coffee canopy would display a negative exponential relationship ( $k = -0.34$ ) when increasing shade tree density (from nil to 29 trees  $\text{ha}^{-1}$ ). The estimated  $k$  was similar to the shade tree extinction coefficient of diffuse radiation measured with a plant canopy analyzer. We showed that the presence of shade trees tends to reverse the diurnal time course of the fraction of  $Q_a$  when compared to a plantation in the open.

Overall, MAESTRA proved to successfully unlock the question of intra-plot heterogeneity for light absorption and to provide defensible light budgets as a continuous and mapped covariable, a crucial step for many field experimentations.

© 2013 Elsevier B.V. All rights reserved.

## 1. Introduction

In the current context where the farmers' margins of adaptation are becoming narrower, agroforestry systems (AFS) emerge as an efficient strategy for the ecological intensification of agriculture (Doré et al., 2011; Nair, 2007). In addition, AFS are an efficient way to improve the resilience of agriculture by buffering the fluctuations in microclimate (Lin, 2007; Siles et al., 2010; Verchot et al., 2007). This is particularly true for tropical agrosystems that are generally

Abbreviations: AFS, Agroforestry system;  $V_c$ , vertical crown projection of tree crown; MTA, mean tilt angle;  $Q$ , photosynthetic photon flux density;  $T$ , transmittance or gap-fraction.

\* Corresponding author.

E-mail address: [fabien.charbonnier@cirad.fr](mailto:fabien.charbonnier@cirad.fr) (F. Charbonnier).

a	absorbed
b	beam
d	diffuse
def	defoliated
i	incident
t	transmitted
cof	coffee
sh	shade tree
sys	system (shade tree + coffee layer)

considered to be highly vulnerable. Climate change is expected to exacerbate this vulnerability (IPCC, 2007), as the onset of significant local warming is likely to occur more rapidly in the tropics than at higher latitudes (Hawkins and Sutton, 2012; Mahlstein et al., 2011). Besides potential climate change effects, tropical agrosystems farmers are already facing the challenge of increasing their productivity (in order to meet the need of the growing human population) while avoiding further dramatic deforestation (World Bank Group, 2012).

Because the multi-strata plant canopies inherent to AFS are heterogeneous and complex in nature, there is a need to better understand processes governing competition/facilitation for resources in order to balance crop production with ecological benefits (Cannell et al., 1996; Sanchez, 1995). However, field experiments alone are unable to describe such interactions due to the long life-span of AFS (a decade minimum) and because of the large number of possible combinations of crop species, shade tree species, plant arrangement and local conditions. Developing process-based models is therefore a prerequisite to further improve our understanding of the complex interactions in AFS (Thornton and Cramer, 2012). Such biophysical models coupled to economical models are needed to support decision-making with respect to sustainable management and understanding of trade-offs between AFS productivity, provision for ecosystem services and resilience to climate change.

In the agroforestry literature, competition for light was generally quantified using the percentage of shade cover (Beer et al., 1998; Bellow and Nair, 2003). Significant improvements are expected from detailed estimation of crown porosity, partitioning between direct and diffuse light, slope, and solar position, in order to assess the spatial and temporal heterogeneity introduced by shade trees. Of high relevance is the quantification of the effects of shade trees on the photosynthetic photon flux density absorbed by the crop underneath ( $Q_a$ ), a key driver of net primary productivity (NPP; Monteith, 1972 and Gower et al., 1999). The decrease of  $Q_a$  due to increasing shade tree density may result in lower carbon assimilation by the crop. An enhanced fraction of diffuse light below the shade trees may compensate somehow for the decrease of  $Q_a$  (Gu et al., 2002; Roderick et al., 2001; Spitters et al., 1986). Process-based models may provide more quantitative and spatially resolved insights of how shade tree density in AFS affects crop  $Q_a$  and NPP.

Choosing a model to characterize the biophysical processes in AFS at the plot scale must consider trade-offs between scale, accuracy and facility of parameterization. Big-leaf (Running and Coughlan, 1988), sun-shade (De Pury and Farquhar, 1997; Roupard et al., 2008; Ryu et al., 2011) and multilayer models (Baldochi and Harley, 1995) all address continuous canopies and were not designed to account for the spatial heterogeneity encountered in AFS. On the other extreme, detailed 3D models are parameter- and time-demanding, which is generally not compatible with a simulation at the whole-plot scale. To date, the models used for AFS are mainly:

- (i) HyPar V1 (Cannell et al., 1998; Lawson et al., 1995; Mobbs et al., 1998), with the option of representing shade trees as a homogeneous layer (“big-leaf”) with a constant LAI. However, using a one-layered model to represent heterogeneous canopies results in a systematic underestimation of transmitted light, where the error increases while LAI decreases (Chen et al., 2008). To account for this, Mobbs et al. (1998) proposed an upgraded version (HyPAR V2) though its further development was abandoned;
- (ii) WaNulCas (Van Noordwijk and Lusiana, 1998), one of the most highly developed AFS models, computes diurnal light interception by 2D shade trees as a simple function of leaf area, but the light transmitted to the crop is reduced only under the shade trees’ crowns;
- (iii) A spatially explicit representation is likely the most relevant approach. Talbot and Dupraz (2012) recently adapted the 3D model of daily light interception developed by Courbaud et al. (2003) with the purpose of mapping transmitted light and using it as an input for the crop growth model STICS (Brisson et al., 2003; Talbot, 2011). However, to date, the model does not manage intra-daily variations in  $Q_a$ ;
- (iv) Lawson et al. (1995) used shade trees described as 3D canopies with MAESTRO (Wang and Jarvis, 1990a); hourly transmitted light was computed and used as incident light in a crop growth model. However, the model was never validated and the authors abandoned the trial because of calculation issues;
- (v) In the forestry field, a few 3D, spatially explicit light interception models with different degrees of complexity are available (see Brunner, 1998) and allow modeling the effect of shade tree density in AFS on crop  $Q_a$ . A few are also coupled with photosynthesis and transpiration routines, like MAESTRA (Medlyn, 2004; Wang and Jarvis, 1990a), RATP (Sinoquet et al., 2001) and Canoak-Flies (Kobayashi et al., 2012) among others. The latter is probably the most refined model in terms of microclimate feedback (highly detailed energy balance + turbulence within canopy) but its parameterization is challenging;
- (vi) Finally, models explicitly describing leaf positions (Dauzat et al., 2008; Dauzat et al., 2001) are among the most accurate for light absorption and can be used as reference for testing other models (Roupsard et al., 2008). However, they can hardly be used at the plot scale due to intense parameterization requirements and calculation issues.

Recently, MAESTRA was upgraded by introducing a complete soil and plant water balance module called SPA (Williams et al., 2001) and renamed MAESPA (Duursma and Medlyn, 2012). This yields a very attractive model for AFS research because it is embedding the limitation for two key resources, light and water (Mobbs et al., 1998). For light interception, MAESPA is entirely based on MAESTRA. MAESTRA has been applied to a wide range of ecosystems, its code and user manual are freely available (<http://bio.mq.edu.au/maestra/>), and the community of users is constantly improving the model. MAESTRA has been used widely for ecophysiological research to investigate the response of photosynthesis and transpiration to drought (Hanson et al., 2004), shading (le Maire et al., 2013) or enhanced atmospheric CO<sub>2</sub> (Janssens et al., 2005). MAESTRA has been used once to predict light absorption in a mixed forest plantation (le Maire et al., 2013). It has seldom been used for predictive simulations except by Grace (Grace, 1988; Grace, 1990) who studied the effects of tree arrangement on  $Q_a$  in a forest plantation. Due to annual pruning, coffee has a multi-stem architecture with resprouts of different ages and is highly heterogeneous in its 3D spatial structure. To our knowledge, this is the first attempt to use MAESTRA with the aim of predicting  $Q_a$  in a 2-layered ecosystem with strong spatial heterogeneity within each layer.

Coffee is one of the main commodities in the World (Pendergrast, 2000). Arabica coffee was traditionally grown under shade trees in order to mimic its original ecology, as an understorey tree in East Africa's highlands forests. Since its introduction to America, it has been mostly grown under shade trees. However, there are different levels of intensification in coffee production systems, ranging from organic to highly intensified, even for AFS. AFS management can be beneficial to arabica coffee quality, especially in suboptimal conditions at low altitude because the cooler understorey temperatures allow a slower ripening of the coffee bean (Beer et al., 1998; Muschler, 2001; Vaast et al., 2006). Coffee can also be grown successfully as a monoculture with high agro-chemical input levels resulting in high yields, but at the expense of coffee quality (especially at low altitude) and damaging ecological externalities. In other words, there is a clear trade-off between yield and quality as well as yield and externalities, with the very relevant question of the impact of shade trees (density and crown extension) on coffee growth and production. The effects of shade on coffee plants have already been the focus of numerous studies (for a review see Damatta, 2004). Nevertheless, to our knowledge the effects of shade trees on the spatio-temporal variability of  $Q_a$  at the plant and plot scale have never been explicitly quantified.

The objectives of the present work were: (i) to verify, in the case of an experimental AFS display, the predictions of MAESTRA with respect to the recorded local variations of light transmission by shade trees and coffee; (ii) to assess the spatial and seasonal variability of  $Q_a$  in the coffee layer; and (iii) to extrapolate the relationship between shade tree density and  $Q_a$  of the coffee layer.

## 2. Material and methods

### 2.1. Study site

The study site is located in central Costa Rica at 1050 m.a.s.l, on the slopes of the Turrialba volcano ( $9^{\circ}56'19''$  N,  $83^{\circ}43'46''$  W). The climate is tropical humid according to the Köppen-Geiger climate classification (Peel et al., 2007). The experimental plot is part of the "Coffee-Flux" experiment evaluating ecosystem services from plot to watershed, in a 1 km<sup>2</sup> multi-instrumented watershed installed within the AQUIARES coffee farm, one of the largest coffee plantations in Costa Rica (660 ha; Gómez-Delgado, 2010; Gómez-Delgado et al., 2011; Taugourdeau et al., 2010). The plantation is made of coffee plants shaded by tall, free-growing *Erythrina poeppigiana* O.F. Cook (Fabaceae), with crown projections covering 15.7% of the farm (Taugourdeau et al., 2010). *Erythrina poeppigiana* is a widely used and fast growing, shade tree in coffee AFS in Central America. It is a large deciduous tree that totally defoliates during February–March in our study site.

A 2.7 ha experimental plot including 14 shade trees was defined around a 25 m high eddy-covariance tower (Fig. 1). Half-hourly averaged climate data, measured on top of the tower, were used as meteorological inputs for MAESTRA: incident photon flux density ( $Q_i$ ) and fraction of diffuse  $Q$  ( $f_d$ ) were recorded with a BF3 sensor (Delta-T devices Ltd, Burwell, UK); temperature and humidity were recorded with a HMP45C probe (Campbell Scientific, Logan, UT, USA); rainfall was measured locally with ARG100 tipping-bucket (R. M. Young, MI, USA). During our experiment (05/2011–04/2012), mean temperature was 19.5 °C, rainfall amounted to 3054 mm with the driest month of April 2012 (78 mm; Fig. 2a),  $Q_i$  ranged from 24 to 41 mol m<sup>-2</sup> day<sup>-1</sup> during the year with  $f_d$  varying from 0.49 to 0.79 (Fig. 2b). Such high values of  $f_d$  are explained by the typical high nebulosity in this humid area. Additionally, litter production and soil water content were monitored. The deep andisols (USDA, 1999) were always close to field capacity, thus never incurring water shortage for the plants (Gomez-Delgado et al., 2011).

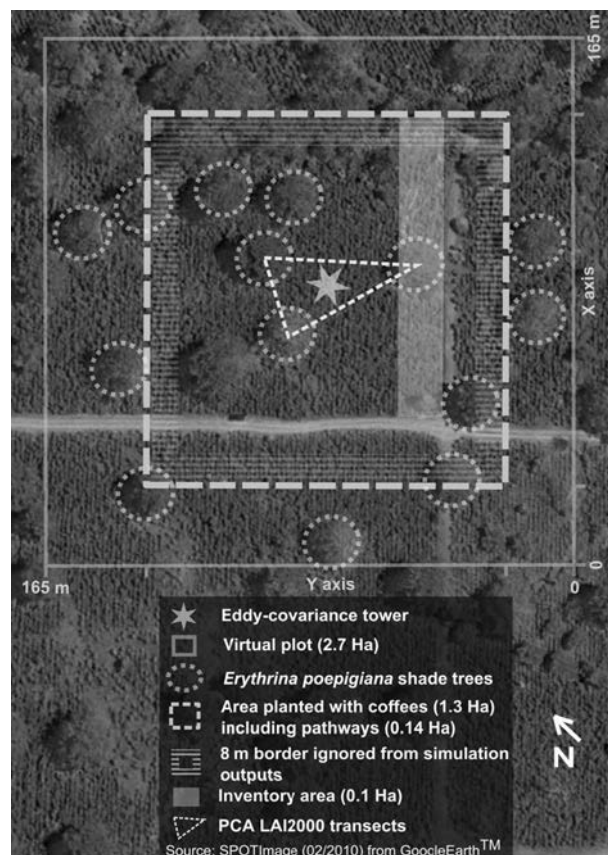

Fig. 1. Satellite image of the experimental plot used for simulations with MAESTRA ( $9^{\circ}56'19''$  N,  $83^{\circ}43'46''$  W).

Although the topography of the watershed was mountainous, the experimental plot was located at the bottom of a shallow valley on gentle and homogeneous slopes (between 4 and 6%). The horizon was masked by mountains, but without any impact on simulations as light was an input variable measured directly above the plot.

The plot was planted in the 1970's with *Coffea arabica* L. var Caturra, at an initial density of 6300 ha<sup>-1</sup>. In 2011, the 40 cm-tall stumps were bearing 1 to 3 resprouts of different ages (with 1 or 2 stumps per location). As a result, the plantation resembled an uneven-aged coppice. The resprouts are pruned selectively every 5 to 6 years as soon as they display a decrease in production of fruiting nodes and thus become less productive or too large for easy coffee harvesting (>2 m high). This annual pruning affects around 15% of the resprouts, among the oldest ones and thus removes a significant fraction of plot LAI. Such management practices lead to a strong spatial heterogeneity of the coffee layer. We decided to use the individual resprout and not the stump as the experimental unit in MAESTRA, in order to base the simulation on the observed cohorts of resprouts and to account for age effects.

Coffee was managed conventionally with high fertilizer levels (273 and 243 kg N ha<sup>-1</sup> yr<sup>-1</sup>; 2011 and 2012, respectively). Weeds were strongly controlled with frequent herbicide applications. Coffee harvesting took place between November 2011 and early February 2012 and the yield of green coffee (commercial coffee) was 1660 kg ha<sup>-1</sup>.

### 2.2. Overview of MAESTRA

MAESTRA is a 3D array, tree-centered, process-based model that calculates  $Q_a$ , absorbed near infra-red radiation and absorbed total infra-red radiation by individual trees using radiation transfer

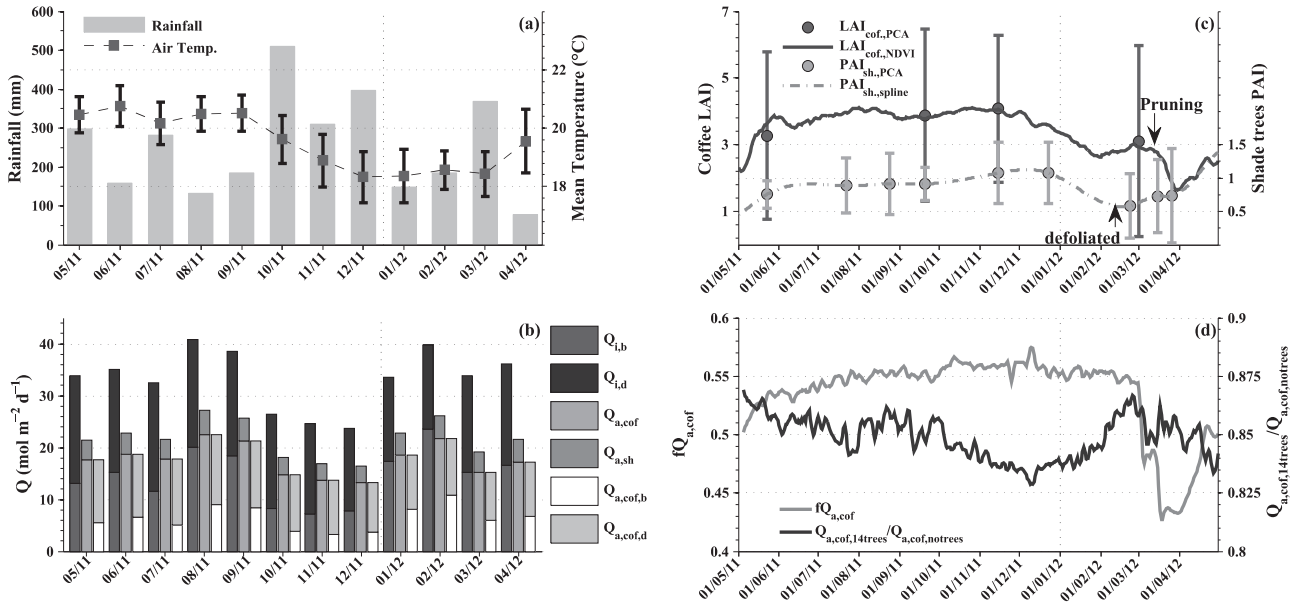

**Fig. 2.** Monthly variations of: a) mean air temperature and rainfall, b) daily beam ( $Q_{i,b}$ ) and diffuse ( $Q_{i,d}$ ) incident  $Q$ ; daily  $Q$  absorbed by coffee and shade trees ( $Q_{a,cof}$  and  $Q_{a,sh}$ ); beam ( $Q_{a,cof,b}$ ) and diffuse ( $Q_{a,cof,d}$ )  $Q$  absorbed by the coffee canopy.  $Q_i$  was recorded on top the eddy-covariance tower from May 1st 2011 to April 30th 2012.  $Q_{a,sh}$  and  $Q_{a,cof}$  were simulated with MAESTRA over the same period. c) Leaf Area Index of the coffee layer ( $LAI_{cof}$ ;  $m^2 m^{-2}$ ) and Plant Area Index of shade trees ( $PAI_{sh}$ ;  $m^2 m^{-2}$ ) measured monthly with a LAI2000 (dark gray dots) and interpolated for coffee from NDVI in proxydetection (continuous line) and for shade trees using a cubic spline function (dotted line).  $LAI_{cof}$  and  $PAI_{sh}$  were computed at plot scale. The large standard deviations of  $LAI_{cof}$  corresponds to the strong within plot variability, in particular row/inter-row differences. Coffee pruning and defoliated shade tree periods are indicated with arrows; d) daily fraction of coffee layer  $Q_a$  ( $fQ_{a,cof}$ ) and ratio of actual  $Q_{a,cof}$  to  $Q_{a,cof}$  for the plantation with no shade trees ( $Q_{a,cof,14trees}/Q_{a,cof,notrees}$ ). The vertical dotted line separates 2011 from 2012.

theory (Norman and Welles, 1983; Wang and Jarvis, 1990a), as described by Medlyn (2004) and Duursma and Medlyn (2012).

In MAESTRA, plants are explicitly positioned on a 2D map. Slope characteristics can be defined for the plot in two perpendicular directions. MAESTRA represents tree crowns with simple geometrical shapes (ellipsoidal, half-ellipsoidal, conical and cylindrical) defined by their height and radius in 2 directions. In MAESTRA, light is only intercepted by leaves: trunk height is an input variable merely used to define the height of the crown base. MAESTRA does not simulate plant growth: rather, crown dimensions and leaf area and their variation over time are input variables of the model. MAESTRA can manage various species with different structural (e.g. leaf angle distributions, distributions of leaf area density, foliage clumping) and physiological parameters within the same plot. MAESTRA predictions can be compared with field measurements of  $Q$  or diffuse transmittance ( $T_d$ ) at defined points with a test module.

### 2.3. MAESTRA parameterization

#### 2.3.1. Inventory: plant position, distribution and dimensions

The coffee layer structure was described via an exhaustive inventory made over 0.1 ha during August 2011: 10 coffee lines comprising a total of 2091 resprouts were measured (Fig. 1). The position of each resprout as well as crown height ( $H_{can}$ ), basal diameter and stump height were recorded.

The mean distance between rows was 1.43 m and between locations within the same row 1.11 m (6300 stump locations per ha). There was a mean of 3.2 resprouts per location (range: 1 to 6). The mean resprout height was 1.2 m but it could reach 3 m. There was no apparent pattern in spatial arrangement of the resprouts within a location. The mean distance between resprouts' stems belonging to the same stump was 40 cm. The resprouts were split into 12 treatments: 6 age classes and 2 shade environment (under shade tree crowns and in the open) given that shading is suspected to affect coffee crown size (Franck, 2005; Vaast et al., 2008).  $H_{can}$  was

**Table 1**

Leaf angle distribution of coffee resprouts and of Erythrina trees. Mean tilt angle (leaf angle from vertical) were measured with i) a digital protractor for coffees and ii) horizontal photographs for Erythrina trees.  $\mu$  and  $\checkmark$  are the parameters of the fitted leaf angle beta distributions according to Goel and Strebel (1983) defined in appendix 2.

	Method	MTA (°)	N	Distribution	$\mu$	$\checkmark$
Coffee	Protractor	45.3 ± 20.4	1900	Plagiophile	1.97	1.95
Erythrina	Horizontal photograph	57.7	400	Planophile	1.48	2.92

significantly affected by resprout age while there was no effect of shade (Fig. 3e). The resprouts were approximately evenly distributed across age classes without any effect of shade on their distribution (Fig. 3d).

A specific inventory performed after the pruning of March 2012 showed that 15% of the oldest resprouts had been removed. Pruning was thus taken into account for the MAESTRA simulations by eliminating the 15% tallest resprouts.

We geolocated the 14 shade trees closest to the eddy-covariance tower. We measured their trunk and total height with a clinometer (Suunto PM5/360PC, Finland), and their horizontal crown extent in 2 directions with a meter tape in July 2012 (Table 2).

#### 2.3.2. Plant growth

A sample of 60 coffee resprouts of 6 age classes and 2 shade environments was monitored every three months between May 2011 and April 2012 (Audebert, 2011). An allometric relationship was derived between crown radius of each resprout ( $R_{can}$ ) and  $H_{can}$  ( $R_{can} = 0.41H_{can}$ ,  $R^2 = 0.73$ ,  $N = 360$ ,  $p < 0.0001$ ). Expansion rates in height and radius were calculated between May 2011 and April 2012. There was no effect of shade on any of those two variables. After a Fisher LSD test ( $\alpha=0.05$ ), different expansion rates were applied according to resprout age and rates were considered constant throughout the year. Both expansion rates decreased with coffee resprout age (Fig. 3a and b). In MAESTRA, individual

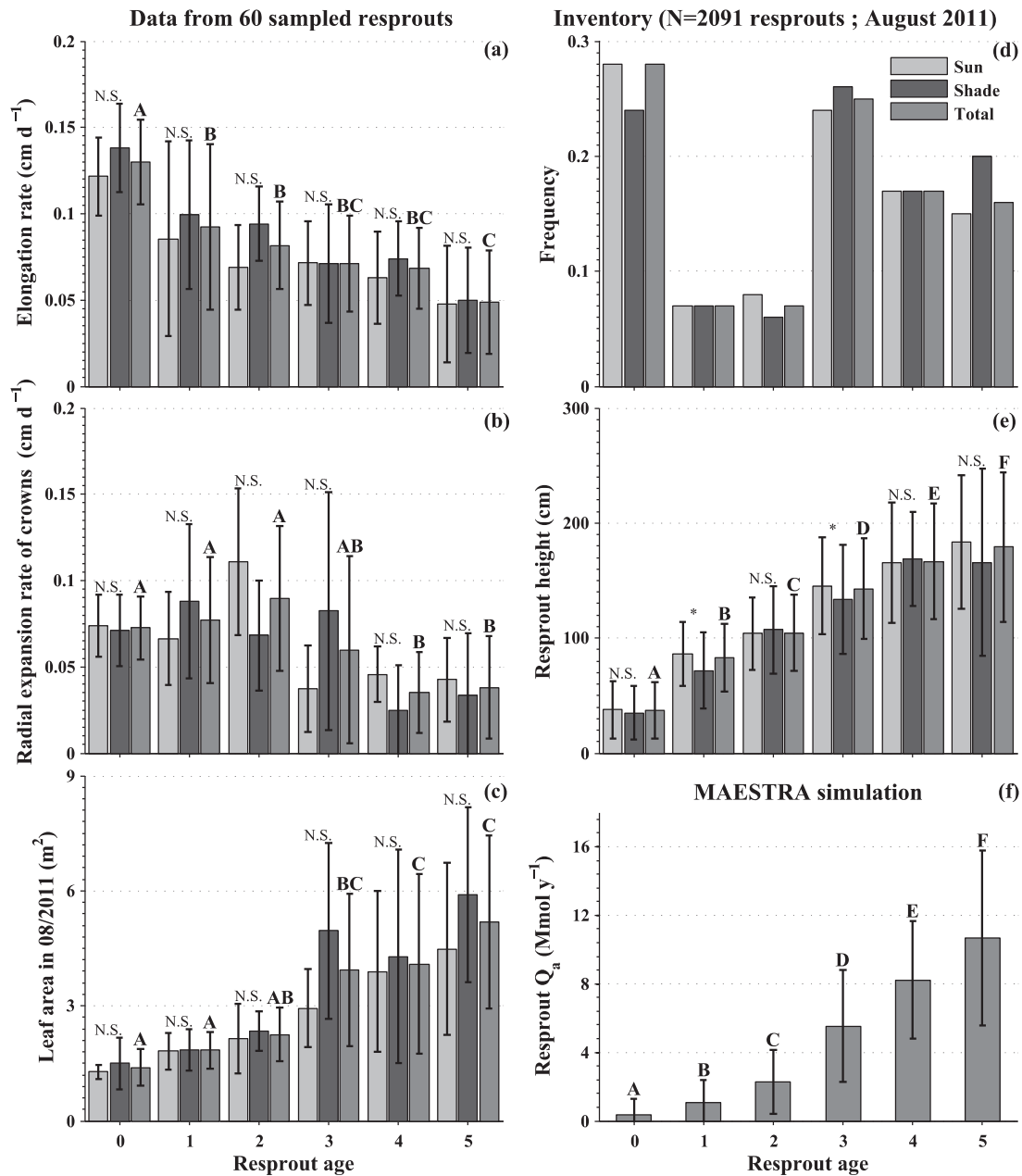

**Fig. 3.** Characteristics of resprouts according to their age and their shade environment (“shade” resprouts are located below the crown of shade trees). Elongation rates (a) and radial expansion rates of resprout crown (b) were calculated from a sample of 60 resprouts between 05/2011 and 04/2012. Mean leaf area (c) was calculated from the sampled resprouts in 08/2011 while  $LAI_{\text{cof}}$  was  $3.9 \text{ m}^2 \text{ m}^{-2}$  at the plot level. Resprout frequency (d) and heights (e) were measured during the 08/2011 inventory. Resprout  $Q_a$  (f) represents the simulated absorbed light by the resprouts during a year in the case of a plantation without shade tree. Error bars represent standard deviations. For each variable and each age class, we compared the means of sun and shade resprouts using a T-test for independent samples (N.S: non significant; \*;  $p < 0.005$ ). We compared the resprout frequency with a T-test for paired samples. There was no differences between sun and shaded resprouts so their values were averaged. For each variable and each age class, groups with statistically different values (represented by different letters) were defined using a LSD Fisher test ( $p < 0.05$ ).

resprouts were shaped as half-ellipsoids of dimensions  $H_{\text{can}}$  and  $R_{\text{can}}$ .

Shade tree growth was not considered during the simulated period.

### 2.3.3. LAI and its allocation to plants

Effective plant area index of coffee layer (PAI) in the plot was monitored monthly along 3 transects of a total length of 130 m (Fig. 1) with a plant canopy analyzer (PCA) LAI2000 (LI-COR, NE,

USA) and was converted into LAI ( $LAI_{\text{cof}}$ ) after a thorough field calibration including destructive sampling and an estimation of clumping (Taugourdeau et al., 2010).

A Normalized Difference Vegetation Index (NDVI) sensor (Pontailier and Hymus, 2003) was placed 25 m above the ground and directed toward the coffee layer with an angle of  $15^\circ$  from vertical and a view angle of  $45^\circ$ . NDVI data were acquired every 30 min on a CR1000 datalogger (Campbell Scientific). The signal was filtered at 30 min according to Soudani et al. (2012) and

the daily average was stored. Daily NDVI was interpolated and smoothed using a 5-day sliding average. We calibrated the relationship between LAI<sub>cof</sub> and 5-day average NDVI as follows:

$$LAI_{cof} = 23.98 * NDVI - 15.33; R^2 = 0.88; RRMSE = 0.07; N = 13(1)$$

Between May 2011 and April 2012, LAI<sub>cof</sub> ranged from 1.6 to 4 m<sup>2</sup> m<sup>-2</sup> (mean 3.4 m<sup>2</sup> m<sup>-2</sup>). NDVI allowed interpolating at least cost LAI<sub>cof</sub> between PCA measurements (Fig. 2c). Its fine temporal resolution captured the effect of pruning that was carried out over one day, March 16th 2012, and reduced LAI<sub>cof</sub> by 30% (Fig. 2c).

MAESTRA requires daily values of leaf area (LA) for each individual resprout. At the time of the August 2011 inventory, the leaf area of the sample resprouts ranged from 0.5 to 9 m<sup>2</sup>. It was significantly affected by resprout age and not by shade (Fig. 3c). We could not directly use leaf area from this dataset in MAESTRA because measurements were too distant in time (ca. 3 months). However, for each of the 60 resprouts sampled (see 2.3.2), LA was linearly correlated with the crown volume of the resprout (Cv) defined as a half-ellipsoid (R<sup>2</sup>=0.65, N=60, p < 0.0001). We used this property to estimate weekly values of leaf area density (LAD; m<sup>2</sup> m<sup>-3</sup>) by solving:

$$LAI_{cof} = \frac{\sum_{j=1}^N LAD \times Cv_j}{A_{PLOT}} \quad (2)$$

where *j* is the *j*th resprout of the virtual plot totaling up to *N* resprouts and A<sub>PLOT</sub> is the area planted with coffee in the virtual plot (m<sup>2</sup>). Mean LAD during the period was 1.71 ± 0.87 m<sup>2</sup> m<sup>-3</sup> (mean ± SD). *N* was diminished by 15% the day following the pruning.

PAI of three representatives *Erythrina* trees (PAI<sub>sh</sub>) was monitored every month from 2010 to 2012, using the isolated-tree protocol available in the FV-2200 software (v. 1.2) of the LAI2000. Transmittance measurements were performed below each tree crown at each date, using the 180° view cap with opening directed to the eastern sector, thus excluding the trunk. One or two of the rings with the highest zenith angles were discarded when the sensor viewed below the bottom of the crown according to a graphical representation. The eastern sides of crown vertical silhouettes were delineated on digital photographs (8 points per semi-crown). The crown volume and projected area were computed and used to convert Plant Area Density per solid angle (m<sup>2</sup> m<sup>-3</sup> crown) into Vertical Crown Projection Plant Area Index (V<sub>c</sub>PAI<sub>sh</sub>: m<sup>2</sup> m<sup>-2</sup> Vertical.Crown.Projection). When trees were defoliated, the V<sub>c</sub>PAI<sub>sh</sub> was only the contribution of non-green elements. V<sub>c</sub>PAI<sub>sh</sub> was further converted into PAI<sub>sh</sub> at the plot scale (Fig. 2c). Light interception by non leafy-elements was not negligible (Table 2), thus V<sub>c</sub>PAI<sub>sh</sub> was used since we were not interested in Q<sub>a</sub> for shade trees but rather in their total interception. Individual shade tree plant area was obtained multiplying V<sub>c</sub>PAI<sub>sh</sub> by shade tree vertical crown projection area (V<sub>c</sub>).

### 2.3.4. Leaf area density

In MAESTRA, leaves can be distributed in the crown according to vertical and horizontal normalized beta distributions functions (Ibrom et al., 2006; Wang et al., 1990). The equation is described in appendix 1. The 6 parameters of those 2 independent beta distributions were calibrated from measurements on the 60 sampled resprouts (see 2.3.2) during July 2012.

Each leaf position was measured relative to the crown base (vertical position) and to the main orthotropic axis (horizontal position). Leaf counts were converted into leaf area (A<sub>l</sub>) after deriving the leaf area of every 20th leaf from its length (L<sub>l</sub>) and width (W<sub>l</sub>)

assuming a constant shape among leaves (B. Rapidel, pers. comm.):

$$A_l = 0.748 \times W_l \times L_l (N = 189, R^2 = 0.98) \quad (3)$$

Leaf area, crown height and crown radius were then normalized. Beta functions were fitted to normalized leaf area density and relative crown height (and radius) data of each resprout according to equations provided in appendix 1. We found a large variability in the parameters of the beta distributions with no effect of the treatments (resprout age or shade environment). Thus, the horizontal (respectively vertical) beta distributions from individual resprouts were averaged. The leaf area density functions are characterized by more leaves on the outer and top regions of the crown due to the acropetal growth of coffee (Fig. 4). Horizontal leaf area density resulted in a power function because the last coefficient of the beta function approached 0 (parameters listed in Table 3).

For *Erythrina*, leaf area distribution was assumed to be homogeneous vertically and horizontally after a visual assessment.

### 2.3.5. Leaf angle distributions

MAESTRA uses a leaf angle distribution that can be either a discrete distribution or an ellipsoidal distribution (Wang and Jarvis, 1988). For coffee plants, leaf inclination angles (angle from horizontal) were measured on 6 resprouts (N=1900 leaves) with a digital protractor Vertex Laser (VL400, Haglöf, Sweden). The base of the protractor was set in parallel to the leaf main rib and the angle read. The measured mean tilt angle (MTA; leaf angle from vertical) was 45°, which is consistent with MTA derived from PCA measurements. For *Erythrina*, leaf inclination angles were recorded on one tree (n=400 leaves) from horizontal photographs taken from the eddy-covariance tower using the method described by Ryu et al. (2010) and Pisek et al. (2013) (Table 1). 16 photographs were shot from 4 to 16 m every 2 meters toward the outer part of the crowns and in holes in the crown with a 10.1 MP camera (Canon Eos 1000D with an EF-S 15–85 mm f/3.5–5.6 IS USM lens) set horizontally with a spirit level. The zoom was set to 85 mm to minimize lens distortion. Leaf inclination angles were measured using the angle tool in ImageJ freeware (<http://rsbweb.nih.gov/ij/>) on leaves only oriented parallel to the viewing point and viewed as a line.

Leaf angles from coffee plants and *Erythrina* were discretized into 9 elevation angle classes (from 0° to 90°) and fitted to a leaf angle beta distribution (Goel and Strebel, 1984, see Appendix 2 for equations and Table 1 for distribution parameters) to parameterize MAESTRA with a smoother discrete distribution. The distribution of leaves was plagiophile in coffee and planophile in *Erythrina*.

### 2.3.6. Leaf optical properties

A sensitivity analysis showed that Q<sub>a</sub> simulated by MAESTRA was affected only marginally (±2%) by variations in the optical properties of the leaves in their range of variation. Consequently optical properties of coffee leaves were obtained from literature rather than measured. Reflectance in PAR and NIR wavelength was spectrally-integrated from a reflectance spectrum provided by Foley et al. (2006) study. Transmittance in PAR was estimated using a generic equation developed by Bauerle et al. (2004) that relates leaf transmittance to SPAD values for many woody species. We measured SPAD values of leaves on 18 coffee plants with 200 leaves per coffee plant (SPAD value = 61 SD ±13). Coffee leaf reflectance in TIR and transmittance in NIR/TIR wavelengths as well as *Erythrina* reflectance and transmittance values were not found in the literature. Thus, we used default values for *Eucalyptus* provided with a MAESTRA example. Leaf optical parameters are provided in Table 3.

### 2.3.7. Shade tree trunks

Locally, transmitted Q may be affected by the presence of massive trunks (Table 2). MAESTRA does not account for the trunk

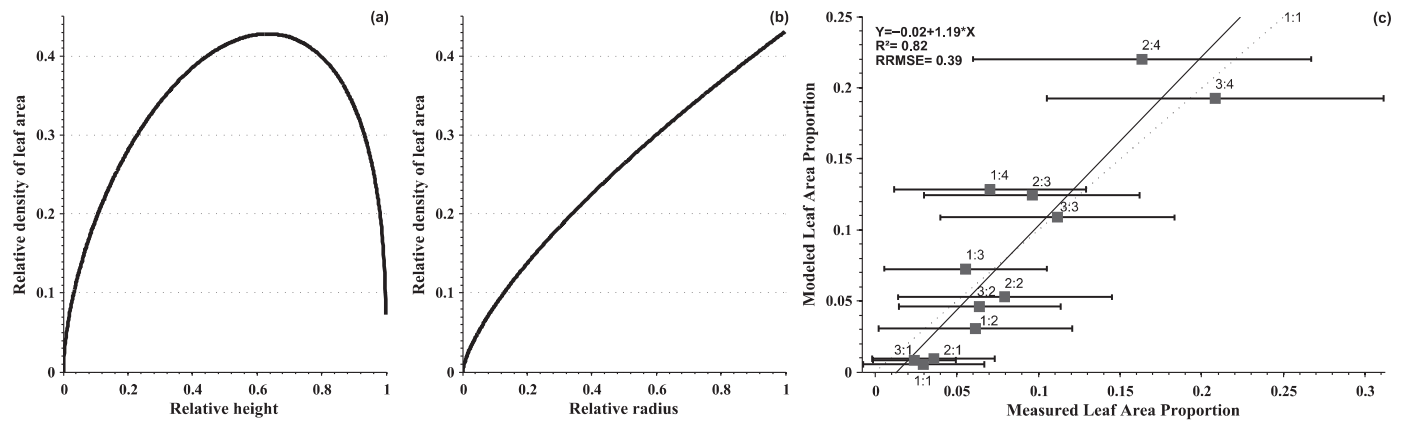

**Fig. 4.** Mean vertical (a) and horizontal (b) resprouts normalized leaf area density (line) following the beta distribution of Wang et al. (1990). Leaf area, resprout height and radius were normalized so that the sum of leaf area was 1, and crown height and radius were ranging between 0 and 1. To improve the nonlinear least squares minimization procedure, the fit was performed on leaf area distributed into the crown divided into 3 vertical (bottom:0 to top:1) and 4 horizontal sections (inside:0 to outside:1). The analyses were performed independently for the two distributions as described in appendix 1. (c) Comparison of measured and modeled leaf area proportion according to its position in the crown. The 1st number represents the vertical position and the 2nd number the horizontal position (e.g. “3:4” is the highest and outermost part of the resprout crown). Horizontal bars represent the standard deviation of measured leaf area proportion of 60 coffee resprouts. The solid line represents the linear regression between measured and modeled leaf area proportion.

**Table 2**  
Characteristics of the *Erythrina poeppigiana* trees.

		Mean ± SD
Measurements on 14 <i>Erythrina</i> of the 2.7 ha plot	Shade tree density ( $\text{ha}^{-1}$ )	5.2
	Tree height (m)	$28.7 \pm 0.52$
	Free Bole Height (m)	$3.7 \pm 1.15$
	DBH (m)	$0.9 \pm 0.06$
	Crown Height (m)	$15 \pm 1.5$
	Crown diameter (m)	$15 \pm 1.8$
	Drip Line Area ( $\text{m}^2$ )	$177 \pm 38$
Measurements on 3 <i>Erythrina</i>	Crown volume ( $\text{m}^3$ )	$2130 \pm 570$
	$V_c \text{PAI}_{sh}$ ( $\text{m}^2 \text{m}_{\text{vertical.crown.projection.area}}^{-2}$ )	$6.3 \pm 3.28$
	$V_c \text{PAI}_{sh, \text{defoliated}}$ ( $\text{m}_{\text{non.green}}^2 \text{m}_{\text{vertical.crown.projection.area}}^{-2}$ )	$2 \pm 0.2$
	Mean $\text{LA}_{sh}$ ( $\text{m}_{\text{leaf}}^2$ )	$914 \pm 50$

component, hence we chose to represent them in the model as cones. Since MAESTRA does not consider the scattered light between volumes, a large area of leaves was assigned to the trunk volume leading to a small amount of transmitted light that mimics the light reflected by trunks. Without this trick, totally opaque trunk would be considered as black objects in MAESTRA, hence leading to underestimation of incoming light in their vicinity (see 3.1.1).

#### 2.4. MAESTRA simulations and data treatment

The 2.7 ha virtual plot was simulated in MAESTRA. It comprised 14 shade trees and an inner area of 1.16 ha planted with coffee resprouts (Figs. 1 and 5). For the coffee layer, the area measured during the inventory was ca.10% of the total inner area. To cover the entire area, the inventory area was replicated 11.6 times (Fig. 1). The simulated coffee plantation represented 20 800 and 17 700 resprouts, before and after pruning, respectively. Changes in crown size and crown leaf area were provided as weekly inputs to the model. MAESTRA was parameterized using the parameters listed in Table 3.

We replicated the simulations on the whole plot to test for the effect of increasing shade tree densities from 0 to 29 trees  $\text{ha}^{-1}$ . The new shade tree locations were chosen to fill empty spaces (as it would probably be done if decided by the farmer).

We computed daily total  $Q_{a, \text{cof}}$  for each resprout of the plot during a complete year (May-11 to April-12).  $Q_a$  was partitioned by the model into diffuse and direct beam  $Q_a$ . Coffee plants located within the 8 m border were taken into account in the calculations to avoid edge effects, but their  $Q_a$  were not used in the analysis

(Fig. 1). The computation time for path-length and light attenuation calculations was too important to make computations on the full plot at once. One hundred subplots ( $101 \text{ m}^2$ ) plus their 8 m buffer zone overlapping the neighboring subplots were simulated separately in parallel on a computing cluster. All shade trees were present for each subplot simulation. After completion of the parallel calculations, the subplots results were joined together to recreate the full scene.

#### 2.5. Field measurements for the verification of light interception

##### 2.5.1. Local verification and calibration of the modeled trunk

The light interception module of MAESTRA was evaluated locally on individual coffee plants. As absorption by plants is difficult to measure, a comparison between simulated and measured light transmission below the canopy is the commonly used approach for model verifications (for examples see Table 5).

$Q$  was recorded during one day above and below 18 coffee plants successively (between 23rd February and 30th April 2012) located at various distances to shade trees and ranked either as “below shade tree crowns” or “open”.  $Q$  was measured with 8 inter-calibrated quantum sensors (Li-190, LI-COR and PAR/CBE 80, Solems, Palaiseau, France; one above and 7 below coffee plants) and half-hourly means were stored in a CR800 datalogger (Campbell Scientific). The sensors were all calibrated against a LI-190 quantum sensor recently calibrated by the manufacturer. Diffuse transmittance of shade trees ( $T_{sh,d}$ ) was calculated as the fraction of diffuse  $Q$  above coffee with respect to that at the top of the eddy-covariance tower recorded with a BF3 sensor ( $Q_{i,d} = Q_{if,d}$ ).  $T_{sh,d}$  was calculated

**Table 3**  
MAESTRA parameterization. Documentation on the parameterization of the light interception module is available at <http://bio.mq.edu.au/maestra/>.

Parameter name and definition	Species	Values										Source
lat: latitude		9°	56'	18"	N'							
long: longitude		83°	43'	43"	W'							
difsky: distribution of diffuse radiation incident from the sky vault		0 (Uniform sky)										
khspersday: number of timesteps per day		48 (every 0.5H)										
bearing: angle the x axis makes with south in clockwise direction (in degrees)		202.9										
xslope: slope in degrees in the x direction		-2.43										
yslope: slope in degrees in the y direction		3.64										
xmax: maximum distance in the x direction (xmin = 0)		165										
ymax: maximum distance in the Y direction (xmax = 0)		165										
rhosol: soil reflectance in PAR, NIR and thermal		0.18	0.25	0.05								Inceptisols Costa Rica in <a href="#">Franck (2005)</a>
atau: leaf transmittance in PAR, NIR and thermal	Coffee	0.036	0.43	0.01								PAR: Derived from <a href="#">Bauerle et al. (2004, fig. 4)</a> for a mean SPAD value of 61. NIR/TIR: default Default values provided with MAESTRA example for eucalyptus <i>Coffea arabica</i> in Costa Rica ( <a href="#">Foley et al., 2006, fig. 4</a> ). Spectrally-averaged values of leaf reflectance for PAR and NIR. TIR: default Default values provided with MAESTRA example for eucalyptus
	Erythrina + trunk	0.093	0.34	0.01								
arho: leaf reflectance in PAR, NIR and thermal	Coffee	0.05	0.55	0.05								
	Erythrina + trunk	0.082	0.49	0.05								
cshape: crown shape	Coffee + Erythrina	ELIP (half-ellipsoidal)										
	Trunk	CONE										
nalpha: number of leaf angle classes from 0 to 90 from horizontal	Coffee + Erythrina	9										
falpha: proportion of leaf area in each angle class.	Coffee	0.036	0.092	0.132	0.156	0.164	0.157	0.134	0.094	0.035		Measured with digital protractor
elp: leaf angle distributions function following ellipsoidal distribution	Erythrina	0.153	0.204	0.197	0.168	0.129	0.087	0.049	0.020	0.003		Measured following <a href="#">Ryu, et al. (2010)</a> default value
jleaf: leaf area distribution in the plant	Erythrina + Trunk	0 (Uniform distribution)										default value
	Coffee	2 (vertical and horizontal distribution)										Averaged from 60 sampled resprouts
bpt: beta dist. parameters for the vertical and horizontal leaf area density	Coffee	2.40	0.60	0.35	0.43	0.71	0					
random: intracrown clumping	Coffee + Erythrina + Trunk	1 (no clumping)										default value



**Table 4**  
Measured features of the 18 coffee plants used for local validation of the MAESTRA light interception module. Diffuse transmittance of the shade tree canopy ( $T_{sh,d}$ ) and of the system (shade tree + coffee canopy;  $T_{sys,d}$ ) was measured with quantum sensors during overcast conditions.

Coffee plant	Local position	Date of measurement	LAI <sub>conf</sub> <sup>1</sup> (m <sup>2</sup> m <sup>-2</sup> )	PAI <sub>sh</sub> <sup>1</sup> (m <sup>2</sup> m <sup>-2</sup> )	Dist. to closest shade tree trunk (m)	Coffee Crown height <sup>2</sup> (m)	Coffee Leaf area <sup>3</sup> (m <sup>2</sup> )	Coffee LAI <sup>4</sup> (m <sup>2</sup> m <sup>-2</sup> )	$T_{sh,d}$	$T_{sys,d}$	LAI neighbourhood <sup>5</sup> (m <sup>2</sup> m <sup>-2</sup> )
1	Open	23/02/12	2.9	0.58	19.9	1.69	8.24	4.70	1.00	0.10	0.46
2		29/02/12	2.9	0.63	16.6	1.04	3.32	2.37	0.90	0.26	0.75
3		02/03/12	2.9	0.64	16.8	1.60	3.26	2.15	1.00	0.09	0.96
4		20/03/12	2.5	0.73	19.0	0.87	2.93	4.05	0.86	0.47	0.71
5		21/03/12	1.6	0.73	20.6	1.37	2.72	3.37	0.81	0.17	0.66
6		22/03/12	1.6	0.73	21.3	1.46	4.01	2.53	0.91	0.27	0.57
		<b>Mean ± SD</b>	<b>2.7 ± 0.6</b>	<b>0.7 ± 0.06</b>	<b>19 ± 2</b>	<b>1.3 ± 0.3</b>	<b>4.1 ± 2.1</b>	<b>3.2 ± 1</b>	<b>0.9 ± 0.1</b>	<b>0.23 ± 0.1</b>	<b>0.7 ± 0.2</b>
7	Below shade tree crowns	23/03/12	1.6	0.73	8.6	0.87	2.24	2.56	0.77	0.29	0.88
8		27/03/12	1.6	0.74	4.4	1.79	3.66	3.51	0.45	0.14	0.40
9		29/03/12	1.6	0.76	8.6	0.79	2.11	3.42	0.65	0.18	1.29
10		30/03/12	1.6	0.76	4.2	0.97	2.16	1.89	0.52	0.14	0.59
11		11/04/12	2.0	0.96	9.0	2.30	18.42	7.67	0.53	0.10	0.82
12		13/04/12	2.0	1	3.9	2.47	15.84	3.97	0.39	0.03	1.04
13		18/04/12	2.4	1.12	7.0	2.45	15.62	4.64	0.16	0.16	0.83
14		20/04/12	2.5	1.17	3.5	2.10	8.19	3.85	0.48	0.14	1.30
15		22/04/12	2.6	1.22	7.5	2.00	8.84	2.89	0.33	0.08	1.59
16		25/04/12	2.5	1.28	3.8	2.20	13.87	4.01	0.22	0.08	0.84
17		26/04/12	2.4	1.31	4.2	2.30	10.04	3.72	0.24	0.06	1.29
18		28/04/12	2.4	1.35	6.0	2.63	10.18	4.10	0.24	0.08	0.33
		<b>Mean ± SD</b>	<b>2.2 ± 0.3</b>	<b>1 ± 0.2</b>	<b>6 ± 2</b>	<b>1.9 ± 0.7</b>	<b>9.3 ± 5.8</b>	<b>3.85 ± 1.4</b>	<b>0.4 ± 0.2</b>	<b>0.12 ± 0.07</b>	<b>0.9 ± 0.4</b>

<sup>1</sup> Plot scale values at the date of the measurement; <sup>2</sup> Maximum crown height for the tallest resprout; <sup>3</sup> Sum of leaf area of all the resprouts for a particular location; <sup>4</sup> Plant Leaf area divided by plant vertical crown projection area; <sup>5</sup> Area of 12.5 m<sup>2</sup> around the coffee of interest. LAI included spaces between plants and was estimated from allometry

**Table 5**  
Examples of verification techniques and predictions for different 3D light model from the literature.

Model	Reference	Crown representation	Parameterization of tree leaf area	Tree species	Variable measured for verification	Verification method	N	Measured T mean ± SD (min,max)	Regression equation between measured and modeled transmittance (x = measured)	R <sup>2</sup>	RRMSE	Rbias
MAESTRA	Our study <sup>1</sup>	Half ellipsoid	NDVI+ Site specific equations for coffee and PCA for shade trees	Coffee and Erythrina	Diffuse transmittance	Quantum Sensors above and below the coffee layer	36	0.36 ± 0.31 (0.05/0.92)	Y=0.93*X+0.03	0.88	30%	1.1%
MAESTRO	Wang & Jarvis (1990b) <sup>2</sup>	Cone	Site specific equations	<i>Picea sitchensis</i> and <i>Pinus radiata</i>	Total transmittance	Quantum sensors	33	0.11 ± 0.08 (0.01/0.32)	Y=0.71*X+0.03	0.69	38%	-4.7%
MAESTRA	le Maire et al. (2013) <sup>3</sup>	Half ellipsoid	Site specific equations	Eucalyptus/Acacia plantation	Diffuse transmittance	PCA in transects in different treatments	18	0.17 ± 0.06 (0.07/0.29)	Y=1.18*X-0.02	0.80	22%	5.8%
FOREST	Cescatti (1997a) <sup>4</sup>	Asymmetric	Site specific equations	<i>Picea abies</i> plantation	Diffuse transmittance	PCA along a transect of different canopy openness	200	0.37 ± 0.2 (0.08/0.77)	Y=1.09*X-0.04	0.96	12%	-1.2%
FORFLUX2	Bartelink (1998) <sup>5</sup>	Cone and half ellipsoid	Site specific equations	Douglas fir and beech plantation	Diffuse transmittance	Quantum sensors along transects. Measurements in overcast conditions	64	0.24 ± 0.3 (0.01/0.94)	Y=1*X+0.03	0.96	25%	12.4%
tRAYci	Brunner (1998) <sup>6</sup>	2 volumes joined at the max. crown spread	LAD adjusted during model calibration	Douglas fir monoculture	Diffuse transmittance	Hemispherical photographs under canopies.	58	0.37 ± 0.33 (0/1)	Y=0.97*X+0.02	0.93	24%	1.8%
OLTREE	Mariscal et al. (2000) <sup>7</sup>	Truncated ellipsoid	LAD derived from PCA	Olive orchard	Diffuse transmittance	PCA under and within canopy	22	0.48 ± 0.19 (0.15/0.9)	Y=0.98*X-0.01	0.95	9%	-4.6%
HiSafe	Talbot, 2011 <sup>8,12</sup>	Ellipsoid	Measured destructively when leaf fall	Walnut tree	Diffuse transmittance	Hemispherical photographs under canopies.	181	0.9 ± 0.08 (0.68/1)	Y=0.92*X+0.07	0.94	2%	0.1%
HedgeGro	Friday and Fownes, 2001 <sup>9</sup>	Long prisms representing rows	Site specific equations	Hedgerows shrub + maize	Total transmittance	Quantum sensors	179	0.47 ± 0.3 (0.02/0.98)	Y=0.86*X+0.06	0.95	13%	-1%
LUBI	Dauzat and Eroy (1997) <sup>10</sup> , Mialet-Serra et al., 2001 <sup>11</sup>	Individual organ representation	Measured destructively	<i>Cocos nucifera</i>	Total transmittance	Quantum sensors	11	0.33 ± 0.12 (0.13/0.48)	Y=0.92*X+0.01	0.94	10%	-4.9%

<sup>1</sup> Fig. 5a and b; <sup>2</sup> Tables 2 and 4; <sup>3</sup> Fig. 3; <sup>4</sup> Fig. 5; <sup>5</sup> Fig. 2; <sup>6</sup> Fig. 4; <sup>7</sup> Fig. 5; <sup>8</sup> Fig. 4; <sup>9</sup> Figs. 7 and 9; <sup>10</sup> Fig. 6; <sup>11</sup> Fig. 2.

<sup>12</sup> Predictions globally are excellent. However, in a tree by tree comparison, the errors could be important (T is overestimated up to 49% for a particular tree). Low values of RRMSE are explained by the low variability in T

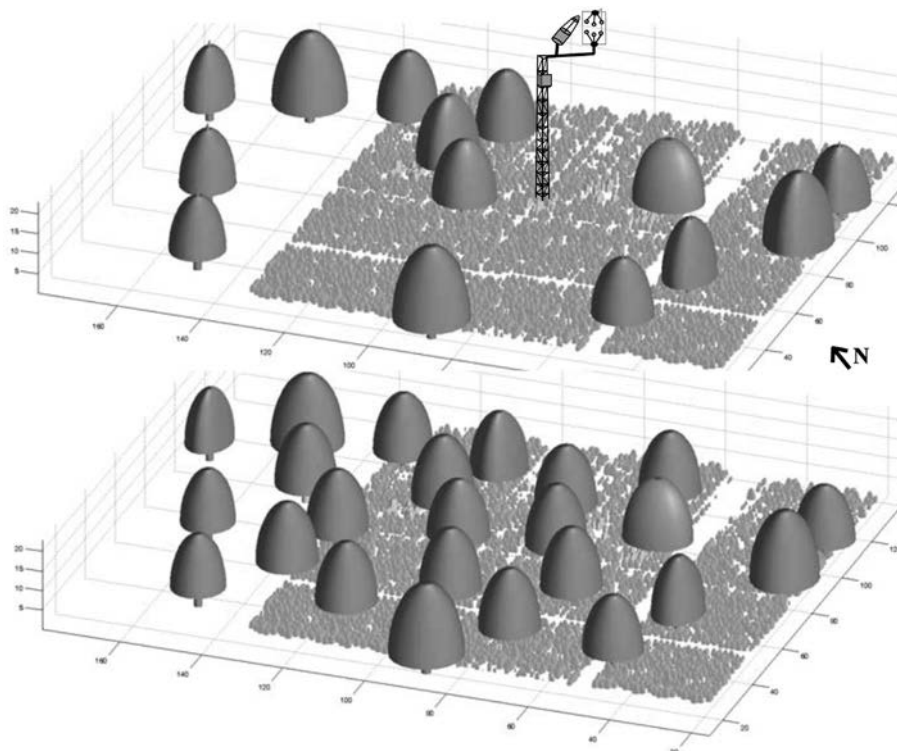

**Fig. 5.** Virtual plots in MAESTRA (inner coffee plot 1.3 ha including pathways), with Erythrina trees in dark gray and coffee plants in light gray. In lighter gray: 18 coffee plants and their close neighbors used for the local verification of the light interception module. The above and below plots represent i) the actual plot (9% cover by trees in the inner plot) and ii) a doubled shade tree density (19% tree cover). Virtual plots were represented using Matlab 2012. The position of the eddy-covariance tower is shown in the top figure only.

only under diffuse conditions with a threshold of  $f_d > 0.6$ . The stability of  $T_{sh,d}$  under diffuse conditions was checked graphically (no spikes). Diffuse transmittance through the 2 layers of AFS ( $T_{sys,d}$ ) was calculated the same way after averaging  $Q$  values from the 7 sensors positioned systematically below the north-west half of the coffee plant crown. In the MAESTRA virtual plot, the position and size of the 18 plants and their closest neighbors (radius  $< 3$  m; in average 10 plants) were described precisely (Table 4). Leaf area of the 18 plants was measured non-destructively as described earlier.

$T_{sh,d}$  and  $T_{sys,d}$  were simulated in MAESTRA with data from the same day than field measurements. A single value of diffuse transmittance was simulated per day because it depends only on leaf area whereas the other structural parameters (leaf angles and distribution in the crown) remain constant.  $T_d$  was simulated for 1 point just above the coffee crown while it was averaged from 10 points ( $1\text{m}^2$ ) below the coffee crown.

$T_{sh,d}$  values were used to find an optimal “leaf area” to fill the trunk module in MAESTRA so that it could mimic the light reflected on the trunk surface. Trunk “leaf area” was calibrated by minimizing the relative root mean squared error (RRMSE) of the relation between simulated and measured  $T_{sh,d}$  for all 18 plants.

### 2.5.2. Verification at plot scale

Verification of angular  $T_d$  reaching a target point from different zenith angles allows testing MAESTRA and its parameterization in terms of leaf area distribution, leaf angle distribution, and also canopy openness.

Diffuse transmittance of the coffee layer was measured monthly between 04/2011 and 03/2012 with PCA LAI2000 along 3 transects (Fig. 1). Diffuse transmittances for 3 zenith angles ( $7^\circ$ ,  $23^\circ$  and  $38^\circ$ ) were averaged using Lang and Xiang (1986) approach.

We simulated diffuse transmittance of the coffee layer for the same 3 angles in the same 3 transects as described by le Maire et al.

(2013). The comparisons were made for 5 contrasting seasons in terms of LAI and canopy openness.

### 2.6. Statistical analysis

Differences among treatments (resprout age classes and shade environment) were assessed using the InfoStat software (Di Rienzo et al., 2011) with split-plot two-way ANOVA (shade effect in the main plot) after checking for data normality (Shapiro-Wilks test) and homoscedasticity. When significant differences were detected among treatments ( $p < 0.05$ ), the latter were compared using Fisher's Least Significant Difference test (Fisher's LSD).

RRMSE and relative bias (Rbias) were used to compare model predictions to observations (Wallach, 2006). Rbias was calculated as follow:

$$Rbias = \frac{\hat{Y} - \bar{Y}}{\bar{Y}} \quad (4)$$

where  $\bar{Y}$  and  $\hat{Y}$  are the mean measured and modeled values, respectively.

## 3. Results

### 3.1. Verification of the MAESTRA light interception module

#### 3.1.1. Suitability of the trunk module

Introducing a trunk module filled with leaves into MAESTRA to mimic a shade tree trunk did not improve significantly the prediction of diffuse transmittance of the shade tree layer. The prediction was slightly improved only for the area below shade trees with a virtual trunk filled with  $600\text{m}^2$  leaves as compared to a situation without any trunk at all. Nevertheless, the decrease in RRMSE was only 0.1%. It is likely that shade tree trunk affects direct more than

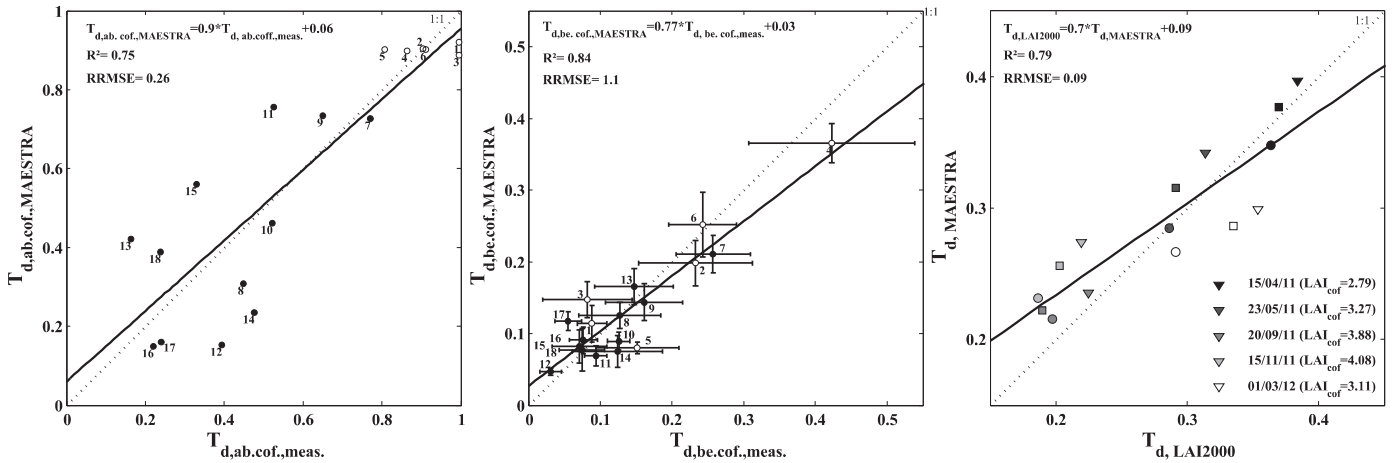

**Fig. 6.** Predicted versus measured diffuse transmittance: (a) of the shade tree canopy and (b) of the system (shade tree + coffee canopy) at the location of 18 coffee plants selected in different shading conditions. Labels from 1 to 6 are coffee plants in the open (open circles) and from 7 to 18 are coffee plants under shade tree crowns (filled circles), according to Table 4. For each coffee plant, diffuse transmittance was measured using 1 and 7 quantum sensors above and below their crowns respectively under diffuse light conditions during 1 day for each coffee plant. Horizontal bars in b) represent the standard deviation of the measured transmittance below the resprout crown. The regression equation removing coffee 4 is  $y = 0.72x + 0.02$ . (c) represents measured and simulated angular diffuse transmittance obtained during 5 LAI2000 campaigns (average of the 3 transects shown in Fig. 1) distributed along the year. Triangles, squares and circles represent the 7°, 23° and 38° zenith angles of PCA LAI2000, respectively. The highest zenith angles were discarded due to interception by the sloped terrain. All regressions are statistically significant ( $p < 0.0001$ ) with intercept not significantly different from 0 ( $p > 0.05$ ). No standard deviation bars are shown neither in a) (only one transmittance value) nor in c) (high plot variability, especially due to row/inter-row differences).

diffuse transmittance (shadowing effect), and could play a more important role during the defoliated period. Therefore, we retained this “leaf area” value. For a sunny day with 25% diffuse irradiance, the virtual trunk reduced the daily light reaching a point at a 2 m distance West (or East) of the trunk by 30%. For diffuse light only, the effect was rather small, except close to the trunk where it reduced the irradiance of the closest coffee plants by 7%. This reduction is of the order of magnitude expected for trunk reflectance (ca. 0.3 in PAR).

### 3.1.2. Verification of local simulations

Diffuse transmittance through the shade tree layer ranged from 0.8 and 1 in the open areas and from 0.16 to 0.77 below shade tree crown (Table 4). The slope of the predictions was close to ideal despite a significant residual variability (RRMSE = 26%, Fig. 6a). The predictions were more accurate in the open areas than below the crowns (RRMSE = 1.3% and 44% respectively) with very little bias (Rbias = -2% and 1% respectively). The local diffuse transmittance below crowns was tightly correlated with the actual distance to the shade tree trunk ( $R^2 = 0.86$ ;  $p < 0.001$ ). This effect was less visible with measured values ( $R^2 = 0.31$ ;  $p < 0.062$ ). This discrepancy is probably due to the fact that shade tree crowns are irregular while MAESTRA assumes uniform crowns. Modeled and measured values of diffuse transmittance below the crown of shade trees were negatively correlated with  $PAI_{sh}$  (Spearman correlation coefficient was -0.51 and -0.77, respectively).

Diffuse transmittance below the coffee canopy ranged from 0.03 to 0.43 (mean = 0.14 SD ± 0.09; Table 4). It was satisfactorily simulated (RRMSE = 23%; Fig. 6b) even though the model tended to slightly underestimate values in the higher range. RRMSE was independent of whether the coffee plants grew below shade tree crowns or not, while the relative biases were -4% and -5% respectively. Individually, prediction errors ranged from -50% to +55% irrespective the position of the coffee plants.

### 3.1.3. Verification of predictions at plot level

The changes in diffuse transmittance below coffee at different LAI<sub>cof</sub> and canopy development stages were satisfactorily represented ( $R^2 = 0.79$ ; RRMSE = 9%) for different zenith angles (Fig. 6c). This indicates an accurate parameterization of the plot, in terms of

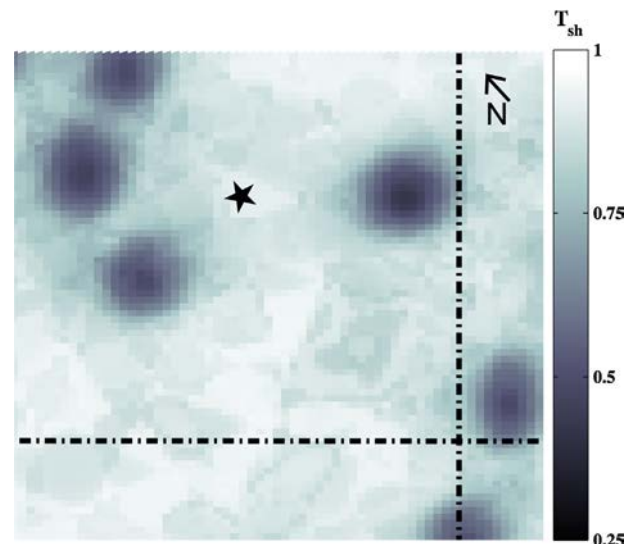

**Fig. 7.** Horizontal map of the yearly-averaged fraction of total transmitted  $Q$  below the shade trees ( $T_{sh}$ ). The map represents the 1.16 ha inner plot. Each pixel covers an area of 1.59 m<sup>2</sup>. The gray scale represents  $T_{sh}$  values. The black star represents the eddy-covariance tower. Dashed lines represent the pathways.

leaf area and angle distribution together with seasonal variations of clumping. Rbias at 7°, 23° and 38° were 3%, 5% and 2%, respectively. There was a small divergence for the last 2 dates (15/11/11 and 01/03/12) but no bias. However, we were not able to compare estimates point by point in the transects due to uncertainties in the spatial positions of the latter.

## 3.2. $Q_n$ budgets and heterogeneity

### 3.2.1. Spatial heterogeneity of light transmitted by the shade trees

At the plot scale and on an annual basis, the total transmittance below shade trees was on average 86% (SD = 16%; Fig. 7) with a 9% tree cover and a  $PAI_{sh}$  of 0.56 m<sup>2</sup> m<sup>-2</sup>. In the actual plot, 77% of the area planted with coffee received over 80% of  $Q_i$ .

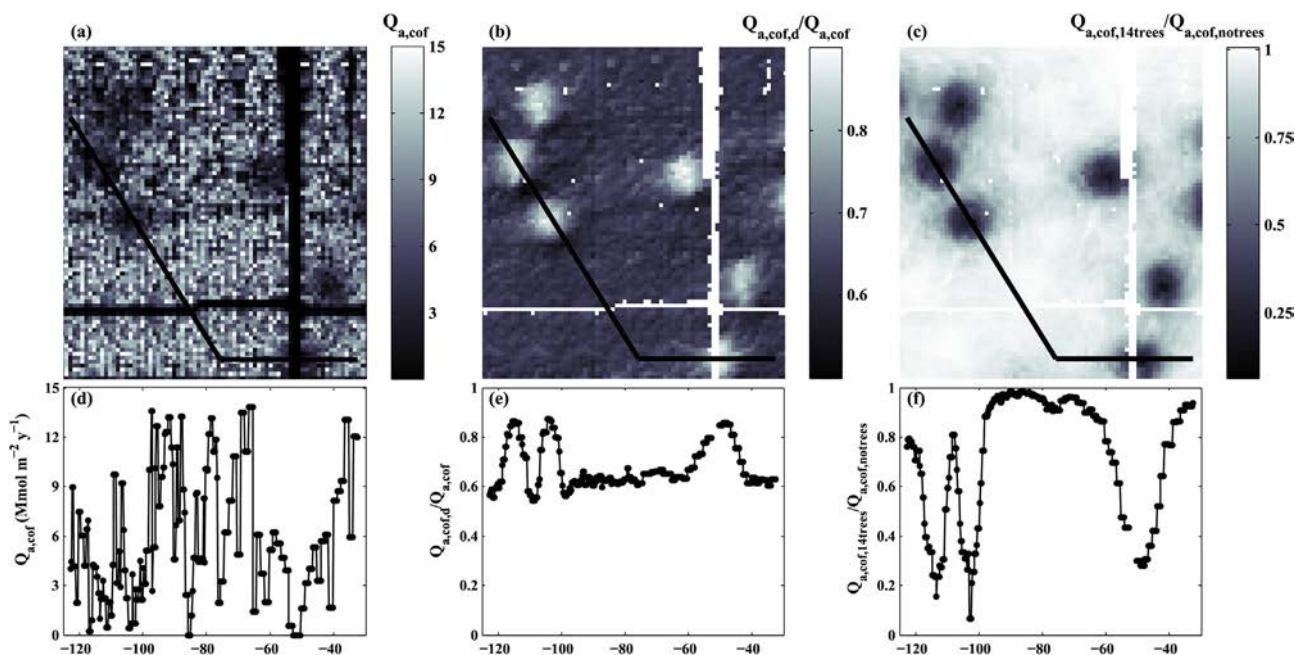

**Fig. 8.** Total  $Q$  absorbed by individual coffee plants in the plot and values obtained along the transect drawn across the plot (a & d), fraction of diffuse irradiance absorbed by coffee plants to total absorbed irradiance ( $Q_{a,cof,d}/Q_{a,cof}$ ; b & e) and ratio of the yearly  $Q_{a,cof}$  in the actual plantation to  $Q_{a,cof}$  in a virtual plantation without shade trees ( $Q_{a,cof,14trees}/Q_{a,cof,notrees}$ , i.e. shading effect; c & f). The gray scales represent the values in the maps. For the sake of visibility, the maps were divided into pixels of a  $1.59\text{ m}^2$  area (area per coffee plant at the initial planting density of  $6300\text{ ha}^{-1}$ ) where  $Q_a$  values of the resprouts located in the same pixel were summed and divided by the pixel surface. The pathways are displayed in black (a) and white (b & c). White isolated pixels in the maps (b) and (c) represent areas without coffees. In the plot (b), values close to 0 correspond to the pathways or to pixels located at the position of a shade tree trunk.

### 3.2.2. Spatial heterogeneity of coffee $Q_a$ in the actual plantation

The total  $Q_a$  absorbed by coffee resprouts varied from  $0.02$  to  $39\text{ Mmol y}^{-1}$  (mean  $4.2 \pm 4.3\text{ Mmol y}^{-1}$ ) for a mean yearly  $\text{LAI}_{cof}$  of  $3.4\text{ m}^2\text{ m}^{-2}$ . Tree-scale results were aggregated to a  $1.59\text{ m}^2$  squared grid for visual representation as maps (Fig. 8 a, b & c). This aggregation scale was chosen because it represents the average area covered by an individual coffee location. Therefore, the large variability at the grid level originates from: i) irregularities in the coffee planting arrangement and eventual coffee mortality; ii) the number of resprouts and their size; iii) competition for light within the coffee layer itself; and iv) the presence of shade trees. In areas without shade trees,  $Q_{a,cof}$  varied from  $2$  to  $14\text{ Mmol m}_{ground}^{-2}\text{ y}^{-1}$  while it reached a maximum of  $9\text{ Mmol m}_{ground}^{-2}\text{ y}^{-1}$  below tree crowns (Fig. 8a and d).

Diffuse-to-total  $Q_{a,cof}$  was  $64\%$  on average, and significantly higher under shade tree crowns ( $\approx 80\%$ ) than in open areas ( $\approx 60\%$ ). In open areas, it was very stable (Fig. 8 b & e). The areas with strong influence of shade trees on diffuse-to-total  $Q_{a,cof}$  corresponded approximately to the projection of shade tree crowns.

In the actual plot (14 trees), the shading effect ( $Q_{a,cof,14trees}/Q_{a,cof,notrees}$ ) was  $14\%$  on average (Fig. 8 c & f). Under the shade trees, it ranged from  $40$  to  $75\%$ . Areas that were not (shading effect  $< 2\%$ ), moderately ( $2\% < \text{shading effect} < 20\%$ ) or highly (shading effect  $> 20\%$ ) influenced by the presence of shade trees represented  $9\%$ ,  $68\%$  and  $23\%$  of the plot area, respectively.

### 3.2.3. Seasonal variations of $Q_a$

Mean monthly  $Q_a$  of shade trees ranged from  $3.1$  to  $4.6\text{ mol m}_{ground}^{-2}\text{ day}^{-1}$  representing between  $15\%$  and  $24\%$  of total  $Q_a$  (mean  $18\%$ ). Absorption by leaves represented on average  $75\%$  of shade tree absorption (ranged from  $0$  (defoliated trees) to  $95\%$  (data not shown)).

Mean monthly  $Q_a$  of the coffee layer ranged from  $13$  to  $22\text{ mol m}_{ground}^{-2}\text{ day}^{-1}$  and paralleled the variations of  $Q_i$  (Fig. 2b).

The fraction of diffuse light in the  $Q_a$  was linearly related to that in the  $Q_i$  (slope =  $0.87$ ).

The daily fraction of  $Q_i$  absorbed by the coffee canopy ( $fQ_{a,cof}$ ) ranged from  $38\%$  to  $60\%$  (mean  $53\% \pm 3\%$ ). It was sensitive to the variations of  $\text{LAI}_{cof}$ , resulting in a  $25\%$  reduction after pruning ( $\text{LAI}_{cof}$  reduced by  $30\%$ ; Fig. 2c and d).  $fQ_{a,cof}$  was also sensitive to variations in  $\text{LAI}$  of shade trees. For example, from December 1st 2011 to February 1st 2012,  $fQ_{a,cof}$  decreased only slightly while  $\text{LAI}_{cof}$  and  $\text{LAI}_{sh}$  were both decreasing: the increase in available  $Q$  for the coffee layer almost compensated the decrease of  $\text{LAI}_{cof}$ . The loss of  $Q_a$  for the coffee layer due to shade trees did not vary much over the year from  $13\%$  when the shade trees were completely defoliated, to  $17\%$  (Fig. 2 d).

### 3.3. Prospective evaluation of light availability in AFS

Possible applications of MAESTRA in the field of agroforestry are numerous. Here, we propose an example to extrapolate the reduction of  $Q_{a,cof}$  at plot scale due to increasing shade tree density and  $\text{LAI}$ . We incrementally increased shade tree density from  $0$  to  $29\text{ trees ha}^{-1}$  ( $0$  to  $50\%$  tree cover;  $\text{PAL}_{sh}$  from  $0$  to  $3.2\text{ m}^2\text{ m}^{-2}$ ) and simulated plot-level  $Q_{a,cof}$  during a year. This range was chosen according to actual conditions prevailing in AFS (Bellow and Nair, 2003). After each simulation, we extracted total, direct beam and diffuse  $Q_a$ . The diminution of  $Q_{a,cof}$  was related to  $\text{PAL}_{sh}$  after fitting negative exponential functions (Fig. 9).  $fQ_a$  and  $Q_a$  decreased by a factor  $3.1$  between a full sun plantation and one with a shade tree cover of  $50\%$ . Those relationships displayed an extinction coefficient ( $k$ ) of  $-0.34$  (Fig. 9 a & b). The diffuse-to-total  $Q_a$  ratio increased only slightly with increasing shade tree density (Fig. 9 c).

We simulated coffee plantation  $fQ_a$  at constant  $\text{LAI}_{cof}$  and  $\text{LAI}_{sh}$  for contrasting days (September 2011) in terms of percentage of diffuse radiation and for different shade tree densities. On a daily basis, we found no significant change of  $Q_{a,cof}$  with the fraction of diffuse radiation whatever the shade tree density (data not shown).

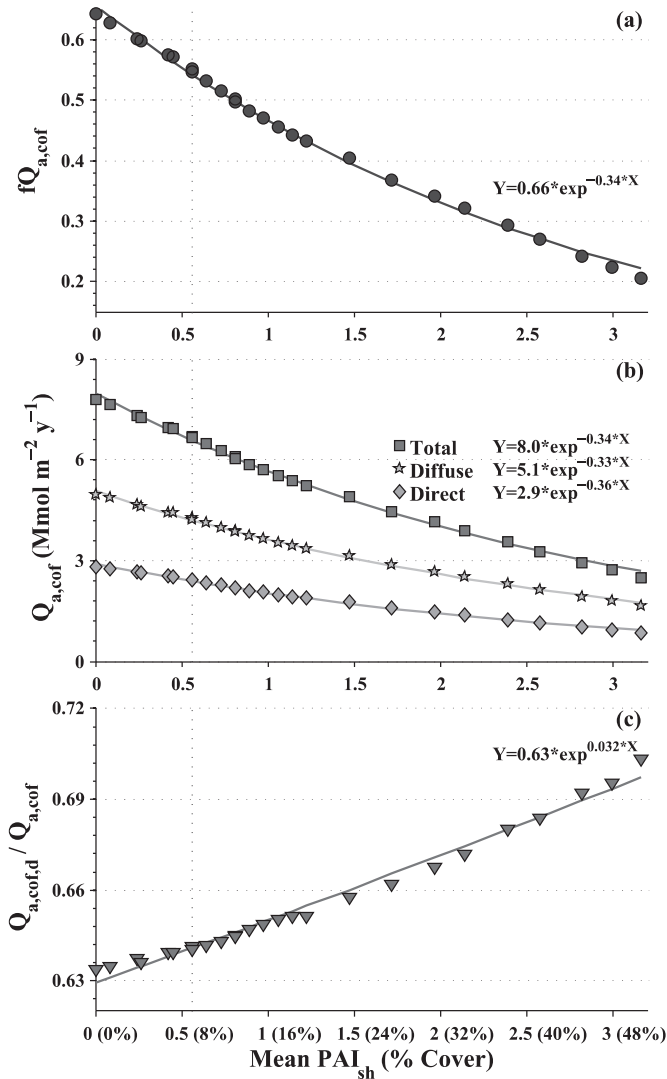
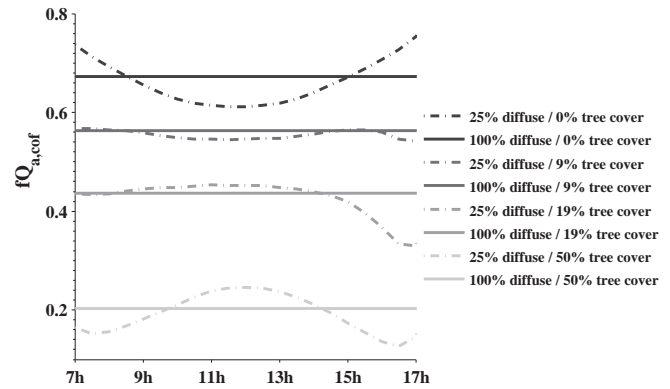

**Fig. 9.** MAESTRA simulations of plot yearly (a)  $Q_{a,cof}$  for the coffee layer normalized by  $Q_i$  ( $fQ_{a,cof}$ ); (b) total, diffuse and direct  $Q_{a,cof}$ ; (c) diffuse-to-total  $Q_a$  ( $Q_{a,cof,d}/Q_{a,cof}$ ) as a function of mean  $PAI_{sh}$  and shade tree cover. X-axis represent averaged values of shade trees  $PAI_{sh}$  between 01/05/2011 to 30/04/2012.  $PAI_{sh}$  ranged from 0 to 3.2 m<sup>2</sup> m<sup>-2</sup> corresponding to a shade tree cover ranging from 0 to 50% while mean yearly coffee LAI was 3.4 m<sup>2</sup> m<sup>-2</sup>. Displayed equations were calculated from  $PAI_{sh}$  values. In the simulation, pathways represented 5.6% of plot area. The vertical dotted line represents the actual shade tree density.

We further investigated the diurnal time course of  $fQ_{a,cof}$  comparing an overcast day (100% diffuse radiation) and a sunny day (25% diffuse radiation) for 4 shade tree densities (0, 5, 11 and 29 tree ha<sup>-1</sup>). In order to disentangle the effect of plantation slope on the time-course of  $fQ_{a,cof}$ , we ran a simulation without slope (Fig. 10). While  $fQ_a$  remained constant over the overcast day for all shade tree densities, it varied by more than 25% during a sunny day. During a sunny day,  $fQ_{a,cof}$  was higher in the early morning and late afternoon for the plantation with no shade trees. An increased shade tree density gradually reversed the time course of  $fQ_{a,cof}$  that was more important at noon than in early morning and late afternoon.

#### 4. Discussion

Light is involved in most of plant physiological processes such as photosynthesis, transpiration and morphogenesis (Sinoquet et al., 2000). The effect of a reduction of irradiance in a coffee AFS can be either beneficial (e.g. improved coffee quality, diminution of water stress, increased light use efficiency) or prejudicial (e.g. diminution



**Fig. 10.** Simulated time course of the fraction of plot  $Q_{a,cof}$  for 2 contrasting days in terms of percentage of diffuse radiation at constant coffee LAI and shade tree PAI. The simulations were run for 4 different shade tree covers: 0, 9%, 19% and 50% corresponding to  $PAI_{sh}$  of 0, 0.56, 1.22 and 3.2 m<sup>2</sup> m<sup>-2</sup>.

of productivity). Simulating satisfactorily the interactive effects of shade trees and coffee on absorbed light is thus a prerequisite to an enhanced comprehension of the interactions (carbon, water and heat fluxes, impact of diseases, etc.) in spatially complex agrosystems.

#### 4.1. Modeling light interception in AFS from plant to plot

To confirm the correct behavior of MAESTRA parameterized for an AFS, we compared its goodness of fit (slope and intercept,  $R^2$ , RRMSE and Rbias) to data gathered from publications using 3D light models (Table 5). As a first remark, those models were all applied to one-layered systems (forests or fruit orchards), never to our knowledge to two or multi-layered systems. Those 3D models display a wide range of refinement. Generally, the time resolution is half-hourly or hourly except for the model by Talbot and Dupraz (2012) with a daily resolution. Model predictions were either validated against total transmitted light using quantum sensors or diffuse transmitted light using hemispherical photographs, plant canopy analyzer or quantum sensors.

Compared to other model predictions (Table 5), the residual biases as well as the residual dispersion ( $R^2 \geq 0.75$ , RRMSE < 0.26) between modeled and measured transmittance suggest that MAESTRA could be successfully used to simulate light budgets in a heterogeneous 2-layer AFS given the set of parameters that we used. MAESTRA predictions in our experimental set up were slightly more accurate than MAESTRA prediction in monospecific forest stands (measuring total transmittance; Wang and Jarvis, 1990b) and comparable to predictions in mixed eucalyptus/acacia (le Maire et al., 2013)(Table 5). We found only these 2 studies where MAESTRA was tested for light transmission.

We believe that some of the residual discrepancies are due to (i) errors during the verification phase in the field; (ii) the accuracy of the parameters and variables that we used in the model; and (iii) assumptions of the MAESTRA model itself (simplification of crown geometry in particular). Those sources of divergences are difficult to disentangle.

Authors developed 3D models with a wide range of complexity in the crown representation: explicit leaf representation (Dauzat and Eroy, 1997), asymmetric crowns considered as a turbid medium (Cescatti, 1997a; Cescatti, 1997b) simplified crown shapes (Bartelink, 1998; Mariscal et al., 2000; Talbot and Dupraz, 2012), crop rows represented as prisms (Friday and Fownes, 2001). The more refined the models of light interception, the better the prediction should be. However, the performance in light transmission does not systematically match model complexity (Table 5).

According to Kobayashi et al. (2012), this highlights the critical issues of model verification strategies (field techniques and sampling). For example, the 3D architectural model of Dauzat and Eroy (1997) used exact organ representations but did not yield the best predictions mainly due to an inexpediency between a highly precise model and insufficient sampling strategy. To better match the model prediction, field sensors should be able to capture the maximum of light variability such as sensors mounted on rail track (Kobayashi et al., 2012).

Most of the models in Table 5 assume a homogeneous leaf area density in the crowns (Bartelink, 1998; Friday and Fownes, 2001; Talbot and Dupraz, 2012), Cescatti (1997a,b) used a simple vertical beta distribution function, others chose a discrete allocation of leaf area into crown voxels (Brunner, 1998; Mariscal et al., 2000). In our study, we used a vertical and horizontal leaf area density distribution for the coffee plants and a homogeneous leaf area density in shade tree crowns. Indeed, field techniques to estimate distributions of leaf area in the crown of tall (and thorny) trees are rather difficult to conduct. This simplification could have led to some of the observed discrepancies. Using MAESTRO/MAESTRA, Wang and Jarvis (1990b) showed that  $Q_a$  was higher when assuming a uniform leaf area density distribution instead of a non uniform distribution, this difference becoming non significant with LAI above  $6 \text{ m}^2 \text{ m}^{-2}$ . This phenomenon is therefore expected to be more important in closed canopies (Ibrom et al., 2006). In the present study, shade tree  $V_c \text{PAI}$  was above  $6 \text{ m}^2 \text{ m}^{-2}$  during 70% of the year. Consequently, we argue that errors due to a misrepresentation of leaf area distribution within the shade tree crown would lead only to marginal errors in transmittance predictions.

Except for Dauzat and Eroy (1997) model, none of the reviewed models account for multiple scattering between two different plants. Intra and inter-crown scattering represents around 6% of  $Q_a$  when simulated by a sun-shade and 3D-architectural model in a one layer coconut plantation (Roupsard et al., 2008). In the case of multi-layer heterogeneous canopies, multiple scattering between the 2 layers could represent slightly higher values. In the present study where the shade trees cover 9% of the plantation, the scattering between layers was expected to remain small. The multiple scattering between coffee crowns is expected to remain small as the reflectance and transmittance of coffee leaves for  $Q$  is around 0.05 and 0.036, respectively (Table 3).

Collecting field inventory data is always a time-consuming step in virtual plot parameterization, especially in high density plantations. Such inventories allow high precision measurements, yet on a necessarily limited scale. We considered that an extensive inventory of a representative area of the plot (0.1 ha; 2090 resprouts; 150 working hours) was a necessary effort to accurately parameterize the model. This approach proved to be reasonable though it should be noted that more efficient approaches exist such as the use of LiDAR or very high resolution digital imagery for parameterizing larger plots. For example, Kobayashi et al. (2012) described individual tree structure (crown height and diameter) and their spatial arrangement within a 3.6 ha savannah plot for their plot parameterization using a first/last return airborne LiDAR. These authors reported an accuracy of 1–2 m with their LiDAR dataset. Nevertheless in our experimental setup, such an accuracy would have led to an inappropriate representation of coffee crown dimensions. Waveform airborne LiDAR can reach an accuracy of 25–30 cm. However, the techniques to reconstruct 3D canopies from airborne LiDAR returns are still under development (Tang et al., 2013) and have never been tested for high density plantations such as coffee. It is likely that combining terrestrial LiDAR observations of plants (e.g. Clawges et al., 2007; Moorthy et al., 2011) with airborne LiDAR will be useful to parameterize models in the near future, particularly for short-stature canopies (Vierling et al., 2012).

#### 4.2. Insights about spatial and temporal heterogeneity in agro-forestry systems

Using MAESTRA, we confirmed that the presence of sparse and large shade trees created a strong spatial heterogeneity in the transmitted light to coffee plants and not just below the shade tree crowns as assumed by shade/non-shade models (Van Noordwijk and Lusiana, 1998; Van Oijen et al., 2010). While the tree cover of the plot area was 9%, 23% of the plot area experienced a transmittance reduction above 20%.

We simulated a coffee plantation without shade trees to study the competition for light in the coffee layer alone. The extinction coefficient ( $k$ ) of the coffee layer was 0.43. A mean annually  $\text{LAI}_{\text{cof}}$  of  $3.4 \text{ m}^2 \text{ m}^{-2}$  resulted in an absorption of 65% of the incident  $Q$ . Due to the uneven-aged nature of the plantation, intra-specific competition between resprouts led to strong variability in  $Q_{a,\text{cof}}$ . At the resprout level, yearly  $Q_a$  was  $2.9 \pm 1.4 \text{ Mmol m}_{\text{leaves}}^{-2} \text{ y}^{-1}$  (average  $\pm$  SD). A simple linear regression showed that crown volume ( $Cv$ ; linearly correlated with leaf area), explained 81% of the variability in resprouts  $Q_a$ , indicating that 19% of the variation was explained by intraspecific and intra-plant competition. In order to further improve this first approximation, we introduced the neighborhood crowding index (NCI) as proposed by Takahashi (1996), allowing us to take into account the competition around each resprout. The original NCI was slightly modified into:

$$\text{NCI} = \sum_{k=1}^N Cv_k / d^2 \quad (5)$$

where  $Cv_k$  is the crown volume of the  $k$ th resprout located at a distance  $d$  from the resprout of interest of crown volume  $Cv$ . After testing multiple models, we considered keeping only  $Cv_k$  given  $Cv_k \geq Cv$  and  $d \leq 2 \text{ m}$ . NCI varied from 0 to 800 and showed a negative exponential relationship with resprout  $Q_a$ , hence we introduced a logarithm term. The final model describing the yearly  $Q_a$  ( $\text{Mmol y}^{-1}$ ) of the resprout was:

$$\begin{aligned} \text{Resprout } Q_a &= 4.08 * Cv - 0.005 * \ln(\text{NCI}) + 0.12; \\ R^2 &= 0.91; N = 15657 \end{aligned} \quad (6)$$

Resprout  $Q_a$  in the shaded plot can be obtained multiplying resprout  $Q_a$  (equation 6) by the fraction of transmitted light by the shade tree layer according to its position on the map (Fig. 7). This equation is proposed as a simple proxy to simulate resprout  $Q_a$  in every other situation where only an inventory can be performed, with a resolution compatible at the plant or resprout scale.

Looking at seasonal variations, we noticed that  $fQ_{a,\text{cof}}$  saturated when  $\text{LAI}_{\text{cof}}$  was above  $2.5 \text{ m}^2 \text{ m}^{-2}$ . In our plantation, the coffee layer is an unclosed canopy and a significant part of incident light reaches the soil in the inter-row spaces. The light absorbed by the soil represented annually  $34 \pm 4\%$  (mean  $\pm$  SD) which is a considerable amount of under-exploited energy. In a closed plantation,  $fQ_a$  would be expected to saturate with a LAI of  $4 \text{ m}^2 \text{ m}^{-2}$  (Gower et al., 1999). Theoretically, an increase in planting density would increase the plot-level  $Q_{a,\text{cof}}$ . In practice, it would negatively affect the movements of workers within the plot for manual harvesting and other management practices (Barros et al., 1995). An ecologically benefiting option could be the installation of a leguminous cover crop in the inter-rows. We also showed that the annual pruning had very strong effects on the seasonal variations of plot-scale  $Q_{a,\text{cof}}$  though this might be somewhat affected by the pruning technique used. In our experimental plot, shade trees were not pruned and their phenology had little impact on seasonal  $Q_{a,\text{cof}}$  although being fully deciduous. Indeed, during the defoliated stage, shade tree branches and trunks still significantly affected  $Q_{a,\text{cof}}$ . A current

practice in coffee AF management is the pruning of shade trees during coffee fruit ripening and/or during the rainy season, in order to maximize carbon assimilation and/or decrease the moisture in the coffee layer (to limit the development of pathogens such as *Mycena citricolor*). In our experimental plot, daily variations in  $Q_{a, \text{cof}}$  were driven by incident  $Q$ . An ANOVA showed that monthly variations in plot  $Q_a$  were explained in order of importance by i) LAI<sub>cof</sub> including the impact of pruning, ii) competition with coffee neighbors, iii) incident  $Q$ , and iv) shade tree phenology. Incident  $Q$  has a low importance in this test due to quite small inter-monthly variations.

#### 4.3. Effect of shade trees on plot $Q_a$

We showed that coffee layer  $Q_a$  decreased with increasing shade tree density, in the same way that diffuse transmittance is related to LAI following Beer-Lambert-Bouguer's law:  $T = \exp^{-k \cdot \text{LAI}}$  (where  $k$  is the extinction coefficient of diffuse light).  $Q_a$  normalized by leaf area displayed a linear relationship with incident  $Q$  (data not shown). The extinction coefficient found in figure 9 (a and b) is exactly the same as the one estimated for *Erythrina* tree using LAI2000 with the isolated tree procedure.  $k$  depends on plant structure, especially leaf inclination and azimuthal distribution as well as on non-randomness distribution of elements within the crown (Bréda, 2003). We suggest here that according to our simulations, at the plot level and under identical LAI and structural parameters, a discontinuous shade tree layer would transmit the same quantity of light as a horizontally closed canopy. There would be no interactions between shade tree crowns when increasing their density, until perhaps a density for which their crowns entangle between each other. It would be then possible to infer at the plot level the reduction of coffee layer  $Q_a$  due to the shading effect knowing shade trees PAI, their extinction coefficient and their vertical crown projection area.

We showed that the presence of shade trees tends to reverse the diurnal time course of the fraction of  $Q_a$  when compared to a plantation in the open. Franck and Vaast (2009) showed that coffee leaf photosynthesis at noon was mainly limited by stomatal closure for a plant in the open area (midday depression). In the case of shaded coffee plant, the stomatal conductance was higher due to an increase in relative humidity induced by the shade trees, or to a lesser accumulation of sucrose (Vaast et al., 2005). We suggest that the presence of shade trees modifies the diurnal time-course of stomatal opening and photosynthesis and that there are compensation effects when photosynthesis is considered over the whole day.

A limitation to the extension of such relationships is that shade affects plant morphology (Beer et al., 1998). In our plantation, we noticed neither an effect on resprout crown development nor on their total leaf area. However it seems likely that increasing shade tree density would favor, until a certain extent, resprout vegetative growth as reported by Cannell (1971). Moreover, it is expected that a stronger shade level will result in an increase of mean leaf area (Franck, 2005). In a further application, we suggest to measure plant structural parameters for a wider range of shade tree densities in order to model the dependency of coffee canopy architecture upon light environment.

#### 4.4. Toward future applications of 3D process based models in AFS

A plant-to-plot modeling approach enabled us to reach beyond the simple dichotomy generally used in agroforestry i.e. shaded versus non shaded areas. In the present model, light absorption is now available as a continuous variable, at the scale of the resprout and up to the plot. Thus, it is now possible to consider the environment of each resprout, assess its own light budget, and use it as a covariable for any field experimental study. For example, this new covariable could improve statistical models when studying the

determinants of yield per resprout, or the incidence of leaf diseases. This new achievement will certainly enhance our understanding of the complex interactions within AFS. For coffee in particular, evidence indicates that the photosynthetic activity of leaves increases with fruit load on the branch (Vaast et al., 2005). NPP measurements combined with estimations of  $Q_a$  would allow the seasonal variations of light use efficiency to be studied according to plant development and fruit load along a gradient of light availability. This approach would be particularly useful for furthering the development of coffee growth and yield models under AFS conditions.

Another perspective is certainly for studying the epidemiology of leaf diseases. For example, Latin America was stroke in 2012 by an historical coffee rust outbreak (Cressey, 2013). The intensity of the rust epidemic is positively correlated with fruit load (Avelino et al., 2006; López-Bravo et al., 2012). Higher temperature and dew are also factors suspected to increase fungal activity (J. Avelino, pers. comm.). Shade trees are expected to decrease the fruit load, diminish the midday coffee canopy temperature and intercept the morning dew. MAESTRA allows mapping light availability and canopy temperature within the plot and hence could allow testing hypotheses on intra-plot spatial variability of leaf rust epidemics.

Another important application of MAESTRA could be the investigation of the "ecological resilience" of coffee AFS (i.e. the ability of the system in maintaining the crop productivity and ecosystem services under climate change). A lasting increase of the mean temperature would reduce the coffee production suitability to higher altitudes (Schroth et al., 2009). A 3D biophysical model such as MAESTRA could help design new AFS optimizing coffee crown temperature by varying shade tree density according to altitude under new short to medium term climate change scenarios (IPCC, 2013). It could also help designing AFS adapted to local conditions by optimizing shade tree LAI that favor an optimal crown temperature for bean development, and hence to improve coffee quality.

## 5. Conclusion

MAESTRA correctly simulated transmittance of the 2 heterogeneous layers in an AFS. This model was used to assess the heterogeneity in irradiance introduced by shade trees as well as the competition within the coffee layer itself. It allowed mapping light budgets for individual plants. A predictive study was conducted with insight on the effects of an increasing shade tree density on variations of plantation  $Q_a$  as well as in variations of diurnal fractions of  $Q_a$ . Proxies were proposed to estimate coffee light budgets per plant from simple inventories, extinction coefficients, and effects of increasing density.

After a careful parameterization and verification procedure, MAESTRA and its updated version MAESPA clearly appear to be powerful research tools to study interactions for light, carbon, water and heat fluxes in complex multistrata systems. Ultimately, these approaches could help to design AFS adapted to specific local conditions that optimize agricultural production while increasing ecological function and resilience.

## Acknowledgements

Fabien Charbonnier's PhD was funded by CIRAD. The work was supported by EU-CAFNET Project, SOERE F-ORE-T observatory network, ANR-Ecosfix project, PCP platform of CATIE, the University of Idaho, and BID Fontagro CafAdapt project. The authors wish to thank Alvaro Barquero for help in installation and maintenance of the experimental display; Alejandra Barquero for data collection in the field; J-M Bonnefond for help in PAR sensor calibrations. Thanks to B. Medlyn and R. Duursma for making the MAESTRA code available and regularly updated. Thanks to B. Medlyn for providing relevant literature references. The authors are thankful to the two



anonymous reviewers for their useful comments and suggestions on an earlier version of the manuscript.

## Appendix A.

Leaf area density function in MAESTRA

In MAESTRA, leaves are distributed in the crown according to vertical and horizontal normalized distribution function modeled by 2 independent beta distributions functions (Ibrom et al., 2006; Wang et al., 1990) following:

$$f(h, r) = ah^b(1-h)^c dh^e(1-h)^f \quad (A1)$$

where  $f(h,r)$  is the normalized leaf area density,  $h$  and  $r$  are the normalized crown height and radius, respectively.  $a, b, c, d, e$  and  $f$  are the fitted parameters. The 6 parameters were first fitted to the measured normalized leaf area. In a second step, the parameter  $a$  is re-computed to meet the following criteria:

$$\int_0^1 ah^b(1-h)^c dh = 1 \quad (A2)$$

$d$  is also re-computed following:

$$\int_0^1 dr^e(1-r)^f dr = \frac{1}{2\pi} \quad (A3)$$

## Appendix B.

Leaf angle distribution from Goel and Strebel (1984)

$$f(\theta, \mu, \nu) = \frac{1}{\pi/2} \frac{\Gamma(\mu + \nu)}{\Gamma(\mu)\Gamma(\nu)} \left(1 - \frac{\theta}{\pi/2}\right)^{\mu-1} \left(\frac{\theta}{\pi/2}\right)^{\nu-1} \quad (A4)$$

where  $\theta$  is the leaf angle from vertical (in radians),  $\mu$  and  $\nu$  are the fitted parameters. The Gamma functions are approximated following:

$$\Gamma(x) = \left(\frac{2\pi}{x}\right)^{0.5} x^x \exp\left(\frac{1}{12x} - \frac{1}{360x^3} - x\right) \quad (A5)$$

where  $x$  represents successively  $\mu$ ,  $\nu$  and  $\mu + \nu$ .

## References

- Audebert, L., 2011. Productivité aérienne du café agroforestier: effets de l'ombrage et de l'âge des rejets, Master II. UHP Nancy I, Nancy, France, 25 pp+Annexes pp.
- Avelino, J., et al., 2006. The intensity of a coffee rust epidemic is dependent on production situations. *Ecol. Modell.* 197 (3–4), 431–447.
- Baldocchi, D.D., Harley, P.C., 1995. Scaling carbon dioxide and water vapour exchange from leaf to canopy in a deciduous forest. II. Model testing and application. *Plant Cell Environ.* 18 (10), 1157–1173.
- Barros, R., Maestri, M., Rena, A., 1995. Coffee crop ecology. *Trop. Ecol.* 36 (1), 1–19.
- Bartelink, H.H., 1998. Radiation interception by forest trees: a simulation study on effects of stand density and foliage clustering on absorption and transmission. *Ecol. Modell.* 105 (2–3), 213–225.
- Bauerle, W.L., Weston, D.J., Bowden, J.D., Dudley, J.B., Toler, J.E., 2004. Leaf absorptance of photosynthetically active radiation in relation to chlorophyll meter estimates among woody plant species. *Sci. Hortic.* 101 (1–2), 169–178.
- Beer, J., Muschler, R., Kass, D., Somarriba, E., 1998. Shade management in coffee and cacao plantations. *Agrofor. Syst.* 38 (1–3), 139–164.
- Bellow, J.G., Nair, P.K.R., 2003. Comparing common methods for assessing understory light availability in shaded-perennial agroforestry systems. *Agric. For. Meteorol.* 114 (3–4), 197–211.
- Bréda, N.J.J., 2003. Ground-based measurements of leaf area index: a review of methods, instruments and current controversies. *J. Exp. Bot.* 54 (392), 2403–2417.
- Brisson, N., et al., 2003. An overview of the crop model STICS. *Eur. J. Agron.* 18 (3–4), 309–332.
- Brunner, A., 1998. A light model for spatially explicit forest stand models. *For. Ecol. Manage.* 107 (1–3), 19–46.
- Cannell, M., 1971. Effects of fruiting, defoliation and ring-barking on the accumulation and distribution of dry matter in branches of *Coffea arabica* L. in Kenya. *Exp. Agric.* 7 (1), 63–74.
- Cannell, M., Mobbs, D., Lawson, G., 1998. Complementarity of light and water use in tropical agroforests. II. Modelled theoretical tree production and potential crop yield in arid to humid climates. *For. Ecol. Manage.* 102 (2–3), 275–282.
- Cannell, M., Van Noordwijk, M., Ong, C., 1996. The central agroforestry hypothesis: the trees must acquire resources that the crop would not otherwise acquire. *Agrofor. Syst.* 34 (1), 27–31.
- Cescatti, A., 1997a. Modelling the radiative transfer in discontinuous canopies of asymmetric crowns. II. Model testing and application in a Norway spruce stand. *Ecological Modelling* 101, 275–284.
- Cescatti, A., 1997b. Modelling the radiative transfer in discontinuous canopies of asymmetric crowns. I. Model structure and algorithms. *Ecol. Modell.* 101 (2–3), 263–274.
- Chen, Q., Baldocchi, D., Gong, P., Dawson, T., 2008. Modeling radiation and photosynthesis of a heterogeneous savanna woodland landscape with a hierarchy of model complexities. *Agric. For. Meteorol.* 148 (6–7), 1005–1020.
- Clawges, R., Vierling, L., Calhoun, M., Toomey, M., 2007. Use of a ground-based scanning lidar for estimation of biophysical properties of western larch (*Larix occidentalis*). *Int. J. Remote Sens.* 28 (19), 4331–4344.
- Courbaud, B., de Coligny, F., Cordonnier, T., 2003. Simulating radiation distribution in a heterogeneous Norway spruce forest on a slope. *Agric. For. Meteorol.* 116 (1–2), 1–18.
- Cressey, D., 2013. Coffee rust regains foothold. *Nature* 493 (7434), 587.
- Damatta, F., 2004. Ecophysiological constraints on the production of shaded and unshaded coffee: a review. *Field Crop. Res.* 86 (2–3), 99–114.
- Dauzat, J., Clouvel, P., Luquet, D., Martin, P., 2008. Using Virtual Plants to Analyse the Light-foraging Efficiency of a Low-density Cotton Crop. *Ann. Bot.* 101 (8), 1153–1166.
- Dauzat, J., Eroy, M.N., 1997. Simulating light regime and intercrop yields in coconut based farming systems. *Eur. J. Agron.* 7 (1–3), 63–74.
- Dauzat, J., Rapidel, B., Berger, A., 2001. Simulation of leaf transpiration and sap flow in virtual plants: model description and application to a coffee plantation in Costa Rica. *Agric. For. Meteorol.* 109 (2), 143–160.
- De Pury, D.G.G., Farquhar, G.D., 1997. Simple scaling of photosynthesis from leaves to canopies without the errors of big-leaf models. *Plant Cell Environ.* 20 (5), 537–557.
- Di Rienzo, J.A. et al. 2011. InfoStat.
- Doré, T., et al., 2011. Facing up to the paradigm of ecological intensification in agronomy: Revisiting methods, concepts and knowledge. *Eur. J. Agron.* 34 (4), 197–210.
- Duursma, R., Medlyn, B.E., 2012. MAESPA: a model to study interactions between water limitation, environmental drivers and vegetation function at tree and stand levels, with an example application to [CO<sub>2</sub>] × drought interactions. *Geosci. Model Dev.* 5, 919–940.
- Foley, S., Rivard, B., Sanchez-Azofeifa, G.A., Calvo, J., 2006. Foliar spectral properties following leaf clipping and implications for handling techniques. *Rem. Sens. Environ.* 103 (3), 265–275.
- Franck, N., 2005. Effet de la charge en fruits et de l'ombrage sur l'assimilation carbonée, la croissance et la production du caféier. PhD thesis, Ecole Nationale Supérieure d'Agronomie, Montpellier, 165 pp.
- Franck, N., Vaast, P., 2009. Limitation of coffee leaf photosynthesis by stomatal conductance and light availability under different shade levels. *Trees* 23 (4), 761–769.
- Friday, J.B., Fownes, J.H., 2001. A simulation model for hedgerow light interception and growth. *Agric. For. Meteorol.* 108 (1), 29–43.
- Goel, N.S., Strebel, D.E., 1984. Simple Beta Distribution Representation of Leaf Orientation in Vegetation Canopies. *Agron. J.* 76 (5), 800–802.
- Gómez-Delgado, F., 2010. Hydrological, ecophysiological and sediment processes in a coffee agroforestry basin: combining experimental and modelling methods to assess hydrological environmental services. PhD thesis, Supagro, Montpellier, 254 pp.
- Gómez-Delgado, F., et al., 2011. Modelling the hydrological behaviour of a coffee agroforestry basin in Costa Rica. *Hydrol. Earth Syst. Sci.* 15 (1).
- Gower, S.T., Kucharik, C.J., Norman, J.M., 1999. Direct and Indirect Estimation of Leaf Area Index, fAPAR, and Net Primary Production of Terrestrial Ecosystems. *Remote Sens. Environ.* 70 (1), 29–51.
- Grace, J.C., 1988. Effect of tree arrangement on intercepted radiant energy and photosynthesis. In: Werger, M.J.A., van der Aart, P.J.M., During, H.J., Verhoeven, J.T.A. (Eds.), *Forest Growth Modelling and Prediction*. US Department of Agriculture Forest Service General Technical Report, pp. 285–292.
- Grace, J.C., 1990. Process-level models for investigating alternative spacing patterns. In: James, R.N., Tarlton, G.L. (Eds.), *New Approaches to Spacing and Thinning in Plantation Forestry*. Ministry of Forestry, FRI Bulletin, pp. 229–232.
- Gu, L., et al., 2002. Advantages of diffuse radiation for terrestrial ecosystem productivity. *J. Geophys. Res.* 107 (D6), 4050.
- Hanson, P.J., et al., 2004. Oak forest carbon and water simulations: model inter-comparisons and evaluations against independent data. *Ecol. Monogr.* 74 (3), 443–489.
- Hawkins, E., Sutton, R., 2012. Time of emergence of climate signals. *Geophys. Res. Lett.* 39 (1), L01702.
- Ibrom, A., et al., 2006. A comparative analysis of simulated and observed photosynthetic CO<sub>2</sub> uptake in two coniferous forest canopies. *Tree Physiol.* 26 (7), 845–864.
- IPCC, 2007. Contribution of Working Group II to the Fourth Assessment Report of the Intergovernmental Panel on Climate Change, 2007. Cambridge, United Kingdom and New York, NY, USA.

- IPCC, 2013. IPCC Fifth Assessment Report. To be released in September 2013. Internet at <http://www.ipcc.ch/>
- Janssens, I.A., et al., 2005. Carbon budget of *Pinus sylvestris* saplings after four years of exposure to elevated atmospheric carbon dioxide concentration. *Tree Physiol.* 25 (3), 325–337.
- Kobayashi, H., et al., 2012. Modeling energy and carbon fluxes in a heterogeneous oak woodland: a three-dimensional approach. *Agric. For. Meteorol.* 152 (0), 83–100.
- Lang, A.R.G., Xiang, Y., 1986. Estimation of leaf area index from transmission of direct sunlight in discontinuous canopies. *Agric. For. Meteorol.* 37 (3), 229–243.
- Lawson, G., et al., 1995. The tree–crop interface – representation by coupling of forest and crop process-models. *Agrofor. Syst.* 30 (1–2), 199–221.
- le Maire, G., et al., 2013. Tree and stand light use efficiencies over a full rotation of single- and mixed-species *Eucalyptus grandis* and *Acacia mangium* plantations. *For. Ecol. Manage.* 288 (15 January 2013), 31–42.
- Lin, B.B., 2007. Agroforestry management as an adaptive strategy against potential microclimate extremes in coffee agriculture. *Agric. For. Meteorol.* 144 (1–2), 85–94.
- López-Bravo, D.F., Virginio-Filho, E.d.M., Avelino, J., 2012. Shade is conducive to coffee rust as compared to full sun exposure under standardized fruit load conditions. *Crop Protect.* 38 (0), 21–29.
- Mahlstein, I., Knutti, R., Solomon, S., Portmann, R.W., 2011. Early onset of significant local warming in low latitude countries. *Environ. Res. Lett.* 6 (3), 034009.
- Mariscal, M.J., Orgaz, F., Villalobos, F.J., 2000. Modelling and measurement of radiation interception by olive canopies. *Agric. For. Meteorol.* 100 (2–3), 183–197.
- Medlyn, B., 2004. A MAESTRO retrospective. In: Mencuccini, M., Moncrieff, J., McNaughton, K., Grace, J. (Eds.), *Forests at the Land–Atmosphere Interface*. CAB International.
- Mialet-Serra, I., Dauzat, J., Auclair, D., 2001. Using plant architectural models for estimation of radiation transfer in a coconut-based agroforestry system. *Agroforestry Systems* 53, 141–149.
- Mobbs, D., et al., 1998. Complementarity of light and water use in tropical agroforests. I. Theoretical model outline, performance and sensitivity. *For. Ecol. Manage.* 102 (2–3), 259–274.
- Monteith, J.L., 1972. Solar radiation and productivity in tropical ecosystems. *J. Appl. Ecol.* 9 (3), 747–766.
- Moorthy, I., et al., 2011. Field characterization of olive (*Olea europaea* L.) tree crown architecture using terrestrial laser scanning data. *Agric. For. Meteorol.* 151 (2), 204–214.
- Muschler, R.G., 2001. Shade improves coffee quality in a sub-optimal coffee-zone of Costa Rica. *Agrofor. Syst.* 51 (2), 131–139.
- Nair, P.K.R., 2007. The coming of age of agroforestry. *J. Sci. Food Agric.* 87 (9), 1613–1619.
- Norman, J.M., Welles, J.M., 1983. Radiative transfer in an array of canopies. *Agron. J.* 75 (3), 481–488.
- Peel, M.C., Finlayson, B.L., McMahon, T.A., 2007. Updated world map of the Köppen–Geiger climate classification. *Hydrol. Earth Syst. Sci. Discuss.* 11, 1633–1644.
- Pendergrast, M., 2000. *Uncommon Grounds: The History Of Coffee And How It Transformed Our World*.
- Pisek, J., Sonntag, O., Richardson, A.D., Möttus, M., 2013. Is the spherical leaf inclination angle distribution a valid assumption for temperate and boreal broadleaf tree species? *Agric. For. Meteorol.* 169 (0), 186–194.
- Pontailleur, J.-Y., Hymus, G., 2003. Estimation of leaf area index using ground-based remote sensed NDVI measurements: validation and comparison with two indirect techniques. *Can. J. Rem. Sens.* 29 (3), 381–387.
- Roderick, M., Farquhar, G., Berry, S., Noble, I., 2001. On the direct effect of clouds and atmospheric particles on the productivity and structure of vegetation. *Oecologia* 129 (1), 21–30.
- Roupsard, O., et al., 2008. Cross-validating Sun-shade and 3D models of light absorption by a tree–crop canopy. *Agric. For. Meteorol.* 148 (4), 549–564.
- Running, S.W., Coughlan, J.C., 1988. A general model of forest ecosystem processes for regional applications. I. Hydrologic balance, canopy gas exchange and primary production processes. *Ecol. Modell.* 42 (2), 125–154.
- Ryu, Y., et al., 2011. Integration of MODIS land and atmosphere products with a coupled-process model to estimate gross primary productivity and evapotranspiration from 1 km to global scales. *Global Biogeochem. Cycles* 25 (4).
- Ryu, Y., et al., 2010. How to quantify tree leaf area index in an open savanna ecosystem: a multi-instrument and multi-model approach. *Agric. For. Meteorol.* 150 (1), 63–76.
- Sanchez, P.A., 1995. Science in agroforestry. *Agrofor. Syst.* 30 (1–2), 5–55.
- Schroth, G., et al., 2009. Towards a climate change adaptation strategy for coffee communities and ecosystems in the Sierra Madre de Chiapas, Mexico. *Mitig. Adapt. Strat. Glob. Change* 14 (7), 605–625.
- Siles, P., Harmand, J.-M., Vaast, P., 2010. Effects of *Inga densiflora* on the microclimate of coffee (*Coffea arabica* L.) and overall biomass under optimal growing conditions in Costa Rica. *Agrofor. Syst.* 78 (3), 269–286.
- Sinoquet, H., Le Roux, X., Adam, B., Ameglio, T., Daudet, F.A., 2001. RATP: a model for simulating the spatial distribution of radiation absorption, transpiration and photosynthesis within canopies: application to an isolated tree crown. *Plant Cell Environ.* 24 (4), 395–406.
- Sinoquet, H., Rakocevic, M., Varlet-Grancher, C., 2000. Comparison of models for daily light partitioning in multispecies canopies. *Agric. For. Meteorol.* 101 (4), 251–263.
- Soudani, K., et al., 2012. Ground-based network of NDVI measurements for tracking temporal dynamics of canopy structure and vegetation phenology in different biomes. *Rem. Sens. Environ.* 123 (0), 234–245.
- Spitters, C.J.T., Toussaint, H.A.J.M., Goudriaan, J., 1986. Separating the diffuse and direct component of global radiation and its implications for modeling canopy photosynthesis Part I. Components of incoming radiation. *Agric. For. Meteorol.* 38 (1–3), 217–229.
- Talbot, G., 2011. L'intégration spatiale et temporelle du partage des ressources dans un système agroforestier noyers-céréales: une clef pour en comprendre la productivité? PhD thesis, Université Montpellier 2, Montpellier, 297 pp.
- Talbot, G., Dupraz, C., 2012. Simple models for light competition within agroforestry discontinuous tree stands: are leaf clumpiness and light interception by woody parts relevant factors? *Agrofor. Syst.* 84 (1), 101–116.
- Tang, S., Dong, P., Buckles, B.P., 2013. Three-dimensional surface reconstruction of tree canopy from lidar point clouds using a region-based level set method. *Int. J. Remote Sens.* 34 (4), 1373–1385.
- Taugourdeau, S., et al., 2010. LAI dynamics of agroforestry and full sun coffee systems in Costa Rica, ASIC2010. Poster Communication and Proceedings, Bali, Indonesia.
- Thornton, P., Cramer, L. (Eds.), 2012. Impacts of climate change on the agricultural and aquatic systems and natural resources within the CGIAR's mandate. CCAFS Working Paper, 23. CGIAR Research Program on Climate Change, Agriculture and Food Security (CAAFS), Copenhagen, Denmark.
- USDA, 1999. Soil taxonomy: A basic system of soil classification for making and interpreting soil surveys. 2nd edition. Natural Resources Conservation Service. U.S. Department of Agriculture Handbook 436.
- Vaast, P., Angrand, J., Franck, N., Dauzat, J., Genard, M., 2005. Fruit load and branch ring-barking affect carbon allocation and photosynthesis of leaf and fruit of *Coffea arabica* in the field. *Tree Physiol.* 25 (6), 753–760.
- Vaast, P., Bertrand, B., Perriot, J.-J., Guyot, B., Génard, M., 2006. Fruit thinning and shade improve bean characteristics and beverage quality of coffee (*Coffea arabica* L.) under optimal conditions. *J. Sci. Food Agric.* 86 (2), 197–204.
- Vaast, P., Kanten, R., Siles, P., Angrand, J., Aguilar, A., 2008. Biophysical Interactions Between Timber Trees and Arabica Coffee in Suboptimal Conditions of Central America. In: Jose, S., Gordon, A.M. (Eds.), *Toward Agroforestry Design. Advances in Agroforestry*. Springer, Netherlands, pp. 133–146.
- Van Noordwijk, M., Lusiana, B., 1998. WaNuLCAS, a model of water, nutrient and light capture in agroforestry systems. *Agrofor. Syst.* 43 (1–3), 217–242.
- Van Oijen, M., Dauzat, J., Harmand, J.-M., Lawson, G., Vaast, P., 2010. Coffee agroforestry systems in Central America. II. Development of a simple process-based model and preliminary results. *Agrofor. Syst.* 80 (3), 361–378.
- Verchot, L., et al., 2007. Climate change: linking adaptation and mitigation through agroforestry. *Mitig. Adapt. Strat. Glob Change* 12 (5), 901–918.
- Vierling, L.A., Xu, Y., Eitel, J.U.H., Oldow, J.S., 2012. Shrub characterization using terrestrial laser scanning and implications for airborne LiDAR assessment. *Can. J. Rem. Sens.* 38 (06), 709–722.
- Wallach, D., 2006. Evaluating crop models. In: Wallach, D., Makowski, D. (Eds.), *Working with dynamic crop models: evaluating, analyzing, parameterizing, and applications*. Elsevier, Amsterdam, pp. 11–49.
- Wang, Y.P., Jarvis, P.G., 1988. Mean leaf angles for the ellipsoidal inclination angle distribution. *Agric. For. Meteorol.* 43 (3–4), 319–321.
- Wang, Y.P., Jarvis, P.G., 1990a. Description and validation of an array model – MAESTRO. *Agric. For. Meteorol.* 51 (3–4), 257–280.
- Wang, Y.P., Jarvis, P.G., 1990b. Influence of crown structural properties on PAR absorption, photosynthesis, and transpiration in Sitka spruce: application of a model (MAESTRO). *Tree Physiol.* 7 (1–4), 297–316.
- Wang, Y.P., Jarvis, P.G., Benson, M.L., 1990. Two-dimensional needle-area density distribution within the crowns of *Pinus radiata*. *For. Ecol. Manage.* 32 (2–4), 217–237.
- Williams, M., Bond, B., Ryan, M., 2001. Evaluating different soil and plant hydraulic constraints on tree function using a model and sap flow data from ponderosa pine. *Plant. Cell Environ.* 24, 679–690.
- World Bank Group, 2012. Turn down the heat: why a 4 °C warmer world must be avoided. World Bank, Washington.

---

## 1 INCREASED LIGHT USE EFFICIENCY OF COFFEE UNDER SHADE TREES 2 COMPENSATES FOR ANPP BUT NOT FOR FRUITING LOSS

---

3 *For submission to Journal of Experimental Botany*

4 Fabien Charbonnier<sup>1,2,3,\*</sup>, Olivier Roupsard<sup>1,3</sup>, Fernando Casanoves<sup>3</sup>, Gueric le Maire<sup>1</sup>, Anne Clément-  
5 Vidal<sup>4</sup>, André Lacointe<sup>5</sup>, Christophe Jourdan<sup>1</sup>, Philippe Thaler<sup>1</sup>, Louise Audebert<sup>6</sup>, Elsa Defresnet<sup>7</sup>,  
6 Aurélie Cambou<sup>8</sup>, Emmanuelle Khac<sup>9</sup>, Alejandra Barquero Aguillar<sup>10</sup>, Patricia Leandro<sup>3</sup>, Karel Van  
7 den Meersche<sup>1,3</sup>, Clémentine Alline<sup>11,3</sup>, Jacques Avelino<sup>12,4</sup>, Laurent Saint-André<sup>1,13</sup>, Philippe  
8 Vaast<sup>1,14</sup>, & Erwin Dreyer<sup>2,15</sup>

9 <sup>1</sup>CIRAD, UMR Eco&Sols (Ecologie Fonctionnelle & Biogéochimie des Sols et des Agro-  
10 écosystèmes), 34060 Montpellier Cedex 2, France

11 <sup>2</sup>Université de Lorraine, UMR 1137 “Ecologie et Ecophysiologie Forestières, F 54500 Vandoeuvre,  
12 France

13 <sup>3</sup>CATIE (Centro Agronómico Tropical de Investigación y Enseñanza), 7170 Turrialba, Costa Rica

14 <sup>4</sup>CIRAD, UMR AGAP, Avenue d'Agropolis, F-34398 Montpellier cedex 5, France

15 <sup>5</sup>INRA, UMR 547 PIAF, F-63100 Clermont-Ferrand, France

16 <sup>6</sup>Faculté des Sciences, Université de Lorraine, F 54500 Vandoeuvre, France

17 <sup>7</sup>AgroCampus Ouest, Centre de Rennes, 35042, Rennes Cedex, France

18 <sup>8</sup>ENSAIA, Ecole Nationale Supérieure d'Agronomie et des Industries Alimentaires, Nancy,  
19 FRANCE

20 <sup>9</sup>AgroParisTech, 34093 Montpellier France

21 <sup>10</sup>Cafetalera Aquiares S.A., PO Box 362-7150 Turrialba, Costa Rica

22 <sup>11</sup>CIRAD, UMR System, 34060 Montpellier, France

23 <sup>12</sup>CIRAD, UPR Bioagresseurs, F-34398 Montpellier, France

24 <sup>13</sup>INRA, Biogéochimie des Ecosystèmes Forestiers, F-54280 Champenoux, France

25 <sup>14</sup>ICRAF, United Nations, Avenue Gigiri, PO Box 30677-00100, Nairobi, Kenya

26 <sup>15</sup>INRA, UMR 1137 “Ecologie et Ecophysiologie Forestières”, F54280 Champenoux, France

27 (\*corresponding author: [fabien.charbonnier@cirad.fr](mailto:fabien.charbonnier@cirad.fr))

## 28 **Abstract**

29 Above-ground net primary productivity (ANPP) and its determinants (Light use efficiency and  
30 absorbed photosynthetic active radiation) were assessed in a coffee agro-forestry system (AFS),  
31 distinguishing the shade tree (*Erythrina poeppigiana*), the coffee (*Coffea arabica*) plant stump and the  
32 coffee plant resprouts (subjected to selective annual pruning). Coffee plant ANPP was assessed using  
33 litter-traps and site-specific allometric equations applied on 60 coffee resprouts monitored every two-  
34 months and during two years. The effects of age and light conditions (under shade trees or in the open)  
35 on annual NPP of wood, leaf and fruit compartments of coffee resprouts were tested. Age and fruit  
36 load were the main determinants of coffee resprout ANPP. The fruit NPP of productive coffee  
37 resprouts was negatively correlated to leaf NPP while the relative allocation of ANPP to the wood  
38 compartment remained almost constant. For productive resprouts, relative allocation to fruits was  
39 independent of resprout age and driven by fruit load. Shade trees did not affect ANPP of coffee  
40 resprouts. Absorbed photosynthetically active radiation (aPAR) decreased severely in shaded coffee  
41 plants, but this was completely compensated for by increased light-use efficiency, resulting in stable  
42 ANPP. However, shading induced a reduction in fruit loads, leading to a lower but inter-annually  
43 stable production while coffee plants grown at full irradiance displayed a strong biennial bearing.

44 After upscaling from plants to plot, system ANPP was 820 and 900 gC m<sup>-2</sup> Y<sup>-1</sup> for year 1 and year 2,  
45 respectively, where coffee layer ANPP represented 80% of system ANPP. Due to annual pruning, the  
46 biomass of coffee resprouts remained quite stable between the 2 years. However, the above-ground net  
47 increment in carbon stocks represented 20% of total above-ground ANPP and was stored in coffee  
48 stumps (55%) and shade tree trunk and branches (45%). Neither the coffee trunk compartment, nor the  
49 below-ground and SOM compartments should be ignored in C sequestration and C-neutral  
50 estimations.

## 51 1. Introduction

52 Net primary productivity (NPP) is the net flux of carbon converted into biomass. It can be quantified  
 53 directly from the increment of biomass over a given time interval, plus litter production and all  
 54 exportations during this interval (Clark *et al.*, 2001), or estimated indirectly as the difference between  
 55 gross primary productivity (GPP) and autotrophic respiration ( $R_a$ ). While the human community  
 56 investigates strategies to feed up to 9 billion people by 2050 in a context of global climate disruption,  
 57 NPP is a highly relevant metric to assess the “limits to growth” for potential human consumption  
 58 (Meadows *et al.*, 2004; Running, 2012). Indeed, NPP is a key determinant of crop productivity. GPP  
 59 or NPP have been assessed at continental/global scale from modeling exercises: (1) using a light-use  
 60 efficiency approach to convert the fraction of incident photosynthetically active radiation absorbed by  
 61 the vegetation (fAPAR) recorded by remote-sensing (Zhao and Running, 2010); (2) using fAPAR  
 62 coupled to a radiation transfer model combined with a sun-shade photosynthesis submodel (De Pury  
 63 and Farquhar, 1997; Ryu *et al.*, 2011), (3) using spatial extrapolations of data of GPP and  $R_a$  recorded  
 64 in a network of eddy-covariance sites (Beer *et al.*, 2010), and (4) using dynamic global vegetation  
 65 models (Krinner *et al.*, 2005; Sitch *et al.*, 2003; Van den Hoof *et al.*, 2013). Despite a reasonable  
 66 agreement among the different approaches for global estimates of GPP (around 120 PgC  $y^{-1}$ ), local  
 67 uncertainties remain large, given the inability of models to take into account the large inter-annual  
 68 variability, given the poor performance of these models to reproduce phenology cycles in different  
 69 ecosystems across years (Keenan *et al.*, 2012; Richardson *et al.*, 2013).

70 NPP of woody plants is still poorly known and allocation patterns among compartments (leaves,  
 71 stems, roots) as well as the determinants of inter and intra-annual variability are seldom assessed given  
 72 the high cost induced by the required field measurements (Navarro *et al.*, 2008; Zanutelli *et al.*, 2013).  
 73 However, reliable NPP estimates are necessary to gain confidence in eddy-covariance estimations, for  
 74 GPP partitioning into NPP and autotrophic respiration ( $R_a$ ), or in Net Ecosystem Productivity (NEP)  
 75 partitioning into NPP and heterotrophic respiration ( $R_h$ ) (Baldocchi, 2003). The lack of NPP data also  
 76 affects plant modelers who need comprehensive datasets to generalize theories on assimilate  
 77 partitioning at whole-plant scale and build crop production models (Génard *et al.*, 2008; Lacoite,  
 78 2000).

79 When comparing NPP between plants or ecosystems, standardization is compulsory. Net assimilation  
 80 rate (NAR) is total NPP per unit of leaf area present on average during the considered interval ( $gC$   
 81  $m_{leaves}^{-2} Y^{-1}$ ) (Hunt *et al.*, 2002; Poorter, 2001). NAR depends directly on the fraction of PAR absorbed  
 82 by the leaves ( $aPAR_{LA} MJ m_{leaves}^{-2} Y^{-1}$ ) and on the efficiency of light conversion into biomass (LUE,  
 83  $gC MJ^{-1}$ ). (Monteith and Moss (1977) :

$$84 \quad NAR = aPAR_{LA} * LUE \quad (1)$$

85 NPP can then be calculated from NAR using plant leaf area (LA):

$$86 \quad NPP = LA * aPAR_{LA} * LUE \quad (2)$$

87 Coffee is one of the world's largest agricultural export by value (FAO, 2011), and a very highly-ranked  
88 commodity (Pendergrast, 2000). Coffee is traditionally cultivated in agroforestry systems (AFS),  
89 especially in Central America.

90 Coffee plant aPAR is reduced under shade trees (Charbonnier *et al.*, 2013), but this might be  
91 compensated to some extent by an increased LUE, resulting in a stable NAR under shade. Increased  
92 LUE under shade is one of the most important hypotheses in AFS research, though it was seldom  
93 explicitly quantified (Dapoigny *et al.*, 2000; Harris *et al.*, 1987; Marrou *et al.*, 2013; Rodrigo *et al.*,  
94 2001). This knowledge gap resulted from the scarcity of models able to address multiple canopy layers  
95 and within layer heterogeneity which are typical of AFS. Recently, Charbonnier *et al.* (2013) proposed  
96 to apply MAESTRA (Medlyn, 2004) for that purpose.

97 To our knowledge, seasonal and inter-annual dynamics of coffee resprout NPP were never assessed  
98 during an entire production cycle (5-6 years). Cannell (1971) recorded during 1.5 years dry matter  
99 partitioning and relative growth rates of productive plants with different fruit loads. He found almost  
100 no seasonal variation in dry matter partitioning among different organs for deblossomed trees; biomass  
101 increased faster in fruiting than deblossomed trees; and a significant decrease in allocation to woody  
102 compartments occurred on the latter. Fruiting trees displayed an enhanced NAR that almost  
103 compensated the decrease in leaf area. Similar findings were reported by Vaast *et al.* (2005) and  
104 Franck *et al.* (2006) for coffee branches: a higher fruit load enhanced leaf photosynthesis and had a  
105 depressive effect on leaf and branch growth rates. This demonstrates the large sink strength of fruits in  
106 coffee plants.

107 Pruning is a management practice that also affects drastically coffee NPP and its partitioning. Every 5  
108 to 6 years, coffee resprouts are pruned because they display a decrease in fruit production or are too  
109 tall for a proper harvest. However, pruning results in the loss of *ca.* 3 years of yield per resprout. There  
110 is a key stake in minimizing the frequency of pruning, according to the reproductive potential of the  
111 resprout, in particular to adjust pruning frequency differently for shaded and non-shaded coffee plants.  
112 Coffee plants display a typical biennial cycle presumably affecting their overall NPP (Camargo and  
113 Camargo, 2001). Biennial bearing is in some cases synchronized at provincial/regional scales  
114 (Bernardes *et al.*, 2012; Monselise and Goldschmidt, 1982) and may affect the rate of carbon  
115 assimilation. Indeed, it was shown that a low fruit load could result in a reduction of photosynthetic  
116 carbon assimilation rates (Cannell, 1985a; DaMatta *et al.*, 2008a; DeJong, 1986; Lescourret *et al.*,  
117 2011; Palmer *et al.*, 1997). Additionally, smaller fruit loads result in a re-allocation of assimilates  
118 within the plant. From an ecological point of view, coffee is a shade-tolerant specie growing natively  
119 as understorey that does not intensively blossom unless conditions become favorable (*i.e.* a fallen tree  
120 make a light well) (Cannell, 1985b). Shade trees were shown to affect negatively blossoming and  
121 buffer to some extent the alternate bearing (Barros *et al.*, 1995; Vaast *et al.*, 2006). As a consequence,  
122 a lower fruit load for shaded coffee would lead to a larger relative allocation of assimilates to  
123 vegetative components (Cannell, 1975).

124 The following questions were addressed in this paper:

- 125 1) What are the main determinants (plant age, shade, fruit load, local competition) affecting the  
126 NPP of above-ground coffee resprout compartments (wood, leaves, fruits)?
- 127 2) What were the determinants of biennial bearing at the plant scale? Were shaded coffee plants  
128 less affected by the biennial bearing? Was there a biennial bearing at plot scale?
- 129 3) How does shading by trees affect the coffee plants NAR and LUE?

130 In this study, we monitored above-ground NPP of coffee resprouts taking into account factors like age  
131 (since pruning), shade condition, initial fruit load and inter-resprout competition. We mapped shade  
132 tree transmittance and computed light budget of individual plants using the 3D MAESTRA light  
133 interception model (Charbonnier *et al.*, 2013). Coffee and shade trees above-ground NPP were then  
134 upscaled to the plot through inventories and assessed per compartment for the two years of  
135 measurements.

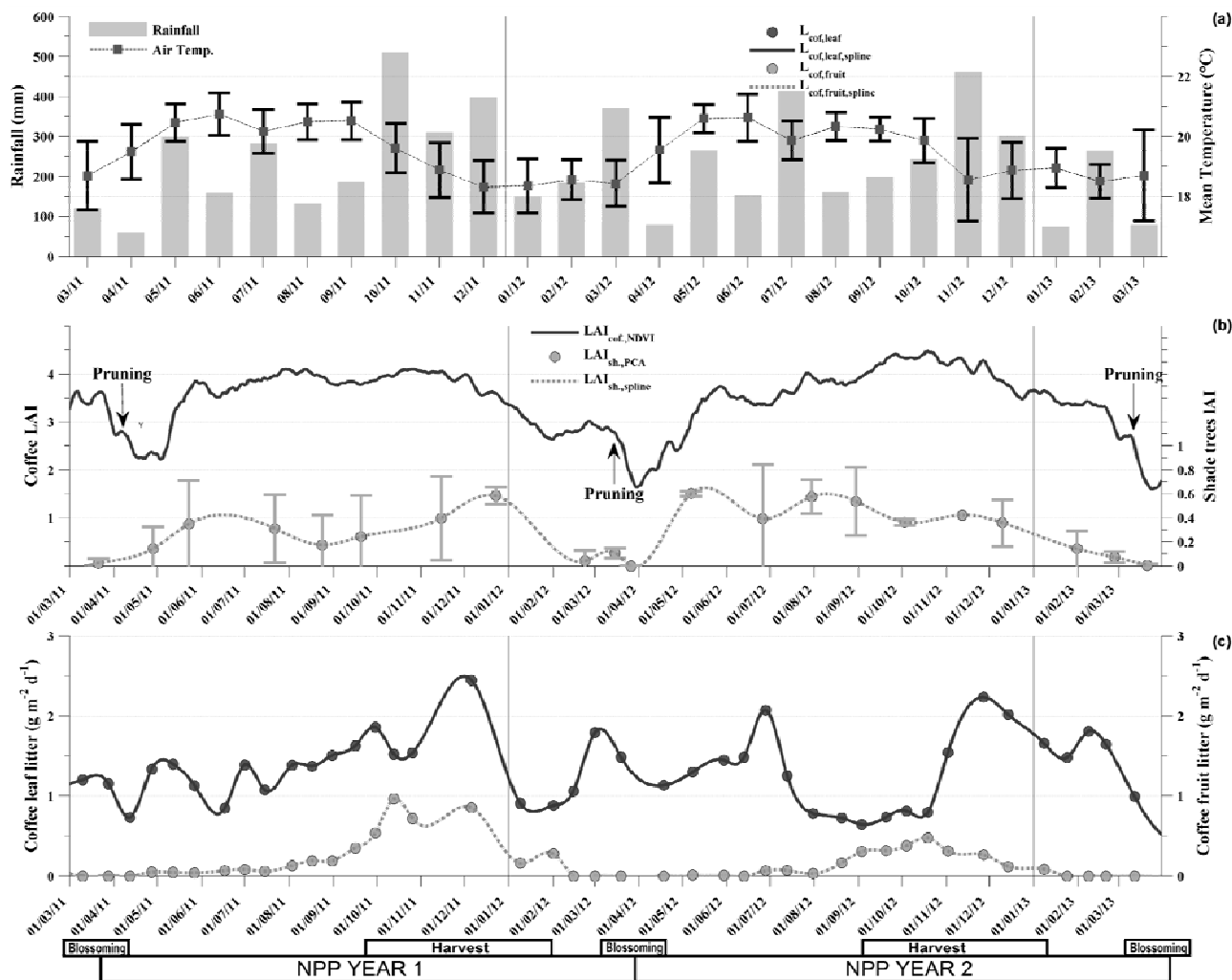

**Figure 1** – a) Time-course of monthly precipitation and mean air temperature from 03/2011 to 03/2013. b) Daily time-course of LAI of the coffee canopy measured by proxy-detection (NDVI) and of shade trees measured with PCA, both intrapolated between dates using a cubic spline function. Error bars represent the standard deviation between the 3 measured shade trees. c) Time course of leaf and fruit litter production harvested with litter traps every 15 days. Litter production was corrected using a linear decomposition rate. Coffee pruning, blossoming, harvests as well as the NPP estimation periods are indicated.



## 136 2. Material and methods

### 137 A. Study site

138 The study site is located in the central Valley of Costa Rica at 1050 m.a.s.l on the slopes of the  
139 Turrialba volcano. The experimental setup is part of the Coffee-Flux Observatory of Ecosystem  
140 Services (<http://www5.montpellier.inra.fr/ecosols/Recherche/Les-projets/CoffeeFlux>) located in  
141 “Finca Aquiares”, one of the largest coffee farms of the country (9° 56' 19" N, 83°43'46" W).  
142 Climate is tropical humid with no dry season (Peel *et al.*, 2007). During the two years of our study  
143 (04/2011 to 03/2013), annual rainfall was 3034 and 2686 mm for year 1 and 2, respectively. April was  
144 the driest month (58 and 78 mm, respectively). Mean air temperature was 19.5°C without significant  
145 seasonal variation (Fig. 1a). Soils are deep andisols with high allophane and organic matter content  
146 (Kinoshita, 2012; USDA-NRCS, 2005). Volumetric soil water content ranged from 0.38 to 0.55 m<sup>3</sup><sub>H<sub>2</sub>O</sub>  
147 m<sup>-3</sup><sub>soil</sub>, and was never limiting for plants (Gómez-Delgado *et al.*, 2011). The plantation was managed  
148 intensively with high fertilizer levels (Charbonnier *et al.*, 2013).

149 The experimental setup was described in Charbonnier *et al.* (2013). The plot is mainly planted with  
150 *Coffea arabica* L. var Caturra and large *Erythrina poeipigiana* O.F. Cook as shade trees (5.2 ha<sup>-1</sup>).  
151 Shade trees exhibited a mean LAI of 0.32 m<sup>2</sup> m<sup>-2</sup> and intercepted in average 14% of the annual  
152 incident light at plot scale (Fig. 1b). Below shade tree crowns however, light transmitted to the coffee  
153 layer was only 30% and the area of influence of the shade trees was much larger than their crown  
154 projection.

155 Coffee growth follows the architectural model of Roux (de Reffye *et al.*, 1997; Hallé and Oldeman,  
156 1970). The monopodial orthotropic axis (trunk) continuously builds up new orthotropic nodes. Each  
157 one may bear 2 opposite and similar plagiotropic axes that can ramify into higher order plagiotropic  
158 axes. There is an important dimorphism between orthotropic and plagiotropic axes. Only plagiotropic  
159 axes bear coffee fruits, and only on the nodes produced during the previous year.

160 Coffee seedlings were initially planted at 6300 locations ha<sup>-1</sup> with 1 or 2 seedlings per location in the  
161 1970's. Coffee plants are grown as an uneven-aged coppice with 1 to 3 resprouts per stump and 1 to 2  
162 stumps per location. Resprouts are pruned selectively every 5 to 6 years when they are considered too  
163 tall for a proper harvest or when fruit production declines. Inventories of the coffee plantation were  
164 carried out over 0.1 ha during August 2010 and August 2011. There was an approximate uniform age  
165 distribution of resprouts. Specific inventories were carried out just after the March 2011 and 2012  
166 pruning to estimate removed wood and leaf biomass. Every year, ~15% of the resprouts were pruned,  
167 leading to a ~30% decrease in plantation LAI (Fig. 1b). Coffee LAI was measured by proxy-detection  
168 with a NDVI sensor located on an eddy-covariance tower. It varied from 1.6 to 4 m<sup>2</sup> m<sup>-2</sup> (mean 3.5 m<sup>2</sup>



**Figure 2** - Satellite image (WorldView image, 02/2010) of the 5 blocks with two subplots in the coffee AFS studied in this experiment.

**Table 1** – Allometric models used to estimate the biomass (g) of the different compartments of coffee resprouts. Linear regressions display the relationship between measured and modeled components for the 12 resprouts used for allometric relationship building (initial dataset) and for the 12 resprouts of the validation data set, successively.

	Model	Initial dataset (N=12)	Validation set (N=12)
Orthotropic branch	$B_{ortho}=0.005*D^2*L$	$B_{mod}=0.99*B_{meas} +17 ; R^2=0.99$	$B_{mod} =0.97*B_{meas} +4 ; R^2=0.99$
<i>D: middle segment diameter (mm); L: middle segment length (cm). Nb: intercept was not significantly different from 0 and was removed</i>			
Plagiotropic branch (all orders)	$B_{plagio}=0.033*D^{0.423}*L^{1.013}$	$B_{mod} =0.99*B_{meas} +3.7 ; R^2=0.98$	$B_{mod} =0.98*B_{meas} +3.7 ; R^2=0.98$
<i>D: branch basal diameter (mm); L: branch length (cm). Nb: intercept was not significantly different from 0 and was removed</i>			
Leaves	$B_{leaves}=(0.748*L*W)/10000*SLA^{-1}$	$B_{mod} =1.01*B_{meas} -3.5 ; R^2=0.92$	
<i>L: Leaf length (cm); W: leaf width (cm). SLA is the specific leaf area (<math>m^2 g^{-1}</math>) that varies according to leaf position in the crown (Table 3).</i>			
Stumps	$B_{stump}=A*36.3$ (N=14; $R^2=0.95$ )		
<i>A: basal stump area (<math>cm^2</math>) Nb: intercept was not significantly different from 0 and was removed. (Defrenet, 2012)</i>			

169 m<sup>-2</sup>) and absorbed 38% to 60% daily incident photosynthetic photon flux density (Q<sub>i</sub>; mean 53% ±3%)  
170 (Charbonnier *et al.*, 2013).

171 Litter was collected every 15 days using twenty-nine, 1.5 m<sup>2</sup> litter traps located on 3 transects between  
172 3 shade trees (Fig. 2). Specific leaf area (SLA) of freshly fallen coffee leaves was assessed on 200  
173 leaves (13.2 ± SD 0.7 m<sup>2</sup> kg<sup>-1</sup>). In order to infer initially produced leaf litter mass, coffee and  
174 *Erythrina* leaf decomposition rates in the litter-traps were followed during 15 typical days (07/2011)  
175 using a standard litterbag (Wang *et al.*, 2007). The decomposition rate was linear during the 15 days of  
176 observation (1.95% and 1.2% of initial dry mass per day for coffee and *Erythrina* leaves, respectively).

## 177 **B. Above-ground NPP of coffee resprouts**

### 178 **i. Destructive sampling for the design of allometric relationships and** 179 **carbon content**

180 Coffee resprouts of 3 age classes (1, 3 and 5 years after pruning) grown either in the open or under  
181 shade tree crowns were harvested with 2 repetitions per treatment. Length, diameter and number of  
182 nodes per axis were recorded and each axis was identified (position and order), dried and weighed  
183 separately to obtain the biomass of orthotropic stems, plagiotropic branches, and leaves. Different  
184 allometric models were applied to orthotropic and plagiotropic branches. No difference was detected  
185 in equation coefficients neither between resprout age nor between shade and open. The allometric  
186 equations were validated on a dataset of 12 coffee resprouts measured the same way than the initial  
187 dataset (Table 1).

188 Leaves were separated by age, shade condition and vertical position in the resprout (high, middle and  
189 lower position). Fresh leaves were scanned with a LI-3100C area meter (LI-COR, NE, USA), oven-  
190 dried and weighed. Specific leaf area (SLA) decreased significantly with higher position in the crown.  
191 No difference was detected between resprout age or shade condition. Mean leaf area was found to vary  
192 according to shade and position in the crown (Table 2). Carbon content was assessed with a CHN  
193 analyzer (EA/NA2000, Carlo Erba Fisons, Milano, Italy). No difference was detected between shade  
194 and position in the crown, so carbon content was averaged by compartment (Table 3)(Cambou, 2012).

### 195 **ii. Statistical design for monitoring plant NPP**

196 Individual coffee resprouts were chosen as the experimental unit in the statistical design. 60 coffee  
197 resprouts were randomly selected in 5 blocks with 2 shade conditions (under shade tree crown and in  
198 the open) and 6 age classes (Fig. 2). Within each sub-block, we selected one coffee resprout per age  
199 class. The sampling respected the frequency distribution of the number of resprouts per coffee plants  
200 observed in the 08/2010 inventory (Charbonnier *et al.*, 2013). Measurements started in March 2011 at

**Table 2** – Mean leaf area (MLA) and specific leaf area (SLA) of 12 resprouts as a function of the light environment and of the position in the crown (3 heights). For each resprout, leaves were pooled by position in the crown. Different letters indicate statistically different values using a LSD-Fisher test ( $p < 0.05$ ).

	Light condition		Position in the coffee resprout crown		
	Under shade tree crown	In the open	High	Medium	Low
<i>N</i> of coffee resprouts	6	6	4	4	4
Mean leaf area (cm <sup>2</sup> )	27.5 ± SD 7.6 <sup>A</sup>	21.7 ± SD 4.1 <sup>B</sup>	20.5 ± SD 5.2 <sup>C</sup>	24.4 ± SD 7.1 <sup>B</sup>	28.1 ± SD 5.2 <sup>A</sup>
SLA (m <sup>2</sup> .kg <sup>-1</sup> )	12.0 ± SD 1.7 <sup>NS</sup>	11.3 ± SD 1.9 <sup>NS</sup>	10.0 ± SD 1.3 <sup>C</sup>	11.6 ± SD 1.4 <sup>B</sup>	13.3 ± SD 1.1 <sup>A</sup>

**Table 3** – Carbon content of coffee and Erythrina compartments

		%C±SD	N
<i>Coffea</i> *	Leaves	46.2±1.03	46
	Branches	46.3±0.99	58
	Fruits	48.6±0.37	100
	Stump	47.7±0.43	53
<i>Erythrina</i> **	Leaves	56.2	ND
	Branches and trunk	43.8	ND

\*Cambou, 2012. Measurements performed in our study site

\*\*Oelbermann et al. (2005), table 1, 19 years old, fertilized trees.

201 the blossoming season and were achieved 2 years later. After the first year of measurements, the 5  
202 year-old sample resprouts were pruned and replaced by newly-emitted resprouts (0 year-old).

203 The transmittance of shade trees computed at a half-hourly time-step and integrated over one year was  
204 modeled using MAESTRA (Charbonnier *et al.*, 2013; Duursma and Medlyn, 2012; Medlyn, 2004)  
205 above each sampled resprout and used as a covariate in the experiment. It ranged between 0.3 and  
206 almost 1. Photosynthetic active radiation absorbed by each individual resprout (aPAR) was computed  
207 using MAESTRA.

### 208 **iii. Biomass measurements and NPP calculations**

209 Resprout dimensions were recorded every 2 months (12 measurements over the experiment) and  
210 converted into biomass using the allometric equations (Table 1). Mean leaf area was calculated at each  
211 date from a systematic sample of leaves: during a session, all resprout leaves were counted (up to 4000  
212 leaves present per resprout, one leaf every twenty was measured for leaf area). The length and basal  
213 diameter of all plagiotropic axes were measured as well as the length and middle diameter of the  
214 orthotropic segments. For fruits, the yearly total harvested biomass was considered. Height, basal  
215 diameter and crown diameter of the neighbor resprouts (in a 2 m radius) were also measured to  
216 document the light environment in MAESTRA.

217 NPP was computed in each compartment as  $NPP = \Delta B + L$  where  $\Delta B$  is the biomass difference (increase  
218 or decrease) and  $L$  is the litter produced between 2 measurements (see Table 4 for calculation details).

219 Leaf and fruit litter production per resprout was estimated from the plot litter collected in the traps  
220 (Table 4). . Branch litter production was erratic and could not be inferred satisfactorily using litter  
221 traps; it was retrieved from loss of length for a particular plagiotropic branch; the fallen segment  
222 biomass was retrieved from the previous measurement session.

223 NPP of fruit production during a year was considered to be the sum of harvested biomass plus litter  
224 production.

225 Stump NPP was calculated from allometric relationships established using stump basal area as a  
226 predictor (Table 1) (Defrenet, 2012) and annual ring width increments. First, we checked on stumps of  
227 known age taken from a location without marked seasonal drought that the number of observed rings  
228 did correspond to the stump actual age (12 years-old stumps from ICAFE experimental station in  
229 Perez Zeledon, Costa Rica (Khack, 2012). Second, ring widths were measured on 10 stumps of our  
230 plot selected in a range of basal area. Ring width (RW; mm) of year  $n$  was increasing logarithmically  
231 with stump basal radius ( $D_k/2$ ) of year  $n-1$  (Table 4).

**Table 4 – NPP compartment calculations**

<b>COFFEE RESPROUT NPP</b>		
<b>Component</b>	<b>NPP calculation</b>	<b>Description &amp; remarks</b>
Orthotropic branch (g <sub>DM</sub> dt)	$NPP_{ortho} = \sum_{i=1}^I (B_{ortho,i}(n) - B_{ortho,i}(n-1)) + B_{ortho,new}$	$B_{ortho,i}(n)$ is the allometric biomass in time $n$ of the $i^{th}$ orthotropic segment among a total of $N$ segments already present in $(n-1)$ .
Plagiotropic branches (g <sub>DM</sub> dt)	$NPP_{plagio} = \Delta \text{plagiotropic biomass} + \text{branches litter production}$ $NPP_{plagio} = \sum_{i=1}^I B_{plagio,i}(n) - \sum_{j=1}^J B_{plagio,j}(n-1) + \sum_{k=1}^K L_{plagio,k}(n-1 \rightarrow n)$	$B_{plagio,i}$ is the biomass of the $i^{th}$ plagiotropic branch among a total of $I$ existing plagiotropic branches at time $n$ . $B_{plagio,j}$ is the biomass of the $j^{th}$ plagiotropic branch among a total of $J$ in $(n-1)$ . $L_{plagio,k}$ is the necromass of the $k^{th}$ plagiotropic branch fallen between $(n-1)$ and $(n)$ , detected during the biometric measurement.
Leaves (g <sub>DM</sub> dt)	$NPP_{leaves} = \Delta \text{leaf biomass} + \text{leaf litter production}$ $NPP_{leaves} = \left( \sum_{H=1}^{H=3} nb_{leaves,H}(n) * MLA_H(n) * \frac{1000}{SLA_H} \right) - \sum_{H=1}^{H=3} \left( nb_{leaves,H}(n-1) * MLA_H(n-1) * \frac{1000}{SLA_H} \right) + L_{leaves,plot}(n-1 \rightarrow n) * \frac{B_{leaves}(n)}{B_{leaves,plot}(n-1)}$	$nb_{leaves,H}$ is the number of leaves in the crown position $H$ , $MLA_H(n)$ the mean leaf area ( $m^2$ ) in crown position $H$ at time $(n)$ , $SLA_H$ is the specific leaf area at crown position $H$ ( $m^2 kg^{-1}$ ). Leaf litter production of every coffee resprout was estimated after weighting leaf litter produced at the plot level between $n-1$ and $n$ by the ratio between the resprout leaf biomass, $B_{leaves}(n)$ , and the plot leaf biomass $B_{leaves,plot}(n-1)$ . $B_{leaves,plot}(n-1)$ was estimated with proxy-NDVI using the mean SLA value measured with dataset presented in Table 3 ( $11.32 m^2 kg_{DM}^{-1}$ ). Leaf litter was collected every 15 days and corrected for decomposition.
Fruit (g <sub>DM</sub> dt)	$NPP_{fruit} = \text{Harvested fruit biomass} + \text{fruit litter production}$ $NPP_{fruit} = \sum_{n=1}^{NH} BH(nh) + \left( \sum_{n=1}^{NH} \sum L_{fruit,plot} * \frac{BH(n)}{\sum BH_{fruit,plot}} \right)$	$BH$ is the resprout harvested biomass during the $n^{th}$ harvest. Fruit litter produced by the resprout was calculated after weighting fruit litter produced during the year at the plot scale ( $L_{fruit,plot}$ ) by the ratio between the resprout harvested fruit biomass and the fruit harvested at the plot scale ( $BH_{fruit,plot}$ ).
<b>COFFEE PLOT ABOVE- GROUND NPP</b>		
Resprout wood (Mg <sub>DM</sub> ha <sup>-1</sup> dt)	$NPP_{wood,plot} = \sum_{age=0}^5 F_{age} * (NPP_{ortho,age} + NPP_{plagio,age}) * \frac{1}{1000}$	Plot scale resprout wood NPP for year 1 was calculated as the sum of mean resprout wood NPP per age class weighted by the frequency of resprout age ( $F_{age}$ ) observed during inventory. $1/1000$ is the ratio to convert NPP from $g m^{-2} year^{-1}$ into $Mg_{DM} ha^{-1} year^{-1}$
Leaves (Mg <sub>DM</sub> ha <sup>-1</sup> dt)	$NPP_{leaves,plot} = \Delta LAI \text{ converted into biomass} + \text{Litter production} + \Delta LAI \text{ conv. into biomass lost during pruning}$ $NPP_{leaves,plot} = (LAI_n - LAI_{n-1}) * \frac{1000}{SLA} + L_{leaves,plot} + \Delta LAI_{pruning} * \frac{1000}{SLA}$	$LAI_n - LAI_{n-1}$ is the difference of LAI between the end and the beginning of the year measured by proxy-detection with NDVI sensor. $SLA$ is the mean SLA presented in Table 3 ( $11.3 m^2 kg^{-1}$ ). $L_{leaves,plot}$ is the sum of leaf litter harvested during the year in twenty-nine, $1.5m^2$ litter traps randomly positioned in the plot. $\Delta LAI_{pruning}$ is the leaf biomass lost during pruning assessed as the difference of LAI before and after pruning (workers avoided to fall the pruned resprouts in the litter traps).
Fruits (Mg <sub>DM</sub> ha <sup>-1</sup> dt)	$NPP_{fruit,plot} = BH_{fruit,plot} + L_{fruit,plot}$	$BH_{fruit,plot}$ is the harvested fruit biomass from the entire plot and weighted at field side. $L_{fruit,plot}$ is the sum of fruit litter harvested during the year in twenty-nine, $1.5m^2$ litter traps randomly positioned in the plot.
Stump (Mg <sub>DM</sub> ha <sup>-1</sup> dt)	$NPP_{stump,plot} = \sum_{k=1}^K 36.3\pi \left[ \left( \frac{D_k(n)}{2} \right)^2 - \left( \frac{D_k(n-1)}{2} \right)^2 \right]$ <p style="text-align: center;">where: <math>D_k(n) = D_k(n-1) + 2 * \left( \ln \frac{D_k(n-1)}{2} * 0.043 + 0.18 \right)</math></p>	Stump biomass in the plot ( $k$ stumps per hectare) was assessed using an inventory $(n-1)$ of distributions of stump basal diameters ( $D$ ) converted into biomass using equation in Table 1 ( $36.3\pi$ originates from there). Stump diameter increment between $n-1$ and $n$ was estimated after studying ring growth as a function of stump radius (cm). Ring growth was related to stump radius through a logarithmic function (eq. A; $R^2=0.46$ ; $p<0.0001$ for the 2 parameters; $N=75$ )
<b>ERYTHRINA PLOT ABOVE-GROUND NPP</b>		
Trunk (Mg <sub>DM</sub> tree <sup>-1</sup> dt)	$NPP_{sh,trunk} = \Delta \text{trunk biomass}$	Increases in trunk biomass was assessed using a permanent girth-tape following method described in section 2.3.
Branches (Mg <sub>DM</sub> tree <sup>-1</sup> dt)	$NPP_{sh,branches} = \Delta \text{branch biomass} + \text{branch litter production}$	$\Delta$ branch biomass was calculated using shade tree PAI when it was completely defoliated following method described in section 2.3.
Leaves (Mg <sub>DM</sub> tree <sup>-1</sup> dt)	$NPP_{sh,leaves} = \text{leaf litter production}$	Erythrina completely defoliates every year.

#### 232 **iv. Assessing above-ground NPP of coffee using plot scale measurements**

233 At plot scale, coffee leaf NPP ( $NPP_{\text{leaf,plot}}$ ) was estimated using (i) a proxy-detection NDVI sensor  
234 (Pontailier and Hymus, 2003) recording LAI variations that were converted into biomass and (ii) litter-  
235 traps for coffee leaf litter production. Leaf NPP of the year 1 was calculated as the difference of LAI  
236 between 03/ 2011 and 03/2012 (just before pruning) and converted into biomass using the mean SLA  
237 of living leaves ( $11.3 \text{ m}^2 \text{ kg}^{-1}$ ) plus the leaf litter production during the same period (Fig. 1c; year 2  
238 from 03/2012 to 03/2013). The leaf fall due to pruning did not end-up in the litter traps, as specified to  
239 the workers. The effect of pruning on leaf area was sensed by the NDVI sensor (Fig. 1b) and  
240 introduced into leaf NPP calculations (Table 4).

241 Fruit NPP at plot level was calculated each year as the sum of fruit biomass, plus litter production  
242 collected in the litter traps during the same period.

#### 243 **C. Above-ground NPP of shade trees**

244 Above-ground NPP of shade trees was computed as the sum of trunk, branches and leaves NPP (Table  
245 4). Trunk diameter was monitored on 10 trees with a permanent tree girth tape (UMS, München,  
246 Germany) every month. Trunk volume was modeled as a truncated cone (Picard *et al.*, 2012). Trunk  
247 height was measured with a clinometer (Suunto PM5/360PC, Finland); it did not increase  
248 significantly over time. Stem taper was estimated using a fallen tree at -4.7% loss of cross-section area  
249 per meter height.

250 Evolution of branch area index (BAI) of 3 living trees was estimated when the shade trees were  
251 defoliated in March 2011, March 2012 and March 2013 using the plant canopy analyzer LAI2000 and  
252 the isolated tree procedure (Li-Cor) (Charbonnier *et al.*, 2013). BAI was converted into branch volume  
253 applying the branch frequency distribution observed on the fallen tree and multiplied by crown  
254 projected area (assumed constant within the 2 year period). Branch litter production was collected in  
255 litter traps located under shade tree crowns (Fig. 2). Wood density and branch density were 0.23 and  
256  $0.35 \text{ g}_{\text{DM}} \text{ cm}^{-3}$  for the trunk and branches, respectively. Because *Erythrina* is deciduous, leaf NPP was  
257 estimated from the biomass of leaves collected between two deciduous phases in the 29 litter traps.

#### 258 **D. Upscaling above-ground NPP to plot scale**

259 Resprout wood NPP was upscaled using the 08/2011 inventory. NPP of the first year (04/2011 –  
260 03/2012) was directly extrapolated from the inventory. For the 2<sup>nd</sup> year the 08/2011 inventory was  
261 corrected for the pruning made during March 2012. We assumed that the number of new resprouts  
262 equaled the number of pruned resprouts (*ca.* 15 %)

263 *Erythrina* NPP was upscaled using the shade tree density ( $5.2 \text{ ha}^{-1}$ ).

## 264 **E. Statistical analysis**

265 Statistical analyses were performed with R (R 2008) and Infostat (Di Rienzo *et al.*, 2011). Linear  
266 mixed models (nlme package) were used for the variance analysis of NPP compartments (wood,  
267 leaves and fruits), net assimilation rate (NAR, biomass produced per m<sup>2</sup> leaf area) and Light Use  
268 Efficiency (biomass produced per MJ of aPAR). Prior to statistical modeling, correlated explanatory  
269 variables were discarded using the generalized variance inflation factor (GVIF >3). Block was defined  
270 as a random effect. Fixed effects were resprout age (0 to 5 years) and the year of measurement.  
271 Covariates were transmittance by the shade tree integrated over the year, neighborhood crowding  
272 index (an index of intraspecific competition; see Charbonnier *et al.*, 2013) and the initial fruit load  
273 (maximum number of initiated fruits at the beginning of the year, expressed in number of fruits per  
274 leaf area). Variance of the dependent variables was changing according to resprout age, thus adequate  
275 variance structure was parameterized using VarIdent in the weight option of the lme function.  
276 Homoscedasticity of Pearson's residuals was assessed visually and their normality was evaluated  
277 using a normalized Q-Q plot and Shapiro-Wilks normality test. Models were selected using a  
278 backward selection approach using the likelihood ratio test as recommended by Zuur *et al.* (2009): the  
279 starting point is the full model with all primary interaction terms. The least significant interaction  
280 terms were discarded successively until all remaining ones were highly significant (p<0.02). Then, the  
281 same method was applied on main terms not present in the interaction terms. In other words, single  
282 terms (significant or not) present in a significant interaction were kept in the model but were not  
283 considered in the results, given that their coefficient would be meaningless (Venables, 1998). Finally,  
284 the variance explained by the final model was assessed by calculating  $R_1^2$  and  $R_2^2$  for linear mixed  
285 model with one random factor (Snijders and Bosker, 1994):  $R_1^2$  and  $R_2^2$  representing the variance of  
286 the 1<sup>st</sup> and 2<sup>nd</sup> level, respectively. The advantage of this method is its ability to assess the variance  
287 explained by the random factor (*i.e.*, the difference between  $R_1^2$  and  $R_2^2$ ) (Nakagawa and Schielzeth,  
288 2013).

289 When standard error of estimation were added (*i.e.* upscaling of NPP), additive random errors were  
290 calculated by means of the error propagation theory (Taylor, 1997) as applied in Zanutelli *et al.*  
291 (2013). When two means (X and Y) and their standard errors (SE) were summed (yielding to Z), the  
292 standard error of Z was calculated following:

$$293 \quad SE_Z = \sqrt{SE_X^2 + SE_Y^2} \quad (3)$$



**Table 5** – Effects of (i) resprout age, (ii) tree shade, (iii) year of measurement, (iv) intraspecific competition and (v) initial fruit load on NPP per compartment, net assimilation rate (NAR, above-ground NPP/mean leaf area) and light use efficiency (LUE, above-ground NPP/aPAR).

	Coefficients (for covariates only)	df	F-value	p-value
<b>Above-ground NPP</b> ( $R_1^2 = 0.58$ ; $R_2^2 = 0.61$ )				
Resprout age		104	61.09	<0.0001
Year of measurement		104	6.87	0.0101
Resprout age* Year of measurement		104	2.19	0.0607
<b>Resprout wood NPP</b> ( $R_1^2 = 0.48$ ; $R_2^2 = 0.51$ )				
Resprout age		103	34.6	<0.0001
Year of measurement		103	12.4	0.0006
Intraspecific competition	-11	103	8.1	0.0052
Resprout age* Year of measurement		103	0.63	0.67
<b>Leaf NPP</b> ( $R_1^2 = 0.48$ ; $R_2^2 = 0.52$ )				
Resprout age		109	40.3	<0.0001
Initial fruit load	-0.16	109	16.1	0.0001
<b>Fruit NPP</b> ( $R_1^2 = 0.68$ ; $R_2^2 = 0.68$ )				
Resprout age		85	27.7	<0.0001
Year of measurement		85	2.6	0.11
Initial fruit load	0.21	85	131.3	<0.0001
Resprout age * Year of measurement		85	2.75	0.033
<b>Above-ground Net Assimilation Rate</b> ( $R_1^2 = 0.24$ ; $R_2^2 = 0.24$ )				
Resprout age		109	5.16	0.0003
Initial fruit load	0.06	109	11.03	0.0012
<b>Above-ground LUE</b> ( $R_1^2 = 0.26$ ; $R_2^2 = 0.37$ )				
Resprout age		90	6.43	0.0001
Shade tree transmittance	-0.72	90	8.80	<0.0039

## 294 3. Results

### 295 A. NPP of the coffee resprouts

#### 296 i. Determinants of above-ground coffee resprout NPP

297 Neither ANPP of the resprouts nor NPP of resprout compartments were affected by shade tree  
298 transmittance (Table 5). ANPP of resprouts ranged between 9 and 2170 gC year<sup>-1</sup> (mean 358 ±SD 256  
299 gC year<sup>-1</sup>) for a biomass varying from 13 to 1160 gC (mean 447 ±SD 298 gC; Fig. 3), indicating a  
300 large turnover. Total ANPP of resprouts increased quasi-linearly with age (Fig. 4a). It was  
301 significantly lower during year 2 (Year 1= 379 gC year<sup>-1</sup>, Year 2= 337 gC year<sup>-1</sup>; Fig. 4b) while mean  
302 biomass was not significantly different between the two years (data not shown). There was no  
303 interaction between resprout age and year (Table 5).

304 NPP of resprout wood (wood from stumps is not included here) represented on average 34% of above-  
305 ground coffee resprout NPP (Fig 5). It varied in parallel to total resprout ANPP: it increased almost  
306 linearly with resprout age and was slightly but significantly lower in year 2 (Fig. 4c & d) and was  
307 negatively affected by the intraspecific competition (Table 5).

308 Leaf NPP ranged from 2 to 476 gC year<sup>-1</sup> (Fig 3 b&c). It increased non-linearly with resprout age,  
309 starting to saturate after 4 years (Fig. 4e). Initial fruit load (the max number of initiated fruit on the  
310 resprout at the beginning of the year) was negatively correlated with leaf NPP (Table 5).

311 Fruit NPP varied from 0 (non-productive resprouts) up to 529 gC year<sup>-1</sup> (Fig 3 b&c). As expected, it  
312 was positively correlated with the initial fruit load (Table 5). Resprout age and year of measurement  
313 interacted significantly also. There was no differences in fruit NPP between years for younger  
314 resprouts (fruits were rare) while it was higher in year 1 for older resprouts (Fig. 3 and 4f), indicating a  
315 strong bi-annuality at resprout scale. Coffee resprouts belonging to the most productive quartile during  
316 the first year were nearly systematically in the quartile of the less productive plants the next year, and  
317 conversely (data not shown).

#### 318 ii. Determinants of the relative allocation of NPP to compartments

319 The impact of years 1 vs. 2, and of initial fruit load on the relative allocation of coffee resprouts ANPP  
320 to compartments are displayed in figure 5.

321 Relative allocation of ANPP to the three compartments varied with resprout age and year of  
322 measurement (Fig. 5a & b). Allocation was oriented towards wood (54%) and leaves (46%) in young  
323 resprouts. In older resprouts, the relative allocation to wood was reduced and stabilized to *ca.* 30% of  
324 ANPP. For 3-5 years old resprouts, allocation to fruits seemed the priority during year 1 (*ca.* 34-40%).  
325 During year 2, allocation to fruits was *ca.* 15% and allocation to leaves was higher (*ca.* 55%).

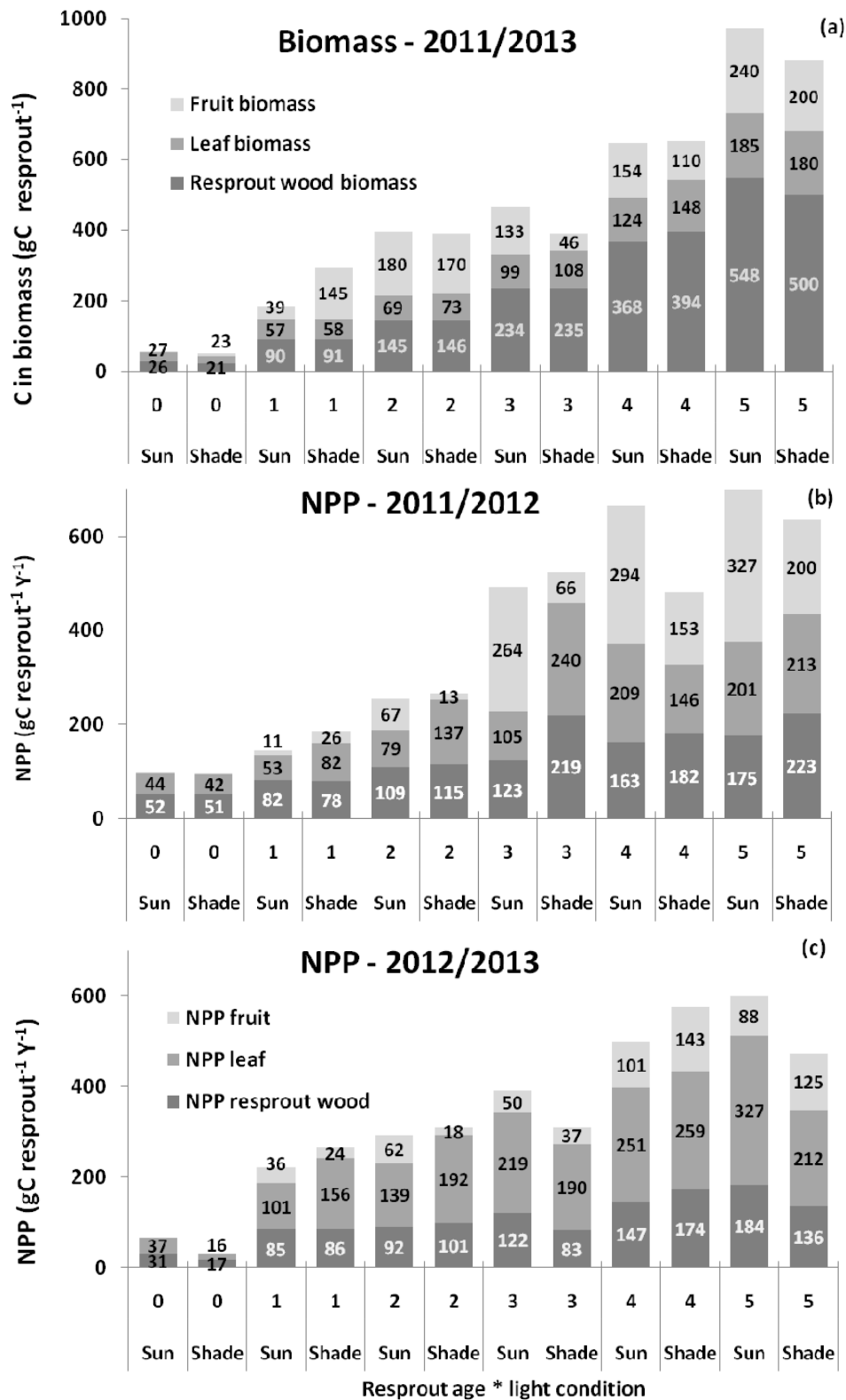

**Figure 3** – Carbon stock in biomass and NPP of coffee resprouts as a function of age and light condition (in the open vs under shade tree crown); (a) average resprout biomass (gC resprout<sup>-1</sup>) over the two years (the fruit compartment was not displayed because it would be redundant with fruit NPP) and the leaf and wood compartments were taken the average of all measurements; comparison of above ground NPP (gC resprout<sup>-1</sup> year<sup>-1</sup>) in year 1 (b) and in year 2 (c).

326 Once the initial fruit load was taken into account, the relative allocation of ANPP to the different  
327 compartments was stable with age of the productive resprouts (2-5 year-old) (Fig. 5c,d). Under a high  
328 initial fruit load (>200 fruits per m<sup>2</sup> leaves), the partitioning was approximately equal between leaves  
329 and wood (*ca.* 30%) while allocation towards fruits was about 40%. With a low fruit load (<10%  
330 allocation), allocation to the wood compartment was only slightly higher but allocation to leaves  
331 increased dramatically (from 30% to 55%). Fruit to leaf NPP ratio (F/L) increased linearly with the  
332 initial fruit load from 0 to 4.5 ( $F/L=0.004*\text{Initial Fruit Load}$ ,  $R^2=0.67$ , data not shown).

### 333 **iii. Determinants of net assimilation rate and light use efficiency**

334 Net assimilation rate (NAR) was  $154 \pm \text{SD } 48 \text{ gC m}^2_{\text{leaves}} \text{ year}^{-1}$  on average (Fig. 6 b&c). A high fruit  
335 load increased NAR by 26% when compared to a low fruit load (data not shown). Mean light use  
336 efficiency of the resprouts (LUE;  $\text{gC MJ}_{\text{aPAR}}^{-1}$ ) was  $0.53 \pm \text{SD } 0.50 \text{ gC MJ}_{\text{aPAR}}^{-1}$  on average (Fig. 6  
337 b&c).

338 LUE decreased at the rate of  $0.07 \text{ gC MJ}_{\text{aPAR}}^{-1}$  every 10% increase in shade tree transmittance (e.g. for  
339 4 years-old resprouts Fig. 6a) while aPAR increased strongly with increasing shade tree transmittance.  
340 It resulted that NAR was not significantly affected by shade tree transmittance (Table 5). A 50% shade  
341 tree transmittance decreased by about 60% the absorbed PAR per unit leaf area ( $\text{aPAR}_{\text{LA}}$ ) of 4 years  
342 old coffee resprouts while their LUE increased by about 50%, resulting into a slight but non-  
343 significant decrease in NAR (Fig. 6).

344 NAR was affected by resprout age: it increased progressively until year 2, remained stable during  
345 years 3-4 and finally decreased the last year (Table 5; Fig. 6b & c). It was explained by the  
346 combination of a decrease in LUE with resprout age and a saturation of absorbed PAR for older  
347 resprouts.

348 Erythrina mean LUE was close to the higher range of coffee LUE ( $0.82 \text{ gC MJ}^{-1}$ ). NAR was much  
349 higher in Erythrina than in coffee ( $879$  and  $809 \text{ gC m}_{\text{leaves}}^{-2} \text{ year}^{-1}$  for year 1 and 2, respectively).

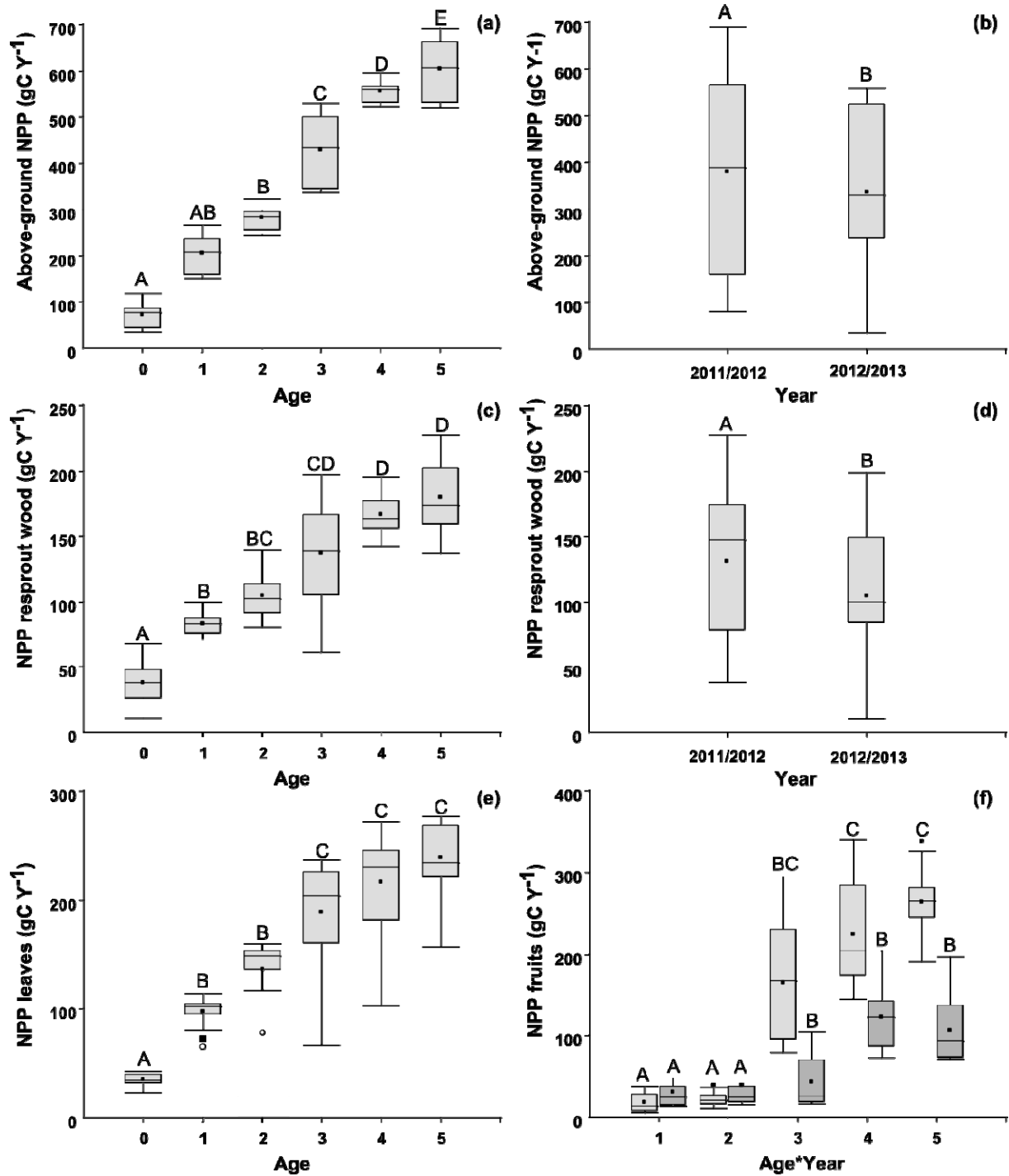
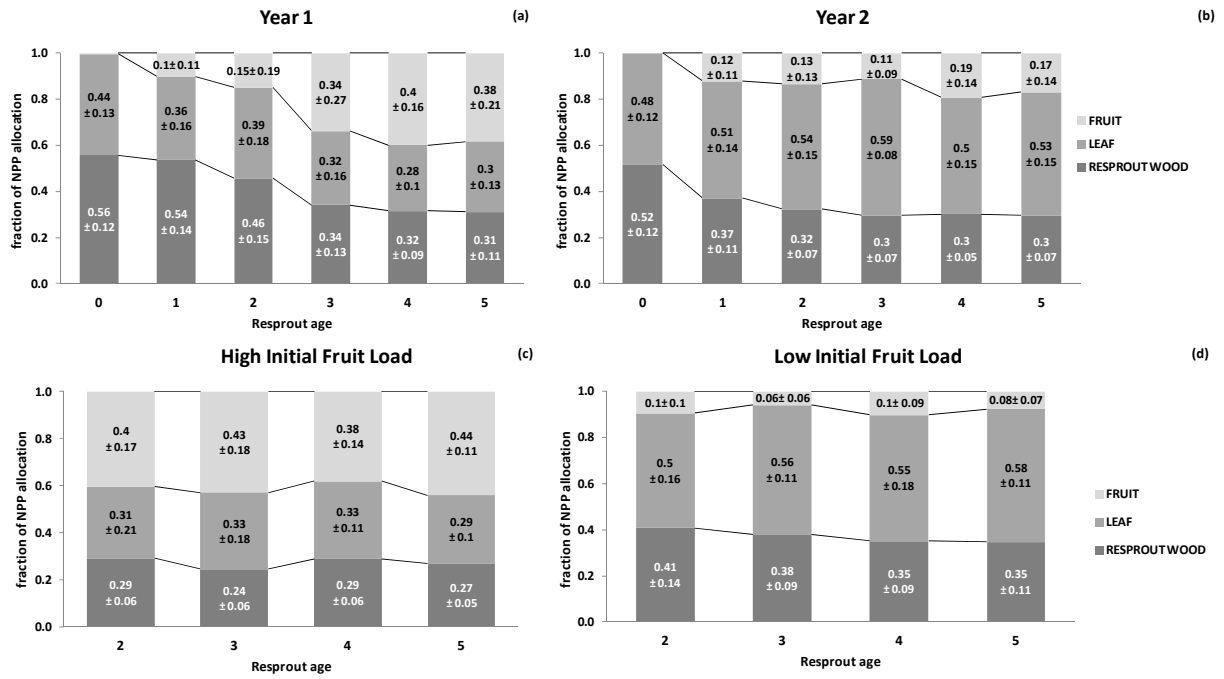

**Figure 4** – Box plots for total above-ground NPP of individual resprouts, NPP of leaves, resprout wood and fruits, as a function of resprout age, year and a combination of year and age. Lines in the boxes: median, points: arithmetical mean, frames: interval between first and third quartiles; and error bars represent 3 times the standard deviation. Extreme values are reported by the circles above or below the boxes.

**B. Above-ground C stock and NPP at plot level**

350  
351 Total above-ground carbon stock (coffee (stump + resprouts) + *Erythrina*) was 2720 gC m<sup>-2</sup> with the  
352 coffee layer accounting for 60% of the total. Coffee stumps represented 62% of the coffee layer C  
353 stock. System ANPP was 820 and 900 gC m<sup>-2</sup> year<sup>-1</sup> during years 1 and 2, respectively. The coffee  
354 resprouts accounted for 78% of system ANPP. Coffee resprout wood, leaf, fruit and stump NPP  
355 represented 31%, 35%, 19% and 15% of coffee layer ANPP, respectively (Table 6). Pruned NPP  
356 represented each year about a third of resprout ANPP. The turnover of coffee above-ground  
357 compartments, as estimated by the ratio between average ANPP and biomass was ca. 40%.

358 *Erythrina* biomass represented 39% of the total biomass. Its contribution to LAI was only 14% and its  
359 ANPP was estimated at 22% of system ANPP (Table 6).



**Figure 5** – Relative allocation ( $\pm$ SD) of coffee resprout NPP to the 3 above-ground compartments (wood, leaves, fruits) according to resprout age and year of measurement (a & b); and initial fruit load (c & d) (a high initial fruit load was considered from 200 fruits per  $m^2$  leaves).

## 360 4. Discussion

### 361 A. Uncertainties in NPP estimates

#### 362 i. Sampling and scaling issues

363 Sampling strategies and verification with independent methods at different scales are keys when  
364 studying heterogeneous systems with high density planting ( $\approx 18\,000$  resprouts  $\text{ha}^{-1}$ ). We chose a fine  
365 description of NPP at twig scale for a fine study of resprout ANPP with necessarily a limited number  
366 of replications. First, we could successfully compare resprout wood NPP at plot and resprout scale  
367 because it displayed low intra-age class variability and was not influenced by fruit load. Second,  
368 reference leaf plot NPP was estimated using a NDVI proxy-detection sensor and leaf litter collected in  
369 traps. Leaf NPP was overestimated by 10% on average when using the resprout-to-plot upscaling. The  
370 overestimation was slightly larger in year 2 of measurement (Table 7). Third, reference fruit plot NPP  
371 was estimated by weighing the harvested biomass and recording fruit litter (Calculation details in  
372 Table 4). The difference in fruit NPP between the reference and the upscaling method was high. The  
373 reference method detected almost no difference in fruit NPP between year 1 and year 2. This large  
374 discrepancy between methods can be explained by the extreme variability in fruit load within the same  
375 age class, leading to possible erratic upscaling from resprout to plot. The upscaling of fruit NPP could  
376 not have been done using the resprout scale NPP without strong errors.

377 Sampling properly for vegetative vigor and for reproductive capacity simultaneously is probably  
378 extremely difficult to achieve, in a context where yield varies drastically between years for a given  
379 resprout.

#### 380 ii. Bias in NPP estimates

381 Using allometric relationships, we did not explicitly consider changes in wood density due to changes  
382 in non-structural carbohydrate content. Filling of non-structural carbohydrate pools in coffee resprouts  
383 were likely to occur during low fruit load years, leading to an underestimation of ANPP in low fruit  
384 load years. It is likely that the cycle of depletion-filling of carbohydrate pools is synchronized with the  
385 coffee plant biennial cycle and thus effect on resprout ANPP would be null when averaged over 2  
386 years. On a yearly basis, resprout ANPP due to non-structural carbohydrates can represent about 10%  
387 of total resprout ANPP (Vaast *et al.*, 2002).

388 Herbivory was not considered though it could consume a significant fraction of NPP (Clark *et al.*,  
389 2001). The coffee berry borer (*Hypothenemus hampei*) reduced by 5-25% the mean weight of perforated  
390 beans (N=1080 beans). In our experimental plot, an independent study showed that the insect had  
391 perforated only 0.8 and 1.6% of harvested beans in shaded and open areas, respectively. The  
392 consumption by the berry borer would then represent less than 1% of fruit NPP and it was neglected.



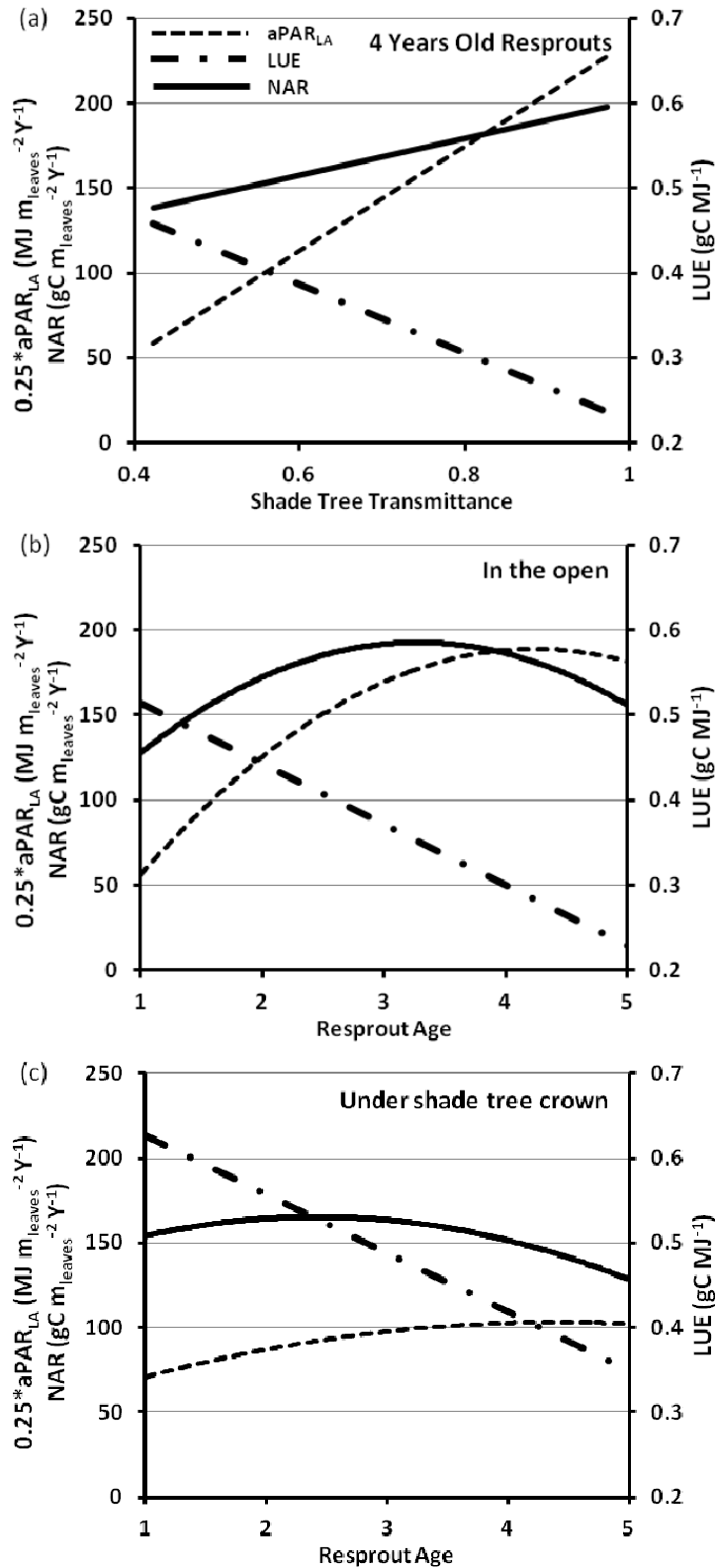

**Figure 6** – Mean absorbed PAR per unit leaf area ( $aPAR_{LA}$ ), light use efficiency (LUE) and net assimilation rate (NAR) of the coffee resprouts as a function of the transmittance of shade trees (4 years old resprout only)(a), age of resprouts growing in the open (b) and age of coffee resprouts growing under shade tree crowns (c).

393 The effects on NPP of leaf diseases such as *Mycena citricolor* or coffee rust were not explicitly  
394 quantified: the same SLA and mean leaf area was applied to all leaves.

## 395 **B. Resprout NPP and its allocation depend mainly on age and fruit load**

### 396 **i. Age effect**

397 The young resprouts needed two complete years to produce their first fruits. Juvenile stage was  
398 characterized by a vegetative build-up: more than half of resprout ANPP was allocated to the wood.  
399 Young resprouts displayed a high LUE and a low net assimilation rate. Indeed, increased LUE did not  
400 compensate for the reduced light interception due to competition by neighboring and larger resprout.

401 The first fruiting nodes were produced on the branches grown during their second year of  
402 development. Consequently, the first year of fruit production happened during the third year of  
403 development. After coffee resprouts had become productive, ANPP still increased with age. Saturation  
404 of ANPP the last year of the resprout cycle was explained by a saturation of aPAR per unit leaf area  
405 that caused decreased NAR and growth rates. The architecture of the largest coffee plants causing  
406 more self-shading may explain this aPAR saturation.

### 407 **ii. Effect of fruit load**

408 In the case of a high initial fruit load, allocation to fruit NPP raised to 40% of resprout ANPP, mainly  
409 at the expense of allocation to leaves. Cannell (1971) found a 45% increase of NAR when comparing  
410 whole plant biomass production with high and low fruit loads. He concluded that coffee fruits  
411 displayed a large sink-strength, which was confirmed later (Franck *et al.*, 2006; Vaast *et al.*, 2005).  
412 The decrease in allocation to leaves coupled with the high fruit sink strength had a negative effect on  
413 the initiation of new nodes (-10% allocation to wood compartment, mainly to plagiotropic twigs). As a  
414 consequence, during years of high fruit load, the initiation of new nodes is reduced, affecting  
415 negatively the yield components of the next year (Beaumont and Fukunaga, 1958).

416 In the case of a low fruit load, relative allocation to leaves was favored and the allocation to wood  
417 compartment was maintained.

418 Relative allocation to compartments was dependent on fruit load and independent on the age of the  
419 reproductive resprout. This highlights quite simple rules for plant modelers: relative allocation to  
420 wood compartments is quite constant and the fruit-to- leaves NPP ratio increases linearly with fruit  
421 load.

### 422 **iii. Effect of shade**

423 Shade affected the yield mainly through a decrease in the initial fruit load. It is generally reported that  
424 shade may alter yield components by favoring vegetative growth at the expense of flowering, by

**Table 6** – Main climate characteristics, stand above-ground carbon stock in biomass and NPP components during the two years of measurements. Values are mean  $\pm$  standard deviation or standard errors.

	2011/2012		2012/2013	
<b>Climate</b>				
Rainfall (mm)	3034		2686	
Mean air temperature ( $^{\circ}$ C)	19.5		19.6	
Incident PAR ( $\text{MJ Y}^{-1}$ )	2693		2699	
Diffuse radiation (%)	56%		57%	
Mean VPD (hPa)	3.55		3.57	
<b>Max LAI (<math>\text{m}^2 \text{m}^{-2}</math>)</b>				
Coffee layer	4.1		4.5	
Erythrina layer	0.59		0.65	
<b>Mean above-ground C stock (<math>\text{gC m}^{-2} \pm \text{SE}</math>)</b>				
<b>Coffee layer</b>	<b>1616 <math>\pm</math> 33</b>		<b>1722 <math>\pm</math> 41</b>	
<i>Resprout wood</i>	511 $\pm$ 25		502 $\pm$ 32	
<i>Leaf</i>	167		183	
<i>Stump</i>	938 $\pm$ 68		1037 $\pm$ 72	
<b>Erythrina layer</b>	<b>1016 <math>\pm</math> 122</b>		<b>1089 <math>\pm</math> 125</b>	
<i>Trunk</i>	512 $\pm$ 27		548 $\pm$ 28	
<i>Branch</i>	483 $\pm$ 120		518 $\pm$ 122	
<i>Leaves</i>	21.6 $\pm$ 0.3		23.8 $\pm$ 0.3	
<b>System above-ground NPP</b>				
<b>819 <math>\pm</math> 56</b>			<b>903 <math>\pm</math> 53</b>	
<b>NPP of the Coffee layer</b>				
	<b>652 <math>\pm</math> 53</b>	% coffee NPP	<b>708 <math>\pm</math> 50</b>	% coffee NPP
<b>Wood</b>	<b>222 <math>\pm</math> 17</b>	<b>34%</b>	<b>197 <math>\pm</math> 17</b>	<b>28%</b>
<i>Litter</i>	12 $\pm$ 2		17 $\pm$ 2	
$\Delta B$	210 $\pm$ 18		181 $\pm$ 17	
<sup>1,2</sup> <i>Pruning</i>	141		154	
<b>Leaves</b>	<b>213</b>	<b>33%</b>	<b>270</b>	<b>38%</b>
<sup>1</sup> <i>Litter</i>	193		232	
<sup>1</sup> $\Delta B$	-31		-6	
<sup>1,3</sup> <i>Pruning</i>	52		44	
<b>Fruits</b>	<b>121</b>	<b>19%</b>	<b>139</b>	<b>20%</b>
<sup>1</sup> <i>Litter</i>	2.3		1.3	
<sup>1</sup> <i>Export</i>	118		138	
<b>Stumps</b>	<b>97 <math>\pm</math> 1.3</b>	<b>15%</b>	<b>102 <math>\pm</math> 1.3</b>	<b>14%</b>
<b>NPP of the Shade tree layer</b>				
	<b>167 <math>\pm</math> 18</b>	% Erythrina NPP	<b>195 <math>\pm</math> 19</b>	% Erythrina NPP
<b>Trunk</b>	<b>35 <math>\pm</math> 4</b>	<b>21%</b>	<b>37 <math>\pm</math> 4</b>	<b>19%</b>
<b>Branches</b>	<b>41 <math>\pm</math> 1</b>	<b>25%</b>	<b>48 <math>\pm</math> 8</b>	<b>24%</b>
<i>Litter</i>	11 $\pm$ 1		9 $\pm$ 0	
$\Delta B$	31 $\pm$ 0		39 $\pm$ 8	
<b>Leaves</b>	<b>89 <math>\pm</math> 18</b>	<b>51%</b>	<b>84 <math>\pm</math> 15</b>	<b>43%</b>
<b>Flowers</b>	<b>5 <math>\pm</math> 2</b>	<b>3%</b>	<b>27 <math>\pm</math> 7</b>	<b>14%</b>
<b>Leaf lifespan (days)</b>				
Coffee leaves	287		295	
Erythrina leaves	92		104	

<sup>1</sup>No error term is presented because they are overall measurements without defined uncertainties; <sup>2</sup>Pruned wood biomass was quantified with field inventories

425 decreasing the number of fruiting nodes (increase in inter-nodes length), and by decreasing the number  
426 of fruit per nodes (DaMatta, 2004). In our study, no difference was detected between sun and shaded  
427 resprouts unlike in other studies (DaMatta, 2004; Franck, 2005).

428 There is also a disagreement about the plasticity of coffee leaves as elicited by shade : Franck and  
429 Vaast (2009) reported an increase of mean leaf area and specific leaf area under shade while Chaves *et*  
430 *al.* (2008) described a low leaf plasticity to shade. In our study, we detected an increase of individual  
431 leaf area in shaded resprouts with no change in SLA. .

#### 432 **iv. Biennial bearing**

433 Under full irradiance conditions, coffee plants invest a considerable amount of energy to ensure the  
434 reproductive success with a depressive effect of fruit load on source organs (decreased leaf NPP) and  
435 depletion of non-structural carbohydrates in woody tissues (Cannell, 1970; Franck, 2005).  
436 Additionally, coffee plants do not display proper fruit abortion mechanisms. During abiotic stress such  
437 as drought they rather completely defoliate than dropping fruits (Cannell, 1985b). Nevertheless, we  
438 observed a larger fruit abortion in year 1 where yield was higher than in year 2. Fruit abortion could  
439 possibly be positively correlated with fruit load, as observed also in coconut tree (Navarro *et al.*,  
440 2008).

441 In other words, branch nodes emitted in year 1 will bear coffee berries in year 2. During a year with a  
442 high fruit load, the coffee plant will invest more assimilates into fruits at the expense of the emission  
443 of new branch nodes (and new leaves), leading to a decrease of fruit production in year 2 (Vaast *et al.*,  
444 2005). This ecological strategy leads to a strong biennial bearing potential, even for young plants  
445 (Cannell, 1985b). Tree shade can buffer the biennial bearing by limiting initial fruit load (Cannell,  
446 1985b; DaMatta, 2004), as in our experiment where there was no fruit production biennial effect for  
447 coffee resprouts growing under the shade tree crown but large biennial effect for resprouts growing in  
448 the open.

449 However, in our study, alternate bearing was detected only in our 60 experimental resprouts, not at the  
450 plot scale. We hypothesize that the absence of clear dry season in our experimental site might explain  
451 partly this absence of plant synchronization at the plot scale.

#### 452 **C. The compensation effect of LUE on ANPP in shaded resprouts**

453 Huxley (1967) studied NAR of coffee seedlings under a gradient of irradiance and found inconsistent  
454 results in the literature. He explained this discrepancy by the variability in plant size among studies  
455 and the effect of self and mutual shading. We found no trend neither in NAR with respect to tree  
456 shade. However, we were able to disentangle the effect of shading from the effect of plant size by  
457 reformulating NAR into its two components:  $aPAR_{LA}$  and LUE.  $aPAR_{LA}$  decreased drastically with  
458 shade and local competition (Charbonnier *et al.*, 2013). Increased LUE allowed coffee plant NAR,

**Table 7** – Comparison of harvested fruit biomass upscaled from resprout to plot level using inventories with the biomass of harvested fruits (on the 2.7 ha experimental plot). Comparison of leaf NPP upscaled from resprout to plot using inventories with leaf NPP calculated directly at the plot level by remote sensing.

	<b>2011-2012</b>	<b>2012-2013</b>		<b>Mean</b>
Biomass assessed from fruit harvest (gC m <sup>-2</sup> )	118	138	+16%	128
<sup>1</sup> Fruit biomass estimated from resprout extrapolation (gC m <sup>-2</sup> )	231 ± 22 +95%	90 ± 21 -35%	-61%	161 +25%
Coffee leaf NPP calculated from NDVI & litter traps (gC m <sup>-2</sup> Y <sup>-1</sup> )	213	270	+27%	241
<sup>1</sup> Coffee leaf NPP extrapolated from resprout measurements (gC m <sup>-2</sup> Y <sup>-1</sup> )	222±26 +5%	313±22 +16%	+41%	268 +11%

<sup>1</sup>The extrapolation technique from resprout to plot was conducted the same way that resprout wood NPP

459 thus ANPP (*i.e.* LA\*NAR), to be maintained even under shade. Indeed, no effect of shade tree  
460 transmittance was found in the statistical analysis of the determinants of NPP.

461 LUE mainly depends on two underlying processes: photosynthesis and respiration, although allocation  
462 also affects LUE on a longer term. It is the result of complex processes and its variations are not trivial  
463 to predict (*e.g.* van Oijen *et al.*, 2004). Five main hypotheses could explain an increased LUE in  
464 shaded resprouts.

465 *Hypothesis 1:* Leaf photosynthesis is related to the absorbed light through a rectangular hyperbola  
466 (Caemmerer and Farquhar, 1981; Medlyn, 1998). The derivative of this relation, leaf LUE, is much  
467 steeper at low incident light. Franck and Vaast (2009) reported that the daily kinetic of leaf  
468 photosynthesis under a 55% reduction of the incident radiation was not significantly different from  
469 that of a leaf under full incident radiation. Coffee photosynthesis saturating at low incident PAR  
470 values ( $\sim 500 \mu\text{mol m}^{-2} \text{s}^{-1}$ ) (DaMatta *et al.*, 2008b), it can be argued that shaded leaves are always  
471 under a non-saturating range of incident PAR. Their photosynthesis is thus always on the most  
472 efficient range of light conversion.

473 *Hypothesis 2:* an increased fraction of diffuse light may enhance LUE, according to Norman and  
474 Arkebauer (29 Nov. 1988) and Anderson *et al.* (2000). In our study, shade trees were shown to  
475 increase the proportion of diffuse radiation under their canopy by 60% to 90% which would result in  
476 an increase by *ca.* 30% of LUE (Charbonnier *et al.*, 2013) according to their model.

477 *Hypothesis 3:* The increased LUE could be explained by the decrease of tissue respiration in the  
478 shaded resprouts. Indeed, tissue respiration depends on temperature (Tjoelker *et al.*, 2001) and shade  
479 trees are known to buffer maximum ambient temperature (Siles *et al.*, 2010). A decrease of 3°C of the  
480 maximum temperature under shade trees (Siles *et al.*, 2010) would lead to a decrease of 25% of  
481 maintenance respiration for a  $Q_{10}$  of 2.4 (Charbonnier *et al.*, in prep.).

482 *Hypothesis 4:* Shading leads to a modification of leaf traits (higher SLA and chlorophyll content),  
483 yielding a more efficient photosynthesis (higher quantum yield and lower light compensation point)  
484 (Evans and Poorter, 2001; Niinemets, 2010). Such changes to coffee leaf anatomy were often reported  
485 in the literature (Franck, 2005; Friend, 1984; Morais *et al.*, 2004). However, apart from an increase in  
486 mean leaf area under shade, we could not evidence any changes in SLA.

487 *Hypothesis 5:* Total below-ground carbon allocation (TBCA) could have been modified, according to  
488 the distance to tree, as a consequence of below-ground competition for instance. Pits in the same  
489 experimental plot indicated that coffee root impacts were actually more numerous below shade than in  
490 the open (6 profiles 0-1.5 m, data not shown), suggesting a higher root biomass below-shade.  
491 Moreover, results from sequential coring (data not shown) indicated no shade effect on fine root NPP  
492 and turnover (Defrenet, 2012). Altogether, those results indicated that the shade effect reported here

493 for above-ground coffee LUE was probably not impaired when considering also the belowground  
494 compartment.

495 Few studies on other crops mainly cultivated in alley-cropping could demonstrate an increased LUE  
496 under shade : i) +26% for groundnut with a decrease of transmitted light of 50%; ii) +27% for millet  
497 with a decrease of irradiance of 50% (Monteith *et al.*, 1991); iii) + 20% for lettuce with a 33%  
498 decrease of irradiance (Dapoigny *et al.*, 2000). Such increases were low compared to those recorded in  
499 our study: LUE was nearly doubled when the transmitted light was reduced by 50%. The reason could  
500 be that microclimate is less altered in alley-cropping compared to AFS (Monteith *et al.*, 1991). Ong *et*  
501 *al.* (1991) suggested that an increased LUE in AFS was unlikely except for shade tolerant species.  
502 Until now, the framework of a conservative LUE was widely applied in crop models, even in  
503 agroforestry (Monteith and Moss, 1977; Monteith *et al.*, 1991).

504 A 3D light interception model combined with biometric measurements allowed us to highlight a large  
505 variability of above-ground LUE in the AFS plot. While available light was decreased under shade  
506 trees, coffee resprout ANPP was maintained thanks to an increased LUE. The explanations leading to  
507 such an increase are numerous and difficult to disentangle between each other. An ongoing research  
508 dedicated to measurements and modeling of plant scale photosynthesis and respiration according to a  
509 gradient of shade should help identifying and quantifying the effects of each hypothesis on LUE.

#### 510 **D. Toward C balance closure in a coffee AFS**

511 Above-ground biomass of coffee estimated in our study at *ca.* 16.5 tC ha<sup>-1</sup> was higher than reported in  
512 the literature because of the 40 years old stumps accounting for 60% of coffee above ground biomass.  
513 Siles *et al.* (2010) and Alpizar *et al.* (1985) reported coffee above-ground carbon stock ranging from 4  
514 to 12 MgC ha<sup>-1</sup> varying with planting density in rather young plantations.

515 Pruning was the most influential management practice on the coffee plant carbon cycle. Every year,  
516 pruning removed 35% of the coffee resprout ANPP (labile part, stumps not included) which  
517 corresponded approximately to the yearly increase in resprout biomass (ignoring the fruits). Thus, the  
518 annual pruning maintained the labile part of the coffee layer to certain equilibrium. Coffee stumps and  
519 shade trees were storing carbon above-ground at the rate of 100 and 70 gC m<sup>-2</sup> Y<sup>-1</sup>, respectively. This  
520 represented a carbon stock increase of 20% of ANPP.

521 AFS ANPP was close to the mean value of tropical evergreen NPP mentioned in a recent meta-  
522 analysis (864 gC m<sup>-2</sup> Y<sup>-1</sup>; Luysaert *et al.*, 2007). Our NPP point fitted well within the global database  
523 describing NPP of multiple sites as a function mean temperature and annual precipitation. As a first  
524 estimation, we would have to add about a quarter to a third of ANPP to obtain total NPP (unpublished  
525 data).

## 526        **5. Conclusions**

527        Main determinants of coffee resprouts ANPP in a coffee AFS were mainly due to resprout age and  
528        fruit load. An important aspect presented in this paper was the absence of effect of shade trees on  
529        coffee resprout ANPP.

530        We could evidence an important compensation effect in an agroforestry system. Light budgets of  
531        shaded plants, quantified through a plant-centered modeling approach, were known to decrease  
532        strongly under shade tree crown. However, based on an epsilon model approach (Monteith), we  
533        showed an important increase in coffee LUE under shade trees that totally compensates for the  
534        decrease in available light. Effect of shade tree transmittance on LUE was quantified and varied  
535        according to resprout age. Older resprouts were shown to have a lower LUE and a saturation of aPAR,  
536        normalized per unit of leaf area, suggesting a less optimal architecture for light interception (self-  
537        shading).

538        Plot scale estimations of NPP provided one of the first complete dataset of above-ground NPP in an  
539        agro-forestry system. Further ongoing studies on below-ground NPP, canopy photosynthesis and  
540        respiration, soil respiration will complete the database for a full cross-validation of fluxes with eddy-  
541        covariance measurements.

## 542        **6. Acknowledgements**

543        The authors would like to thank CIRAD for providing the PhD scholarship of Fabien Charbonnier,  
544        CATIE for laboratory facilities and AQUIARES farm for hosting the Coffee-Flux platform since 2009.  
545        The work was supported by EU-CAFNET Project, SOERE F-ORE-T observatory network, ANR-  
546        Ecosfix project, ANR-MACACC project, PCP platform of CATIE, BID Fontagro Caf' Adapt project.  
547        The authors wish to warmly thank Alvaro Barquero Navarro for help in installation and maintenance  
548        of the experimental display; Jenny Barquero Aguillar, Cindy Rojas Aguillar, Mariella Jara Vargas,  
549        Carlos Calvo Barquero, Rodrigo Calvo Pereira for data collection in the field; Grace Granados  
550        Barquero for ring growth analysis. Thank you to Bernard Barthes for his help with NIRS  
551        measurements and statistical analysis. Satellite image was provided by DigitalGlobe.



## 552 7. References

- 553 Alpizar, L., Fassbender, H.W., Heuveland, J., Enriquez, G., Folster, H., 1985. Agroforestry Systems of  
554 Coffee (*Coffea arabica*) with Laurel (*Cordia alliodora*) and Poro (*Erythrina poeppigiana*) in Turrialba,  
555 Costa-Rica .1. Biomass and Nutrients. Turrialba 35, 233-242.
- 556 Anderson, M.C., Norman, J.M., Meyers, T.P., Diak, G.R., 2000. An analytical model for estimating  
557 canopy transpiration and carbon assimilation fluxes based on canopy light-use efficiency. Agricultural  
558 and Forest Meteorology 101, 265-289.
- 559 Baldocchi, D.D., 2003. Assessing the eddy covariance technique for evaluating carbon dioxide  
560 exchange rates of ecosystems: past, present and future. Global Change Biology 9, 479-492.
- 561 Barros, R.S., Maestri, M., Rena, A.B., 1995. Coffee Crop Ecology. Tropical Ecology 36, 1-19.
- 562 Beaumont, J.H., Fukunaga, E.T., 1958. Factors Affecting the Growth and Yield of Coffee in Kona,  
563 Hawaii Hawaii Agricultural Experiment Station Bulletin of the American Meteorological Society 113,  
564 40 p.
- 565 Beer, C., Reichstein, M., Tomelleri, E., Ciais, P., Jung, M., Carvalhais, N., Rodenbeck, C., Arain, M.A.,  
566 Baldocchi, D., Bonan, G.B., Bondeau, A., Cescatti, A., Lasslop, G., Lindroth, A., Lomas, M., Luyssaert,  
567 S., Margolis, H., Oleson, K.W., Rouspard, O., Veenendaal, E., Viovy, N., Williams, C., Woodward, F.I.,  
568 Papale, D., 2010. Terrestrial Gross Carbon Dioxide Uptake: Global Distribution and Covariation with  
569 Climate. Science 329, 834-838.
- 570 Bernardes, T., Moreira, M.A., Adami, M., Giarolla, A., Rudorff, B.F.T., 2012. Monitoring Biennial  
571 Bearing Effect on Coffee Yield Using MODIS Remote Sensing Imagery. Remote Sensing 4, 2492-2509.
- 572 Caemmerer, S., Farquhar, G.D., 1981. Some relationships between the biochemistry of  
573 photosynthesis and the gas exchange of leaves. Planta 153, 376-387.
- 574 Camargo, A.P.d., Camargo, M.B.d., 2001. Definition and outline for the phenological phases of  
575 arabica coffee under brazilian tropical conditions. Agrometeorologia, Bragantia Campinas 60(1), 65-  
576 68.
- 577 Cambou, A., 2012. Mesures des sucres lents et rapides d'organes de caféier par double approche  
578 VISNIR et Biochimique. ENSAIA, Nancy, p. p. 30.
- 579 Cannell, M.G.R., 1970. The contribution of carbohydrates from vegetative laterals to the growth of  
580 fruits on the bearing branches of *Coffea arabica*. Turrialba 20, p.15-19.
- 581 Cannell, M.G.R., 1971. Production and distribution of dry matter in trees of *Coffea arabica* L. in Kenya  
582 as affected by seasonal climatic differences and the presence of fruits. Annals of Applied Biology 67,  
583 99-120.
- 584 Cannell, M.G.R., 1975. Crop physiological aspects of coffee bean yield: A review. J. Coffee Res. 5, 7-  
585 20.

- 586 Cannell, M.G.R., 1985a. Dry matter partitioning in tree crops, in: Cannell, M.G.R., Jackson, J.E. (Eds.),  
587 Attributes of trees as crop plants. Abbots Ripton, Institute of Terrestrial Ecology, pp. 160-193.
- 588 Cannell, M.G.R., 1985b. Physiology of the coffee crop, in: Clifford, M.N., Willson, K.C. (Eds.), Coffee:  
589 Botany, Biochemistry and Production of Beans and Beverage. Croom Helm, London, pp. 108-134.
- 590 Charbonnier, F., le Maire, G., Dreyer, E., Casanoves, F., Christina, M., Dauzat, J., Eitel, J.U.H., Vaast, P.,  
591 Vierling, L.A., Roupsard, O., 2013. Competition for light in heterogeneous canopies: Application of  
592 MAESTRA to a coffee (*Coffea arabica* L.) agroforestry system. Agricultural and Forest Meteorology  
593 181, 152-169.
- 594 Charbonnier, F., Roupsard, O., Dreyer, E., Bonnefond, J.M., Christina, M., Jarri, L., Siles, P., Rapidel ,  
595 B., Harmand, J.M., Vaast, P., Nouvellon, Y., Robelo, A., le Maire, G., in prep. Modeling the intra-plot  
596 variability of Light and Water Use efficiencies in a 2-layered heterogeneous coffee (*Coffea arabica* L.)  
597 agroforestry system. To be submitted to Plant, Cell & Environment.
- 598 Chaves, A.R.M., Ten-Caten, A., Pinheiro, H.A., Ribeiro, A., DaMatta, F.M., 2008. Seasonal changes in  
599 photoprotective mechanisms of leaves from shaded and unshaded field-grown coffee (*Coffea arabica*  
600 L.) trees. Trees-Structure and Function 22, 351-361.
- 601 Clark, D.A., Brown, S., Kicklighter, D.W., Chambers, J.Q., Thomlinson, J.R., Ni, J., 2001. Measuring net  
602 primary production in forests: concepts and field methods. Ecological Applications 11, 356-370.
- 603 DaMatta, F.M., 2004. Ecophysiological constraints on the production of shaded and unshaded coffee:  
604 a review. Field Crop. Res. 86, 99-114.
- 605 DaMatta, F.M., Cunha, R.L., Antunes, W.C., Martins, S.C.V., Araujo, W.L., Fernie, A.R., Moraes,  
606 G.A.B.K., 2008a. In field-grown coffee trees source-sink manipulation alters photosynthetic rates,  
607 independently of carbon metabolism, via alterations in stomatal function. New Phytologist 178, 348-  
608 357.
- 609 DaMatta, F.M., Ronchi, C.P., Maestri, M., Barros, R.S., 2008b. Ecophysiology of coffee growth and  
610 production. Brazilian Journal of Plant Physiology 19, 485-510.
- 611 Dapoigny, L., de Tourdonnet, S., Roger-Estrade, J., Jeuffroy, M.-H., Fleury, A., 2000. Effect of nitrogen  
612 nutrition on growth and nitrate accumulation in lettuce (*Lactuca sativa* L.), under various conditions  
613 of radiation and temperature. Agronomie 20, 843-855.
- 614 De Pury, D.G.G., Farquhar, G.D., 1997. Simple scaling of photosynthesis from leaves to canopies  
615 without the errors of big-leaf models. Plant, Cell & Environment 20, 537-557.
- 616 de Reffye, P., Fourcaud, T., Blaise, F., Barthélémy, D., Houllier, F., 1997. A functional model of tree  
617 growth and tree architecture. Silva Fennica 31, 297-311.
- 618 Defrenet, E., 2012. Evaluation de la biomasse et de la productivité souterraine du caféier dans un  
619 système agroforestier du Costa Rica. Master II Productions Végétales option Ingénierie des  
620 Agrosystèmes. Agrocampus Ouest Rennes-France. 29 pp + Annexes.

- 621 DeJong, T.M., 1986. Fruit effects on photosynthesis in *Prunus persica*. *Physiologia Plantarum* 66, 149-  
622 153.
- 623 Di Rienzo, J.A., Casanoves, F., Balzarini, M.G., Gonzalez, L., Tablada, M., Robledo, C.W., 2011.  
624 InfoStat, versión 24-03-2011 ed. Universidad Nacional de Córdoba, Córdoba, Argentina.
- 625 Duursma, R., Medlyn, B.E., 2012. MAESPA: a model to study interactions between water limitation,  
626 environmental drivers and vegetation function at tree and stand levels, with an example application  
627 to [CO<sub>2</sub>] × drought interactions. *Geoscientific Model Development* 5, 919-940.
- 628 Evans, J.R., Poorter, H., 2001. Photosynthetic acclimation of plants to growth irradiance: the relative  
629 importance of specific leaf area and nitrogen partitioning in maximizing carbon gain. *Plant, Cell &*  
630 *Environment* 24, 755-767.
- 631 FAO, 2011. FAOSTAT Agriculture Data. <http://faostat.fao.org/>.
- 632 Franck, N., 2005. Effet de la charge en fruits et de l'ombrage sur l'assimilation carbonée, la croissance  
633 et la production du caféier. PhD thesis, Ecophysiologie végétale - Développement et adaptation des  
634 plantes - Biologie des systèmes intégrés, Agronomie et Environnement. Ecole Nationale Supérieure  
635 d'Agronomie, Montpellier, p. 165.
- 636 Franck, N., Vaast, P., 2009. Limitation of coffee leaf photosynthesis by stomatal conductance and  
637 light availability under different shade levels. *Trees* 23, 761-769.
- 638 Franck, N., Vaast, P., Génard, M., Dauzat, J., 2006. Soluble sugars mediate sink feedback down-  
639 regulation of leaf photosynthesis in field-grown *Coffea arabica*. *Tree Physiology*, 517–525.
- 640 Friend, D., 1984. Shade adaptation of photosynthesis in *Coffea arabica*. *Photosynthesis Research* 5,  
641 325-334.
- 642 Génard, M., Dauzat, J., Franck, N., Lescourret, F., Moitrier, N., Vaast, P., Vercambre, G., 2008. Carbon  
643 allocation in fruit trees: from theory to modelling. *Trees - Structure and Function* 22, 269-282.
- 644 Gómez-Delgado, F., Roupsard, O., Lemaire, G., Taugourdeau, S., Pérez, A., Van Oijen, M., Vaast, P.,  
645 Rapidel, B., Voltz, M., Bonnefond, J.M., Imbach, P., Moussa, R., 2011. Modelling the hydrological  
646 behaviour of a coffee agroforestry basin in Costa Rica. *Hydrology and Earth System Sciences* 15.
- 647 Hallé, F., Oldeman, R.A.A., 1970. Essai sur l'architecture et la dynamique de croissance des arbres  
648 tropicaux. Masson et Cie, Monographie 6, 178pp.
- 649 Harris, D., Natarajan, M., Willey, R.W., 1987. Physiological basis for yield advantage in a  
650 sorghum/groundnut intercrop exposed to drought. 1. Dry-matter production, yield, and light  
651 interception. *Field Crop. Res.* 17, 259-272.
- 652 Hunt, R., Causton, D.R., Shipley, B., Askew, A.P., 2002. A Modern Tool for Classical Plant Growth  
653 Analysis. *Annals of Botany* 90, 485-488.

- 654 Huxley, P.A., 1967. The effects of artificial shading on some growth characteristics of Arabica and  
655 Robusta coffee seedlings. I. The effects of shading on dry weight, leaf area and derived growth data.  
656 *Journal of Applied Ecology* 4, 291-308.
- 657 Keenan, T.F., Baker, I., Barr, A., Ciais, P., Davis, K., Dietze, M., Dragoni, D., Gough, C.M., Grant, R.,  
658 Hollinger, D., Hufkens, K., Poulter, B., McCaughey, H., Raczka, B., Ryu, Y., Schaefer, K., Tian, H.,  
659 Verbeeck, H., Zhao, M., Richardson, A.D., 2012. Terrestrial biosphere model performance for inter-  
660 annual variability of land-atmosphere CO<sub>2</sub> exchange. *Global Change Biology* 18, 1971-1987.
- 661 Khack, E., 2012. Plasticité et interactions Génotype-Environnement de la productivité, partition de la  
662 biomasse et tolérance à la sécheresse chez des hybrides F1 de caféier au Costa Rica. AgroParisTech,  
663 Montpellier, France, p. 79.
- 664 Kinoshita, R., 2012. Strategies for soil quality assessment using VNIR hyperspectral spectroscopy.  
665 Cornell, USA. , New-York. Master Sc. 89pp.
- 666 Krinner, G., Viovy, N., de Noblet-Ducoudré, N., Ogée, J., Polcher, J., Friedlingstein, P., Ciais, P., Sitch,  
667 S., Prentice, I.C., 2005. A dynamic global vegetation model for studies of the coupled atmosphere-  
668 biosphere system. *Global Biogeochemical Cycles* 19, GB1015.
- 669 Lacoite, A., 2000. Carbon allocation among tree organs: A review of basic processes and  
670 representation in functional-structural tree models. *Ann. For. Sci.* 57, 521-533.
- 671 Lambers, H., Chapin III, F.S., Pons, T.L., 2008. *Plant Physiological Ecology*. Springer.
- 672 Lescourret, F., Moitrier, N., Valsesia, P., Génard, M., 2011. QualiTree, a virtual fruit tree to study the  
673 management of fruit quality. I. Model development. *Trees - Structure and Function* 25, 519-530.
- 674 Luysaert, S., Inghima, I., Jung, M., Richardson, A.D., Reichstein, M., Papale, D., Piao, S.L., Schulze,  
675 E.D., Wingate, L., Matteucci, G., Aragao, L., Aubinet, M., Beer, C., Bernhofer, C., Black, K.G., Bonal, D.,  
676 Bonnefond, J.M., Chambers, J., Ciais, P., Cook, B., Davis, K.J., Dolman, A.J., Gielen, B., Goulden, M.,  
677 Grace, J., Granier, A., Grelle, A., Griffis, T., GrÜNwald, T., Guidolotti, G., Hanson, P.J., Harding, R.,  
678 Hollinger, D.Y., Hutyrá, L.R., Kolari, P., Kruijt, B., Kutsch, W., Lagergren, F., Laurila, T., Law, B.E., Le  
679 Maire, G., Lindroth, A., Loustau, D., Malhi, Y., Mateus, J., Migliavacca, M., Misson, L., Montagnani, L.,  
680 Moncrieff, J., Moors, E., Munger, J.W., Nikinmaa, E., Ollinger, S.V., Pita, G., Rebmann, C., Rouspard,  
681 O., Saigusa, N., Sanz, M.J., Seufert, G., Sierra, C., Smith, M.L., Tang, J., Valentini, R., Vesala, T.,  
682 Janssens, I.A., 2007. CO<sub>2</sub> balance of boreal, temperate, and tropical forests derived from a global  
683 database. *Global Change Biology* 13, 2509-2537.
- 684 Marrou, H., Wery, J., Dufour, L., Dupraz, C., 2013. Productivity and radiation use efficiency of lettuces  
685 grown in the partial shade of photovoltaic panels. *European Journal of Agronomy* 44, 54-66.
- 686 Meadows, D., Randers, J., Meadows, D., 2004. *Limits to growth : the 30-year update*. White River  
687 Junction, VT : Chelsea Green Pub. Co.
- 688 Medlyn, B., 2004. A MAESTRO Retrospective, in: Mencuccini, M., Moncrieff, J., McNaughton, K.,  
689 Grace, J. (Eds.), *Forests at the Land-Atmosphere Interface*. CABI Publishing.

- 690 Medlyn, B.E., 1998. Physiological basis of the light use efficiency model. *Tree Physiology* 18, 167-176.
- 691 Monselise, S.P., Goldschmidt, E.E., 1982. Alternate Bearing in Fruit Trees, *Horticultural Reviews*. John  
692 Wiley & Sons, Inc., pp. 128-173.
- 693 Monteith, J.L., Moss, C.J., 1977. Climate and the Efficiency of Crop Production in Britain [and  
694 Discussion]. *Philosophical Transactions of the Royal Society of London. B, Biological Sciences* 281,  
695 277-294.
- 696 Monteith, J.L., Ong, C.K., Corlett, J.E., 1991. Microclimatic interactions in agroforestry systems. *For.*  
697 *Ecol. Manage.* 45, 31-44.
- 698 Morais, H., Medri, M.E., Marur, C.J., Caramori, P.H., Ribeiro, A.M.D., Gomes, J.C., 2004. Modifications  
699 on leaf anatomy of *Coffea arabica* caused by shade of pigeonpea (*Cajanus cajan*). *Brazilian Archives*  
700 *of Biology and Technology* 47, 863-871.
- 701 Nakagawa, S., Schielzeth, H., 2013. A general and simple method for obtaining R<sup>2</sup> from generalized  
702 linear mixed-effects models. *Methods in Ecology and Evolution* 4, 133-142.
- 703 Navarro, M.N.V., Jourdan, C., Sileye, T., Braconnier, S., Mialet-Serra, I., Saint-Andre, L., Dauzat, J.,  
704 Nouvellon, Y., Epron, D., Bonnefond, J.M., Berbigier, P., Rouziere, A., Bouillet, J.P., Roupsard, O.,  
705 2008. Fruit development, not GPP, drives seasonal variation in NPP in a tropical palm plantation. *Tree*  
706 *Physiology* 28, 1661-1674.
- 707 Niinemets, Ü., 2010. A review of light interception in plant stands from leaf to canopy in different  
708 plant functional types and in species with varying shade tolerance. *Ecol Res* 25, 693-714.
- 709 Norman, J.M., Arkebauer, T.J., 29 Nov. 1988. Predicting Canopy Photosynthesis and Light-Use  
710 Efficiency from Leaf Characteristics, in: Anaheim, D.C.-o.t.C.S.S.o.A.a.D.A.-o.t.A.S.o.A.i. (Ed.),  
711 *Modeling Crop Photosynthesis—from Biochemistry to Canopy*, California, USA, pp. 75-94.
- 712 Oelbermann, M., Voroney, R.P., Schlönvoigt, A.M., Kass, D.C.L., 2005. Decomposition of *Erythrina*  
713 *poeppigiana* leaves in 3-, 9-, and 18-year-old alley cropping systems in Costa Rica. *Agroforestry*  
714 *Systems* 63, 27-32.
- 715 Ong, C.K., Corlett, J.E., Singh, R.P., Black, C.R., 1991. Above and below ground interactions in  
716 agroforestry systems. *For. Ecol. Manage.* 45, 45-57.
- 717 Palmer, J.W., Giuliani, R., Adams, H.M., 1997. Effect of crop load on fruiting and leaf photosynthesis  
718 of 'Braeburn'/M.26 apple trees. *Tree Physiology* 17, 741-746.
- 719 Peel, M.C., Finlayson, B.L., McMahon, T.A., 2007. Updated world map of the Köppen-Geiger climate  
720 classification. *Hydrology and Earth System Sciences Discussions* 11, 1633-1644.
- 721 Pendergrast, M., 2000. *Uncommon Grounds: The History Of Coffee And How It Transformed Our*  
722 *World*, First Trade Paper Edition ed.

- 723 Picard, N., Saint André, L., Henry, M., 2012. Manual for building tree volume and biomass allometric  
724 equations. FAO, CIRAD.
- 725 Pontailleur, J.-Y., Hymus, G., 2003. Estimation of leaf area index using ground-based remote sensed  
726 NDVI measurements: validation and comparison with two indirect techniques. Canadian Journal of  
727 Remote Sensing 29, 381-387.
- 728 Poorter, L., 2001. Light-dependent changes in biomass allocation and their importance for growth of  
729 rain forest tree species. Functional Ecology 15, 113-123.
- 730 R 2008. R: A Language and Environment for Statistical Computing., in: Team, R.D.C. (Ed.).
- 731 Richardson, A.D., Keenan, T.F., Migliavacca, M., Ryu, Y., Sonnentag, O., Toomey, M., 2013. Climate  
732 change, phenology, and phenological control of vegetation feedbacks to the climate system.  
733 Agricultural and Forest Meteorology 169, 156-173.
- 734 Rodrigo, V.H.L., Stirling, C.M., Teklehaimanot, Z., Nugawela, A., 2001. Intercropping with banana to  
735 improve fractional interception and radiation-use efficiency of immature rubber plantations. Field  
736 Crop. Res. 69, 237-249.
- 737 Running, S.W., 2012. A Measurable Planetary Boundary for the Biosphere. Science 337, 1458-1459.
- 738 Ryu, Y., Baldocchi, D.D., Kobayashi, H., van Ingen, C., Li, J., Black, T.A., Beringer, J., van Gorsel, E.,  
739 Knohl, A., Law, B.E., Rouspard, O., 2011. Integration of MODIS land and atmosphere products with a  
740 coupled-process model to estimate gross primary productivity and evapotranspiration from 1 km to  
741 global scales. Global Biogeochemical Cycles 25.
- 742 Siles, P., Harmand, J.-M., Vaast, P., 2010. Effects of *Inga densiflora* on the microclimate of coffee  
743 (*Coffea arabica* L.) and overall biomass under optimal growing conditions in Costa Rica. Agroforestry  
744 Systems 78, 269-286.
- 745 Sitch, S., Smith, B., Prentice, I.C., Arneth, A., Bondeau, A., Cramer, W., Kaplan, J.O., Levis, S., Lucht,  
746 W., Sykes, M.T., Thonicke, K., Venevsky, S., 2003. Evaluation of ecosystem dynamics, plant geography  
747 and terrestrial carbon cycling in the LPJ dynamic global vegetation model. Global Change Biology 9,  
748 161-185.
- 749 Snijders, T.A.B., Bosker, R.J., 1994. Modeled Variance in Two-Level Models. Sociological Methods &  
750 Research 22, 342-363.
- 751 Taylor, J.R., 1997. An introduction to error analysis: the study of uncertainties in physical  
752 measurements. University science books.
- 753 Tjoelker, M.G., Oleksyn, J., Reich, P.B., 2001. Modelling respiration of vegetation: evidence for a  
754 general temperature-dependent Q10. Global Change Biology 7, 223-230.
- 755 USDA-NRCS, 2005. Global Soil Regions. USDA-NRCS, Soil Survey Division, World Soil Resources,  
756 Washington D.C.

- 757 Vaast, P., Angrand, J., Franck, N., Dauzat, J., Genard, M., 2005. Fruit load and branch ring-barking  
758 affect carbon allocation and photosynthesis of leaf and fruit of *Coffea arabica* in the field. *Tree*  
759 *Physiology* 25, 753-760.
- 760 Vaast, P., Bertrand, B., Perriot, J.-J., Guyot, B., Génard, M., 2006. Fruit thinning and shade improve  
761 bean characteristics and beverage quality of coffee (*Coffea arabica* L.) under optimal conditions.  
762 *Journal of the Science of Food and Agriculture* 86, 197-204.
- 763 Vaast, P., Dauzat, J., Genard, M., 2002. Modeling the effects of fruit load, shade and plant water  
764 status on coffee berry growth and carbon partitioning at the branch level. *Acta Horticulturae* 584, 57-  
765 62.
- 766 Van den Hoof, C., Vidale, P.L., Verhoef, A., Vincke, C., 2013. Improved evaporative flux partitioning  
767 and carbon flux in the land surface model JULES: Impact on the simulation of land surface processes  
768 in temperate Europe. *Agricultural and Forest Meteorology* 181, 108-124.
- 769 van Oijen, M., Dreccer, M.F., Firsching, K.H., Schnieders, B.J., 2004. Simple equations for dynamic  
770 models of the effects of CO<sub>2</sub> and O<sub>3</sub> on light-use efficiency and growth of crops. *Ecological Modelling*  
771 179, 39-60.
- 772 Venables, W., 1998. Exegeses on Linear Models, S-PLUS User's Conference.
- 773 Wang, Q., Wang, S., Fan, B., Yu, X., 2007. Litter production, leaf litter decomposition and nutrient  
774 return in *Cunninghamia lanceolata* plantations in south China: effect of planting conifers with  
775 broadleaved species. *Plant and Soil* 297, 201-211.
- 776 Zanotelli, D., Montagnani, L., Manca, G., Tagliavini, M., 2013. Net primary productivity, allocation  
777 pattern and carbon use efficiency in an apple orchard assessed by integrating eddy covariance,  
778 biometric and continuous soil chamber measurements. *Biogeosciences* 10, 3089-3108.
- 779 Zhao, M., Running, S.W., 2010. Drought-Induced Reduction in Global Terrestrial Net Primary  
780 Production from 2000 Through 2009. *Science* 329, 940-943.
- 781 Zuur, A.F., Ieno, E.N., Walker, N., Saveliev, A.A., Smith, G.M., 2009. Mixed effects models and  
782 extensions in ecology with R. Springer, New York, USA.
- 783
- 784

---

1 **MODELING THE INTRA-PLOT VARIABILITY OF LIGHT AND WATER USE**  
2 **EFFICIENCIES IN A 2-LAYERED HETEROGENEOUS COFFEE (*COFFEA ARABICA L.*)**  
3 **AGROFORESTRY SYSTEM**

---

4 *For submission to Plant, Cell, Environment*

5 Fabien Charbonnier<sup>1,2,3,4,\*</sup>, Olivier Roupsard<sup>1,4</sup>, Erwin Dreyer<sup>2,3</sup>, Jean-Marc Bonnefond<sup>5</sup>, Mathias  
6 Christina<sup>1</sup>, Laura Jarri<sup>7</sup>, Pablo Siles<sup>8</sup>, Bruno Rapidel<sup>9,4</sup>, Jean-Michel Harmand<sup>1</sup>, Philippe Vaast<sup>1,10</sup>,  
7 Yann Nouvellon<sup>1,11</sup> Alfonso Robelo<sup>12</sup> & Gueric le Maire<sup>1</sup>

8 <sup>1</sup>CIRAD, UMR Eco&Sols (Ecologie Fonctionnelle & Biogéochimie des Sols et des Agro-  
9 écosystèmes), 34060 Montpellier Cedex 2, France

10 <sup>2</sup>Université de Lorraine, UMR 1137 “Ecologie et Ecophysiologie Forestières, F 54500 Vandoeuvre,  
11 France

12 <sup>3</sup>INRA, UMR 1137 “Ecologie et Ecophysiologie Forestières”, F54280 Champenoux, France

13 <sup>4</sup>CATIE (Centro Agronómico Tropical de Investigación y Enseñanza), Turrialba, 30501, Costa Rica

14 <sup>5</sup>INRA, UR1263 EPHYSE, F-33140 Villenave d'Ornon, France

15 <sup>7</sup>Supagro, 34060 Montpellier cedex 01, France

16 <sup>8</sup>Bioversity International, Rome, Italy

17 <sup>9</sup>CIRAD, UMR System, SupAgro Montpellier, 2 place P. Viala, 34060 Montpellier, France

18 <sup>10</sup>ICRAF, United Nations Avenue, Gigiri, PO Box 30677-00100, Nairobi, Kenya

19 <sup>11</sup>Atmospheric Sciences Department, USP, IAG, São Paulo, Brazil

20 <sup>12</sup>Cafetalera AQUIARES S.A., PO Box 362-7150 Turrialba, Costa Rica

21 (\*corresponding author: [fabien.charbonnier@cirad.fr](mailto:fabien.charbonnier@cirad.fr))



## 22 **Abstract**

23 MAESPA, a 3D light absorption, photosynthesis and transpiration model was applied for the first time  
24 in an agroforestry system to assess the spatial and temporal variability of net photosynthesis (A),  
25 transpiration (T), photosynthetic light-use efficiency (LUE) and transpiration efficiency (TE). We  
26 upscaled the model from leaf to plant and then to plot. We parameterized photosynthesis and stomatal  
27 conductance models of coffee and shade trees at leaf scale. Eighteen coffee plants were enclosed in a  
28 dynamic-transient gas exchange chamber to monitor A and T during several days. A and T were  
29 successfully compared with simulations by the MAESPA model. MAESPA was then run for the trees  
30 of the whole agroforestry system during an entire year. Fluxes of A and T modeled at plot scale were  
31 compared to eddy-covariance measurements. A was satisfactorily simulated but T was underestimated  
32 for the highest transpiration rates. We discussed the possible causes of this discrepancy. The spatial  
33 variability of A, LUE and shading effect on A was assessed. Coffee plant LUE was found to increase  
34 by 25% under shade tree crowns. Averaged for the plot and over a complete year, shading effect  
35 (mean shade tree PAI was 0.57) lead to a decrease in absorbed PAR by the coffee layer by 15%, coffee  
36 LUE increased by 6%, and coffee GPP decreased by 12%. However, we were not able in this paper to  
37 model the spatial variability of T and TE due to strong discrepancies between measured and modeled  
38 plot transpiration and transpiration efficiency. We identified potential problems in energy balance  
39 calculations that need a deeper look. We suggest specific verifications on MAESPA coding, sensitivity  
40 analysis (aerodynamic conductance) and additional field measurement (soil evaporation in particular)  
41 in order to track the source of discrepancies.

42 Overall, MAESPA model was proven to model satisfyingly A and LUE in a non limited tropical  
43 coffee AFS. Before going further in testing the model in water limited conditions, we strongly suggest  
44 to identify and fix the problems of MAESPA in simulating energy and water fluxes.

## 45 **Abbreviations**

- 46 A: Photosynthesis net of leaf respiration
- 47 Ac: Canopy photosynthesis net of leaf respiration
- 48 AFS: Agroforestry System
- 49 aPAR: absorbed photosynthetically active radiation
- 50 Ca: Ambient CO<sub>2</sub> molar fraction
- 51 Ci: CO<sub>2</sub> molar fraction in the inter-mesophyllian spaces
- 52 D: Leaf-to-air vapor pressure deficit ( $W_i - W_a$ )
- 53 g<sub>c</sub>: Canopy conductance to CO<sub>2</sub>
- 54 g<sub>s</sub>: Leaf stomatal conductance to CO<sub>2</sub>
- 55 LAI: Leaf area index
- 56 LUE<sub>leaf</sub>: Leaf light use efficiency (A/aPAR)
- 57 LUE<sub>can</sub>: Canopy light use efficiency (Ac/aPAR)
- 58 T: transpiration
- 59 TE<sub>leaf</sub>: Transpiration efficiency (A/T) at leaf scale
- 60 TE<sub>can</sub>: Transpiration efficiency (A/T) at plant/canopy scale
- 61 VPD: Vapor pressure Deficit
- 62 W<sub>a</sub>: Air water vapor pressure
- 63 W<sub>i</sub>: Saturation water vapor pressure at leaf temperature

## 64 1. Introduction

65 Among agricultural practices, agroforestry systems (AFS) are expected to display a larger potential of  
66 resilience to climate change when compared to monocultures, according to IPCC (2007). However,  
67 given the lack of meta-analyses and modeling tools, it is difficult to assess the validity of this  
68 statement (Thornton and Cramer, 2012). Predicting satisfactorily heat, carbon and water fluxes is a  
69 prerequisite to investigate the potential of agroforestry systems facing global changes (Charbonnier *et*  
70 *al.*, 2013). Modeling should help designing ecologically, economically and locally optimized  
71 agroforestry systems (AFS; *e.g.* shade tree species & density vs. elevation) that could buffer higher  
72 temperatures or sustain episodes of soil water deficit. However, AFS convey a large spatial variability  
73 in terms of energy, photosynthesis and transpiration (Charbonnier *et al.*, 2013; Dauzat and Eroy, 1997;  
74 Lamanda *et al.*, 2008; Tournebize and Sinoquet, 1995) and intra-plot heterogeneity or interactions  
75 between plants require models with a high spatial and temporal resolution.

76 Gross Primary Productivity (GPP) is the gross carbon influx into an ecosystem, due to the  
77 photosynthetic activity. AFS are expected to increase the total GPP of the ecosystem with respect to  
78 monocultures if the facilitation effects between shade trees and understorey overtake competition  
79 effects (van der Werf *et al.*, 2007). Indeed, due to the vertical stratification of AFS, such systems may  
80 intercept irradiance more efficiently than a monoculture (Cannell *et al.*, 1996). However, AFS result in  
81 a decrease of incident irradiance above the understorey crop. This decrease could be partly  
82 compensated by a larger light-use efficiency (LUE: the ratio of carbon entry per unit of absorbed  
83 photosynthetically active solar radiation, aPAR), thus avoiding a decrease of GPP in the understorey.  
84 The exact definition of LUE varies according to the processes, or the degree of temporal and spatial  
85 integration.

- 86 i) At leaf scale, instantaneous net photosynthesis increases with aPAR following a non-rectangular  
87 hyperbola (Ögren and Evans, 1993), the derivative of this relation,  $LUE_{leaf}$ , being larger under  
88 low irradiance.
- 89 ii) At canopy scale and for short term, the trends in  $LUE_{can}$  remain controversial. The response of  
90 canopy photosynthesis to aPAR can be considered close to linear with no saturation (stable  
91  $LUE_{can}$ ) because increasing irradiance results in more light reaching the shaded leaves and  
92 because nitrogen distribution in the canopy is adjusted to optimize canopy photosynthesis  
93 (Anderson *et al.*, 2000; Haxeltine and Prentice, 1996; Medlyn, 1998). On the opposite, van Oijen  
94 *et al.* (2004) described a decrease of  $LUE_{can}$  with increasing aPAR. At this scale, the fraction of  
95 diffuse radiation is of critical importance because diffuse radiation is expected to penetrate deeper  
96 into the canopy than direct radiation and enhance canopy photosynthesis (Gu *et al.*, 2002; Spitters  
97 *et al.*, 1986). Anderson *et al.* (2000) modeled an increase in  $LUE_{can}$  that was proportional to the  
98 fraction of diffuse radiation.

99 iii) At canopy scale and in the long run, Monteith and Moss (1977) used a wide crop survey to  
100 evidence a linear relationships between biomass accumulation and aPAR, *i.e.* a constant LUE<sub>NPP</sub>  
101 for a given crop. This theory gave birth to epsilon models, widely adopted by modelers to create  
102 crop growth models or assess regional/continental/global primary productivity (*e.g.* Zhao and  
103 Running (2010)). In this framework, LUE of a specific crop is modulated solely by temperature,  
104 soil water content or crop phenology (Zhao *et al.*, 2005).

105 Plant transpiration (T) is useful for leaf photosynthesis because it contributes to maintain leaf  
106 temperature within a favorable range for photosynthesis (Lambers *et al.*, 2008). Transpiration is  
107 regulated by stomata that are sensitive to irradiance, leaf-to-air vapor pressure deficit, leaf water  
108 potential and ambient CO<sub>2</sub> concentration (Jarvis, 1978; Leuning, 1995; Tuzet *et al.*, 2003). At leaf  
109 level, instant transpiration efficiency (TE<sub>leaf</sub>) is the ratio through net CO<sub>2</sub> assimilation rate (A) to  
110 transpiration (T). TE<sub>leaf</sub> depends on intrinsic TE<sub>leaf</sub> and on leaf-to-air deficit (W<sub>i</sub>-W<sub>a</sub>). Intrinsic TE is  
111 the ratio of A to stomatal conductance to water (g<sub>sw</sub>). According to Condon *et al.* (2004), TE<sub>leaf</sub> can be  
112 written :

$$113 \quad TE_{leaf} = \frac{A}{T} \approx \frac{A}{g_{sw}(W_i - W_a)} \quad (1)$$

114 In AFS, shade trees generally buffer maximum air temperature and increase air relative humidity (Lin,  
115 2007; Siles *et al.*, 2010). Hence, we would expect a spatial gradient of TE<sub>leaf</sub>, and potentially higher  
116 values below the shade trees. Upscaling TE from leaf to plant and to plot level (TE<sub>can</sub>) may be done  
117 through plant/canopy CO<sub>2</sub> assimilation (instantaneous, daily, yearly transpiration efficiency), or by  
118 using net primary productivity (TE<sub>NPP</sub>). Scaling from TE<sub>leaf</sub> to TE<sub>NPP</sub> requires an estimation of the  
119 fraction of assimilated carbon lost (respiration of non photosynthesizing tissues, exudates, turnover  
120 etc.) and the fraction of water lost independently of photosynthesis losses (nighttime and non  
121 photosynthetic organ transpiration) (Farquhar *et al.*, 1989).

122 Scaling leaf carbon and water exchanges from leaf to plant and to plot requires a complex  
123 mathematical and geometrical formulation of physical and physiological processes (effects of climate  
124 and plantation structure on light interception, energy/carbon/water balance and microclimate). Models  
125 are a formal simplification of biological processes; modelers generally chose to enhance the  
126 mathematical representation of a particular process considered as most influential at the expense of  
127 another. This is typically the case for radiation transfer and photosynthesis models that ignore the  
128 effect of turbulence on local microclimate or that represent simplified energy balance in the visible,  
129 near and thermal infrared. Indeed, the representation of those physical processes in spatially  
130 heterogeneous systems involve highly complex algebraic formulations and requires a complex  
131 parameterization (Kobayashi *et al.*, 2012). MAESPA (Duursma and Medlyn, 2012) is a 3D radiation  
132 transfer and photosynthesis model that does not embark the above-cited refinements. We aim here at

133 assessing whether those simplifying hypotheses in MAESPA allow a realistic representation of the  
134 spatial variability of carbon and water exchanges in agro-forestry systems. An earlier version of  
135 MAESPA, MAESTRA, was already applied successfully to model i) transpiration at plant scale  
136 (Medlyn *et al.*, 2007), ii) photosynthesis at canopy scale (Ibrom *et al.*, 2006) and iv) photosynthesis  
137 and transpiration at plot scale (Hanson *et al.*, 2004). To our knowledge MAESPA has never been  
138 verified at both plant and canopy scale in the same study. Neither has it been used to simulate carbon  
139 and water exchange in AFS. In the coffee physiology literature, carbon and water exchanges were  
140 seldom estimated at plant scale (Gomez *et al.*, 2005), and never on mature plants in field conditions.  
141 The characterization of those fluxes at plant scale is expected to provide quantitative insights on the  
142 determinants of plant productivity and efficiency according to varying environmental conditions.

143 A careful parameterization of leaf gas exchange and plantation structure, together with step by step  
144 model verification at plant and plot scale, should increase our confidence in model predictions.

145 Leaf and whole plant chambers are widely used tools to assess leaf and plant carbon and water  
146 exchanges and their response to environmental factors. Enclosure leads to physical modifications such  
147 as a decrease of net radiation or an increase of the diffuse fraction (Denmead *et al.*, 1993). They also  
148 display statistical weakness given that the sampled leaves or plants necessarily represent a small part  
149 of natural variability (Baldocchi, 2003). On the other hand, eddy-covariance (EC) in AFS typically  
150 allows estimating GPP and evapo-transpiration fluxes at a fine temporal scale over a few hectares. EC  
151 measurements by nature do not allow a spatial characterization of those fluxes. Partitioning fluxes  
152 between the main crop and shade trees can be achieved measuring EC between the 2 layers (Misson *et al.*,  
153 2007; Roupsard *et al.*, 2006). However, a lower aerodynamic mixing and a strong spatial  
154 variability of net radiation below the shade tree canopy make the energy balance closure uncertain. We  
155 argue here that once verified, model can be used to separate the fluxes from the different canopy  
156 layers.

157 The main questions addressed in this study were:

158 - How do leaf, plant and plot scale conductance, photosynthesis and transpiration vary according to  
159 main driving variables (aPAR, Leaf-to-air vapor pressure deficit) in a coffee AFS?

160 - Is MAESPA able to reproduce reliably instantaneous and daily integrated values of photosynthesis,  
161 transpiration,  $LUE_{can}$  and  $TE_{can}$  at plant and plot scale?

162 - How do compensation effects occur below shade trees for yearly integrated photosynthesis,  
163 transpiration,  $LUE_{can}$  and  $TE_{can}$ ?

164 We parameterized the plant physiological parameters of MAESPA with leaf gas exchange records and  
165 ran simulations using the 2.7 ha mock-up presented in Charbonnier *et al.* (2013). We measured water

166 and carbon exchanges of 18 mature coffee plants enclosed in a transient-state chamber and compared  
167 measurements with MAESPA simulations. We then compared carbon and water fluxes measured  
168 above the canopy by eddy-covariance with MAESPA simulations for the whole plot over an entire  
169 year. Finally, we used this whole-plot simulation to document spatial variations in photosynthesis,  
170 transpiration,  $LUE_{can}$  and  $TE_{can}$ .

## 171 2. Material and methods

### 172 A. Study site

173 The study site is located on the Caribbean side of the central Valley of Costa Rica at 1050 m.a.s.l on  
174 the slopes of the Turrialba volcano (9° 56' 19'' N, 83°43'46'' W). The experimental setup is part of  
175 the “Coffee-Flux” platform (Charbonnier *et al.*, 2013; Gómez-Delgado *et al.*, 2011) located in “Finca  
176 Aquiares”, one of the largest coffee farms of the country. Climate is tropical humid with no dry season  
177 (Peel *et al.*, 2007). Over 2009-2012, mean annual rainfall was 3167 mm with April being the driest  
178 month (84 mm) while mean air temperature was 19.5°C without noticeable seasonal variations. Soils  
179 are deep (4m or more) Andisols (USDA-NRCS, 2005) with high organic matter content. Volumetric  
180 soil water content ranged from 0.38 to 0.55 and was never limiting for plants (Gómez-Delgado *et al.*,  
181 2011), considering their deep root system (4 m) and rainfall distributions.

182 The experimental setup was described in Charbonnier *et al.* (2013). Briefly, a 2.7 ha experimental plot  
183 was defined around a 25 m high eddy-covariance tower, embedded in a 0.9 km<sup>2</sup> watershed with  
184 similar cover. The area was planted in the 1970's with *Coffea arabica* L. var Caturra and large  
185 *Erythrina poeppigiana* O.F. Cook as shade trees. Coffee was initially planted at 6300 locations per ha  
186 with 1 or 2 seedlings per location. The coffee canopy is managed as an uneven-aged coppice with 1 to  
187 3 resprouts per stump. An inventory showed that the resprouts were approximately evenly distributed  
188 along age classes with a random spatial pattern. About 15% resprouts are pruned selectively every  
189 year when considered unproductive or too tall for an easy harvest, which leads to a 30% decrease in  
190 coffee canopy LAI. Coffee LAI varied between 1.6 and 4 (mean 3.4) and absorbed from 38% to 60%  
191 of daily incident photosynthetic photon flux density (PAR<sub>i</sub>; mean 53% ±3%). Large amounts of  
192 fertilizer were brought every year (*ca.* 215 kg N ha<sup>-1</sup> yr<sup>-1</sup> during the 2000-2012 period).

193 The shading canopy is provided by freely growing *Erythrina poeppigiana* O.F. Cook planted at a low  
194 density (5.2 ha<sup>-1</sup>) and about 20 m high. Their Plant Area Index ranged from 0.5 (totally defoliated  
195 period) to 1.2 and their aPAR represented *ca.* 7% of PAR<sub>i</sub>.

### 196 B. MAESPA parameterization

197 MAESPA simulated adequately light interception in this AFS (Charbonnier *et al.*, 2013). The same  
198 parameters for plant structure as well as the virtual plot were used for the current application.

199 MAESPA is coupled with a photosynthetic-stomatal conductance model  
200 ([bio.mq.edu.au/research/projects/maespa](http://bio.mq.edu.au/research/projects/maespa)). Leaf photosynthesis and transpiration are calculated with  
201 the Farquhar and Caemmerer (1982) model using an iterative process to solve for leaf temperature  
202 (Leuning *et al.*, 1995). MAESPA cannot simulate the micro-climate apart from radiation, therefore air  
203 temperature and relative humidity do not vary spatially in MAESPA; however leaf temperature is

Table 1 - Parameters used in the MAESPA model.

PARAMETER NAME AND DEFINITION	SPECIES	VALUES	UNITS	SOURCE
<b>Plot aerodynamic conductance Monteith (1965)</b>				
ZHT: wind speed measurement height		3	m	
ZPD: zero-plane displacement		1.43	m	
ZOHT: roughness length		0.27	m	
<b>Stomatal conductance submodel:</b>				
CONDUNIT: Specify if the conductance are for CO <sub>2</sub> or H <sub>2</sub> O	Coffee & <i>Erythrina</i> Coffee & <i>Erythrina</i>	BBO CO2		Medlyn (2011)
WLEAF: mean leaf width	Coffee <i>Erythrina</i>	0.068 0.2	m	
NSIDES: number of leaf sides with stomata	Coffee & <i>Erythrina</i>	1		
	Coffee	0.0033		
$g_0$	<i>Erythrina</i>	0.001	mol m <sup>-2</sup> s <sup>-1</sup>	Field measurements in ambient conditions A <sub>w</sub> /Q <sub>i</sub> curves at ambient Ca on seedlings
$g_1$	Coffee <i>Erythrina</i>	2.15 14	dimensionless	Field measurements in ambient conditions A <sub>w</sub> /Q <sub>i</sub> curves at ambient Ca on seedlings
<b>Photosynthesis submodel:</b>				
VCMAX: Maximal rate of carboxylation by Rubisco at 25°C	Coffee <i>Erythrina</i>	44.06 75	μmol m <sup>-2</sup> s <sup>-1</sup>	Field A <sub>w</sub> /C <sub>i</sub> curves A <sub>w</sub> /C <sub>i</sub> curves on seedlings
JMAX: Maximal rate of light-driven electron transport at 25°C	Coffee <i>Erythrina</i>	88.21 112	μmol m <sup>-2</sup> s <sup>-1</sup>	Field A <sub>w</sub> /Q <sub>i</sub> curves A <sub>w</sub> /Q <sub>i</sub> curves on seedlings
THETA: Curvature coefficient	Coffee <i>Erythrina</i>	0.96 0.7	dimensionless	Franck (2005) A <sub>w</sub> /Q <sub>i</sub> curves on seedlings
AJQ: maximum quantum yield of electron transport	Coffee <i>Erythrina</i>	0.222 0.48	mol(electron) mol(photon) <sup>-1</sup>	Field A <sub>w</sub> /Q <sub>i</sub> curves A <sub>w</sub> /Q <sub>i</sub> curves on seedlings
RD: leaf respiration	Coffee <i>Erythrina</i>	0.17 0.89	μmol m <sup>-2</sup> s <sup>-1</sup>	Chamber measurements A <sub>w</sub> /Q <sub>i</sub> curves on seedlings
EAVJ: Activation energy of VCMAX	Coffee & <i>Erythrina</i>	37000	J mol <sup>-1</sup>	
EDVJ: activation energy of Jmax	Coffee & <i>Erythrina</i>	220000	J mol <sup>-1</sup>	
DELSJ: electron-transport temperature response parameter	Coffee & <i>Erythrina</i>	710	J K <sup>-1</sup>	de Pury & Farquhar (1997)
EAVC: activation energy of JMAX	Coffee & <i>Erythrina</i>	51560	J mol <sup>-1</sup>	
<b>Leaf respiration submodel: R<sub>s</sub>(T<sub>amb</sub>) = RD exp(Q10F(T<sub>amb</sub> - RTEMP))</b>				
Q10F: exponential coefficient of the temperature response of foliage respiration	Coffee <i>Erythrina</i>	0.0873 0.0575		Mean value estimated from nocturnal whole plant-chamber (corresponding to Q10=2.4 in eq. 5). Default value for <i>Eucalyptus</i> provided in MAESTRA example.
RTEMP: temperature at which the values of RD are specified	Coffee <i>Erythrina</i>	21 25	°C	Mean temperature measured during nocturnal whole plant-chamber measurements Default value for <i>Eucalyptus</i> provided in MAESTRA example.
DAIRESP: fraction by which dark respiration is reduced in the light	Coffee & <i>Erythrina</i>	0.4		Estimate from Yin et al. (2011) for C <sub>3</sub> species
TBELOW: minimum temperature at which respiration occurs; below this, R <sub>s</sub> (T) is set to zero	Coffee & <i>Erythrina</i>	10	°C	Minimum temperature in our study site



204 adjusted and thus can affect locally photosynthesis and transpiration. We deactivated the water balance  
 205 module of MAESPA, given that the soil water content was never limiting and had no influence on the  
 206 computations. We also checked that the radiation interception calculation was equal than in the  
 207 previous study with MAESTRA (Charbonnier *et al.*, 2013).

208 We parameterized MAESPA physiological module using leaf gas exchange measured with a portable  
 209 photosynthesis chamber Li-Cor LI-6400 (Li-Cor, Lincoln, NE, USA) with an attached blue-red light  
 210 source (6400-02 LED). Measurements were carried out during the sunniest period (April 2012) on 24  
 211 fully-expanded leaves from the upper 2<sup>nd</sup> third of the crown of coffee resprouts of three different ages  
 212 (1, 3 and 5 years old) and from either plants growing in the open or below the canopy of the trees.  
 213 Two  $A_n/C_i$  curves (net leaf assimilation and intercellular CO<sub>2</sub> concentration, respectively) per leaf  
 214 were recorded under 2000  $\mu\text{mol}_{\text{photons}} \text{m}^{-2} \text{s}^{-1}$  PAR at a chamber temperatures close to 25°C. Maximal  
 215 rate of carboxylation by Rubisco ( $V_{\text{cmax}}$ ;  $\mu\text{mol} \text{m}^{-2} \text{s}^{-1}$ ) and rate of electron transport ( $J$ ;  $\mu\text{mol}_e \text{m}^{-2} \text{s}^{-1}$ )  
 216 were assessed using the fitting tool developed by Dubois *et al.* (2007). Curves that did not meet  
 217 convergence criterion were discarded. Maximum rate of assimilation ( $A_{\text{max}}$ ;  $\mu\text{mol} \text{m}^{-2} \text{s}^{-1}$ ), apparent  
 218 maximum quantum-yield ( $\alpha$ ;  $\text{mol}_{\text{CO}_2} \text{mol}^{-1}_{\text{photon}}$ ) and maximum rate of electron transport ( $J_{\text{max}}$ ;  
 219  $\mu\text{mol}_{\text{electron}} \text{m}^{-2} \text{s}^{-1}$ ) were retrieved from  $A/Q_i$  curves at 25°C and 2000  $\mu\text{mol} \text{mol}^{-1}$  ambient CO<sub>2</sub> mole  
 220 fraction. Curves were fitted to derive the parameters with the von Caemmerer and Farquhar (1981)  
 221 photosynthesis model; the convexity factor  $\Theta$  was set at 0.96 (Franck, 2005). We found no difference  
 222 with the position of the trees (shade vs. open areas) nor with tree ages for any parameter.  
 223 Consequently, all parameter values were averaged (Table 1).

224 Stomatal conductance model was parameterized using leaf gas exchange measurements recorded  
 225 under ambient conditions during the sunniest and driest weeks (March-April 2013) under ambient  
 226 CO<sub>2</sub>, RH, Ta and irradiance (transparent-window) on 25 fully-expanded leaves with different positions  
 227 in the crown during *ca.* 30 mn per leaf. Stomatal conductance to CO<sub>2</sub> ( $g_s$ ) was fitted (non linear  
 228 regression, NLINFIT function in Matlab) to the model proposed by Medlyn *et al.* (2011) after  
 229 discarding curves that did not display a positive linear relationship between  $g_s$  and  $A_n$  (15% discarded).

$$230 \quad g_s \cong g_0 + \left(1 + \frac{g_1}{\sqrt{D}}\right) * \frac{A_n}{C_a} \quad (2)$$

231 where  $g_0$  ( $\text{mol}_{\text{air}} \text{m}^{-2} \text{s}^{-1}$ ) and  $g_1$  (dimensionless) are the fitted parameters when considering  
 232 conductance to CO<sub>2</sub>, D is the leaf-to-air water pressure deficit (kPa).

233 Photosynthetic parameters for *Erythrina poeppigiana* ( $V_{\text{cmax}}$ ,  $J_{\text{max}}$  and  $R_d$ ) were estimated from  $A/C_i$  and  
 234  $A_n/Q_i$  curves on 10 leaves of small trees growing outdoor in well-watered, 15-L pots following the  
 235 methodology described above. Stomatal conductance parameters of Medlyn *et al.* (2011) model were  
 236 fitted using  $A_n-Q_i$  data measured on the same 10 leaves (Table 1).

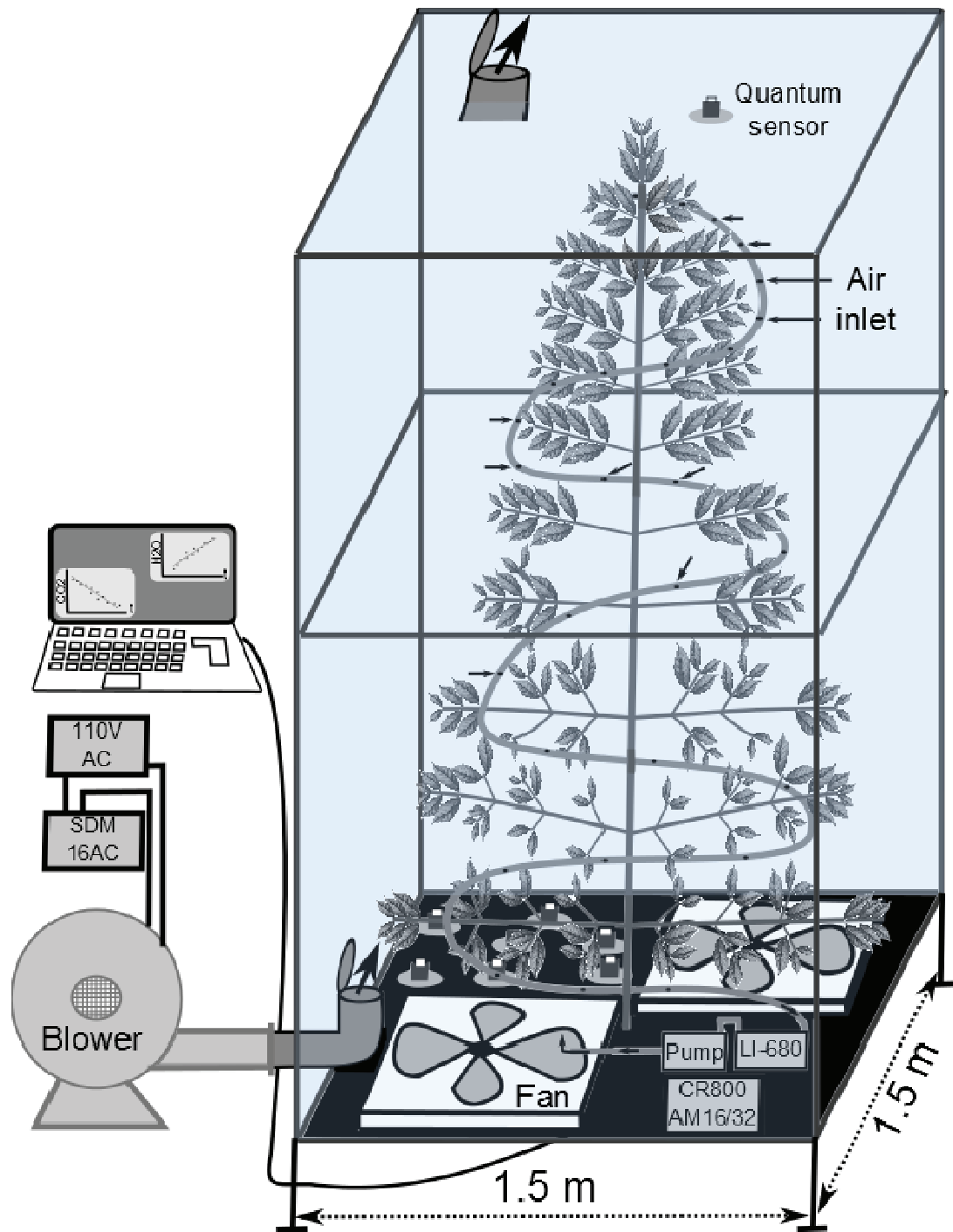

**Figure 1** - Schematic diagram of the dynamic transient-state chamber used to measure  $\text{CO}_2$  and  $\text{H}_2\text{O}$  fluxes of entire coffee plants in the field. In the open mode (no measurement), outside ambient air was forced into the chamber by a blower through a one-way valve, and exited the chamber by another one way valve located on the top of the chamber. In the closed mode (during measurements), the blower was turned off, one-way valves closed by gravity to seal the chamber. Two 120W fans were automatically turned on to mix the air inside the chamber. Sample air was aspirated ( $1 \text{ L s}^{-1}$ ) at different locations in the chamber through a perforated tubing and passed through an IRGA (LI-840, LI-COR) to record the changes in  $\text{CO}_2$  and  $\text{H}_2\text{O}$  concentrations. Data was logged. 30 seconds after the chamber closure to allow a purge of the tubing. The blower was controlled by a SDM 16AC (Campbell Scientific) and turned off 3 mn every 30 mn to allow the measurements in closed mode.

## 237 **C. Measurement of carbon and water exchanges in the field**

### 238 **i. Plant scale measurements with a whole-plant chamber**

239 Eighteen coffee plants (stump+ 1 to 4 resprouts) were measured in sequence using a dynamic closed  
240 chamber in the field, during one to three days per plant. The sampling was designed as a split-plot:  
241 irradiance was the main factor (under shade tree canopies and in open areas) and 3 age classes of  
242 resprouts per plot (1, 3 and 5 years old) were defined. Only coffee plants bearing equi-annual resprouts  
243 were selected.

244 Prior to enclosure, the relative position of each resprout was recorded. Biomass of the woody  
245 components was estimated with allometric relationships (Audebert, 2011) and plant leaf area was  
246 measured non destructively (Charbonnier *et al.*, 2013). We found no difference in specific leaf area  
247 among age and irradiance factors, thus leaf biomass was derived from leaf area using a unique SLA  
248 value ( $11.4 \text{ m}^2 \text{ kg}^{-1}$ ).

#### 249 ***Main features of the dynamic transient-state chamber***

250 The chamber consisted of a rectangular cuboid aluminum structure placed on a rectangular steel frame  
251 base set horizontally on the ground around the coffee plant stump (Fig. 1). A soft black polyester  
252 tarpaulin was stuck permanently on the basal frame and wrapped hermetically around the trunk in  
253 order to exclude the soil from measurements. A transparent polyethylene envelope was designed to fit  
254 the cuboid structure, after checking for its inertia to  $\text{CO}_2$  and  $\text{H}_2\text{O}$ . The envelope was made of  
255 rectangular pieces of 0.7 mm thick plastic stuck together hermetically with a polyurethane glue. The  
256 transmittances of the plastic sheet for photon flux density and global radiation were measured during  
257 two days with Li-COR Li-190 quantum sensors (91% transmittance) and LI-200 SL pyranometer  
258 (92% transmittance).

259 An air blower ( $5 \text{ m}^3 \text{ mn}^{-1}$ , 1800 W) located outside the chamber was connected to the bottom of the  
260 chamber through a one-way valve ( $\varnothing 180 \text{ mm}$ ). An outlet one-way valve was installed on top of the  
261 chamber. When the blower was turned on, the air entered the chamber through the bottom one-way  
262 valve, flew through the chamber inflating it and exited through the top valve (Fig. 1). When the blower  
263 was turned-off, the chamber was hermetically closed and two 100 W fans ( $\varnothing 50 \text{ cm}$ ) inside the  
264 chamber were mixing the air so that all plant leaves would quiver.

265 During measurements, air was aspirated by a  $1 \text{ l mn}^{-1}$  vacuum pump (N86KNDC, KNF, Village-Neuf,  
266 France) through a pipe wrapped around the plant and perforated by multiple holes to allow multiple  
267 sampling in the chamber. The  $\text{CO}_2/\text{H}_2\text{O}$  concentration in the aspirated air was measured by an Infra-  
268 Red Gas Analyzer (IRGA; LI-840, Li-COR) and was rejected within the chamber, in front of a fan.  
269 The IRGA and all pipes remained inside the chamber, to minimize response time and avoid leaks or  
270 diffusion effects.  $\text{CO}_2/\text{H}_2\text{O}$  concentrations were recorded at 1 Hz in a laptop located outside the

271 chamber. The system was fully automated with a synchronous device (SDM-CD16AC Campbell  
272 Scientific) allowing day-long measurements. A leakage and diffusion test was performed on the closed  
273 empty chamber with fans turned on and with a [CO<sub>2</sub>] increased by 100 ppm relatively to ambient  
274 [CO<sub>2</sub>]. Leakage and diffusion were assessed from a linear regression between chamber [CO<sub>2</sub>] and time  
275 after closure. Leakage and diffusion were found to be 0.06 ppm mn<sup>-1</sup> and were neglected. Temperature  
276 within the chamber during measurements was 85% of the time in a range of -2°C to +4°C compared to  
277 ambient temperature while VPD ranged 91% of the time between -0.5 and +1 kPa compared to  
278 ambient VPD. Data outside this range were discarded. Two chambers were designed: one (2.3 m<sup>3</sup> and  
279 1.1 m<sup>2</sup> basal areas) for the small coffee plants and one (5.62 m<sup>3</sup> and 2.6 m<sup>2</sup> basal area) for larger ones.  
280 The chamber volume was estimated from the dimensions of the inflated chamber.

281 Ancillary measurements were recorded at 0.5 Hz on a CR800 datalogger and an AM16/32 multiplexer  
282 (Campbell Scientific, Logan, UT, USA). Air temperature was measured at the center of the chamber  
283 with a shaded and ventilated copper-constantan thermocouple (∅ 0.5 mm, OMEGA Engineering,  
284 Stanford, CT, USA) and relative humidity with a HMP45C probe (Campbell Scientific). Leaf  
285 temperature was measured with 6 fine copper-constantan thermocouples (∅ 0.07 mm, OMEGA  
286 Engineering) adjusted below 6 leaves at 3 different crown heights. Incident and transmitted Q above  
287 and below the coffee plant within the chamber were measured with 8 inter-calibrated quantum sensors  
288 (Li-190, LI-COR and PAR/CBE 80, Solems, Palaiseau, France; one above and 7 below coffee plants).

289 Sap-flow measurements were performed on a sample of 6 coffee plants, to verify independently plant  
290 transpiration records. We used stem heat-balance gauges operated at constant power (Dynagage,  
291 Dynamax, Houston, TX, USA). In principle, such gauges do not require calibration; however, we  
292 confirmed their reliability from a potted experiment in a greenhouse, with the gravimetric method. A  
293 gauge was settled in one resprout per plant and sap-flow velocity was recorded every 30 seconds and  
294 converted into sap-flow density following Van Bavel and Van Bavel (1990). Sap-flow was  
295 extrapolated to the whole plant after weighting for the whole plant leaf area. Sap-flow was compared  
296 with transpiration measured concurrently.

### 297 ***Chamber operation and calculations***

298 Gas exchange was recorded every 30 mn. Measurements started 40 seconds after the blower was  
299 turned off in order to allow the valve to close, the gas concentration to stabilize and air within the  
300 chamber to be mixed efficiently by fans (Pérez-Priego *et al.*, 2010).

301 Apparent photosynthesis and transpiration were calculated following Steduto *et al.* (2002):

$$302 \quad E = \frac{\rho \delta W}{\delta t} \frac{V}{S} \quad (3)$$

$$A = \frac{\rho \delta C}{\delta t} \frac{V}{S} \quad (4)$$

303  
304 where E is the transpiration rate ( $\text{mmol}_{\text{H}_2\text{O}} \text{m}^{-2}_{\text{leaves}} \text{s}^{-1}$ ) and A is the apparent photosynthetic rate  
305 ( $\mu\text{mol}_{\text{CO}_2} \text{m}^{-2}_{\text{leaves}} \text{s}^{-1}$ ) respectively,  $\delta W / \delta t$  is the change in water vapor molar fraction ( $\text{mmol}_{\text{H}_2\text{O}} \text{mol}_{\text{air}}^{-1}$   
306  $\text{s}^{-1}$ ),  $\delta C / \delta t$  is the change in  $\text{CO}_2$  molar fraction against time ( $\mu\text{mol}_{\text{CO}_2} \text{mol}_{\text{air}}^{-1} \text{s}^{-1}$ ), V is the chamber  
307 volume ( $\text{m}^3$ ), S is plant leaf area ( $\text{m}^2$ ) and  $\rho$  is the air density ( $\text{mol}_{\text{air}} \text{m}_{\text{air}}^{-3}$ ) computed from perfect gas  
308 law.

309 The  $\text{CO}_2$  concentration given by the IRGA was corrected for  $\text{CO}_2$  dilution effect (Penning de Vries *et*  
310 *al.*, 1984) as recommended by LI-COR ():

$$C = \frac{C_{\text{IRGA}}}{1 - W/1000} \quad (5)$$

311 where  $C_{\text{IRGA}}$  is the  $\text{CO}_2$  molar fraction given by the IRGA ( $\mu\text{mol} \text{mol}_{\text{air}}^{-1}$ ).

312 Wagner *et al.* (1997) assumed that photosynthesis and transpiration remain constant over a short time  
313 step if the conditions remain constant. Nevertheless, it is currently admitted that the estimation of  
314 those fluxes using a linear regression model lead to an underestimation of 10% (Pérez-Priego *et al.*,  
315 2010; Wagner *et al.*, 1997). Indeed, the introduction of the plant into a chamber distorts the linear  
316 process (*i.e.* due to temperature and humidity increase). Wagner *et al.* (1997) introduced a second  
317 order polynomial model of time to take this effect into account.  $\delta W / \delta t$  can therefore be written :

$$\frac{\delta W}{\delta t} = b + 2ct \quad (6)$$

318  
319  
320 When  $t=0$ , b is the initial slope, or the exchange rate unaffected by the chamber closure (Wagner *et al.*,  
321 1997). The same procedure is applied on  $\delta C / \delta t$ .

322 Closure time was tested to minimize the difference between a simple regression and the quadratic  
323 regression model (Eq. 3) and was set to 100 seconds.

### 324 **Leaf and wood respiration**

325 Respiration rates (R;  $\mu\text{mol} \text{g}_{\text{DM}}^{-1} \text{s}^{-1}$ ) of leaves and woody elements were measured during the night  
326 and applied to daily measurements after a correction for temperature. An average  $Q_{10}$  for leaf and  
327 wood together was estimated for each plant following:

$$R = R_{\text{ref}} * \exp^{Q_{10} * (T - T_{\text{ref}}) / 10} \quad (7)$$

329 where  $R_{\text{ref}}$  is the mean night-time whole plant respiration ( $\mu\text{mol}_{\text{CO}_2} \text{g}_{\text{DM}}^{-1} \text{s}^{-1}$ ) and  $T_{\text{ref}}$  is the mean night  
 330 time temperature ( $^{\circ}\text{C}$ ).  $Q_{10}$  ranged from 1.5 to 4 according to the plant (mean: 2.4) and no effect of  
 331 plant age or irradiance environment was found. Leaf and wood night-time respiration were partitioned  
 332 according to their respective biomass. A 40% reduction of leaf respiration was applied during daytime  
 333 to the fraction of leaf biomass to account for inhibition by light (Atkin *et al.*, 1998; Yin *et al.*, 2011).  
 334 Canopy assimilation ( $A_c$ ) was calculated deducing wood respiration from apparent photosynthesis ( $A$ ).

### 335 *Canopy conductance of single plants*

336 We computed the canopy conductance to  $\text{CO}_2$  of single plants following a “top-down” approach  
 337 (Baldocchi *et al.*, 1991) considering the canopy as a “big-leaf” and inverting the Penman-Monteith  
 338 equation (Stewart, 1988). It is currently admitted that this approach captures the dynamic of canopy  
 339 conductance but absolute values range from 0.4 to 1.3 times the real canopy conductance depending  
 340 on aerodynamic roughness of the canopy and stomatal aperture (Baldocchi *et al.*, 1991). Despite those  
 341 uncertainties, Pérez-Priego *et al.* (2010) applied this approach to estimate plant canopy conductance  
 342 ( $g_c$ ,  $\text{m s}^{-1}$ ) in a chamber. They proposed a simplified approach that avoided computing the net radiation  
 343 and soil heat flux, while considering the aerodynamic resistance to be negligible in a well ventilated  
 344 chamber:

$$345 \quad g_c = 0.625 \frac{\gamma}{\rho C_p} \frac{10^3 \lambda E}{VPD} \quad (8)$$

346 where 0.625 is the diffusion ratio of  $\text{CO}_2$  through  $\text{H}_2\text{O}$ ,  $\gamma$  is the psychrometric constant ( $\text{kPa K}^{-1}$ ),  $C_p$   
 347 the specific heat capacity of air at constant pressure ( $\text{kJ kg}_{\text{air}}^{-1} \text{K}^{-1}$ ),  $\rho$  the air density ( $\text{kg}_{\text{air}} \text{m}^{-3}$ ),  $VPD$   
 348 ( $\text{kPa}$ ),  $\lambda$  is the specific heat of vaporization ( $\text{MJ kg}_{\text{H}_2\text{O}}^{-1}$ ) and  $E$  is the transpiration rate ( $\text{kg}_{\text{H}_2\text{O}} \text{m}_{\text{leaves}}^{-2}$   
 349  $\text{s}^{-1}$ ).  $g_c$  was first calculated in  $\text{m s}^{-1}$ , then converted into  $\text{mol m}_{\text{leaves}}^{-2} \text{s}^{-1}$  according to Körner (1994).

$$350 \quad g_c (\text{mol}_{\text{air}} \text{m}_{\text{leaves}}^{-2} \text{s}^{-1}) = \frac{g_c (\text{ms}^{-1}) P}{R(T + 273.16)} \quad (9)$$

351 where  $R$  is the gas constant value ( $8.314 \text{ J mol}^{-1} \text{K}^{-1}$ ),  $P$  is the atmospheric pressure ( $\text{Pa}$ ),  $T$  is the air  
 352 temperature ( $^{\circ}\text{C}$ ).

## 353 ii. Eddy-covariance (EC)

### 354 *Measurements*

355 The experiment was set up in accordance with the Carboeuroflux recommendations (Aubinet *et al.*,  
 356 2000) and  $\text{H}_2\text{O}$  fluxes were already reported in (Gomez-Delgado *et al.*, 2011). Eddy-covariance  
 357 measurements were performed continuously in 2011, above the Erythrina and coffee trees' canopy (26  
 358 m, triangular antenna), in the middle of the experimental plot. It was assumed that footprint was not an  
 359 issue in such a large and homogeneous system. Although the topography of the watershed was

360 mountainous, the plot was located at the bottom of a shallow valley on gentle and homogeneous slopes  
361 (between 4 and 6%): such conditions were likely prone to nocturnal advection and CO<sub>2</sub> leakage and it  
362 was decided not to invest into any CO<sub>2</sub> profiling system, rather to adjust flux partitioning strategies.  
363 3D wind components and temperature were measured on top of the tower with a WindMaster  
364 ultrasonic anemometer (Gill Instruments, Lymington, UK) at 20 Hz. CO<sub>2</sub> and H<sub>2</sub>O fluctuations were  
365 measured with a Li-7500 open path (LiCor, Lincoln, NE, USA), calibrated monthly with a 500 ppm  
366 CO<sub>2</sub> tank and adjusting linear relationships with continuous water vapor molar fraction measurements  
367 (HMP45C of the weather station placed on top of the tower). The calibration coefficients were  
368 interpolated linearly between two calibration dates.

### 369 ***Data processing and quality check***

370 Raw data were collected and pre-processed in the field by “Tourbillon” software (INRA-  
371 Bioclimatologie, Bordeaux, France) into SLT files at 20Hz. The files were post-processed into half-  
372 hourly values in the laboratory for a time-integration period of 300 s, using EdiRe software  
373 (University of Edinburgh, UK), applying the following steps: (1) unit modifications, application of  
374 instrument calibration corrections and statistical operations; (2) spike removal for wind components  
375 (U,V, W), temperature (T), CO<sub>2</sub> (Q) and H<sub>2</sub>O (Q); (3) linear de-trending of sonic T, C and Q; (4)  
376 coordinate rotation to align coordinate system with the stream lines of the 30 min averages using a  
377 planar fit tool (INRA-Bordeaux) on monthly batches of data, separated by wind sectors; (5)  
378 determining time-lag values C and Q using a cross-correlation procedure; (6) computing mean values,  
379 turbulent fluxes and characteristic parameters, *e.g.* the Monin–Obhukov stability index Z/L; (7)  
380 correcting for high-frequency losses via transfer functions based on Kaimal–Moore’s co-spectral  
381 models (Kaimal *et al.*, 1972; Moore, 1986); (8) performing a Webb-Pearman-Leuning correction to  
382 account for the effects of fluctuations of temperature and water vapor on measured fluctuations of C  
383 and Q (Webb *et al.*, 1980); (9) spectra and co-spectra were computed. Two main statistical tests were  
384 used: (1) the stationary test was applied to pairs of specified signals. Standard deviations and  
385 covariances of W and C were computed on short time intervals of 1 min, and these values were  
386 compared to those computed on the chosen time run of 30 min, following Foken and Wichura (1996).  
387 Only data corresponding to a difference lower than 30% (periods defined as steady-state conditions)  
388 were retained. (2) The statistical test was based on the integral turbulence characteristics of wind  
389 components and temperature. The  $\sigma_w/U^*$  and  $\sigma_w/T^*$  ratios of the data signals (where  $\sigma$  is the standard  
390 deviation of the specified signals) were computed and compared to their parameterized values  
391 according to different ranges of stability (Z/L parameter). Only data matching with a difference of less  
392 than 50% were retained.

### 393 **Gap-filling and flux partitioning**

394 Using the previous statistical tests, the retained EC data corresponded to “high-quality data” with a  
395 general flag from 1 to 3. Finally, 58% of momentum flux and  $U^*$ , 49% of sensible heat flux (H), 42%  
396 of latent heat flux ( $\lambda E$ ) and  $CO_2$  flux data were retained for 2011.

397 Gap-filling and flux partitioning of  $CO_2$  were performed using the online tool provided at  
398 <http://www.bgc-jena.mpg.de/~MDIwork/eddyproc/index.php>. We avoided using either C profiles or  
399 the  $U^*$ -filtering method to estimate nocturnal ecosystem respiration, assuming possible night-time  
400 advection in our conditions (slope = 5%, mountainous surroundings). Else, we relied on the gap-filling  
401 strategy proposed by Lasslop *et al.* (2010), in order to derive ecosystem respiration ( $R_e$ ) only from  
402 daily data curve fitting. Gap-filling of H and  $\lambda E$  was performed independently (Falge *et al.*, 2001;  
403 Roupsard *et al.*, 2006).

### 404 **Canopy conductance**

405 Canopy conductance was assessed only during periods when foliage and superficial soil were dry, in  
406 order to minimize the contribution of intercepted water and of soil evaporation, *i.e.* periods without  
407 rain during the last 48 hours. We used the Stewart (1988) equation (inversion of Penman-Monteith  
408 equation) using eddy-covariance measurement. Boundary layer conductance was calculated using  
409 Monteith (1965) formula. Wind speed and VPD (HOBO Weather Station, Contoocook, NH, USA,  
410 calibrated against the Campbell weather station on top of the eddy-covariance tower) were measured  
411 at 3 m height, just above the coffee canopy. Net radiation ( $R_n$ ; NR-Lite, Kipp and Zonen, Delft, The  
412 Netherlands) was measured at the top (26 m) of the tower. Only data with  $R_n > 20 \text{ W m}^{-2}$  and positive  
413 GPP were used. The soil heat flux was ignored. The aerodynamic conductance was computed  
414 according to Stewart (1988). Canopy conductance was finally normalized by system LAI  
415 (coffee+Erythrina).

## 416 **D. MAESPA simulations and data analysis**

417 For the validation of MAESPA at plant scale,  $PAR_i$  measured with a BF3 sensor (Delta-T devices Ltd,  
418 Burwell, UK) at the top of the eddy-covariance tower was reduced by 9% to account for chamber lid  
419 absorbance. Air temperature and RH input were those measured inside the plant chamber. Wind speed  
420 was set constant at  $2 \text{ m s}^{-1}$ . For whole plot simulations, we used  $PAR_i$  measured at the top of the eddy-  
421 covariance tower as well as air temperature, RH and wind speed measured at 3 m above the coffee  
422 canopy (HOBO weather station).

423 We first simulated gas exchange of the plants enclosed in the chamber. The virtual plot was precisely  
424 parameterized in the areas where the enclosed plants were located in terms of neighboring plant  
425 position, dimensions and leaf area (Charbonnier *et al.*, 2013). We simulated  $\mu PAR$ , net photosynthesis,



426 transpiration and plant stomatal conductance the same day and same time of the day of their  
427 measurements.

428 Simulations of the whole plantation GPP and evapotranspiration were run for comparison with eddy-  
429 covariance measurements during the whole year 2011. Simulations of the coffee layer plus shade trees  
430 were run in a computer cluster as detailed in Charbonnier *et al.* (2013).

431 Slope, intercept and  $R^2$  of the linear regressions between half-hourly modeled and measured net  
432 photosynthesis and transpiration were performed to falsify model predictions. Additionally, the  
433 modeling efficiency statistics (EF) was used to estimate the goodness-of-fit (Wallach, 2006):

434

$$EF = 1 - \frac{\sum (y_i - \hat{y}_i)^2}{\sum (y_i - \bar{y}_i)^2} \quad (10)$$

435 where  $y_i$ ,  $\hat{y}_i$  were the  $i^{\text{th}}$  measured and predicted values, respectively;  $\bar{y}_i$  is the mean measured value.  
436 EF is similar to  $R^2$  but use the 1:1 line as a reference rather than the regression line. As in Hanson *et*  
437 *al.* (2004), we will consider values superior to 0.5 as a good agreement between model predictions and  
438 measurements.

439

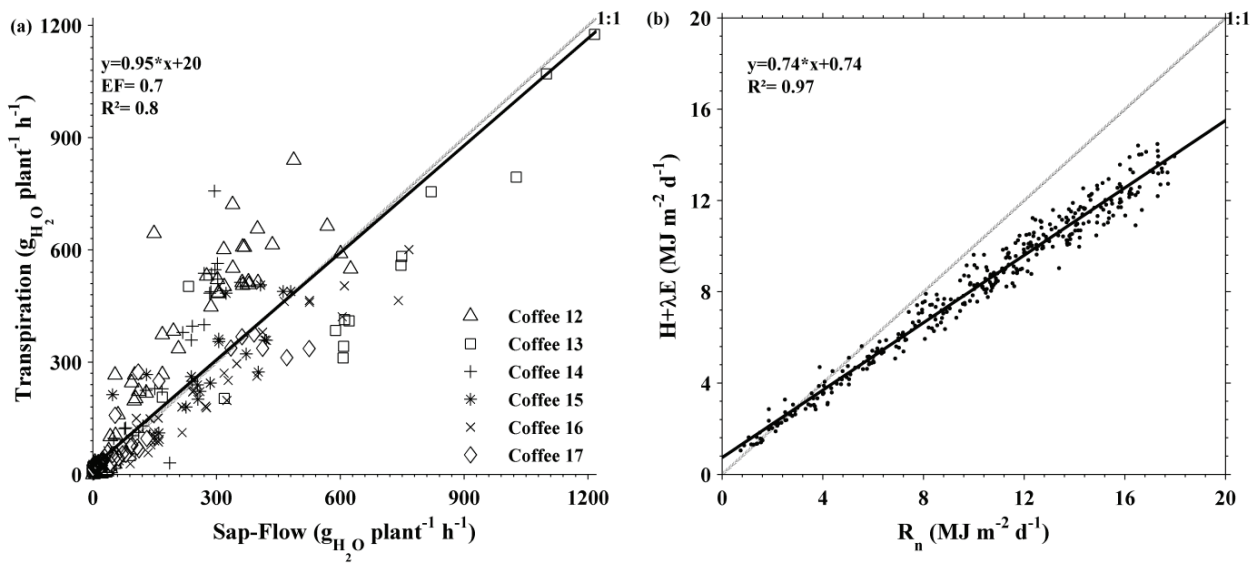

**Figure 2** – Verification of measurements at plant and plot scale. a) Comparison between transpiration measured with the whole-plant chamber at a 30 mn pace and sap-flow measured with heat-balance probes (Dynagage, Dynamax) at the same moment, for 6 coffee plants. Regression equations represent the relationships between the 2 methods. EF is the modeling efficiency. b) Energy balance closure at the plot scale for 2011 (one dot is the gap-filled sum of  $H+\lambda E$  per day).

### 440 3. Results

#### 441 A. Verification of measurements at plant and plot scale

##### 442 i. Transpiration at plant scale

443 There was a good agreement between time-course of sap-flow and transpiration measured by the  
444 chambers (Fig. 2a). Sap-flow ranged between plants from a daily maximum of 357 to 1220 g<sub>H2O</sub> plant<sup>-1</sup>  
445 h<sup>-1</sup>. Adding a 20 mn lag to transpiration measurement slightly improved the agreement ( $R^2 \geq 0.78$ ).  
446 Transpiration was either slightly overestimated or underestimated depending on the plant (slope range:  
447 0.75-1.6). Those observations indicate that the H<sub>2</sub>O exchanges were satisfactorily measured in the  
448 chamber, hence that its volume was estimated correctly.

##### 449 ii. Energy balance closure at plot scale

450 The energy balance closure, as obtained on gap-filled daily sums of  $(H + \lambda E_{g-f})$  was ca. 74% of  $R_n$  (Fig.  
451 2b), in conditions where heat storage in soil, plants and air was neglected.  $R^2$  of the regression was  
452 very satisfactory (0.97) indicating that despite footprint issues between  $R_n$  and  $H + \lambda E$  affecting the  
453 slope, the strong correlation was an argument in favor of proper conditions for measuring energy  
454 fluxes.

#### 455 B. Leaf scale stomatal conductance model

456 Measured leaf  $g_s$  under ambient conditions ranged from 0.0012 to 0.04 mol m<sup>-2</sup> s<sup>-1</sup> (mean=0.011) (Fig.  
457 3a) while leaf-to-air pressure deficit varied most of the time between 1.5 and 3.5 kPa (data not shown).  
458  $A_n$  reached maximum values of 5.7  $\mu\text{mol m}_{\text{leaves}}^{-2} \text{s}^{-1}$  in the range of  $\text{PAR}_i$  (0-500  $\mu\text{mol}_{\text{photons}} \text{m}^{-2} \text{s}^{-1}$ ) in  
459 ambient conditions (Fig. 4a).  $A_n$  was related to aPAR through a non-rectangular hyperbola with a  
460 saturation of the response at ca. aPAR > 150  $\mu\text{mol m}_{\text{leaves}}^{-2} \text{s}^{-1}$  (Fig. 4a). Maximum recorded  
461 transpiration rates were 1.7 mmol<sub>H2O</sub> m<sub>leaves</sub><sup>-2</sup> s<sup>-1</sup> (Fig. 4b). Transpiration efficiency displayed a slightly  
462 negative relationship with leaf-to-air VPD and was in average 4.6  $\mu\text{mol}_{\text{CO}_2} \text{mmol}_{\text{H}_2\text{O}}$  (data not shown).

463 The leaf stomatal conductance model proposed by Medlyn *et al.* (2011) performed slightly better than  
464 the other available models in MAESPA: Jarvis (1978), Ball *et al.* (1987) or Leuning (1995).  
465 However, all models underestimated higher  $g_s$  values, (Fig. 3a). Additionally, the model displayed  
466 lower and fairly constant intrinsic water use efficiency ( $A_{n_{\text{meas}}}/G_{s_{\text{mod}}}$ ; Mean = 84.6 ± SD 24  $\mu\text{mol}_{\text{CO}_2}$   
467 mol<sup>-1</sup>), while we found a greater variability in the measured data ( $A_{n_{\text{meas}}}/G_{s_{\text{meas}}}$ ; Mean = 113 ± SD 45  
468  $\mu\text{mol}_{\text{CO}_2} \text{mol}^{-1}$ ).

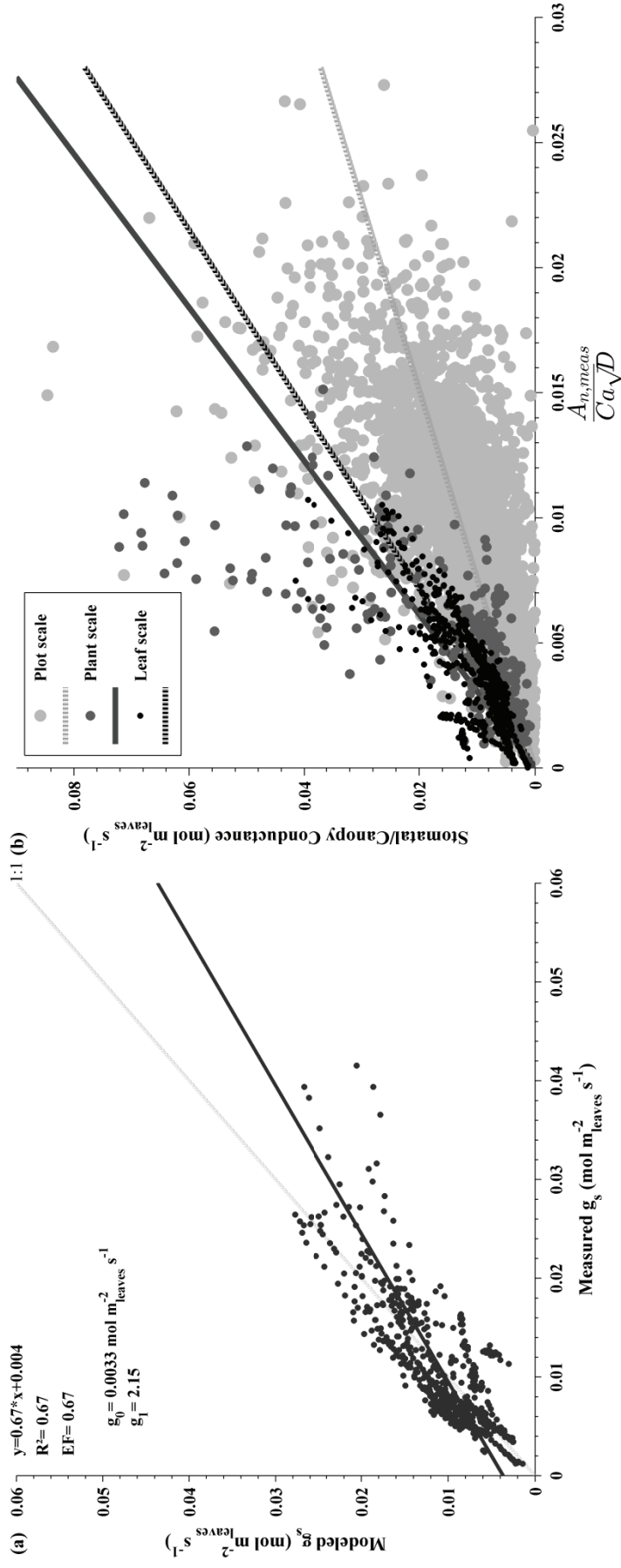

**Figure 3** – a) Measured versus modeled leaf stomatal conductance to  $\text{CO}_2$  using the model by Medlyn (2011). Values of fitted parameters are displayed in the plot. Data were measured in February-March 2013 during the drier period. (b) Conductance to  $\text{CO}_2$  plotted as a function of  $A/Ca\sqrt{D}$  at leaf scale, plant scale and plot scale derived from measured data. Leaf stomatal conductance was measured with a LI-6400 (LI-COR) at ambient air temperature, RH, Ca and incident PAR (transparent window). Canopy conductance of a single plant was computed by inverting a simplified version of Penman-Monteith model (Pérez-Priego et al., 2010) using transpiration and leaf-to-air deficit (D) measured in the whole-plant chamber and considering the aerodynamic resistance null. Canopy conductance was computed by inverting the Penman-Monteith model using eddy-covariance measurement of transpiration as well as VPD and wind speed measured just above the coffee canopy. The slopes of the lines are approximates to the  $g_1$  parameter of Medlyn (2011) stomatal conductance model and forced to origin for ease-of-comparison.

## 469 C. Measured and modeled fluxes at plant scale

### 470 i. Canopy conductance of coffee plants

471 Canopy conductance of single coffee plants ( $g_{c,plant}$ ) reached a maximum of  $0.072 \text{ mol m}_{leaves}^{-2} \text{ s}^{-1}$   
472 (mean=0.015) while D inside the chamber varied from 0.3 to 3.2 kPa (Fig. 3b).

### 473 ii. Net carbon assimilation and light use efficiency of coffee plants

474  $A_c$  in the chamber reached a maximum of  $6.2 \text{ } \mu\text{mol m}_{leaves}^{-2} \text{ s}^{-1}$ .  $A_c$  displayed a similar response to  
475 aPAR than at leaf scale (Fig. 4a), and under shade or in the open (data not shown). Light  
476 compensation point was  $85 \text{ } \mu\text{mol}_{photons} \text{ m}^{-2} \text{ s}^{-1}$  of incident PAR just above the plant. Maximum  $A_c$  was  
477 generally lower for shaded coffee plants due to lower aPAR (data not shown).

478 The response of plant  $A_c$  to aPAR was well reproduced by MAESPA even though modeled responses  
479 were less variable than measured ones (Fig. 5a). At high aPAR, the model inclined to slightly  
480 overestimate  $A_c$ . The slope of the modeled *versus* measured  $A_c$  relationship was 1 and the dispersion  
481 was reasonable ( $R^2=0.77$  and  $EF=0.68$ ; Fig. 5b). Modeled daily  $A_c$  was overestimated by 5% (full  
482 range -9 to +29%, data not shown).

483 Instant plant  $LUE_{can}$  was estimated satisfactorily, except during early morning and late afternoon, due  
484 to the large impact of small biases when modeling low aPAR values. Measured  $LUE_{can}$  integrated over  
485 the day was nearly doubled for coffee plants at low irradiance environment (0.029 against 0.016  
486  $\text{mol}_{CO_2} \text{ mol}_{photon}^{-1}$ ; Fig. 6d) while shade tree transmittance was *ca.* 50%. Modeled daily plant  $LUE_{can}$   
487 was less variable; it was slightly overestimated at high irradiance and underestimated at lower  
488 irradiance (+23 and -6%, respectively; Fig. 6d). Thus, the model predicted a smaller difference in  
489  $LUE_{can}$  between shaded and non shaded coffee plants (+25% only).

### 490 iii. Transpiration rates and transpiration efficiency of coffee plants

491 Maximum measured transpiration rate was  $1.7 \text{ mmol}_{H_2O} \text{ m}_{leaves}^{-2} \text{ s}^{-1}$ . It was positively correlated to  
492 leaf-to-air deficit, as expected (Fig. 4b). MAESPA captured quite well instantaneous plant  
493 transpiration with a 7% underestimation for highest values ( $R^2=0.76$  and  $EF=0.73$ ; Fig. 5c). Daily  
494 integrated values were also slightly underestimated (-6% on average) with a greater underestimation  
495 for shaded plants (-16% against +12% for plants at high irradiance).

496 Both measured and modeled instant values of plant  $TE_{can}$  followed the same non-linear decrease with  
497 D, modeled TE being slightly overestimated (+ 9%; Fig. 6a). The response to D did not differ  
498 according to the coffee plant irradiance environment. The relationship between modeled and measured  
499 instant plant  $TE_{can}$  was significant ( $R^2=0.5$ ; Fig. 6b). Integrating plant  $TE_{can}$  over a day improved  
500 significantly the correlation between model and measurement ( $R^2=0.75$ ). Model overestimated by 8%

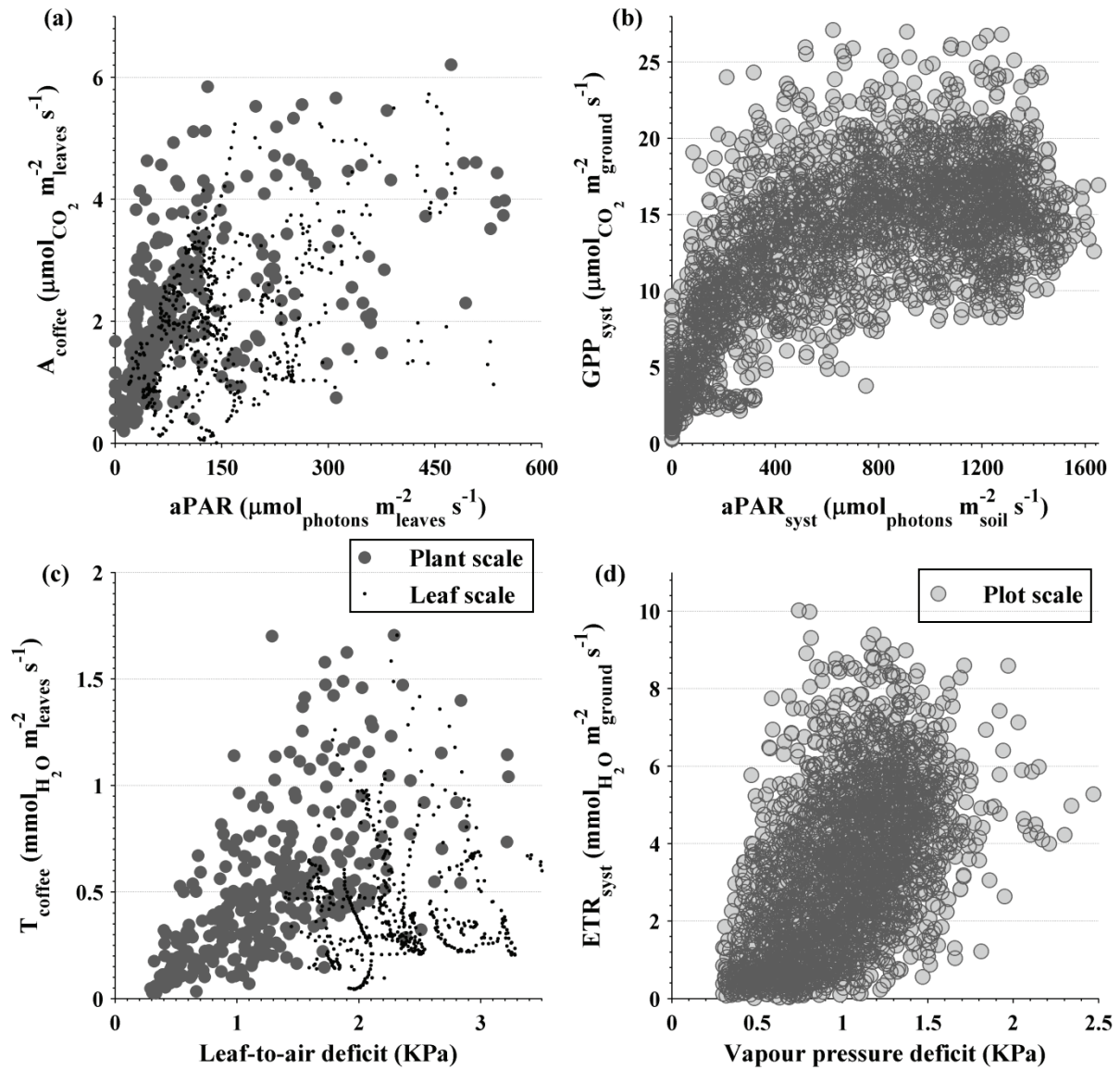

**Figure 4** - (a) Half-hourly response of measured photosynthesis of coffee leaves and plants to absorbed PAR. (b) Response of measured gross primary productivity of the system (*Erythrina*+*Coffee* layers) to absorbed PAR. (c) Response of measured transpiration of coffee leaves and plants to leaf-to-air deficit. (d) Response of measured ETR of the system (*Erythrina*+*Coffee*+soil layers) to vapour pressure deficit. Leaf aPAR was computed after multiplying the value of incident PAR inside the leaf cuvette by leaf absorptance ( $1 - \text{transmittance} - \text{reflectance} = 0.91$ ). aPAR at plant and plot scale was modeled by MAESPA. Plant scale canopy assimilation and transpiration were measured together with leaf-to-air vapor pressure deficit in the whole-plant chamber. Plot scale GPP and evapo-transpiration were measured with eddy-covariance (non rainy days only to avoid plant re-evaporation); VPD was measured above the coffee canopy.

501 and 13% daily  $TE_{can}$  of shaded and unshaded coffee plants, respectively (Fig. 6c). We detected no  
502 difference in  $TE_{can}$  of shaded and non-shaded plants.

## 503 **D. Measured and modeled fluxes at plot scale**

### 504 **i. Plot canopy conductance**

505  $g_c$  varied over the same range than conductance of single plants (up to  $0.085 \text{ mol m}_{leaves}^{-2} \text{ s}^{-1}$ ;  
506 mean= $0.013 \text{ mol m}_{leaves}^{-2} \text{ s}^{-1}$ ; Fig. 3b). We found no direct relationship between  $g_c$  and VPD.

### 507 **ii. Plot GPP and light use efficiency**

508 At plot scale, maximum measured GPP per  $\text{m}^2$  of leaves (coffee+*Erythrina*) was higher than at leaf  
509 and plant scale (coffee only, *Erythrina* excluded) measurements at comparable levels of aPAR (max:  
510  $8.2 \text{ } \mu\text{mol m}_{leaves}^{-2} \text{ s}^{-1}$ ). GPP per square meter of ground could reach  $27 \text{ } \mu\text{mol m}_{ground}^{-2} \text{ s}^{-1}$  (Fig. 4b).  
511 Saturation of GPP also seemed to occur at higher aPAR ( $>300 \text{ } \mu\text{mol m}_{leaves}^{-2} \text{ s}^{-1}$ ). Modeled  
512 instantaneous GPP was very similar to eddy-covariance measurement (Fig. 7a). However modeled  
513 values were overestimated by 11% when cumulated for the whole year 2011. The spread of the  
514 modeled GPP relationship with aPAR increased with GPP.

515 For 2011, yearly estimated GPP were 2051 and 2241  $\text{gC m}_{soil}^{-2} \text{ Y}^{-1}$  using eddy-covariance and  
516 MAESPA output, respectively. Most of monthly estimates of GPP were overestimated by the model  
517 (mean: 15% overestimation) (Fig. 8). However, the seasonal dynamics were quite consistent with the  
518 measurements and the monthly standard deviations was well accounted for by the model. Modeled  
519 GPP of shade trees accounted for 20-35% of plot GPP depending on seasons.

520 Spatial variability of GPP of the coffee layer within the agroforestry plot was mapped using MAESPA  
521 outputs (Fig. 9). The variability within the coffee layer was high, due mainly to the variability in  
522 coffee plant LAI and aPAR, resulting in a difficult visual separation of shade trees' effects on coffee  
523 plant GPP (Fig. 9a). However, the transect (Fig. 9d) indicated a reduction by around half of maximum  
524 values of GPP under shade tree crowns. The spatial variability of  $LUE_{can}$  was strongly influenced by  
525 shade trees (Fig. 9 b&e): it varied between 1.2 and 1.6  $\text{gC MJ}_{aPAR}^{-1}$  for coffee plants located under  
526 shade tree crowns (mean  $1.3 \text{ gC MJ}_{aPAR}^{-1}$ ) and varied little in the open areas ( $\approx 1.05 \text{ gC MJ}_{aPAR}^{-1}$ ).

527 When comparing the actual AF plantation with a virtual coffee monoculture, GPP could be reduced  
528 locally by up to 75% (Fig. 10c&f). In average over a complete year, aPAR decreased by 15% in the  
529 actual plantation compared to a coffee monoculture,  $LUE_{can}$  increased by 6%, and as a consequence  
530 GPP decreased by 12%.

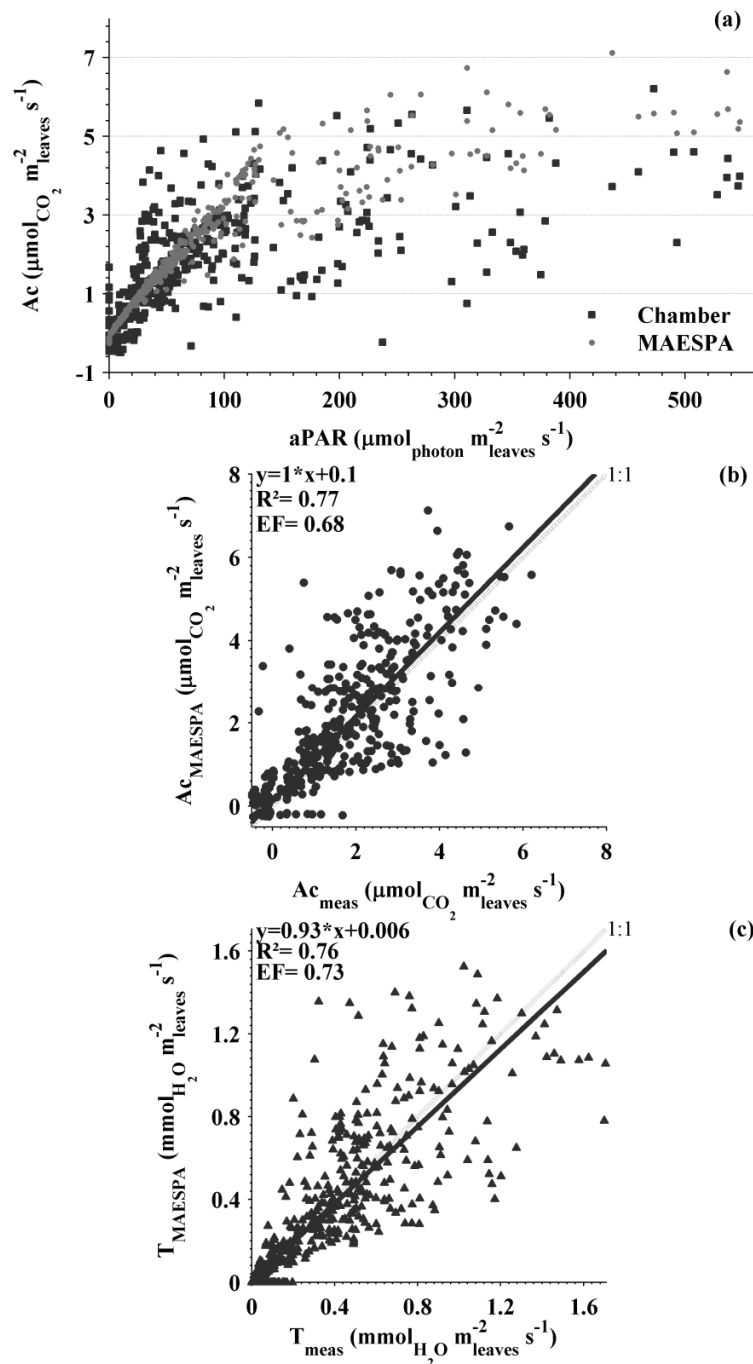

**Figure 5** – a) Response of half-hourly measured and modeled canopy assimilation ( $Ac$ ) to  $aPAR$  at plant scale. Measured versus modeled canopy assimilation (b) and transpiration (c). Measurements were carried out in whole-plant canopy chamber on coffee plants during 1 to 3 days per coffee plants during the drier season (February-April 2012). Only measurements from 6 AM to 6 PM were kept. Half-hourly measurements were standardized by leaf area. Simulations of  $aPAR$ , photosynthesis and transpiration were run with MAESPA for the same day and same time of the day of the measurement.



### 531 **iii. Plot transpiration**

532 Maximum transpiration rates measured with eddy-covariance were  $3.3 \text{ mmol}_{\text{H}_2\text{O}} \text{ m}_{\text{leaves}}^{-2} \text{ s}^{-1}$   
533 (Erythrina+coffee leaves), *i.e.* nearly two-fold higher than at leaf and plant scales ( $10 \text{ mmol}_{\text{H}_2\text{O}} \text{ m}_{\text{ground}}^{-2} \text{ s}^{-1}$ ; Fig. 4b). Transpiration rate displayed a strong linear correlation with VPD measured above the  
534 coffee canopy (Fig. 4d).  
535

536 Although coffee plant transpiration was well simulated by MAESPA (Fig. 5c), plot transpiration was  
537 unsatisfactory simulated (Fig. 7b). From  $1 \text{ mmol}_{\text{H}_2\text{O}} \text{ m}_{\text{leaves}}^{-2} \text{ s}^{-1}$ , the model failed in increasing  
538 transpiration, resulting in a curve-shaped cloud of points. As a consequence, further analyses on plot  
539 transpiration were discarded. The map of transpiration, TE and shading effect on transpiration are  
540 displayed in Appendix 1 as a potential diagnostic tool for the understanding of this discrepancy but  
541 cannot be considered as a reliable result so far.

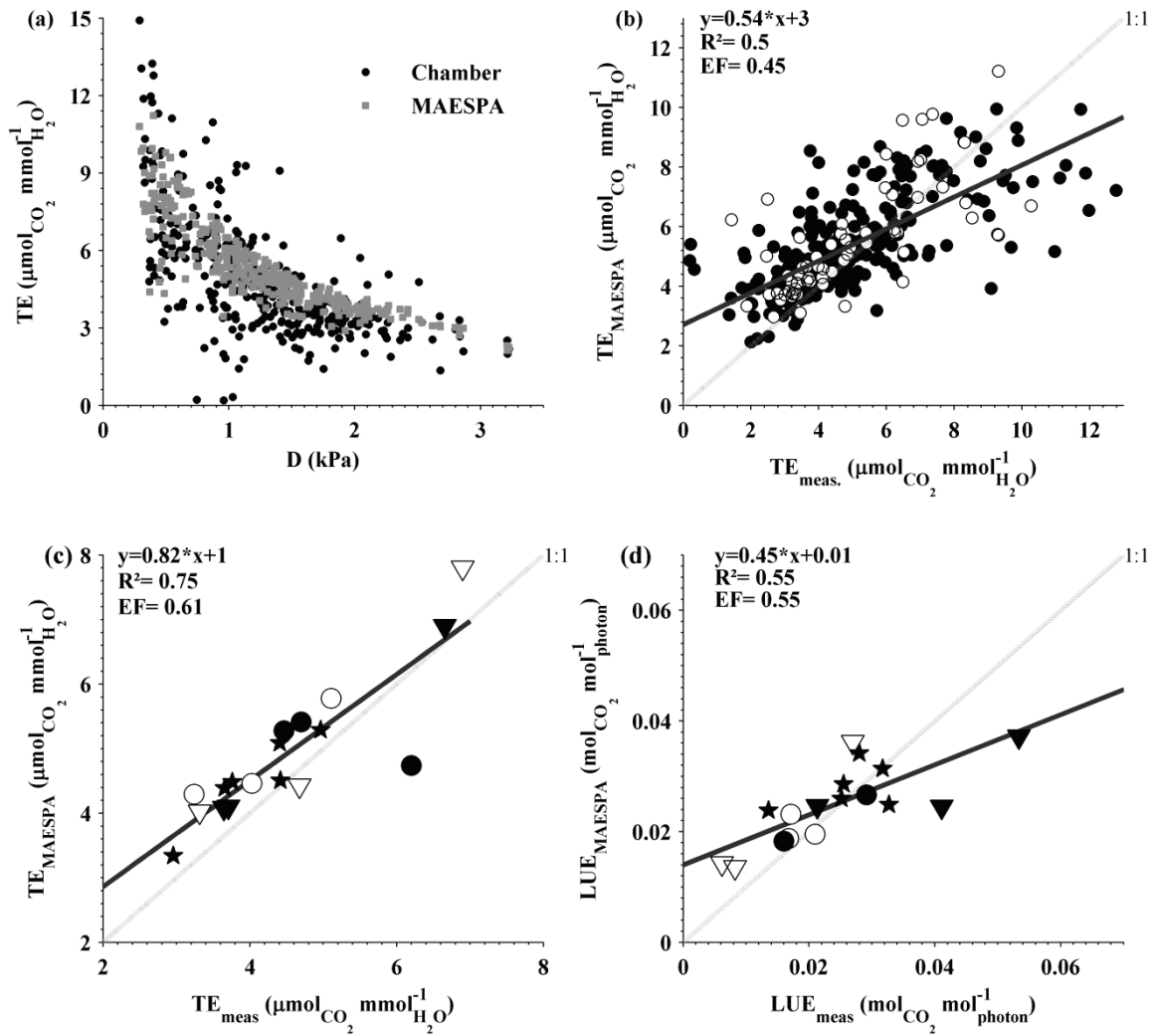

**Figure 6** –Plant transpiration efficiency (TE) a) Measured and modeled relationships between TE and leaf-to-air pressure deficit (D). b) Measured versus modeled TE: coffee plants growing in the open and growing under shade tree crown are represented by white and black marker, respectively. c) and d) measured vs. modeled responses of **daily integrated** TE and LUE, respectively: coffee plants growing in the open and growing under shade tree crown are represented by white and black marker, respectively; coffee plants bearing resprouts of 1, 3 and 5 years old are represented by circle, triangle and stars, respectively. Regression line, regression equation and statistics are displayed in the plots.

## 542 4. Discussion

### 543 A. Insights on the comparison between model and measurements at 3 544 scales

545 Our approach consisted in a step by step model/data inter-comparison, starting from the verification of  
546 measurements (sapflow in the chamber, energy balance closure for eddy-covariance measurement), the  
547 comparison of plant scale measurements at different irradiance levels and finally the comparison of  
548 plot scale estimations. Divergence between model and measurements are difficult to assess because  
549 they may origin from bias in model parameterization, misrepresentation of modeled processes, ignored  
550 processes by the model, uncertainties and errors in measurements. These sources of errors may be  
551 either canceled by other errors, propagated over scales, summed over space and time (Jarvis, 1995).  
552 MAESPA was parameterized with several independent measurements, without any parameter  
553 optimization or calibration. MAESPA was shown to predict satisfactorily net photosynthesis,  
554 transpiration, LUE and TE at plant scale. However at plot scale, measurement differed markedly  
555 between observed and modeled fluxes, with a slightly overestimated GPP and a strongly saturating  
556 transpiration. The objective of this part of the discussion is to source the potential errors in fluxes  
557 predictions.

#### 558 i. Stomatal conductance

559 Predicting correctly leaf  $g_s$  is crucial when using a coupled leaf photosynthesis-transpiration model  
560 (Farquhar and Sharkey, 1982). For this purpose, it is necessary to have an extended set of reliable field  
561 data for model calibration. Measuring  $g_s$  in the field is a non trivial work as stomata are very sensitive  
562 to changes in ambient conditions. Moreover, the number of measured leaves in the field is necessarily  
563 limited. It is thus important to gain confidence in measurements. Our dataset was found to be in the  
564 same cloud of points than Fanjul *et al.* (1985) study who measured leaf  $g_s$  on the same cultivar at  
565 about the same altitude (1200 masl) in Mexico during a non-fruiting season; their stomatal  
566 conductance decreased dramatically with air vapor pressure deficit (D); maximum  $g_s$  was  $0.35 \text{ mol m}^{-2}$   
567  $\text{s}^{-1}$  at  $D=0.2 \text{ kPa}$  and fell down to  $0.06 \text{ mol m}^{-2} \text{ s}^{-1}$  at  $D=1.2 \text{ kPa}$  (the latter value was similar to those  
568 from our dataset at the same D). Franck and Vaast (2009) measured leaf  $g_s$  on the same cultivar, same  
569 altitude in Costa Rica but during the rainy season and the fruiting season. They found the same  
570 rational decrease of  $g_s$  with D but  $g_s$  was 2.6 times higher in average than Fanjul *et al.* and our dataset.  
571 We fitted his dataset with the Medlyn *et al.* (2011) model and found that  $g_1$  was 4 times higher than  
572 found in our study. From this point, we can conclude to a potentially strong seasonal variations of  
573 coffee leaves stomatal conductance, not taken into account in our simulations (Barros *et al.*, 1997).  
574 Higher  $g_s$  values from Franck and Vaast (2009) could be partly explained by the enhancing effect of  
575 fruit sink demand (DaMatta *et al.*, 2008a).

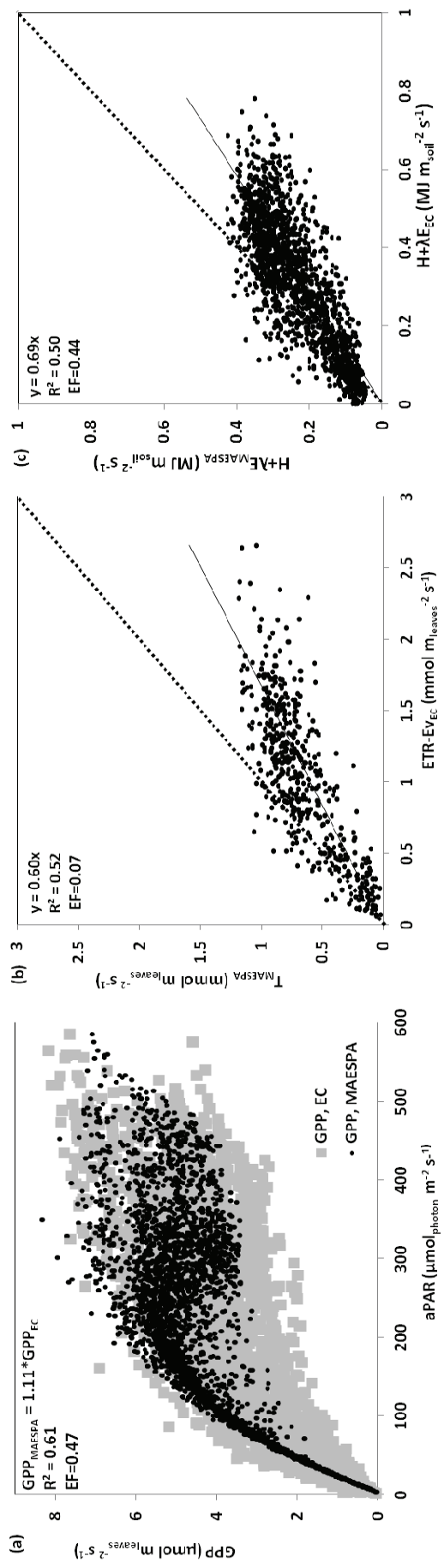

**Figure 7** - Plot scale comparison of half-hourly measured vs modeled gross primary productivity (GPP) as a function of aPAR (a), measured vs modeled transpiration (T; b) and  $H+\lambda E$  (c). GPP data were measured using eddy-covariance technique (EC). Only half-hourly values with no rains for the past 3 hours were used. Transpiration data were inferred from evapotranspiration (ETR) measured by eddy-covariance using only values with no rains for the last 48 hours, so that  $ETR \approx T$ .  $H$  was measured at the top of the EC tower with a net radiation sensor. MAESPA simulations were run over the entire 2011 year on a computer cluster for the whole plantation (14 Erythrina + 2.7 ha of coffee plants).

576 While a certain consensus has risen on the biochemical photosynthesis model of Farquhar, the most  
577 widely used stomatal conductance models are based on empirical relationships (Ball *et al.*, 1987;  
578 Jarvis, 1978; Leuning, 1995). Recently, Medlyn *et al.* (2011) published an optimization model based  
579 on the theory of optimal stomatal behavior (Cowan and Farquhar, 1977). This theory hypothesizes an  
580 optimal stomatal conductance to maximize carbon gain while minimizing water loss by transpiration  
581 over a given time period, *i.e.* corresponding to the concept of intrinsic water use efficiency ( $WUE_i$ ). In  
582 the model, the unique fitted parameter  $g_1$  is inversely proportional to  $WUE_i$ . In this theoretical  
583 framework,  $g_1$  is expected to be quite conservative within the same species. Although, the stomatal  
584 conductance of our dataset was reasonably predicted by this model, measured and modeled  $WUE_i$   
585 ( $An_{meas}/g_{s,meas}$  vs.  $An_{mod}/g_{s,mod}$ ) differed markedly. Model predicted a nearly stable  $An/g_s$  while  
586 measured  $WUE_i$  displayed a high variability. Indeed, a weak correlation between  $An$  and  $g_s$  was  
587 already reported by DaMatta *et al.* (2008b) and Franck and Vaast (2009), especially in period of lower  
588 fruit sink (DaMatta *et al.*, 2008b) or under low irradiance (Franck and Vaast, 2009). Additionally, we  
589 could raise a “technical” explanation for this absence of correlation. Depending on measurement  
590 technique, stomata may be in a transient state -. Small changes in incident light may influence stomatal  
591 aperture or closure. During this transient phase, the  $A/T$  ratio used to calculate stomatal conductance  
592 may be misestimated and may lead to difficulties in model parameterization (Y. Nouvellon, Pers.  
593 Comm.). Finally, plants stomata in natural conditions are most of the time in transient conditions and  
594 this could influence widely daily water fluxes (Rayment *et al.*, 2000; Violet-Chabrand *et al.*, 2013).

595 At plant scale, the modeled instantaneous TE was over-estimated at low measured TE and under-  
596 estimated at high measured TE (Fig. 6d). This could be explained by the transient state of stomata  
597 while doing measurements (temperature may increase by 1-2 degrees over the 2 mn of the  
598 measurement), and maybe highlighted by the non-linear response of canopy conductance to  $A/Ca\sqrt{D}$  at  
599 plant scale (Fig. 3b). When integrated daily, measured and model TE matched much better.

600 The hypothesis of seasonal variations of stomatal conductance could not explain the discrepancies in  
601 transpiration rates estimations at plot scale. Indeed, the saturation of the modeled response of  
602 transpiration was of the same magnitude when using only data gathered during the season without fruit  
603 (February-April 2013).

604 At this stage, we can hypothesize a strong seasonality in stomatal conductance, and thus the  $g_1$   
605 parameter of the Medlyn model may vary drastically. We would recommend at this point to: 1/  
606 screening the seasonal variations of  $g_s$ , with a specific focus on the effect of fruit load and  
607 development stages; 2/ to test specifically the theory of optimality on coffee stomatal behavior as in  
608 Duursma *et al.* (2013) study on cotton. However, the uncertainties on stomatal estimations may  
609 explain only partly the strong discrepancies at plot scale.

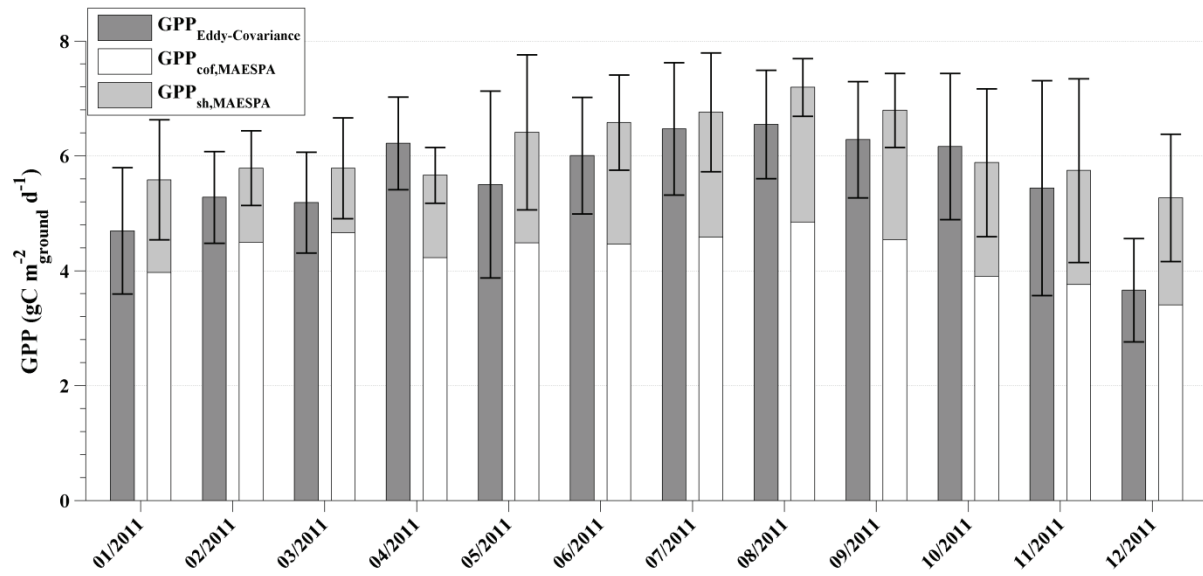

**Figure 8** – Monthly variations of mean daily GPP measured by eddy-covariance and modeled with MAESPA. Modeled GPP was partitioned into coffee layer and shade tree GPP. Error bars represent the standard deviation of daily variations within the month.

## 610 ii. Photosynthesis

611 There was a good general agreement between modeled and measured photosynthesis at leaf, plant and  
612 plot scales (Fig. 4a). The initial slope of the modeled and measured photosynthesis response to aPAR  
613 was satisfactorily reproduced. However, maximum modeled photosynthesis values were higher than  
614 measured. It resulted that daily estimates of photosynthesis were overestimated by 10% at plant and  
615 15% at plot scale in average. The contribution of *Erythrina* to plot GPP (30% GPP for 7% aPAR)  
616 seemed high, even with a 2-fold higher  $V_{cmax}$  for *Erythrina* when compared to coffee. Photosynthetic  
617 parameters of young *Erythrina* in well-watered pots could have been overestimated.

618 The dispersion in modeled vs. measured response of photosynthesis to aPAR at plant scale could be  
619 explained by the slight under- or over-estimation of plant aPAR due to the model simplifications in  
620 shade tree crown shapes, intracrown clumping, etc (Charbonnier *et al.*, 2013). However, carbon  
621 exchanges of coffee plants under shade tree crowns matched the model better than coffee plants in the  
622 open where there is no effect of shade trees ( $R^2=0.75$  and  $0.57$  for low and high irradiance  
623 environment, respectively).

624 Photosynthesis of coffee plants at high irradiance environment was over-estimated by 30% against a  
625 9% underestimation for plants growing at low irradiance. This phenomenon could be explained by an  
626 over-estimation of photosynthesis at the highest incident PAR. Indeed, a saturation and then a decline  
627 of leaf photosynthesis with high incident PAR were often reported in coffee literature. This decline has  
628 been interpreted by non-stomatal limitations of photosynthesis, such as by photoinhibition or Triose-  
629 Phosphate-Use (TPU) limitations, without clear consensus among authors yet (DaMatta, 2004;  
630 DaMatta *et al.*, 2008b; Franck and Vaast, 2009). This limitation was accounted for by Ögren and  
631 Sjöström (1990) and was applied successfully on coffee by Franck (2005). It could be reasonably  
632 included in MAESPA code. This decline at leaf and plant scale could have led to the observed  
633 overestimation at plot scale, where *ca.* 75% of the coffee plants received more than 80% of incident  
634 radiation (Charbonnier *et al.*, 2013). Studying residuals between modeled and measured GPP, we  
635 found that modeled GPP was overestimated with increasing diffuse PAR only. We could not find other  
636 correlations between residuals and any climatic variable (PAR<sub>i</sub>, VPD, thermic radiation, Température,  
637 time of the day, coffee or shade tree LAI and their interaction).

638 At plot scale, the absence of such photosynthesis decline at high irradiances was likely due to  
639 *Erythrina* GPP that saturate at higher irradiance than coffee plants.

640 Modeled GPP was less variable than GPP estimated from Eddy-covariance (EC) which reveals not  
641 only variability in biological processes but also information on the nature of turbulent fluxes. Thus we  
642 do not expect MAESPA to match perfectly EC datasets (Ibrom *et al.*, 2006). EC is also subject to  
643 random and systematic bias, especially in non-ideal conditions (slope, heterogeneous cover...). The

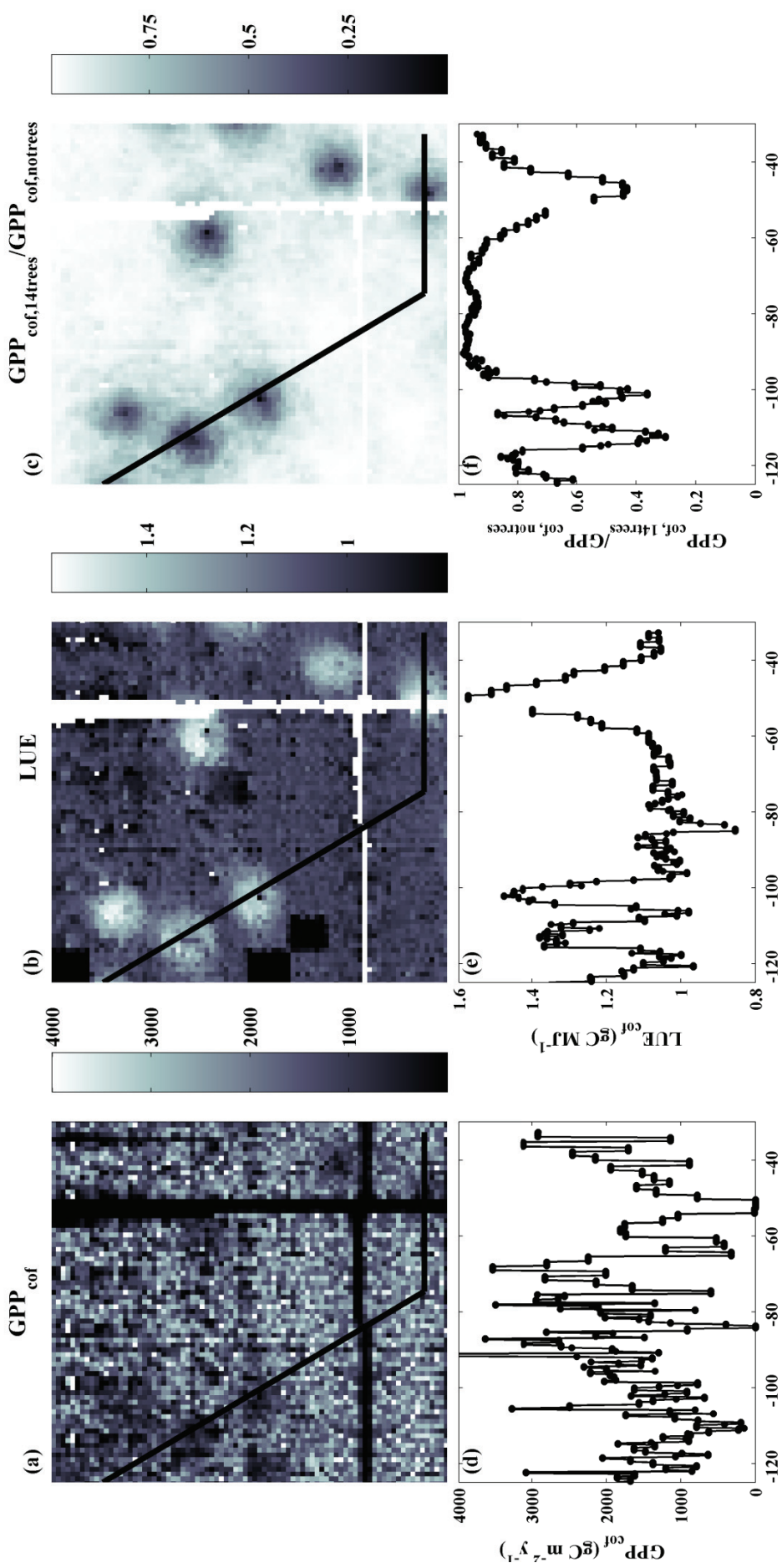

**Figure 9** - Maps of GPP of individual coffee plants in the plot and values obtained along the transect drawn across the plot (a & d), Light Use Efficiency integrated over the year ( $GPP/aPAR$ ; b & e) and ratio of the yearly GPP in the actual plantation (14 shade trees) to GPP in a virtual plantation without shade trees ( $GPP_{cof,14trees} / GPP_{cof,notrees}$  i.e. shading effect; c & f). The gray scales represent the values in the maps. For the sake of visibility, the maps were divided into pixels of a  $1.59\ m^2$  area (area per coffee plant at the initial planting density of  $6300\ ha^{-1}$ ) where GPP and aPAR values of the resprouts located in the same pixel were summed and divided by the pixel surface. The pathways are displayed in black (a) and white (b & c). White isolated pixels in the maps (b) and (c) represent areas without coffees. In the plot (b), values close to 0 correspond to the pathways and to pixels located at the location of a shade tree trunk.



644 variability of turbulence, the lack of energy balance closure, the variability in EC footprint according  
645 to changes in wind speed and wind, deviation of gas analyzer calibration are the main sources of  
646 biases (Baldocchi, 2003).

### 647 **iii. Transpiration**

648 Plant scale transpiration was slightly underestimated (-7%), with a higher underestimation for coffee  
649 plants at high irradiance (30% and 20% underestimation for high and low irradiance plants).

650 Modeled plot transpiration was much lower than measured plot ETR. For the sake of this comparison,  
651 we assumed non-significant water evaporation from soils after a 2-days drying of the superficial layer.  
652 This assumption should be taken cautiously as Charbonnier *et al.* (2013) showed that 35% of iPAR  
653 was reaching the soil, especially in the inter-row spaces.

654 Modeled sum of sensible (H) and latent ( $\lambda E$ ) heat fluxes appeared to be nearly linearly related to  
655 measured  $H+\lambda E$  (Fig. 7c), due to the fact that underestimation of modeled  $\lambda E$  at high transpiration  
656 rates was partially compensated by an overestimation of H at high transpiration rates. Regarding the  
657 slope (0.6), it must be stressed that measured H originated from the sum of soil H and vegetation H,  
658 while modeled H was only calculated for the vegetation, and the slope should be improved when  
659 adding a modeled soil H term (output of MAESPA when the water balance module is activated). Our  
660 interpretation is an inadequate partitioning of energy in MAESPA, when considered at the plot scale.  
661 We tested the effect of running or not the iterative process to adjust leaf temperature to solve the  
662 stomatal conductance-photosynthesis model (Leuning, 1995). Very suprisingly, we found very little  
663 differences in canopy temperature between the 2 options ( $\pm 0.1^\circ\text{C}$ ) which is not consistent with 5-7°C  
664 differences observed between coffee leaves and air reported by Lopez-Bravo *et al.* (2012) or Siles *et al.*  
665 (2010) and make us suspect a potential problem in solving the energy balance equation. Those  
666 problems in simulating higher transpiration rates were also met by Moreaux (2012) who advocated for  
667 an incorrect estimation of NIR and thermal radiations and also on an inadequate simulation of canopy  
668 aerodynamic conductance. Those points must be investigated before any publication on transpiration  
669 as modeled with MAESPA.

## 670 **B. Spatial variability of GPP in a coffee AFS**

671 Spatial variability of GPP of the coffee layer in the AFS was high due to the cumulated effect of shade  
672 trees and the spatial LAI heterogeneity within the coffee layer. Variation between pixels was strong  
673 and depended mainly on coffee LAI present on the pixel. A larger pixel area would incline to an  
674 averaged LAI and a lower spatial variability. Given the small pixel size, the effect of shade trees on  
675 spatial heterogeneity of GPP of the coffee layer was not the main source of variation, even if shade  
676 trees decrease by half maximum GPP. The main effect was the spatial variability of coffee LAI.

677 LUE<sub>can</sub> increased by up to 50% under shade trees, with a mean increase of 25% under shade tree  
678 crown, which is consistent with already measured data (Dapoigny *et al.*, 2000; Monteith *et al.*, 1991).  
679 LUE<sub>can</sub> was affected on a slightly larger area than shade tree crown projection area. Some extra  
680 simulations on varying the percentage of diffuse to direct light did not affect significantly LUE<sub>can</sub>  
681 under shade tree crowns. According to the model, this increase is mainly explained by the decrease in  
682 light intensity more than change in light quality. The coffee plants located under low irradiance  
683 environment are mostly under the steeper slope regime of the photosynthesis to aPAR response curve.

684 However, this increase in LUE<sub>can</sub> did not fully compensate the reduction of GPP due to the reduction  
685 in aPAR. Charbonnier *et al.* (in prep.) found that aerial NPP of coffee plants was not affected by the  
686 light environment. Hence, while GPP is actually reduced below shade trees, several sources of  
687 compensation could contribute to minimize the impact on NPP; the increase of LUE, the differential  
688 allocation between aerial and below-ground parts and possibly a reduction of autotrophic respiration  
689 below shade trees, a consequence of smoothed temperature fluctuations.

## 690 **5. Conclusion**

691 This study was a first attempt in trying to validate a 3D photosynthesis and transpiration model,  
692 MAESPA in a 2-layer heterogeneous agroforestry system. A careful approach made of independent  
693 parameterization and verification steps at leaf, plant and plot scale allowed to highlight good model  
694 predictions but also some specific problems.

695 When compared to whole plant-chamber and EC measurements, MAESPA was shown to simulate  
696 satisfactorily the photosynthesis and  $LUE_{can}$ . It was proven to be a powerful tool to simulate at fine  
697 spatial and temporal scale the spatial variability of the carbon fluxes which could not have been done  
698 with field measurements only. MAESPA could now be used to simulate the effects of different shade  
699 tree arrangement on plot carbon budgets and their spatial variation.

700 On the other hand, we showed uncertainties in the simulation of transpiration. Our 2-scales  
701 verification procedure showed that simulations of transpiration were satisfactorily at plant scale but  
702 became largely underestimated at plot scale. It highlighted uncertainties in measurements (e.g.  
703 underestimation of soil  $\lambda E$ ), together with potential problems in the model energy balance algorithm.  
704 A lot of work remains to be done before dealing with the microclimate and local effect of shade trees  
705 on coffee plant transpiration efficiency. Indeed, maps in Appendix 1 show a stable to decreasing TE  
706 for coffee plants located under shade tree crowns which appears rather counter intuitive. Once those  
707 problems solved, MAESPA could be tested in a system with limited water resources.

## 708 **6. Acknowledgements**

709 The authors would like to thank CIRAD for providing the PhD scholarship of Fabien Charbonnier,  
710 CATIE for laboratory facilities and AQUIARES farm for hosting the Coffee-Flux platform since 2009.  
711 The work was supported by EU-CAFNET Project, SOERE F-ORE-T observatory network, ANR-  
712 Ecosfix project, ANR-MACACC project, PCP platform of CATIE, BID Fontagro Caf' Adapt project.  
713 The authors wish to thank Alvaro Barquero Navarro for help in installation and maintenance of the  
714 experimental display and care of the chamber during night-time measurements; Grace Granados  
715 Barquero for leaf gas exchange measurements; Alejandra Barquero Aguillar, Jenny Barquero Aguillar,  
716 Cindy Rojas Aguillar and Mariella Jara Vargas for plant biometric description. We thank Muriel  
717 Navarro for valuable advices on chamber design.

718 **7. References**

- 719 Anderson, M.C., Norman, J.M., Meyers, T.P., Diak, G.R., 2000. An analytical model for estimating  
720 canopy transpiration and carbon assimilation fluxes based on canopy light-use efficiency. *Agricultural*  
721 *and Forest Meteorology* 101, 265-289.
- 722 Atkin, O.K., Evans, J.R., Siebke, K., 1998. Relationship between the inhibition of leaf respiration by  
723 light and enhancement of leaf dark respiration following light treatment. *Functional Plant Biology* 25,  
724 437-443.
- 725 Audebert, L., 2011. Productivité aérienne du café agroforestier: effets de l'ombrage et de l'âge des  
726 rejets, *Biologie et Ecologie pour la Forêt, l'Agronomie et l'Environnement*. Master II. UHP Nancy I,  
727 Nancy, France, p. 25 pp + Annexes.
- 728 Baldocchi, D.D., 2003. Assessing the eddy covariance technique for evaluating carbon dioxide  
729 exchange rates of ecosystems: past, present and future. *Global Change Biology* 9, 479-492.
- 730 Baldocchi, D.D., Luxmoore, R.J., Hatfield, J.L., 1991. Discerning the forest from the trees: an essay  
731 on scaling canopy stomatal conductance. *Agricultural and Forest Meteorology* 54, 197-226.
- 732 Ball, J.T., Woodrow, I.E., Berry, J.A., 1987. A model predicting stomatal conductance and its  
733 contribution to the control of photosynthesis under different environmental conditions, in: Biggins, J.  
734 (Ed.), *Progress in Photosynthesis Research*, pp. 221-224.
- 735 Barros, R., Mota, J., Da Matta, F., Maestri, M., 1997. Decline of vegetative growth in *Coffea arabica* L  
736 in relation to leaf temperature, water potential and stomatal conductance. *Field Crop. Res.* 54, p.65-72.
- 737 Cannell, M., Van Noordwijk, M., Ong, C., 1996. The central agroforestry hypothesis: the trees must  
738 acquire resources that the crop would not otherwise acquire. *Agroforest Syst* 34, 27-31.
- 739 Charbonnier, F., le Maire, G., Dreyer, E., Casanoves, F., Christina, M., Dauzat, J., Eitel, J.U.H., Vaast,  
740 P., Vierling, L.A., Roupsard, O., 2013. Competition for light in heterogeneous canopies: Application  
741 of MAESTRA to a coffee (*Coffea arabica* L.) agroforestry system. *Agricultural and Forest*  
742 *Meteorology* 181, 152-169.
- 743 Charbonnier, F., Roupsard, O., Casanoves, F., Le Maire, G., Lacoïnte, A., Clément-Vidal, A., Jourdan,  
744 C., Audebert, L., Defresnet, E., Cambou, A., Khac, E., Barquero, A., Leandro, P., Van den Meersche,  
745 K., Alline, C., Avelino, J., Saint-André, L., Vaast, P., Dreyer, E., in prep. Increased light use  
746 efficiency of coffee under shade trees compensates for ANPP but not for fruiting. To be submitted in  
747 *Journal of Experimental Botany*.
- 748 Condon, A.G., Richards, R.A., Rebetzke, G.J., Farquhar, G.D., 2004. Breeding for high water-use  
749 efficiency. *Journal of Experimental Botany* 55, 2447-2460.
- 750 Cowan, I.R., Farquhar, G.D., 1977. Stomatal function in relation to leaf metabolism and environment,  
751 in: Jennings, D.H. (Ed.), *Integration of activity in the higher plant*. Society for Experimental Biology,  
752 Cambridge, UK.

- 753 DaMatta, F.M., 2004. Ecophysiological constraints on the production of shaded and unshaded coffee:  
754 a review. *Field Crop. Res.* 86, 99-114.
- 755 DaMatta, F.M., Cunha, R.L., Antunes, W.C., Martins, S.C.V., Araujo, W.L., Fernie, A.R., Moraes, G.,  
756 2008a. In field-grown coffee trees source-sink manipulation alters photosynthetic rates, independently  
757 of carbon metabolism, via alterations in stomatal function. *New Phytologist* 178, 348-357.
- 758 DaMatta, F.M., Cunha, R.L., Antunes, W.C., Martins, S.C.V., Araujo, W.L., Fernie, A.R., Moraes,  
759 G.A.B.K., 2008b. In field-grown coffee trees source-sink manipulation alters photosynthetic rates,  
760 independently of carbon metabolism, via alterations in stomatal function. *New Phytologist* 178, 348-  
761 357.
- 762 Dapoigny, L., de Tourdonnet, S., Roger-Estrade, J., Jeuffroy, M.-H., Fleury, A., 2000. Effect of  
763 nitrogen nutrition on growth and nitrate accumulation in lettuce (*Lactuca sativa* L.), under various  
764 conditions of radiation and temperature. *Agronomie* 20, 843-855.
- 765 Dautzat, J., Eroy, M.N., 1997. Simulating light regime and intercrop yields in coconut based farming  
766 systems. *European Journal of Agronomy* 7, 63-74.
- 767 Denmead, O.T., Dunin, F.X., Wong, S.C., Greenwood, E.A.N., 1993. Measuring water use efficiency  
768 of Eucalypt trees with chambers and micrometeorological techniques. *Journal of Hydrology* 150, 649-  
769 664.
- 770 Dubois, J.-J.B., Fiscus, E.L., Booker, F.L., Flowers, M.D., Reid, C.D., 2007. Optimizing the statistical  
771 estimation of the parameters of the Farquhar-von Caemmerer-Berry model of photosynthesis. *New*  
772 *Phytologist* 176, 402-414.
- 773 Duursma, R., Medlyn, B.E., 2012. MAESPA: a model to study interactions between water limitation,  
774 environmental drivers and vegetation function at tree and stand levels, with an example application to  
775 [CO<sub>2</sub>] × drought interactions. *Geoscientific Model Development* 5, 919-940.
- 776 Duursma, R.A., Payton, P., Bange, M.P., Broughton, K.J., Smith, R.A., Medlyn, B.E., Tissue, D.T.,  
777 2013. Near-optimal response of instantaneous transpiration efficiency to vapour pressure deficit,  
778 temperature and [CO<sub>2</sub>] in cotton (*Gossypium hirsutum* L.). *Agricultural and Forest Meteorology* 168,  
779 168-176.
- 780 Falge, E., Baldocchi, D., Olson, R., Anthoni, P., Aubinet, M., Bernhofer, C., Burba, G., Ceulemans,  
781 R., Clement, R., Dolman, H., Granier, A., Gross, P., Grünwald, T., Hollinger, D., Jensen, N.-O., Katul,  
782 G., Keronen, P., Kowalski, A., Ta Lai, C., Law, B.E., Meyers, T., Moncrieff, J., Moors, E., William  
783 Munger, J., Pilegaard, K., Rannik, Ü., Rebmann, C., Suyker, A., Tenhunen, J., Tu, K., Verma, S.,  
784 Vesala, T., Wilson, K., Wofsy, S., 2001. Gap filling strategies for long term energy flux data sets.  
785 *Agricultural and Forest Meteorology* 107, 71-77.
- 786 Fanjul, L., Arreola, R., Mendez, C., 1985. Stomatal responses to environmental variables in shade and  
787 sun-grown coffee plants in Mexico. *Exp. Agric.* 21, 249-258.
- 788 Farquhar, G.D., Caemmerer, S., 1982. Modelling of Photosynthetic Response to Environmental  
789 Conditions, in: Lange, O.L., Nobel, P.S., Osmond, C.B., Ziegler, H. (Eds.), *Physiological Plant*  
790 *Ecology II*. Springer Berlin Heidelberg, pp. 549-587.

- 791 Farquhar, G.D., Ehleringer, J.R., Hubick, K.T., 1989. Carbon Isotope Discrimination and  
792 Photosynthesis. *Annual Review of Plant Physiology and Plant Molecular Biology* 40, 503-537.
- 793 Farquhar, G.D., Sharkey, T.D., 1982. Stomatal Conductance and Photosynthesis. *Annual Review of*  
794 *Plant Physiology* 33, 317-345.
- 795 Foken, T., Wichura, B., 1996. Tools for quality assessment of surface-based flux measurements.  
796 *Agricultural and Forest Meteorology* 78, 83-105.
- 797 Franck, N., 2005. Effet de la charge en fruits et de l'ombrage sur l'assimilation carbonée, la croissance  
798 et la production du caféier. PhD thesis, Ecophysiologie végétale - Développement et adaptation des  
799 plantes - Biologie des systèmes intégrés, Agronomie et Environnement. Ecole Nationale Supérieure  
800 d'Agronomie, Montpellier, p. 165.
- 801 Franck, N., Vaast, P., 2009. Limitation of coffee leaf photosynthesis by stomatal conductance and  
802 light availability under different shade levels. *Trees* 23, 761-769.
- 803 Gomez-Delgado, F., Roupsard, O., le Maire, G., Taugourdeau, S., Perez, A., van Oijen, M., Vaast, P.,  
804 Rapidel, B., Harmand, J.M., Voltz, M., Bonnefond, J.M., Imbach, P., Moussa, R., 2011. Modelling the  
805 hydrological behaviour of a coffee agroforestry basin in Costa Rica. *Hydrology and Earth System*  
806 *Sciences* 15, 369-392.
- 807 Gómez-Delgado, F., Roupsard, O., Lemaire, G., Taugourdeau, S., Pérez, A., Van Oijen, M., Vaast, P.,  
808 Rapidel, B., Voltz, M., Bonnefond, J.M., Imbach, P., Moussa, R., 2011. Modelling the hydrological  
809 behaviour of a coffee agroforestry basin in Costa Rica. *Hydrology and Earth System Sciences* 15.
- 810 Gomez, L.F., Lopez, J.C., Riano, N.M., Lopez, Y., Montoya, E.C., 2005. Diurnal changes in leaf gas  
811 exchange and validation of a mathematical model for coffee (*Coffea arabica* L.) canopy  
812 photosynthesis. *Photosynthetica* 43, 575-582.
- 813 Gu, L., Baldocchi, D., Verma, S.B., Black, T.A., Vesala, T., Falge, E.M., Dowty, P.R., 2002.  
814 Advantages of diffuse radiation for terrestrial ecosystem productivity. *Journal of Geophysical*  
815 *Research* 107, 4050.
- 816 Hanson, P.J., Amthor, J.S., Wullschleger, S.D., Wilson, K.B., Grant, R.F., Hartley, A., Hui, D., Hunt,  
817 J.E.R., Johnson, D.W., Kimball, J.S., King, A.W., Luo, Y., McNulty, S.G., Sun, G., Thornton, P.E.,  
818 Wang, S., Williams, M., Baldocchi, D.D., Cushman, R.M., 2004. Oak forest carbon and water  
819 simulations: model intercomparisons and evaluations against independent data. *Ecological*  
820 *Monographs* 74, 443-489.
- 821 Haxeltine, A., Prentice, I.C., 1996. A general model for the light-use efficiency of primary production.  
822 *Functional Ecology* 10, 551-561.
- 823 Ibrom, A., Jarvis, P.G., Clement, R., Morgenstern, K., Oltchev, A., Medlyn, B.E., Wang, Y.P.,  
824 Wingate, L., Moncrieff, J.B., Gravenhorst, G., 2006. A comparative analysis of simulated and  
825 observed photosynthetic CO<sub>2</sub> uptake in two coniferous forest canopies. *Tree Physiology* 26, 845-864.
- 826 IPCC, 2007. Latin America, in: Parry, M.L., Canziani, O.F., Palutikof, J., Van der Linden, P.J.,  
827 Hanson, C.E. (Eds.), *Climate Change 2007: Impacts, Adaptation and Vulnerability. Contribution of*

- 828 Working Group II to the Fourth Assessment Report of the Intergovernmental Panel on Climate  
829 Change. Cambridge University Press, Cambridge, UK.
- 830 Jarvis, P.G., 1978. The interpretation of the variations in leaf water potential and stomatal conductance  
831 found in canopies in the field. *Philosophical Transactions of the Royal Society of London. B,*  
832 *Biological Sciences* 273, 593-610.
- 833 Jarvis, P.G., 1995. Scaling processes and problems. *Plant, Cell & Environment* 18, 1079-1089.
- 834 Kaimal, J.C., Wyngaard, J.C., Izumi, Y., Coté, O.R., 1972. Spectral characteristics of surface-layer  
835 turbulence. *Quarterly Journal of the Royal Meteorological Society* 98, 563-589.
- 836 Kobayashi, H., Baldocchi, D.D., Ryu, Y., Chen, Q., Ma, S., Osuna, J.L., Ustin, S.L., 2012. Modeling  
837 energy and carbon fluxes in a heterogeneous oak woodland: A three-dimensional approach.  
838 *Agricultural and Forest Meteorology* 152, 83-100.
- 839 Körner, C., 1994. Leaf Diffusive Conductances in the Major Vegetation Types of the Globe, in:  
840 Schulze, E.-D., Caldwell, M. (Eds.), *Ecophysiology of Photosynthesis*. Springer Berlin Heidelberg, pp.  
841 463-490.
- 842 Lamanda, N., Dauzat, J., Jourdan, C., Martin, P., Malezieux, E., 2008. Using 3D architectural models  
843 to assess light availability and root bulkiness in coconut agroforestry systems. *Agroforestry Systems*  
844 72, 63-74.
- 845 Lambers, H., Chapin III, F.S., Pons, T.L., 2008. *Plant Physiological Ecology*. Springer.
- 846 Lasslop, G., Reichstein, M., Papale, D., Richardson, A.D., Arneeth, A., Barr, A., Stoy, P., Wohlfahrt,  
847 G., 2010. Separation of net ecosystem exchange into assimilation and respiration using a light  
848 response curve approach: critical issues and global evaluation. *Global Change Biology* 16, 187-208.
- 849 Leuning, R., 1995. A critical appraisal of a combined stomatal-photosynthesis model for C3 plants.  
850 *Plant, Cell & Environment* 18, 339-355.
- 851 Leuning, R., Kelliher, F.M., De Pury, D.G.G., Schulze, E.D., 1995. Leaf nitrogen, photosynthesis,  
852 conductance and transpiration: scaling from leaves to canopies. *Plant, Cell & Environment* 18, 1183-  
853 1200.
- 854 LI-COR, Application Note #129, The importance of water vapor measurements and corrections.
- 855 Lin, B.B., 2007. Agroforestry management as an adaptive strategy against potential microclimate  
856 extremes in coffee agriculture. *Agricultural and Forest Meteorology* 144, 85-94.
- 857 Medlyn, B.E., 1998. Physiological basis of the light use efficiency model. *Tree Physiology* 18, 167-  
858 176.
- 859 Medlyn, B.E., Duursma, R.A., Eamus, D., Ellsworth, D.S., Prentice, I.C., Barton, C.V.M., Crous,  
860 K.Y., De Angelis, P., Freeman, M., Wingate, L., 2011. Reconciling the optimal and empirical  
861 approaches to modelling stomatal conductance. *Global Change Biology* 17, 2134-2144.

- 862 Medlyn, B.E., Pepper, D.A., O'Grady, A.P., Keith, H., 2007. Linking leaf and tree water use with an  
863 individual-tree model. *Tree Physiology* 27, 1687-1699.
- 864 Misson, L., Baldocchi, D.D., Black, T.A., Blanken, P.D., Brunet, Y., Curiel Yuste, J., Dorsey, J.R.,  
865 Falk, M., Granier, A., Irvine, M.R., Jarosz, N., Lamaud, E., Launiainen, S., Law, B.E., Longdoz, B.,  
866 Loustau, D., McKay, M., Paw U, K.T., Vesala, T., Vickers, D., Wilson, K.B., Goldstein, A.H., 2007.  
867 Partitioning forest carbon fluxes with overstory and understory eddy-covariance measurements: A  
868 synthesis based on FLUXNET data. *Agricultural and Forest Meteorology* 144, 14-31.
- 869 Monteith, J.L., 1965. Evaporation and environment, XIXXTII symposium of the Society for  
870 Experimental Biology. Cambridge Univ. Press, pp. 205-233.
- 871 Monteith, J.L., Moss, C.J., 1977. Climate and the Efficiency of Crop Production in Britain [and  
872 Discussion]. *Philosophical Transactions of the Royal Society of London. B, Biological Sciences* 281,  
873 277-294.
- 874 Monteith, J.L., Ong, C.K., Corlett, J.E., 1991. Microclimatic interactions in agroforestry systems. *For.*  
875 *Ecol. Manage.* 45, 31-44.
- 876 Moore, C.J., 1986. Frequency response corrections for eddy correlation systems. *Boundary-Layer*  
877 *Meteorol* 37, 17-35.
- 878 Moreaux, V., 2012. Observation et modélisation des échanges d'énergie et de masse de jeunes  
879 peuplements forestiers du Sud-Ouest de la France, École doctorale Sciences et Environnements  
880 Bordeaux 1, Bordeaux, p. 282 p.
- 881 Ögren, E., Evans, J.R., 1993. Photosynthetic light-response curves. *Planta* 189, 182-190.
- 882 Ögren, E., Sjöström, M., 1990. Estimation of the effect of photoinhibition on the carbon gain in leaves  
883 of a willow canopy. *Planta* 181, 560-567.
- 884 Peel, M.C., Finlayson, B.L., McMahon, T.A., 2007. Updated world map of the Köppen-Geiger climate  
885 classification. *Hydrology and Earth System Sciences Discussions* 11, 1633-1644.
- 886 Penning de Vries, F.W.T., Akkersdijk, J.W.J., Oorschot, J.L.P.v., 1984. An error in measuring  
887 respiration and photosynthesis due to transpiration. *Photosynthetica* 18, 146-149.
- 888 Pérez-Priego, O., Testi, L., Orgaz, F., Villalobos, F.J., 2010. A large closed canopy chamber for  
889 measuring CO<sub>2</sub> and water vapour exchange of whole trees. *Environmental and Experimental Botany*  
890 68, 131-138.
- 891 Rayment, M.B., Loustau, D., Jarvis, P.G., 2000. Measuring and modeling conductances of black  
892 spruce at three organizational scales: shoot, branch and canopy. *Tree Physiology* 20, 713-723.
- 893 Roupsard, O., Bonnefond, J., Irvine, M., Berbigier, P., Nouvellon, Y., Dautzat, J., Taga, S., Hamel, O.,  
894 Jourdan, C., Saintandre, L., 2006. Partitioning energy and evapo-transpiration above and below a  
895 tropical palm canopy. *Agricultural and Forest Meteorology* 139, 252-268.



- 896 Siles, P., Harmand, J.-M., Vaast, P., 2010. Effects of *Inga densiflora* on the microclimate of coffee  
897 (*Coffea arabica* L.) and overall biomass under optimal growing conditions in Costa Rica. *Agroforestry*  
898 *Systems* 78, 269-286.
- 899 Spitters, C.J.T., Toussaint, H.A.J.M., Goudriaan, J., 1986. Separating the diffuse and direct component  
900 of global radiation and its implications for modeling canopy photosynthesis Part I. Components of  
901 incoming radiation. *Agricultural and Forest Meteorology* 38, 217-229.
- 902 Steduto, P., Çetinkökü, Ö., Albrizio, R., Kanber, R., 2002. Automated closed-system canopy-chamber  
903 for continuous field-crop monitoring of CO<sub>2</sub> and H<sub>2</sub>O fluxes. *Agricultural and Forest Meteorology*  
904 111, 171-186.
- 905 Stewart, J.B., 1988. Modelling surface conductance of pine forest. *Agricultural and Forest*  
906 *Meteorology* 43, 19-35.
- 907 Thornton, P., Cramer, L., 2012. Impacts of climate change on the agricultural and aquatic systems and  
908 natural resources within the CGIAR's mandate, CCAFS Working Paper. CGIAR Research Program  
909 on Climate Change, Agriculture and Food Security (CAAFS), Copenhagen, Denmark.
- 910 Tournebise, R., Sinoquet, H., 1995. Light interception and partitioning in a shrub/grass mixture.  
911 *Agricultural and Forest Meteorology* 72, 277-294.
- 912 Tuzet, A., Perrier, A., Leuning, R., 2003. A coupled model of stomatal conductance, photosynthesis  
913 and transpiration. *Plant, Cell & Environment* 26, 1097-1116.
- 914 USDA-NRCS, 2005. Global Soil Regions. USDA-NRCS, Soil Survey Division, World Soil  
915 Resources, Washington D.C.
- 916 Van Bavel, M.G., Van Bavel, C.H.M., 1990. Dynagage installation and operation manual. Dynamax  
917 Inc., Houston, TX, USA.
- 918 van der Werf, W., Keesman, K., Burgess, P., Graves, A., Pilbeam, D., Incoll, L.D., Metselaar, K.,  
919 Mayus, M., Stappers, R., van Keulen, H., Palma, J., Dupraz, C., 2007. Yield-SAFE: A parameter-  
920 sparse, process-based dynamic model for predicting resource capture, growth, and production in  
921 agroforestry systems. *Ecological Engineering* 29, 419-433.
- 922 van Oijen, M., Dreccer, M.F., Firsching, K.H., Schnieders, B.J., 2004. Simple equations for dynamic  
923 models of the effects of CO<sub>2</sub> and O<sub>3</sub> on light-use efficiency and growth of crops. *Ecological*  
924 *Modelling* 179, 39-60.
- 925 Violet-Chabrand, S., Dreyer, E., Brendel, O., 2013. Performance of a new dynamic model for  
926 predicting diurnal time courses of stomatal conductance at the leaf level. *Plant, Cell & Environment*  
927 36, 1529-1546.
- 928 von Caemmerer, S., Farquhar, G.D., 1981. Some relationships between the biochemistry of  
929 photosynthesis and the gas exchange of leaves. *Planta* 153, 376-387.
- 930 Wagner, S.W., Reicosky, D.C., Alessi, R.S., 1997. Regression Models for Calculating Gas Fluxes  
931 Measured with a Closed Chamber. *Agron. J.* 89, 279-284.

- 932 Wallach, D., 2006. Evaluating crop models, in: Wallach, D., Makowski, D. (Eds.), Working with  
933 dynamic crop models : evaluating, analyzing, parameterizing, and applications. Elsevier, Amsterdam,  
934 pp. 11-49.
- 935 Webb, E.K., Pearman, G.I., Leuning, R., 1980. Correction of flux measurements for density effects  
936 due to heat and water vapour transfer. Quarterly Journal of the Royal Meteorological Society 106, 85-  
937 100.
- 938 Yin, X., Sun, Z., Struik, P.C., Gu, J., 2011. Evaluating a new method to estimate the rate of leaf  
939 respiration in the light by analysis of combined gas exchange and chlorophyll fluorescence  
940 measurements. Journal of Experimental Botany.
- 941 Zhao, M., Heinsch, F.A., Nemani, R.R., Running, S.W., 2005. Improvements of the MODIS terrestrial  
942 gross and net primary production global data set. Remote Sensing of Environment 95, 164-176.
- 943 Zhao, M., Running, S.W., 2010. Drought-Induced Reduction in Global Terrestrial Net Primary  
944 Production from 2000 Through 2009. Science 329, 940-943.
- 945
- 946

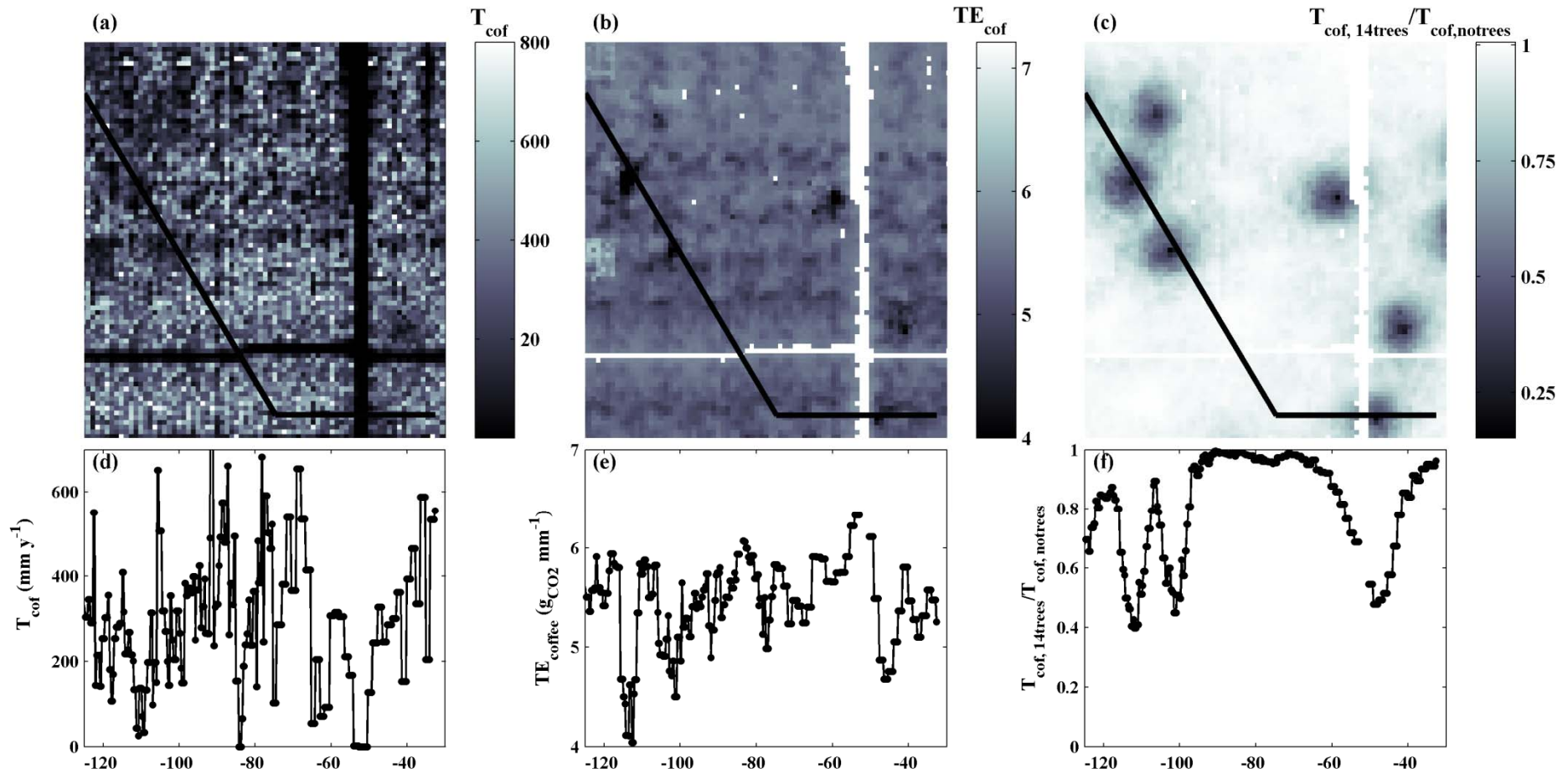
947 **Appendix 1 – Spatial variability of transpiration and transpiration efficiency**

948

949 **Appendix 1** - Maps of transpiration of individual coffee plants in the plot and values obtained along the transect drawn across the plot (a & d), Transpiration  
 950 Efficiency integrated over the year ( $GPP/T$ ; b & e) and ratio of the yearly  $T$  in the actual plantation to  $T$  in a virtual plantation without shade trees ( $T_{\text{cof},14\text{trees}}/$   
 951  $T_{\text{cof},\text{notrees}}$ , i.e. shading effect; c & f). The gray scales represent the values in the maps. For the sake of visibility, the maps were divided into pixels of a  $1.59 \text{ m}^2$   
 952 area (area per coffee plant at the initial planting density of  $6300 \text{ ha}^{-1}$ ) where  $GPP$  and  $T$  values of the resprouts located in the same pixel were summed and  
 953 divided by the pixel surface. The pathways are displayed in black (a) and white (b & c). White isolated pixels in the maps (b) and (c) represent areas without  
 954 coffees. In the plot b), values close to 0 correspond to the pathways or to pixels located at the position of a shade tree  $t$

---

## Leaf area index as an indicator of ecosystem services and management practices: an application for coffee agroforestry

---

Simon Taugourdeau<sup>a,b</sup>, Gueric le Maire<sup>a,c</sup>, Jacques Avelino<sup>d,e,f</sup>, Jeffrey R. Jones<sup>e,l</sup>, Luis G. Ramirez<sup>i</sup>, Manuel Jara Quesada<sup>i</sup>, Fabien Charbonnier<sup>a,g</sup>, Federico Gómez-Delgado<sup>h</sup>, Jean-Michel Harmand<sup>a</sup>, Bruno Rapidel<sup>j,e</sup>, Philippe Vaast<sup>a,k</sup>, Olivier Roupsard<sup>a,e,\*</sup>

<sup>a</sup>CIRAD, UMR Eco&Sols (Ecologie Fonctionnelle & Biogéochimie des Sols et des Agro-écosystèmes), 34060 Montpellier, France

<sup>b</sup>Université de Lorraine - UMR 1121 Agronomie et Environnement, F-54500 Vandoeuvre, France

<sup>c</sup>CIRAD, UMR TETIS (Territoires, Environnement, Télédétection et Information Spatiale), 34398 Montpellier, France

<sup>d</sup>CIRAD, UPR Bioagresseurs, TA A-106/02, Montpellier F-34398, France

<sup>e</sup>CATIE (Tropical Agricultural Centre for Research and Higher Education), 7170 Turrialba, Costa Rica

<sup>f</sup>IICA-PROMECAFE, AP55, 2200 Coronado, San José, Costa Rica

<sup>g</sup>Université de Lorraine, UMR EEF (Ecologie et Ecophysiologie Forestières), F 54500 Vandoeuvre, France

<sup>h</sup>ICE, 10032 San José, Costa Rica

<sup>i</sup>Cafetalera Quijano S.A., PO Box 362-7150 Turrialba, Costa Rica

<sup>j</sup>CIRAD, UMR System, SupAgro Montpellier, 2 place P. Viala, 34060 Montpellier, France

<sup>k</sup>ICRAF, United Nations Avenue, Gigiri, PO Box 30677-00100, Nairobi, Kenya

<sup>l</sup>REDD/CCAD/GIZ Project, German International Cooperation Agency- Deutsche Gesellschaft für Internationale Zusammenarbeit, Friedrich-Ebert-Allee 40. 53113 Bonn, Germany

23

\*Corresponding author : [olivier.roupsard@cirad.fr](mailto:olivier.roupsard@cirad.fr), O. Roupsard, tel. (506)25565034

## 25        **Abstract**

26        Scalable indicators are promising to assess Ecosystem Services (ES). In a large (660 ha) coffee  
27 agroforestry farm, we calibrated the relationship between the Normalized Difference Vegetation Index  
28 (NDVI) calculated on a High Resolution (HR) satellite image and ground-truth LAI, providing a 2-  
29 layer (shade trees and coffee) LAI calibration with LAI 2000 and a new technique based on a the  
30 cumulative distribution of LAI along transects. We calibrated the relationship between the derived  
31 HR-LAI farm map and NDVI from the Moderate Resolution Imaging Spectroradiometer (MODIS) in  
32 order re-construct LAI time-series (2001 to 2011).

33        MODIS Coffee LAI varied seasonally between 2.4 and 4.4 m<sup>2</sup> m<sup>-2</sup>, with a maximum by the end of  
34 wet season (peak of harvest), steep decline during the drier-cooler season, minimum after annual  
35 coffee pruning, recovery during the next rainy season and pause during the grain filling period.  
36 MODIS also detected significant inter-annual variations in LAI originating from annual pruning,  
37 rotation, as well as a progressive LAI recovery taking up to 4 years.

38        We related the coffee-LAI time-series with farm registries to examine the impacts of management  
39 on LAI and on selected ES, namely yield and hydrological services. Nitrogen fertilization was  
40 adjusted annually by the farmer and appeared as the best yield predictor ( $R^2 = 0.53$ ). Combining N-  
41 fertilization with LAI from 6 significant months of the year, the prediction was improved ( $R^2 = 0.74$ ),  
42 confirming LAI as an important co-predictor of yield. We ended up with a yield prediction model  
43 including also the percentage of pruned resprouts ( $R^2 = 0.79$ ), with perspectives in terms of regional  
44 yield mapping or reconstruction of historical yield time-series.

45        The impacts of varying LAI (from nil to double actual values) on hydrological services were  
46 simulated. LAI affected the partitioning between green water (evapotranspiration) and blue water  
47 (infiltration, aquifer recharge, streamflow), thus the water provisioning.

48        We discussed how LAI was influenced by natural factors (phenology, interaction between  
49 vegetative and reproductive compartments, climate) and by management (pruning, renovation). We  
50 confirmed LAI as a powerful scalable indicator for several major ES.

51        *Keywords:* Agroforestry systems / LAI / Ecosystem Services / Remote Sensing / Coffee / Hydrology

## 52        **1. Introduction**

53        Coffee is one of the World's largest agricultural export by value (FAO, 2011), and a very highly-  
54 ranked commodity (Pendergrast, 2009). It was the third-largest agricultural export of Costa Rica in  
55 monetary value in 2008 (FAO, 2011). Arabica coffee plantations of Costa Rica are located in sensitive  
56 areas, particularly on volcanic slopes susceptible to soil erosion and in watersheds that are crucial for  
57 providing water for human consumption and hydropower, or in areas pertaining to biological corridors  
58 (DeClerck *et al.*, 2010). They are usually managed quite intensively (conventional coffee), even in  
59 agroforestry systems (AFS). However, there are different levels of intensification in coffee production  
60 systems, ranging from organic to highly intensified. AFS may offer significant advantages when  
61 compared to monoculture (Beer *et al.*, 1998; Dupraz and Liagre, 2008). Shade trees can enhance the  
62 net primary productivity of these systems directly or indirectly, allowing a more efficient resource  
63 acquisition thanks to complementary and facilitation effects. In coffee AFS, shade trees were reported  
64 to modify the microclimate (Lopez-Bravo *et al.*, 2012; Siles *et al.*, 2010a), to reduce superficial runoff  
65 and deep drainage, to promote deep water uptake (Cannavo *et al.*, 2011), to reduce erosion at plot scale  
66 (Ataroff and Monasterio, 1997) and to decrease nutrient leaching (Harmand *et al.*, 2007). More  
67 generally, AFS were reported to enhance carbon sequestration (Albrecht and Kandji, 2003;  
68 Hergoualc'h *et al.*, 2012) and biodiversity conservation (Mendez *et al.*, 2007; Mendez *et al.*, 2009;  
69 Philpott *et al.*, 2008; Somarriba *et al.*, 2004).

70        Ecosystem services (ES) are the benefits provided by ecosystems to humanity (MEA, 2005). In  
71 developing countries, Costa Rica pioneered payments for environmental services (PES) by  
72 establishing a national program for PES to rural communities placed under the Forest Law of 1996.  
73 An agroforestry component was introduced in 2004 by FONAFIFO, the National Fund for Forest  
74 Financing (Pagiola, 2008). It includes the mitigation of greenhouse gases emissions and the provision  
75 of hydrological services. Typical spatial and temporal scales for the payment of ES are farm or  
76 watershed levels and annual or pluri-annual periods, respectively. Therefore, it is necessary to obtain  
77 information on ES at these different scales. In order to reward ES according to their real value rather  
78 than to coarse averages, common perception or even myths, reliable and standardized methods to  
79 quantify ES are necessary, ideally combining experimentations, modeling and identifying relevant  
80 indicators (Rapidel *et al.*, 2011).

81        We hypothesize here that Leaf Area Index (LAI), defined as the total leaf area per unit soil area  
82 (Gower *et al.*, 1999) would provide a powerful model parameter and also a valuable indicator of  
83 management practices and ES in agricultural systems, provided that we could separate the 2 layers and  
84 scale LAI from plant to plot and to the landscape. At the plant scale, coffee is an evergreen-  
85 broadleaved perennial plant, but its LAI varies seasonally (Siles *et al.*, 2010b; van Kanten and Vaast,  
86 2006) due to environmental conditions (Matoso-Campanha *et al.*, 2004; Righi *et al.*, 2007), biological  
87 factors such as diseases (Avelino *et al.*, 2007; Avelino *et al.*, 1991; Lopez-Bravo *et al.*, 2012), or to

88 management such as pruning and fertilizing. LAI was reported as a good indicator of coffee vigour  
89 (Charmetant *et al.*, 2007), or energy and gas exchanges (Charbonnier *et al.*, 2012). At the plot scale,  
90 LAI was long reported to affect microclimate (Ong *et al.*, 2000), evapotranspiration (Jung *et al.*, 2010),  
91 hydrological services (Gómez-Delgado, 2010), erosion control (Ataroff and Monasterio, 1997),  
92 biomass and growth (le Maire *et al.*, 2011a; Marsden *et al.*, 2010), gross and net primary productivities  
93 (Beer *et al.*, 2010; Gower *et al.*, 1999; Roy *et al.*, 2001).

94 Remote-sensing of LAI via satellite imagery can provide the LAI data required by models  
95 dedicated to simulate processes such as canopy light budgets (Charbonnier *et al.*, 2013; Gower *et al.*,  
96 1999; Roupsard *et al.*, 2008), rainfall interception, evapotranspiration, surface temperature, reflectance  
97 or photosynthesis. It should also allow the upscaling in time and space of ES, proven that they are  
98 closely related to LAI. Multispectral satellite images provide measurements of reflectance for different  
99 spectral bands, from which it is possible to calculate spectral Vegetation Indices (VI). These VI are  
100 linked to the optical properties of vegetation. For instance, green vegetation absorbs the red radiation  
101  $\rho_{RED}$  (low reflectance), and reflects a large proportion of the near infrared radiation  $\rho_{NIR}$  (high  
102 reflectance). The most widely used VI, the Normalized Difference Vegetation Index (NDVI) is  
103 calculated on the basis of these two spectral bands (Rouse *et al.*, 1973). NDVI can be correlated with  
104 the fraction of photosynthetic active radiation absorbed by the vegetation ( $fAPAR$ ), being itself related  
105 to LAI through non-linear models (Gower *et al.*, 1999). However, the relationship between NDVI and  
106 LAI depends on the plant species, the target image, the soil type (le Maire *et al.*, 2006) and most  
107 probably on the plot structure (e.g. planting density of coffee and shade trees). Due to the generally  
108 small scale of coffee plantations or to the presence of shade trees, there have been only few remotely-  
109 sensed applications developed for coffee, except for land mapping and soil classifying using Landsat  
110 (Cordero-Sancho and Sader, 2007), yield and bi-annual yield pattern in monoculture of arabica coffee  
111 (Bernardes *et al.*, 2012; Brunsell *et al.*, 2009), berry ripeness using airborne imagery (Johnson *et al.*,  
112 2004), or exposure to frost (Rafaelli *et al.*, 2006). The relationship between coffee yield and VI indices  
113 is delayed and probably much affected by phenological characteristics (e.g. bi-annual pattern,  
114 flowering intensity and fruit load, leaf shedding), climatic factors and management (e.g. pruning,  
115 shade). For instance, (Brunsell *et al.*, 2009) used lagged correlation analyses and deviations from the  
116 annual cycle to correlate the moderate spatial resolution (250 m aggregated at 1km) and 8-day  
117 temporal resolution of MODIS products (NDVI converted into fractional vegetation and radiometric  
118 temperature) with yield and bi-annual pattern of arabica coffee in Minas Gerais-Brazil, a region  
119 submitted to drought stress. Bernardes *et al.* (2012) reported that most correlations observed between  
120 yield and VI indices were rather weak, although very useful to monitor bi-annual production pattern  
121 and hence to improve coffee-crop models.

122 We stress that the true LAI is actually required for process models, VIs being only surrogates. No  
123 study has attempted to estimate the actual LAI from VIs in coffee. A refined seasonal LAI forcing is  
124 key to model coffee yield (Rodriguez *et al.*, 2011), due to complex vegetative and reproductive phases,

125 ruled by specific water and saturation deficit requirements (Carr, 2001; DaMatta, 2004) and also due  
126 to bi-annual production pattern. To our knowledge, the detailed seasonal pattern, the inter-annual  
127 variability and the management effects on LAI have not been described so far, due to the practical  
128 difficulty of LAI monitoring, and they deserve more efforts using tools for upscaling. The impacts of  
129 farm management on coffee LAI and yield, such as shading, pruning, harvesting, renovation,  
130 fertilization have little or not been taken into account in the previous remote sensing studies.  
131 Moreover, AFS are typically multilayer, heterogeneous, complex and interactive, which makes their  
132 monitoring and modelling quite challenging. For instance, shade trees, crops and soil interact for light  
133 capture and microclimate, both spatially and temporally. However, not attempt was made to separate  
134 LAI originating from shade trees and to that of the coffee sub-layer in AFS.

135 The aims of the present study conducted at the scale of a large coffee agroforestry farm of Costa  
136 Rica (660 ha) were (i) to calibrate the relationship between High Resolution (HR) NDVI and LAI after  
137 separating the 2 layers (shade trees and coffee), resulting in a HR-LAI map of the farm; (ii) to calibrate  
138 the relationship between the HR-LAI map and MODIS NDVI in order re-construct the past time-series  
139 of LAI (2001 to 2011); (iii) to assess the impacts of farm management (pruning, harvesting,  
140 renovation, fertilization) on LAI; and (iv) to highlight the relationships between management, LAI and  
141 two main ES, namely coffee yield and hydrological services.



## 142 2. Materials and methods

### 143 A. Study site

144 The study was conducted in the Central-Caribbean region of Costa Rica, in one of the largest  
145 coffee farm of the country (Aquiares farm: 660 ha), “Rainforest Alliance™” certified, located 15 km  
146 from CATIE (Centro Agronómico Tropical de Investigación y Enseñanza). The Aquiares farm  
147 elevation is ranging from 750 up to 1,400 m.a.s.l. with a mean slope of 20%. It has been hosting the  
148 “Coffee-Flux”<sup>1</sup> observatory of Ecosystem Services in coffee agroforestry since 2009, and shared its  
149 farm management historical data. Embedded within the farm, our experimental watershed lies between  
150 the coordinates 83°44’39” and 83°43’35” (Western longitude), and between 9°56’8” and 9°56’35”  
151 (Northern latitude) (Gómez-Delgado et al., 2011). Soils belong to the order of andisols (USDA, 1999),  
152 which are soils developing from volcanic ejecta, under weathering and mineral transformation  
153 processes, with high allophane and organic matter content (Kinoshita, 2012) and very high  
154 infiltrability (Gómez-Delgado, 2010). According to the Köppen-Geiger classification (Peel et al.,  
155 2007), the climate is tropical humid with no dry season and strongly influenced by the climatic  
156 conditions on the Caribbean hillside. The mean annual rainfall for the period 1973-2009 was 3014 mm  
157 at the Aquiares farm. Monthly rainfall is usually at its low between February and April with less than  
158 200 mm of rainfall per month. The driest month is March, with a 10-year average of 123 mm, whereas  
159 the wettest month is December, with an average of 329 mm. In 2009, mean monthly net radiation  
160 ranged from 5.7 to 13.0 MJ m<sup>-2</sup> d<sup>-1</sup>, air temperature from 17.0 to 20.8 °C, relative air humidity from 83  
161 to 91%, windspeed at 2 m high from 0.4 to 1.6 m s<sup>-1</sup> and Penman-Monteith reference  
162 evapotranspiration (Allen et al., 1998) from 1.7 to 3.8 mm d<sup>-1</sup>, all measured inside the watershed.

163 The Aquiares farm is planted with coffee (*Coffea arabica* L., dwarf var. Caturra mainly) on bare  
164 soil with an initial planting density of 1.11 m on the row and 1.43 m in-between rows, *i.e.* 6,300  
165 positions ha<sup>-1</sup>, 2 coffee stumps per position and with a stump age >30 years. Each stump was bearing  
166 an average of 3 stems being selectively pruned: exhausted stems older than 5-6 years were pruned  
167 every year in March, representing *ca.* 15% of total stems and *ca.* 25% of total coffee LAI. The canopy  
168 openness of coffee was around 25% and average canopy height around 1.2 m. Green coffee yield  
169 between 1994 and 2011 averaged 1375 kg ha<sup>-1</sup> yr<sup>-1</sup> (SD = 341), while coffee price averaged 121 \$ bag<sup>-1</sup>  
170 (SD = 39).

171 Shade was provided by free-growing *Erythrina poeppigiana* trees, the most widely used shade tree  
172 in coffee AFS of Costa Rica, usually pruned. To comply with eco-certification criteria of the  
173 Rainforest Alliance™ recommendations (promoting tall trees to provide more habitats for  
174 biodiversity), the *Erythrina* trees were here conducted in free growth after 2001. They showed an

---

<sup>1</sup> Coffee-Flux: <http://www5.montpellier.inra.fr/ecosols/Recherche/Les-projets/CoffeeFlux>

**Table 1:** Specifications of the very high spatial resolution (VHSR) images. PC = panchromatic; MS = multispectral

Aquisition date	Sensor	Resolution (m)	Zenital view angle (°)	Zenital solar angle (°)	Cloud cover (%)	Coordinates of the center
February 18, 2008	Worldview	PC 0.5 m	8.6	36.8	0.0	9°55'55.46 ; - 83°43'35.9
March 29, 2010	Worldview2	PC 0.5 m / MS 2 m	19.3	23.6	1.9	9°54'30.12; -83°41'55.37

175 average canopy height of *ca.* 20 m, a density of  $7.4 \text{ ha}^{-1}$ , and  $15.7\% \pm \text{SD } 5.5 \text{ m}^2$  plot coverage by  
176 canopy, as assessed on 570 ha using the 2010 image.

177 The Aquiares farm is managed quite intensively (upper conventional mode), with fertilizers  
178 adjusted thrice a year after surveys of the fruiting load ( $214 \text{ kg N ha}^{-1} \text{ yr}^{-1}$ ;  $\text{SD} = 44$ ; 2000-2012). As  
179 weeds are frequently and drastically controlled, the soil is assumed to be covered mainly by litterfall.

## 180 **B. Remotely sensed NDVI**

181 Two very high spatial resolution images (VHSR) were used (Table 1). A 0.5 m resolution  
182 panchromatic archive image (2008) was used mainly to pre-select the position of the field LAI  
183 transects across the farm. A multispectral image taken in March 2010 (simultaneously with field LAI  
184 transects) at 2 m resolution was used to map LAI at farm scale. Prior to their use, the images were  
185 geometrically and atmospherically corrected. An ortho-rectification (correction of the image according  
186 to terrain and geometry) was performed using the 10 m resolution digital terrain model from the  
187 TERRA-1998 project (CENIGA, 1998). We checked this ortho-rectification with the help of ground  
188 GPS measurements. We performed atmospheric corrections using the Dark Object Subtraction method  
189 (Song *et al.*, 2001), as in (Soudani *et al.*, 2006). NDVI was then calculated on this VHSR image  
190 ( $\text{NDVI}_{\text{HR}}$ ).

191 MODIS instruments onboard Terra and Aqua satellites acquire images almost every day with a  
192 resolution close to 250 meters at nadir for the red and near infrared bands. The image acquisitions  
193 began in 2000 for Terra satellite and in 2002 for Aqua satellite. Products MOD13Q1 and MYD13Q1  
194 are 16 day composite products (downloaded here as subsets, <http://daac.ornl.gov/MODIS/>). These  
195 images have already been corrected for geometry and atmospheric effects, and filtered from daily  
196 reflectance to keep the best vegetation index in a 16 day window for each pixel (composite image).  
197 The pixel data quality is provided as a Pixel Reliability class, together with information about sun and  
198 view geometries. We performed additional filtering by discarding data of poor quality based on the  
199 Pixel Reliability class, data acquired with a view angle higher than  $35^\circ$ , and data showing abrupt  
200 changes of NDVI that are not compatible with the vegetation dynamics (le Maire *et al.*, 2011b;  
201 Marsden *et al.*, 2010; Viovy *et al.*, 1992). We discarded approximately 50% of the data from both  
202 Terra and Aqua, keeping around 12 dates per year fairly well distributed throughout the year. The  
203 spline coefficients for interpolation were chosen to smooth the intra-monthly variability on NDVI  
204 values but keeping the inter-monthly (*i.e.* seasonal) variability. The data were then re-sampled at 10  
205 days for the 2001-2011 period which is called below the MODIS NDVI ( $\text{NDVI}_{\text{MOD}}$ ) continuous time  
206 series.

207 For the LAI calibration of the MODIS pixels, we superimposed the MODIS pixel grid of the  
208 Aquiares farm in shapefile format onto the VHSR images. We considered that the reflectance of a  
209 MODIS pixel in its native sinusoidal projection corresponds to a regular squared grid of measurements

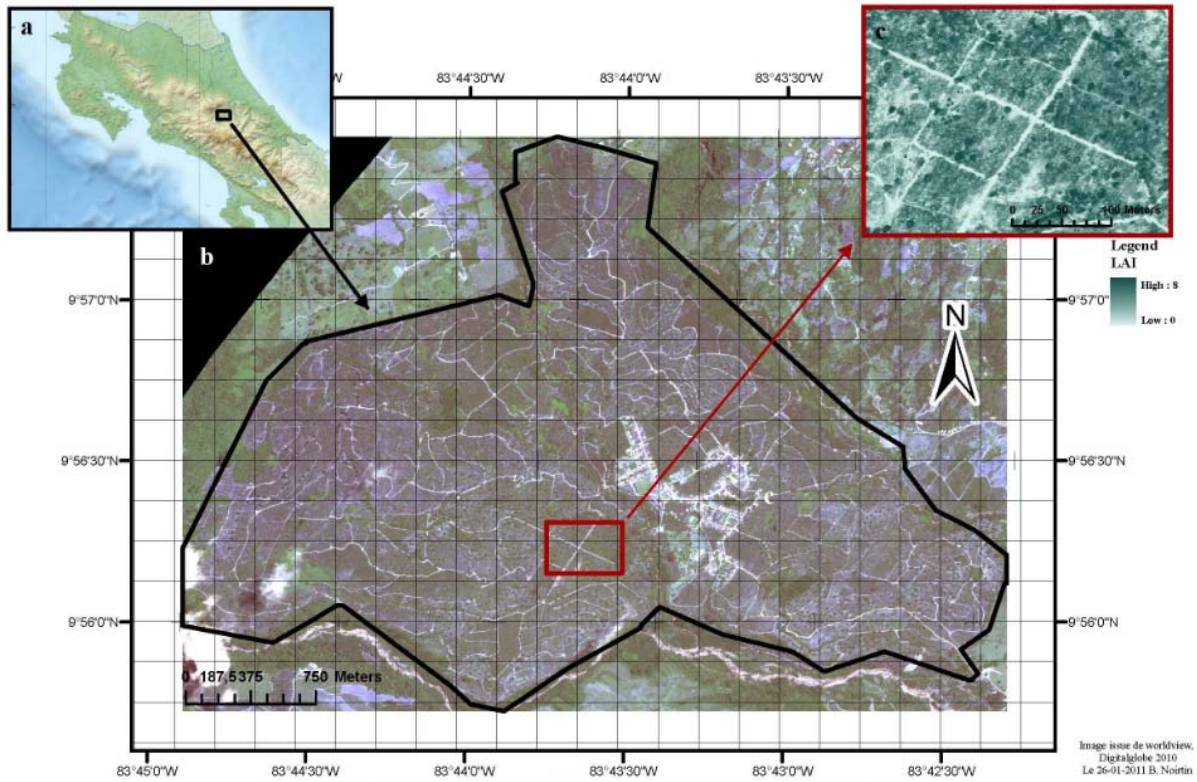

**Figure 1** - Study site : a) location of the Aquiares farm in Costa Rica; b) MODIS pixel grid layed over the Worldview2 image (March 29, 2010); c) detail of the LAIHR map obtained after this study, showing coffee, shade trees and routes (2 m resolution).

**Table 2:** Characteristics of 3 *Erythrina poeppigiana* trees used for computing shade tree leaf area index and dynamics and upscale to the farm.

Scale	Characteristics	Mean	SD
3 trees 2010 average	Tree height (m)	28.70	0.52
	DBH (m)	0.92	0.06
	Free bole height (m)	3.67	1.15
	Drip Line Area (DLA: m <sup>2</sup> )	212.7	24
	Crown volume (m <sup>3</sup> )	2135	570
	Plant Area Density (PAD: m <sup>2</sup> m <sup>-3</sup> )	0.49	0.28
	DLPAI <sub>eff,tree</sub> (m <sup>2</sup> m <sub>drip line area</sub> <sup>-2</sup> )	6.33	3.28
	DLPAI <sub>eff,tree,defoliated</sub> (m <sub>non green</sub> <sup>2</sup> m <sub>drip line area</sub> <sup>-2</sup> )	2.03	0.20
	DLLAI <sub>eff,tree</sub> (m <sub>leaf</sub> <sup>2</sup> m <sub>drip line area</sub> <sup>-2</sup> )	4.30	2.08
LAI <sub>eff,tree</sub> (m <sup>2</sup> tree <sup>-1</sup> )	914	50	
Whole Farm 2010 average	Total tree drip-line projected area (%)	15.70	5.5
	Tree density (tree ha <sup>-1</sup> )	7.38	-
	LAI <sub>eff,tree</sub> (m <sup>2</sup> m <sub>soil</sub> <sup>-2</sup> )	0.67	0.33

210 (Fig. 1). Seven pixels were sampled out of a total of 91, according to their homogeneity and  
211 representativeness (density, position of trees, tree coverage, visible in the VHSR image). Two 45 m-  
212 long LAI 2000 transects were sampled for each of these 7 pixels, resulting in 14 transects  
213 representative of the canopy cover conditions of the farm.

## 214 **C. Ground-truth PAI and LAI, separated by layer**

### 215 **i. Effective plant area index ( $PAI_{eff}$ ) by layer obtained under transects**

216 The directional (zenithal angles of the LAI-2000, all averaged azimuthally,  $270^\circ$  view cap) light  
217 transmittance of vegetation cover (trees and coffee separately) was measured along the 14 transects at  
218 one single date using two LAI 2000 (LI-COR, 1992) devices under diffuse light conditions, after  
219 matching the two instruments every day. The reference (R) LAI-2000 was placed in an open space to  
220 monitor automatically the incident radiation above the plots every 30 s. The second instrument was  
221 operated manually along transects in a repetitive sequence: one measurement above the coffee plants  
222 (AC) (below the shade trees), followed by 4 measurements below the coffee plants (BC) along  
223 diagonals between 2 coffee plant locations. The angular transmittance of the shade trees was derived  
224 from  $AC / R$ , and of coffee from  $BC / AC$ . The transmittances calculated from the two most horizontal  
225 rings of the LAI 2000 were discarded to avoid light interception by sloped terrain, and their weight  
226 was transferred onto ring # 3, following Thimonier et al. (2010). The effective plant area index was  
227 obtained from angular transmittances of the shade trees ( $PAI_{eff,tree}$ ) and coffee layers ( $PAI_{eff,coffee}$ )  
228 separately, after inverting the Beer's law for turbid media.

229 We stress that at this stage, only one average PAI value was available per layer, per transect and  
230 per date, while clumping and green-to-non-green effects remained confounded into  $PAI_{eff}$ .

### 231 **ii. Refining shade tree LAI and recording its seasonal pattern**

232  $PAI_{eff,tree}$  of three representative *Erythrina poeppigiana* shade trees from tower plot (Tab. 2) was  
233 monitored every month from 2010 to 2012, using the isolated-tree protocol available in the FV-2200  
234 software (v. 1.2) of LAI-2000. Transmittance measurements were performed below each tree crown, at  
235 each date, using the  $180^\circ$  view cap, excluding the trunk. One or two of the lowest view angles were  
236 discarded whenever the sensor viewed below the crown. The crown shapes were delineated on digital  
237 photographs (8 points per half crown), the crown volumes and drip-line areas were computed and used  
238 to convert Plant Area Density per solid angle ( $m^2 m^{-3}_{crown}$ ) into Drip Line Plant Area Index  
239 ( $DLP AI_{eff,tree}: m^2 m^{-2}_{dripline\_area}$ ). When the shade trees defoliated (once per year), the mean  
240  $DLP AI_{eff,tree,defoliated}$  was recorded and subsequently subtracted from the monthly data to obtain the Drip  
241 Line Leaf Area Index ( $DLLAI_{eff,tree}$ ). An average (2010-2012) seasonal variation of  $DLLAI_{eff,tree}$  was  
242 computed and assumed to represent the dynamics for the whole farm during that particular period.

243 The tree drip-line area was measured for the whole farm using the VHRS image of 2010, after  
 244 manual delineation of the tree crowns in every MODIS pixel, resulting in an average canopy dripline  
 245 projection of  $15.7\% \pm \text{SD } 5.5$  on the plot. For 2010, we computed  $\text{LAI}_{\text{eff},\text{tree}}$  ( $\text{m}^2_{\text{leaf}} \text{m}^{-2}_{\text{soil}}$ ) on a per day  
 246 and per MODIS pixel basis, as the product of  $\text{DLLAI}_{\text{eff},\text{tree}}$  and of the 2010 dripline area. From 2001  
 247 (onset of the free growth of *Erythrina* stumps) to 2010, we assumed that  $\text{DLLAI}_{\text{eff},\text{tree}}$  had grown  
 248 linearly, applying the same seasonal variations as measured in 2010-2012.  $\text{LAI}_{\text{eff},\text{tree}}$  was subtracted  
 249 from  $\text{LAI}_{\text{MOD}}$  to derive  $\text{LAI}_{\text{MOD},\text{coffee}}$  from 2001 to 2011.

### 250 **iii. Refining coffee LAI with direct field sampling**

251 A direct measurement of coffee LAI ( $\text{LAI}_{\text{true},\text{coffee}}$ ) was performed in a calibration subplot of 38.16  
 252  $\text{m}^2$ . This subplot comprised 24 neighboring coffee locations. The total number of leaves of each coffee  
 253 was counted (total around 57,000 leaves for 24 plants). The length ( $l$ : cm) and width ( $w$ : cm) of every  
 254 20<sup>th</sup> leaf were measured to compute leaf area (LA) from an empirical relationship (Eq. 1) obtained  
 255 with a calibrated leaf area meter (LI-3100c (LI-COR, 1996));

$$256 \quad LA_{\text{coffee}} = 0.748 \cdot l \cdot w; R^2 = 0.98; N = 188 \quad (1)$$

257 The total leaf area of each coffee tree was obtained by multiplying its number of leaves by its  
 258 average area per leaf. LAI per coffee location was obtained by dividing the total plant leaf area by the  
 259 field space occupied by a coffee plant, which was  $1.59 \text{ m}^2$ .

260 In order to calibrate the relationship between  $\text{PAI}_{\text{eff},\text{coffee}}$  and  $\text{LAI}_{\text{true},\text{coffee}}$  and to address the following  
 261 issues (*i*) interception caused by the non-green parts, such as stems and branches; (*ii*) non-random  
 262 distribution of the foliage (clumping), we performed 180 LAI-2000 measurements on a systematic grid  
 263 placed below the 24 coffee locations of the calibration subplot, consistently with the protocol  
 264 described for the transects. The best prediction of  $\text{LAI}_{\text{true},\text{coffee}}$  was obtained after bulking the true LAI  
 265 of 4 neighboring coffee plants together.

### 266 **iv. Re-computing LAI from the transects**

267 Considering that the transects were performed at one single date, we had no information on  
 268  $\text{DLPAI}_{\text{eff},\text{tree},\text{defoliated}}$ , hence we relied on  $\text{PAI}_{\text{eff},\text{tree}}$  only. However, for the coffee layer in the transects,  
 269 we used the calibrated relationship described above to derive  $\text{LAI}_{\text{true},\text{coffee}}$  from  $\text{PAI}_{\text{eff},\text{coffee}}$ .  $\text{LAI}_{\text{transect}}$   
 270 was finally computed for each single point of the transect ( $\text{LAI}_{\text{point}}$ ) as:

$$271 \quad \text{LAI}_{\text{transect}} = \sum_{i=1}^n \frac{\text{LAI}_{\text{point}}}{n} \cong \sum_{i=1}^n \frac{(\text{LAI}_{\text{true},\text{coffee}} + \text{PAI}_{\text{eff},\text{tree}})}{n} \quad (2)$$

272

## 273 **D. Calibrating the relationship between LAI<sub>transect</sub> and NDVI**

274 The relationship between high resolution LAI (LAI<sub>HR</sub>) and NDVI (NDVI<sub>HR</sub>) was considered to be  
275 of the following generic form, as proposed by (le Maire et al., 2006):

$$276 \quad LAI_{HR} = \max\left(0; \frac{a}{\ln(NDVI_{HR})} + b\right) \quad (3)$$

277 Where  $a$  and  $b$  are calibrated parameters.

278 It was not possible to calibrate this relationship directly at pixel scale on the VHSR image since: (i)  
279 the “footprint” area of one given LAI-2000 measurement (LAI<sub>point</sub>) is difficult to estimate, and (ii)  
280 there remained uncertainties for the exact LAI<sub>point</sub> locations on the image. Equation 3 being non-linear,  
281 it was also not possible to use an adjustment based on the average LAI value of all measurements of  
282 the transect (LAI<sub>transect</sub>). We used an original method which assumes that the distribution of LAI<sub>HR</sub>  
283 calculated on all transects should be very similar to the distribution of all LAI<sub>point</sub> measurements.  
284 Therefore, the calibration of  $a$  and  $b$  parameters of Eq. 3 was performed by adjusting the cumulative  
285 distributions of LAI<sub>point</sub> with simulated LAI<sub>HR</sub>. Once calibrated, the equation was applied to the 2 m  
286 resolution NDVI<sub>HR</sub> map to yield a 2 m resolution LAI<sub>HR</sub> map.

287 To check the result of the calibration of Eq. 3, LAI<sub>transect</sub> values (averages of LAI<sub>points</sub> by transects)  
288 were compared to LAI<sub>HR</sub> extracted from the transect pixels on the high-resolution LAI<sub>HR</sub> map. Three  
289 additional transects, not used during the calibration phase, were also used for verification.

290 The  $r^2$  of the direct calibration between the 14 field LAI<sub>transect</sub> and NDVI<sub>MOD</sub> was very low ( $r^2=0.02$ ,  
291 results not shown). This was mainly due to the heterogeneity inside a MODIS pixel, that was not well  
292 accounted for by the transects. Hence, it was decided to use the LAI<sub>HR</sub> map to up-scale from field  
293 transects to MODIS pixels and then to farm. The LAI<sub>HR</sub> map was used to convert MODIS NDVI into  
294 MODIS LAI, with MODIS NDVI data selected on the same acquisition date than the VHSR image  
295 (March 2010). LAI<sub>HR</sub> was averaged for every MODIS pixel of the grid, before drawing the  
296 relationship. Similarly to Eq. 3, the following equation (Eq. 4) was adjusted:

$$297 \quad LAI_{MOD} = \max\left(0; \frac{a'}{\ln(NDVI_{MOD})} + b'\right) \quad (4)$$

298 With  $a'$  and  $b'$  adjusted on the MODIS-pixel averaged LAI<sub>HR</sub> vs. NDVI<sub>MOD</sub> data, using the 91  
299 pixels of Aquiares farm plus coffee pixels surrounding the farm (total = 227 pixels). Using a larger  
300 coffee area allowed to include pixels of higher NDVI<sub>MOD</sub> value.

301 Equation 4 was then applied for every NDVI<sub>MOD</sub> time-series of the farm between 2001 and 2011.  
302 Fifty-five percent of the NDVI<sub>MOD</sub> data were filtered out (mainly due to cloudiness), the other 45%  
303 were used to calculate LAI<sub>MOD,coffee</sub> using Eq. 4 on all 91 MODIS pixels of the farm.

## 304 **E. On-farm data to for management, climate and yield**

305 Aquiares farm registries conveyed information for every year (2001-2011) on daily rainfall, area  
306 under coffee cultivation, yield (kg of green coffee ha<sup>-1</sup> yr<sup>-1</sup>; per zone of harvest), percentage of pruned  
307 coffee resprouts, coffee quality, coffee price, agrochemical inputs, labor, etc.

308 The nearest (9 km) long-term climate station was in CATIE, with daily data available since 1949.  
309 In the Aquiares tower plot, we recorded climate data at the semi-hourly time-step since 2009, cross-  
310 compared daily data with CATIE and estimated climate data for Aquiares at the daily time-step from  
311 2001 to 2011 for PR: precipitation (mm), RH: relative air humidity (%), SR: global solar radiation (MJ  
312 m<sup>-2</sup>), Tmin: daily minimum air temperature, Tmax: daily maximum air temperature (°C) and ET<sub>O</sub>:  
313 Reference evapotranspiration (Allen *et al.*, 1998).

314 The historical coffee yield data were available at the Aquiares farm each year with the details for 4  
315 sub-zones of coffee collection. The average LAI<sub>MOD,coffee</sub> of each month (2001-2011) and the Pearson's  
316 correlation coefficients with yield of the same year (year N) and of year N-1 were computed.

317 One major management practice is the annual coffee pruning, undertaken generally between  
318 January and April of each year, and affecting directly the amount of resprouts, thus the harvest  
319 potential of the following years. The pruning intensity is variable every year at the plot scale,  
320 according to several factors (coffee price, ageing of the resprouts, exhausted orthotropic stems or died  
321 branches due to overproduction or disease attacks, etc.). The difference in the LAI time series between  
322 January and April, was compared with on-farm data of pruning intensity, with the hypothesis of the  
323 more negative the difference, the more severe the pruning. It was tested if LAI<sub>MOD,coffee</sub> during these  
324 months could be used as a remote tracer of pruning intensity.

## 325 **F. Hydrological services**

326 The impact of LAI on four hydrological services, (i) the provision of water (Provisioning  
327 Ecosystem Service) by streamflow (Q), (ii) the superficial runoff (closely linked to laminar erosion),  
328 (iii) the aquifer charge and (iv) the evapo-transpiration (ETR) was simulated using the locally-verified  
329 Hydro-SVAT model (Gómez-Delgado *et al.*, 2011). The simulated watershed was 0.9 km<sup>2</sup>. We tested  
330 four contrasted LAI scenarios (actual LAI with seasonal variations, average annual LAI, LAI=zero,  
331 double LAI). The model simulated streamflow at the outlet of the watershed and we inverted the water  
332 balance partitioning per compartment (interception, superficial and sub-superficial runoff, infiltration,  
333 drainage, aquifer recharge, baseflow) and also evapo-transpiration. Here, we slightly modified the



334 original model: parameter  $r$ , the ratio between transpiration and potential evapo-transpiration, was not  
335 set to constant, but rather adjusted as a function of LAI ( $r = 0.168 \cdot \text{LAI}$ ), following the principle  
336 proposed by Granier *et al.* (1999), after maximizing the Nash-Sutcliffe index.

### 337 **G. Statistical analysis**

338 Statistical analysis were performed with R (R 2008). NDVI data were interpolated in time using a  
339 smoothing spline routine (package 'stats'), based on a piecewise-polynomial function. Simple  
340 regressions and ANOVAs were performed using the 'stats' package. The relationships between  
341  $\text{LAI}_{\text{MOD,coffee}}$  and meteorological data were assessed using Principal Component Analysis (PCA)  
342 performed using monthly meteorological data between 2001 and 2011, the monthly average of  
343  $\text{LAI}_{\text{MOD,coffee}}$  of the farm being added as a supplementary variable. Multiple regressions for predicting  
344 yield were performed using the 'car', and 'gvlma' packages. Model diagnostics used the 'car' and  
345 'MASS' packages. In order to avoid autocorrelated covariables in the multiple regression for yield, we  
346 selected only native covariables (that were not computed from each other: N-fertilizer input (yr N),  
347 LAI<sub>coffee</sub> from months June-July (yr N-1), January to April (yr N), August to September (yr N) and  
348 Pruning (yr N)), performed a PCA ('FactoMineR' package) and predicted yield according to the  
349 projections of the latter covariables on the three principal components that were all significant.

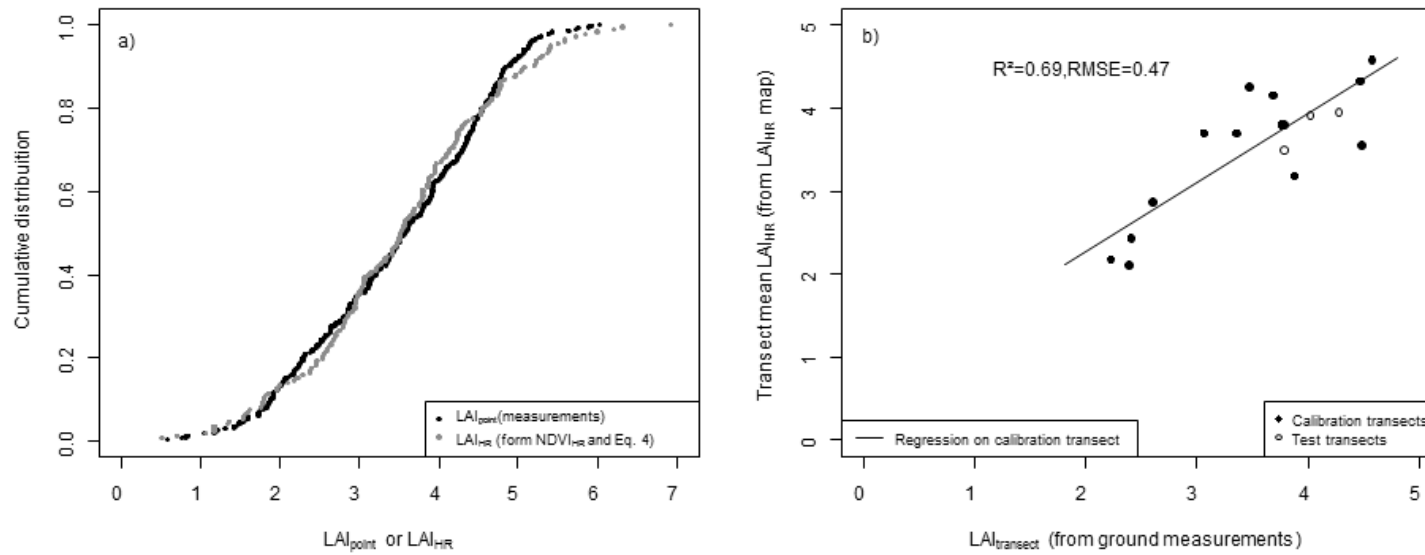

**Figure 2:** Calibration of the relationship between transect measurements of LAI ( $LAI_{point}$ , see Eq. 3) and NDVI from the Worldview2 high resolution image ( $NDVI_{HR}$ ): a) cumulated distribution adjustment between field  $LAI_{point}$  and  $NDVI_{HR}$  for all measurements of the 14 LAI 2000 transects of the farm (parameters a and b of Eq. 4 were adjusted); b) comparison of mean values of  $LAI_{transect}$  and of  $LAI_{HR}$  (3 test transects were used for verification).

### 350 **3. Results**

#### 351 **A. Scaling LAI per layer from plants to farm**

##### 352 **i. From PAI<sub>eff,coffee</sub> to LAI<sub>true,coffee</sub>**

353 On the calibration grid placed under 24 coffee locations, the relationship between LAI<sub>true,coffee</sub>  
354 (obtained from leaf count and leaf area) and PAI<sub>eff,coffee</sub> (obtained by LAI 2000) was:

$$355 \quad LAI_{true,coffee} = 0.883 \cdot PAI_{eff,coffee,3rings} + 0.936; R^2 = 0.71; N = 24; p < 0.001 \quad (5)$$

356 We did not force Eq. 5 through origin, due to potential non-linear effects in the relationship for low  
357 values of PAI (PAI<1) that were not present in this dataset. Equation 5 was further used to compute  
358 LAI<sub>true,coffee</sub> in the 14 transects used to calibrate NDVI<sub>HR</sub> across the farm.

##### 359 **ii. Aggregation/clumping in coffee**

360 The empirical parameters of Eq. 5 were assumed to reflect mixed effects of the contribution non-  
361 green elements to light interception and of clumping (the inverse of aggregation). Clumping was  
362 considered to be the sum of macro-clumping between the rows (influenced by planting density) and of  
363 micro-clumping within the plants. We assumed from a simple geometrical representation of the coffee  
364 architecture that non-green elements represented *ca.* 0.123 m<sup>2</sup> m<sup>-2</sup>. We computed LAI<sub>eff,coffee</sub> as the  
365 difference between PAI<sub>eff,coffee</sub> and this value. We obtained the following relationship:

$$366 \quad LAI_{true,coffee} = 1.18 \cdot LAI_{eff,coffee,3rings}; R^2 = 0.61; N = 24; p < 0.001 \quad (6)$$

367 The slope represents aggregation, estimated to be 1.18 on average (clumping index of 1/1.18=0.85).

##### 368 **iii. Calibration of High Resolution LAI (LAI<sub>HR</sub>) from field transects and HR- 369 LAI map for the farm**

370 From the 14 LAI 2000 transects performed within the farm for both coffee and shade tree layers,  
371 LAI<sub>transect</sub> was computed according to Eq. 2. The average of all LAI<sub>transect</sub> was 3.44 with a standard  
372 deviation of 0.80 (min = 2.22 max = 4.57). On average, PAI<sub>eff</sub> of the shade trees was 7% of LAI<sub>transect</sub>.

373 The average NDVI<sub>HR</sub> of all pixels that were crossed by a LAI transect was 0.75 ± 0.06 SD (min =  
374 0.47, max=0.84). Soil NDVI<sub>HR</sub> was measured on 30 pixels of bare soil (NDVI values around 0.30 for  
375 LAI = 0), and were included in the cumulative distribution adjustment. The parameter adjustment  
376 between NDVI<sub>HR</sub> and LAI<sub>transect</sub> using the cumulative distribution adjustment methodology (Fig. 2a;  
377 Eq. 3) yielded a = -1.246 and b = -1.058.

378 The relationship between the average LAI<sub>transect</sub> and the corresponding average LAI<sub>HR</sub> yielded  
379 r<sup>2</sup>=0.69 and a RMSE=0.47 (Fig. 2b). The three transects, not used for adjustment, confirmed the

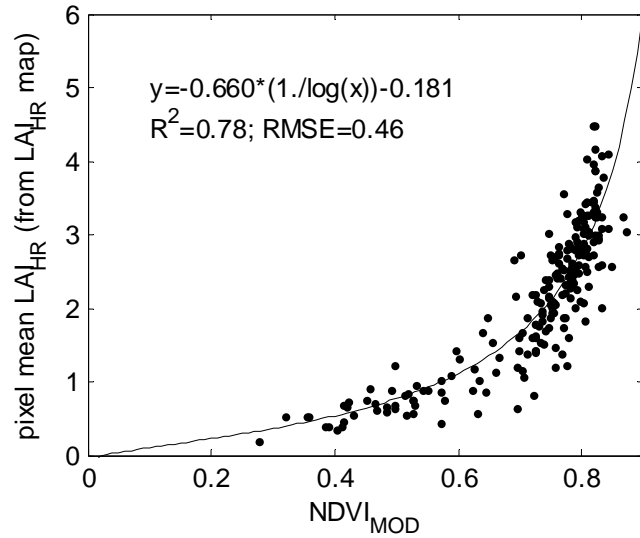

**Figure 3:** Relationship between MODIS NDVI ( $NDVI_{MOD}$ ) and mean high resolution LAI (from  $LAI_{HR}$  map). Mean  $LAI_{HR}$  per MODIS pixel was obtained after averaging the  $LAI_{HR}$  data for each of the 227 MODIS pixels.  $NDVI_{MOD}$  was obtained from the MODIS NDVI time-series interpolated at the same date than the Worldview 2 image used for creating the  $LAI_{HR}$  map. Equation 5 was calibrated (i.e.  $a'$  and  $b'$  were adjusted).

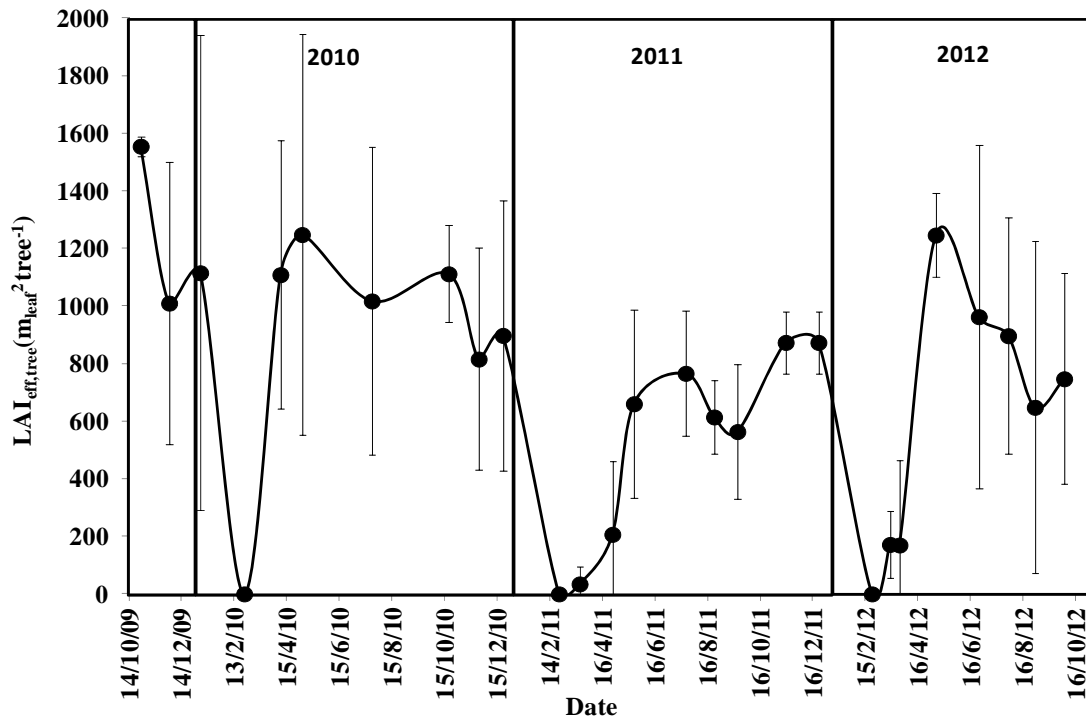

**Figure 4:** Time-series of tree  $LAI_{eff,tree}$  as measured between 2009 and 2012 on 3 shade trees of *Erythrina poeppigiana*.

380 relationship with an average error between  $LAI_{\text{transect}}$  and  $LAI_{\text{HR}}$  of 6%. Equation 3 was then applied to  
 381 the 2-meter resolution  $NDVI_{\text{HR}}$  image of the farm, thus creating a 2-meter resolution  $LAI_{\text{HR}}$  map (Fig.  
 382 1c). The average  $LAI_{\text{HR}}$  of the farm was calculated from this map, with a value of  $2.81 \pm 1.33$  SD (min  
 383 = 0, max = 7.91) on the 29<sup>th</sup> of March, 2010 (Tab. 1).

#### 384 **iv. Calibration of moderate resolution LAI ( $LAI_{\text{MOD}}$ )**

385 The average  $NDVI_{\text{MOD}}$  of the MODIS pixels of the farm and its surroundings were very consistent  
 386 with the  $NDVI_{\text{HR}}$  *i.e.*  $0.76 \pm 0.06$  SD (min = 0.43, max = 0.85), calculated at the same date of  
 387 acquisition than the VHSR image (March 2010) for 227 MODIS pixels. The parameter adjustment  
 388 between  $NDVI_{\text{MOD}}$  and  $LAI_{\text{HR}}$  (Eq. 4) yielded  $a' = -0.660$  and  $b' = -0.181$ , with ( $R^2 = 0.78$ ; p value  $< 0.01$ ;  
 389 RMSE = 0.46; N = 227) (Fig. 3).

#### 390 **v. Seasonal pattern of shade tree LAI**

391  $PAI_{\text{eff,tree}}$  of three representative shade trees from the eddy covariance-plot was monitored every  
 392 month from 2010 to 2012. When the shade trees defoliated completely (around 20<sup>th</sup> of February every  
 393 year), the area index of non-green elements was recorded. For instance in 2010, the defoliated mean  
 394 drip line plant area index,  $DLP AI_{\text{tree,defoliated}}$ , was  $2.03 \pm 0.2$  SD  $\text{m}^2_{\text{non-green}} \text{m}^{-2}_{\text{drip\_line\_area}}$ , representing on  
 395 average 32% of the maximum value of  $DLP AI_{\text{tree}}$  (Tab. 2). According to Fig. 4,  $LAI_{\text{eff,tree}}$  fluctuated  
 396 monthly from nil to  $1555 \text{ m}^2_{\text{leaf}} \text{ tree}^{-1}$ . The overall pattern of leafing was quite consistent with the  
 397 rainfall, showing two minima during the drier seasons (January to April and September) and a  
 398 maximum during the heavy rains.

### 399 **B. Seasonal and inter-annual LAI dynamics**

400 From the MODIS time series (2001-2011) for the farm pixels, 10-day bins of farm  $LAI_{\text{MOD}}$  ranged  
 401 between 1.9 and 5.9 (Fig. 5a), the contribution of  $PAI_{\text{eff,tree}}$  was computed and subtracted to yield  
 402  $LAI_{\text{MOD,coffee}}$ . When averaged over the whole Aquiares farm, the annual  $LAI_{\text{MOD,coffee}}$  (Fig. 5b) was  $3.50$   
 403  $\pm 0.22$  SD (minimum and maximal annual values of 3.06 and 3.78, respectively) for the 2001-2011  
 404 period, *i.e.* the inter-annual variations of  $LAI_{\text{MOD}}$  were small when considered at the farm-scale (CV =  
 405 6.3 %). However, some years displayed a larger spatial variability such as 2001-2003 (renovation  
 406 phase) and 2010 (Fig. 5b). Erythrina trees represented an average LAI of 0.67 in 2010 (Tab. 2), *i.e.*  
 407 around 16% of the total farm LAI.

408 When averaged for every MODIS pixel of the farm and for every day of the year (Fig. 5c), the  
 409 seasonal pattern of  $LAI_{\text{MOD,coffee}}$  was disclosed: (1) high value of  $LAI_{\text{MOD,coffee}}$  ( $4.41 \text{ m}^2 \text{ m}^{-2}$ ) by the  
 410 beginning of the year, (2) decline until April (long drier and cooler season characterized by leaf  
 411 shedding ending up with the selective pruning of coffee resprouts), finally reaching a minimum value  
 412 around  $2.4 \text{ m}^2 \text{ m}^{-2}$ , (3) LAI recovery with the return of rainfall up to  $3.73 \text{ m}^2 \text{ m}^{-2}$  in July-August, (4) a

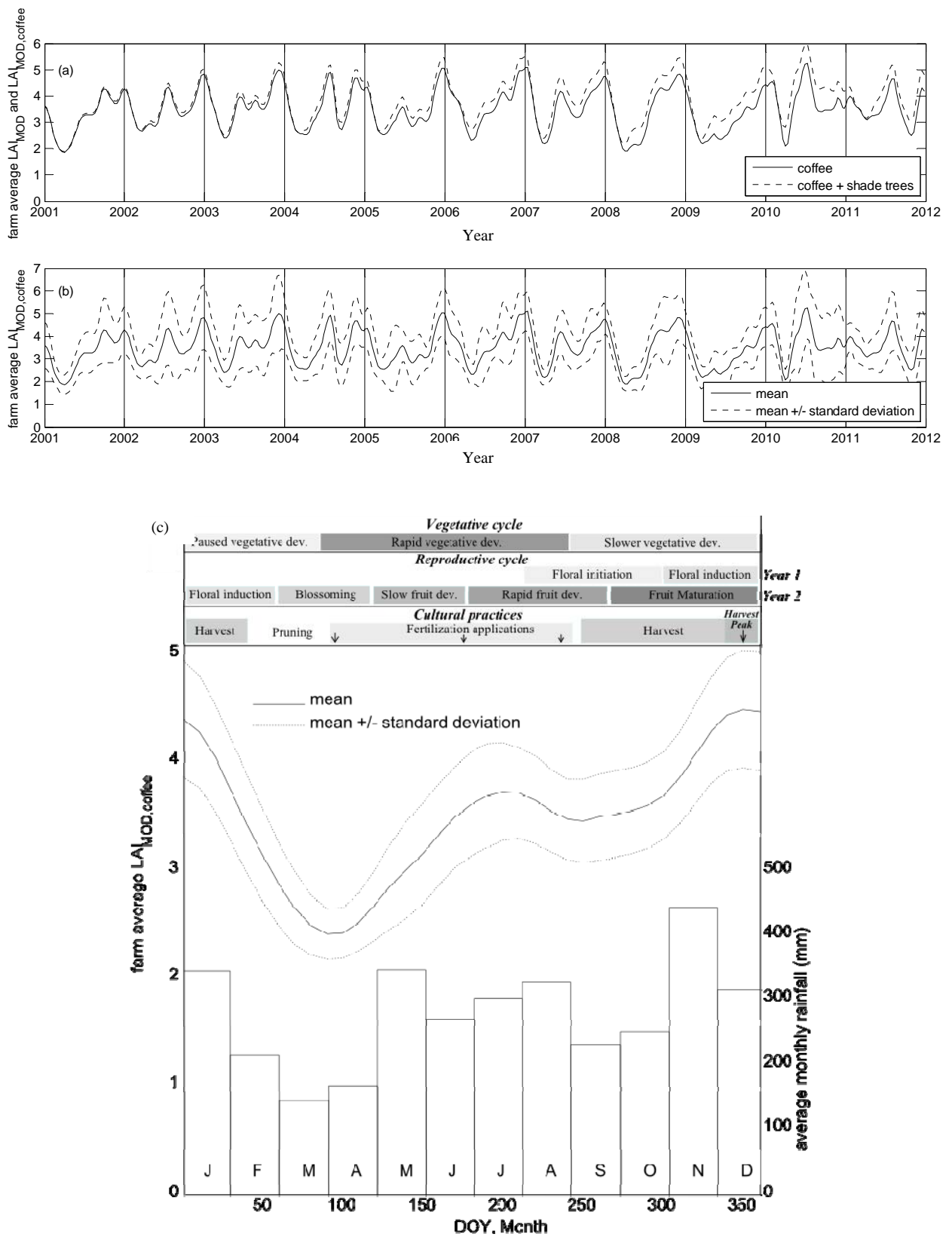

**Figure 5:** Farm average time series (2001-2011) of LAI<sub>MOD</sub>: a) time course (2001-2011) of LAI of the farm, after distinguishing the respective contribution of coffee and shade trees; b) time course of LAI<sub>MOD,coffee</sub> averaged over the entire Aquiares farm and its standard deviation; c) average seasonal variations (10-day interval) of LAI<sub>MOD,coffee</sub> and of monthly rainfall, with indication of vegetative, reproductive cycles and cultural practices. Each dot was the average  $\pm$  SD value for all 91 MODIS pixels of the Aquiares farm averaged over the 2001-2011 period.

413 secondary decrease in September (short drier season, grain filling), and (5) a final increase between  
414 October and December.

### 415 **C. Correlations between coffee LAI and climate**

416 From Fig. 5b, it appeared that the monthly rainfall distribution varied rather consistently with  
417  $LAI_{MOD,coffee}$ . A Principal Component Analysis (PCA) was performed by using the monthly averaged  
418 climate variables (2001-2011) and adding  $LAI_{MOD,coffee}$  as a supplementary variable (Fig. 6). The first  
419 two PCA components accounted for 70% of the total variance. The first axis was driven by solar  
420 radiation (SR), potential evapotranspiration ( $ET_0$ ) and relative air humidity (RH). The second axis was  
421 driven mainly by minimal temperature ( $T_{min}$ ).  $LAI_{MOD,coffee}$  was correlated positively with precipitation  
422 (PR) (p-value = 0.0315; N=132), RH (p-value < 0.001; N=132) and negatively with  $ET_0$  (p-value =  
423 0.001), maximum temperature of the day (p-value = 0.004) and global radiation (p-value < 0.001).

### 424 **D. Sensing by MODIS of the impacts of pruning practices on LAI**

425 MODIS data were crossed with farm registries for pruning (timing and modality). Figure 7a shows  
426 the ability of MODIS to pinpoint the timing of pruning practices on  $LAI_{MOD,coffee}$ . For instance on one  
427 given pixel, the old coffee plants were renovated (uprooted) in 2003, resulting in a very low  
428  $LAI_{MOD,coffee}$  recorded in March (the shade trees were not pruned). As new coffee were then planted  
429 and left un-pruned during 3 years (2004-2006),  $LAI_{MOD,coffee}$  recovered towards its initial values after 4  
430 years. After full recovery, about one fifth of the coffee shoots were selectively pruned every year in  
431 April (eliminating the oldest unproductive resprouts), and the average annual LAI remained quite  
432 steady.

433 Post-processing of MODIS data also allowed distinguishing between various modalities of coffee  
434 pruning (Fig. 7b). The LAI difference between January and April each year is supposed to be affected  
435 by both the leaf shedding occurring during the drier-cooler season and by the pruning intensity. This  
436 index appeared to be significantly different between plots, according to the pruning modality that they  
437 received: un-pruned plots (NP) displayed the lowest difference, followed by plots that were pruned  
438 (P), and finally plots that were renovated, *i.e.* with a severe pruning (SP).

### 439 **E. LAI and Ecosystem Services**

#### 440 **i. Predicting coffee yield**

441 Yield was positively correlated with N-fertilizer inputs of the same year (year N) (Tab. 3;  $R^2 =$   
442 0.53; p = 0.01; N = 11 years, 2001-2011).

443 Yield did not appear to be correlated with  $LAI_{MOD,coffee}$ , if simply considering 12-months bins  
444 (Tab.3). However, average yield of year N was positively and significantly correlated to some  
445 particular monthly values of  $LAI_{MOD,coffee}$ , namely: (i) from June to July of year N-1; (ii) from January

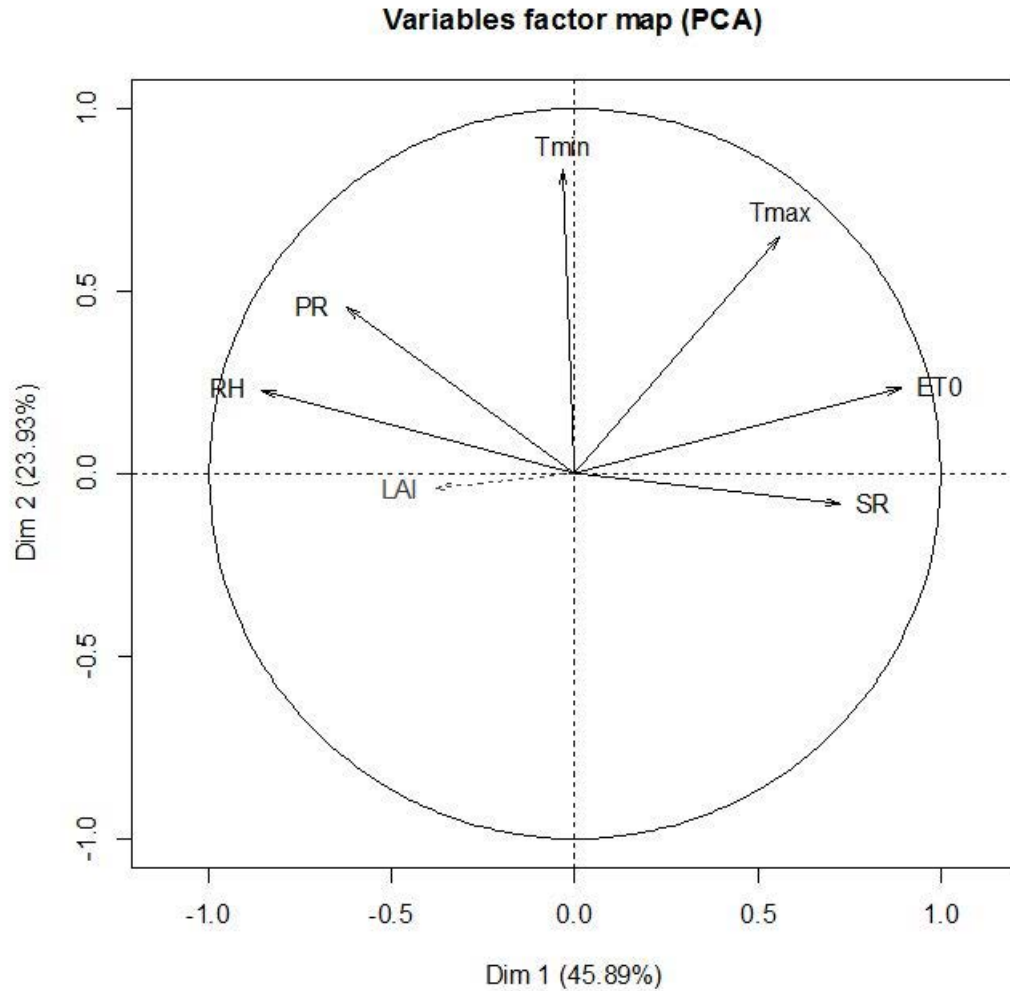

**Figure 6:** Principal Component Analysis (PCA) of meteorological data and of  $LAI_{MOD,coffee}$  considered for the whole Aquiares farm, at the monthly time step and between 2001 and 2011. (PR: precipitation (mm), RH: relative air humidity (%), SR: global solar radiation ( $MJ m^{-2}$ ), Tmin: daily minimum air temperature, Tmax: daily maximum air temperature ( $^{\circ}C$ ),  $ET_0$ : Reference evapotranspiration (Allen et al., 1998) (mm)). The average monthly  $LAI_{MOD,coffee}$  at farm scale was added as a supplementary variable. The first 2 axes of the PCA explained 70% of the variability.



446 to April of year N; and (iii) from August and September of year N, *i.e.* a total of eight significant  
447 months (Fig. 8), obtained with the precision of four zones and 11 years (N=44). The correlation level  
448 and significance were highest for the months of July (year N-1), February and August (year N).

449 In order to add N-fertilization, Pruning and LAI data from year N-1 into the yield prediction model,  
450 we had to consider whole-farm averages, not 4 zones, due to available data (N=11). We combined N-  
451 fertilization and LAI for the six significant months of year N and obtained  $R^2 = 0.69$ ;  $p=0.01$ , hereby  
452 confirming the importance of adding LAI in a yield prediction model. Better multiple regressions were  
453 obtained after distinguishing LAI<sub>coffee</sub> for January-April and for August-September ( $R^2 = 0.74$ ;  $p =$   
454  $0.02$ ) and adding the pruning percentage in the regression ( $R^2 = 0.80$ ;  $p = 0.03$ ). Adding LAI<sub>coffee</sub> from  
455 year N-1 did not spur the result. However, some covariables were not independent in the latter  
456 multiple regression. In spite of being of practical interest for best prediction, this regression was over-  
457 parameterized from a statistical point of view. Therefore, we also performed also PCA using native  
458 covariables only (excluding covariables computed from each other) and modeled yield as a function of  
459 the projection of the eleven data points on the three significant main components of the PCA (Fig. 9;  
460 Tab. 3;  $R^2 = 0.79$ ;  $p = 0.01$ ).

## 461 ii. LAI and hydrological services

462 We varied LAI according to four scenarios (Tab. 4) in the Hydro-SVAT model, in order to estimate  
463 its impact on four important hydrological services, namely the provisioning of water by the  
464 streamflow (Q), the actual evapotranspiration (ETR), the superficial runoff (Runoff) and the flow  
465 through the aquifer (Aquifer), after infiltration and deep drainage. According to the following  
466 scenarios:

467 (i) LAI is from MODIS (this study), interpolated on the semi-hourly time-step (scenario 1). The  
468 modeled (scenario 1) values of streamflow  $Q_{mod}$  and evapotranspiration,  $ETR_{mod}$  were compared to  
469 the measured values (scenario 0) obtained with a flume ( $Q_{meas}$ ) and an eddy-covariance tower  
470 ( $ETR_{meas}$ ), respectively, yielding less than 3% difference on the annual cumulative values for both  
471 variables, while the Nash-Sutcliffe coefficient for Q was satisfactory (0.89). Both measured and  
472 modeled data agreed that Q was around 62% and ETR around 23% of rainfall (Rainfall = 3260 mm  
473 in 2009), respectively, while the remainder was attributed to cumulative errors or imbalances. In  
474 this basin, superficial runoff was only 4% of rainfall (hence laminar erosion is very low) and 58%  
475 of rainfall flowed through the Aquifer;

476 (ii) Only the average annual stand LAI of 3.8 was used (scenario 2), ignoring the seasonal fluctuations  
477 of MODIS-LAI, in order to test the scenarios where models are run with a constant LAI by default.  
478 We did not observe any significant impact on the annual deviations of Q and;

a)

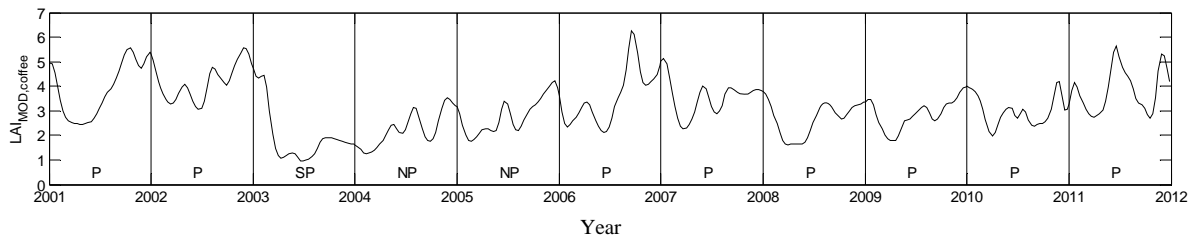

b)

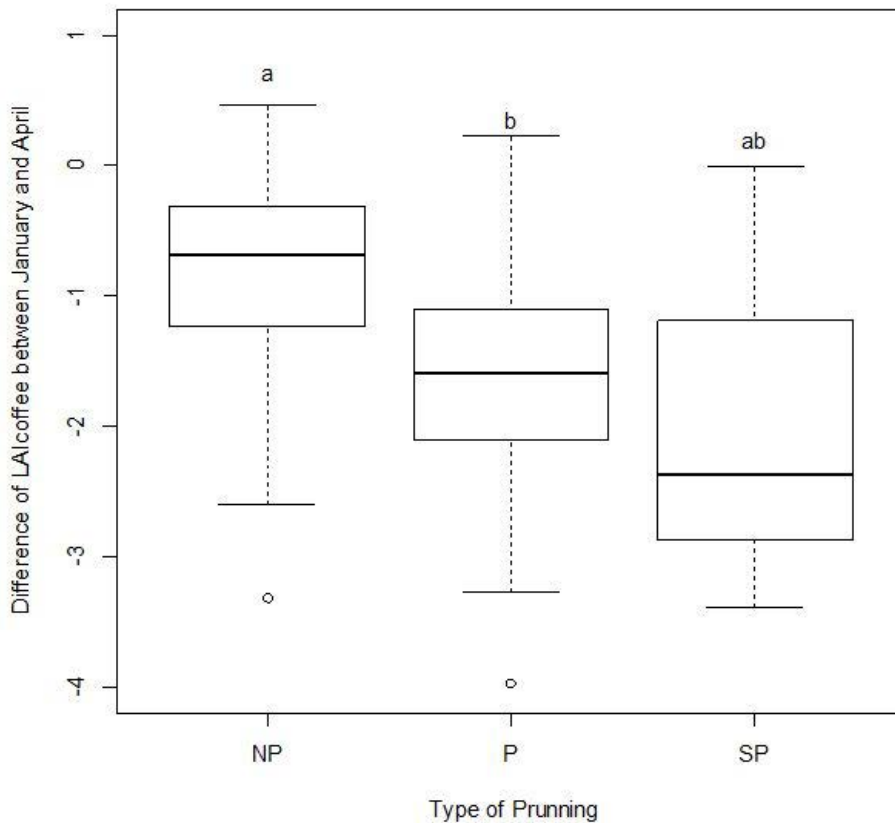

**Figure 7:** Sensing by MODIS of the impacts of various coffee pruning practices on LAI ( $LAI_{MOD,coffee}$ ). Different pruning practices were recorded: normal coffee pruning (P), severe pruning (SP), no pruning (NP). a) Example of the impacts of successive pruning practices on a  $LAI_{MOD,coffee}$  time-series (average ten given pixel from Aquiares farm where farm information was detailed enough). b) Distinguishing pruning practices during the drop of the monthly  $LAI_{MOD,coffee}$  between January and April. Letters refer to a Kruskal-Wallis test ( $p$ -value=0.05).

- 479 (iii) LAI was set close to zero ( $LAI = 0.1$ ; scenario 3), as it normally happens during a plot clear  
480 cutting for renovation (e.g. Fig. 7a). In this situation,  $ETR_{mod}$  decreased by 64%, whereas  $Q_{mod}$  and  
481 flow through Aquifer increased by around 20%;
- 482 (iv) LAI was set to double the initial average value ( $LAI = 7.6$ ; scenario 4), simulating very high  
483 LAI conditions for this site. In this situation,  $ETR_{mod}$  would be enhanced by 61%, whereas  $Q_{mod}$   
484 and Aquifer would decrease by around 18%.

**Table 3:** Coffee yield prediction for year N at the scale of the whole farm using simple & multiple regression or Principal component analysis (PCA). Covariables are N-fert (nitrogen fertilizer), LAI<sub>coffee</sub> for different bins of months (from year N or from year N-1) and Pruning (% of coffee resprouts being pruned on year N). One data point is the average farm value for 2001-2011.

Predicted variable (kg <sub>green coffee</sub> ha <sup>-1</sup> yr <sup>-1</sup> )	Yield (yr N)									
Covariable (s)	Covariable unit	Intercept	Slope covar 1	Slope covar 2	Slope covar 3	Slope covar 4	dF	F	p	R <sup>2</sup>
LAI (yr N)	m <sup>2</sup> m <sup>-2</sup>	-559.5	547.6	-	-	-	9	1.53	0.25	0.15
N-fert (yr N)	kgN ha <sup>-1</sup> yr <sup>-1</sup>	178.2	5.7	-	-	-	9	10.28	0.01	0.53
Pruning (yr N)	% of resprouts	1684.2	-17.4	-	-	-	9	3.90	0.08	0.30
N-fert+LAI 6 months (yr N)	-	-1332.2	4.0	565.1	-	-	8	8.82	0.01	0.69
N-fert+LAI Jan.-Apr. (yr N) + LAI Aug.-Sep. (yr N)	-	-1758.1	4.4	258.4	390.0	-	7	6.76	0.02	0.74
N-fert+LAI Jan.-Apr. (yr N) + LAI Aug.-Sep. (yr N) + Pruning (yr N)	-	-1235.2	4.1	177.5	380.8	-8.2	6	5.88	0.03	0.80
Significant Principal components 1 to 3 of PCA(*)	-	1359.9	189.3	81.8	-36.6	-	7	8.95	0.01	0.79

(\*)N-fertilizer input (yr N), LAI<sub>coffee</sub> from months June-July (yr N-1), January to April (yr N), August to September (yr N) and Pruning (yr N)

## 485 **4. Discussion**

486 Apart from methodological aspects, our discussion is focused on the sources of variability in LAI  
487 and on the potential of LAI as an indicator of ecosystem services (ES).

488 In cropping systems, leaf area index (LAI) is expected to vary according to natural effects (e.g.  
489 crop phenology, its synchronization with environmental factors and incidence of leaf diseases), but  
490 also to the timing of crop management (fertilization, harvest, pruning, renovation, treatments, etc.)  
491 which is adjusted inter-annually according to the local and international, socio-economical contexts  
492 (local practices, fluctuations of international prices, certification requirements, etc.). From the analysis  
493 of long-term LAI series, it is theoretically possible to dissociate seasonal from inter-annual effects, but  
494 also natural from management effects. Regarding coffee plantations, three main factors will affect LAI  
495 directly, (i) the phenological cycle expanding over two years (Camargo and Camargo, 2001), (ii) the  
496 seasonally-dependent interactions between leaves and fruits on reproductive and vegetative nodes  
497 (Franck et al., 2007; Vaast et al., 2005) and (iii) the management.

498 Indicators are variables providing information on complex systems in order to help their  
499 understanding and allow the users to take appropriate decisions (Mitchell et al., 1995). We argue here  
500 that LAI could be considered as an excellent integrated indicator of Ecosystem Services, such as  
501 *Provisioning* (yield, water), *Regulating* (carbon sequestration and climate regulation), and *Support*  
502 (Net Primary Production, soil organic matter).

### 503 **A. An improved methodology for scaling-up LAI from plants to farm in** 504 **coffee agroforestry systems**

505 At the plot and farm scales, we used MODIS-NDVI in a coffee AFS, hereby contributing to  
506 broaden its use previously restricted to monoculture by Rafaelli et al. (2006) and Brunsell et al. (2009)  
507 who correlated NDVI with coffee yield and analyzed the effect of some climatic variables, such as  
508 frost and precipitation, on yield. Only NDVI was used in these latter studies and no attempt has been  
509 undertaken so far to assess the true LAI inside the MODIS pixels, or to separate LAI of shade tree  
510 from that of coffee at the landscape scale. Although LAI is actually the key variable for process  
511 models, the lack of studies on the relationship between LAI and NDVI in coffee systems is noticeable.  
512 The difficulty to infer LAI from NDVI in humid ecosystems with high LAI comes primarily from the  
513 saturation of the NDVI-LAI relationship (i.e. with LAI greater than ~3-4, see Fig. 3). Secondly,  
514 calibrating MODIS-NDVI via ground-truth LAI is rather difficult in heterogeneous systems where the  
515 intra-MODIS pixel variability can be much higher than the inter-pixel one. The heterogeneity issue  
516 was addressed here through a 3-step calibration:

517 (i) field calibration of LAI inverted from light-transmittance (using LAI 2000) vs the actual LAI.

518 Coffee LAI has already been inverted from transmittance in (Mendez et al., 2009; Righi et al.,

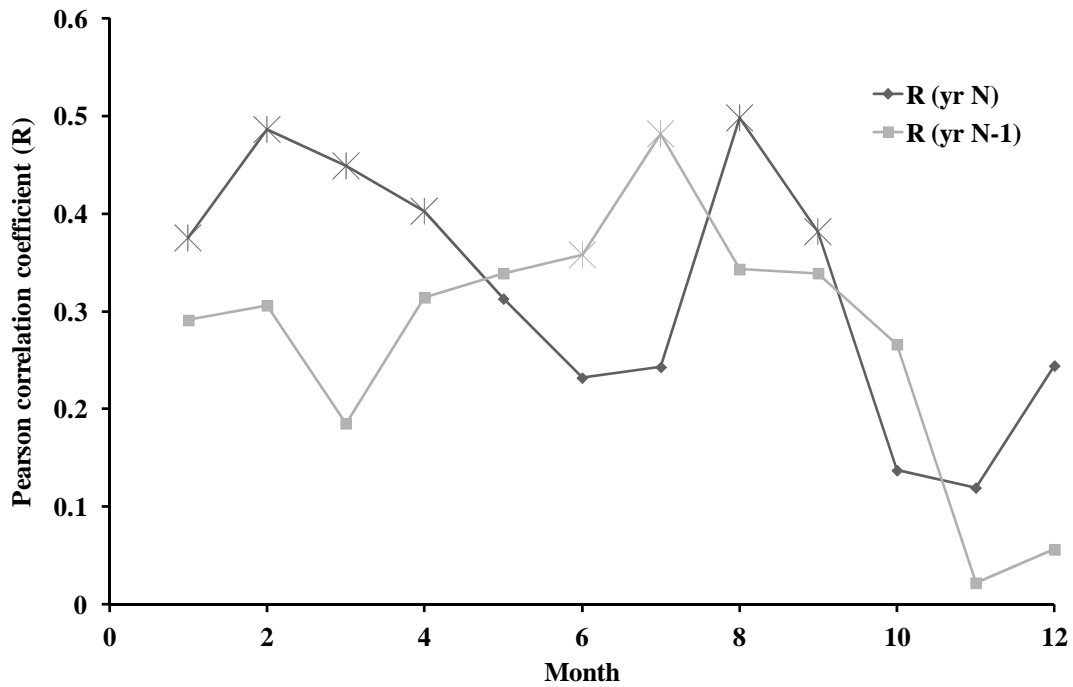

**Figure 8:** Monthly variations of the Pearson's R correlation coefficient between the yield of the current year (year N) and the average  $LAI_{MOD,coffee}$  of the past months, from year N (dark line) or from year N-1 (gray line). Each correlation was obtained using 4 production zones\* 11 years (2001-2011) = 44 data available on-farm. Star symbols for significant correlations (pvalue < 0.05).

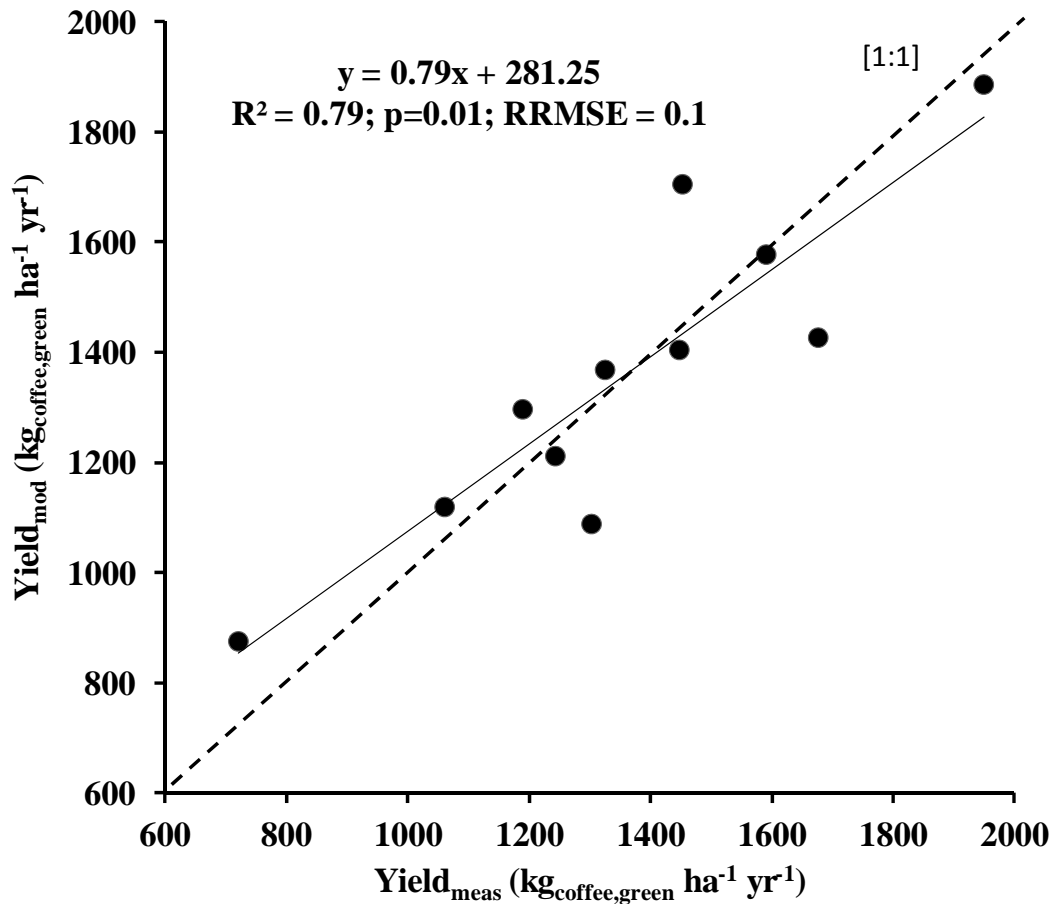

**Figure 9:** Prediction of coffee yield by Principal Component Analysis (PCA: the 3 first axes were significant), using five covariables (N-fertilizer input (yr N),  $LAI_{coffee}$  from months June-July (yr N-1), January to April (yr N), August to September (yr N) and Pruning (yr N)). Each point is the average for one given year (2001-2011). Dotted line is [1:1].

519 2007; Siles *et al.*, 2010a), where the influence of some environmental (e.g. light) and agronomic  
520 (e.g. shade tree species) factors on the LAI was tested, and when LAI was linked with  
521 ecophysiological process such as coffee transpiration (van Kanten and Vaast, 2006). In our  
522 mountainous terrain, the measurements with 4 and 5 rings of the LAI2000 appeared to be  
523 inappropriate and the best correlation was achieved using only the three inner rings. Field transects  
524 with LAI 2000 did allow capturing the heterogeneity between groups of coffee plants (e.g. missing  
525 plants, effects of the presence of shade trees on coffee LAI, effects of pruning practices).  
526 Furthermore, we could not separate one single coffee plant from its direct neighbors using the LAI  
527 2000 and proposed that the minimum detectable LAI unit was actually a group of four neighboring  
528 coffee plants.

529 (ii) We were not able to separate LAI of shade trees and to that of coffee using high resolution (HR)  
530 multispectral images, a consequence of the low band resolution in multispectral images and of the  
531 uncertainty in the footprint match between the field transect and the HR-image. Hence, we relied  
532 on transects, achieved only once at the date of the acquisition of the high resolution image, where  
533 we estimated shade tree PAI only from the transmittance of the tree layer (using LAI-2000), thus  
534 assuming a spherical distribution of their leaf angles, no clumping and we considered that the  
535 uncertainties were of minor importance in the present conditions of a low tree density. For three  
536 trees only, we could subtract the contribution of non-green elements after monitoring them during a  
537 few years and access  $LAI_{\text{eff,trees}}$ , and this for used to subtract tree LAI dynamics from the whole  
538 ecosystem. We argue that overlooking leaf angles and clumping in the shade tree layer is probably  
539 acceptable for other AFS studies as long as they display a rather low tree density or a low relative  
540 tree LAI (particularly applicable when the trees are defoliated), when compared to the understorey.  
541 Certainly, this can become an issue in AFS with high shade tree LAI. It should be possible in the  
542 future to estimate tree leaf angle distribution from horizontal photographs taken from a ladder (Ryu  
543 *et al.*, 2010) and thus refine the calculation of the extinction coefficient. Regarding clumping in  
544 trees, it could be estimated after comparison with direct methods, such as litter-traps. We stress  
545 here the importance of promoting HR-hyperspectral tools in AFS for separating the layers,  
546 especially when the spectral signatures of trees and crops cannot be separated by multispectral  
547 images only. Finally, NDVI is prone to saturation for high LAI values and another potential  
548 limitation is the crop + shade tree total LAI in some dense AFS, especially in the humid regions

549 (iii) field calibration between LAI and NDVI from a very high resolution image, yielding  $LAI_{\text{HR}}$   
550 and a 2-m resolution map of LAI in the farm: one entanglement of this upscaling was to match the  
551 footprints of  $NDVI_{\text{HR}}$  with those of the field LAI transects. We only achieved this reasonably after  
552 using a cumulative distribution adjustment. This kind of adjustment is generally not recommended  
553 for extreme values. However, the regression seemed correct even for high and low LAI (Fig. 2).  
554 The regression was calibrated on a large range of LAI across the farm, which gave us confidence to

555 use this equation for all pixels. We assumed that the relationship between  $NDVI_{HR}$  and LAI was  
556 constant over one whole given image. Our verification using 3 independent transects indicated that  
557 the calibration was reliable. More broadly, this original technique can be useful when attempting to  
558 match ecological measurements in the field with an index obtained from very high resolution  
559 images. Indeed, LAI-NDVI relationships depend on the images used to infer NDVI (relative  
560 spectral response, acquisition geometry, image resolution, etc.) and therefore need to be calibrated  
561 locally (le Maire et al., 2006; Soudani et al., 2006).

562 (iv) calibration between  $LAI_{HR}$  from the high resolution map and MODIS-NDVI, yielding  
563  $LAI_{MOD}$ . This step makes the temporal scaling up possible (from 2001 to present), although  
564 decreasing the spatial resolution (250 m). In all cases, the calibration is not considered accurate for  
565 very low and high LAI values (see Fig. 3). In tropical humid regions, cloudiness remains a  
566 substantial burden (Hmimina et al., 2013), LAI seasonality is sensed by MODIS but one given year  
567 can be prone to a substantial uncertainty, whereas multi-year averages provide more confidence in  
568 the overall seasonal pattern.

## 569 **B. Detecting the natural sources of variation of LAI**

570 LAI is by nature a dynamic variable integrating leaf initiation and expansion on one side, and leaf  
571 senescence and abscission on the other side. We stress that LAI is actually the balance between leaf  
572 area build-up and leaf shedding but does not inform *per se* on the dynamics of leaf production (net  
573 primary productivity of the leaf compartment, requiring sequential leaf counting) nor on leaf shedding  
574 (requiring litter collection).

### 575 **i. Coffee layer**

576 From the MODIS time-series, we observed a major coffee LAI buildup during the beginning of the  
577 wet season (May), followed by a slow increasing trend from June to December. According to (Gómez-  
578 Delgado et al., 2011), there was no true dry season in our study. The major LAI drop occurred during  
579 the “drier-cooler” season (January-March) though, and we also observed a minor LAI drop in  
580 September, which corresponds to a minor “drier” period. The magnitude of variation of LAI along the  
581 year was around a factor of 2. Regarding vegetative growth and leaf initiation, coffee pertains to the  
582 plant architectural model of Rauh (Hallé and Oldeman, 1970) and as such initiates new metamers  
583 simultaneously on the orthotropic and on the plagiotropic axes, each node initiating 2 leaves which are  
584 bearing axillary buds (able to further develop into vegetative axes or inflorescences). LAI buildup is  
585 thus submitted to the same seasonal fluctuations as the growth flushes of the axes (Silva et al., 2004).

586 Camargo and Camargo (2001) proposed a comprehensive scheme for the phenology (vegetative  
587 and reproductive development) of Arabica coffee, stressing that the phenology was based on a 2-year  
588 cycle: the vegetative and reproductive cycles last around 1.5 year, with a lag phase. The vegetative



589 cycle (newly emitted axes) starts just after the dry season *i.e.* after the blossoming (here in April).  
590 Coffee phenology expands over two years and leaf lifespan normally reaches 1.5 year: (i) in Year 1  
591 initiation and expansion during the wet and vegetative period (newly emitted leaves on the new  
592 flushes of the orthotropic and plagiotropic axes), then floral initiation at the axillary buds followed by  
593 blossoming at the end of Year 1; (ii) in Year 2, feeding the fruit sinks, then abscission centered at the  
594 time of the fruit harvest.

595 Although the coffee reproductive cycle has been widely documented and models attempting to  
596 simulate it using the climate are numerous, models coupling the vegetative and reproductive cycle  
597 remain limited (Rodriguez *et al.*, 2011). Leaf phenology, including lifespan, growth and shedding will  
598 be discussed here. Leaf lifespan was reported to vary in coffee, according to latitude, elevation and  
599 climate, in particular diminishing during dry spells or increasing under irrigation (Silveira, 1996;  
600 Silveira and Carvalho, 1996). When a long and intense dry season does exist (e.g. in Brazil, Minas  
601 Gerais), the succession of these phenological stages can be well-defined in time at the plant, plot, or  
602 regional scales, resulting in grouped blossoming and harvest period every year: in this case, the  
603 magnitude of variation of LAI can be large. On the contrary, when the dry season is not very well  
604 defined such as in our experiment, each phenological event can spread out over long periods and  
605 overlap with each other, leading to several successive blossoms, cohorts of fruits and harvesting  
606 periods. This occurs typically in regions closer to the Equator (latitude is 9°N here). Regarding leaf  
607 growth inferred from the LAI buildup, our analysis (Fig. 6) suggested that all the climate variables,  
608 except temperatures, co-varied and were associated with LAI. Although the relationships between  
609 these climate variables and LAI cannot be dissociated, some plausible effects of specific variables on  
610 LAI can be inferred, considering the particular conditions of the study. LAI was positively correlated  
611 with monthly rainfall and to its closely related variables such as HR, but LAI appeared not-correlated  
612 with temperature variables. Our results thus confirm the general rule reported in the literature: when  
613 temperature is favorable, the shoot growth of the Arabica coffee shows a periodicity closely following  
614 the rainfall distribution (Maestri and Barros, 1977; Rena *et al.*, 1994). Leaf expansion was also  
615 reported to vary seasonally with leaves growing faster and reaching larger sizes when expansion is  
616 initiated at the beginning of the rainy hot season (Rena and Maestri, 1985). Regarding leaf shedding,  
617 we found a negative correlation between LAI and solar radiation or related variables (potential  
618 evapotranspiration,  $ET_o$ ), suggesting that when radiation increased, LAI decreased. However, the slow  
619 growth of axes observed during the “drier-cooler” season in our experiment (data not shown) is  
620 unlikely to be associated with any soil moisture decline. In Brazil, irrigation during the dry season  
621 does not alter the overall pattern of growth (a quiescent phase is still observed during the dry season in  
622 the irrigated plots), although it may affect the rates of shoot growth (Mota *et al.*, 1997). However, the  
623 lowering temperatures are suspected there to trigger the declining of growth rates through the  
624 quiescent phase (DaMatta *et al.*, 2008). In our conditions, we also observed concordance between  
625 temperature minima and the “drier” season.

626 Apart from purely climatic factors, leaf senescence and abscission are also often considered to be  
627 dependent on the demand of the reproductive sinks, fruits being considered as the largest carbon sink  
628 on coffee (DaMatta et al., 2008; Franck et al., 2007; Vaast et al., 2005) after autotrophic respiration.  
629 Although leaf shedding is rather continuous along the year, we observed the largest leaf shedding  
630 during the drier-cooler season when there are no fruit left on branches, and a secondary phase in  
631 August-September, when the fruit demand for growth is high and might compete intensively with the  
632 leaves (unpublished results). As the decline started actually in August, *i.e.* when the fruit harvest was  
633 not intensive yet, we hypothesize that competition between compartments or translocations from  
634 leaves to fruits could be responsible for the secondary leaf shedding. This hypothesis should be tested  
635 under contrasting situations for climate and management before concluding, however. Falling leaves  
636 are mainly the eldest ones attached to reproductive nodes bearing ripening fruits, incautious manual  
637 harvesting definitively enhances leaf shedding, especially for the oldest leaves, but these leaves are  
638 close to natural abscission anyway. The harvest peak in our conditions also corresponded to the peak  
639 of leaf shedding, occurring in December.

640 Last, two diseases may also contribute to leaf shedding at the end of the year, coffee leaf rust  
641 (*Hemileia vastatrix*), whose incidence peak is normally found towards harvest peak (Avelino et al.,  
642 1991), and American leaf spot disease (*Mycena citricolor*), which develops a lot due to the abundant  
643 rainfalls which occur during this period (Avelino et al., 2007). Monitoring LAI by remote sensing is a  
644 promising tool to study the impacts of these diseases or the efficiency of their treatment. Coffee leaf  
645 rust impacts coffee mainly at low altitude, can cause severe lesions on leaves during the harvest peak,  
646 hasten leaf fall and provoke branch death, before the onset of the drier season, with consequently  
647 severe impacts on yield during the following year. At higher altitude (1300 m) in another farm of  
648 Costa Rica (La Hilda), we observed with the same methodology (unpublished results) that defoliation  
649 in the month of January was more pronounced during the years of heavy attacks by defoliator fungus  
650 *Mycena citricolor*, the impact of which was already known to vary with coffee cultivar, crop  
651 management, elevation and annual climatic conditions (Avelino et al., 2007). Coupling the assessment  
652 of disease incidence observed in the field with canopy defoliation at larger scale using remote sensing  
653 on the long term would allow better modeling of the footprints, dynamics and impacts of leaf diseases  
654 and help prepare the farmers and decision makers against severe defoliations at different scales.  
655 Inversely, it would be also possible to study how farmers react using disease control practices or not,  
656 according to the coffee prices and cash availability for instance. It was also observed that fertilizer  
657 inputs reduced the incidence of coffee leaf diseases and their impact by stimulating the incorporation  
658 of new healthy leaves over time, for coffee leaf rust for American leaf spot disease (Avelino et al.,  
659 2007; Avelino et al., 2006).

660 As a whole, considering the natural LAI dynamics in our experiment, we could confirm that shoot  
661 elongation determines LAI build-up and that both were mainly relying on the rainy months, whilst

662 LAI decline was centered on the drier-cooler months, and secondarily during grain filling. Leaf area  
663 build-up and leaf shedding are quite continuous along the year. Dissociating leaf growth from leaf  
664 shedding in LAI would require the use of litter-traps for instance. The rather low LAI magnitude of  
665 variation (less than a factor of 2) observed along the year in our study is probably related to the  
666 absence of water stress and to the overlapping of several reproductive cohorts, which does not induce  
667 seasonally intensive competition between fruits and leaves (Silveira, 1996; Silveira and Carvalho,  
668 1996).

## 669 **ii. Shade tree layer**

670 *Erythrina poeppigiana* was planted with a low density (7.4 trees ha<sup>-1</sup>) and freely-growing (no  
671 pruning), resulting in tall (> 20 m) but sparse trees with a crown projection area of *ca.* 15%. *Erythrina*  
672 shed its leaves completely during the drier-cooler season (LAI=0 in mid February), while blossoming,  
673 then leafed-on in March to reach a plateau in May to December. The non-green (stem + branches) area  
674 index of these trees was measured in February (value of 2 m<sup>2</sup> m<sup>-2</sup> of projected crown), and their LAI  
675 was ~16% of ecosystem LAI. The LAI dynamics of the two layers appeared to be rather synchronized,  
676 with a minimum during the “drier-cooler” season.

## 677 **C. Effects of management on coffee LAI**

678 At the plot scale, coffee LAI is probably influenced first by the choice of the coffee cultivar, by the  
679 planting density and also by the shade density, according to Mendez et al. (2009) who showed that  
680 shade tree species had a major influence on coffee LAI. Several reports compared shaded and full sun  
681 situations, showing that coffee LAI and other foliar parameters, such as specific leaf area (SLA) and  
682 leaf photosynthesis were affected by the shading tree (Franck and Vaast, 2009; Franck et al., 2006;  
683 Lopez-Bravo et al., 2012; Siles et al., 2010b).

684 At farm, landscape or regional scales, LAI, while monitored remotely (using MODIS for instance)  
685 becomes a promising indicator of coffee vegetative vigor and of coffee practices, allowing studying  
686 the impact of management alternatives. Annual pruning of the oldest senescent or exhausted coffee  
687 shoots occurs during the “drier-cooler” season while coffee LAI is already naturally depleted, hereby  
688 eliminating *ca* 15% of the shoots, i.e. *ca* 25% of LAI, considering that mainly the oldest and tallest  
689 shoots are pruned. According to farmer’s information, the pruning intensity is being adjusted for every  
690 year and for every plot, according to the degree of exhaustion of the resprouts and to their height  
691 (harvesting easiness criteria). Besides, a periodic pattern is normally applied, with one year strongly  
692 pruned, one year intermediate and one year lightly pruned. Considering that the pruning intensity is  
693 adjusted plot per plot and plant per plant, it is unlikely that the resolution of MODIS would be fine  
694 enough to detect such spatial adjustments. We could not find a remotely sensed method to evaluate  
695 accurately the intensity of the yearly pruning at farm scale, nor to distinguish it from the natural  
696 seasonal LAI depletion occurring between January and April. However, remote sensing proved to be

697 successful to detect the time of full renovation of a plot (excavation of the coffee plants and  
698 replanting), and the time for LAI to recover, which was around 4 years (Fig. 7). Farmers can decide to  
699 fully renovate their coffee plots, either when the coffee stumps become too old (starting after 30 years)  
700 and show signs of exhaustion (e.g. stop resprouting after the pruning), or when the coffee prices are  
701 very low, hereby anticipating for a higher coffee productivity for the next expected period of high  
702 prices. During periods of high prices, the farmers rather try to minimize the pruning practices and  
703 invest more into inputs (fertilizers, herbicides, pest management). Hence, LAI monitoring appears a  
704 promising tool to study the adaptation of farmer's practices to the economical context.

## 705 **D. LAI and Ecosystem Services**

### 706 **i. LAI and the Provisioning Service (Coffee yield)**

707 Predicting coffee yield early during the reproductive cycle is of paramount importance for the  
708 farmers, because it helps adjusting the management during the whole cycle, for instance fertilization,  
709 manpower, processing and also negotiating sale contracts in advance. At the regional scale, tools for  
710 estimating the past yield are also of practical interest for e.g. studying the impacts of biophysical and  
711 socio-economical constraints and anticipate solutions for the future. Practically, many large farms in  
712 Costa Rica estimate their final annual harvest from 3 campaigns of fruit load inventory, allowing them  
713 to adjust precisely the fertilizer inputs (thrice a year) and to anticipate yield 3 months in advance of  
714 harvest. Leaf number on the branch was long reported to affect the fruit set in coffee (Rao and Setly,  
715 1953; Phillips, 1970), maybe through carbohydrate supply Cannel (1971a) together with several other  
716 factors (flower number, rainfall during anthesis). Using MODIS, (Brunsell *et al.*, 2009) already  
717 evidenced the relationship between NDVI and coffee yield but did not investigate which could be the  
718 key months. During the 2001-2011 interval, we observed a positive relationship between remotely  
719 sensed LAI of 8 specific months and coffee yield of the current year (year N) (Fig. 8). The specific  
720 months were grouped here into:

- 721 (i) Year N-1: June and July correspond to the LAI recovery after the drier-cooler season, *i.e.* after the  
722 first and main flush of new axes of year N-1, which are expected to settle the new nodes that will  
723 further blossom and bear fruits during year N. A good correlation between yield of year N and  
724 vegetative status in June-July of year N-1 sounds logical.
- 725 (ii) Year N, January to April: January to April correspond to the declining LAI phase observed during  
726 the drier-cooler months of year N. The vegetative vigor (high LAI) at the end of the harvest (drier-  
727 cooler season) has been used already as an indicator of productivity and is a key parameter for the  
728 selection of coffee varieties (Bertrand *et al.*, 2005; Carvalho *et al.*, 2009; Charmetant *et al.*, 2007).  
729 A coffee plant bearing only few leaves during the drier-cooler months is more likely to be pruned  
730 for rejuvenating the plot, with direct negative impacts on the yield of year N;

**Table 4:** Effects of LAI on the simulations of the water balance partitioning and hydrological services at watershed scale by the Hydro-SVAT model (Gomez-Delgado et al., 2011). Q: streamflow; ETR: actual evapo-transpiration; Runoff: superficial runoff; Aquifer: flow through aquifer. Data computed for 2009 (Rainfall = 3260 mm).

Scenario #	Scenario #	LAI <sub>farm</sub>	Nash-Sutcliffe index	Q (mm yr <sup>-1</sup> )	%Diff Q	ETR (mm yr <sup>-1</sup> )	%Diff ETR	Runoff (mm yr <sup>-1</sup> )	%Diff Runoff	Aquifer (mm yr <sup>-1</sup> )	%Diff Aquifer
0	Measured	MODIS	-	2012	-	764		-		-	
1	Modelled	MODIS	0.89	2056	2.2	754	-1.3	123.5	-	1878	-
2	Modelled	LAI <sub>moy</sub> = 3.8	0.89	2060	2.4	748	-2.0	123.5	0.0	1883	0.2
3	Modelled	LAI = 0.1	0.74	2467	22.6	275	-64.0	123.8	0.3	2269	20.8
4	Modelled	LAI = 7.6	0.81	1665	-17.3	1226	60.5	121.9	-1.3	1509	-19.6

731 (iii) Year N, August to September: a low LAI here can be the result of many factors: foliar pests,  
732 else lack of fertilizer. We hypothesize a high LAI achieved during this period presumably allows a  
733 higher photosynthesis rate per plant and more available carbohydrates grain filling and vegetative  
734 growth, hence less competition between leaves and fruits.

735 The simple regression between mean annual LAI and annual yield was not significant. However,  
736 when using the six specific months of year N of LAI<sub>coffee</sub>, the correlation was much improved.  
737 Including June and July LAI<sub>coffee</sub> from year N-1 did not improve that result anymore, though.

## 738 **ii. Towards a statistical crop yield model including LAI**

739 At the farm and annual scale, we found that yield was positively correlated with N-fertilizer inputs.  
740 This result is actually straightforward, considering practices of farmers who evaluate fruit load just  
741 before adjusting the amount of fertilizer (thrice per year). Actually, it does not mean that the crop  
742 responds to higher level of fertilizer, but rather that the fertilizer is applied to anticipate the fruit  
743 demand, according to the farmers' experience. Adding LAI variable into the model substantially  
744 improved the prediction (Tab. 3), confirming that LAI is an important indicator of yield and deserves  
745 to be taken into account. Although the prediction of yield performed best after using N-fertilizer input,  
746 LAI from months January to April, LAI from months August to September and Pruning into the  
747 regression (Fig. 9;  $R^2 = 0.79$ ), of main practical interest for coffee research institutes is probably the  
748 prediction of yield using N-fertilizer and LAI only, since pruning intensity might be very difficult to  
749 obtain practically (Tab. 3;  $R^2 = 0.74$ ). Such studies could estimate past yield and reconstruct yield  
750 time series wherever yield data is not available. The latter regression would remain of limited interest  
751 for the farmer itself since it requires data on late months (September) of year N, *i.e.* a time when the  
752 farmer already has rather good estimates of his yield.

753 The genericity of the model could be tested in different situations. Obviously, it would also be  
754 necessary to investigate the key role of flowering intensity and the impact of diseases to improve the  
755 model.

## 756 **iii. LAI and Hydrological Services**

757 We varied LAI in the Hydro-SVAT model (Gómez-Delgado *et al.*, 2011) already calibrated and  
758 verified in the same watershed, in order to estimate the impact of LAI on four important hydrological  
759 services, namely the provisioning of water by the streamflow (Q), the actual evapotranspiration (ETR),  
760 the superficial runoff (Runoff) and the flow through the aquifer (Aquifer). We changed LAI according  
761 to four scenarios (Table 4). When LAI was from MODIS (this study), interpolated on the semi-hourly  
762 time-step (scenario 1), the superficial runoff was only 4% of rainfall (hence laminar erosion was very  
763 low) and 58% of rainfall flowed through the Aquifer. As a whole, the watershed appeared to be very  
764 conservative for hydrological services (Gómez-Delgado *et al.*, 2011). When only the average annual

765 stand LAI of 3.8 was used (scenario 2), we did not observe any significant impact on the annual  
766 deviations of Q and ETR indicating that using a constant LAI could be a reasonable simplification for  
767 estimating the annual water provisioning service at the annual scale in similar ecosystems for instance.

768 When LAI was set close to zero (LAI = 0.1; scenario 3), as it normally happens during a plot clear  
769 cutting for renovation we simulated that water would be shifted to the aquifer and then to the river if  
770 not transpired by the plants. The impact on superficial runoff and laminar erosion would remain  
771 negligible, though, in this particular type of soil with a high permeability. When LAI was set to double  
772 the initial average value (LAI = 7.6; scenario 4), simulating very high LAI conditions for this site. We  
773 confirmed water shortage in the river when the crop is intensively managed. Higher water  
774 consumption by the vegetation has potential favorable feedback on climate through beneficial effect  
775 on rainfall regime. The impact on superficial runoff and laminar erosion would remain low.

776 From this modeling exercise, we could illustrate the paramount importance of assessing accurate  
777 values of LAI when estimating several hydrological services. The simulated results indicate the kind  
778 of the expected impacts on Q, aquifer, superficial runoff and ETR in a tropical humid coffee  
779 agroforestry basin when LAI is managed from minimum to maximum values. However, our  
780 simulations correspond to a watershed with very high soil infiltrability. Under conditions of lower  
781 infiltrability, in a different watershed for instance, increasing LAI and thus root systems could have  
782 improved substantially the infiltration-to-runoff ratio. Hence, it would be of high interest to compare  
783 the simulations reported here with contrasting situations, such as on soils with low infiltrability, drier  
784 areas where ETR would represent more than 23% of the rainfall partitioning, or else after varying the  
785 shade tree density.

786 Apart from its impact on yield and on hydrological services which were presented here as  
787 examples, we stress that LAI is also a key factor other ecosystem services for instance for Gross  
788 Primary Productivity (GPP or canopy photosynthesis), which is driving the net primary productivity  
789 and the Provisioning Services (Charbonnier *et al.*, 2012). It is also likely that correlations could be  
790 evidenced between LAI and soil organic matter.

## 791 **5. Conclusions**

792 This study presents a novel combined approach to upscale LAI from plant to farm in a two-layer  
793 coffee agroforestry system, after separating the shade tree and coffee layers, with time resolution from  
794 10 days to decade. It was based on a combination of high and moderate resolution remote sensing,  
795 calibrated with ground-truth (LAI 2000 transects, direct and LAI 2000 LAI measurements for coffee  
796 and LAI 2000 isolated-tree protocol for the shade tree).

797 Coffee LAI showed seasonal variations that could be explained by natural factors (coffee  
798 phenology, interactions between reproductive and vegetative compartments and climate) or by  
799 management (pruning, renovation).

800 We stressed that LAI is a promising indicator for several ecosystem services (ES):

801 • Combined with data on N-fertilizer inputs, and preferably with information on the pruning  
802 intensity, LAI<sub>coffee</sub> enhances dramatically the accuracy of coffee yield estimations, with perspectives in  
803 terms of regional yield mapping or reconstruction of historical yield time-series.

804 • LAI had a significant impact on the partitioning between green (evapotranspiration) and blue  
805 water (infiltration, aquifer recharge, streamflow), thus on the water provisioning and erosion  
806 regulating ES.

807 It is assumed that more ES could be related to LAI, for instance Gross and Net Primary  
808 Productivity, or Soil Organic Matter, and that remotely sensed LAI could feed process and empirical  
809 models. Management practices affecting LAI may impact ES and their trade-offs. Remotely-sensed  
810 LAI by MODIS could be useful to interpret impacts of leaf diseases

## 811 **6. Acknowledgements**

812 The authors would like to thank CIRAD for providing the MSc scholarship to Simon Taugourdeau,  
813 CATIE for laboratory facilities and AQUIARES farm for hosting the Coffee-Flux platform since 2009.  
814 The field work and image acquisition (Digitalglobe) was sponsored by EU-CAFNET project, GIP-  
815 Ecofor (SOERE) observatory network, Fontagro CAF'Adapt project, ANR Ecosfix Project and AIRD  
816 SAFSE project.

817 We are much indebted to the Barquero family and collaborators for their excellent field assistance  
818 and to all students and contributors to the Coffee-Flux project. Many thanks also to Claire Marsden  
819 and Yann Nouvellon for valuable advices.



820 **7. References**

- 821 Albrecht, A., Kandji, S.T., 2003. Carbon sequestration in tropical agroforestry systems.  
822 Agriculture Ecosystems & Environment 99, 15-27.
- 823 Allen, R., Pereira, L., Raes, D., Smith, M., 1998. Crop evapotranspiration. Guidelines for  
824 computing crop water requirements, FAO Irrigation and drainage paper 56. Available at  
825 <http://www.fao.org/docrep/X0490E/X0490E00.htm>, p. 301 pp.
- 826 Ataroff, M., Monasterio, M., 1997. Soil erosion under different management of coffee  
827 plantations in the Venezuelan Andes. Soil Technology 11, 95-108.
- 828 Avelino, J., Cabut, S., Barboza, B., Barquero, M., Alfaro, R., Esquivel, C., Durand, J.F.,  
829 Cilas, C., 2007. Topography and crop management are key factors for the development of  
830 American leaf spot epidemics on coffee in Costa Rica. Phytopathology 97, 1532-1542.
- 831 Avelino, J., Muller, R.A., Cilas, C., Pascual, H.V., 1991. Development and behavior of coffee  
832 orange rust (*Hemilia vastatrix* Berk and Br) in plantations undergoing modernization, planted  
833 with dwarf varieties in South-East Mexico. Cafe Cacao The 35, 21-37.
- 834 Avelino, J., Zelaya, H., Merlo, A., Pineda, A., Ordoñez, M., Savary, S., 2006. The intensity of  
835 a coffee rust epidemic is dependent on production situations. Ecological Modelling 197, 431-  
836 447.
- 837 Beer, C., Reichstein, M., Tomelleri, E., Ciais, P., Jung, M., Carvalhais, N., Rodenbeck, C.,  
838 Arain, M.A., Baldocchi, D., Bonan, G.B., Bondeau, A., Cescatti, A., Lasslop, G., Lindroth,  
839 A., Lomas, M., Luyssaert, S., Margolis, H., Oleson, K.W., Rouspard, O., Veenendaal, E.,  
840 Viovy, N., Williams, C., Woodward, F.I., Papale, D., 2010. Terrestrial Gross Carbon Dioxide  
841 Uptake: Global Distribution and Covariation with Climate. Science 329, 834-838.
- 842 Beer, J., Muschler, R., Kass, D., Somarriba, E., 1998. Shade management in coffee and cacao  
843 plantations. Agroforestry Systems 38, 139-164.
- 844 Bernardes, T., Moreira, M.A., Adami, M., Giarolla, A., Rudorff, B.F.T., 2012. Monitoring  
845 Biennial Bearing Effect on Coffee Yield Using MODIS Remote Sensing Imagery. Remote  
846 Sensing 4, 2492-2509.
- 847 Bertrand, B., Etienne, H., Cilas, C., Charrier, A., Baradat, P., 2005. Coffea arabica hybrid  
848 performance for yield, fertility and bean weight. Euphytica 141, 255-262.
- 849 Brunzell, N.A., Pontes, P.P.B., Lamparelli, R.A.C., 2009. Remotely sensed phenology of  
850 coffee and its relationship to yield. GIScience and Remote Sensing 46, 289-304.
- 851 Camargo, A.P.d., Camargo, M.B.d., 2001. Definition and outline for the phenological phases  
852 of arabica coffee under brazilian tropical conditions. Agrometeorologia, Bragantia Campinas  
853 60(1), 65-68.

- 854 Cannavo, P., Sansoulet, J., Harmand, J.M., Siles, P., Dreyer, E., Vaast, P., 2011. Agroforestry  
855 associating coffee and *Inga densiflora* results in complementarity for water uptake and  
856 decreases deep drainage in Costa Rica. *Agriculture Ecosystems & Environment* 140, 1-13.
- 857 Carr, M.K.V., 2001. The water relations and irrigation requirements of coffee. *Exp. Agric.* 37,  
858 1-36.
- 859 Carvalho, G.R., Botelho, C.E., Bartholo, G.F., Pereira, A.A., Nogueira, A.M., de Carvalho,  
860 A.M., 2009. Behavior of F-4 progenies obtained from crossing of Icatu with Catimor. *Cienc.*  
861 *Agrotec.* 33, 47-52.
- 862 CENIGA, 1998. Hojas Topográficas Escala 1:25000. Proyecto TERRA.
- 863 Charbonnier, F., Le Maire, G., Dreyer, E., Casanoves, F., Christina, M., Dauzat, J., Eitel, J.,  
864 Vaast, P., Vierling, L., Roupsard, O., 2013. Competition for light in heterogeneous canopies:  
865 application of MAESTRA to coffee (*Coffea arabica* L.) agroforestry systems. *Agric. For.*  
866 *Met.* Accepted with minor revision June 2013.
- 867 Charbonnier, F., Roupsard, O., Dreyer, E., le Maire, G., 2012. Using the MAESTRA model to  
868 simulate light interactions and photosynthesis in a heterogeneous agroforestry system. Oral  
869 Presentation, 30th AMS Conference on Agricultural and Forest Meteorology. American  
870 Meteorological Society, Boston, MA, USA.
- 871 Charmetant, P., Etienne, H., Santacreo, R., Cisneros, B., Anzueto, F., Gil, S., Alpizar, E.,  
872 Bertrand, B., 2007. *Coffea arabica* clones from F1 hybrids in Central America. 21st  
873 International Conference on Coffee Science, Montpellier, France, 11-15 September, 2006,  
874 1140-1146.
- 875 Cordero-Sancho, S., Sader, S.A., 2007. Spectral analysis and classification accuracy of coffee  
876 crops using Landsat and a topographic-environmental model. *International Journal of Remote*  
877 *Sensing* 28, 1577-1593.
- 878 DaMatta, F.M., 2004. Ecophysiological constraints on the production of shaded and unshaded  
879 coffee: a review. *Field Crops Research* 86, 99-114.
- 880 DaMatta, F.M., Ronchi, C.P., Maestri, M., Barros, R.S., 2008. Ecophysiology of coffee  
881 growth and production. *Brazilian Journal of Plant Physiology* 19, 485-510.
- 882 DeClerck, F.A.J., Chazdon, R., Holl, K.D., Milder, J.C., Finegan, B., Martinez-Salinas, A.,  
883 Imbach, P., Canet, L., Ramos, Z., 2010. Biodiversity conservation in human-modified  
884 landscapes of Mesoamerica: Past, present and future. *Biological Conservation* 143, 2301-  
885 2313.
- 886 Dupraz, C., Liagre, F., 2008. *Agroforesterie : des arbres et des cultures.* France Agricole.
- 887 FAO, 2011. FAOSTAT Agriculture Data. <http://faostat.fao.org/>.

- 888 Franck, N., Vaast, P., 2009. Limitation of coffee leaf photosynthesis by stomatal conductance  
889 and light availability under different shade levels. *Trees* 23, 761-769.
- 890 Franck, N., Vaast, P., Dauzat, J., 2007. Coffee a shade-adapted plant: Implications on its  
891 carbon balance and consequences on coffee yield and quality in agroforestry systems. 21st  
892 International Conference on Coffee Science, Montpellier (France), 11th - 15th September  
893 2006, 1023-1031.
- 894 Franck, N., Vaast, P., Génard, M., Dauzat, J., 2006. Soluble sugars mediate sink feedback  
895 down-regulation of leaf photosynthesis in field-grown *Coffea arabica*. *Tree physiology* 26,  
896 517-525.
- 897 Gómez-Delgado, F., 2010. Hydrological, ecophysiological and sediment processes in a coffee  
898 agroforestry basin: combining experimental and modelling methods to assess hydrological  
899 environmental services. PhD Thesis., Centre international d'études supérieures en sciences  
900 agronomiques -Montpellier Supagro; Ecole doctorale Systèmes Intégrés en Biologie,  
901 Agronomie, Géosciences, Hydrosiences, Environnement (SIBAGHE), Montpellier, p. 254.
- 902 Gómez-Delgado, F., Roupsard, O., le Maire, G., Taugourdeau, S., Perez, A., van Oijen, M.,  
903 Vaast, P., Rapidel, B., Harmand, J.M., Voltz, M., Bonnefond, J.M., Imbach, P., Moussa, R.,  
904 2011. Modelling the hydrological behaviour of a coffee agroforestry basin in Costa Rica.  
905 *Hydrol. Earth Syst. Sci.* 15, 369-392.
- 906 Gower, S.T., Kucharik, C.J., Norman, J.M., 1999. Direct and indirect estimation of leaf area  
907 index, f(APAR), and net primary production of terrestrial ecosystems. *Remote Sensing of*  
908 *Environment* 70, 29-51.
- 909 Granier, A., Breda, N., Biron, P., Villette, C., 1999. A lumped water balance model to  
910 evaluate duration and intensity of drought constraints in forest stands. *Ecol. Model.* 116, 269-  
911 283.
- 912 Hallé, F., Oldeman, R.A.A., 1970. Essai sur l'architecture et la dynamique de croissance des  
913 arbres tropicaux. Masson et Cie, Monographie 6, 178pp.
- 914 Harmand, J.M., Avila, H., Dambrine, E., Skiba, U., de Miguel, S., Renderos, R.V., Oliver, R.,  
915 Jimenez, F., Beer, J., 2007. Nitrogen dynamics and soil nitrate retention in a *Coffea arabica*-  
916 *Eucalyptus deglupta* agroforestry system in Southern Costa Rica. *Biogeochemistry* 85, 125-  
917 139.
- 918 Hergoualc'h, K., Blanchart, E., Skiba, U., Henault, C., Harmand, J.-M., 2012. Changes in  
919 carbon stock and greenhouse gas balance in a coffee (*Coffea arabica*) monoculture versus an  
920 agroforestry system with *Inga densiflora*, in Costa Rica. *Agriculture Ecosystems &*  
921 *Environment* 148, 102-110.
- 922 Hmimina, G., Dufrene, E., Pontailier, J.Y., Delpierre, N., Aubinet, M., Caquet, B., de  
923 Grandcourt, A., Burban, B., Flechard, C., Granier, A., Gross, P., Heinesch, B., Longdoz, B.,  
924 Moureaux, C., Ourcival, J.M., Rambal, S., Saint Andre, L., Soudani, K., 2013. Evaluation of  
925 the potential of MODIS satellite data to predict vegetation phenology in different biomes: An

- 926 investigation using ground-based NDVI measurements. *Remote Sensing of Environment* 132,  
927 145-158.
- 928 Johnson, L.F., Herwitz, S.R., Lobitz, B.M., Dunagan, S.E., 2004. Feasibility of monitoring  
929 coffee field ripeness with airborne multispectral imagery. *Applied Engineering in Agriculture*  
930 20, 845-849.
- 931 Jung, M., Reichstein, M., Ciais, P., Seneviratne, S.I., Sheffield, J., Goulden, M.L., Bonan, G.,  
932 Cescatti, A., Chen, J., de Jeu, R., Dolman, A.J., Eugster, W., Gerten, D., Gianelle, D.,  
933 Gobron, N., Heinke, J., Kimball, J., Law, B.E., Montagnani, L., Mu, Q., Mueller, B., Oleson,  
934 K., Papale, D., Richardson, A.D., Rouspard, O., Running, S., Tomelleri, E., Viovy, N.,  
935 Weber, U., Williams, C., Wood, E., Zaehle, S., Zhang, K., 2010. Recent decline in the global  
936 land evapotranspiration trend due to limited moisture supply. *Nature* 467, 951-954.
- 937 Kinoshita, R., 2012. Strategies for soil quality assessment using VNIR hyperspectral  
938 spectroscopy. Cornell, USA. , New-York. Master Sc. 89pp.
- 939 le Maire, G., Francois, C., Soudani, K., Davi, H., Le Dantec, V., Saugier, B., Dufrene, E.,  
940 2006. Forest leaf area index determination: A multiyear satellite-independent method based  
941 on within-stand normalized difference vegetation index spatial variability. *Journal of*  
942 *Geophysical Research-Biogeosciences* 111.
- 943 le Maire, G., Marsden, C., Nouvellon, Y., Grinand, C., Hakamada, R., Stape, J.-L., Laclau, J.-  
944 P., 2011a. MODIS NDVI time-series allow the monitoring of Eucalyptus plantation biomass.  
945 *Remote Sensing of Environment* 115, 2613-2625.
- 946 le Maire, G., Marsden, C., Verhoef, W., Ponzoni, F.J., Lo Seen, D., Begue, A., Stape, J.L.,  
947 Nouvellon, Y., 2011b. Leaf area index estimation with MODIS reflectance time series and  
948 model inversion during full rotations of Eucalyptus plantations. *Remote Sensing of*  
949 *Environment* 115, 586-599.
- 950 LI-COR, 1992. LAI-2000 Plant canopy analyser: Instruction manual, LI-COR Inc., Lincoln,  
951 NE.
- 952 LI-COR, 1996. LI-3100 Area meter: Instruction manual, LI-COR Inc., Lincoln, NE.
- 953 Lopez-Bravo, D.F., Virginio-Filho, E.d.M., Avelino, J., 2012. Shade is conducive to coffee  
954 rust as compared to full sun exposure under standardized fruit load conditions. *Crop*  
955 *Protection* 38, 21-29.
- 956 Maestri, M., Barros, R., 1977. Coffee, in: Alvim PT, K.T. (Ed.), *Ecophysiology of Tropical*  
957 *Crops*. Academic Press, London, pp. 249-278.
- 958 Marsden, C., le Maire, G., Stape, J.-L., Seen, D.L., Rouspard, O., Cabral, O., Epron, D., Lima,  
959 A.M.N., Nouvellon, Y., 2010. Relating MODIS vegetation index time-series with structure,  
960 light absorption and stem production of fast-growing Eucalyptus plantations. *For. Ecol.*  
961 *Manage.* 259, 1741-1753.

- 962 Matoso-Campanha , M., Silva Santos , R., de Freitas , G., Martinez , H., Ribeiro Garcia, S.,  
963 Finger , F., 2004. Growth and yield of coffee plants in agroforestry and monoculture systems  
964 in Minas Gerais, Brazil. *Agroforestry Systems*, 75–82.
- 965 MEA, 2005. Millennium Ecosystem Assessment (MEA). *Ecosystems and Human Well-*  
966 *Being: Synthesis*. Island Press, Washington. 155pp.
- 967 Mendez, V.E., Gliessman, S.R., Gilbert, G.S., 2007. Tree biodiversity in farmer cooperatives  
968 of a shade coffee landscape in western El Salvador. *Agriculture Ecosystems & Environment*  
969 119, 145-159.
- 970 Mendez, V.E., Shapiro, E.N., Gilbert, G.S., 2009. Cooperative management and its effects on  
971 shade tree diversity, soil properties and ecosystem services of coffee plantations in western El  
972 Salvador. *Agroforestry Systems* 76, 111-126.
- 973 Mitchell, G., May, A., McDonald, A., 1995. PICABUE: a methodological framework for the  
974 development of indicators of sustainable development. *International Journal of Sustainable*  
975 *Development & World Ecology* 2, 104-123.
- 976 Mota, J.W.S., Barros, R.S., DaMatta, F.M., Maestri, M., 1997. Vegetative growth in *Coffea*  
977 *arabica* L. as affected by irrigation, daylength and fruiting. *Tropical Ecology* 38, 73-79.
- 978 Ong, C.K., Black, C.R., Wallace, J.S., Khan, A.A.H., Lott, J.E., Jackson, N.A., Howard, S.B.,  
979 Smith, D.M., 2000. Productivity, microclimate and water use in *Grevillea robusta*-based  
980 agroforestry systems on hillslopes in semi-arid Kenya. *Agriculture, Ecosystems &*  
981 *Environment* 80, 121-141.
- 982 Pagiola, S., 2008. Payments for environmental services in Costa Rica. *Ecological Economics*  
983 65, 712-724.
- 984 Peel, M.C., Finlayson, B.L., McMahon, T.A., 2007. Updated world map of the Köppen-  
985 Geiger climate classification. *Hydrol. Earth Syst. Sci.* 11, 1633-1644.
- 986 Pendergrast, M., 2009. Coffee: Second to Oil? *Tea & Coffee Trade Journal*, 38–41.
- 987 Philpott, S.M., Arendt, W.J., Armbrecht, I., Bichier, P., Diestch, T.V., Gordon, C., Greenberg,  
988 R., Perfecto, I., Reynoso-Santos, R., Soto-Pinto, L., Tejeda-Cruz, C., Williams-Linera, G.,  
989 Valenzuela, J., Zolotoff, J.M., 2008. Biodiversity loss in Latin American coffee landscapes:  
990 review of the evidence on ants, birds, and trees. *Conservation Biology* 22, 1093-1105.
- 991 R 2008. R: A Language and Environment for Statistical Computing. [http://www.r-](http://www.r-project.org/)  
992 [project.org/](http://www.r-project.org/), in: Team, R.D.C. (Ed.).
- 993 Rafaelli, D.R., Moreira, M.A., Faria, R.T.d., 2006. Analysis of the MODIS data potential to  
994 monitor (state and local level) frost impact on coffee. *Agricultura em Sao Paulo* 53, 5-15.

- 995 Rapidel, B., DeClerck, F., Le Coq, J.F., Beer, J., 2011. Ecosystem Services from Agriculture  
996 and Agroforestry: Measurement and Payment. Earthscan, London, UK 430 pp, p. 430.
- 997 Rena, A.B., Barros, R., Maestri, M., Söndahl, M., 1994. Coffee, in: Schaffer B, A.P. (Ed.),  
998 Handbook of Environmental Physiology of Tropical Fruit Crops: Sub-Tropical and Tropical  
999 Crops. CRC Press, Boca Raton, pp. 101-122.
- 1000 Rena, A.B., Maestri, M., 1985. Fisiologia do cafeeiro. Piracicaba (Brasil), Associacao  
1001 Brasileira para Pesquisa da Potassa e do Fosfato, 26-40.
- 1002 Righi, C.A., Bernardes, M.S., Lunz, A.M.P., Pereira, C.R., Dourado Neto, D., Favarin, J.L.,  
1003 2007. Measurement and simulation of solar radiation availability in relation to the growth of  
1004 coffee plants in an agroforestry system with rubber trees. Revista Arvore 31, 195-207.
- 1005 Rodriguez, D., Ricardo Cure, J., Miguel Cotes, J., Gutierrez, A.P., Cantor, F., 2011. A coffee  
1006 agroecosystem model: I. Growth and development of the coffee plant. Ecological Modelling  
1007 222, 3626-3639.
- 1008 Roupsard, O., Dauzat, J., Nouvellon, Y., Deveau, A., Feintrenie, L., Saint-Andre, L., Mialet-  
1009 Serra, I., Braconnier, S., Bonnefond, J.M., Berbigier, P., Epron, D., Jourdan, C., Navarro, M.,  
1010 Bouillet, J.P., 2008. Cross-validating Sun-shade and 3D models of light absorption by a tree-  
1011 crop canopy. Agricultural and Forest Meteorology 148, 549-564.
- 1012 Rouse, J.W., Haas, R.H., Schell, J.A., Deering, D.W., 1973. Monitoring vegetation systems in  
1013 the great plains with ERTS, Third ERTS Symposium, SP-351. NASA, Washington, D. C.
- 1014 Roy, J., Saugier, B., Mooney, H.A., 2001. Terrestrial global productivity. Academic Press,  
1015 San Diego. 573 pp.
- 1016 Ryu, Y., Sonnentag, O., Nilson, T., Vargas, R., Kobayashi, H., Wenk, R., Baldocchi, D.D.,  
1017 2010. How to quantify tree leaf area index in an open savanna ecosystem: A multi-instrument  
1018 and multi-model approach. Agricultural and Forest Meteorology 150, 63-76.
- 1019 Siles, P., Harmand, J.M., Vaast, P., 2010a. Effects of *Inga densiflora* on the microclimate of  
1020 coffee (*Coffea arabica* L.) and overall biomass under optimal growing conditions in Costa  
1021 Rica. Agroforestry Systems 78, 269-286.
- 1022 Siles, P., Vaast, P., Dreyer, E., Harmand, J.M., 2010b. Rainfall partitioning into throughfall,  
1023 stemflow and interception loss in a coffee (*Coffea arabica* L.) monoculture compared to an  
1024 agroforestry system with *Inga densiflora*. Journal of Hydrology 395, 39-48.
- 1025 Silva, E.A., DaMatta, F.M., Ducatti, C., Regazzi, A.J., Barros, R.S., 2004. Seasonal changes  
1026 in vegetative growth and photosynthesis of Arabica coffee trees. Field Crops Research 89,  
1027 349-357.
- 1028 Silveira, J.S.M., 1996. Irrigação em café: café conilon irrigado no Espírito Santo, Proceedings  
1029 of the 1º Simpósio Estadual do Café, CETCAF, pp. 66-83.

- 1030 Silveira, J.S.M., Carvalho, C.H.S., 1996. Efeito da época de irrigação sobre o crescimento do  
1031 ramo plagiotrópico e da longevidade foliar do café conilon, Proceedings of the 22º Congresso  
1032 Brasileiro de Pesquisas Cafeeiras, PROCAFÉ, pp. 99-100.
- 1033 Somarriba, E., Harvey, C.A., Samper, M., Anthony, F., Gonzalez, J., Staver, C., Rice, R.A.,  
1034 2004. Biodiversity conservation in neotropical coffee (*Coffea arabica*) plantations,  
1035 Agroforestry and Biodiversity Conservation in Tropical Landscapes. Island Press;  
1036 Washington; USA, pp. 198-226.
- 1037 Song, C., Woodcock, C.E., Seto, K.C., Lenney, M.P., Macomber, S.A., 2001. Classification  
1038 and change detection using Landsat TM data: when and how to correct atmospheric effects?  
1039 Remote sensing environment 75, 230-244.
- 1040 Soudani, K., Francois, C., le Maire, G., Le Dantec, V., Dufrene, E., 2006. Comparative  
1041 analysis of IKONOS, SPOT, and ETM+ data for leaf area index estimation in temperate  
1042 coniferous and deciduous forest stands. Remote Sensing of Environment 102, 161-175.
- 1043 Thimonier, A., Sedivy, I., Schleppi, P., 2010. Estimating leaf area index in different types of  
1044 mature forest stands in Switzerland: a comparison of methods. European Journal of Forest  
1045 Research 129, 543-562.
- 1046 USDA, 1999. Soil Taxonomy, A Basic System of Soil Classification for Making and  
1047 Interpreting Soil Surveys, Washington, USA.
- 1048 Vaast, P., Angrand, J., Franck, N., Dauzat, J., Génard, M., 2005. Fruit load and branch ring-  
1049 barking affect carbon allocation and photosynthesis of leaf and fruit of *Coffea arabica* in the  
1050 field. Tree physiology 25, 753-760.
- 1051 van Kantén, R., Vaast, P., 2006. Transpiration of arabica coffee and associated shade tree  
1052 species in sub-optimal, low-altitude conditions of Costa Rica. Agroforestry Systems 67, 187-  
1053 202.
- 1054 Viovy, N., Arino, O., Belward, A.S., 1992. The Best Index Slope Extraction (BISE) – a  
1055 method for reducing noise in NDVI time series,. International Journal of Remote Sensing 13,  
1056 1585-1590
- 1057
- 1058
- 1059

---

---

# Abstract

---

---

Compared to monocultures, agroforestry systems (AFS) are expected to provide enhanced resource-use efficiency and larger ecosystem services. However, due to the complexity of the interactions occurring in AFS, it is challenging to quantify and decompose the effects of shade trees on the main crop net primary productivity (NPP). Few process-based models are able to analyze the interactions between crop and shade trees for carbon and water. Interactions for light, water and energy occurring between tree and crops might have counterintuitive effects on photosynthesis, light use efficiency (LUE), transpiration efficiency and microclimate. We showed that a 3D process-based model, MAESPA, was able to quantitatively describe the spatial variability of those processes from the plant to the plot, and from hourly to yearly timescales. MAESPA simulated satisfactorily light interception in a 2-layer heterogeneous coffee AFS. It was used to produce powerful explanatory variables in AFS experiments and to analyze the determinants of coffee plant NPP. LUE displayed a 2-fold increase for shaded coffee plants totally compensating the expected decrease of local irradiance interception, and coffee plant ANPP was the same below shade trees or in the open. MAESPA also simulated satisfactorily carbon exchange at whole plant and plot scales, when compared to gas exchange records in a whole-plant chamber, or with eddy-covariance records above the canopy. We used MAESPA to simulate the spatial variability of photosynthesis and LUE. Overall, MAESPA proved to be a relevant model to quantify spatial interactions. The next very relevant development would be to couple it to a model of carbon allocation among organs in the coffee plants.

**Keywords:** agroforestry, coffee, 3D model, photosynthesis, transpiration, resource-use-efficiency, NPP

---

---

# Résumé

---

---

Comparés aux monocultures, les systèmes agroforestiers (SAF) sont censés permettre une meilleure efficacité d'utilisation de la ressource et améliorer les services écosystémiques. Cependant, la complexité des interactions se produisant dans les SAF rend délicate la quantification et la décomposition des effets des arbres d'ombrage sur la productivité primaire nette (NPP) de la culture principale. Peu de modèles sont capables d'analyser les effets des interactions entre culture principale et arbres d'ombrage sur les échanges de CO<sub>2</sub> et d'eau. En effet, les interactions pour la lumière, l'eau et la chaleur se produisant entre culture et arbres d'ombrage peuvent produire des effets contre-intuitifs sur la photosynthèse, l'efficacité d'utilisation de la lumière (LUE), l'efficacité de transpiration et le microclimat. Nous montrons que MAESPA, un modèle 3D mécaniste, peut-être utilisé pour étudier la variabilité de ces processus à des échelles allant de la plante à la parcelle, et de la demi-heure à l'année entière. MAESPA a simulé de manière satisfaisante l'interception de la lumière dans un SAF à base de caféier composé de 2 couches hétérogènes. Des variables modélisées par MAESPA ont été utilisées pour produire de puissantes variables explicatives dans un dispositif expérimental étudiant les déterminants de la NPP aérienne (ANPP) du caféier. Il a été démontré que LUE était deux fois plus élevée pour les caféiers poussant à l'ombre ce qui compensait totalement la diminution de leurs budgets lumineux, résultant en une absence de différence de ANPP entre caféiers de plein soleil et caféiers d'ombrage. MAESPA a aussi simulé de manière satisfaisante les échanges de CO<sub>2</sub> à l'échelle du caféier et à l'échelle de la parcelle, lorsque comparés à des mesures d'échanges gazeux dans des chambres plantes entières ou à des enregistrements de flux turbulents au-dessus de la canopée, respectivement. Nous avons utilisé MAESPA pour simuler la variabilité spatiale de la photosynthèse et de LUE. MAESPA a démontré être un modèle robuste pour quantifier les interactions spatiales dans un SAF. Le prochain développement pertinent de cette approche serait de coupler MAESPA avec un modèle d'allocation du carbone dans les organes des plants de caféiers.

**Mots-clés :** agroforesterie, caféier, modèle 3D, photosynthèse, transpiration, efficacité d'utilisation de la ressource, productivité primaire