



HAL
open science

Selective transport of gases in gas-liquid membrane system

Maxim Shalygin

► **To cite this version:**

Maxim Shalygin. Selective transport of gases in gas-liquid membrane system. Other. Institut National Polytechnique de Lorraine, 2007. English. NNT : 2007INPL022N . tel-01752814

HAL Id: tel-01752814

<https://hal.univ-lorraine.fr/tel-01752814v1>

Submitted on 29 Mar 2018

HAL is a multi-disciplinary open access archive for the deposit and dissemination of scientific research documents, whether they are published or not. The documents may come from teaching and research institutions in France or abroad, or from public or private research centers.

L'archive ouverte pluridisciplinaire **HAL**, est destinée au dépôt et à la diffusion de documents scientifiques de niveau recherche, publiés ou non, émanant des établissements d'enseignement et de recherche français ou étrangers, des laboratoires publics ou privés.



AVERTISSEMENT

Ce document est le fruit d'un long travail approuvé par le jury de soutenance et mis à disposition de l'ensemble de la communauté universitaire élargie.

Il est soumis à la propriété intellectuelle de l'auteur. Ceci implique une obligation de citation et de référencement lors de l'utilisation de ce document.

D'autre part, toute contrefaçon, plagiat, reproduction illicite encourt une poursuite pénale.

Contact : ddoc-theses-contact@univ-lorraine.fr

LIENS

Code de la Propriété Intellectuelle. articles L 122. 4

Code de la Propriété Intellectuelle. articles L 335.2- L 335.10

http://www.cfcopies.com/V2/leg/leg_droi.php

<http://www.culture.gouv.fr/culture/infos-pratiques/droits/protection.htm>

INSTITUT NATIONAL POLYTECHNIQUE DE LORRAINE
Ecole Nationale Supérieure des Industries Chimiques
Laboratoire des Sciences du Génie Chimique
Ecole Doctorale RP2E

THESE

Présentée en vue d'obtenir le grade de

DOCTEUR DE L'INPL
Spécialité : Génie des Procédés

Par

Maxim SHALYGIN

**Réalisation et caractérisation du transport sélectif gazeux de
contacteurs gaz-liquide à membrane**

Selective transport of gases in gas-liquid membrane system

Soutenue publiquement à Moscou (Russie) le 26 Avril 2007

Jury

Rapporteurs : M. P. AIMAR (LGC, Toulouse)
M. V. VOROTYNTSEV (Université Nizhny Novgorod)

Examineurs : M. E. FAVRE (LSGC, Nancy)
M. V. KHOTIMSKII (Topchiev Institute, Moscou)
M. D. ROIZARD (LSGC, Nancy)
M. V. TEPLYAKOV (Topchiev Institute, Moscou)

Résumé

Ce travail rapporte l'étude de systèmes membranaires à valves sélectives (SMV), qui combinent les avantages des techniques de séparation par membrane et par absorption. La 1^{ère} partie du mémoire présente l'étude du transport de matière en régime permanent et transitoire dans les SMV élaborés à partir de membranes polymères denses et de solution aqueuses. Dans la 2^{ème} partie le développement d'un modèle mathématique original pour la simulation des SMV est proposé ainsi que son évaluation expérimentale pour les séparations CO₂/CH₄/H₂, avec des solutions aqueuses confinées de K₂CO₃. Des améliorations simultanées de la perméabilité (≈ 4 fois) et de la sélectivité (>20 fois) ont été obtenues pour CO₂ avec le mélange CO₂/H₂. Un logiciel basé sur un nouveau modèle de transport de gaz dans ces contacteurs membranaires prenant en compte la sorption physique et chimique dans la phase liquide a été développé pour le calcul de la perméabilité en régime transitoire ou permanent.

Mots-clés : membrane, gaz, absorption, séparation, processus, polymères, modélisation, génie des procédés

Abstract

Combined gas-liquid membrane systems gather the advantages of membrane and absorption separation techniques. Specifically, *selective membrane valves* (SMV called *flowing liquid membranes*) were studied, i.e. creation, gas transport experiments, liquid nature and temperature dependences, and modelling. SMV use a flowing layer of liquid supported between two membranes. The 1st part of the dissertation reports the study of steady and non-steady state gas transports in SMV built out dense polymeric membranes. In the 2nd part is given the development of an original mathematical model for SMV simulation and its experimental assessment for CO₂/CH₄/H₂ mixtures with aqueous solutions of K₂CO₃. From systematic studies of steady and non-steady state processes, both in flow-through and circulating modes, it was found that increasing of temperature and liquid carrier concentration (K₂CO₃) leads to the simultaneous rise of permeability and selectivity during CO₂ recovery from CO₂/H₂ mixture.

Key-words: membrane, gas, absorption, separation, processes, polymers, modelling, chemical engineering

Thèse en cotutelle

SHALYGIN G. Maxim

REALIZATION ET CHARACTERIZATION DU TRANSPORT

SELECTIF GAZEUX DE CONTACTEURS

GAZ-LIQUIDE A MEMBRANE

SELECTIVE TRANSPORT OF GASES

IN GAS-LIQUID MEMBRANE SYSTEM

préparée à

INSTITUT A.V.TOPCHIEV DE SYNTHESE PETROCHIMIQUE

(ACADEMIE RUSSE DES SCIENCES)



Russian Academy of Sciences

et au

LABORATOIRE DES SCENCES DU GÉNIE CHIMIQUE

(Institut National Polytechnique de Lorraine)



UPR6811 CNRS



Moscow – Nancy – 2007

Jury

Supervisors: Professor **TEPLYAKOV Vladimir**
Professor **FAVRE Eric**
Dr. **KHOTIMSKII Valery**
Dr. **ROIZARD Denis**

Official opponents: Professor **VOROTYNTSEV Vladimir**
Professor **AIMAR Pierre**

Le manuscrit en russe de la thèse est disponible à la bibliothèque de l'Institut A.V.TOPCHIEV de Synthèse Petrochimique, Académie Russe des Sciences (TIPS, 29 Leninskiy prospect, 119991 Moscow, Russia, e-mail: tips@ips.ac.ru).

La soutenance est prévue le 26 avril 2007 au TIPS de Moscou.

Sommaire

- Résumé court du mémoire en français
- Résumé court du mémoire en anglais
- Résumé long du mémoire en anglais
- Articles et actes de congrès et colloques :
 - 01_Shalygin_Euromembrane_2004_Hamburg_Germany
 - 02_Shalygin_Membranes_2004_Moscow_In_Russian
 - 03_Shalygin_36th_Seminar_Nancy_Karlsruhe_2005
 - 04_Shalygin_2nd_FR_Seminar_PICS_Nancy_2005
 - 05_Shalygin_Permea_2005_Poland
 - 06_Shalygin_Mempro3_Nancy_2006
 - 07_Shalygin_Article_Colloid_Journal_68_4_2006_In_Russian.
 - 08_Shalygin_Article_Desalination_200_2006
 - 09_Shalygin_3rd_FR_Seminar_PICS_Moscow_2006
 - 10_Shalygin_Article_Separation_and_Purification_Technologies_In_Press

Intérêt du sujet. Dans de nombreux cas, le traitement de gaz par les méthodes classiques de séparation est économiquement peu favorable et il y aurait avantage à utiliser des méthodes de séparation plus performantes : par exemple, citons les mélanges gazeux complexes en pétrochimie, les émissions de cheminée des centrales électriques, etc. En particulier la capture du CO₂ et la séparation de mélanges ternaires gazeux contenant H₂, CH₄ et CO₂ (cas typique en production de biocarburant) sont actuellement impossibles par les méthodes membranaires connues.

Les systèmes contacteurs à membranes de type gaz-liquides, qui sont au cœur de ce travail, combinent les avantages des techniques de séparation par membrane et par absorption. Ce travail rapporte l'étude de systèmes membranaires à valves sélectives (SMV, également appelés contacteurs membranaires à liquide circulant, Fig.1), comprenant leur élaboration, l'étude expérimentale du transport de matière, l'influence du liquide circulant et de sa température, et leur modélisation.

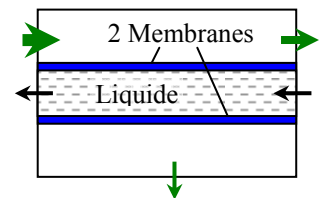

Fig. 1.: Schéma d'un SMV

La 1^{ère} partie du mémoire rapporte l'étude du transport de matière en régimes permanent et transitoire dans les SMV élaborés à partir de membranes polymères denses et de solution aqueuses. Dans la 2^{ème} partie le développement d'un modèle mathématique original pour la simulation des SMV est proposé ainsi que son évaluation expérimentale.

Résultats. A partir d'études systématiques du transport sélectif des SMV réalisées avec ou sans recirculation de la phase liquide, on a constaté que l'augmentation de la température (jusqu'à 60°C) et de la concentration aqueuse de K₂CO₃ induisaient une amélioration simultanée de la perméabilité (≈ 4 fois) et de la sélectivité (>20 fois) pour CO₂ avec le mélange CO₂/H₂. Les relations gouvernant les propriétés de séparation et les paramètres opératoires (concentration, température, vitesse de la phase liquide) ont ainsi été déterminées ; en particulier, soulignons qu'elles permettent d'identifier des conditions de fonctionnement pour la séparation des mélanges complexes (CO₂/CH₄/H₂). Un logiciel basé sur un nouveau modèle théorique de transport de gaz dans ces contacteurs membranaires prenant en compte la sorption physique et chimique dans la phase liquide a été développé pour le calcul de la perméabilité en régimes transitoire ou permanent. Les résultats donnés par les calculs du logiciel, en bon accord avec les données expérimentales, permettent de simuler les propriétés de séparation des SMV pour des mélanges complexes.

Conclusion. Les résultats obtenus prouvent que les SMV sont un nouveau système membranaire très flexible, bien adapté à la séparation sélective de mélanges gazeux. Grâce à leurs propriétés de séparation non-linéaires avec les paramètres opératoires (i.e. température, nature, concentration et flux du liquide d'absorption) il est possible de trouver des optimum pour réaliser des séparations complexes. Cette étude démontre ainsi le fort potentiel des SMV pour des applications industrielles.

Scope. There are a number of gas processes where classical separation methods are economically unprofitable and where gas membrane separation methods could be used: many examples can be found such as multicomponent gas mixtures of petroleum chemistry, waste stream emissions of power plants, etc. In particular the recovery of CO₂ from gas mixtures and the separation of ternary gas mixtures containing H₂, CH₄ and CO₂ (typical gas components in bio fuel production) is actually impossible by known membranes methods.

Combined gas-liquid membrane systems, which are the topic of this work, both gather the advantages of membrane and absorption separation techniques. Specifically, *selective membrane valves* (SMV, also called *flowing liquid membranes*, Fig.1) were studied, i.e. creation, gas transport experiments, liquid nature and temperature dependences, and modeling. SMV use a flowing layer of liquid supported between two membranes.

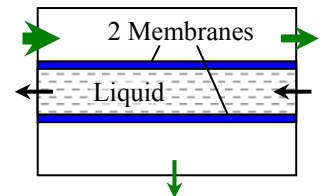

Fig. 1.: Schematic representation of SMV

The first part of the dissertation reports the study of steady and non-steady state gas transports in SMV built out dense polymeric membranes. In the 2nd part is given the development of an original mathematical model for SMV simulation and its experimental assessment.

Results. From systematic studies of steady and non-steady state processes of gas transport, both in flow-through and circulating modes, it was found that increasing of temperature (up to 60°C) and liquid carrier concentration (K₂CO₃) leads to the simultaneous rise of permeability (4 times) and selectivity (>20 times) during CO₂ recovery from CO₂/H₂ gas mixture. General dependencies between gas separation and operating parameters (concentration, temperature, liquid velocity) were drawn leading to operating conditions for separation of complex gas mixtures (e.g. CO₂/CH₄/H₂).

A software based on a new theoretical model of gas transport in SMV involving physical and chemical sorption in liquid phase has been developed. It can be used for calculation of SMV permeability in both steady and non-steady state gas transfer conditions. Results given by the calculations of the software are in good agreement with experimental data, which allows using it to predict SMV separation properties.

Conclusion. Obtained results show that SMV is a very “flexible” membrane system well efficient to tune gas transfer properties within a wide range of experimental conditions. Gas separation properties of SMV non-linearly depend on operation parameters (i.e. temperature, chemical absorbent concentration and liquid flux) and therefore can be optimized to achieve effective separation. Experimental results and computations show the use of SMV under high temperature conditions could have very attracting potentialities for industrial applications.

DISSERTATION ABSTRACT

SHALYGIN G. Maxim

**SELECTIVE TRANSPORT OF GASES
IN GAS-LIQUID MEMBRANE SYSTEM**

prepared at

***A.V.TOPCHIEV INSTITUTE OF PETROCHEMICAL SYNTHESIS
(RUSSIAN ACADEMY OF SCIENCES)***



Russian Academy of Sciences

and

***LABORATOIRE DES SCENCES DU GÉNIE CHIMIQUE
(Institut National Polytechnique de Lorraine INPL)***



Moscow – Nancy – 2007

The work has been done under convention between *A.V.TOPCHIEV Institute of Petrochemical Synthesis* of Russian Academy of Sciences (TIPS RAS, 29 Leninskiy prospect, 119991 Moscow, Russia) and *Laboratoire des Sciences du Génie Chimique (UPR 6811), Groupe ENSIC (LSGC-ENSIC)*, 1 rue Grandville - BP 451 F - 54001 Nancy, France).

Supervisors:	Professor	TEPLYAKOV Vladimir
	Professor	FAVRE Eric
	Doctor	KHOTIMSKII Valery
	Doctor	ROIZARD Denis
Official opponents:	Professor	VOROTYNTSEV Vladimir
	Professor	AIMAR Pierre

The Russian version of dissertation is available in the library of A.V.TOPCHIEV Institute of Petrochemical Synthesis RAS (29 Leninskiy prospect, 119991 Moscow, Russia, e-mail: tips@ips.ac.ru).

Relevance of the dissertation theme. Nowadays membrane technologies of gas separation and gas conditioning have been well developed at the industrial scale. Indeed membrane technologies are now applied for air separation [1, 2] (production of technical nitrogen or oxygen enrichment), hydrogen recovery [1], natural gas conditioning [1, 3, 4]. There are a number of gas processes where classical separation methods are economically unprofitable and where gas membrane separation methods could be used. Many examples can be found in multicomponent gas mixtures of petroleum chemistry, waste stream emissions of power plants, power sources recovery processes from bioreactors during organic waste treatment. In particular the recovery of CO₂ from gas mixtures is being now seriously considered for many of these above cases, but that would need membranes with higher selectivity and permeability than the ones already available. Commercially available membranes, such as poly-(dimethylsiloxane) based ones (PDMS) have limited selectivity and poor mechanical properties avoiding the preparation of extra thin film. On the other hand, the separation of ternary gas mixtures containing H₂, CH₄ and CO₂ (typical gas components in bio fuel production) is actually impossible by known polymeric membranes because of low selectivity for pair CO₂/H₂.

The potential of membrane separation methods has been widely expanded by the creation of combined gas-liquid membrane systems (GLMS) which both gather the advantages of membrane and absorption separation techniques. Three general types of GLMSs can be distinguished:

- first, *liquid membranes* (LM), where a liquid phase forms a membrane entrapped inside a microporous membrane whose resulting separation properties depend on the gas transfer properties of the liquid phase;
- second, *membrane contactors* (MC), which use the sorption properties of liquid whereas the membrane forms the gas-liquid interface;
- and third, *selective membrane valves* (SMV), which use a flowing layer of liquid supported between two membranes (SMV is also called *flowing liquid membrane*).

SMV is the most flexible system because it can operate as well as LM or MC. Besides SMV with suitable absorbent separates ternary gas mixture to single components.

The best separation results can be obtained when the liquid used in the SMV acts as a chemical sorbent which can reversibly react with one of the gas mixture components; however the prediction of results of separation demands the solution of differential equations set which in many cases has no analytical solution, and thus requires the application of special software. The development of separation technologies based on SMV is also restrained by limited assortment of high-permeable dense polymeric membranes in order to provide as required mass transfer as stability of the system during the time at high pressure difference between the phases, advanced temperature and in presence of different chemicals in liquid. In addition, approaches of the effective liquid carrier selection to optimize SMV operations are actually not determined.

Taking into account problems mentioned above, the topic of this work is of current importance. The creation of selective gas transfer models for SMV in both steady and non-steady state conditions, presents a theoretical and practical strong interest for the prediction of SMV gas separation properties, especially in cases where mass transfer involves a chemical reaction in liquid phase.

Aim of the work. First, the study of gas transfer characteristics of SMV with dense polymeric membranes, physical and chemical absorption in liquid phase against temperature, absorbent concentration and absorbent flow rate for CO₂-containing gas mixtures. Second, the development of mathematical model of gas transfer (including non-steady transfer) in SMV with dense polymeric membranes, physical and chemical absorption in liquid phase and experimental validation of the model.

Scientific novelty. Systematic studies of steady and non-steady gas transfer in SMV with dense poly-(vinyltrimethylsilane) (PVTMS) membranes and aqueous K₂CO₃ solutions (concentrations 0.1-3 mol/l) in temperature range 22-80°C have been done for the first time. The permeability of SMV was investigated in flow-through and circulating operation modes at laminar liquid flow regime without mixing. It was found that increasing of temperature (up to 60°C) and carrier

concentration (K_2CO_3) leads to the simultaneous rise of permeability (factor: 3.5 times) and selectivity (more than 20 times) during CO_2 recovery from CO_2/H_2 gas mixture.

Analytical equations of SMV permeability dependence on liquid phase flow rate in flow-through and circulating modes are derived the first time.

Mathematical model of gas transfer which takes into account diffusion, convection and chemical interaction in liquid phase of SMV with dense polymeric membranes was developed. The software based on mathematical model of SMV has been developed and used for calculation of SMV permeability in both steady and non-steady state gas transfer conditions. Results given by the calculations of the software are in good agreement with experimental data, which allows using it to predict SMV separation properties.

New construction of SMV-module which allows to form thin (from 50 μm) liquid layer without a net-spacer was designed. This construction provides laminar liquid flow between membranes without mixing.

Practical importance. It was demonstrated the possibility of using of SMV as flexible gas separation system which has a number of adjustable parameters (absorbent composition and flow rate, temperature, operating mode) for control of gas transfer characteristics in wide range that allows to carry out optimization if requirements of separation or task is changed. Advantages and prospects of SMV application with an absorbent chemical liquid for CO_2 recovery from different gas mixtures were shown. Developed software is applicable for calculation of SMV gas separation characteristics and allows its adaptation for gas transfer calculation in other GLMSs.

Approbation of the work. Parts of the work were presented on Scientific Conference Membranes-2004 (October 2004, Klyazma, Russia), 36th Nancy-Karlsruhe Seminar (June 2005, Nancy-Ventron, France), International Scientific Conference Permea-2005 (September 2005, Polyanitsa-Zdroi, Poland), International Scientific Conference Mempro-2006 (April 2006, Nancy, France), French-Russian Seminars PICS (October 2004, Klyazma, Russia; June 2005, Nancy, France; October 2006,

Moscow, Russia), International Scientific Conference Euromembrane-2006 (September 2006, Taormina, Messina, Italy).

Background. The work has been done in the frame of joint post-graduate study supported by the French Embassy in Moscow. Experimental part, including modernization of experimental setup, design and production of the membrane module, experiments and computations, was done in TIPS RAS (Moscow) during the period of 21 month (58% of time). Theoretical part, including literature review, development of the SMV model, software creation and computations, was done in LSGC-ENSIC (Nancy) during the period of 15 month (42% of time).

ABSTRACT OF THE MANUSCRIPT

Chapter 1: Literature review

1.1. Gas-liquid membrane systems.

Membrane gas separation is scientific domain which quickly develops at present time in food, chemical, and petrochemical industries. Membrane technology is characterized by a number of advantages [5]: separation process can be continuous; low energy consumptions; combination with other processes; scaling up; properties of membranes are different and can be controlled. At the same time there are disadvantages such as [5]: concentration polarization and membrane fouling; limited lifetime; generally low selectivity.

Low selectivity of high permeable membranes is main disadvantage in gas separation area. In spite of availability of several hundreds of known polymeric materials for gas separation only 8-9 polymers are used in 90% of cases [6]. To improve efficiency of separation process permeability and selectivity of membrane should be increased. It is possible to increase membrane permeability by creation of asymmetric or composite membranes with thin dense layer. For today dense layer thickness of 0.1 μm and lower can be achieved that provides high gas fluxes through membranes. However membrane selectivity depends only on polymer properties and usually is low for high permeable polymers. At the same time absorption methods are widely used in industry for gas separation for a long time where high selectivity is achieved due to application of chemical absorbents. The most classical example is based on absorption of a gas into a liquid flowing in a column. Important step in membrane technology was development of membrane contactors (MC), which combine membrane and absorption separation technologies. Other example of such combination is liquid membranes (LM). These gas-liquid membrane systems (GLMS) are more effective because they have advantages of membrane technology such as compactness and flexibility with combination of high absorption selectivity [7, 8]. It is worth to note also that

GLMSs can separate CO₂/H₂ gas mixtures, traditionally known as a "difficult case" to be solved by membrane technology.

Advantages of LMs compared to polymeric membranes can be clearly seen in Fig.1.1 which represents Robeson's diagram for pair CO₂/N₂. The upper bond in Fig.1.1 described by Robeson [9] (dotted line) is an empirical expression which is obtained from numerous experimental results and relates to polymeric materials. Thus, it is subject to change providing more selective membrane materials are identified [6].

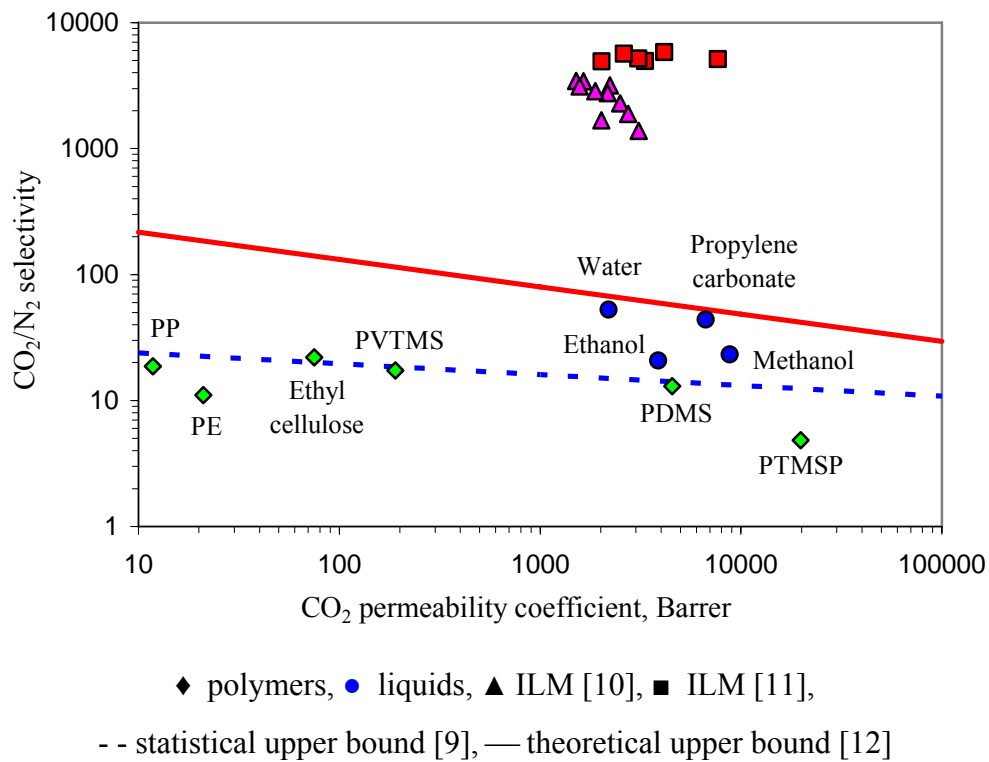

Fig. 1.1. Separation properties of polymers and liquids for pair of CO₂/N₂.

The second upper bond (solid line) shown in Fig.3 results from a theoretical approach developed by Freeman [12]. This computation is based on correlations proposed for the estimation of solubility and diffusivity in polymers, under the hypothesis of a strict physical process (no chemical reaction). It can be seen that traditional membrane separation performances are below the first line, while physical liquid solvents remain below the second one. Simple liquids such as water or alcohol

demonstrate good separation properties compared to polymeric materials that proves the interest focused on LMs. Moreover, the selectivity of LM can be significantly improved in presence of specific molecules in added in the liquid phase which provides the facilitated transport of a given mixture's component. Immobilized LMs (ILM) with carbonate ions in liquid phase are an example of this case in Fig.1.1. The separation performances of chemical liquid absorbents used in ILMs [10, 11] are considerably higher and over the upper bonds. This mode of representation clearly establishes the potentialities of chemically reacting systems in liquid phase and explains why these attract attention.

Other advantage of GLMSs compared to traditional absorption technique is to provide and exactly determined geometry of liquid phase and gas-(membrane)-liquid interface. Furthermore, membranes play a role of physical barrier between the phases. As a result we have possibility to adjust flow rates independently as well as other operating parameters like temperature, liquid concentration, etc. These characteristics can explain the technical advantages of GLMSs.

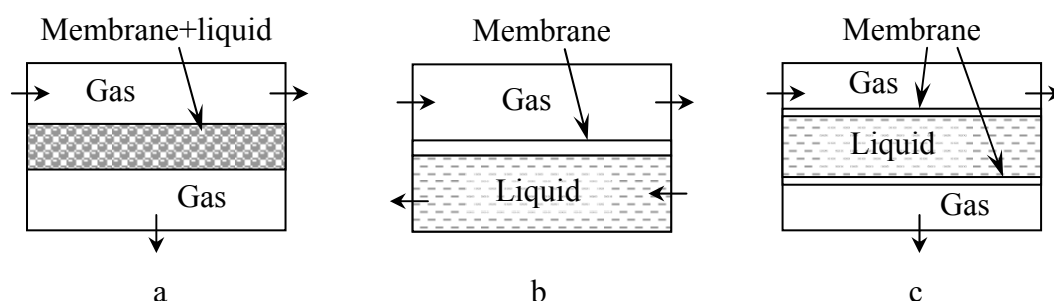

Fig. 1.2. Different types of GLMSs: a – liquid membrane, b – membrane contactor, c – selective membrane valve.

There are other examples which demonstrate efficiency of application of GLMSs in gas separation [7, 13, 14].

Three types of GLMSs can be distinguished (Fig.1.2): liquid membranes (LM), membrane contactors (MC), selective membrane valves (SMV, also called flowing liquid membranes).

1.2. Liquid membranes.

In LMs liquid layer plays role of membrane. Porous hydrophilic membrane usually is used for preparation of LM where liquid is supported by surface tension forces. Sometimes additional hydrophobic porous or dense membranes are used as support on both sides of LM. Thus gas transport properties of LM depend not only on liquid properties but also on used polymeric membranes properties (porosity, tortuosity etc.). LMs usually show super-high selectivity and permeability if liquid contains a chemical absorbent which reversibly reacts with one of gas mixture components (see Fig.1.1). This is the result of the component transfer by *facilitated transport* mechanism which has been studied by many researchers [10, 11, 15-27]. Facilitated transport leads to increasing of the flux of the component which reversibly reacts with a *carrier* presented in liquid. Reversible reaction generates additional way for the component transfer (in chemical form as a complex). The contribution of this additional component flux can be several times higher than contribution of diffusion flux of the component in molecular form that explains high efficiency of LMs.

Unfortunately wide application of LMs is limited because of their disadvantages such as evaporation of liquid that leads to membrane degradation, sensitivity to pressure drop between gas phases, impossibility of creation of stable ultra-thin liquid layers. Some disadvantages is possible to overcome, for example to use a gel instead of liquid [28].

LMs with facilitated transport are used for [26]: O₂ recovery (hemoglobin solutions), CO recovery (CuCl₂ solutions), CO₂ recovery (alkali metals carbonate solutions and aliphatic amines solutions), olefin/paraffin separation (AgNO₃ solutions).

First study of facilitated transport was devoted to O₂ transfer in hemoglobin solution [29]. The application of facilitated transport to improve separation properties of LM was done for the first time in the work [15] where authors used LM with Cs₂CO₃ aqua solution for CO₂ recovery from air in closed life support system. Using of 6.4N Cs₂CO₃ solution raised LM selectivity from 22 (pure

water) up to 1500, but permeability decreased in 3 times that is result of salting-out effect. Adding of catalyst (NaAsO_2) gave increasing of permeability to initial level and selectivity up to 4100.

Table 1.1 summarizes results of some works dedicated to study of LMs for CO_2 recovery from different gas mixtures. It is clearly seen from the table that separation properties of LMs are considerably higher than ones of polymeric membranes.

Table 1.1.

The composition and selectivity of LMs for CO_2 recovery from gas mixtures.

Gas mixture	LM support	Liquid phase	Selectivity	Ref.
CO_2/O_2	Cellulose acetate	Aqueous CS_2CO_3 (+ NaAsO_3)	22-1500 (4100)	[15]
CO_2/N_2	Celgard 2400	DEA solution	56-276	[20]
CO_2/N_2	-	DEA solution	90-244	[22]
$\text{CO}_2/\text{C}_2\text{H}_6$	Celgard 3500	DEA and PEG solutions	10-145	[23]
CO_2/CH_4	Polyvinylidenedifluoride	MEA, EDA, AMP, DEA, TEA, MDEA solutions	60-1800	[24]
CO_2/N_2	Polyvinylidene fluoride	water-glycerol- Na_2CO_3	1050-3440	[10]
CO_2/N_2	Polyacrylonitrile, Cuprophane, Polysulphone	water-glycerol- Na_2CO_3 Na-glicine-glycerol	127-1381 1150-5830	[11]

In most cases LMs had flat geometry but hollow fiber LMs were investigated as well [11]. It is necessary to mark the work [24] where authors studied influence of temperature on CO_2 transfer and showed that at 45°C CO_2 flux through LM with MEA is 2.5 times higher than at 25°C .

There are a lot of works dedicated to mathematical description of facilitated gas transport in LMs [14, 16, 18, 19, 21, 26, 27]. Some authors obtained analytical solutions for different cases but all these solutions (except described in [21]) give suitable results only for limiting situations (instantaneous chemical reactions, low concentration of carrier etc.). Generally numerical solution of differential equation system is necessary. For example authors of the work [18] solved the equations system numerically and received graphic dependencies which allow to find combination of LM's parameters to obtain optimal facilitation factor. Unfortunately dependencies don't give any

information about real gas fluxes under these parameters that makes impossible optimization of separation process.

One can conclude that the study of facilitated transport is the task of current importance. Also suitable theoretical calculations can be obtained only by numerical solution of differential equation system.

1.3. Membrane contactors.

Membrane contactor (MC) is analog of absorption column where gas-liquid interface is formed by a membrane. Such a way of interface formation has advantages [13]: independent variation of gas and liquid fluxes, no dispersion of one phase into another, high specific area, mass exchange area is known and constant value, arbitrary orientation of membrane module. At the same time there is a number of disadvantages caused mainly because of polymeric membranes application [13]: additional mass transfer resistance in membranes, limited temperature range, instability of membranes to some absorbents, changing of gas transfer characteristics during the time because of penetration of liquid to membrane pores (if porous membranes are used).

Membranes applied in MC can be porous or dense (asymmetric or composite). In case of porous membrane utilization there are two possible conditions of membrane: wetted and non-wetted (Fig.1.3).

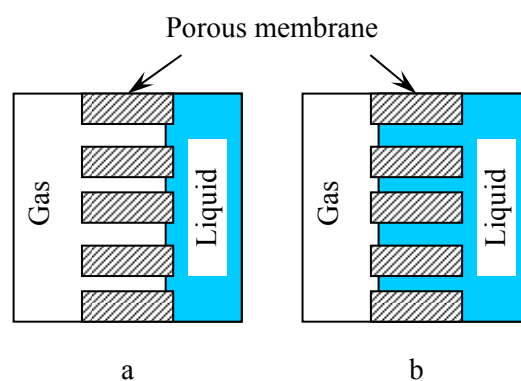

Fig. 1.3. Porous membrane condition: a – non-wetted membrane, b – wetted membrane.

Presence of liquid in pores introduce additional mass transfer resistance and non-wetted membrane condition is preferable. To keep membranes in non-wetted condition application of hydrophobic membranes and accurate pressure drop control are necessary. Nevertheless some researchers have found that even if these requirements are maintained liquid penetrate to membrane pores during the time [30, 31].

In spite of the fact that membrane introduce additional resistance high specific area of MC makes it more effective than absorption column. For this reason hollow fiber MCs have received wide distribution.

Mathematical description of gas transfer in MCs generally is complex problem because it is necessary to take into account diffusion in membranes and liquid, convection in gas and liquid phases and chemical interaction of components. There are empirical and theoretical approaches to gas transfer description in MCs.

Empirical approach is based on combination of driving force with mass transfer coefficient which depends on individual mass transfer coefficients of gas phase, membrane and liquid phase. This approach is more simple and known equations from heat exchange theory can be used for different geometries and flow directions in MC [13, 32-34]. Unfortunately in general case prediction of MC separation properties is inaccurate [35] especially in presence of chemical reactions in liquid phase [36].

Theoretical approach is based on mass transfer description in MC by differential equations which take into account diffusion, convection and chemical interaction of components and usually have complex boundary conditions. This approach allows to predict separation properties of MC in wide range of operational conditions and doesn't need carrying out of preliminary experiments if all necessary values (diffusion and solubility coefficients, chemical reactions constants etc.) are known. However numerical solution of the differential equation system usually is needed that demands application of special software. In spite of complexity of such approach it becomes more preferable in present time [35-38]. Examples of mass transfer mathematical description in MCs can be found

in [35, 36, 39] including presence of chemical reaction in liquid phase [37, 40, 41]. Authors of some works developed simplified models with analytical solutions [7, 42-45].

It is possible to conclude that for this moment numerical solution of the differential equation system is the most accurate and perspective method for prediction of MC separation properties.

1.4. Selective membrane valves.

Selective membrane valve (SMV) is membrane system which consists of two polymeric membranes and flowing liquid layer between them (Fig.1.4). This three-layer system separates two gas phases. Another name of SMV is *flowing liquid membrane*. Flowing liquid layer gives SMV such advantages compared to LMs as stability [14], mass transfer regulation and possibility of ternary gas mixtures separation [46]. The regulation of mass transfer from one gas phase to another is possible by changing the flux of a liquid. If liquid at inlet is pure increasing of liquid flux will lead to decreasing of gas flux through SMV (closing of valve).

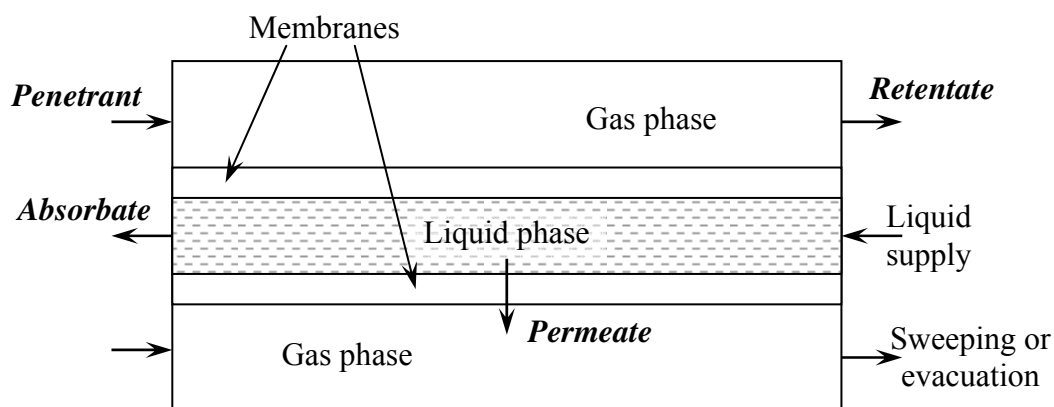

Fig. 1.4. The scheme of selective membrane valve.

There are two operating modes of SMV: flow-through and recycling. In flow-through mode liquid from outlet is removed from the system; in recycling mode liquid from outlet is supplied back to inlet. If liquid is stagnant SMV is similar to LM. If gas mixture is supplied to both gas phases SMV

is similar to MC. Possibility of variation of operating mode and the way of gas and liquid supply gives SMV high flexibility.

It was found that SMV with aqueous AgNO_3 can be effectively used for separation of ethylene/ethane gas mixture [14]. The comparison between SMV and LM has shown that SMV permeability and time stability are much better (Fig.1.5).

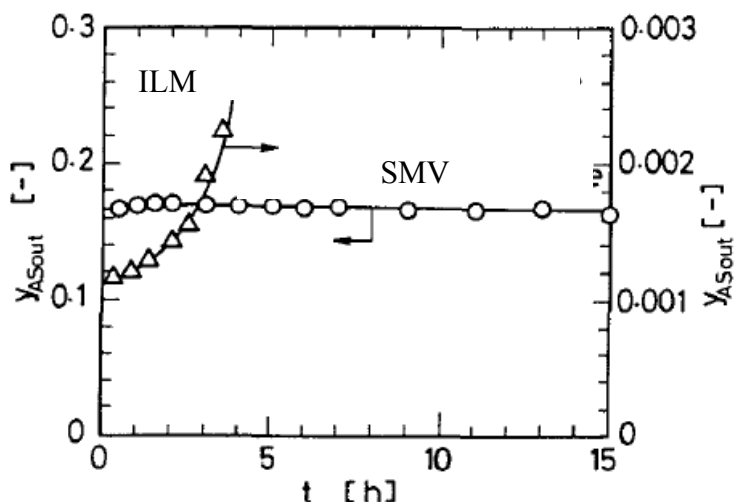

Fig. 1.5. The stability of ILM and SMV properties during the time [14].

Another important property of SMV is ability of separation of ternary gas mixtures [46-49]. It was shown that system consisting of SMV and MC (as desorber) with 20% MEA solution can separate ternary gas mixture $\text{H}_2/\text{CH}_4/\text{CO}_2$ (30/30/40%) with purity of components 99/90/98% respectively [50].

Installation of turbulence promoter in liquid phase leads to decreasing of mass transfer resistance in liquid at higher liquid fluxes [14, 51]. In flow-through mode SMV permeability increases and then continuously decreases [51] while in circulating mode SMV permeability continuously rises [14] at high liquid fluxes that provides advantage of SMV compared to LM.

Membranes are used in SMV as liquid layer support. They should be high permeable and their separation properties are not important. For this reason porous hydrophobic membranes can be used in SMV. However the problem of wetting appears in this case similarly to MCs.

Mathematical description of gas transfer in SMV is presented in a number of works [14, 46-48] including analytical solutions for flow-through and circulating modes and chemical reactions in liquid phase however in general case the numerical solution of differential equation system is necessary.

All existing models of SMV assume plug flow in liquid phase with active mixing in transverse direction. These conditions are attractive from productivity point of view and can be achieved in presence of turbulence promoter at high liquid fluxes (turbulent flow regime) but high liquid flux can be not optimal case from separation point of view. Geometry of turbulence promoter and liquid flux have an influence on gas transfer in SMV. This influence is difficult to predict without experimental testing. Also the creation of turbulent liquid flow demands high energy consumptions. Following problems mentioned above the development of mathematical model of SMV with laminar liquid flow without mixing is the problem of current importance.

1.5. Membranes and liquid absorbents for gas-liquid membrane systems.

The selection of membrane and absorption liquid for GLMSs is one the most important questions. Moreover this selection can not be done separately because of permanent contact between membrane and liquid. Flowing liquid and interface geometry created by membranes make operation of SMV similar to operation of MC. It allows to conclude that selection of membrane-liquid combination for SMV is also similar to that one for MC.

General criteria of liquid absorbent selection were defined in [52] as:

- high reaction rate;
- high surface tension (on case of porous membranes utilization);
- chemical compatibility with membrane material;
- low vapour pressure;
- stability;
- easiness of regeneration.

It is possible to add such evident requirements as high sorption capacity and low cost. Using of porous membranes is preferable because they have low mass transfer resistance but in this case the problem of membrane wetting is arising so their hydrophobicity is important and proper pressure drop between gas and liquid phases should be maintained. Table 1.2 represents data of wettability of commercially available polymeric membranes [52, 53]. One can note that poly-(tetrafluoroethylene) membranes (PTFE) are the most resistant to wetting. Another advantage of PTFE membranes is their high chemical stability. However their cost is high compared for example to polypropylene membranes (PP).

Table 1.2.

Wetting data for commercially available porous membranes by different absorbents of CO₂.

Liquid phase	PTFE	PP	PVDF	PES (+PDMS)	PE
Water	–	–	–	–	–
Propylene carbonate	–	–	+	+	n/d
Selexol	–	+	+	+	n/d
N-methyl pyrrolidone	+	+	+	+	n/d
Dimethylformamide	+	+	+	+	n/d
Tributylphosphate	+	+	+	+	n/d
Glycerol triacetate	–	+	+	+	n/d
n-formyl formalin	–	–	+	+	n/d
MEA, amines	–	+	–	(+)	+
Amino acid salts	n/d	–	n/d	n/d	n/d
NaOH, KOH	–	+/-	n/d	n/d	–

+ - wetting, – - no wetting, n/d - no data.

It is possible to avoid membrane wetting if asymmetric or composite membrane with dense layer on liquid side is used. Presence of dense layer allows also to increase stability of GLMS and to apply high pressure drop between gas and liquid phases [54, 55]. Main disadvantage of dense membranes is their low permeability compared to porous membranes.

Two types of liquid absorbents can be marked out: physical and chemical. The difference is lies in values of interaction energy between absorbate and absorbent. For physical absorbents this energy

in low and the dependence of gas partial pressure on its concentration in absorbent is linear in wide range. Known physical absorbents for CO₂ are propylene carbonate, acetone, diethyl ether and others [56]. Regeneration of physical absorbents can be done easy by decreasing of gas partial pressure. Usually they used at high concentration of the component to be removed (>30%). Their main disadvantage is impossibility to provide deep purification without high losses of other components. Table 1.3 represents values of CO₂ capacity of different widely used physical absorbents.

Table 1.3.
CO₂ solubility in physical absorbents [56].

Absorbent	Solubility, m ³ (CO ₂)/m ³ (liq.), <i>p</i> = 1 bar, (<i>T</i> , °C)
Water	0.878 (20)
Cyclohexane	1.71 (20)
Benzene	2.3 (20)
Carbon tetrachloride	2.34 (25)
Ethanol	2.67 (20)
Propylene carbonate	3.09 (25)
Methanol	3.32 (20)
5-methyl-N-methyl pyrrolidone	3.41 (25)
N-methyl pyrrolidone	3.57 (25)
Methyl acetate	6.5 (20)
Acetone	7.2 (20)

Chemical absorbents are characterized by non-linear dependence of gas concentration in absorbent on its partial pressure. Chemical absorption is used for fine cleaning at low concentration of absorbed component because capacity of chemical absorbent is high even at low gas partial pressures that is clearly seen from the Table 1.4. For regeneration of chemical absorbents high temperatures are usually applied.

Besides high CO₂ sorption capacity of chemical absorbent it is also important to take into account chemical reaction rate. Constants of chemical reaction rate are presented in Table 1.5.

Table 1.4.

Sorption capacity of chemical absorbents of CO₂.

Absorbents	Capacity, m ³ (CO ₂)/m ³ (liq.) at 25°C, $p = 1$ bar	Reference
Water	0.762	[57]
K ₂ CO ₃ 5% mass (0.4 mol/l)	9.89	[58]
K ₂ CO ₃ 10% mass (0.8 mol/l)	18.5	[58]
MEA 15% mass (2.5 mol/l)	32.9 ($p(\text{CO}_2) = 0.1$ bar)	[59]

Table 1.5.

Chemical reaction rate constants of different CO₂ absorbents (non-saturated by CO₂).

Absorbent	Concentration, mol/l	Temperature, K	Reaction rate constant with CO ₂	Reference
K ₂ CO ₃ + KAsO ₂	1.5	303	6 [*]	[60]
	0.2	303	1.32×10 ² [*]	[60]
Na ₂ CO ₃ +NaAsO ₂	0.6	298	2.2 [*]	[60]
	0.4	298	9.2×10 ¹ [*]	[60]
MEA	-	298	5.92×10 ³ ^{**}	[24]
		298	7.00×10 ³ ^{**}	[61]
		308	1.01×10 ⁴ ^{**}	[24]
		318	1.68×10 ⁴ ^{**}	[24]
DEA	-	298	1.41×10 ³ ^{**}	[24]
		298	1.20×10 ³ ^{**}	[61]
TEA	-	298	3.74 ^{**}	[24]
MDEA	-	298	5.1 ^{**}	[24]
2-amino-2-methyl-1-propanol	-	298	8.10×10 ² ^{**}	[24]
Ethylenediamine	-	298	1.27×10 ⁴ ^{**}	[24]
		298	1.50×10 ⁴ ^{**}	[61]
Piperazine	-	298	5.37×10 ⁴ ^{**}	[61]
Piperidine	-	298	6.00×10 ⁴ ^{**}	[61]
Morpholine	-	298	2.00×10 ⁴ ^{**}	[61]

* s⁻¹, ** l/(mol·s)

One can see that reaction rate of traditional CO₂ chemical absorbents such as Na₂CO₃ and K₂CO₃ is very low and adding of catalyst is necessary. Nevertheless they can be attractive because of their non-volatility, low viscosity and non-toxicity compared for example with MEA.

Mixtures of physical and chemical absorbents can be used in order to combine their advantages. The example of such combination is series of absorbents named CORAL developed in Netherlands [31, 62]. Thus the search of membranes and absorbents for application in GLMSs is comprehensive task which should be solved individually for each particular case.

General conclusions and task definition.

Different types of GLMSs for gas separation were considered. The comparison of mass transfer description for each system was carried out and the problem of membrane and liquid absorbent combination search for GLMSs was also covered. Following conclusions can be done:

1. Application of GLMSs allows to achieve high efficiency of gas mixture separation due to combination of advantages of membrane and absorption separation techniques. To obtain best results of separation it is necessary to use chemical or mixed absorbents.
2. SMV unites advantages of LMs and MCs and can operate as these systems as well. At the same time separation properties of SMV were not widely investigated. Also all existing models of SMV are suitable only for limiting case (active mixing in liquid phase).
3. By the example of LMs and MCs it was shown that in general case modeling of gas transfer needs numerical solution of differential equation system which takes into account diffusion, convection and chemical interaction of components.
4. In order to avoid some problems and to provide stability of GLMS for a long time it is necessary to use high permeable asymmetric or composite membranes with dense layer.

Taking into account the conclusions of literature review this work includes following tasks:

- the development of mathematical model of gas transfer in SMV which takes into account diffusion, convection and chemical reactions in liquid phase at laminar flow without mixing;
- the creation of the software based on developed model for calculation of CO₂ transfer (including non-steady) in SMV with aqueous K₂CO₃ in different operating modes;
- theoretical and experimental study of gas transfer properties and separation of CO₂-containing gas mixtures in SMV with physical and chemical absorbents; the comparison between calculation and experimental results.

Chapter 2: Theoretical part.

This chapter is dedicated to the development of new theoretical models concerning SMV mass transfer parameters encompassing a flowing liquid layer and the chemical absorption in the liquid phase. Also simplified approach of gas transfer in SMV with physical absorption in liquid which allows to obtain analytical solution is presented.

One of the most important tasks is increasing of the efficiency of separation system. For GLMSs it means increasing of productivity and selectivity. System productivity can be raised due to reduction of mass transfer resistance both in membranes and in liquid phase. When high permeable membranes are used main mass transfer resistance in SMV is in liquid phase [51]. There are two ways to decrease resistance in liquid phase: mixing of liquid in transverse direction; decreasing of liquid layer thickness. Unfortunately, these two ways practically are mutually exclusive. Mixing can be organized by switching to turbulent flow regime or by introducing turbulent promoter in liquid channel that is difficult to realize in thin liquid channel. Besides, greater energy consumption will be necessary in this case. Second way (decreasing of liquid layer thickness) was used in this work.

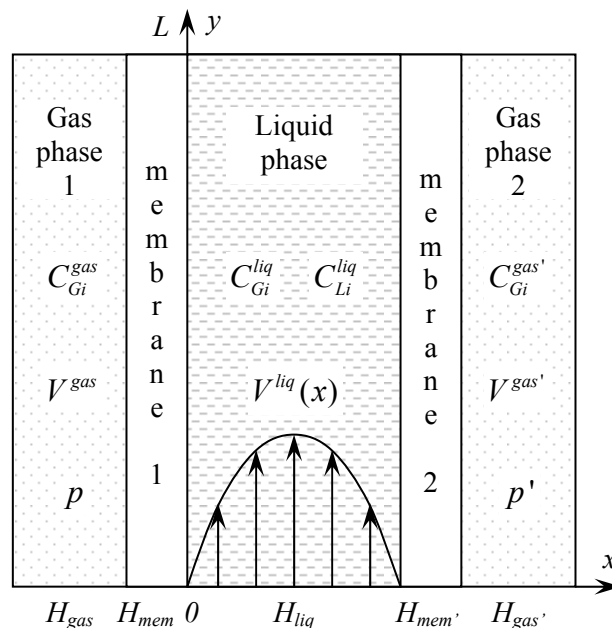

Fig. 2.1. Coordinates of SMV used in mathematical model.

A SMV with in thin liquid layer with laminar flow regime was created. Mathematical model of mass transfer in SMV without mixing in liquid phase is absent in present time. Existing models also suppose steady state mass transfer process. It was shown [63] that efficiency of separation can be improved due to utilization of non-steady state operation regimes of membrane system. This chapter is dedicated to development of mathematical model of non-steady mass transfer in flat geometry SMV-module with parallel gas and liquid flows and chemical absorption in liquid phase. The model takes into account diffusive and convective transfer of components which takes place mainly in two mutual perpendicular directions (Fig.2.1).

2.1. Mathematical model of gas transfer in SMV. General case.

Gas transfer in SMV with chemical absorbent consists of following steps: diffusion through the first membrane; diffusive and convective transfer in liquid phase accompanied (for reacting component) or no (for non-reacting component) by chemical reaction; diffusion through the second membrane. Taking into account that in general case mass transfer description is complex hydro- and thermodynamic problem [1] following assumptions were made to simplify mathematical equations: *a)* isothermal process; *b)* plug flow in gas phases; *c)* thickness of liquid channel is much lower than its length and width; *d)* laminar flow regime of liquid phase; *e)* longitudinal diffusion (in *y* axis direction) in liquid phase is possible to neglect; *f)* steady state mass transfer in membranes; *g)* diffusion and solubility coefficients of components are independent of concentration changes caused by diffusion and chemical reactions; *h)* gas mixture components are only volatile components (*G*); *i)* volume change of liquid phase is negligible during absorption of volatile components; *j)* applicability of Henry's law in membranes and liquid; *k)* no pressure gradient in gas phases; *l)* gas behavior is similar to ideal gas;

Fig.2.1 represents the scheme and coordinates of SMV used in mathematical model. Let's consider that gas mixture is supplied to the first gas phase. Due to the difference of membrane and liquid transport properties for components of gas mixture separation occurs and concentration of

components changes along y -axis. Component flux in gas phase is proportional to its concentration and total flux (assumption b) and changes because of component diffusion through the membrane. Following assumptions b and f mass balance equation of a component in first gas phase can be written as:

$$\frac{\partial J_{Gi}^{gas}(y,t)}{\partial y} = BD_{Gi}^{mem} \frac{C_{Gi}^{mem}(0,y,t) - C_{Gi}^{mem}(-H_{mem},y,t)}{H_{mem}} \quad (2.1)$$

Assumptions d,e,g,i allows to consider transfer in liquid phase as diffusion in x -axis direction and convection in y -axis direction as well conversion of components due to chemical reactions. In this case non-steady mass transfer of volatile (G) and non-volatile (L) components in liquid phase can be represented by equations:

$$\frac{\partial C_{Gi}^{liq}(x,y,t)}{\partial t} = D_{Gi}^{liq} \frac{\partial^2 C_{Gi}^{liq}(x,y,t)}{\partial x^2} - V^{liq}(x) \frac{\partial C_{Gi}^{liq}(x,y,t)}{\partial y} + R_{Gi}^{liq}(x,y,t) \quad (2.2)$$

$$\frac{\partial C_{Li}^{liq}(x,y,t)}{\partial t} = D_{Li}^{liq} \frac{\partial^2 C_{Li}^{liq}(x,y,t)}{\partial x^2} - V^{liq}(x) \frac{\partial C_{Li}^{liq}(x,y,t)}{\partial y} + R_{Li}^{liq}(x,y,t) \quad (2.3)$$

Sweep gas or vacuum can be applied to keep low concentration of gas mixture components in second gas phase. In first case mass transfer description is similar to Eq.2.1:

$$\frac{\partial J_{Gi}^{gas'}(y,t)}{\partial y} = BD_{Gi}^{mem'} \frac{C_{Gi}^{mem'}(H_{liq},y,t) - C_{Gi}^{mem'}(H_{liq} + H_{mem'},y,t)}{H_{mem'}} \quad (2.4)$$

If vacuum is applied it is possible to introduce additional assumption of ideal mixing regime in second gas phase that gives following equation for component flux:

$$J_{Gi}^{gas'}(t) = \frac{BD_{Gi}^{mem'}}{H_{mem'}} \int_0^L [C_{Gi}^{mem'}(H_{liq},y,t) - C_{Gi}^{mem'}(H_{liq} + H_{mem'},y,t)] dy \quad (2.5)$$

$$C_{Gi}^{mem'}(H_{liq} + H_{mem'},y,t) = p' S_{Gi}^{mem'} J_{Gi}^{gas'}(t) \left(\sum_i J_{Gi}^{gas'}(t) \right)^{-1} \quad (2.6)$$

Boundary conditions for situation of co-current flows of gas and liquid in SMV are presented below. It is assumed that all fluxes are supplied at coordinate $y=0$ and boundary condition for the first gas phase in general form can be written as:

$$J_{Gi}^{gas}(0,t) = \bar{J}_{Gi}^{gas}(t) \quad (2.7)$$

The concentration of a component in membrane in gas-membrane interface is proportional to its partial pressure in gas phase (assumption *j*):

$$C_{Gi}^{mem}(-H_{mem}, y, t) = p S_{Gi}^{mem} J_{Gi}^{gas}(y, t) \left(\sum_i J_{Gi}^{gas}(y, t) \right)^{-1} \quad (2.8)$$

Supplied liquid may contain as non-volatile as volatile components remained after desorption step for example:

$$C_{Gi}^{liq}(x, 0, t) = \bar{C}_{Gi}^{liq}(t) \quad (2.9)$$

$$C_{Li}^{liq}(x, 0, t) = \bar{C}_{Li}^{liq}(t) \quad (2.10)$$

Applicability of Henry's law and absence of volatile components accumulation in membrane-liquid interface allows us to write boundary conditions as follows:

$$\frac{C_{Gi}^{liq}(0, y, t)}{S_{Gi}^{liq}} = \frac{C_{Gi}^{mem}(0, y, t)}{S_{Gi}^{mem}} \quad (2.11)$$

$$\frac{C_{Gi}^{mem}(H_{liq}, y, t)}{S_{Gi}^{mem'}} = \frac{C_{Gi}^{liq}(H_{liq}, y, t)}{S_{Gi}^{liq}} \quad (2.12)$$

$$D_{Gi}^{liq} \frac{\partial C_{Gi}^{liq}(x, y, t)}{\partial x} \Big|_{x=0} = D_{Gi}^{mem} \frac{\partial C_{Gi}^{mem}(x, y, t)}{\partial x} \Big|_{x=0} \quad (2.13)$$

$$D_{Gi}^{mem'} \frac{\partial C_{Gi}^{mem'}(x, y, t)}{\partial x} \Big|_{x=H_{liq}} = D_{Gi}^{liq} \frac{\partial C_{Gi}^{liq}(x, y, t)}{\partial x} \Big|_{x=H_{liq}} \quad (2.14)$$

Non-volatile components can't cross membrane-liquid interface and their fluxes are equal to zero:

$$\frac{\partial C_{Li}^{liq}(x, y, t)}{\partial x} \Big|_{x=0} = \frac{\partial C_{Li}^{liq}(x, y, t)}{\partial x} \Big|_{x=H_{liq}} = 0 \quad (2.15)$$

If sweep gas is applied boundary condition for second gas phase is similar to Eq.2.7:

$$J_{Gi}^{gas'}(0,t) = \bar{J}_{Gi}^{gas'}(t) \quad (2.16)$$

Boundary condition in second gas-membrane interface is similar to Eq.2.8:

$$C_{Gi}^{mem'}(H_{liq} + H_{mem'}, y, t) = p' S_{Gi}^{mem'} J_{Gi}^{gas'}(y, t) \left(\sum_i J_{Gi}^{gas'}(y, t) \right)^{-1} \quad (2.17)$$

Usually it is assumed that at initial moment components of gas mixture are absent in the system. In this case initial conditions can be represented as:

$$J_{Gi}^{gas}(y, 0) = J_{Gi}^{gas'}(y, 0) = 0 \quad (2.18)$$

$$C_{Gi}^{mem}(x, y, 0) = C_{Gi}^{liq}(x, y, 0) = C_{Gi}^{mem'}(x, y, 0) = 0 \quad (2.19)$$

$$C_{Li}^{liq}(x, y, 0) = \bar{C}_{Li}^{liq}(x, y) \quad (2.20)$$

The function of liquid phase velocity distribution has parabolic profile across liquid layer (assumptions *c* and *d*):

$$V^{liq}(x) = \frac{4V_{max}^{liq}}{H_{liq}^2} x(H_{liq} - x) \quad (2.21)$$

$$V_{max}^{liq} = 3V_{aver}^{liq}/2 \quad (2.22)$$

Description presented above is general mathematical model of mass transfer in SMV. It can be used for calculation of SMV gas separation properties if values of diffusion and solubility coefficients and reaction rate and reaction equilibrium constants and reaction mechanism are known. Number of equations, initial and boundary conditions depends on number of gas mixture components and reacting components (including reaction products). In all cases the system of mathematical equations can be solved only numerically.

The transport of CO₂, O₂ and H₂ in SMV with distilled water and aqueous K₂CO₃ solutions (chemical absorbents of CO₂) was studied in this work. The mathematical model of CO₂ transfer and mechanism of CO₂ interaction with aqueous K₂CO₃ solutions are presented below.

2.2. CO₂ absorption in aqueous carbonate solutions of alkali metals.

When carbonate of alkali metal (Li₂CO₃, Na₂CO₃, K₂CO₃, etc.) dissolves in water it dissociates into metal and carbonate ions:



Reaction of carbonate ions with water gives bicarbonate ions and hydroxyl ions:



$$K_C = \frac{[CO_3^{2-}]}{[HCO_3^-][OH^-]} \quad (2.24a)$$

Sometimes, reaction presented above is written as:



$$K'_C = \frac{[CO_3^{2-}][H_3O^+]}{[HCO_3^-]} \quad (2.24c)$$



$$K_W = [H_3O^+][OH^-] \quad (2.25a)$$

CO₂ interaction with solution goes by two parallel reactions:



$$K_1 = \frac{[H_3O^+][HCO_3^-]}{[CO_2]} \quad (2.26a)$$



$$K_2 = \frac{[HCO_3^-]}{[CO_2][OH^-]} \quad (2.27a)$$

At 24°C forward and reverse reaction rate constants of reaction (2.24) are equal to 6.00×10^9 l/(mol·s) and 1.22×10^6 s⁻¹ respectively [64] and water formation rate (reaction 2.25) is 1.40×10^{11} l/(mol·s). It is several orders higher than reaction rate constants of reactions (2.26) and (2.27) which are equal to: $k_1 = 2.4 \times 10^{-2}$ s⁻¹, $k_{-1} = 5.71 \times 10^4$ l/(mol·s), $k_2 = 1.41 \times 10^4$ l/(mol·s), $k_{-2} = 3.11 \times 10^{-4}$ s⁻¹ [64] at the same conditions. Therefore, reactions (2.24) and (2.25) are rate controlling reactions and reactions (2.26) and (2.27) can be considered as instantaneous reactions during CO₂ absorption. Overall reaction of CO₂ with carbonate ion is:



$$K_{ov} = \frac{[HCO_3^-]^2}{[CO_2][CO_3^{2-}]} \quad (2.28a)$$

Here it is assumed that activity coefficients of all species are equal to unity. The approach of CO₂ interaction with carbonate solution described above was used by many researchers [10, 15-17, 27, 36, 37, 64-66]. Equations allowing to calculate values of reaction rate and equilibrium constants are presented literature and given in Table 2.1.

Table 2.1.

Reaction rate and equilibrium constants for the system CO₂-aqueous K₂CO₃ solution.

Constant	Equation	Units	Reference
k_1	$\log_{10} k_1 = 329.85 - 110.541 \log_{10} T - 17265.4 / T$	s ⁻¹	[65]
k_2	$\log_{10} k_2 / k_2^\infty = 0.08I$ $\log_{10} k_2^\infty = 13.635 - 2895 / T$ $\log_{10} k_2^\infty = 11.916 - 2382 / T$ $\log_{10} k_2^\infty = 8.916 - 2383 / T$	l/(mol·s)	[67] [65] [37] [64]
K_1	$\log_{10} K_1 = 14.843 - 0.03279T - 3404.7 / T$	mol/l	[65]
K_2	$K_2 = K_1 / K_w$	l/mol	[65]
K'_C	$\log_{10} K'_C = 6.498 - 0.0238T - 2902.4 / T$	mol/l	[65]
K_C	$\log_{10} K_C = 0.4134 - 0.006737T - 1568.94 / T$	l/mol	[68]
K_w	$\log_{10} K_w = -23.5325 + 0.03184T$ $\log_{10} K_w = 61.2062 - 22.477 \log T - 5839.5 / T$	mol ² /l ²	[36] [69]

2.3. Mathematical model of CO₂ transfer in SMV with aqueous K₂CO₃.

General model developed in paragraph 2.1 can be adapted to any practical case if number of transferred components and reaction mechanism are known. The model of CO₂ transfer in aqueous K₂CO₃ solution is presented below.

Following reaction mechanism described in paragraph 2.2, CO₂ consumption and formation is controlled by reactions of CO₂ with water and hydroxyl ions, therefore, CO₂ reaction term is written as:

$$R_{CO_2}^{liq} = C_{HCO_3^-}^{liq} \left(k_{-1} C_{H_3O^+}^{liq} + k_{-2} \right) - C_{CO_2}^{liq} \left(k_1 + k_2 C_{OH^-}^{liq} \right) \quad (2.29)$$

Since concentrations of H_3O^+ , OH^- and CO_3^{2-} are always in equilibrium (reactions 2.26 and 2.27), they can be expressed of CO_3^{2-} concentration then Eq.2.29 is possible to rewrite as:

$$R_{CO_2}^{liq} = C_{HCO_3^-}^{liq} \left(k_{-1} K_C K_W \frac{C_{HCO_3^-}^{liq}}{C_{CO_3^{2-}}^{liq}} + k_{-2} \right) - C_{CO_2}^{liq} \left(k_1 + k_2 \frac{C_{CO_3^{2-}}^{liq}}{K_C C_{HCO_3^-}^{liq}} \right) \quad (2.30)$$

From the overall reaction of CO_2 with carbonate solution (Eq.2.28) it follows:

$$R_{CO_3^{2-}}^{liq} = R_{CO_2}^{liq} \quad (2.31)$$

$$R_{HCO_3^-}^{liq} = -2R_{CO_2}^{liq} \quad (2.32)$$

Thus besides CO_2 transfer in liquid phase it is necessary to take into account transfer and interaction of carbonate ions and bicarbonate ions. If we consider transfer of single CO_2 and in the second gas phase vacuum is applied then gas CO_2 concentration is constant along SMV and determined by its pressure. The transfer of components in liquid phase is described by the differential equation system:

$$\begin{cases} \frac{\partial C_{CO_2}^{liq}(x, y, t)}{\partial t} = D_{CO_2}^{liq} \frac{\partial^2 C_{CO_2}^{liq}(x, y, t)}{\partial x^2} - V^{liq}(x) \frac{\partial C_{CO_2}^{liq}(x, y, t)}{\partial y} + R_{CO_2}^{liq}(x, y, t) \\ \frac{\partial C_{CO_3^{2-}}^{liq}(x, y, t)}{\partial t} = D_{CO_3^{2-}}^{liq} \frac{\partial^2 C_{CO_3^{2-}}^{liq}(x, y, t)}{\partial x^2} - V^{liq}(x) \frac{\partial C_{CO_3^{2-}}^{liq}(x, y, t)}{\partial y} + R_{CO_2}^{liq}(x, y, t) \\ \frac{\partial C_{HCO_3^-}^{liq}(x, y, t)}{\partial t} = D_{HCO_3^-}^{liq} \frac{\partial^2 C_{HCO_3^-}^{liq}(x, y, t)}{\partial x^2} - V^{liq}(x) \frac{\partial C_{HCO_3^-}^{liq}(x, y, t)}{\partial y} - 2R_{CO_2}^{liq}(x, y, t) \end{cases} \quad (2.33)$$

The function $V^{liq}(x)$ is similar to Eq.2.19. Gas-membrane interface conditions are:

$$C_{CO_2}^{mem}(-H_{mem}, y, t) = p_{CO_2} S_{CO_2}^{mem} \quad (2.34)$$

$$C_{CO_2}^{mem'}(H_{liq} + H_{mem'}, y, t) = p'_{CO_2} S_{CO_2}^{mem'} \quad (2.35)$$

Membrane-liquid interface conditions are:

$$\frac{C_{CO_2}^{liq}(0, y, t)}{S_{CO_2}^{liq}} = \frac{C_{CO_2}^{mem}(0, y, t)}{S_{CO_2}^{mem}} \quad (2.36)$$

$$\frac{C_{CO_2}^{mem'}(H_{liq}, y, t)}{S_{CO_2}^{mem'}} = \frac{C_{CO_2}^{liq}(H_{liq}, y, t)}{S_{CO_2}^{liq}} \quad (2.37)$$

$$D_{CO_2}^{liq} \frac{\partial C_{CO_2}^{liq}(0, y, t)}{\partial x} = D_{CO_2}^{mem} \frac{C_{CO_2}^{mem}(0, y, t) - C_{CO_2}^{mem}(-H_{mem}, y, t)}{H_{mem}} \quad (2.38)$$

$$D_{CO_2}^{liq} \frac{\partial C_{CO_2}^{liq}(H_{liq}, y, t)}{\partial x} = D_{CO_2}^{mem'} \frac{C_{CO_2}^{mem'}(H_{liq} + H_{mem'}, y, t) - C_{CO_2}^{mem'}(H_{liq}, y, t)}{H_{mem'}} \quad (2.39)$$

$$\frac{\partial C_{CO_3^{2-}}^{liq}(0, y, t)}{\partial x} = \frac{\partial C_{CO_3^{2-}}^{liq}(H_{liq}, y, t)}{\partial x} = \frac{\partial C_{HCO_3^-}^{liq}(0, y, t)}{\partial x} = \frac{\partial C_{HCO_3^-}^{liq}(H_{liq}, y, t)}{\partial x} = 0 \quad (2.40)$$

Conditions at liquid inlet in flow-through mode:

$$C_{CO_2}^{liq}(x, 0, t) = \bar{C}_{CO_2}^{liq} \quad (2.41)$$

$$C_{CO_3^{2-}}^{liq}(x, 0, t) = \bar{C}_{CO_3^{2-}}^{liq} \quad (2.42)$$

$$C_{HCO_3^-}^{liq}(x, 0, t) = \bar{C}_{HCO_3^-}^{liq} \quad (2.43)$$

Conditions at liquid inlet in recycling mode:

$$C_{CO_2}^{liq}(x, 0, t) = \frac{1}{H_{liq} V_{aver}^{liq}} \int_0^{H_{liq}} V^{liq}(x) C_{CO_2}^{liq}(x, L, t) dx \quad (2.44)$$

$$C_{CO_3^{2-}}^{liq}(x, 0, t) = \frac{1}{H_{liq} V_{aver}^{liq}} \int_0^{H_{liq}} V^{liq}(x) C_{CO_3^{2-}}^{liq}(x, L, t) dx \quad (2.45)$$

$$C_{HCO_3^-}^{liq}(x, 0, t) = \frac{1}{H_{liq} V_{aver}^{liq}} \int_0^{H_{liq}} V^{liq}(x) C_{HCO_3^-}^{liq}(x, L, t) dx \quad (2.46)$$

Initial conditions:

$$C_{CO_2}^{liq}(x, y, 0) = \bar{C}_{CO_2}^{liq} \quad (2.47)$$

$$C_{CO_3^{2-}}^{liq}(x, y, 0) = \bar{C}_{CO_3^{2-}}^{liq} \quad (2.48)$$

$$C_{HCO_3^-}^{liq}(x, y, 0) = \bar{C}_{HCO_3^-}^{liq} \quad (2.49)$$

Potassium carbonate mass balance:

$$\frac{1}{H_{liq}L} \int_0^{H_{liq}} \int_0^L \left[C_{CO_3^{2-}}^{liq}(x, y) + \frac{C_{HCO_3^-}^{liq}(x, y)}{2} \right] dx dy = m \quad (2.50)$$

SMV permeability is determined as average flux through the second membrane normalized by pressure drop:

$$Q_{CO_2} = \frac{D_{CO_2}^{mem'}}{H_{mem'}L(p_{CO_2} - p'_{CO_2})} \int_0^L \left[C_{CO_2}^{mem'}(H_{liq} + H_{mem'}, y) - C_{CO_2}^{mem'}(H_{liq}, y) \right] dy \quad (2.51)$$

Table 2.2 shows equations for CO₂ diffusion and solubility coefficients calculation. Described model can be used for calculation of transfer of other (non-reacting) gases if $R_G^{liq} = 0$.

Table 2.2.

Diffusion and solubility coefficients of CO₂ in aqueous K₂CO₃ solution.

Constant	Equation	Units	Reference
D_{CO_2}	$D_{CO_2}^{liq} = \frac{0.0235 \times \exp(-2119/T)}{(1 + 0.354m)^{0.82}}$	cm ² /s	[36]
$D_{HCO_3^-}$	$D_{HCO_3^-}^{liq} = D_{CO_3^{2-}}^{liq} = D_{CO_2}^{liq} \sqrt{\mu_{CO_2} / \mu_{HCO_3^-}}$	cm ² /s	[16]
S_{CO_2}	$\log_{10} S_{CO_2}^{liq} = -5.30 + 1140/T - 0.125m$	mol/(l·atm)	[36]

2.4. Simplified models of gas transfer in SMV with physical absorbent

The model presented above is required applying of numerical methods of calculation to solve the differential equation system that demands special software. Nevertheless introducing of some additional assumptions gives the possibility to obtain analytical solution. Models for calculation of SMV permeability in flow-through and recycling modes without applying of numerical methods are presented below.

Following assumptions were made: *a)* perfect mixing in gas phases; *b)* uniform velocity profile in liquid phase; *c)* gas transfer is diffusion in *x*-axis direction and convection in *y*-axis direction; *d)* membranes are high-permeable and their mass transfer resistance is negligible compared to resistance of liquid phase; *e)* no chemical reactions; *f)* diffusion and solubility coefficients and liquid flux are constant; *g)* Henry's law applicability; *h)* steady state process.

2.4.1. SMV permeability in flow-through mode

Assumptions *b* and *c* allow to consider gas flux through SMV as superposition of fluxes through liquid layers dy which move along y -axis because of convection (Fig.2.2). Let's suppose that liquid at inlet is "clean" towards absorbed gas, then non-steady gas diffusion in x -axis direction occurs during movement of layer dy between membranes (assumption *c*). At the same time membrane-liquid boundary conditions for layer dy are constant (assumptions *a* and *d*). This allows to consider gas transfer through layer dy during its movement between membranes as non-steady gas transfer during the time of dy -layer presence between membranes. The same approach was used in [70] for description of absorption process in MC with taking into account diffusion in liquid phase.

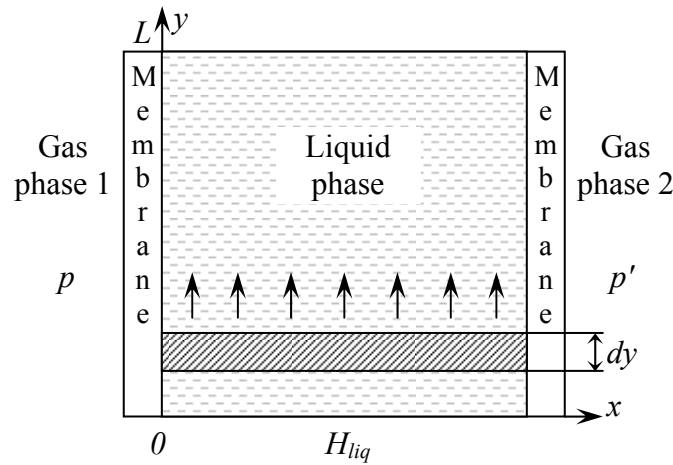

Fig. 2.2. Coordinates used in simplified model.

Since membrane resistance is negligible (assumption *d*) we suppose $H_{mem} = H_{mem'} = 0$. Non-steady diffusion is described by second Fick's law:

$$\frac{\partial C_G^{liq}(x,t)}{\partial t} = D_G^{liq} \frac{\partial^2 C_G^{liq}(x,t)}{\partial x^2} \quad (2.52)$$

Initial and boundary conditions in our case are:

$$\begin{cases} C_G^{liq}(x,0) = 0 \\ C_G^{liq}(0,t) = p_G S_G^{liq} = C_1^0 \\ C_G^{liq}(H_{liq},t) = p'_G S_G^{liq} = C_2^0 \end{cases} \quad (2.53)$$

The solution of Eq.2.52 with initial and boundary conditions (2.53) is:

$$C_G^{liq}(x,t) = \frac{C_2^0 - C_1^0}{H_{liq}}x + C_1^0 + \frac{2}{\pi} \sum_n \frac{C_2^0(-1)^n - C_1^0}{n} \sin\left(\frac{n\pi x}{H_{liq}}\right) \exp\left(-\left(\frac{n\pi}{H_{liq}}\right)^2 D_G^{liq} t\right) \quad (2.54)$$

Gas flux through dy -layer is equal to the flux at coordinate $x=H_{liq}$. According to first Fick's law diffusion flux is:

$$j_G^{liq}(x,t) = -D_G^{liq} \frac{\partial C_G^{liq}(x,t)}{\partial x} \quad (2.55)$$

$$\frac{\partial C_G^{liq}(x,t)}{\partial x} = \frac{C_2^0 - C_1^0}{H_{liq}} + \frac{2}{H_{liq}} \sum_n (C_2^0(-1)^n - C_1^0) \cos\left(\frac{n\pi x}{H_{liq}}\right) \exp\left(-\left(\frac{n\pi}{H_{liq}}\right)^2 D_G^{liq} t\right) \quad (2.56)$$

Then gas flux through layer dy is described as:

$$j_G^{liq}(H_{liq}, t) = -D_G^{liq} \left[\frac{C_2^0 - C_1^0}{H_{liq}} + \frac{2}{H_{liq}} \sum_n (C_2^0 - C_1^0(-1)^n) \exp\left(-\left(\frac{n\pi}{H_{liq}}\right)^2 D_G^{liq} t\right) \right] \quad (2.57)$$

Time coordinate t and layer position coordinate y are interconnected by average liquid speed:

$$t = \frac{y}{V_{aver}^{liq}} \quad (2.58)$$

Replacing time t by coordinate of layer dy we obtain:

$$j_G^{liq}(H_{liq}, y) = -D_G^{liq} \left[\frac{C_2^0 - C_1^0}{H_{liq}} + \frac{2}{H_{liq}} \sum_n (C_2^0 - C_1^0(-1)^n) \exp\left(-\frac{(n\pi)^2 D_G^{liq}}{V_{aver}^{liq}} y\right) \right] \quad (2.59)$$

Total flux through SMV is equal to superposition of fluxes through each layer dy along the system:

$$J_G^{liq} = B \int_0^L j_G^{liq}(H_{liq}, y) dy \quad (2.60)$$

After integration of Eq.2.59 we obtain final equation for gas flux calculation through SMV in flow-through mode depending on liquid flux:

$$J_G^{liq} = \frac{D_G^{liq} BL(C_1^0 - C_2^0)}{H_{liq}} + \frac{2BH_{liq}V_{aver}^{liq}}{\pi^2} \sum_n \frac{C_2^0 - C_1^0(-1)^n}{n^2} \left[\exp\left(-\left(\frac{n\pi}{H_{liq}}\right)^2 \frac{D_G^{liq} L}{V_{aver}^{liq}}\right) - 1 \right] \quad (2.61)$$

2.4.2. SMV permeability in recycling mode

In recycling mode liquid leaving SMV is supplied back to liquid inlet. At steady state gas concentration in liquid is equal to average concentration (because of liquid mixing during it pumping).

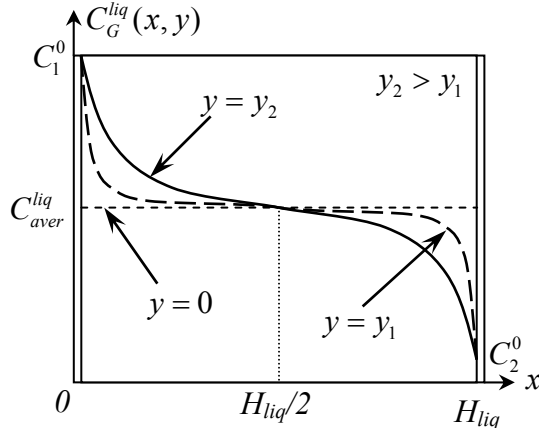

Fig. 2.3. Gas concentration profiles

in cross-section of SMV in recycling mode at steady state.

At steady state gas concentration in liquid at inlet is equal to average value of gas concentration on both sides of liquid layer in consequence of linear dependence of gas concentration in liquid on gas partial pressure (assumption g). In all other respects the approach to gas transfer description in SMV in recycling mode is similar to the case considered above for flow-through mode.

In order to use solution (2.54) of Eq.2.52 let's consider the changing of gas concentration profiles in liquid phase at steady state (Fig.2.3). At liquid inlet gas concentration is:

$$C_{aver}^{liq} = (C_1^0 + C_2^0) / 2 \quad (2.62)$$

It is easy to note that concentration profile is symmetric relatively to the point $x=H_{liq}/2$ where gas concentration is constant along all the system. Also gas absorption flux (at $x=0$) and gas desorption flux (at $x=H/2$) are equal at steady state. These features allow to consider only $x \in [0; H_{liq} / 2]$ region. In this case initial and boundary conditions are:

$$\begin{cases} C_G^{liq}(x, 0) = (C_1^0 + C_2^0) / 2 \\ C_G^{liq}(0, t) = C_2^0 \\ C_G^{liq}(H_{liq} / 2, t) = (C_1^0 + C_2^0) / 2 \end{cases} \quad (2.63)$$

In order to simplify mathematical equations the following substitution is made:

$$\tilde{C}_G^{liq}(x, t) = C_G^{liq}(x, t) - (C_1^0 + C_2^0) / 2 \quad (2.64)$$

Then initial and boundary conditions are transformed to:

$$\begin{cases} \tilde{C}_G^{liq}(x, 0) = 0 \\ \tilde{C}_G^{liq}(0, t) = C_1^0 - (C_1^0 + C_2^0) / 2 = \tilde{C}_1^0 \\ \tilde{C}_G^{liq}(H_{liq} / 2, t) = \tilde{C}_2^0 = 0 \end{cases} \quad (2.65)$$

The solution of Eq.2.52 with conditions (2.65) is similar to Eq.2.54:

$$\tilde{C}_G^{liq}(x, t) = \frac{-\tilde{C}_1^0}{H_{liq} / 2} x + \tilde{C}_1^0 - \frac{2}{\pi} \sum_n \frac{\tilde{C}_1^0}{n} \sin\left(\frac{n\pi}{H_{liq} / 2} x\right) \exp\left(-\left(\frac{n\pi}{H_{liq} / 2}\right)^2 D_G^{liq} t\right) \quad (2.66)$$

Gas flow through the layer dy at coordinate $x=0$ is:

$$j_G^{liq}(0, t) = -D_G^{liq} \left[\frac{-\tilde{C}_1^0}{H_{liq} / 2} - \frac{2}{H_{liq} / 2} \sum_n \tilde{C}_1^0 \exp\left(-\left(\frac{n\pi}{H_{liq} / 2}\right)^2 D_G^{liq} t\right) \right] \quad (2.67)$$

Coordinates t and y are interconnected analogously to (2.58). After substitution of (2.58) in (2.67)

we get:

$$j_G^{liq}(0, y) = -D_G^{liq} \left[\frac{-\tilde{C}_1^0}{H_{liq} / 2} - \frac{2}{H_{liq} / 2} \sum_n \tilde{C}_1^0 \exp\left(-\left(\frac{n\pi}{H_{liq} / 2}\right)^2 \frac{D_G^{liq} y}{V_{aver}^{liq}}\right) \right] \quad (2.68)$$

Gas flux through SMV we obtain similar to Eq.2.60:

$$J_G^{liq} = B \int_0^L j_G^{liq}(0, y) dy \quad (2.69)$$

Integration of (2.69) gives final equation:

$$J_G^{liq} = \frac{D_G^{liq} B L \tilde{C}_1^0}{H_{liq} / 2} + \frac{B H_{liq} V_{aver}^{liq}}{\pi^2} \sum_n \frac{\tilde{C}_1^0}{n^2} \left[1 - \exp\left(-\left(\frac{n\pi}{H_{liq} / 2}\right)^2 \frac{D_G^{liq} L}{V_{aver}^{liq}}\right) \right] \quad (2.70)$$

The advantage of described models is existence of analytical solution that allows relatively easy to calculate the dependence of gas flux through SMV on liquid flux in flow-through and recycling modes.

Chapter 3: Experimental part.

3.1. The preparation of SMV-module.

An original construction of SMV-module was designed. It allows to create liquid layer with thickness from 0.05 to 1 mm without a net-shaped spacer that provides liquid flow without mixing (in laminar flow regime). SMV-module was built based on two identical parts. One part consists of the metal base (with connection holes and channels), membrane support (U-shaped spacer for gas phase stream) and membrane. Bands of polyethylene were stuck on two sides of a part to provide the required space between membranes (liquid layer thickness). Different parts were united and the encapsulation of membrane module was carried out using an epoxy resin (Fig.3.1).

Two SMV-modules with liquid layer thickness 210 μm and 260 μm with an effective membrane area of 26 and 20 cm^2 respectively were prepared. It is important to note that in the permeation zone of the liquid layer there was no any spacer that could affect gas transport or induce mixing or turbulence in liquid flow.

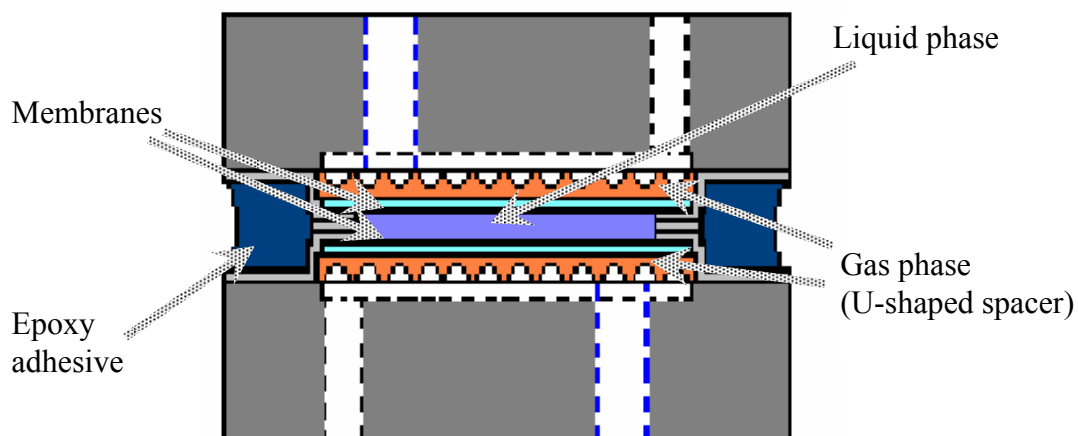

Fig. 3.1. The cross-section of SMV-module.

3.2. Membranes.

Asymmetric poly-(vinyltrimethylsilane) membranes (PVTMS) with a thin dense layer (approximately thickness 0.2 μm) were used. The cross-section of the membrane is shown in

Fig.3.2. PVTMS is high permeable polymer (Table 3.1) chemically stable in base solutions. The permeability of PVTMS membranes is about 1600 l/(m²·h·atm) for CO₂ and 1700 (l/m²·h·atm) for H₂. Membranes were installed in such a way that dense layer was turned to the liquid phase in order to avoid penetration of liquid to the porous structure of membrane.

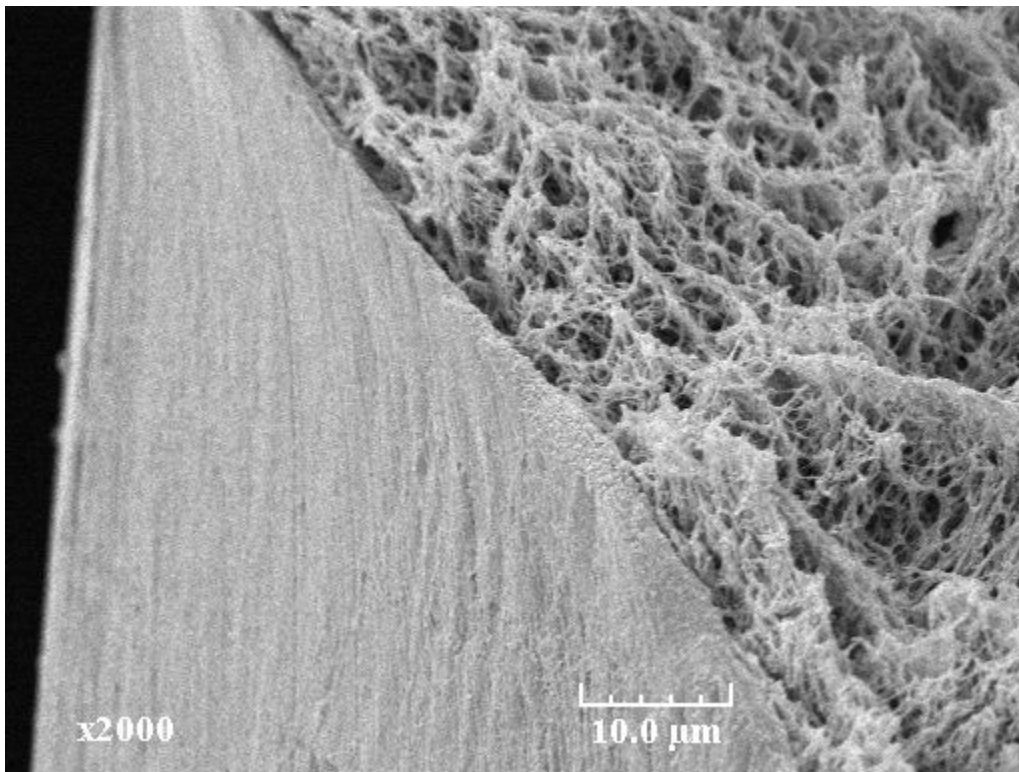

Fig. 3.2. The cross-section of PVTMS membrane (received in LSGC/ENSIC, Nancy, France).

Table 3.1.
Gas transport parameters in homogeneous PVTMS films at 25°C [71].

Gas	Diffusion coefficient D, 10 ⁻⁶ cm ² /s	Solubility coefficient S, 10 ⁻³ cm ³ /(cm ³ ·cmHg)	Permeability coefficient P, Barrer
He	37	0.46	180
H ₂	18	1.1	200
O ₂	0.76	5.8	44
N ₂	0.36	3.0	11
CO ₂	0.52	38.0	190
CH ₄	0.18	10.0	18

$$1[\text{Barrer}] = 10^{10} \text{ cm}^3 \cdot \text{cm} / (\text{cm}^2 \cdot \text{s} \cdot \text{cmHg})$$

3.3. Experimental setup.

The measurement of SMV permeability was carried out using modernized experimental setup for evaluation of gas transfer parameters in polymeric membranes. The differential method of permeability determination was used. Fig.3.3 represents the scheme of the experimental setup which also allows the registration of gas transfer in non-steady state by thermal conductivity detector (TCD). SMV-module and two humidifiers are placed in thermostated oven. Humidifiers are used for reducing of water vapour transfer through the membranes. A dryer (with CaCl_2) was inserted before the entrance of TCD in order to avoid the damage of TCD and to reduce background signal caused by water vapour. Gas chromatograph (GC) TSVET-500 was used for determination of gases concentration in gas streams.

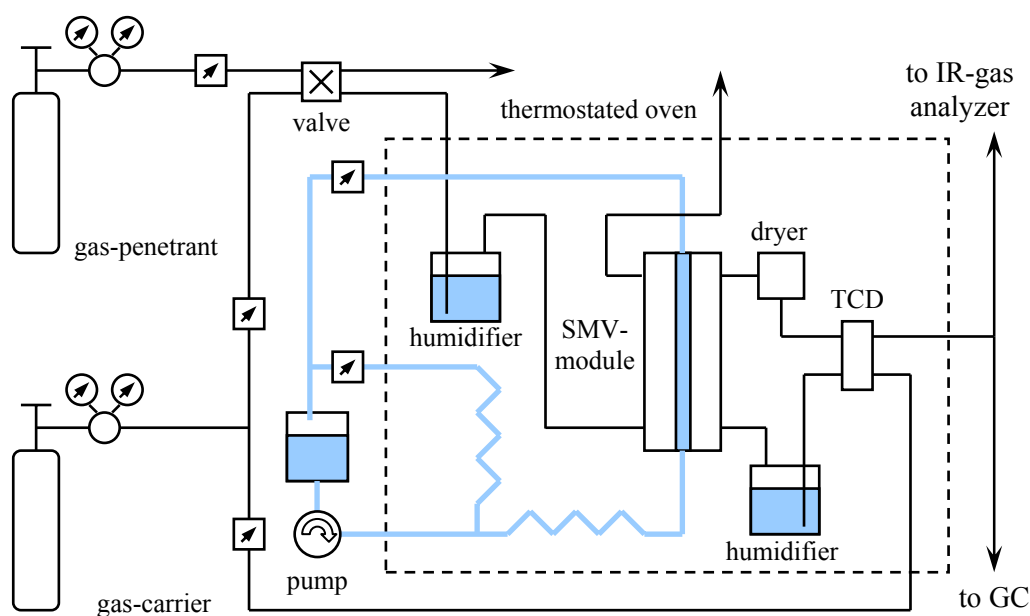

Fig. 3.3. The scheme of experimental setup.

CO_2 concentration was also measured by infrared (IR) CO_2 -gas analyzer "Riken Fine" RI-550A. Signals from TCD, GC and IR-gas analyzer were transformed and recorded in digital form by the firmware "ECOCHROM" developed in N.D.ZELINSKII General Chemistry Institute RAS.

3.4. Experimental technique.

In order to check the dense layer integrity of membranes in prepared SMV-module O₂/He and N₂/He gas mixtures were supplied to the liquid channel between membranes. The oxygen and nitrogen permeability of each membrane were determined and the oxygen over nitrogen selectivity (α_{O_2/N_2}) was calculated. Only modules having the expected separation selectivity (more than 3.2) were used in further experiments. Distilled water and aqueous K₂CO₃ were used as absorbents. Aqua solutions were prepared using distilled water and dry K₂CO₃ with purity 99.5%. SMV-module was placed in thermostated oven with given temperature. Since there was no spacer between membranes in permeation area a liquid was supplied with overpressure of 0.1-0.2 bar to press both membranes to membrane support in order to provide constant liquid layer thickness in full area. The pressure in gas channels was equal to atmospheric pressure. Pure helium or argon was used as sweeping gas. At initial time sweep gas was supplied to both gas phases of SMV until the signal measured by TCD wasn't stable (zero line registration). At given moment sweep gas was changed to feed by turning the switch valve and non-steady process of gas transfer in SMV was registered by TCD. After reaching of steady state GC was used for determination of gas stream composition from SMV outlet. The scheme with two regulators and bypass was used to adjust the flux of a liquid. Gas and liquid fluxes were measured using volumetric technique. Reynolds numbers in flowing liquid were smaller than 200 to provide laminar liquid flow.

Chapter 4: Results and discussion.

General characteristics of separation systems (including membrane systems) are productivity and selectivity. Dependencies of these characteristics of SMV on such parameters as liquid flux, chemical absorbent concentration, temperature and operating mode were investigated. Pure gases as well as gas mixtures were used in experiments.

4.1. SMV with physical sorption in liquid phase.

The permeability of SMV with stagnant and moving liquid was studied. Distilled water was used as a physical sorbent. If liquid is stagnant SMV can be considered as a three-layer membrane [48] and its permeability can be calculated using resistance model:

$$Q^{-1} = \sum_i Q_i^{-1} \quad (4.1)$$

$$Q_i = \frac{D_i S_i}{H_i} \quad (4.2)$$

Gas diffusion and solubility coefficients from Table 3.1 and Table 4.1 were used in calculation. Since these coefficients depend on temperature their values were corrected for experimental temperature (22°C). Values of solubility were obtained by interpolation of tabulations and diffusion coefficients were corrected with the following equation [72]:

$$D(T_2) = D(T_1) \frac{T_2 \eta(T_1)}{T_1 \eta(T_2)} \quad (4.3)$$

Noticeable dispersion of the values of gas diffusion coefficients in water obtained from different sources (see Table 4.1) means its low accuracy that also affects the accuracy of SMV permeability calculation. Table 4.2 represents results of calculation and shows average deviation between calculation and experiment equal to 9.1% for CO₂ and about 30% for O₂ and H₂. Taking into account large dispersion of diffusivity values and experimental error (around 8%) it is possible to conclude that agreement between calculation and experiment is satisfactory. The contribution of

membranes and liquid layer in overall mass transfer resistance was also calculated. The resistance in liquid phase is presented in Table 4.2 as a part of overall resistance.

Table 4.1.

Gas diffusion (D) and solubility (S) coefficients in water.

Gas	[73]		[72]		[36]	[73]	[65]
	$D, 10^{-9} \text{ m}^2/\text{s}$ at 20°C	$^*D, 10^{-9} \text{ m}^2/\text{s}$	$D, 10^{-9} \text{ m}^2/\text{s}$ ($T, ^\circ\text{C}$)	$^*D, 10^{-9} \text{ m}^2/\text{s}$	$D, 10^{-9} \text{ m}^2/\text{s}$ at 22°C	$S, \text{ m}^3/(\text{m}^3 \cdot \text{atm})$	$S, \text{ m}^3/(\text{m}^3 \cdot \text{atm})$
CO ₂	1.77	1.87	1.46 (18)	1.64	1.78	0.822	0.888
O ₂	1.80	1.91	2.6 (25)	2.39	-	0.0299	-
H ₂	5.13	5.43	3.6 (18)	4.04	-	0.0179	-

* values corrected with Eq.4.3 for temperature 22°C.

Calculation shows that resistance in liquid phase is more than 98% for CO₂ and nearly 100% for O₂ and H₂. It means that gas transfer properties of prepared SMV depend almost on properties of liquid phase and it is possible to neglect the contribution of membranes. Last conclusion is important because simplified models of gas transfer in SMV with flowing liquid phase described in Chapter 2 are based on such assumption.

Table 4.2.

The comparison between calculated and experimental of permeability (Q) of SMV with stagnant liquid (liquid phase – distilled water, $H_{liq} = 260 \mu\text{m}$).

Gas	$Q_{exp}, 1/(\text{m}^2 \cdot \text{h} \cdot \text{atm})$	$Q_{calc}^{min}, 1/(\text{m}^2 \cdot \text{h} \cdot \text{atm})$	$Q_{calc}^{max}, 1/(\text{m}^2 \cdot \text{h} \cdot \text{atm})$	$\left \frac{Q_{calc}^{min} + Q_{calc}^{max}}{2Q_{exp}} - 1 \right , \%$	Mass transfer resistance in liquid phase $Q/Q_{liq}, \%$
CO ₂	22.6	18.4	22.6	9.3	>98.2
O ₂	0.670	0.788	0.985	32	>99.6
H ₂	0.896	1.00	1.34	31	>99.9

Developed in Chapter 2 mathematical model allows to calculate non-steady gas transfer in SMV.

Fig.4.1 shows calculated and experimental CO₂ flux through SMV with stagnant water.

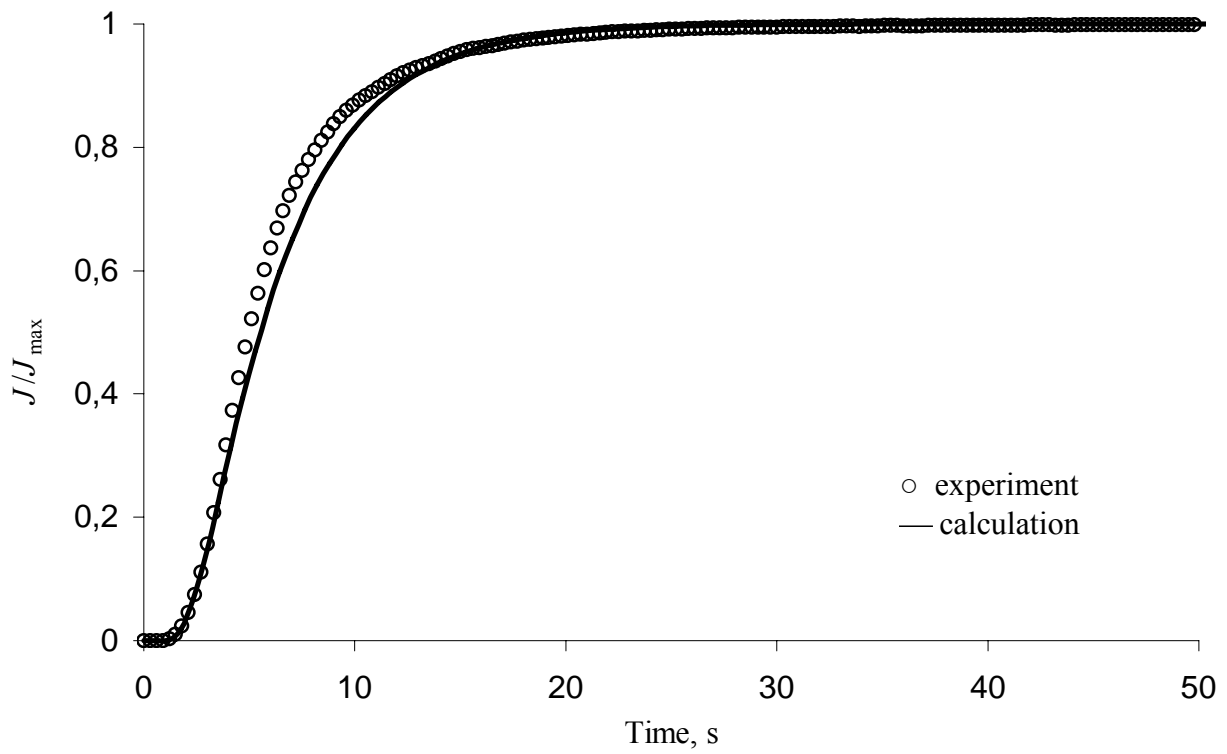

Fig. 4.1. Non-steady flux of CO₂ in SMV with stagnant liquid layer (distilled water, $H_{liq} = 260 \mu\text{m}$).

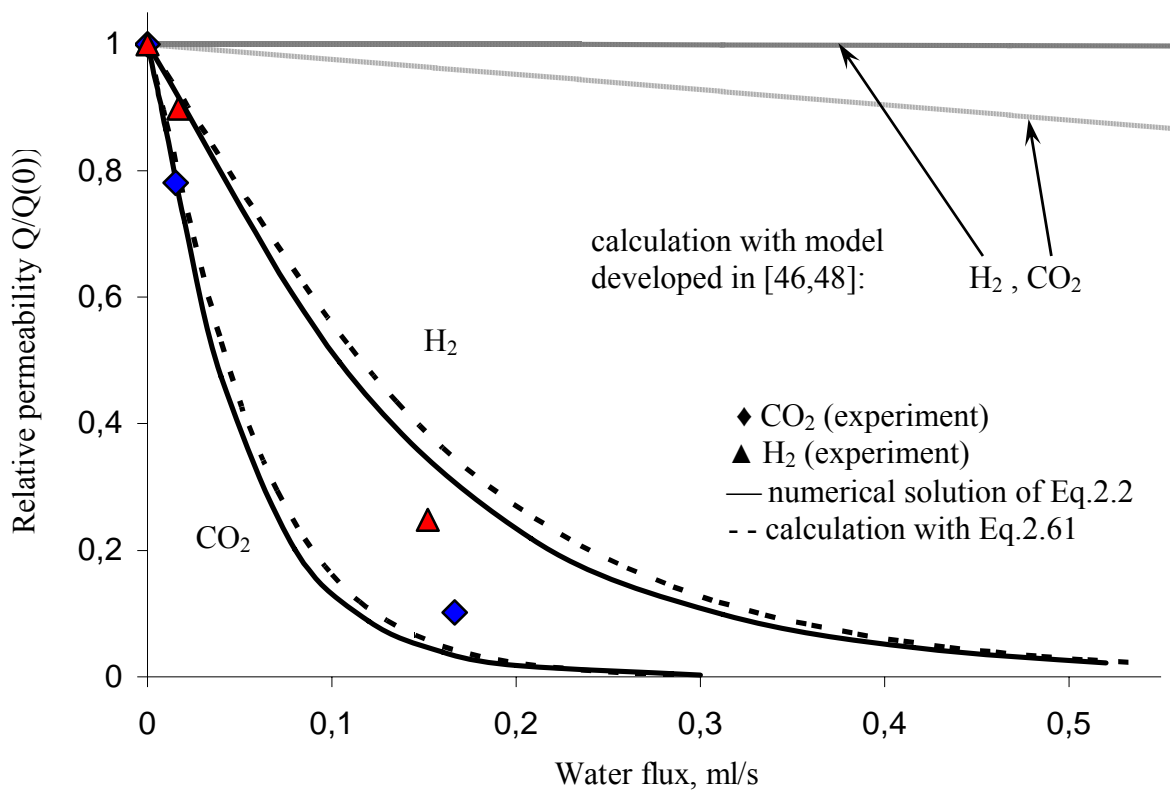

Fig. 4.2. Permeability of SMV with water in flow-through mode ($H_{liq} = 260 \mu\text{m}$, $T = 22^\circ\text{C}$).

These dependencies are well correlated that proves relevance of developed model for the case of physical sorption in liquid.

Permeability of SMV with moving liquid was investigated in flow-through and circulating operating modes. Fig.4.2 demonstrates the dependence of SMV permeability on liquid flux in flow-through mode (liquid supplied to SMV is pure) for CO₂ and H₂. Values of permeability are normalized on permeability of SMV with stagnant liquid. Theoretical dependencies calculated by numerical solution of Eq.2.2 and using simplified model (Eq.2.61) well correlate as between each other as with experimental results that proves possibility of utilization of both models for this case. Using of average diffusion coefficients (Table 4.1) can explain some deviation between calculation and experiment. Dependencies obtained using another model of gas transfer in SMV are also presented in Fig.4.2. Another model proposed in [46, 48] assumes active mixing of liquid phase across liquid channel. Big difference between these dependencies and others means that assumptions of gas transfer in liquid phase to be used in model are very important.

Decreasing of SMV permeability with increasing of liquid flux in flow-through mode is caused by limited gas diffusion speed during the saturation of pure inflow liquid. For this reason gas concentration gradient near second membrane decreases at high liquid fluxes that is demonstrated in Fig.4.3(a,b). This figure shows the distribution of CO₂ concentration in liquid phase that was obtained during numerical solution of differential equation (2.2) with respective boundary conditions using developed software.

In contrast to flow-through mode SMV permeability in circulating mode increases at higher liquid fluxes (Fig.4.4) because liquid at inlet is partially saturated. At steady state gas concentration in liquid at inlet is equal to average concentration. Increasing of liquid flux leads to expansion of average gas concentration zone and gas concentration gradient near second membrane increases that is clearly seen in Fig.4.5. Theoretical dependencies shown in the picture demonstrate the same behavior but the agreement between calculation and experiment is satisfactory only in case of numerical solution of differential equation.

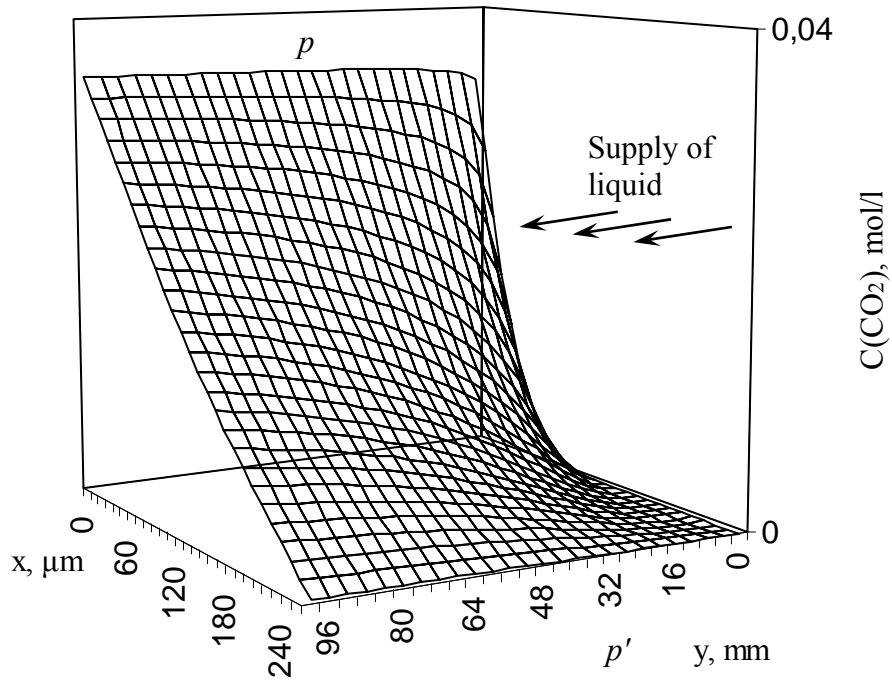

Fig. 4.3(a). The distribution of CO₂ concentration in liquid phase (water) of SMV in flow-through mode at liquid flux 0.05 ml/s ($H_{liq} = 260 \mu\text{m}$, $T = 22^\circ\text{C}$).

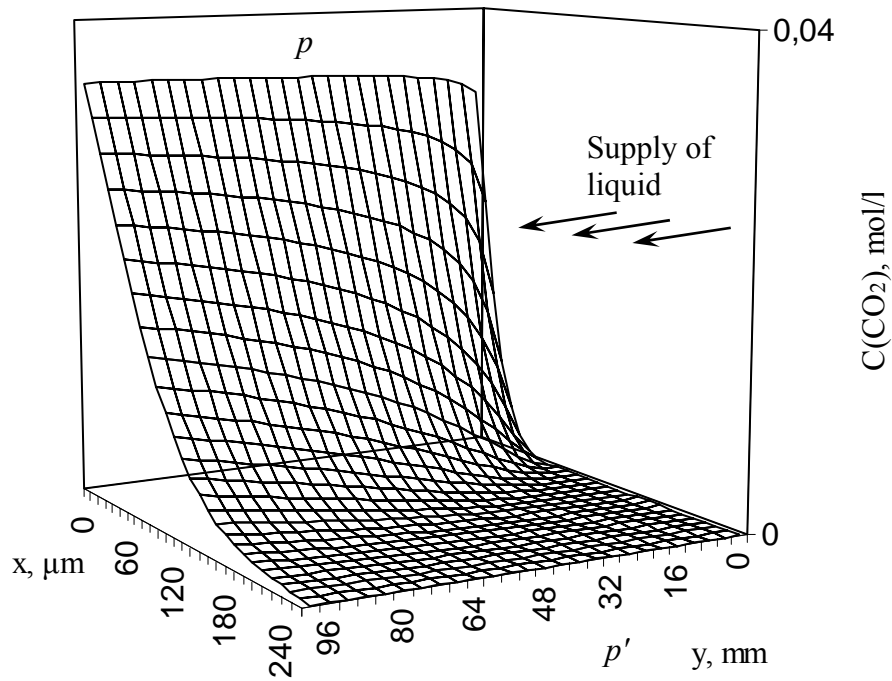

Fig. 4.3(b). The distribution of CO₂ concentration in liquid phase (water) of SMV in flow-through mode at liquid flux 0.2 ml/s ($H_{liq} = 260 \mu\text{m}$, $T = 22^\circ\text{C}$).

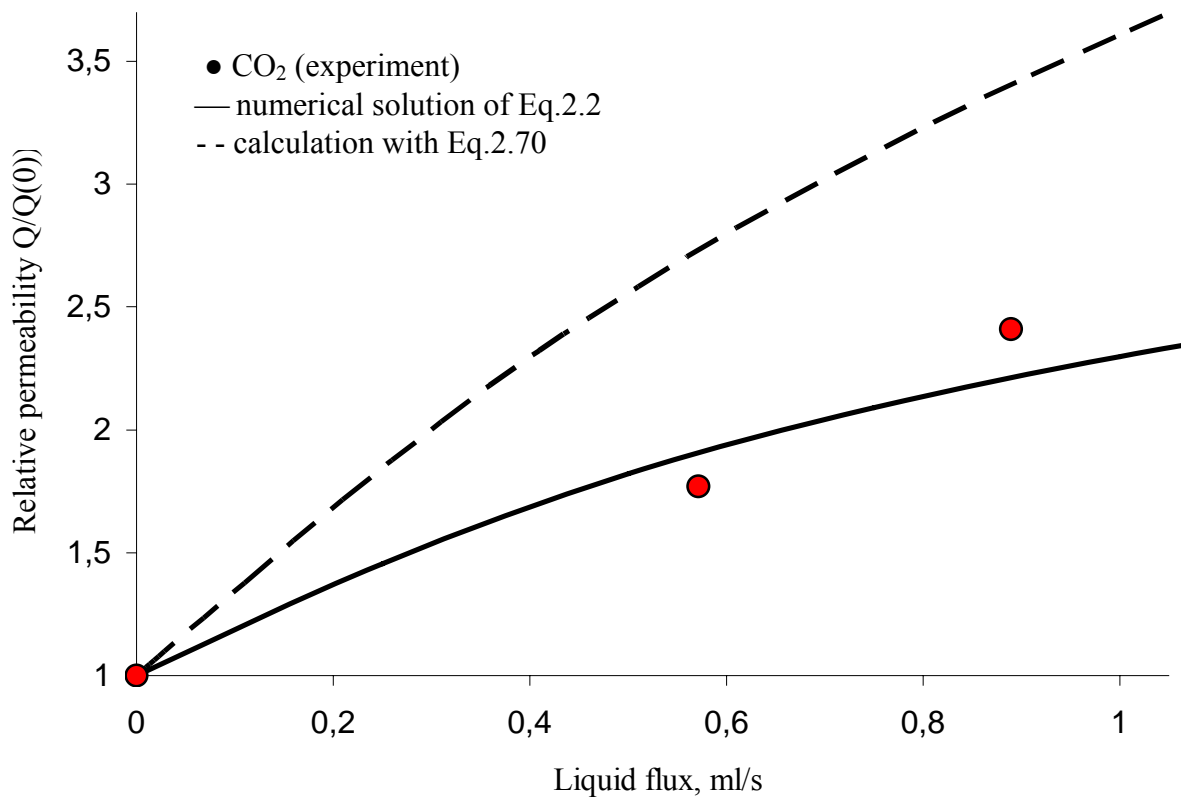

Fig. 4.4. Permeability of SMV with water in circulating mode ($H_{liq} = 210 \mu\text{m}$, $T = 22^\circ\text{C}$).

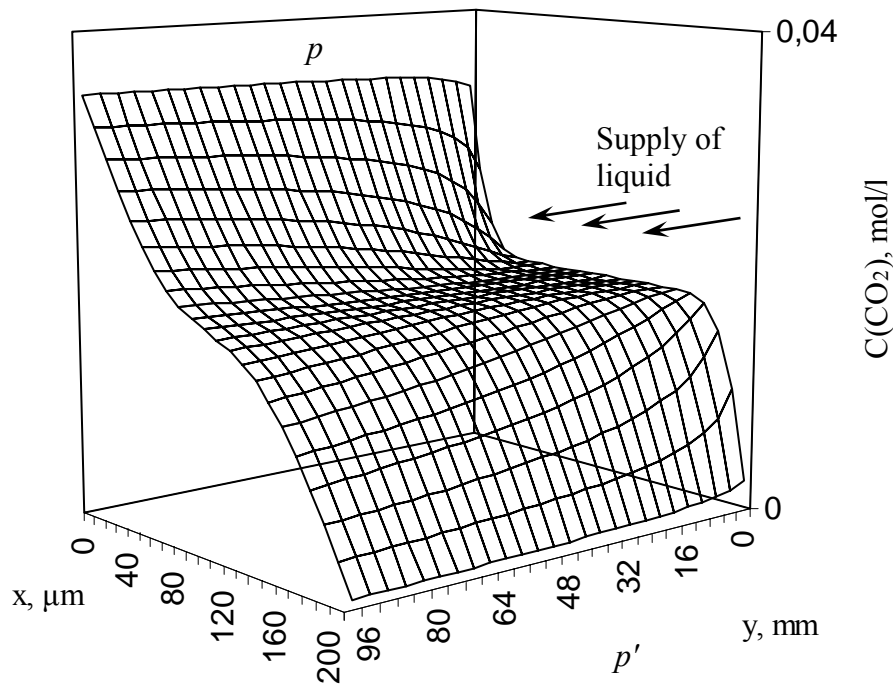

Fig. 4.5. The distribution of CO_2 concentration in liquid phase (water) of SMV in circulating mode at liquid flux 0.8 ml/s ($H_{liq} = 210 \mu\text{m}$, $T = 22^\circ\text{C}$).

4.2. SMV with chemical sorption in liquid phase.

The transfer of CO₂ in SMV with aqueous K₂CO₃ (chemical absorbent of CO₂) was studied. As a result of non-linear sorption isotherm of CO₂ in potassium carbonate solution (Fig.4.6) [74] using of the concept "permeability" is not correct because of normalization on gas partial pressure drop. From Fig.4.6 one can see that the same pressure drop Δp can give different driving force ΔC and therefore different gas flux. This means that SMV permeability (as permeability of a liquid membrane with chemical absorbent) depends on experimental conditions i.e. values of gas partial pressure on both sides of SMV.

Non-steady CO₂ transfer in SMV was studied at room temperature with different concentration of K₂CO₃ in solution. Fig.4.7 represents theoretical and experimental dependencies which show significant increasing of the time of non-steady state compared to pure water (Fig.4.1). This is the result of CO₂ consumption by non-saturated K₂CO₃ solution during its diffusion through liquid layer. The more concentration of the solution the more time is needed for its saturation. For non-reacting gases this effect is absent. Theoretical dependencies were obtained by numerical solution of differential equation system (2.33) with developed software. They show more fast increasing of CO₂ flux compared to experimental. Two explanations can be suggested: first, the influence of heating during CO₂ absorption in non-saturated solution; second, non-equilibrium conditions in gas-membrane and membrane-liquid interfaces of first membrane because of high absorption flux of CO₂ that leads to membrane permeability decreasing [75].

Slow increase of the CO₂ flux on permeate side can be used for gas mixture separation in non-steady state conditions. When using the SMV with 1 mol/l solution during the first 100 seconds CO₂ flux is negligibly small and extraction of pure second component is possible.

The computer program for calculation of CO₂ transfer in K₂CO₃ solutions, created in the frame of the work, allows calculating the concentration profiles of reacting species in liquid layer. Fig.4.8(a) shows the distribution of CO₂ concentration at initial moment ($t \sim 0$) and at steady state ($t \rightarrow \infty$) that confirms high CO₂ flux (high concentration gradient) near first membrane at initial moment.

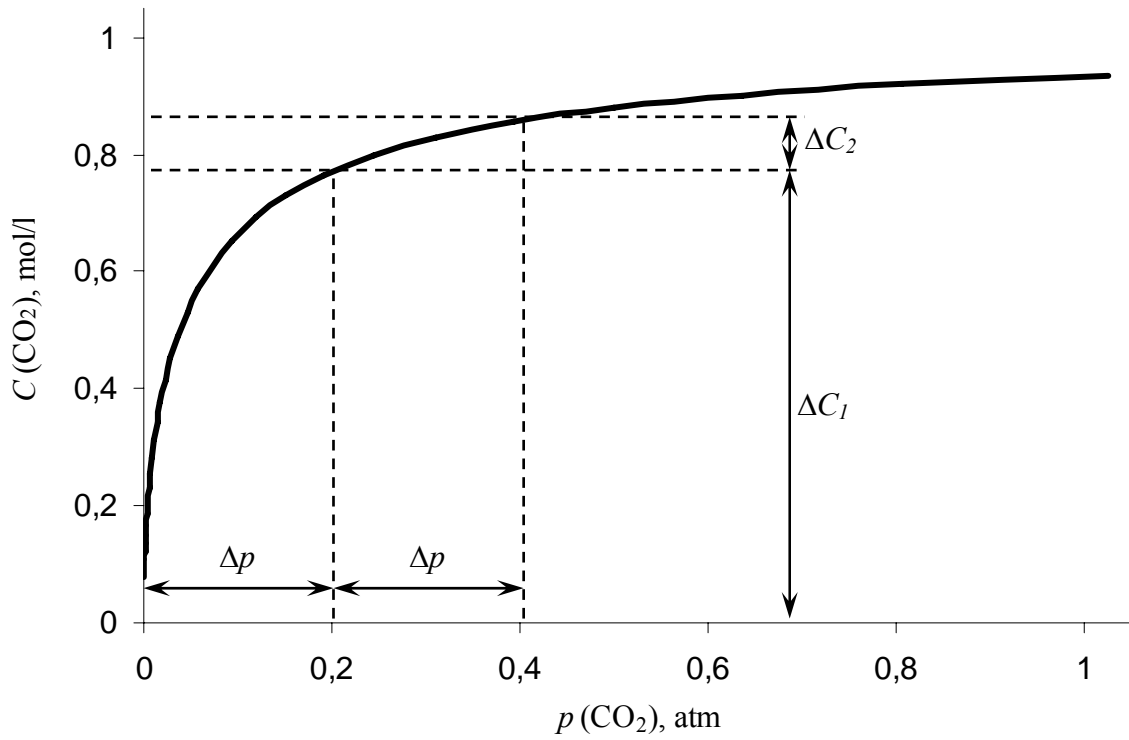

Fig. 4.6. CO₂ sorption isotherm in K₂CO₃ aqueous solution [74]
 ($C(\text{K}_2\text{CO}_3) = 1 \text{ mol/l}$, $T = 60^\circ\text{C}$).

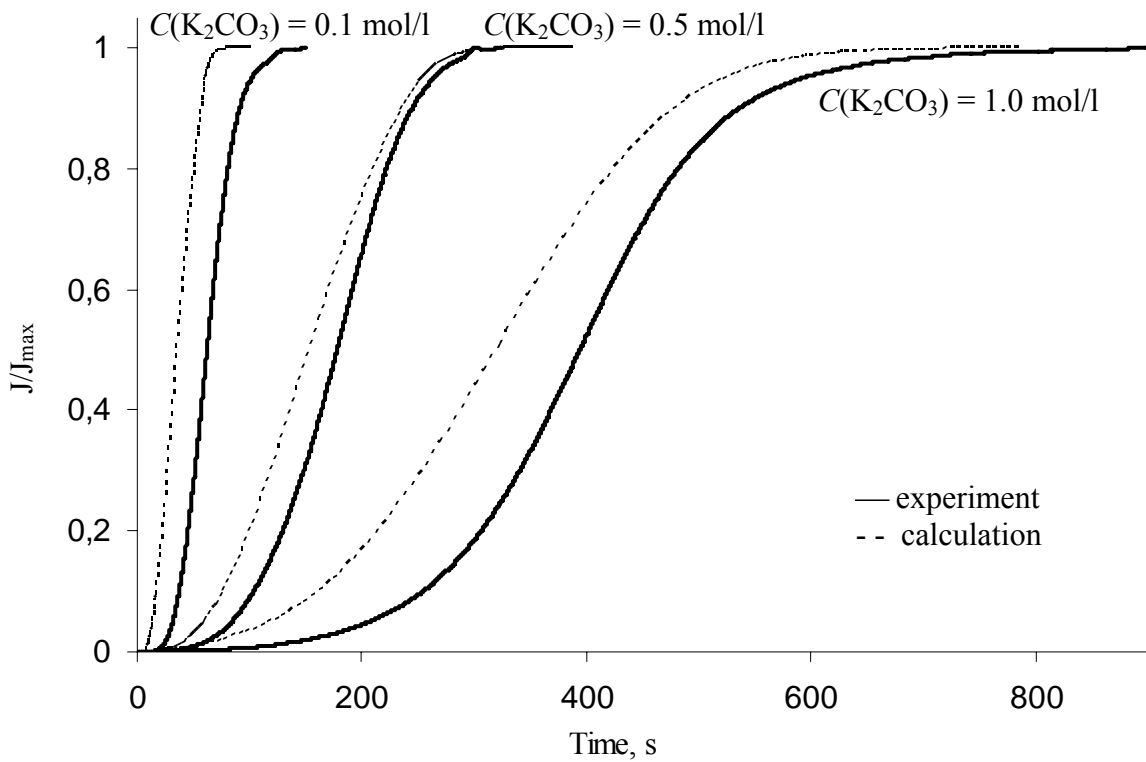

Fig. 4.7. Non-steady CO₂ flux in SMV with aqueous K₂CO₃
 ($H_{liq} = 260 \mu\text{m}$, $T = 22^\circ\text{C}$).

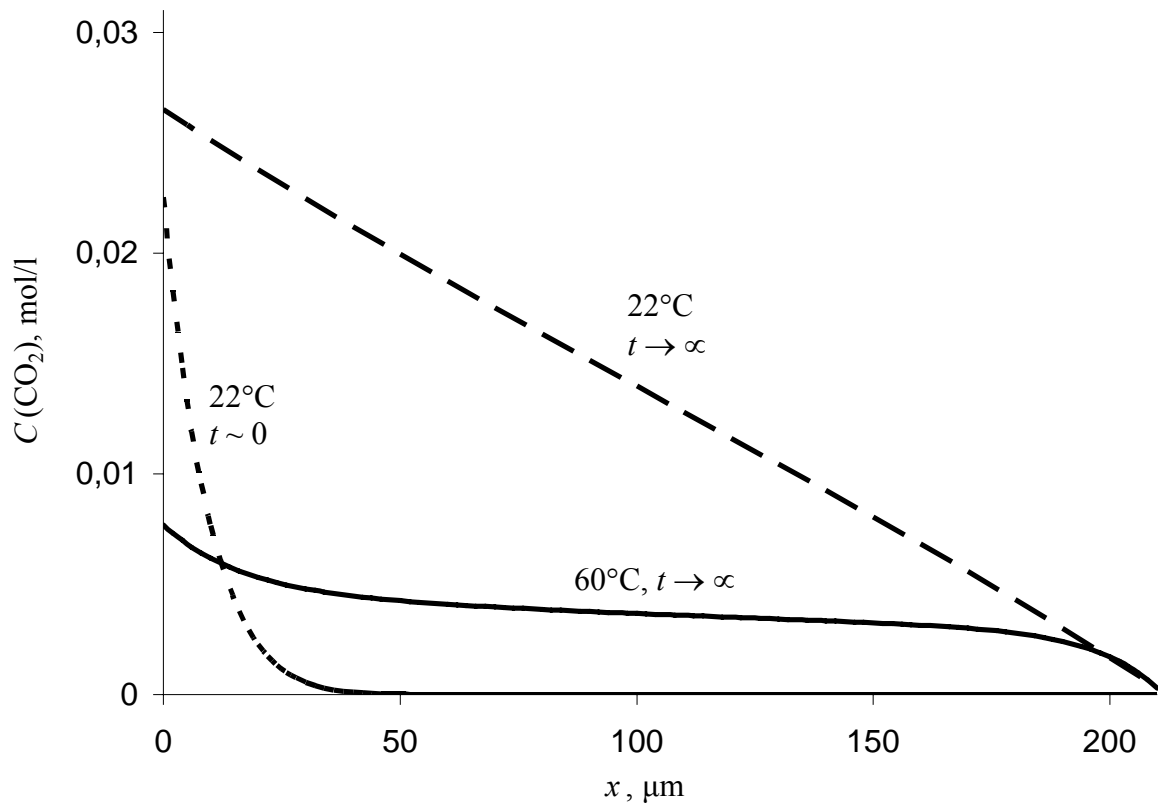

Fig. 4.8(a). Theoretical distribution of CO₂ concentration in SMV liquid phase at 22 and 60°C at initial moment and at steady state ($C(K_2CO_3) = 1 \text{ mol/l}$, $H_{liq} = 210 \text{ } \mu\text{m}$).

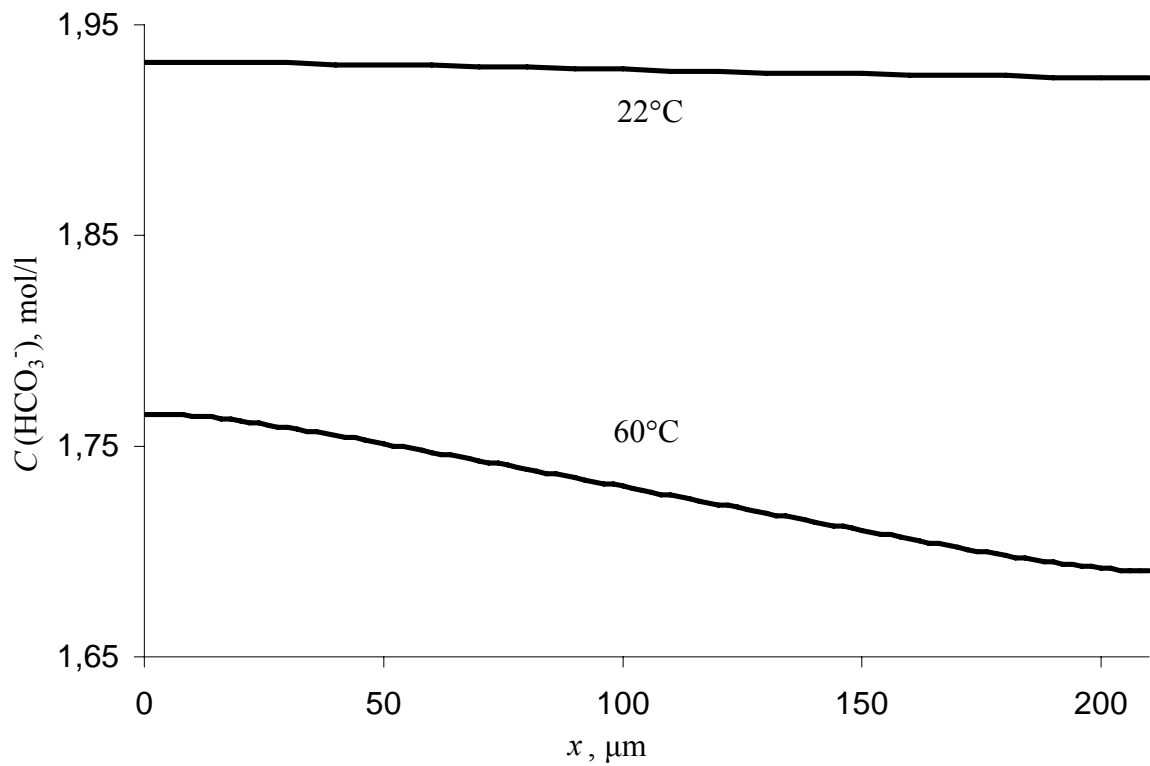

Fig. 4.8(b). Theoretical distribution of HCO₃⁻ concentration in SMV liquid phase at 22 and 60°C at steady state ($C(K_2CO_3) = 1 \text{ mol/l}$, $H_{liq} = 210 \text{ } \mu\text{m}$).

Theoretical and experimental study of temperature and K_2CO_3 concentration influence on CO_2 transfer in SMV was carried out. Absolute pressure in gas phases was equal to atmospheric pressure therefore at temperatures 60 and 80°C CO_2 partial pressure in first gas phase was significantly reduced by water vapor pressure which is equal to 1.99×10^4 and 4.74×10^4 Pa respectively [72].

At room temperature (22°C) CO_2 flux decreases when potassium carbonate concentrations increases (Fig.4.9). This is the result of salting-out effect (decreasing of diffusion and solubility (in molecular form) coefficients at higher salt concentration) and small contribution of facilitated transport due to slow chemical reactions rate. Increasing of temperature clearly raises the rate of chemical reactions and therefore CO_2 flux increases significantly (Fig.4.9). A strong dependence of CO_2 flux on K_2CO_3 concentration and temperature is observed in the initial range, and a maximum is reached afterwards. This is the result of significant improvement of CO_2 facilitated transport because of higher reaction rate at high temperatures. Fig.4.8(b) demonstrates that CO_2 flux in chemical form (as HCO_3^- ion) at 60°C is much higher than at 22°C.

The good agreement between model predictions and experimental results shown in Fig.4.9 should be stressed, especially when one takes into account the large temperature and concentration range which has been covered. The raising of temperature up to 110°C (typical temperature in industrial absorption process of CO_2 recovery with hot potassium carbonate), addition of reaction promoters such as amines or arsenides (as in industrial CO_2 recovery processes) undoubtedly can significantly improve system productivity.

At the same time, the dependence of the flux of non-reacting gases such as H_2 and O_2 on potassium carbonate concentration is similar to CO_2 flux dependence at room temperature. Increasing of temperature has no noticeable effect on the flux of these gases (Fig.4.11). The result of this contrary behavior at high temperature of reacting and non-reacting gases induces a considerable rise of CO_2/H_2 and CO_2/O_2 selectivity. More specifically, at 60°C, CO_2/H_2 selectivity is 210 (at 3 mol/l concentration of K_2CO_3) that is 20 times higher than selectivity of pure water and about 2 orders higher than selectivity of high permeable polymeric membranes.

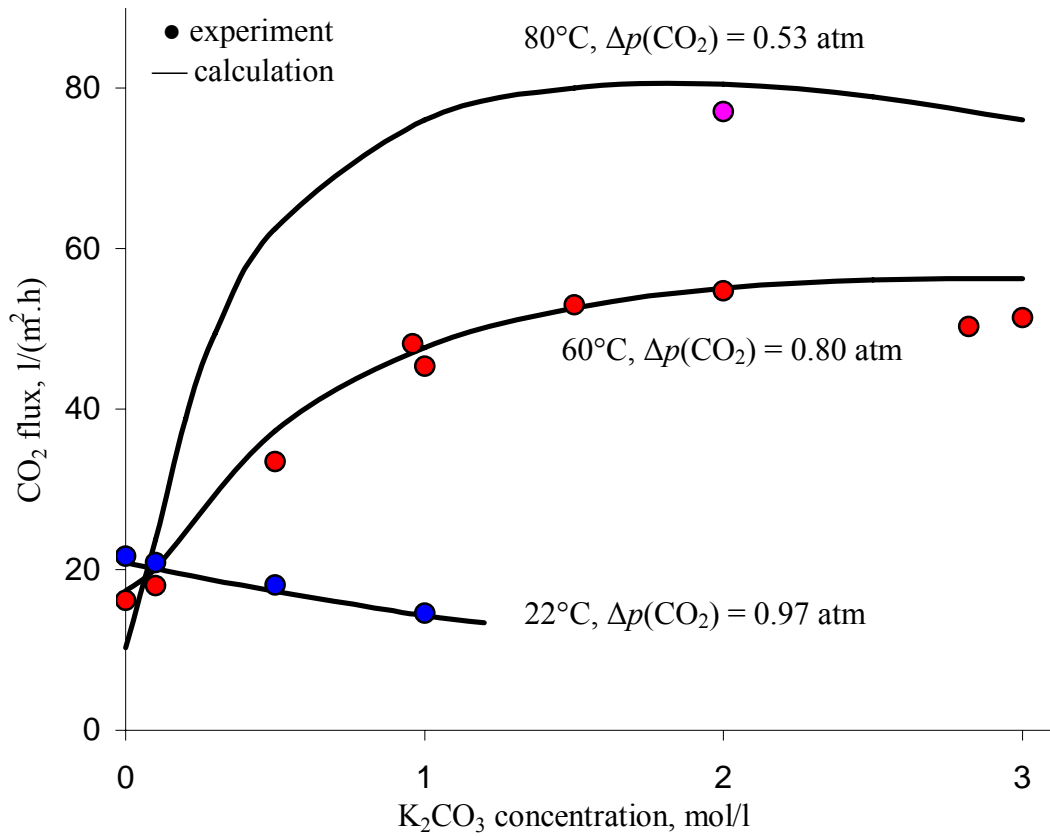

Fig. 4.9. The comparison of theoretical and experimental dependencies of CO₂ flux through SMV with aqueous K₂CO₃ ($H_{liq} = 210 \mu\text{m}$).

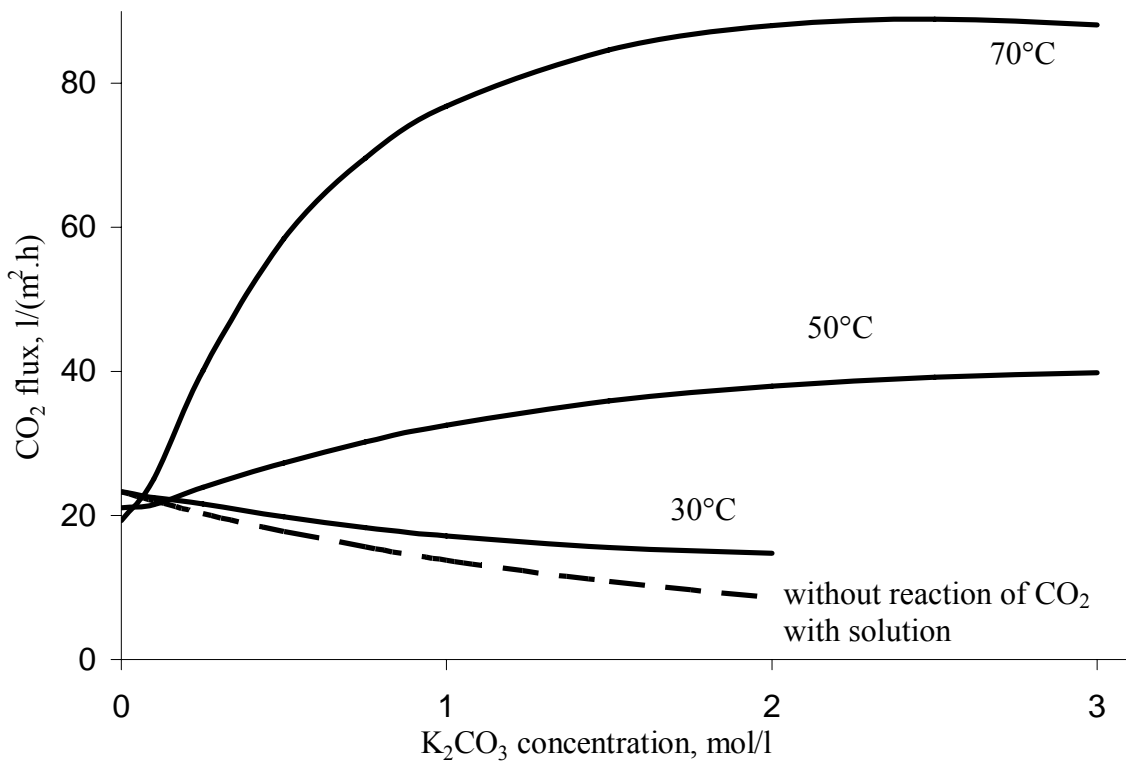

Fig. 4.10. Theoretical dependencies of CO₂ flux through SMV at different temperatures ($H_{liq} = 210 \mu\text{m}$, $\Delta p(\text{CO}_2) = 1 \text{ atm}$).

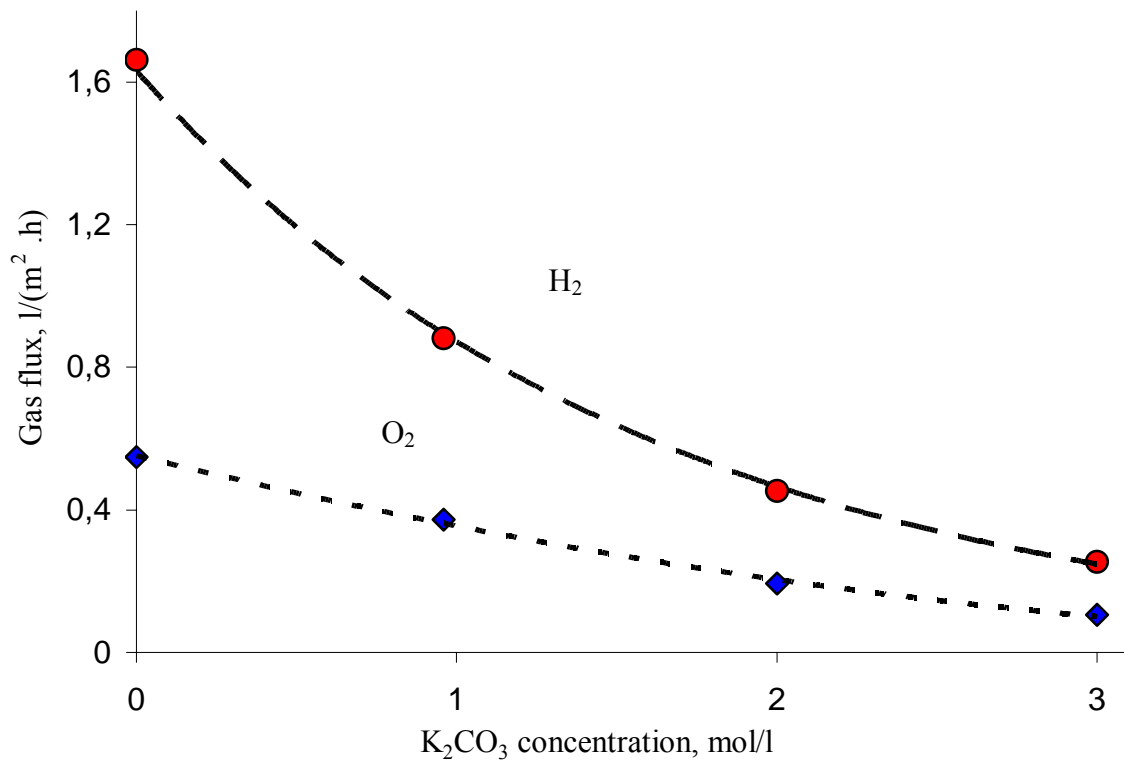

Fig. 4.11. The dependence of H₂ and O₂ fluxes through SMV on K₂CO₃ concentration at 60°C ($h_{liq} = 210 \mu\text{m}$, $\Delta p = 0.8 \text{ atm}$).

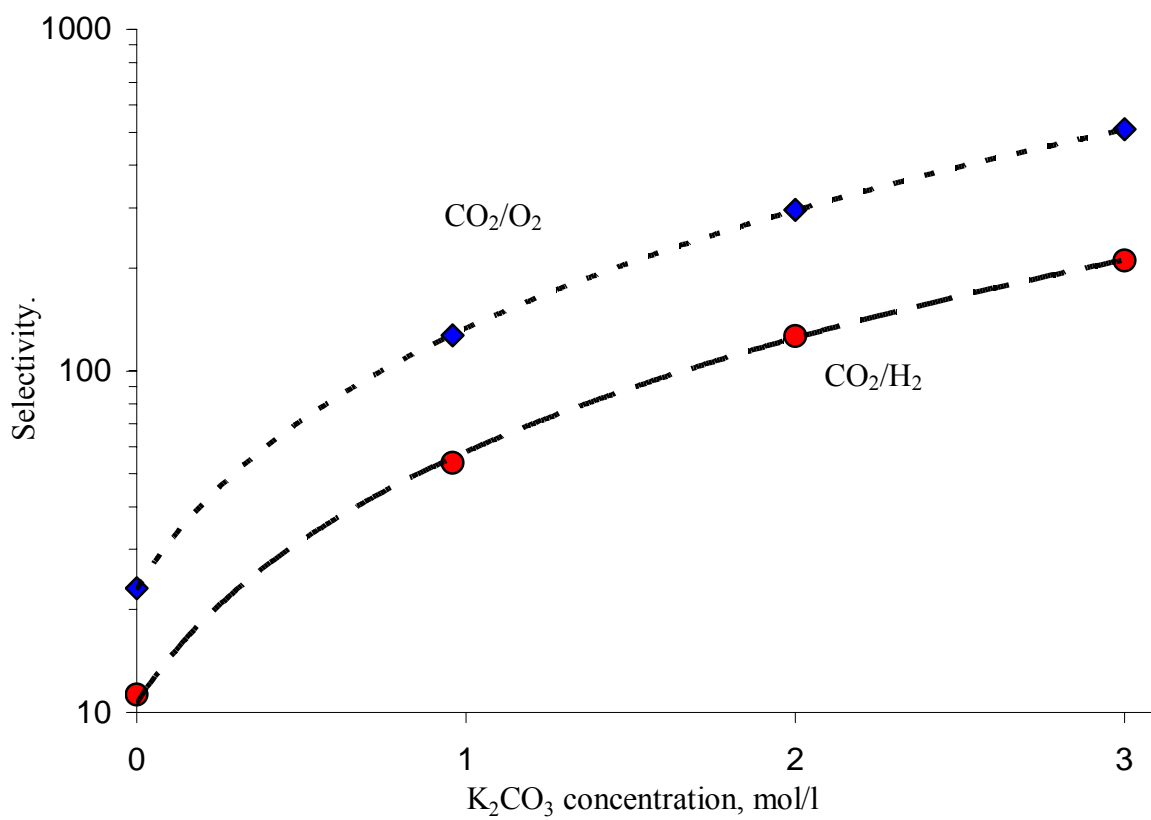

Fig. 4.12. The dependence of SMV selectivity on K₂CO₃ concentration at 60°C ($h_{liq} = 210 \mu\text{m}$, $\Delta p = 0.8 \text{ atm}$).

Maximal selectivity observed for CO₂/O₂ was 500 (T=60°C, C(K₂CO₃)=1 mol/l). In work [15] the selectivity of ILM for the same pair of gases was 1500 (room temperature, 6.4N Cs₂CO₃ solution) or 4100 (room temperature, 6.4N Cs₂CO₃ solution + NaAsO₂) when CO₂ concentration in feed was less than 5%. It is important to note that almost all data presented in Table 1.1 was obtained at low CO₂ partial pressure in feed stream. At the same time in a number of works [10, 11, 20, 22-24] it was shown that permeability (or permeability coefficient) and selectivity of ILMs significantly increase if reacting gas partial pressure is low in feed stream.

For example results of work [20] show that increasing of CO₂ partial pressure drop from 11.65 to 126.5 cmHg leads to decreasing of permeability coefficient from 482×10⁻⁹ to 97.4×10⁻⁹ cm³·cm/(cm²·s·cmHg) and selectivity CO₂/N₂ from 276 to 56. Authors of work [24] have found that CO₂ permeability coefficient and CO₂/CH₄ selectivity of ILM with aqueous MEA solution (2 mol/l) decreases in 10 times when CO₂ partial pressure in feed stream increases from 4.6 to 98 kPa. These examples show that comparison of gas separation properties of LMs with chemical absorbents is difficult task and values of permeability coefficient and selectivity don't fully describe characteristics even of single LM.

In most of works dedicated to ILMs CO₂/N₂ gas mixture was used. The calculation based on data from [72, 73] shows that N₂ flux in SMV with water should be about 2.37 times lower than O₂ flux. Evaluative calculation of selectivity of SMV with aqueous K₂CO₃ (3 mol/l) at 60°C gives value 500×2.37=1185 for pair of gases CO₂/N₂. This value is higher than for ILM studied in works [20, 22] and in 3 and 5 times lower than obtained in works [10] and [11] respectively. At the same time in this work CO₂ partial pressure in feed was 0.8 atm at 60°C that seems to be more close to real conditions of separation for example of biogas [76]. SMV permeability coefficient $P(\text{CO}_2) = 4.8 \times 10^{-7}$ cm³·cm/(cm²·s·cmHg) that is approximately equal to ILM one described in works [20] and [11] where CO₂/N₂ selectivity was 276 and 5830 respectively.

Thus it is shown that SMV with aqueous K₂CO₃ at high (>60°C) temperature provides high permeability and selectivity for CO₂ recovery from different gas mixtures.

It is important to note that raising of temperature and solution concentration leads to a simultaneous increasing of permeability and selectivity of membrane system that is generally speaking an exception in membrane technology. Such a great separation property can also be achieved using LM with aqueous potassium carbonate but the stability of LMs usually is low. Indeed the liquid evaporation leads to the degradation of LM that will be especially quick at high temperatures. SMV allows to renew the liquid during its pumping and therefore to keep the time stability of the membrane system.

The study of CO₂ flux through SMV in flow-through mode shows a quick decrease in the presence of K₂CO₃ (Fig.4.13). This is the result of the reaction of CO₂ with "pure" carbonate solution during its transfer. A good correlation between the model predictions and experimental data is observed. Increasing of K₂CO₃ concentration and liquid flux can completely block CO₂ transfer through SMV. At the same time the permeability of other gases does not fall so dramatically. At high liquid fluxes it is even possible to achieve the inversion of selectivity when H₂ or O₂ permeability is higher than CO₂ one.

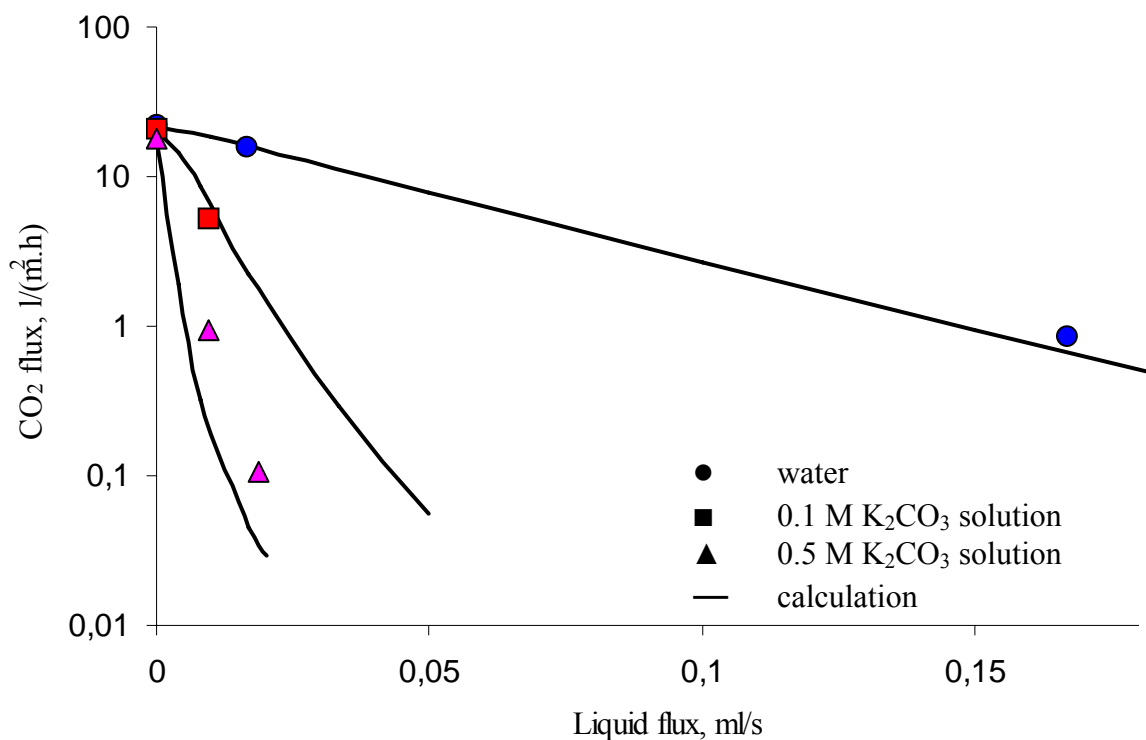

Fig. 4.13. The dependence of CO₂ flux in SMV on liquid flux and K₂CO₃ concentration ($h_{liq} = 260 \mu\text{m}$, $\Delta p_{CO_2} = 0.97 \text{ atm}$).

Conclusion

1. Gas separation characteristics of selective membrane valve (SMV) have been studied. It was shown the possibility gas transfer control by variation of operating parameters (temperature, absorbent concentration, liquid flux and operating mode) that characterize SMV as a "flexible" separation gas-liquid membrane system. Permeability and selectivity of SMV can be changed within a wide range that allows to carry out optimization of separation process for particular task.
2. An original construction of SMV-module was designed. This construction allows to form thin (from 50 μ m) flat liquid channels between membranes without a spacer in permeation zone and allows to carry out the study of non-steady gas transfer in SMV.
3. It was shown that at high ($\geq 60^{\circ}\text{C}$) temperature SMV with aqueous K_2CO_3 has high selectivity ($\alpha_{\text{CO}_2/\text{H}_2} > 200$, $\alpha_{\text{CO}_2/\text{O}_2} > 500$) and CO_2 permeability ($Q > 75 \text{ l/m}^2\cdot\text{h}\cdot\text{atm}$) that allows effectively separate CO_2 -containing gas mixtures.
4. Mathematical model of gas transfer in SMV with chemical absorption in liquid phase at laminar flow regime without mixing was developed for the first time. It was shown that the software based on developed model can be used for calculation of CO_2 transfer in SMV with aqueous K_2CO_3 in wide range of temperatures and concentrations. The software allows algorithm modification for calculation of gas transfer in other gas-liquid membrane systems.

Perspectives

Following directions of the future work can be suggested:

- the study of SMV potential for real separation of gas mixtures i.e. operation with high concentration gradient of gas mixture components at inlet and outlet of SMV;
- the study of influence of different chemical reaction promoters and effect of turbulence promoter in flowing liquid phase;
- the application of the developed model and software for prediction of transport parameters and separation properties of SMV with different chemical absorbents that could be used for separation of other gas mixtures (for example AgNO_3 solution for ethane/ethylene separation);
- the study of separation of three component gas mixtures by SMV working with desorber for regeneration of a liquid.

Acknowledgements

The study in collaboration was supported by French Embassy in Moscow and CNRS. Financial support of the work was provided by Grant PICS 3303, Grant RFBR-CNRS 05-03-22000 and Integrated Project n°019825-(SES6) "HYVOLUTION". I wish to thank my parents for their help and support, Vladimir Teplyakov and Valery Khotimskii for providing the study in collaboration, Denis Roizard and Eric Favre for their help and kind attitude when I was far from my home and all my friends and colleagues from Russia, France, Spain and Colombia.

Abbreviations:

GLMS – gas-liquid membrane system
LM – liquid membrane
MC – membrane contactor
SMV – selective membrane valve
PDMS – poly-(dimethylsiloxane)
PTFE – poly-(tetrafluoroethylene)
PVTMS – poly-(vinyltrimethylsilane)
MEA – monoethanolamine
DEA – diethanolamine
TEA – triethanolamine
MDEA – methyldiethanolamine

Nomenclature:

B width [m]
 C concentration [kmol/m³]
 D diffusion coefficient [m²/s]
 H thickness [m]
 J flux [kmol/s]
 K chemical reaction equilibrium constant
 L length [m]
 p partial pressure [Pa]
 Q permeability [kmol/(m²·s·Pa)]
 R component consumption rate [kmol/(m³·s)]
 S solubility coefficient [kmol/(m³·Pa)]
 t time [s]
 T temperature [K]
 V velocity [m/s]
 x transverse coordinate [m]
 y longitudinal coordinate [m]

Indice:

0 boundary
aver average
max maximal
min minimal
gas gas
mem membrane
liq liquid
i component
G volatile component
L non-volatile component

Publications

1. V.V.Tepliyakov, L.G.Gasanova, A.Yu.Okunev, M.G.Shalygin, V.Usachov, N.I.Laguntsov, Gas/Vapour Separation Contactors based on Non-porous Membranes: Experience and Application Potential, Proceedings of Euromembrane-2004, September 2004, Hamburg, Germany, p. 189.
2. M.G.Shalygin, E.V.Vorobieva, V.V.Tepliyakov, The study of gas transfer parameters in selective membrane valve, Proceedings of Russian Scientific Conference MEMBRANES-2004, October 2004, Moscow-Klyazma, Russia, p. 211 (In Russian).
3. M.Shalygin, E.Vorobieva, V.Tepliyakov, Selective membrane valve for gas separation, Proceedings of 36th Nancy-Karlsruhe Seminar, June 2005, Nancy-Ventron, France, p. 28.
4. M.Shalygin, CO₂ recovery using selective membrane valve (SMV), Proceedings of 2nd French-Russian Seminar PICS, June 2005, Nancy, France, p. 14.
5. M.G.Shalygin, E.V.Vorobieva, V.V.Tepliyakov, Gas transport studying in combined membrane system with moving liquid carrier, Proceedings of Membrane Science and Technology Conference of Visegrad Countries PERMEA 2005, September 2005, Poland, 66-67.
6. M.Shalygin, V.Tepliyakov, D.Roizard, E.Favre, CO₂ recovery using selective membrane valve with aqueous potassium carbonate as a carrier. Influence of temperature on separation properties, Proceedings of International Conference «Mempro-3», April 2006, Nancy, France, P64-1.
7. M.G.Shalygin, A.Yu.Okunev, D.Roizard, E.Favre, V.V.Tepliyakov, Gas permeability of combined membrane system with mobile liquid carrier, Colloid Journal 68, #4 (2006) 566-574 (In Russian).
8. M.Shalygin, V.Tepliyakov, D.Roizard, E.Favre, CO₂ transport study in combined membrane system with aqueous potassium carbonate as a liquid carrier, Desalination 200 (2006) 106-108.
9. M.Shalygin, Supported liquid membrane with aqueous potassium carbonate for separation of CO₂/H₂ gas mixture, Proceedings of 3rd French-Russian Seminar PICS, October 2006, Moscow, Russia, p. 21.
10. M.G.Shalygin, E.V.Vorobieva, V.V.Tepliyakov, Gas transport in combined membrane system with moving liquid carrier, Separation and Purification Technology, In Press, Corrected Proof, Available online at www.sciencedirect.com 16 July 2006.

References

- [1] Дытнерский Ю.И., Брыков В.П., Каграманов Г.Г., Мембранное разделение газов. М.: Химия, 1991, 344.
- [2] R.Prasad, F.Notaro, D.R.Thompson, Evolution of membranes in commercial air separation, *J. Membrane Sci.*, 1994, 94, 225-248.
- [3] B.D.Bhide, S.A.Stern, Membrane processes for the removal of acid gases from natural gas. I. Processes configurations and optimization of operating conditions, *J. Membrane Sci.*, 1993, 81, 209-237.
- [4] B.D.Bhide, S.A.Stern, Membrane processes for the removal of acid gases from natural gas. II. Effects of operating conditions, economic parameters, and membrane properties, *J. Membrane Sci.*, 1993, 81, 239-252.
- [5] Мулдер М., Введение в мембранную технологию. М.: Мир, 1999, 513.
- [6] R.W.Baker, Future directions of membrane gas separation technology, *Ind. Eng. Chem. Res.*, 2002, 41, 6, 1393-1411.
- [7] Бекман И.Н., Бессарабов Д.Г., Сандерсон Р.Д., Диффузионные процессы в абсорбционном модуле мембранного контактора, *Вестн. Моск. Ун-та. Сер.2 Химия*, 2000, 41, 4, 266-270.
- [8] M.Mavroudi, S.P.Kaldis, G.P.Sakellaropoulos, Reduction of CO₂ emissions by a membrane contacting process, *Fuel*, 2003, 82, 2153-2159.
- [9] L.M.Robeson, Correlation of separation factor versus permeability for polymeric membranes, *J. Membrane Sci.*, 1991, 62, 165.
- [10] H.Chen, A.S.Kovvali, S.Majumdar, K.K.Sirkar, Selective CO₂ separation from CO₂-N₂ mixtures by immobilized carbonate-glycerol membranes, *Ind. Eng. Chem. Res.*, 1999, 38, 3489-3498.
- [11] H.Chen, G.Obuskovic, S.Majumdar, K.K.Sirkar, Immobilized glycerol-based liquid membranes in hollow fibers for selective CO₂ separation from CO₂-N₂ mixtures, *J. Membrane Sci.*, 2001, 183, 75-88.
- [12] B.D.Freeman, Basis of permeability/selectivity tradeoff relations in polymeric gas separation membranes, *Macromolecules*, 1999, 32, 375-380.
- [13] Alan Gabelman, Sun-Tak Hwang, Hollow fiber membrane contactors, *J. Membrane Sci.*, 1999, 159, 61-106.
- [14] M.Teramoto, H.Matsuyama, T.Yamashiro, S.Okamoto, Separation of ethylene from ethane by a flowing liquid membrane using silver nitrate as a carrier, *J. Membrane Sci.*, 1989, 45, 1-2, 115-136.
- [15] W.J.Ward, W.L.Robb, Carbon dioxide-oxygen separation: facilitated transport of carbon dioxide across a liquid film, *Science*, 1967, 156, 1481-1484.
- [16] N.C.Otto, J.A.Quinn, The facilitated transport of carbon dioxide through bicarbonate solutions, *Chem. Eng. Sci.*, 1971, 26, 6, 949-961.
- [17] S.R.Suchdeo, J.Schultz, The permeability of gases through reacting solutions: the carbon dioxide-bicarbonate membrane system, *Chem. Eng. Sci.*, 1974, 29, 1, 13-23.
- [18] L.L.Kemena, R.D.Noble, N.J.Kemp, Optimal regimes of facilitated transport, *J. Membrane Sci.*, 1983, 15, 259-274.

- [19] O.A.Basaran, P.M.Burban, S.R.Auvil, Facilitated transport with unequal carrier and complex diffusivities, *Ind. Eng. Chem. Res.*, 1989, 28, 108.
- [20] Asim K.Guha, Sudipto Majumdar, Kamalesh K.Sirkar, Facilitated transport of CO₂ through an immobilized liquid membrane of aqueous diethanolamine, *Ind. Eng. Chem. Res.*, 1990, 29, 2093-2100.
- [21] M.Teramoto, Approximate solution of facilitated factors in facilitated transport, *Ind. Eng. Chem. Res.*, 1994, 33, 9, 2161.
- [22] A.Chakma, Separation of CO₂ and SO₂ from flue gas streams by liquid membranes, *Energy Comers. Mgmt.*, 1995, 36, 6-9, 405-410.
- [23] Samit Saha, Amit Chakma, Selective CO₂ separation from CO₂/C₂H₆ mixtures by immobilized diethanolamine/PEG membranes, *J. Membrane Sci.*, 1995, 98, 157-171.
- [24] M.Teramoto, Q.Huang, T.Watari, Ya.Tokunaga, R.Nakatani, T.Maeda, H.Matsuyama, Facilitated transport of CO₂ through supported liquid membranes of various amine solutions - effects of rate and equilibrium of reaction between CO₂ and amine, *J. Chem. Eng. Japan*, 1997, 30, 2, 328-335.
- [25] A.Alhusseini, A.Ajbar, Mass transfer in supported liquid membranes: a rigorous model, *Mathematical and Computer Modelling*, 2000, 32, 465-480.
- [26] Mohamed Hassan Al-Marzouqi, Kees J. A. Hogendoorn, Geert F. Versteeg, Analytical solution for facilitated transport across a membrane, *Chemical Engineering Science*, 2002, 57, 4817-4829.
- [27] Morales-Cabrera M.A., Perez-Cisneros E.S., Ochoa-Tapia J.A., An approximate solution for the CO₂ facilitated transport in sodium bicarbonate aqueous solutions, *J. Membrane Sci.*, 2005, 256, 98-107.
- [28] W.L.Robb, D.L.Reinhard, US Patent 3,335,545, 1967
- [29] P.F.Scholander, Oxygen transport through haemoglobin solutions, *Science*, 1960, 131, 585.
- [30] A.M.Barbe, P.A.Hogan, R.A.Johnson, -, *J. Membrane Sci.*, 2000, 172, 149.
- [31] P.S.Kumar, J.A.Hogendoorn, P.H.M.Feron, G.F.Versteeg, New absorption liquids for the removal of CO₂ from dilute gas streams using membrane contactors, *Chemical Engineering Science*, 2002, 57, 1639-1651.
- [32] R.Prasad, K.K.Sirkar, Solvent extraction with microporous hydrophilic and composite membranes, *AIChE J.*, 1987, 33, 7, 1057-1066.
- [33] M.A.Leveque, Les lois de la transmission de chaleur par convection, *Ann. Mines*, 1928, 13, 201-299.
- [34] S.R.Wickramasinghe, M.J.Semmens, E.L.Kussler, Mass transfer in various hollow fiber geometries, *J. Membrane Sci.*, 1992, 69, 235-250.
- [35] V.Y.Dindore, D.W.F.Brilman, G.F.Versteeg, Modelling of cross-flow membrane contactors: physical mass transfer processes, *J. Membrane Sci.*, 2005, 251, 209-222.
- [36] Y.Lee, R.D.Noble, B.Yeomb, Y.Park, K.Lee, Analysis of CO₂ removal by hollow fiber membrane contactors, *J. Membrane Sci.*, 2001, 194, 1, 57-67.
- [37] V.Y.Dindore, D.W.F.Brilman, G.F.Versteeg, Modelling of cross-flow membrane contactors: mass transfer with chemical reactions, *J. Membrane Sci.*, 2005, 255, 275-289.
- [38] Окунев А.Ю., Лагунцов Н.И., Селективный массоперенос в мембранном абсорбере, *Инженерно-физический журнал*, 2006, 79, 5, 26-35.

- [39] H.Kreulen, C.A.Smolders, G.F.Versteeg, W.P.M. van Swaaij, Microporous hollow fibre membrane modules as gas-liquid contactors. Part 1. Physical mass transfer processes, *J. Membrane Sci.*, 1993, 78, 197-216.
- [40] H.Kreulen, C.A.Smolders, G.F.Versteeg, W.P.M. van Swaaij, Microporous hollow fibre membrane modules as gas-liquid contactors. Part 2. Mass transfer with chemical reaction, *J. Membrane Sci.*, 1993, 78, 217-238.
- [41] Sujatha Karoor, Kamalesh K. Sirkar, Gas absorption studies in microporous hollow fiber membrane modules, *Ind. Eng. Chem. Res.*, 1993, 32, 674-684.
- [42] Шелёхин А.Б., Тепляков В.В., Бекман И.Н., Математическое описание процессов газопереноса в мембранных абсорберах, *ТОХТ*, 1992, 26, 4, 1-5.
- [43] Бессарабов Д.Г., Бекман И.Н., Модель массопереноса в интегрированных мембранно-абсорбционных газоразделительных системах с подвижным селективным абсорбентом, *Вестн. Моск. Ун-та. Сер.2 Химия*, 1993, 34, 6, 604-611.
- [44] Бекман И.Н., Бессарабов Д.Г., Сандерсон Р.Д., Разделение газовой смеси в абсорбционном модуле мембранного контактора, *Вестн. Моск. Ун-та. Сер.2. Химия*, 2001, 42, 1, 60-66.
- [45] P.S.Kumar, J.A.Hogendoorn, P.H.M.Feron, G.F.Versteeg, Approximate solution to predict the enhancement factor for the reactive absorption of a gas in a liquid flowing through a microporous membrane hollow fiber, *J. Membrane Sci.*, 2003, 213, 231-245.
- [46] I.N.Beckman, D.G.Bessarabov, V.V.Teplyakov, Selective membrane valve for ternary gas mixture separation: model of mass transfer and experimental test, *Ind. Eng. Chem. Res.*, 1993, 32, 2017-2022.
- [47] I.N.Beckman, D.G.Bessarabov, V.V.Teplyakov, A.V.Teplyakov, Integrated membrane systems with moving liquid carriers for multicomponent gas separation, 3rd Int. Conf. Effective Membrane Processes, London, 1993, 297-306.
- [48] Бессарабов Д.Г., Бекман И.Н., Феноменологическая теория селективной газопроницаемости в мембранном затворе, *Вестн. Моск. Ун-та. Сер.2 Химия*, 1993, 34, 2, 194-199.
- [49] Бекман И.Н., Бессарабов Д.Г., Дзелме Ю.Р., Тепляков В.В., Устройство для мембранного разделения газовой смеси, патент №2056148, 1996
- [50] V.Teplyakov, E.Sostina, I.Beckman, A.Netrusov, Integrated membrane system for gas separation in biotechnology: potential and prospects, *World J. of Microbiology & Biotechnology*, 1996, 12, 5, 477-485.
- [51] D.G.Bessarabov, E.P.Jacobs, R.D.Sanderson, I.N.Beckman, Use of nonporous polymeric flat-sheet gas-separation membranes in a membrane-liquid contactor: experimental studies, *J. Membrane Sci.*, 1996, 113, 2, 275-284.
- [52] J.-L.Li, B.-H.Chen, Review of CO₂ absorption using chemical solvents in hollow fiber membrane contactors, *Separation and Purification Technology*, 2005, 41, 109-122.
- [53] V.Y.Dindore, D.W.F.Brilman, F.H.Geuzebroek, G.F.Versteeg, Membrane-solvent selection for CO₂ removal using membrane gas-liquid contactors, *Separation and Purification Technology*, 2004, 40, 133-145.
- [54] K.Nymeijer, T.Visser, R.Assen, M.Wessling, Super selective membranes in gas-liquid membrane contactors for olefin/paraffin separation, *J. Membrane Sci.*, 2004, 232, 107-114.
- [55] K.Li, W.K.Teo, *Separation and Purification Technology*, 1998, 13, 79.
- [56] Справочник азотчика. М.: Химия, 1986,

- [57] Химическая энциклопедия. М.: Советская энциклопедия, 1988, 623.
- [58] Sung-Bum Park, Choon-Sik Shim, Huen Lee, Kew-Ho Lee, Solubilities of carbon dioxide in the aqueous potassium carbonate and potassium carbonate-poly(ethylene glycol) solutions, *Fluid Phase Equilibria*, 1997, 134, 141-149.
- [59] Hirofumi Migita, Kohei Soga, Yasuhiko H.Mori, Gas Absorption in a Wetted-Wire Column, *AIChE Journal*, 2005, 51, 8, 2190-2198.
- [60] M.M.Sharma, P.V.Danckwerts, Fast reactions of CO₂ in alkaline solutions - (a) Carbonate buffers with arsenite, formaldehyde and hypochlorite as catalysts (b) Aqueous monoisopropanolamine (1-amino-2-propanol) solutions, *Chem. Eng. Sci.*, 1963, 18, 729-735.
- [61] Sanjay Bishnoi, Gary T.Rochelle, Absorption of carbon dioxide into aqueous piperazine: reaction kinetics, mass transfer and solubility, *Chem. Eng. Sci.*, 2000, 55, 5531-5543.
- [62] Paul H.M.Feron, Albert E.Jansen, CO₂ separation with polyolefin membrane contactors and dedicated absorption liquids: performances and prospects, *Separation and Purification Technology*, 2002, 27, 231-242.
- [63] I.N.Beckman, Unusual membrane processes: non-steady state regimes, nonhomogeneous and moving membranes. 1994,
- [64] A.H.G.Cents, D.W.F.Brilman, G.F.Versteeg, CO₂ absorption in carbonate/bicarbonate solutions: the Danckwerts-criterion revisited, *Chem. Eng. Sci.*, 2005, 60, 5830-5835.
- [65] P.V.Danckwerts, M.M.Sharma, The absorption of carbon dioxide into solutions of alkalis and amines (with some notes on hydrogen sulphide and carbonyl sulphide), *Chem. Eng.*, 1966, 44, CE244-CE280.
- [66] R.Pohorecki, E.Kucharski, Desorption with chemical reaction in the system CO₂-aqueous solution of potassium carbonate, *Chem. Eng. J.*, 1991, 46, 1-7.
- [67] M.R.Rahimpour, A.Z.Kashkooli, Enhanced carbon dioxide removal by promoted hot potassium carbonate in a split-flow absorber, *Chem. Eng. and Processing*, 2004, 43, 857.
- [68] H.Hikita, S.Asai, T.Takatsuka, Absorption of carbon dioxide into aqueous sodium hydroxide and sodium carbonate and bicarbonate solutions, *Chem. Eng. J.*, 1976, 11, 131-141.
- [69] C.Tsonopoluos, D.M.Coulson, L.W.Inman, Ionization constants of water pollutants, *J. Chem. Eng. Data*, 1976, 21, 190-193.
- [70] A.B.Shelekhin, I.N.Beckman, Gas separation processes in membrane absorber, *J. Membrane Sci.*, 1992, 73, 73-85.
- [71] Тепляков В.В., Молекулярная и фазовая структура полимеров и их газоразделительные свойства. Диссертация. М.: ИНХС им.А.В.Топчиева РАН, 1992,
- [72] Физические величины. Справочник. Москва: Энергоатомиздат, 1991, 1232.
- [73] Рамм В.М., Абсорбция газов. М.: Химия, 1976,
- [74] I.G.C.Dryden, Equilibrium between gaseous carbon dioxide and hydrogen sulphide and solutions of alkali carbonates, bicarbonates and hydrosulphides. Part I. Potassium salts, *J.S.C.I.*, 1947, 66, February, 59-62.
- [75] M.A.Islam, H.Buschatz, D.Paul, Non-equilibrium surface reactions - a factor in determining steady state diffusion flux, *J. Membrane Sci.*, 2002, 204, 1-2, 379-384.
- [76] Моисеев И., Платэ Н., Топливо будущего, *Химический журнал*, 2006, 6, 45-50.

AUTORISATION DE SOUTENANCE DE THESE
DU DOCTORAT DE L'INSTITUT NATIONAL
POLYTECHNIQUE DE LORRAINE

o0o

VU LES RAPPORTS ETABLIS PAR :

Monsieur Pierre AIMAR, Directeur de Recherche, Laboratoire de Génie Chimique, Toulouse

Monsieur Vladimir VOROTYNTSEV, Professeur, Université de Nizhny Novgorod, Russie

Le Président de l'Institut National Polytechnique de Lorraine, autorise :

Monsieur SHALYGIN Maxim

à soutenir devant un jury de l'INSTITUT NATIONAL POLYTECHNIQUE DE LORRAINE,
une thèse intitulée :

**"Réalisation et caractérisation du transport sélectif gazeux de contacteurs gaz-liquide à
membrane (Selective transport of gases in gas-liquid membrane system)".**

en vue de l'obtention du titre de :

DOCTEUR DE L'INSTITUT NATIONAL POLYTECHNIQUE DE LORRAINE

Spécialité : « **Génie des procédés et des produits** »

Fait à Vandoeuvre, le 11 avril 2007

Le Président de l'I.N.P.L.,

F. LAURENT



NANCY BRABOIS
2, AVENUE DE LA
FORET-DE-HAYE
BOITE POSTALE 3
F - 54501
VANDŒUVRE CEDEX