



HAL
open science

Caractérisation moléculaire et biochimique de la formation du bois de coeur chez le noyer noir (*Juglans nigra* L.) : accumulation des flavonoïdes et expression des gènes contrôlant leur biosynthèse

Isacco Beritognolo

► To cite this version:

Isacco Beritognolo. Caractérisation moléculaire et biochimique de la formation du bois de coeur chez le noyer noir (*Juglans nigra* L.) : accumulation des flavonoïdes et expression des gènes contrôlant leur biosynthèse. Sylviculture, foresterie. Université Henri Poincaré - Nancy 1, 2001. Français. NNT : 2001NAN10260 . tel-01754334

HAL Id: tel-01754334

<https://hal.univ-lorraine.fr/tel-01754334>

Submitted on 30 Mar 2018

HAL is a multi-disciplinary open access archive for the deposit and dissemination of scientific research documents, whether they are published or not. The documents may come from teaching and research institutions in France or abroad, or from public or private research centers.

L'archive ouverte pluridisciplinaire **HAL**, est destinée au dépôt et à la diffusion de documents scientifiques de niveau recherche, publiés ou non, émanant des établissements d'enseignement et de recherche français ou étrangers, des laboratoires publics ou privés.



AVERTISSEMENT

Ce document est le fruit d'un long travail approuvé par le jury de soutenance et mis à disposition de l'ensemble de la communauté universitaire élargie.

Il est soumis à la propriété intellectuelle de l'auteur. Ceci implique une obligation de citation et de référencement lors de l'utilisation de ce document.

D'autre part, toute contrefaçon, plagiat, reproduction illicite encourt une poursuite pénale.

Contact : ddoc-theses-contact@univ-lorraine.fr

LIENS

Code de la Propriété Intellectuelle. articles L 122. 4

Code de la Propriété Intellectuelle. articles L 335.2- L 335.10

http://www.cfcopies.com/V2/leg/leg_droi.php

<http://www.culture.gouv.fr/culture/infos-pratiques/droits/protection.htm>



S.C.D. - U.H.P. NANCY 1
BIBLIOTHEQUE DES SCIENCES
Rue du Jardin Botanique - BP 11
54601 VILLERS-LES-NANCY Cedex



Centre de Recherche d'Orléans

U.F.R. Sciences et Technique Biologiques

Thèse

Présentée pour l'obtention du titre de

Docteur de l'Université Henri Poincaré, Nancy 1

Spécialité : Biologie Végétale et Forestière

par

Isacco BERITOGNOLO

Caractérisation moléculaire et biochimique de la formation du bois de cœur chez le noyer noir (*Juglans nigra* L.). Accumulation des flavonoïdes et expression des gènes contrôlant leur biosynthèse.

Soutenue publiquement devant la commission d'examen

<i>Président :</i>	Pierre DIZENGREMEL	Professeur, Université Nancy (France)
<i>Rapporteurs :</i>	Elisabeth MAGEL	Professeur assistant, Université Tuebingen (Allemagne)
	Alain BOUDET	Professeur, Université. Toulouse (France)
<i>Examineurs :</i>	Mireille CABANÉ	Maître de conférence, Université Nancy (France)
	Christian BRETON	Chargé de recherche, INRA Orléans (France)
	Christian JAY-ALLEMAND	Directeur de recherche, INRA Orléans (France)

Remerciements

A l'issue de ce travail de thèse, réalisé au sein de l'Unité Amélioration, Génétique et Physiologie Forestière du Centre de Recherche INRA d'Orléans, je tiens à remercier tout particulièrement :

Marc Bonnet-Masimbert et **Jean-Charles Bastien**, respectivement adjoint au chef de du Département Forêt et Milieu Naturel de l'INRA et directeurs de l'Unité Amélioration, Génétique et Physiologie Forestières, qui m'ont accueilli dans ce laboratoire de recherche où j'ai pu développé mon travail scientifique.

Christian Jay-Allemand, directeur de thèse, qui m'a initié à la physiologie des composés phénoliques, et a constamment suivi et soutenu mon travail du point de vue scientifique et humain.

Christian Breton, qui m'a formé aux techniques moléculaires et a contribué d'une manière déterminante à la discussion du sujet de thèse et au développement des stratégies expérimentales les plus appropriées.

Les membres du comité de thèse **Dominique DeVienne**, **Mireille Cabanné**, **François Lefèvre** et **Maria Emilia Malvolti**, pour leurs remarques et conseils, qui se sont avérés très utiles pour la réussite de ce travail.

Les membres de l'équipe Physiologie : **Jean-Paul Charpentier**, qui a suivi et réalisé les analyses physiques et biochimiques des échantillons de bois ; **Nathalie Noël**, qui a réalisé les analyses des composés phénoliques et m'a aidé d'une manière efficace lors des extractions d'acides nucléiques ; **Philippe Label**, qui m'a souvent conseillé et avec qui j'ai eu des fructueuses discussions scientifiques ; **Bernard Bruant** et **Pierrette Capelli**, qui m'ont soutenu avec leur aide précieuse et leur sympathie.

Toutes les équipes de recherche travaillant dans le programme européen **Walnut BRAINS** (FAIR CT96-1887), qui ont contribué à l'avancement des connaissances sur la physiologie du bois.

Enrico Brugnoli, directeur de l'Istituto per l'Agroselvicoltura CNR (Porano, Italie), qui m'a accueilli dans son laboratoire pendant 2 mois pour la réalisation d'une partie des analyses moléculaires.

Francesco Cannata et **Maria Emilia Malvolti** (CNR, Italie), qui m'ont initié au travail de recherche, m'ont mis en contact avec l'INRA d'Orléans et m'ont toujours soutenu dans la préparation de mon sujet de thèse.

L'**Union Européenne**, qui a financé mon travail par l'attribution d'une bourse de trois ans dans le cadre du programme Marie Curie Fellowships (CT96-5050).

Tout le personnel de l'**Unité Amélioration, Génétique et Physiologie Forestière de l'INRA d'Orléans** et, d'une manière particulière, les stagiaires et les doctorants qui m'ont apporté leur soutien et leur amitié.

Alessio Giovannelli, avec qui j'ai partagé la première année de travail à l'INRA, ainsi que la première l'expérience de vie dans un pays étranger.

Enfin, je tiens à remercier très chaleureusement **ma famille** et **mes amis**, que j'ai laissés en Italie et qui m'ont beaucoup encouragé pendant mon séjour en France.

Table of content

1.	Introduction	8
2.	Introduction (version française)	14
3.	Bibliographic review	21
3.1	Heartwood formation	21
3.1.1	Definitions	21
3.1.2	Quantitative aspects of heartwood formation	21
3.1.3	Chemical aspects of heartwood formation.....	24
3.1.3.1	Water and gases.....	24
3.1.3.2	Storage substances	25
3.1.3.3	Ethylene.....	25
3.1.3.4	Wood extractives.....	26
3.1.3.5	Extractives distribution in the stem of trees	30
3.2	Physiology of heartwood formation	31
3.2.1	Formation of heartwood extractives	32
3.2.2	Biological functions of heartwood.....	34
3.2.3	Induction of heartwood formation: hypothesis.....	35
3.3	Flavonoid compounds	37
3.3.1	Chemical structure	37
3.3.2	Biosynthesis	37
3.3.3	Biological functions.....	40
3.3.4	Regulation of flavonoid biosynthesis. Example of chalcone synthase activity.....	41
3.4	Genes controlling flavonoid biosynthesis	44
3.4.1	Structural genes	44
3.4.2	Regulatory genes	44
4.	Experimental work	47
4.1	Introduction	47
4.2	Description of the plant material	50
4.2.1	Collection of trees and wood samples	50
4.2.2	Selection of wood samples for biochemical and molecular analyses	50
4.3	Characterisation of heartwood formation in <i>Juglans nigra</i>	53
4.3.1	Introduction.....	53
4.3.2	Localisation of heartwood and transition zone	53

4.3.3	Moisture content	57
4.3.4	Phenolic extractives	59
4.3.5	Discussion.....	61
4.3.5.1	Dynamics of heartwood formation.....	61
4.3.5.2	Dynamics of extractive accumulation	62
4.3.5.3	Characterisation of the transition zone.....	63
4.3.6	Conclusions.....	64
4.4	Set-up of the techniques for molecular analyses on aged xylem.....	66
4.4.1	Introduction.....	66
4.4.2	Detection and cloning of gene transcripts.....	66
4.4.2.1	Isolation of mRNA.....	69
4.4.3	Set-up of techniques for the extraction of total RNA	74
4.4.4	Cloning of homologous cDNA probes	78
4.4.4.1	Reverse Transcriptase PCR	78
4.4.4.2	Cloning and sequencing of cDNA fragments	79
4.4.4.3	3' RACE.....	81
4.4.5	Conclusions.....	83
4.5	Flavanol accumulation and gene expression during xylem ageing and heartwood formation in <i>Juglans nigra</i>	85
4.5.1	Introduction.....	85
4.5.2	Results.....	88
4.5.2.1	Flavanol accumulation in <i>Juglans nigra</i> xylem	88
4.5.2.2	Expression of structural genes	88
4.5.2.3	Accumulation and activity of PAL and CHS proteins	93
4.5.3	Discussion.....	95
4.5.3.1	Flavanols accumulate in the transition zone between sapwood and heartwood	95
4.5.3.2	Structural genes of phenylpropanoid pathway are differentially expressed during heartwood formation.....	96
4.5.3.3	Physiological role of phenylpropanoid structural genes during xylem differentiation and heartwood formation.....	99
4.5.4	Conclusions.....	101
5.	<i>General conclusions and perspectives</i>	102
6.	<i>Conclusions generales et perspectives (version française)</i>	110
7.	<i>Methods</i>.....	119
7.1	Isolation of mRNA I. Extraction with Dynal Lysis Binding buffer.....	119

7.2	Isolation of mRNA II. Extraction with modified Urea buffer	120
7.3	Purification of mRNA from cell lysate by Oligo d(T) Dynabeads.....	122
7.4	Purification of mRNA from total RNA by Oligo d(T) Dynabeads.....	123
7.5	Extraction of total RNA	124
7.6	cDNA synthesis.....	126
7.7	Reverse Transcriptase - Polymerase Chain Reaction (RT-PCR).....	127
7.8	3' RACE.....	128
7.9	Primers used for RT-PCR reactions	130
7.10	Cloning of PCR products	131
7.11	Northern blotting, dot blotting and hybridisations	132
7.12	Analysis of phenolic compounds.....	133
8.	<i>Appendix</i>	134
8.1	Sequences of cDNA clones.....	134
8.1.1	Phenylalanine ammonia-lyase. Clone <i>PAL xyll</i>	135
8.1.2	Cinnamate 4-hydroxylase. Clone <i>C4H xyll</i>	137
8.1.3	4-Coumarate:CoA ligase. Clone <i>4CL xyll</i>	139
8.1.4	Chalcone synthase. Clone <i>CHS xyll</i>	141
8.1.5	Flavanone 3-hydroxylase. Clone <i>F3H xyll</i>	142
8.1.6	Dihydroflavonol 4-reductase. Clone <i>DFR xyll</i>	144
8.1.7	Dihydroflavonol 4-reductase. Clone <i>DFR 143</i>	145
8.2	Sequence alignments.....	147
8.2.1	Phenylalanine ammonia-lyase	148
8.2.2	Cinnamate 4-hydroxylase	150
8.2.3	4-Coumarate-CoA ligase	151
8.2.4	Chalcone synthase	153
8.2.5	Flavanone 3-hydroxylase.....	154
8.2.6	Dihydroflavonol 4-reductase	155
9.	<i>Bibliographic references</i>	156

List of abbreviations

- bp Base Pairs
- BSA Bovine Serum Albumin
- C4H Cinnamate 4-hydroxylase
- cDNA Complementary DNA
- CHI Chalcone isomerase
- CHS Chalcone synthase
- 4CL 4-Coumarate-CoA ligase
- CTAB Hexadecyltrimethylammonium Bromide
- DFR Dihydroflavonol 4-reductase
- DIECA Diethyldithiocarbamic Acid
- DMACA 4-Dimethylamino-cinnamaldehyde
- DNA Deoxyribonucleic Acid
- dNTP Deoxynucleoside Triphosphate
- DTT Dithiothreitol
- DX Differentiating Xylem
- DW Dry Weight
- E2 Ellagic Acid Derivative 2
- EDTA Ethylenediaminetetraacetic Acid
- F3H Flavanone 3-hydroxylase
- FW Fresh Weight
- G3 Gallic Acid Derivative 3
- HEPES 4-(2-hydroxyethyl)-1-piperazineethane-sulfonic acid
- HJG Hydrojuglone Glucoside
- HPLC High Performance Liquid Chromatography
- IAA Isoamyl alcohol
- IPTG Isospropyl- β -D-thiogalactoside
- ISW Inner Sapwood
- KDa Kilo Dalton
- LiDS Lithium Dodecyl Sulphate
- M-MLV Moloney Murine Leukemia Virus
- mRNA Messenger RNA
- OD Optical Density
- OSW Outer Sapwood
- PAGE Polyacrylamide Gel Electrophoresis

- PAL Phenylalanine ammonia-lyase
- PCR Polymerase Chain Reaction
- PEG Polyethylen Glycol
- PVP Polyvinylpyrrolidone
- PVPP Polyvinylpolypyrrolidone
- RACE Rapid Amplification of cDNA Ends
- RNA Ribonucleic Acid
- RNase Ribonuclease
- RT Reverse Transcription
- RT-PCR Reverse Transcriptase-Polymerase Chain Reaction
- 60S Ribosomal Protein 60S
- SDS Sodium Dodecyl Sulphate
- SSC Saline Sodium Citrate
- T_m Melting Temperature
- TRIS Tris(hydroxymethyl)aminomethane
- TZ Transition Zone
- UV Ultraviolet
- X-Gal 5-Bromo-4-chloro-3-indolyl-β-D-galactoside
- WC Water Channels

Introduction

1. Introduction

Walnut species belong to the genus *Juglans* of the family *Juglandaceae*. All walnut species are native to temperate or subtropical climates and are deciduous trees with aromatic compound leaves and woody-shelled nuts (Figure 1). All walnut species have 32 diploid chromosomes and many, but not all, are capable of hybridising with each other. Most walnut species are highly regarded for their timber and all of them produce edible nuts [Leslie and McGranahan, 1998].

In Europe, the English walnut (*Juglans regia* L.), the black walnut (*Juglans nigra* L.), and their interspecific hybrids (*Juglans nigra* x *Juglans regia*) are highly regarded for the production of high quality timber. *Juglans regia* (Figure 1a) is native to the mountains of central Asia. However, millennia of transport in commerce widespread, naturalisation from cultivated trees, and extensive deforestation make precise determination of the native range impossible. *Juglans regia* is now largely cultivated all over the world for the production of fruits and high quality timber. In Europe, its wood has been appreciated since a long time. At present, it is the most priced timber among the species cultivated in Europe. In 1999 in French market, the price of logs on fields ranged 600 to 900 €/m³. *Juglans nigra* (Figure 1b) is native to the eastern USA. In northern America, this species can be found as spontaneous trees and is largely cultivated in plantations for timber production. *Juglans nigra* is now planted in Europe both as a timber species and as a rootstock for orchard trees [Leslie and McGranahan, 1998]. *Juglans nigra* wood presents technical features very similar to *Juglans regia* wood. In the USA, it is largely utilized by the furniture industry. In Europe, this wood is less priced than *Juglans regia* wood mainly because of the difference in colour and vein patterns. *Juglans nigra* trees are appreciated for timber production because of the length and straightness of their logs. In the last decades, interspecific walnut hybrids (*Juglans nigra* x *Juglans regia*) (Figure 1c) have been introduced in Europe for wood production. Interspecific hybrids are characterised by a faster growth than the parent species, a good adaptability to poor soils, and a forest growth habit similar to *Juglans nigra*, suitable for the production of high quality wood. The mechanical characteristics of hybrid walnut wood are similar to those of the parent species and its colour is intermediate between *Juglans nigra* and *Juglans regia* wood. The market of hybrid walnut logs is still very limited, but it is expected that their price will be intermediate between *Juglans nigra* and *Juglans regia* logs. [Institut pour le développement forestier, 1997]

Walnut wood has a medium density, a homogenous texture, and its good mechanical characteristics make it suitable for most uses (Figure 2). Its heartwood presents a good durability, whilst the sapwood is not very resistant against parasites and is often attacked by insects (*Lyctus* spp.) [Nardi Berti, 1979]. The uses of high quality walnut wood are mainly veneer and cabinet-making. A traditional use is the production of gunstocks. [Nardi Berti, 1979; Institut pour le développement forestier, 1997]. At present, the high value of walnut wood is mainly linked to its aesthetic features. It is highly appreciated for its brown colour and figured vein patterns (Figure 3).



Figure 1. Walnut (*Juglans* spp) trees in plantation.

a: *Juglans regia* trees. Nola, Italy.

b: *Juglans nigra* trees. France.

c: *Juglans nigra* x *J. regia* interspecific hybrids. Bordeaux, France.

The commercial value of walnut logs depends on several factors affecting the efficiency of the transformation into wood products: size of the logs, presence of defects (i.e. knots, cracks, and wounding), and relative amount of sapwood and heartwood. The value of wood products (boards, veneer) depends on wood colour, grain (vein patterns), and presence of defects [Giannini and Mercurio, 1997]. The market preferences for clear wood (from young trees with little heartwood, clear colour, and homogenous veins) or figured wood (from old trees with much heartwood, dark colour, and contrasting veins) vary according to different final uses. Nowadays, for industrial production of furniture pieces, the colour of walnut wood is considered less important than it was many years ago because of a wide use of artificial colouring. In example, Italian furniture industries prefer clear homogenous wood which is suitable for artificial colouring and large scale production of standard quality products. On the contrary, the figured wood with dark colour and contrasting vein patterns is preferred in France and northern Europe, especially by artisan furniture manufacturers for cabinet-making and inlay works.

The European production of walnut trees is not sufficient to cover the demand of wood industry for high-quality timber. In Italy, where the use of walnut wood by furniture industries is well developed, 21% of walnut wood transformed is imported from foreign countries, mainly from ex-Yugoslavia countries (W-BRAINS data). In France, the situation is similar and the Institute for Forestry Development (IDF) promotes the installations of new walnut plantations since 1967. The long term objective of this programme is to increase the cultivation of walnut of about one thousand hectares per year in order to obtain in the next half century a wood production covering the French industrial demand [Institut pour le développement forestier, 1997]. The European Union supports financially the installation of new walnut plantations for wood production (Reg. no. 2080/92). Because of such policies, in Europe the surface of walnut plantations for wood production has increased in the last years. As for other timber species supported by the European Union policies, the cultivation of walnut plays an important role as non-food culture for the reconversion and diversification of marginal lands neglected by agriculture.

In this context, a major objective of RTD (research, technology, and development) programmes was to increase the production of high-quality wood in Europe using walnut. In the last decade, two research projects focused on walnut cultivation have been funded by the European Union. The first research project, titled "European development of walnut trees for wood and fruit production as an alternative and extensive system to agricultural crops" (contract AIR3-CT92-0142), was developed since 1992 to 1995. The main objectives of this project were: to gain scientific knowledge about the physiology and the genetic resources of walnut in Europe; to increase the large-scale propagation of selected genotypes; to develop new cultural systems suitable for walnut plantations; to analyse the economy of the walnut forest-woody chain in Europe. The second project titled "Walnut: production of high quality timber in Europe. Up to date tools for tree adaptation, wood standards and management" (contract FAIR-CT96-1887, W-BRAINS acronym) started in 1997 and is now reaching its end.

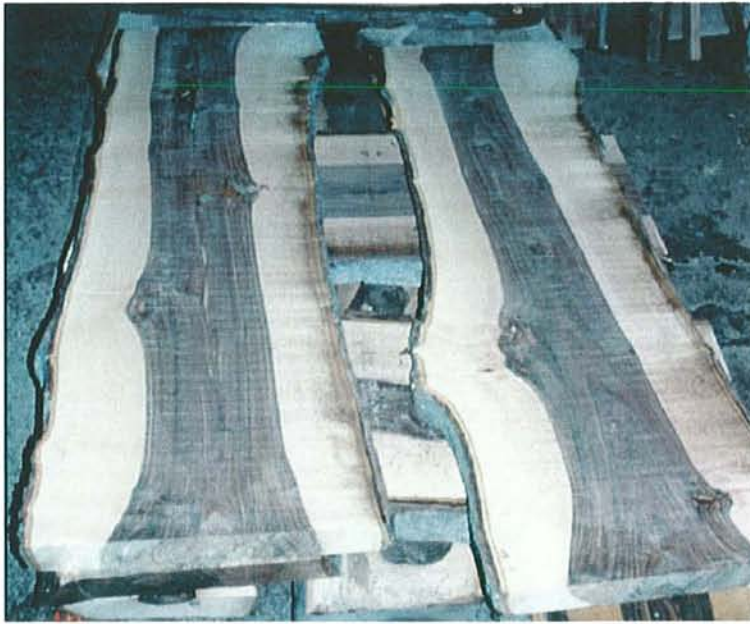

Figure 2. Boards sewed from a *Juglans regia* tree. It is visible the dark coloured heartwood in the center of the stem, surrounded by the clear sapwood.



Figure 3. High valuable figured veneer obtained from a *Juglans regia* tree. The contrasted patterns of vein colour are highly appreciated for cabinet making and joinery.

The objectives of this project are: to determine criteria of walnut wood quality for commercial applications; to increase the resources of walnut trees planted in Europe; to enhance the knowledge in genetic, physiology, and technology of wood production. The work programme involves a multi-disciplinary approach in the following fields: tree physiology, wood characterisation, wood technologies, wood products standardisation, genetics and breeding, silviculture, information networks, and economy. The experimental work of this thesis was developed within the frame of this research project.

Scientific research is necessary to reach a better knowledge of the physiological mechanisms controlling wood quality. Colour and durability are two important features determining the commercial evaluation and industrial uses of walnut wood. Wood ageing and heartwood formation are the main physiological processes involved in the formation of wood colour and durability. [Hillis, 1987]. Heartwood formation is a natural ageing process of the sapwood tissues leading to the death of the parenchyma cells contained in the inner portion of the stem and branches (Figure 2). Concomitant to the ageing and death of parenchyma cells are the disappearance of storage substances and the accumulation of phenolic substances called extractives. These phenolic substances are responsible for the darker colour of the heartwood when compared to the sapwood. The heartwood is also more resistant than sapwood against the attacks of insects and micro organisms [De Groot *et al.*, 2000]. This is the result of both the removal of storage substances and the accumulation of extractives that are toxic to parasites or inhibit their attacks [Schultz and Nicholas, 2000]. The natural durability of wood has a great industrial, economic, and ecological importance. The durability of wood products for outdoor uses is often increased by expensive chemical preservation treatments with substances that are toxic for parasites. Such treatments are frequently realised with very toxic compounds containing chrome, copper, or arsenic and, thus, represent a source of dangerous pollution for the ecosystems and a threat for the human health.

Heartwood formation can therefore be considered a key process in the physiological control of wood quality. Despite of its importance, the physiology of heartwood formation is still poorly understood. The accumulation of phenolic extractives is linked to heartwood formation and plays a key role for the quality of wood products. Actually, most of the scientific research on the physiology of heartwood formation has been focused on the accumulation of extractives [Hillis, 1987]. Great progress has been achieved in understanding this process at the biochemical level. Experimental evidence supports the hypothesis that extractive accumulation is the result of *in situ* biosynthesis in aged wood tissues. [Higuchi, 1997; Hillis, 1987; Magel, 2000]. In *Robinia pseudoacacia*, it has been shown that the phenolic biosynthetic pathway is up-regulated in the transition zone during heartwood formation and leads to the accumulation of flavonoid extractives [Magel, 2000]. The knowledge of the physiological basis of heartwood formation is progressively enlarging but very few information is available about the expression of genes.

The main objective of this thesis was to identify the genes involved in the control of wood quality. The research work focussed on studying the molecular basis of heartwood formation. Because of its influence on colour and durability of wood, the formation of heartwood was targeted as a physiological process

potentially leading to the identification of genes controlling wood quality. Three main questions were addressed by this work:

- **How is the accumulation of phenolic extractives regulated during wood ageing and heartwood formation?**
- **Are genes encoding the enzymes of phenolic biosynthesis expressed in aged xylem**
- **Is the accumulation of phenolic extractives controlled at the gene expression level?**

The experimental strategy was based on the analyses of expression of candidate genes. The starting hypothesis was that the accumulation of phenolic extractives, occurring during heartwood formation, should be related to the expression of genes controlling the **phenolic biosynthetic pathways**. To test this hypothesis, we studied the expression of genes encoding the enzymes of phenylpropanoid and flavonoid pathways across transversal sections of *Juglans nigra* stems, spanning from the differentiating xylem to the heartwood.

The species *Juglans nigra* was chosen as a good model plant to study heartwood formation and extractive accumulation. The comparison of results obtained from wood samples collected at different seasonal periods allowed to monitor the seasonal trends of heartwood formation, phenolic accumulation, and gene expression. A large tree sampling of mature walnut trees was realised in the frame of the programme W-BRAINS and provided wood samples suitable for this research work. A preliminary phase of the work consisted of an integrated characterisation of these wood samples. This step allowed to identify and select the wood samples and the seasonal periods that were more relevant for the molecular analyses.

The results obtained supported the hypothesis that flavonoid extractives accumulating during the transformation of sapwood into heartwood are actively synthesized in the ageing xylem tissues, especially in the transition zone. The similarity between the distribution of flavonoid extractives in wood tissues and the expression patterns of genes encoding the key enzymes of flavonoid pathway indicated that, in *Juglans nigra* trees, flavonoid accumulation was mainly controlled at the transcriptional level. According to the seasonal variations observed, we propose some hypothesis about the seasonal dynamics of heartwood formation. It seems that the extension of heartwood in *Juglans nigra* trees occurred mainly during summer while the expression of flavonoid metabolism genes was specifically activated in the transition zone during winter period.

Introduction

(version française)

2. Introduction (version française)

Les espèces de noyer appartiennent au genre *Juglans*, de la famille des Juglandacées. Toutes les espèces de noyer sont originaires des climats tempérés ou subtropicaux et sont des arbres possédant des feuilles caduques, riches en composés aromatiques et des noix pourvues d'une coquille lignifiée (Figure 1). Toutes les espèces de noyer ont 32 chromosomes ($2n = 32$) et beaucoup, mais pas toutes, sont capables de s'hybrider les unes avec les autres. Beaucoup d'espèces de noyers sont considérées importantes pour leur bois d'œuvre et la plupart d'entre elles produisent des noix comestibles [Leslie et McGranahan, 1998].

Le noyer commun (*Juglans regia* L.), le noyer noir (*Juglans nigra* L.) originaire de l'Amérique du nord, et leurs hybrides interspécifiques (*Juglans nigra* x *Juglans regia*) produisent du bois d'œuvre de haute qualité. *Juglans regia* (Figure 1a-vf) est originaire des montagnes de l'Asie Centrale. Cependant, les échanges commerciaux effectués depuis des millénaires à grande échelle, la domestication des arbres cultivés, ainsi que la déforestation, font qu'une détermination précise de la zone d'origine est impossible. Le noyer commun (*Juglans regia*) est maintenant largement cultivé dans le monde entier pour la production de fruits et la haute qualité de son bois d'œuvre. En Europe, son bois est apprécié depuis longtemps. C'est le bois plus coûteux parmi les espèces cultivées en Europe. En 1999, sur le marché français, le prix du bois de noyer commun sur pied pouvait atteindre 600 à 900 €/m³. Le noyer noir (*Juglans nigra*) est originaire de l'Est des USA (Figure 1b-vf). En Amérique du Nord, cette espèce peut se disséminer naturellement et est largement cultivée pour la production de bois d'œuvre. Elle est maintenant plantée en Europe à la fois comme espèce pour le bois et utilisée comme porte-greffe pour les variétés fruitières [Leslie et McGranahan, 1998]. Le bois de *Juglans nigra* présente des propriétés mécaniques similaires au bois de *Juglans regia*. Aux USA, il est beaucoup utilisé par l'industrie du meuble. En Europe, ce bois est moins apprécié que le bois de *Juglans regia* principalement à cause de la différence de couleur et de veinure. Les arbres de *Juglans nigra* sont appréciés pour la production de bois d'œuvre à cause de la longueur et la rectitude de leur tronc. Dans la dernière décennie, les noyers hybrides interspécifiques (*Juglans nigra* x *Juglans regia*) (Figure 1c-vf) ont été obtenus en Europe pour la production de bois. Ils sont caractérisés par une croissance plus rapide que les espèces parentales, une bonne adaptabilité aux sols moins riches, une croissance en ambiance forestière comparable à *Juglans nigra* et appropriée pour la production d'un bois de haute qualité. Les caractéristiques mécaniques du bois du noyer hybride sont similaires à celles des espèces parentales et sa couleur est intermédiaire entre le bois de *Juglans nigra* et *Juglans regia*. Le marché des grumes de noyer hybride est encore très limité mais on s'attend à ce que son prix soit intermédiaire entre celui de *Juglans nigra* et *Juglans regia*. [Institut pour le développement forestier, 1997].



Figure 1-vf. Arbres de noyer (*Juglans* spp) en plantation.

a: arbres de *Juglans regia*. Nola, Italie.

b: arbres de *Juglans nigra*. France.

c: hybrides interspécifiques *Juglans nigra* x *J. regia*. Bordeaux, France.

Le bois de noyer à une densité moyenne, une texture homogène et ses bonnes caractéristiques mécaniques font qu'il est approprié pour de nombreux usages (Figure 2-vf). Son bois de cœur présente une bonne durabilité, tandis que son aubier, peu résistant contre les parasites, est souvent attaqué par les insectes (*Lyctus* spp.) [Nardi Berti, 1979]. Les usages du bois de noyer de haute qualité sont principalement le placage et l'ébénisterie. Une autre utilisation traditionnelle est la production de crosses de fusil. [Nardi Berti, 1979; Institut pour le développement forestier, 1997]. Actuellement, la haute valeur du bois de noyer est principalement liée à ses caractéristiques esthétiques. Il est très apprécié pour sa couleur brune et les motifs marqués par les veinures (Figure 3-vf).

La valeur commerciale des troncs de noyer dépend de plusieurs facteurs affectant le rendement de la transformation en bois utilisable : taille des troncs, présence de défauts (nœuds, fentes et blessures) et quantité relative aubier / bois de cœur. La valeur marchande des produits (planches, placage) dépend de la couleur du bois, du grain (dessin des veines) et de la présence de défauts [Giannini et Mercurio, 1997]. Les préférences du marché pour du bois clair (venant d'arbres jeunes avec peu de bois de cœur, une couleur claire et une veinure homogène) ou du bois figuré (venant d'arbres âgés avec beaucoup de bois de cœur, une couleur foncée et des veinures contrastées) varie en fonction des différentes utilisations finales. De nos jours, pour la production industrielle de meubles, la couleur du bois de noyer est considérée moins importante qu'il y a quelques années du fait d'une large utilisation de systèmes de coloration artificielles. Par exemple, l'industrie du meuble italienne préfère un bois clair homogène qui est approprié pour la coloration artificielle et une production sur large échelle de produits de qualité standard. Au contraire, le bois figuré avec une couleur foncée et des veinures contrastées est préféré en France et dans le Nord de l'Europe, spécialement par les artisans pour l'ébénisterie et la marqueterie.

La production européenne d'arbres de noyers n'est pas suffisante pour couvrir la demande de l'industrie du bois pour un bois d'œuvre de haute qualité. En Italie, où l'utilisation du bois de noyer par l'industrie du meuble est bien développée, 21% du bois de noyer transformé est importé de l'étranger, principalement des pays de l'ex-Yougoslavie (Contrat européen FAIR CT96-1887). En France, la situation est similaire et l'Institut pour le Développement Forestier (IDF) favorise l'installation de nouvelles plantations de noyer depuis 1967. L'objectif à long terme de ce programme est d'augmenter la culture du noyer d'environ mille hectares par an, afin d'obtenir dans le prochain demi-siècle une production de bois qui couvre la demande des industriels français [Institut pour le développement forestier, 1997]. L'Union Européenne supporte financièrement l'installation de nouvelles plantations pour la production de bois (Reg. No. 2080/92). Grâce à de telles mesures, les surfaces de plantation de noyer pour la production de bois en Europe ont augmenté au cours des dernières années. Comme pour d'autres espèces à bois supportées par la politique de l'Union Européenne, la culture du noyer joue un rôle important comme culture non alimentaire pour la reconversion et la diversification des terres marginales délaissées par l'agriculture.

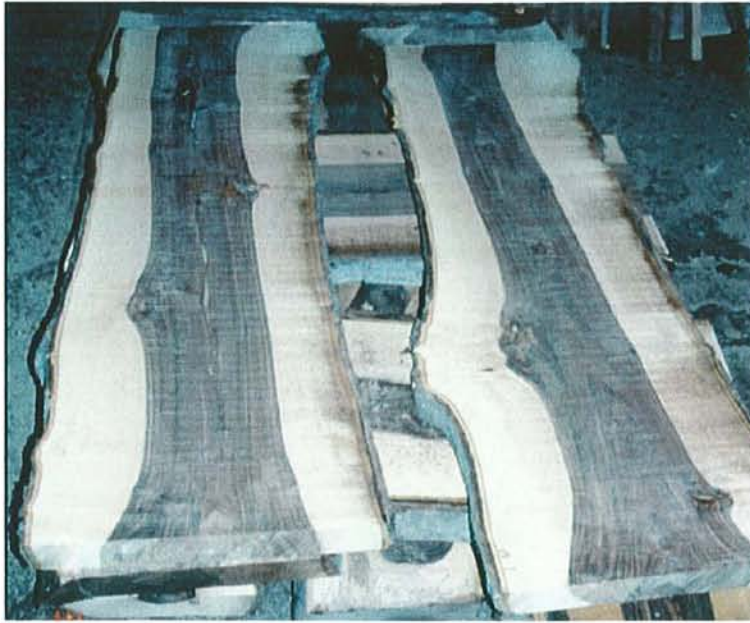

Figure 2-vf. Planches produites après sciage d'une grume de *Juglans regia*. Dans la partie centrale des deux planches, le bois de coeur de couleur sombre (brun foncé) se distingue très nettement de l'aubier de couleur claire situé en périphérie.



Figure 3-vf. Placage figuré de haute qualité obtenu d'un arbre de *Juglans regia*. Les veinures de couleur contrastée sont très appréciées pour l'ébénisterie et la marqueterie.

Dans ce contexte, un objectif majeur des programmes européens RTD (Recherche, Technologie et Développement) est d'augmenter la production de bois de haute qualité en utilisant le noyer. Dans la dernière décennie, deux projets de recherche concentrés sur la culture du noyer ont été financés par l'Union Européenne. Le premier projet de recherche intitulé « Développement européen du noyer pour la production de bois et de fruit comme un système alternatif et extensif à la culture agricole » (contrat AIR3-CT92-0142) a été développé de 1992 à 1995. Les principaux objectifs de ce projet étaient: d'acquérir des connaissances scientifiques sur la physiologie et les ressources génétiques du noyer en Europe; d'augmenter la propagation à grande échelle des géotypes sélectionnés; de développer des nouveaux systèmes culturels appropriés pour les plantations de noyer; d'analyser, sur le plan économique, la filière forêt-noyer à bois en Europe. Le deuxième projet, intitulé « Noyer : production de bois de haute qualité en Europe. Nouveaux outils pour l'adaptation des arbres, la standardisation du bois et la gestion » (contrat FAIR-CT96-1887, acronyme W-BRAINS), est commencé en 1997 et arrive maintenant à sa fin. Les objectifs de ce projet sont: de déterminer les critères de qualité du bois de noyer pour les applications commerciales; d'augmenter les ressources en noyers plantés en Europe; d'accroître les connaissances en génétique, physiologie, et technologie de production du bois. Le programme de travail a consisté à une approche multidisciplinaire dans les domaines suivants: physiologie de l'arbre, caractérisation du bois, technologies du bois, standardisation des produits du bois, génétique et amélioration, sylviculture, réseau d'information, et économie. Le travail expérimental de cette thèse a été développé dans le cadre de ce second projet de recherche européen.

La recherche scientifique est nécessaire pour acquérir des meilleures connaissances sur les mécanismes physiologiques contrôlant la qualité du bois. La couleur et la durabilité sont deux caractéristiques importantes déterminant l'évaluation commerciale et les utilisations industrielles du bois de noyer. Le vieillissement du bois et la formation du bois de cœur sont les principaux processus physiologiques impliqués dans la formation de la couleur et durabilité du bois. [Hillis, 1987]. La formation du bois de cœur est un processus naturel de vieillissement de l'aubier aboutissant à la mort des cellules parenchymateuses contenues dans la portion interne du tronc et des branches (Figure 2-vf). Le vieillissement et la mort des cellules parenchymateuses s'accompagnent de la disparition des substances de réserves et l'accumulation de substances phénoliques appelées extractibles. Ces substances phénoliques sont responsables de la couleur plus foncée du bois de cœur quand on la compare à celle de l'aubier. Le bois de cœur est aussi plus résistant que l'aubier aux attaques par les insectes et les microorganismes [De Groot *et al.*, 2000]. C'est le résultat, à la fois, de l'élimination des substances de réserves et de l'accumulation des extractibles qui limitent les attaques parasitaires [Schultz et Nicholas, 2000]. Dans le futur, la durabilité naturelle du bois prendra une grande importance sur les plans industriel, économique et écologique. La durabilité des produits du bois destinés à une utilisation en plein air est souvent augmentée par de coûteux traitements chimiques de préservation par des substances toxiques pour les parasites. De plus, de tels traitements sont fréquemment réalisés avec des composés très toxiques contenant du chrome,

du cuivre ou de l'arsenic. Ils représentent une source de pollution dangereuse pour les écosystèmes et une menace pour la santé humaine.

La formation du bois de cœur peut, par conséquent, être considérée comme un processus clé dans le contrôle physiologique de la qualité du bois. Malgré son importance, la physiologie de la formation du bois de cœur n'est pas encore bien comprise. L'accumulation des composés phénoliques solubles est liée à la formation du bois de cœur et joue donc un rôle clé pour la qualité des produits du bois. Beaucoup de recherches scientifiques sur la physiologie de la formation du bois de cœur ont été focalisées sur l'accumulation des extractibles [Hillis, 1987]. De grands progrès ont été accomplis dans la compréhension de ce processus à un niveau biochimique. Les preuves expérimentales soutiennent l'hypothèse que l'accumulation des extractives est le résultat d'une biosynthèse *in situ* dans les tissus âgés du bois. [Higuchi, 1997; Hillis, 1987; Magel, 2000]. Chez *Robinia pseudoacacia*, il a été montré que la voie de biosynthèse des composés phénoliques est activée dans la zone de transition aubier / bois de cœur durant la formation du bois de cœur et conduit à l'accumulation des flavonoïdes en particulier [Magel, 2000]. Les connaissances des bases physiologiques de la formation du bois de cœur sont progressivement développées, mais très peu d'informations sont disponibles au sujet de l'expression des gènes durant ce processus.

L'objectif général de cette thèse a été d'identifier les gènes impliqués dans le contrôle de la qualité du bois. Le travail de recherche a été centré sur la formation du bois de cœur, responsable de la couleur et la durabilité du bois. La formation du bois de cœur ou duraminisation est un processus physiologique qui est gouverné par des gènes contrôlant la qualité du bois. Trois questions principales sont posées par ce travail :

- Comment est régulée l'accumulation des composés phénoliques durant le vieillissement des cellules du bois et plus particulièrement pendant la formation du bois de cœur ?
- Les gènes codant les enzymes de la voie de biosynthèse des composés phénoliques sont-ils exprimés dans le xylème âgé ?
- L'accumulation des composés phénoliques solubles est-elle contrôlée au niveau de l'expression de ces gènes ?

La stratégie expérimentale a été basée sur les analyses de l'expression de gènes candidats. L'hypothèse de départ était que l'accumulation des composés phénoliques, ayant lieu durant la formation du bois de cœur, était sous contrôle de l'expression des gènes impliqués dans la voie de biosynthèse de ces composés phénoliques. Pour tester cette hypothèse, nous avons étudié l'expression de gènes codant les enzymes de la voie de biosynthèse des phénylpropanoïdes et des flavonoïdes dans différents cernes formant le tronc de *Juglans nigra*, allant du xylème en différenciation au bois de cœur.

L'espèce *Juglans nigra* a été choisie comme plante modèle pour l'étude de la formation du bois de cœur et de l'accumulation des extractibles dans la zone de transition aubier / bois de cœur. La comparaison des résultats obtenus à partir d'échantillons de bois collectés à différentes saisons a permis de mettre en évidence les variations saisonnières (accumulation des composés phénoliques et expression des gènes candidats) pendant la formation du bois de cœur. Un large échantillonnage d'arbres de noyers

adultes a été réalisé dans le cadre du programme W-BRAINS et a fourni les échantillons de bois appropriés pour ce travail de recherche. Une phase préliminaire de ce travail a consisté en une caractérisation intégrée de ces échantillons de bois. Cette étape a permis d'identifier et sélectionner les échantillons de bois et d'identifier les saisons les plus pertinentes pour les analyses moléculaires.

Les résultats obtenus soutiennent l'hypothèse que les flavonoïdes solubles accumulés durant la transformation de l'aubier en bois de cœur sont activement synthétisés dans les tissus de xylème âgé, spécialement dans la zone de transition. La concordance entre la distribution des flavonoïdes dans les tissus du bois et le patron d'expression des gènes codant les enzymes clés de la voie de biosynthèse des flavonoïdes indique que, dans les arbres âgés de *Juglans nigra*, l'accumulation des flavonoïdes était principalement contrôlée au niveau transcriptionnel. D'après les variations saisonnières observées, nous proposons plusieurs hypothèses à propos de la dynamique saisonnière de la formation du bois de cœur. Il semble que l'extension du bois de cœur chez les arbres *Juglans nigra* a lieu principalement pendant l'été, tandis que l'expression des gènes du métabolisme des flavonoïdes était spécifiquement activée dans la zone de transition durant la période hivernale.

Bibliographic review

3. Bibliographic review

3.1 Heartwood formation

3.1.1 Definitions

Different zones can usually be observed in cross-sections of tree stems: a pale-coloured outer zone, called sapwood, and a dark coloured inner core, the heartwood, that is often concentric. Between these major zones there may be a third narrow zone, often paler in colour, called the transition zone (Figure 4).

The basic definitions of these wood zones were given by an anonymous in the 50's. **Sapwood** is defined as “*the portion of the wood that, in a living tree, contains living cells and reserve materials (e.g. carbohydrates)*” [Anonymous, 1957]. **Heartwood** is defined as “*the inner layers of the wood, which, in a living tree, have ceased to contain living cells, and in which the reserve materials have been removed or converted into heartwood substances*” [Anonymous, 1957]. The **transition zone** can be defined as a “*narrow, often pale-coloured, zone surrounding the heartwood, still containing living cells. It is usually devoid of starch, impermeable to liquids, with a moisture content lower than the sapwood and sometimes than the heartwood*” [Chattaway, 1952; Hillis, 1987]. The width of the transition zone is usually about 1 to 3 growth rings. It is usually visible by eye, but in some species such as *Juglans nigra* is not easily to be identified in freshly cut wood [Nelson, 1976]. In some species, a precise narrow transition zone cannot be identified and the transition between sapwood and heartwood is gradual. This zone is defined as **intermediate wood** with transitional characteristics between sapwood and heartwood [Anonymous, 1957].

Although widely spread, heartwood formation is not general. There are relatively few tree species, which do not form heartwood. They can grow to a considerable size still containing starch and living cells at the centre of the stem. Some examples are *Alnus glutinosa*, *Alnus incana*, *Populus tremuloides*, *Aesculus hippocastanum*, *Carpinus betulus*, *Corylus avellana*, and *Sambucus nigra* [Hillis, 1987].

3.1.2 Quantitative aspects of heartwood formation

The sapwood has three main functions in the living tree. It conducts sap, provides a rigid support for the crown, and serves as an important reservoir for the storage of food substances (mainly carbohydrates) [Hillis, 1987]. From the physiological point of view, heartwood formation can be considered as a reduction of the proportion of sapwood relative to the total volume of wood. The proportion of sapwood varies considerably according to genetic (species and genotype) and environmental factors (climate, soil, forestry practices) [Hillis, 1987]. The regularity of initiation of heartwood formation and of the number of growth rings in the heartwood indicates a genetic control of this process. However, the starting age of the transformation is affected by environmental factors.

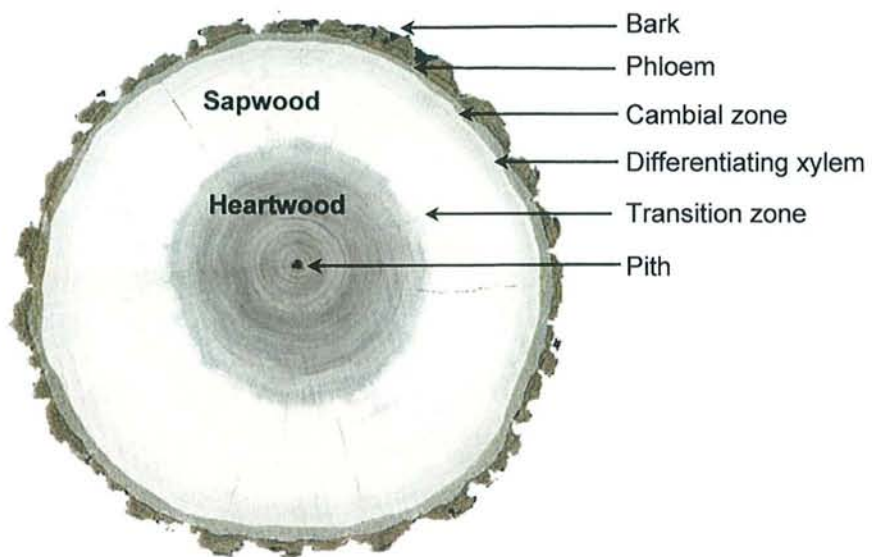

Figure 4. Cross section of the stem of a 23 year old *Juglans nigra* tree. Photo of a lyophilised stem disc. Different wood zones can be observed. In the *cambial zone*, the cambium produces *phloem* outwards and *xylem* inwards during the growth season. The completely differentiated xylem is called *sapwood* and contains living cells and reserve substances. In the center of the stem the oldest sapwood rings are progressively transformed into *heartwood*, which does not contain living cells nor reserve substances and is darker than the surrounding sapwood. The innermost portion of the sapwood that is being transformed into heartwood is called *transition zone*. This zone is visible in the xylem of some tree species as a paler narrow band around the heartwood. In freshly cut wood, as well as in lyophilised specimens, of *Juglans nigra* the transition zone is not easily visible.

A great variability can be found within a species both for the starting age of heartwood formation and for the proportion of sapwood present at a certain age. Trees of the same species grown in different environments may show variable proportion of sapwood. Many examples are reported by Hillis [1987]. Heartwood began to form in *Pinus sylvestris* trees after 25, 40, and 70 years in southern, central and northern Sweden respectively [Hägglund, 1951, quoted in Hillis, 1987]. The number of sapwood rings in mature *Quercus robur* trees, grown in different parts of Europe in the past 800 years, ranged between 7 to 24 with the means (14 to 18) being different for different regions [Baillie *et al.*, 1985, quoted in Hillis, 1987]

The heritability, or the ratio of the genetic variance to the total variance, has been studied in relation to heartwood formation in some tree species. In *Pinus radiata*, experimental estimations of heritability indicated that the variation due to genetics and that due to environmental factors were about equal. The narrow sense heritability (for quantitative characters, the narrow sense heritability is the ratio of additive genetic variance to phenotypic variance and expresses the proportion of phenotypic value that can be inherited) for the heartwood area proportion was estimated as 0.2 [Nicholls and Brown, 1974].

An important factor strictly correlated to the proportion of sapwood is the age of the tree. In *Juglans nigra* and *Prunus serotina*, it has been found that the percentage of sapwood volume decreases with the age of the tree [Nelson, 1975; 1976; Nelson *et al.*, 1981]. In several broadleaved and coniferous species, a direct correlation has been found between the growth rate and the proportion of sapwood [Hillis, 1987]. As it would be expected from this observation, trees grown in good sites present usually a faster growth and wider sapwood than trees grown on poor sites. This relationship was reported for *Juglans nigra* trees [Szopa *et al.*, 1980]. The correlation between the volume of sapwood and the growth rate is clearly explained by the conduction function of sapwood. The higher is the growth rate of the tree, the greater should be the sap flux needed by the crown [Hillis, 1987]. As a consequence of this relationship, relatively greater volumes of heartwood are formed in slow-growing trees than in fast-growing trees.

3.1.3 Chemical aspects of heartwood formation

3.1.3.1 Water and gases

A biological feature strongly affected by heartwood formation is the moisture content inside the stem. The parameter commonly used to define the moisture content of wood is the percentage of water content relative to wood dry weight. In the sapwood, the moisture content can vary seasonally, probably in relationship with the storage function of the living xylem. However, it is interesting to consider the moisture variations across cross-sections of the stem. In conifers, the moisture content generally decreases within the transition zone and it is much lower in the heartwood (ranging from 30 to 70%) than in the sapwood (ranging from 80 to 250%). On the contrary, in some angiosperms the moisture content is higher in the heartwood than in the sapwood. This type of moisture distribution was reported also in *Juglans nigra* [Hillis, 1987]. In some angiosperm species, such as *Fraxinus mandshurica*, *Populus maximowiczii*, and *Ulmus davidiana* the heartwood is wetter than the sapwood in all seasons of the year. In other species, such as *Fagus crenata*, the moisture content of sapwood is higher than the one of the heartwood in the winter, but can be lower in the summer [Hillis, 1987]. Very few information exists about the moisture present in the transition zone of angiosperm trees. The few available data indicate that the moisture markedly decreases when passing from the sapwood to the adjacent transition zone. This pattern of moisture distribution was observed in the stem of *Quercus robur*, in which the water content is lower in the transition zone than in the heartwood and in the sapwood [Ebermann and Stich, 1985]. Interestingly, a similar distribution of water was observed in cross-sections of *Cryptomeria japonica* [Nobuchi and Harada, 1983, Nobuchi *et al.*, 1985].

Concomitant with the decrease of water content in wood cells is the increase of gas content. The water/gas ratio seems relatively stable in the transition zone of trees. The water/gas ratio in the transition zone of *Fagus*, and *Populus* was similar for the two species [Hillis, 1987]. In addition, in *Cryptomeria japonica* the moisture content was seasonally constant in the transition zone, whilst it was seasonally variable in the sapwood [Nobuchi and Harada, 1983]. These observations suggest the existence of a physiological threshold of the water/gas ratio in the transition zone. This threshold could be linked to heartwood formation. Some authors proposed that when the water/gas ratio in the cell lumen drops below a specific threshold value, the transformation of sapwood into heartwood is triggered.

3.1.3.2 Storage substances

The storage substances that can be found in wood are mainly starch or lipids or both. Indeed, *Juglans*, *Robinia*, *Betula*, *Populus*, *Prunus*, and *Abies* species accumulate both starch and lipids in their wood. Lipids do not represent a quantitatively important reserve, but they could play a qualitatively important role during transformation of sapwood into heartwood [Hillis, 1987]. In *Robinia pseudoacacia*, starch grains disappeared from the innermost sapwood in late summer and this was immediately followed by an increase in size of the lipid droplets. Following that, the formation of the heartwood started and it enlarged rapidly [Nobuchi *et al.*, 1984]. These observations suggest an involvement of lipids in heartwood formation. Nevertheless, starch has received a greater attention in research works both for its central role in the primary metabolism and for its relative importance as major reserve substance. The presence of starch is typical of sapwood but its distribution in the sapwood can be uneven and some part of living sapwood can be devoid of starch. The amount of starch in the sapwood varies among the species and can be as much as 7% of the wood. It can vary greatly according to the season and the climatic conditions. Starch content generally decreases in the transition zone and is absent in the heartwood, therefore it is considered as an indicator of the boundary zone between sapwood and heartwood [Hillis, 1987].

In *Juglans nigra* aged trees sampled at different seasonal periods, the content of starch and sucrose strongly decreased with increasing age of the xylem growth rings. In the transition zone, sucrose was present only in early June and later during autumn. Both starch and sucrose were absent in the heartwood. The content of glucose and fructose was very low in *Juglans nigra* stem. In contrast to most of heartwood forming species, the heartwood of *Juglans nigra* contains considerable amounts of glucose. It was postulated that deglycosylation of phenolic glycosides (e.g. hydrojuglone glucoside), probably occurring in the heartwood, might contribute to the accumulation of glucose [Magel *et al.*, 2001]. Actually, relatively high amounts of HJG gradually accumulate in ageing sapwood of *Juglans spp* trees and abruptly disappear in the heartwood [Burtin *et al.*, 1998]. A β -glucosidase enzyme catalysing with high affinity the hydrolysis of hydrojuglone glucoside (HJG) into juglone and glucose was purified from *Juglans regia* cotyledons [Duroux *et al.*, 1998]. This enzyme could catalyse the hydrolysis of HJG and the liberation of glucose during the transformation of sapwood into heartwood in *Juglans nigra*. Monosaccharides, such as mannose, glucose, arabinose and xylose were also found in the heartwood of *Picea abies*, *Pinus sylvestris*, and *Quercus* species [Hillis, 1987; Magel, 2000].

3.1.3.3 Ethylene

In plants, the phytohormone ethylene is often associated with the ageing of tissue and accumulation of polyphenols [Hillis, 1987]. Since sapwood ageing and heartwood formation are marked by an accumulation of polyphenols, many authors postulated that ethylene could be responsible for inducing phenolic synthesis in ageing sapwood. Experimental evidence supports this hypothesis. The application of ethrel (ethylene-releasing compound) to the sapwood of a small *Rhus succedanea* tree resulted in the

formation of typical heartwood polyphenols. In addition, this compound induced the localised formation of heartwood when locally injected into the sapwood of young *Azadirachta indica* trees. This artificially induced heartwood showed characteristics very similar to normal heartwood [Hillis, 1987].

In *Juglans nigra* sapwood, the rate of ethylene production generally decreased from outermost sapwood to the transition zone. In this zone, ethylene production peaked in the dormant season, concomitant with the increase of activity of phenol oxidizing enzymes (peroxidase, tyrosinase, and laccase). These data were considered as an indication that heartwood formation activity is intense during the dormant period [Nelson, 1978]. Because of its relationship with phenolic metabolism, the rate of ethylene production was proposed as a potential biochemical marker for early selection of *Juglans nigra* trees forming higher proportion of heartwood. Nevertheless, experiments employing 5 open pollinated families in two plantation sites revealed no significant genetic variation in ethylene production among the five families analysed [Nelson *et al.*, 1981].

3.1.3.4 Wood extractives

The term of extractives includes a large number of compounds of different classes, which can be extracted from wood with solvents. Some authors consider as extractives only the compounds, which are soluble in organic solvents. However, organic compounds soluble in aqueous solvents (i.e. tannins) are also considered to be extractives. The extractives composition has been used for taxonomic purposes in a number of tree species. The accumulation of extractives is often associated with the ageing of sapwood and the formation of heartwood. Extractives which increase in amount during heartwood formation may be divided into four main classes [Hillis, 1987]:

- Galactans and cyclitols.
- Terpenoids.
- Fatty acids and related compounds.
- Phenolic compounds.

Phenolic compounds are the most widespread extractives and are second only to carbohydrates in abundance. Phenolic extractives have important functions in determining the features of heartwood, especially concerning its colour and durability [Hillis, 1987]. These compounds show large structure variability. The major classes of phenolic extractives that can be found in the wood of trees are:

Simple phenols

According to Hillis [1987] simple phenols cannot be classed as heartwood extractives. They include phenolic acids, hydrolysable tannins, hydroxycinnamic acids and their bicyclic derivatives (coumarins) (Figure 5). Hydrolysable tannins are esters of phenolic acids and sugars [Higuchi, 1997].

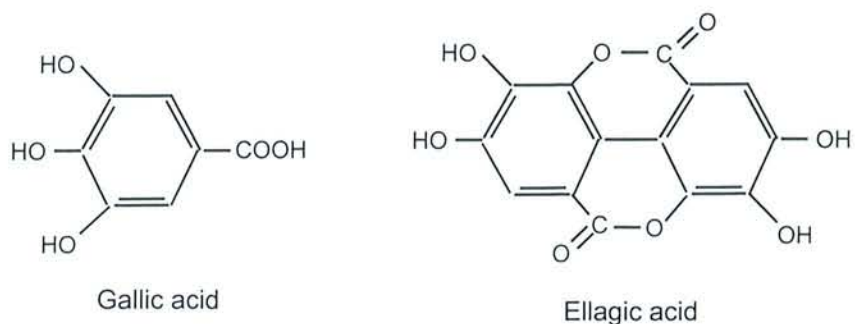

Figure 5. Example of chemical structures of simple phenolics. Gallic acid and ellagic acid derive from the hydrolysis of gallotannins and ellagitannins (hydrolysable tannins), respectively (Higuchi, 1997).

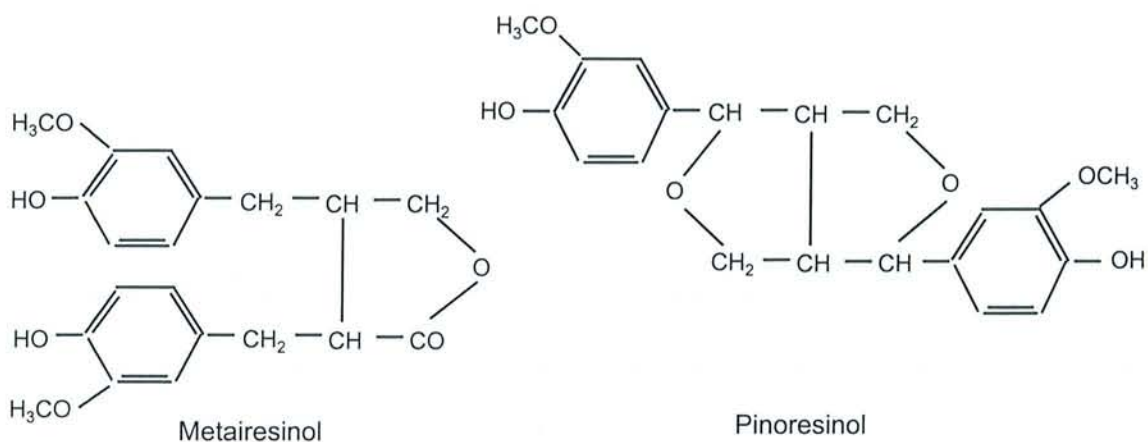

Figure 6. Chemical structures of lignans. These compounds consist of two phenylpropane units. They can be found in the heartwood of both coniferous and broad-leaved trees. (Hillis, 1987).



Figure 7. Chemical structures of quinones. Hydrojuglone glucoside accumulate in the sapwood of *Juglans nigra* and *Juglans regia* trees (Burtin *et al.*, 1998). Lapachol and tectoquinone occur in the heartwood of *Tectona grandis* (Higuchi, 1997).

These compounds are subdivided into gallotannins, which yield gallic acid by hydrolysis, and ellagitannins, which yield ellagic acid [Haslam, 1989]. Ellagic acid derivatives accumulate in the inner sapwood and in the heartwood of walnut [Burtin *et al.*, 1998] and ellagitannins accumulate in the heartwood of *Castanea sativa* and *Quercus petraea* [Peng *et al.*, 1991]. The derivatives of hydroxycinnamic acids occur only in small quantities in woody tissues. However, coumarins can be found in lesions such as scopoletin in the sapwood of *Prunus domestica* affected by the fungus *Stereum purpureum* [Hillis, 1987]

Lignans

These compounds consist of two phenylpropane units linked in different ways (Figure 6) and can be found in considerable quantities in the heartwood of both angiosperms and conifers [Hillis, 1987]

Quinones

The majority of quinones found in plants are benzoquinones, naphthoquinones, or anthraquinones [Thomson, 1979] (Figure 7). These compounds have a yellow to purple colour, confer high durability to wood against microorganisms, termites, and shipworms. Quinones have been extracted from the wood of plants belonging to families that are tentatively classified into three groups according to the chemical structure of quinones that are present. Group 1: Leguminosae, Boraginaceae, Ebenaceae, Rhamnaceae; group 2: Bignoniaceae, Juglandaceae, Proteaceae, Rubiaceae, Verbenaceae, Rutaceae; group 3: Malvaceae, Sterculiaceae, Ulmaceae [Higuchi, 1997; Hillis, 1987]. The naphthoquinone hydrojuglone glucoside (HJG) is one of the main extractives of walnut wood. Large amount of this compound were found in the sapwood of *Juglans nigra*, *Juglans regia*, and their interspecific hybrids. This compound is considered as a major precursor of heartwood colour in walnut [Burtin *et al.*, 1998].

Stilbenoids

Both the stilbenes and flavonoids are derived from a common intermediate involving the ester group of a hydroxycinnamic acid and a nucleophilic attack by an anion of acetyl-CoA resulting in a six-carbon side chain. The side chain is folded in different ways, and different mechanisms of cyclization are applied resulting in stilbenoid (C₆-C₂-C₆) (Figure 8) or flavonoid (C₆-C₃-C₆) compounds (Figure 9). Stilbenes are found in the heartwood of both angiosperms and conifers [Hillis, 1987].

Flavonoids

Flavonoids include thousands of compounds differing in the degree of saturation of the heterocyclic ring and the variation of hydroxylation of the aromatic rings (Figures 9 and 11). They are accumulated in the heartwood as glycosides or aglycones. They can exist also as polymers. The polymers based on units of flavan-3-ols and flavan-3,4-diols are known as condensed tannins. In wood, condensed tannins occur more frequently than hydrolysable tannins. The colour of the red, yellow, and brown heartwood is mainly due to flavonoids and related compounds [Higuchi, 1997; Hillis, 1987]. The chemical structure as well as the biosynthesis of flavonoids will be dealt with in details in the following chapters.

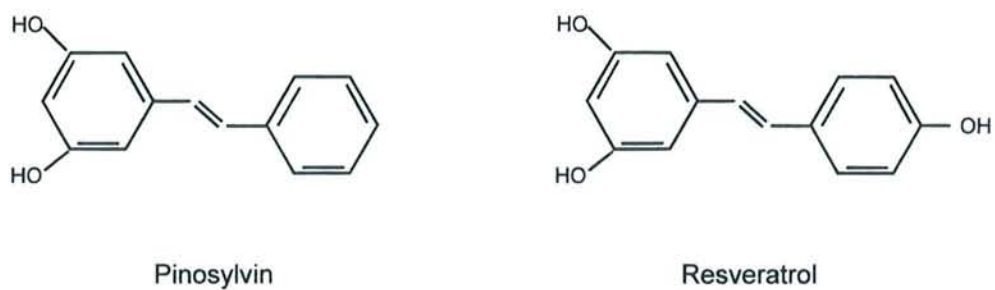

Figure 8. Chemical structures of stilbenes. Stilbenes are found in the heartwood of many trees species. These compounds were often used for taxonomic purpose. Pinosylvin occurs in the wood of Pinaceae. Resveratrol occurs in the wood of *Eucalyptus wandoo* (Hillis, 1987).

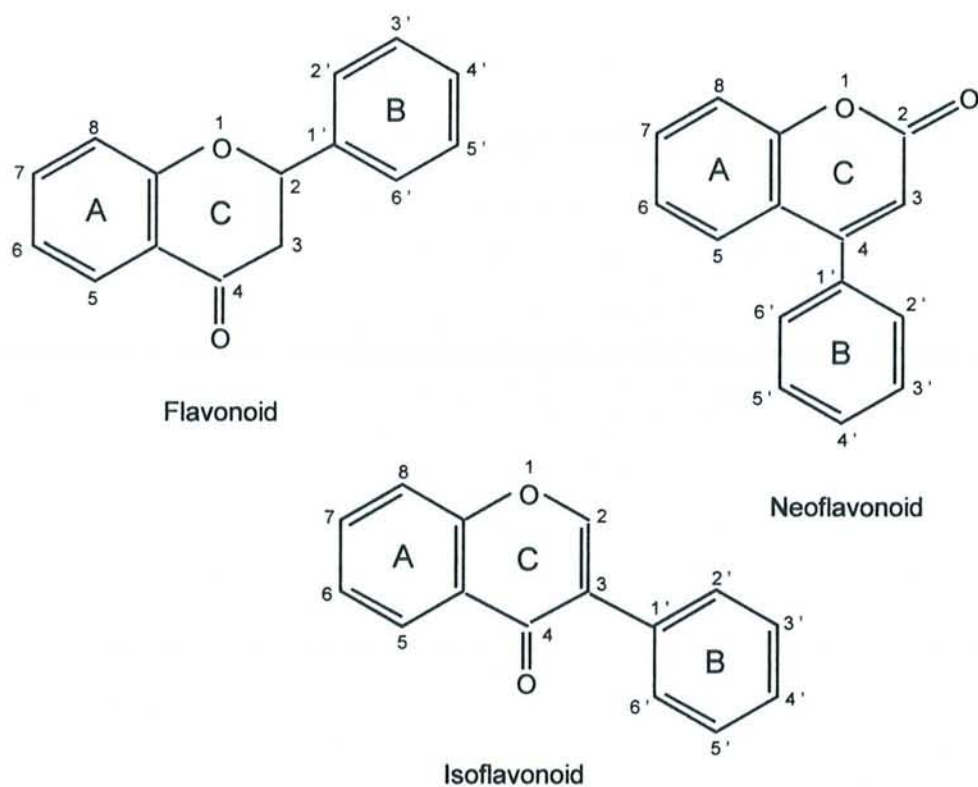

Figure 9. Basic chemical structures of flavonoid compounds

Polymerised polyphenols

The phenolic extractives of heartwood are largely present in a polymerised form and with constitutions that is mostly unknown. Probably slow oxidation and polymerisation occur in the heartwood over many years. These reactions could be explained by non-enzymatic oxidation that has been shown to occur in several species [Hillis, 1987].

3.1.3.5 Extractives distribution in the stem of trees

The amount of extractives accumulated in tree stems can vary according to the vertical and the radial position in the stem. The heartwood is characterised by a higher extractive content than the sapwood. Generally, in stem cross-sections containing heartwood, the extractive amount increases according to the age of the xylem growth rings, reaching its maximum in the transition zone or in the heartwood periphery. The extractive amount usually decreases from the bottom to the top of the tree [Hillis, 1987]. In cross-sections of an old *Sequoia sempervirens* stem, the aqueous extractive content increased from the pith to the periphery of the heartwood and from the top to the butt of the log. A similar pattern was observed in other species such as *Pseudotsuga menziesii*, *Tectona grandis*, and *Acacia* spp. [Hillis, 1987]. The distribution of the flavonoid dihydroquercetin in cross-sections at three different height levels in *Pseudotsuga menziesii* and *Larix occidentalis* trunks showed also a similar distribution pattern [Gardner and Barton, 1960; Dellus *et al.*, 1997a, 1997b]. In *Robinia pseudoacacia* trees sampled at different season, the amounts of flavonoids (dihydrorobinetin and robinetin) and hydroxycinnamate strongly increased in the transition zone when compared to the middle and outer sapwood [Magel *et al.*, 1994]. In *Juglans nigra*, *Juglans regia*, and their interspecific hybrids, the amount of hydrojuglone glucoside, quercitrin, and ellagic acid derivatives increased in sapwood according to the age of the xylem growth rings, and reached their maximum in the transition zone. Moreover, samples taken at butt level showed extractive content higher than samples taken at higher level above ground [Burtin *et al.*, 1998].

3.2 Physiology of heartwood formation

Heartwood formation can be considered as the final step in the life cycle of xylem cells. During their differentiation from the cambial zone to the heartwood zone, the different wood cells undergo specific changes according to their nature and fate. These processes begin with the division of cambial meristematic cells, producing secondary phloem outwards and secondary xylem inwards. Cells then elongate, and cellulose deposition and lignification of secondary cell walls occur. During their differentiation, the xylem cells forming vascular elements lose their protoplasm, whilst parenchyma cells (axial parenchyma and rays) remain alive in the mature secondary xylem that forms the sapwood [Bosshard, 1965; Fengel, 1970; Larson, 1994]. After a variable number of years, the inner part of the sapwood becomes physiologically inactive forming the heartwood [Hillis, 1987]. The formation of the heartwood is a complex process, characterised by three major phenomena: i) decrease of carbohydrate content; ii) formation and deposition of heartwood extractives (mainly phenolic compounds); iii) death of parenchyma cells.

These phenomena take place in the parenchyma cells that remain alive in the sapwood. Such cells are involved in storage and movement of reserve substances, wound healing, and formation of secondary products, including extractives [Hillis, 1987]. The proportion of living parenchyma cells usually decreases within the transition zone and drops to zero in the heartwood. In a comparative study of 26 broad-leaved tree species, it was shown that the proportion of living parenchyma cells present in the sapwood is almost 100% from the cambium to the transition zone, where it decreased to zero at the limit of the heartwood [Nobuchi *et al.*, 1987]. Experimental evidence shows that the parenchyma cells remaining alive in the transition zone undergo marked metabolic and cytological changes. Frey-Wyssling and Bosshard, [1959] observed that in broad leaved and coniferous species the xylem parenchyma cells show degeneration of nuclei and mitochondria as the distance from the cambium increases and, finally, disintegration of nuclei in the transition zone. However, in the ring-porous species *Juglans regia*, *Robinia pseudoacacia*, *Quercus robur*, and *Prunus avium* the slenderness degree of nuclei (the ratio between the maximum and the minimum diameter of cell nucleus, that is considered as an index of the cellular activity) decreases within the inner sapwood and then increases in the transition zone. In addition, starch disappears in the transition zone before nuclei disintegration. The variations in the slenderness degree and the disappearance of starch suggest an increase of metabolic activity in the transition zone [Hillis, 1987].

The physiological changes of xylem parenchyma cells over their whole life cycle have been largely studied in the coniferous tree *Cryptomeria japonica* (Japanese cedar) by Nobuchi *et al.*, [1982; 1985] and Nobuchi and Harada [1983]. The wood of this species is characterised by a sharply distinct transition zone, paler in colour, often referred to as “white zone”. In the outer sapwood, the percentage of living cells was close to 100%, whilst it dropped to about 50% in the inner sapwood and then decreased to zero across the transition zone. The moisture content suddenly decreased at the limit between the sapwood and the transition zone. In this zone, it was lower than both in sapwood and heartwood. In addition, the moisture

content of the transition zone was almost constant and did not show seasonal fluctuations as moisture contents of sapwood and heartwood did. Bordered pits were opened in the sapwood but they became suddenly aspirated in the transition zone, concomitant to moisture decrease. The authors proposed that pit aspiration could form a barrier for water movement between the sapwood and the transition zone. Starch was present only in the living cells and disappeared in the transition zone. Lipid droplets were observed both in sapwood and heartwood but showed structural changes and extra cellular localisation within the transition zone. As the moisture content, starch and lipid contained in the transition zone did not show any seasonal fluctuations, whilst variations were observed in the sapwood. The distribution of soluble phenolic substances was opposite to that of starch and living cells. Phenolic extractives were present in small amounts in the sapwood, increased in the transition zone, and reached the maximum level in the outer rings of the heartwood. Microscope observations of wood sections revealed the presence of 3 types of coloured parenchyma cells. In the first cell type, nuclei and organelles were absent, the coloration was pale, due to little amounts of coloured substances. These cells were died in the inner sapwood, before entering in the transition zone. The authors postulated that the coloured substances present in them might come from surrounding living cells. In the second cells type, nuclei and organelles were present together with starch grains and some coloured substances. These cells, observed mainly in the inner sapwood, were living and produced polyphenols. In the third cell type, nuclei, organelles, and starch were absent and the colouration was deep. This third cell type derived from the death of the second cell type.

According to the present knowledge arising from cytological, histological, and biochemical studies, Higuchi [1997] proposed a 3 steps model to describe the main changes leading to heartwood formation. In the first step some inducing factors, at present unknown, trigger the transformation of sapwood into heartwood at the molecular level. In the second step, genes controlling phenolic biosynthesis are activated and expressed in the transition zone, inducing an increase of the metabolic activity and the synthesis of phenolic extractives that accumulate in the vacuoles. In the third and last step, the living parenchyma cells die, their nucleus and organelles disintegrate and the phenolics previously accumulated are released and diffuse both in the matrix of cells walls and in the lumen of adjacent cells.

3.2.1 Formation of heartwood extractives

The formation of phenolic extractives is of great scientific and industrial interest because it affects the natural colour and durability of wood products. The origin of heartwood extractives has been subject of scientific dispute for a long time. Since the 60's, two main theories have been proposed to explain the accumulation of extractives occurring during ageing of sapwood: "translocation" and "*in situ* synthesis". The "translocation theories" proposed that extractives were produced in leaves or other organs and then transported to the inner part of the stem through the phloem and the parenchyma cells of the sapwood. Stewart [1966] proposed an original excretion function for the heartwood. According to Stewart's theory, toxic by-products, originated as waste from metabolic pathways, would be detoxicated by active translocation to the centre of the stem. In this zone, the "toxic" substances would reach a lethal

concentration causing the death of the parenchyma cells and thus the formation of the heartwood. The “translocation” theories did not account for some characteristics of heartwood: a localised increase of extractive content is observed in the transition zone of many tree species; several differences in chemical composition exist between the extractives from heartwood and those from other plant organs (leaves, fruits); heartwood extractives are often chemically complex and require energy-consuming reactions for their formation, whilst waste products are usually less complex compounds [Hillis, 1987].

Experimental evidence supports the hypothesis that extractives are actively formed *in situ* in sapwood tissues. Chattaway [1952] first observed that, at the cytological level, the death of the living parenchyma cells in the transition zone is preceded by a period of enhanced metabolic activity. Several biochemical parameters indicated that metabolic activities possibly linked to extractive synthesis increased in the transition zone when compared to outer parts of the sapwood. A peak of respiration rate in the transition zone was reported for *Pinus radiata* [Shain and Mackay, 1973], *Robinia pseudoacacia* [Höll and Lenzian, 1973], and *Populus tremula* [Hillis, 1987], indicating that energy-consuming reactions occurred where heartwood was formed. The amount of several water-soluble vitamins increased in the sapwood-heartwood boundary of *Pinus strobus* [Ziegler, 1968]. As many of these vitamins are co-enzymes, such results suggested an increased enzymatic activity. More recent works demonstrated that the activity of enzymes involved in the synthesis of phenolics increased in the transition zone. An increase of peroxidase activity in the inner part of the sapwood was reported for *Juglans nigra* [Nelson, 1978] and *Quercus robur* [Ebermann and Stich, 1985]. Moreover, in *Juglans nigra* trees the peak of peroxidase activity was concomitant to a peak of ethylene production, which is usually associated with phenolic biosynthesis. Finally, in *Robinia pseudoacacia* an increase of the activities of enzymes controlling phenylpropanoid and flavonoid pathways (phenylalanine ammonia-lyase and chalcone synthase) was observed in the transition zone and correlated with the distribution of flavonoids in the stem [Magel *et al.*, 1991; 1994; Magel and Hübner, 1997].

As phenolic extractives appear to be synthesized in the sapwood, it is expected that reserve substances are consumed in the same site to provide the energy and the carbon skeleton needed by the phenolic biosynthetic pathways. As mentioned above, starch is present in the sapwood, but its content decreases in the transition zone of trees and disappears in the heartwood. The distribution of storage carbohydrates in cross-section of trees is opposite to the distribution of some phenolic extractives. Therefore, some authors proposed that carbohydrates are transported to the aged sapwood, where they would be used for the biosynthesis of extractives [Hillis, 1987; Höll, 2000]. A first evidence of this mechanism was obtained by experiments using radioactively labelled sugars administered to the cambial region of *Eucalyptus sieberiana* trees. The labelled precursors were translocated to the inner part of the sapwood and then converted to labelled polyphenols in the transition zone two to three weeks later [Hillis and Hasegawa, 1963]. The relationship between primary and secondary metabolism has been better elucidated in *Robinia pseudoacacia*. On one hand, the starch content decreased from the outer sapwood to the transition zone [Höll, 2000]. On the other hand, flavonoids were specifically accumulated following an opposite

distribution pattern [Magel, 2000]. In the same way, sucrose was detectable in the transition zone during the period of heartwood formation (autumn). The activity of sucrose synthesizing enzymes (sucrose-phosphate synthase) was preferably located in the storage part of the stem, the middle and inner sapwood. On the contrary, the activity of sucrose degrading enzymes (sucrose synthase, neutral invertase) was high in the differentiating xylem during the cambial activity period (spring-summer) and in the transition zone during the heartwood formation period (autumn) [Magel, 2000]. Semi-quantitative RT-PCR showed that the level of sucrose-synthase transcripts correlated with the amounts of enzyme protein and its activity, indicating an up-regulation at the transcription level. The enhanced sucrose degrading activity coincided with the increased activity of PAL and CHS and the accumulation of flavonoids. These results indicate that sucrose is used for xylogenesis at the cambium level and for extractive biosynthesis in the old sapwood [Magel, 2000].

3.2.2 Biological functions of heartwood

During the evolution, many, but not all, woody species developed heartwood in the core of the stem. This process occurs with certain regularity, indicating that it is under control of genetic factors and it must have a biological significance [Hillis, 1987]. The transport and storage functions of the sapwood are correlated to the size of the crown and to the growth rate of the tree (see also “Quantitative aspects of heartwood formation”). In a living tree, the major physiological effect of heartwood formation is a reduction in the volume of the living sapwood. It has been postulated that heartwood formation is a compensation mechanism keeping the sapwood volume at the optimal level according to the needs of the plant. However, the apparent need of an adequate volume of sapwood does not account for the tree species which never form heartwood, even when reaching considerable diameter (see also “Definitions”). Furthermore, this simple explanation does not account for the chemical changes occurring in the transition zone, the most striking being the accumulation of heartwood extractives. These compounds have a consistent chemical composition and sometimes are highly specific of taxonomic groups. This indicates that they are produced according to a genetic program and have probably evolved for particular functions. Many extractives are phenolics, which show antimicrobial properties. The heartwood does not contain living cells and, thus, it is unable to actively react to any parasite attacks. Extractives can provide some form of resistance, especially against microorganisms. From this point of view, the activation of both carbohydrate catabolism and phenolic biosynthesis in sapwood growth rings being transformed into heartwood can be considered as a cellular mechanism developed by long-lived trees to protect their wood structure over long term ageing. This metabolic activation has 2 major consequences:

- i) total consumption of carbohydrates contained in the sapwood, thus limiting the development of parasites.
- ii) accumulation of toxic substances against parasites.

3.2.3 Induction of heartwood formation: hypothesis

Fungal infections.

The first hypothesis about factors inducing heartwood formation was the involvement of fungal infections inside the stem of trees. Although some workers succeeded in inducing heartwood formation by artificial fungal inoculations, this hypothesis could not be considered as a general explanation for heartwood formation [Hillis, 1987].

Detoxication

In the 60's, Stewart [1966] proposed that some toxic by-products originated from plant metabolism would be detoxicated by transferring them to the inner part of the stem. The increasing concentration of these toxic products would cause the death of the inner parenchyma cells, thus forming heartwood.

Hormone-like substance

Bamber [1976] proposed the existence of a hormone-like substance regulating heartwood formation. This factor, called *Heartwood Inducing Substance* (HIS), would move centripetally from the cambium to the pith, reaching a threshold level in the centre of the stem, where it would trigger the heartwood formation.

Ethylene

Later, the attention has been focused mainly on ethylene and water content as potential factors inducing heartwood formation. Peaks of ethylene production were observed in the transition zone of *Juglans nigra* [Nelson, 1978] and *Pinus radiata* [Shain and Hillis, 1973] during the dormant season, considered as the period of heartwood formation. Moreover, it was possible to induce artificially the formation of heartwood in young trees by local applications of ethylene [Hillis, 1987].

Water content

Both in angiosperms and coniferous trees, the passage between the sapwood and the transition zone is concomitant to a sudden reduction of the moisture content. Bordered pits are often aspirated at the limit between the sapwood and the transition zone, indicating a mechanism limiting the water movements toward the transition zone. In this xylem zone, the moisture content is invariably lower than in the sapwood [Nobuchi and Harada, 1983]. These observations suggest the existence of a precise threshold value of the water/gas ratio that could trigger the formation of heartwood.

Mechanical stress

Recently, the effects of mechanical stresses have also been taken into account. In *Pinus pinaster* trees, when the stem growth is eccentric, due to stem lean, bending or wind action, the shape of the heartwood is also eccentric. The number of growth rings of sapwood transformed into heartwood is greater on the compressed side of the tree. The reason for such eccentricity is not known. Stokes and Berthier [2000] proposed two main hypotheses to explain it. The first hypothesis considers the mechanical function of heartwood, contributing to the stability of the tree. The second hypothesis considers the formation of heartwood as a compensation process, ensuring an optimal amount of sapwood around the trunk. Berthier *et al.* [2000] demonstrated that heartwood does not play a significant mechanical role for the stability of

Pinus pinaster trees. On the opposite, a significant correlation was found between the sapwood surface area at different heights and the crown surface area, suggesting that heartwood formation serves to maintain an optimal proportion of functional sapwood. The physiological mechanisms by which the eccentric formation of heartwood is mediated are not known. The hypotheses proposed by Stokes and Berthier [2000] include higher ethylene production on the compressed side and altered water content in wood cells due to the mechanical bending stress.

3.3 Flavonoid compounds

3.3.1 Chemical structure

Flavonoids are phenolics compounds characterised by a $C_6-C_3-C_6$ structure composed of the C_6-C_3 (phenylpropane) fragment that contains the aromatic B ring, and of the C_6 fragment that contains the A aromatic ring. Flavonoids are classified into flavonoids, isoflavonoids and neoflavonoids based on the different substitution position of the B ring on the C ring (Figure 9). Flavonoids are further classified into flavones, flavanones, chalcones, aurones, catechins and leucoanthocyanidins based on the modifications of the C ring (Figure 11). Flavonoids are widely distributed in the plant kingdom, but isoflavonoids and neoflavonoids occur only in a few higher plants, mainly belonging to *Leguminosae* [Higuchi, 1997].

3.3.2 Biosynthesis

Flavonoid biosynthetic pathway represents a branch of the general phenylpropanoid pathway (Figure 10), which includes compounds having the common phenyl-propane structure. The enzymes catalysing the main steps of these pathways are listed in table 1. The general phenylpropanoid pathway forms 4-coumaryl-CoA, the common precursor for the synthesis of lignin monomers, lignans, suberins, stilbenes, and flavonoids. This pathway starts from phenylalanine, which is synthesized via the shikimate/arogenate pathway. The key reaction, the deamination of phenylalanine, is catalysed by phenylalanine ammonia-lyase (PAL). The product of the reaction, *trans*-cinnamate, is hydroxylated to 4-coumarate by 4-coumarate-CoA ligase (C4H). The activation of 4-coumarate by formation of the CoA ester is catalysed by 4-coumarate-CoA (4CL) [Heller and Forkmann, 1994].

Flavonoid synthesis starts with the condensation of one molecule of 4-coumaryl-CoA and three molecules of malonyl-CoA yielding naringenin chalcone (Figure 11). The B ring and part of the heterocyclic ring C are provided by 4-coumaryl-CoA, whereas the A ring originates from three malonyl-CoA units. This reaction is catalysed by the enzyme chalcone synthase (CHS). The chalcone is subsequently isomerised by the enzyme chalcone flavanone isomerase (CHI) to yield a flavanone. From these central intermediates, the pathway diverges into several branches. Flavanones are the direct precursors for the large class of flavones that are involved in phytoalexin synthesis, and for the formation of two flavonoid intermediates, the dihydroflavonols and the flavan-4-ols. Flavones are synthesized from flavanones by introduction of double bond between C-2 and C-3. The enzyme flavone synthase (FNS) catalyses this reaction. Formation of isoflavones from flavanones is catalysed by 2-hydroxyl-isoflavanone synthase (IFS). This reaction involves a shift of the aryl ring B from position 2 to 3. The reduction of the carbonyl group of flavanones gives rise to flavan-4-ols.

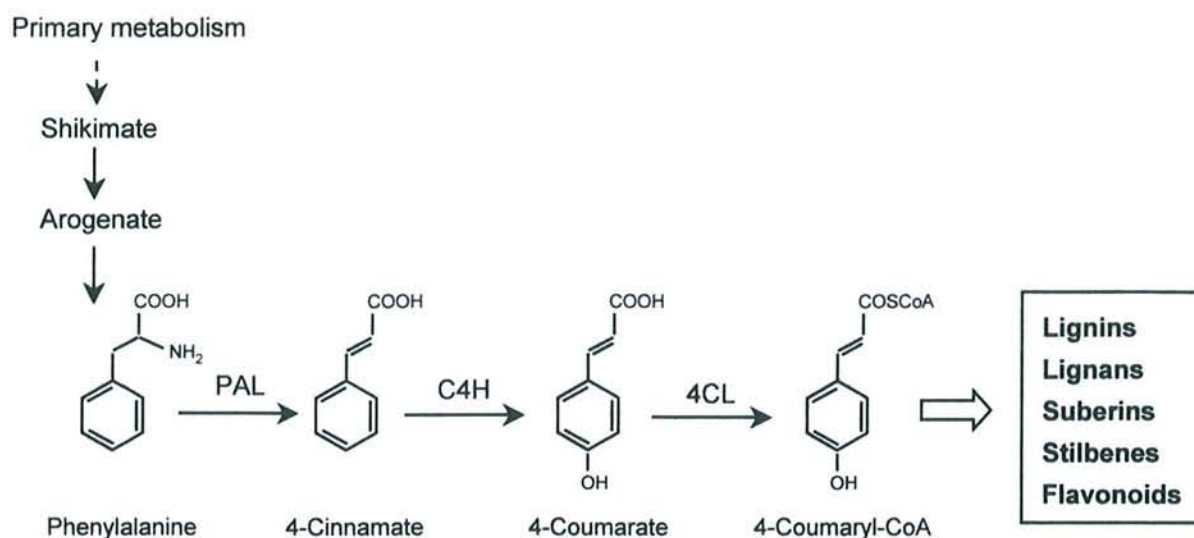

Figure 10. Scheme illustrating the general phenylpropanoid pathway that provides precursors for the synthesis of lignins, lignans, suberins, stilbenes, and flavonoids. The enzymes catalysing the metabolic steps are listed in table 1 below.

Table 1. List of enzymes catalysing the reactions leading to the synthesis of the major flavonoid classes (Heller and Forkmann, 1993).

Enzyme	Acronym	EC number
General phenyl propanoid pathway		
Phenylalanine ammonia-lyase	PAL	4.3.1.5
Cinnamate 4-hydroxylase	C4H	1.14.13.11
4-Coumarate:CoA ligase	4CL	6.2.1.12
Flavonoid pathway		
Chalcone synthase	CHS	2.3.1.74
Chalcone isomerase	CHI	5.5.1.6
2-Hydroxyisoflavanone synthase	IFS	
2-Hydroxyisoflavanone dehydratase	IFD	
Flavone synthase	FNS	
Flavanone 4-reductase	FNR	1.1.1.234
Flavanone 3-hydroxylase	F3H or FHT	1.14.11.9
Flavonol synthase	FLS	
Dihydroflavonol 4-reductase	DFR	1.1.1.219
Leucoanthocyanidin 4-reductase (flavan-3,4- <i>cis</i> -diol 4-reductase)	LAR	
Anthocyanidin synthetase	ANS	
Flavonoid 3-O-glucosyl-transferase	FGT	2.4.1.91

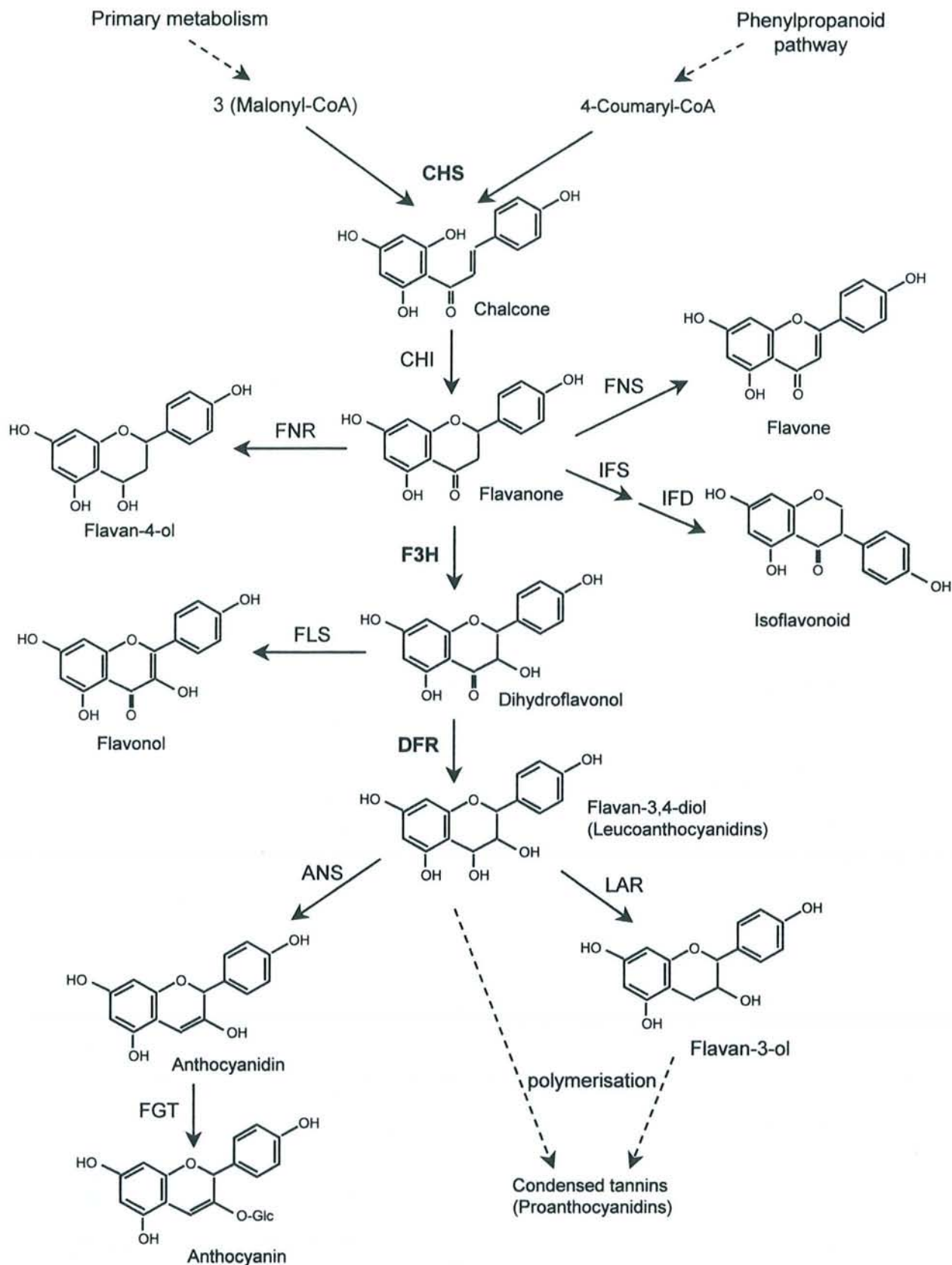

Figure 11. Scheme illustrating the biosynthesis of the major flavonoid classes. The enzymes catalysing the metabolic steps are listed in table 1.

The reaction is catalysed by flavanone 4-reductase (FNR) and provides precursors for the formation 3-deoxyanthocyanins, which occur in a restricted number of plant families. Finally, flavanones can be hydroxylated in position 3 to dihydroflavonols, which are biosynthetic intermediates of flavonols, catechins, proanthocyanidins and anthocyanidins. This reaction is catalysed by flavanone 3-hydroxylase (F3H or FHT). [Heller and Forkmann, 1994]

Dihydroflavonols are the direct substrates for the formation of flavonols and flavan-3,4-diols, which are also known as leucoanthocyanidins. Flavonols are formed from dihydroflavonols by introduction of a double bond between C-2 and C-3. The reaction is catalysed by flavanol synthase (FLS). The reduction of dihydroflavonols in position 4, catalysed by dihydroflavonol 4-reductase (DFR), leads to flavan-3,4-diols, which are intermediates in catechin, proanthocyanidin and anthocyanidin formation. Catechins (flavan-3-ols) are synthesized from flavan-3,4-diols by further reduction in position 4. This reaction is catalysed by flavan-3,4-*cis*-diol reductase (LAR). Proanthocyanidins, also called condensed tannins, originate from condensation of flavan-3,4-diols and flavan-3-ols, forming complex polymers. The enzymes catalysing these reactions are not yet known. Flavan-3-ols and their oligomeric derivatives (i.e. condensed tannins) are usually referred to as flavanols [McMurrough and Baert, 1994; Treutter, 1989]. Flavan-3,4-diols are also the precursors for one of the most important flavonoid classes, the anthocyanins. These compounds are formed via the intermediates anthocyanidins by the catalysis of anthocyanidin synthase (ANS). Owing to the instability of the anthocyanidins under physiological conditions, the formation of 3-*O*-glucoside is supposed to be obligatory. One enzyme catalysing this reaction is the UDP-glucose:flavonoid 3-*O*-glucosyl-transferase (FGT). [Heller and Forkmann, 1994]

The simple flavonoids with a single hydroxy group in the B-ring can be extensively modified. Many enzymes have been described, catalysing hydroxylation, methylation, glycosylation, acylation and a number of other reactions on flavonoids. Glycosylation is an important modification that allows to increase the solubility of these compounds in water. This reaction is also a prerequisite for acylation of the carbohydrate moiety with carboxylic acids. Many flavonoids are present as glucosides [Heller and Forkmann, 1994].

3.3.3 Biological functions

Flavonoids represent an important group of secondary metabolites. These compounds are unique to plants and play an essential role in their successful adaptation to life as sedentary organisms. They exhibit a wide spectrum of biological functions related to the interaction between plants and their environment [Koes *et al.*, 1994; Shirley, 1996].

Pigmentation and visual signalling.

Flavonoids are well known for the coloration they provide in blue, red, purple (anthocyanins), and yellow (aurones and chalcones) pigments of flowers, fruits, and leaves and the brown pigments of seeds. Such pigmentation has often an attraction role for pollinators and for seed dispersers to flowers and to ripened fruits respectively. [Mol *et al.*, 1998]

Defence against UV irradiation.

Flavonoids can absorb light over a wide range of the light spectrum, including UV light. It has been proposed that they act as “sunscreens” protecting the plant from harmful UV irradiation. This is confirmed by the observation that flavonoid-deficient mutants of *Arabidopsis thaliana* are hypersensitive to UV-B radiation. It seems that flavonoids can protect DNA from UV-induced damage [Koes *et al.*, 1994; Shirley, 1996].

Plant reproduction and fertility.

Many plants accumulate flavonoids in the anthers and the pistil. Analyses of maize and petunia mutants deficient in flavonoid synthesis show that flavonoids play an essential role in pollen viability for these species. The mechanism through which flavonoids promote pollen tube development is still unclear and their presence is not essential for other species. Actually, flavonoids are apparently not required for fertility in other model species such as *Arabidopsis*, *Petroselinum crispum*, and *Antirrhinum majus*. [Koes *et al.*, 1994; Shirley, 1996]

Interaction between plants and microorganisms.

Certain flavonoids participate in the interaction between plants and microorganisms both pathogenetic and symbiotic. Some flavonoids, called phytoalexins, are important signalling molecules functioning as defence factors against fungal infections. The best known examples are the isoflavonoids, characteristic of leguminous plants. Flavonoids can also act as attractive factors for bacteria. They play a central role as signalling molecules in the establishing of symbiosis between leguminous plants and nitrogen fixer bacteria (*Rhizobium*). [Koes *et al.*, 1994; Shirley, 1996]

Flavonoids as wood extractives

The accumulation of flavonoid compounds during the ageing of wood tissues has been reported for many species, such as *Larix occidentalis* [Gardner and Barton, 1960], *Eucalyptus* [Hillis, 1956], *Robinia pseudoacacia* [Magel *et al.*, 1994], *Pseudotsuga menziesii* [Dellus *et al.*, 1997a, 1997b] and *Juglans* spp (walnut) [Burtin *et al.*, 1998]. The accumulation of these compounds confers durability, especially against fungal infections and some flavonoids that accumulate in the sapwood can act as phytoalexins [Kemp and Burden, 1986]. Flavonoids are also chromophores responsible for the main colour of some woods [Dellus, 1995; Dellus *et al.*, 1997a].

3.3.4 Regulation of flavonoid biosynthesis. Example of chalcone synthase activity.

The biosynthesis of flavonoids may be induced by a range of environmental and developmental stimuli. The metabolic chain linking the inducing factors to the final products (flavonoids) involves different levels of activation and regulation. *In vivo*, they include signal perception, transduction, gene transcription, protein synthesis, and modulation of enzyme activity [Dangl *et al.*, 1989; Koes *et al.*, 1994; Martin, 1993; Mol *et al.*, 1996].

Chalcone synthase is considered as a key enzyme in the biosynthesis of flavonoids. This enzyme is a representative example of the structural genes of flavonoid pathway. The activity of CHS can theoretically

be regulated at all levels mentioned above. At the protein level, two mechanisms can regulate the enzyme activity, inhibition of catalytic activity and turnover of the enzymatic protein. CHS activity is inhibited non-competitively by its downstream products, such as the flavanone naringenin and the chalcone naringenin-chalcone. This inhibition was measured *in vitro*. Although there may be a fine tuning of CHS activity by the accumulation of end products, there is no evidence that this mechanism is significant *in vivo*. It seems unlikely that the inhibiting concentrations of end products are reached *in vivo* under normal physiological conditions [Martin, 1993]. There are few experimental studies focused on the control of CHS turnover. CHS protein can exist as inactive and active form. In *Petroselinum vulgare* cell cultures stimulated by light, the half-lives of the active and inactive form were estimated to be 6 hours and 18 hours respectively. There is no evidence for modulation of CHS activity through changing rates of turnover. Therefore, the induction of CHS activity in this species should be the result of *de novo* protein synthesis [Martin, 1993].

The control of CHS synthesis could theoretically operate at several points:

- transcriptional control.
- RNA processing
- post-transcriptional modifications,
- translational control,
- post-translational modifications,

There is no evidence of any post-translational modifications of CHS protein, but some experimental results indicate that, in *Zea mays*, CHS synthesis can be regulated at the translational level [Martin, 1993]. The data concerning post-transcriptional control are also limited. A direct relationship between *CHS* transcription and accumulation of *CHS* mRNA usually exist without the indication of rate-limiting processing steps [Martin, 1993]. The bulk of experimental data indicates that CHS activity is determined by the transcription rate of CHS genes [Koes *et al.*, 1994]. One possible exception to the transcriptional regulation of CHS activity has been showed in a study of GUS expression driven by the promoter of a *Petunia CHS* gene. Anthocyanin production in *Petunia* is restricted to the epidermis and the vascular tissue of the flowers. Nevertheless, GUS activity was detected in floral mesophyll tissues [Koes *et al.*, 1990]. A similar discrepancy was found in the GUS expression pattern driven by a promoter fragment of the *Antirrhinum CHS* gene in transgenic tobacco. In these experiments, no expression of *CHS* was found in roots of 4-week-old tobacco plants, although GUS activity in transgenic plants was very high in the same sites [Martin, 1993]. The authors suggested the possibility of post-transcriptional control of *CHS* gene expression. These discrepancies between the activity of *CHS* promoters and the expression of *CHS* genes have been observed in transgenic plants. Therefore, it is not clear whether a post-transcriptional control of CHS exist *in vivo* in natural non-transgenic organisms.

In woody tissues of *Juglans nigra* x *J. regia* a good mathematical correlation was found between the extractable CHS activity and the flavonoid content [Claudot *et al.*, 1993; 1997]. Such tight correlation tends to exclude post-translational regulatory mechanisms modulating CHS activity *in vivo* at the protein

level. In cross-sections of *Robinia pseudoacacia* stems, the extractable CHS activity was correlated with the amount of CHS protein and with the content of flavonoids, suggesting the absence of any post-translational control [Magel and Hübner, 1997]. These data indicate that the flavonoid amount accumulated in *Robinia* stems would be determined mainly by the amount of CHS proteins and suggest that the expression of CHS genes could control the flavonoid synthesis in the ageing xylem.

3.4 Genes controlling flavonoid biosynthesis

The flavonoid biosynthetic pathway is controlled by two classes of genes. The first class includes the structural genes, which encode the enzymatic proteins catalysing the biochemical reactions. The second class includes the regulatory genes, encoding the proteins that modulate the expression of the structural genes.

3.4.1 Structural genes

The bulk of experimental evidence shows that flavonoid biosynthesis is controlled primarily at the level of transcription of the structural genes [Koes *et al.*, 1994; Martin, 1993]. The great variety of flavonoid structures implies that specific enzymes are involved in the synthesis of specific flavonoid compounds (Figure 11). Thus, the type and the amount of flavonoids formed by plants appear to be mainly linked to the transcription rate of the genes encoding the enzymes of the flavonoid pathway. The distribution of different classes of flavonoids throughout the plant kingdom suggests that they have appeared sequentially during evolution. Chalcones, flavanones and flavonols appeared with the ancestors of a class of *Bryophyte*. With the first vascular plants (*Pteridophyte*, ferns) proanthocyanidins appeared, while anthocyanins appeared together with the first flowering plants (angiosperms). It has been speculated that the different enzymes and genes involved in the pathway appeared also sequentially. According to this theory, the “early” genes *CHS*, *CHI*, *F3H* would be older than “late” genes such as *DFR* and *ANS* [Stafford, 1991].

The structural genes of flavonoid pathway are often present in multiple copies and organised as multigene families. In example, *CHS* is encoded by a single gene in *Petroselinum vulgare* [Dangl *et al.*, 1989], while seven or more gene copies have been estimated in *Petunia hybrida* [Koes *et al.*, 1989], *Phaseolus vulgaris* [Ryder *et al.*, 1987], *Pisum sativum* [Harker *et al.*, 1990], and *Glycine maxima* [Akada and Dube, 1995]. The different members of *CHS* family may be differentially expressed in different tissues and/or in response to different stimuli [Harker *et al.*, 1990; Junghans *et al.*, 1993; Ryder *et al.*, 1987]. Gene duplication and divergence are thought to play an important role in the evolution of genes. The presence of multiple copies is thought to be in relationship with the evolution of different biological functions for flavonoids. Thus, the appearance of new flavonoids during evolution of plants would have required that some structural genes participated to the synthesis of different compounds. In order to control specifically the synthesis of different flavonoids, these genes would have been duplicated. Gene duplication provided the biosynthetic pathway with a flexible system to regulate differentially and independently the synthesis of several flavonoids [Koes, *et al.*, 1994].

3.4.2 Regulatory genes

Recently, more and more information is being gathered on the structures and the *cis*-acting elements of several phenylpropanoid biosynthetic gene promoters. *PAL*, *CHS*, and *DFR* are the gene used in many of the research studies. In several maize genes, a C1-motif and a R-motif have been identified. These motifs

are important for co-activation by MYB-like and bHLH (basic region/helix-loop-helix) classes of transcription factors respectively. In maize, the MYB-like family includes the proteins C1 and P1, and the bHLH family includes the R-like factors [Bodeau and Walbot, 1996]. Two regulatory genes isolated in *Petunia hybrida*, orthologues of maize C1 and R genes, were able to fully complement mutations of C1 genes in maize. Nevertheless, they were not able to induce the expression of early structural genes in *Petunia* [Quattrocchio *et al.*, 1998]. The authors concluded that flavonoid regulatory genes are functionally equivalent and that the species-specific differences in regulation reside in the promoters of the structural genes. Analyses of the *Phaseolus CHS* promoter sequence indicated that a 39 base pairs region, containing both G-box and H-box elements, was sufficient to direct the typical *CHS* tissue-specific expression. However, these elements required additional *cis*-element to modulate the level and the temporal expression during plant development in transgenic tobacco plants [Faktor *et al.*, 1997]. The H-box shares similarity with the C1-motif and may act as a MYB recognition element. The G-box belongs to a large family of ACGT elements (ACEs), which generally are recognised by bZIP-type (basic region/leucine zipper) factors [Hartmann *et al.*, 1998]. Taken together, there are three types of elements identified in many of the analyses: MYB recognition elements, ACEs or G-box-like elements, and bHLH factor binding sites (R-motifs), which are related to ACEs. The combinatorial interaction of these elements, which has been found repeatedly, provides the specificity in the promoter- and stimulus- dependent gene activation process [Weissbar and Jenkins, 1998].

Based on the *cis*-element data, a number of the corresponding DNA-binding proteins have been isolated by biochemical means. A MYB protein that recognises a MYB element in the *CHS* promoter has been identified from parsley. A bZIP factor that binds to both the G-box and H-box motifs of the French bean *CHS* promoter has been isolated from soybean. It is expected that the proteins recognising the elements *in vitro* will be transcription factors *in vivo*. However, there is some apparent contradiction between the biochemical data obtained from a number of species, including parsley, bean, tobacco, and *Arabidopsis*, and the genetic data from maize, petunia and snapdragon. By genetic means, MYB-like transcription factors have been identified as regulators of anthocyanin biosynthesis. Biochemical approaches identified MYB-like and bZIP factors. Thus, there is agreement about the involvement of MYB-domain transcription factors, but there are no genetic data supporting the involvement of bZIP factors in regulating anthocyanin biosynthesis. This apparent contradiction could be due to the differences between the biological systems used for genetic analyses and the ones used for the biochemical approach [Weissbar and Jenkins, 1998].

It has been proposed that the sequential evolution of flavonoid compounds has led to the evolution of suitable control mechanisms for the newly appearing structural genes [Koes *et al.*, 1994]. Furthermore, with the acquisition of new flavonoid functions, the expression of pre-existing genes ("early" genes as *CHS*) needed to be modified, because their expression is required for the biosynthesis of all flavonoids. Koes *et al.* [1994] proposed a model for the evolution of regulatory mechanisms from a common origin. In pre-angiosperm plants, *CHS* expression is needed for the synthesis of chalcones, flavanones, and flavonols and is under the control of a first ancestor set of regulatory genes. The structural genes for

proanthocyanidin and anthocyanin synthesis (*DFR* and others) would have been linked to another set of regulatory genes. Therefore, the expression of the early genes (*CHS*, *CHI*, and *F3H*) had to be linked to the expression of late genes, allowing primitive (chalcones, flavanones, and flavonols) and derived (proanthocyanidin and anthocyanin) flavonoids to be synthesized independently. This may have been achieved by the addition of appropriate modules in the promoters of flavonoid structural genes, giving them the necessary specificity. Alternatively, some structural genes may have been duplicated, followed by coupling of single gene members to regulatory mechanism specific of the different final products.

Experimental work

4. Experimental work

4.1 Introduction

The long-term objective of this work is to identify genes controlling wood quality in walnut. Studying heartwood formation at the molecular level appeared as a promising experimental approach providing access to the genes involved in the control of wood quality. Wood ageing and heartwood formation are considered as the major physiological processes contributing to the natural colour and durability of wood [Hillis, 1987]. These processes strongly affect wood quality but are poorly understood at the molecular level. The factors triggering heartwood formation and regulating heartwood extension are not known. Nevertheless, it is known that the phenolic metabolism is strongly activated in the transition zone between sapwood and heartwood, resulting in the accumulation of phenolic substances that are mainly responsible for wood colour and durability [Magel, 2000]. **The identification of the genes controlling the accumulation of phenolic substances in wood tissues represents a key step in the understanding of wood physiology as well as in the genetic improvement of wood quality.** It has been shown that the activity of some key enzymes of phenolic biosynthesis is up-regulated in the transition zone between sapwood and heartwood [Magel, 2000]. Experimental data suggest that such increase of enzyme activity could be controlled at the transcription level. Nevertheless, no experimental results are available about the expression of genes encoding the key enzymes of phenolic metabolism in aged xylem. A main question arises. **“Are phenolic structural genes specifically expressed in the aged sapwood being transformed into heartwood?”** In order to answer such question, this work focussed on studying the expression of genes encoding the enzymes of phenolic biosynthetic pathways in the xylem of *Juglans nigra* trees.

Juglans nigra trees have been considered as a suitable biological model to study heartwood formation at the molecular level. They form large amounts of heartwood and their wood is deeply coloured by the accumulation of specific phenolic compounds [Nelson, 1976; Burtin *et al.*, 1998]. In the frame of the E.U. research programme “W-BRAINS” (FAIR CT96-1887), a periodical sampling of mature *Juglans nigra* trees was carried out in 1997 and 1998. Stem discs were collected from these trees and used to study the physiology of wood formation. **Our experimental strategy consisted in studying the expression of candidate genes in wood samples** of the stem spanning the differentiating xylem to heartwood and representing the different stages of xylem ageing. Our interest was focused on the biosynthesis and accumulation of flavonoid compounds. The expression of genes encoding the enzymes of phenylpropanoid and flavonoid biosynthesis (PAL, C4H, 4CL, CHS, F3H, and DFR) was studied across stem section of *Juglans nigra* trees.

Some preliminary experimental steps were carried out before approaching the analyses of gene expression. These steps included the choice of trees and wood samples to be analysed, the development of molecular biology techniques appropriate for aged xylem tissues, and the cloning of homologous cDNA

probes. The sampling of trees carried out in "W-BRAINS" programme covered more than one year and included 10 *Juglans nigra* trees harvested every 5-6 weeks between 1997 and July 1998. Tree samples were anatomically characterised in order to determine the relative proportion of sapwood and heartwood and establish an integrated description of the dynamics of heartwood formation in *Juglans nigra* trees. The most representative wood samples were selected to perform molecular analyses in order to target the key periods of heartwood formation. This selection was mainly based on the biochemical analyses of polyphenolic compounds carried out at the INRA Research Centre of Orléans. Finally, five trees, representing contrasted periods of heartwood formation, were used for the molecular analyses of gene expression. From the technical point of view, it was necessary to test and adapt different protocols for the isolation of RNA from very aged xylem. The difficulties were both in the nature of the tissues and in the scarcity of scientific information about molecular analyses on wood. The cloning of homologous cDNA probes from *Juglans nigra* xylem provided the molecular tools suitable for reliable hybridisation analyses both for DNA (Southern) and RNA (northern) blots. Several candidate genes were studied but the preliminary molecular analyses revealed that the yield of RNA extractable from aged xylem samples was very low. Therefore, for gene expression analyses, it was necessary to apply techniques requiring low amounts of RNA (RT-PCR, dot blots).

The **experimental work** is divided in four parts

1. *Description of the plant material.*

In this first part, the *Juglans nigra* trees collected and the sampling of wood samples used for biochemical and molecular analyses are presented in details.

2. *Characterisation of heartwood formation in Juglans nigra.*

The results of the biochemical analyses and anatomical observations carried out on wood samples are given here in order to provide an integrated description of the dynamics of heartwood formation in *Juglans nigra*. Some hypotheses were proposed about the seasonal dynamics of heartwood extension. On this basis, it was possible to determine the key seasonal periods on which molecular analyses were subsequently performed.

3. *Set-up of the techniques for molecular analyses on aged xylem*

The different techniques tested for the isolation of RNA from wood are presented and compared in this part. The technical problems linked to the analyses of aged xylem are discussed. The cloning of cDNA fragments corresponding to the candidate genes expressed in xylem tissues is also described and the sequences of the partial cDNA clones obtained is given as appendix. The cloned cDNA fragments were used as homologous probes for gene expression analyses.

4. *Flavanol accumulation and gene expression during xylem ageing and heartwood formation in Juglans nigra.*

The main physiological results are presented in this part. Xylem samples collected at different seasonal periods were analysed to monitor the flavanol content and the transcription levels of genes encoding PAL, C4H, 4CL, CHS, F3H, and DFR enzymes. Moreover, the amount and the catalytic activity of PAL and

CHS proteins were analysed at Tübingen University (Germany) by Professor Magel's team. The overall results indicate that the synthesis of flavanols, occurring during heartwood formation, is controlled by the expression of the genes encoding CHS, F3H, and DFR enzymes. It was postulated that the high flavanol accumulation observed in the transition zone was due to *de novo* biosynthesis and regulated at the transcription level.

Description of the plant material

4.2 Description of the plant material

4.2.1 Collection of trees and wood samples

A large collection of wood samples from *Juglans nigra* trees was realised within the frame of the E.U. research programme W-BRAINS (FAIR CT96-1887) in 1997 and 1998. The *Juglans nigra* trees used in this study were grown in a plantation installed in 1974 and maintained by M.C. Leclerc de Hautecloque at Lisieux (France). These trees belonged to a half-sib progeny. One 23-24 year old *Juglans nigra* tree was felled periodically, according to the following calendar. Height and diameter of the tree stems were measured and the diameter at breast height (1.3 m) is reported below.

Sampling date	Diameter at 1.3 m height
• June 3rd 1997	239 mm
• July 15 th 1997	226 mm
• August 26 th 1997	207 mm
• October 10 th 1997	235 mm
• November 26 th 1997	261 mm
• January 6 th 1998	166 mm
• February 17 th 1998	236 mm
• March 31 st 1998	190 mm
• May 12 th 1998	236 mm
• July 28 th 1998	197 mm

Each tree was cut 10 cm above the ground and the stem portion located between 70 cm and 120 cm above the ground was sliced into 12 wood discs 2 cm thick. The wood discs were numbered and ordered from the bottom to the top to identify their original position in the standing tree. After slicing, the wood discs were immediately frozen in liquid nitrogen and freeze dried under vacuum during 6-7 days. The lyophilised wood discs were stored under dry atmosphere in sealed containers at room temperature until analysis.

4.2.2 Selection of wood samples for biochemical and molecular analyses

In order to monitor the variations of physiological parameters during xylem differentiation and heartwood formation, different xylem growth rings, spanning from the differentiating xylem to the outer heartwood were sampled from the lyophilised wood discs. The bark and the phloem were separated from the xylem. Single annual growth rings of the xylem were separated by a chisel and ordered by age. The following xylem growth rings were sampled for biochemical and molecular analyses (Figure 12).

- **Differentiating xylem (DX):** the outermost increment ring, formed by cambial activity in spring and summer. During this period the differentiating xylem is not completely lignified and can be easily scraped off using a scalpel.

- **Outer sapwood (OSW):** the two outermost differentiated and mature growth rings
- **Inner sapwood (ISW):** two growth rings in central position between the cambial zone and the heartwood
- **Transition zone (TZ):** the innermost growth rings of sapwood bordering the coloured heartwood and having started the transformation into heartwood. This particular zone was identified by its endogenous fluorescence under ultraviolet (UV) light (Figure 13). In some tree species, the transition zone can be easily localised because of its different colour. On the contrary, in freshly cut and lyophilised wood of *Juglans nigra* the transition zone is not visible, but it emits a blue fluorescence when illuminated by long wave UV light. The origin of this fluorescence is probably due to two main phenolic compounds separated by TLC and HPLC, but not identified yet [Jay-Allemand, 2000, pers. comm.]. The combined analyses of physiological parameters that typically characterise the transition zone, in example the moisture content, confirmed that the fluorescent wood coincided with the transition zone. Therefore, the UV fluorescence was utilized to easily identify the growth rings contained in the transition zone. For all of the trees used in this study, the fluorescent zone corresponded to the light coloured wood usually referred to as sapwood. The transition zone was usually two growth rings wide.
- **Outer heartwood (OHW):** the two outermost growth rings of coloured heartwood, inwards the transition zone.

Lyophilised xylem samples were homogenised to a fine powder using a steel ball mill apparatus (Danguomeau, France).

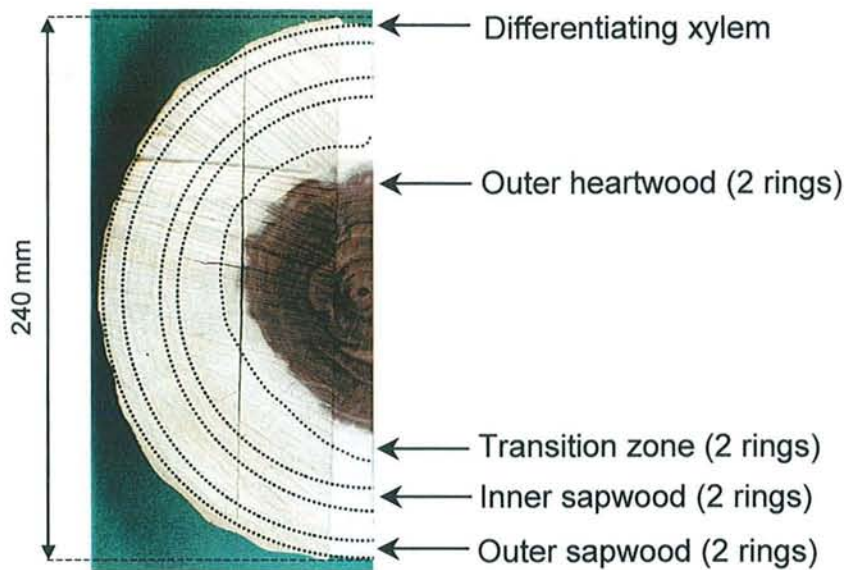

Figure 12. Wood samples used for biochemical and molecular analyses. Photo of a lyophilised wood disc collected from a 23 year old *Juglans nigra* tree in June 1997. The different samples listed below are indicated by dotted lines.

Differentiating xylem (DX): the outermost increment ring, formed by cambial activity in spring and summer.

Outer sapwood (OSW): the two outermost differentiated and mature growth rings.

Inner sapwood (ISW): two growth rings in central position between cambium and heartwood.

Transition zone (TZ): two innermost growth rings of sapwood bordering the coloured heartwood. The transition zone was identified by fluorescence under UV light (see figure 13).

Outer heartwood (OHW): two outermost growth rings of coloured heartwood.

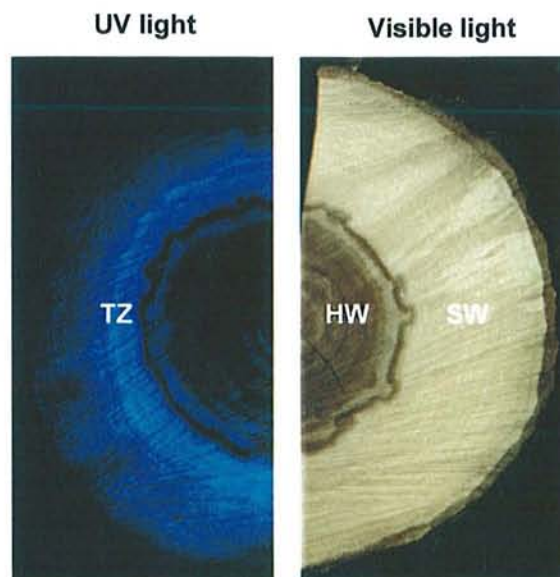

Figure 13. Photo of a lyophilised wood disc from *Juglans nigra* stem illuminated by ultraviolet (UV) light (on the left) and visible light (on the right) respectively. The wood disc was collected from the stem of a 23 year old tree in February 1998. The blue fluorescent zone around the heartwood corresponds to the transition zone. In lyophilised wood of *Juglans nigra* the transition zone is not visible under normal light but it emits a blue fluorescence under UV light illumination. This technique was used to identify and sample the xylem part corresponding to the transition zone.

Legend. SW: sapwood. HW: heartwood. TZ: transition zone.

Characterisation of heartwood formation in
Juglans nigra

4.3 Characterisation of heartwood formation in *Juglans nigra*

4.3.1 Introduction

The objectives of this part of the work were to give an integrated description of the wood samples used in this study, to propose some hypotheses about the seasonal dynamics of heartwood formation, and to select the seasonal periods and the samples to be used for molecular analyses.

It seems that formation and extension of heartwood are seasonally regulated. In *Robinia pseudoacacia* trees, it was demonstrated that the heartwood extends outwards between July and October [Nobuchi *et al.*, 1984]. In *Juglans nigra* trees, the seasonal variations of ethylene production and phenol-oxidizing enzyme activities measured in the transition zone suggested that heartwood formation started at the end of the cambial activity and continued during the dormancy period [Nelson, 1978]. In our experimental design, the *Juglans nigra* trees were periodically collected over a whole year period in order to study the seasonal dynamics of heartwood formation.

The transformation of sapwood into heartwood is a complex ageing process involving many physiological changes. Many experimental works deal with specific aspects of heartwood formation but only for a few species different experimental approaches have been integrated. In *Robinia pseudoacacia*, heartwood formation has been investigated by different approaches including anatomy, histology, biochemistry, and molecular biology, thus reaching a better and better understanding of its physiological basis [Magel, 2000; Nobuchi *et al.*, 1984]. The integration of complementary experimental approaches appears to be a suitable strategy to better understand the physiological mechanisms and the dynamics of heartwood formation in *Juglans nigra*. All of the wood samples used in this study were characterised by different approaches: localisation of the heartwood and the transition zone, determination of moisture content, and distribution of major phenolic extractives accumulated in xylem.

4.3.2 Localisation of heartwood and transition zone

The wood discs sampled from 10 *Juglans nigra* trees between June 1997 and July 1998 were analysed in order to determine the localisation and the extension of sapwood and heartwood within cross-sections of stems. Based on previous works [Burtin *et al.*, 1998; Burtin, 1999], the presence of brown coloration was used as criterion to visually localise the heartwood. Each growth ring from the bark to the pith was visually examined to estimate the surface proportion of coloured wood and the radial position (ring age) of the sapwood/heartwood boundary with respect to the cambial zone (age). Since the shape of the heartwood is often not regular, the sapwood/heartwood boundary could overlap several growth rings. Thus, some rings of the transition zone were partially filled with heartwood.

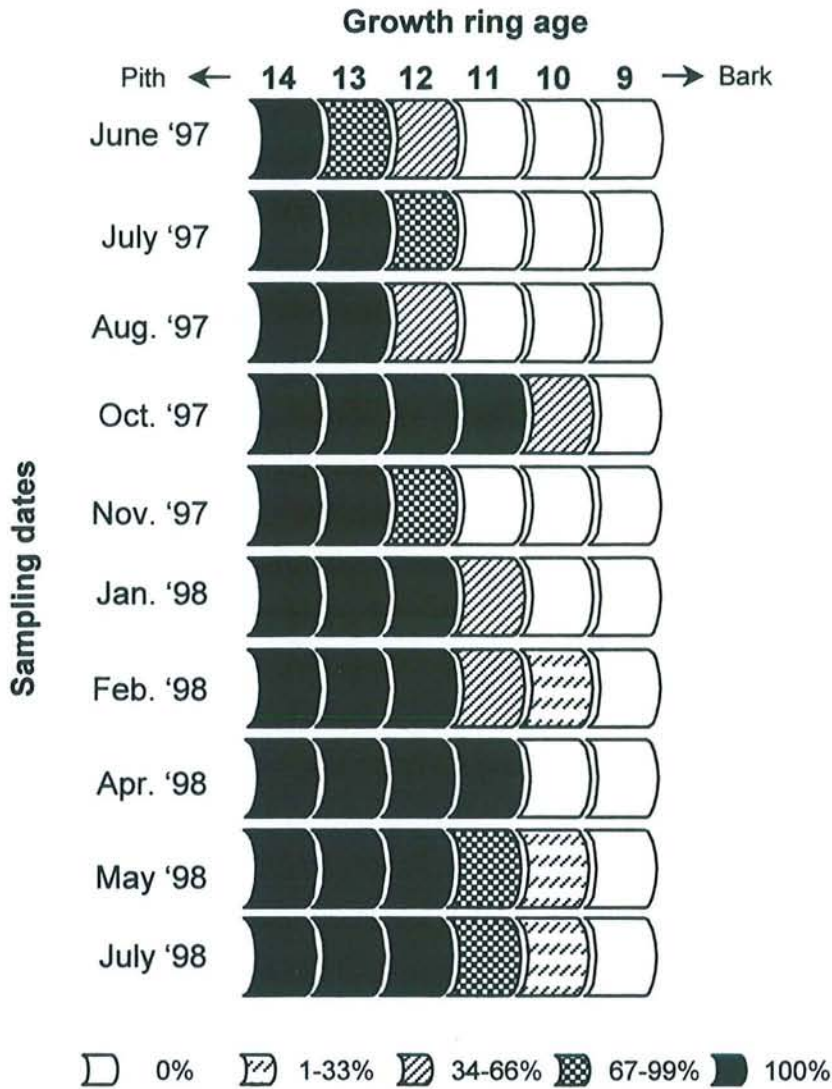
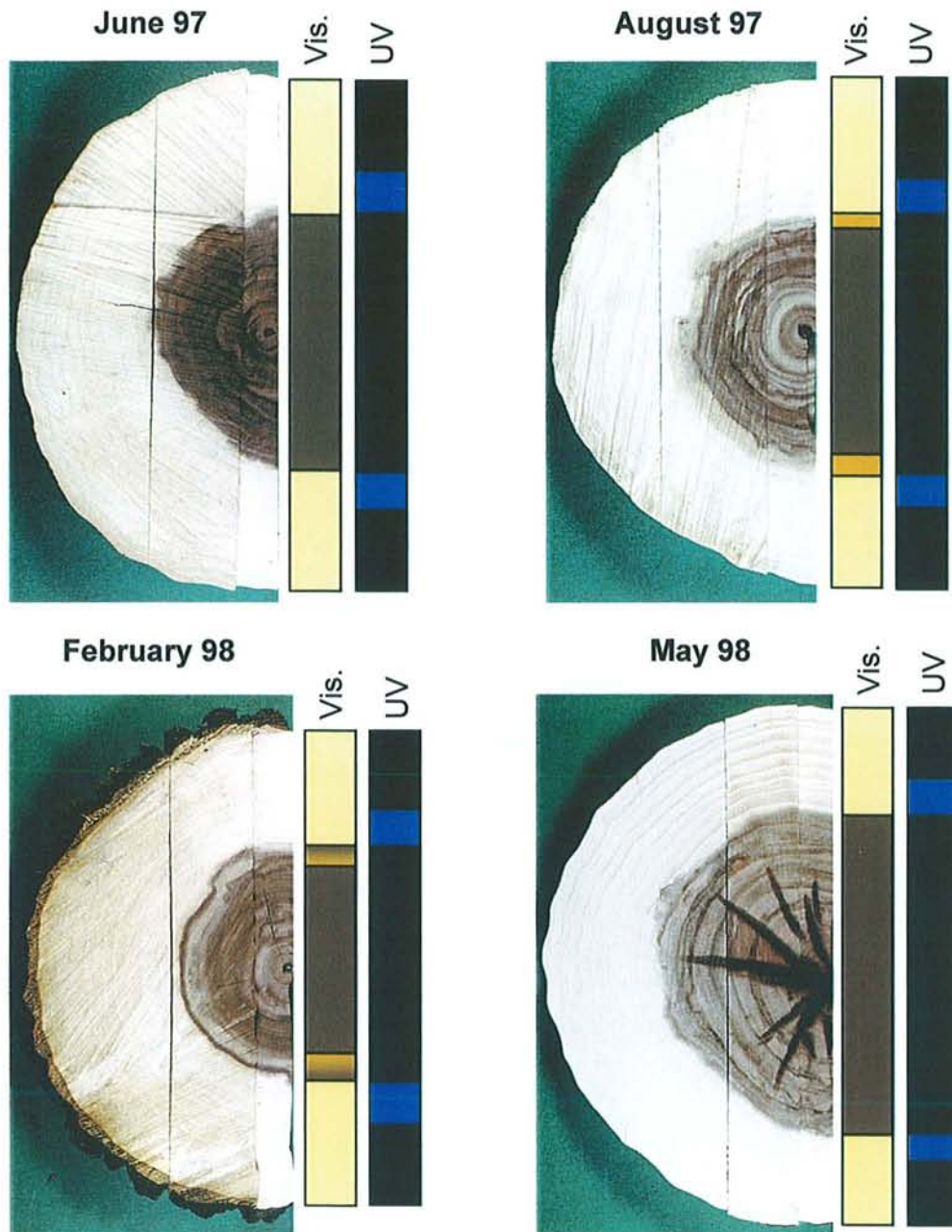

Figure 14. Radial distribution of the coloured heartwood and position of the sapwood/heartwood boundary in cross sections of stems collected from 23 year old *Juglans nigra* trees at different dates. The surface proportion of coloured wood was visually estimated for each growth ring. An arbitrary ranking of growth rings into five range classes was applied. The growth rings covering the variation range of the sapwood/heartwood boundary are shown in this figure.

For the sapwood/heartwood bordering growth rings, the proportion of heartwood was roughly estimated and the rings were ranked into five arbitrary classes ranging 0% to 100%.

The results of these anatomical observations are presented in figure 14. The number of sapwood rings, including the ones partially coloured, varied between 10 (October 1997 and April 1998) and 13 rings (June 1997). The shape of the heartwood was regular only for the tree collected in April 1998, in which the border of the coloured heartwood coincided with a single growth ring. For the other trees, the heartwood border overlapped 1 to 2 rings. With the exception of October 1997, all of the trees sampled in 1997 had 12-13 sapwood rings, while the trees sampled in 1998 had 10-11 sapwood rings.

Not only the position, but also the colour of the heartwood border showed variations among the different trees studied (Figure 15). In trees collected in spring, the outer heartwood colour was similar to that of the inner heartwood and the heartwood border was sharp. In trees collected during summer, the outer heartwood was slightly coloured and its border was fading. In other trees, collected during winter, the outer heartwood was less coloured than the inner heartwood but its border was darker and sharp.



Legend







Visible light (Vis.)	
	Non-coloured sapwood
	Dark coloured heartwood
	Light coloured heartwood with a fading border
	Light coloured heartwood with a dark border
Ultraviolet light (UV)	
	No fluorescence under UV light
	Blue fluorescence under UV light (Transition zone)

Figure 15. Photos of lyophilised wood discs collected from the stem of 22-23 year old *Juglans nigra* trees at different dates. These samples are representative of different types of heartwood boundary. On the right of each wood disc it is presented a schematic representation of the colour zones that are recognisable under visible light and UV light respectively. The blue fluorescence under UV light illumination corresponds to the transition zone (see also figure 13).

4.3.3 Moisture content

In species forming heartwood, the transition zone is characterised by a moisture content lower than the sapwood and sometimes than the heartwood. A drop of the moisture content is a particular feature that distinguishes the transition zone from the adjacent wood zones [Hillis, 1987]. Therefore, it is interesting to study the moisture content as a marker of the transition zone. The relative water content ((Fresh weight-Dry weight)/Dry weight) was measured in the wood discs used in this study. Contiguous wood samples were cut across diameter sections of wood discs and the water content was measured each centimetre from the bark to pith. The results corresponding to two representative trees are presented in figure 16. High values of moisture content were observed in the bark (about 100%) and in the heartwood (from 100 to 150%), in which the moisture content was always much higher than in the sapwood. The moisture content gradually increased from the heartwood border to the pith. For all of the trees, the lowest values (from 50 to 75%) were observed in the innermost sapwood rings bordering the heartwood that were often drier than both the adjacent sapwood and heartwood rings. These innermost dry growth rings corresponded to the blue fluorescent zone visible under UV light illumination.

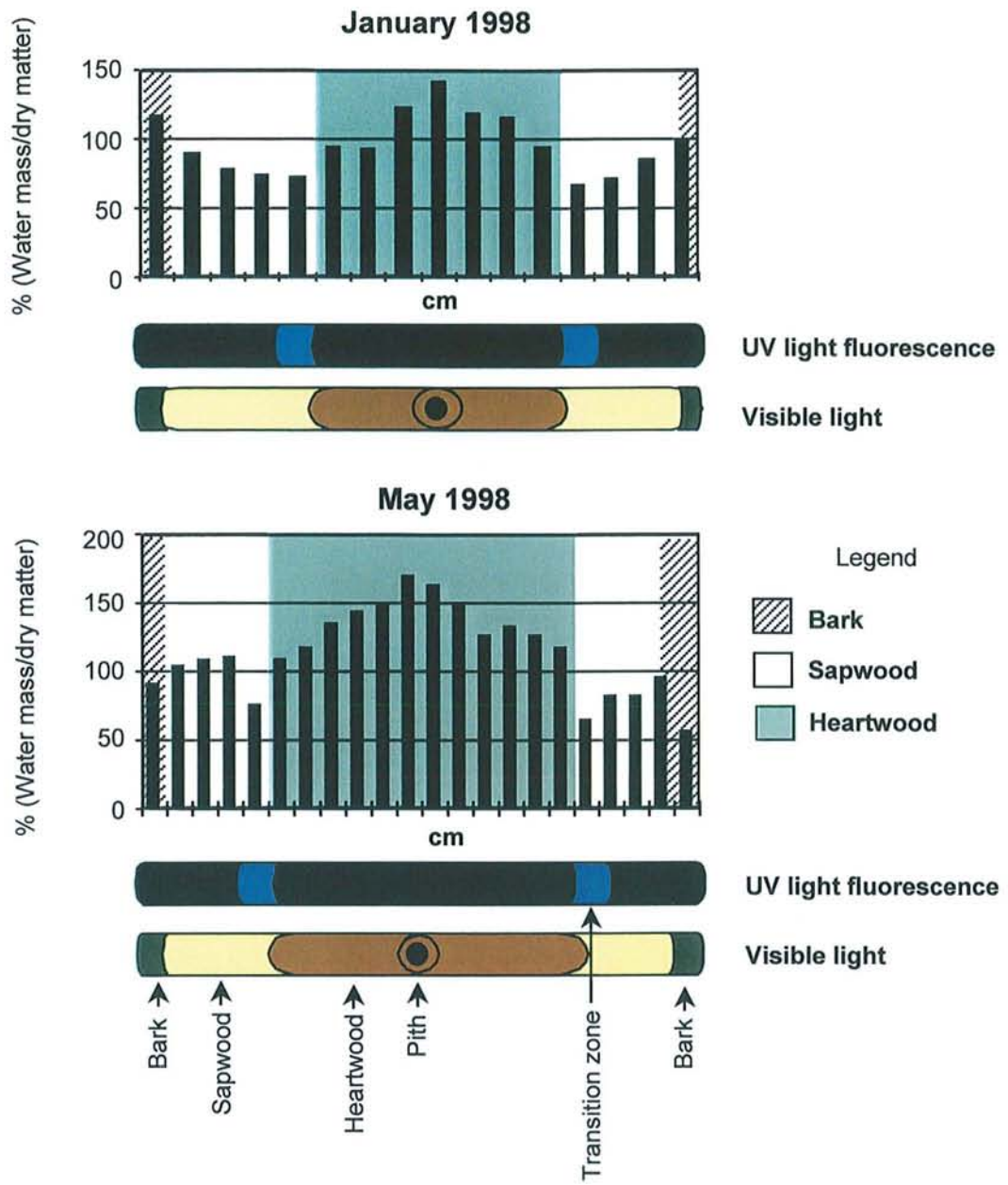

Figure 16. Moisture content of wood samples collected from the stem of 23 year old *Juglans nigra* trees. The moisture content was measured in fresh wood discs across a bark to bark radial section passing through the pith. Fresh wood samples were cut every cm, weighted and dried at 110°C until a constant dry weight was reached. The values are expressed as percentage of water mass versus dry matter. $\text{Moisture content} = 100 \times [(\text{fresh weight} - \text{dry weight}) / \text{dry weight}]$.

4.3.4 Phenolic extractives

This part of the study aimed at describing the dynamics of phenolic accumulation in the xylem of *Juglans nigra* trees over the entire period of sampling (June 1997-July 1998). The relative content of phenolic compounds was measured in the inner sapwood and in the transition zone in order to monitor the seasonal variations and to point out the periods during which more intense phenolic accumulation occurred. Several compounds were measured by High Performance Liquid Chromatography (HPLC) and DMACA colorimetric analysis. The data referring to hydrojuglone-glucoside (HJG), ellagic acid derivatives (E2), gallic acid derivatives (G3), and flavanols are presented here in figure 17. Flavonoid compounds other than flavanols, (flavonols or dihydroflavonols) were not detected in extracts from *Juglans nigra* xylem as previously reported by Burtin *et al.* [1998].

HJG, which is the major identified phenolic extractive of *Juglans* wood [Burtin *et al.*, 1998], did not accumulate markedly in the transition zone when compared to the inner sapwood. On the opposite, the ellagic acid derivative E2, the gallic acid derivative G3, and flavanols were accumulated preferentially in the transition zone, where their relative contents were several fold higher than in the inner sapwood. The highest values of HJG content were observed during the summer, with a decreasing trend from June 1997 to October 1997. HJG content remained relatively low during winter and spring (about half of the values measured in summer) and increased again in July 1998. A similar seasonal trend was observed for the compounds E2 and G3. The highest values of flavanol content were measured in summer. A gradual decrease of these compounds was observed through the autumn to reach the lowest values during winter. The values increased again in the following spring. In general, the relative content of HJG, E2, G3, and flavanols was high during summer, low during autumn, and winter, and increased again in spring.

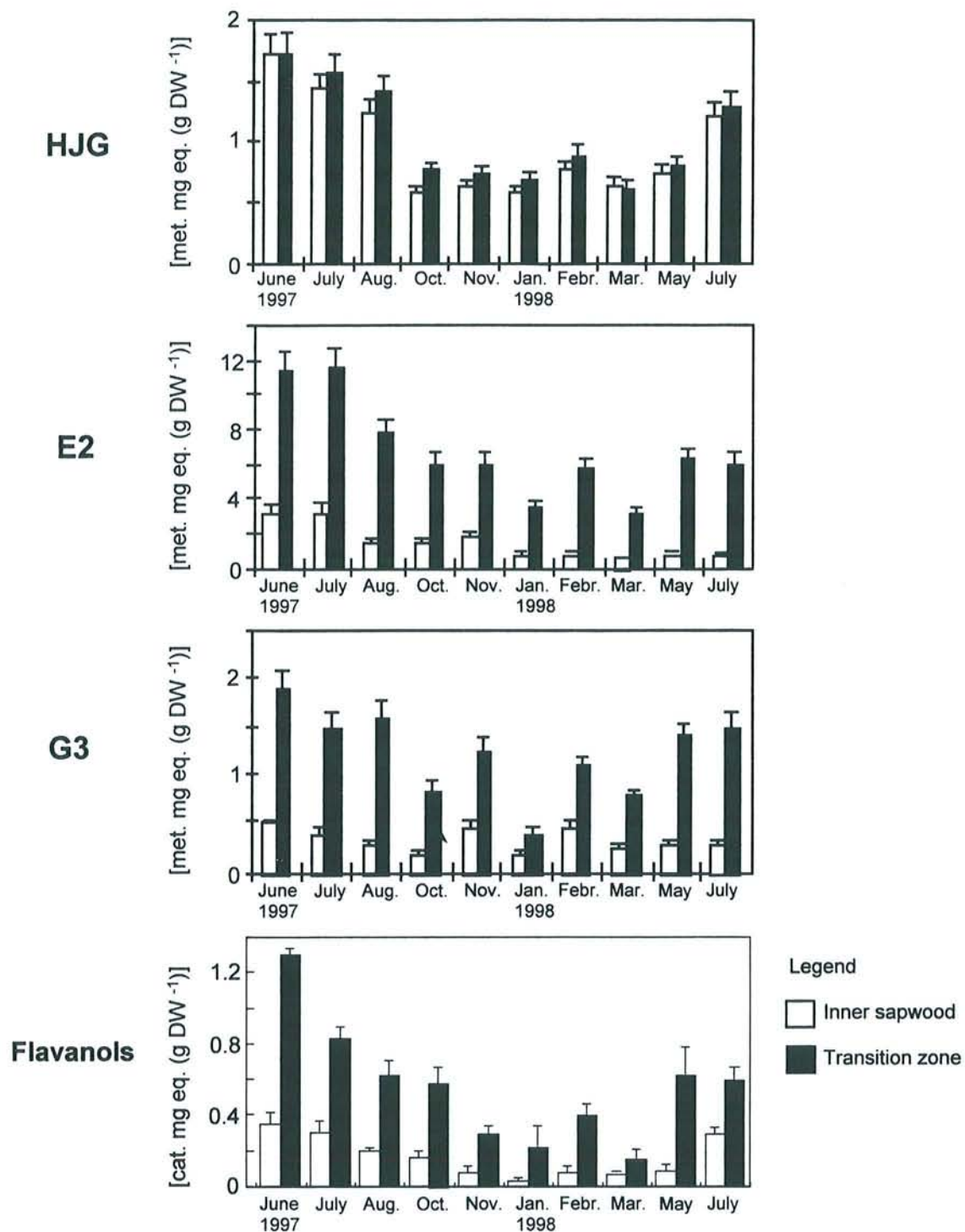

Figure 17. Seasonal variation of the relative content of phenolic extractives accumulated in the sapwood and the transition zone of *Juglans nigra* trees collected periodically from June 1997 to July 1998. Values are the mean of 3 independent analyses performed on the same wood sample. Standard deviations are displayed as bars. HJG: hydrojuglone glucoside. E2: ellagic acid derivative. G3: gallic acid derivative. Cat. mg eq.: catechin mg equivalent. Met. mg eq.: methoxyflavone mg equivalent.

4.3.5 Discussion

4.3.5.1 Dynamics of heartwood formation

The ten trees collected for this study showed a similar general behaviour as concerning the heartwood formation. Except for the tree collected in October 1997, the number of sapwood rings was very similar in the trees collected in the same seasonal period (Figure 14). This similarity indicates regularity for heartwood formed by genetically related trees, with the same age, and grown in the same environment. The trees used in this study originated from a half-sib progeny. The homogeneity of heartwood formation observed in these trees could be the results of both a common genetic base and common environmental conditions. From our experimental design, no conclusions can be drawn about the relative importance of genetic and environmental effects on the variability of this trait.

However, by studying a half-sib progeny test, Rink [1987] estimated that in *Juglans nigra* the heartwood area is heritable and the estimates of narrow sense heritability h^2 (the proportion of phenotypic variation that is inherited) of sapwood and heartwood area were 0.40 and 0.56, respectively. These data indicate that heartwood formation is under a relatively strong genetic control. Therefore, the common genetic base of half-sib trees used in this study could explain the homogenous behaviour observed in this plantation.

According to some theories, a biological function of heartwood formation is to keep the sapwood volume at the optimal value necessary to carry out its physiological functions of nutrients transport and storage. [Hillis, 1987]. Trees would compensate for radial growth by forming heartwood and thus reducing the number of sapwood rings. It was expected that during the sampling period (June 1997- July 1998) the heartwood expanded outwards and new heartwood rings were formed in order to compensate the radial growth and keep an optimal sapwood volume. In our experimental design, the trees were sampled by a destructive method, therefore it was not possible to monitor exactly the dynamics of heartwood expansion by observing the changes that occurred in single trees during a time interval. Nevertheless, with only one exception (October 1997), all of the trees collected in 1997 had 12-13 sapwood rings, whilst the trees collected in 1998 had 10-11 sapwood rings (Figure 14). This apparent trend suggests that, during the period of sampling, the heartwood could have expanded outwards by about 2-3 growth rings. By reducing the number of sapwood rings, the volume of sapwood would be adjusted to the needs of the trees as concerning nutrient transport and storage. The fact that during one year the heartwood expansion covered more than one annual ring would be a geometric compensation for the different section surface of the outermost rings of the sapwood (maximum diameter) and of the heartwood (smaller diameter).

An important issue is to know how the initial formation and expansion of heartwood are controlled. In the trees studied, the number of sapwood rings was quite conserved, although the diameters of the trees were variable. This suggests that the initiation of heartwood formation could be mainly driven by the age of the growth rings (temporal control) and not by the physical distance from the cambium (spatial control).

This hypothesis was already proposed by Nelson [1976] who reported that *Juglans nigra* trees exhibited strong temporal control and weak spatial control over the senescence of sapwood parenchyma cells (heartwood formation). This means that a given walnut tree at a certain age will tend to have a certain number of sapwood growth rings, regardless of the rate of radial growth [Nelson, 1976].

Another interesting issue is the period of heartwood formation. In several species, the formation of heartwood is seasonally regulated [Hauch and Magel, 1998; Nelson, 1976; Nobuchi *et al.*, 1984]. The changes in the colour and shape of the heartwood border, that were observed in the present study, suggest that, in *Juglans nigra*, heartwood expansion is probably a cyclic process occurring mainly in summer and autumn. In June 1997, when the cambial activity was high, the heartwood border was sharp and dark coloured. Later, in summer, the heartwood border became light coloured and fading. It is likely that, during the summer period, heartwood was expanding and the newly formed heartwood rings were in the early stages of cell death and oxidation. The light colour could be due both to a partial oxidation of phenolics and to the coexistence of living (non coloured) and dead (coloured) parenchyma cells. In autumn and winter, the heartwood border was sharp again and its colour became darker at the periphery. In this phase, the expansion of heartwood had probably stopped but the oxidation of phenolics continued, starting from the border of the newly formed heartwood. In the following spring, we observed the same situation as in June 1997. The outer heartwood became completely oxidized, as dark as the inner heartwood. The outer heartwood rings, formed during the summer, probably underwent cell decompartmentalization and phenolics oxidation and polymerisation over autumn and winter, resulting in a dark coloration. According to this hypothesis, heartwood formation in *Juglans nigra* could be a cyclic process including an initial geometric expansion during summer, followed by degenerative and oxidative processes during autumn and winter. This hypothesis is in agreement with previous reports. By periodical sampling of increment cores, Nobuchi *et al.* [1984] showed that, in *Robinia pseudoacacia*, the heartwood formation occurred mainly between July and October, and then continued slowly during autumn and winter and stopped in March. By monitoring the seasonal variations of ethylene production and phenol-oxidizing enzyme activities in the transition zone of *Juglans nigra*, Nelson [1978] estimated that heartwood formation started at the end of the cambial activity and continued during the dormancy period.

4.3.5.2 Dynamics of extractive accumulation

As already observed for the amount of heartwood, the ten trees analysed in this study showed similar behaviour as the accumulation of phenolic extractives was considered (Figure 17). The extractives analysed showed two different patterns of distribution. The first type of distribution was characteristic of HJG. This compound did not accumulate significantly in the transition zone, when compared to the inner sapwood. E2, G3, and flavanols showed a different distribution. Their relative contents were much higher in the transition zone than in the inner sapwood. **These marked differences suggest that these phenolic compounds were actively accumulated in the transition zone.** Our results are in agreement with previous observations. Burtin *et al.* [1998] reported that, in *Juglans spp* trees, HJG content gradually

increased from the bark to the transition zone and then dramatically decreased in the outer heartwood. This pattern of distribution could be explained by a continuous accumulation in sapwood over time, resulting in a HJG content that linearly increases according to the age of the growth rings. The distribution of the compound E2 was also very similar to previous data reported by Burtin *et al.* [1998] for this compound. These authors observed that in *Juglans nigra* trees the relative content of the compound E2 was about two fold higher in the transition zone than in the middle and inner sapwood and reached the highest values in the heartwood.

All of the extractives included in this study showed a similar trend of seasonal variation (Figure 17). The highest values were observed in summer 1997, whilst the lowest ones were characteristic of winter. Intermediate decreasing contents were measured in the samples taken in autumn and increasing values were measured in spring 1998. These data suggest that summer could be the period of maximum phenolic accumulation, whilst the dormant season could be the period of lowest activity. The overall results draw a cyclic seasonal trend with high accumulation in early summer, decreasing values during late summer and autumn, and a gradual increase in spring.

4.3.5.3 Characterisation of the transition zone

The transition zone is not simply a boundary between living and died xylem. Many physiological changes occur in this xylem zone and lead to the formation of heartwood. The number of living parenchyma cells dramatically decreases within the transition zone [Nobuchi *et al.*, 1987]. At the biochemical level, storage substances, especially starch, disappear and phenolic substances are accumulated [Magel, 2000]. At the physical level, the transition zone is often paler than both the sapwood and the heartwood and its moisture content is lower than in the sapwood and sometimes than in the heartwood. [Hillis, 1987]. These differences are considered as markers of the transition zone and indicate that this xylem zone is physiologically distinct from both the bordering sapwood and heartwood.

We analysed the *Juglans nigra* wood samples by different methods, obtaining an integrated characterisation and localisation of the transition zone. Different physical and biochemical parameters changed markedly in the 2-3 innermost sapwood rings, thus indicating that this xylem part corresponded to the transition zone. The moisture content of the innermost sapwood rings was the lowest measured in each wood section. High contents of phenolic extractives were accumulated in the same growth rings. Moreover, we observed that, in lyophilised wood samples, this putative transition zone was characterised by a bright blue fluorescence when observed under UV light. The origin of such fluorescence is now under study. It would be related to the accumulation of two major soluble phenolic compounds not identified yet [Jay-Allemand, pers. comm.]. In the same *Juglans nigra* trees, Magel [pers. comm.] already observed a similar bright blue fluorescence in the innermost sapwood rings still containing living cells. Due to its transitional location between clear sapwood and coloured heartwood, its fluorescence, and characteristic biochemical behaviour, the authors classified that fluorescent zone as transition zone. Actually, Magel [pers. comm.] observed that, except for the trees collected in spring, the starch content decreased to zero in

the blue fluorescent zone. The absence of starch is considered as a fundamental biochemical marker of the transition zone [Hillis, 1987].

Unlike other tree species, in freshly cut wood of *Juglans nigra* the transition zone has the same colour as the sapwood. It is therefore difficult to directly identify it in a simple manner. The correspondence between the blue fluorescence and the marked localised variations of some physiological parameters indicated that such fluorescence could be used as a physical marker to easily localise the growth rings corresponding to the transition zone. In the trees studied, the transition zone typically localised by this method corresponded to the two innermost growth rings of the clear sapwood. Its width sometimes ranged from 1 to 3 growth rings.

4.3.6 Conclusions

Both the localisation of the heartwood and the distribution and amount of phenolics extractives were very similar in the 10 trees studied. This similar behaviour indicates that the physiological processes controlling heartwood formation and extractive accumulation are well conserved. The trees studied belonged to a half-sib progeny, thus, their similar physiological behaviour could be explained by their genetic similarity.

By comparing the wood samples collected at different seasonal periods, it was possible to distinguish some possible temporal trends in the dynamics of heartwood extension and extractive accumulation. It seems that, for both processes, the summer season corresponded to an active period whilst the winter season corresponded to a very low activity. Autumn and spring would be transitional phases, characterised by gradual variation of the metabolic processes.

Different physical (moisture content and fluorescence) and biochemical parameters (phenolic extractives) showed marked variations in the transition zone corresponding typically to the two innermost sapwood growth rings. High content of phenolic extractives were accumulated in the transition zone of all the trees studied. The observed distribution of extractives suggested that these substances could be actively synthesized in the ageing sapwood and especially in the transition zone. These substances can contribute to the natural colour and durability of *Juglans nigra* heartwood. The physiological mechanisms controlling their biosynthesis represent an attractive model for further investigations by mean of biochemical and molecular analyses. The choice of a suitable plant material is a fundamental step to perform such analyses.

The integrated characterisation of *the Juglans nigra* trees was useful in choosing, and sampling wood samples (growth rings) representative of the different ageing stages leading to heartwood formation. Based on these results, five trees, representing putative key periods of heartwood formation, were selected to perform more detailed molecular analyses. July 1997 would represent an active period in which new heartwood is forming and extractives are synthesized. October 1997 would represent a transitional phase of reducing activity. January 1998 would be representative of the minimal activity. May 1998 could represent a new flush of vegetative activity. Finally, July 1998 would represent a new active period. The

comparison of July 1997 and July 1997 allows to verify the hypothesis that heartwood formation is a cyclic process, seasonally regulated.

**Set-up of the techniques for molecular analyses
on aged xylem**

4.4 Set-up of the techniques for molecular analyses on aged xylem

4.4.1 Introduction

In the literature, very few experimental works describe the isolation of RNA from lignified and aged xylem. Most of the published results concern the extraction of RNA from xylem collected from young shoots of tree species such as *Populus tremuloides* [Hu *et al.*, 1998], *Populus kitakamiensis* [Osakabe *et al.*, 1995], and *Pinus taeda* [Chang *et al.*, 1993]. In few cases attempts were made to analyse separately the different parts of xylem, such as differentiating xylem of *Pinus taeda* [Whetten and Sederoff, 1992], compression wood and side wood, and differentiating xylem of *Pinus taeda* [Allona *et al.*, 1998], and developing xylem and phloem of *Populus tremula x tremuloides* [Sterky *et al.*, 1998]. Only one paper reported the analyses of gene expression in very aged xylem including the transition zone [Hauch and Magel, 1998]. No data were reported about the RNA yield that can be extracted from these tissues. Moreover, the aged sapwood presents some features that can limit the applicability and efficiency of the techniques commonly used for the isolation and analysis of nucleic acids and proteins.

- The number of living cells is very low. Only parenchyma cells remain alive in sapwood and their number strongly decreases in the transition zone [Nobuchi *et al.*, 1987].
- High amounts of polyphenols accumulate with the ageing of xylem, especially in the transition zone [Hillis, 1987].

These characteristics can represent obstacles to obtain sufficient amounts of RNA of suitable quality for molecular analyses. Thus, in a first phase we had two main objectives:

- to detect the expression of candidate genes in *Juglans nigra* xylem,
- to clone cDNA fragments corresponding to candidate genes.

The candidate genes under study corresponded to the structural genes encoding the main enzymes of the general phenylpropanoid and flavonoid biosynthetic pathways: phenylalanine ammonia-lyase (PAL), cinnamate 4-hydroxylase (C4H), 4-coumarate-CoA ligase (4CL), chalcone synthase (CHS), flavanone 3-hydroxylase (F3H), and dihydroflavonol-4-reductase (DFR).

4.4.2 Detection and cloning of gene transcripts

According to the biological features of differentiated xylem, the yield of RNA from aged sapwood was expected to be low. For this reason, a RT-PCR strategy was chosen to test the RNA extraction procedures and to provide a basis for the analysis of gene expression (Figure 18). This technique is fast and presents a high sensitivity if compared to hybridisation techniques like dot blot and northern blot [Larrick and Siebert, 1995]. The purification of PolyA⁺ RNAs (mRNA) by oligo-thimidylylated (oligo (dT)) Dynabeads (Dyna, France) appeared a suitable system to purify the mRNA template for RT-PCR reactions (Figure 19).

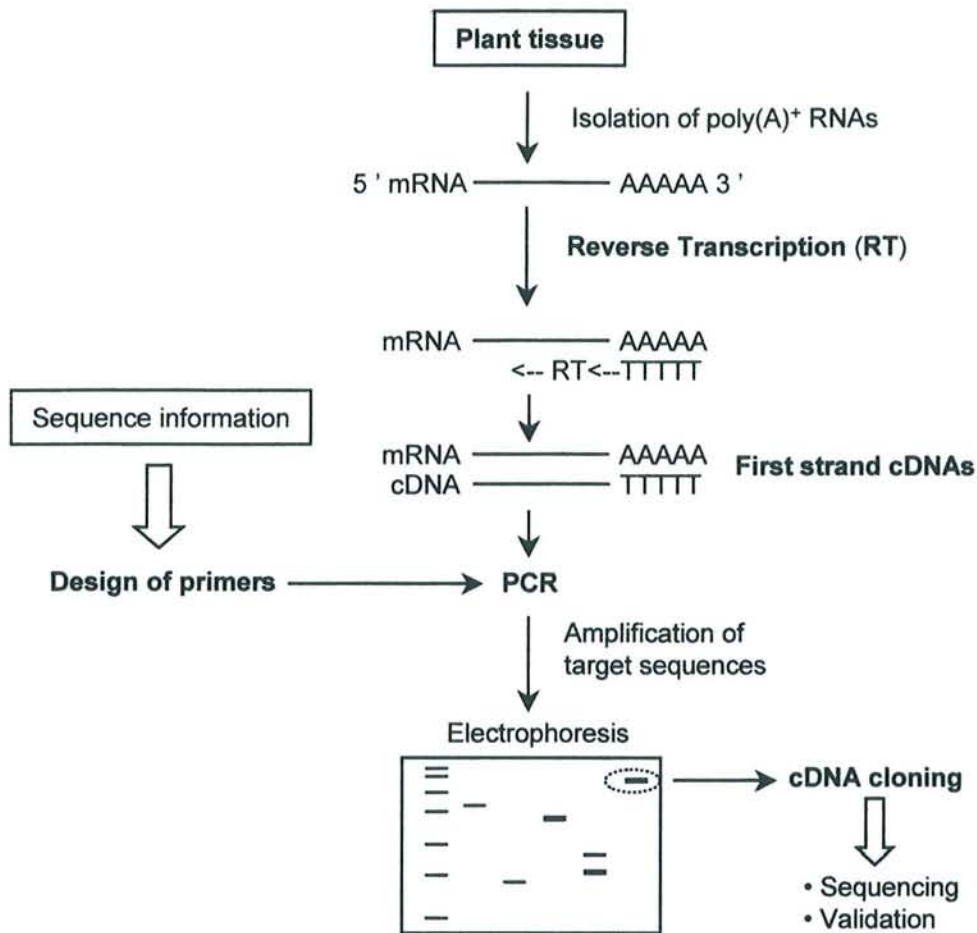

Figure 18. Schematic representation of Reverse Transcriptase PCR (RT-PCR). RNA or mRNA is first isolated from tissues and used as template for reverse transcription to obtain first strand cDNAs. This cDNA population is used as template for PCR using primers designed to amplify a selected coding region belonging to the genes studied. If a gene is expressed, its coding sequence is present in the cDNA population and the PCR reaction may allow the amplification of the corresponding fragment according to the specificity of the couple of primers.

Based on the sequence information, the amplified fragments are selected according to their size, cloned, and sequenced to verify their homology to known sequences.

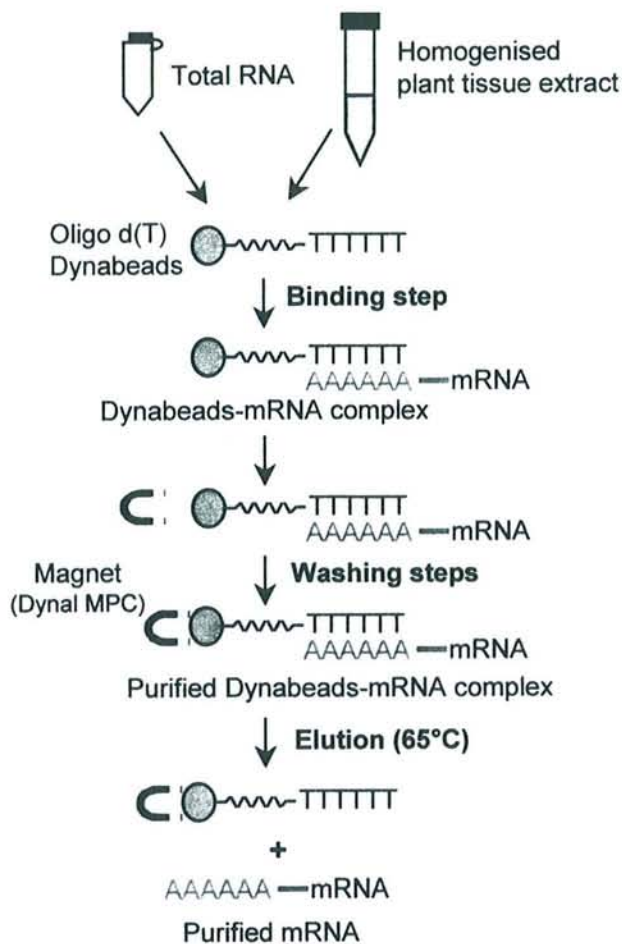

Figure 19. Schematic representation of the Dynabeads system for the isolation of poly(A)⁺RNA. Dynabeads are uniform, superparamagnetic, polystyrene beads (2.8 μm in size). They have 25 nucleotides long oligo(dT) chains, covalently attached to their surface. They are designed for the rapid isolation of pure mRNA directly from lysate of cells as well as from total RNA. The method relies on base pairing between the poly(A)⁺ residues at the 3' end of mRNAs and oligo(dT) residues coupled to the surface of the beads. The paramagnetic beads are separated using a magnet particle concentrator (Dyna MPC). Several washing steps can be performed while mRNAs are hybridised to the Dynabeads. Finally, the purified mRNAs are released from the beads (at 65°C) and eluted in RNase free water.

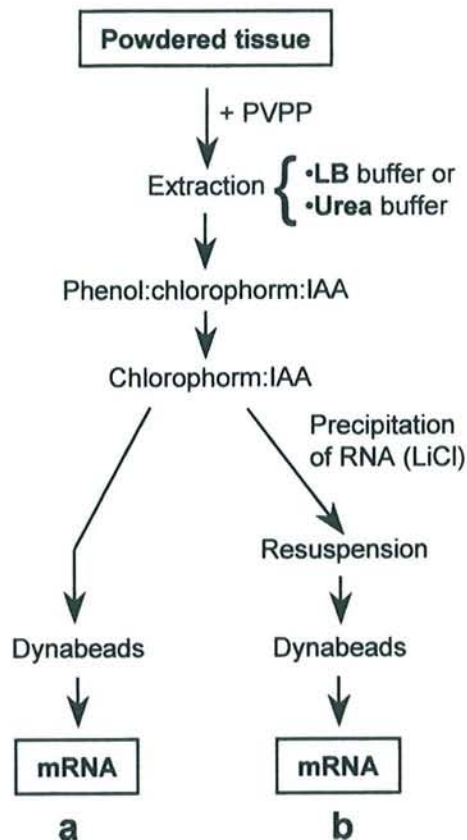

Figure 20. Flow diagram of the procedures used to isolate poly(A)⁺RNA from xylem tissues. This procedure was applied using both the LB buffer and the Urea buffer for lysis and extraction. The Dynabeads system illustrated above was used for the final purification of poly(A)⁺RNA. IAA: isoamyl-alcohol.

a: For the **differentiating xylem**, poly(A)⁺RNA are isolated directly from the homogenised tissue.
b: For the **sapwood** and the **transition zone**, a selective precipitation of RNA by 2M LiCl is performed before the final purification with Dynabeads.

This system is particularly efficient for the purification of very small amounts of mRNA. It was successfully used for the construction of cDNA libraries starting from individual leaf cells of *Lycopersicon esculentum* [Karrer *et al.*, 1995] or from *Zea mays* embryos available in limited quantities [Breton *et al.*, 1995], both representing very little amounts of mRNAs as starting material.

4.4.2.1 Isolation of mRNA

The first tests of mRNA extraction were performed on differentiating xylem collected in June 1997 from one *Juglans nigra* tree. This xylem sample was collected during the active growth period, but contained already lignified cells and thus represented a good plant material to test the experimental procedures. Two extraction protocols compatible with the Dynabeads system were tested and compared: the first one uses the Lysis Binding buffer (LB buffer) suggested by Dynal, the second one uses an extraction buffer with high Urea concentration (Urea buffer) [Hengerer, 1993] (Figure 20). The two protocols were modified in order to adapt them to each type of wood xylem sample. For both of the procedures, a detailed protocol is given in the “Methods” section. The main modifications were the addition to the lysis buffer of polyvinyl polypyrrolidone (PVPP) to block polyphenols and of sodium metabisulphite as antioxidant. Moreover, a purification step with phenol:chlorophorm:isoamyl-alcohol (25:24:1) was performed before the purification of mRNA with the Dynabeads. This step further purifies the raw extract by eliminating proteins and substances that are soluble in organic solvents.

Relative estimations of mRNA content in each extract were performed by an ethidium bromide staining method (Figure 21a). The signal obtained from the Urea buffer extraction was 2 to 4 fold higher than the one obtained from the LB buffer. Because of the very little amounts of mRNA available, RT-PCR analyses were used to evaluate the quality of mRNA obtained with the protocols tested. mRNAs extracted with each protocol were reverse transcribed into cDNAs and the sequences corresponding to some candidate genes were amplified by PCR (Figure 21b). Three genes were used as target template for RT-PCR reactions: *water channel (WC)*, *chalcone synthase (CHS)*, and *dihydroflavonol 4-reductase (DFR)*. *WC* genes encode aquaporins, which are membrane proteins involved in the transport of water [Kaldnhoff *et al.*, 1998; Kjellbom *et al.*, 1999]. The amplified region (about 390 bp for the coding sequence) contains some introns, which allow to discriminate the PCR products obtained from genomic DNA. Therefore, RT-PCR analyses can detect the presence of genomic DNA in the mRNA template (Figure 22). The absence of genomic DNA was also verified by direct amplification of an aliquot of the purified mRNA (data not shown).

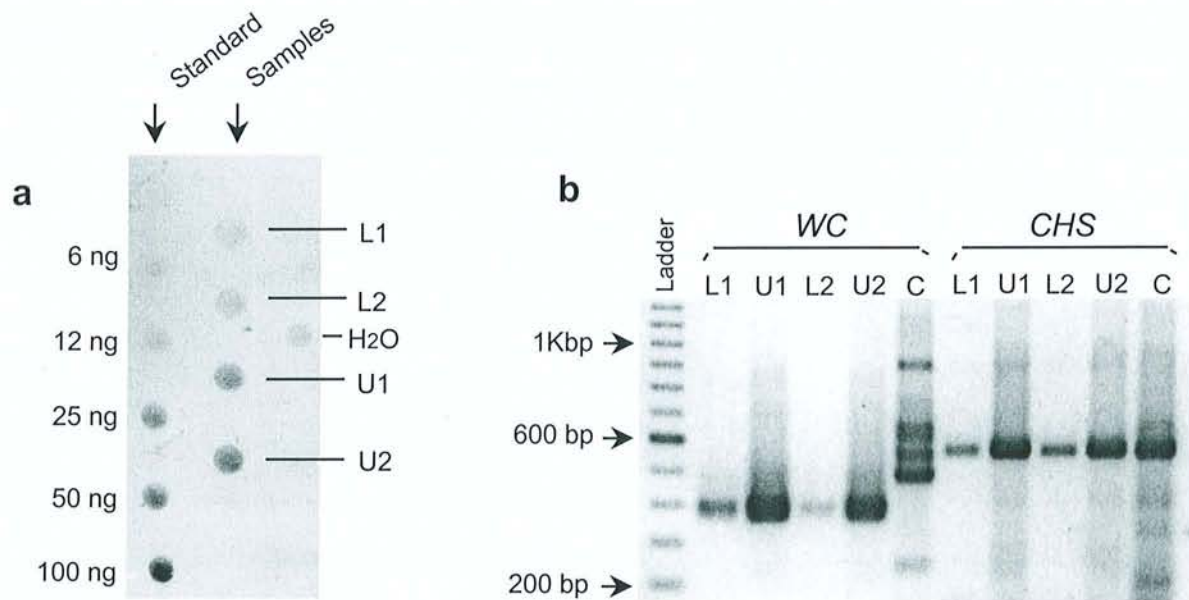

Figure 21. Comparison of two extraction procedures for the isolation of mRNA from differentiating xylem with the use of the Dynabeads system. The first procedure uses an extraction buffer called Lysis Buffer (L), the second one uses an extraction buffer called Urea Buffer (U). mRNAs were isolated from 100 mg (DW) of differentiating xylem collected from *Juglans nigra* trees in June 1997. Two independent extractions (1 and 2) were carried out for each procedure. The mRNAs isolated with the two procedures were reverse transcribed to obtain first strand cDNAs.

a) Direct quantification of mRNA extract by ethidium bromide staining. Half μ l of mRNA extract in water (equivalent to 8 mg of dry tissue) were mixed to 4.5 μ l drops of ethidium bromide solution (1 μ g/ml) on a Petri dish. After 15 min of incubation in the dark, nucleic acids were visualised by fluorescence under UV light. A series of dilutions of certified mRNA (Stratagene) were used as standard.

b) Result of RT-PCR analyses. First strand cDNAs were used as templates for PCR reactions to amplify sequences encoding the proteins water channel (WC) and chalcone synthase (CHS). *Juglans nigra* genomic DNA (100ng) was used as control (C) for the PCR reactions. An equal volume of cDNA template, equivalent to 8 mg of dry xylem, was used in each PCR reaction. Ten out of 25 μ l of PCR reaction were separated by electrophoresis on 1.2% agarose gel in 1xTAE buffer system at 4V/cm. The amplified fragments were visualised by ethidium bromide staining. Ladder 100 bp (Gibco BRL).

Equal volumes of cDNA were used as templates for the PCR reactions with degenerate primers. RT-PCR results showed that the procedure based on UREA buffer gave better results with differentiated xylem (Figure 21b). These results are in agreement with the ethidium bromide quantification of mRNAs. The higher RT-PCR signal obtained from Urea buffer extraction could be due to the corresponding higher amount of mRNA template used for RT-PCR reactions. Based on these results, it is not possible to state if any differences existed in the quality of mRNAs obtained with the two protocols tested. However, the aim of this comparison test was to select the extraction protocol giving the best overall efficiency for both the quality and the amount of the mRNA extracted. Therefore, the UREA based protocol was retained for subsequent extraction tests on the transition zone, expected to be the most difficult xylem sample for RNA extractions. This protocol was again modified to be applied to the transition zone. Big amounts of powdered wood were necessary to extract enough mRNA for RT-PCR reactions. Therefore, a precipitation step by 2M lithium chloride (LiCl) was introduced prior Dynabeads purification (Figure 20). This precipitation was performed in order to reduce the volume of raw extract to a volume compatible with the use of Dynabeads.

The first assays carried out on transition zone did not allow to amplify any cDNA fragments (data not shown). Since the absence of amplification could be due to some inhibitory substances present in the transition zone, a test was performed by adding differentiating xylem to the transition zone as internal standard (Figure 23). Positive results were obtained from the differentiating xylem and from the transition zone mixed with the differentiating xylem. Both *WC* and *DFR* genes were amplified and the correct size of the amplified *WC* fragment testified the absence of genomic DNA in the mRNA template. On the contrary, RT-PCR signals obtained from the transition zone were of bad quality. The multiple amplified fragments of *WC* genes corresponded to the intron containing sequences and thus revealed the presence of residual genomic DNA in the template mRNA. The *DFR* genes were not amplified from the transition zone template. These data demonstrated that the negative results obtained from the transition were probably due to a very low mRNA yield.

Additional tests were done on the transition zone using bigger amounts of wood powder. The first RT-PCR results from the transition zone were obtained using a volume of cDNA template equivalent to 50 mg of dry xylem (Figure 24). The degenerate primers used in the PCR reactions targeted sequences encoding *WC*, *PAL*, *C4H*, *4CL*, *CHS*, *F3H*, and *DFR*. The expression of all of the genes tested were detected in the differentiating xylem while only genes *WC* and *CHS* were detected in the transition zone. Moreover, the signal obtained for *CHS* gene was very faint, suggesting that the lack of amplification for the other genes was due to a very low amount of template. To test this hypothesis, aliquots of the PCR reactions giving negative results were amplified by a second PCR.

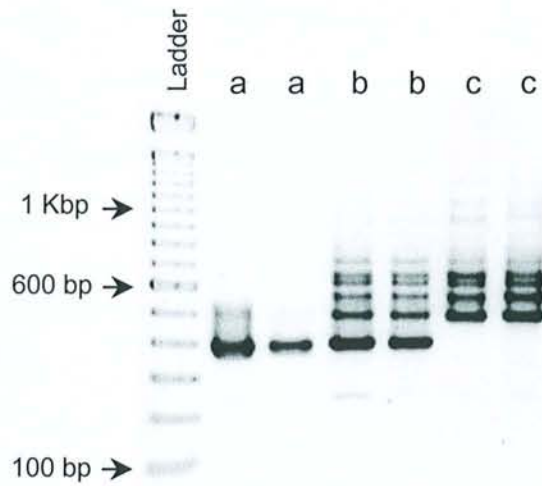

Figure 22. Results of PCR reactions with degenerated primers that amplify sequences encoding water channel proteins (WC). Templates. a: cDNA; b: cDNA contaminated by genomic DNA; c: genomic DNA of *Juglans nigra*. The amplified sequence contains some introns that are visible only in the PCR products obtained from genomic DNA. The presence of these introns allows to detect the presence of genomic DNA in the mRNA used for RT-PCR analyses.

Ten out of 25 μ l of PCR reaction were separated by electrophoresis on 1.2% agarose gel in 1xTAE buffer system at 4V/cm. The amplified fragments were visualised by ethidium bromide staining. Ladder 100 bp (Gibco BRL).

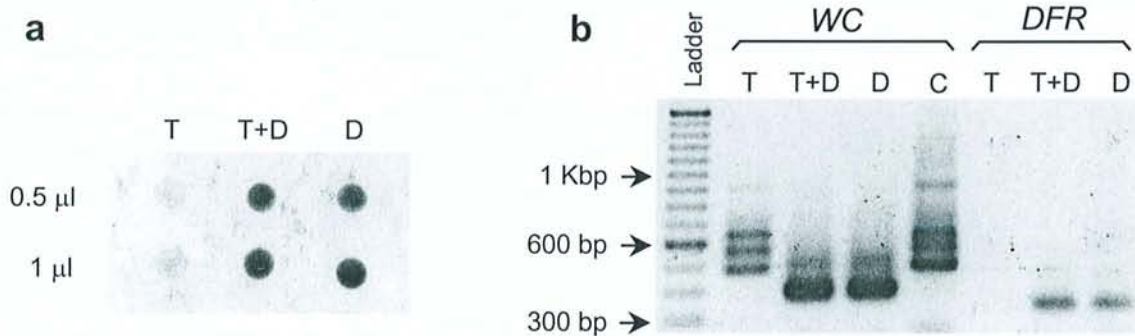

Figure 23. Test of mRNA isolation from the transition zone with the use of an internal standard. Differentiating xylem and transition zone, collected from *Juglans nigra* in June 1997, were extracted separately and in mixture by adding the differentiated xylem to the transition zone as internal standard. mRNAs were isolated using the procedure based on the UREA buffer, as explained in the Methods section, and reverse transcribed to obtain first strand cDNAs.

Legend, T: transition zone (1.3 g DW). T+D: transition zone (1.1 g DW) + differentiating xylem (200 mg DW). D: differentiating xylem (200 mg DW)

a) Quantitation of mRNA extracts by ethidium bromide staining. 0.5 μ l and 1 μ l of mRNAs suspension in water were mixed to 4.5 μ l drops of ethidium bromide solution (1 μ g/ml) on a Petri dish. After 15 min of incubation in the dark, nucleic acids were visualised by fluorescence under UV light.

b) Results of RT-PCR analyses. First strand cDNAs obtained from mRNAs isolated from the different tissues were used as templates for PCR reactions to amplify sequences encoding water channel proteins (WC) and dihydroflavonol 4-reductase (DFR). *Juglans nigra* genomic DNA (100ng) was used as control (C) for the PCR reactions. Ten out of 25 μ l of PCR reaction were separated by electrophoresis on 1.2% agarose gel in 1xTAE buffer system at 4V/cm. The amplified fragments were visualised by ethidium bromide staining. Ladder 100 bp (Gibco BRL).

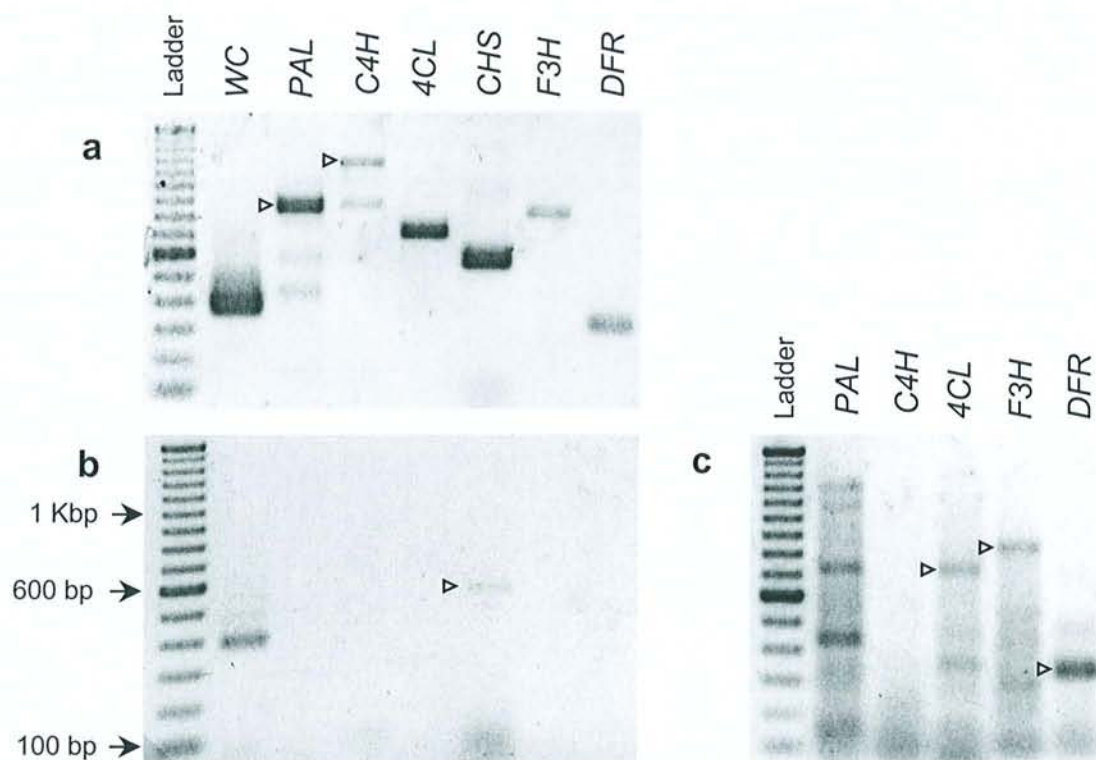

Figure 24. Results of RT-PCR analyses carried on differentiating xylem and transition zone of a *Juglans nigra* tree collected in June 1997.

mRNAs were isolated using the procedure based on the UREA buffer (as indicated in figure 20) and reverse transcribed to obtain first strand cDNAs. Equal amounts of first strand cDNAs were used as template for each PCR reaction. Degenerated primers were used to amplify sequences corresponding to the genes encoding water channel proteins (WC), phenylalanine ammonia-lyase (PAL), cinnamate 4-hydroxylase (C4H), 4-coumarate-CoA ligase (4CL), chalcone synthase (CHS), flavanone 3-hydroxylase (F3H), and dihydroflavonol 4-reductase (DFR). Ten out of 25 μ l of PCR reaction were separated by electrophoresis on 1.2% agarose gel in 1xTAE buffer system at 4V/cm. The amplified fragments were visualised by ethidium bromide staining. When multiple fragments were amplified, the specific PCR product corresponding to the size of candidate gene cDNA fragment is indicated by an arrow. Ladder 100 bp (Gibco BRL).

a) Results of RT-PCR analyses obtained from the differentiating xylem. Equal amounts of cDNA equivalent to 8 mg (DW) of tissue were used for each PCR reaction.

b) Results of RT-PCR analyses obtained from the transition zone. Equal amounts of cDNA equivalent to 50 mg (DW) of tissue were used for each PCR reaction.

c) Results of RT-PCR analyses obtained from the transition zone after two consecutive PCR amplifications. A second PCR reaction was realised from an aliquote (1 μ l) of the RT-PCR reactions that gave no amplification after the first PCR.

The second amplification allowed the detection of cDNA fragments corresponding to genes *4CL*, *F3H*, and *DFR*. However, the extreme magnification of two consecutive PCRs caused the amplification of many spurious fragments smaller than the targeted sequence.

Conclusions

By adapting a protocol based on an extraction buffer with a high molarity of urea, it was possible to extract mRNA of quality suitable for RT-PCR analyses from both differentiating xylem and transition zone. Using this extraction procedure coupled with the RT-PCR technique, the expression of some candidate genes was detected for the first time in the transition zone. These results were promising but indicated that the mRNA yield from the transition zone was very low (roughly estimated to be 1500 to 3000 fold less than from the differentiating xylem). Because of this low yield, the amount of purified mRNA was not easy to quantify in a simple and reliable manner, therefore, the extraction of total RNA appeared as suitable approach for quantitative analyses of gene expression.

4.4.3 Set-up of techniques for the extraction of total RNA

The first phase of technical set-up showed that the expression of candidate genes were detectable in different xylem parts, including the transition zone. The cloning of cDNA fragments corresponding to the candidate genes would allow hybridisation analyses. The second phase of technical set-up aimed at providing tools for such analyses of gene expression. In order to compare the transcript levels of candidate genes in different xylem samples, it was necessary to analyse equal amounts of mRNA. Purified mRNAs did not appear as the best material because the amounts extractable from the transition zone were very low and did not allow an easy and reliable quantification. For this reason, an extraction procedure was developed for the isolation of total RNA. Two procedures were tested and compared (Figure 25 and 26). The first one consisted in a modification of the protocol based on the Urea buffer [Hengerer, 1993], already utilized in preliminary steps for the isolation of mRNA. The second procedure corresponded to the protocol published by Chang *et al.* [1993]. This technique is based on the use of CTAB as lysis agent. The Urea procedure was modified in order to obtain total RNA.

For both procedures, total RNAs were pre-purified by precipitation with 2M LiCl and finally purified by ethanol precipitation. Total RNAs were quantified and used for hybridisation analyses (dot blot, northern blot). Indeed mRNAs for RT-PCR analyses were purified from total RNA using the Dynabeads system.

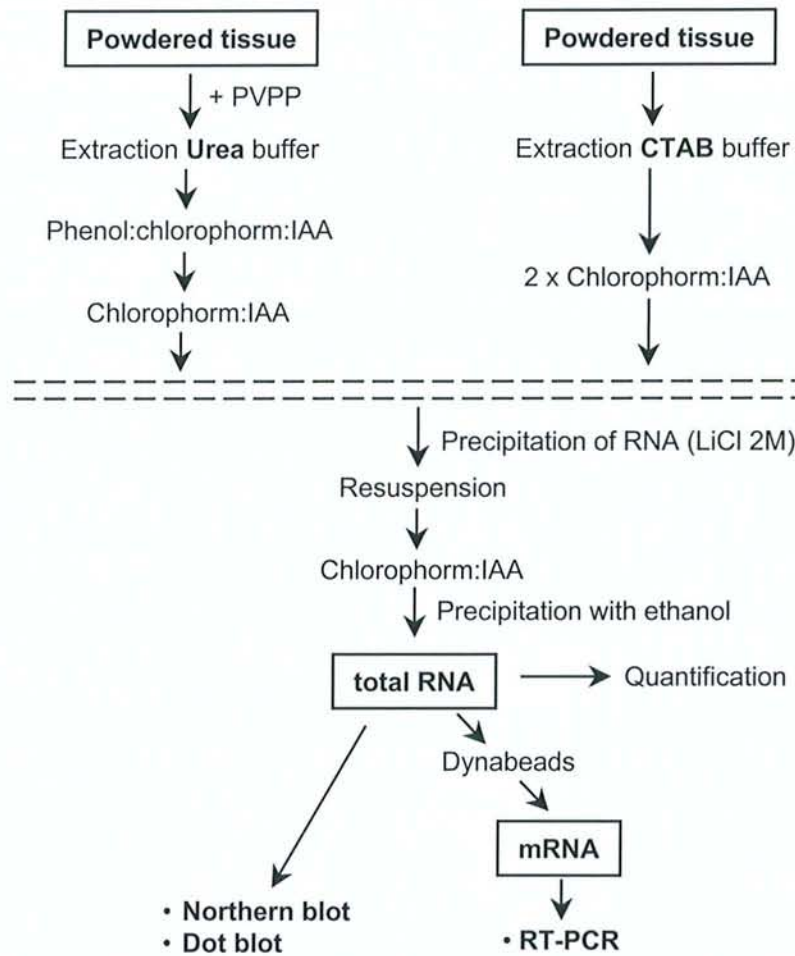

Figure 25. Flow diagram of the procedures used for the isolation of total RNA from xylem tissues. Two extraction buffers, Urea and CTAB buffer (described in Methods section), were tested for the extraction of powdered tissue of transition zone. The steps following the selective precipitation by 2M LiCl are common to both procedures. IAA: isoamyl-alcohol.

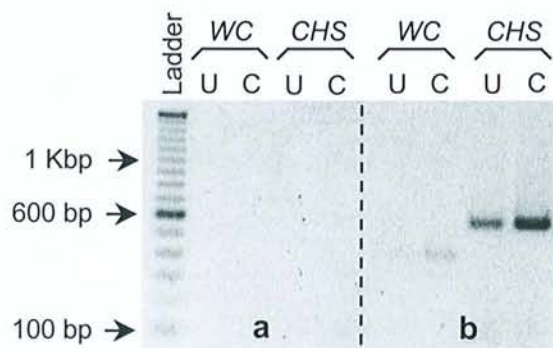

Figure 26. Comparison of two procedures for the isolation of total RNA from the transition zone. The first procedure uses an extraction buffer based on high molarity of Urea (U), the second one uses an extraction buffer based on CTAB (C).

Results of direct PCR amplification from purified mRNA (a) and of RT-PCR analyses from cDNA (b). For both procedures total RNA was isolated from 2 g (DW) of transition zone. mRNAs were purified from 1 µg of total RNA and used for RT-PCR. Equal volumes of cDNA equivalent to 88 mg of tissue (DW) were used as template to amplify sequences encoding water channel proteins (WC) and chalcone synthase (CHS). Ten out of 25 µl of PCR reaction were separated by electrophoresis on 1.2% agarose gel in 1xTAE buffer system at 4V/cm. The amplified fragments were visualised by ethidium bromide staining. Ladder 100 bp (Gibco BRL).

The two procedures for RNA extraction were tested using 2 g (DW) of transition zone. The amount and purity of RNA extracted were estimated by spectrophotometric quantification. RT-PCR analyses were also performed as described above. The results of the spectrophotometric assay are given below

Protocol	RNA yield (trans. zone) µg RNA / g xylem (DW)	Absorbance ratio 260 nm / 280 nm
Urea buffer	0.84	1.39
CTAB buffer	0.54	1.65

The amount of nucleic acids is calculated from the absorbance at 260 nm. One unity of optical density (OD) corresponds to an RNA concentration of 40 µg/ml. The chemical purity is estimated by the ratio between absorbance at 260 nm (nucleic acids) and absorbance at 280 nm (proteins). This ratio is an index of residual protein contaminating the RNA extract. For pure nucleic acids, it is generally comprised between 1.8 and 2.0 [Sambrook *et al.*, 1989]. The extraction tests showed that the RNA yield from the transition zone was very low (0.5 to 0.8 µg/g DW). These very low amounts could explain the weak RT-PCR signals obtained when using non quantified amounts of mRNA templates. For both samples, the 260/280 ratio was lower than the optimal range. RNA obtained with the CTAB buffer showed a higher purity than RNAs obtained with the Urea buffer.

PolyA⁺ RNAs (mRNA) were purified from total RNA using the Dynabeads system and used for RT-PCR analyses. The purification of mRNA and the synthesis of first strand cDNA were carried out using equal amounts of total RNA (1 µg) as starting template. By using quantified total RNA, it was possible to perform RT-PCR analyses with equal amounts of transcripts (Figure 26). For both procedures, the direct amplification of mRNA by PCR gave no results, thus demonstrating the absence of any contamination of genomic DNA in the purified mRNA (Figure 26a). For both WC and CHS genes, the result of RT-PCR analyses showed that the RNA extracted with the CTAB buffer has a higher quality than the RNA extracted with the Urea buffer (Figure 26b).

After testing different procedures for the isolation of total and messengers RNA, the extraction protocol based on CTAB buffer [Chang *et al.*, 1993] was chosen for the analyses of gene expression on xylem samples. It was modified in order to improve the recovery of low amounts of RNA from big amounts of xylem.

- The duration of the lysis step at 56°C was extended to 10 minutes.
- In the steps requiring a separation of the supernatant phase (i.e. chlorophorm:IAA purifications), a great care was taken at increasing the recovery efficiency. In example, by transferring the interphase in a smaller tube and repeating the separation.
- The duration of the selective precipitation of RNA by 2M LiCl was extended to 36-48h instead of the usual overnight period. This change was particularly effective for the oldest xylem samples (inner

sapwood and transition zone), while it made no difference for the younger xylem samples richer in RNA.

- Glycogen was added prior to the ethanol precipitation. Glycogen precipitates together with the nucleic acids and acts as a carrier for small amounts of RNA.

This extraction protocol worked well with all of the xylem samples used for gene expression analyses and spanning from the differentiating xylem to the transition zone. The table below reports the values of RNA yield and purity obtained from different samples, averaged over five different *Juglans nigra* trees used in this study.

Xylem sample	RNA yield μg RNA / g xylem (DW)	Absorbance ratio 260 nm / 280 nm
Differentiating xylem	2267.74	1.81
Outer Sapwood	28.76	1.84
Inner Sapwood	4.44	1.79
Transition zone	1.80	1.87

The purity of RNA was good for all of the xylem samples, and the results of gene expression analyses (see chapter “Flavanol accumulation and gene expression during xylem ageing and heartwood formation in *Juglans nigra*”) confirmed that RNA quality was constant for all of the samples. On the contrary, the RNA yields per g of xylem (DW) were very variable according to the age of the xylem growth rings. They were relatively high in the differentiating xylem and strongly decreased in the sapwood. The lowest values were obtained from the transition zone, about 1000 fold lower than in the differentiating xylem. This pattern could be correlated with the proportion of living cells present in the different sapwood zone [Nobuchi *et al.*, 1987].

Conclusions

An extraction procedure based on the use of CTAB demonstrated to be suitable for the extraction of total RNA of good quality from walnut xylem. Only little modifications were done in order to improve the recovery of very small RNA amounts from the aged sapwood. The extraction of total RNA, easy to be precisely quantified, allowed to overcome the obstacles linked to the heterogeneity of RNA yield between the different xylem growth rings. This made possible quantitative analyses of gene expression comparing very different xylem samples, such as the differentiating xylem and the transition zone. The quantification of total RNA by spectrophotometer revealed that the yield obtained from the transition zone was about one thousand fold lower than from the differentiating xylem. This low yield imposed limitations to the type and number of analyses that were realised to study the expression of the candidate genes.

4.4.4 Cloning of homologous cDNA probes

4.4.4.1 Reverse Transcriptase PCR

The technique RT-PCR was chosen for the detection of gene transcripts in xylem samples and to clone cDNA fragments to be used as homologous probes in hybridisation experiments. A flow chart illustrating the reverse transcriptase-PCR (RT-PCR) process is shown in figure 18. The advantages of the RT-PCR technique include its versatility, sensitivity, and rapidity [Larrick and Siebert, 1995]. If the sequence of a gene is known in the same or in other species, the conservation of consensus aminoacid sequences often allows to design suitable degenerate primers. The tremendous amplification power of PCR provides a high sensitivity. One ng of total RNA may be sufficient to detect the transcripts of genes expressed at relatively high level [Larrick and Siebert, 1995]. The rapidity and the sensitivity of PCR analyses make it possible to analyse easily the expression of several genes at once, from the same cDNA population. As for all PCR-based techniques, RT-PCR can be potentially subjected to the production of artefacts. For this reason, the generation of a PCR product of predicted size is not sufficient to draw any conclusions and the identity of the PCR product must be verified by a second method. This is typically achieved by nucleotide sequencing, restriction mapping or sequence-specific probe hybridisation. Obtaining a nucleotide sequence is the most convincing verification, and the lowering costs of sequencing reactions make this approach more and more utilized.

The amplification of cDNA fragments by RT-PCR can be inefficient if the match between the target cDNA template and primers is not perfect. To reduce this risk the primers are usually designed according to the most conserved portions of the target sequence. Even in the case of highly conserved amino acid sequence, mismatches can exist due to the degeneracy of the genetic code (one aminoacid can be coded by multiples codons). Because of that, the primers targeted to particular aminoacid sequences must also be degenerate to encode the possible permutations of codon sequences. This is particularly important when the homologous sequence of the gene is not known and the primers are designed on the alignment of sequences obtained from other species. Another relevant aspect is that many genes are organised as multigene families. The use of degenerate primers makes it possible to detect by RT-PCR all of the transcripts of the same gene families [Preston, 1997]. Degenerate primers represent a mix of all possible permutations of codons. The template DNA will be recognized only by a small fraction of the primers. This implies that the higher is the degeneracy of the primer sequence, the lower is the concentration of the effective primer.

In our experiments, degenerate primers were prepared to amplify and clone cDNA sequences corresponding to the genes encoding the enzymes of the general phenylpropanoid (PAL, C4H, 4CL) and flavonoid pathways (CHS, CHI, F3H, DFR). In addition, primers allowing the amplification of sequences encoding Water Channel proteins (WC) and 60S ribosomal proteins (60) were used as control for the quality of cDNA templates. The sequence of the primers used for RT-PCR reactions is given in the "Methods" section.

4.4.4.2 Cloning and sequencing of cDNA fragments

The genes studied in this work are involved in the biosynthesis of phenolic compounds. The differentiating xylem was used as starting material to clone cDNA fragments corresponding to the candidate genes under study. It was expected that most of the genes controlling the phenolic metabolism were transcribed at high level in the youngest xylem part. Poly(A)⁺ RNAs were isolated from the differentiating xylem of *Juglans nigra* collected in June 1997 using the procedure based on the Urea buffer as explained in the “Methods” section. After reverse transcription, the obtained first strand cDNA was used as template for the amplification of sequences corresponding to the genes listed below.

The first evaluation of the RT-PCR results was based on the similarity between the sizes of the amplified fragments and the sizes predicted from the known sequences. The size of the amplified fragments is given below.

- Phenylalanine ammonia-lyase 856 bp
- Cinnamate 4-hydroxylase 1171 bp
- 4-Coumarate-CoA ligase 707 bp
- Chalcone synthase 553 bp
- Chalcone isomerase no amplification
- Flavanone 3-hydroxylase 815 bp
- Dihydroflavonol 4-reductase 321 bp
- Water Channel proteins 390 bp
- 60S ribosomal proteins 360 bp

Positive results were obtained for all of the genes, except for *CHI*. In some cases, additional fragments of smaller size were amplified together with the expected target fragment. This was probably due to a non-perfect setting of PCR conditions that allowed non-specific annealing of the primers. The PCR products of the expected size were cloned using the TA Cloning Kit (Invitrogen, Netherlands) as described in the “Methods” section.

The cloned inserts were sequenced and the sequences obtained are presented in the “Appendix” section. The obtained sequences were compared to the sequence databases using the software Blast n (v 2.0.12 and 2.0.13) [Altschul *et al.*, 1997]. The results of the Blast search are reported in the table 2. The homology with sequence already identified in other species ranged between 78 and 85%. These results confirmed that each cloned fragment corresponded to the candidate genes targeted, and validated the specificity of the RT-PCR reactions.

Table 2. Sequence homology analysis of the cDNA fragments cloned from differentiating xylem of *Juglans nigra*. The clone *60S rh21*, encoding 60S ribosomal proteins was cloned from *Juglans regia*, (Breton, unpublished). Results of sequence comparison realised by the software Blast n (v. 2.0.12 and 2.1.2). The sequence accessions showing the highest matching scores with the *Juglans nigra* cDNA clones are listed with the respective nucleotide identity.

PAL: phenylalanine ammonia lyase. *C4H*: cinnamate 4-hydroxylase. *4CL*: 4-coumarate:CoA ligase. *CHS*: chalcone synthase. *F3H*: flavanone 3-hydroxylase. *DFR*: dihydroflavonol 4-reductase. *60S*: ribosomal protein 60S.

cDNA Clones		Matching sequences		% Identity
Name	Sequence length (bp)	Accession number and reference	Species	Nucleotides
PAL <i>xyl1</i>	856	U43338 Seelenfreund D., et al, 1996. Plant Physiol. 111: 348-348	<i>Citrus limon</i>	80
C4H <i>xyl1</i>	1171	U47293 Ge L., and Chiang V.L. 1996. Plant Physiol. 112: 861-861	<i>Populus tremuloides</i>	81
4CL <i>xyl1</i>	707	U50846 Lee D., and Douglas C.J, 1996 Plant Physiol. 112(1): 193-205	<i>Nicotiana tabacum</i>	82
CHS <i>xyl1</i>	553	AJ132323 Laplaze L. et al, 1999 Plant Physiol. 121: 113-122	<i>Casuarina glauca</i>	85
		X94995 Claudot A.C., et al., 1999 Plant Physiol.Biochem. 37: 721-730	<i>Juglans nigra x Juglans regia</i>	85
F3H <i>xyl1</i>	815	AB023790 Shiokawa K., et al., Unpublished	<i>Ipomoea batatas</i>	83
DFR 143 (3' RACE)	910	Y11749 Sanmartin M., et al., Unpublished	<i>Vitis vinifera</i>	78
DFR <i>xyl1</i>	321	Y11749 Sanmartin M., et al., Unpublished	<i>Vitis vinifera</i>	85
60S <i>rh21</i>	686	X78213 Backhaus R.A. et al., 1994, Plant Physiol. 106: 395-395	<i>Parthenium argentatum</i>	83

The lowest value of homology (78%) obtained for the *DFR* 3' RACE can be explained by the presence of the 3' Untranslated Region (UTR) which is highly variable between species. The deduced amino peptide sequences of the cloned cDNA fragments were analysed by the software GeneJockey (Applied Biosystem's). The peptide sequences were compared to the sequences cloned in other species by realising clustal multiple alignments. The sequence alignments are presented in the "Appendix" section. The comparison with the amino acid sequences of other species allowed to verify the presence of the conserved consensus aminoacids.

4.4.4.3 3' RACE

For *DFR* genes, the primers used in RT-PCR experiments allowed to amplify and clone a fragment of 321 base pairs. This couple of degenerate primers was used for the RT-PCR analyses of gene expression. The size of the cloned fragment was considered too small to prepare digoxigenin labelled probes of sufficient sensitivity. A larger cDNA fragment encoding *DFR* was cloned using the technique 3' RACE (Rapid Amplification of cDNA Ends). In this RT-PCR technique, the forward primer anneals to an internal sequence and the reverse primer contains a poly(T) oligonucleotide annealing to the poly(A) tail of mRNA. The partial 3' end of cDNA comprised between the primers is then amplified by PCR [Frohman *et al.*, 1988; Zhang and Frohman, 1997] (Figure 27).

The forward primer was designed according to the cloned *DFR* coding sequence of 321 bases. In 3' RACE the use of a reverse oligo (dT) primer that anneals to all of the cDNAs reduces that the specificity and the efficiency of the amplification. To achieve the specific amplification of only *DFR* sequences, a PCR technique based on "nested" primers was used. This technique consists of two consecutive PCR rounds using two different nested primers. A first PCR was performed using an external primer in order to enrich the template in the cDNAs encoding *DFR*. An aliquot of the first PCR product was then amplified again using a nested primer located downstream of the first primer, thus reaching a high specificity of amplification. For the design of these primers, two outer and two inner amino acid regions were selected in the *DFR* known sequence. For each of the two regions, the primers were designed within aminoacid stretches producing the lowest degeneracy. Among all the possible primers, we selected the sequences being 18 to 22 nucleotides long to ensure annealing specificity and having a melting temperature (T_m) ranging between 55° and 65°C. The thermodynamic stability of undesired hairpin and dimer structures was also tested to exclude the primers showing such problems.

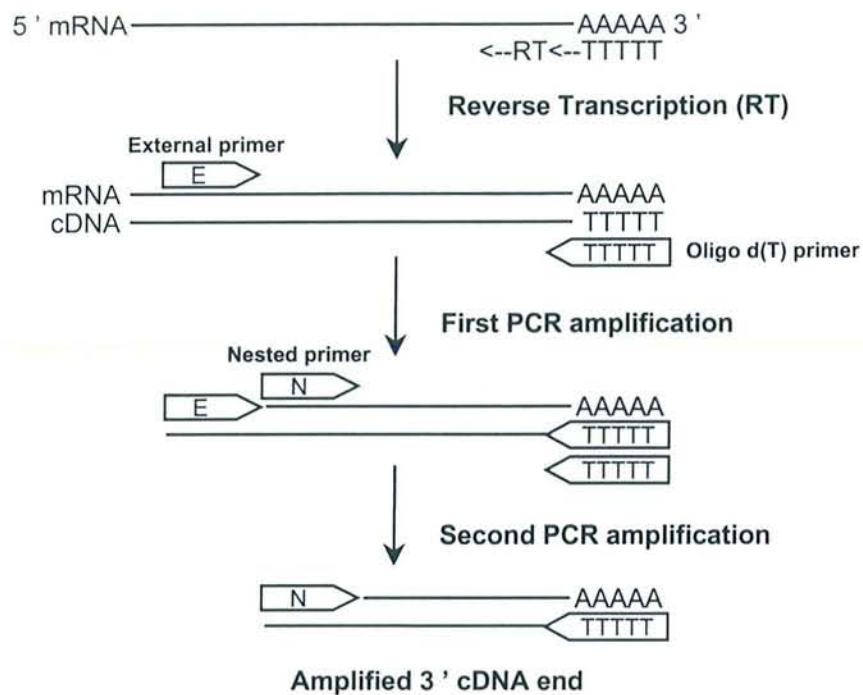

Figure 27. Schematic representation of classic 3' RACE (Rapid Amplification of cDNA Ends). The forward primer anneals to an internal sequence and the reverse primer contains a poly(T) oligonucleotide that anneals to the poly(A) tail. The partial 3' end of cDNA comprised between the primers is then amplified by PCR.

To achieve a high specificity of amplification, a PCR technique based on “**nested**” primers was used. Two consecutive PCR rounds are performed using two different nested primers. The first PCR with low amplification ratio uses a first external primer in order to enrich the template in the target sequence. An aliquote of the first PCR product is then amplified again using a nested primer located downstream of the first one.

The cDNA template used in the 3' RACE cloning was synthesized from mRNA isolated from differentiating xylem collected on *Juglans nigra* in July 1997. Multiple combinations of nested primers were tested. Two 3' RACE reactions gave amplified fragments showing the predicted size (about 1000 bp and 950 bp) that were cloned using the TA Cloning Kit (Invitrogen, Netherlands) as described in the "Methods" section. For each cloning reaction, six recombinant *E. coli* clones were selected and tested by PCR to verify the presence and the size of the insert. Finally, one positive clone was sequenced on both strands. The sequence obtained was identified and analysed as described above. This sequence is presented in the "Appendix" section. It included 689 coding and 177 non-coding nucleotides before the poly (A) tail. This 3' RACE sequence was partially overlapped with the previously cloned DFR fragment over 178 nucleotides with a 100% identity. The overlapping of the two clones generated a contig of 1010 nucleotides including the poly (A) tail.

The sequence obtained by 3' RACE was utilized to design a reverse primer as close as possible to the 3' end of the coding sequence. This primer was used together with the most external 3' RACE forward primer in order to amplify a 637 bp fragment to be used as probe for hybridisations.

By using RT-PCR and 3'RACE techniques, it was possible to clone homologous cDNA fragments corresponding to most of the candidate genes under study. The use of differentiating xylem as starting material allowed to access to many genes involved in the phenolic metabolism and expressed in xylem tissues. The sequencing of the cloned fragments validated the specificity of the RT-PCR analyses. Both the homology search and sequence alignments confirmed the identity of the walnut cDNA clones, that could then be used as homologous probes for hybridisation analyses both on RNA and DNA blots. In addition, the cDNA sequences obtained provide information to design gene specific primers both for complementary RT-PCR analyses and for further cDNA cloning.

4.4.5 Conclusions

The set-up of procedures for the isolation of RNA and mRNA from xylem samples spanning from the differentiating xylem to the transition zone represented a time consuming issue of this thesis. The main difficulties encountered were the low RNA yield of aged sapwood and the heterogeneity of the different xylem samples analysed. **The isolation of mRNA, coupled with RT-PCR provided a fast and sensitive tool to detect the expression of candidate genes in *Juglans nigra* xylem and to clone cDNA fragments.**

By RT-PCR, it was possible to show for the first time that some structural genes controlling the flavonoid metabolism were expressed in the transition zone. This first result suggested that the structural genes of the flavonoid metabolism are good candidates to study heartwood formation at the molecular level. Nevertheless, purified mRNAs did not allow an easy a reliable quantification. Therefore, the isolation of total RNA of good quality was necessary to study the dynamics of gene expression in ageing xylem. We developed an extraction protocol suitable for the isolation of RNA of good quality from very different wood samples, such as the differentiating xylem and the transition zone.

The **cloning of cDNA fragments corresponding to the candidate genes** allowed to validate the specificity of the RT-PCR amplification and **provided the homologous probes** necessary for hybridisation analyses. The availability of the homologous probes allowed to study the expression of many candidate genes. However, **the very low yield of RNA from the aged sapwood limited the number of analyses based on traditional techniques that generally require large amounts of RNA.**

**Flavanol accumulation and gene expression
during xylem ageing and heartwood formation**

4.5 Flavanol accumulation and gene expression during xylem ageing and heartwood formation in *Juglans nigra*

In this section, we present an integrated study of the physiological mechanisms controlling flavanol accumulation in the stems of *Juglans nigra* trees. Xylem growth rings spanning from the differentiating xylem to the heartwood were sampled from five trees sampled at different seasonal periods. These xylem samples were analysed by different and complementary techniques to monitor the dynamics of flavanol accumulation in parallel with the expression patterns of flavonoid structural genes. These results were integrated by analyses of PAL and CHS proteins that were carried out by Dr. Elisabeth Magel's team at Tübingen University (Germany).

4.5.1 Introduction

The accumulation of phenolic extractives related to heartwood formation is widely reported in many broadleaved and coniferous tree species and greatly affects the natural colour and durability of wood and therefore wood products [De Groot *et al.*, 2000; Dellus *et al.*, 1997a, 1997b; Fengel, 1991; Magel, *et al.*, 1994; Nobuchi *et al.*, 1985; Peng *et al.*, 1991]. The nature of major wood extractives is well known and has been largely used for chemotaxonomic purposes [Hillis, 1987]. The first attempts to study the molecular mechanisms leading to their synthesis, however, started recently [Hauch and Magel, 1998; Label *et al.*, 2000; Magel, 2000]. Recently, important progress was achieved in the understanding of the biochemistry of heartwood formation by demonstrating the *in situ* biosynthesis of phenolic heartwood extractives in the broadleaved tree species *Robinia pseudoacacia*. Moreover, it was shown that a close interrelationship exists between primary metabolism, which provides energy and the carbon skeleton, and secondary metabolism, which produces phenolic substances [for review see Magel, 2000].

The involvement of the flavonoid metabolic pathway in heartwood formation was reported for several tree species belonging to different taxa, such as *Larix occidentalis* [Gardner and Barton, 1960], *Eucalyptus* [Hillis, 1956], *Robinia pseudoacacia* [Magel *et al.*, 1994], *Pseudotsuga menziesii* [Dellus *et al.*, 1997a, 1997b] and *Juglans* spp (walnut) [Burtin *et al.*, 1998], indicating that this process is widely spread among tree species forming heartwood. The accumulation of flavonoids in many herbaceous plant species is correlated with the coordinate expression of flavonoid structural genes that encode the enzymes of flavonoid biosynthesis. These results indicate that the synthesis of these compounds is mainly regulated at the transcription level [Koes *et al.*, 1994]. Similar mechanisms could take place in the transition zone of trees, where heartwood is formed and flavonoids are accumulated.

Three main questions were addressed by this work.

- How do flavonoids accumulate in the xylem of *Juglans nigra* stems during xylem ageing and heartwood formation?
- Where are they synthesized?

- Are there any correlations between the distribution of flavonoids in the xylem and the expression patterns of genes encoding enzymes of phenylpropanoid and flavonoid pathways?

The present study focussed on the analysis of transcripts and proteins involved in flavonoid synthesis occurring during differentiation and ageing of xylem in *Juglans nigra* L. (*Juglans nigra*) trees. The key enzymes of phenylpropanoid and flavonoid biosynthesis were chosen as candidates (Figure 28). Phenylalanine ammonia-lyase (PAL), cinnamate 4-hydroxylase, and 4-coumarate--CoA ligase (4CL) are the enzymes of the general phenylpropanoid pathway, which provides precursors for lignin, suberin, and flavonoid synthesis. PAL is considered the key enzyme of this metabolic pathway. Chalcone synthase (CHS) is the key enzyme of the flavonoid pathway. Flavanone 3-hydroxylase (F3H) catalyses an intermediate step leading to dihydroflavonols. Finally, dihydroflavonol 4-reductase (DFR) catalyses the reaction leading to the formation of flavan-3,4-diols (leucoanthocyanidins), which are precursors of both anthocyanins and condensed tannins (proanthocyanidins). The expression of the genes encoding these enzymes was studied in xylem samples in parallel with the accumulation of flavanols. Moreover, PAL and CHS proteins were detected by immunoblotting in the same xylem samples. The comparison between young and aged xylem collected at different seasonal periods allowed the monitoring of the dynamics of flavanols accumulation and showed which genes are expressed during the differentiation and ageing of xylem.

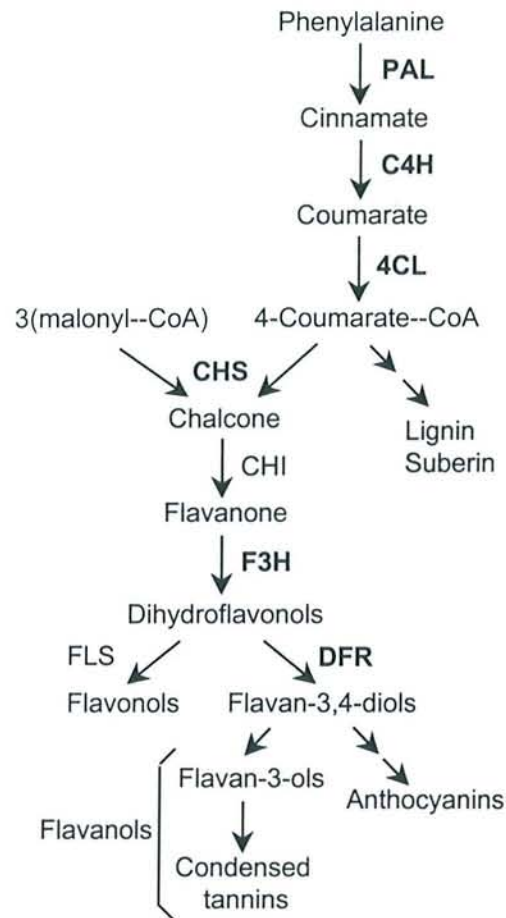

Figure 28. Simplified metabolic pathway of phenylpropanoid and flavonoid biosynthesis. The enzymes investigated in this work are displayed in bold characters. PAL: phenylalanine ammonia-lyase; C4H: cinnamate 4-hydroxylase; 4CL: 4-coumarate--CoA ligase; CHS: chalcone synthase; CHI: chalcone isomerase; F3H: flavanone-3-hydroxylase; FLS: flavonol synthase; DFR: dihydroflavonol 4-reductase.

4.5.2 Results

4.5.2.1 Flavanol accumulation in *Juglans nigra* xylem

Preliminary analyses revealed that flavanols are the only flavonoid compounds accumulating in the xylem of *Juglans nigra* trees. Burtin *et al.* [1998] reported that flavonols accumulate in the wood of *Juglans regia* L (English walnut), but not in that of *Juglans nigra*. It was checked whether flavonoid compounds other than flavanols accumulated in the *Juglans nigra* samples used in this study. Analyses performed by HPLC methods confirmed that neither dihydroflavonols nor flavonols could be detected in *Juglans nigra* wood (results not shown).

The content of flavanols was determined in different xylem growth rings spanning from the differentiating xylem to the outer heartwood at different periods of the year (May, July, October, and January) using a specific colorimetric assay (4-dimethylamino-cinnamaldehyde, DMACA) (Figure 29). Flavanols were detected in every xylem sample analysed but with great variability that could be related to the differences in physiological age. The highest accumulation (600-800 $\mu\text{g g}^{-1}$ dry weight) was generally observed in the transition zone between sapwood and heartwood. Independently of the sampling date, the amounts of flavanols were 2 to 4 fold higher in the transition zone than in the inner sapwood. The lowest contents of flavanols were always observed in the outer sapwood, except in January samples. Relatively high amounts of flavanols were measured in the outer heartwood, as shown in July 1998 (600 $\mu\text{g g}^{-1}$ dry weight), as well as in differentiating xylem sampled in May and July 1998. Flavanols clearly accumulated with the ageing of sapwood. Such a radial trend was verified for all trees analysed in this study, with the exception of samples from January 1998.

4.5.2.2 Expression of structural genes

Some difficulties were experienced for the extraction and purification of RNA from aged sapwood. The yield of RNA significantly dropped between differentiating xylem and mature sapwood. The RNA yield from differentiating xylem (average 2 mg per g of dry weight) was comparable to the amount that is generally obtained from leaves [Chang *et al.*, 1993]. Decreasing yields were obtained from sapwood samples. In the transition zone, the yields were very low and ranged between 0.2 and 5 $\mu\text{g RNA per g}$ of dry weight. No RNA was detected in extracts from heartwood by spectrophotometric quantification. This was confirmed by the absence of RT-PCR amplification products from this xylem zone (results not shown). The low RNA yield obtained from the transition zone limited the possibility to perform usual analyses of gene expression, such as northern blotting, which require relatively big amounts of RNA.

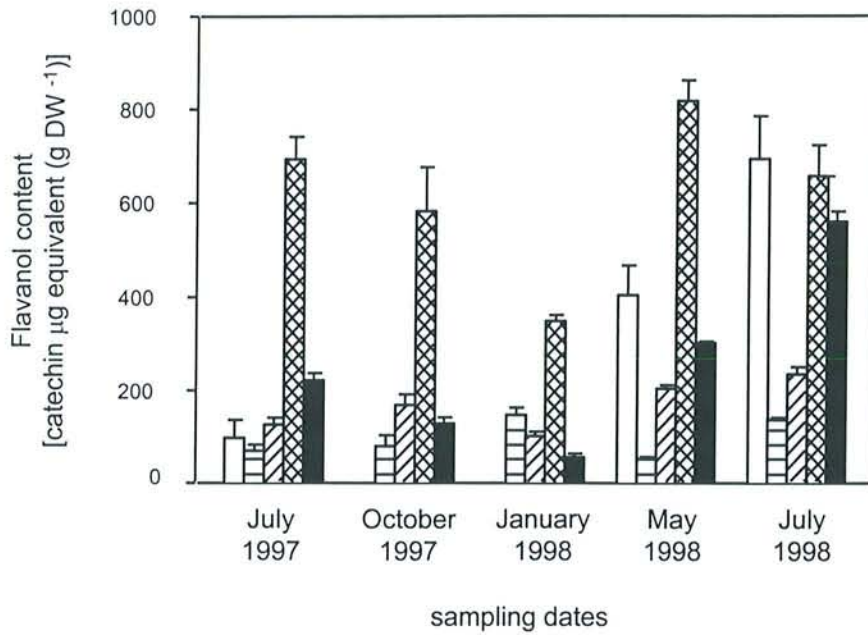







Figure 29. Accumulation of flavanols across stem sections of *Juglans nigra* L. trees collected at different dates. Flavanol content was measured after reaction with 4-dimethylamino-cinnamaldehyde. Values are the mean of 3 independent analyses performed on the same wood sample. Standard deviations are displayed as bars. Each bar group represents a different sampling date. The samples analysed are:

- | | | |
|---|---|--|
|  differentiating xylem |  outer sapwood |  inner sapwood |
|  transition zone |  outer heartwood | |

The differentiating xylem tissue was not present in the trees collected in October and January.

The homologous probes hybridising to sequences encoding PAL, 4CL, CHS, F3H, and DFR were used in this study. A probe corresponding to a *Juglans regia* L. sequence encoding 60S ribosomal protein (60S) was used as control for RNA loading in northern blot experiments (Breton, unpublished). The size of cDNA probes was respectively 856 bp for *PAL*, 707 bp for *4CL*, 553 bp for *CHS*, 815 bp for *F3H*, 637 bp for *DFR*, and 360 bp for *60S*.

Initially, analyses of gene expression were carried out by northern blot on the July 1998 samples, which gave the highest yield in RNA extractions. The results of hybridisation with different probes are presented in the figure 30. The reference probe *60S*, used for RNA loading control, gave a constant signal in sapwood and a much stronger signal in differentiating xylem. The ethidium bromide detection of RNA after gel electrophoresis confirmed that some differences in RNA loading existed among the samples analysed. For *PAL*, *CHS*, and *F3H* genes, similar transcript levels were observed in differentiating xylem. On the contrary, contrasted patterns were found in sapwood samples. For *PAL*, the highest transcript accumulation was found in the outer sapwood and a weak signal was detected in the transition zone. An opposite pattern was observed for *CHS* and *F3H*, with the strongest hybridisation signal in the inner sapwood and transition zone. No hybridisation signal was obtained for *DFR* genes, even if the corresponding probe showed a normal sensitivity (data not shown).

Secondly, the analyses of gene expression were extended to xylem samples collected at different seasonal periods, using RNA dot blot and RT-PCR methods (Figure 31). The results obtained by dot blot from July 1998 samples strictly correlated with northern blot results (Figure 31a). Dot blot and RT-PCR analyses showed two homogenous groups of genes according to their expression patterns (Figure 31b). The first group included genes encoding enzymes of the general phenylpropanoid pathway (*PAL*, *C4H*, and *4CL*). Because of the limiting RNA amounts available, *C4H* genes were not included in dot blot analyses. *C4H* genes were analysed by RT-PCR and the pattern obtained was very similar to *PAL* and *4CL* dot blots. For *PAL*, *C4H* and *4CL*, the highest transcript accumulation was observed in differentiating xylem and outer sapwood. Interestingly, an accumulation of *PAL* transcripts was found in the transition zone, particularly in October, whereas no signal was observed in the inner sapwood. The second group included genes encoding enzymes specific for flavonoid biosynthesis (*CHS*, *F3H*, and *DFR*). For *CHS* and *F3H*, a high transcript accumulation was found in differentiating xylem and transition zone. Transcript levels increased according to the age of the sapwood growth rings, reaching their maximum in the transition zone. This radial trend was observed at each sampling date, although the general amount of transcript varied according to the season. For *DFR*, a very weak hybridisation signal was obtained by dot blot in differentiating xylem and transition zone. Therefore, the expression of *DFR* genes was detected by RT-PCR (Figure 31b). *DFR* genes showed RT-PCR patterns similar to *CHS* and *F3H* dot blots. All the genes studied were analysed by RT-PCR in order to test the consistency between dot blot and RT-PCR results. A good similarity was found between dot blot and RT-PCR results, thus supporting the reliability of RT-PCR results obtained for *C4H* and *DFR*.

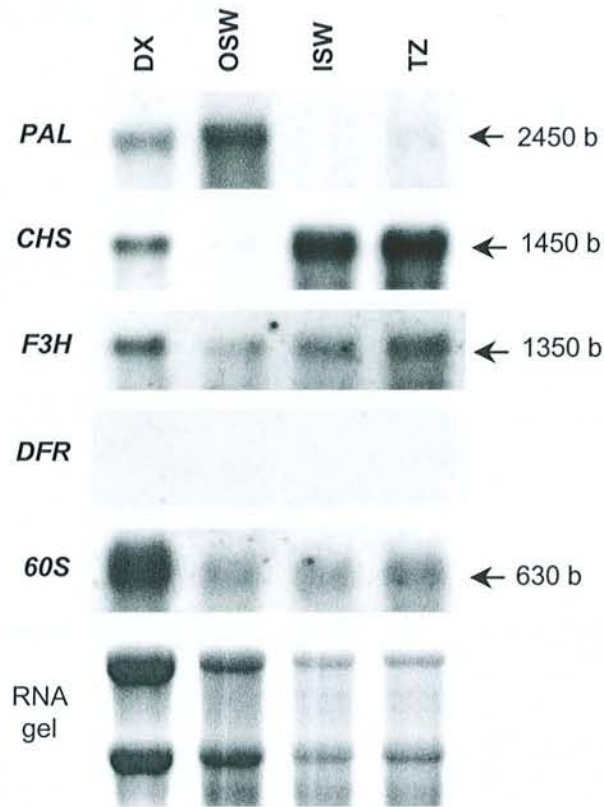

Figure 30. Autoradiogram of northern blot analyses showing transcript accumulation of flavonoid structural genes across the stem of *Juglans nigra* L. tree collected in July 1998.

RNA was isolated from differently aged xylem samples: **differentiating xylem (DX)**, **outer sapwood (OSW)**, **inner sapwood (ISW)**, and **transition zone (TZ)**. Each lane contained 10 µg of total RNA (RNA gel). The membranes were hybridised with digoxigenin labelled homologous cDNA fragments of the following genes: *phenylalanine ammonia-lyase (PAL)*, *chalcone synthase (CHS)*, *flavanone-3-hydroxylase (F3H)*, *dihydroflavonol 4-reductase (DFR)*, and *60S ribosomal protein (60S)* (used for loading control). The bottom panel represents ethidium bromide staining of RNA after electrophoresis. **b:** bases.

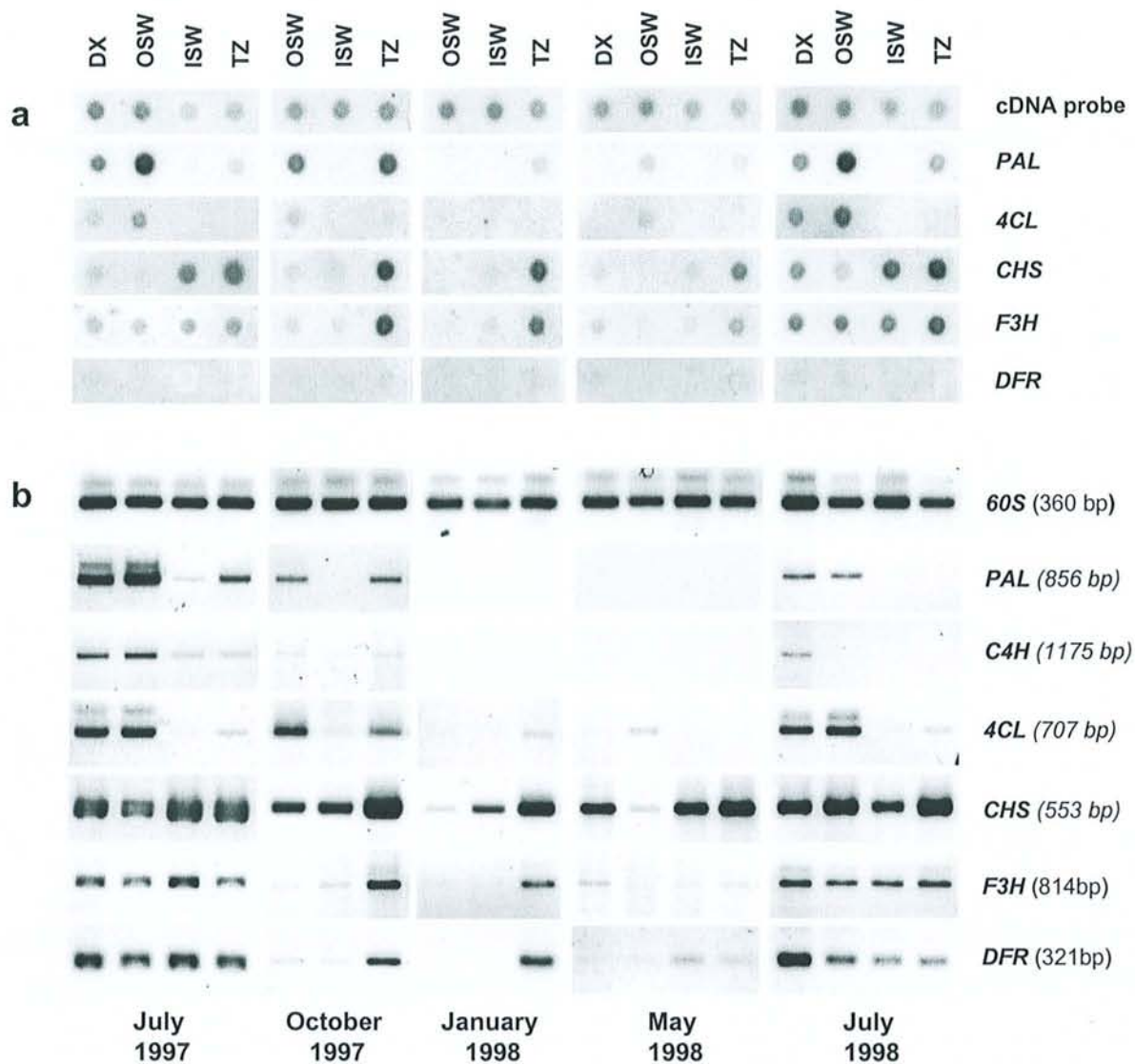

Figure 31. Accumulation of transcripts of flavonoid structural genes across stem sections of *Juglans nigra* L. trees. Each vertical block represents a different sampling date. DX: differentiating xylem; OSW: outer sapwood; ISW: inner sapwood; TZ: transition zone.

a) Autoradiogram of RNA dot-blot analysis. One μg of total RNA was dot blotted and hybridised with digoxigenin labelled homologous cDNA fragments of the following genes: *phenylalanine ammonia-lyase (PAL)*; *4-coumarate-CoA ligase (4CL)*, *chalcone synthase (CHS)*, *flavanone-3-hydroxylase (F3H)*, and *dihydroflavonol 4-reductase (DFR)*. A complex cDNA probe prepared from differentiating xylem was used as control for loading.

b) Electrophoresis of RT-PCR products. mRNAs purified from 50 ng of total RNA were used as template for reverse transcription and PCR amplification of sequences corresponding to *PAL*, *cinnamate 4-hydroxylase (C4H)*, *4CL*, *CHS*, *F3H* and *DFR* genes. Amplification of *60S ribosomal protein* genes was used as control to test the amount and quality of cDNA templates. Fragment sizes are given in brackets. bp: base pairs.

When considering the seasonal trend of gene expression, higher transcript levels were found in summer and autumn whilst lower ones were observed in winter and spring. These seasonal variations were particularly marked for *PAL*, *C4H*, and *4CL*. In addition, very similar expression patterns were observed in samples collected in July 1997 and July 1998.

4.5.2.3 Accumulation and activity of *PAL* and *CHS* proteins

PAL and *CHS* are considered as the key enzymes of the general phenylpropanoid and flavonoid pathways, respectively. Our results showed that two groups of genes, represented by *PAL* and *CHS*, were differentially regulated during xylem differentiation and ageing. Thus, it was interesting to investigate whether these differences influence the tissue specific distribution of enzyme protein pools.

In all sapwood samples, the total amount of soluble proteins was approx. 1mg per g dry weight. Independent of the sampling date, the protein content slightly decreased within the transition zone. Much higher values were measured in the differentiating xylem where the protein content was 10-20 fold higher than in the sapwood. Western immunoblottings were employed in order to study the distribution of enzyme protein pools of *PAL* and *CHS* within the different xylem samples (Figure 32). Two *PAL* immunoreactive polypeptides, of about 77 kDa and 83 kDa, showed a specific distribution. In the differentiating xylem and autumn outer sapwood, both *PAL* polypeptides were detected whilst only the smaller polypeptide was detected in aged sapwood and transition zone. *PAL* proteins were detected in traces or even absent in the inner part of the transition zone. Relatively high amounts of *PAL* protein were found in the inner sapwood collected in January, May, and October. For *CHS*, an immunoreactive band of about 45 kDa was detected. In October, January, and May, *CHS* proteins accumulated preferentially in the transition zone. In the samples harvested in July 1997, *CHS* proteins were mainly detected in the inner sapwood and differentiating xylem, whereas in July 1998 *CHS* was more homogeneously distributed in all xylem samples, but with stronger signals in the outer sapwood and the transition zone.

In *Robinia pseudoacacia* trees, *PAL* proteins were found in all wood samples, but enzyme activities showed high variability, with the highest values being measured in the transition zone [Magel and Hübner, 1997]. Catalytic activities of *PAL* and *CHS* were measured in *Juglans nigra* xylem samples. In all mature sapwood samples, activities of both *PAL* and *CHS* were low and ranged 0 to 0.2 pKat per mg protein. Catalytic activities of *PAL* and *CHS* increased within the transition zone from October to May and reached 0.4-0.6 pKat and 0.15-0.35 pKat per mg protein, respectively.

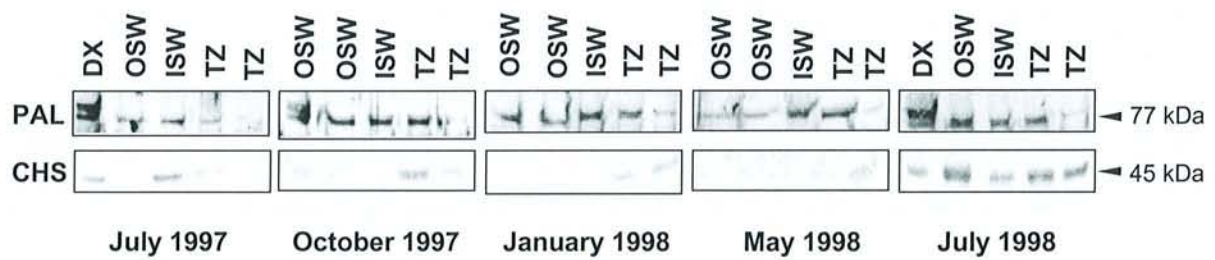

Figure 32. Accumulation of phenylalanine ammonia-lyase (PAL) and chalcone synthase (CHS) proteins across stem sections of *Juglans nigra* L. trees. Immunological detection in crude extracts was obtained with rabbit-antisera raised against PAL from parsley and CHS from spinach. Blocks represent different sampling dates. In each block xylem samples are ordered from left to right according to their position from cambium to pith. Each lane corresponds to an individual growth ring. DX: differentiating xylem; OSW: outer sapwood; ISW: inner sapwood; TZ: transition zone.

4.5.3 Discussion

Heartwood formation is a physiological process occurring in many tree species, which generally increases the natural colour and durability of wood [Hillis, 1987]. Carbohydrate and phenolic metabolic pathways are known to be involved in this process but little information is available about gene expression during heartwood formation [Magel, 2000]. Recently, the expression of flavonoid structural genes, *CHS*, *F3H*, and *DFR* was detected by RT-PCR in xylem samples of *Juglans nigra* trees ranging from differentiating xylem to the transition zone [Label *et al.*, 2000]. However, such results were not sufficient to elucidate any relationships between the gene expression level and the synthesis of phenolics. This issue was specifically addressed in the present work by analysing xylem samples collected at different seasonal periods and by using quantitative analyses of gene expression.

4.5.3.1 Flavanols accumulate in the transition zone between sapwood and heartwood

We have monitored the accumulation of flavanols in xylem growth rings of *Juglans nigra* trees undergoing differentiation, ageing, and heartwood formation. Flavanols accumulation occurred mainly in correspondence of two developmental phases: differentiation of xylem and ageing of sapwood (Figure 29). Flavanol content was high in differentiating xylem in May and July 1998, but strongly decreased in the adjacent outer sapwood. The disappearance of most flavanols in the outer sapwood could be linked to xylem differentiation with the death of cells forming vessels and fibres and the loss of their protoplasm. To better understand the decrease of flavanols in sapwood it would be of great interest to know in which cells of differentiating xylem flavanols are mostly accumulated. Together with the drop in flavanol content, the differentiation of secondary xylem is marked by the deposition of lignin in secondary cells walls. This opposite pattern of accumulation could mark a shift of phenolic metabolism from flavonoid synthesis to lignin synthesis during the last steps of xylem differentiation. In ageing sapwood, the flavanol content increased according to the age of growth rings. The highest values were invariably measured in the transition zone, where flavanol content was 2-4 fold higher than in the inner sapwood. Flavanol content dropped drastically in outer heartwood when compared to the adjacent transition zone. Such decrease of phenolic content from transition zone to outer heartwood was previously observed in English walnut and *Juglans nigra* trees [Burtin *et al.*, 1998]. During heartwood formation, parenchyma cells die and phenolics accumulated in the vacuole are released and diffuse in the newly formed heartwood. These compounds are then subjected to enzymatic and non-enzymatic reactions. They can be oxidised producing brown coloured compounds which are no more detected as flavanols. Oxidised flavanols can polymerise forming condensed tannins [Haslam, 1989]. The DMACA assay detects both monomeric and polymeric flavanols but the degree of polymerisation can modify the efficiency of the detection [Treutter, 1989; Treutter *et al.*, 1994]. Finally, flavanols that diffuse into the cell wall matrix could bind chemically to lignin free radicals and become non-extractable [Haslam, 1989].

The flavanol accumulation patterns that we have observed were homogenous among the different trees analysed over a one-year period and are in agreement with previous observations [Burtin et al., 1998]. This indicates that the physiological mechanisms controlling extractives accumulation in ageing xylem are stable and conserved in *Juglans spp.* trees. Similar distributions of phenolic extractives across the sapwood were already reported in many tree species [Hillis, 1987; Higuchi, 1997]. The accumulation of flavonoids in the transition zone was reported in other broadleaved species such as *Robinia pseudoacacia*, [Magel et al., 1994] and *Juglans spp.* [Burtin et al., 1998]. The authors postulated that flavonoids accumulated in the transition zone were synthesized *in situ* using carbohydrates translocated via the ray parenchyma cells. In the present study, this hypothesis was further investigated by molecular and biochemical analyses.

4.5.3.2 Structural genes of phenylpropanoid pathway are differentially expressed during heartwood formation

The analyses of expression of structural genes controlling flavonoid biosynthesis (*PAL*, *4CL*, *CHS*, *F3H*, and *DFR*) provided useful clues to better understand how flavanol biosynthesis is regulated in ageing xylem. The genes studied showed highly contrasted patterns of expression. It was possible to distinguish two groups of genes showing coordinate patterns of expression. The first group included *PAL*, *C4H* and *4CL* genes, encoding enzymes of the general phenylpropanoid pathway. The second group included *CHS*, *F3H*, and *DFR* genes, encoding enzymes specific of the flavonoid pathway.

The expression of *PAL*, *C4H*, and *4CL* was detected in two distinct sites, the young part of xylem (differentiating xylem and outer sapwood) and the oldest part (transition zone). For *PAL*, *C4H*, and *4CL*, the transcript level varied according to the age of the xylem samples. In addition, the radial patterns of expression changed according to the season. The highest transcript levels were detected in the outer sapwood in July and May, whereas they peaked in the transition zone in October and January. Moreover, the level of *PAL*, *C4H*, and *4CL* expression was very low in January and May. This variation in dynamics suggests two different levels of regulation. The first level would be developmental and dependent on the age of the tissues. The second level would be temporal, according to the season of sampling. The coordinate expression of *PAL*, *C4H*, and *4CL* was previously reported for many plant species. In plants and cell cultures of *Petroselinum hortense* (parsley) stimulated by light and elicitors, Ragg et al. [1981] observed a coordinate induction and turnover of *PAL* and *4CL* transcripts. In *Arabidopsis thaliana* plants, the inoculation with fungal pathogens induced the coordinate expression of *PAL*, *C4H*, and *4CL* [Ehltling et al., 1999]. Koopmann et al. [1999] proposed that these three genes form a regulatory unity. The molecular basis of the common regulation of *PAL*, *C4H*, and *4CL* genes would be in the conservation of regulatory elements of their promoters. High homologies were found between the sequences of *PAL* and *4CL* promoters in parsley, consistently with the coordinate expression of these genes in response to different stimuli [Logemann et al., 1995].

The immunological detection of *PAL* proteins, as well as the distribution of its catalytic activity, suggest that the regulation of the activity of this enzyme is quite complex and could be controlled at

different levels, from gene transcription to post-translational modification. The sizes of the PAL polypeptides detected (about 77 kDa and 83 kDa) were consistent with the values observed in other species and corresponded to one subunit of the tetrameric PAL protein [Lewis *et al.*, 1999]. The amount of PAL protein was almost constant in the sapwood with a slight decrease observed in the transition zone (Figure 32). Such radial distribution did not correlate with the expression of *PAL* genes, which was very variable and never detected in the inner sapwood. These observations suggest that the turnover of PAL proteins could be very long. Therefore, PAL could be synthesized and stored in xylem for a long time. This hypothesis would be consistent with the strong expression of *PAL* genes detected in outer sapwood in July. A large pool of PAL proteins would be produced at the periphery of sapwood and then stored over years during ageing of xylem cells. The increase of *PAL* transcript level observed in the transition zone did not result in an additional increase of protein amount. A possible explanation is that an additional synthesis of *PAL* transcripts would be required in the transition zone to compensate for any protein loss occurring in very aged sapwood. Another possible explanation is that some PAL isoforms could be specifically synthesized in the transition zone, thus requiring *de novo* transcription of specific genes. In most species, PAL is encoded by a multigene family and single gene members are specifically expressed in xylem tissues [Lewis *et al.*, 1999]. In *Populus kitakamiensis*, only two *PAL* genes out of four were expressed in stems tissues developing secondary xylem [Osakabe *et al.*, 1995]. In *Pinus contorta*, PAL is encoded by 8-10 loci. Among these, one gene was over expressed in differentiating secondary xylem whilst another *PAL* gene was not expressed in this xylem zone [Butland *et al.*, 1998]. Preliminary Southern blot analyses were realized on walnut genomic DNA. The *PAL* probe revealed 1-3 restriction fragments suggesting the presence of at least two loci encoding PAL (results not shown). Gene specific probes would be required to elucidate whether specific genes are expressed during differentiation of xylem in *Juglans nigra*. Another relevant result was the detection of an additional heavier PAL polypeptide (83 kDa) in differentiating xylem in July and outer sapwood in October. This polypeptide, detected only in the current increment ring, could be specific of differentiating xylem during the growth season and thus could be linked to lignification processes.

The distribution of PAL proteins did not correlate with the distribution of its catalytic activity. Preliminary analyses realized on *Juglans nigra* showed that PAL activity was higher in the transition zone than in the inner sapwood in October, January, and May. A similar distribution of PAL protein pool and PAL activity was previously observed in stems of *Robinia pseudoacacia* trees [Magel and Hübner, 1997]. Even though PAL was detected in all living xylem of *Robinia pseudoacacia* trees, its activity was much higher in the transition zone than in the middle sapwood. The authors postulated that PAL activity was regulated by post-translational modification. It is known that PAL activity can be regulated by post-translational modifications [Dixon and Paiva, 1995]. The enzymatic activity is strongly inhibited by its reaction product, cinnamate [Jones, 1984]. Phosphorylation status also plays a role in the inactivation and turnover of PAL enzyme in *Phaseolus vulgaris* L. [Bolwell, 1992]. It is likely that similar mechanisms could be involved in the modulation of PAL activity in the xylem of *Juglans nigra*.

The second group of coordinately expressed genes included *CHS*, *F3H*, and *DFR*, which correspond to the structural genes of the flavonoid pathway. The expression of these genes was detected mainly in two sites: differentiating xylem and aged sapwood (inner sapwood and transition zone). In differentiating xylem, *CHS* and *F3H* expression was detected in both May and July. In sapwood, the transcript level increased according to the age of the growth rings reaching its maximum in the transition zone whatever the sampling date. Very similar patterns were obtained by RT-PCR for *DFR* genes, especially in October and January. It is likely that the very low hybridisation signal obtained with the *DFR* probe was due to a low copy number of *DFR* transcripts. Similar situations were encountered in *Lotus corniculatus* plants by Bavage *et al.* [1997] and in *Forsythia x intermedia* flowers by Rosati *et al.* [1997]. RT-PCR analyses were used by these authors to detect *DFR* transcripts.

The coordinate transcription of flavonoid structural genes has often been observed as rapid response to stresses inducing an accumulation of flavonoid compounds. In dark grown plants of *Perilla frutescens*, *CHS*, *F3H*, and *DFR* transcription were induced in a coordinate manner in response to light exposure [Gong *et al.*, 1997]. In the same manner *PAL*, *CHS*, *CHI* (chalcone isomerase), and *DFR* were coordinately induced by light in *Arabidopsis thaliana* seedlings and plants [Kubasek *et al.*, 1992; 1998]. In many cases, the expression patterns of early and late genes of the flavonoid pathway revealed different regulatory mechanisms. In developing flowers of *Gerbera hybrida*, *DFR* expression was tissue specific and correlated with anthocyanin accumulation while the localisation of *CHS* expression was more general [Helariutta *et al.*, 1995]. On the contrary, in developing flowers of *Solanum tuberosum*, *CHS* expression correlated with the accumulation of flavonols but *F3H* and *FLS* (flavanol synthase) expression did not correlate [van Eldik *et al.*, 1997]. In our experiments, the expression of *CHS*, *F3H*, and *DFR* appeared to be coordinate. However, both temporal and spatial intervals of our sampling are quite large and could mask small differences in expression patterns. In *Arabidopsis thaliana* seedlings, *PAL*, *CHS*, *CHI*, and *DFR* genes appeared to be coordinately induced by light within a daily sampling resolution, but at a smaller time scale, the different genes were shown to be sequentially induced [Kubasek *et al.*, 1992].

The distribution of CHS proteins was quite different from the distribution of PAL proteins. CHS was specifically accumulated in the transition zone in October, January, and May, whilst its distribution was more homogenous in xylem samples collected in July. The size of the detected polypeptide (45 kDa) was in the range observed in other plant species and corresponded to one subunit of the CHS homodimeric protein [Dangl *et al.*, 1989; Martin, 1993]. Contrary to PAL, the distribution of CHS proteins correlated with the expression patterns of the corresponding genes. Therefore, gene transcription would result directly in accumulation of CHS proteins. Preliminary assays showed that CHS activity was much higher in the transition zone than in the inner sapwood in October and January. Even if these data are still partial, they suggest that CHS activity would be directly regulated by the amount of the corresponding protein without post-translational modulation. Our results concerning CHS distribution and activity are very similar to those observed in *Robinia pseudoacacia* trees by Magel *et al.* [1991] and Magel and Hübner [1997]. These authors found a higher CHS activity in the transition zone than in the middle sapwood and the catalytic

activity correlated with the amount of CHS proteins. The bulk of available experimental data indicate that CHS activity in plants is mainly regulated by the transcription rate of *CHS* genes. In *Petroselinum vulgare* cell cultures CHS enzyme can exist as inactive and active forms, both presenting half-lives estimated as 6-18 hours [Martin, 1993]. Therefore, maintaining CHS activity *in vivo* requires continuous gene transcription and protein synthesis.

4.5.3.3 *Physiological role of phenylpropanoid structural genes during xylem differentiation and heartwood formation*

Northern blot analyses provided an interesting comparison between differentiating xylem and mature sapwood. The *ribosomal protein 60S* probe, used for RNA loading control, gave a much stronger hybridisation signal in differentiating xylem than in mature sapwood. It is likely that the physiological differences between differentiating xylem and sapwood could contribute to these results. Both samples belong to xylem but are very different from the physiological point of view. Differentiating xylem is a very active zone in which many developmental events take place: cambial cell division, cell extension, tissue differentiation, secondary cell wall deposition, and lignification. On the contrary, only parenchyma cells stay alive in sapwood, without any cell proliferation and with a general lower metabolic activity [Hillis, 1987; Nobuchi *et al.*, 1985; 1987]. Using *60S* transcript level as an index of general transcription/translation level, it is possible to discriminate differentiating xylem from sapwood. In differentiating xylem, the *60S* signal was strong but *PAL*, *CHS*, and *F3H* signals showed medium intensity. In this young xylem part, the strong expression of *60S* genes testified an intense transcription activity of many different genes, in accordance with an intense metabolic activity. The opposite situation was observed in sapwood, where the general transcript level was lower, whereas the expression of *PAL*, *CHS*, and *F3H* was higher than in differentiating xylem. These differences indicate that a restricted number of genes are expressed in sapwood, but phenylpropanoid genes represent a high proportion of the total transcript.

It is very interesting to compare the patterns of gene expression observed in the different xylem to the relative content of flavanols. In young xylem, the expression of *PAL*, *C4H* and *4CL* genes did not correlate with the accumulation of flavanols, since the highest transcript accumulation was detected in outer sapwood, where the flavanol content was very low. In differentiating xylem, the transcription of these genes is expected to be linked to the lignification of secondary cell walls. No expression was detected in differentiating xylem in May, when the cambial activity had just started and the young xylem cells were mainly dividing and elongating. The transcript levels increased in July, when lignification process was fully active. The specific expression of *PAL*, *C4H*, and *4CL* in plant tissues undergoing lignification was already demonstrated in many species. In herbaceous plants, the localisation of *PAL* transcription is strictly associated with the lignified vascular tissues [Lee *et al.*, 1995; Liang *et al.*, 1989; Koopmann *et al.*, 1999]. Moreover, the expression of *PAL* in differentiating secondary xylem of trees was reported for *Populus kitakiamensis* [Osakabe *et al.*, 1995] and *Pinus* spp [Butland *et al.*, 1998; Whetten and Sederoff, 1992].

Interestingly, the highest accumulation of *PAL* transcripts in *Juglans nigra* was observed in outer sapwood in July. This differentiated xylem part was one to two year old. Lignin deposition occurs during the first year of life of a xylem cell [Higuchi, 1997]. Therefore, one can wonder what is the role of such a strong expression of *PAL* genes in the outer sapwood. A possible explanation is that this high transcription activity could serve to produce a large pool of inactive PAL proteins that might be activated later according to metabolic needs. The second site of expression of *PAL*, *C4H*, and *4CL* was in the transition zone. *PAL* transcript was always detected in this xylem sample, but it was particularly high in October. Since no transcripts were detected in the inner sapwood, the expression of *PAL*, *C4H*, and *4CL* in ageing sapwood appears to be specifically correlated with the final steps of wood ageing leading to heartwood formation. Flavanols accumulated mainly in the transition zone, therefore, the transcription of phenylpropanoid genes could significantly contribute to the synthesis of these compounds during heartwood formation.

The expression patterns of *CHS*, *F3H*, and *DFR* were highly correlated with the accumulation of flavanols. The transcript levels were high in differentiating xylem, where high flavanol contents were observed in May and July 1998. In sapwood, the expression levels increased according to the age of the sapwood rings as flavanol content did. Indeed, the strongest expression was detected in the transition zone where flavanol content reached its maximum. This close correlation indicates that flavanol biosynthesis is mainly activated at the transcription level in the innermost sapwood growth rings being transformed into heartwood. To our knowledge, there is only one published report showing the specific expression of genes in the transition zone related to extractives biosynthesis. In *Robinia pseudoacacia* trees, mRNAs encoding sucrose synthase were mostly accumulated in differentiating xylem and in transition zone, in summer and autumn, respectively [Hauch and Magel, 1998]. The sucrose degrading activity was up-regulated at the transcription level in the transition zone. The authors proposed that the cleavage of sucrose could act as source for the biosynthesis of lignin in differentiating xylem and of heartwood extractives in the transition zone. Our results concerning the expression of flavonoid structural genes in *Juglans nigra* are in close agreement with this hypothesis and demonstrate that flavanol biosynthesis is regulated at the transcription level in ageing sapwood of *Juglans nigra*.

For all of the genes studied, the expression patterns observed in July 1997 and July 1998 were strikingly similar. The molecular mechanisms controlling wood differentiation and heartwood formation appear to be regulated in a cyclic manner, probably by tree phenology. It is interesting to note that, for *PAL*, *CHS*, *F3H*, and *DFR*, high transcript levels were detected in the transition zone in October and January, corresponding to the end of the vegetative period and dormancy, respectively. The fact that the transcription activity was still high while trees were not growing suggests that some metabolic activities specifically linked to heartwood formation may occur during autumn and winter.

4.5.4 Conclusions

The distribution of flavanols in *Juglans nigra* xylem correlated with the expression pattern of flavonoid structural genes. A strong flavanol accumulation was found in the transition zone where sapwood is transformed into heartwood. *CHS*, *F3H*, and *DFR* genes were strongly expressed in the transition zone, especially in autumn and winter. The transcript levels of *PAL*, *C4H*, and *4CL* genes did not correlate with flavanol accumulation. However, *PAL* genes were strongly expressed in the transition zone of samples collected in autumn. Thus, their transcription could contribute to phenolic biosynthesis in this zone. The accumulation of CHS proteins correlated with the transcript level of *CHS* genes, whilst PAL proteins accumulation did not correlate with the transcript level of *PAL* genes. Such differences suggest that PAL and CHS proteins differ in the mode of regulation at the transcription and post-translation level.

The overall results indicate that, in *Juglans nigra*, flavanols are *de novo* synthesized in aged xylem, especially during the transformation of sapwood into heartwood. Flavanol accumulation appeared to be regulated mainly at the transcription level by the expression of *CHS*, *F3H*, and *DFR* genes.

To our knowledge, this is the first report describing the expression of flavonoid structural genes in xylem growth rings covering all differentiation stages from xylogenesis to heartwood formation. Our results provide original information and open new perspectives for the understanding of physiological processes linked to long-term differentiation of xylem.

General conclusions and perspectives

5. General conclusions and perspectives

The long-term objective of this thesis was to identify genes controlling wood quality in walnut. The formation of heartwood is mainly marked by the disappearance of storage substance, the accumulation of phenolic extractives, and the death of parenchyma cells. These changes are largely responsible for the natural colour and durability of wood. **Our research strategy focussed on the molecular basis of heartwood formation, considered as a key process for the biological determination of wood properties.** Most of the research work in this field has been addressed to the accumulation of extractives. The bulk of experimental evidence supports the hypothesis the extractives are *de novo* synthesized in the aged sapwood cells being transformed into heartwood [Hillis, 1987; Magel, 2000]. **The identification of the genes controlling extractive accumulation in walnut wood represents a scientific stake for the understanding of wood physiology and for the genetic improvement of wood quality.**

Three main objectives have been achieved in the present work:

- Set-up of methods for molecular analyses on aged xylem.
- Better knowledge of the regulation of flavonoid metabolism in secondary xylem.
- Better knowledge of heartwood formation in walnut.

- ***Methods for molecular analyses on aged xylem***

Very few data about gene expression during heartwood formation were published up to now [Hauch and Magel, 1998]. The technical problems encountered in purifying RNA from very aged xylem have probably hampered molecular analyses in this field. **We present for the first time an extensive study of gene expression in *Juglans nigra* secondary xylem,** performed with different techniques including northern blot, dot blot, and RT-PCR. **The quality and the reproducibility of the results obtained demonstrate that it is possible to purify good quality RNA suitable for molecular analyses from aged secondary xylem.** The protocols for RNA analyses developed in this thesis represent a technical breakthrough in this field and open new perspectives to the molecular investigations on heartwood formation. The continuation of this work will include the construction of cDNA libraries from the aged xylem and particularly from the transition zone. Such libraries would represent a source to identify the genes controlling physiological processes occurring during xylem ageing and heartwood formation.

- ***Regulation of flavonoid metabolism in secondary xylem***

The starting hypothesis of this thesis was that the strong accumulation of flavanols, observed in the transition zone of black walnut, was due to an active *in situ* biosynthesis. Previous results showed that the accumulation of flavonoids in the transition zone of *Robinia pseudoacacia* was spatially and temporally concomitant to an increase of catalytic activities of PAL and CHS enzymes [Magel, 2000]. These data strongly supported the hypothesis of *in situ* biosynthesis. Nevertheless, it remained unknown if the activation of phenolic metabolism during heartwood formation was controlled by the specific expression

of genes. **Our results clearly show a tight correlation between the accumulation of flavanols in the aged xylem and the expression of genes encoding the enzymes of flavonoid pathway (structural genes).** Such correlation was previously observed in herbaceous plant species in which flavonoid biosynthesis has been deeply studied [Koes *et al.*, 1994; Shirley, 1996]. **Our results confirm that similar molecular mechanisms control flavonoid biosynthesis in herbaceous plants and in the xylem of trees.** Two main points about the physiology of flavanol accumulation in secondary xylem can be underlined. **The first point is the long term temporal regulation: flavanol biosynthesis clearly increases with ageing of xylem and especially in the transition zone during the transformation of sapwood into heartwood. The second point is the metabolic regulation of flavonoid biosynthesis, which is likely to be mainly controlled at the transcription level.** Detailed measurements of catalytic activities are needed to determine to which extent the activities of flavonoid biosynthetic enzymes are regulated at the transcription (mRNA synthesis) and/or the post-translation (protein activation and turnover) levels.

The research in this field could be expanded into two ways: study of structural genes and of regulatory genes. The localised expression of structural genes in the transition zone suggests that some genes encoding specific enzyme isoforms could be expressed during heartwood formation. We performed some preliminary analyses to detect the specific expression of *CHS* genes in the different parts of *Juglans nigra* xylem. A PCR-RFLP method (Figure 33), previously developed by El-Euch [1997] to study *CHS* genes expression in *Juglans regia* microcuttings, was applied to analyse the *Juglans nigra* xylem samples collected in July 1997 [Beritognolo *et al.*, 1999]. The first results we obtained (Figure 34) show that one *CHS* sequence present in *Juglans nigra* genome was not expressed in the xylem. At least two different *CHS* sequences were expressed in the xylem but no differences were detected between the differentiated xylem, the sapwood, and the transition zone. The PCR-RFLP technique demonstrated to be efficient in detecting the expression of different *CHS* sequences. This type of analysis could be extended to trees sampled in other seasonal periods. In addition, the sequence information obtained from the cloned cDNA fragments could be useful to apply the PCR-RFLP approach to the other candidate genes studied in this thesis. The identification of genes specifically expressed in the transition zone could allow the cloning of gene promoters specific of the transition zone.

The transcription of structural genes is only an intermediate step of the metabolic chain regulating flavonoid biosynthesis. This research work did not include the regulatory genes of flavonoid pathway. These genes encode transcription factors controlling the expression of structural genes. While the transcription of structural genes provides the enzymes catalysing the biochemical reactions, the transcription of regulatory genes determines the site, the time, and the intensity of flavonoid synthesis.

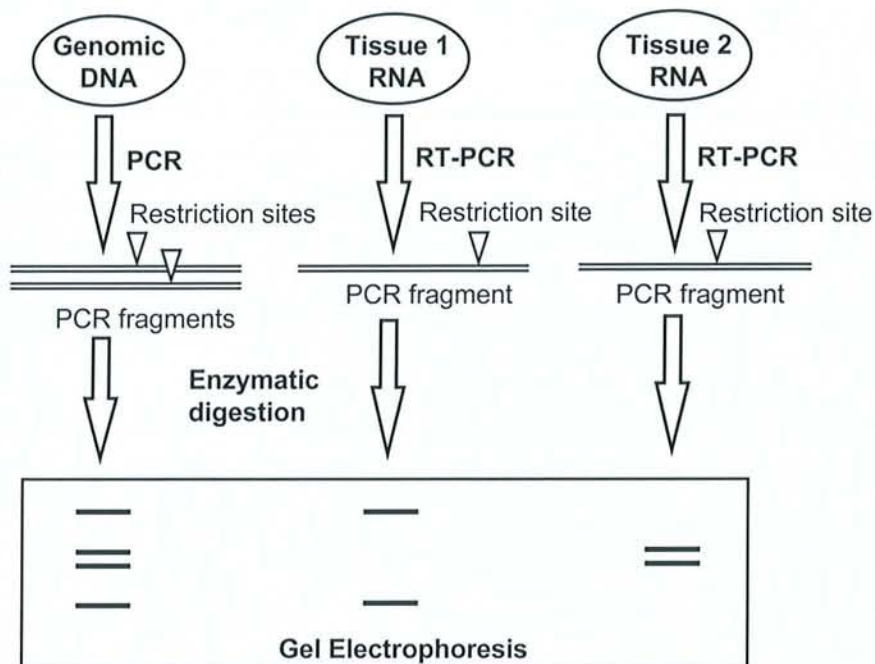

Figure 33. Principle of PCR-RFLP technique. Gene sequences present in the genomic DNA or in the cDNA population (expressed genes) are amplified by PCR and then cleaved with restriction endonucleases. The differences in presence and/or position of restriction sites allow to discriminate the different gene sequences.

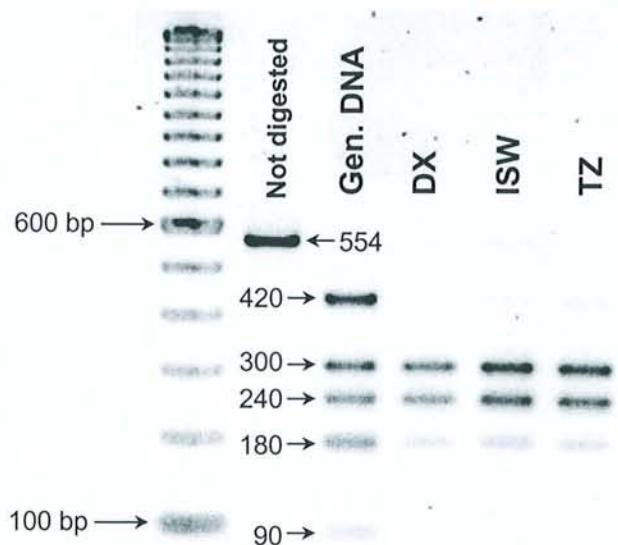

Figure 34. PCR-RFLP analyses of *CHS* sequences expressed in xylem samples collected from a 23 years old *Juglans nigra* tree in July 1997. Genomic DNA and mRNA were isolated from xylem samples and used for PCR and RT-PCR reactions to amplify a 554 bp internal coding sequence of *CHS* genes. The amplified fragments were digested with *Tha* I endonucleases and then separated by electrophoresis on 2% agarose gel in 0.5xTBE buffer system at 4V/cm. The samples analysed are described in figure 12.

Legend. **Gen. DNA**: genomic DNA; **DX**: differentiated xylem; **ISW**: inner sapwood; **TZ**: transition zone. The restriction patterns obtained from cDNA show less fragments than from genomic, indicating that one or more *CHS* sequences are not expressed in xylem. The presence of three main fragments of 300, 240, and 180 bp indicates that at least two different *CHS* sequences are expressed in xylem samples. No differences were observed between the *CHS* sequences expressed in DX, ISW, and TZ samples.

The role of flavonoid regulatory genes is well known in some herbaceous plant species such as *Petunia hybrida*, *Antirrhinum majus*, and *Zea mays* [For review see Dooner *et al.*, 1991; Mol *et al.*, 1996; Weissbar and Jenkins, 1998]. The regulatory genes identified in these species belong to three classes: bZIP type transcription factors, bHLH type transcription factors, and MYB-like transcription factors. The extremely high potential of regulatory genes for manipulating flavonoid synthesis has been demonstrated in *Zea mays*. The production of different classes of flavonoids was obtained from *Zea mays* cell cultures engineered to express different transcription factors coupled with inducible promoters [Bruce *et al.*, 2000; Grotewold *et al.*, 1998]. In the same species, the allelic variation of regulatory genes is responsible for the quantitative variation of flavonoid amount. By mapping RFLP markers corresponding to many structural and regulatory genes of flavonoid pathway, Byrne *et al.* [1996] demonstrated that two regulatory genes corresponded to QTLs controlling the amount of the flavonoid maysin (C-glycosyl flavone) accumulated in *Zea mays* silks. It is likely that similar regulatory mechanisms occur in herbaceous plants and in trees. The knowledge acquired in herbaceous species is a good starting point for the characterisation of regulatory genes controlling flavanol biosynthesis in xylem tissues. The role of MYB like transcription factors in the regulation of flavonoid biosynthesis has been demonstrated in herbaceous plants such as *Zea mays*, *Antirrhinum majus*, and *Petunia hybrida* [Dooner and Robbins, 1991; Holton and Cornish, 1995; Martin, 1997; Mol *et al.*, 1998; Quattrocchio *et al.*, 1998]. Moreover, MYB orthologues have been cloned from the differentiating secondary xylem of *Pinus taeda* trees [Newman and Campbell, 2000]. MYB proteins can be considered as good candidates for regulating the expression of flavanoid structural genes in the sapwood of trees. This is a promising research perspective to understand the genetic control of wood quality. In the long term, it could be possible to use regulatory genes as a molecular tool for both genetic transformation and marker assisted selection of trees.

- **Heartwood formation in walnut**

The third main outcome of this thesis is a better understanding of xylem ageing and heartwood formation. Five *Juglans nigra* trees collected in different seasonal periods showed a homogenous behaviour as concerning heartwood formation and extractive accumulation. This homogeneity indicates that the physiological processes linked to heartwood formation are well conserved in different trees. The temporal trends of physical, biochemical, and molecular parameters suggest that heartwood formation is a seasonally regulated cyclic process, probably linked to tree phenology. It seems that heartwood expansion occurs mainly during summer and autumn. Seasonal trends were also observed for the relative content of phenolic extractives accumulated in xylem and for the expression patterns of flavonoid structural genes. On one hand, the highest values of phenolic extractive content were observed during summer. On the other hand, a strong expression of flavonoid structural genes was specifically detected in the transition zone during autumn and winter. This temporal shift is very interesting to understand the mechanisms triggering and regulating flavanol biosynthesis. A better knowledge of such mechanisms requires parallel analysis of flavanol accumulation, transcript level, enzyme pool content, and catalytic activities. To investigate the

activities. To investigate the seasonal regulation of heartwood formation and extractive accumulation, it is necessary to set-up experiments including periodical analyses of xylem samples taken from the same trees as well as sampling of more trees at the same date.

The experimental data presented in this work and obtained with physical, biochemical, and molecular methods give an integrated description of the different stages of xylem ageing and especially of the final transformation of sapwood into heartwood. The characterisation of the transition zone by different methods is particularly relevant because heartwood is formed in this xylem zone. **The marked and concomitant variations of UV fluorescence, water content, flavonoid content, and gene expression observed in the transition zone indicate that the physiological processes leading to heartwood formation are specifically localised in this narrow xylem zone. The overall results underline the relevance of secondary xylem of trees as biological model to study long term ageing processes.** The xylem layers represented by growth rings can be considered as a geometric array of the different ageing stages that are present at the same time in a cross-section. The variation of physiological parameters observed at a certain time from the differentiating xylem to the heartwood can be considered as a temporal dynamics of xylem ageing over many years. In such a model, the specific physiological status of the differentiating xylem and the transition zone provide the extreme time scale references allowing to compare samples from different trees.

Higuchi [1997] first proposed a basic model describing the process of heartwood formation into three main steps, as reported below. Higuchi postulated that a specific expression of genes would lead to the *in situ* synthesis of phenolic extractives. Our results perfectly confirm Higuchi's hypothesis about the activation of genes encoding enzymes of phenylpropanoid (PAL, C4H, and 4CL) and flavonoid (CHS, F3H, and DFR) biosynthesis.

The process of heartwood formation [from Higuchi, 1997]

Sapwood ray parenchyma	Intermediate wood ray parenchyma	Heartwood ray parenchyma
>>>	>>>	
Inducers: ethylene, wounding, etc.	Activation of genes encoding enzymes of general phenylpropanoids metabolism and synthesis of heartwood extractives (PAL, 4CL, CHS, CHI, etc)	Accumulation of heartwood extractives Autolysis

Gathering the experimental results of the present work with the previous knowledge about heartwood formation [Hillis, 1987; Higuchi, 1997] and with the recent biochemical and molecular data obtained in

Juglans spp [Burtin et al., 1998, Label et al., 2000] and in *Robinia pseudoacacia* [Magel, 2000], we **propose an original scheme to describe the main physiological processes linked to xylem ageing and heartwood formation** (Figure 35). The ageing of secondary xylem starts in the outer sapwood, which has the role of storage reservoir and upwards transport of water and nutrients. The parenchyma cells contained in the outer sapwood are rich of starch which is the main reserve compound stored in xylem. On the contrary, the content of phenolic compounds reaches the lowest levels in the outer sapwood. As xylem growth rings undergo ageing, the starch synthesis capacity (ADP-glucose pyrophosphorylase activity) reduces while the starch degradation activity increases. Consequently, starch content decreases in the inner sapwood and disappears in the transition zone. In parallel with the decrease of starch, phenolic compounds start accumulating in the inner sapwood and much more markedly in the transition zone. These phenolic compounds are precursors of heartwood extractives. They accumulate in the vacuole, which enlarges, filling the lumen of parenchyma cells contained in the transition zone. The accumulation of phenolic compounds is the result of *de novo* biosynthesis, as demonstrated in *Robinia pseudoacacia* and *Juglans nigra* by the correlation between the high activity of key enzyme catalysing the biosynthetic reactions, such as CHS and flavonoid content. Such increase of enzyme activity is mainly controlled at the transcription level by the expression of genes encoding the enzymatic proteins, as demonstrated in the present work.

The energy and the carbon skeleton needed for phenolic biosynthesis come from the degradation of carbohydrates. The concomitant decrease of starch content and increase of phenolic content, occurring during xylem ageing, indicate that starch could serve for phenolic synthesis. Nevertheless, the hydrolysis of the starch present in sapwood could not be sufficient to balance the bulk of carbon-skeleton fixed in phenolic compounds. Therefore, phenolic biosynthesis is dependent on the transport of carbon from the phloem and the outer sapwood to the inner sapwood. Sucrose is actively transported from the outer sapwood to the inner sapwood and transition zone, where it provides the main carbon source for phenolic biosynthesis. A high sucrose-phosphate synthase (SPS) activity in the outer sapwood is responsible for the synthesis of sucrose, while a high sucrose synthase (SuSy) acts as a sink in the transition zone, providing soluble sugars used for phenolic biosynthesis. A strong correlation between the increase of SuSy activity and the expression of *SuSy* genes, observed in the transition zone, indicates that the degradation of sucrose is mainly controlled at the transcription level.

The last step of xylem ageing corresponds to the death of living parenchyma cells. Once entered in the transition zone, the parenchyma cells show a transient period of enhanced cellular activity as testified by the increased volume of nucleoli and the slenderness degree of cell nuclei. In the inner part of the transition zone the disappearance of nucleoli is followed by the progressive degeneration and disintegration of cell nuclei. Subsequently, the cells undergo autolysis and the cellular membranes disintegrate. This event marks the definitive transformation of sapwood into heartwood.

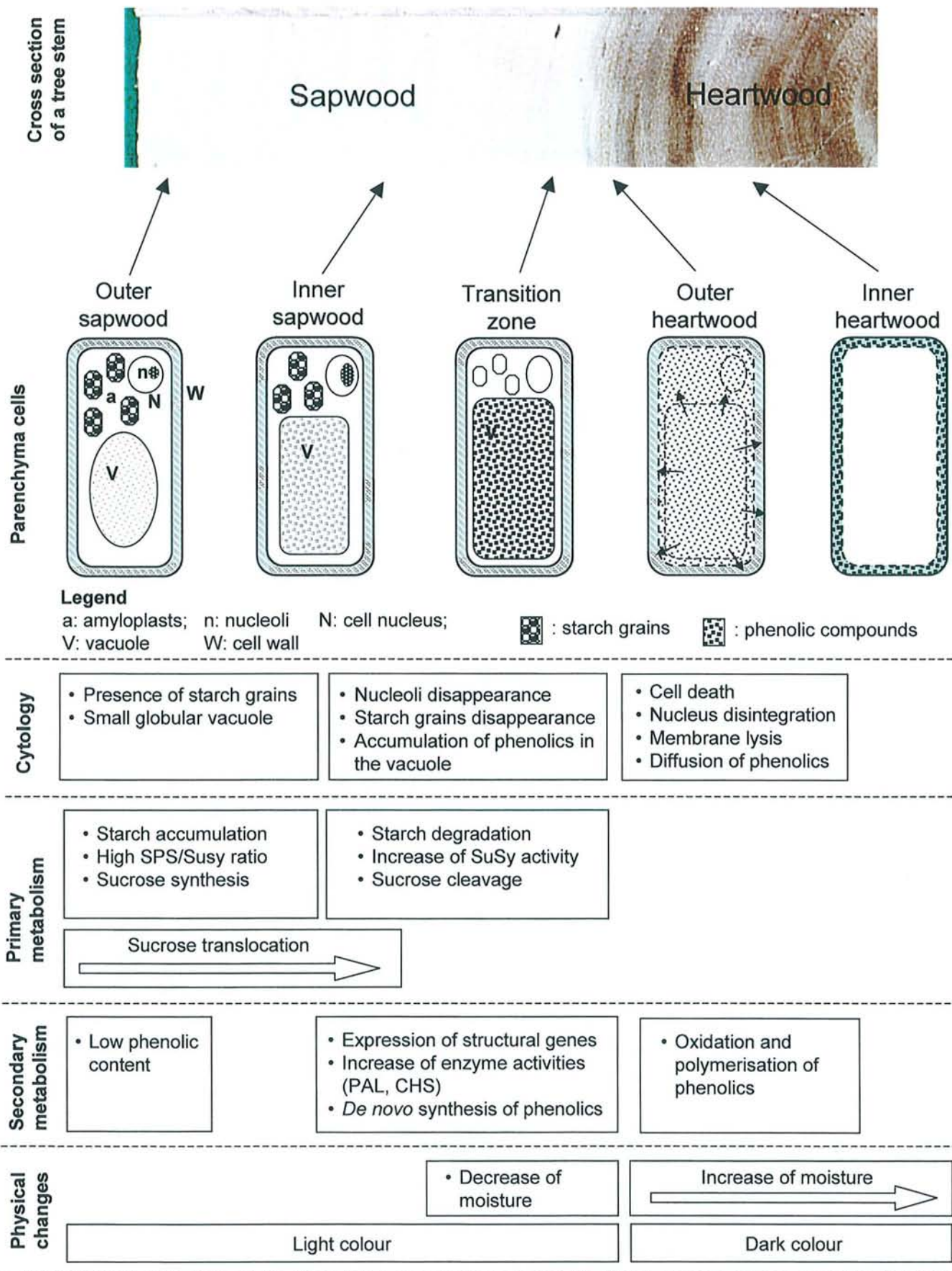

Figure 35. Simplified representation of physiological changes occurring in secondary xylem of broadleaved trees during the main stages of xylem ageing and heartwood formation.

SPS: sucrose-phosphate synthase; SuSy: sucrose synthase;

PAL: phenylalanine ammonia-lyase; CHS: chalcone synthase

The phenolics accumulated in the vacuole are released into the cell lumen and part of them can be bounded to the matrix of cell walls. The different phenolic substances, previously compartmentalised, become exposed to phenol-oxidizing enzymes and undergo oxidation and polymerisation. These reactions are partially catalysed by enzymes but also partially driven by spontaneous chemical reaction of unstable radicals. The final products are represented by new polyphenolic macromolecules of complex chemical structure. The oxidized polyphenols are darker than their precursors and are responsible for the marked colour difference between heartwood and sapwood.

The model presented above is mainly the result of quantitative approaches to study the role of primary and secondary metabolism in the formation of extractives. The localisation of physiological processes at the tissue and cellular level would be of great interest to complement the existing information and to achieve a better understanding of the cellular events. The research perspectives in this field could include the *in situ* localisation of transcripts, proteins, and metabolites (i.e. flavonoids). Previous works reported the tissue specific localisation of polyphenols in the sapwood and heartwood of *Juglans* spp trees [Burtin, 1999]. These observations show that, in the sapwood, phenolic extractives are mainly localised in radial parenchyma cells, while in the heartwood they are present both in radial and axial parenchyma. It would be interesting to localise transcripts (by *in situ* hybridisation) and flavanols (by colorimetric reaction) in microscopic section of xylem samples corresponding to the main stages of heartwood formation. This approach would provide more precise information about the transcriptional control of flavanol biosynthesis.

Most of the experimental data available about the physiology of heartwood formation concern the formation of phenolic extractives. New research work is necessary to understand the basic physiological mechanisms regulating heartwood formation. The modern tools of functional genomics appear promising for the discovery of genes and proteins involved in heartwood formation. The construction of cDNA libraries from the transition zone of *Robinia pseudoacacia* trees has been recently approached in order to obtain EST of genes preferentially expressed during heartwood formation [Han *et al.*, 2000]. The methods developed in this thesis demonstrate the technical feasibility of a similar approach to study heartwood formation in *Juglans* spp. trees. Based on the results of this thesis, a new sampling of xylem from *Juglans nigra* trees has been recently realised by INRA Orléans laboratory in order to construct cDNA libraries from xylem tissues involved in heartwood formation [Breton, pers. comm.].

Conclusions generales et perspectives

(version française)

6. Conclusions generales et perspectives (version française)

L'objectif à long terme de cette thèse était d'identifier les gènes contrôlant la qualité du bois chez le noyer. La formation du bois de cœur est principalement marquée par la disparition des substances de réserve, l'accumulation des extractibles phénoliques et la mort des cellules parenchymateuses. Ces changements sont largement responsables de la couleur naturelle et de la durabilité du bois. Notre démarche était focalisée sur les événements moléculaires liés à la formation du bois de cœur, considérée comme un processus clé pour la détermination biologique des propriétés du bois. La plupart des travaux de recherche dans ce domaine ont concerné l'accumulation des extractibles. L'ensemble de ces données expérimentales soutient l'hypothèse que les extractibles sont synthétisés *de novo* dans les cellules âgées de l'aubier qui se transforment en bois de cœur [Hillis, 1987; Magel, 2000]. L'identification des gènes contrôlant l'accumulation des extractibles dans le bois de noyer représente un enjeu scientifique pour la compréhension de la physiologie du bois et pour l'amélioration génétique de la qualité du bois. Trois principaux objectifs ont été atteints par ce travail :

1. Mise au point de méthodes pour les analyses moléculaires sur le xylème âgé.
2. Meilleure connaissance de la régulation du métabolisme des flavonoïdes dans le xylème secondaire.
3. Meilleure connaissance de la formation du bois de cœur chez le noyer.

• *Méthodes pour les analyses moléculaires sur le xylème âgé*

Très peu de données sur l'expression des gènes durant la formation du bois de cœur ont été publiées jusqu'à ce jour [Hauch et Magel, 1998]. Les problèmes techniques rencontrés pour la purification des ARN à partir du xylème très âgé ont probablement limité les analyses moléculaires dans ce domaine. Nous présentons, pour la première fois, une vaste étude d'expression des gènes dans le xylème de *Juglans nigra*, effectuée par des techniques différentes incluant northern blot, dot blot et RT-PCR. La qualité et la reproductibilité des résultats obtenus démontrent qu'il est possible de purifier des ARN pour conduire des analyses moléculaires de qualité à partir du xylème secondaire âgé. Les protocoles développés pour analyser les ARN dans le cadre de cette thèse représentent une véritable percée technique et ouvrent des nouvelles perspectives d'étude sur la formation du bois de cœur. La poursuite de ce travail devrait notamment inclure la construction de banques d'ADNc à partir du xylème âgé et plus particulièrement de la zone de transition. Ces banques d'ADNc permettront d'identifier des gènes impliqués dans le contrôle des processus physiologiques liés au vieillissement du xylème et à la formation du bois de cœur.

• *Régulation du métabolisme des flavonoïdes dans le xylème secondaire*

L'hypothèse de départ de ce travail de thèse est que la forte accumulation de flavanols observée dans la zone de transition du *Juglans nigra* est due à une biosynthèse active *in situ*. Des résultats précédents ont montré que l'accumulation des flavonoïdes dans la zone de transition de *Robinia pseudoacacia* était spatialement et temporellement concomitante à l'augmentation des activités catalytiques des enzymes

PAL et CHS [Magel, 2000]. Ces dernières données soutiennent fortement l'hypothèse de biosynthèse *in situ*. Néanmoins, il restait à déterminer si l'activation du métabolisme phénolique pendant la formation du bois de cœur dépendait de l'expression des gènes codant les enzymes correspondantes. Nos résultats démontrent clairement une étroite corrélation entre l'accumulation des flavanols dans le xylème âgé et l'expression des gènes structuraux codant les enzymes de la voie de biosynthèse des flavonoïdes. Ce type de corrélation a déjà été observé chez les plantes herbacées pour lesquelles la biosynthèse des flavonoïdes a été très étudiée [Koes *et al.*, 1994; Shirley, 1996]. Nos résultats confirment que des mécanismes moléculaires similaires sont impliqués dans le contrôle de la biosynthèse des flavonoïdes au niveau des tissus xylémiens chez le noyer. Deux principaux aspects concernant l'accumulation des flavanols dans le xylème secondaire peuvent être soulignés. Le premier concerne la régulation à long terme liée au développement de l'arbre : la biosynthèse des flavanols augmente nettement avec le vieillissement du xylème et plus spécialement dans la zone de transition pendant la transformation de l'aubier en bois de cœur. Le second concerne la régulation métabolique de la biosynthèse des flavonoïdes qui est vraisemblablement contrôlé au niveau transcriptionnel. Des dosages d'activités enzymatiques restent toutefois nécessaires pour préciser encore le niveau de régulation de la biosynthèse des flavonoïdes qui se situerait au niveau de la synthèse des ARN et/ou au niveau des protéines elles-mêmes (activation, inhibition et dégradation).

Les travaux de recherche dans ce domaine pourraient se développer dans deux directions comprenant l'étude des gènes structuraux ou des gènes régulateurs. L'expression de certains gènes structuraux dans la zone de transition suggère que des gènes codant des isoformes particulières pourraient être exprimés pendant la formation du bois de cœur. Nous avons déjà pu observer l'expression spécifique de différents gènes *CHS* dans différentes parties du bois de *Juglans nigra*. La technique de PCR-RFLP (Figure 33-vf), précédemment utilisée par El-Euch [1997] pour étudier l'expression des gènes *CHS* dans les microboutures de *Juglans regia*, a été mise en œuvre sur les échantillons de xylème de *Juglans nigra* récoltés en juillet 1997 [Beritognolo *et al.*, 1999]. Les premiers résultats obtenus (Figure 34-vf) montrent qu'une séquence de *CHS*, parmi celles représentées dans le génome de *Juglans nigra*, n'est pas exprimée dans le xylème. Au moins deux différentes séquences de *CHS* sont exprimées dans le xylème mais aucune différence n'a été détectée entre le xylème différencié, l'aubier et la zone de transition. Cette technique s'est avérée être d'une bonne efficacité pour détecter l'expression de différentes séquences de *CHS*. Ce type d'analyse pourrait être appliqué à d'autres échantillons d'arbres abattus à différentes saisons. De plus, les informations de séquence acquises à partir des fragments d'ADNc clonés pourraient être utiles pour étendre les analyses par PCR-RFLP aux autres gènes candidats étudiés dans cette thèse. L'identification de gènes exprimés spécifiquement dans la zone de transition permettrait par la suite de cloner leurs promoteurs.

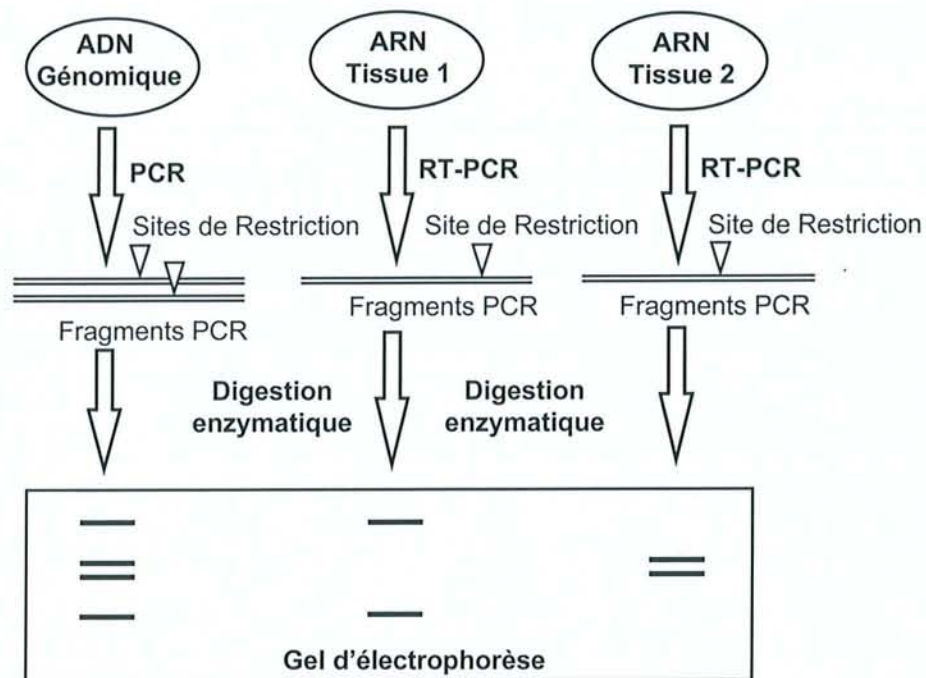

Figure 33-vf. Principe de la technique de PCR-RFLP. Les séquences de gènes présentes dans l'ADN génomique ou dans les populations d'ADNc (gènes exprimés) sont amplifiées par PCR puis coupées par des endonucléases de restriction. Les variations des sites de restriction permettent de mettre en évidence les différences de séquence entre gènes.

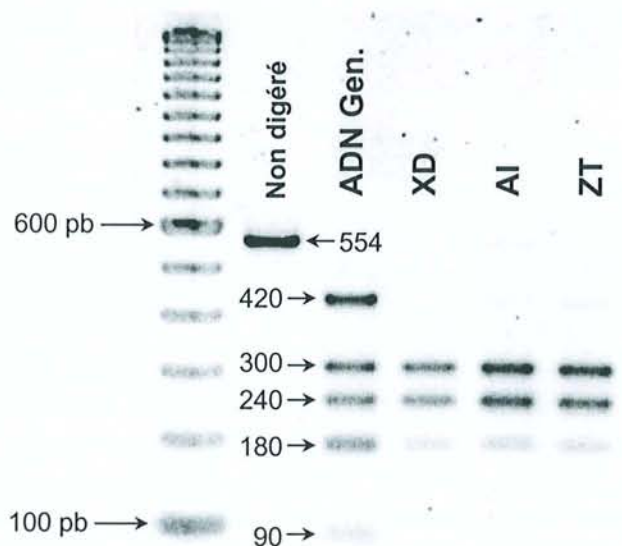

Figure 34-vf. Analyses par PCR-RFLP des séquences de *CHS* exprimées dans les échantillons de xylème collectés sur un arbre *Juglans nigra* âgé de 23 ans en juillet 1997. L'ADN génomique et les ARNm ont été isolés à partir d'échantillons de xylème et utilisés pour amplifier par PCR et RT-PCR un fragment interne de 554 pb des séquences codantes des gènes *CHS*. Les fragments amplifiés ont été digérés avec *Tha* I puis séparés par électrophorèse sur gel d'agarose à 2% dans un tampon 0.5xTBE à 4V/cm. Les échantillons analysés sont décrits dans la figure 12. **ADN Gen.:** ADN génomique; **XD:** xylème en différenciation; **AI:** Aubier interne; **ZT:** Zone de transition.

Les schémas de restriction obtenus à partir des ADNc révèlent moins de fragments que ceux issus d'ADN génomique indiquant qu'au moins une séquence *CHS* n'est pas exprimée dans le xylème. La présence de trois principaux fragments de 300, 240, and 180 pb montre qu'au moins deux différentes séquences de *CHS* sont exprimées dans le xylème. Aucune différence n'a été observée entre les séquences *CHS* exprimées dans le xylème en différenciation, l'aubier interne et la zone de transition.

La transcription des gènes structuraux est seulement une étape de la régulation de la voie de biosynthèse des flavonoïdes. Ce travail de recherche n'a pas pris en compte les gènes régulateurs du métabolisme des flavonoïdes. Ces gènes codent des facteurs de transcription qui contrôlent l'expression des gènes structuraux. Alors que la transcription des gènes structuraux permet la production des enzymes catalysant les réactions biochimiques, l'activité des gènes régulateurs détermine quant à elle le site, le période, et l'intensité de synthèse des flavonoïdes. Le rôle de ces gènes régulateurs est bien connu chez différentes espèces de plantes herbacées telles que *Petunia hybrida*, *Antirrhinum majus* et *Zea mays* [revues: Dooner *et al.*, 1991; Mol *et al.*, 1996; Weissbar et Jenkins, 1998]. Les gènes régulateurs identifiés chez ces espèces appartiennent à trois classes de facteurs de transcription: bZIP, bHLH et MYB. L'utilité de ces gènes régulateurs pour moduler la production de flavonoïdes a été démontrée chez *Zea mays*. La production de différentes classes de flavonoïdes a été obtenue à partir de culture cellulaire de *Zea mays* transformées pour exprimer différents facteurs de transcription fusionnés à des promoteurs inductibles [Bruce *et al.*, 2000; Grotewold *et al.*, 1998]. Chez cette même espèce, des variations alléliques au niveau des gènes régulateurs sont responsables des variations quantitatives observées au niveau des quantités de flavonoïdes accumulées. Grâce à des marqueurs RFLP correspondant à de nombreux gènes structuraux et régulateurs du métabolisme des flavonoïdes, Byrne *et al.* [1996] ont démontré que deux gènes régulateurs correspondaient à des QTLs contrôlant les quantités de maysin (C-glycosyl flavone) s'accumulant au niveau des soies chez *Zea mays*. Il est vraisemblable que des mécanismes de régulation voisins se retrouvent chez les arbres. Les connaissances acquises chez les plantes herbacées constituent une bonne base pour caractériser les gènes régulateurs contrôlant la biosynthèse des flavanols dans les tissus xylémiens. Le rôle des facteurs de transcription de type MYB dans la régulation de la biosynthèse des flavonoïdes a été montré chez *Zea mays*, *Antirrhinum majus* et *Petunia hybrida* [Dooner and Robbins, 1991; Holton et Cornish, 1995; Martin, 1997; Mol *et al.*, 1998; Quattrocchio *et al.*, 1998]. De plus, des gènes orthologues de la famille *MYB* ont été clonés à partir de xylème secondaire différencié chez *Pinus taeda* [Newman et Campbell, 2000]. Les protéines MYB peuvent être considérées comme de bonnes candidates pour réguler l'expression des gènes impliqués dans la synthèse des flavanoïdes dans l'aubier des arbres. C'est très certainement un voie de recherche prometteuse qui permettra de mieux aborder les mécanismes génétiques contrôlant la qualité du bois. A plus long terme, il sera possible d'utiliser chez les arbres ces gènes régulateurs dans le cadre de programme de recherche incluant la transformation génétique et la sélection assistée par marqueurs.

- **Formation du bois de cœur chez le noyer.**

Une autre retombée de cette thèse est une meilleure compréhension du vieillissement du xylème et de la formation du bois de cœur. Cinq arbres *Juglans nigra*, récoltés à différentes saisons, ont montré un comportement homogène concernant la formation du bois de cœur et l'accumulation de composés phénoliques solubles. Cette homogénéité indique que les processus physiologiques liés à la formation du bois de cœur sont bien conservés chez les différents arbres étudiés. Les variations saisonnières, observées

au niveau des différents paramètres physiques, biochimiques et moléculaires, suggèrent que la formation du bois de cœur est un processus cyclique régulé au cours des saisons et probablement lié à la phénologie de l'arbre. Il semble que l'expansion du bois de cœur a lieu principalement pendant l'été et l'automne. Des modifications saisonnières ont aussi été observées au niveau des teneurs en composés phénoliques solubles dans le xylème et au niveau des patrons d'expression des gènes codant les enzymes du métabolisme des flavonoïdes. D'une part, les plus fortes teneurs en composés phénoliques solubles ont été observées pendant l'été. D'autre part, une forte expression des gènes codant les enzymes du métabolisme des flavonoïdes a été mise en évidence dans la zone de transition pendant l'automne et l'hiver. Ce décalage dans le temps est très intéressant pour comprendre les mécanismes déclenchant et régulant la biosynthèse des flavanols. Une meilleure connaissance de ces mécanismes nécessitera l'analyse simultanée des teneurs en flavanols, de la quantité de transcrits, d'enzymes et des niveaux de leurs activités. Pour étudier la régulation saisonnière de la formation du bois de cœur et l'accumulation de composés phénoliques solubles, il sera nécessaire d'analyser des carottes de xylème prélevées périodiquement sur un même arbre et sur plusieurs arbres à une date donnée.

Les données expérimentales présentées dans ce travail, acquises par des approches moléculaires, biochimiques et physiques, permettent de proposer une description intégrée des différentes étapes du vieillissement du xylème et plus spécialement de l'étape finale conduisant à la transformation en bois de cœur. La caractérisation de la zone de transition basée sur différents critères est pertinente. Des variations marquées et simultanées de la fluorescence, de la teneur en eau et en flavonoïdes, ainsi que des quantités de transcrits, observées dans la zone de transition, indiquent que les processus physiologiques conduisant à la formation du bois de cœur sont spécifiquement localisés dans cette étroite région xylémienne. L'ensemble de ces résultats confirme l'importance du xylème secondaire en tant que modèle biologique pour étudier les processus de vieillissement sur le long terme chez les arbres. A un temps donné, les cernes composant une rondelle de bois peuvent être considérés comme une structure ordonnée et représentative des différentes étapes du vieillissement du xylème. Les variations des paramètres physiologiques observées à un temps donné entre le xylème en différenciation et le bois de cœur forment donc un système dynamique du vieillissement xylémien couvrant de nombreuses années. Dans un tel modèle, l'état physiologique du xylème en différenciation et de la zone de transition zone fournissent des repères temporeux précis permettant de comparer les échantillons entre différents arbres.

Higuchi [1997] a été le premier à proposer un modèle décrivant la formation du bois de cœur en trois principales étapes comme indiqué ci-dessous. Il a postulé qu'une expression spécifique de gènes pourrait conduire à une synthèse *in situ* des composés phénoliques solubles. Nos résultats confirment clairement l'hypothèse d'Higuchi sur l'activation des gènes codant les enzymes du métabolisme des phenylpropanoïdes (PAL, C4H et 4CL) et des flavonoïdes (CHS, F3H et DFR).

Les étapes de la formation du bois de cœur [Higuchi, 1997]

Aubier parenchyme radial >>>	Zone de transition parenchyme radial >>>	Bois de cœur parenchyme radial
Inducteurs: éthylène, blessure, etc.	Activation des gènes codant les enzymes du métabolisme général des phenylpropanoïdes et synthèse des extractibles du bois de cœur (PAL, 4CL, CHS, CHI, etc.)	Accumulation des extractibles Autolyse

En tenant compte des premières données sur la formation du bois de cœur [Hillis, 1987; Higuchi, 1997] et des résultats récents obtenus au niveau biochimique et moléculaire chez *Juglans* spp [Burtin et al., 1998; Label et al., 2000] et *Robinia pseudoacacia* [Magel, 2000], nous proposons un nouveau schéma pour décrire les principaux processus physiologiques conduisant au vieillissement du xylème et à la formation du bois de cœur (Figure 35-vf). Le vieillissement du xylème secondaire démarre dans l'aubier externe, qui possède un rôle de stockage et de transport de l'eau et des nutriments. Les cellules parenchymateuses présentes dans l'aubier externe sont riches en amidon qui est la principale source de réserves carbonées stockées dans le xylème. Au contraire, les teneurs en composés phénoliques mesurées dans l'aubier externe sont les plus faibles. Lors du vieillissement des cernes d'aubier, les capacités de synthèse d'amidon dépendant de l'activité de l'ADP-glucose pyrophosphorylase diminuent alors que la dégradation de l'amidon augmente. En conséquence, les teneurs en amidon décroissent dans l'aubier interne pour disparaître dans la zone de transition. Corrélativement à la disparition de l'amidon, l'accumulation de composés phénoliques débute dans l'aubier interne pour être encore plus marquée dans la zone de transition. Ces composés phénoliques sont les précurseurs des extractibles du bois de cœur. Ils s'accumulent au niveau des cellules parenchymateuses de la zone de transition dans les vacuoles qui s'agrandissent jusqu'à remplir le lumen. L'accumulation de ces composés phénoliques est le résultat d'une synthèse *de novo* démontrée chez *Robinia pseudoacacia* et *Juglans nigra* par la corrélation entre des fortes activités enzymatiques catalysant ces réactions de biosynthèse (CHS) et les teneurs en flavonoïdes. L'augmentation de ces activités enzymatiques est principalement régulée au niveau transcriptionne, comme nous l'avons montré dans ce travail.

Les apports en énergie et en carbone nécessaires pour la synthèse des composés phénoliques proviennent de la dégradation des sucres. La diminution de la teneur en amidon, qui est concomitante à l'augmentation des teneurs en composés phénoliques, indique que l'amidon est mobilisé pour la synthèse des phénols lors du vieillissement de l'aubier. Cependant, l'hydrolyse de l'amidon présente dans l'aubier pourrait ne pas être suffisante pour fournir le carbone utilisé dans cette synthèse.

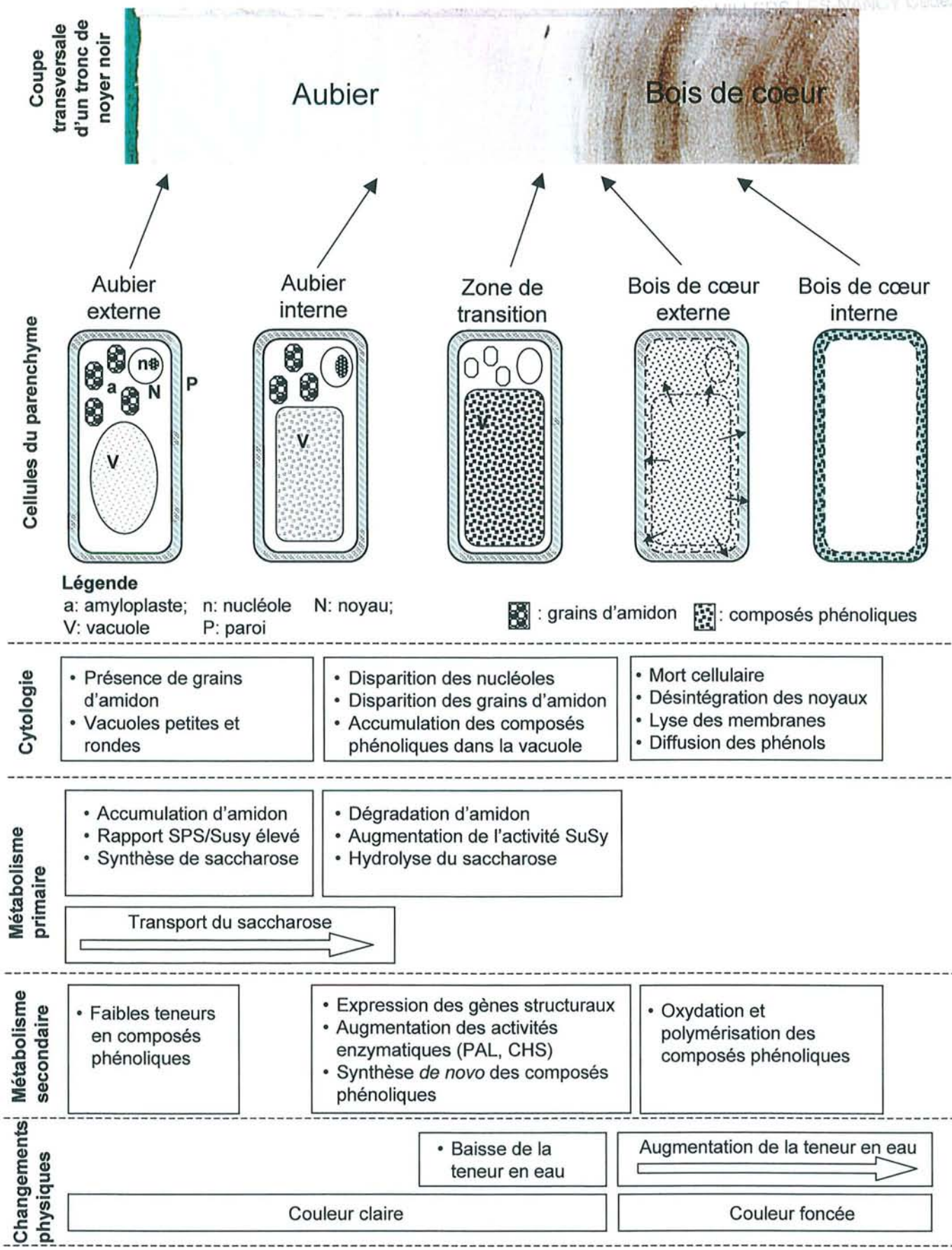

Figure 35-vf. Représentation simplifiée des changements physiologiques ayant lieu dans le xylème secondaire des espèces feuillues pendant les principales phases du vieillissement du xylème et de la formation du bois de cœur.
 SPS: saccharose-phosphate synthase; SuSy: saccharose synthase;
 PAL: phenylalanine ammonia-lyase; CHS: chalcone synthase

De ce fait, la synthèse des composés phénoliques pourrait être dépendante d'un apport de carbone qui migrerait via le phloème vers l'aubier externe puis vers l'aubier interne. Le saccharose est activement transporté de l'aubier externe vers la zone de transition pour être utilisé comme source de carbone pour la synthèse des composés phénoliques. Une forte activité de la sucrose-phosphate synthase (SPS) dans l'aubier externe est responsable de la synthèse de saccharose, alors qu'une forte activité sucrose synthase (SuSy) agit comme un puits dans la zone transition, fournissant les sucres solubles pour la biosynthèse des phénols. Une forte corrélation entre l'augmentation des activités SuSy et l'expression des gènes correspondant est observée dans la zone de transition indiquant que la dégradation du saccharose est contrôlée principalement au niveau transcriptionnel.

La dernière étape du vieillissement du xylème correspond à la mort des dernières cellules parenchymateuses vivantes. Une fois intégrées dans la zone de transition, les cellules parenchymateuses présentent une activité métabolique forte, mais transitoire, révélée par l'augmentation du volume des nucléoles et la diminution du diamètre des noyaux. Dans la partie interne de la zone de transition, la disparition des nucléoles est suivie par une dégradation progressive suivie d'une désintégration des noyaux. Par la suite, les cellules se lysent et leurs membranes se désintègrent. Ces événements marquent la transformation définitive de l'aubier en bois de cœur. Les composés phénoliques accumulés dans la vacuole sont alors relargués dans le lumen et pour partie se lient à la matrice pariétale. Les différents composés phénoliques, jusqu'alors compartimentés au sein des cellules, se retrouvent exposés à l'action des oxydases (peroxydases et phénoloxydases) conduisant à des processus d'oxydation et de polymérisation. Ces réactions sont catalysées partiellement par ces enzymes, mais peuvent être aussi issues de réactions chimiques spontanées liées à la présence de radicaux libres. Les produits de ces réactions correspondent à des macromolécules de nature polyphénolique ayant des structures chimiques complexes. Ces composés oxydés et polymérisés sont généralement de couleur plus foncée que leurs précurseurs et expliquent les différences de couleur importantes entre l'aubier et le bois de cœur.

Le modèle présenté ci-dessus résulte d'études quantitatives menées sur les métabolismes primaire et secondaire impliqués dans la formation des extractibles. Des analyses conduites aux niveaux tissulaire et cellulaire par l'intermédiaire des techniques d'histolocalisation des transcrits, des protéines et des métabolites (flavonoïdes) permettrait de préciser les informations obtenues à ce jour et de mieux comprendre l'ensemble des mécanismes cellulaires impliqués dans la formation du bois de cœur. Des travaux antérieurs ont déjà permis de localiser des polyphénols dans l'aubier et le bois de cœur chez *Juglans* spp [Burtin, 1999]. Ces observations montrent que les extractibles étaient principalement localisés dans les cellules parenchymateuses radiales au niveau de l'aubier alors que dans le bois de cœur ils sont présents à la fois dans les cellules parenchymateuses axiales et radiales. A l'aide de coupes observées en microscopie optique, effectuées au niveau de la zone de transition à certaines périodes clés de la formation du bois de cœur, il serait intéressant de relier l'accumulation des transcrits par hybridation *in situ* à celle des flavanols par histochimie. Cette approche permettrait de préciser la régulation transcriptionnelle de la synthèse des flavanols que nous avons mise en évidence au cours de cette thèse.

La plupart des données expérimentales concernant la physiologie de la formation du bois de cœur a été obtenue à partir d'analyses des composés phénoliques solubles. De nouvelles études seraient nécessaires pour comprendre d'une façon plus approfondie les mécanismes physiologiques fondamentaux régulant la formation du bois de cœur. Les outils de la génomique fonctionnelle semblent aujourd'hui très prometteurs pour découvrir les gènes et les protéines impliqués dans la formation du bois de cœur. La construction de banques d'ADNc à partir des tissus de la zone de transition chez *Robinia pseudoacacia* a été récemment réalisée afin d'obtenir des ESTs de gènes préférentiellement exprimés pendant la formation du bois de cœur [Han *et al.*, 2000]. Les méthodes développées dans cette thèse démontrent clairement la faisabilité d'une telle approche pour étudier d'une manière plus complète la duraminisation chez *Juglans* spp.. Basé sur les résultats de la thèse, un nouvel échantillonnage de xylème de *Juglans nigra* a été récemment effectué par le laboratoire de l'INRA d'Orléans afin de construire plusieurs banques d'ADNc de tissus xylémiens impliqués dans la formation du bois de cœur [C. Breton, comm. pers.].

Methods

7. Methods

7.1 Isolation of mRNA I. Extraction with Dynal Lysis Binding buffer

This procedure was adapted from the protocol proposed by the Dynabeads (Dynal) technical handbook for the plant tissues. Due to the high phenolic content of walnut tissues, the composition of the extraction buffer has been modified by adding PVPP, sodium metabisulphite, and cysteine. A purification step with phenol:chlorophorm:IAA has been performed on the cell lysate prior the Dynabeads purification

Lysis Binding buffer

- 100 mM TRIS-HCl, pH 8.0
- 500 mM LiCl
- 10 mM EDTA
- 1% Lithium dodecyl sulphate (LiDS)
- 11 mM DTT (freshly added just before use)
- 11 mM Sodium metabisulphite (freshly added just before use)
- 20 mM Cysteine (freshly added just before use)

Protocol

1. Homogenise the sample into powder. Lyophilised samples can be homogenised at room temperature. Fresh or frozen samples must be homogenised in liquid nitrogen.
2. Add an amount of PVPP equal to the weight of the sample.
3. Suspend thoroughly the homogenised sample in the Lysis Binding buffer (LB) (7.5 ml / g fresh weight) in a polypropilene centrifuge tube.
4. Add 1 volume of phenol:chlorophorm:isoamyl alcohol (IAA) (25:24:1) equilibrated at pH 4.3 and mix the two phases by inverting the tube several times.
5. Centrifuge at 10,000 g for 10 minutes at 4°C and recover the clear aqueous phase (upper phase) in a new tube.
6. Add 1 volume of chlorophorm:IAA (24:1), mix the two phases by inverting the tube several times.
7. Centrifuge at 10,000 g for 5 minutes at room temperature and recover the clear aqueous phase in a new tube. The raw extract is now ready of the purification of mRNA by Dynabeads.

7.2 Isolation of mRNA II. Extraction with modified Urea buffer

This procedure was originally designed to purify mRNA directly from small amounts of animal tissues using the Dynabeads system [Hengerer, 1993]. The extraction buffer is based on HEPES (4-(2-hydroxyethyl)-1-piperazineethane-sulfonic acid) and is characterised by a high molarity (4M) of UREA and presence of proteinase K, as enzyme inhibitor and protein degrading agent, respectively. After homogenisation of the sample, the lysis is performed at 56°C. This temperature ensures that all nucleases are inactive, while proteinase K is still active and digests the proteins present in the homogenate.

The extraction buffer has been modified as follows. NaCl has been replaced by LiCl, SDS has been replaced by LiDS. Sodium metabisulphite and PVPP have been added. A purification step with phenol:chlorophorm:IAA has been performed on the cell lysate prior the Dynabeads purification.

Extraction buffer (Urea buffer)

- 4M Urea
- 100 mM HEPES-HCl pH 7.5
- 180 mM LiCl
- 10 mM EDTA
- 1% LiDS
- 11 mM DTT (freshly added just before use)
- 11 mM Sodium metabisulphite (freshly added just before use)
- 8 U/ml Proteinase K (freshly added just before use)

Protocol

1. Homogenise the sample into powder. Lyophilised samples can be homogenised at room temperature. Fresh or frozen samples must be homogenised in liquid nitrogen.
2. Add an amount of PVPP equal to the weight of the sample.
3. Suspend thoroughly the homogenised sample in the Urea buffer (UB) (7.5 ml / g fresh weight) pre-warmed at in a polypropylene centrifuge tube.
4. Incubate at 56°C for 30 minutes.
5. Add 6.5 % (vol./vol.) of 5M LiCl to increase LiCl concentration to 500 mM, (necessary for the binding of mRNA to the Dynabeads).
6. Add 1 volume of phenol:chlorophorm:isoamyl alcohol (IAA) (25:24:1) equilibrated at pH 4.3 and mix the two phases by inverting the tube several times
7. Centrifuge at 10,000 g for 10 minutes at 4°C and recover the clear aqueous phase (upper phase) in a new tube.
8. Add 1 volume of chlorophorm:IAA (24:1), mix the two phases by inverting the tube several times.
9. Centrifuge at 10,000 g for 5 minutes at room temperature and recover the clear aqueous phase in a new tube. This raw extract is now ready for the purification of mRNA by Dynabeads.

Remark

For extraction from big amounts of sample (as is the case for aged sapwood) the volume of the raw extract is reduced by selective precipitation of RNA with 2M LiCl. After the step 9, one fourth volume of 10 M LiCl is added to the raw extract. Total RNA is then selectively precipitated overnight on ice and recovered by centrifugation at 13,000 g for 30 minutes at 4°C. The pellet is then resuspended in the extraction buffer (LB or Urea buffer with LiCl 500 mM) and is ready for the purification by Dynabeads.

7.3 Purification of mRNA from cell lysate by Oligo d(T) Dynabeads

1X Washing Buffer

- 10 mM TRIS-HCl, pH 7.5
- 150 mM LiCl
- 1 mM EDTA

Protocol

a) Preliminary conditioning of Dynabeads

1. Resuspend the Dynabeads (Dyna) thoroughly before use
2. Transfer the needed amount of Dynabeads (1,5 μ l / mg fresh weight) to a new 1.5 ml microcentrifuge tube placed in the Dynal Magnetic Particle Concentrator (Dyna MPC).
3. Allow the Dynabeads to separate during 30 seconds and then remove the supernatant
4. Prewash the Dynabeads twice with 150 μ l of the extraction buffer used (LB buffer or Urea buffer) using the Dynal MPC.
5. Resuspend the Dynabeads in 100 μ l of extraction buffer.

Remark

When using the Urea extraction buffer, the Dynabeads must be conditioned with a buffer containing LiCl 500 mM.

b) Purification of mRNA

1. Add the raw extract from cell lysate to the Dynabeads. Mix gently and thoroughly.
2. Incubate at room temperature for 5 minutes and then on ice for 5 minutes. During this step, the Dynabeads anneal to the poly(A)⁺ RNA.
3. Place the tube in the Dynal MPC on ice for 2 minutes and remove the supernatant.
4. Wash the Dynabeads 3 times with 0.5 ml of Washing Buffer (WB) on ice using the Dynal MPC. Remove completely the WB after the final washing step.
5. To elute the mRNA, resuspend the Dynabeads in 10 to 30 μ l of RNase free water, heat at 65°C for 2 minutes and place the tube immediately in the Dynal MPC. When the Dynabeads are separated, remove the eluted mRNA in a new tube.
6. Repeat the previous step to improve the quantitative recovery of mRNA.

7.4 Purification of mRNA from total RNA by Oligo d(T) Dynabeads

2X Binding Buffer

- 20 mM TRIS-HCl, pH 7.5
- 1 M LiCl
- 2 mM EDTA

1X Washing Buffer

- 10 mM TRIS-HCl, pH 7.5
- 150 mM LiCl
- 1 mM EDTA

Protocol

a) Conditioning of Dynabeads

1. Resuspend the Dynabeads thoroughly before use
2. Transfer the needed amount of Dynabeads (3.4 μ l Dynabeads / μ g total RNA) to a new 1.5 ml microcentrifuge tube placed in the Dynal Magnetic Particle Concentrator (Dynal MPC).
3. Allow the Dynabeads to separate during 30 seconds and then remove the supernatant
4. Remove the tube from the Dynal MPC and prewash the Dynabeads two times with 100 μ l of 2X Binding Buffer. For each washing step resuspend the Dynabeads in the 2X Binding Buffer and remove the supernatant with the aid of the Dynal MPC.
5. Resuspend the Dynabeads in 100 μ l of 2X Binding Buffer.

b) Purification of mRNA

1. Adjust the volume of total RNA to 100 μ l with RNase free water
2. Heat at 65°C for 2 minutes to disrupt any secondary structure.
3. Add the total RNA to the Dynabeads suspension and mix gently and thoroughly.
4. Incubate at room temperature for 5 minute and then on ice for 5 minutes. During this step the Dynabeads anneal with the poly(A)⁺ RNA.
5. Place the tube in the Dynal MPC on ice for 2 minutes and remove the supernatant.
6. Wash the Dynabeads 3 times with 0.5 ml of Washing Buffer (WB) on ice using the Dynal MPC. Remove completely the WB after the final washing step.
7. To elute the mRNA resuspend the Dynabeads in 10 to 30 μ l of RNase free water, heat at 65°C for 2 minutes and place the tube immediately in the Dynal MPC. When the Dynabeads are separated, remove the eluted mRNA in a new tube.
8. Repeat the previous step to improve the quantitative recovery of mRNA.

7.5 Extraction of total RNA

The procedure described here was published by Chang *et al.* [1993]. It has been slightly modified in order to improve the recovery of low amounts of RNA from big amounts of wood sample.

Extraction Buffer

- 2% CTAB (hexadecyltrimethylammonium bromide)
- 2% PVP 40,000 (polyvinylpyrrolidone)
- 100 mM TRIS-HCl pH 8.0
- 25 mM EDTA
- 2 M NaCl
- 0.5 g/l spermidine (freshly added just before use)
- 2% (vol/vol) β -mercaptoethanol (freshly added just before use)

Solve the components of the buffer (except spermidine and β -mercaptoethanol) in RNase free water. Adjust the pH to 8.0 and fix the final volume. Sterilise at 120°C for 21 minutes. Spermidine is prepared as 100x solution (50 g/l) in RNase free water, then aliquoted and stored at -20°C until use.

SSTE

- 1 M NaCl
- 0.5 % SDS
- 10 mM TRIS-HCl pH 8.0
- 1 mM EDTA

Protocol

1. Homogenise the sample to powder. Lyophilised samples can be homogenised at room temperature. Fresh or frozen samples must be homogenised in liquid nitrogen.
2. Add 5ml / g sample (FW) of prewarmed (65°C) extraction buffer and mix thoroughly.
3. Incubate at 65°C for 10 minutes
4. Extract two times with an equal volume of chlorophorm:IAA (24:1). Mix thoroughly by inverting several times. Centrifuge at 5000 g for 10 minutes at room temperature and recover the aqueous phase.
5. Add ¼ volume of ice cold 10M LiCl and mix. The RNA is selectively precipitated overnight on ice. For samples giving very low RNA yield (i.e. transition zone), the extension of this precipitation step to 36-48 hours improve RNA recovery.
6. Centrifuge at 13,000 g for 30 minutes at 4°C and discard the supernatant.
7. Resuspend the pellet in 750 μ l of SSTE and transfer in a 1.5 ml microcentrifuge tube.
8. Extract two times with an equal volume of chlorophorm:IAA as described in step 4.

9. Add 2 volumes of ice-cold ethanol or 0.6 volumes of ice-cold isopropanol and mix gently by inverting the tube. Nucleic acids are then precipitated at -20°C for 2 hours. For samples containing very low RNA amount (i.e. from the transition zone) the recovery efficiency can be improved by adding one μg of glycogen, as carrier, before alcohol precipitation.
10. Centrifuge at 13,000 g for 20' at 4°C to recover the precipitated RNA. Discard the supernatant and wash the pellet with 400 μl of 70% ethanol.
11. Centrifuge at 13,000 g for 10' at 4° . Discard the supernatant, dry the RNA pellet and resuspend it in RNase free water.

7.6 cDNA synthesis

This protocol is designed to reverse transcribe 1 µg of mRNA or 1 to 50 µg of total RNA into first strand cDNA. The reaction volume is 41 µl and can be scaled up or down.

RT mix

- RT buffer (Gibco BRL) 8 µl
- DTT (100 mM) 4 µl
- dNTP (10 mM) 2 µl
- RNase inhibitor (Pharmacia 40 U/µl) 1 µl
- Bovine Serum Albumin (5 µg/µl) 1 µl

Protocol

1. Mix RNA or mRNA template, resuspended in 20 µl water, with 4 µl of Oligo d(T)₁₂₋₁₈ primer (100 µg/ml).
2. Denature at 70°C for 10 minutes, and then chill on ice for 5 minutes.
3. Add the RT mix (16 µl) and incubate at 42°C for 2 minutes. Oligo d(T) primers anneal to the poly(A)⁺ tail of mRNA.
4. Add 1 µl of Reverse Transcriptase enzyme (M-MLV or Superscript, Gibco BRL, 200 U/µl).
5. Incubate at 42°C for 1 to 2 hours.

7.7 Reverse Transcriptase - Polymerase Chain Reaction (RT-PCR)

In RT-PCR analyses, a volume of cDNA equivalent to 50 ng of total RNA was routinely used as template in PCR reaction of 25 μ l volume. For RT-PCR cloning, the PCR reactions were carried out in a volume of 50 μ l.

PCR mix

- PCR buffer (10X) 2.5 μ l
- MgCl₂ (25 mM) 2 μ l
- dNTP (10 mM) 0.5 μ l
- Primer forward (10 μ M) 2.5 μ l
- Primer reverse (10 μ M) 2.5 μ l
- Taq DNA Polymerase (5 U/ μ l) 0.1 μ l (Promega or Pharmacia)
- cDNA template 1-4 μ l
- Water up to 25 μ l

Thermal programme

- Prewarming, **30 sec.** at **80°C**
- Initial denaturation, **4 min.** at **94°C**. PCR tubes are placed in the thermocycler when the temperature has reached 94°C.
- Amplification, **30 cycles** of: **45 sec.** at **94°C**, **1 min.** at **50°C** (annealing), **45 sec.** to **1 min. 45 sec.** at **72°C**. The annealing temperature is adjusted according to the melting temperature of the primers. The temperature of 50°C is appropriate for the primers used in this study. The duration of the step at 72°C (DNA synthesis) depends on the length of amplified sequences and is calculated as 1 minute / 800 bases of length.
- Final extension, **7 min.** at **72°C**.

7.8 3' RACE

First PCR

PCR mix (reaction volume 50 µl)

- PCR buffer (10X) 5 µl
- MgCl₂ (25 mM) 4 µl
- dNTP (10 mM) 1 µl
- Gene specific Primary primer (10 µM) 5 µl
- Oligo d(T) primer (10 µM) 2.5 µl
- Taq DNA Polymerase (5 U/µl) 0.5 µl (JumpStart, Sigma. For hot-start PCR)
- Template: first strand cDNA 2 µl (equivalent to 100 ng of total RNA)
- Water up to 50 µl

Thermal programme (Touch down)

The “touch down” programme consists of a progressive reduction of the annealing temperature to increase the specificity of primer fixation.

- Prewarming **30 sec.** at **80°C**
- Initial denaturation **4 min.** at **94°C**.
- First amplification, **5 cycles** of: **30 sec.** at **94°C**, **1 min.** at **65°C**, **1 min. 30 sec.** at **72°C**. The duration of the step at 72°C (DNA synthesis) depends on the length of the amplified sequence and is calculated as 1 minute / 800 bases of length.
- Second amplification, **10 cycles** of: **30 sec.** at **94°C**, **1 min.** at **60°C**, **1 min. 30 sec.** at **72°C**.
- Third amplification, **15 cycles** of: **30 sec.** at **94°C**, **1 min.** at **55°C**, **1 min. 30 sec.** at **72°C**.
- Final extension, **7 min.** at **72°C**.

Second PCR (Nested primers)

PCR mix (reaction volume 50 μ l)

- PCR buffer (10X) 5 μ l
- MgCl₂ (25 mM) 4 μ l
- dNTP (10 mM) 1 μ l
- Nested primer (10 μ M) 5 μ l
- Oligo d(T)-Zap primer (10 μ M) 2.5 μ l
- Taq DNA Polymerase (5 U/ μ l) 0.5 μ l (JumpStart, Sigma. For hot-start PCR)
- Template: product of the first PCR 1 μ l

Thermal programme

- Prewarming 30 sec. at 80°C
- Initial denaturation 4 min. at 94°C.
- Amplification, 30 cycles of: 30 sec. at 94°C, 1 min. at 55°C, 1 min. 30 sec. at 72°C.
- Final extension, 7 min. at 72°C.

7.9 Primers used for RT-PCR reactions

For *CHS* genes, the primers were prepared according to sequence published by El Euch *et al.* [1998]. No homologous sequences were available for the other candidate genes, therefore the sequences known in other species were aligned to determine the consensus aminoacids (see also “Sequence alignments” in the “Appendix” section). Degenerate primers were then prepared according to the most conserved aminoacid stretches. The list of the candidate genes targeted in this study, with the size of the amplified fragments, and the respective sequences of the primers giving positive RT-PCR results are given below.

<i>Gene</i>	<i>Fragment size (bp)</i>	<i>Forward Primer</i>	<i>Reverse Primer</i>
PAL	856	5'-GAYGARGTNAARMGNATGGT 3'	5' CCRTCNARDATRTGYTCCAT 3'
C4H	1172	5' AAYTGGYTNCARGTNGGNGAYGA 3'	5' AARTCRTT(I)CCRTTNGCYTCNAC 3'
4CL	707	5' CARCARGTNGAYGGNGARAA 3'	5' ACYTGRAANCCYTTRTAYTT 3'
CHS	553	5' GAATTCATGTAYCARCARGGBTGCTTYGC 3'	5' GCTCTAGACRCAIGCRCTBGACATRTTICC 3'
F3H	815	5' GARGAYGARMGNCCNAARGT 3'	5' GGRTTYTGRAANGTNGCDAT 3'
DFR	321	5' YT(I)AC(I)YT(I)TGGAARGCNGA 3'	5' AARTACATCCANCCNGT NATYTT 3'
60S	360	5' TCCACCGCAGATGAAGGTTG 3'	5'TTCAATCTCTTAGTCAAATA 3'
WC	390	5' GG(I)CAY(I)T(I)AAYCC(I)GC(I)GTNAC 3'	5'GG(I)CCRAA(I)SH(I)CK(I)GC(I)GGRTT 3'

Legend

- **PAL**: phenylalanine ammonia lyase.
- **4CL**: 4-coumarate:CoA ligase.
- **F3H**: flavanone 3-hydroxylase.
- **60S**: ribosomal protein 60S.
- **C4H**: cinnamate 4-hydroxylase.
- **CHS**: chalcone synthase.
- **DFR**: dihydroflavonol 4-reductase.
- **WC**: water channel proteins (aquaporins).

Degenerate code.

K=(G or T), **M**=(A or C), **R**=(A or G), **S**=(G or C), **W**=(A or T), **Y**=(C or T)

B=(not A), **D**=(not C), **H**=(not G), **V**=(not T), **N**=(any), **I**=(inosine)

7.10 Cloning of PCR products

Purification of PCR products from agarose gel

Prior to cloning, the amplified fragments were separated by gel electrophoresis, then eluted from the gel and purified. 25 to 35 μ l of fresh PCR reaction were separated in 1.2% agarose gel in 1X TAE buffer system, at 3V/cm. After staining with ethidium bromide, the amplified fragments to be cloned were cut off the gel using a scalpel under UV light transillumination. Purifications of the amplified fragments from the gel were performed using the Micropure or Ultrafree systems (Amicon) and the ultra filtration concentrator Microcon 50 (Amicon). All the purification steps were carried out at 4°C according to the manufacturer's instructions. The purified PCR products were recovered in 2-4 μ l of TRIS-HCl 10 mM pH 8.0. Half of this volume was used for immediate ligation and cloning.

Cloning into plasmid vectors

The cloning of PCR products was done using the Original TA Cloning Kit (Invitrogen) according to the manufacturer's instructions. This kit utilizes the property of *Taq DNA* polymerase of adding a single deoxyadenosine (A) to the 3' end of the PCR products. The linearized plasmid vector provided in the kit has single 3' deoxythymidine (T) residues complementary to the ends of PCR products. This makes the ligation between the PCR insert and the vector very efficient. After ligation, the cloning vector was used to transform competent *Escherichia coli* cells (strain TOP 10 F' or strain INV α F'). The selection of recombinant clones was performed on LB agar medium [Sambrook *et al.*, 1989] containing kanamycin (50 μ g/ml), X-Gal (5-bromo-4-chloro-3-indolyl- β -D-galactoside) (40 μ l of 40 mg/ml solution for each Petri dish), and IPTG (isopropyl- β -D-thiogalactoside) (40 μ l of 100 mM solution for each Petri dish) colonies. For each cloning reaction, some recombinant colonies were selected and sub cultured to extract bacterial DNA minipreparations (DNA minipreparations). The extraction of bacterial DNA was carried out using the PlasmidPURE Miniprep kit (Sigma, France).

7.11 Northern blotting, dot blotting and hybridisations

Northern blot analyses were carried out using 10 µg of total RNA according to Sambrook *et al.* [1989]. RNAs were separated by electrophoresis on denaturing formaldehyde gel, stained with ethidium bromide, and transferred onto a positively charged nylon membrane (Roche). Dot blot analyses were carried out with 1 µg of total RNA. RNA samples were denatured and dot blotted onto a nylon membrane (Roche) according to manufacturer's instructions. Serial dilutions (0.1-100 pg) of denatured homologous PCR products corresponding to each probe were blotted on the same membrane as a control for hybridisation specificity and probe sensitivity.

Membranes were hybridised with digoxigenin labelled cDNA probes corresponding to the genes studied. A cDNA probe corresponding to a *Juglans regia* gene encoding 60S ribosomal protein was used in northern blot experiments as control for gel loading [Breton, pers. comm.]. A total cDNA complex probe was prepared by non-selective PCR using RNA extracted from differentiating xylem (July 1997 sample) as starting material [Breton *et al.*, 1995]. This probe was used in dot blot experiments to estimate the relative amount of transcripts dotted for each sample. Two independent dot blot analyses were carried on two distinct RNA extracts. The hybridised probes were detected by AP-conjugated antibody and CDPStar™ chemiluminescent substrate (Roche). Probe labelling, hybridisation, and detection were carried out according to manufacturer's instructions. Membrane washings were performed at high stringency conditions (final washings with 0.1X SSC, 0.1% SDS at 65°C).

7.12 Analysis of phenolic compounds

The method used for phenolics analyses was adapted from El Euch *et al.* [1998]. Soluble phenolic compounds were extracted from 20 mg of dry wood powder by 2 ml acetone/water (8:2, v:v) at pH 2.0 containing 0.1 M β -gluconolactone as an inhibitor of β -glucosidases to prevent hydrolysis of glucosides in the organic solvent. The mixture was homogenised by sonication for 30 min and centrifuged at 12000 g for 20 min. One ml of supernatant was removed and dried under vacuum using a Speed-vac system. The dry residue was diluted in 250 μ l of pure methanol and centrifuged (5000 g for 30 sec) before the quantitative analysis of flavanols. All the steps were carried out at 4°C and final extracts were stored at -20°C until analysis. Flavanols were quantified by a specific colorimetric method using 4-dimethylamino-cinnamaldehyde (DMACA) as chemical reagent [Treutter, 1989; Treutter *et al.* 1994]. Fifty μ l of phenolic extract, 930 μ l methanol and 20 μ l DMACA solution (100 mg DMACA in 10 ml H₂SO₄ 1.5 M) were mixed and incubated for 2h at room temperature. The light absorbance at 630 nm was measured spectrophotometrically and the flavanol content was determined from a standard curve based on catechin and expressed in μ mol catechin per gram dry weight (DW).

HPLC analyses were performed according to the following protocol. After centrifugation (5,000 g for 2 min), 30 μ L of the final phenolic extract were separated, characterised and quantified by HPLC (Beckman, Gold system). The chromatographic separations were performed using a column Licrospher 100 RP-18e (5 μ m), 250 x 4 mm, (Merck, Germany) at a flow rate of 1 ml/min with the following linear elution gradient system: 0-16 min: 15-30 % solvent B (methanol:acetonitrile, 1:1, v:v) in solvent A (1% acetic acid); 16-27 min: 30 % B; 27-32 min: 30-100 % B; 32-37 min: 100 % B; 37-40 min: 100-15% B. Phenolic compounds were characterised by their retention time and UV spectra (diode array: 230-430 nm). The presence of flavonoids was verified by co-chromatography of authentic standard (Quercitrin and Myricitrin; Extrasynthese, France). The quantification of the phenolic compounds was performed at 340 nm and 280 nm after determination of the purity of each peak by means of scans performed at the beginning and the end of the peaks.

Appendix

8. Appendix

8.1 Sequences of cDNA clones

The sequences of the cDNA fragments cloned from the differentiating xylem of *Juglans nigra* are presented in this section. The cDNA clones were sequenced on both strands starting from the M13 forward and M13 reverse sequences of the plasmid vector (PCR 2.1, Invitrogen). The sequences obtained were translated into aminoacids to determine the deduced peptide sequences. Except for the clone C4H xyl1, all of the sequences presented here were submitted to the EMBL sequence database and the corresponding accession number is given for each sequence.

8.1.1 Phenylalanine ammonia-lyase. Clone *PAL xyl1*

Sequence of a cDNA fragment encoding PAL cloned by RT-PCR from the differentiating xylem of *Juglans nigra*. EMBL accession number **AJ278454**. The aminoacids stretches corresponding to the PCR primers are underlined.

```

      10      20      30      40      50      60      70
      |      |      |      |      |      |      |
GACGAGGTCAAACGGATGGTGGAGGAGTACCGGAAGCCGGTGGTCCGGCTAGGNGGGGAGACCCTGACCATTTTCGCAG
D E V K R M V E E Y R K P V V R L X G E T L T I S Q

      80      90      100     110     120     130     140     150
      |      |      |      |      |      |      |      |
GTAGCAGCTATTGCAACCCACGACGCTGGGGTCAAGGTGGAGCTTTCCGAGGAAGCTCGAGCCGGCGTCAAGGCCAGC
V A A I A T H D A G V K V E L S E E A R A G V K A S

      160     170     180     190     200     210     220     230
      |      |      |      |      |      |      |      |
AGCGACTGGGTTCATGAACAGCGTCAACAACGGCACCGACAGCTATGGTGTCAACCACCGGTTTCGGTGC AACCTCTCAT
S D W V M N S V N N G T D S Y G V T T G F G A T S H

      240     250     260     270     280     290     300     310
      |      |      |      |      |      |      |      |
AGGAGGACCAAGCAGGGTGGTGCCTTCAGAAGGAGCTTATCAGATTCTTGA ACTCTGGAATCTTTGGCAATGGCACT
R R T K Q G G A L Q K E L I R F L N S G I F G N G T

      320     330     340     350     360     370     380     390
      |      |      |      |      |      |      |      |
GAATCTTGCCACACATTACCTCACTCTGCGACGAGGGCGGGATGCTTGTGAGGATCAACACCCTCCTCCAAGGTTAC
E S C H T L P H S A T R A A M L V R I N T L L Q G Y

      400     410     420     430     440     450     460
      |      |      |      |      |      |      |
TCGGGCATCAGATTTGAGGTGATGGAAGCCATAGCCAAGCTAATCAACCATAACGTTACCCCGTGCTTACCACTCCGG
S G I R F E V M E A I A K L I N H N V T P C L P L R

      470     480     490     500     510     520     530     540
      |      |      |      |      |      |      |      |
GGTACAATCAGTGCATCGGGCGACCTGGTTCCTCTGTCTTACATCGCCGGTCTTTTGATAGGCAGGCCTAACTCCAAG
G T I S A S G D L V P L S Y I A G L L I G R P N S K
```

550	560	570	580	590	600	610	620
GCTGTAGGACCCAATGGAGAGTCCCTGGACGCCGCTAAGGCCTTTCAATTAGCCGGGATGGATGGCGGGTTCTTTGAG							
A V G P N G E S L D A A K A F Q L A G I D G G F F E							
630	640	650	660	670	680	690	700
TTGCAACCCAAAGAGGGTCTGGCACTTGTGAATGGCACTGCAGTAGGATCTGGCTTAGCTTCCATGGTTCTGTTTGAG							
L Q P K E G L A L V N G T A V G S G L A S M V L F E							
710	720	730	740	750	760	770	780
GCCAACATAGTCGCAGTTCTTTTCAGAAATCTTATCAGCAATTTTTGCAGAAGTCATGCAAGGGAAACCCGAGTTCACA							
A N I V A V L S E I L S A I F A E V M Q G K P E F T							
790	800	810	820	830	840	850	
GACCACTTGACACATAAATTGAAGCACCCCTGGACAGATAGAGGCAGCAGCTATAATGGAACACATTCTCGACGG							
D H L T H K L K H H P G Q I E A A A I <u>M E H I L D G</u>							

8.1.2 Cinnamate 4-hydroxylase. Clone *C4H xy11*.

Sequence of a cDNA fragment encoding C4H, cloned by RT-PCR from the differentiating xylem of *Juglans nigra*. The aminoacids stretches corresponding to the PCR primers are underlined.

```

      10      20      30      40      50      60      70
      |      |      |      |      |      |      |
AATTGGCTGCAAGTGGGGGATGACTTGAACCATAGGAACCTTACCGACATGGCCAAGAAATTCGGGGACATATTCTTG
N W L Q V G D D L N H R N L T D M A K K F G D I F L

      80      90      100     110     120     130     140     150
      |      |      |      |      |      |      |      |
CTCCGGATGGGCCAGCGTAACCTCGTGGTGGTGTCTGTCACCGGACCTGGCCAAAGAGGTCTCTGCACACCCAGGGGGTG
L R M G Q R N L V V V S S P D L A K E V L H T Q G V

      160     170     180     190     200     210     220     230
      |      |      |      |      |      |      |      |
GAGTTCGGGTCCAGGACCCGGAACGTGGTGTTCGACATATTCACCGGGAAGGGCCAGGACATGGTGTTCACGGTTTAC
E F G S R T R N V V F D I F T G K G Q D M V F T V Y

      240     250     260     270     280     290     300     310
      |      |      |      |      |      |      |      |
GGCGAGCATTGGAGGAAGATGAGGCGGATCATGACCGTCCCTTTCTTCACCAACAAGGTGGTCCAGCAGCACAGGTTTC
G E H W R K M R R I M T V P F F T N K V V Q Q H R F

      320     330     340     350     360     370     380     390
      |      |      |      |      |      |      |      |
GGGTGGGAAGACGAGGCGGCGAGCGTGGTGGAGGAGCTGAAGAAGACTCCAGAAGCTTCGACGACTGGGATCGTTCATA
G W E D E A A S V V E E L K K T P E A S T T G I V I

      400     410     420     430     440     450     460
      |      |      |      |      |      |      |
GGGAGGCGGTTGCAGCTGATGATGTACAACAACATGTACAGGATCATGTTCCACAGACGGTTTGAGAGCGTGGACGAC
R R R L Q L M M Y N N M Y R I M F H R R F E S V D D

      470     480     490     500     510     520     530     540
      |      |      |      |      |      |      |      |
CCCTTGTTTCGTGAAACTCAGAGCTTTGAACGGAGAGAGGAGTAGATTGGCCCAGAGCTTTGAATACAACATATGGCGAC
P L F V K L R A L N G E R S R L A Q S F E Y N Y G D

      550     560     570     580     590     600     610     620
      |      |      |      |      |      |      |      |
TTCATTCCCATTTTGAGACCTTTCTTGAGAGGCTACCTCAAGATCTGCAAGGAAGTCAAGGAGAGGAGGTTGCAGCTT
F I P I L R P F L R G Y L K I C K E V K E R R L Q L
```

630 640 650 660 670 680 690 700
 | | | | | | |
 TTCAAGGATTATTTTCATCGAGGAGAGGAAGAACTGTCGAGCACAGAGGCAACGGACAACGAAGGATTGAAATGTGCA
 F K D Y F I E E R K K L S S T E A T D N E G L K C A

710 720 730 740 750 760 770 780
 | | | | | | |
 ATGGACCATATTCTGGATGCTGAGAAGAAAGGGGAAATCAATGAAGACAACCGTGCTTTACATTGTTGAGAACATTAAC
 M D H I L D A E K K G E I N E D N V L Y I V E N I N

790 800 810 820 830 840 850
 | | | | | | |
 GTTGCTGCTATTGAAACAACACTATGGTCTATTGAGTGGGGGCTTGCAGAACTTGTGAACCATCCTAGAGTCCAAAAG
 V A A I E T T L W S I E W G L A E L V N H P R V Q K

860 870 880 890 900 910 920 930
 | | | | | | |
 AAGCTCCAGCAAGAGCTTGATAAGGTGCTTGGACCTGGTGTGCAAGTCACGGAGCCTGACATCCAGAATCTCCCTTAC
 K L Q Q E L D K V L G P G V Q V T E P D I Q N L P Y

940 950 960 970 980 990 1000 1010
 | | | | | | |
 CTTCAGGCTGTGGTCAAAGAGGTTCTCAGGCTCAGGATGGCAATCCCTCTTCTTGTACCACACATGAACCTCAATGAG
 L Q A V V K E V L R L R M A I P L L V P H M N L N E

1020 1030 1040 1050 1060 1070 1080 1090
 | | | | | | |
 GCAAACTCGGTGGTTATGATATCCCTGCAGAAAGCAAATCTTGGTGAATGCATGGTGGCTCGCCAACAACCCAGCC
 A K L G G Y D I P A E S K I L V N A W W L A N N P A

1100 1110 1120 1130 1140 1150 1160 1170
 | | | | | | |
 CACTGGAAAAAACCAGAAGAGTTTCGCCAGAGAGGTTCTTGAAGAGGAGTCCCAGGTAGAAGCAAATGGCAACGATTT
 H W K K P E E F R P E R F L E E E S Q V E A N G N D

8.1.3 4-Coumarate:CoA ligase. Clone 4CL xyl1

Sequence of a cDNA fragment encoding 4CL, cloned by RT-PCR from the differentiating xylem of *Juglans nigra*. EMBL accession number **AJ278455**. The aminoacids stretches corresponding to the PCR primers are underlined.

```

      10      20      30      40      50      60      70
      |      |      |      |      |      |      |
CAGCAGGTGGATGGGGAGAATCCAAACCTCTACTTCCGCAGCGAGGACGTGATTCTGTGCGTGCTGCCTCTGTTTCAC
Q Q V D G E N P N L Y F R S E D V I L C V L P L F H

      80      90      100     110     120     130     140     150
      |      |      |      |      |      |      |      |
ATTTACTCCCTGAACTCTGTCTTTCTTTGCGGATTACGAGCTGGAGCAGCCATTTTGCTCATGCAGAAGTTCGAGATT
I Y S L N S V F L C G L R A G A A I L L M Q K F E I

      160     170     180     190     200     210     220     230
      |      |      |      |      |      |      |      |
GTTTCCCTGCTGCAGCTTATACAGAAGTACAAGGTGAGCATCATGCCTGTTGTCCCGCCGATTGTGTTGGCCATATCT
V S L L Q L I Q K Y K V S I M P V V P P I V L A I S

      240     250     260     270     280     290     300     310
      |      |      |      |      |      |      |      |
AAGTCCCAGATCTCGACAAGTATGATCTTTCGTCGATAAAAATGCTCAAGTCTGGAGGGGCGCCGCTGGGAAAGGAA
K S P D L D K Y D L S S I K M L K S G G A P L G K E

      320     330     340     350     360     370     380     390
      |      |      |      |      |      |      |      |
ATTGAAGAAACTGTGAAGGCGAAGTTTCCCAATGCTAAATTTGGTCAGGGATACGGAATGACAGAGGCAGGTCCCCTA
I E E T V K A K F P N A K F G Q G Y G M T E A G P V

      400     410     420     430     440     450     460
      |      |      |      |      |      |      |
CTGTCAATGTGTTTGGCATTGCCCCAAGAACCATTGAGGTGAAATCAGGAGCATGTGGCACTGTTGTAAGGAATGCT
L S M C L A F A K E P F E V K S G A C G T V V R N A

      470     480     490     500     510     520     530     540
      |      |      |      |      |      |      |      |
GAAATGAAGATCATCGACCCCGAAACTGGTTCCTCCCTGCCCCGCAACCAACCTGGAGAGATTTGCATTAGAGGAGAC
E M K I I D P E T G S S L P R N Q P G E I C I R G D

      550     560     570     580     590     600     610     620
      |      |      |      |      |      |      |      |
CAGATCATGAAAGGTTACATTAATGATCCGGAAGCCACAGACAGAACCATAGACAGAGAGGGTTGGTTACATACCGGC
Q I M K G Y I N D P E A T D R T I D R E G W L H T G

```

630 640 650 660 670 680 690 700
| | | | | | | |
GATGTCGGCTTCATTGACGACGACGACGAGCTCTTCATCGTTGATCGGTTGAAGGAACTGATCAAATACAAAGGCTTCCAGGT
D V G F I D D D D E L F I V D R L K E L I K Y K G F Q V

8.1.4 Chalcone synthase. Clone *CHS xy11*

Sequence of a cDNA fragment encoding CHS, cloned by RT-PCR from the differentiating xylem of *Juglans nigra*. EMBL accession number **AJ278456**. The aminoacids stretches corresponding to the PCR primers are underlined.

```

      10      20      30      40      50      60      70
      |      |      |      |      |      |      |
ATGATGTATCAGCAAGGTTGCTTTGCCGGTGGCACGGTCCTCCGCCTAGCAAAAGACCTTGCTGAGAACAACAAGGTT
M M Y Q Q G C F A G G T V L R L A K D L A E N N K G

      80      90      100      110      120      130      140      150
      |      |      |      |      |      |      |      |
GCACGTGTGCTCGTCGTGTGCTCCGAAATCACCGCCGTCACATTCCGTGGGCCTAGTGACGCCACCTCGATAGTCTT
A R V L V V C S E I T A V T F R G P S D A H L D S L

      160      170      180      190      200      210      220      230
      |      |      |      |      |      |      |      |
GTGGGCCAGGCCTTGTTTGGAGATGGTGCAGCTGCAATCATAAATTGGAGCTGATCCAATCCCCGAGGTCGAGAAGCCT
V G Q A L F G D G A A A I I I G A D P I P E V E K P

      240      250      260      270      280      290      300      310
      |      |      |      |      |      |      |      |
TTATTTGAATTAGTCTCTGCGGCCCAAACAATTCTCCCCGATAGTGATGGGGCCATCGATGGGCATCTTCGCGAGGTT
L F E L V S A A Q T I L P D S D G A I D G H L R E V

      320      330      340      350      360      370      380      390
      |      |      |      |      |      |      |      |
GGGCTTACATTCCATCTCCTAAAGGATGTTCCCTGGGCTCATTTCAAAGAACATTGAGAAGAGTTTGGTGGAGGCCTTC
G L T F H L L K D V P G L I S K N I E K S L V E A F

      400      410      420      430      440      450      460
      |      |      |      |      |      |      |
CAACCCTTAGGCATCACAGATTGGAACCTCTCTTTTTGGATCGCACACCCTGGTGGGCCTGCAATCCTGGACCAAGTA
Q P L G I T D W N S L F W I A H P G G P A I L D Q V

      470      480      490      500      510      520      530      540
      |      |      |      |      |      |      |      |
GAGGAGAAGTTGGCTCTCAAGCCCCGAAAAGTTGCGTTCACACGTCACGTGCTTAGCGAGTATGGCAACATGTCCAGC
E E K L A L K P E K L R S T R H V L S E Y G N M S S

      550
      |
GCCTGCG
A C
```

8.1.5 Flavanone 3-hydroxylase. Clone *F3H.xyl1*

Sequence of a cDNA fragment encoding F3H, cloned by RT-PCR from the differentiating xylem of *Juglans nigra*. EMBL accession number **AJ278457**. The aminoacids stretches corresponding to the PCR primers are underlined.

```

      10      20      30      40      50      60      70
      |      |      |      |      |      |      |
GAGGATGAGAGACCCAAGGTTGCTTACAATCAATTCAGCACTGAAATCCCCATCATCTCGCTTGCCGGGATAGACGAA
E D E R P K V A Y N Q F S T E I P I I S L A G I D E

      80      90      100     110     120     130     140     150
      |      |      |      |      |      |      |      |
GTCCATGGCCGGAGGACCGAGATTTGCCAGAAAATCGTCGAGGCCTGTGAGGACTGGGGTATTTTCCAGGTGGTTCGAT
V H G R R T E I C Q K I V E A C E D W G I F Q V V D

      160     170     180     190     200     210     220     230
      |      |      |      |      |      |      |      |
CATGGCGTCGATGCCAGTCTAATCTCCGACATGACACGICTTGCCCGTGACTTCTTCGCCATGCCTCCCGAGGAAAAG
H G V D A S L I S D M T R L A R D F F A M P P E E K

      240     250     260     270     280     290     300     310
      |      |      |      |      |      |      |      |
CTTCGTTTCGACATGTCCGGCGGCAAGAAGGGCGGTTTCATTGTCTCCAGCCATCTGCAAGGAGAAGCAGTGCAAGAT
L R F D M S G G K K G G F I V S S H L Q G E A V Q D

      320     330     340     350     360     370     380     390
      |      |      |      |      |      |      |      |
TGGCGTGAAATTGTGACATATTTCTCATACCCAATTAGGACCAGAGACTATTCGAGGTGGCCGGACAAGCCAGAAGGG
W R E I V T Y F S Y P I R T R D Y S R W P D K P E G

      400     410     420     430     440     450     460
      |      |      |      |      |      |      |
TGGAGAAAGGTGACGGAGGAGTACAGTGACAAATTGATGGGACTGGCATGCAAACCTGTTGGAAGTGCTATCGGAGGCG
W R K V T E E Y S D K L M G L A C K L L E V L S E A

      470     480     490     500     510     520     530     540
      |      |      |      |      |      |      |      |
ATGGGATTAGAGAAGGAAGCATTGACCAAGGCTTGCGTGGATATGGACCAAAGGTTGTGGTTAATTACTATCCAAAA
M G L E K E A L T K A C V D M D Q K V V V N Y Y P K
```

550 560 570 580 590 600 610 620
 | | | | | | |
 TGTCCACAGCCAGACCTCACATTGGGGCTAAAGCGCCACACAGATCCTGGCACCATCACTCTGTTGTTGCAGGACCAG
 C P Q P D L T L G L K R H T D P G T I T L L L Q D Q

630 640 650 660 670 680 690 700
 | | | | | | |
 GTGGGTGGGCTTCAGGCCACCAGGGATGGCGGCAAGACCTGGATCACTGTTTCAGCCTGTTGAAGGAGCTTTCGTCGTC
 V G G L Q A T R D G G K T W I T V Q P V E G A F V V

710 720 730 740 750 760 770 780
 | | | | | | |
 AATCTGGAGACCATGGTCATTTCTGAGTAACGGGAGGTTCAAGAACGCTGATCACCAAGCAGTGGTGAACCTCAAAC
 N L G D H G H F L S N G R F K N A D H Q A V V N S N

790 800 810
 | | |
 TACAGTCGATTGTCCATCGCCACCTTCCAAAACCC
 Y S R L S I A T F Q N P

8.1.6 Dihydroflavonol 4-reductase. Clone *DFR xy11*

Sequence of a cDNA fragment encoding DFR, cloned by RT-PCR from the differentiating xylem of *Juglans nigra*. EMBL accession number **AJ278458**. The aminoacids stretches corresponding to the PCR primers are underlined.

```

      10      20      30      40      50      60      70
      |      |      |      |      |      |      |
TCTGACGCTGTGGAAGGCTGACCTGGCGGACGAAGGAAGCTTTGACGCCGCGATTGACGGGAGCACCGGAGTGTTC
L T L W K A D L A D E G S F D A A I D G S T G V F H

      80      90      100     110     120     130     140     150
      |      |      |      |      |      |      |      |
CGTGGCCACGCCTATGGATTTGAGTCAAAGACCCCGAGAATGAAGTGATAAAGCCAACGGTCAACGGCGTGTTAAG
V A T P M D F E S K D P E N E V I K P T V N G V L S

      160     170     180     190     200     210     220     230
      |      |      |      |      |      |      |      |
CATCATGAAAGCATGCGTCCAAGCAAAAACCGTTCGCAGGCTTGTCTTCACATCATCCGCTGGAGCCCTTGATGTTTC
I M K A C V Q A K T V R R L V F T S S A G A L D V S

      240     250     260     270     280     290     300     310
      |      |      |      |      |      |      |      |
AGAGCACCAAAGGCCAGTCTATGATGAAAGCTGCTGGAGTGATGTTGAATTCTGCAGGGCCAAAAAATGACTGGCTG
E H Q R P V Y D E S C W S D V E F C R A K K M T G W

      320
      |
GATGTA C T T
M Y
```

8.1.7 Dihydroflavonol 4-reductase. Clone *DFR 143*

Sequence of the 3' end of a cDNA encoding DFR, cloned by 3'RACE from the differentiating xylem of *Juglans nigra*. EMBL accession number **AJ278459**. The aminoacids stretches corresponding to the PCR primers are underlined.

```

      10      20      30      40      50      60      70
      |      |      |      |      |      |      |
AACGGCGTGTTAAGCATCATGAAAGCATGCGTCCAAGCAAAAACCGTTTCGCAGGCTTGTCTTCACATCATCCGCTGGA
N G V L S I M K A C V Q A K T V R R L V F T S S A G

      80      90      100     110     120     130     140     150
      |      |      |      |      |      |      |      |
GCCCTTGATGTTTCAGAGCACCAAAGGCCAGTCTATGATGAAAGCTGCTGGAGTGATGTTGAATTCTGCAGGGCCAAA
A L D V S E H Q R P V Y D E S C W S D V E F C R A K

      160     170     180     190     200     210     220     230
      |      |      |      |      |      |      |      |
AAAATGACTGGATGGATGTATTTTGTGTCTAAGACACAGGCTGAGCAAGCCGCATGGAAGTTTGCCAAAGAGAACAAC
K M T G W M Y F V S K T Q A E Q A A W K F A K E N N

      240     250     260     270     280     290     300     310
      |      |      |      |      |      |      |      |
TTGACTTTGTGTCAGTGTGATACCCCTTTAGTGGTTGGACCATTCTCATGCCCTCAATGCCACCAAGTCTCATTACC
L D F V S V I P P L V V G P F L M P S M P P S L I T

      320     330     340     350     360     370     380     390
      |      |      |      |      |      |      |      |
GCGCTGTCCCCTATCACTGGGAATGAAGCTCATTATTCGATCATAAAGCAAGGACAATTTGTTCACTTGGATGACCTT
A L S P I T G N E A H Y S I I K Q G Q F V H L D D L

      400     410     420     430     440     450     460
      |      |      |      |      |      |      |
TGCATGGGCCACATTTATCTATTTGAGCACCCCAAGGCAGAGGGCAGGTATCTTTGCTCCGCATGCGATGCTACCATT
C M G H I Y L F E H P K A E G R Y L C S A C D A T I

      470     480     490     500     510     520     530     540
      |      |      |      |      |      |      |      |
CTTGATGTTGCAAAATTGCTCAGAGAAAAATTCCCAGAGTGCAATGTCCCCACAAAATTCAAGGGTGTGGACGAGAGC
L D V A K L L R E K F P E C N V P T K F K G V D E S
```

550 560 570 580 590 600 610 620
 | | | | | | |
 TTGGAGATTATCTCTTTCAATTCAAAAAAGATAAAAGATTGGGGTTTCAGTTCAAGTACAGCTTGGAGGACATGTTT
 L E I I S F N S K K I K D L G F Q F K Y S L E D M F

630 640 650 660 670 680 690 700
 | | | | | | |
 GTGGAAGCGGTCCAAACATGCCGAGCCAAGGGATTGCTTCCTCCGGCGGCTGAAAAAACTCTTGA CGGCACAAACTA
 V E A V Q T C R A K G L L P P A A E K T L oStop codon

710 720 730 740 750 760 770 780
 | | | | | | |
 AGGTTGTATGTGTTGTACGTGTAACATTTATTCTGGTACTCAAATAATGGTCTTTTAAATCTCTTATGGGATCAGGG

790 800 810 820 830 840 850
 | | | | | | |
 CTATCTCCGTTGTGATCTCAAGGGGAGAATTAATTTTCAGAGTTGTATGAACTGATGGTTTGTAAATGTAAATTTATTT

860 870 880 890 900 910
 | | | | | |
 GTGGCATCTAAA

8.2 Sequence alignments

The deduced peptide sequences of the cDNA fragments cloned from the differentiating xylem of *Juglans nigra* were compared to the peptide sequences of the corresponding genes already identified in other species. Clustal multiple alignments of peptide sequences, realised using the software GeneJockey (Applied Biosystem's), are presented in this section. The conservation of the consensus amino acids confirmed the identity of the cDNA fragments cloned from *Juglans nigra*.

8.2.1 Phenylalanine ammonia-lyase

Clustal alignment of peptide sequences of phenylalanine ammonia-lyase (PAL) from several species in comparison to the sequence cloned from *Juglans nigra* (marked in bold).

Legend. Pinus t.: *Pinus taeda*, Glycine m.: *Glycine maxima*. Citrus l.: *Citrus limon*. Populus k.: *Populus kitakamiensis*. Juglans n.: *Juglans nigra* (clone PAL xy11)

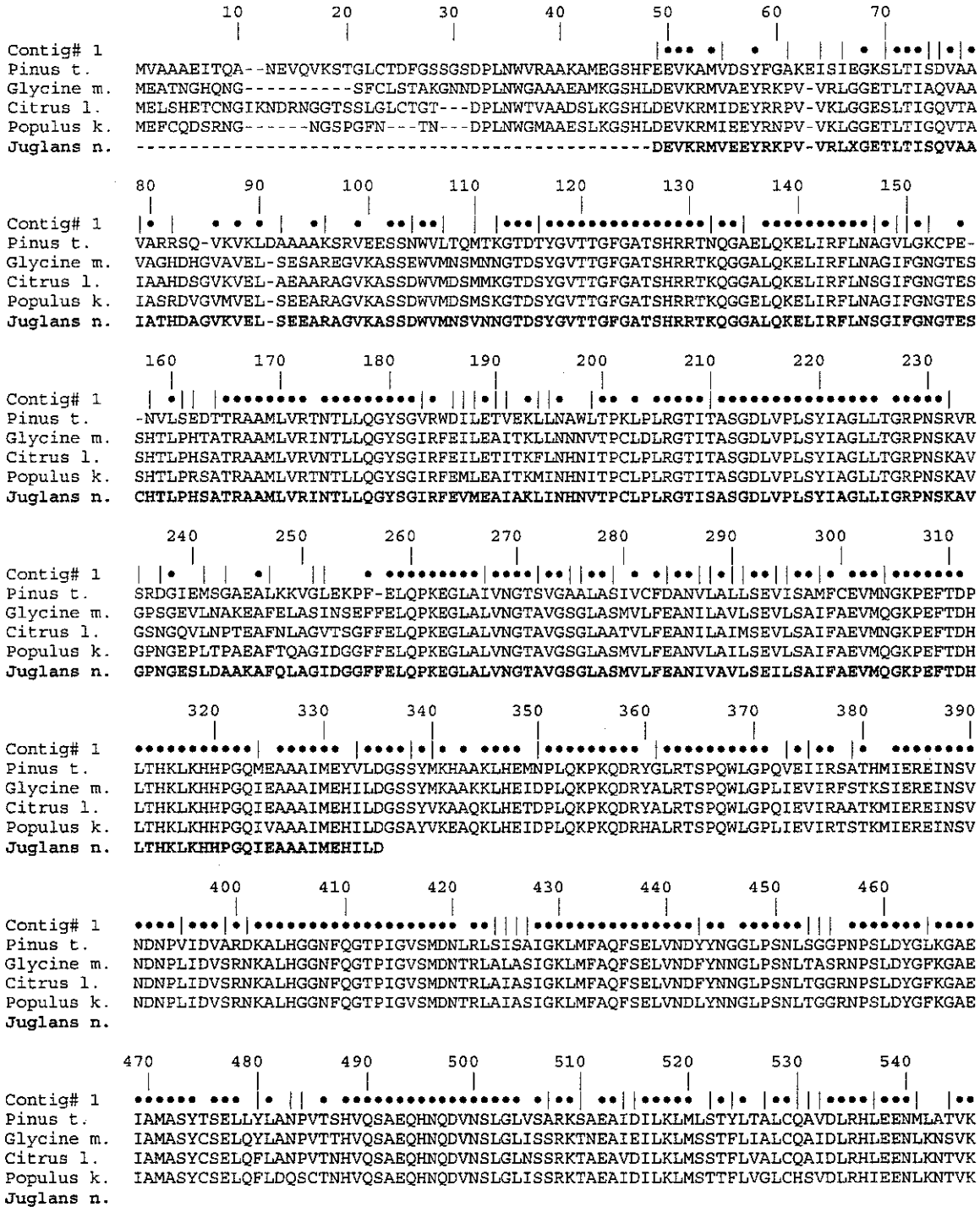

550 560 570 580 590 600 610 620

Contig# 1
Pinus t. QIVSQVAKKTLSTGLNGELLGGRFCEKDLLQVVDNEHVFSYIDDDPCNASYPLTQKLRNILVEHAFKNAEAGEKDPNTSI
Glycine m. NTVSQVSKRILTTGVNGELHPSRFCEKDLLKVVVDREYIFSYIDDDPCSATYPLMQKLRQVLVDHALVNAEKEKDVNSSI
Citrus l. NTVSQVAKRVLTMGVNGELHPSRFCEKDLIKVVVDREYVFAYIDDDPCSASSPLMQKLRQVLVDHALDNGDREKNSTTSI
Populus k. ISVSQLP-RVLTMGFNGELHPSRFCEKDLLKVVVDREHVFSYIDDDPCSATYPLMQKLRQVLVEHALVNGEKVRNSTTSI
Juglans n.

630 640 650 660 670 680 690 700

Contig# 1
Pinus t. FNKIPVFEAELKAQLEPQVSLARESVDKGTSPDPRIQECSRYPYEFVRNQLGKLLSGTRTISPGEVIEVVYDAIS
Glycine m. FQKIAIFEEELKNLLPKEVEGARAAYESGKAAIPNKIQECSRYPYKFFVREELGTLLTGKVRSPGEEFDKLFAMC
Citrus l. FQKIGAFEDELKTLKPKEVEIARTELESGNAAIPNRIKECSRYPYKIVREDIGTSLLTGKVRSPGEEFDKVFAMC
Populus k. FQKIGSFEEELKTLKPKEVESARLEVENGNPAIPNRIKECSRYPYKFFVREELGTSLLTGKVRSPGEEFDKVFAMC
Juglans n.

710 720 730 740 750

Contig# 1
Pinus t. EDKIVVPLFKCLDGWKGLAHSEINNLRSPLYNDCYDLSPRMLLLMLLFSDFPDWS
Glycine m. QGKIIDPLMECLGEWNGA-----PLPI-----S
Citrus l. EGKLIDPMECLKEWNGA-----PLPIC-----N
Populus k. AGKLIDPMECLKEWNGA-----PLPIC
Juglans n.

8.2.2 Cinnamate 4-hydroxylase

Clustal alignment of peptide sequences of cinnamate 4-hydroxylase (C4H) from several species in comparison to the sequence cloned from *Juglans nigra* (marked in bold).

Legend. Pinus t.: *Pinus taeda*, Glycine m.: *Glycine maxima*, Citrus s.: *Citrus sinensis*, Populus k.: *Populus kitakamiensis*, Juglans n.: *Juglans nigra* (clone C4H xyl1)

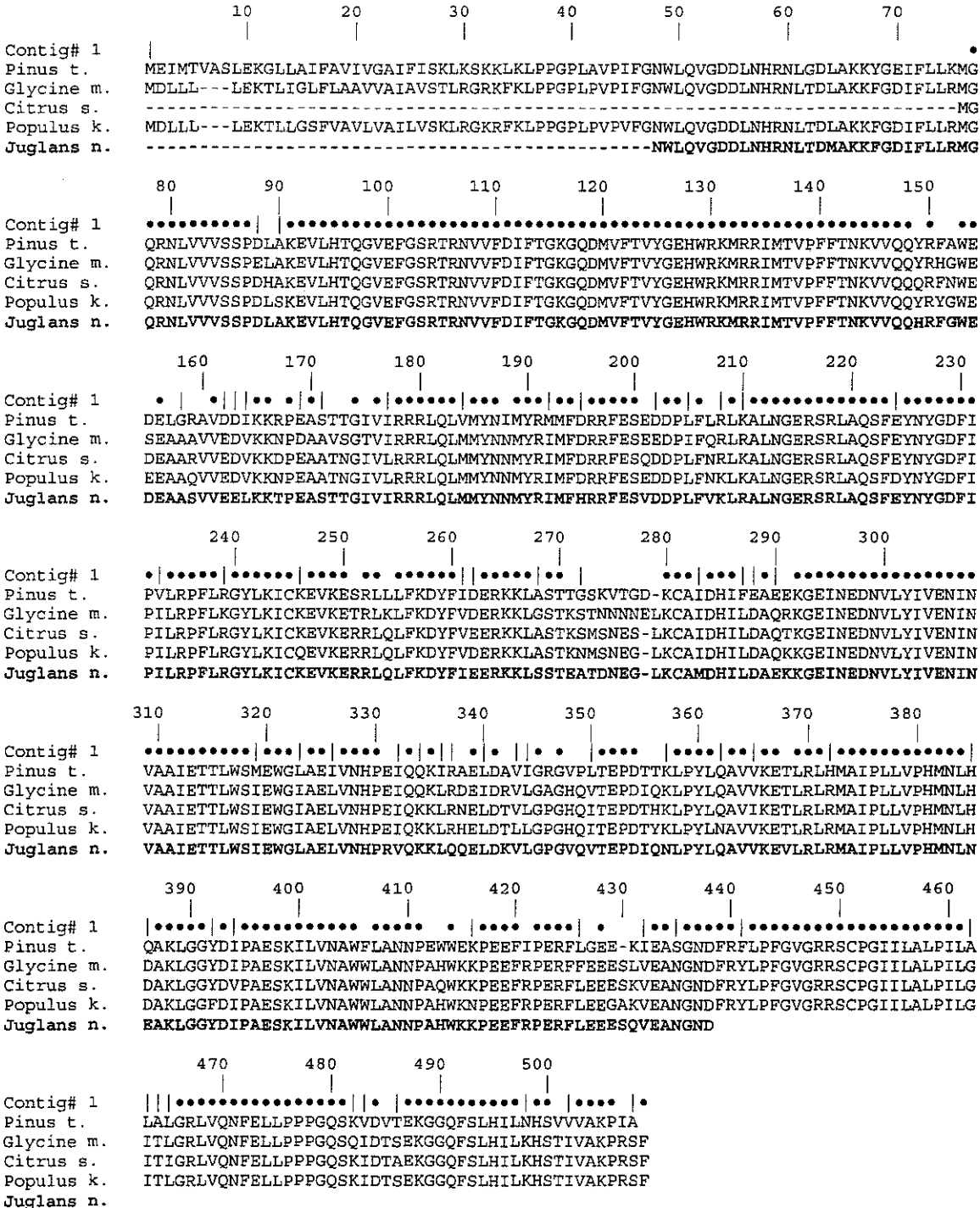

8.2.3 4-Coumarate-CoA ligase

Clustal alignment of peptide sequences of 4-coumarate-CoA ligase (4CL) from several species in comparison to the sequence cloned from *Juglans nigra* (marked in bold).

Legend. Pinus t.: *Pinus taeda*, Glycine m.: *Glycine maxima*. Populus t.: *Populus tremuloides*. Nicotiana t.: *Nicotiana tabacum*. Juglans n.: *Juglans nigra* (clone 4CL xyl1).

```

                10         20         30         40         50         60         70
                |         |         |         |         |         |         |
Contig# 1
Pinus t.      MANGIKKVEHLYRSKLPDIEISDHLPLHSYCFERVAEFADRPLCIDGATDRTYCFSEVELISRKVAAGLAKLGLQQ
Glycine m.    -----
Populus t.    MNPQ---EFIFRSKLPDIYIPKNLPLHSYVLENLSKHSSKPLINGANGDVVYTYADVELTARRVASGLNKIGIQQ
Nicotiana t.  MEKDTKQVDIIIFRSKLPDIYIPNHLPLHSYCFENISEFSSRPCLINGANKQIYTYADVELNSRKVAAGLHKQGIQP
Juglans n.    -----

                80         90         100        110        120        130        140        150
                |         |         |         |         |         |         |         |
Contig# 1
Pinus t.      QQVVMLLLPNCEIFAFVFMGASVIRGAVTTANPFYKPEIAKQAKAAGARIIVTLAAYVEKLADLQS---HDVLV
Glycine m.    -----AKLIITQAMYVDKLRNHDGAKLGEDFKV
Populus t.    GDVIMLFLPSSPEFVLAFLGASHRGAMITANPFSTPAELAKHAKASRAKLLITQACYYEKVKDFA---RESDVKV
Nicotiana t.  KDTIMILLPNSPEFVFAFIGASYLGAISTMANPLFTPAEVVQAKASSAKIIVTQACHVNKVKDYA---FENDVKI
Juglans n.    -----

                160        170        180        190        200        210        220
                |         |         |         |         |         |         |
Contig# 1
Pinus t.      ITIDDAPKEGCOHISVLTEADETQCPAVKIHPPDDVVALPYSSGTTGLPKGVMLTHKGLVSSVAQQVDGENPNLYFH
Glycine m.    VTVDPPP-ENCLHFSVLSEANESDVPEVEIHPDDAVAMPFSSGTTGLPKGVMLTHKSLTTSVAQQVDGENPNLYLT
Populus t.    MCVDSAP-DGASLFRHTQADENEVQVDISPDDVVALPYSSGTTGLPKGVMLTHKGLTTSVAQQVDGDNPNLYFH
Nicotiana t.  ICIDSAP-EGCLHFSVLQANEHDIPEVEIQPDDVVALPYSSGTTGLPKGVMLTHKGLVTSVAQQVDGENPNLYIH
Juglans n.    -----QQVDGENPNLYFR

                230        240        250        260        270        280        290        300
                |         |         |         |         |         |         |         |
Contig# 1
Pinus t.      SDDVILCVLPLPHIYLSLNSVLLCALRAGAATLIMQKFNLTTCLELIQKYKVTVAIVPPIVLDITKSPIVSQYDVS
Glycine m.    TEDVLLCVLPLPHIFSLNSVLLCALRAGSAVLLMQKFEIGTLLELIQRHRVSVAMVPPPLVLALAKNPMVADFELS
Populus t.    SEDVILCVLPMPHIYALNSMMLCGLRVGASILMPKFEIGSLLGLIEKYKVSIAPVVPPVMMIAIAKSPDLKHDLS
Nicotiana t.  SEDVMLCVLPLPHIYLSLNSVLLCGLRVGAAILIMQKFDIVSFLLELIQRYKVTIGPFVPPVILAIKSPMVDYDLS
Juglans n.    SEDVILCVLPLPHIYLSLNSVFLCGLRAGAAILLMQKFEIVSLLQLIQKYKVSIMPVPPVIVLAIKSPDLKDYLS

                310        320        330        340        350        360        370        380
                |         |         |         |         |         |         |         |
Contig# 1
Pinus t.      SVRIIMSGAAPLGKELEDALRERFPKAIIFGQGYGMTEAGPVLAMNLAFAKNPFPVKSGSCGTVVRNAQIKILDDET
Glycine m.    SIRLVLSGAAPLGKELEELRNRMPQAVLGGQYGMTEAGPVLMSCLGFAKQPFQTKSGSCGTVVRNAELKVDPET
Populus t.    SLRMIKSGGAPLGKELEDTVRAKFPQARLGGQYGMTEAGPVLAMCLAFAKEPFDIKPGACGTVVRNAEMKIVDPET
Nicotiana t.  SVRTVMGSAAPLGKELEDTVRAKFPNAKLGQYGMTEAGPVLAMCLAFAKEPFEIKSGACGTVVRNAEMKIVDPKT
Juglans n.    SIKMLKSGGAPLGKEIEETVKAFFNAKFGQYGMTEAGPVLMSCLAFAKEPFEVKSACGTVVRNAEMKIIDPET

                390        400        410        420        430        440        450
                |         |         |         |         |         |         |
Contig# 1
Pinus t.      GESLPHNQAGEICIRGPEIMKGYINDPESTAATIDEGWLHTGDVVEYIDDDDEEIFVDRVKEIKYKGFQVAPAE
Glycine m.    GRSLGYNQAGEICIRGQIMKGYLNDEAATASTIDSEGWLHTGDVGYVDDDEEIFVDRVKELIKYKGFQVAPAE
Populus t.    GVSLPRNQAGEICIRGDQIMKGYLNDPEATSRITIDKEGWLHTGDIGYIDDDDELFIVDRLKELIKYKGFQVAPTEL
Nicotiana t.  GNSLPRNQAGEICIRGDQIMKGYLNDPEATARTIDKEGWLHTGDIGYIDDDDELFIVDRLKELIKYKGFQVAPAE
Juglans n.    GSSLPRNQAGEICIRGDQIMKGYINDPEATDRTIDREGWLHTGDVGFIDDDDELFIVDRLKELIKYKGFQ

                460        470        480        490        500        510        520        530
                |         |         |         |         |         |         |         |
Contig# 1
Pinus t.      EALLVAHPSIADAADVVPQKHEEAGEVPVAFVVKSS--EISEQEIKEFVAKQVIFYKRIHRVYFVDAIPKSPSGKIL
Glycine m.    EGLLVSHPSIADAADVVPQKDVAAAGEVPVAFVVRNSNGFDLTEAVKEFIAKQVVIFYKRLHKVYFVHAIKSPSGKIL
Populus t.    EALLIAHPEISDAAVGLKDEDEAGEVPVAFVVKSEKQATEDEIKQYISKQVIFYKRIKRVFFIEAIPKAPSGKIL
Nicotiana t.  EALLLNHPNISDAADVPMKDEQAGEVPVAFVVRNSGSTITIDEVKDFISKQVIFYKRIKRVFFVDAIPKSPSGKIL
Juglans n.    -----

```

540

```
Contig# 1      ••|•| |•  
Pinus t.      RKDLRSRLAA-----K  
Glycine m.    RKDLRAKLETAATQTP  
Populus t.    RKNLKEKL--PG---I  
Nicotiana t.  RKDLRAKL--AAGLPN  
Juglans n.
```

8.2.4 Chalcone synthase

Clustal alignment of peptide sequences of chalcone synthase (CHS) from several species in comparison to the sequence cloned from *Juglans nigra* (marked in bold).

Legend. Pinus d.: *Pinus densiflora*, Glycine m.: *Glycine maxima*. Camellia s.: *Camellia sinensis*.

Juglans hyb. *Juglans nigra* x *regia*. *Juglans* n.: *Juglans nigra* (clone CHS xyl1).

	10	20	30	40	50	60	70
Contig# 1	•						
Pinus d.	MAETLGLDLEAFRKAQRADGPATILAI	TATPPNAVDQSSYPDYYPFKITNSEH	MTLKEKFRMCDKSAIKKRYMY				
Glycine m.	M-----VSVAEIRQAQRAEGPATILAI	TANPPNRVDQSTYPDYYPFRITNSDH	MTELKEKFRMCDKSMIKRYMY				
Camellia s.	M-----VTVEEVRAQRAEGPATVMAI	TATPPNCVDQSTYPDYYPFRITNSEH	KTELKEKFRMCDKSMIKKRYMY				
<i>Juglans</i> hyb.	M-----VTVEDVRAQRAEGPATVMAI	TATPPNCVDQSAYPDYYPFRITNSEH	KTELKEKFKRMCEKSMIKKRYMH				
<i>Juglans</i> n.	-----	-----	-----	-----	-----	-----	-----
	80	90	100	110	120	130	140
Contig# 1							
Pinus d.	LTEEILKENPNVCEYMAPSLDARQDMV	VVEVPRLGKEAAAKAIKEWGQPKSKI	THVIFCTTSGVDMPGADYQLTKL				
Glycine m.	LNEEILKENPNMCAYMPSLDRQDMVV	VEVPKLGKEAAVKAKEWGQPKSKI	THLIFCTTSGVDMPGADYQLTKQ				
Camellia s.	LTEEILKENPNVCEYMAPSLDARQDM	VVEVPRLGKEAATKAKEWGQPKSKI	THLVFCTTSGVDMPGADYQLTKL				
<i>Juglans</i> hyb.	LTEEILKENPNVCEYMAPSLDARQDM	VVEVPRLGKEAATKAKEWGQPKSKI	THLVFCTTSGVDMPGADYQLTKL				
<i>Juglans</i> n.	-----	-----	-----	-----	-----	-----	-----
	160	170	180	190	200	210	220
Contig# 1		•••••	•••••	•••••	•••••	•••••	•••••
Pinus d.	LGLRPSVKRVMYQQGCFAGGTVLRVAK	DLAENNRGARVLVVCSEITAVTFRG	PSDTHLDSMVQALFGDGAAALI				
Glycine m.	LGLRPHYKRYMMYQQGCFAGGTVLRL	LAKDLAENNKGARVLVVCSEITAVT	FRGSDTHLDSLQALFGDGAAAVI				
Camellia s.	LGLRPSVKRLMMYQQGCFAGGTVLRL	LAKDLAENNKGARVLVVCSEITAVT	FRGSDAHLDSLQALFGDGAAAI				
<i>Juglans</i> hyb.	LGLRPSVKRLMMYQQGCFAGGTVLRL	LAKDLAENNKGARVLVVCSEITAVT	FRGSDTHLDSLQALFGDGAAALI				
<i>Juglans</i> n.	-----	MMYQQGCFAGGTVLRLAKDLAENNK	GARVLVVCSEITAVTFRGSDAHLDSL	QALFGDGAAAI			
	230	240	250	260	270	280	290
Contig# 1	• •• •••••	•••••	•••••	•••••	•••••	•••••	•••••
Pinus d.	VGADPVPQVEKPCFELMWTQTI	LPDSGDAIDGHLREVGLTFHLLK	DVPGLISKNIEKSLVEAFQQLG	ISDWNQLF			
Glycine m.	VGSDPIQVEKPLYELVWTAQTI	APDSGDAIDGHLREVGLTFHLLK	DVPGLIVSKNIDKALFEAFNPL	NI	SDYNSIF		
Camellia s.	VGSDPIPEVEKPLFELVSAQA	TILPDSGDAIDGHLREVGLTFHLLK	DVPGLISKNIEKSLNEAFQPL	NI	TDWNSLF		
<i>Juglans</i> hyb.	VGADPVPQVEKPLFELVSAQA	TILPDSGDAIDGHLREVGLTFHLLK	DVPGLISKNIEKSLVEAFQPL	GI	TDWNSLF		
<i>Juglans</i> n.	IGADPIPEVEKPLFELVSAQA	TILPDSGDAIDGHLREVGLTFHLLK	DVPGLISKNIEKSLVEAFQPL	GI	TDWNSLF		
	310	320	330	340	350	360	370
Contig# 1	•••••	•••••	•••••	•••••	•••••	•••••	•••••
Pinus d.	WIAHPGGPAILDQVEAKLNLDPK	KLRA	TQVLS	DYGNMSSACVHFI	LDEM	RKSSQ	QNGCSTTGEGLDVGVLF
Glycine m.	WIAHPGGPAILDQVEQKLGKPE	KMKATR	DVLS	SEYGNMSSACVLF	LDEM	RKSAEN	GKTTGEGLDVGVLFG
Camellia s.	WIAHPGGPAILDQVELKALKPE	KLRATR	HVLSE	YGNMSSACVLF	LDEM	RKSSAK	GLKTTGEGLDVGVLFG
<i>Juglans</i> hyb.	WIAHPGGPAILDQVESKLEL	KPEKLR	TRHVLSE	YGNMSSACVLF	LDEM	RKSSAE	DRLKTTGEGLDVGVLFG
<i>Juglans</i> n.	WIAHPGGPAILDQVEEK	LALKPE	KLRSTR	HVLSEYGNMSSAC			
	390						
Contig# 1	••• •••••	•• ••					
Pinus d.	GLTVETVVLKSVPLQQ						
Glycine m.	GLTIETVVLHLSVAI						
Camellia s.	GLTVETVVLHLSVST						
<i>Juglans</i> hyb.	GLTVETVVLHLSVSA						
<i>Juglans</i> n.							

8.2.5 Flavanone 3-hydroxylase

Clustal alignment of peptide sequences of Flavanone 3-hydroxylase (F3H) from several species in comparison to the sequence cloned from *Juglans nigra*. (marked in bold)

Legend. *Vitis v.*: *Vitis vinifera*. *Citrus s.*: *Citrus sinensis*. *Ipomoea b.*: *Ipomoea batatas*. *Matthiola i.*: *Matthiola incana*. *Juglans n.*: *Juglans nigra* (clone F3H xyl1).

```

      10      20      30      40      50      60      70
Contig# 1
Vitis v.  MAPT--TLTALAGEKTLQSSFVRDEDERPKVAYNDFSNEIPVISLTKESMKLAAVVDEICRKIVEACEDWGI FQVV
Citrus s.  MAP--STLTALAGEKTLNPSFVRFQDERPKVAYNEFSNEIPVISLA-GIDDVGGKRAEICKKIVEACEDWGI FQVV
Ipomoea b. MAATLSTLTALAGEKSLQSSFVRDEDERPKVGYNEFSDEIPVISLK-GIDDVNGRRVQIRNDIVKACEDWGI FQVV
Matthiola i. -AP--GTLTELAGEKSLNSKFVRDEDERPKVAYNEFSDEIPVISLA-GIDDVGKRGEICREIVEACENWGI FQVV
Juglans n.  -----EDERPKVAYNQFSTEIPIISLA-GIDEVHGRRTEICQKIVEACEDWGI FQVV

      80      90      100     110     120     130     140     150
Contig# 1
Vitis v.  NHGVDSNLISEMTRLAREFFALPPEENVRFDMSGGKGGFIVSSHLQGEAVQDWREIVTYFSYPLRTRDYSRWPDK
Citrus s.  DHGVDARLISDMTRLAREFFALPPEEKLRFDMSGGKGGFIVSSHLQGEAVKDWREIVTYFSYPLRTRDYSRWPDK
Ipomoea b.  DHGVDAGLIGEMTRLSKDFALPPEEKLRFDMSGGKGGFIVSSHLQGEAVKDWREIVTYFSYPPVRARDYSRWPDK
Matthiola i. DHGVDTSLVADMTRLARDFFALPPEEKLRFDMSGGKGGFIVSSHLQGEAVQDWREIVTYFSYPPVRARDYSRWPDK
Juglans n.  DHGVDASLISDMTRLARDFFAMPPEEKLRFDMSGGKGGFIVSSHLQGEAVQDWREIVTYFSYPIRTRDYSRWPDK

      160     170     180     190     200     210     220
Contig# 1
Vitis v.  PEGWRSVTQEYSEKLMGLACKLLEVLSEAMDLDKDALTNACVDMQKVVVNFYPCPQPDLLTGLKRRHTDPGTITL
Citrus s.  PEGWMEVTKEYSDKLMGVACKLLEVLSEAMGLEKEALTKACVDMQKIVVNYYPKCPQPDLLTGLKRRHTDPGTITL
Ipomoea b.  PEGWRAVTEKYSEKLMGLACKLLEVLSEAMGLEKEALTKACVDMQKVVVNFYPCPQPDLLTGLKRRHTDPGTITL
Matthiola i. PQGWAKVTEEYSEKLMGLACKLLEVLSEAMGLEKESLTNACVDMQKIVVNYYPKCPQPDLLTGLKRRHTDPGTITL
Juglans n.  PEGWRKVTEEYSDKLMGLACKLLEVLSEAMGLEKEALTKACVDMQKVVVNYYPKCPQPDLLTGLKRRHTDPGTITL

      230     240     250     260     270     280     290     300
Contig# 1
Vitis v.  LLQDQVGGGLQATRGGKTWITVQPVEGAFVFNLDGHHYLSNGRFRKNADHQAVVNSNHSRSLSIATFQNPAPPEATVY
Citrus s.  LLQDQVGGGLQATKDNKGTWITVQPIEGAFVFNLDGHHYLSNGRFRKNADHQAVVNSNSSRSLSIATFQNPAPPEATVY
Ipomoea b.  LLQDQVGGGLQATKDGKGTWITVQPVDFGAFVFNLDGHHFLSNGRFRKNADHQAVVNSERSRVSISATFQNPAPPEATVY
Matthiola i. LLQDQVGGGLQATRDDGNTWITVQPVEGAFVFNLDGHHFLSNGRFRKNADHQAVVNSNSSRSLSIATFQNPAPPEATVY
Juglans n.  LLQDQVGGGLQATRGGKTWITVQPVEGAFVFNLDGHHFLSNGRFRKNADHQAVVNSNYSRSLSIATFQNP

      310     320     330     340     350     360
Contig# 1
Vitis v.  PLKIREGEEKAVLEGPIITFAEMYRRKMSKDLELARLKKLAKEQQQ---QDVEKAKLESKPIDQILA
Citrus s.  PLKIREGEEKVLEEPIPFSEMYRRKMSKDLELARLKKLANEKKQYSEKA---KLDAPIEEILA
Ipomoea b.  PLTVREGDKPIMEEPIITFAEMYRRKMSKDLELARLKKFAKEQQQIVKAAAADKNLETKPIDQILA
Matthiola i. PLKIVREGEKAIMPEEPIITFAEMYRRKMRDLELARLKKLAKEEHNHKE-----AAKPLDQILA
Juglans n.

```

8.2.6 Dihydroflavonol 4-reductase

Clustal alignment of peptide sequences of dihydroflavonol 4-reductase (DFR) from several species in comparison to the sequence cloned from *Juglans nigra* (marked in bold).

Legend. Glycine m.: *Glycine maxima*. Ipomoea p.: *Ipomoea purpurea*. Fragaria x a.: *Fragaria x ananassa*. Vitis v.: *Vitis vinifera*. Juglans n. 1: *Juglans nigra* clone DFR xyl1, cDNA fragment cloned by RT-PCR, 2: *Juglans nigra* clone DFR 143, 3' end of cDNA cloned by 3' RACE.

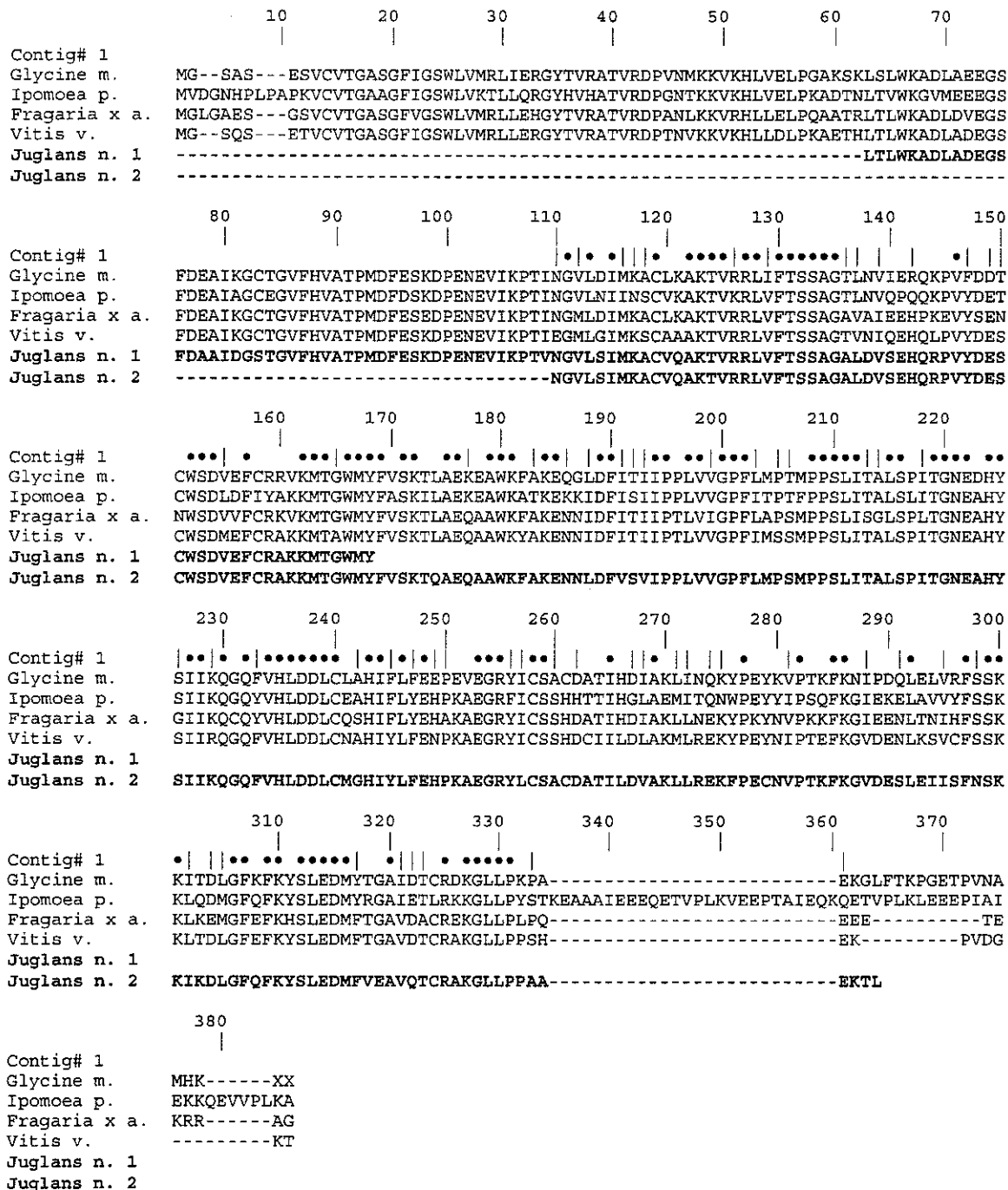

Bibliographic references

9. Bibliographic references

- Akada, S. and Dube, S. K. 1995.** Organization of soybean chalcone synthase gene clusters and characterization of a new member of the family. *Plant Mol Biol* 29: 189-199.
- Allona, I., Quinn, M., Shoop, E., Swope, K., St.Cyr, S., Carlis, J., Riedl, J., Retzel, E., Campbell, M. M., Sederoff, R. and Whetten, R. W. 1998. Analysis of xylem formation in pine by cDNA sequencing. *Proc Natl Acad Sci USA* 95: 9693-9698.
- Altschul, S. F., Madden, T. L., Schaffer, A. A., Zhang, J., Zhang, Z., Miller, W. and Lipman, D. 1997.** Gapped BLAST and PSI-BLAST: a new generation of protein database search programs. *Nucl Acids Res* 25: 3389-3402.
- Baillie, M. G., Hillam, J., Briffa, K. R. and Brown, D. M. 1985.** Re-dating the English art-historical chronologies. *Nature* 315: 317-319.
- Bamber, R. K. 1976.** Heartwood, its function and formation. *Wood Sci Technol* 10: 1-8.
- Bavage, A. D., Davies, I. G., Robbins, M. P. and Morris, P. 1997.** Expression of an *Antirrhinum* dihydroflavonol reductase gene results in changes in condensed tannin structure and accumulation in root cultures of *Lotus corniculatus* (bird's foot trefoil). *Plant Mol Biol* 34: 443-458.
- Beritognolo, I., Burtin, P., Breton, C., Charpentier, J.-P., Janin, G., Label, P. and Jay-Allemand, C., 1999.** Heartwood formation in walnut: involvement of phenolic metabolism. ISHS, Fourth international walnut symposium Bordeaux, France, 12-16 September 1999. Poster.
- Berthier, S., Kokutse, A. D., Stokes, A. and Fourcaud, T. 2000.** Irregular heartwood formation in leaning stems of maritime pine (*Pinus pinaster* Ait.). *Annals Bot* in press:
- Bodeau, J. P. and Walbot, V. 1996.** Structure and regulation of the maize *Bronze2* promoter. *Plant Mol Biol* 32: 599-609.
- Bolwell, G. P. 1992.** A role in the down-regulation of phenylalanine ammonia-lyase in suspension-cultured cells of french bean. *Phytochem* 31: 4081-4086.
- Bosshard, H. H. 1965.** Aspects of the aging process in cambium and xylem. *Holzforschung* 19: 65-69.
- Breton, C., Chaboud, A., Matthys-Rochon, E., Bates, E. E. M., Cock, J. M., Fromm, H. and Dumas, C. 1995.** PCR-generated cDNA library of transition-stage maize embryos: cloning and expression of calmodulin genes during early embryogenesis. *Plant Mol Biol* 27: 105-113.
- Bruce, W., Folkerts, O., Garnaat, C., Crasta, O., Roth, B. and Bowen, B. 2000.** Expression profiling of the maize flavonoid pathway genes controlled by estradiol-inducible transcription factors CRC and P. *Plant Cell* 12: 65-79.
- Burtin, P., Jay-Allemand, C., Charpentier, J. P. and Janin, G. 1998.** Natural wood colouring process in *Juglans* sp. (*J. nigra*, *J. regia* and hybrid *J. nigra* 23 x *J. regia*) depends on native phenolic compounds accumulated in the transition zone between sapwood and heartwood. *Trees* 12: 258-264.
- Burtin, P. 1999.** Origine biochimique de la couleur du bois de noyer (*Juglans* spp.). Ph.D. Dissertation. Université Henri Poincaré, Nancy 1, France, 28-5-1999. 228 pages.

Butland, S. L., Chow, M. L. and Ellis, B. E. 1998. A diverse family of phenylalanine ammonia-lyase genes expressed in pine trees and cell cultures. *Plant Mol Biol* 37: 15-24.

Byrne, P. F., McMullen, M. D., Snook, M. E., Musket, T. A., Theury, J. M., Widstrom, N. W., Wiseman, B. R. and Coe, E. H. 1996. Quantitative trait loci and metabolic pathways: Genetic control of the concentration of maysin, a corn earworm resistance factor, in maize silks. *Proc Natl Acad Sci USA* 93: 8820-8825.

Chang, S., Puryear, J. and Cairney, J. 1993. A simple and efficient method for isolating RNA from pine trees. *Plant Mol Biol Rep* 11: 113-116.

Chattaway, M. M. 1952. The sapwood-heartwood transition. *Aust For* 26: 25-34.

Claudot, A.-C., Jay-Allemand, C., Magel, E. A. and Drouet, A. 1993. Phenylalanine ammonia-lyase, chalcone synthase and polyphenolic compounds in adult and rejuvenated hybrid walnut tree. *Trees* 7: 92-97.

Claudot, A.-C., Ernst, D., Heinrich, S. and Drouet, A. 1997. Chalcone synthase activity and polyphenolic compounds of shoot tissues from adult and rejuvenated walnut trees. *Planta* 203: 275-282.

Dangl, J., Hahlbrock, K. and Schell, J. 1989. Regulation and structure of chalcone synthase genes. In: Vasil, I. K. (ed), *Cell culture and somatic cell genetics of plants*, Academic Press, New York, pp. 155-173.

De Groot, R. C., Woodward, B. and Hennon, P. E. 2000. Natural decay resistance of heartwood from dead, standing yellow-cedar trees: laboratory evaluations. *For Prod J* 50: 53-59.

Dellus, V. 1995. Polyphénols et origine biochimique de la couleur du bois de coeur de sapin de Douglas *Pseudotsuga menziesii* [Mirb.] Franco. Ph.D. Dissertation. Université Paul Sabatier. Toulouse, France, 15-9-1995. 211 pages.

Dellus, V., Scalbert, A. and Janin, G. 1997a. Polyphenols and colour of douglas-fir heartwood. *Holzforschung* 51: 291-295.

Dellus, V., Mila, I., Scalbert, A., Menard, C., Michon, V. and Herve du Penhoat, C. L. M. 1997b. Douglas-fir polyphenols and heartwood formation. *Phytochem* 45: -1573.

Dixon, R. A. and Paiva, N. L. 1995. Stress-induced phenylpropanoid metabolism. *Plant Cell* 7: 1085-1097.

Dooner, H. K., Robbins, T. P. and Jorgensen, R. A. 1991. Genetic and developmental control of anthocyanin biosynthesis. *Annual Rev Plant Physiol Plant Mol Biol* 25: 173-199.

Duroux, L., Delmotte, F. M., Lancelin, J.-M., Kéraviss, G. and Jay-Allemand, C. 1998. Insight into naphthoquinone metabolism: b-glucosidase-catalysed hydrolysis of hydrojuglone β -D-glucopyranoside. *Biochem J* 333: 275-283.

Ebermann, R. and Stich, K. 1985. Distribution and seasonal variation of wood peroxidase activity in oak (*Quercus robur*). *Wood Fiber Sci* 17: 391-396.

Ehltling, J., Büttner, D., Wang, Q., Douglas, C. J., Somssich, I. E. and Kombrink, E. 1999. Three 4-coumarate:coenzyme A ligases in *Arabidopsis thaliana* represent two evolutionary divergent classes in angiosperms. *Plant J* 19: 9-20.

El Euch, C., Jay-Allemand, C., Pastuglia, M., Doumas, P., Charpentier, J. P., Capelli, P. and Jouanin, L. 1998 . Expression of antisense chalcone synthase RNA in transgenic hybrid walnut microcuttings. Effect on flavonoid content and rooting ability. *Plant Mol Biol* 38: 467-479.

El Euch, C. 1997. Caractérisation des gènes chalcone synthase (*chs*) chez le noyer hybride *Juglans nigra* x *Juglans regia* et modulation de l'activité CHS par la stratégie antisens. Ph.D. Dissertation. Université de Paris-Sud Centre d'Orsay, France, 20-2-1997. 113 pages.

Faktor, O., Loake, G., Dixon, R. A. and Lamb, C. J. 1997. The G-box and H-box in a 39 bp region of a French bean chalcone synthase promoter constitute a tissue-specific regulatory element. *Plant J* 11: 1105-1113.

Fengel, D. 1970. Ultrastructural changes during aging of wood cells. *Wood Sci Technol* 4: 176-188.

Fengel, D. 1991. Chemical studies on the wood of quebracho colorado (*Schinopsis balansae* Engl.) Part I. Composition of sapwood and heartwood. *Holzforschung* 45: 259-263.

Frey-Wyssling, A. and Bosshard, H. H. 1959. Cytology of the ray cells in sapwood and heartwood. *Holzforschung* 13: 129-137.

Frohman, M. A., Dush, M. K. and Martin, G. R. 1988. Rapid production of full-length cDNAs from rare transcripts: amplification using a single gene-specific oligonucleotide primer. *Proc Natl Acad Sci USA* 85: 8998-9002.

Gardner, K. H. and Barton, G. M. 1960. The distribution of dihydroquercetin in Douglas-fir and western larch. *For Prod J* 10: 171-173.

Giannini, R., Mercurio, R. 1997. Il noce comune per la produzione legnosa. Avenue Media, Bologna, Italy.

Gong, Z., Yamazaki, M., Sugiyama, M., Tanaka, Y. and Saito, K. 1997. Cloning and molecular analysis of structural genes involved in anthocyanin biosynthesis and expressed in a forma-specific manner in *Perilla frutescens*. *Plant Mol Biol* 35: 915-927.

Grotewold, E., Chamberlin, M., Snook, M., Siame, B., Butler, L., Swenson, J., Maddock, S., Clair, G. S. and Bowen, B. 1998. Engineering secondary metabolism in maize cells by ectopic expression of transcription factors. *Plant Cell* 10: 721-740.

Han, K.-H., Kamden, P., Retzel, E., Davis, J. and Kapur, V., 2000. Genomics of heartwood formation. Proceedings of the 6th International Congress of Plant Molecular Biology. Québec, Canada, 18-24 June 2000. *Supplement to Plant Molecular Biology Reporter*, 18(2): abstract S26-10.

Harker, C. L., Ellis, T. H. N. and Coen, E. S. 1990. Identification and genetic regulation of the chalcone synthase multigene family in pea. *Plant Cell* 2: 185-194.

- Hartmann, U., Valentine, W. J., Christie, J. M., Hays, J., Jenkins, G. I. and Weisshaar, B. 1998.** Identification of UV/blue light-response elements in the *Arabidopsis thaliana* chalcone synthase promoter using a homologous protoplast transient. *Plant Mol Biol* 36: 741-754.
- Haslam, E. 1989.** Plant polyphenols. Vegetable tannins revisited. Cambridge University Press, Cambridge, Great Britain.
- Hauch, S. and Magel, E. 1998.** Extractable activities and protein content of sucrose-phosphate synthase, sucrose synthase and neutral invertase in trunk tissues of *Robinia pseudoacacia* L. are related to cambial wood production and heartwood formation. *Planta* 207: 266-274.
- Hägglund, E. 1951.** The chemistry of wood. Academic Press, London: pp 15-16.
- Helariutta, Y., Kotilainen, M., Elomaa, P. and Teeri, T. 1995.** *Gerbera hybrida* (Asteraceae) imposes regulation at several anatomical levels during inflorescence development on the gene for dihydroflavonol-4-reductase. *Plant Mol Biol* 28: 935-941.
- Heller, W. and Forkmann, G. 1994.** Biosynthesis of flavonoids. In: Harborne, J. B. (ed), The flavonoids: Advances in research since 1986, Chapman & Hall, London, pp. 499-535.
- Hengerer, B. 1993.** A rapid procedure for mRNA extraction from a large number of samples. *BioTechniques* 14: 522-524.
- Higuchi, T. 1997.** Biochemistry and molecular biology of wood. Springer-Verlag, Berlin, Germany. p 362.
- Hillis, W. E. 1956.** Leucoanthocyanidins as the possible precursors of extractives in woody tissues. *Aust J Biol Sci* 9: 263-280.
- Hillis, W. E. and Hasegawa, M. 1963.** The formation of polyphenols in trees. 1. Administration of ¹⁴C glucose and subsequent distribution of radioactivity. *Phytochem* 2: 195-199.
- Hillis, W. E. 1987.** Heartwood and tree exudates. Springer-Verlag, Berlin, Germany. p 268.
- Holton, T. A. and Cornish, E. C. 1995.** Genetics and biochemistry of anthocyanin biosynthesis. *Plant Cell* 7: 1071-1083.
- Höll, W. and Lendzian, K. 1973.** Respiration in the sapwood and heartwood of *Robinia pseudoacacia*. *Phytochem* 12: 975-977.
- Höll, W. 2000.** Distribution, fluctuation and metabolism of food reserves in the wood of trees. In: Savidge, R. A., Barnett, J., and Napier, R. (eds), Cell and molecular biology of wood formation, BIOS Scientific Publishers Ltd, Oxford, pp. 347-362.
- Hu, W.-J., Kawaoka, A., Tsai, C.-J., Lung, J., Osakabe, K., Ebinuma, H. and Chiang, V. L. 1998.** Compartmentalized expression of two structurally and functionally distinct 4-coumarate:CoA ligase genes in aspen (*Populus tremuloides*). *Proc Natl Acad Sci USA* 95: 5407-5412.
- Institut pour le développement forestier 1997.** Les noyers à bois. Institut pour le développement forestier, Paris, France. p 144.
- Jones, D. H. 1984.** Phenylalanine ammonia-lyase: regulation of its induction and its role in plant development. *Phytochem* 23: 1349-1984.

Junghans, H., Dalkin, K. and Dixon, R. A. 1993. Stress response in alfalfa (*Medicago sativa* L.). 15. Characterization and expression patterns of members of a subset of the chalcone synthase multigene family. *Plant Mol Biol* 22: 239-253.

Kaldenhoff, R., Grote, K., Zhu, J.-J. and Zimmermann, U. 1998. Significance of plasmalemma aquaporins for water-transport in *Arabidopsis thaliana*. *Plant J* 14: 121-128.

Karrer, E. E., Lincoln, J. E., Hogenhout, S., Bennett, A. B., Bostock, R. M., Martineau, B., Lucas, W. J., Gilchrist, D. G. and Alexander, D. 1995. *In situ* isolation of mRNA from individual plant cells: Creation of cell-specific cDNA libraries. *Proc Natl Acad Sci USA* 92: 3814-3818.

Kemp, M. S. and Burden, R. S. 1986. Phytoalexins and stress metabolites in the sapwood of trees. *Phytochem* 25: 1261-1269.

Kjellbom, P., Larsson, C., Johansson, I., Karlsson, M. and Johansson, U. 1999. Aquaporins and water homeostasis in plants. *Trends Plant Sci* 4: 308-314.

Koes, R. E., Spelt, C. E., van den Elzen, P. J. M. and Mol, J. N. M. 1989. Cloning and molecular characterization of the chalcone synthase multigene family of *Petunia hybrida*. *Gene* 81: 245-257.

Koes, R. E., van Blokland, R., Quattrocchio, F., van Tunen, A. J. and Mol, J. N. M. 1990. Chalcone synthase promoters in *Petunia* are active in pigmented and unpigmented cell types. *Plant Cell* 2: 379-392.

Koes, R. E., Quattrocchio, F. and Mol, J. N. M. 1994. The flavonoids biosynthetic pathway in plants: function and evolution. *BioEssay* 16: 123-132.

Koopmann, E., Logemann, E. and Hahlbrock, K. 1999. Regulation and functional expression of cinnamate 4-hydroxylase from parsley. *Plant Physiol* 119: 49-55.

Kubasek, W. L., Shirley, B. W., McKillop, A., Goodman, H. M., Briggs, W. and Ausubel, F. M. 1992. Regulation of flavonoid biosynthetic genes in germinating *Arabidopsis* seedlings. *Plant Cell* 4: 1229-1236.

Kubasek, W. L., Ausubel, F. M. and Shirley, B. W. 1998. A light-independent developmental mechanism potentiates flavonoid gene expression in *Arabidopsis* seedlings. *Plant Mol Biol* 37: 217-223.

Label, P., Beritognolo, I., Burtin, P., Dehon, L., Couée, I., Breton, C., Charpentier, J.-P. and Jay-Allemand, C. 2000. Cambial activity and xylem differentiation in walnut (*Juglans sp.*). In: Savidge, R., Barnett, J., and Napier, R. (eds), Cell and molecular biology of wood formation, BIOS Scientific Publishers Ltd, Oxford, pp. 209-221.

Larrick, J. W., Siebert, P. D. 1995. Reverse transcriptase PCR. Hellis Horwood, London. 346 p.

Larson, P. R. 1994. The vascular cambium. Springer Verlag, Berlin, Germany. 725 p.

Lee, D., Ellard, M., Wanner, L. A., Davis, K. R. and Douglas, C. J. 1995. The *Arabidopsis thaliana* 4-coumarate:CoA ligase (*4CL*) gene: stress and developmentally regulated expression and nucleotide sequence of its cDNA. *Plant Mol Biol* 28: 871-884.

Leslie, C. A. and McGranahan, G. H. 1998. The origin of walnut. In: Ramos, D. E. (ed), Walnut production manual, University of California, Oakland, California, pp. 3-7.

Lewis, N. G., Davin, L. B. and Sarkanen, S. 1999. The nature and function of lignins. In: Barton, S. H. D. R. and Nakanishi, K. (eds), *Comprehensive natural products chemistry. Carbohydrates and their derivatives including tannins, cellulose and related lignins*, Elsevier, Amsterdam, New York, pp. 617-745.

Liang, X., Dron, M., Schmid, J., Dixon, R. A. and Lamb, C. J. 1989. Developmental and environmental regulation of a phenylalanine ammonia-lyase-b-glucuronidase gene fusion in transgenic tobacco plants. *Proc Natl Acad Sci USA* 86: 9284-9288.

Logemann, E., Parniske, M. and Hahlbrock, K. 1995. Modes of expression and common structural features of the complete phenylalanine ammonia-lyase gene family in parsley. *Proc Natl Acad Sci USA* 92: 5905-5909.

Magel, E., Drouet, A., Claudot, A. C. and Ziegler, H. 1991. Formation of heartwood substances in the stem of *Robinia pseudoacacia* L. I. Distribution of phenylalanine ammonium lyase and chalcone synthase across the trunk. *Trees* 5: 203-207.

Magel, E., Jay-Allemand, C. and Ziegler, H. 1994. Formation of heartwood substances in the stemwood of *Robinia pseudoacacia* L. II. Distribution of nonstructural carbohydrates and wood extractives across the trunk. *Trees* 8: 165-171.

Magel, E. and Hübner, B. 1997. Distribution of phenylalanine ammonia lyase and chalcone synthase within trunks of *Robinia pseudoacacia* L. *Bot Acta* 110: 314-322.

Magel, E. 2000. Biochemistry and physiology of heartwood formation. In: Savidge, R., Barnett, J., and Napier, R. (eds), *Molecular and cell biology of wood formation*, BIOS Scientific Publishers Ltd, Oxford, pp. 363-376.

Magel, E., Amani, A.-L. and Hampp, R. 2001. Non-structural carbohydrates and catalytic activities of sucrose metabolizing enzymes in trunks of two *Juglans* species and their role in heartwood formation. *Holzforschung* 55: 135-145.

Martin, C. and Paz-Ares, J. 1997. MYB transcription factors in plants. *Trends Genet* 13: 67-73.

Martin, C. R. 1993. Structure, function, and regulation of the chalcone synthase. *Int Rev Cytol* 147: 233-284.

McMurrough, I. and Baert, T. 1994. Identification of proanthocyanidins in beer and their direct measurement with a dual electrode electrochemical detector. *J Inst Brew* 100: 409-416.

Mol, J., Jenkins, G., Schäfer, E. and Weiss, D. 1996. Signal perception, transduction and gene expression involved in anthocyanin biosynthesis. *Critical Rev Plant Sci* 15: 525-557.

Mol, J., Grotewold, E. and Koes, R. 1998. How genes paint flowers and seeds. *Trends Plant Sci* 3: 212-217.

Nardi Berti, R. 1979. La struttura anatomica del legno ed il riconoscimento dei legnami italiani di più corrente impiego. Consiglio Nazionale delle Ricerche, Istituto del legno, Firenze, Italy.

Nelson, N. D. 1975. Extractives produced during heartwood formation in relation to amounts of parenchyma in *Juglans nigra* and *Quercus rubra*. *Can J For Res* 5: 291-301.

Nelson, N. D. 1976. Gross influences on heartwood formation in black walnut and black cherry trees. U.S. Department of Agriculture Forest Service, Forest Products Laboratory, Madison, WIS, USA.

Nelson, N. D. 1978. Xylem ethylene, phenol-oxidizing enzymes, and nitrogen and heartwood formation in walnut and cherry. *Can J Bot* 56: 626-634.

Nelson, N. D., Rietveld, W. J. and Isebrands J.G. 1981. Xylem ethylene production in five black walnut families in the early stages of heartwood formation. *For Sci* 27: 537-543.

Newmann, L. J. and Campbell, M. M. 2000. MYB proteins and xylem differentiation. In: Savidge, R. A., Barnett, J., and Napier, R. (eds), BIOS Scientific Publishers Ltd, Oxford, pp. 437-444.

Nicholls, J. W. P. and Brown, A. G. 1974. The inheritance of heartwood formation in *Pinus radiata* D. Don. *Silvae Genetica* 23: 138-141.

Nobuchi, T., Kuroda, K., Ryutarou, I. and Harada Hiroshi . 1982. Cytological study of the seasonal features of heartwood formation of sugi (*Cryptomeria japonica* D. Don). *Mokuzai Gakkaishi* 28: 669-676.

Nobuchi, T. and Harada, H. 1983. Physiological features of the "white zone" of sugi (*Cryptomeria japonica* D. Don) cytological structure and moisture content. *Mokuzai Gakkaishi* 29: 824-832.

Nobuchi, T., Sato, T., Iwata, R. and Harada, H. 1984. Season of heartwood formation and the related cytological structure of ray parenchyma cells in *Robinia pseudoacacia* L. *Mokuzai Gakkaishi* 30: 628-636.

Nobuchi, T., Matsuno, H. and Harada, H. 1985. Radial distribution of heartwood phenols and the related cytological structure in the fresh wood of sugi (*Cryptomeria japonica* D. Don). *Mokuzai Gakkaishi* 31: 711-718.

Nobuchi, T., Tokuchi, N. and Harada, H. 1987. Variability of heartwood formation and cytological features in broad-leaved trees. *Mokuzai Gakkaishi* 33: 596-604.

Osakabe, Y., Osakabe, K., Kawai, S., Katayama, Y. and Morohoshi, N. 1995. Characterization of the structure and determination of mRNA levels of the phenylalanine ammonia-lyase gene family from *Populus kitakamiensis*. *Plant Mol Biol* 28: 1141.

Peng, S., Scalbert, A. and Monties, B. 1991. Insoluble ellagitannins in *Castanea sativa* and *Quercus petraea* woods. *Phytochem* 30: 775-778.

Preisig-Müller, R., Schwekendiek, A., Brehm, I., Reif, H.-J. and Kindl, E. 1999. Characterization of a pine multigene family containing elicitor-responsive stilbene synthase genes. *Plant Mol Biol* 39: 221-229.

Preston, G. M. 1997. Cloning gene family members using the polymerase chain reaction with degenerate oligonucleotide primers. In: Cowell, I. G. and Austin, C. A. (eds), Methods in molecular biology, Vol. 69. cDNA library protocols, Humana Press, Totowa, NJ, USA, pp. 97-113.

Quattrocchio, F., Wing, J. F., van der Woude, K., Mol, J. N. M. and Koes, R. 1998. Analysis of bHLH and MYB domain proteins: species-specific regulatory differences are caused by divergent evolution of target anthocyanin genes. *Plant J* 13: 475-488.

Ragg, H., Kuhn, D. N. and Hahlbrock, K. 1981. Coordinated regulation of 4-coumarate-CoA ligase and phenylalanine ammonia-lyase mRNAs in cultured plant cells. *J Biol Chem* 256: 10061-10065.

Rink, G. 1987. Heartwood color and quantity variation in a young black walnut progeny test. *Wood Fiber Sci* 19: 93-100.

Rosati, C., Cadic, A., Duron, M., Renou, J.-P. and Simoneau, P. 1997. Molecular cloning and expression analysis of dihydroflavonol 4-reductase gene in flower organs of *Forsythia x intermedia*. *Plant Mol Biol* 35: 303-311.

Ryder, T. B., Hedrick, S. A., Bell, J. N., Liang, X., Clouse, S. D. and Lamb, C. J. 1987. Organization and differential activation of a gene family encoding the plant defense enzyme chalcone synthase in *Phaseolus vulgaris*. *Mol Gen Genet* 210: 219-233.

Sambrook, J., Fritsch, E. F., Maniatis, T. 1989. Molecular cloning: a laboratory manual, 2nd Edn. Cold Spring Harbor Laboratory Press, New York. pp 7.0-7.84.

Schultz, T. P. and Nicholas, D. D. 2000. Naturally durable heartwood: evidence for a proposed dual defensive function of the extractives. *Phytochem* 54: 47-52.

Shain, L. and Hillis, W. E. 1973. Ethylene production in xylem of *Pinus radiata* in relation to heartwood formation. *Can J Bot* 51: 1331-1335.

Shain, L. and Mackay, J. F. G. 1973. Seasonal fluctuations in respiration of aging xylem in relation to heartwood formation in *Pinus radiata*. *Can J Bot* 51: 737-741.

Shirley, B. W. 1996. Flavonoid biosynthesis: "new" functions for an "old" pathway. *Trends Plant Sci* 1: 377-382.

Stafford, H. A. 1991. Flavonoid evolution: an enzymic approach. *Plant Physiol* 96: 680-685.

Sterky, F., Regan, S., Karlsson, J., Hertzberg, M., Rohde, A., Holmberg, A., Amini, B., Bhalerao, R., Larsson, M., Villaroel, R., Van Montagu, M., Sandberg, G., Olsson, O., Teeri, T. T., Boerjan, W., Gustafsson, P., Uhlén, M., Sundberg, B. and Lundeberg, J. 1998. Gene discovery in the wood-forming tissues of poplar: Analysis of 5,692 expressed sequence tags. *Proc Natl Acad Sci USA* 95: 13330-13335.

Stewart, C. M. 1966. Excretion and heartwood formation in living trees. *Science* 153: 1068-1074.

Stokes, A. and Berthier, S. 2000. Irregular heartwood formation in leaning stems of maritime pine (*Pinus pinaster* Ait.) is related to eccentric radial stem growth. *For Ecol Manage* 135: 115-121.

Szopa, P. S., Garrett, H. E. and McGinnes, E. A. Jr. 1980. Growth -quality evaluation of black walnut wood. Part I - Specific gravity, growth rate, and percent extractables for trees grown on three different sites in Missouri. *Wood Science* 13: 95-98.

Thomson, R. H. 1979. Recent advances in the chemistry and biochemistry of quinone pigments. In: Swain, T., Harborne, J. B., and Van Sumere, C. F. (eds), *Biochemistry of plant phenolics*, Plenum Press, New York, pp. 287-312.

Treutter, D. 1989. Chemical reaction detection of catechins and proanthocyanidins with 4-dimethylamino-cinnamaldehyde. *J Chromatogr* 467: 185-193.

Treutter, D., Santos-Buelga, C., Gutmann, M. and Kolodziej, H. 1994. Identification of flavan-3-ols and proanthocyanidins by high-performance liquid chromatography and chemical reaction detection. *J Chromatogr* 667: 290-297.

van Eldik, G. J., Reijnen, W. H., Rüter, R. K., van Herpen, M. M. A., Schrauwen, J. A. M. and Wullems, G. J. 1997. Regulation of flavonol biosynthesis during anther and pistil development, and during pollen tube growth in *Solanum tuberosum*. *Plant J* 11: 105-113.

Weisshaar, B. and Jenkins, G. I. 1998. Phenylpropanoid biosynthesis and its regulation. *Curr Opin Plant Biol* 1: 251-257.

Whetten, R. W. and Sederoff, R. R. 1992. Phenylalanine ammonia-lyase from loblolly pine. *Plant Physiol* 98: 380-386.

Zhang, Y. and Frohman, M. A. 1997. Using rapid amplification of cDNA ends (RACE) to obtain full-length cDNAs. In: Cowell, I. G. and Austin, C. A. (eds), *Methods in molecular biology*, Vol. 69. cDNA library protocols, Humana Press, Totowa, NJ, USA, pp. 61-87.

Ziegler, H. 1968. Biological aspects of heartwood formation. *Holz Roh-Werkst* 26: 61-68.

Abstract

The main objective of this thesis was to identify genes controlling walnut wood quality. The formation of heartwood contributes to the natural colour and durability of wood. This physiological process was investigated at the biochemical and molecular levels in mature *Juglans nigra* trees. The temporal dynamics of heartwood expansion, the accumulation of flavonoid extractives, and the expression of genes encoding enzymes of flavonoid pathway were studied in xylem samples from *Juglans nigra* stems. Protocols for RNA extraction were optimised for very aged xylem samples and cDNA fragments corresponding to the genes under study were cloned from *Juglans nigra* xylem in order to obtain homologous probes. The comparison among samples collected at different seasonal periods suggested that new heartwood is formed mainly in the summer season. In all of the trees studied, soluble phenolic extractives accumulated during ageing of xylem growth rings. Flavanols strongly accumulated in the transition zone between sapwood and heartwood, suggesting that their biosynthesis was up-regulated concomitant to heartwood formation. The flavanol content in xylem correlated with the transcript levels of genes encoding the enzymes chalcone synthase (CHS), flavanone 3-hydroxylase (F3H), and dihydroflavonol 4-reductase (DFR) (flavonoid pathway). On the contrary, the expression patterns of genes encoding the enzymes phenylalanine ammonia-lyase (PAL), cinnamate 4-hydroxylase (C4H), and 4-coumarate-CoA ligase (4CL) (general phenylpropanoid pathway) did not correlate with the distribution of flavanols, even though *PAL* genes were strongly expressed in the transition zone. The comparison of transcript levels, protein pools, and catalytic activities of PAL and CHS suggested that the activities of these enzymes might differ in the mode of regulation. PAL activity would be regulated at the post-translation level, while CHS activity would be mainly regulated at the transcription level. The overall results indicate that in *Juglans nigra* trees flavanols are *de novo* synthesized in aged xylem, especially during the transformation of sapwood into heartwood. Flavanol accumulation appeared to be regulated mainly at the transcription level by the expression of genes encoding CHS, F3H, and DFR.

Résumé

Le principal objectif de cette thèse a été d'identifier les gènes contrôlant la qualité du bois de noyer. La formation du bois de cœur contribue à la couleur et la durabilité naturelle du bois. Ce processus physiologique a été étudié au niveau biochimique et moléculaire chez des arbres matures de *Juglans nigra*. La dynamique temporelle de l'expansion du bois de cœur, l'accumulation de flavonoïdes et l'expression des gènes codant pour les enzymes de la biosynthèse des flavonoïdes ont été étudiés à partir d'échantillons de xylème du tronc de *Juglans nigra*. Les protocoles pour l'extraction d'ARN ont été optimisés pour les échantillons de xylème très âgés et des fragments d'ADNc correspondants aux gènes étudiés ont été clonés à partir du xylème de *Juglans nigra* afin d'obtenir des sondes homologues. La comparaison entre les échantillons collectés à différentes saisons suggère que le nouveau bois de cœur soit formé principalement en été. Chez tous les arbres étudiés, des phénols solubles étaient accumulés durant le vieillissement des cernes de xylème. Des flavanols étaient fortement accumulés dans la zone de transition entre l'aubier et le bois de cœur, suggérant que leur biosynthèse soit activée en concomitance avec la formation du bois de cœur. Les teneurs en flavanols dans le xylème corrélaient avec le niveau d'expression des gènes codant pour les enzymes chalcone synthase (CHS), flavanol 3-hydroxylase (F3H) et dihydroflavonol 4-reductase (DFR) (voie des flavonoïdes). Au contraire, le patron d'expression des gènes codant pour les enzymes phénylalanine ammonia-lyase (PAL), cinnamate 4-hydroxylase (C4H) et coumarate:CoA ligase (4CL) (voie générale des phénylpropanoïdes) n'étaient pas corrélés avec la distribution des flavanols bien que les gènes *PAL* étaient fortement exprimés dans la zone de transition. La comparaison des niveaux des transcrits, des quantités de protéines et des activités catalytiques relatives à PAL et CHS suggèrent que les activités de ces enzymes aient des différents modes de régulation. L'activité de la PAL pourrait être régulée au niveau post-transcriptionnel tandis que l'activité de la CHS serait principalement régulée au niveau transcriptionnel. L'ensemble des résultats indique que, chez *Juglans nigra*, les flavanols sont synthétisés *de novo* dans le xylème âgé, spécialement durant la transformation de l'aubier en bois de cœur. L'accumulation des flavanols apparaît être régulée principalement au niveau transcriptionnel par l'expression des gènes codant pour la CHS, F3H et DFR.

Monsieur BERITOGNOLO Isacco

DOCTORAT de l'UNIVERSITE HENRI POINCARÉ, NANCY-I
en BIOLOGIE VEGETALE & FORESTIERE

VU, APPROUVÉ ET PERMIS D'IMPRIMER

Nancy, le *12 novembre 2001* n° 590

Le Président de l'Université

