



AVERTISSEMENT

Ce document est le fruit d'un long travail approuvé par le jury de soutenance et mis à disposition de l'ensemble de la communauté universitaire élargie.

Il est soumis à la propriété intellectuelle de l'auteur. Ceci implique une obligation de citation et de référencement lors de l'utilisation de ce document.

D'autre part, toute contrefaçon, plagiat, reproduction illicite encourt une poursuite pénale.

Contact : ddoc-theses-contact@univ-lorraine.fr

LIENS

Code de la Propriété Intellectuelle. articles L 122. 4

Code de la Propriété Intellectuelle. articles L 335.2- L 335.10

http://www.cfcopies.com/V2/leg/leg_droi.php

<http://www.culture.gouv.fr/culture/infos-pratiques/droits/protection.htm>

Université de Lorraine

École doctorale Stanislas – Langages -Temps - Sociétés

Samantha Dub

LA CÉRAMIQUE ANTIQUE DE L'AGGLOMÉRATION SECONDAIRE DE GRAND (VOSGES)

Volume II : Annexes



Thèse présentée et soutenue publiquement le 12 novembre 2018 à l'Université de Lorraine (Nancy)

En vue de l'obtention du titre de docteur Langues, littératures et civilisations spécialité Histoire,
civilisation, archéologie et art des mondes anciens et médiévaux

Sous la direction de Sandrine Huber

Devant un jury composé de :

Sandrine Huber, Professeur d'archéologie classique, université de Lille : directrice

Catherine Abadie-Reynal, Professeur d'archéologie classique, université de Lyon 2 : rapporteur

Pierre Nouvel, Professeur en archéologie classique, université de Bourgogne : rapporteur

Thierry Dechezleprêtre, Conservateur en chef du patrimoine, Conseil général des Vosges : examinateur

Armand Desbat, Directeur de recherche émérite, Maison de l'Orient méditerranéen, Lyon : examinateur

Marie-France Meylan-Krause, Directrice des sites et musée romains d'Avenches (Suisse) : examinateur

Pascal Vipard, Maître de conférences en Antiquités nationales, université de Lorraine : examinateur

Université de Lorraine

École doctorale Stanislas – Langages -Temps - Sociétés

Samantha Dub

LA CÉRAMIQUE ANTIQUE DE L'AGGLOMÉRATION SECONDAIRE DE GRAND (VOSGES)

Volume II : Annexes



Thèse présentée et soutenue publiquement le 12 novembre 2018 à l'Université de Lorraine (Nancy)

En vue de l'obtention du titre de docteur Langues, littératures et civilisations spécialité Histoire,
civilisation, archéologie et art des mondes anciens et médiévaux

Sous la direction de Sandrine Huber

Devant un jury composé de :

Sandrine Huber, Professeur d'archéologie classique, université de Lille : directrice

Catherine Abadie-Reynal, Professeur d'archéologie classique, université de Lyon 2 : rapporteur

Pierre Nouvel, Professeur en archéologie classique, université de Bourgogne : rapporteur

Thierry Dechezleprêtre, Conservateur en chef du patrimoine, Conseil général des Vosges : examinateur

Armand Desbat, Directeur de recherche émérite, Maison de l'Orient méditerranéen, Lyon : examinateur

Marie-France Meylan-Krause, Directrice des sites et musée romains d'Avenches (Suisse) : examinateur

Pascal Vipard, Maître de conférences en Antiquités nationales, université de Lorraine : examinateur

ANNEXE A

LES ROISES

Planche I

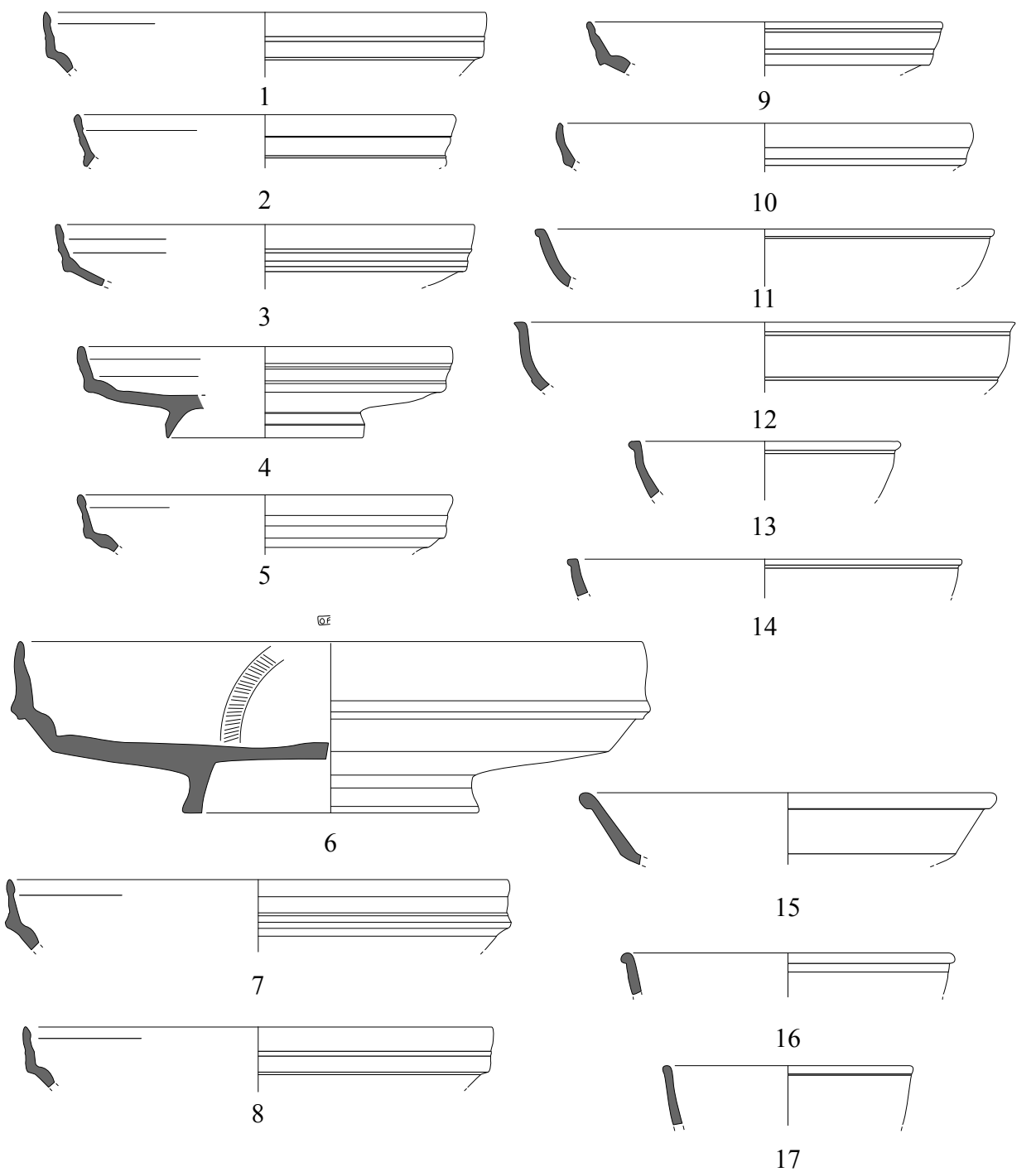

ANNEXE A
 LES ROISES
 Planche II

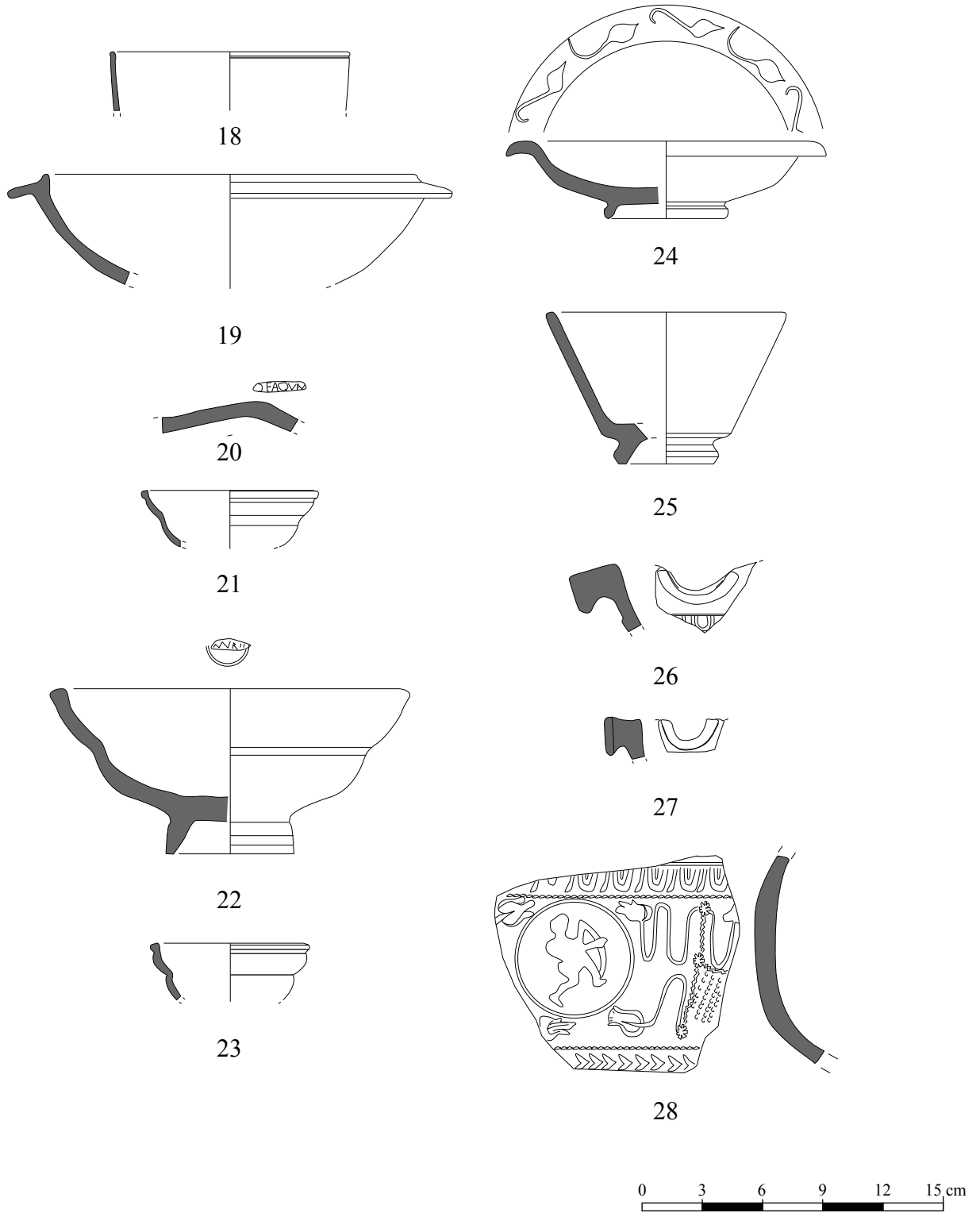

ANNEXE A
LES ROISES
Planche III

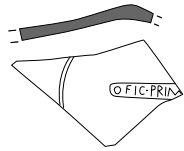

29



30

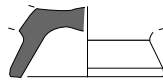

31

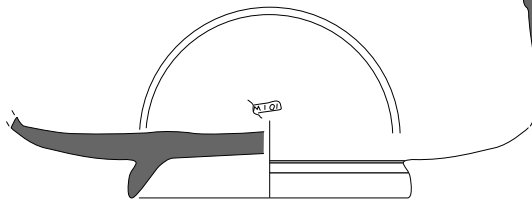

32



33

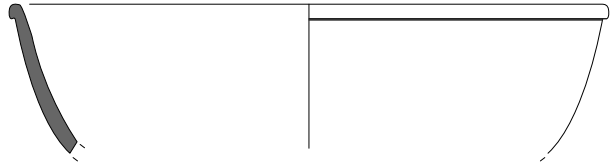

34

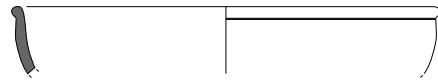

35

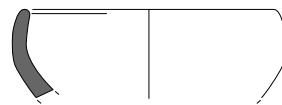

36

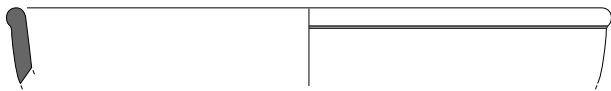

37

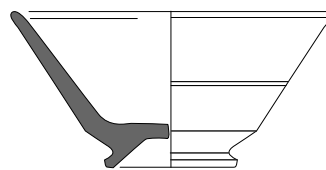

38

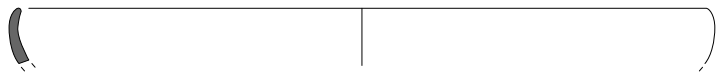

39

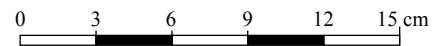

ANNEXE A
LES ROISES
Planche IV

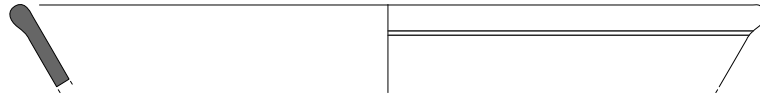

40



41

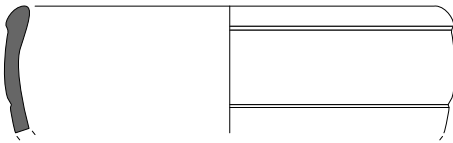

42

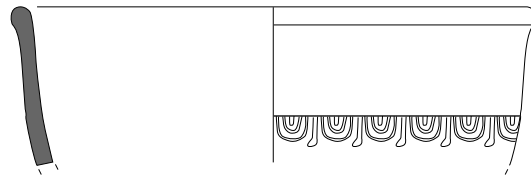

48

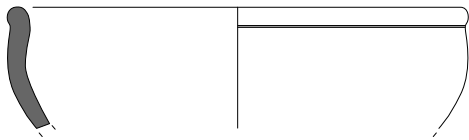

43

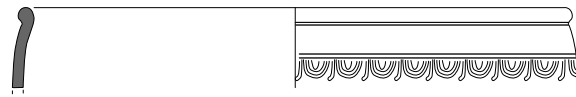

49

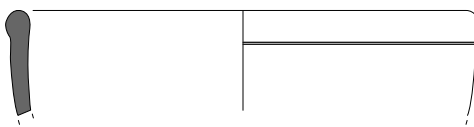

44

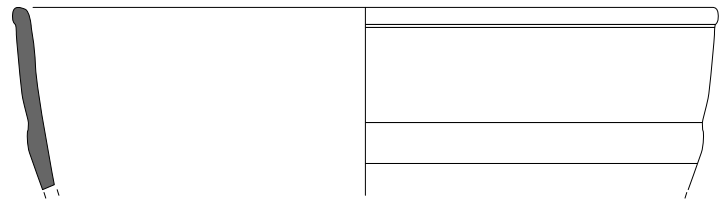

50

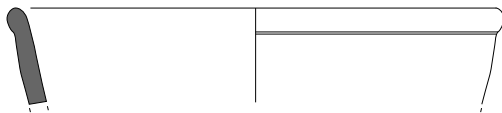

45

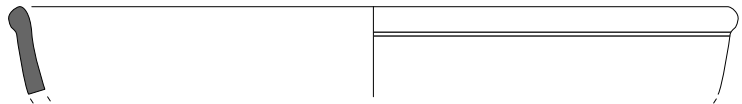

51

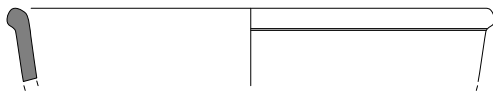

46

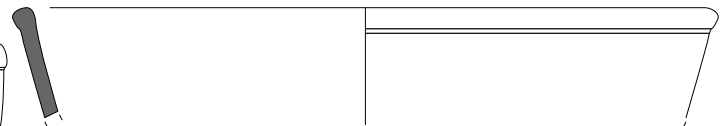

52

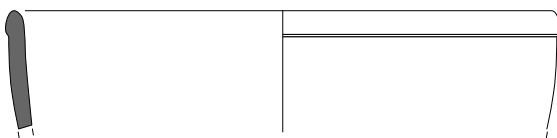

47



53

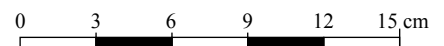

ANNEXE A
LES ROISES
Planche V

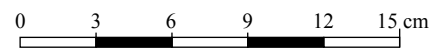
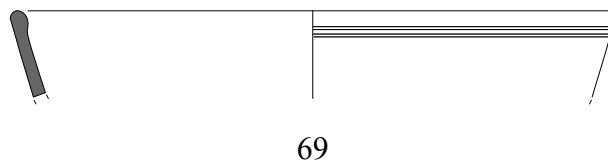
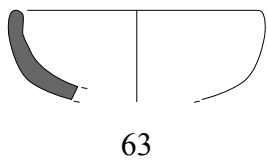
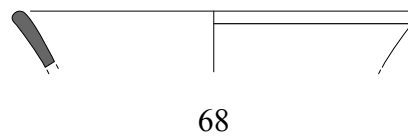
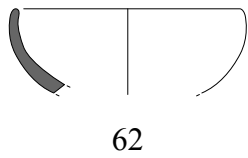
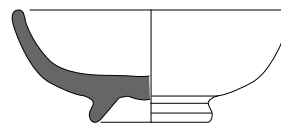
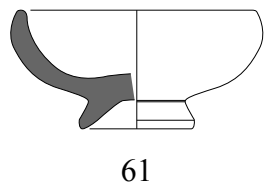
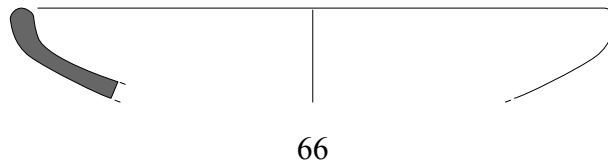
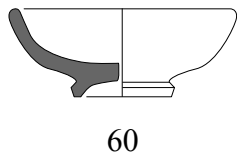
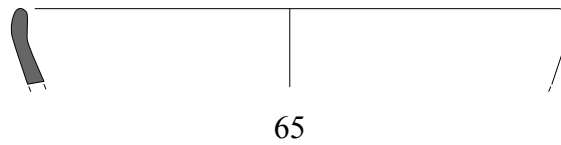
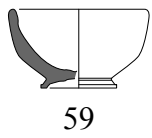
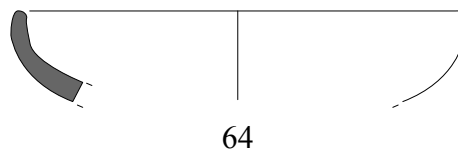
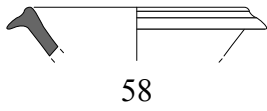
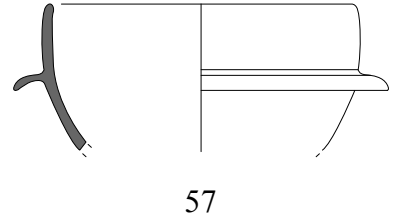
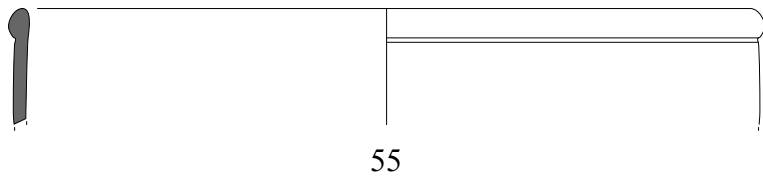
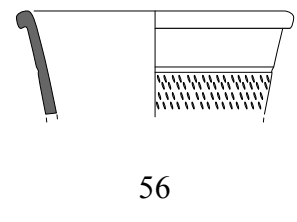
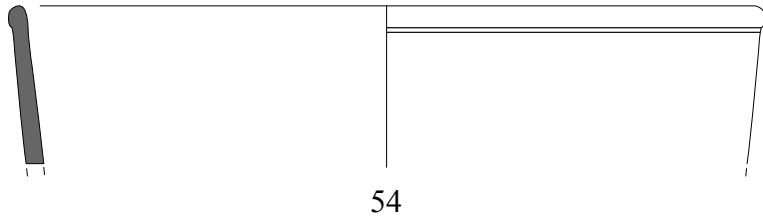

ANNEXE A
LES ROISES
Planche VI

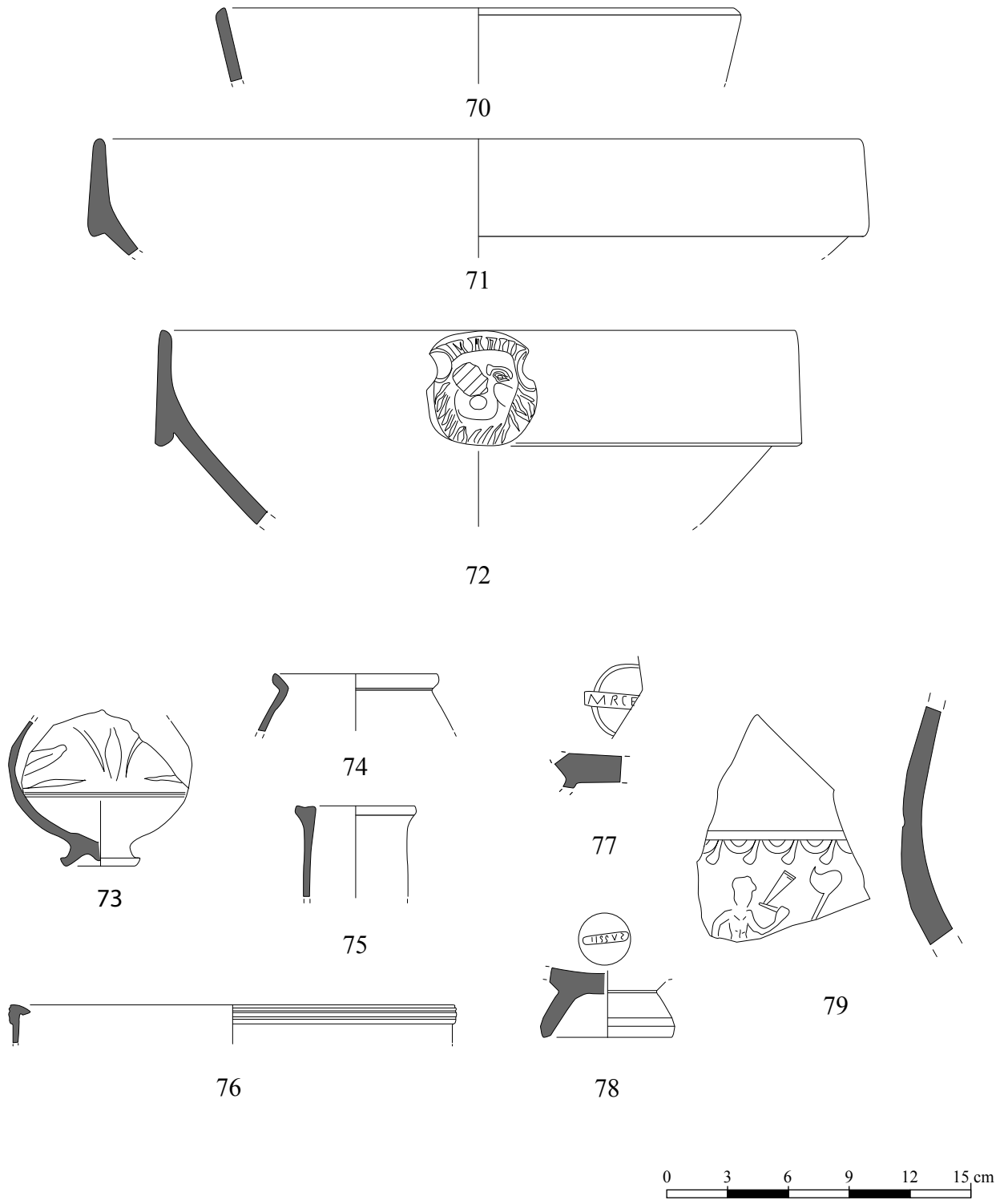

ANNEXE A
 LES ROISES
 Planche VII

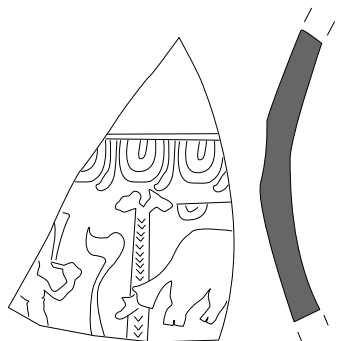

80

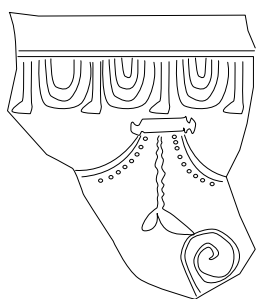

81

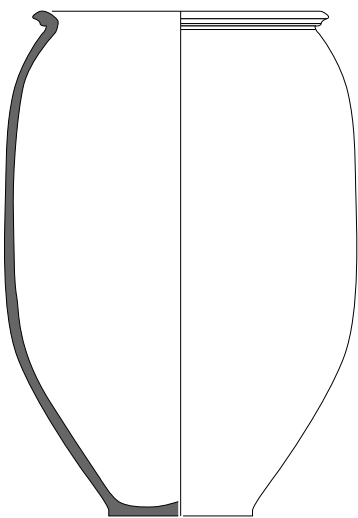

82

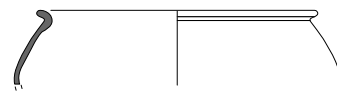

83

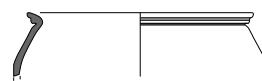

84

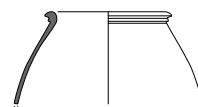

85

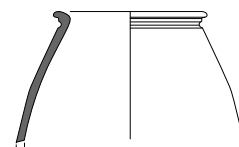

86



87

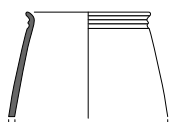

88

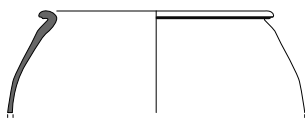

89

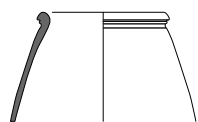

90

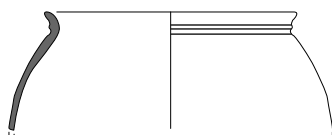

91

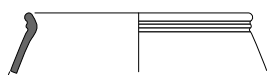

92



93

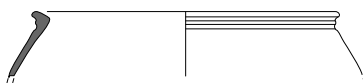

94



95

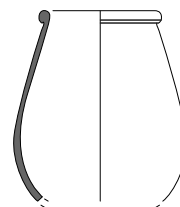

96

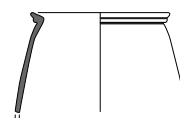

97

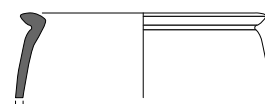

98



ANNEXE A
 LES ROISES
 Planche VIII

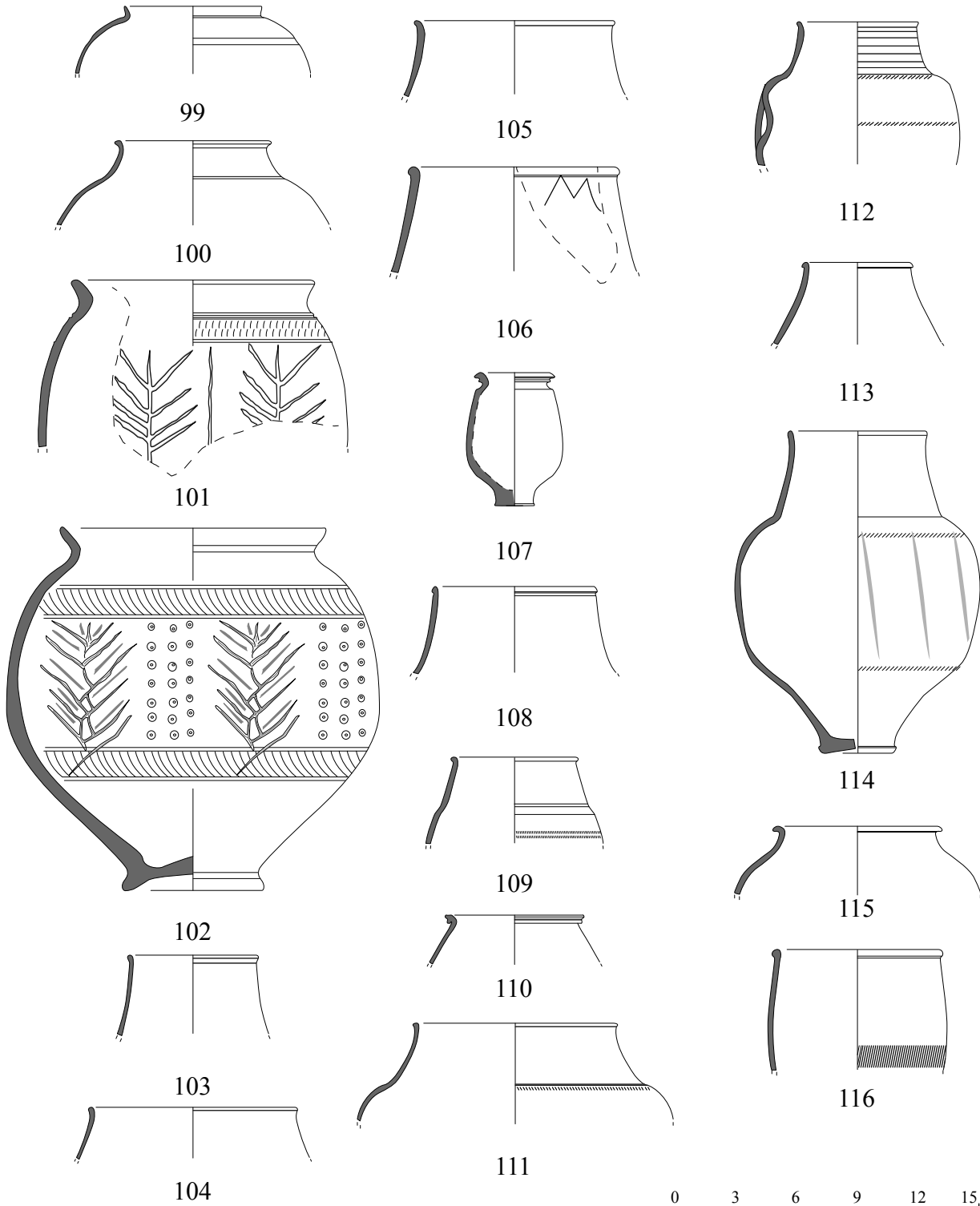

ANNEXE A
LES ROISES
Planche IX

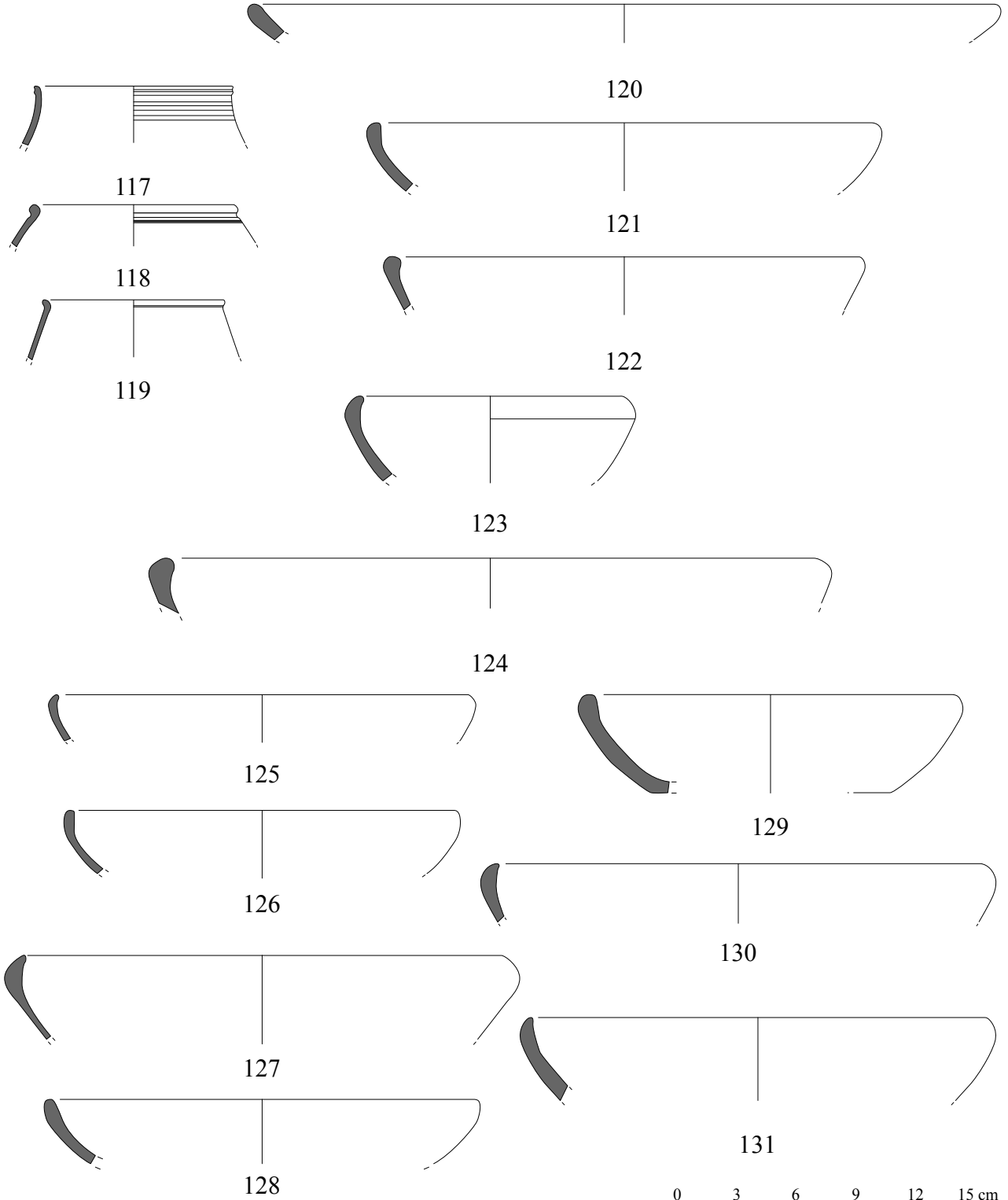

ANNEXE A
LES ROISES
Planche X

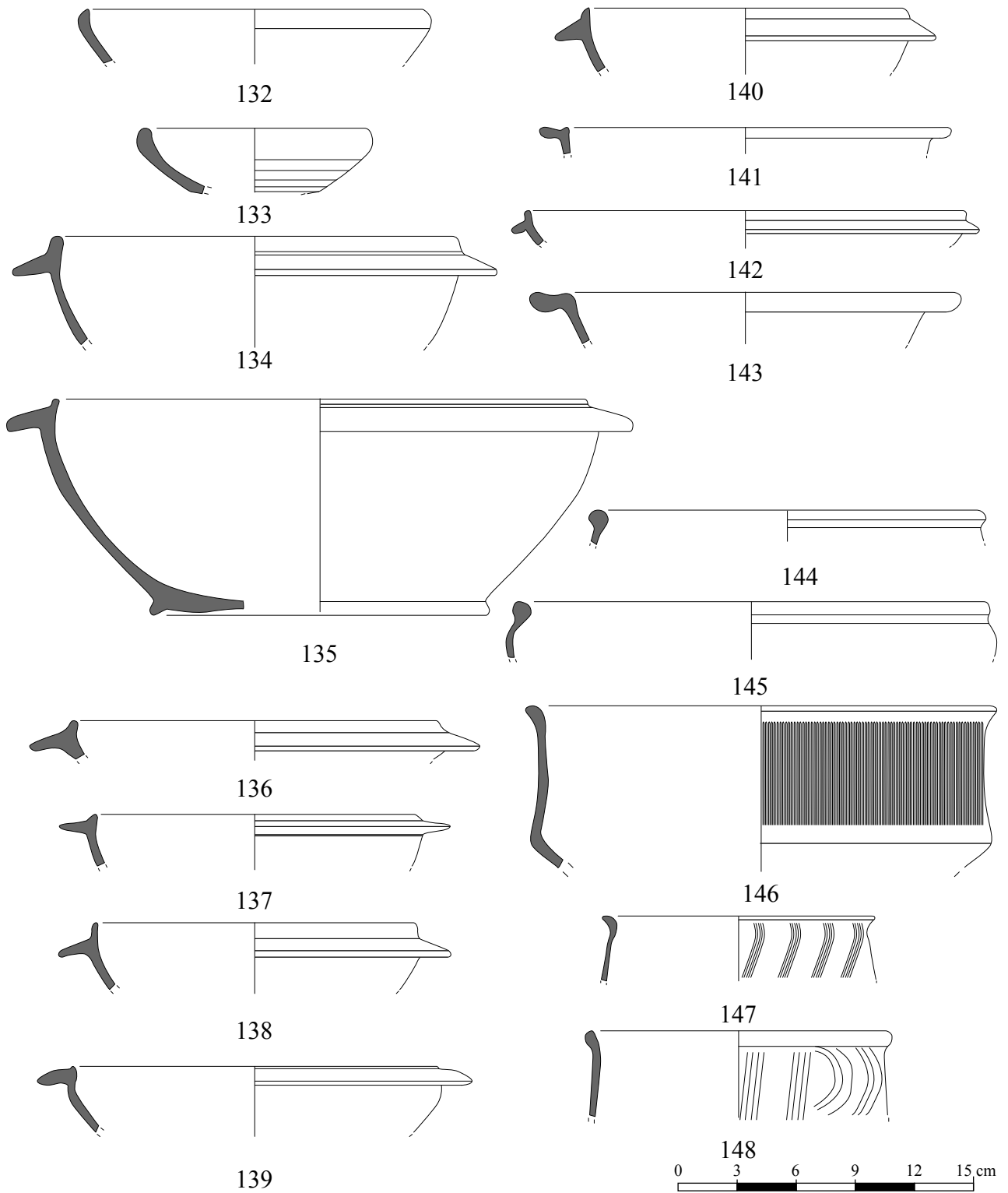

ANNEXE A
LES ROISES
Planche XI

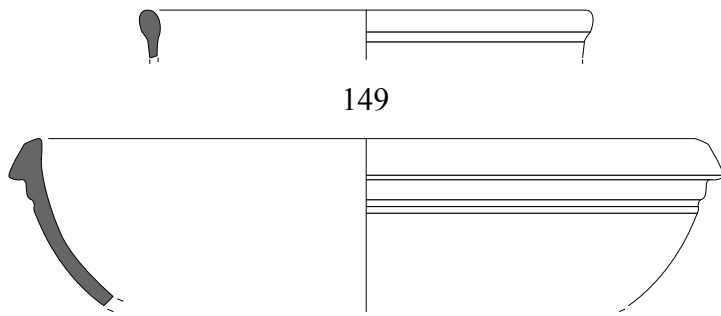

149

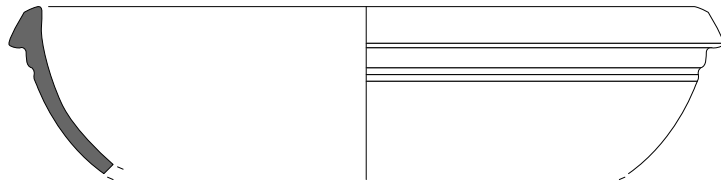

150

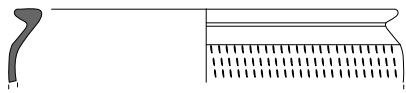

151



152

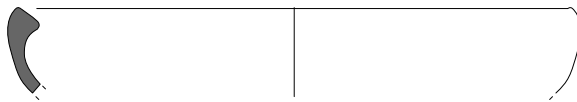

153



154

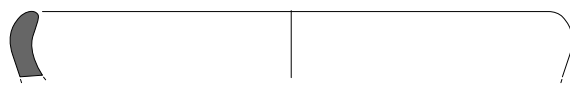

155

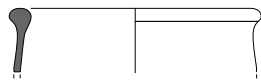

156



157



158

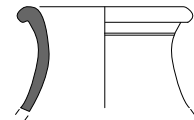

159



160

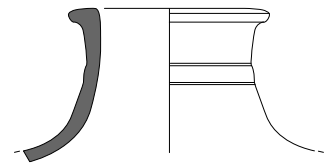

161

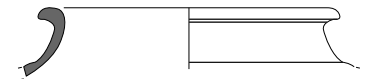

162



163

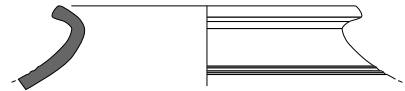

164

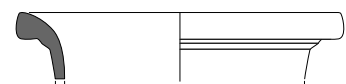

165

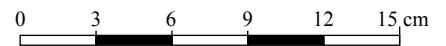

ANNEXE A
LES ROISES
Planche XII

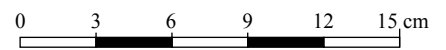
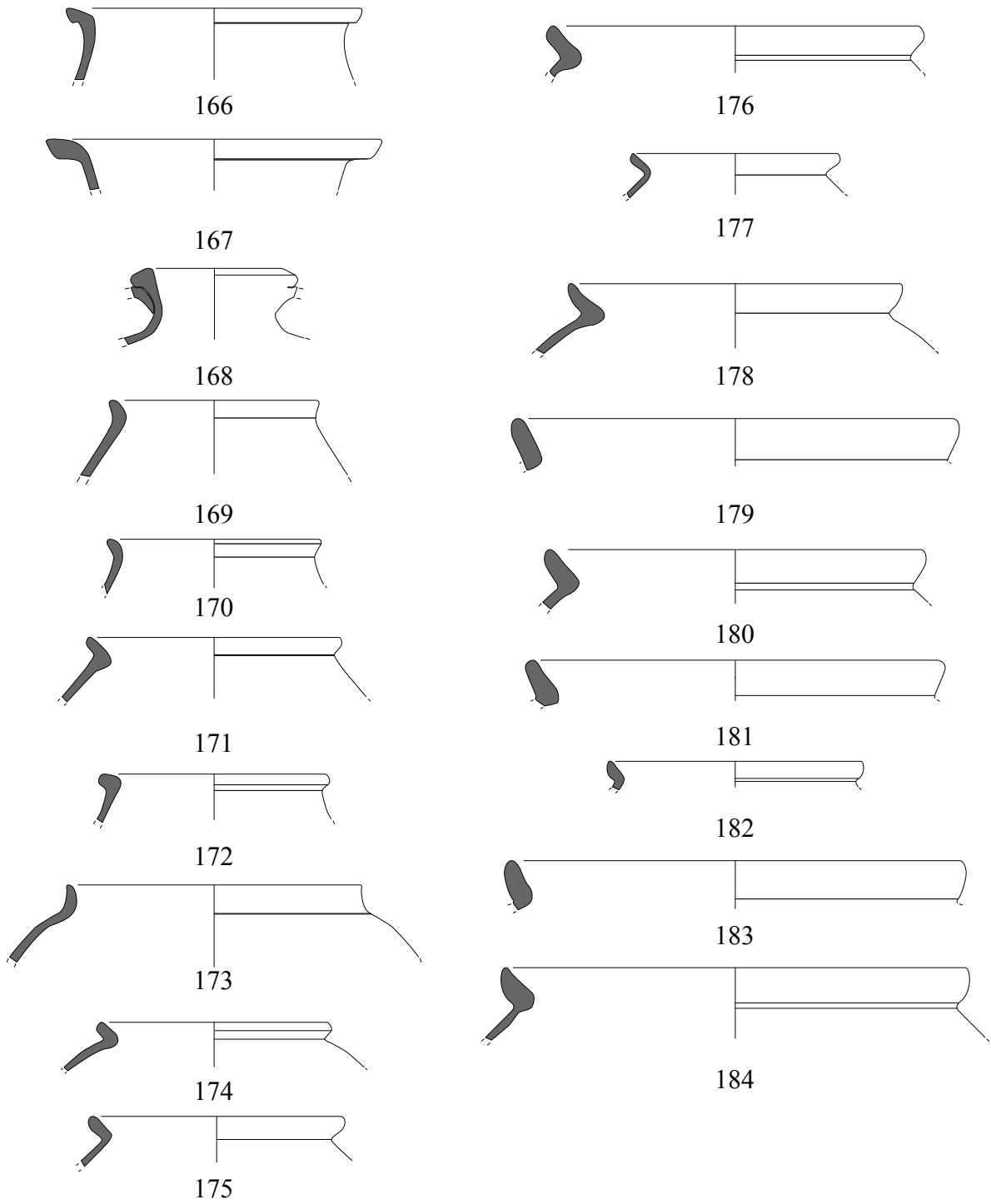

ANNEXE A
LES ROISES
Planche XIII

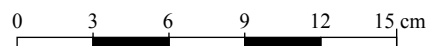
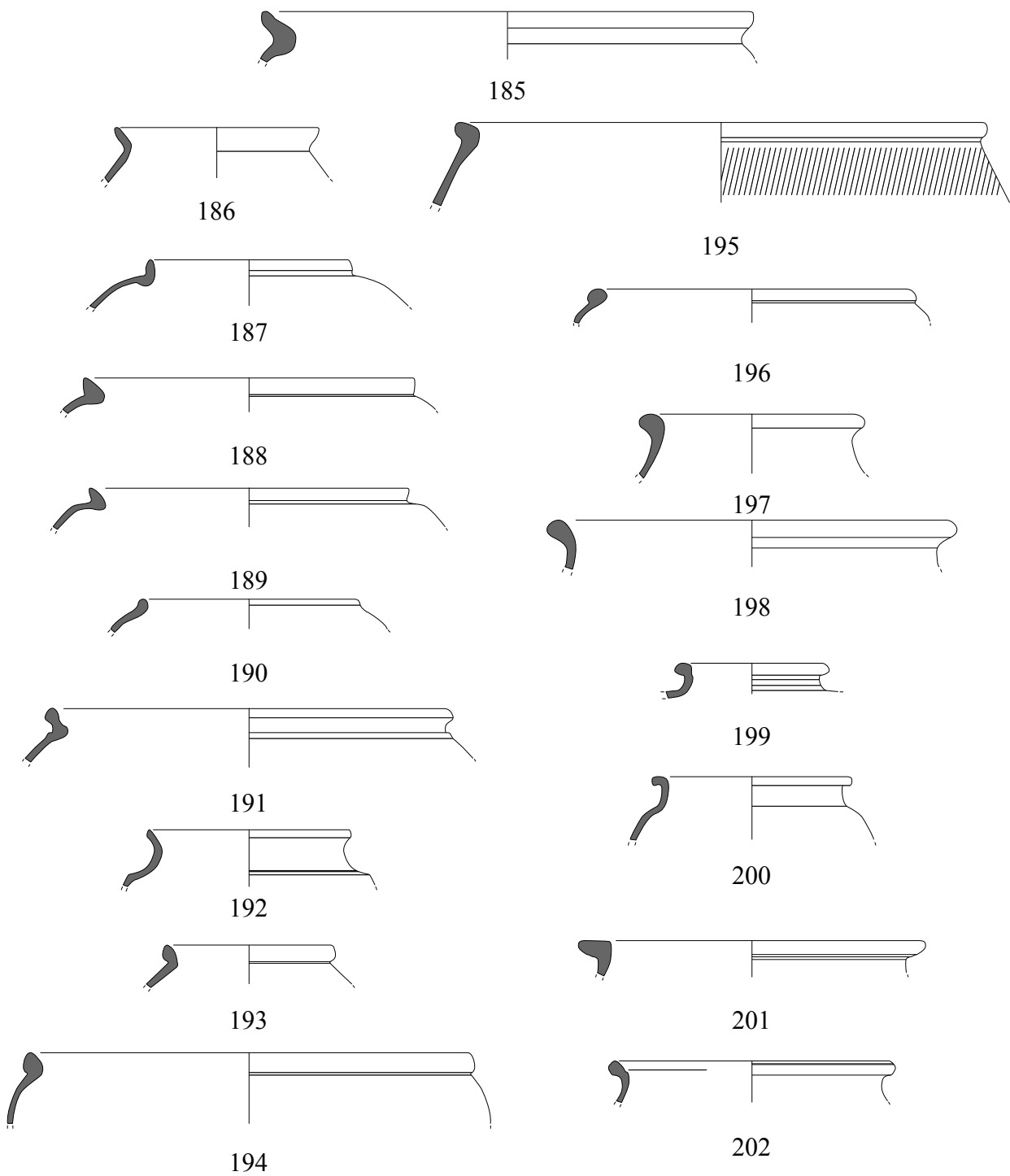

ANNEXE A
LES ROISES
Planche XIV

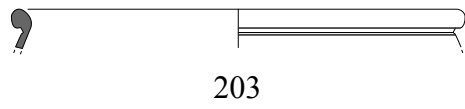

203



204

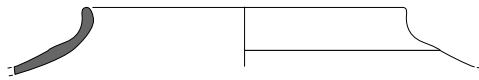

205



206



207



208

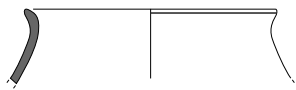

209

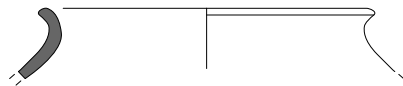

210



211



212



213

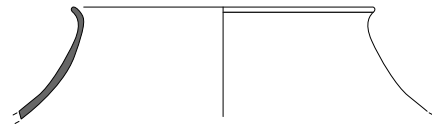

214

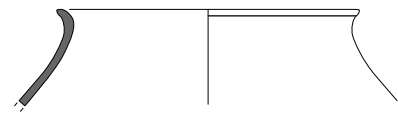

215

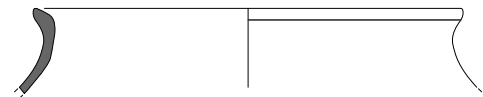

216

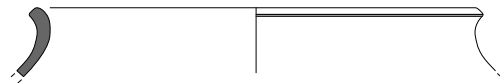

217

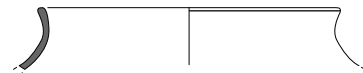

218

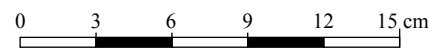

ANNEXE A
LES ROISES
Planche XV

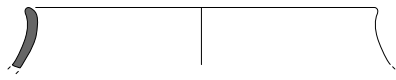

219



227

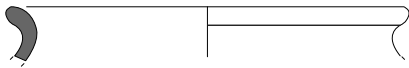

220



228

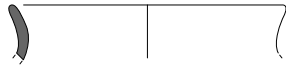

221

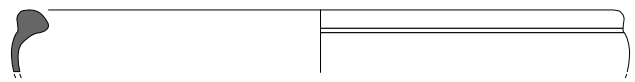

229

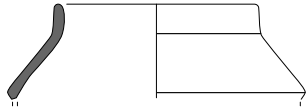

222

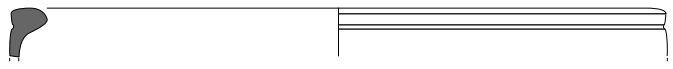

230



223

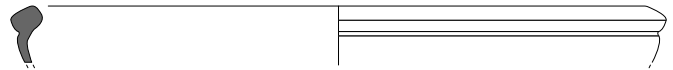

231

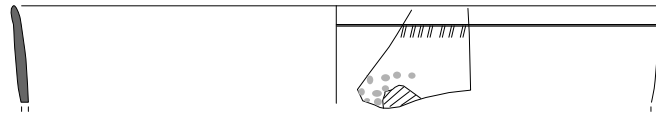

224

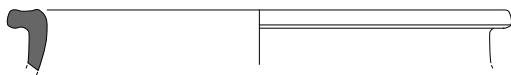

225

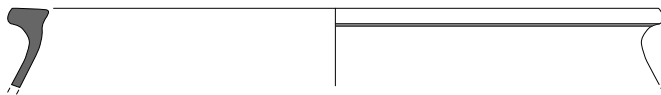

226

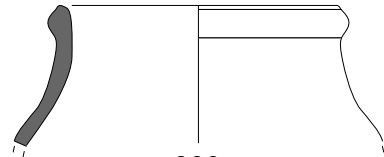

233

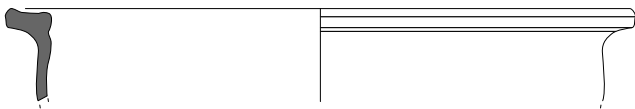

232

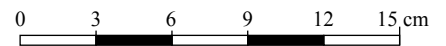

ANNEXE A
LES ROISES
Planche XVI

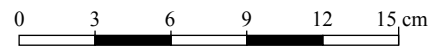
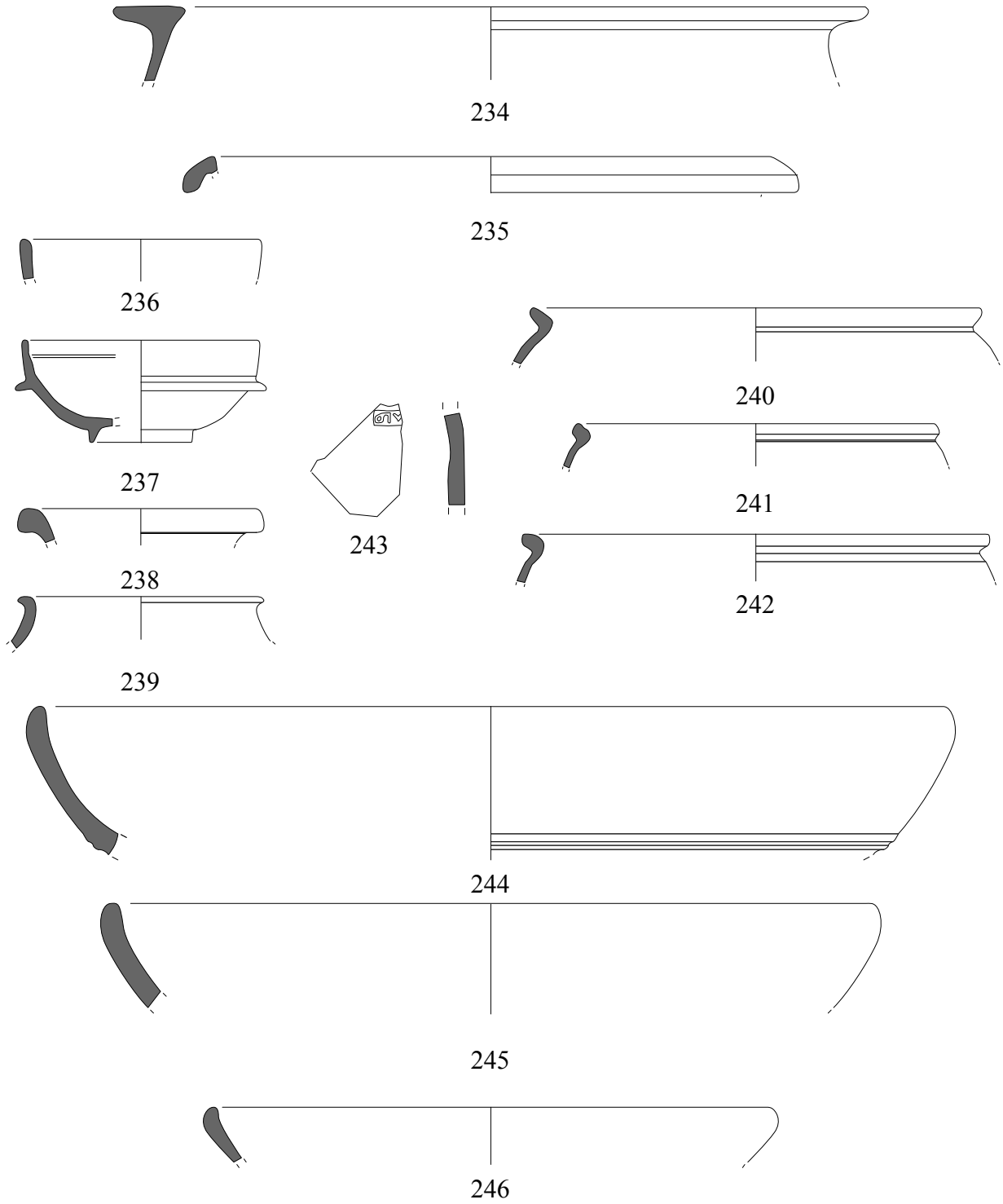

ANNEXE A
LES ROISES
Planche XVII



247

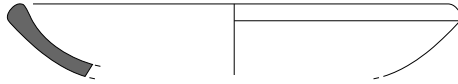

248

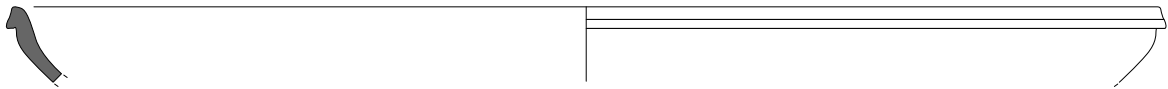

249



250

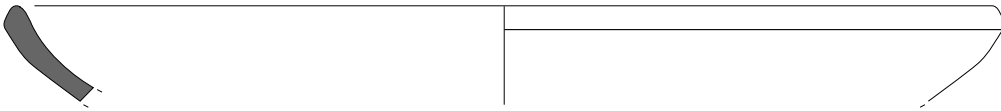

251

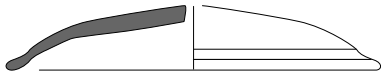

252

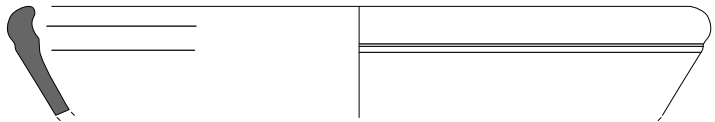

253

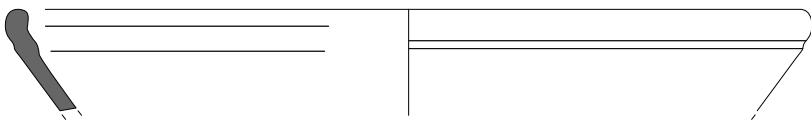

254

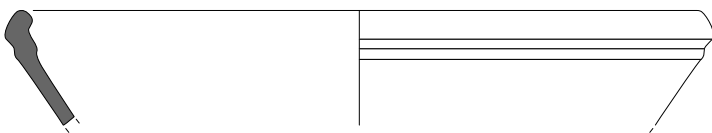

255

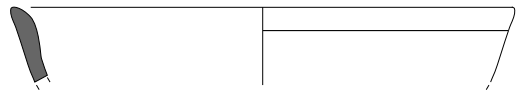

256



257

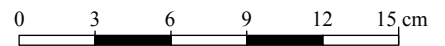

ANNEXE A
LES ROISES
Planche XVIII

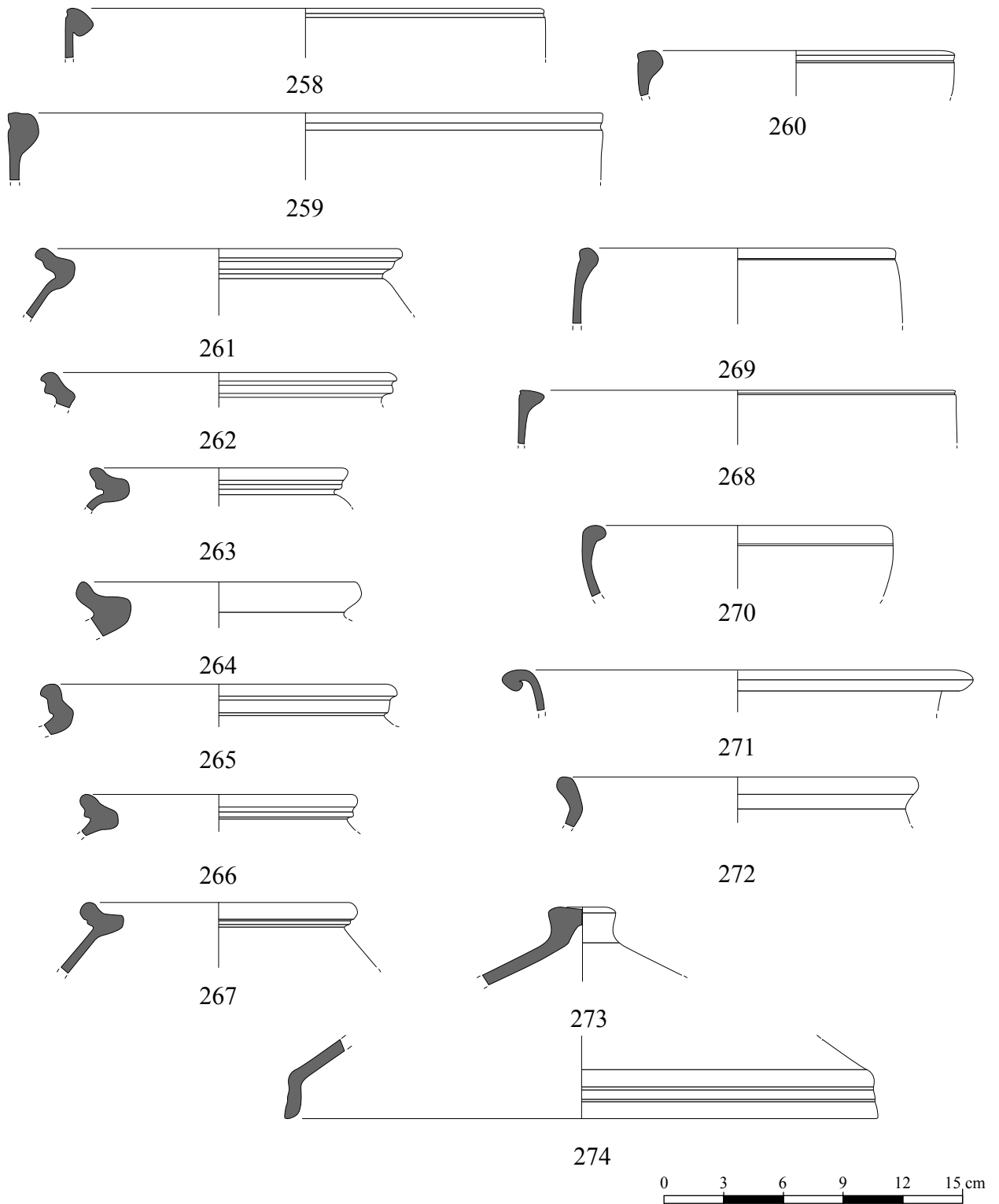

ANNEXE A
LES ROISES
Planche XIX

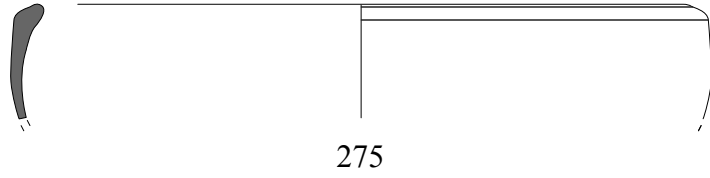

275



276



277



278

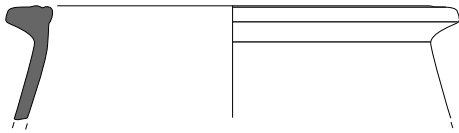

279

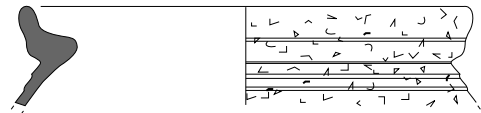

283

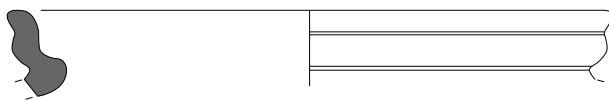

280



284

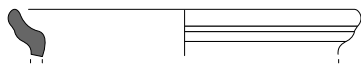

281

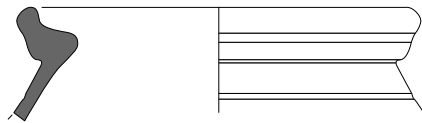

285

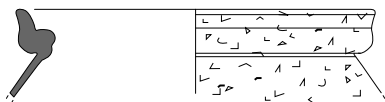

282

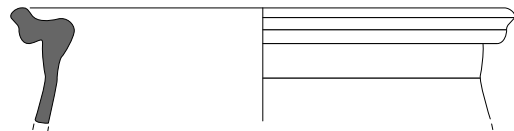

286

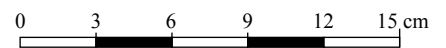

ANNEXE A
LES ROISES
Planche XX

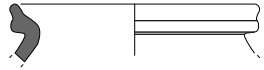

287



288



289

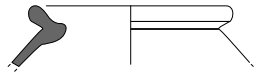

290

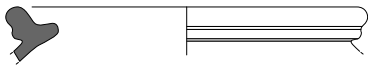

291

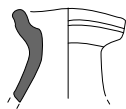

292

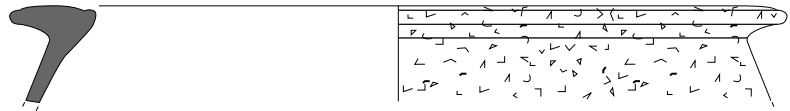

295

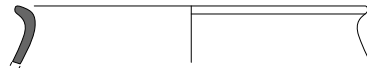

296

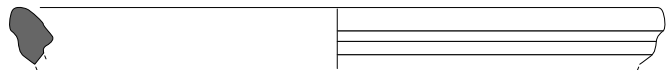

297

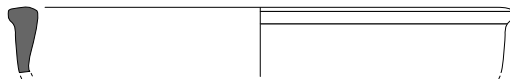

298

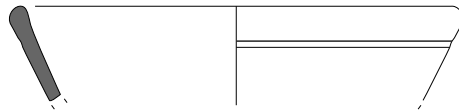

299



300



293

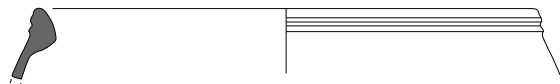

294

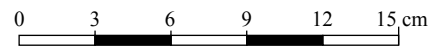

ANNEXE A
LES ROISES
Planche XXI

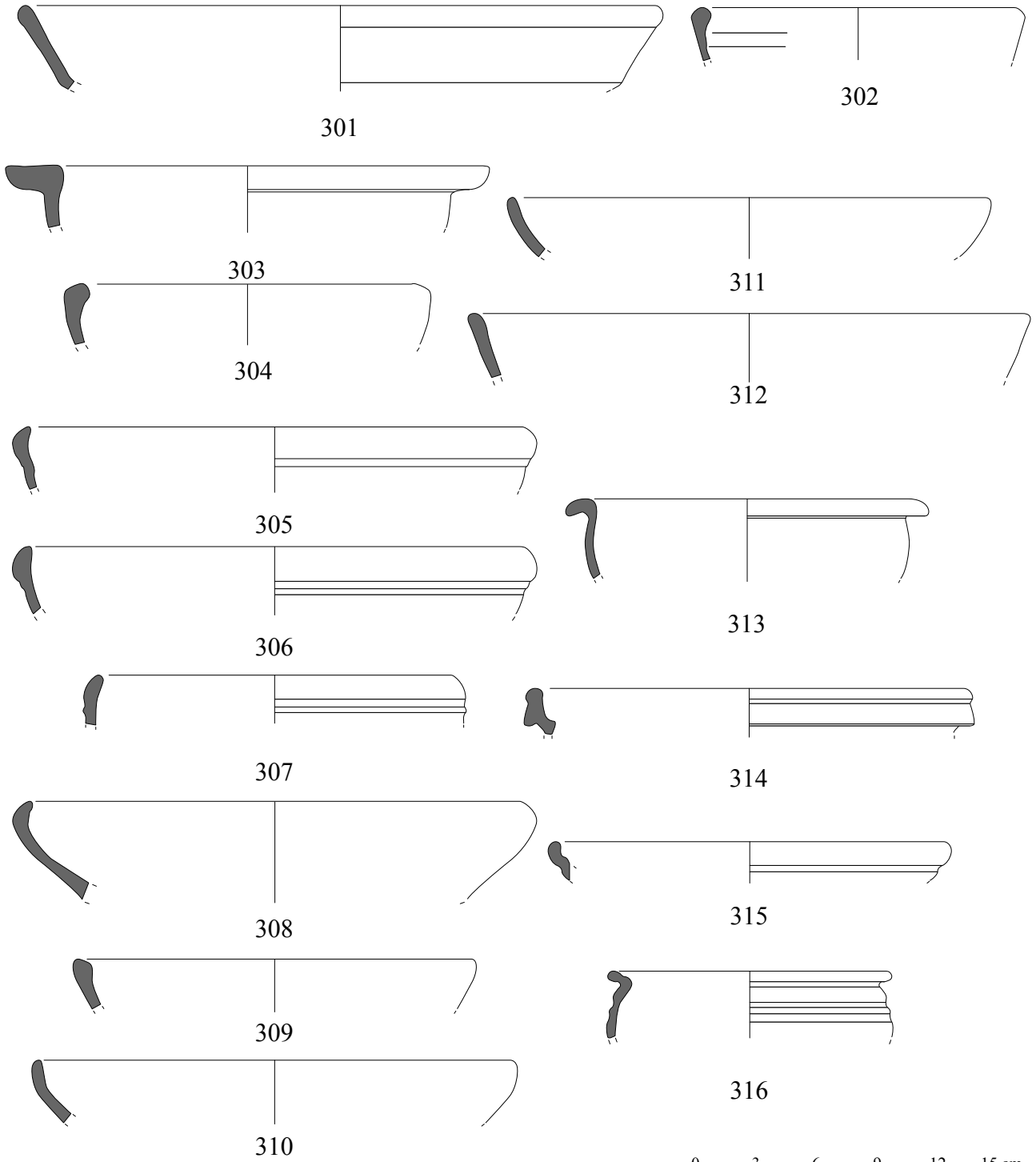

ANNEXE A
 LES ROISES
 Planche XXII

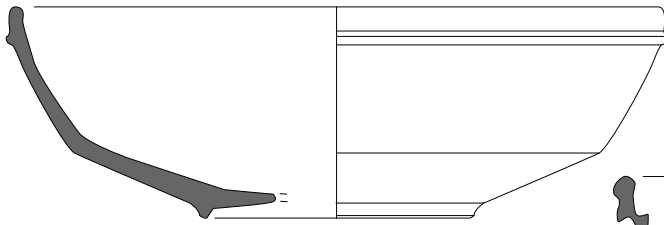

317



325

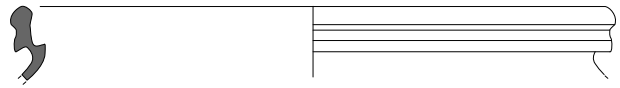

326

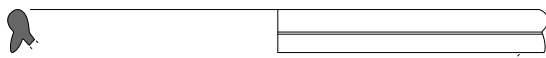

318



327



319

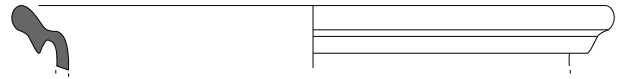

328



320



329

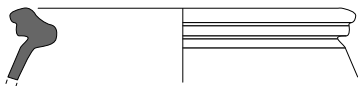

321



330

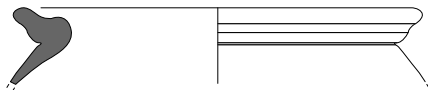

322



331

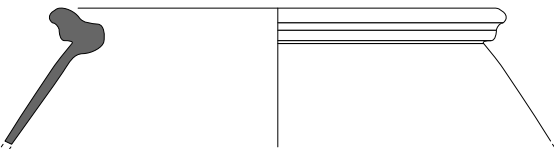

323

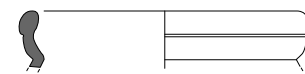

332



333

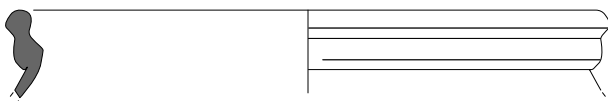

324



334

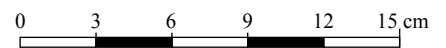

ANNEXE A
LES ROISES
Planche XXIII



335



336

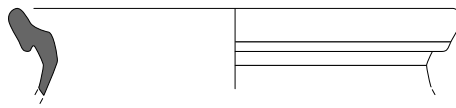

337

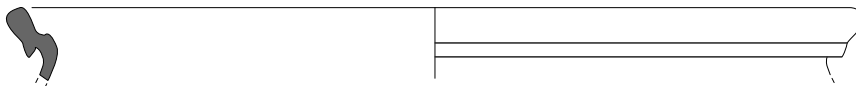

338

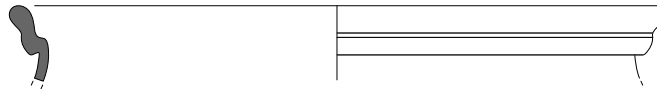

339

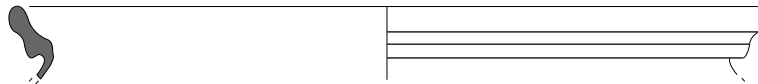

340

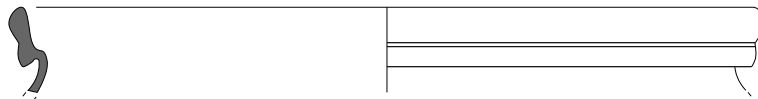

341

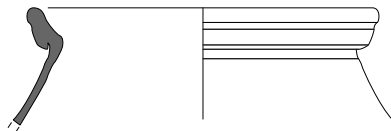

342

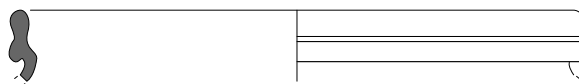

343

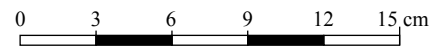

ANNEXE A
LES ROISES
Planche XXIV

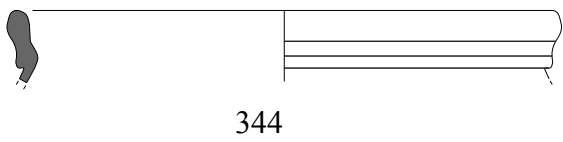

344

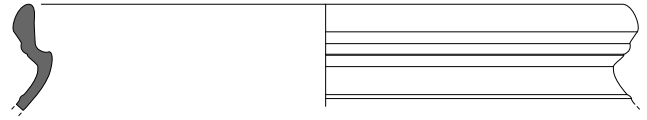

352

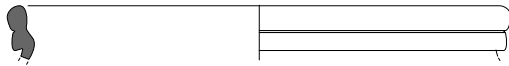

345

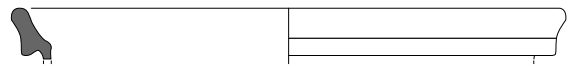

353

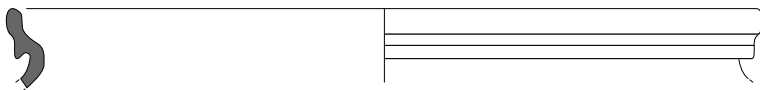

346

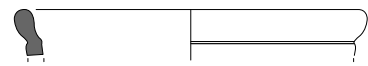

347

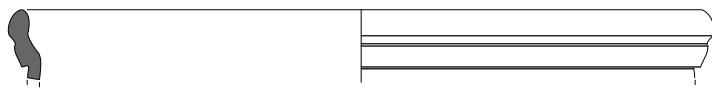

348

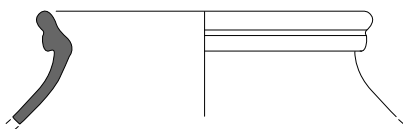

349



355

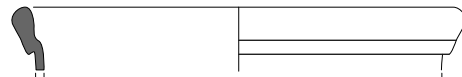

356

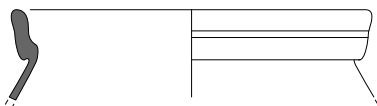

350



357

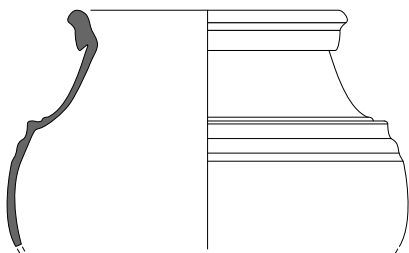

351



358

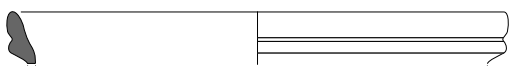

354

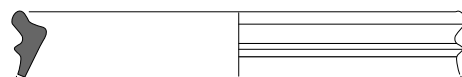

359

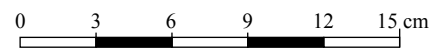

ANNEXE A
LES ROISES
Planche XXV

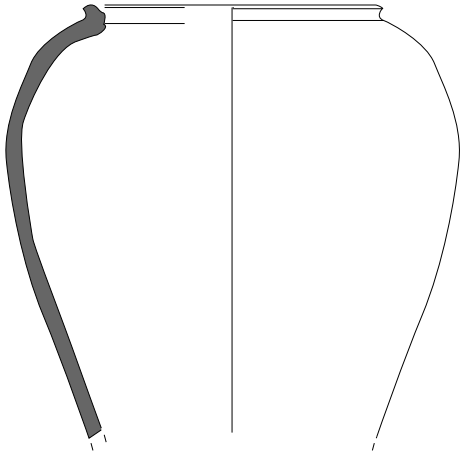

360

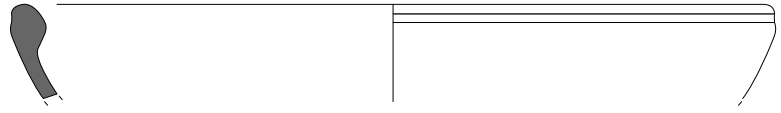

364

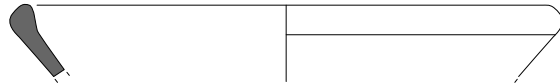

365



366

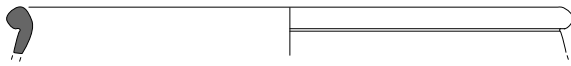

361



362

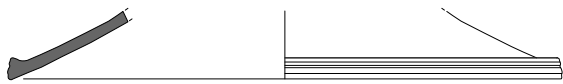

363

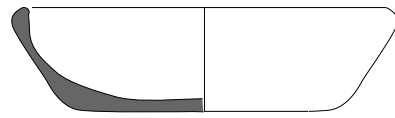

367

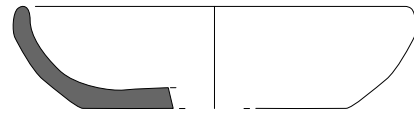

368

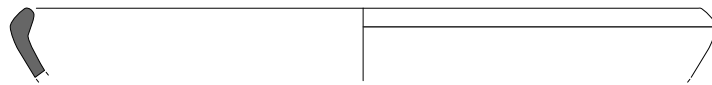

369



370

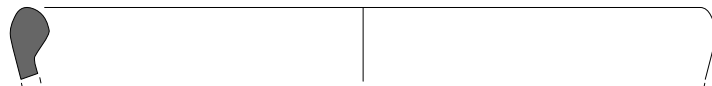

372

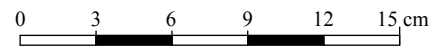

ANNEXE A
LES ROISES
Planche XXVI

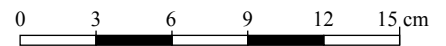
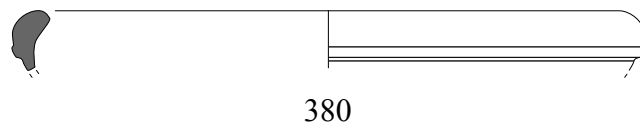
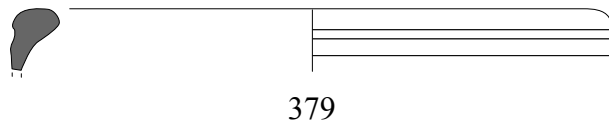
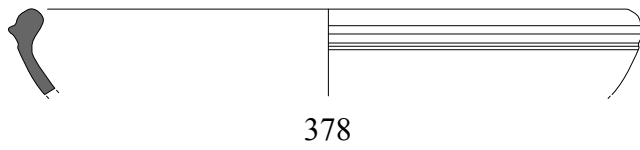
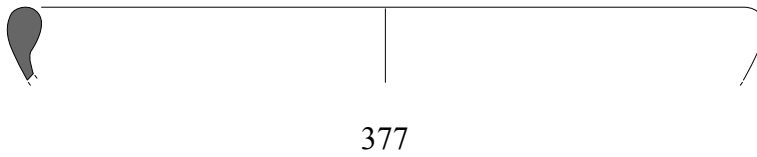
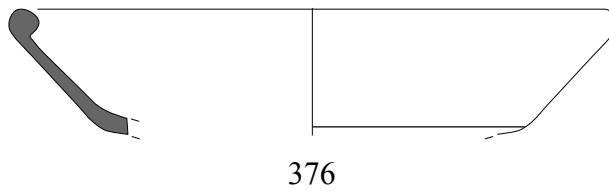
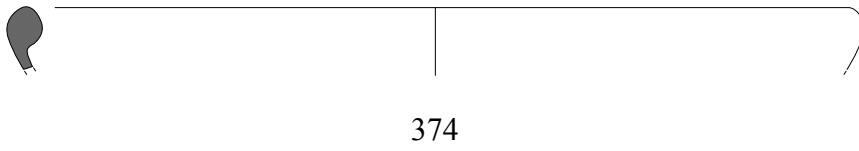
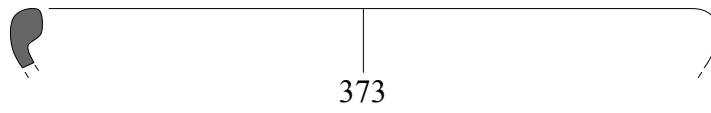
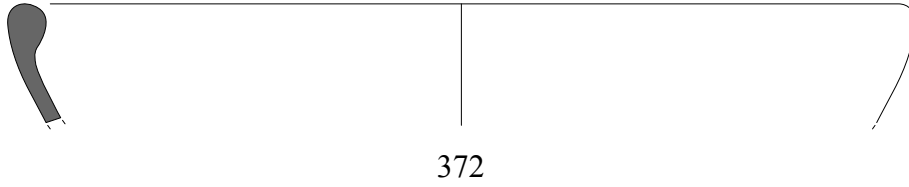

ANNEXE A
LES ROISES
Planche XXVII

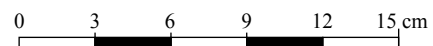
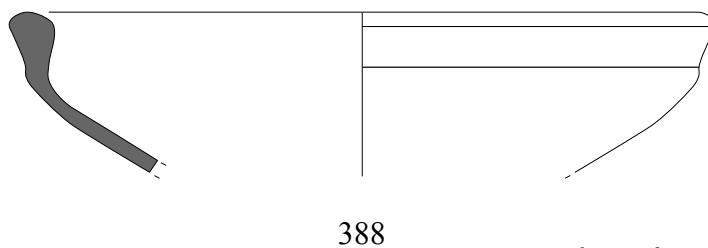
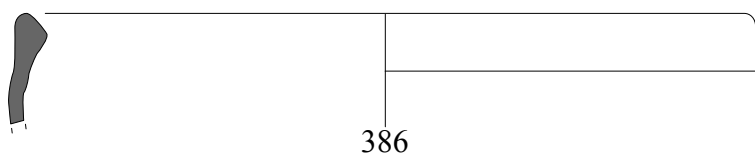
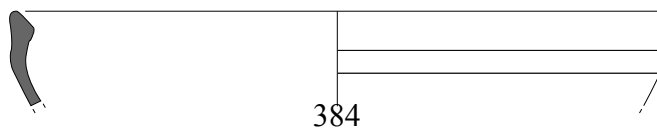
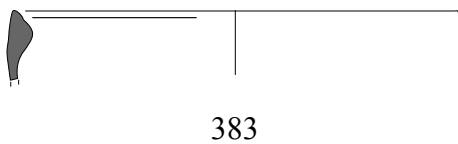
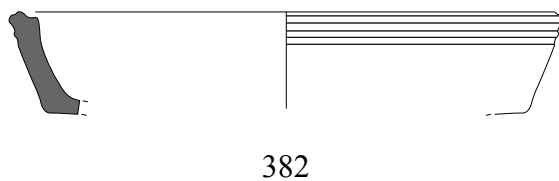
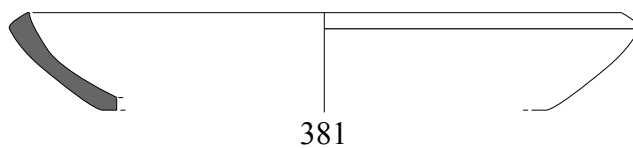

ANNEXE A
LES ROISES
Planche XXVIII

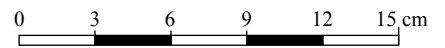
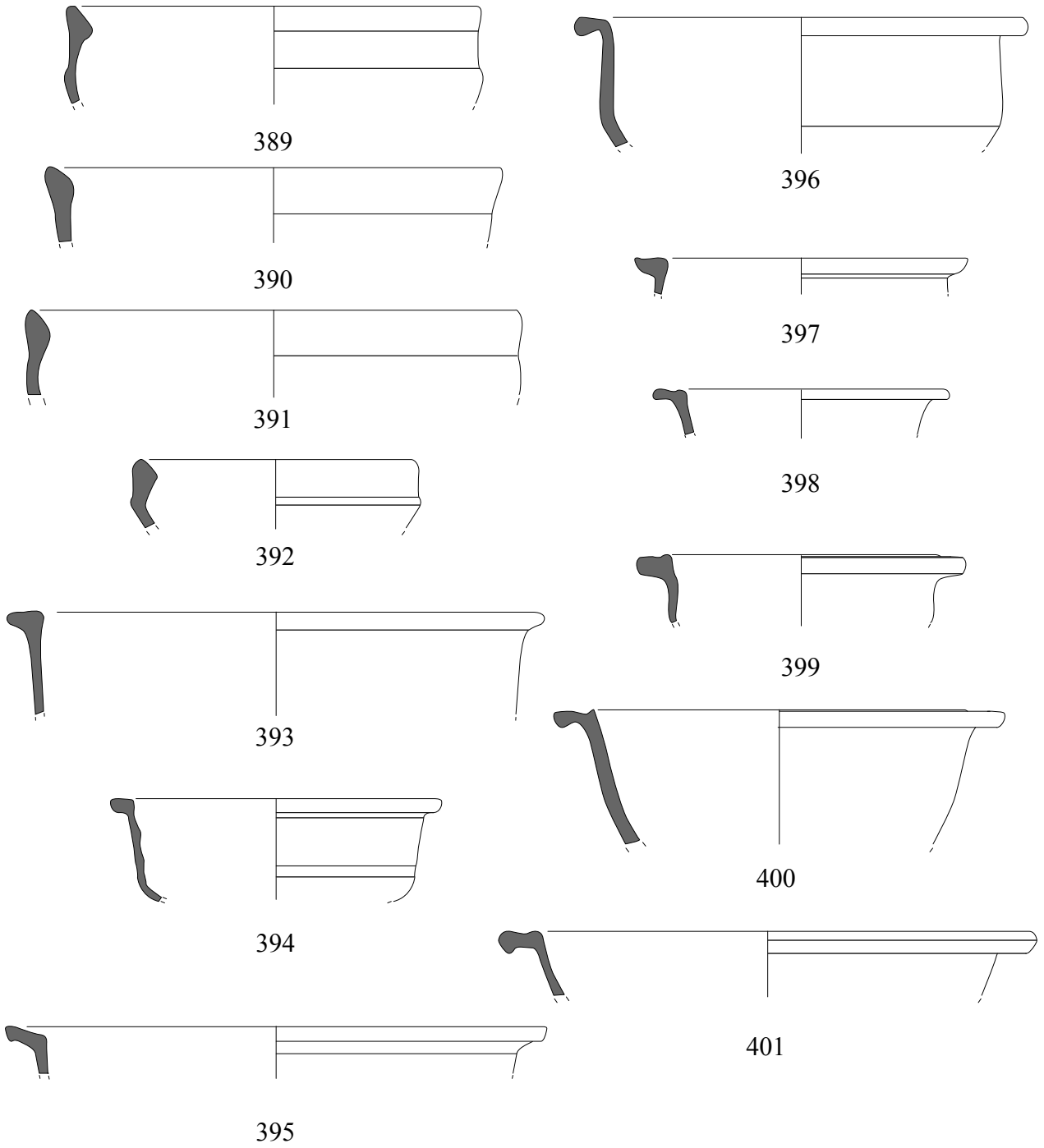

ANNEXE A
LES ROISES
Planche XXIX

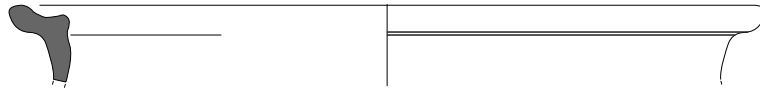

402

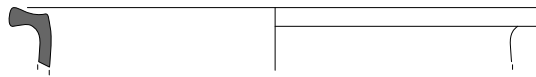

403

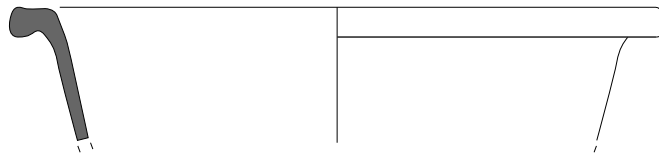

404

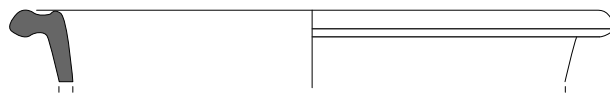

405



406

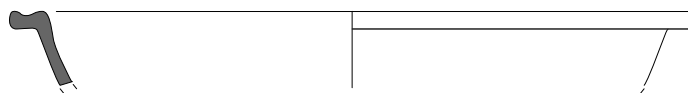

407

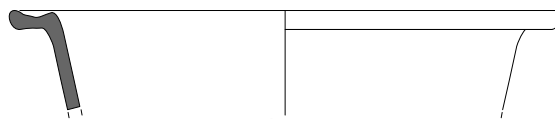

408

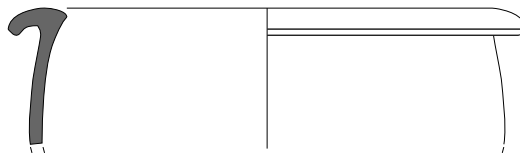

409

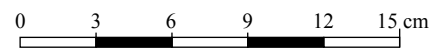

ANNEXE A
LES ROISES
Planche XXX

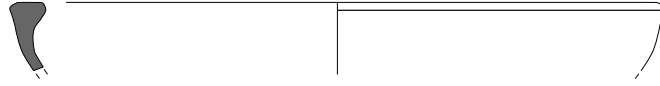

410



411

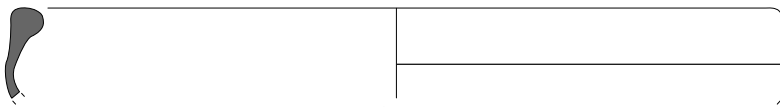

412

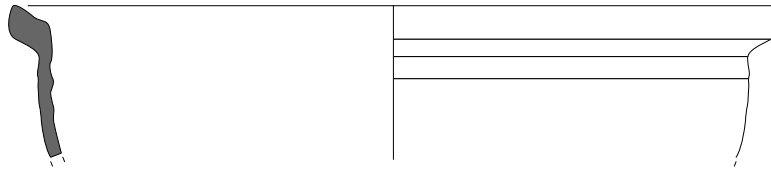

413

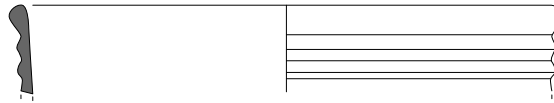

414

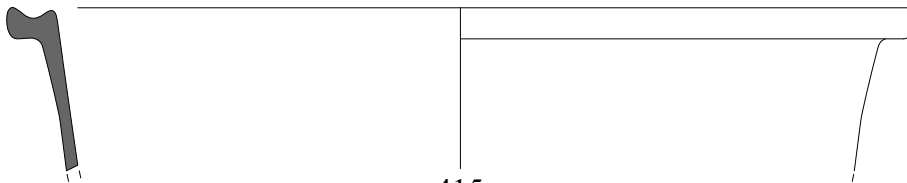

415

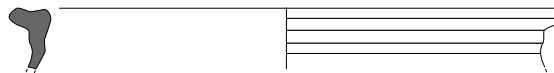

416



417

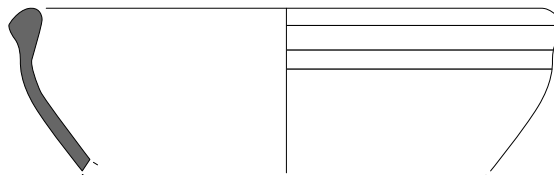

418

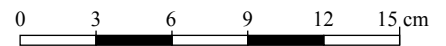

ANNEXE A
LES ROISES
Planche XXXI



419

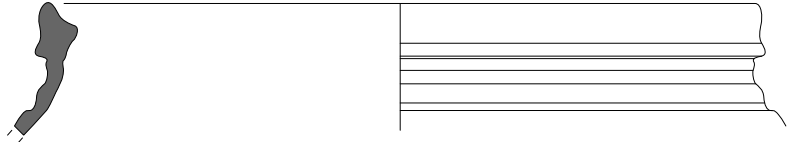

420

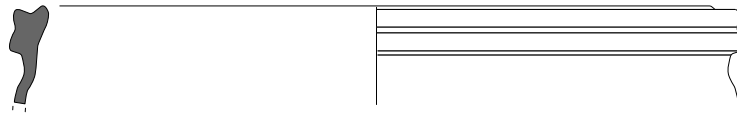

421

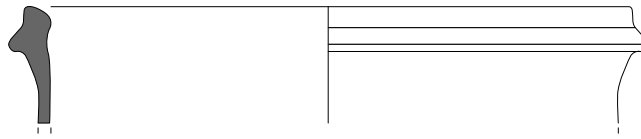

422

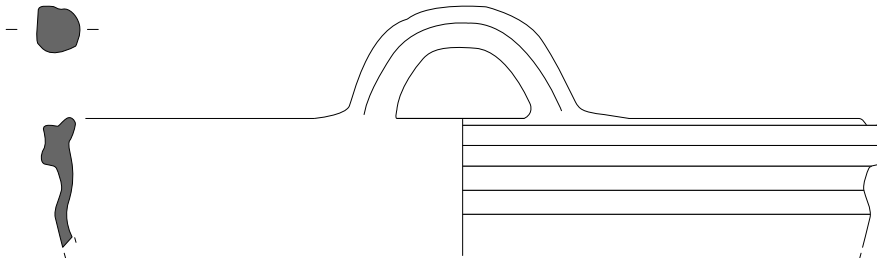

423

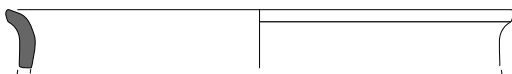

424

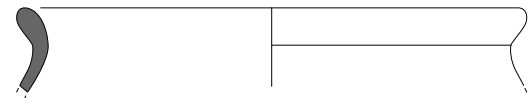

426

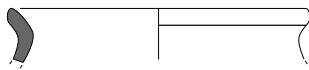

425

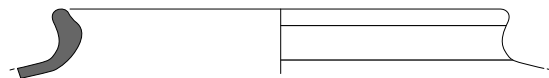

427

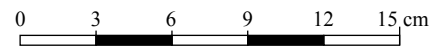

ANNEXE A
LES ROISES
Planche XXXII

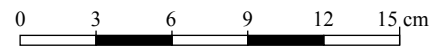
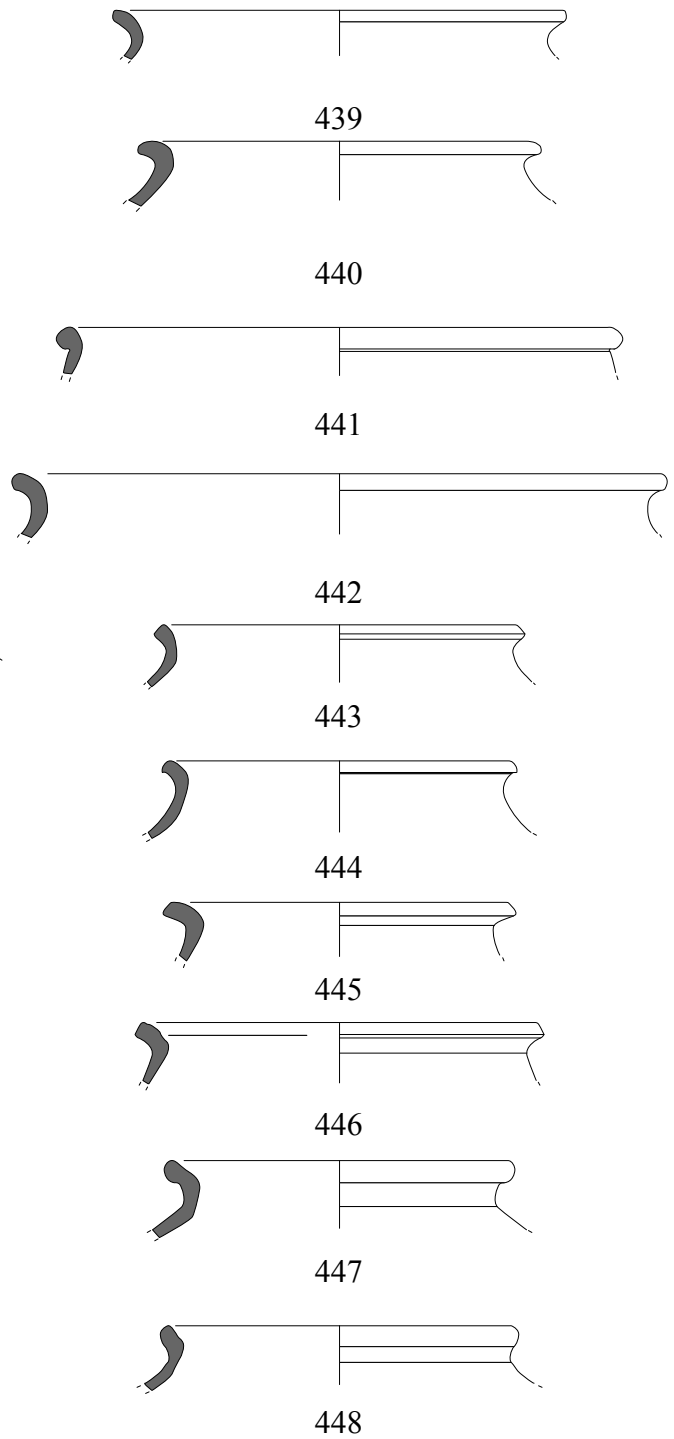
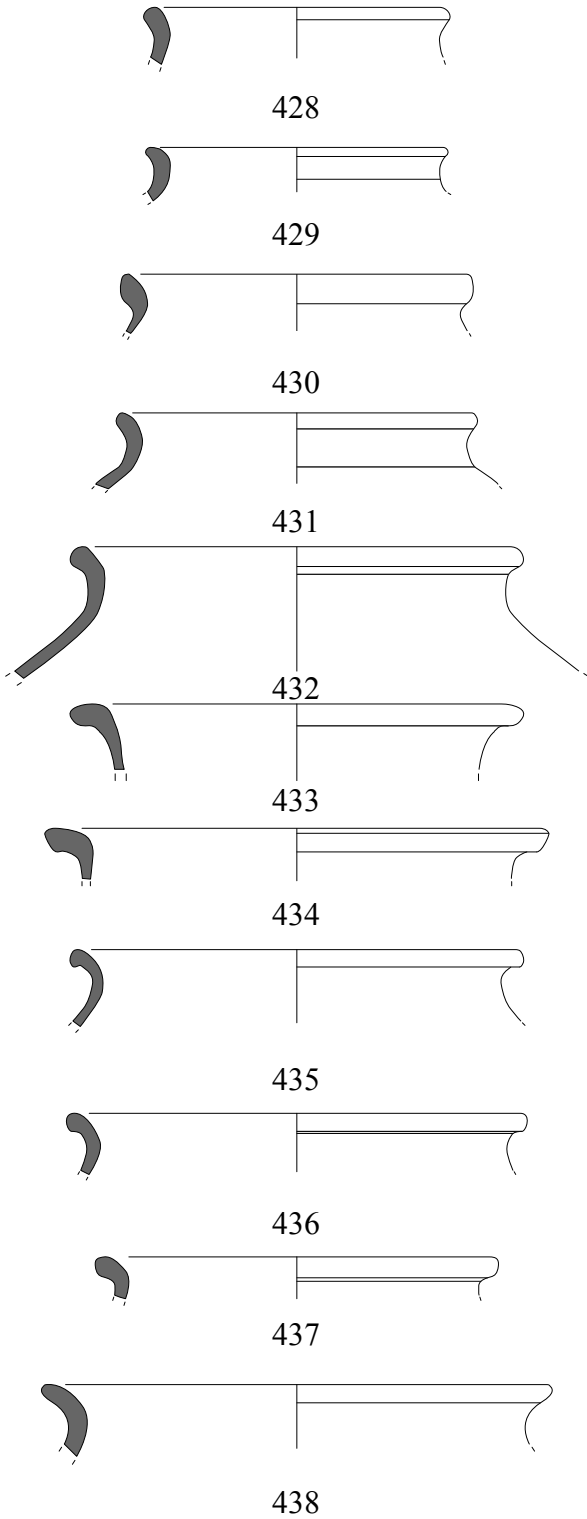

ANNEXE A
LES ROISES
Planche XXXIII

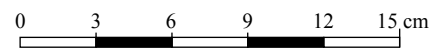
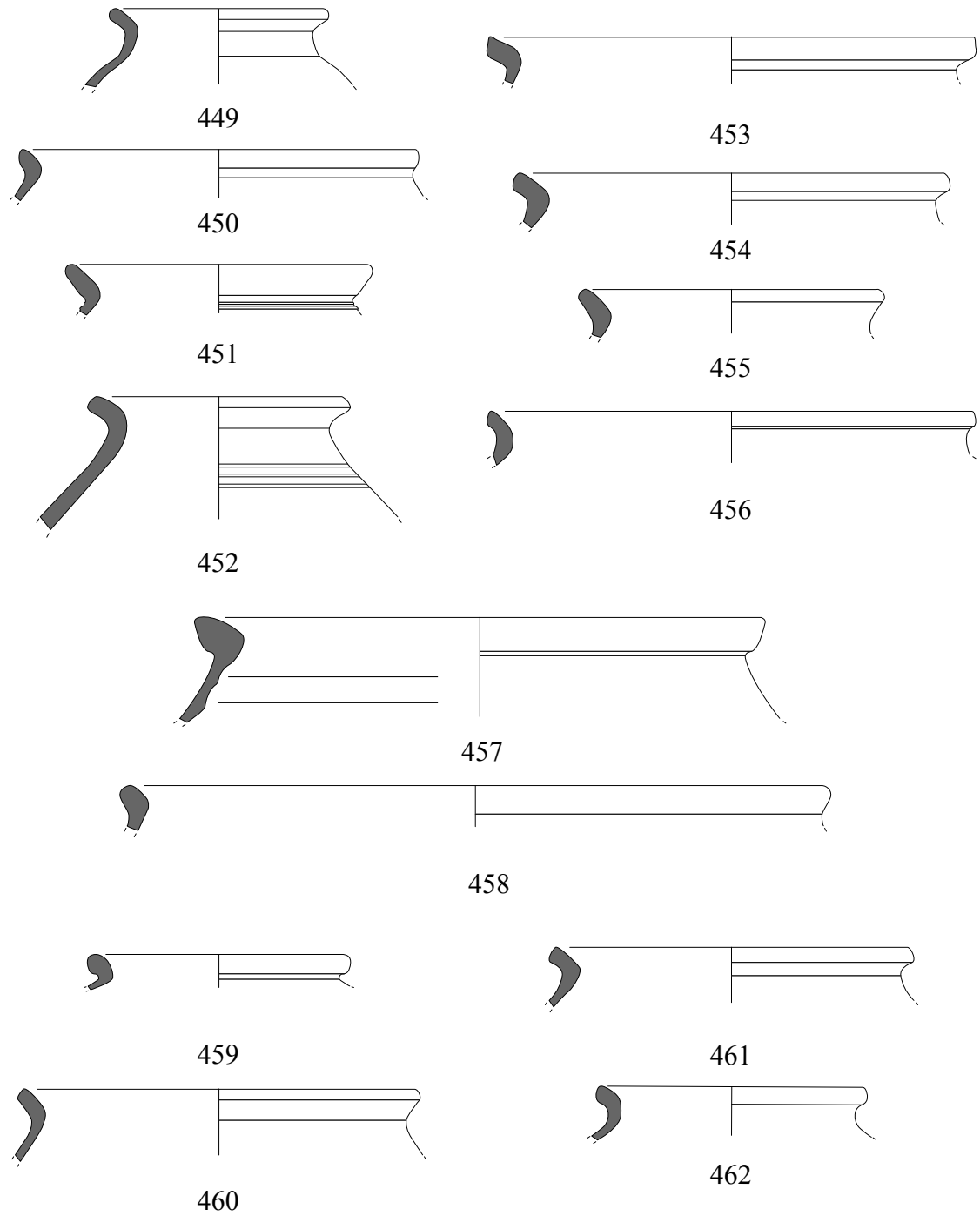

ANNEXE A
LES ROISES
Planche XXXIV

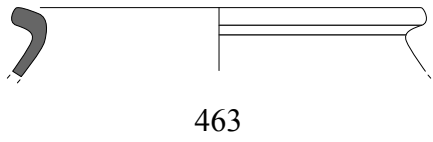

463

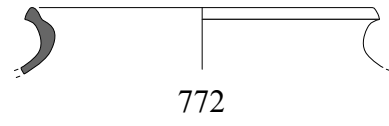

772

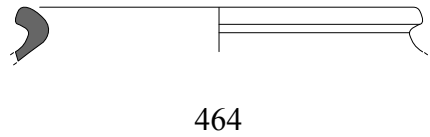

464

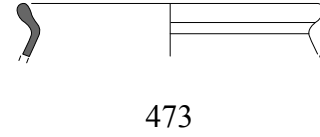

473

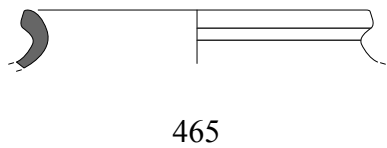

465

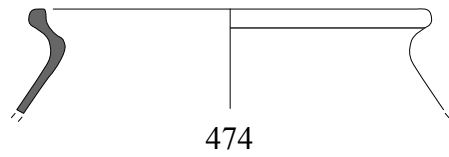

474



466



475

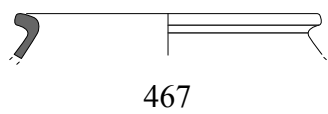

467

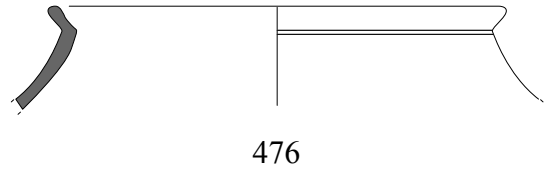

476



468



477



469

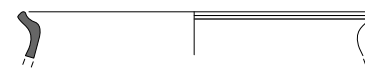

478

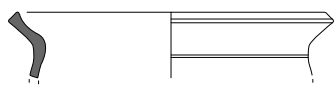

470

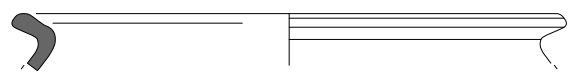

479

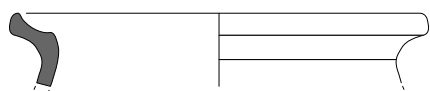

471



480

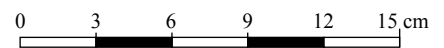

ANNEXE A
LES ROISES
Planche XXXV

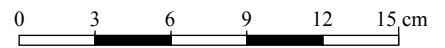
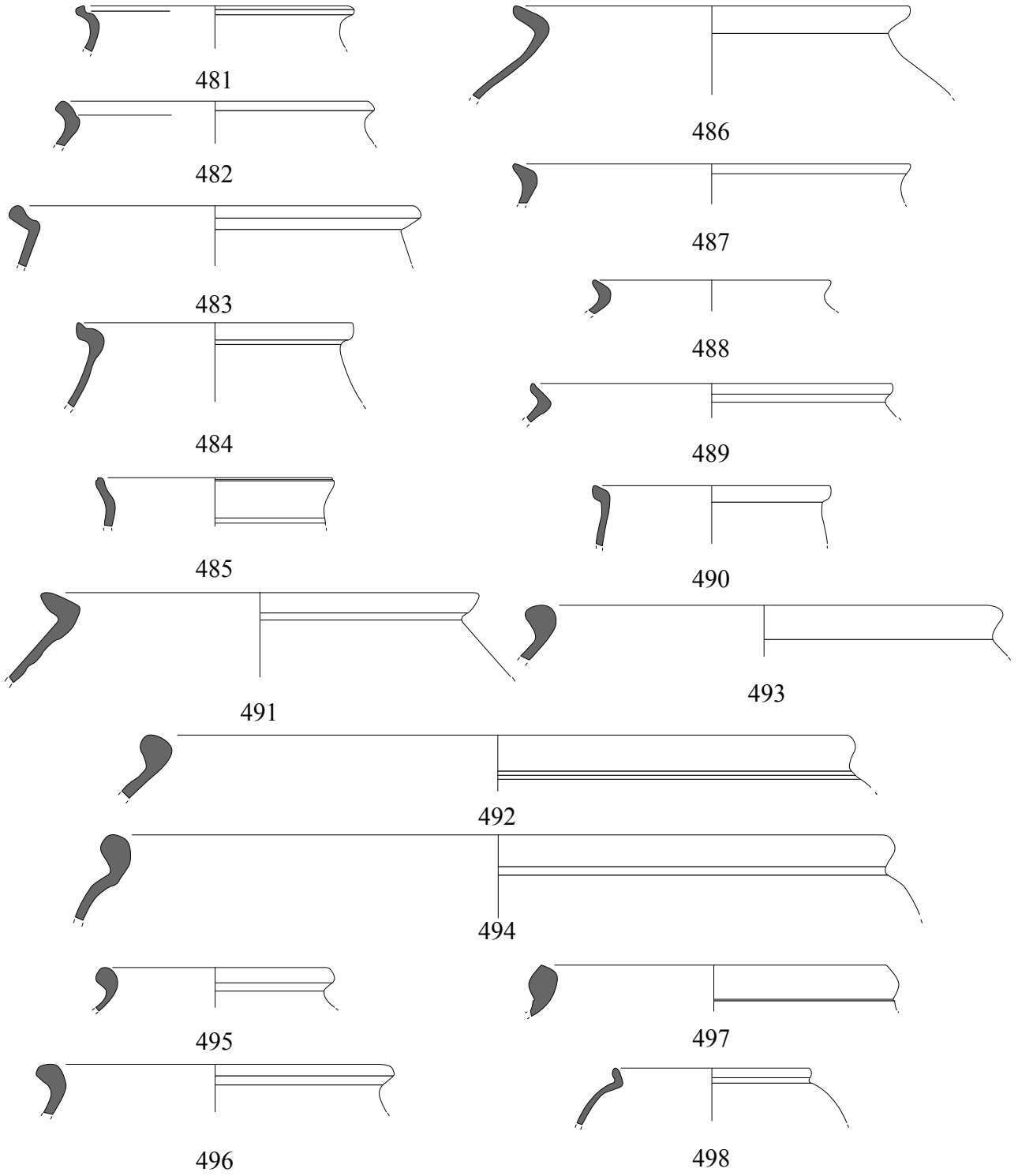

ANNEXE A
 LES ROISES
 Planche XXXVII

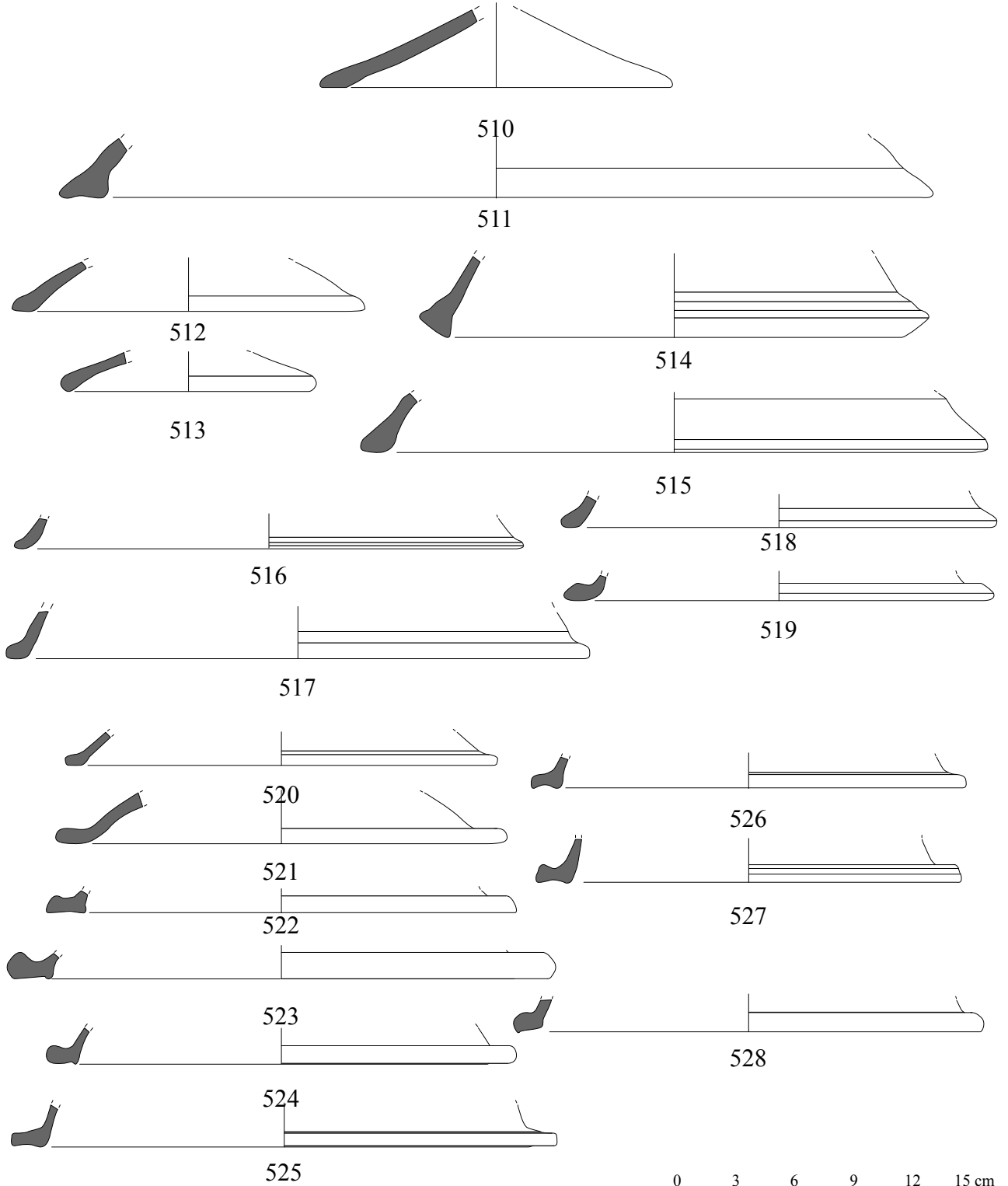

ANNEXE A
LES ROISES
Planche XXXVII

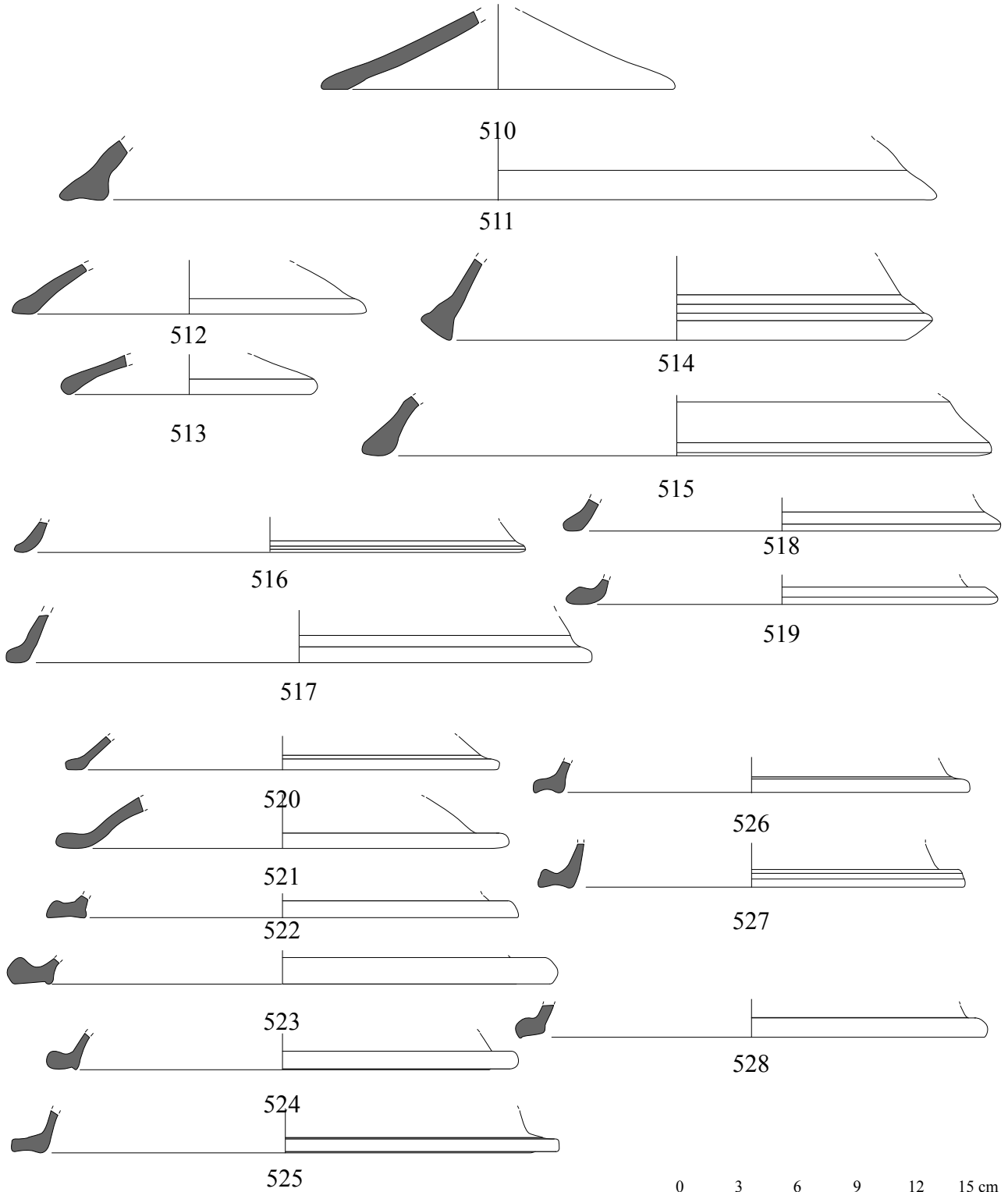

ANNEXE A
LES ROISES
Planche XXXVIII

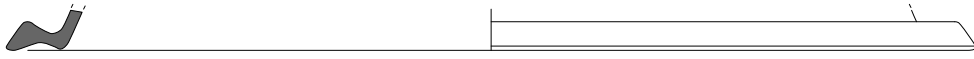

529



530



531



532



533



534



535



536



537



538

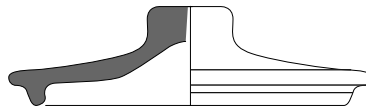

539

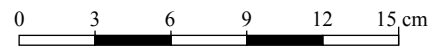

ANNEXE A
LES ROISES
Planche XXXIX

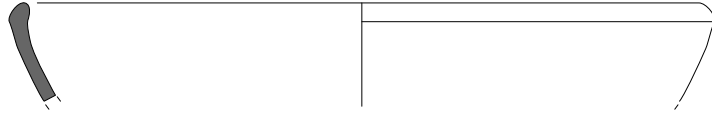

540



541

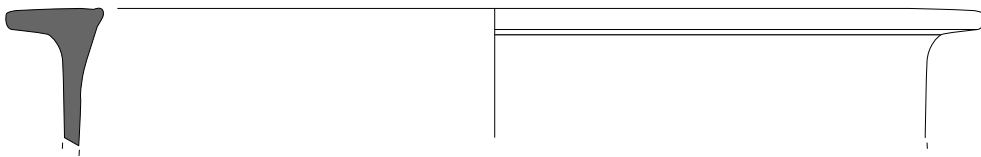

542

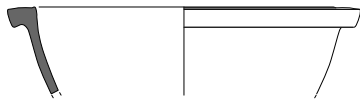

543

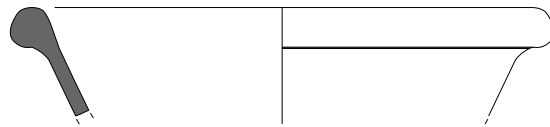

544

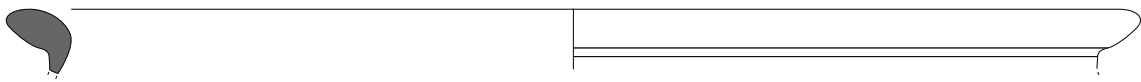

545



546



547

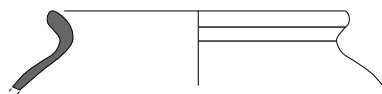

551

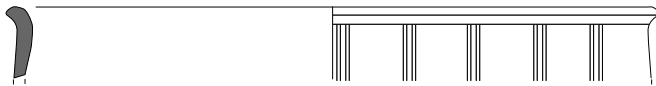

548

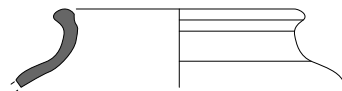

552



549

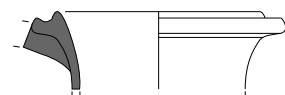

550

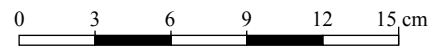

ANNEXE A
 LES ROISES
 Planche XL

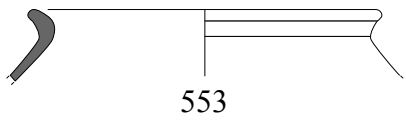

553

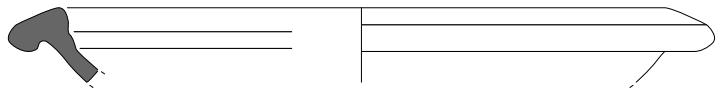

559



554

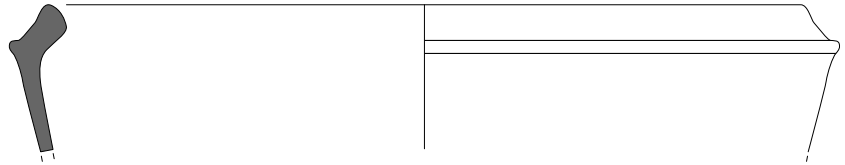

560



555

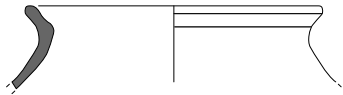

556

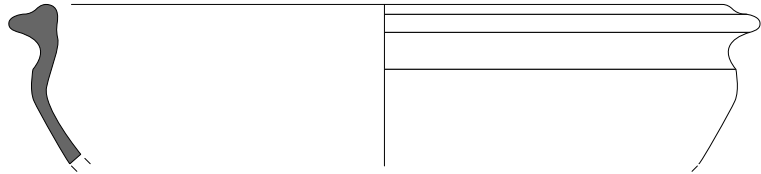

561

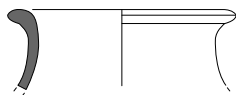

557

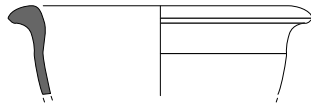

562

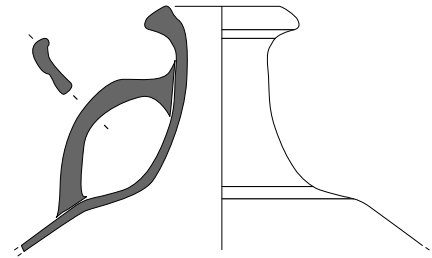

564



558

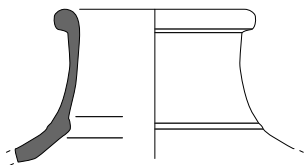

565



563



566

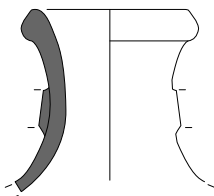

568

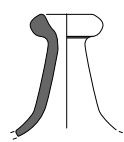

569

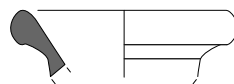

571

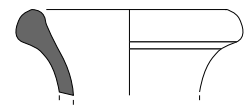

573

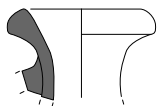

567

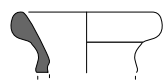

570



572

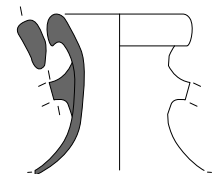

574

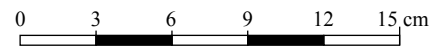

ANNEXE A
 LES ROISES
 Planche XLI

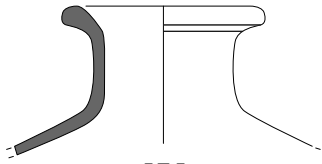

575



583

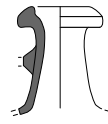

591

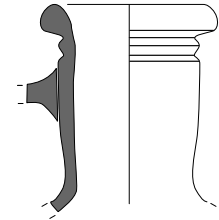

599

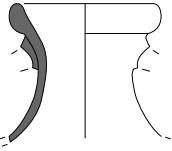

576

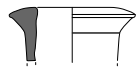

584

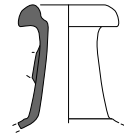

592

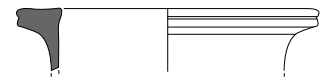

600

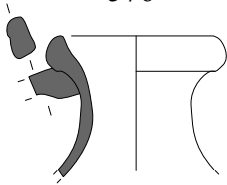

577

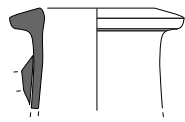

585



593



601

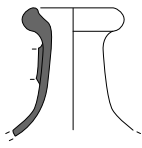

578



586

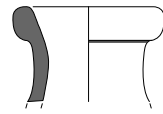

594

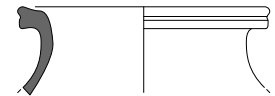

602

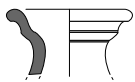

579

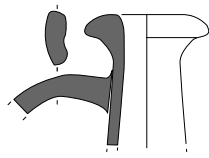

587



595

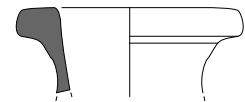

603



580

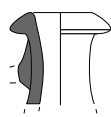

588

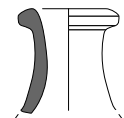

596

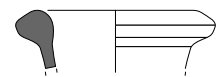

604

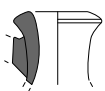

581

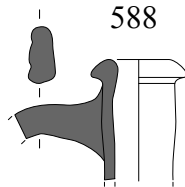

589

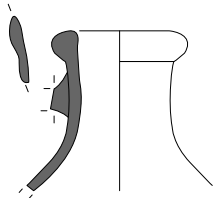

597

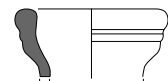

605

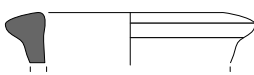

582

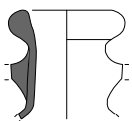

590

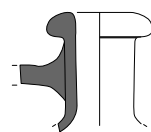

598

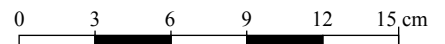

ANNEXE A
 LES ROISES
 Planche XLII

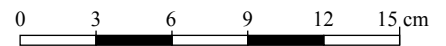
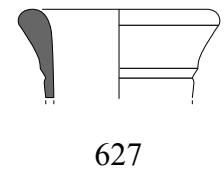
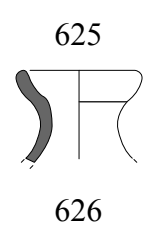
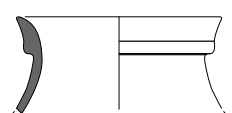
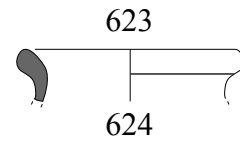
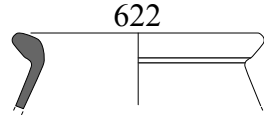
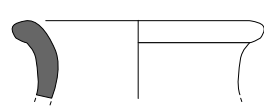
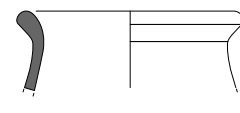
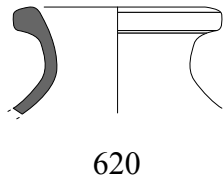
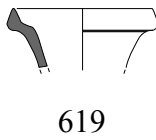
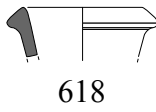
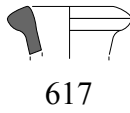
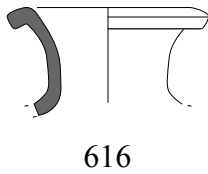
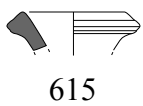
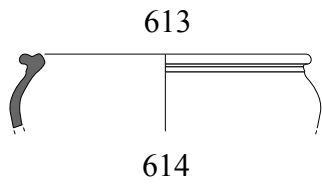
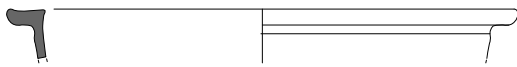
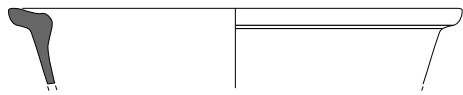
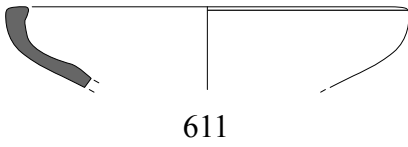
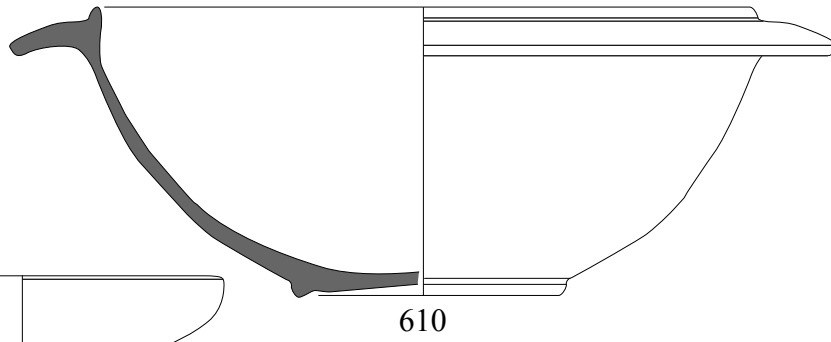
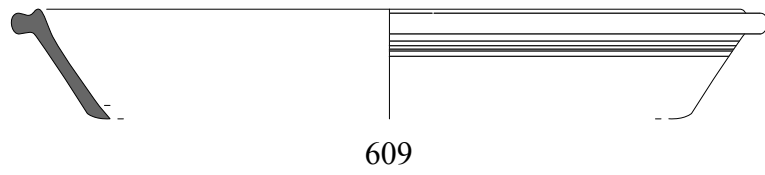
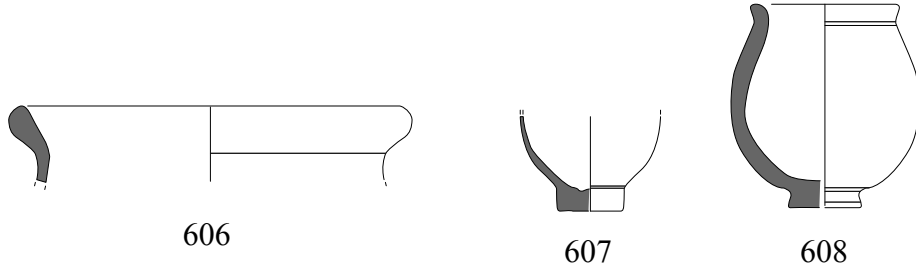

ANNEXE A
 LES ROISES
 Planche XLIII

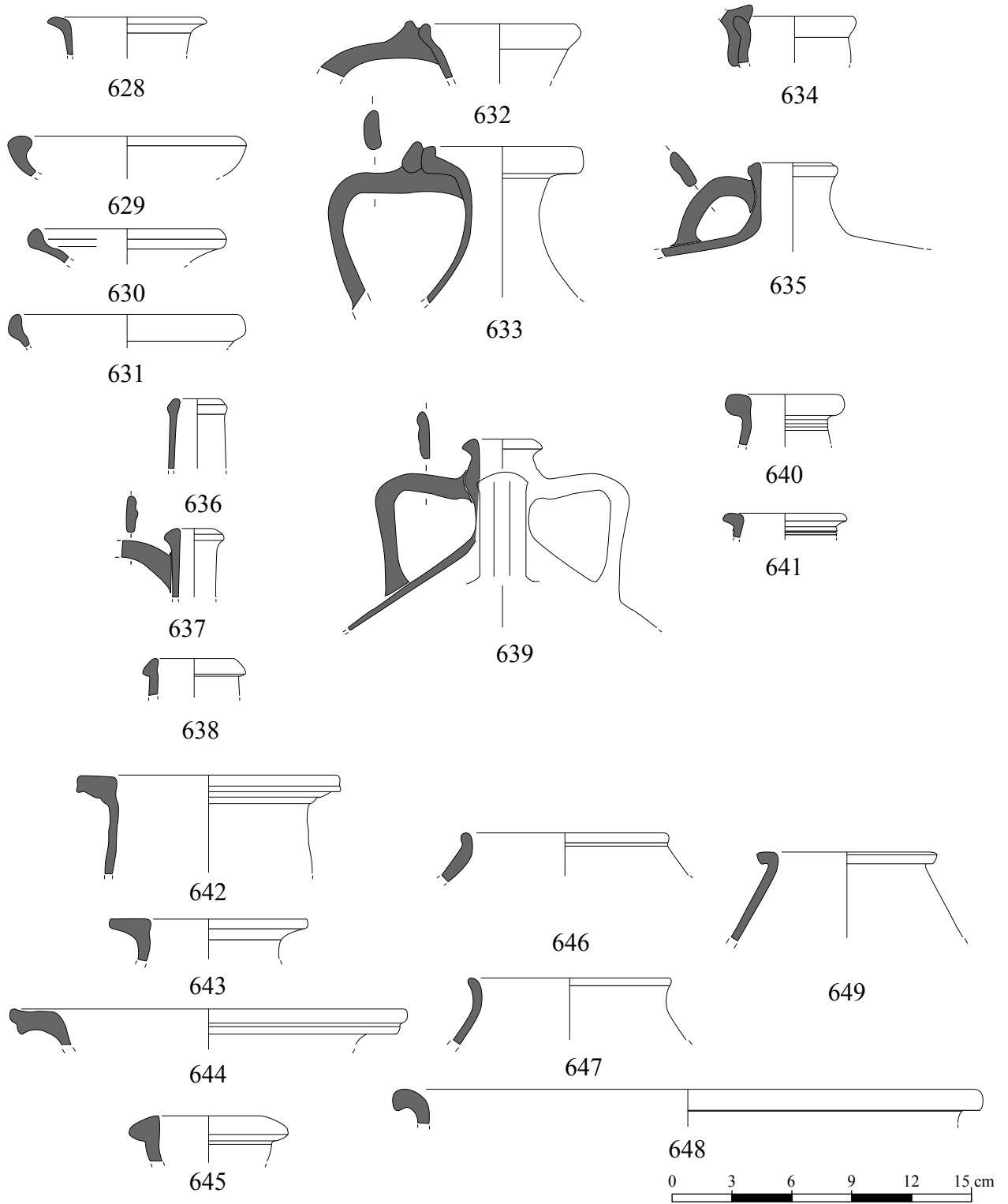

ANNEXE A
 LES ROISES
 Planche XLIV

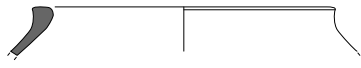

650

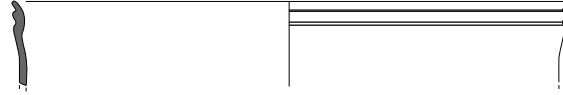

659

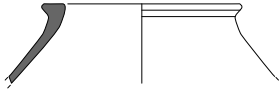

651

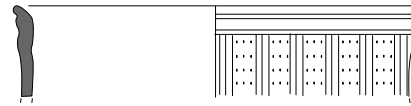

660

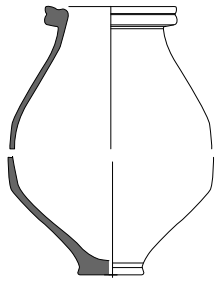

652



661

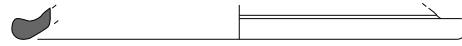

662



653

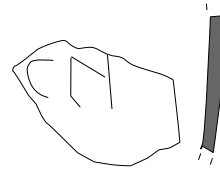

663



654

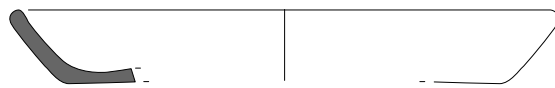

664



655

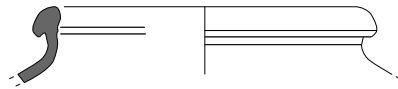

656



665



657

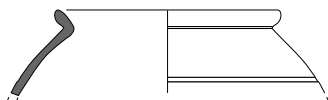

658

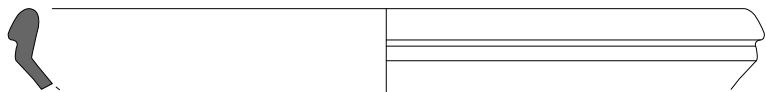

666

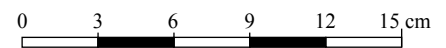

ANNEXE A
 LES ROISES
 Planche XLV

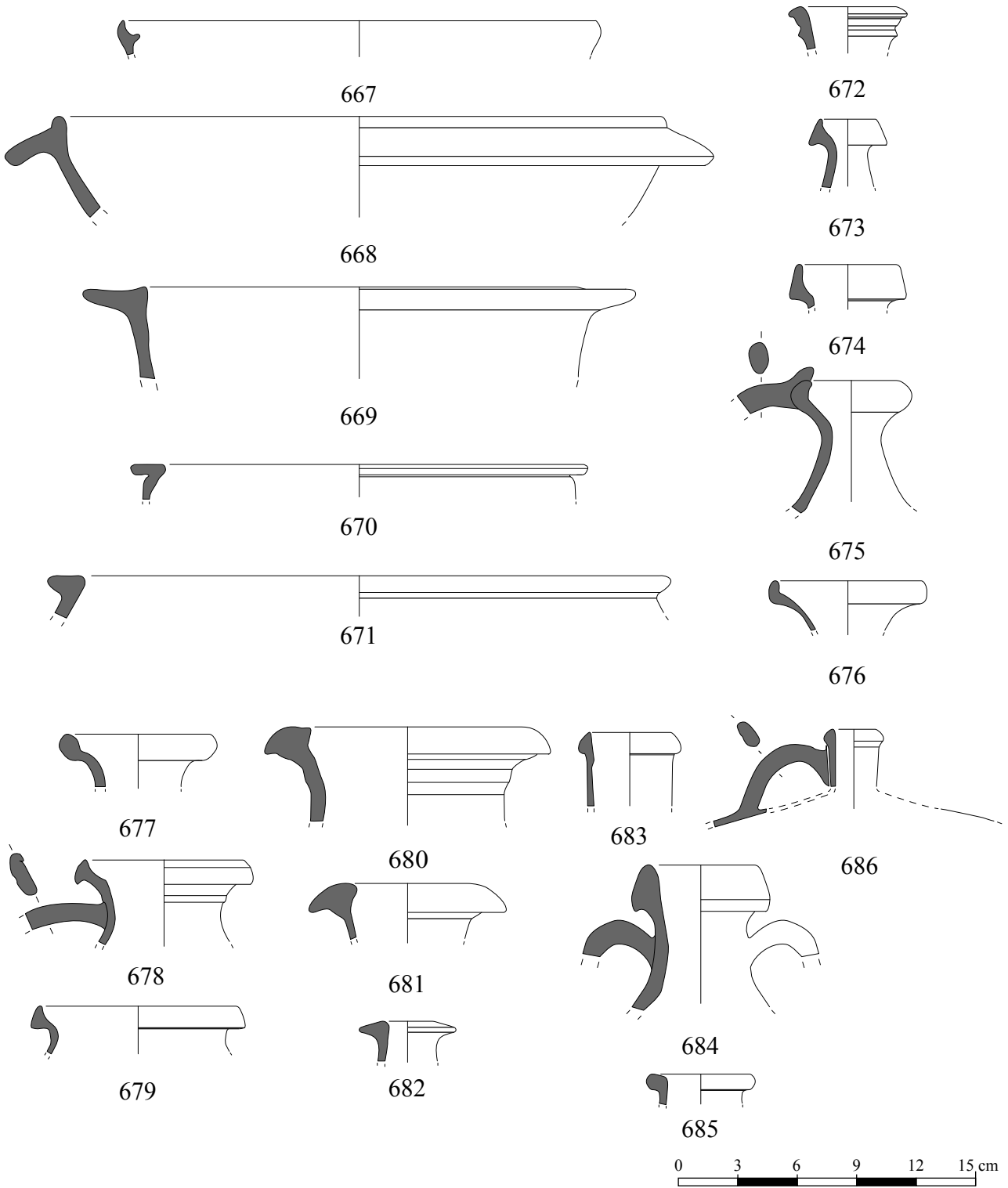

ANNEXE A
 LES ROISES
 Planche XLVI

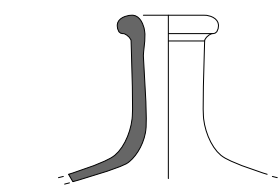

687

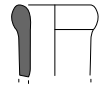

688

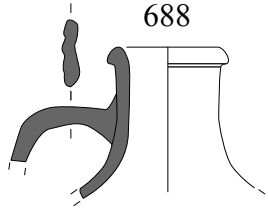

689



690

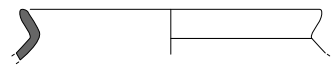

705



706

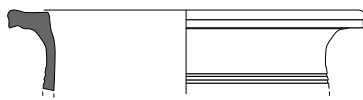

691

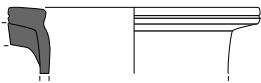

692



693



694

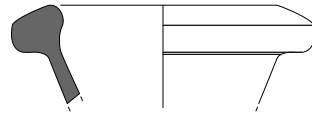

695

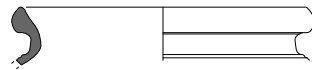

696

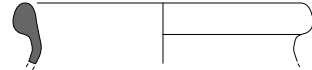

697



698



699



700



701



702



703

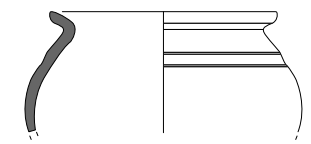

704



707

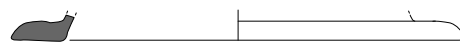

708



709

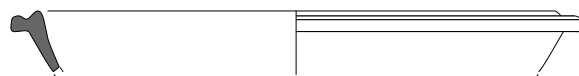

710

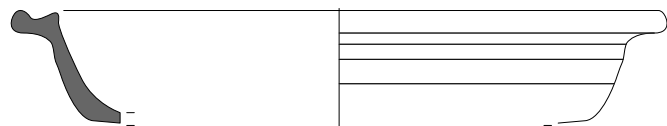

711

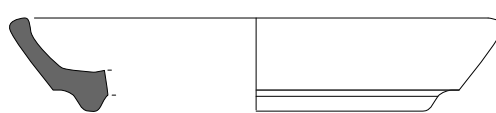

712

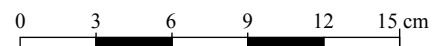

ANNEXE A
LES ROISES
Planche XLVII

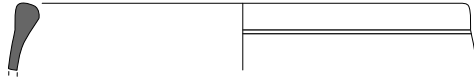

713



714

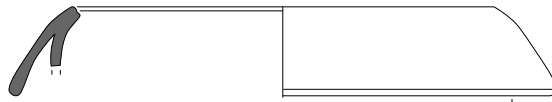

715

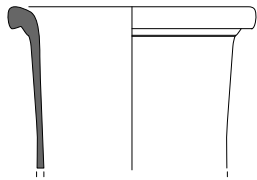

716

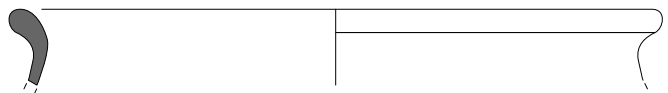

720

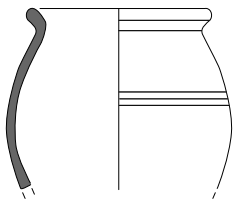

717

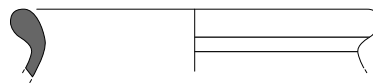

721



722

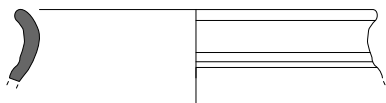

718



723

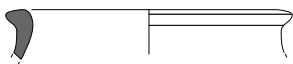

719

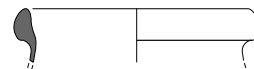

724



725

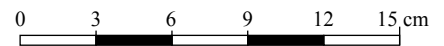

ANNEXE A
LES ROISES
Planche XLVIII

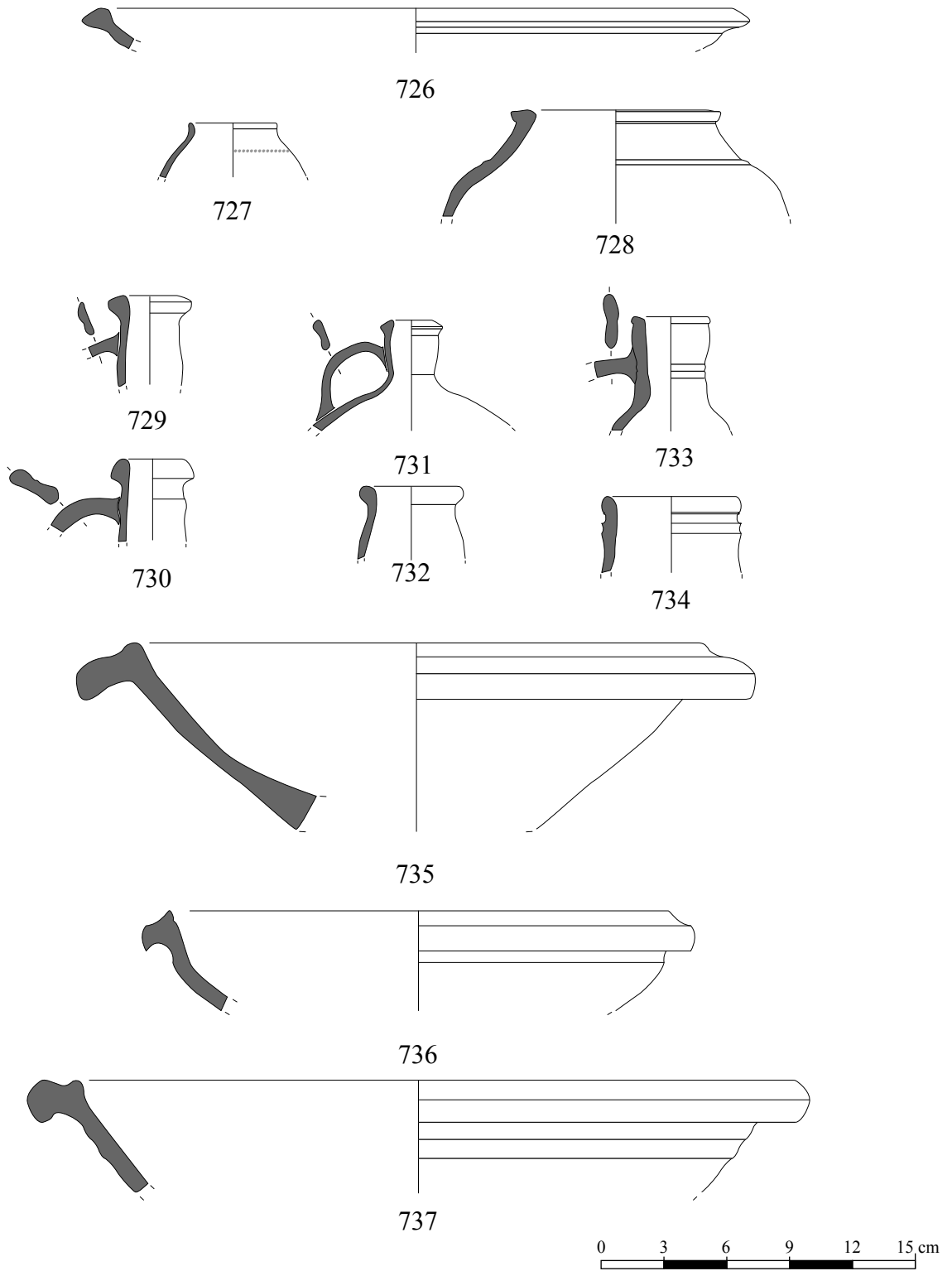

ANNEXE A
LES ROISES
Planche XLIX

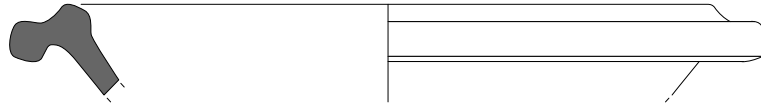

738

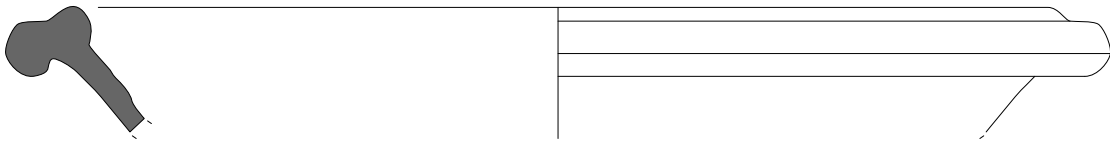

739

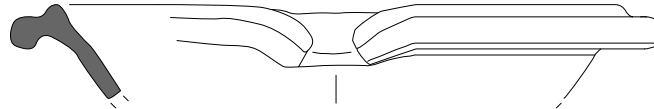

740

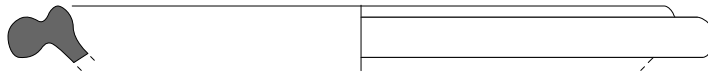

741

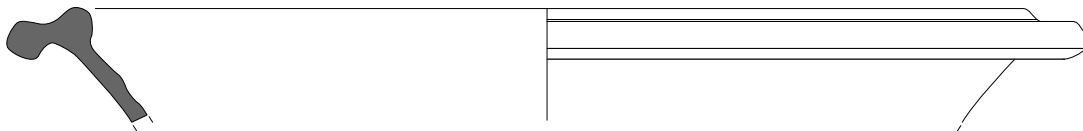

742

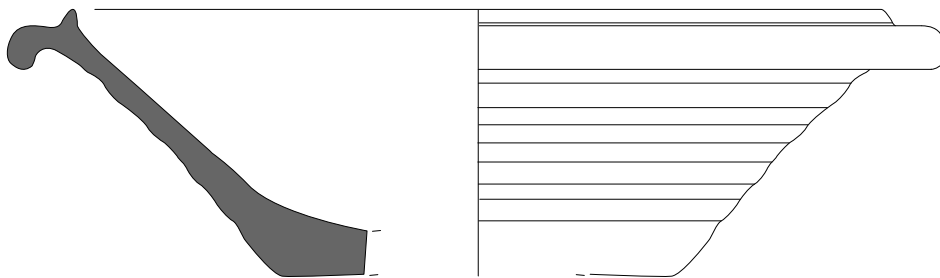

743

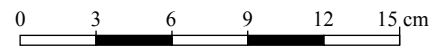

ANNEXE A
LES ROISES
Planche L

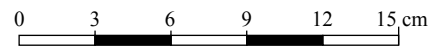
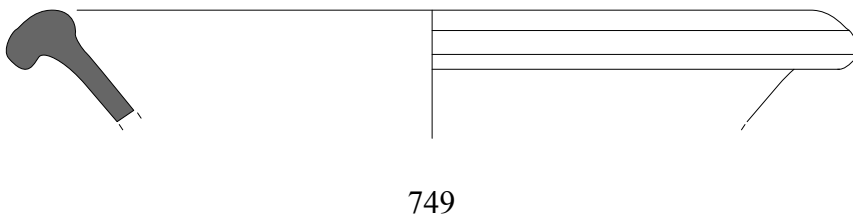
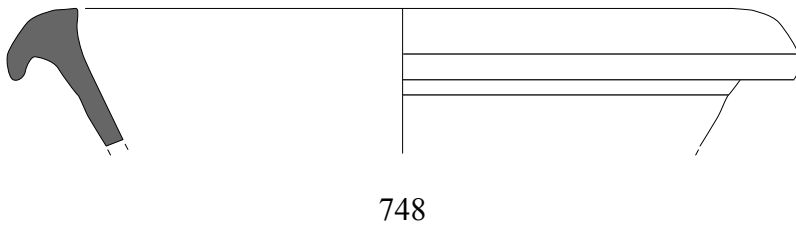
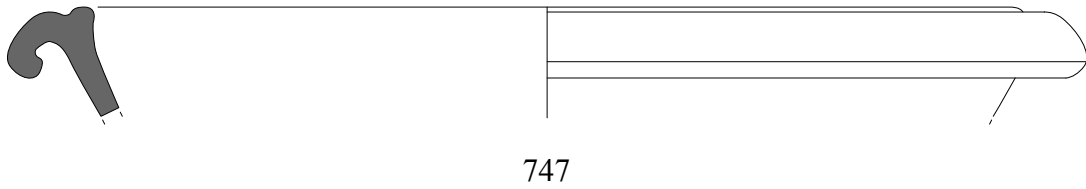
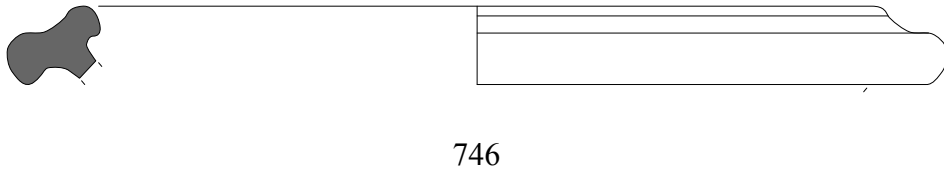
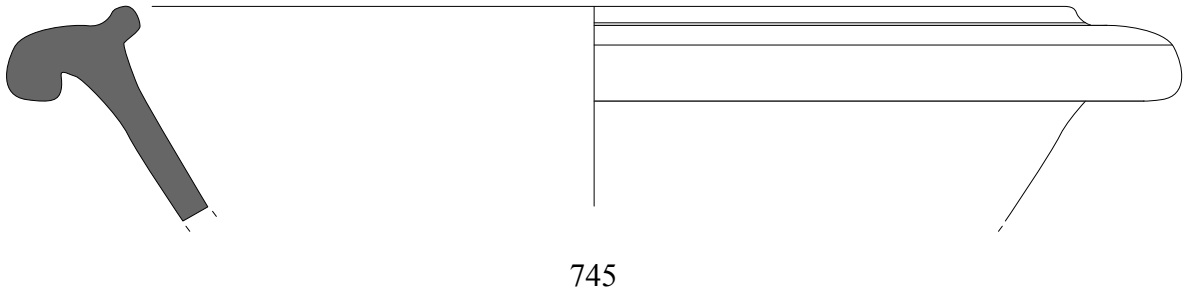
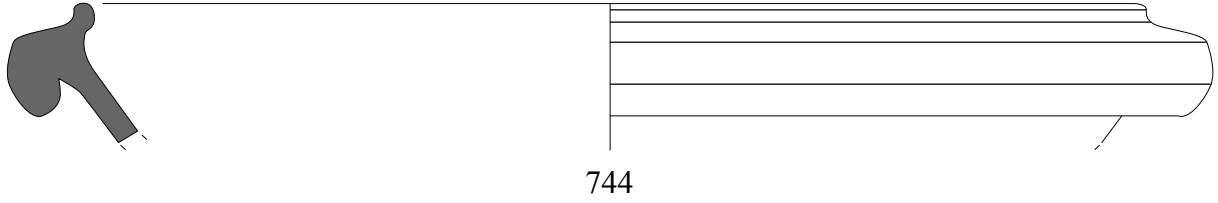

ANNEXE A
LES ROISES
Planche LI

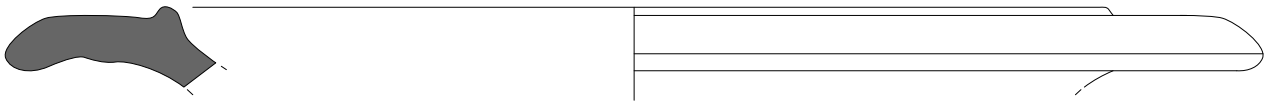

750

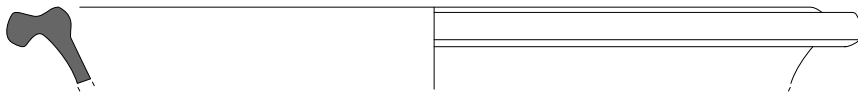

751

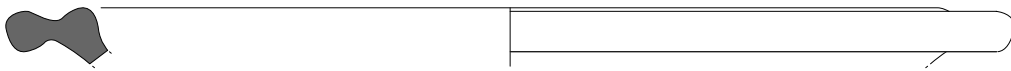

752

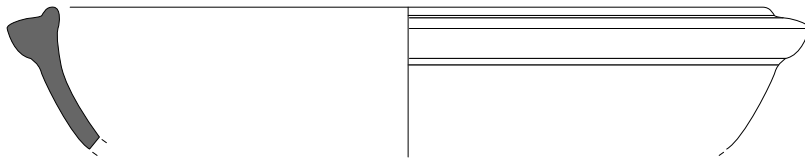

753

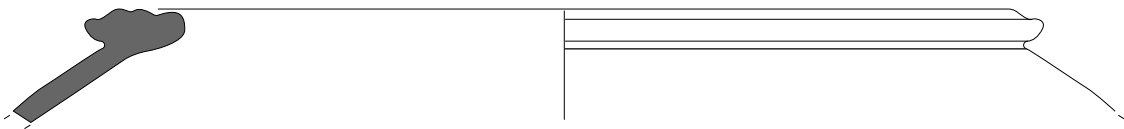

754



755

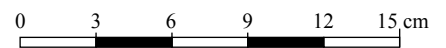

ANNEXE A
LES ROISES
Planche LII

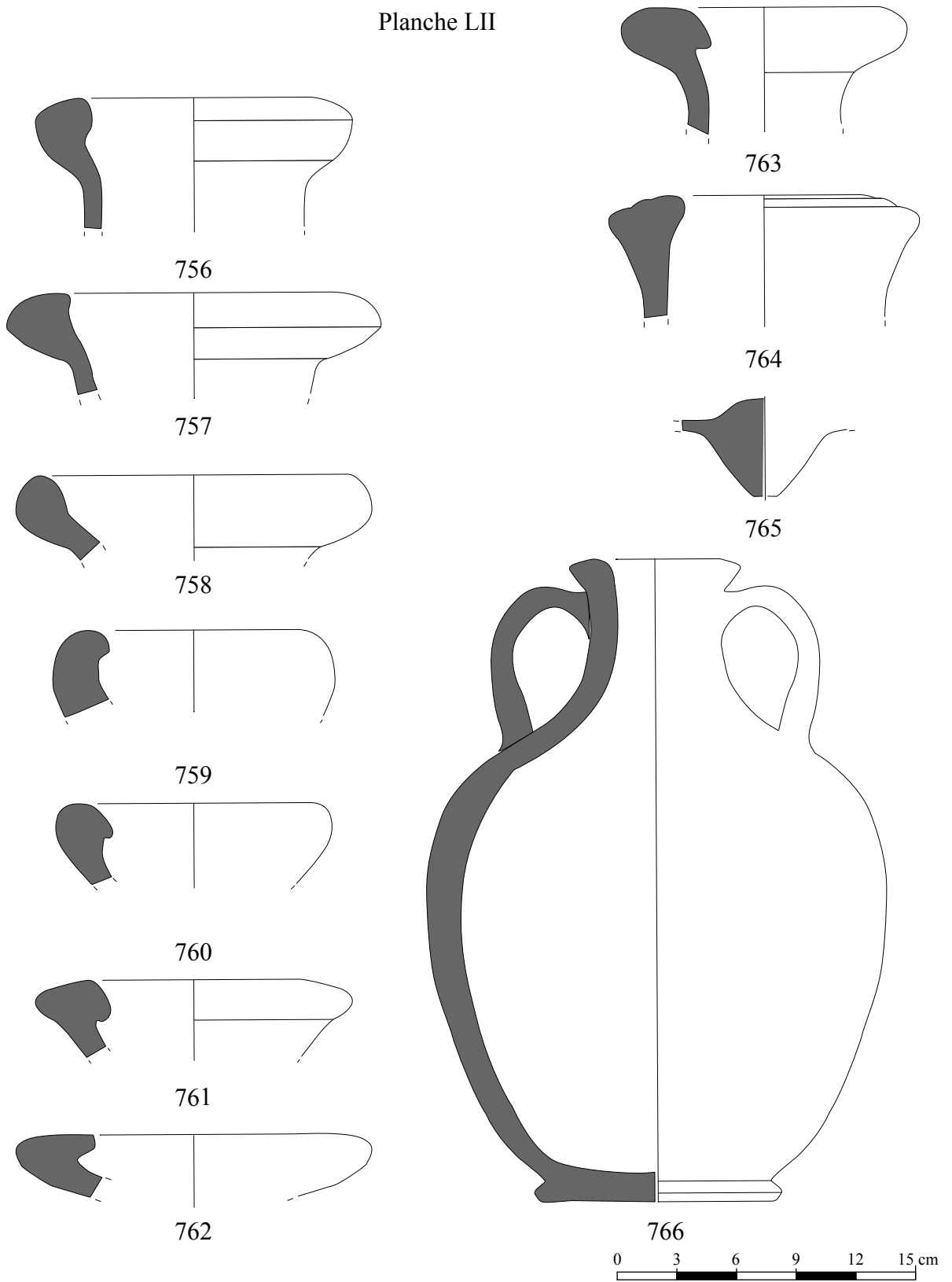

ANNEXE A
LES ROISES
Planche LIII

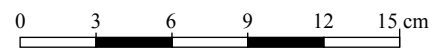
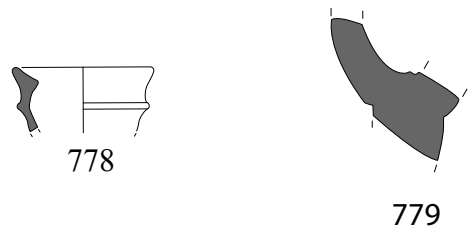
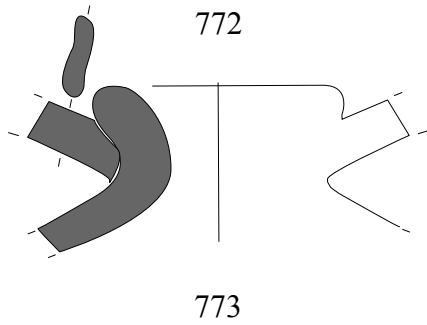
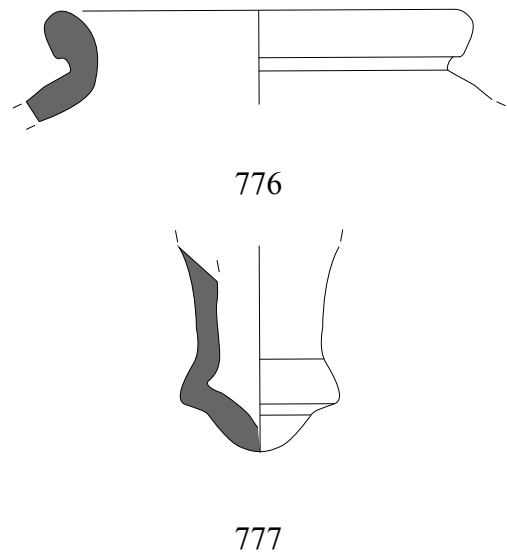
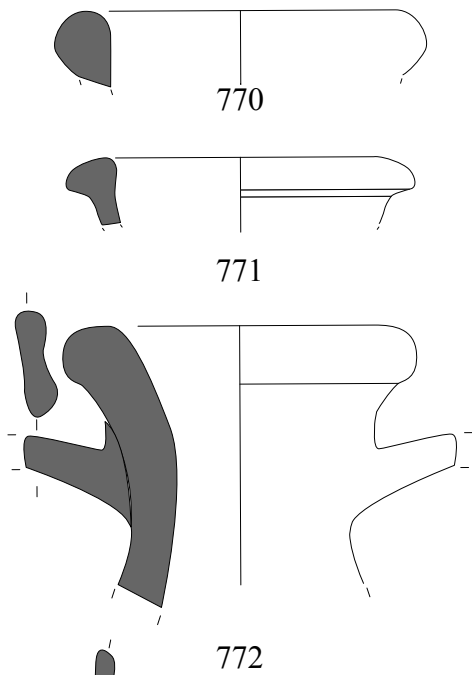
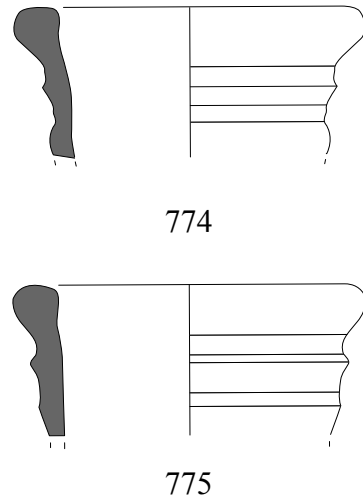
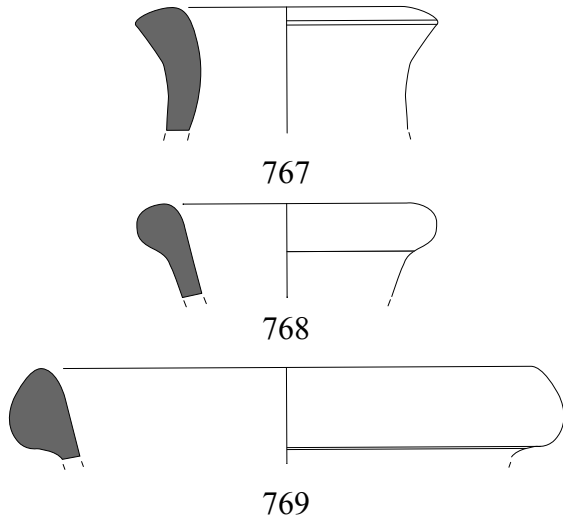

ANNEXE A
LES ROISES
Planche LIV

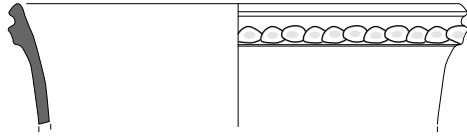

780

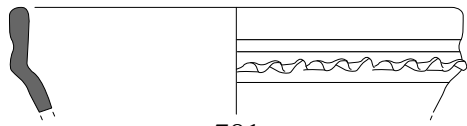

781

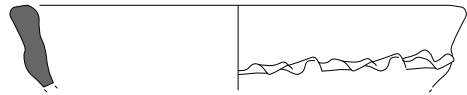

782

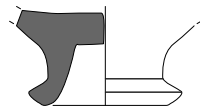

783

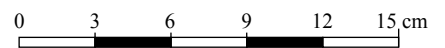

ANNEXE A
 RUE DE L'AMPHITHEATRE
 Secteur 1
 Planche I



005.1

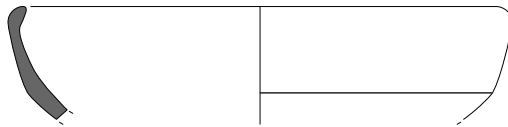

014.1



014.2

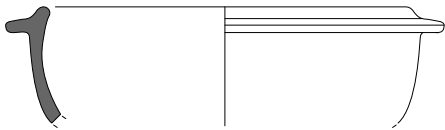

014.3



014.9

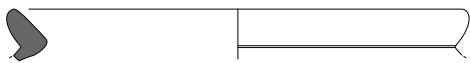

014.4



014.5

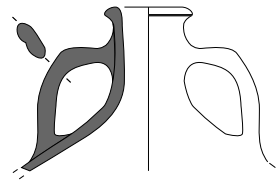

014.10



014.6

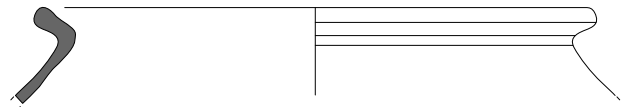

021.1

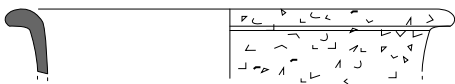

014.7

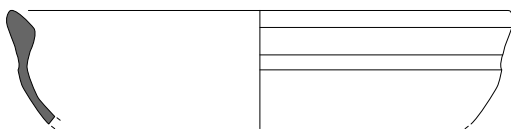

014.8

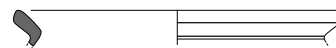

Cave 1.1

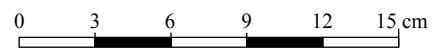

ANNEXE A
RUE DE L'AMPHITHEATRE
Secteur 3
Planche II

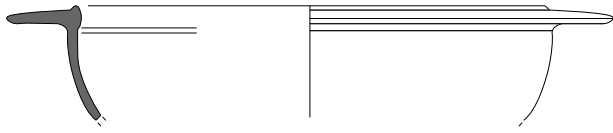

006.1

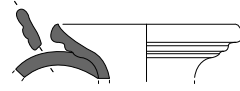

3008.1

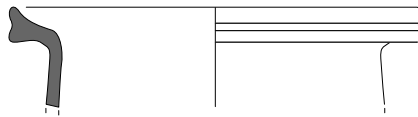

3008.2



3008.3

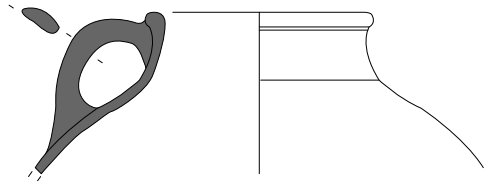

3008.4

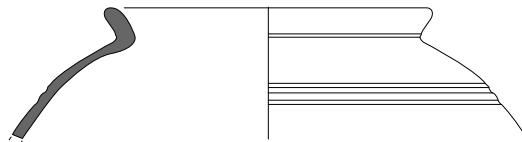

3008.5

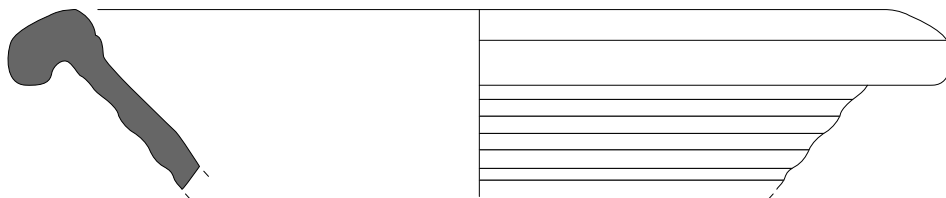

3008.6

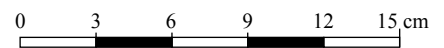

ANNEXE A
RUE DE L'AMPHITHEATRE
Secteur 3
Planche III



3021.1



3021.2

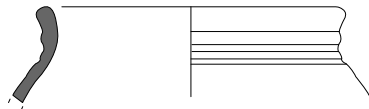

3021.3

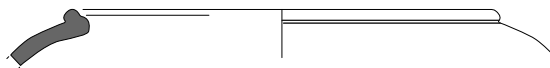

3021.4

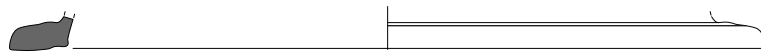

3021.5

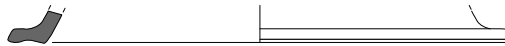

3021.6

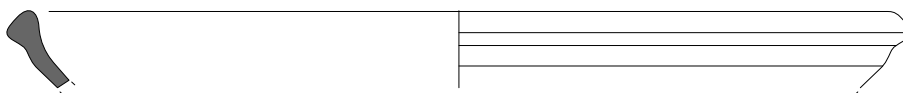

3021.7

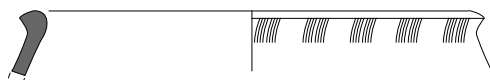

3022.1

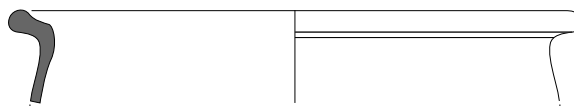

3022.2

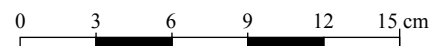

ANNEXE A
RUE DE L'AMPHITHEATRE
Secteur 3
Planche IV

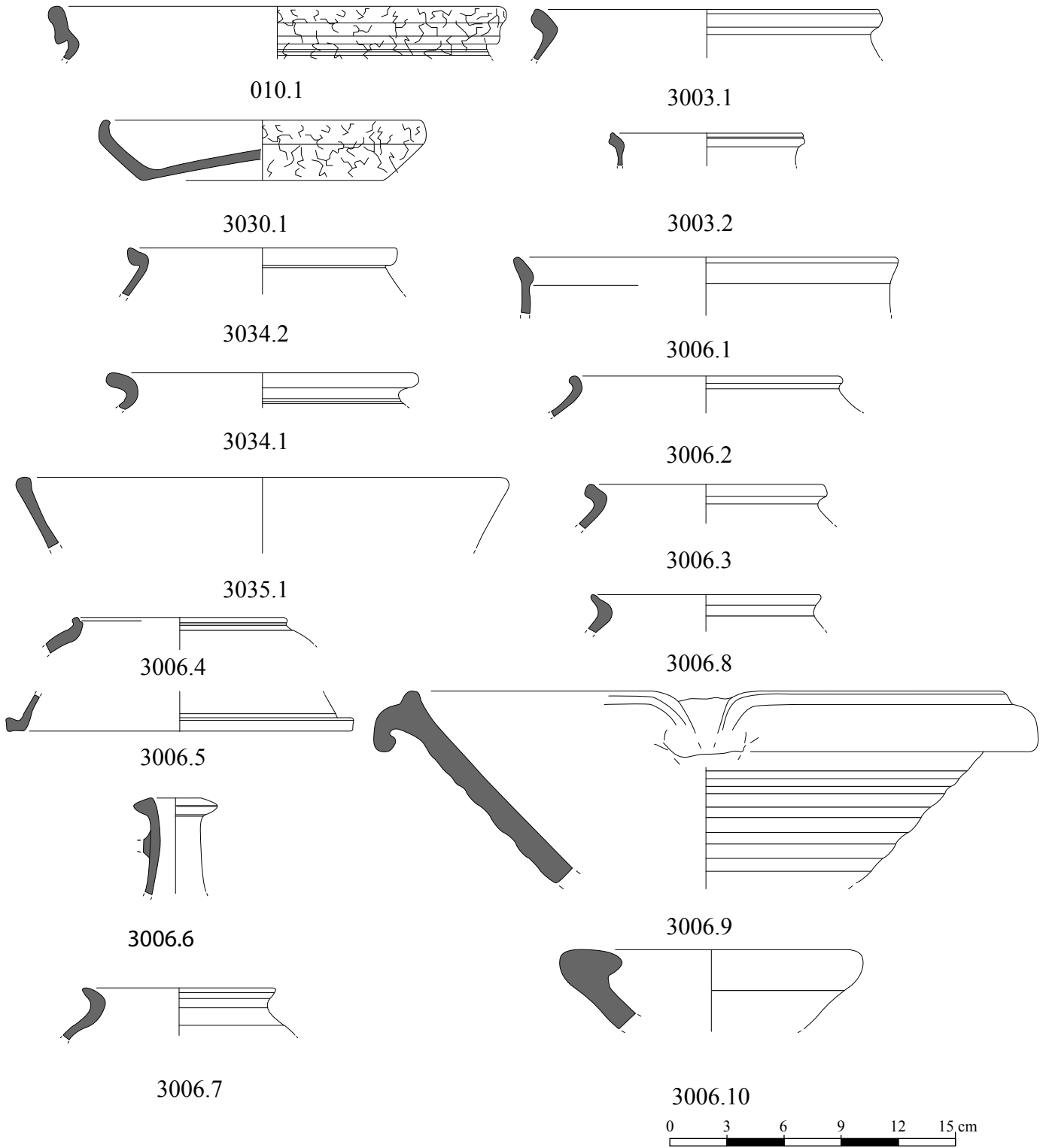

ANNEXE A
RUE DE L'AMPHITHEATRE
Secteur 3
Planche V

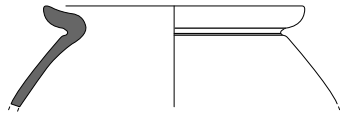

3007.1

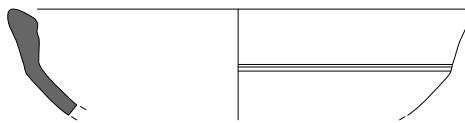

3007.2



3007.3



3048.1

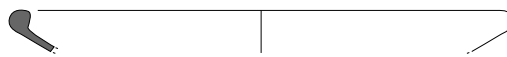

3048.2

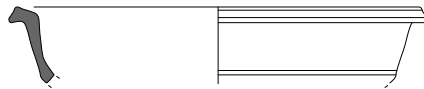

3049.1

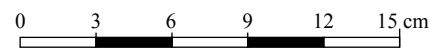

ANNEXE A
RUE DE L'AMPHITHEATRE
Secteur 4
Planche VI

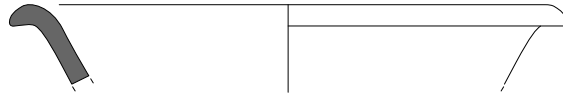

4007.1

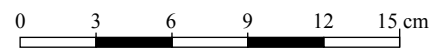

ANNEXE A
RUE DE L'AMPHITHEATRE
Secteur 5
Planche VII

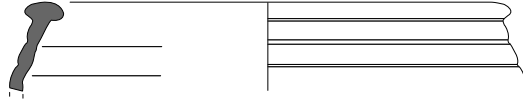

5001.1

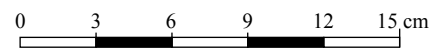

ANNEXE A
RUE DE L'AMPHITHEATRE
Secteur 6
Planche VIII

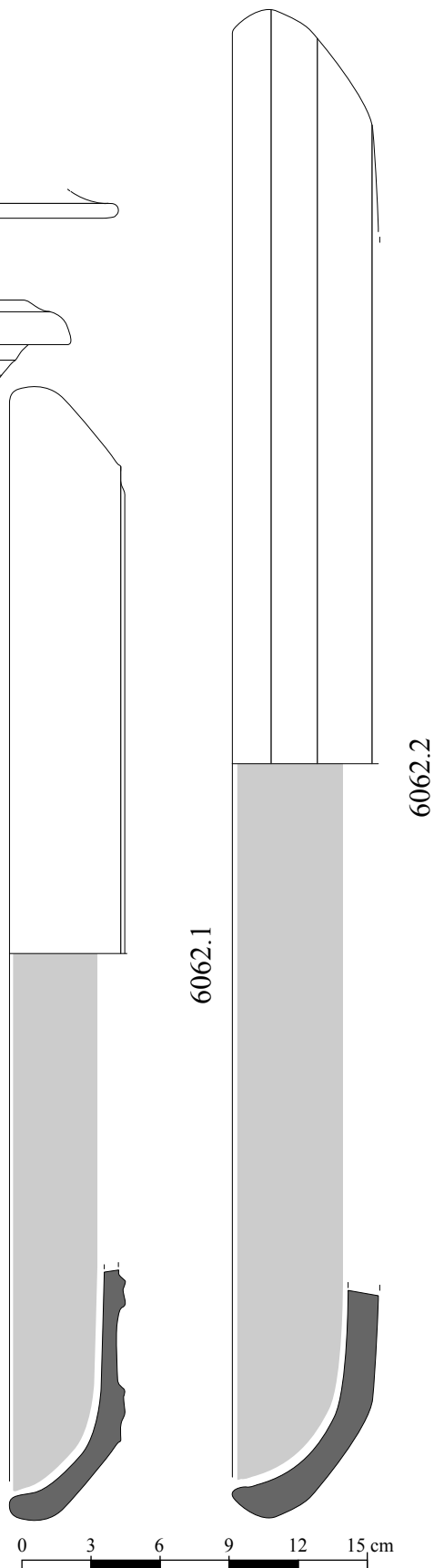
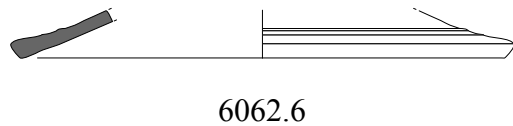
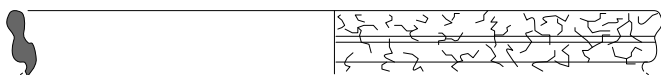
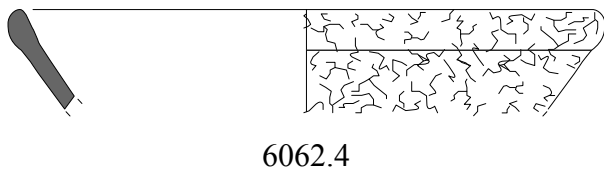
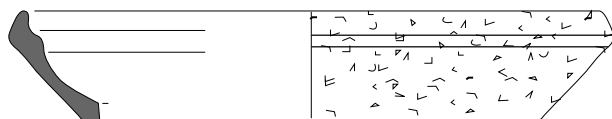
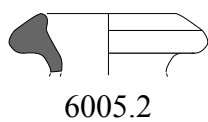
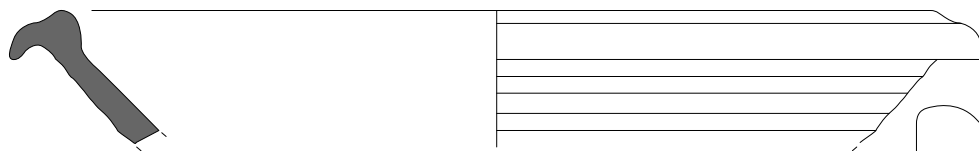
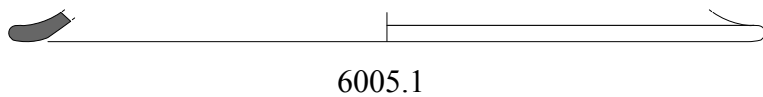

ANNEXE A
RUE DE L'AMPHITHEATRE
Secteur 6
Planche IX

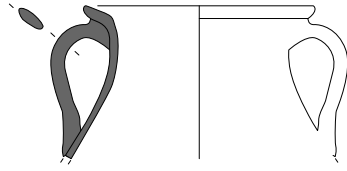

6062.7

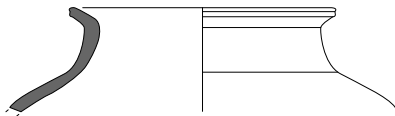

6062.8



6064.1

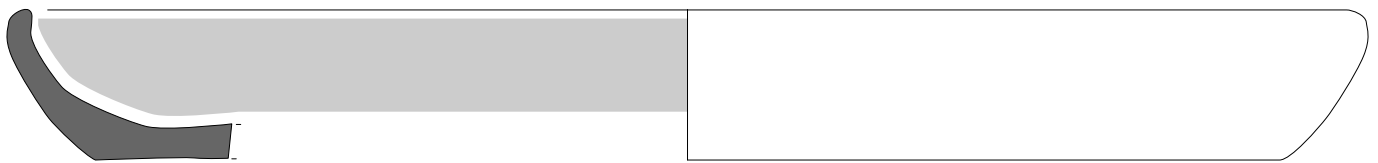

6065.1

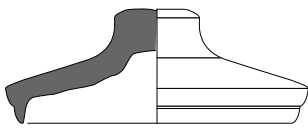

6065.2

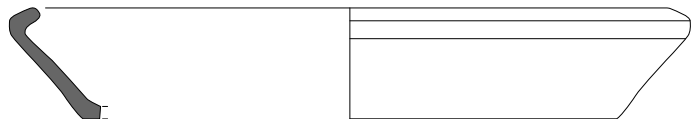

6019.1

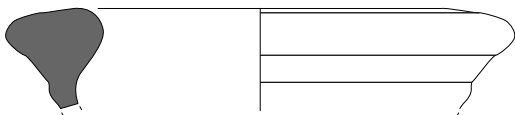

6021.1



6019.1

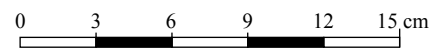

ANNEXE A
RUE DE L'AMPHITHEATRE
Secteur 6
Planche X

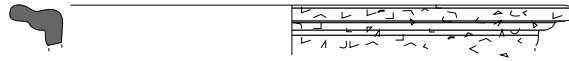

6022.1

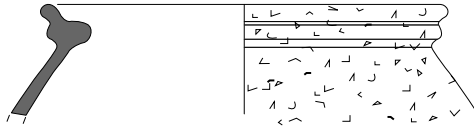

6022.2

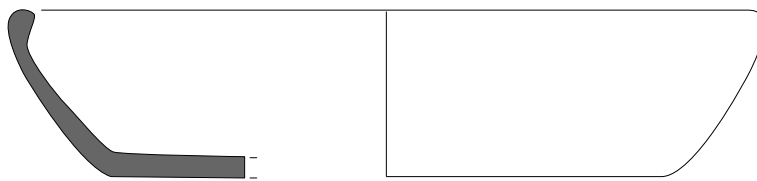

6022.3

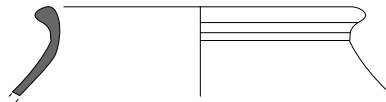

6022.4



6025.1

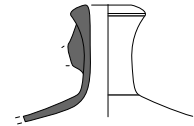

6025.3



6025.2

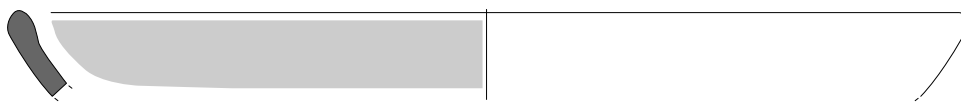

6024.1

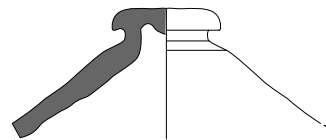

6024.2



6024.3

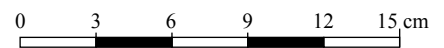

ANNEXE A
RUE DE L'AMPHITHEATRE
Secteur 6
Planche XI

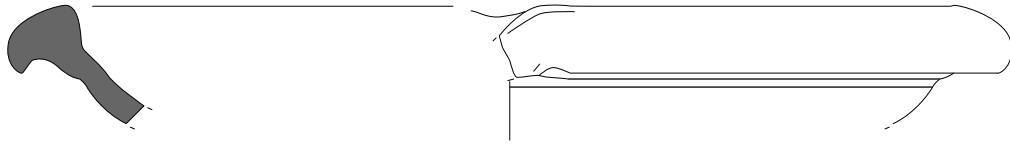

6024.4



6026.1

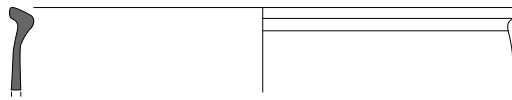

6028.1

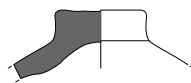

6028.2

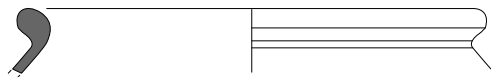

6030.1



6045.1



6045.2



6045.3

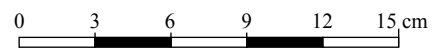

ANNEXE A
RUE DE L'AMPHITHEATRE
Secteur 6
Planche XII

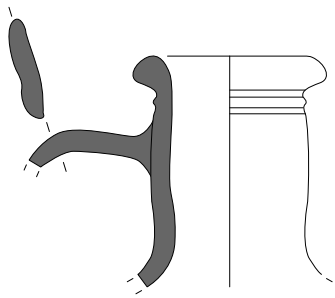

6045.4



6056.2

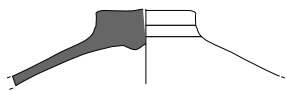

6056.3

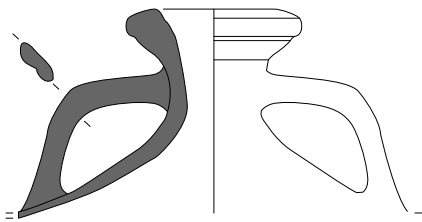

6056.4

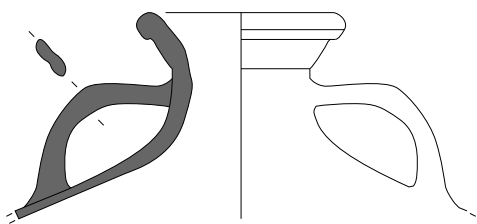

6056.5

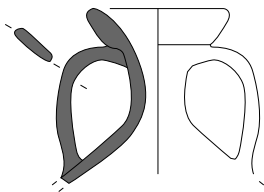

6056.6

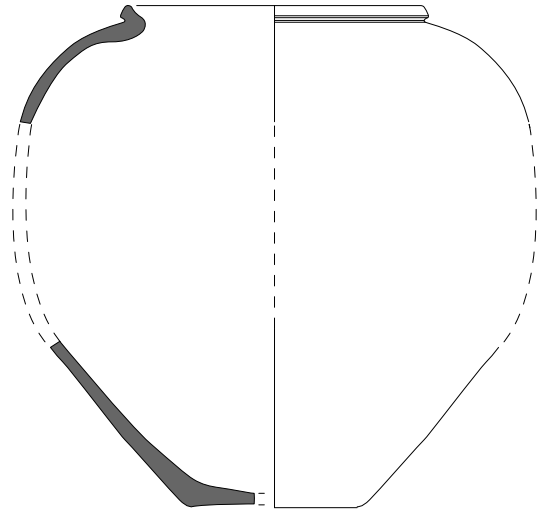

6056.1

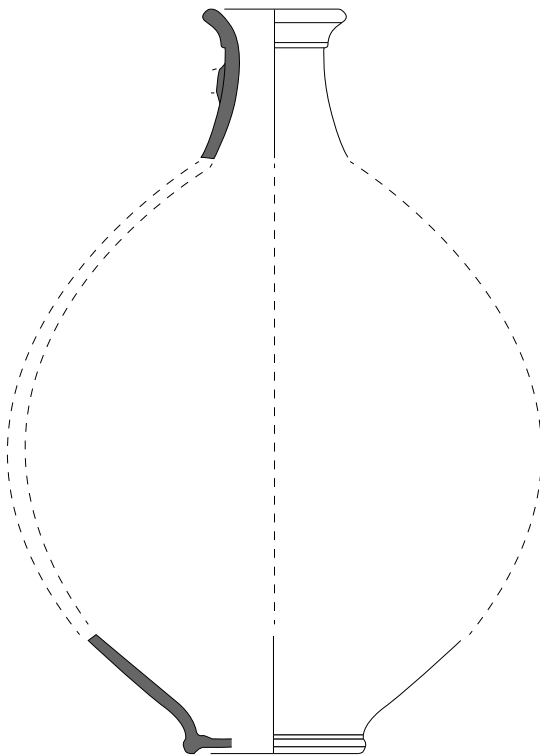

6056.7

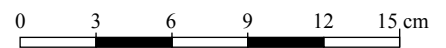

ANNEXE A
RUE DE L'AMPHITHEATRE
Secteur 6
Planche XIII

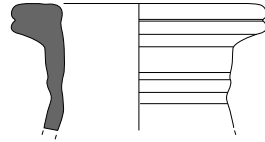

6056.8

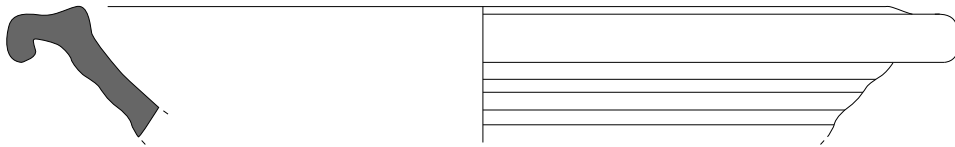

6056.9

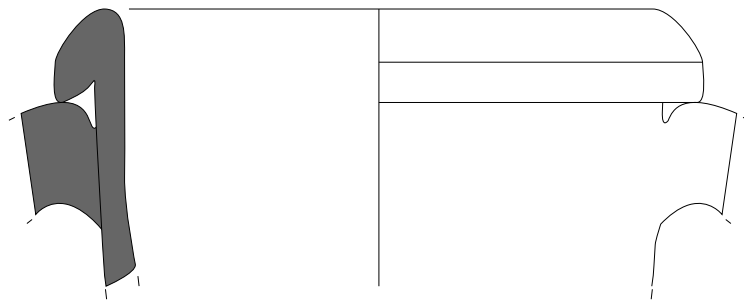

6056.10

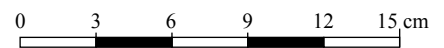

ANNEXE A
RUE DE L'AMPHITHEATRE
Secteur 7
Planche XIV

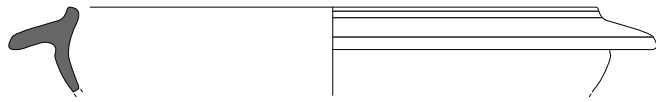

7000.1

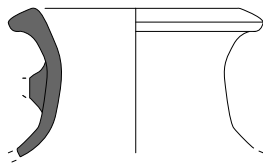

7001.1

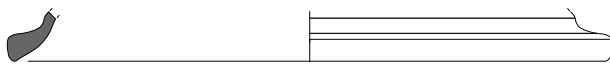

7007.1

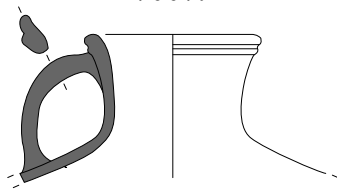

7007.2



7010.1



7020.1

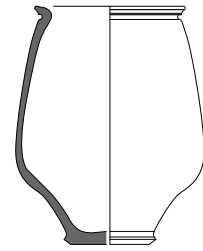

7021.1

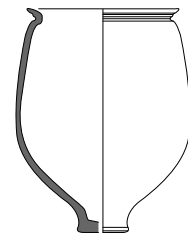

7021.2



7011.1



7011.2

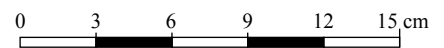

ANNEXE A
RUE DE L'AMPHITHEATRE
Secteur 7
Planche XV

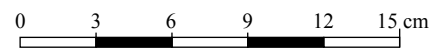
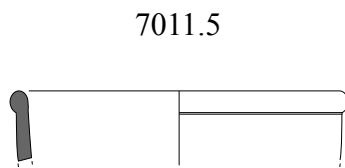
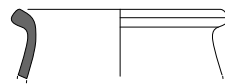
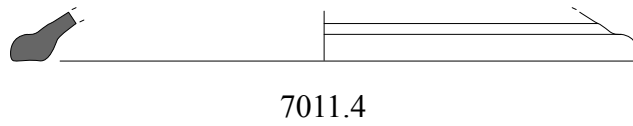
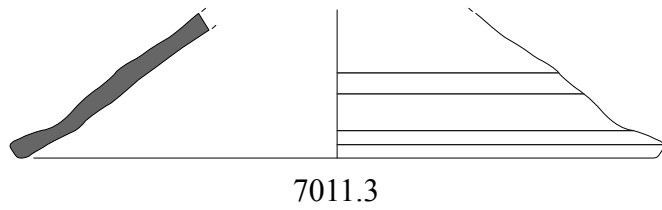

ANNEXE A
RUE DE L'AMPHITHEATRE
Secteur 9
Planche XVI

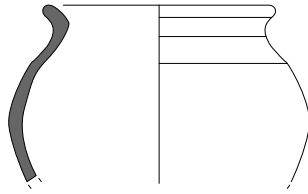

9008.1

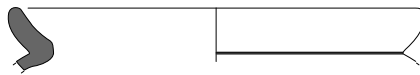

9010.1

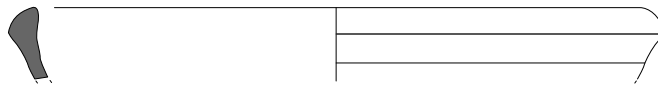

9010.2



9010.3

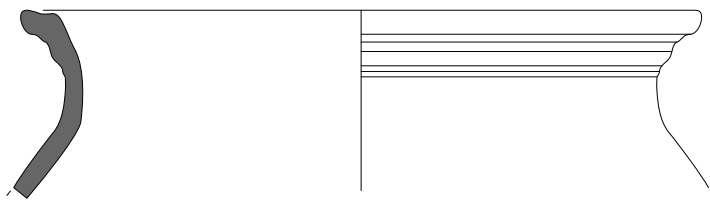

9010.4



9010.5

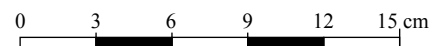

ANNEXE A
RUE DE L'AMPHITHEATRE
Secteur 10
Planche XVII

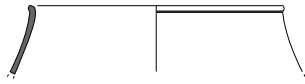

10022.1

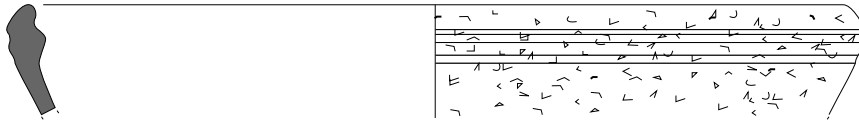

10022.2

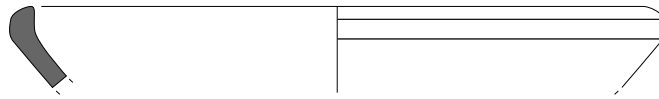

10022.3

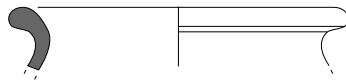

10022.4



10022.5



10023.1

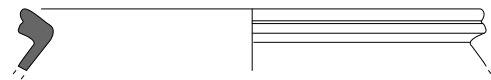

10023.5



10023.2



10023.6



10023.3

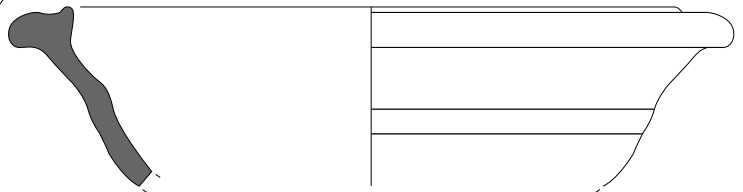

10023.7



10023.4

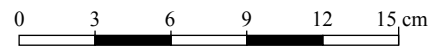

ANNEXE A
RUE DE L'AMPHITHEATRE
Secteur 10
Planche XVIII

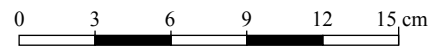
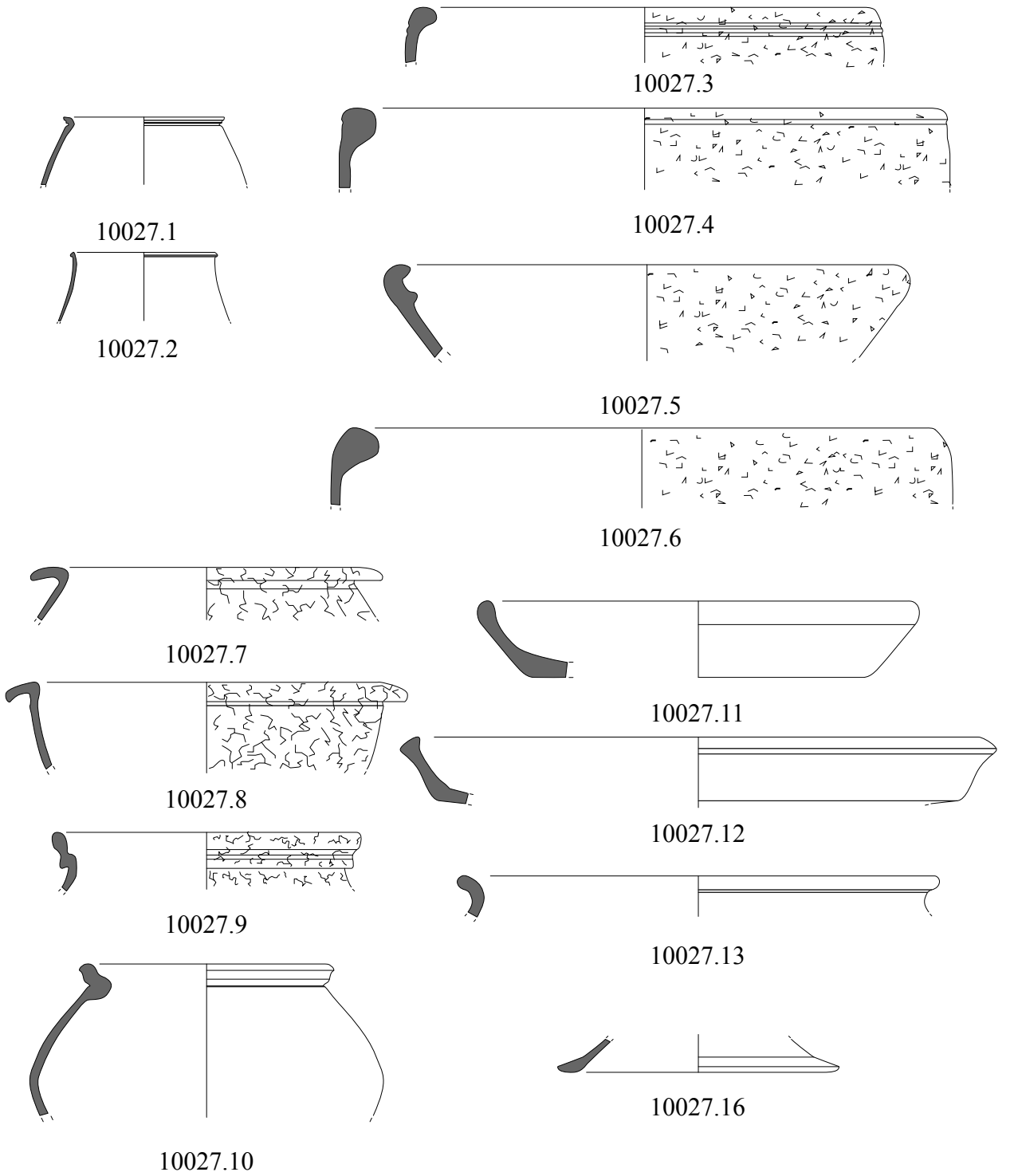

ANNEXE A
RUE DE L'AMPHITHEATRE
Secteur 10
Planche XIX

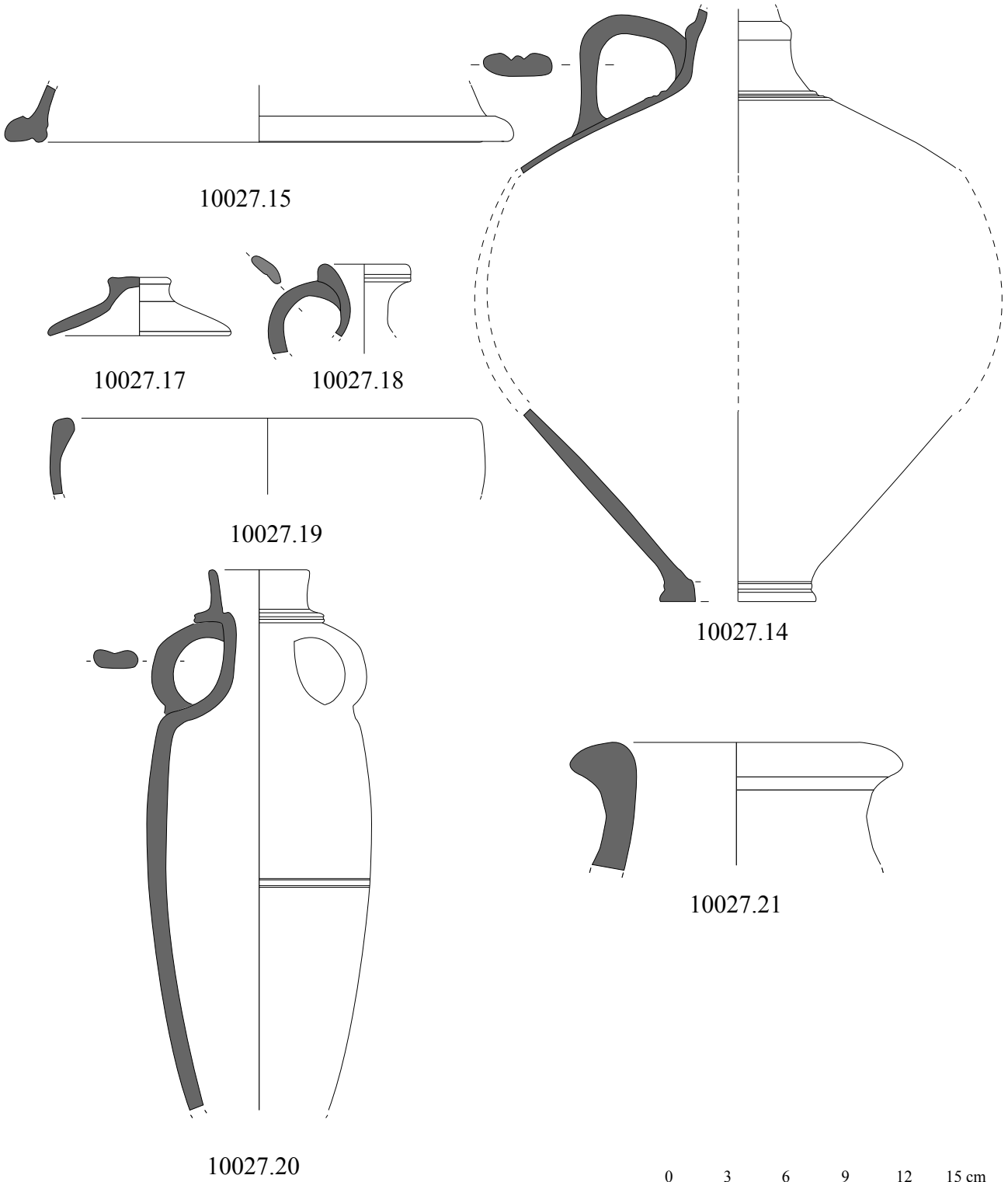

ANNEXE A
RUE DE L'AMPHITHEATRE
Décapage
Planche XX

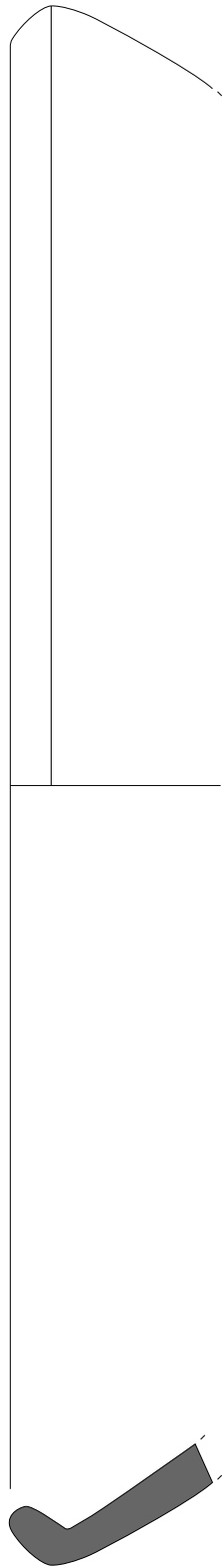

001.3



001.1



001.2

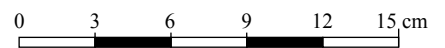

ANNEXE A
RUE DE L'AMPHITHEATRE
S2
Planche XXI

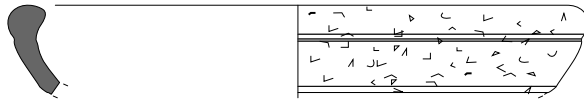

S2.1

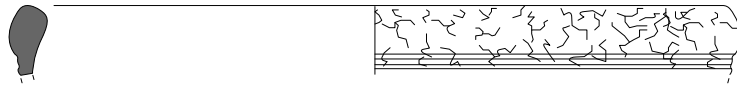

S2.2

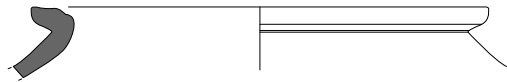

S2.3



S2.4

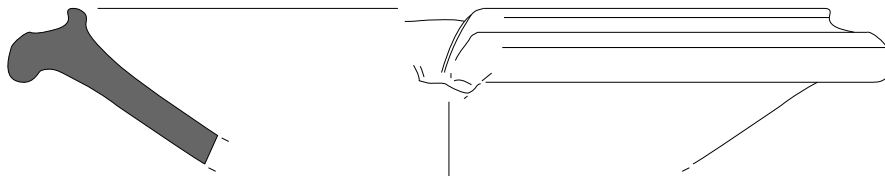

S2.5

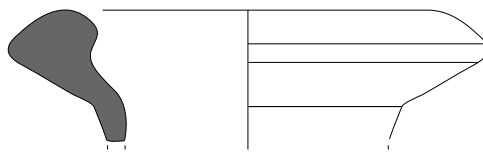

S2.6

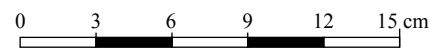

ANNEXE A
RUE DE L'AMPHITHEATRE
S3
Planche XXII

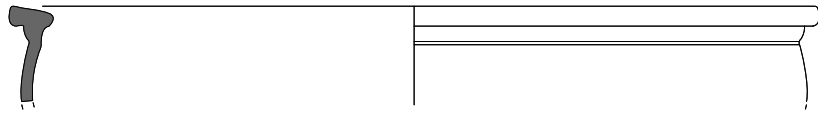

S3.1

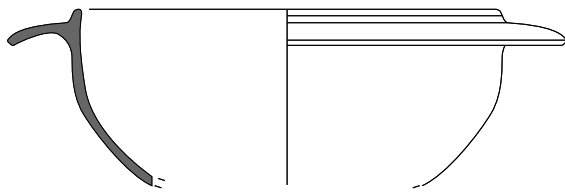

S3p.1

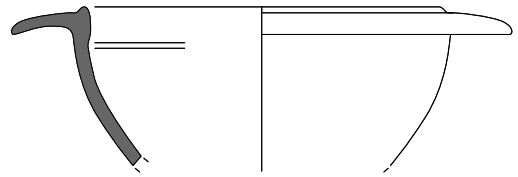

S3p.3

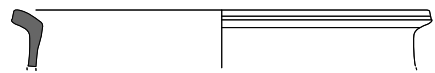

S3p.4

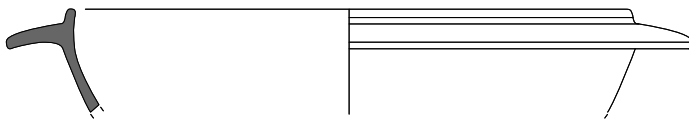

S3p.2

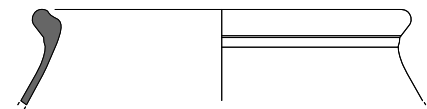

S3p.5

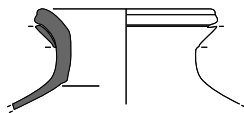

S3p.6

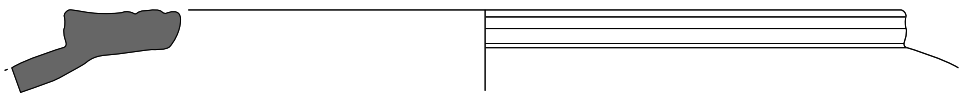

S3p.7

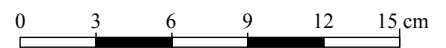

ANNEXE A
RUE DE L'AMPHITHEATRE
S5
Planche XXIII

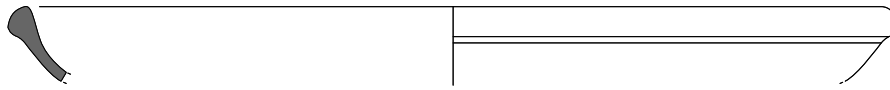

S5.1



S5.2

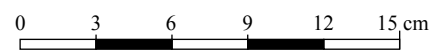

ANNEXE A
RUE DE L'AMPHITHEATRE
S6
Planche XXIV

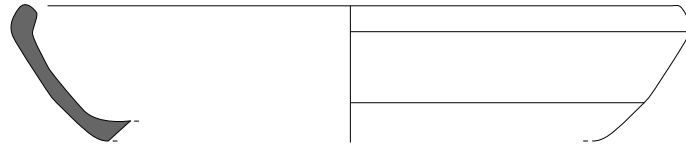

S6.1

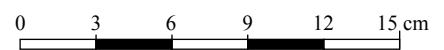

ANNEXE A
RUE DE L'AMPHITHEATRE
(issu de Feller 1996 p. 133-138)

Planche I

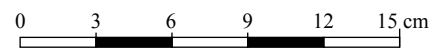
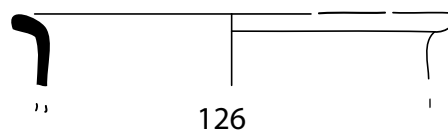
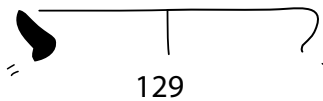
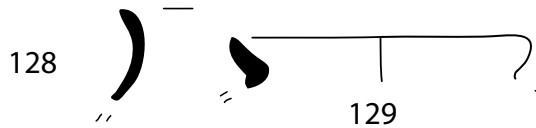
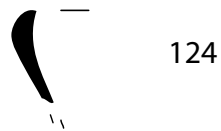
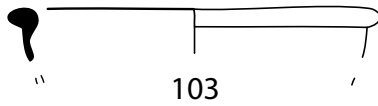
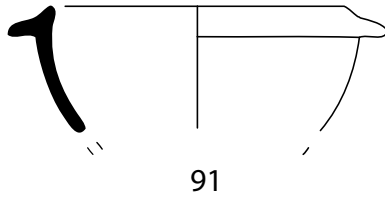
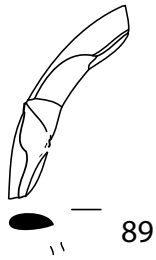

ANNEXE A
 RUE DE L'AMPHITHEATRE
 (issu de Feller 1996 p. 133-138)

Planche II

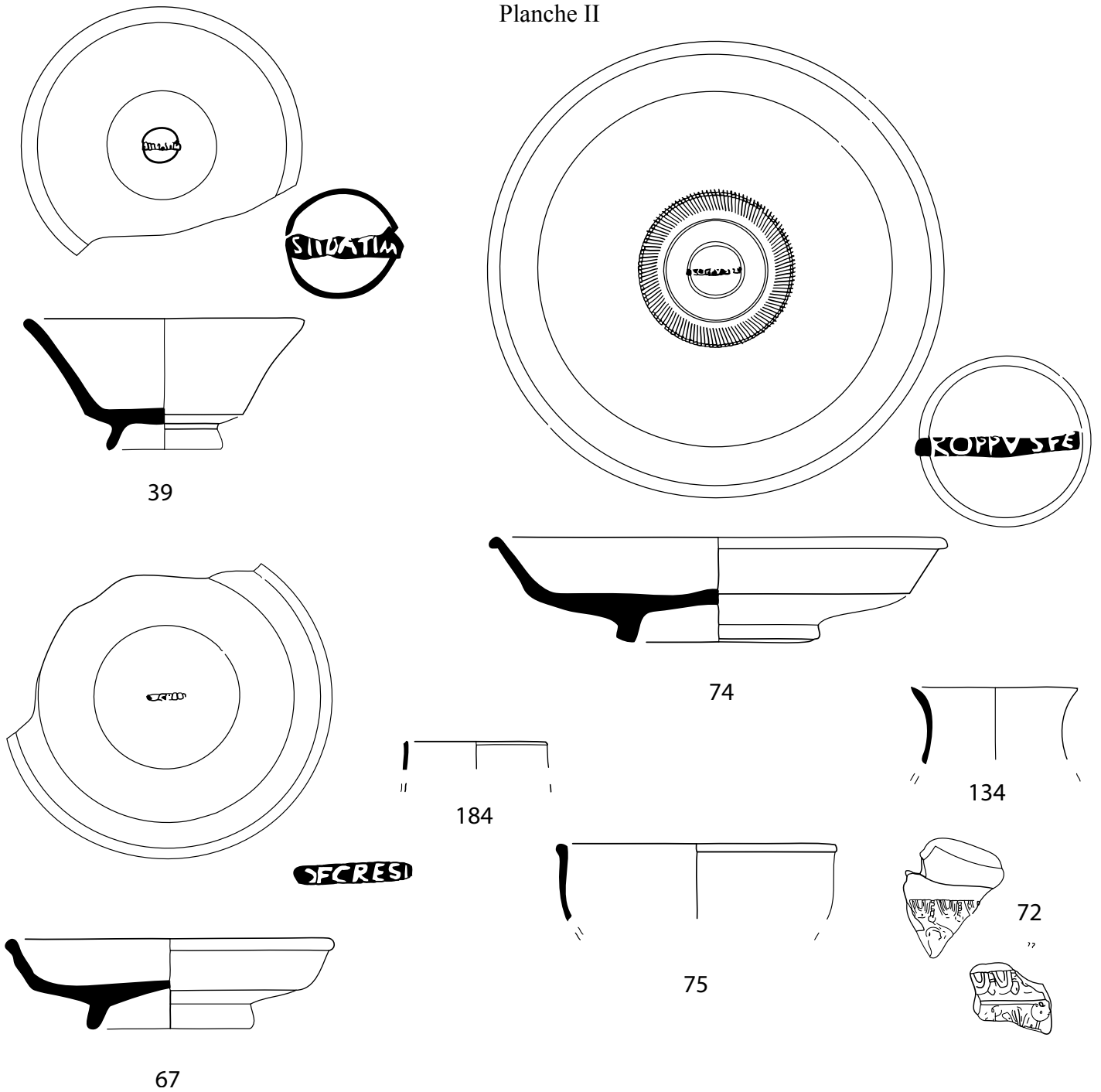

ANNEXE A
RUE DE L'AMPHITHEATRE
(issu de Feller 1996 p. 133-138)

Planche II suite

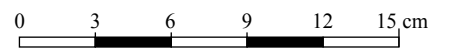
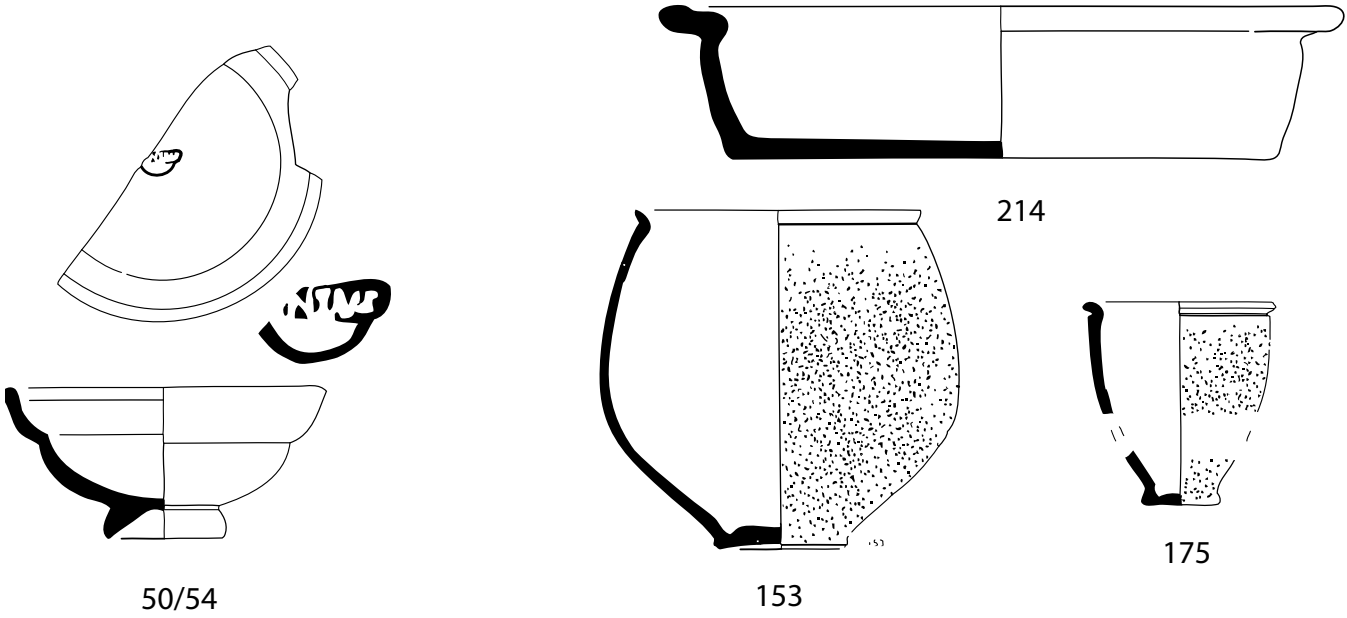

ANNEXE A

RUE DE L'AMPHITHEATRE
(issu de Feller 1996 p. 133-138)

Planche III

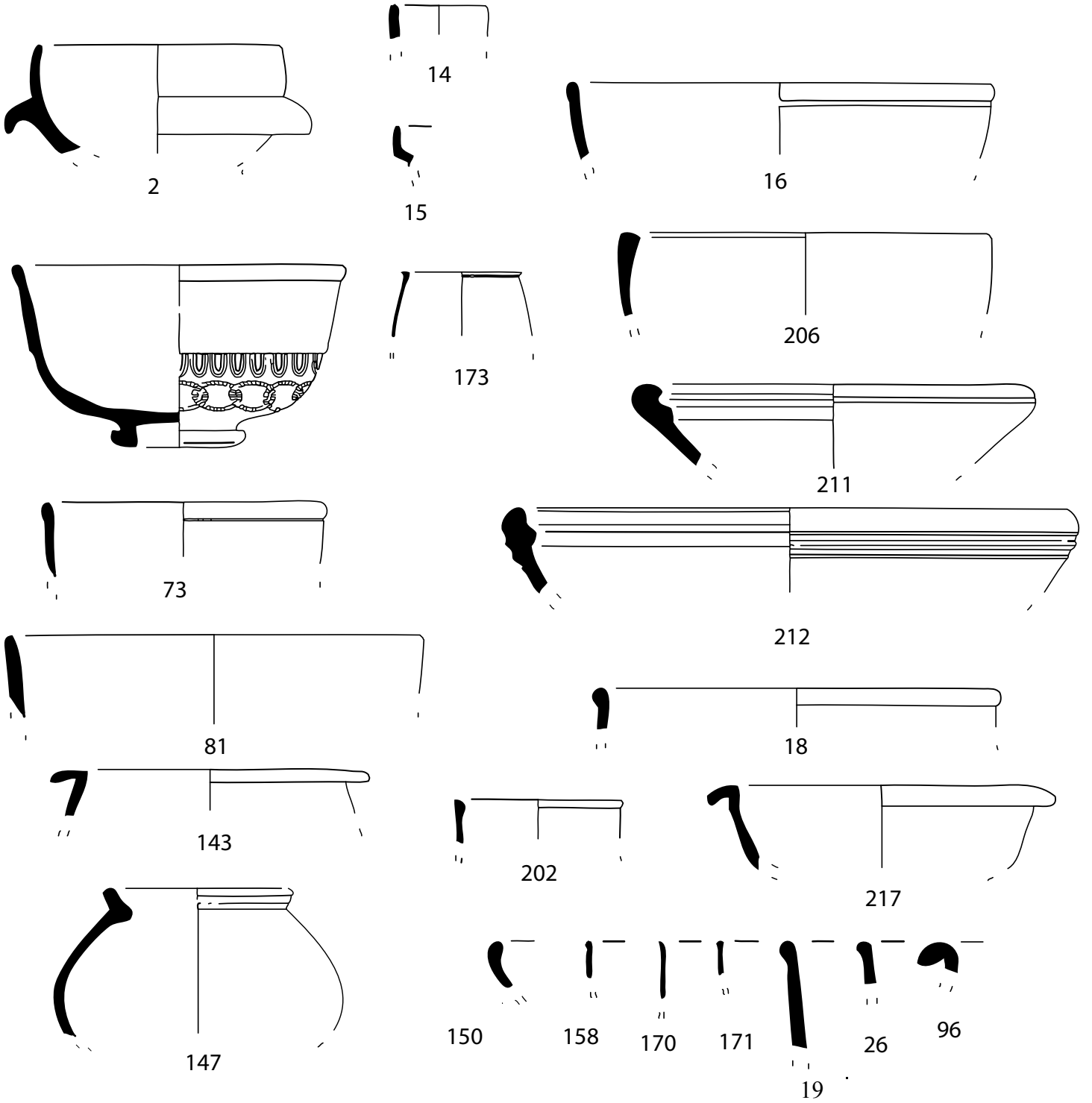

ANNEXE A
RUE DE L'AMPHITHEATRE
(issu de Feller 1996 p. 133-138)

Planche III suite

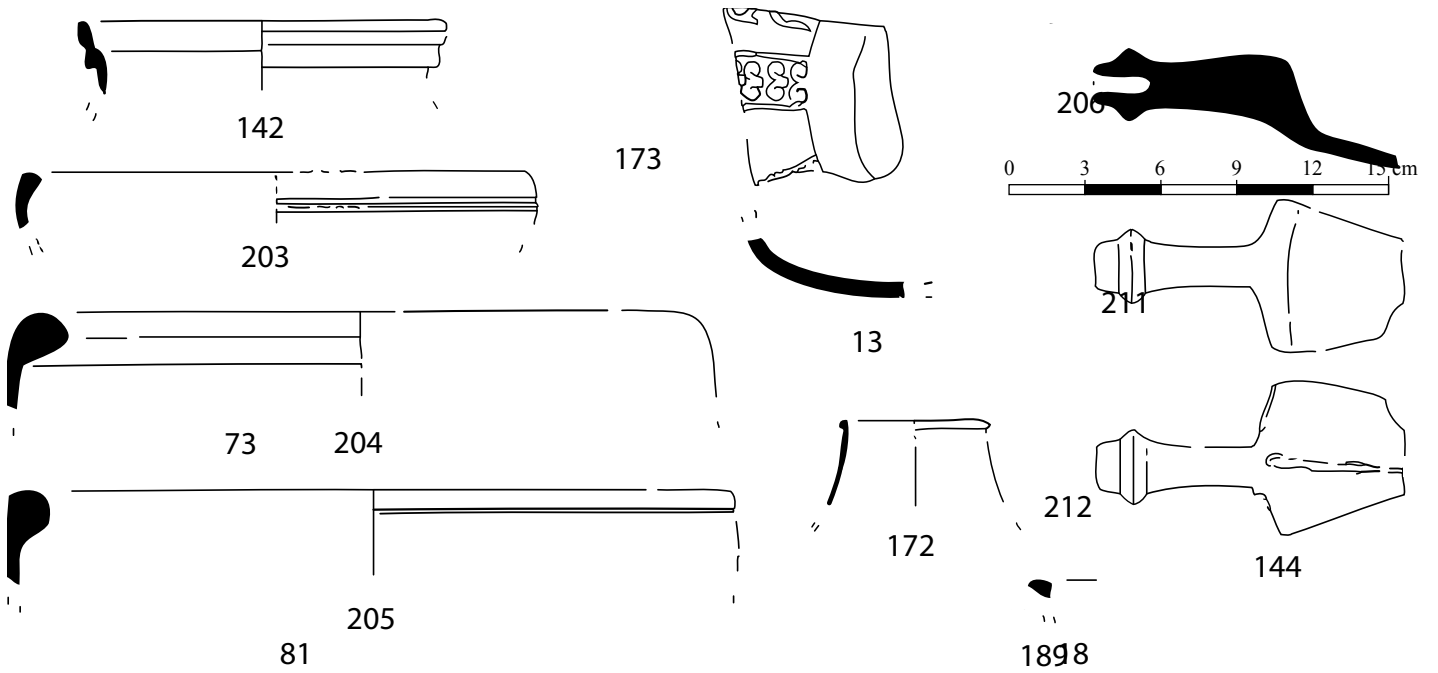

ANNEXE A
PUITS DAINVILLE
Planche I

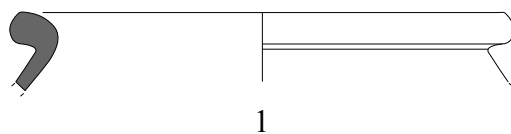

ANNEXE A
PUITS DUSSEAUX
Planche I

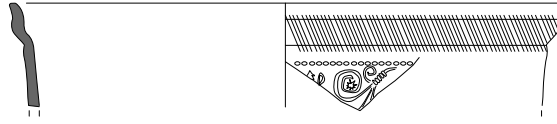

1

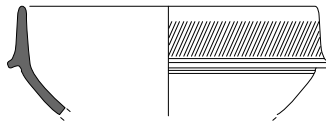

2

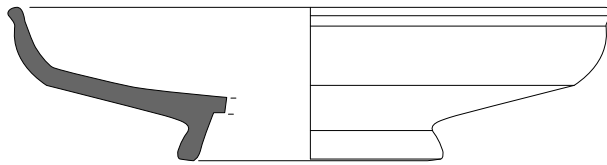

3

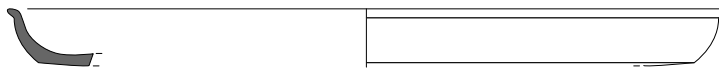

4

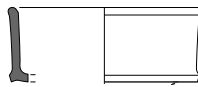

5

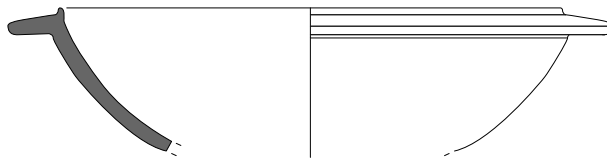

6

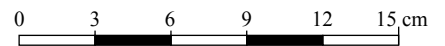

ANNEXE A
PUITS DUSSEAUX
Planche I

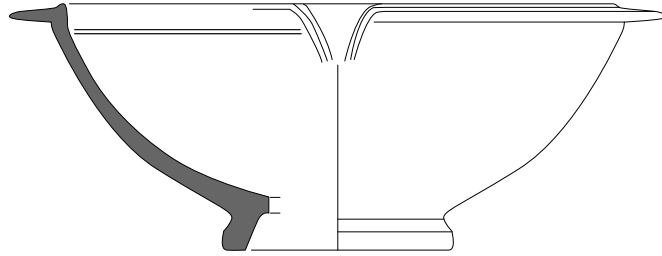

7

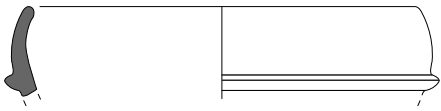

8

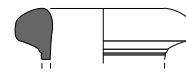

12

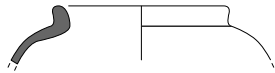

9

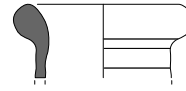

13



10

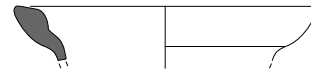

14

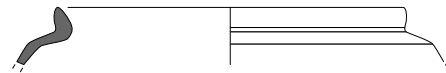

15

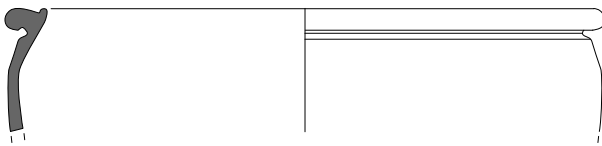

11

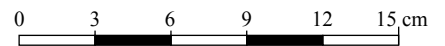

ANNEXE A
PUITS MEYER

Planche I

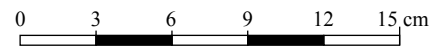
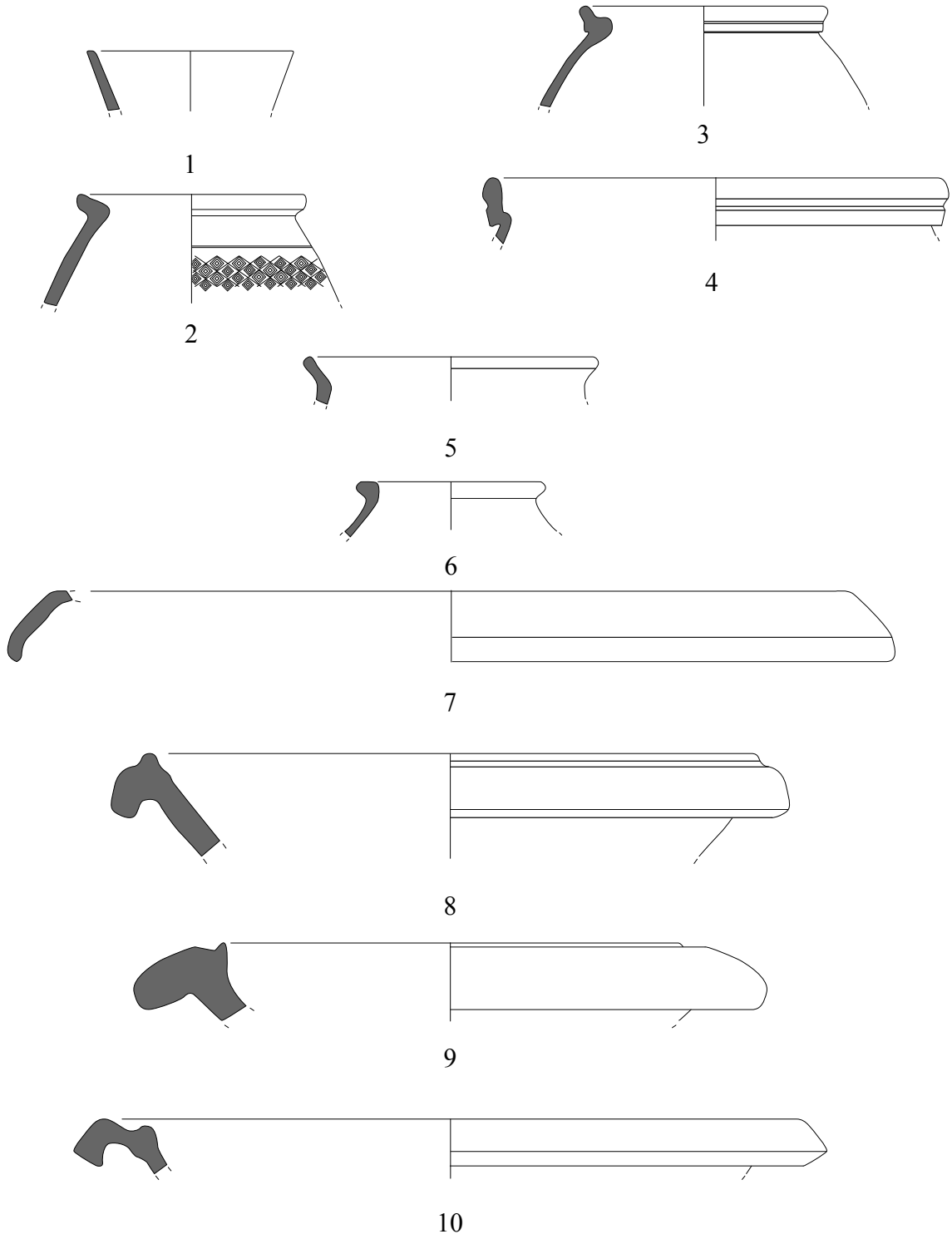

ANNEXE A
PUITS MORLOT
Planche I

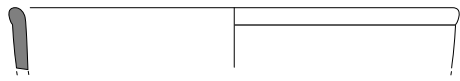

1

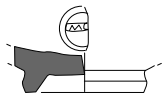

2

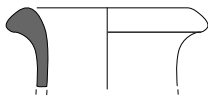

3



4



5



6



7



8

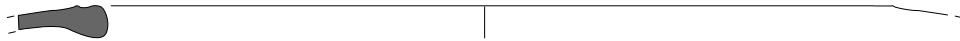

9

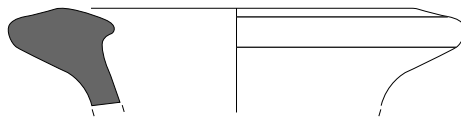

10

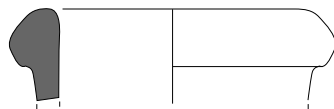

11

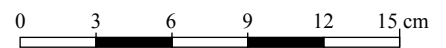

ANNEXE A
PUITS MOSER
Planche I

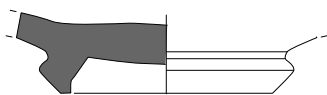

1

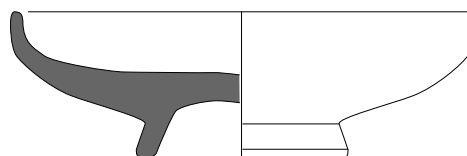

4

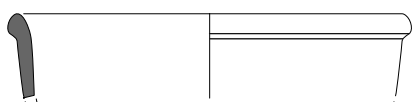

2

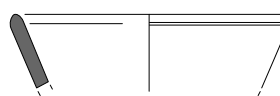

5

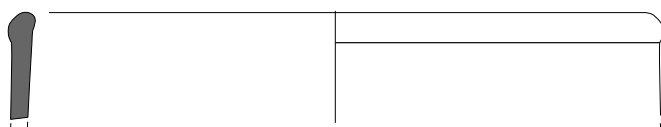

3

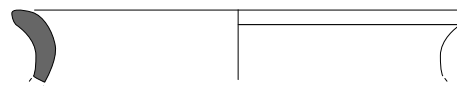

6



7



12



8

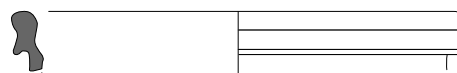

13

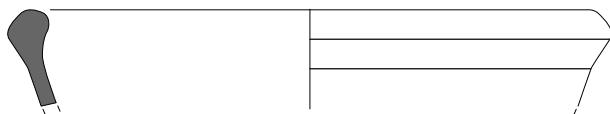

9

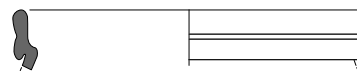

14

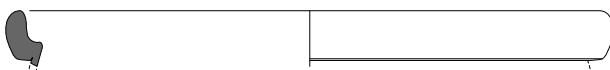

10

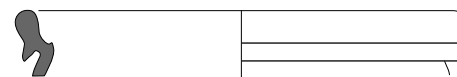

15

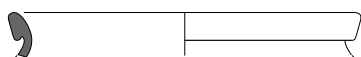

11

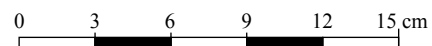

ANNEXE A
PUITS MOSER
Planche II

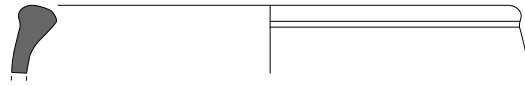

16

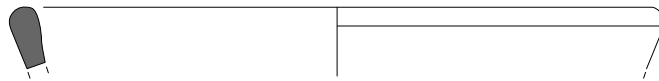

17



18

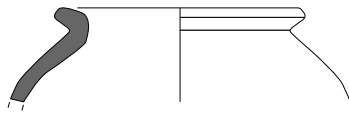

19



20



21



22

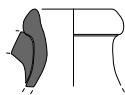

23



24

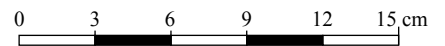

ANNEXE A
PUITS CHAMPE MARGERITE

Planche I

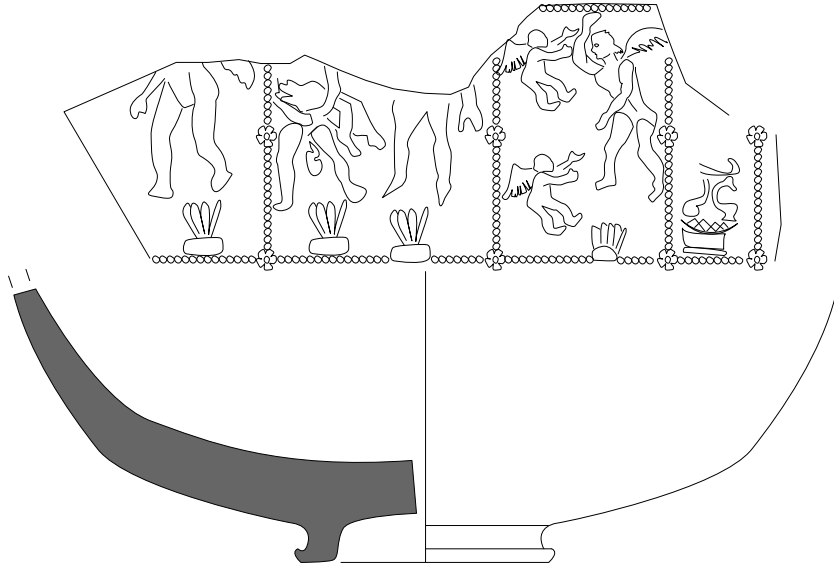

1

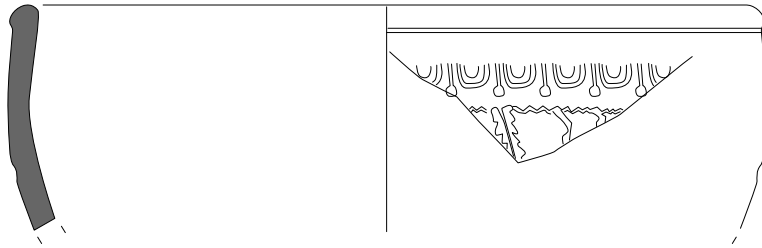

2

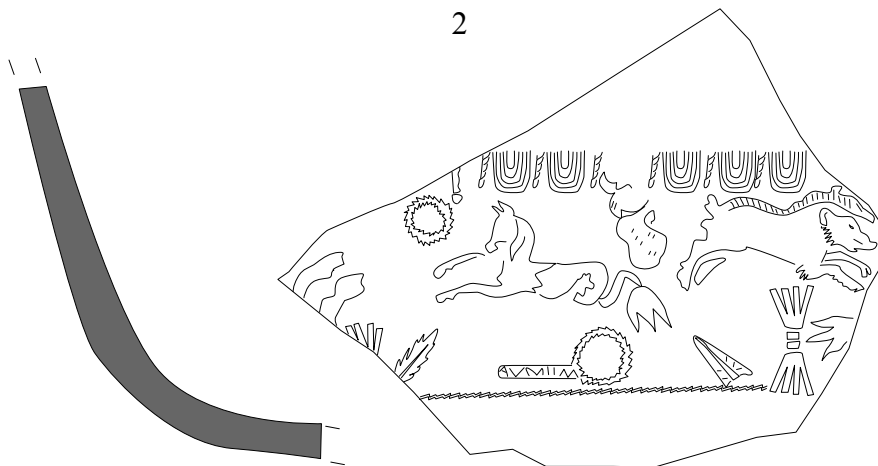

3

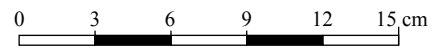

ANNEXE A
PUITS CHAMPE MARGERITE
Planche II

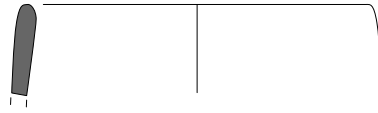

4

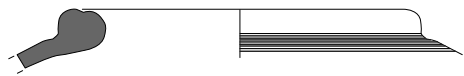

5



6

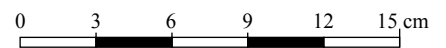

ANNEXE A
PUITS AUX TABLETTES

Planche I

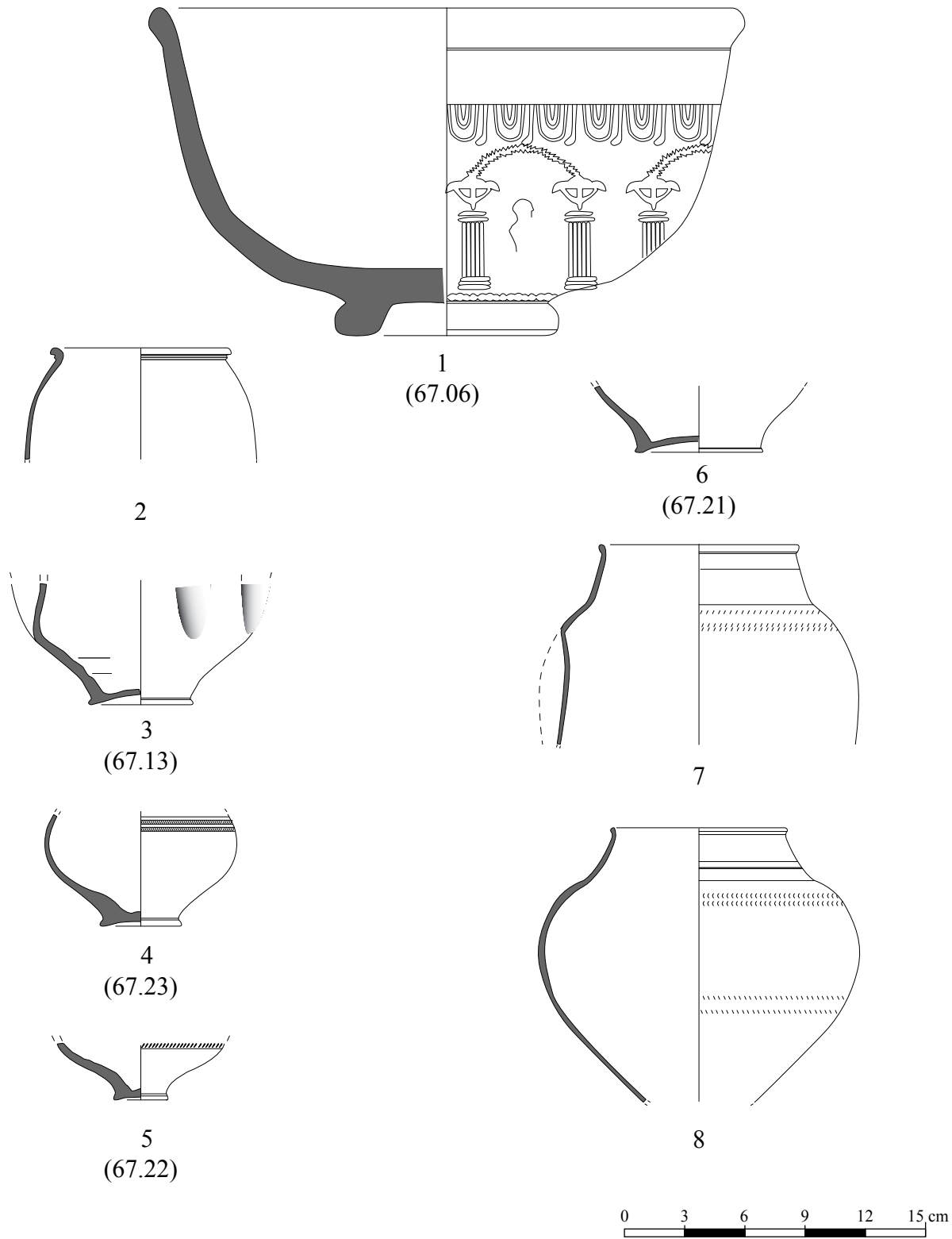

ANNEXE A
 PUIXS AUX TABLETTES

Planche II

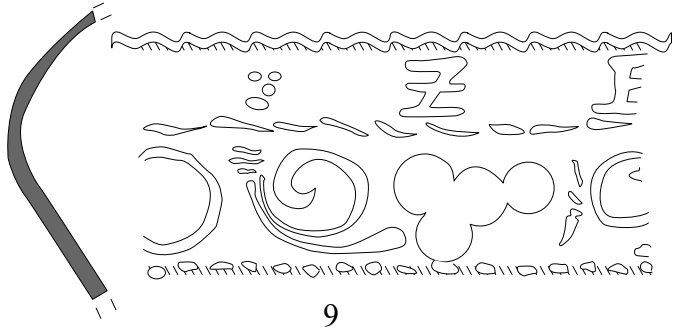

9

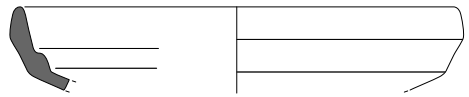

11

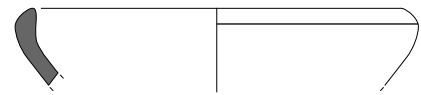

12

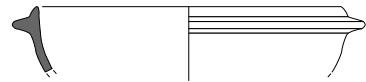

13

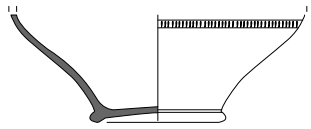

10



17

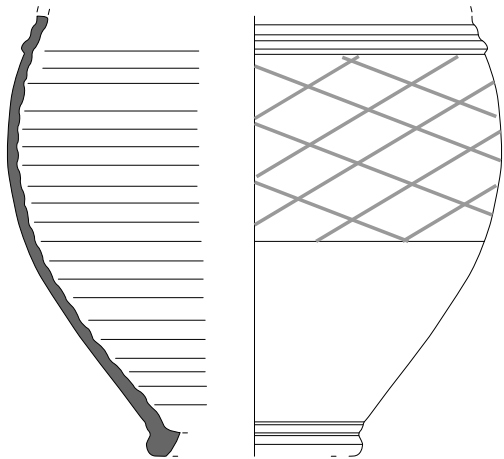

14
 (67.12)

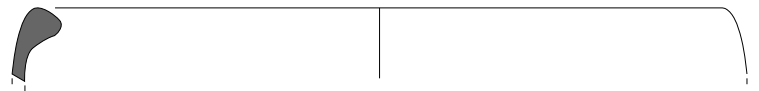

18

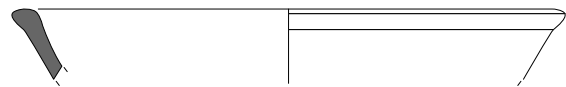

19

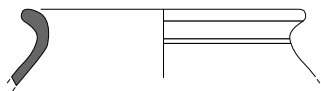

15

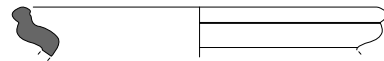

20

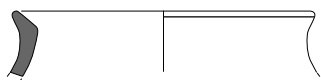

16



21

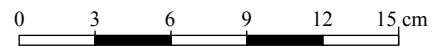

ANNEXE A
PUITS AUX TABLETTES

Planche III

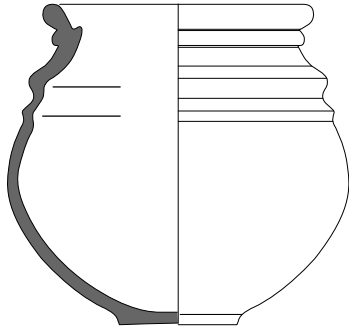

22
(67.02)

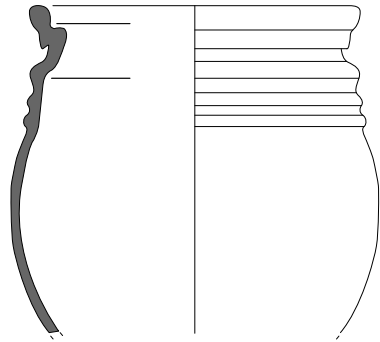

24
(67.16)

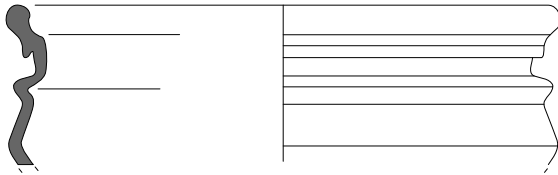

23
(67.10B)

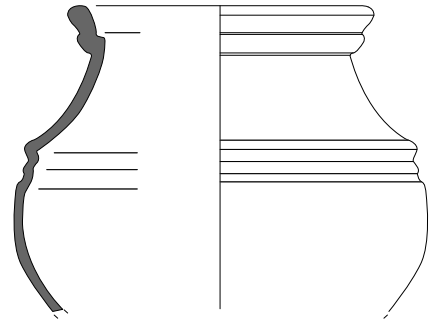

25
(67.03)

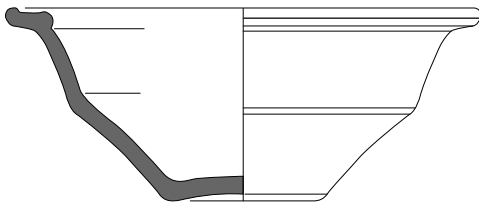

26
(67.09)

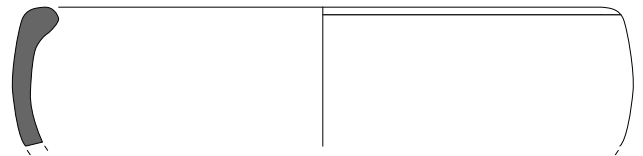

28

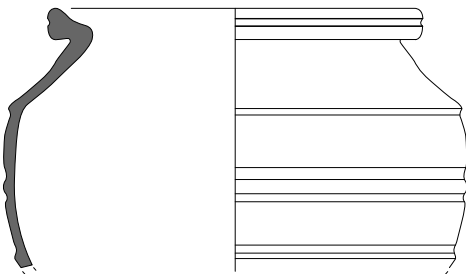

27
(67.24)

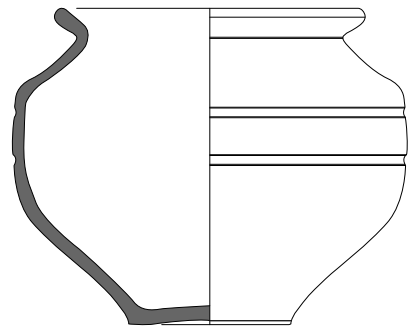

29
(67.11)

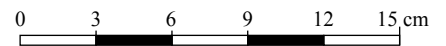

ANNEXE A
PUITS AUX TABLETTES
Planche IV

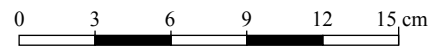
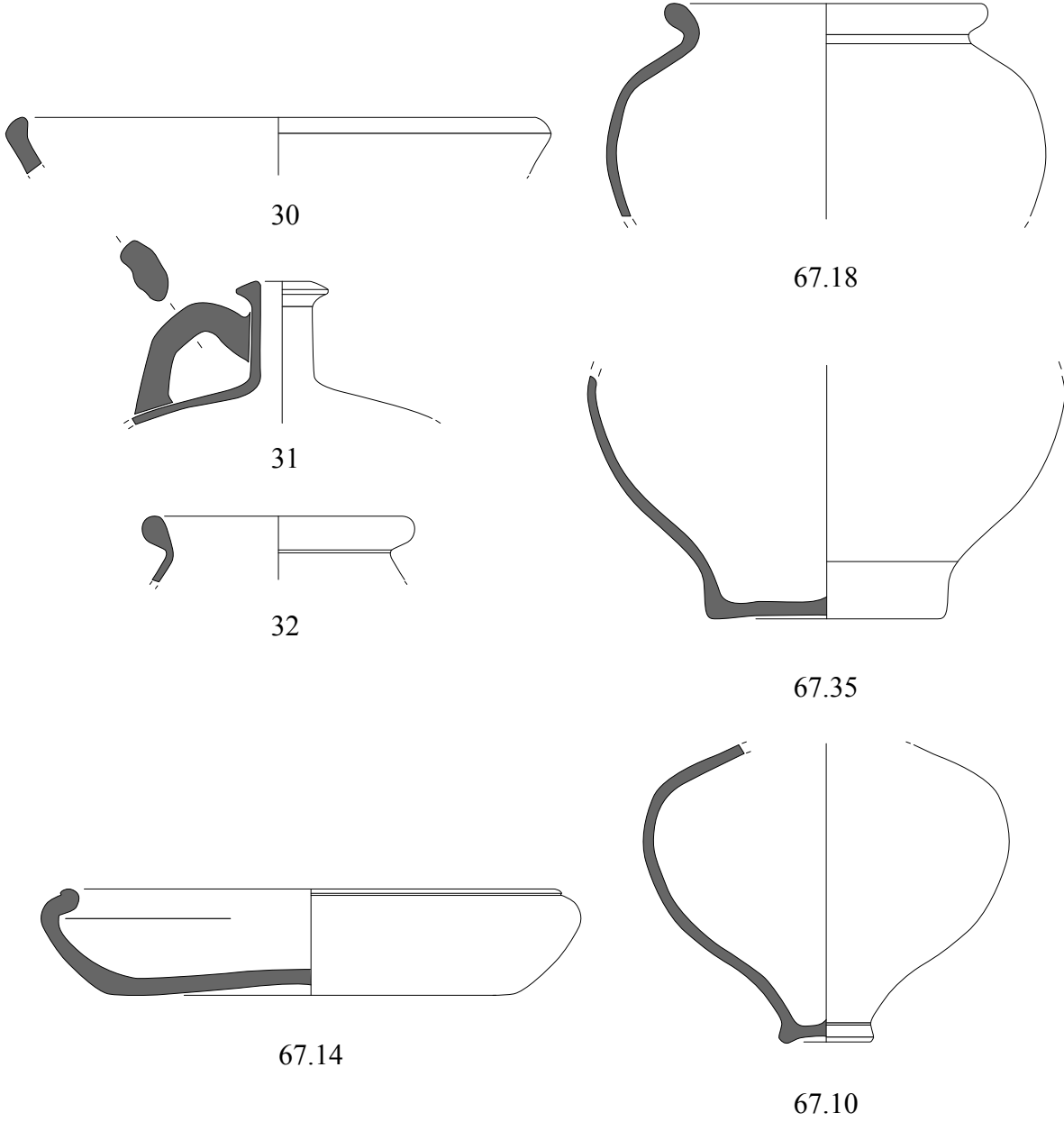

ANNEXE A
 PUIFS AUX TABLETTES
 Planche V

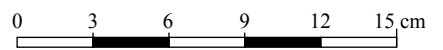
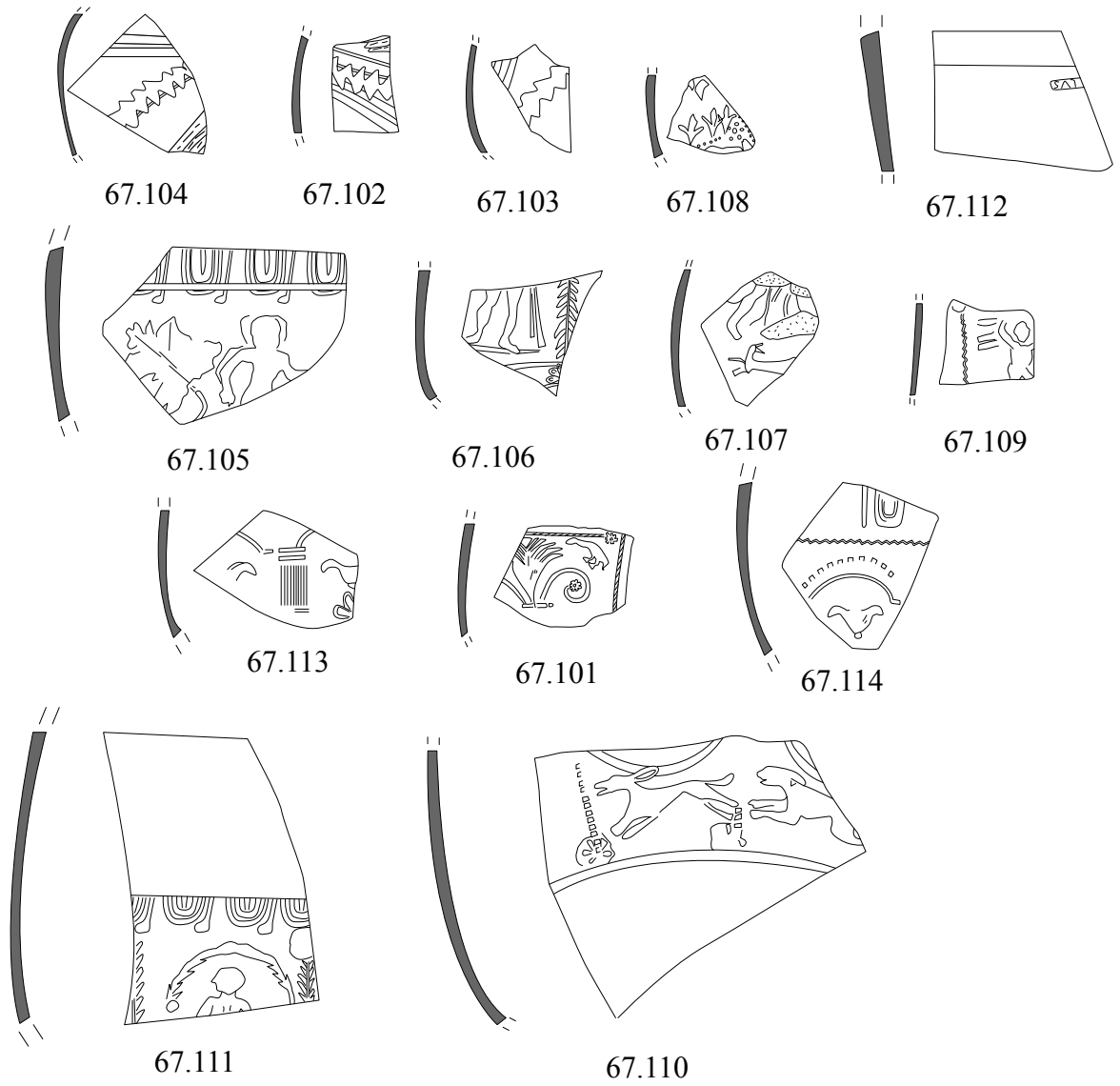

ANNEXE A
PUITS AUX TABLETTES
Planche VI

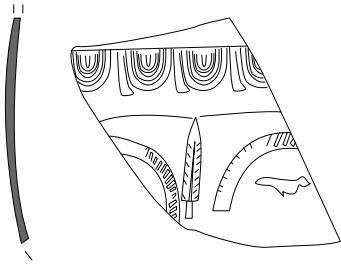

67.121

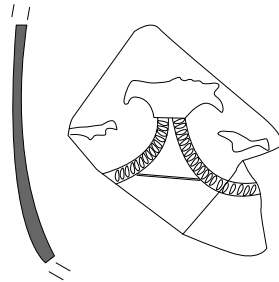

67.118

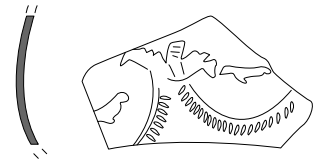

67.120

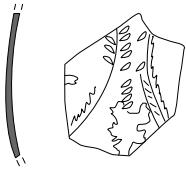

67.117

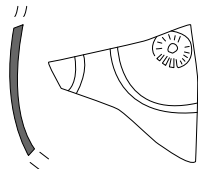

67.115



67.116

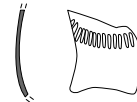

67.119

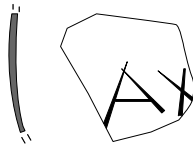

67.205

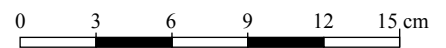

ANNEXE A
PUITS CHEMIN HLM
Planche I

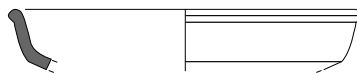

1

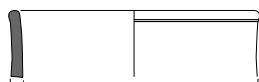

2

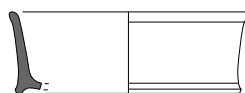

3

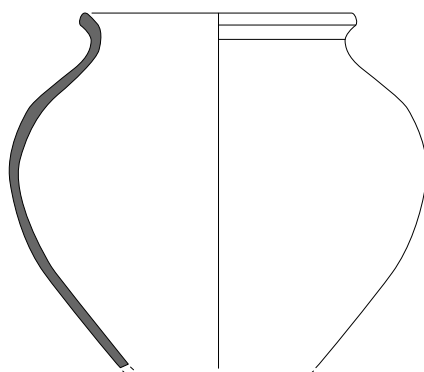

4

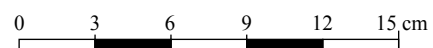

ANNEXE A
 PUIITS PERRIN

Planche I

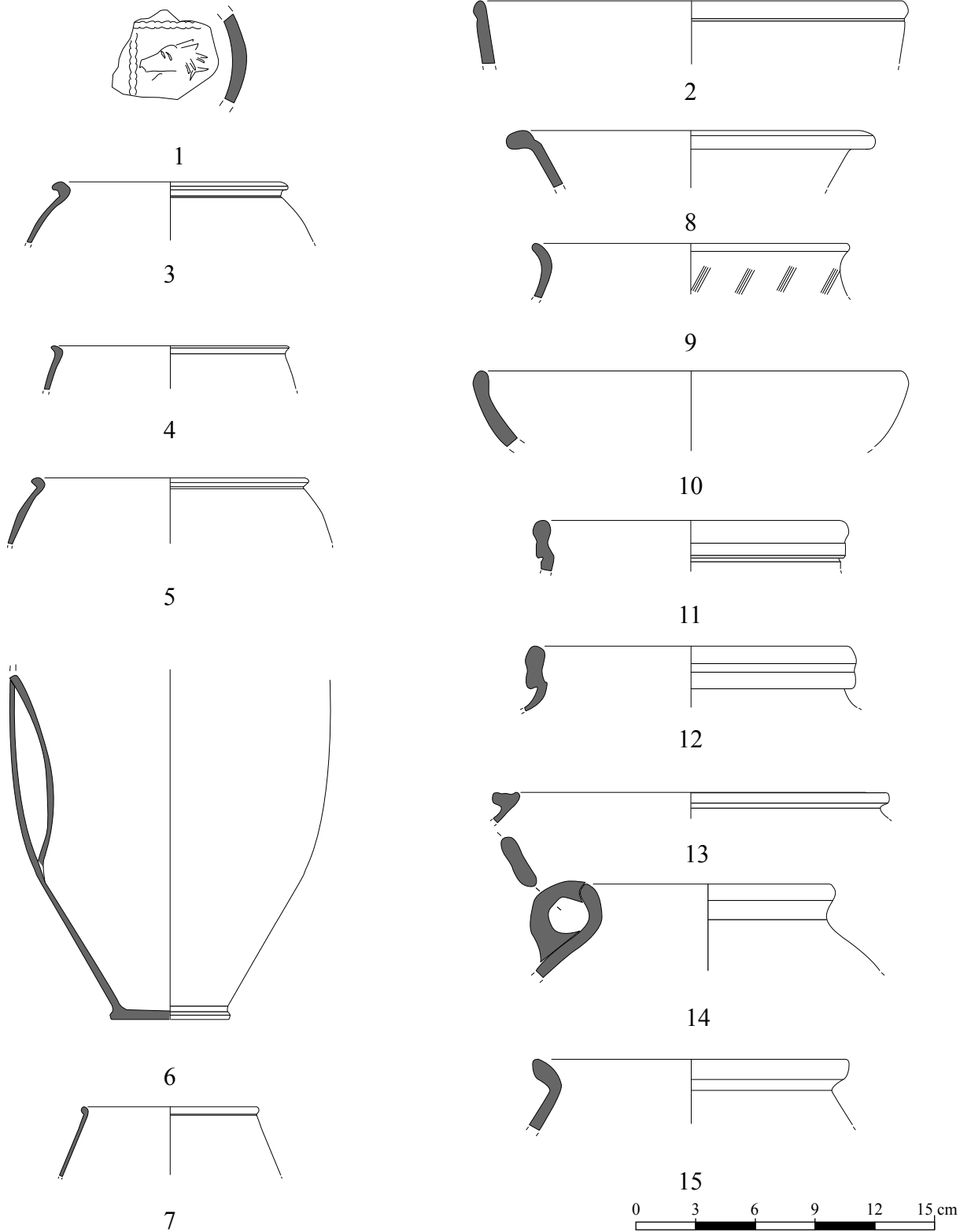

ANNEXE A
PUITS PERRIN
Planche II

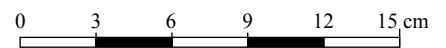
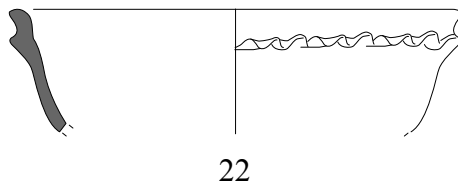
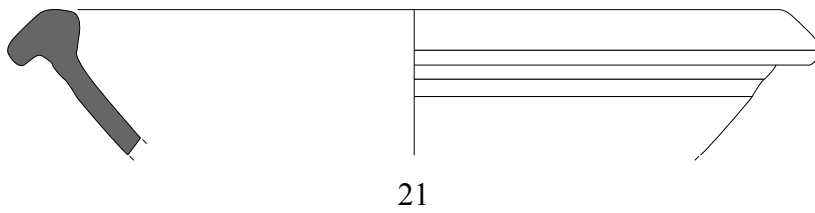
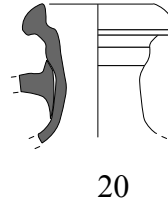
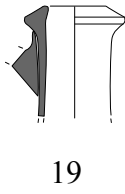
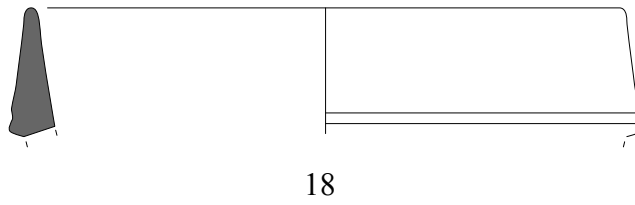
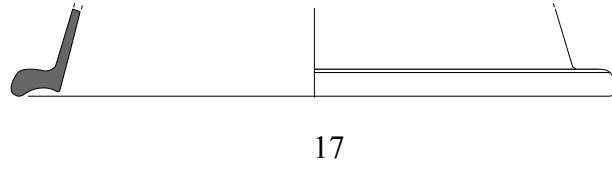
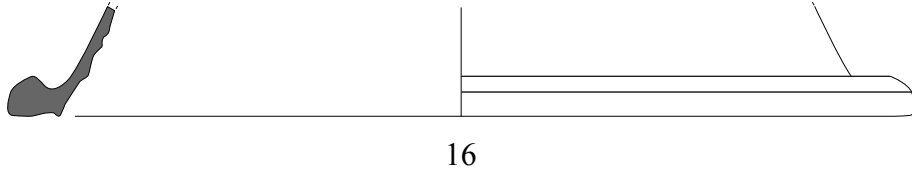

ANNEXE A
PUITS LOULOU
Planche I

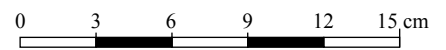
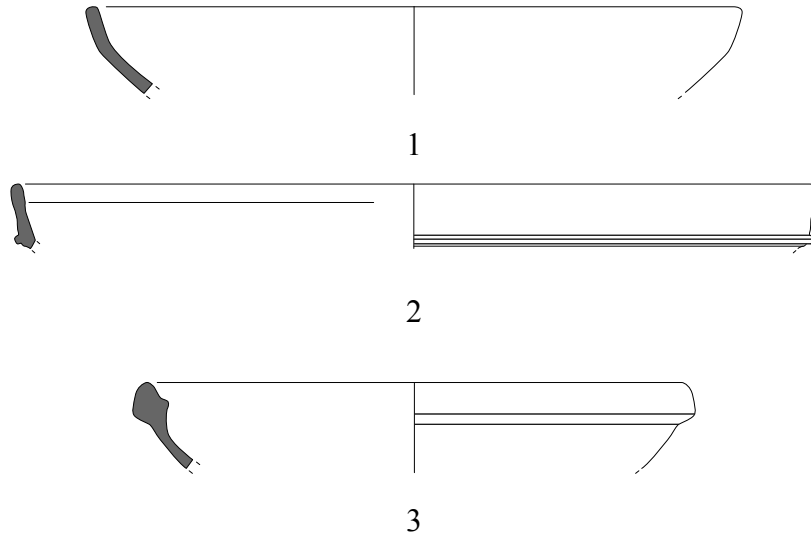

ANNEXE A
Puits Pierrat «Rue de la moucherie»
Planche I

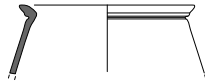

1

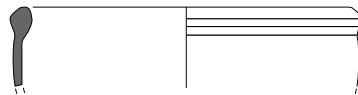

2



3

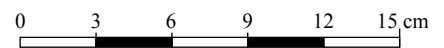

ANNEXE A
PUITS PIZZAGALLI

Planche I

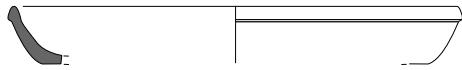

1

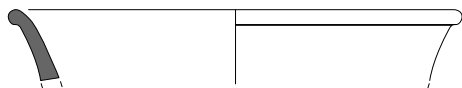

2

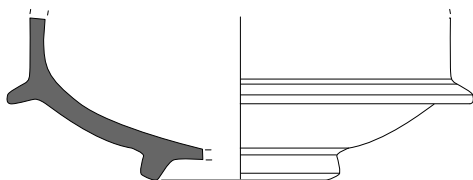

3

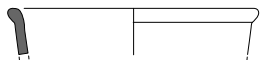

4



5

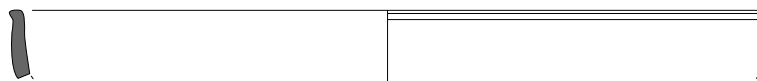

6



7

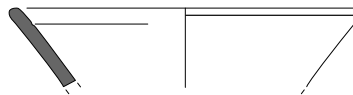

8

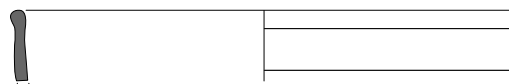

9

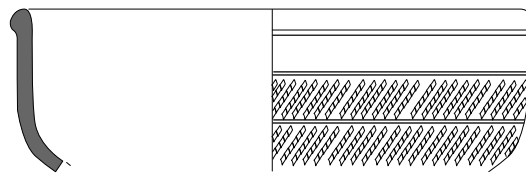

10

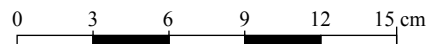

ANNEXE A
PUITS PIZZAGALLI

Planche II

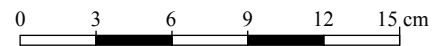
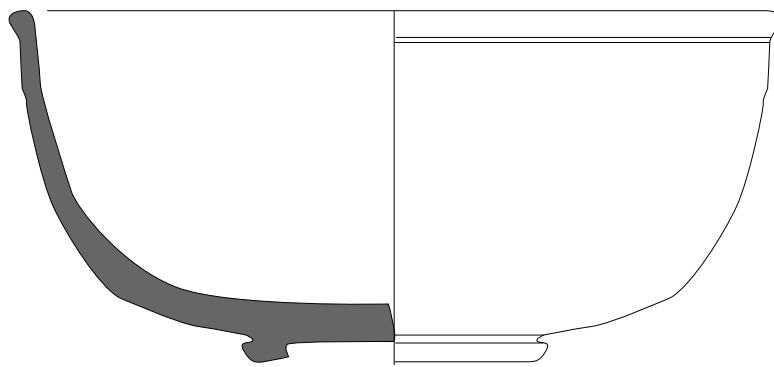
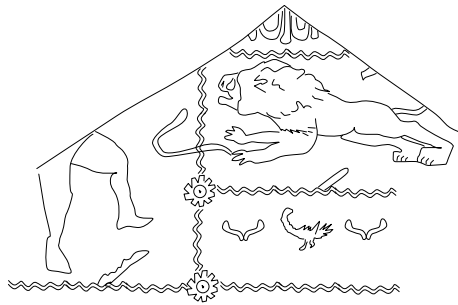
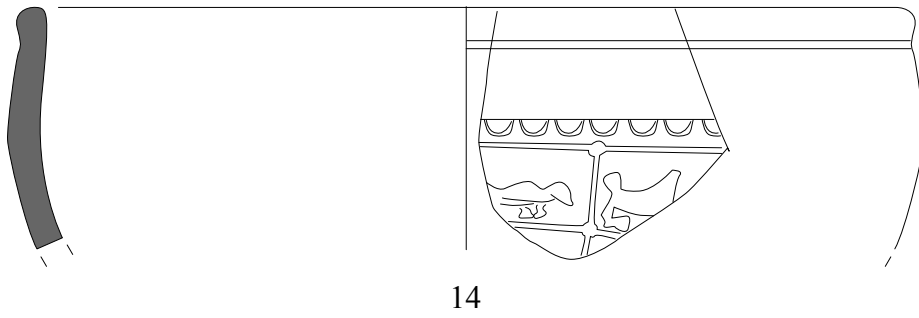
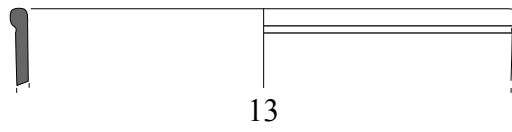
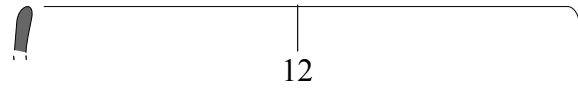
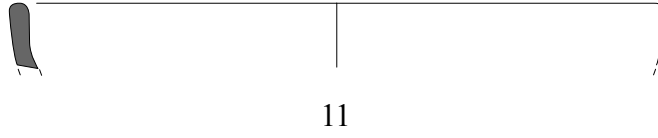

ANNEXE A
PUITS PIZZAGALLI
Planche III

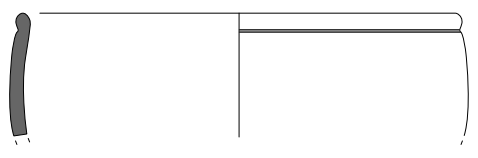

16

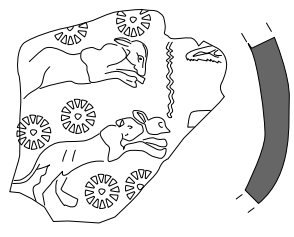

18

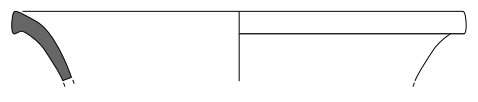

17

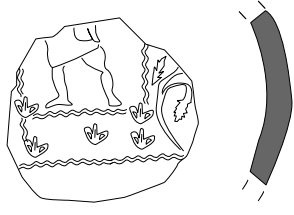

19

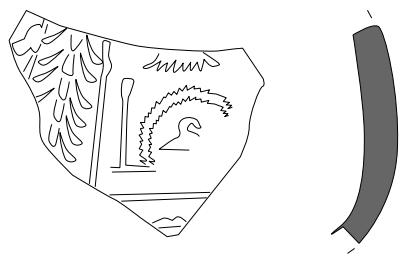

20

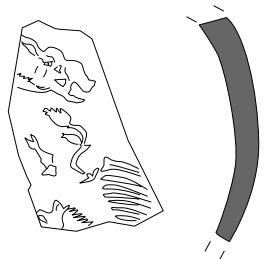

21

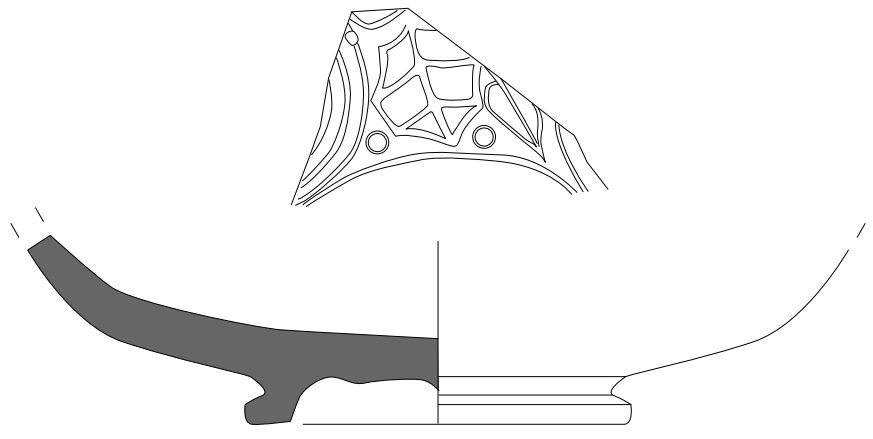

22

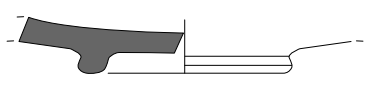

23

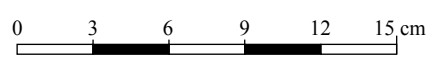

ANNEXE A
 Puits PIZZAGALLI
 Planche IV

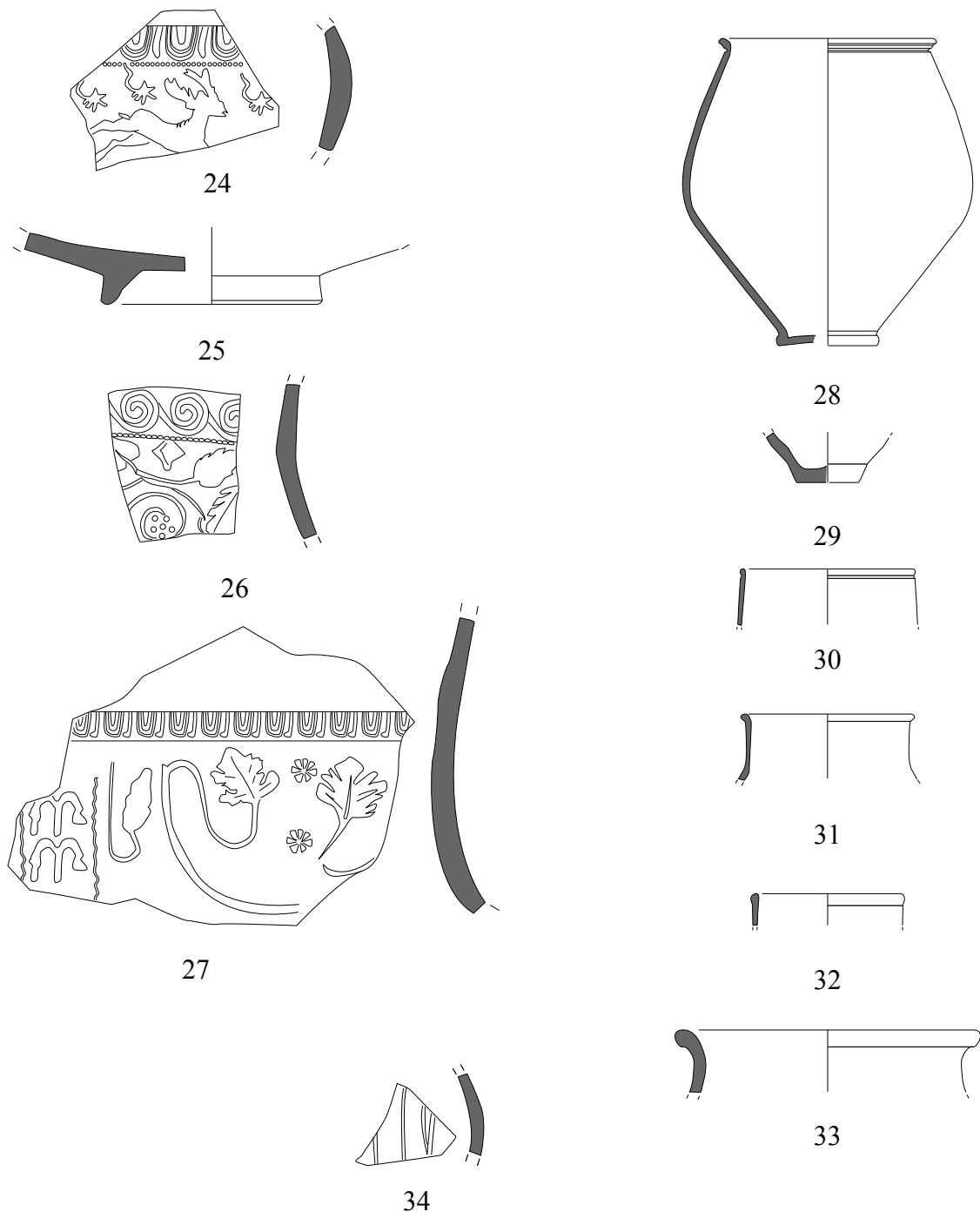

ANNEXE A
PUITS PIZZAGALLI

Planche V

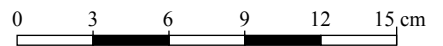
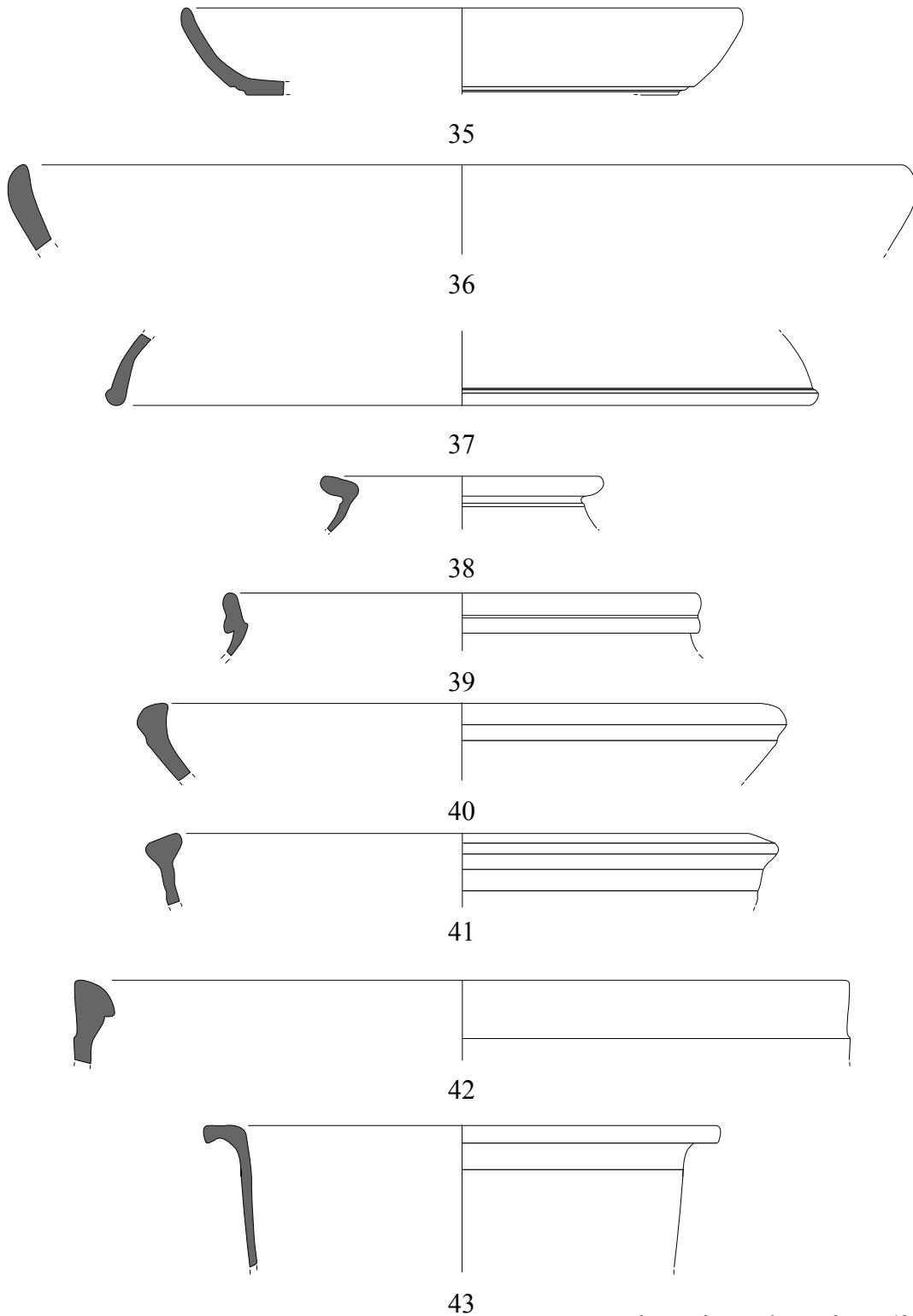

ANNEXE A
PUITS PIZZAGALLI
Planche VI

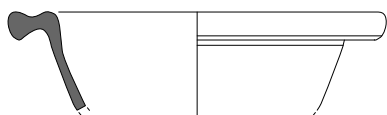

44

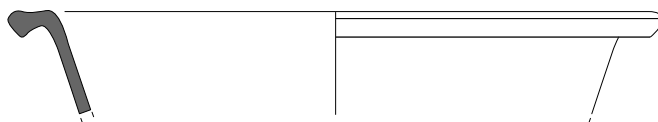

48

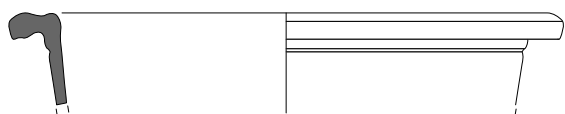

45

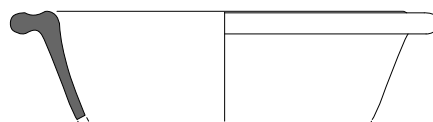

49

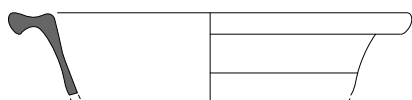

46

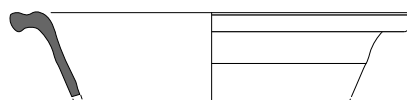

50



47

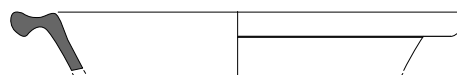

51

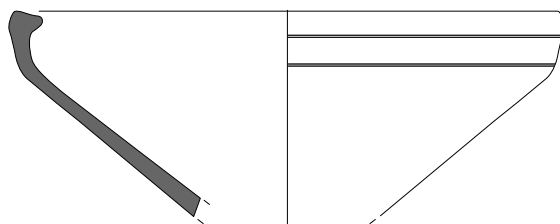

52

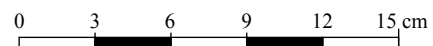

ANNEXE A
PUITS PIZZAGALLI
Planche VII

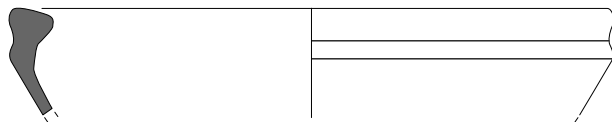

53

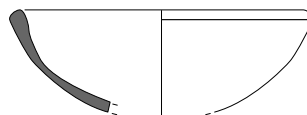

56



54

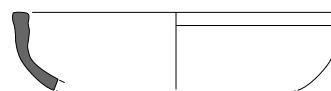

57

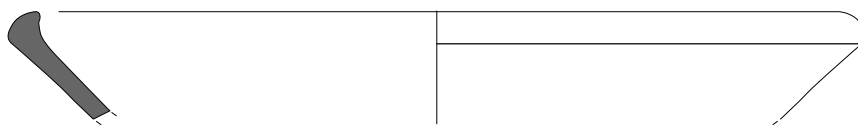

55

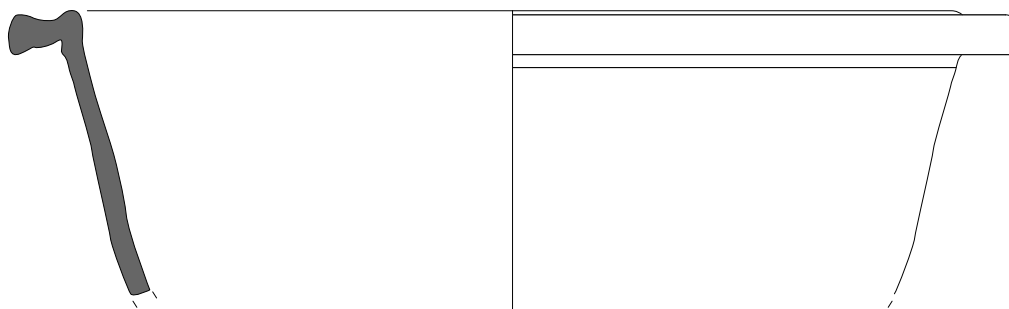

58

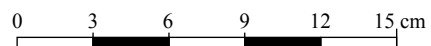

ANNEXE A
PUITS PIZZAGALLI
Planche VIII

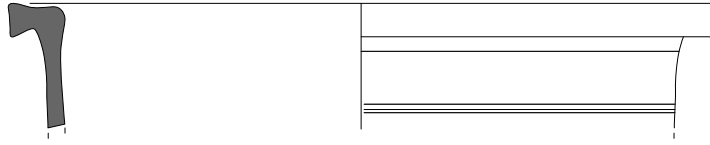

59

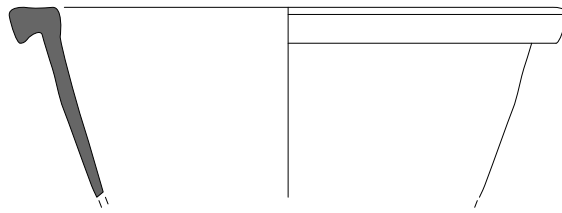

60

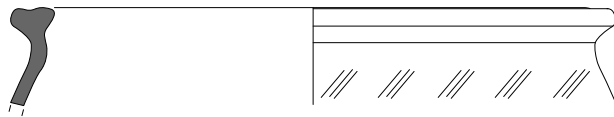

61

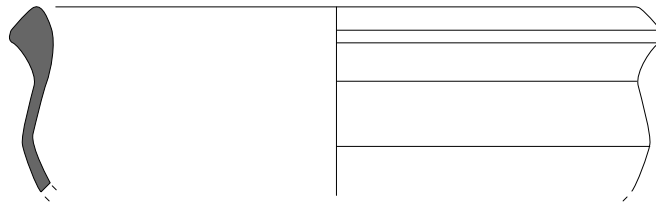

62

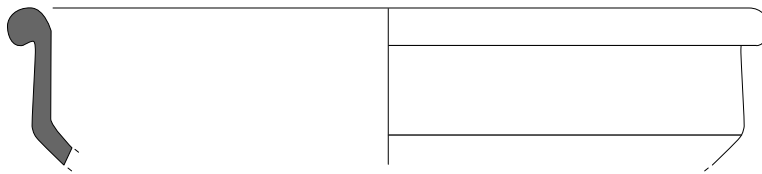

63

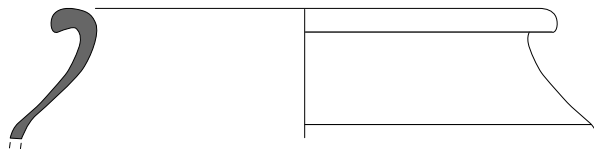

64

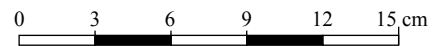

ANNEXE A
PUITS PIZZAGALLI
Planche IX

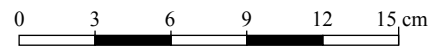
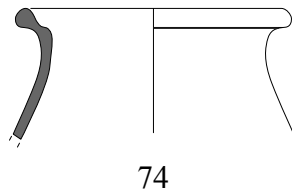
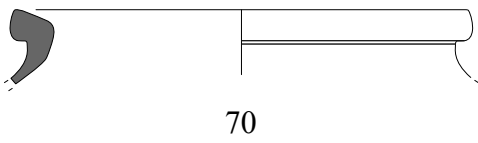
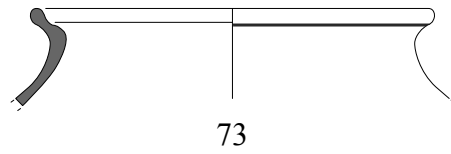
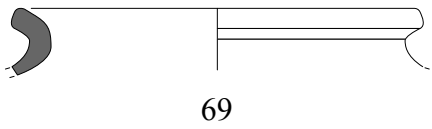
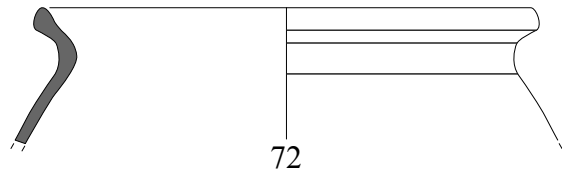
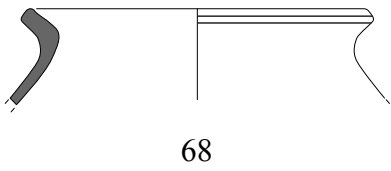
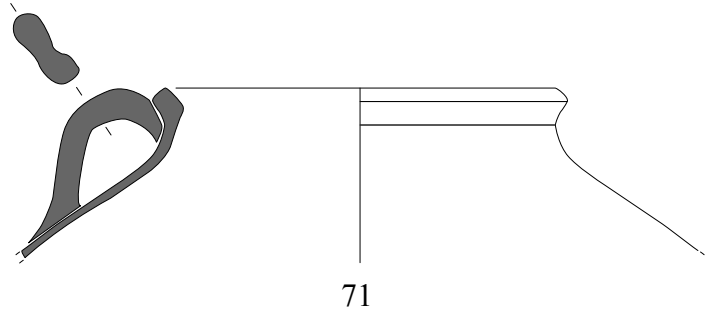
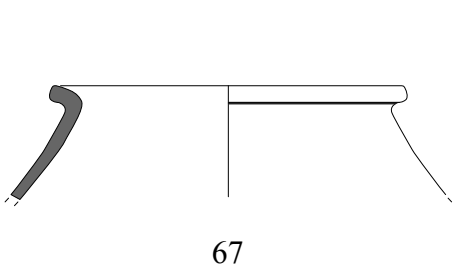
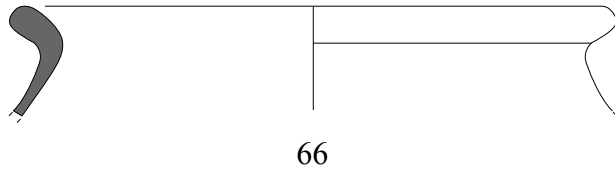
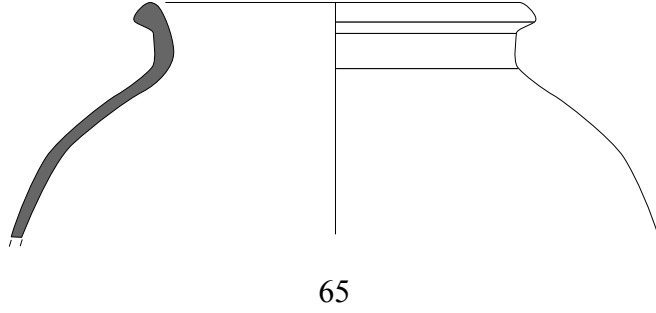

ANNEXE A
PUITS PIZZAGALLI

Planche X

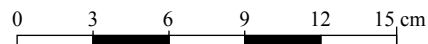
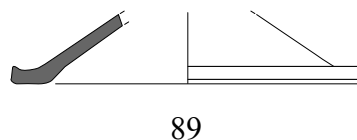
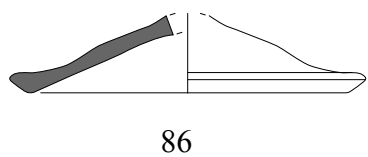
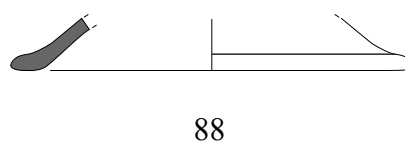
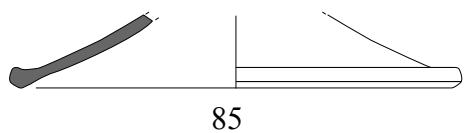
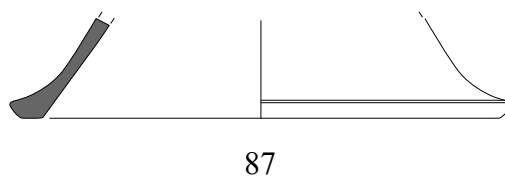
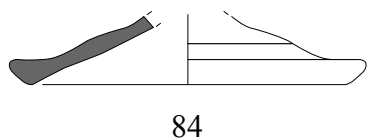
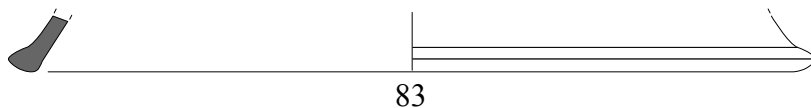
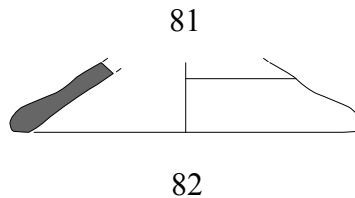
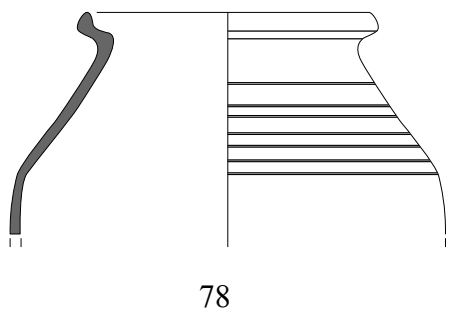
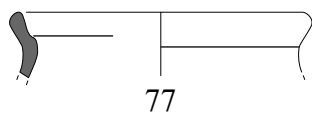
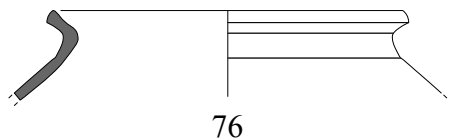
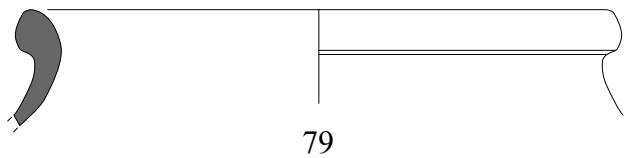
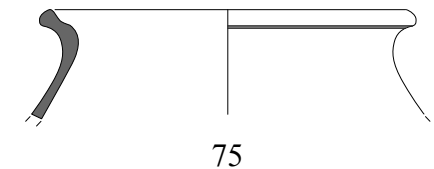

ANNEXE A
PUITS PIZZAGALLI
Planche XI



90



93



91



94



92

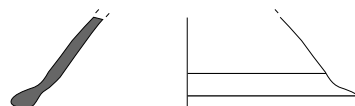

95

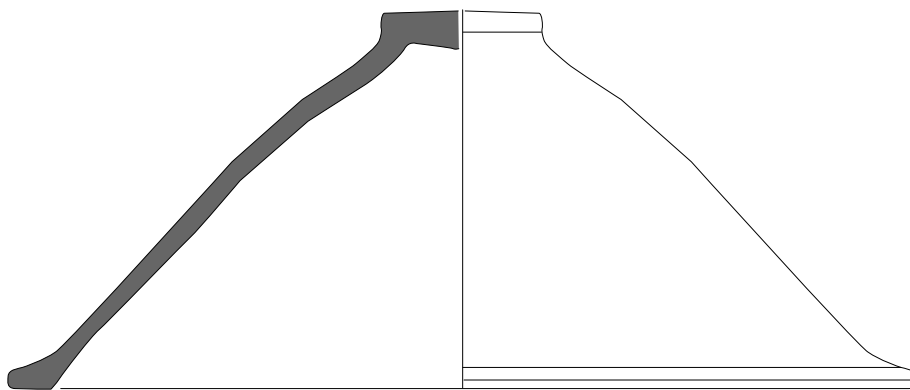

96

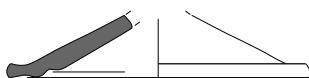

97



98

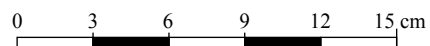

ANNEXE A
 PUIITS PIZZAGALLI
 Planche XII

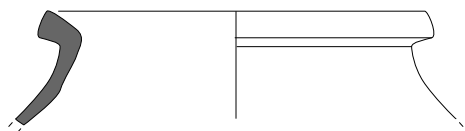

99



101

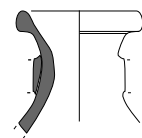

102

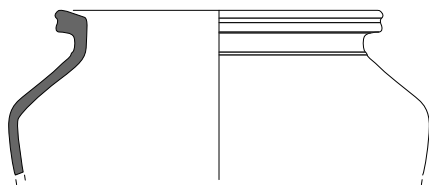

100

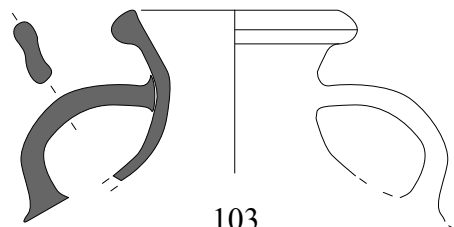

103

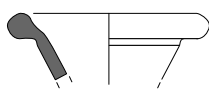

104

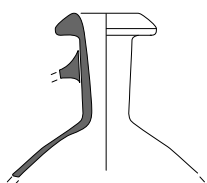

108

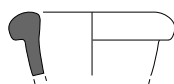

111

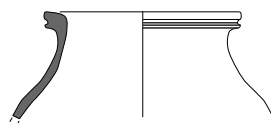

114



115

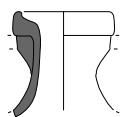

105

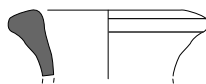

112

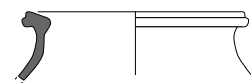

116

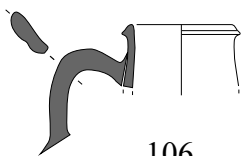

106

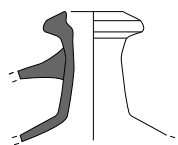

109

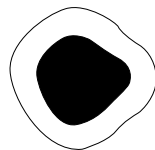

113

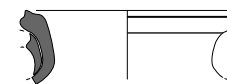

117

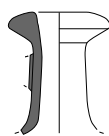

107



110

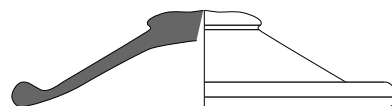
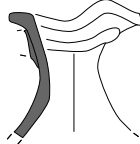

118

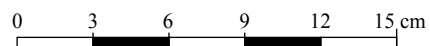

ANNEXE A
PUITS PIZZAGALLI
Planche XIII

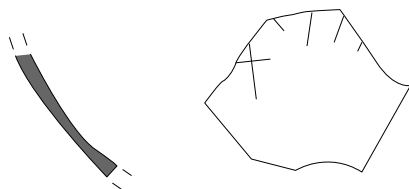

119

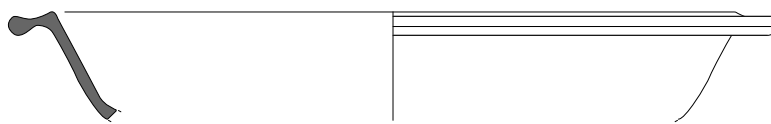

120

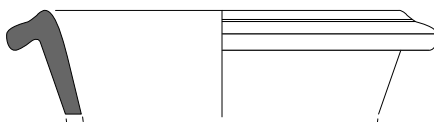

121

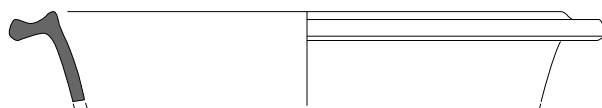

122

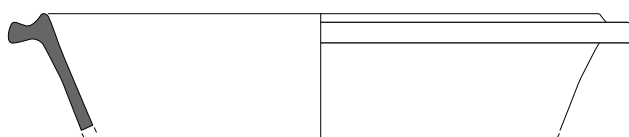

123



ANNEXE A
PUITS PIZZAGALLI
Planche XIV

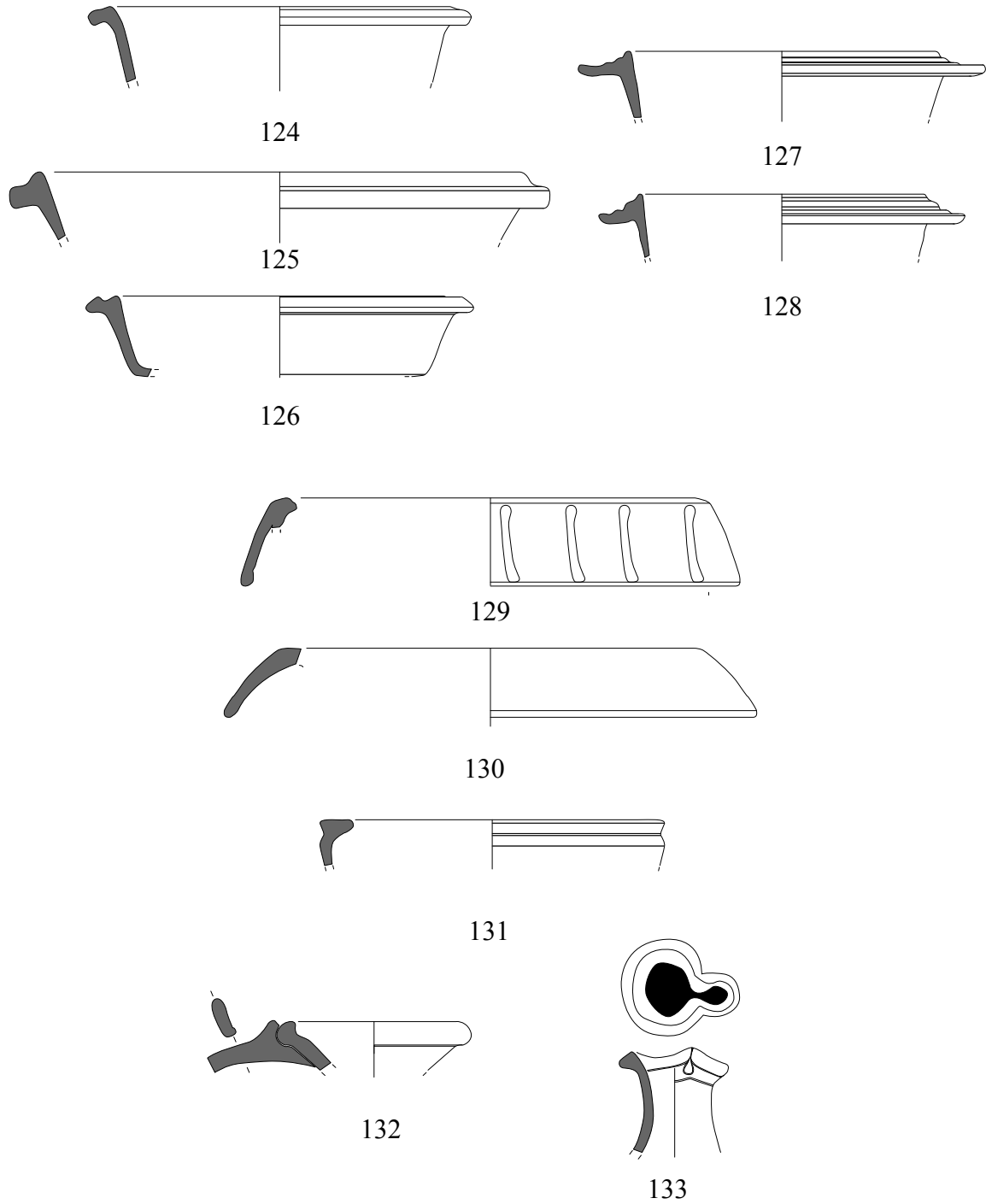

ANNEXE A
PUITS PIZZAGALLI
Planche XV

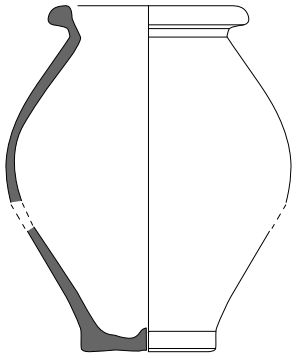

134

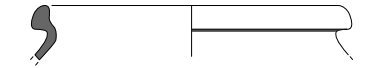

138



139

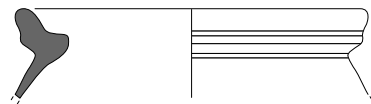

140

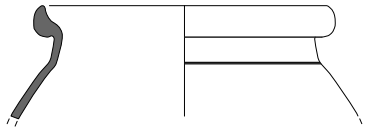

135

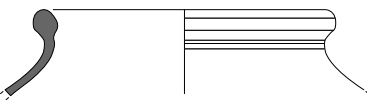

136

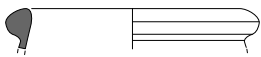

137

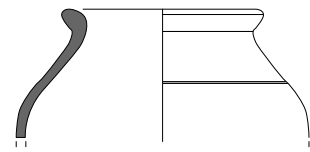

141

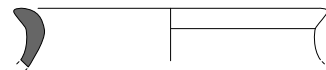

142

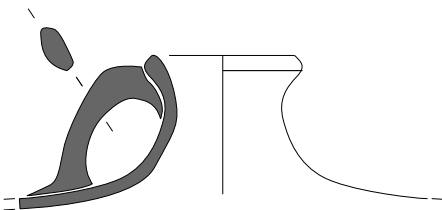

143



144

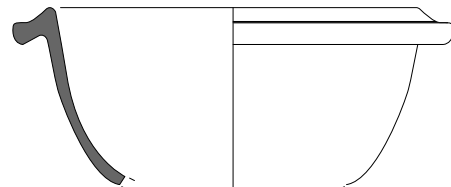

145

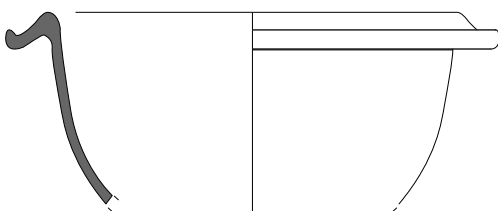

146

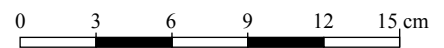

ANNEXE A
PUITS PIZZAGALLI
Planche XVI

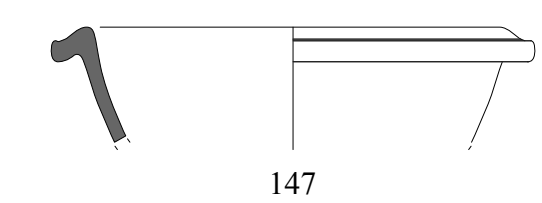

147

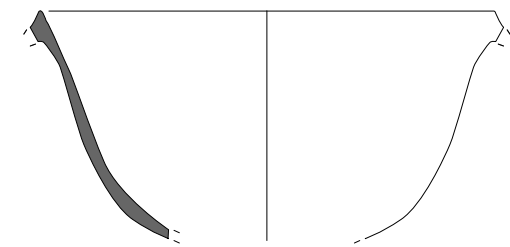

149

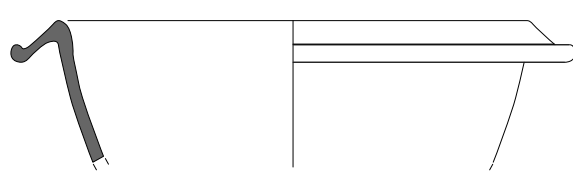

148

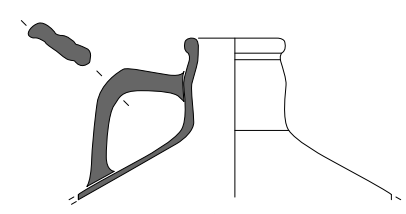

150

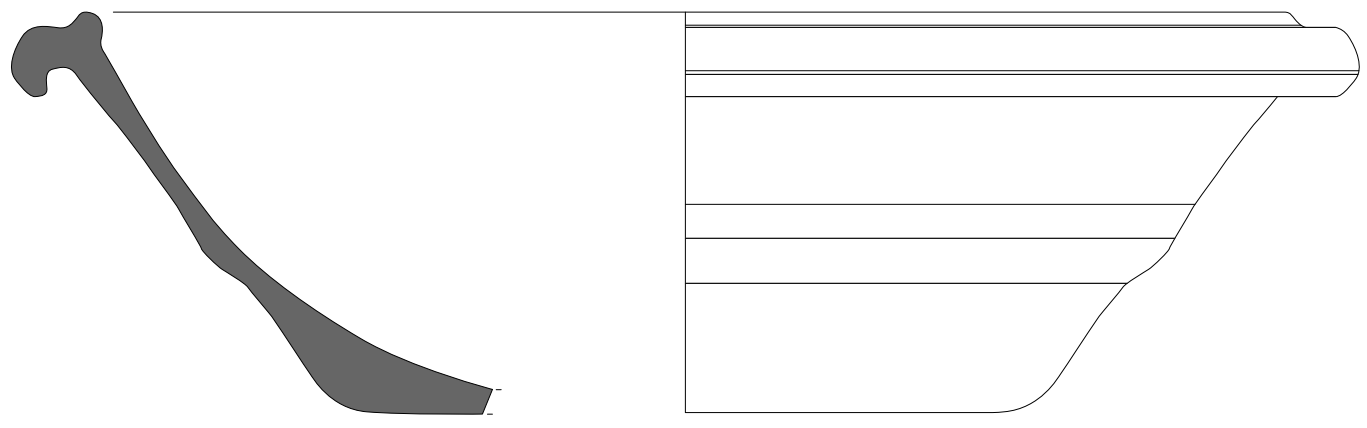

151

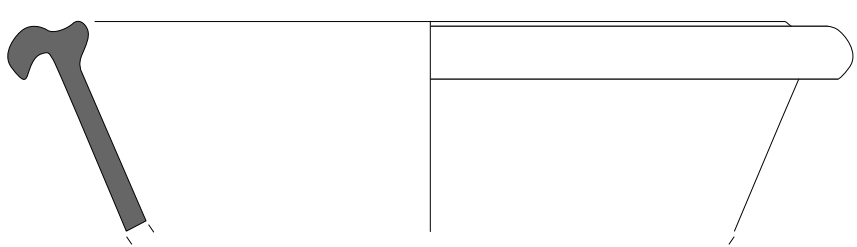

152

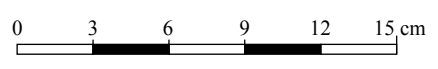

ANNEXE A
PUITS PIZZAGALLI
Planche XVII

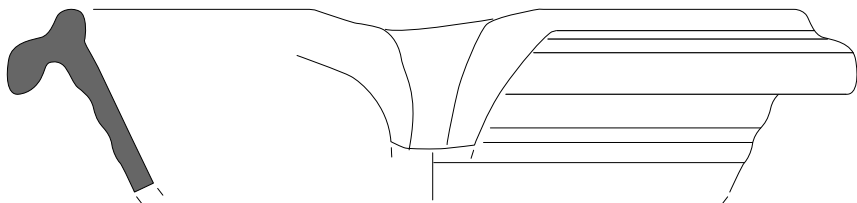

153

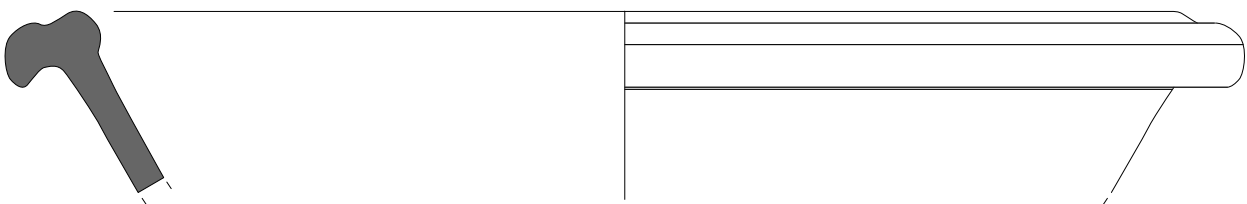

154

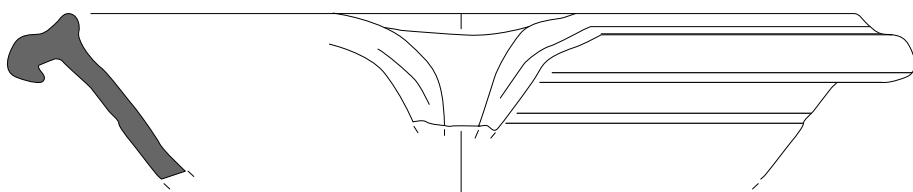

155

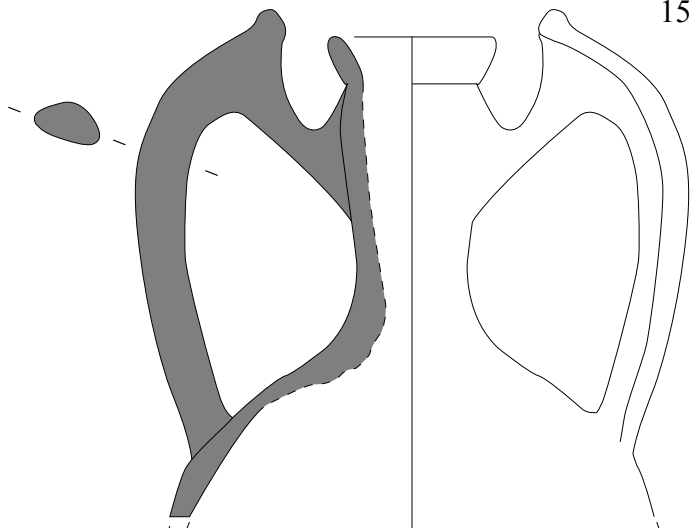

156

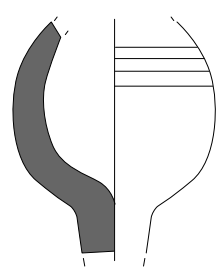

157

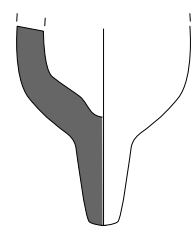

158

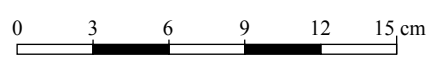

ANNEXE A
PUITS PIZZAGALLI
Planche XVIII

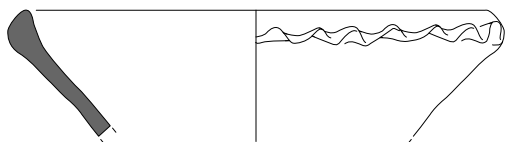

159

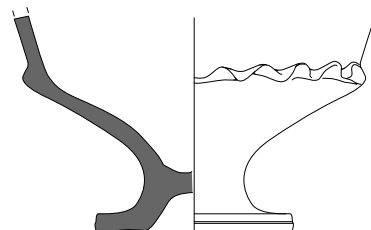

160

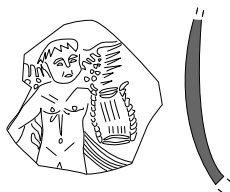

161

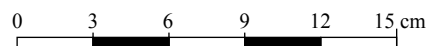

ANNEXE A
PUITS PIZZAGALLI
Planche XIX

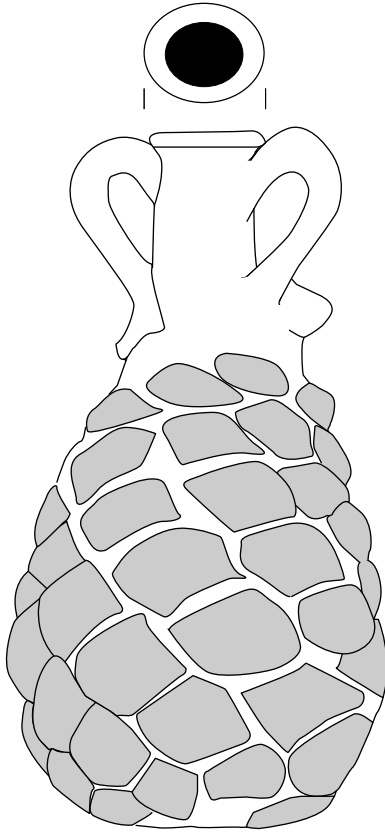

162

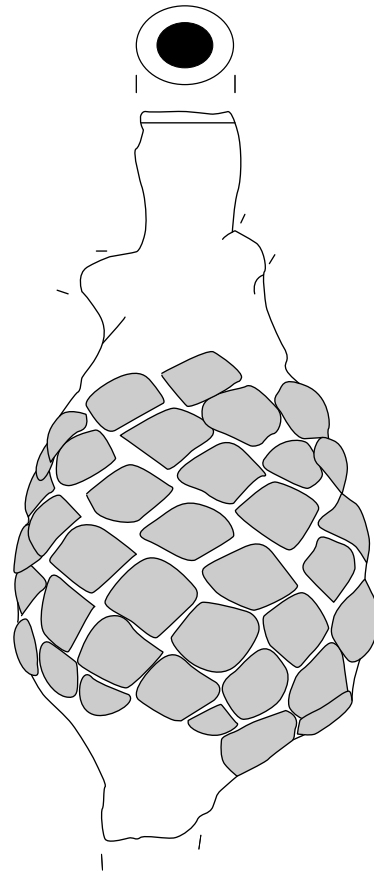

162

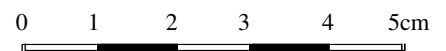

ANNEXE A
PUITS PIZZAGALLI
Planche XX

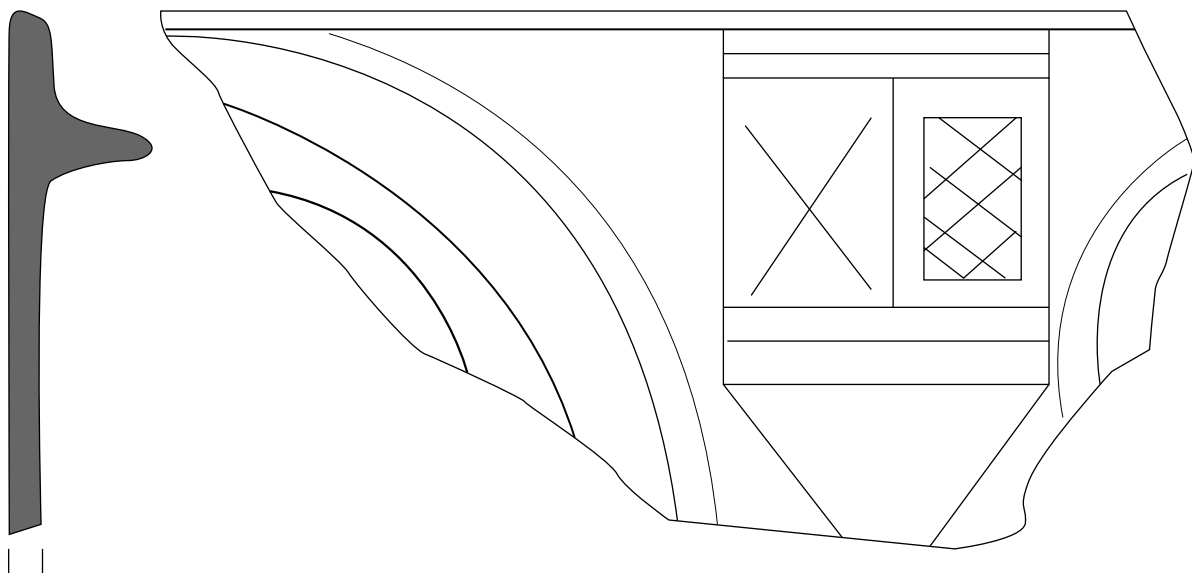

164

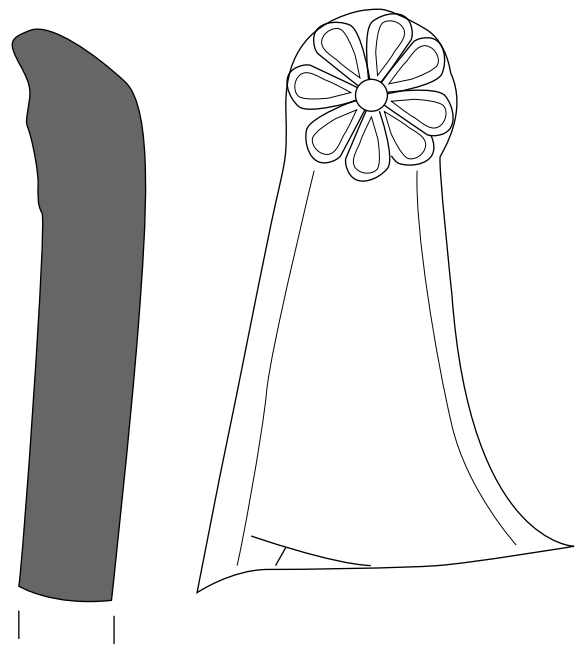

165

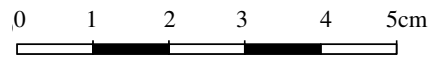

ANNEXE A
PUITS RUE DE LA CHAPELLE
Planche I



1



2

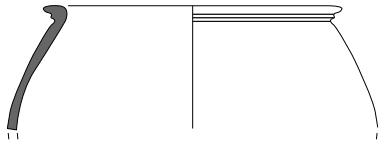

3

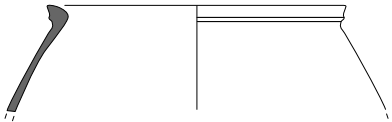

4

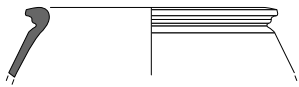

5

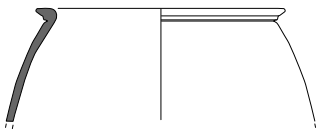

6

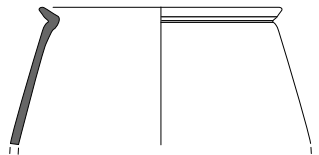

7

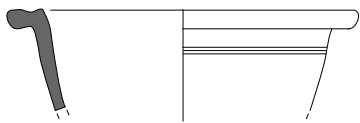

14

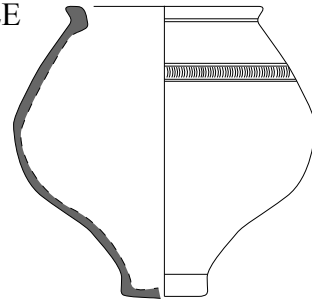

8

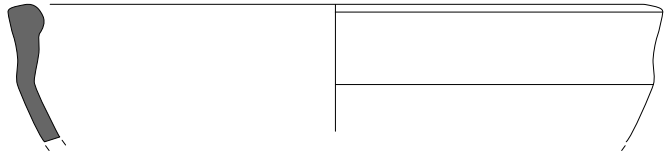

9

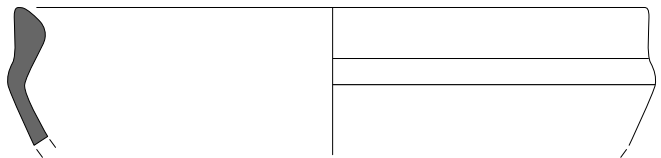

10



11

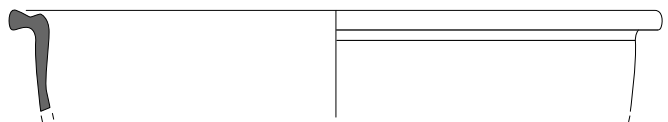

12

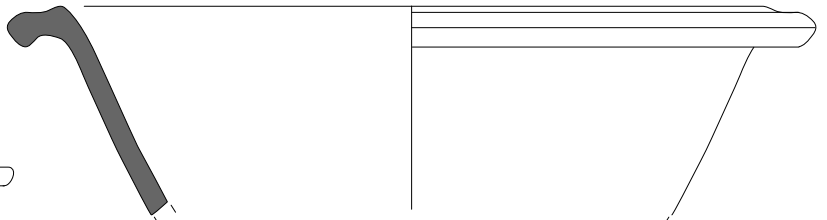

13

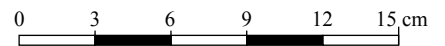

ANNEXE A
PUITS RUE DE LA CHAPELLE
Planche II

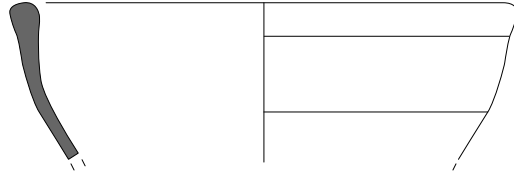

15

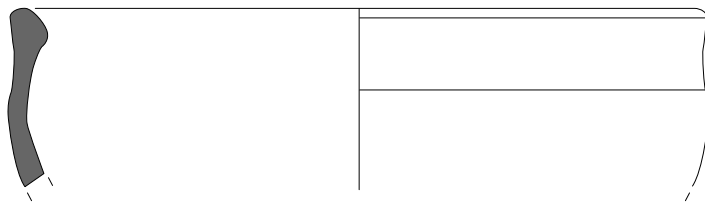

16

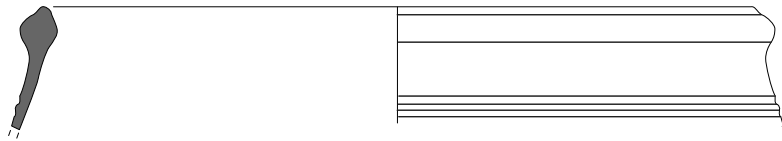

17

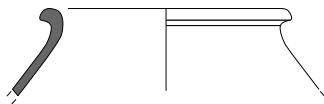

18

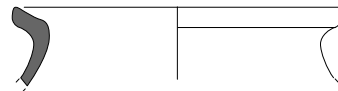

21

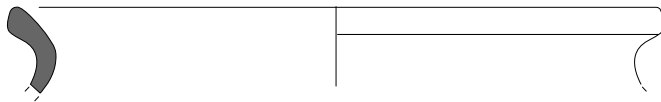

19



22



20

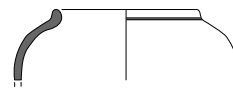

23

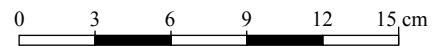

ANNEXE A
PUITS RUE DE LA CHAPELLE
Planche III

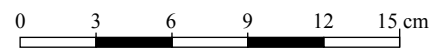
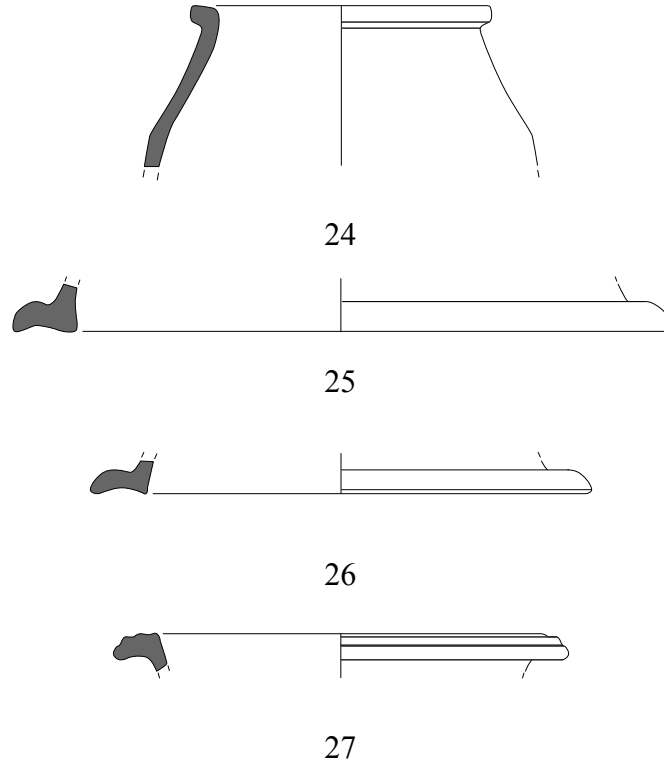

ANNEXE A
Puits Schneider
Planche I

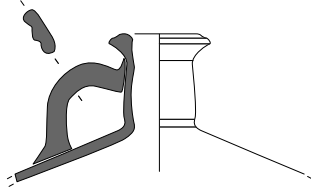

1

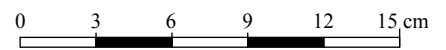

ANNEXE A
 Puits Spindler
 Planche I

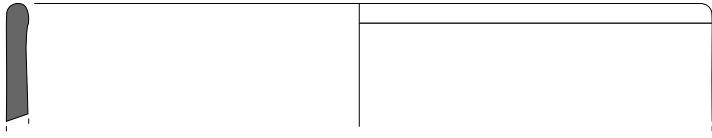

1

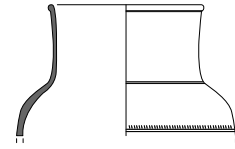

7

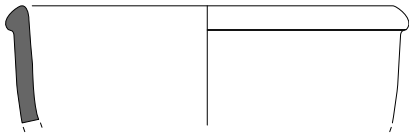

2



8

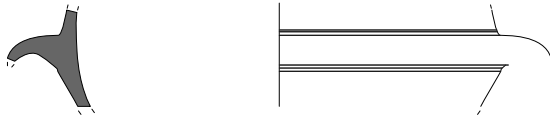

3

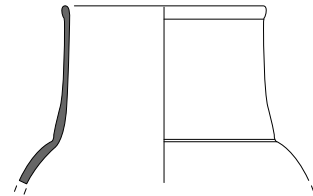

9

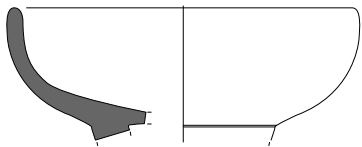

4

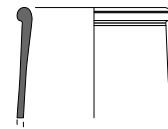

10



5



6

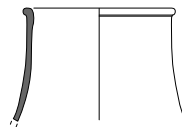

11



12

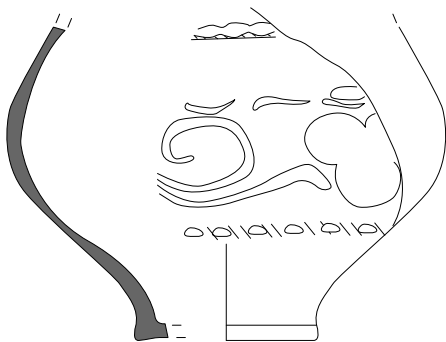

15

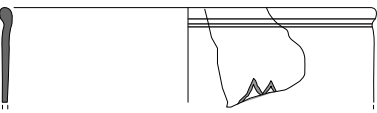

13



14

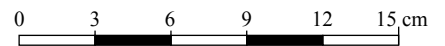

ANNEXE A
Puits Spindler
Planche II

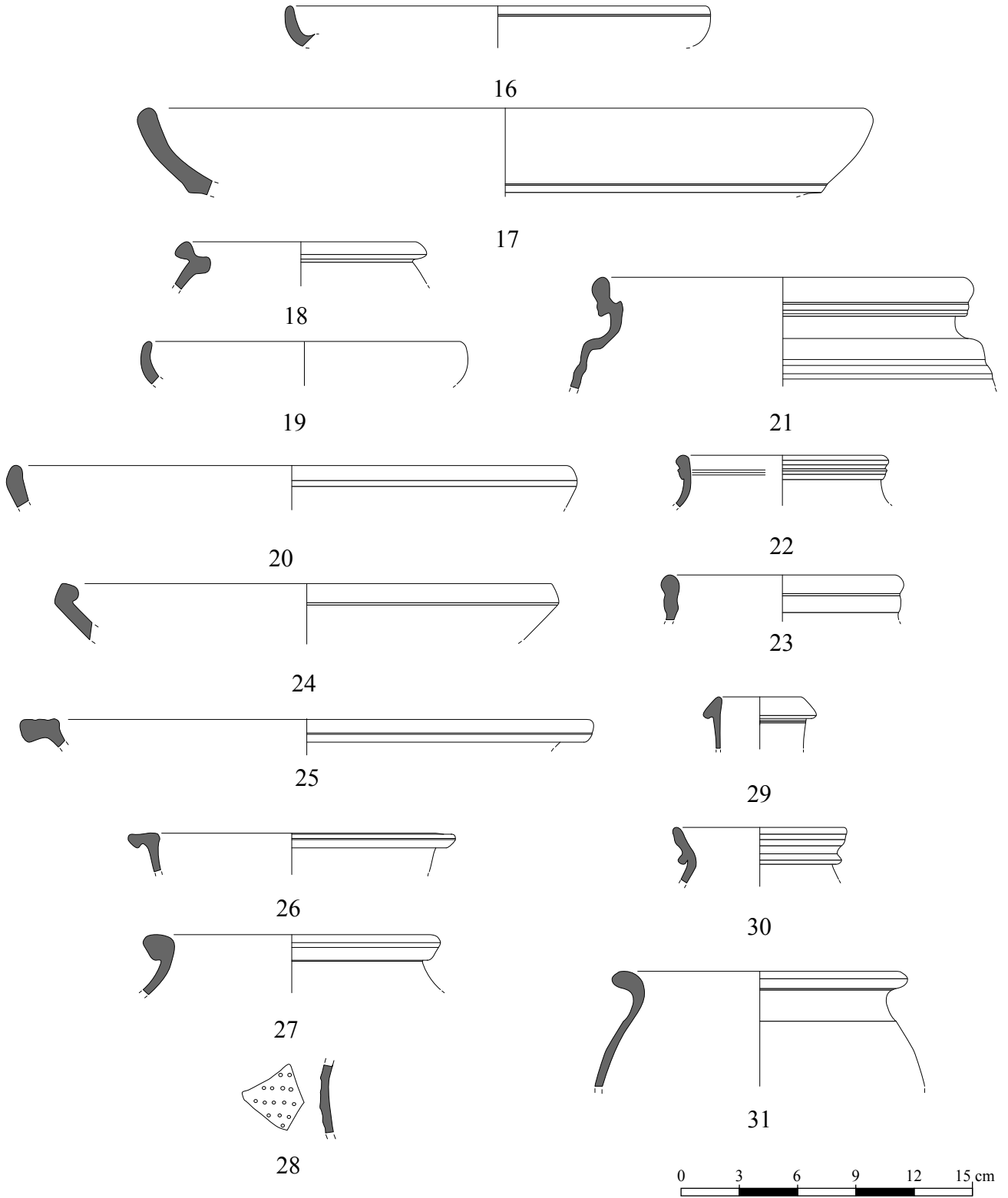

ANNEXE A
PUITS TANG
Planche I

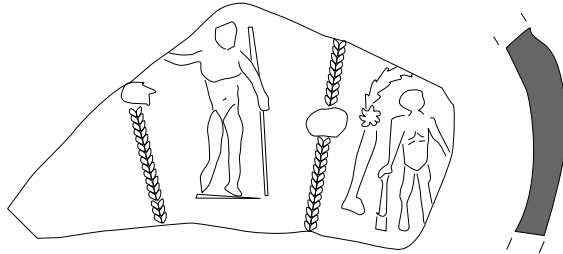

1

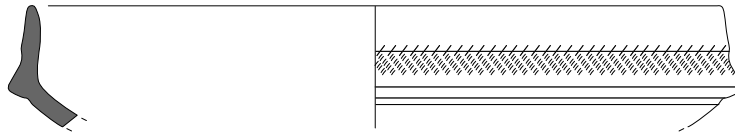

2

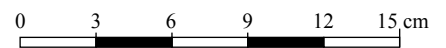

ANNEXE A
PUITS INCONNUS

Planche I

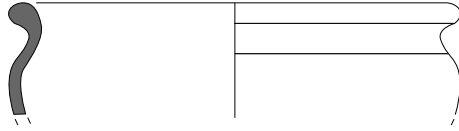

1

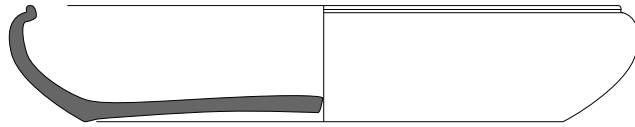

2

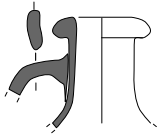

3

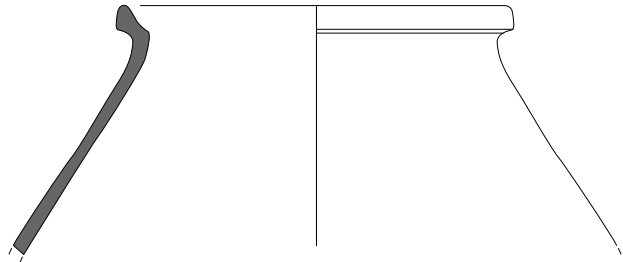

4

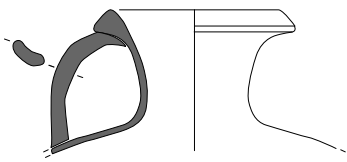

5

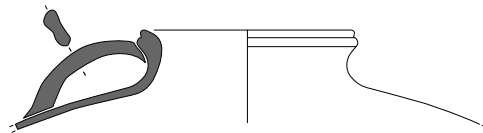

7

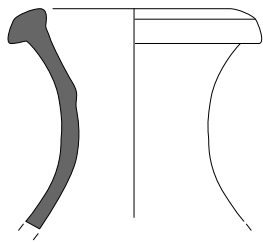

6

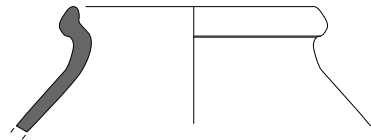

8

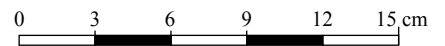

ANNEXE A
PUITS INCONNUS
Planche II

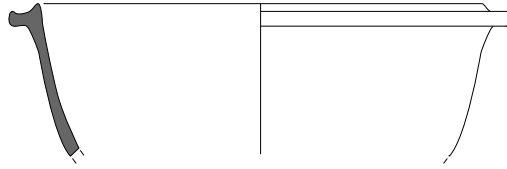

9

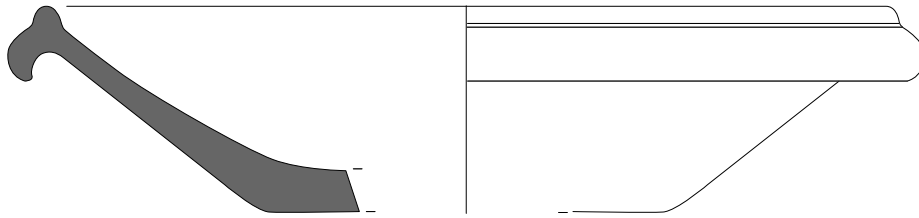

10



12

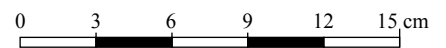

ANNEXE A
 AMPHITHEATRE
 Planche I

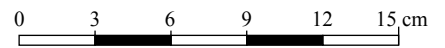
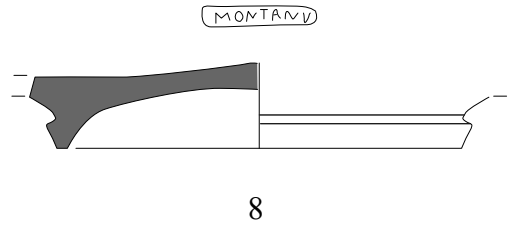
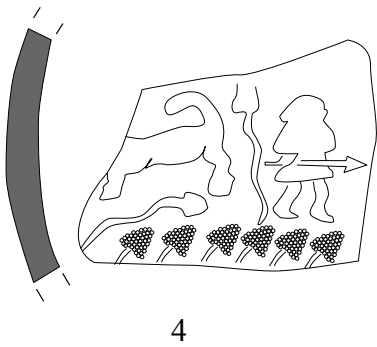
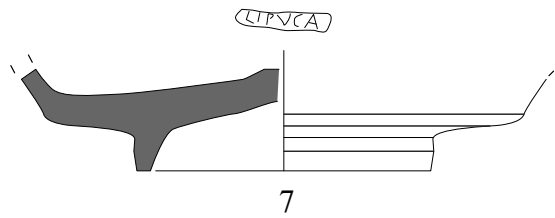
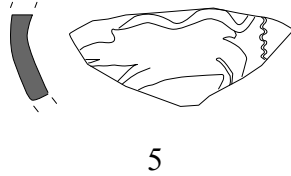
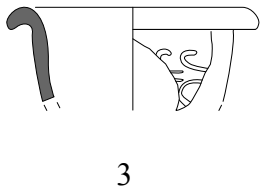
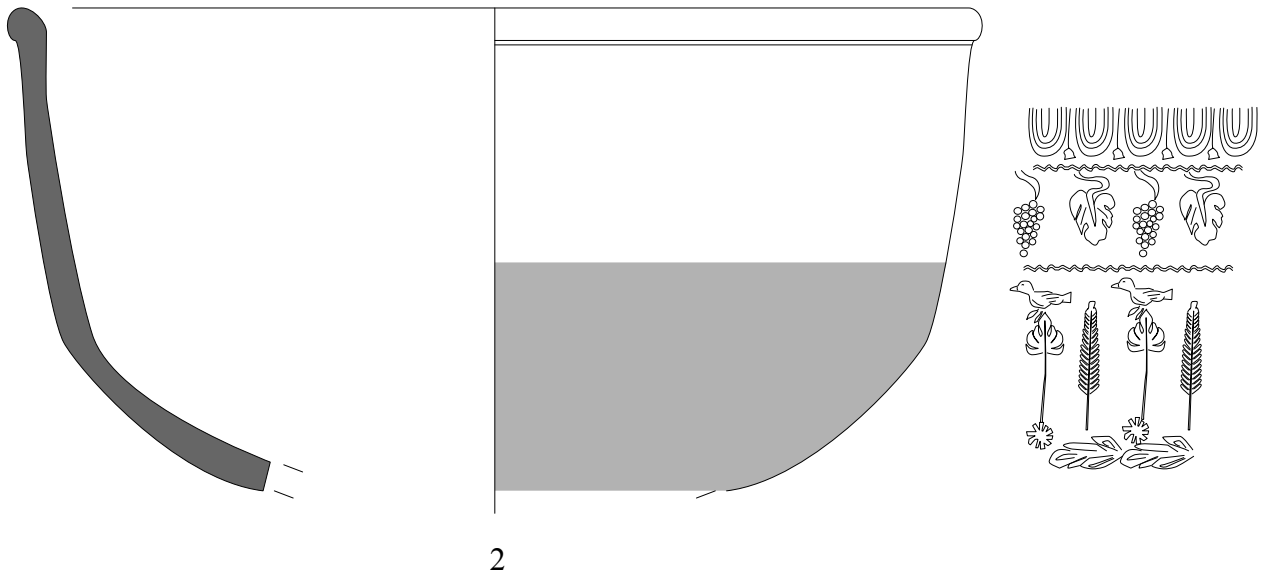
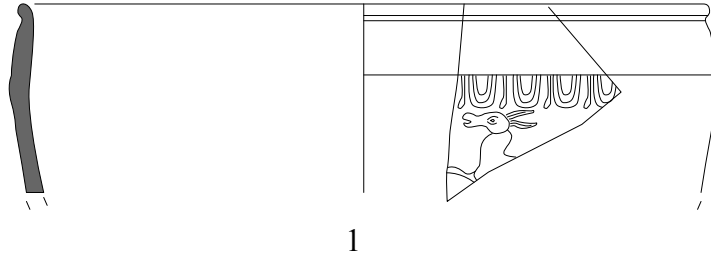

ANNEXE A
AMPHITHEATRE

Planche II

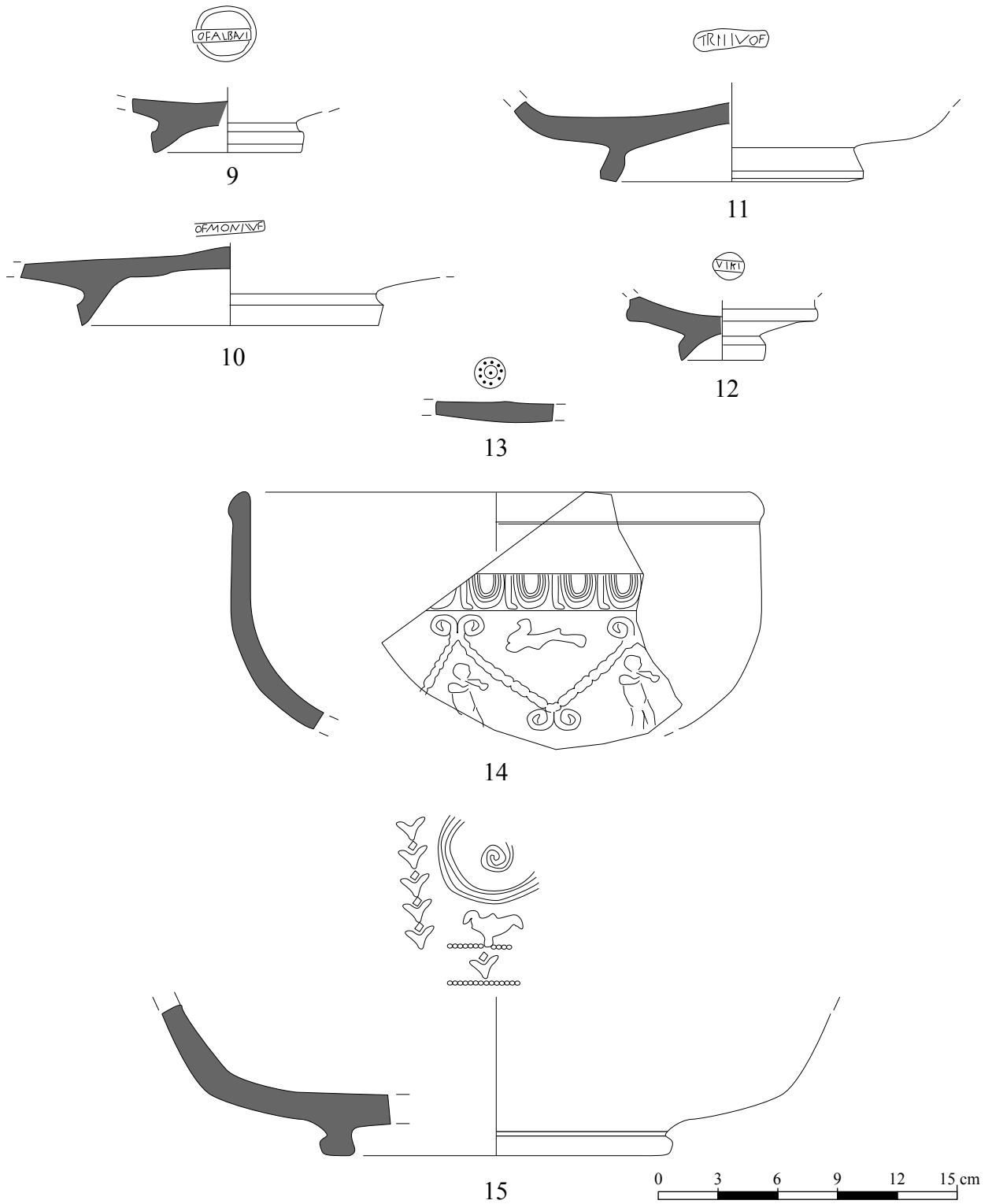

ANNEXE A
 AMPHITHEATRE
 Planche III

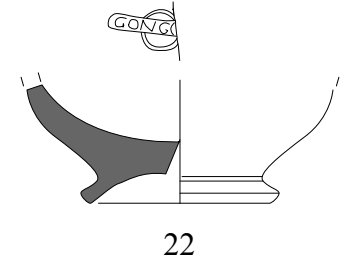
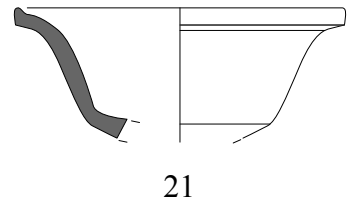
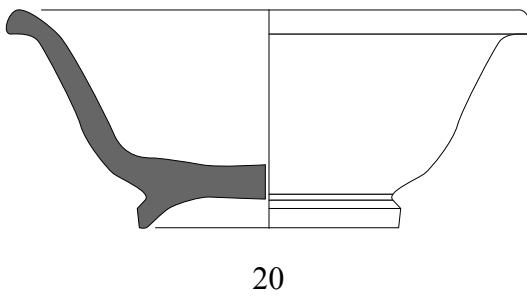
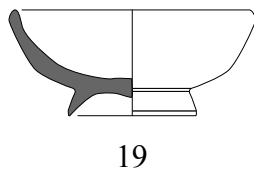
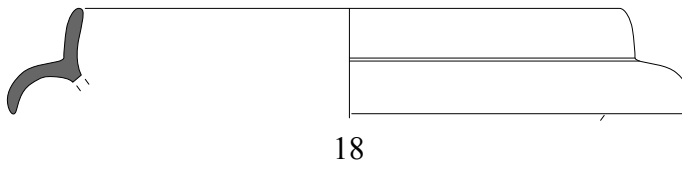
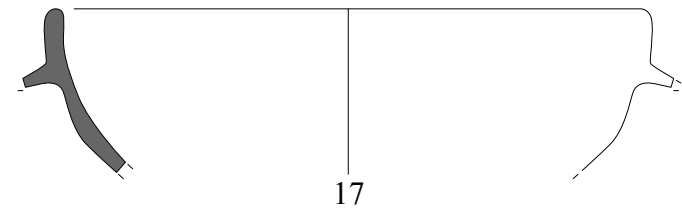
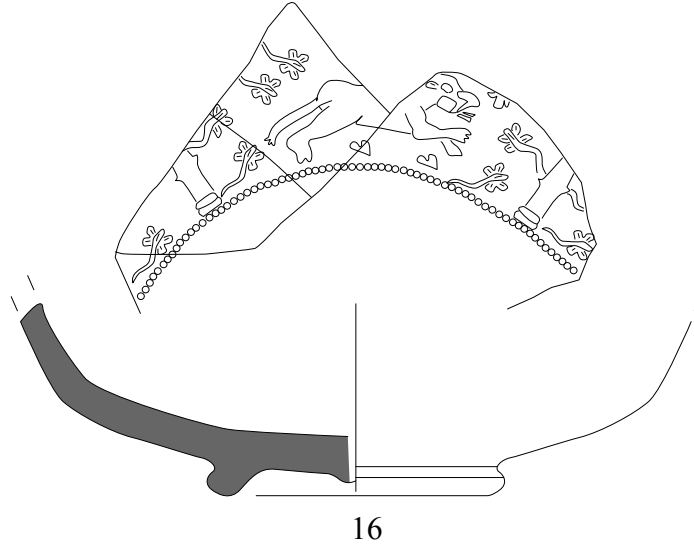

23

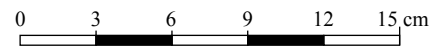

ANNEXE A
AMPHITHEATRE
Planche IV

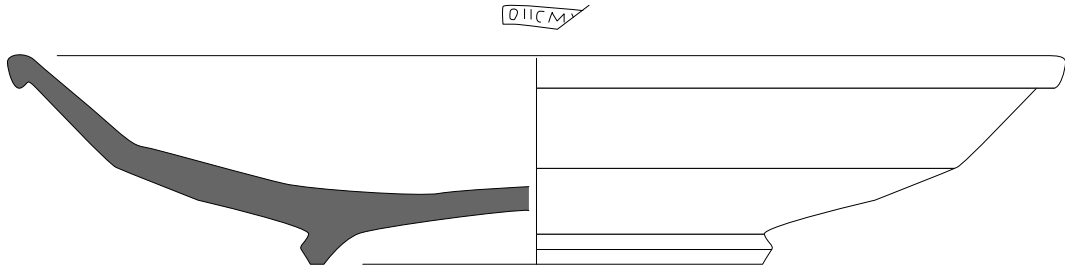

24

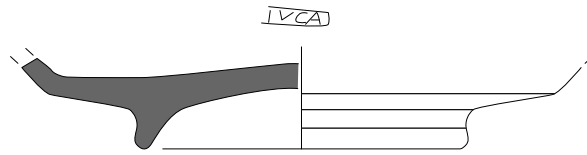

25

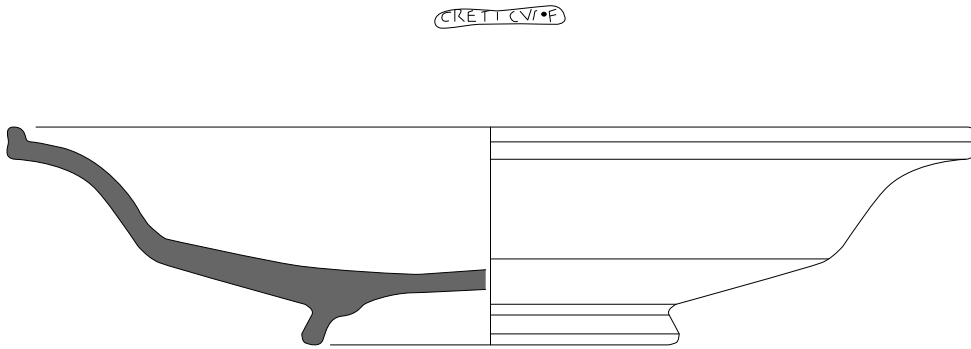

26

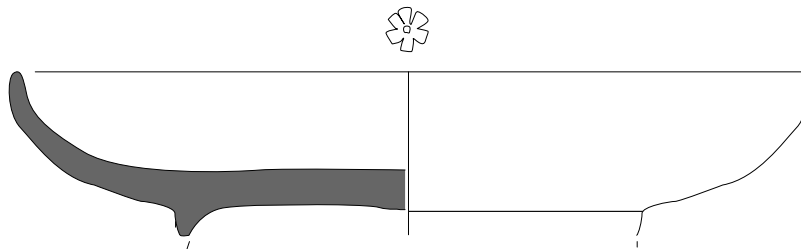

27

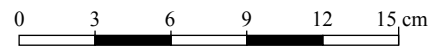

ANNEXE A
AMPHITHEATRE
Planche V

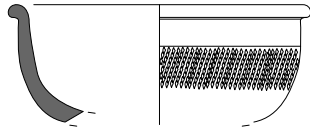

28

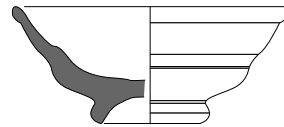

33

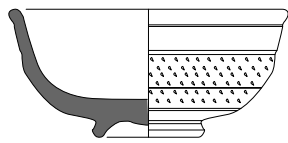

29

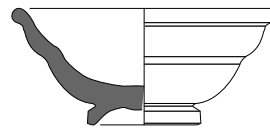

34

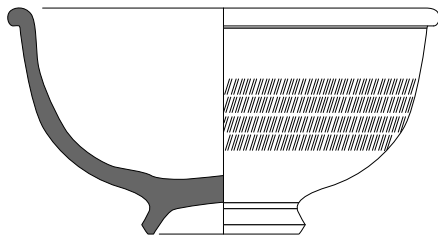

30

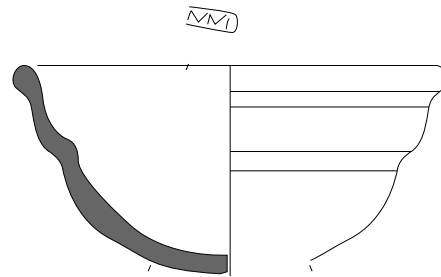

35

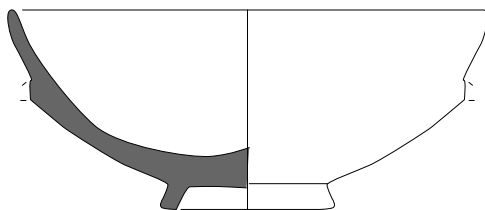

31

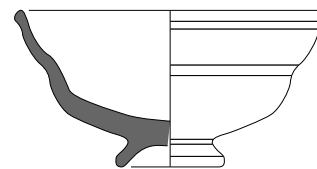

36

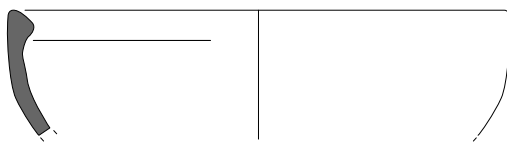

32

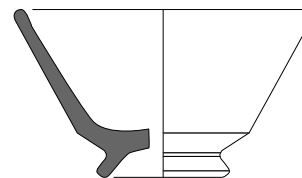

37

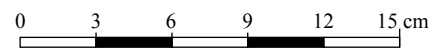

ANNEXE A
 AMPHITHEATRE

Planche VI

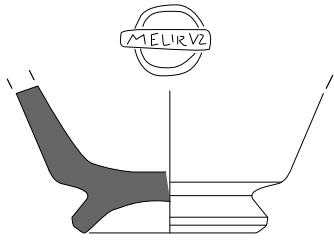

38

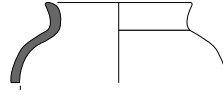

43

COVS

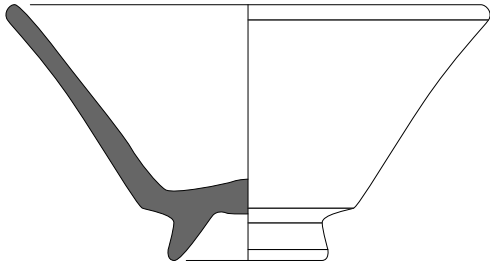

39

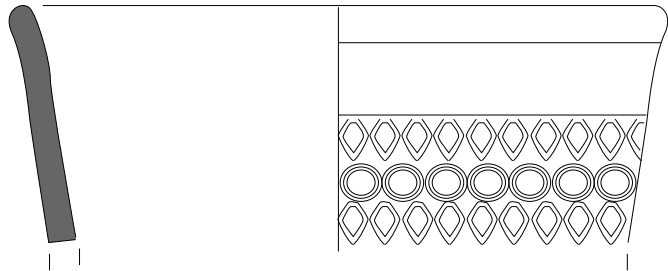

44

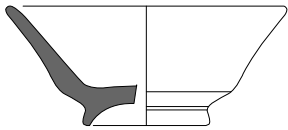

40

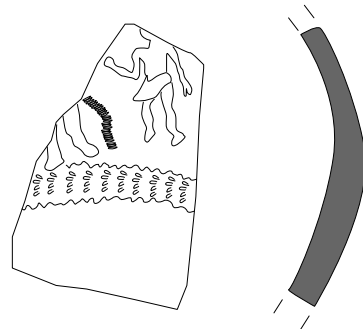

45

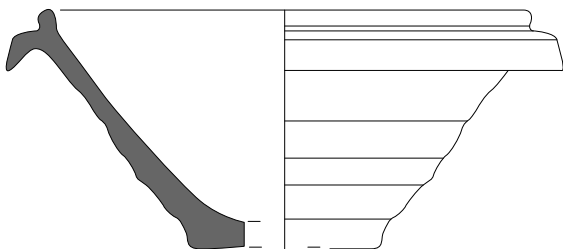

41

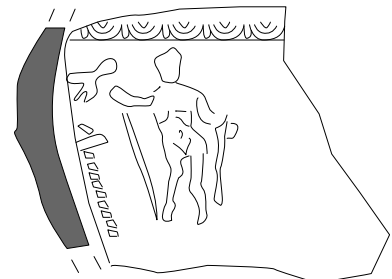

46

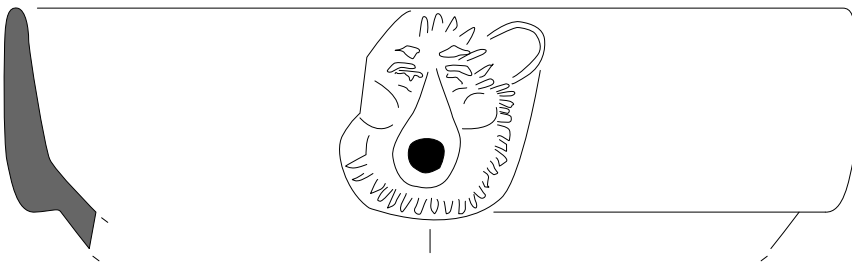

42

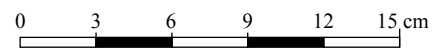

ANNEXE A
 AMPHITHEATRE

Planche VII

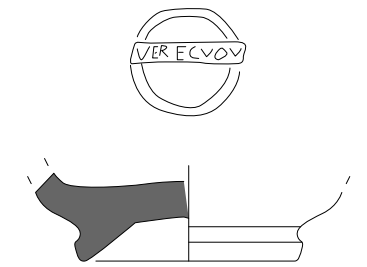

47



48

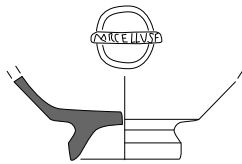

49

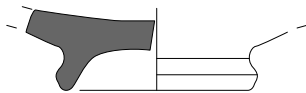

50

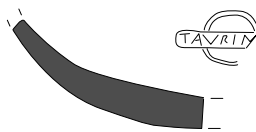

51

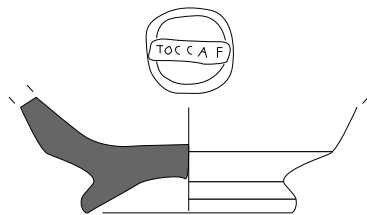

52



53

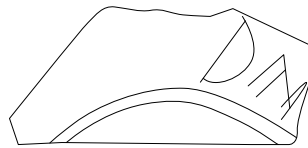

54

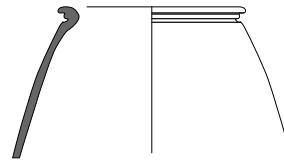

55

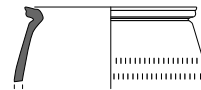

56

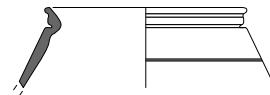

57



58

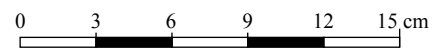

ANNEXE A
AMPHITHEATRE
Planche VIII

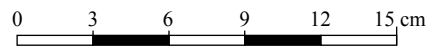
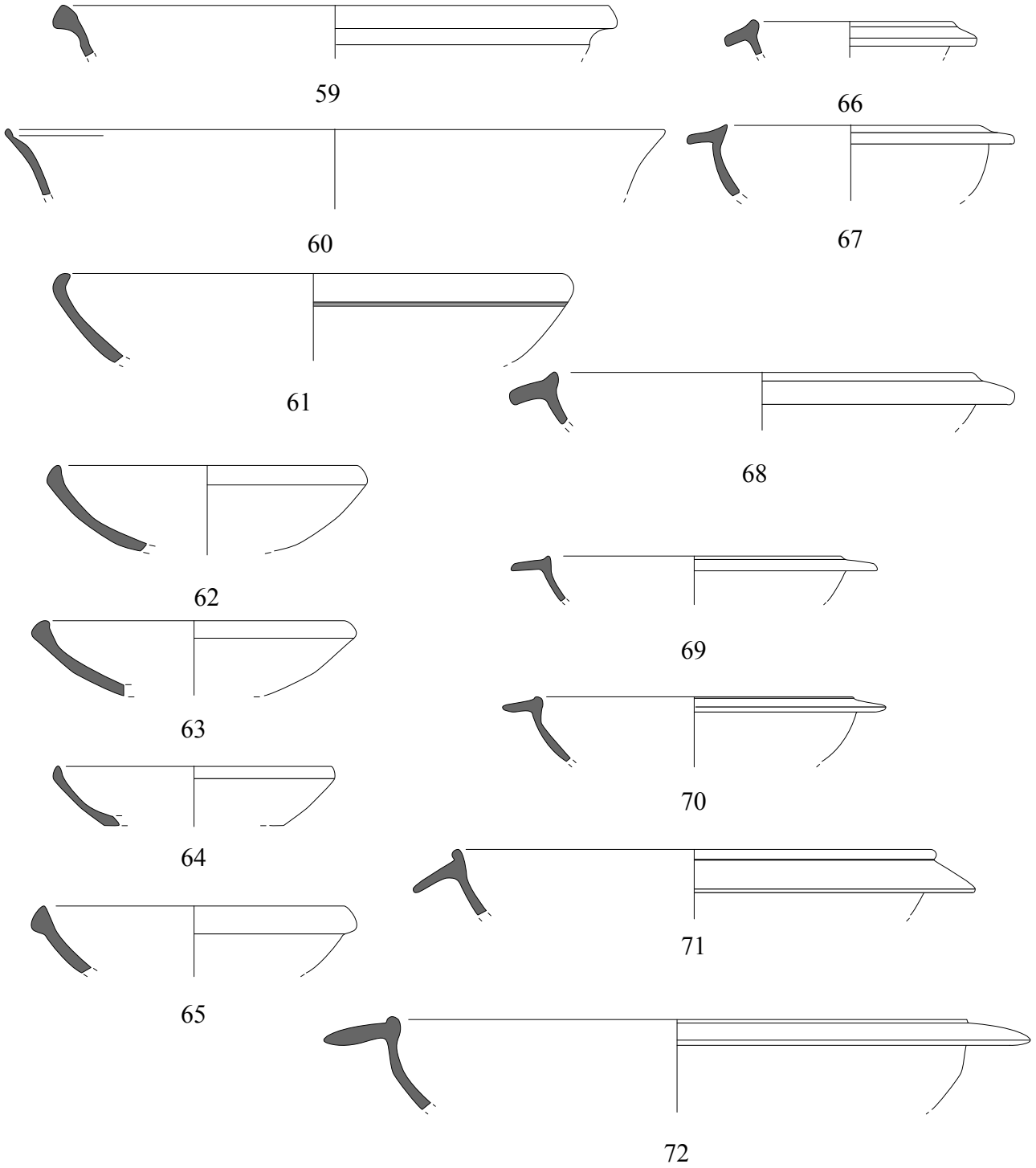

ANNEXE A
AMPHITHEATRE
Planche IX

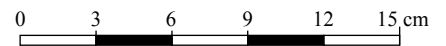
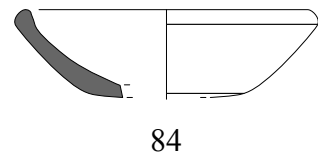
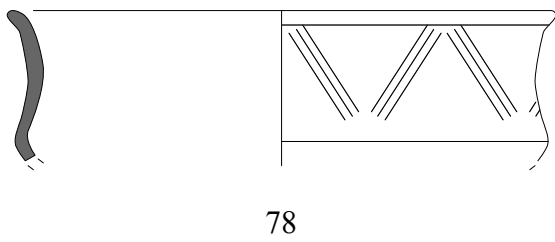
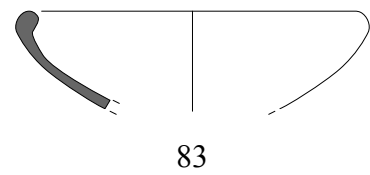
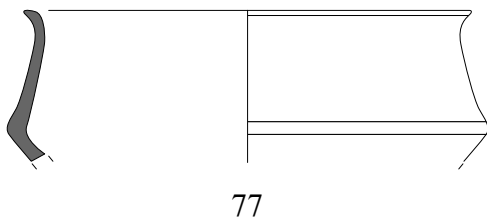
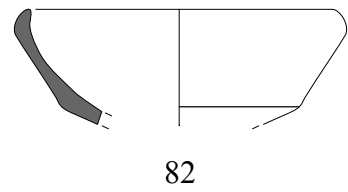
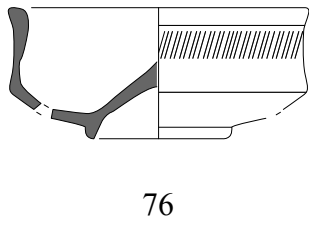
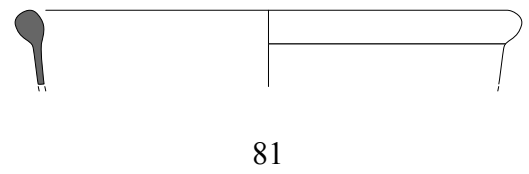
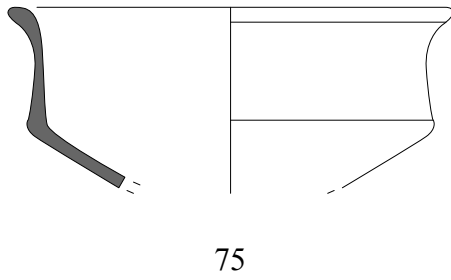
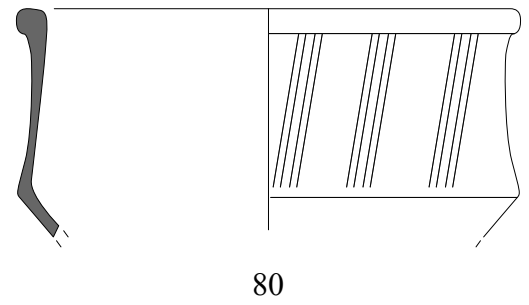
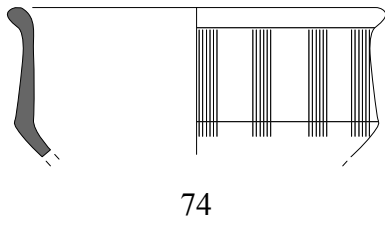
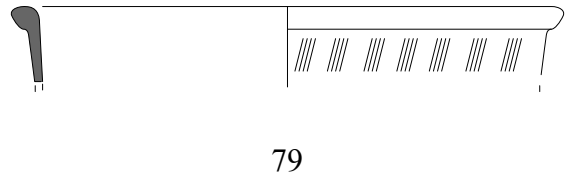
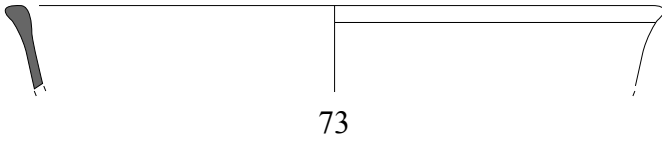

ANNEXE A
AMPHITHEATRE

Planche X

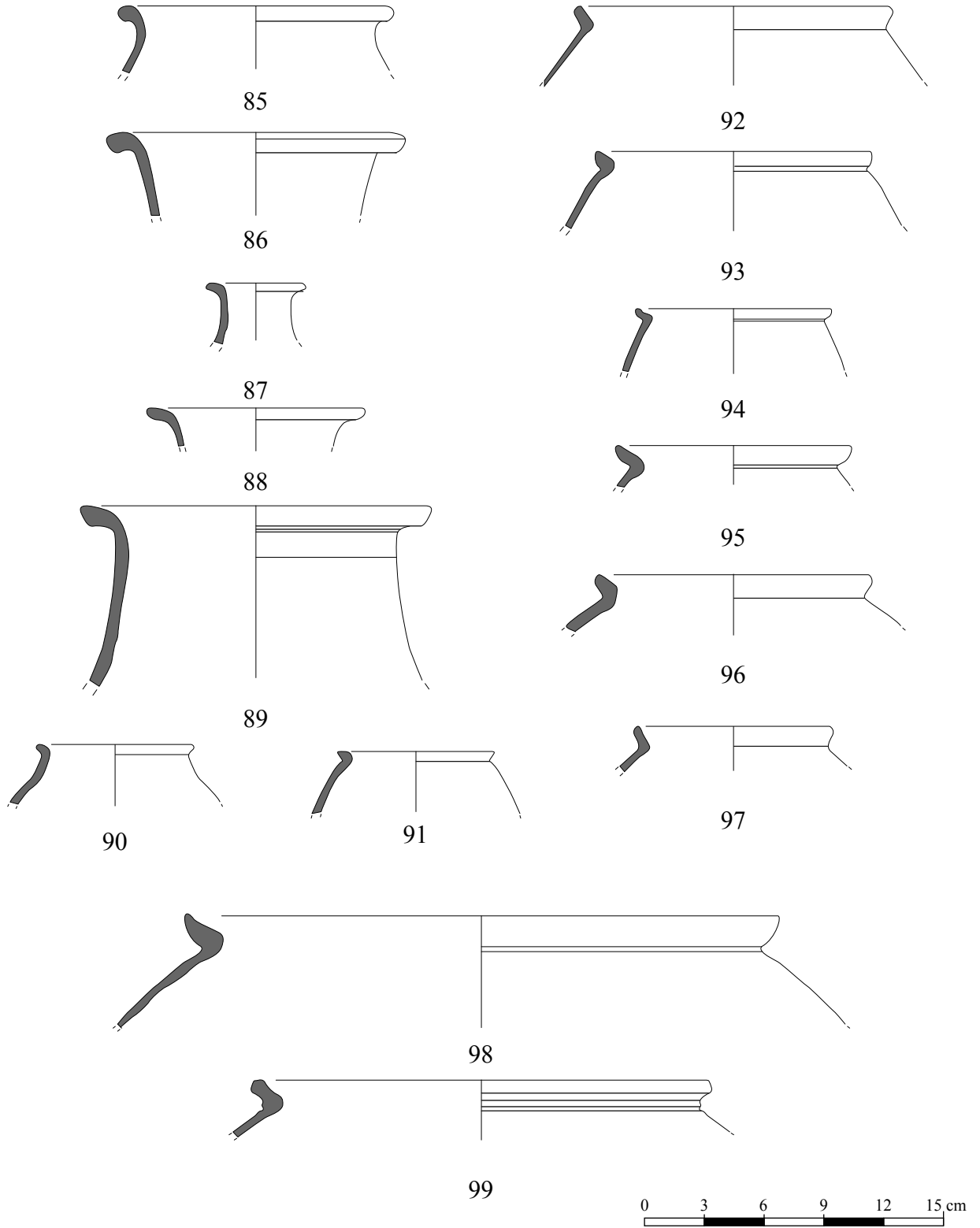

ANNEXE A
AMPHITHEATRE

Planche XI

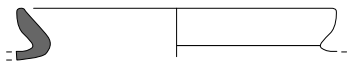
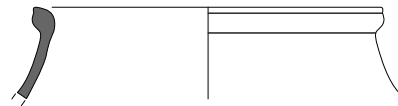
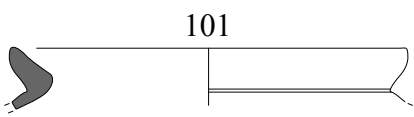
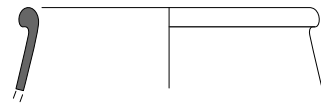
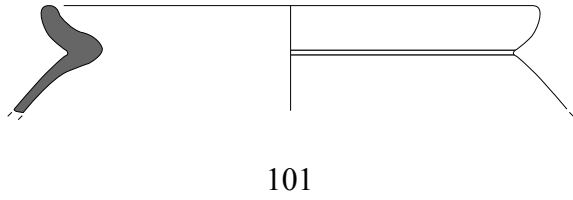
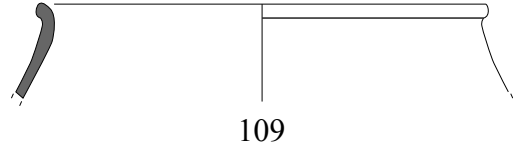
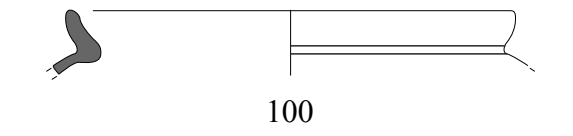

112

104

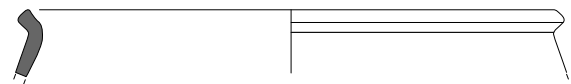
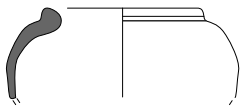

105

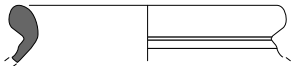

113



106

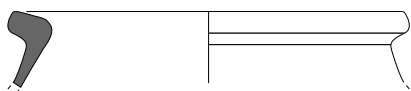

114

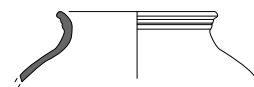

107

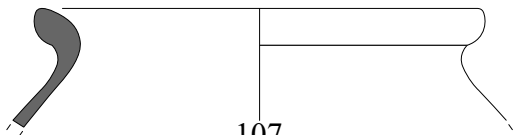

115



108

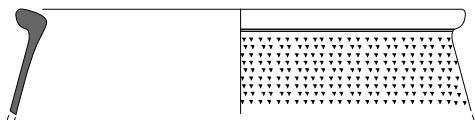

116

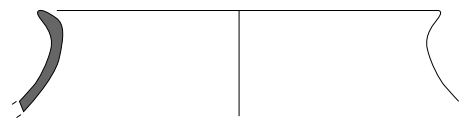

108

116

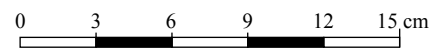

ANNEXE A
 AMPHITHEATRE
 Planche XII

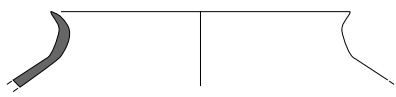

117

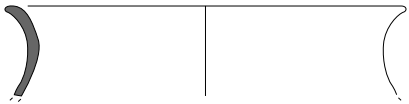

118

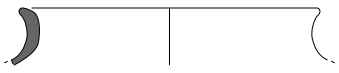

119

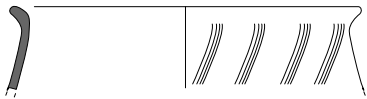

120

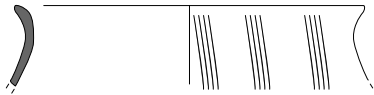

121



122

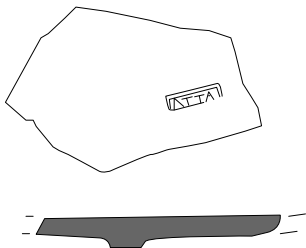

123

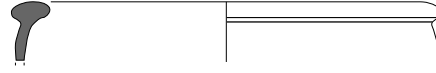

124



125

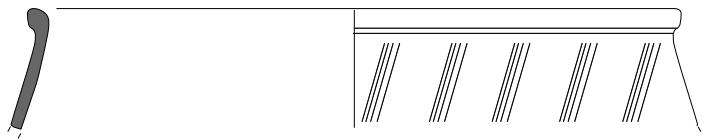

126

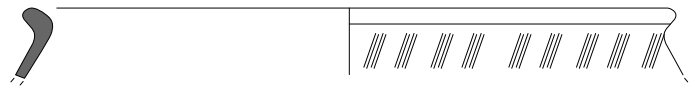

127

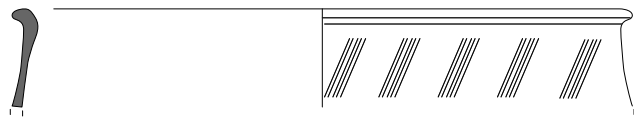

128

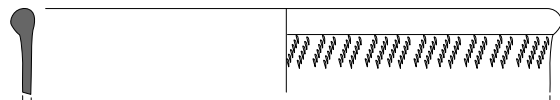

129

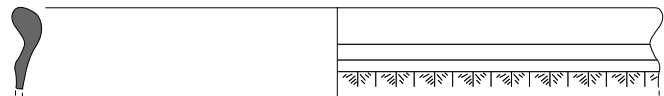

130

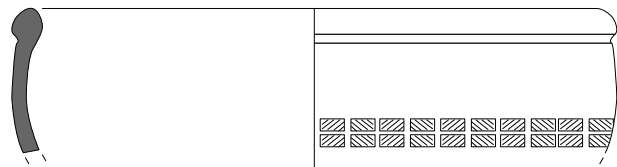

131

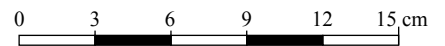

ANNEXE A
AMPHITHEATRE
Planche XIII

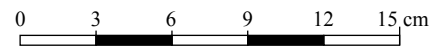
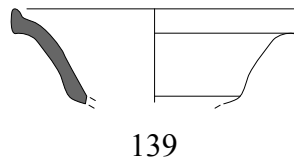
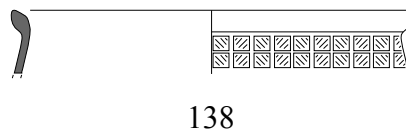
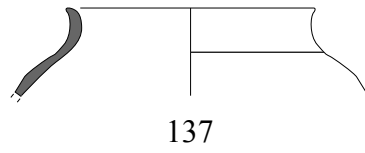
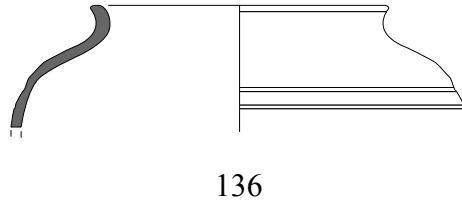
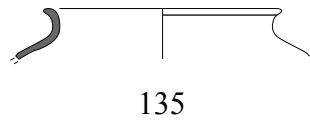
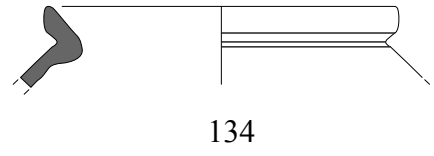
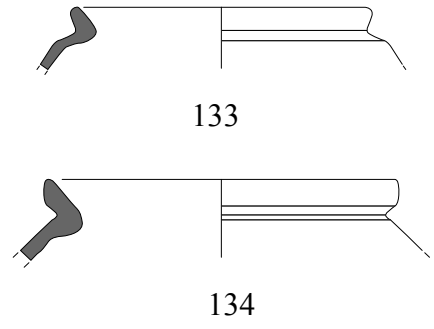
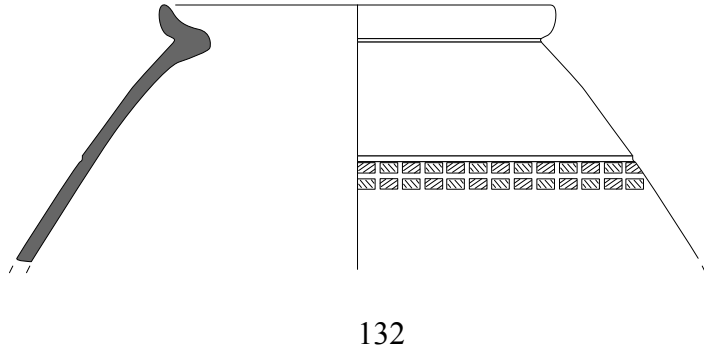

ANNEXE A
AMPHITHEATRE
Planche XIV

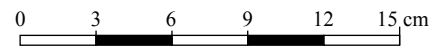
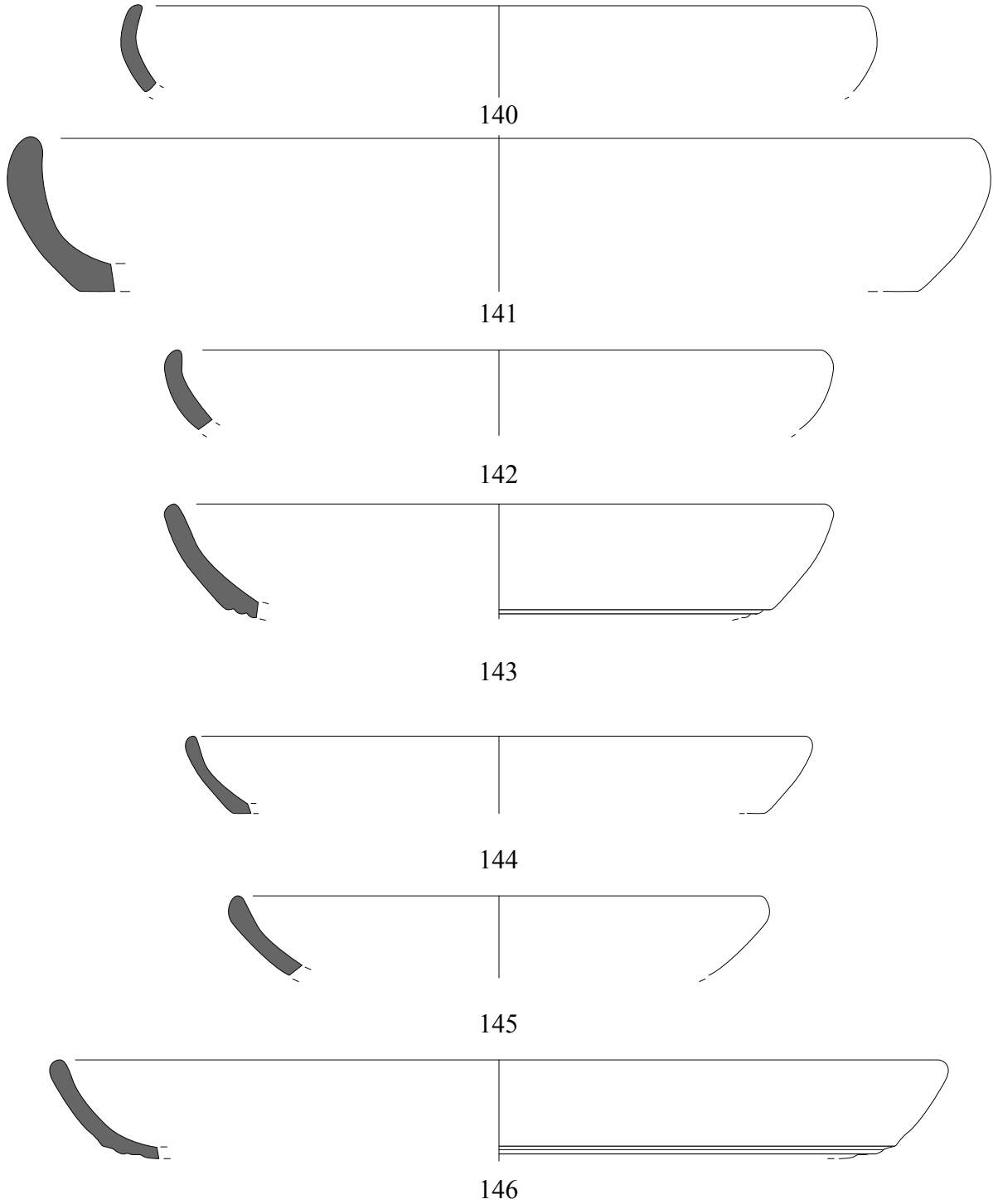

ANNEXE A
AMPHITHEATRE
Planche XV

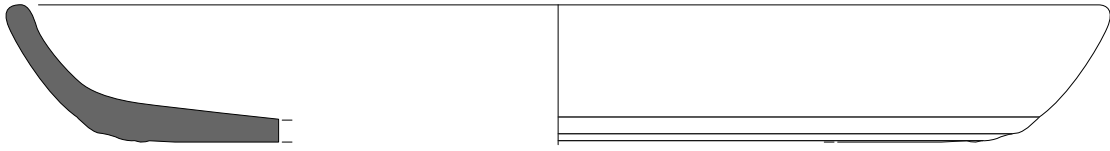

147

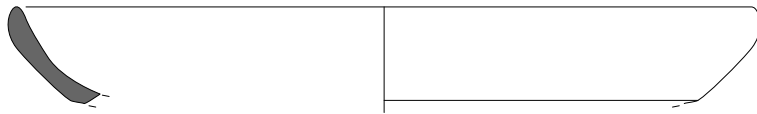

148

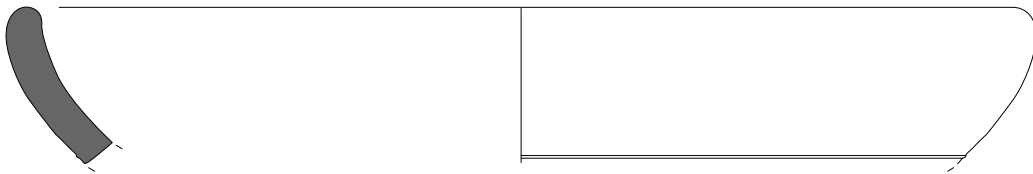

149

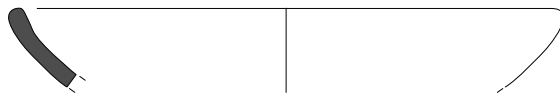

150

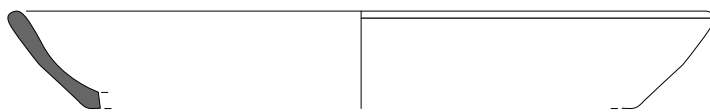

151



152

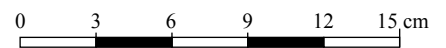

ANNEXE A
AMPHITHEATRE
Planche XVI

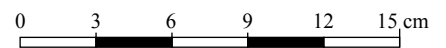
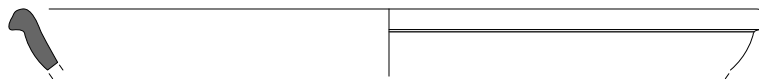
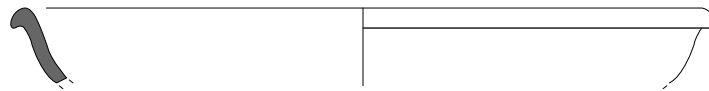
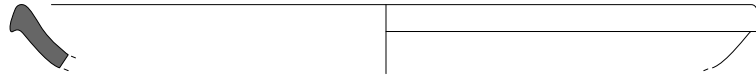
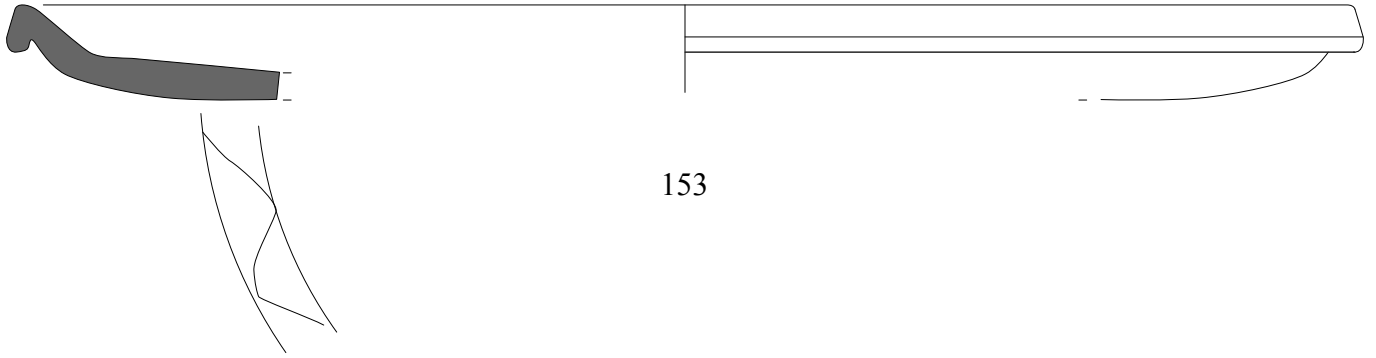

ANNEXE A
AMPHITHEATRE
Planche XVII

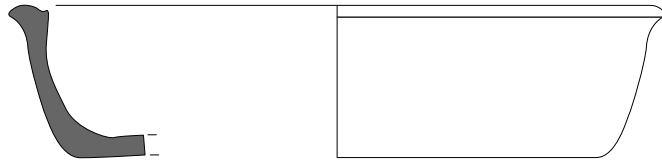

159

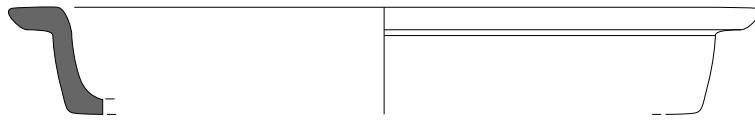

160

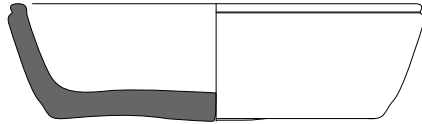

161



162

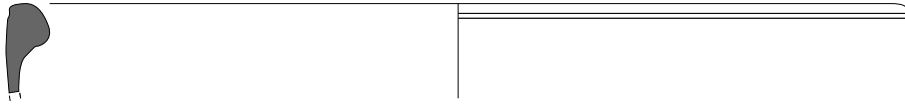

163

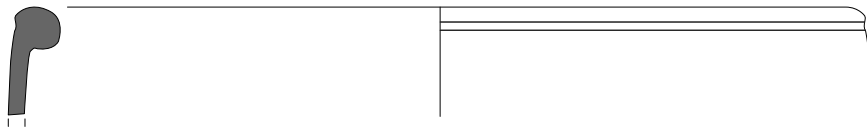

164

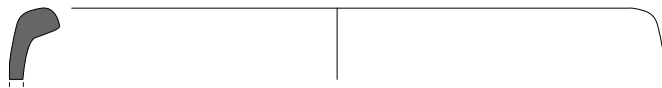

165

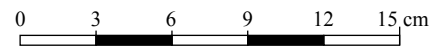

ANNEXE A
AMPHITHEATRE
Planche XVIII

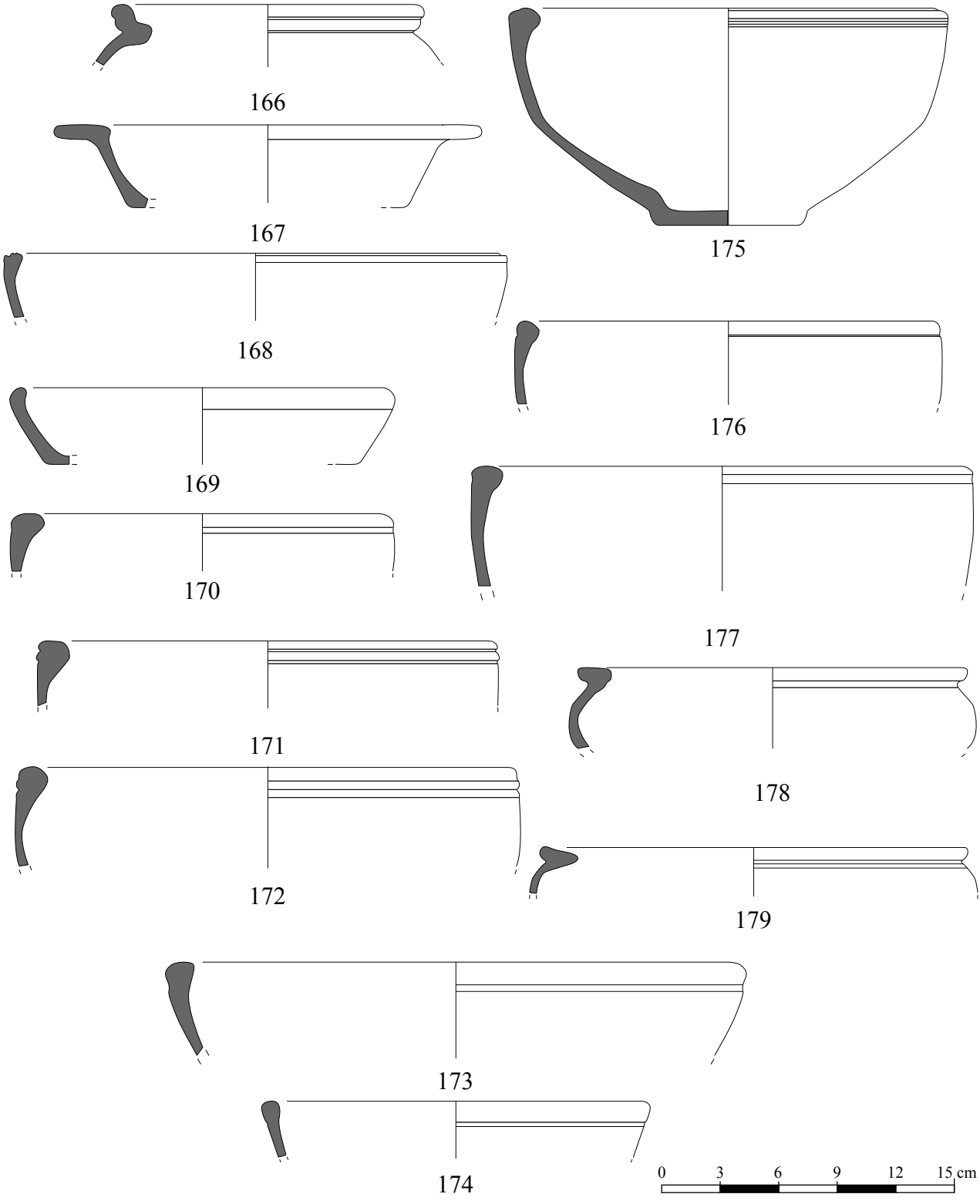

ANNEXE A
AMPHITHEATRE

Planche XIX

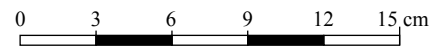
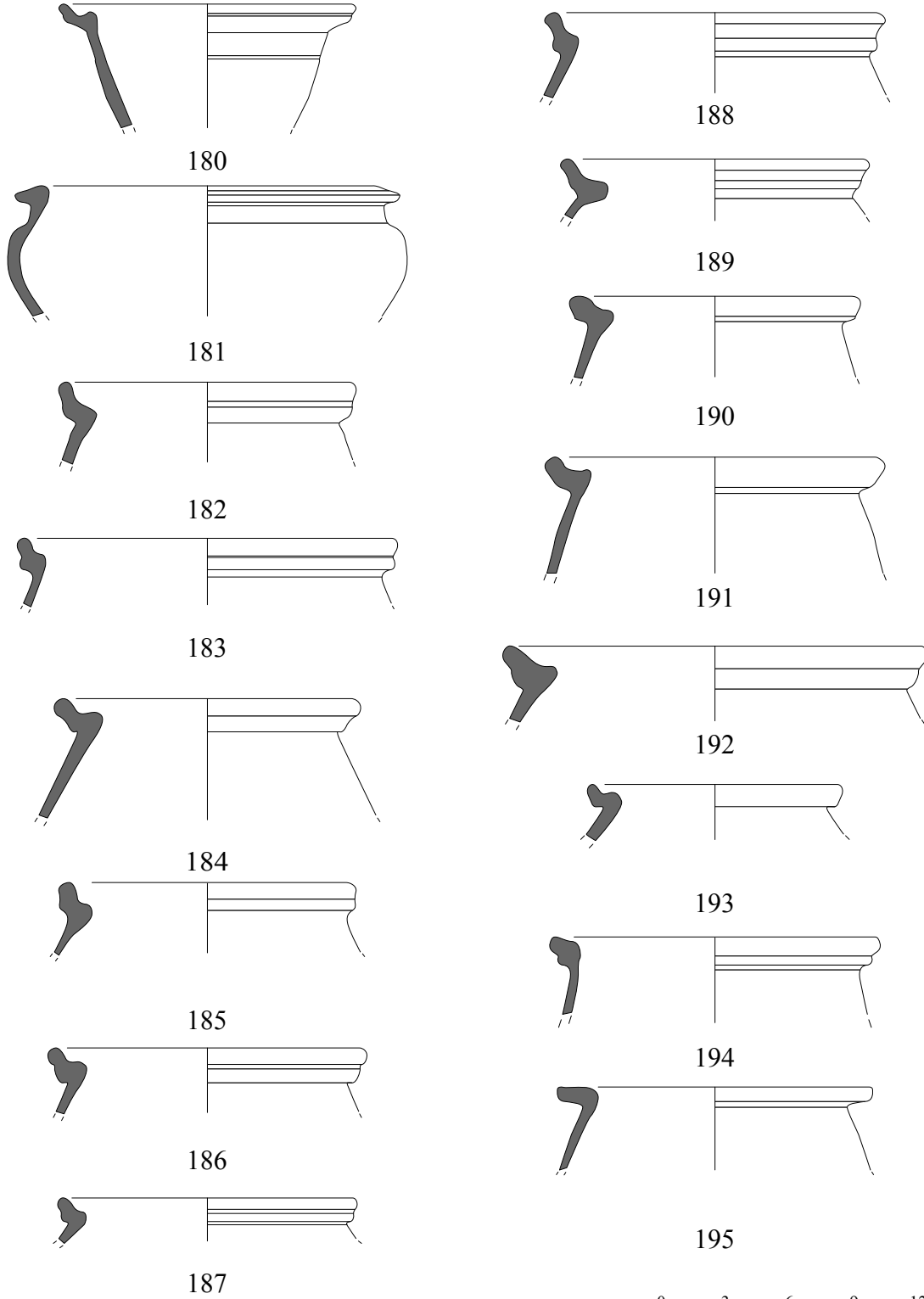

ANNEXE A
AMPHITHEATRE

Planche XX

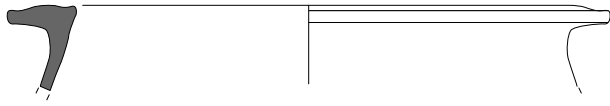

196

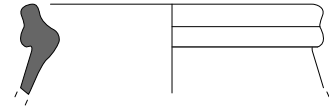

198

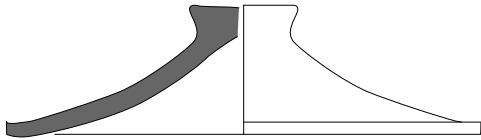

197

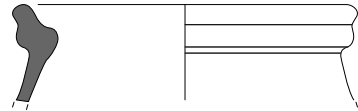

199



200

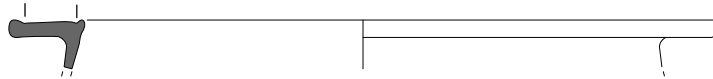

201

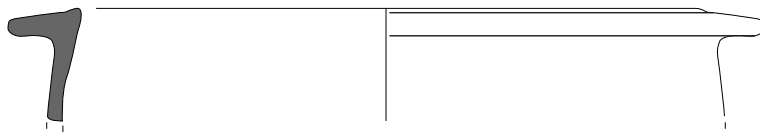

202

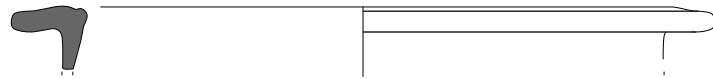

203

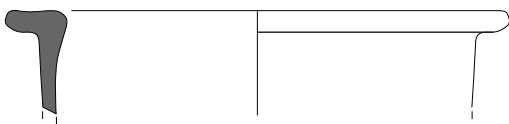

204

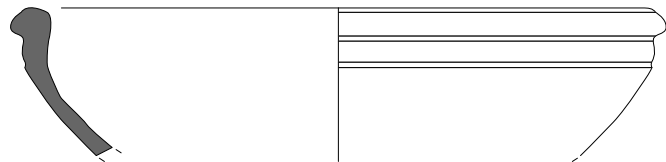

205

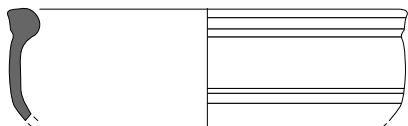

206

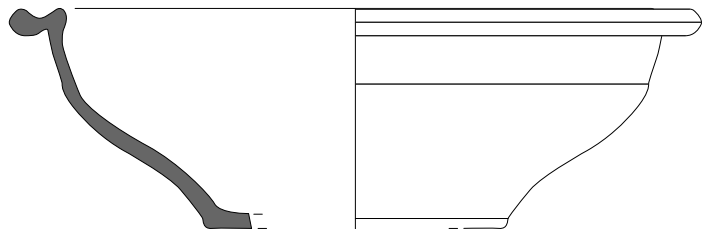

207

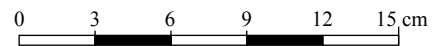

ANNEXE A
AMPHITHEATRE

Planche XXI

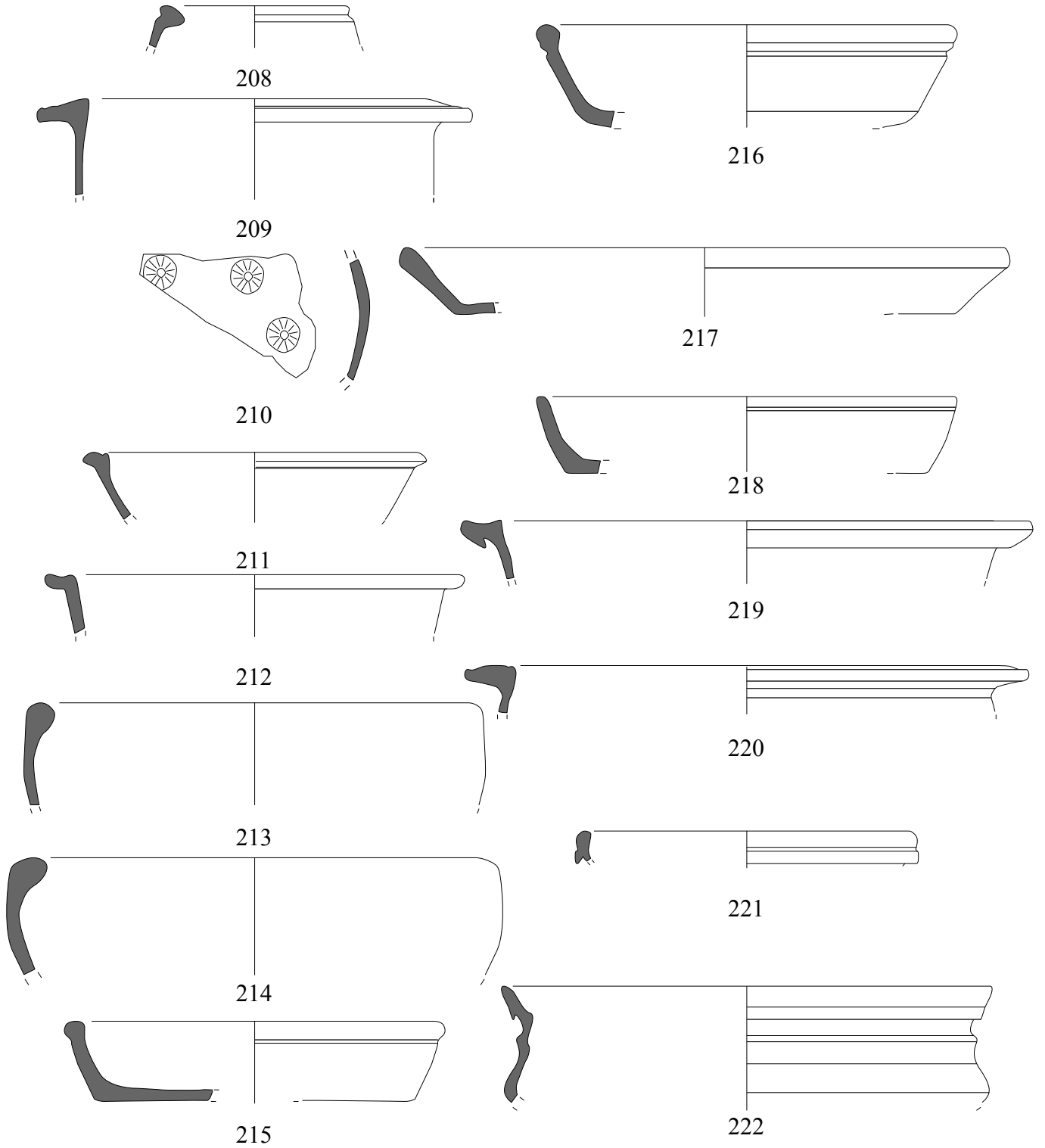

0 3 6 9 12 15 cm

ANNEXE A
AMPHITHEATRE
Planche XXII

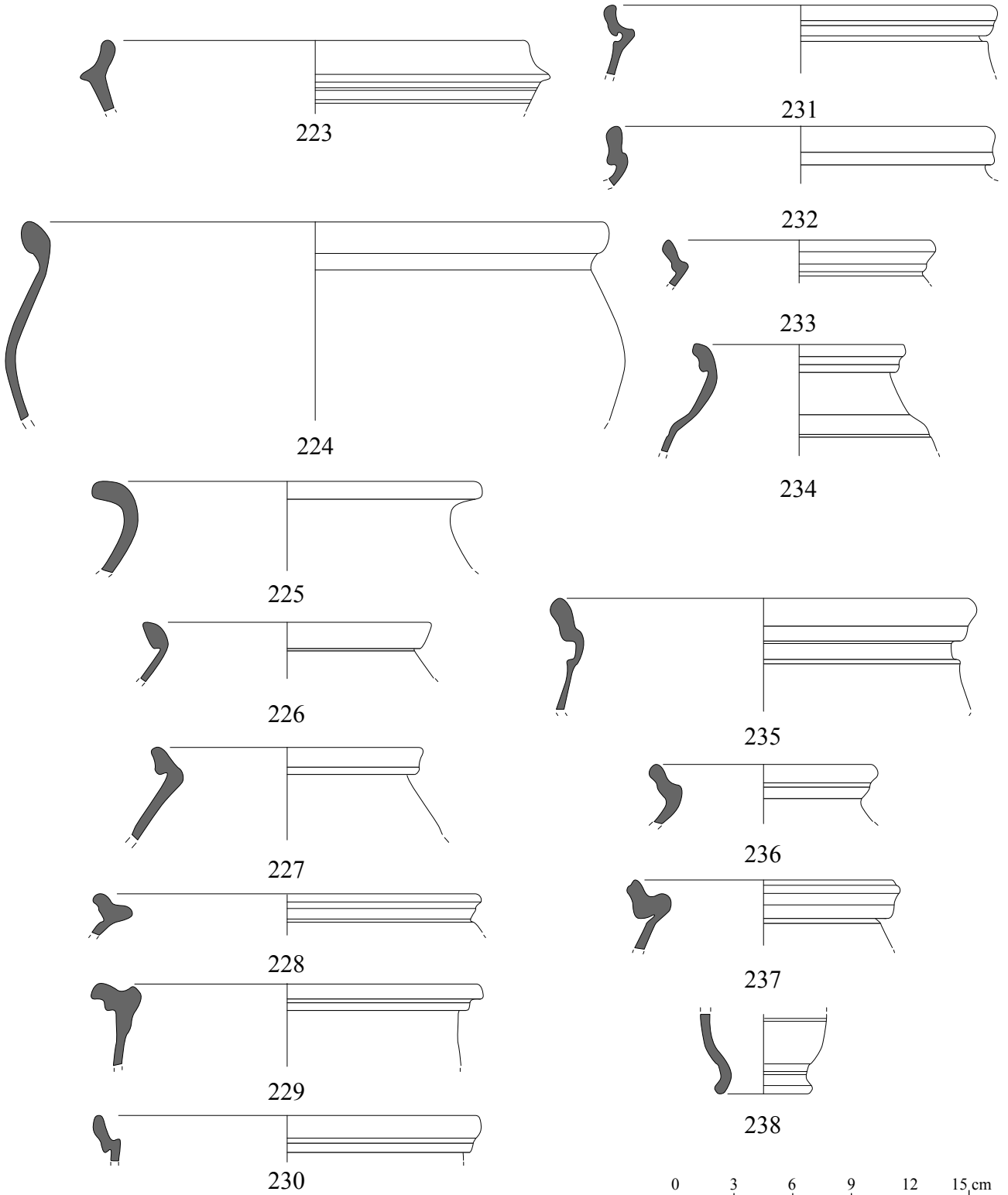

ANNEXE A
AMPHITHEATRE
Planche XXIII

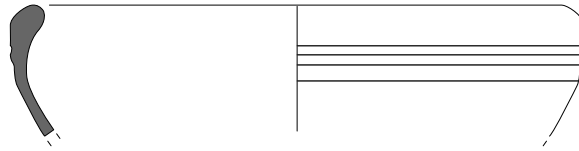

239

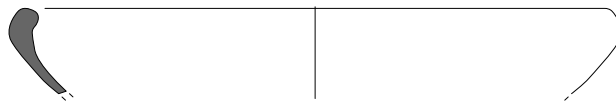

240



241



242

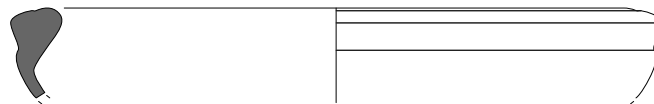

243



244

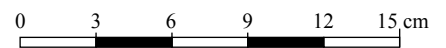

ANNEXE A
AMPHITHEATRE
Planche XXIV

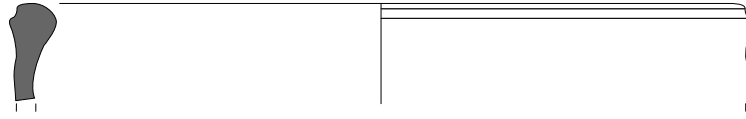

245

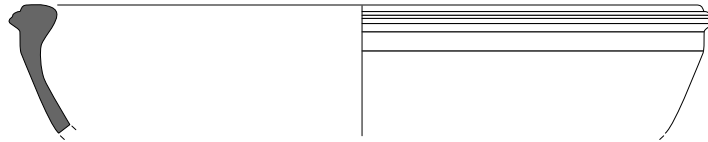

246

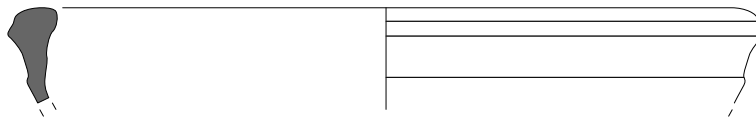

247

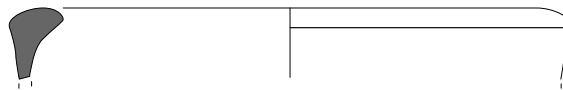

248

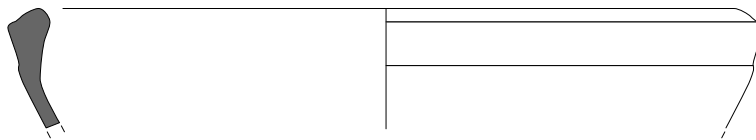

249

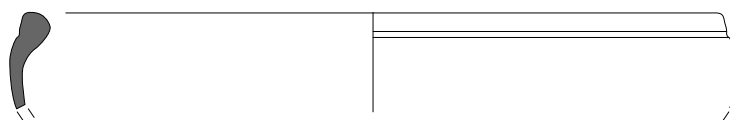

250

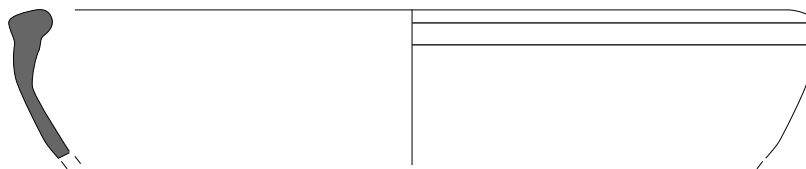

251

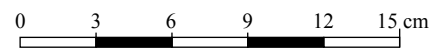

ANNEXE A
AMPHITHEATRE
Planche XXV

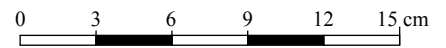
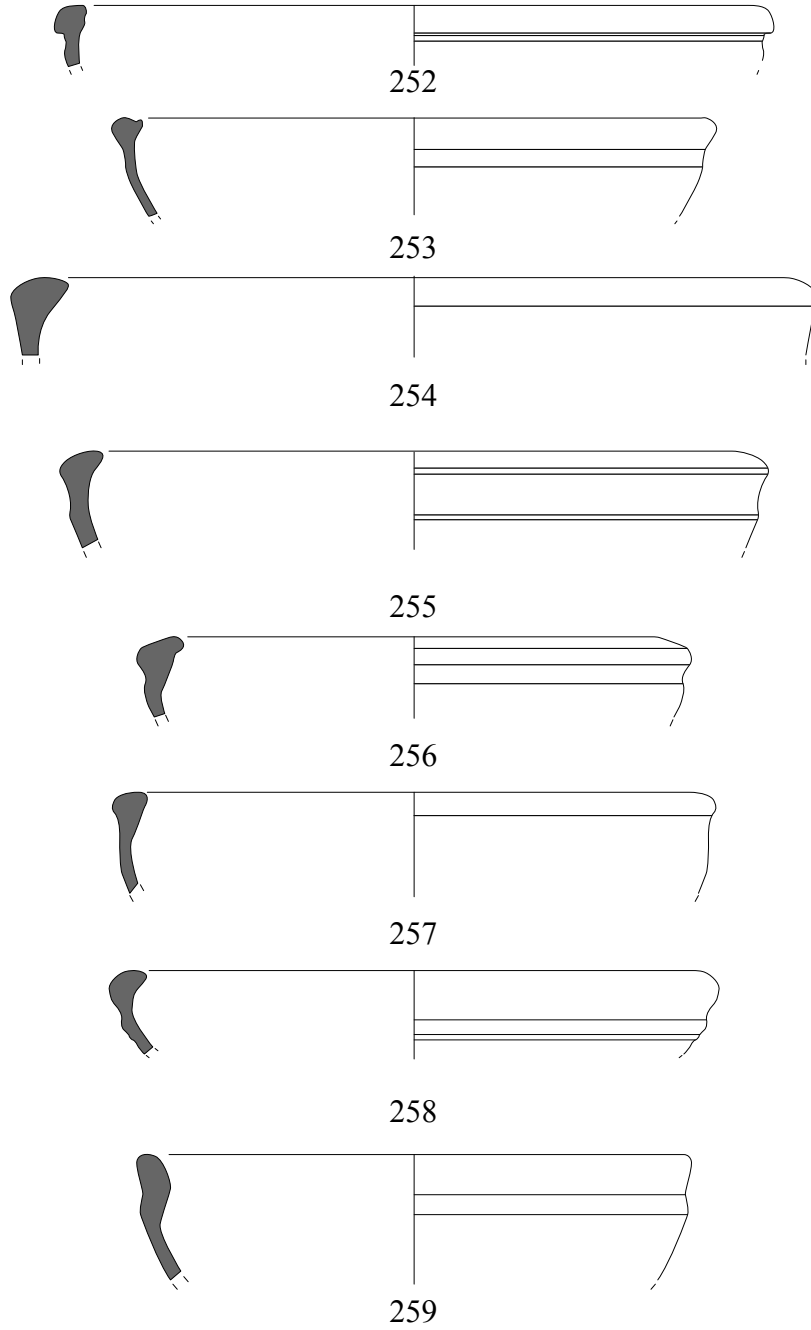

ANNEXE A
AMPHITHEATRE
Planche XXVI



260

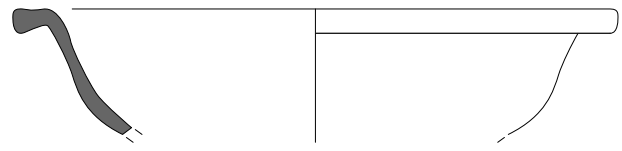

268



261

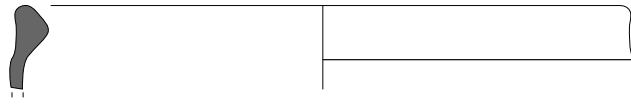

262

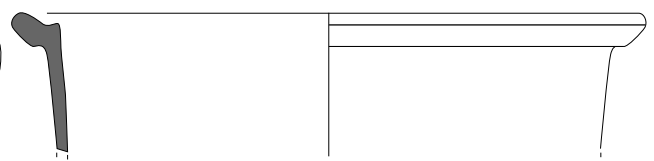

269

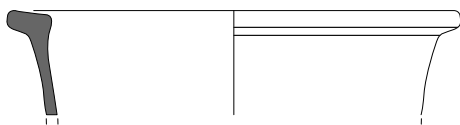

263

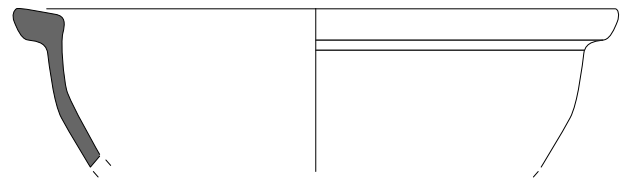

270

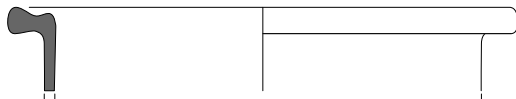

264

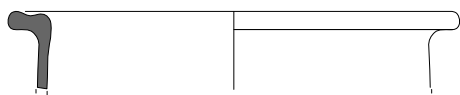

265

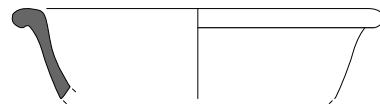

271

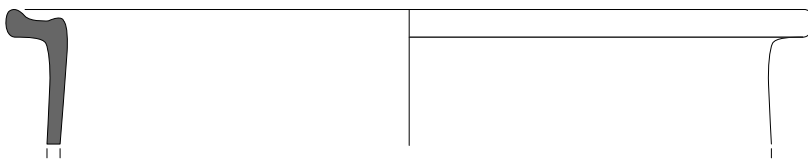

266

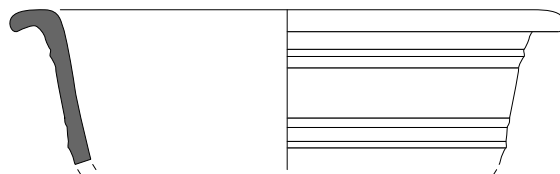

267

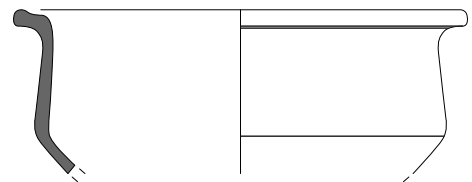

272

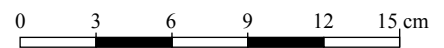

ANNEXE A
AMPHITHEATRE
Planche XXVII

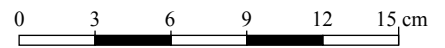
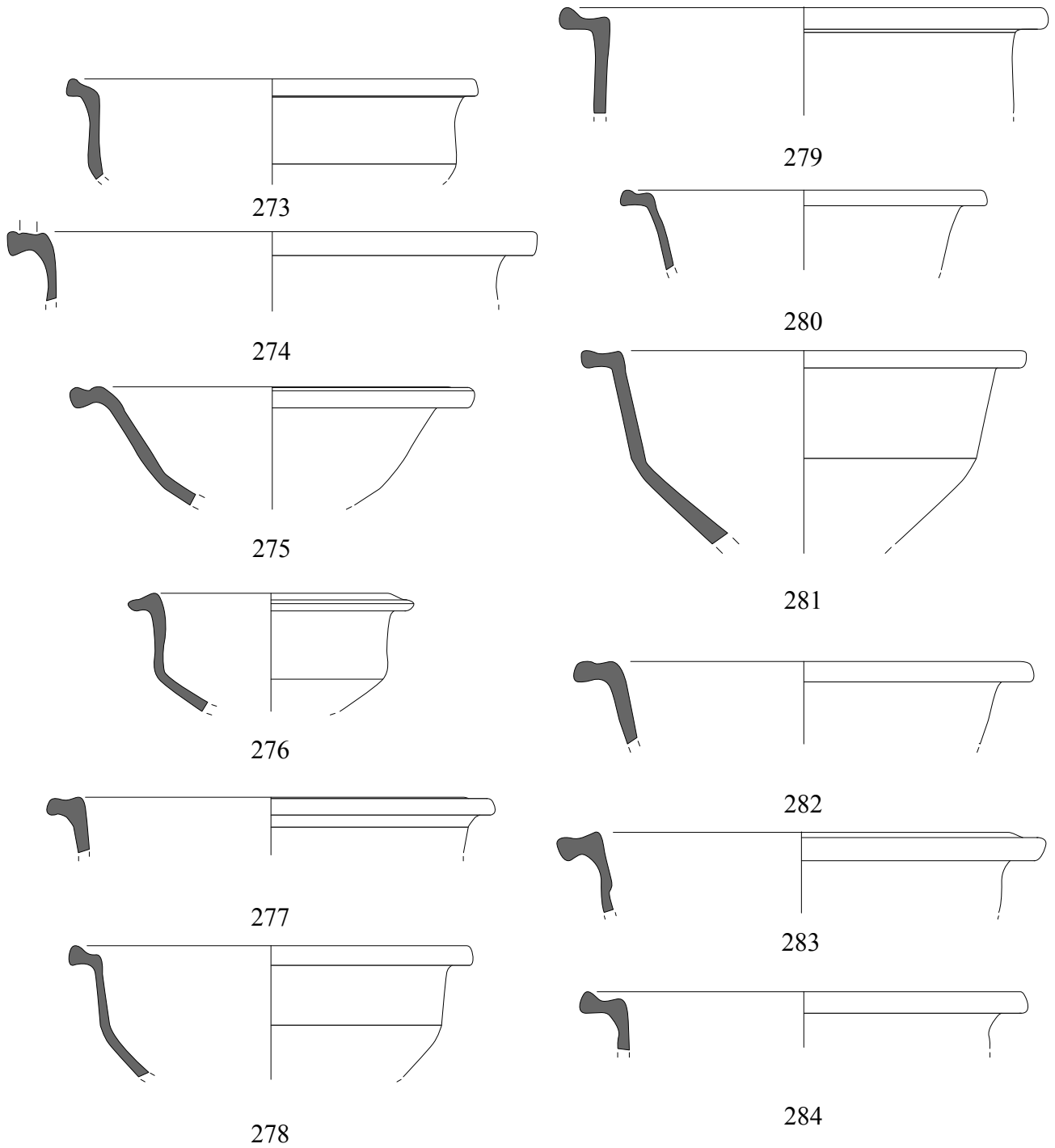

ANNEXE A
AMPHITHEATRE
Planche XXVIII

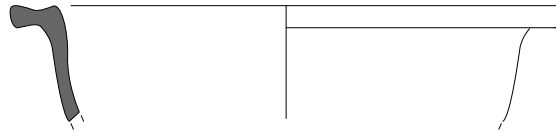

285

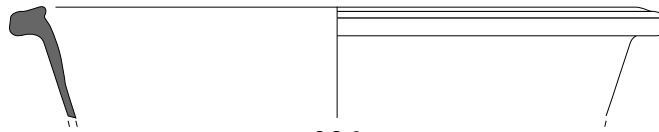

286

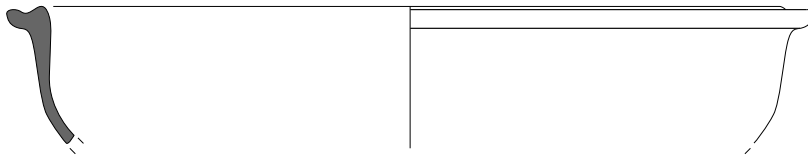

287

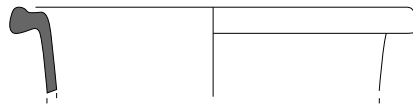

288

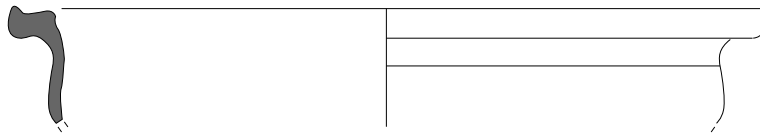

289

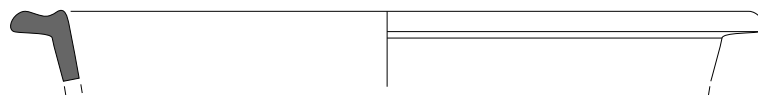

290

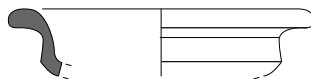

291

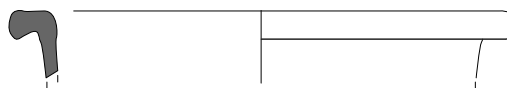

292

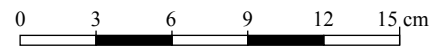

ANNEXE A
AMPHITHEATRE
Planche XXIX

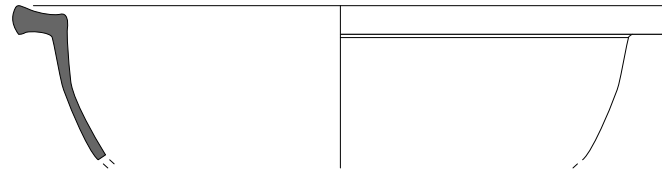

293

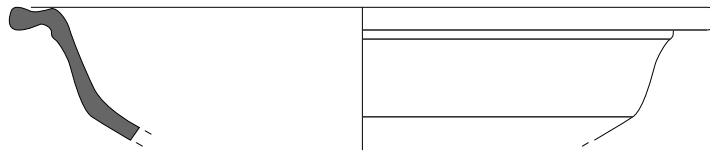

294

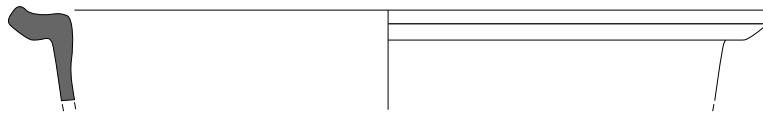

295

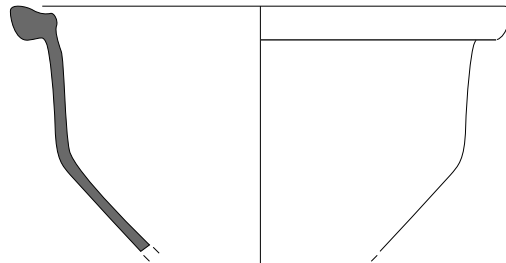

296

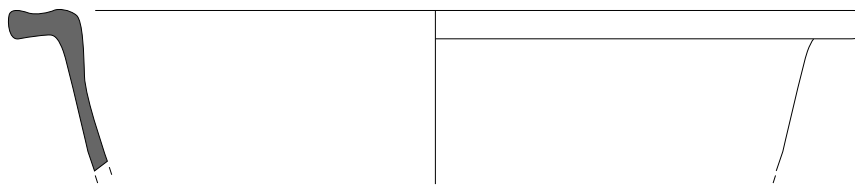

297

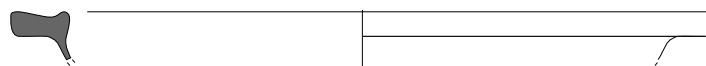

298

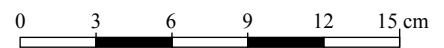

ANNEXE A
AMPHITHEATRE
Planche XXX

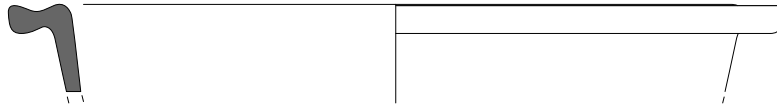

299

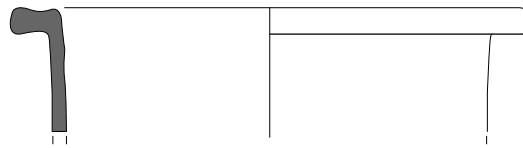

300



301

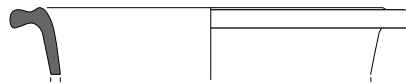

302



303

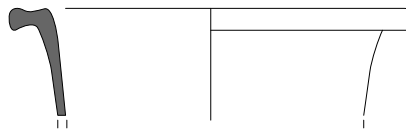

304

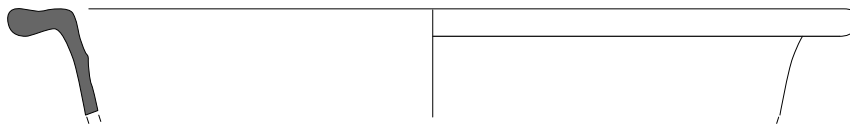

305

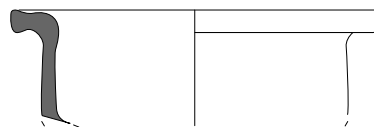

306

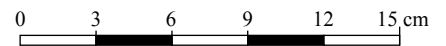

ANNEXE A
AMPHITHEATRE
Planche XXXI

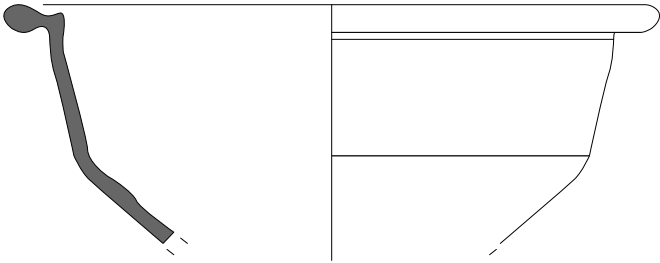

307

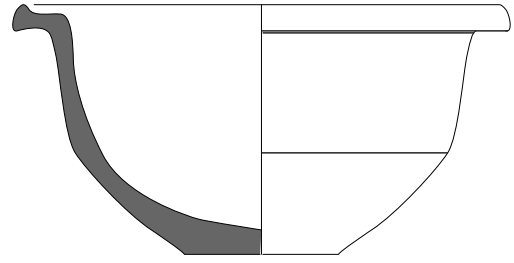

311

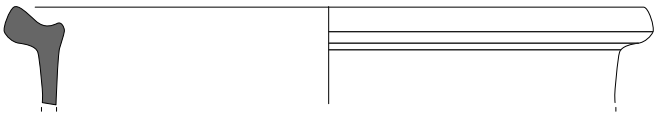

308

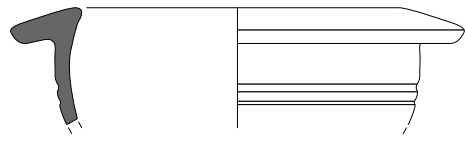

312

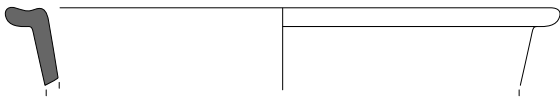

309

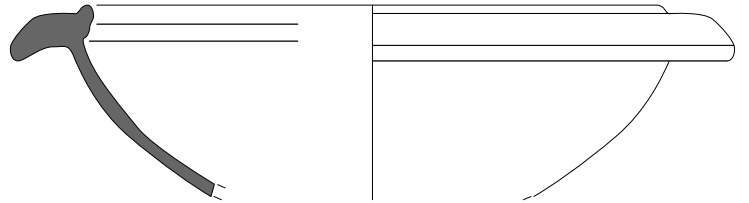

313

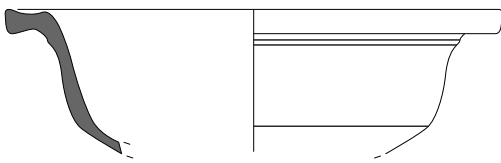

310

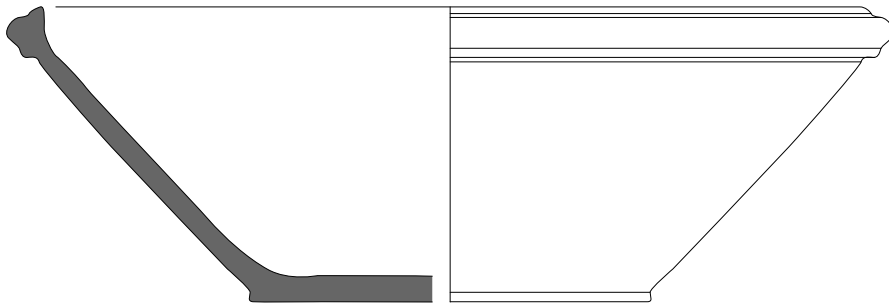

314

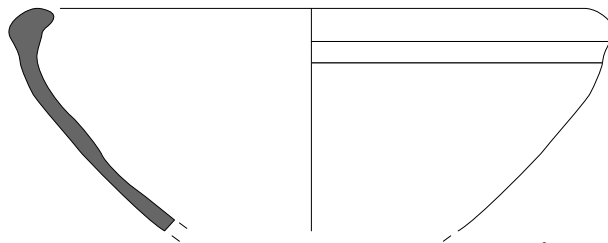

315

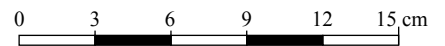

ANNEXE A
AMPHITHEATRE
Planche XXXII

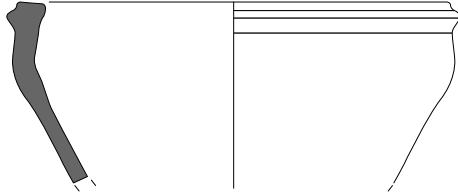

316

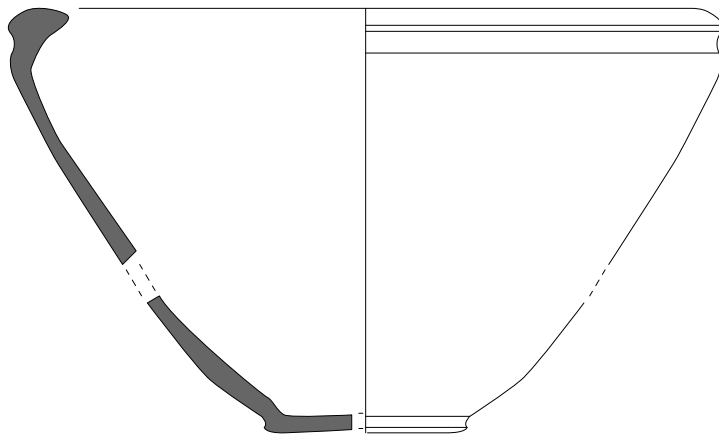

317

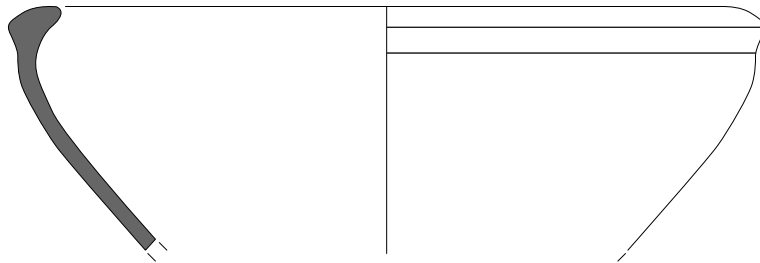

318

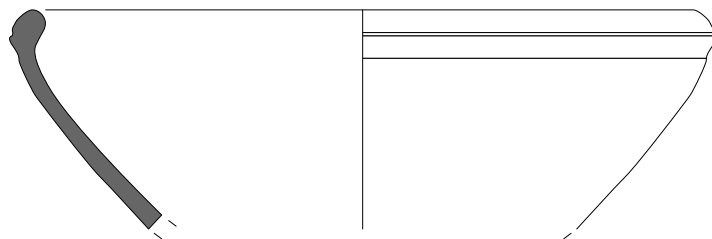

319

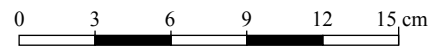

ANNEXE A
AMPHITHEATRE
Planche XXXIII

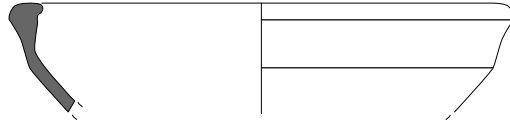

320

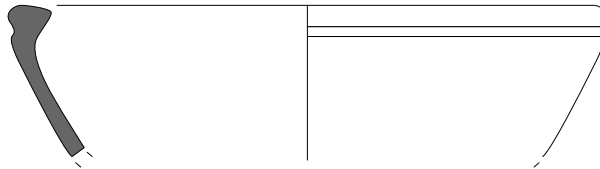

321

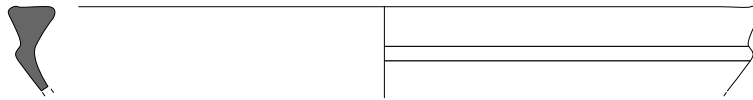

322

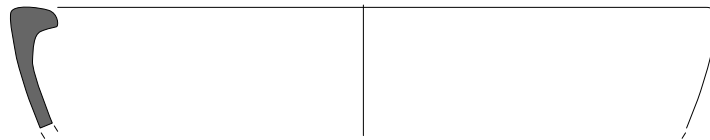

323

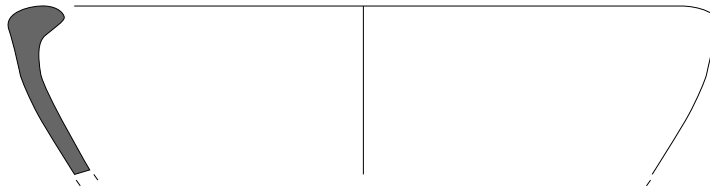

324

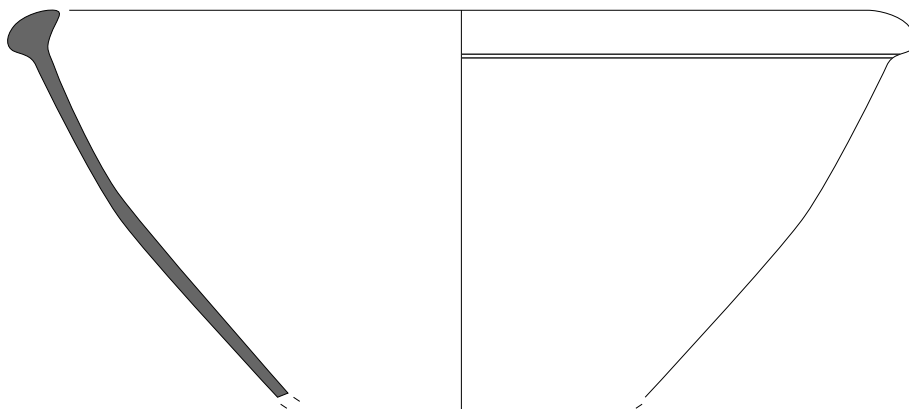

325

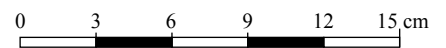

ANNEXE A
AMPHITHEATRE
Planche XXXIV

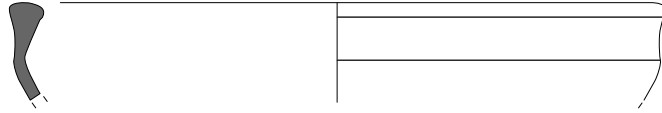

326

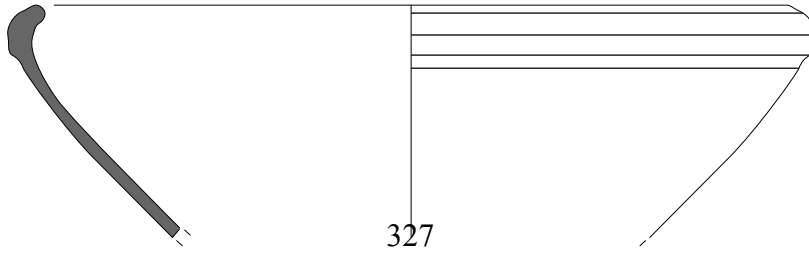

327

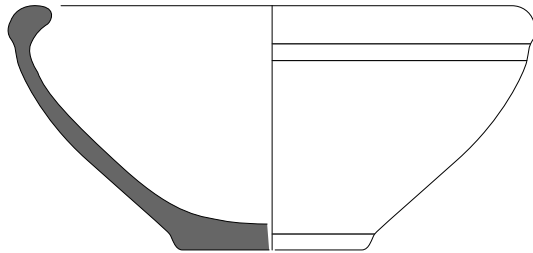

328

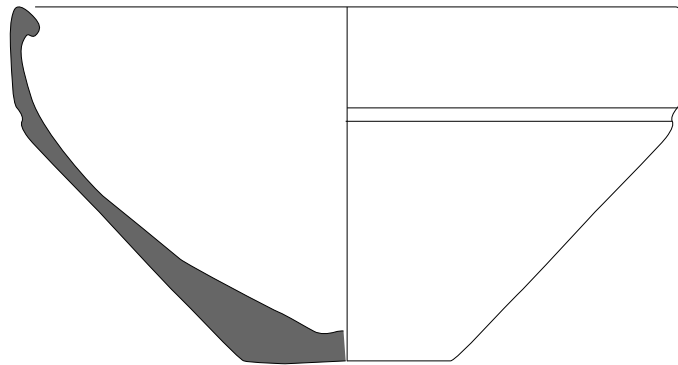

329

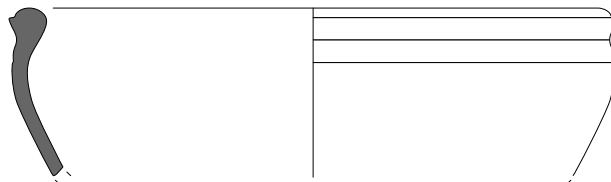

330

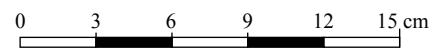

ANNEXE A
AMPHITHEATRE
Planche XXXVI

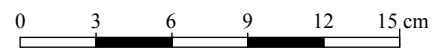
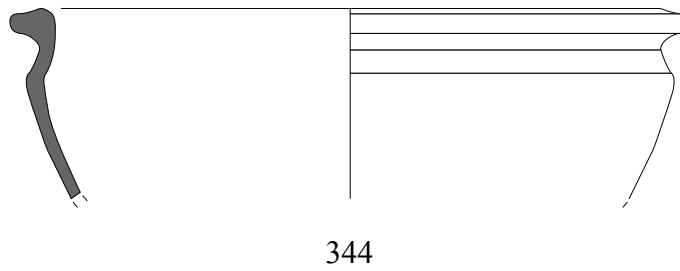
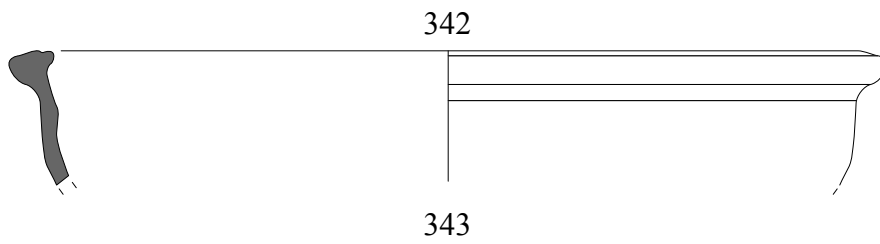
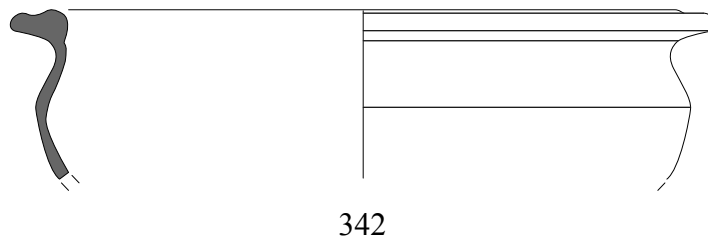
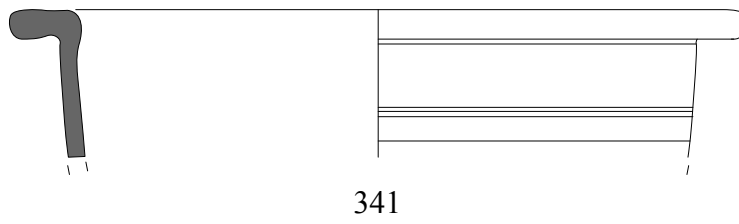
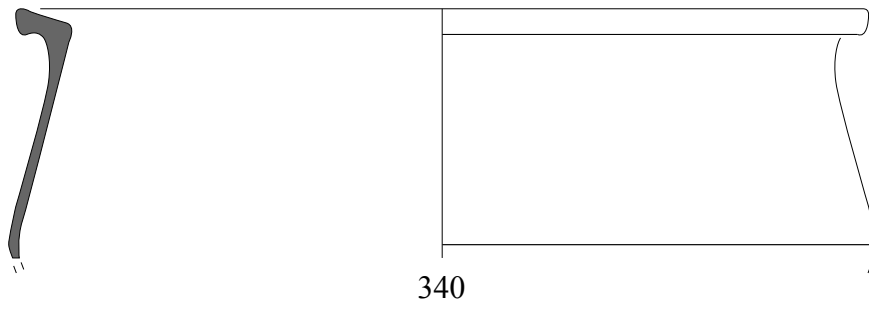
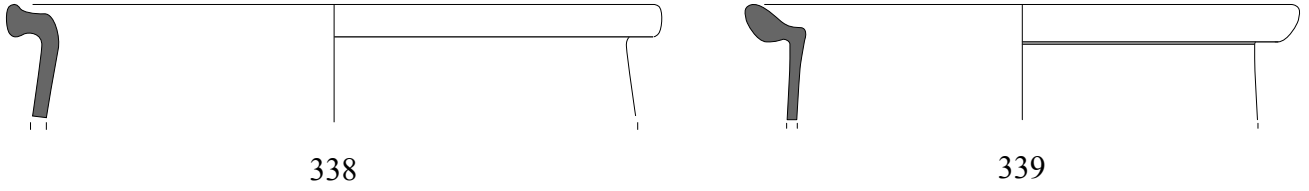

ANNEXE A
AMPHITHEATRE
Planche XXXVI

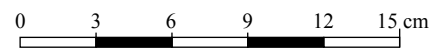
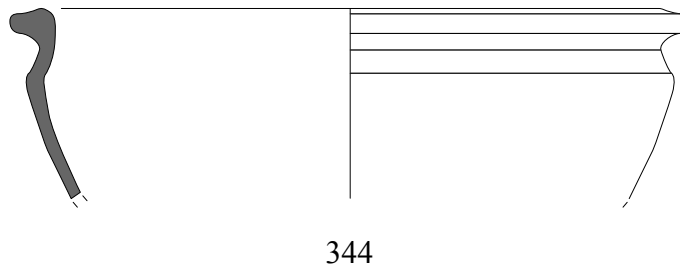
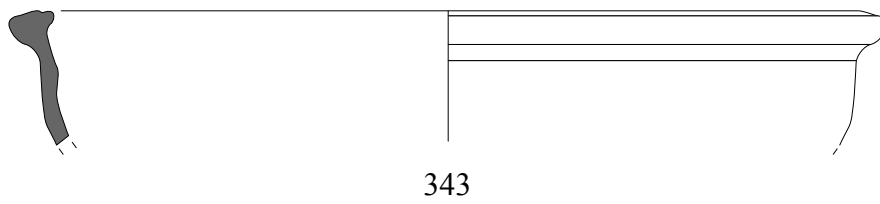
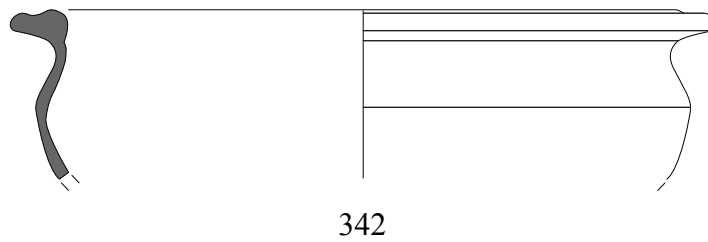
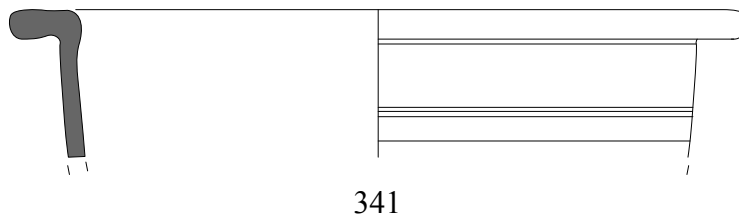
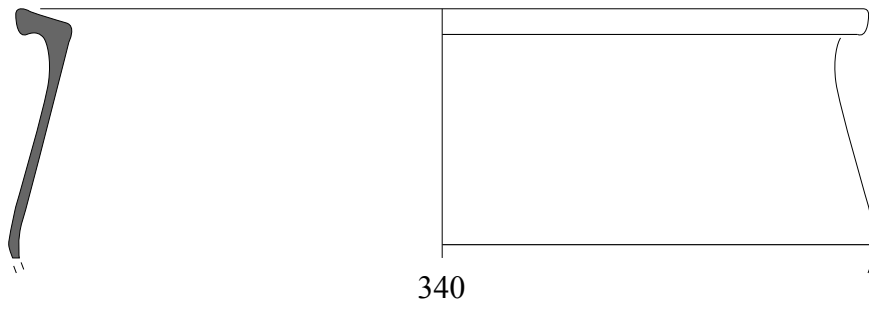
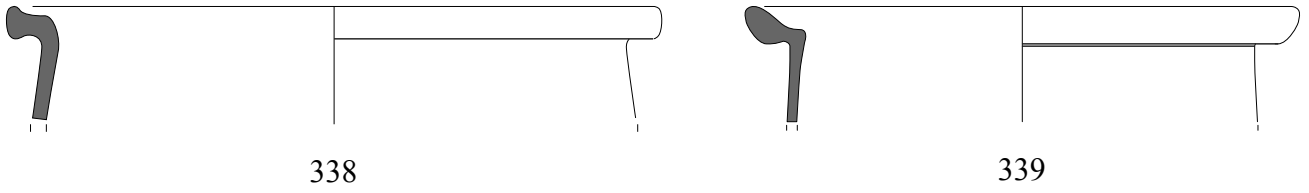

ANNEXE A
AMPHITHEATRE
Planche XXXVII

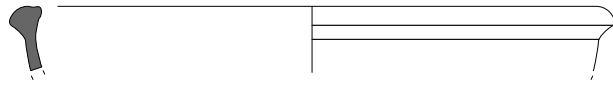

345

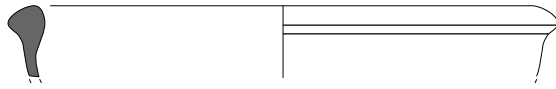

346

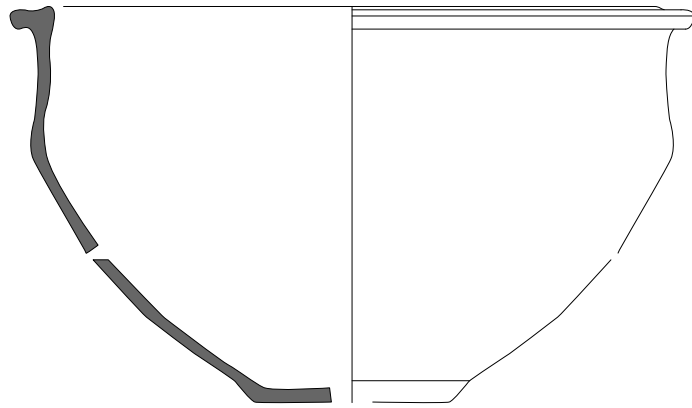

347

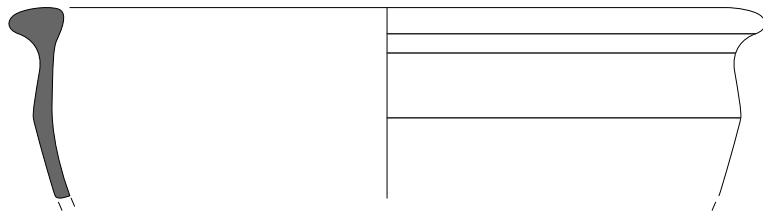

348

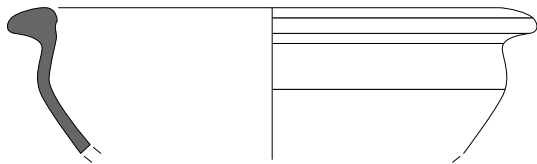

349

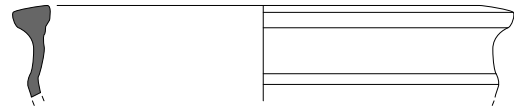

350

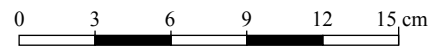

ANNEXE A
AMPHITHEATRE
Planche XXXVIII

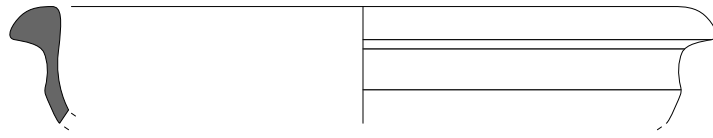

351

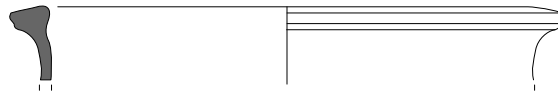

352



353

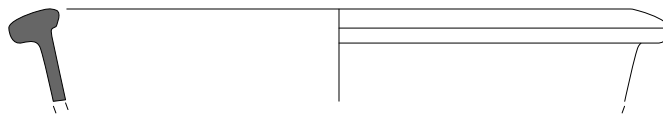

354

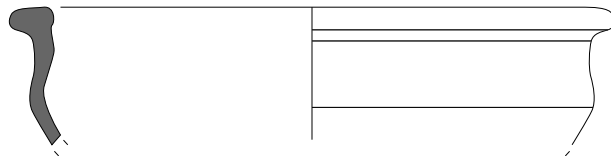

355

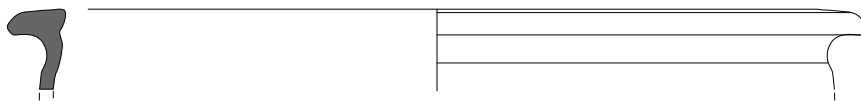

356

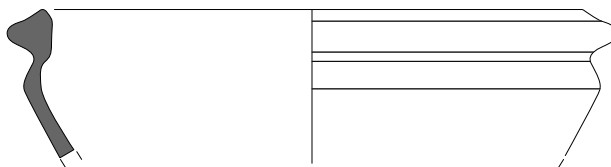

357

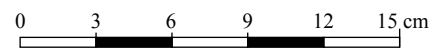

ANNEXE A
AMPHITHEATRE
Planche XXXIX

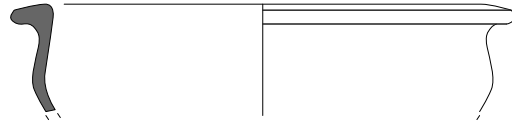

358

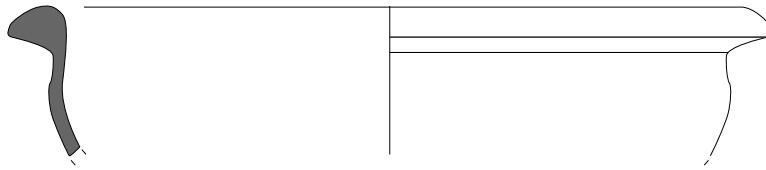

359

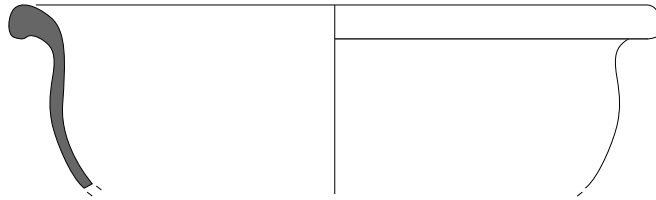

360

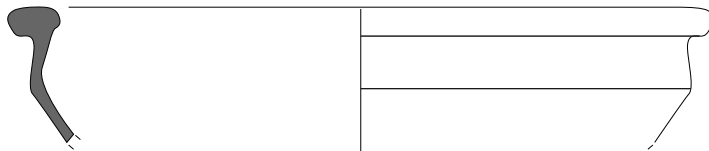

361

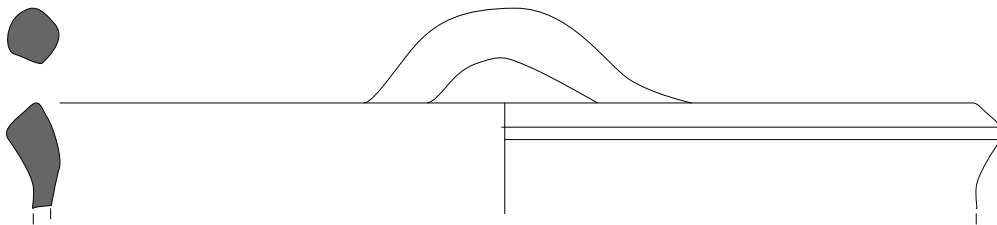

362

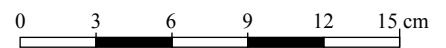

ANNEXE A
AMPHITHEATRE
Planche XL

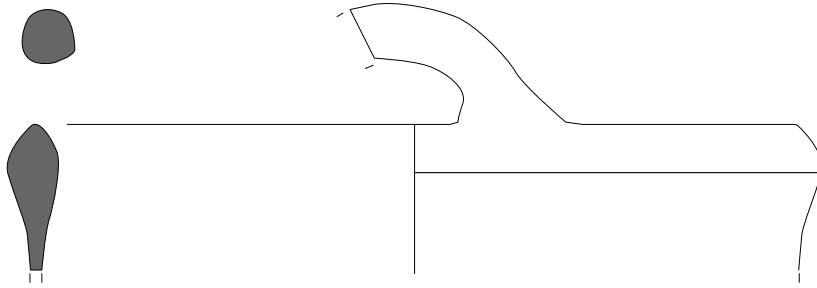

363

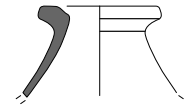

367

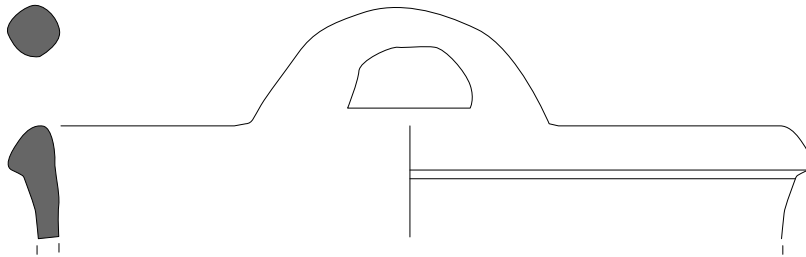

364

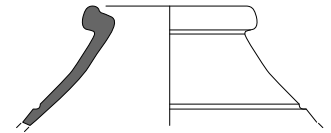

368

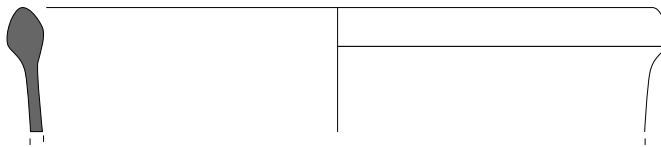

365

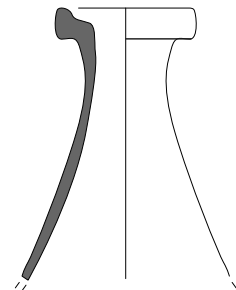

369

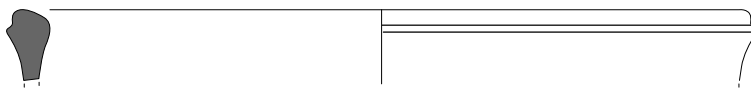

366

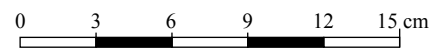

ANNEXE A
AMPHITHEATRE
Planche XLI

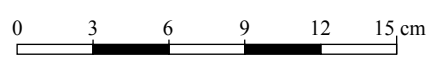
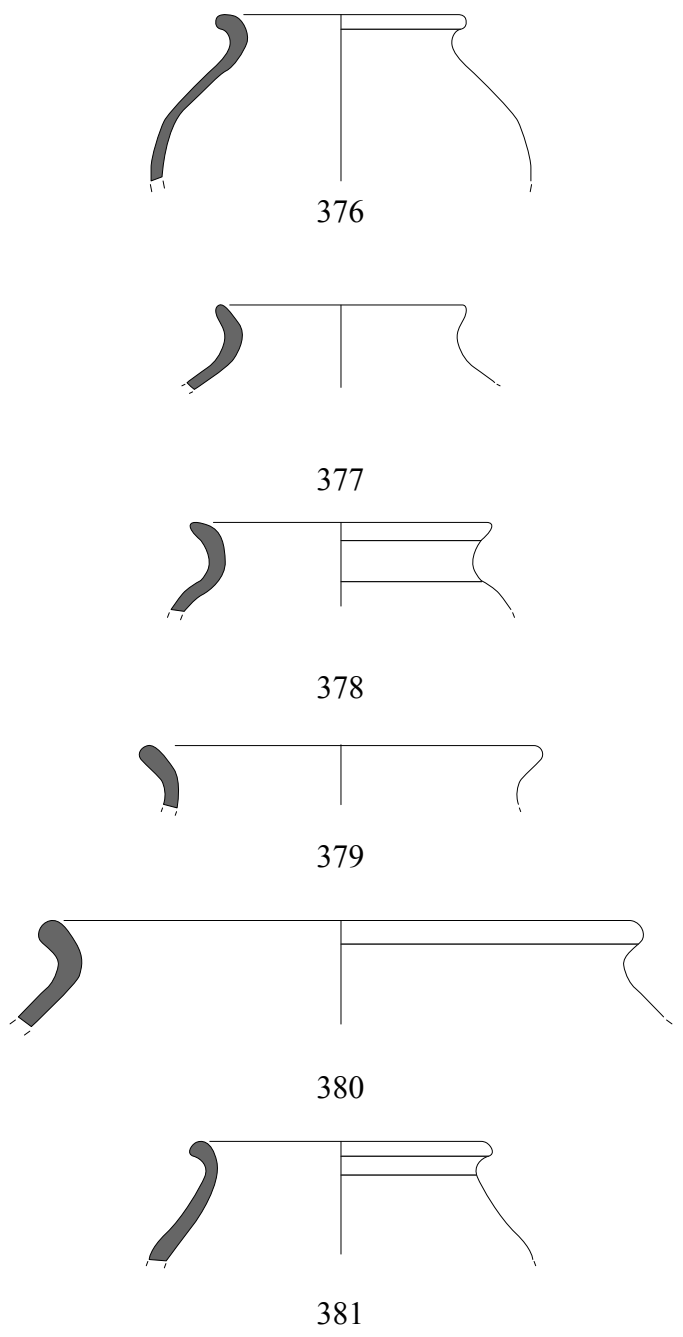
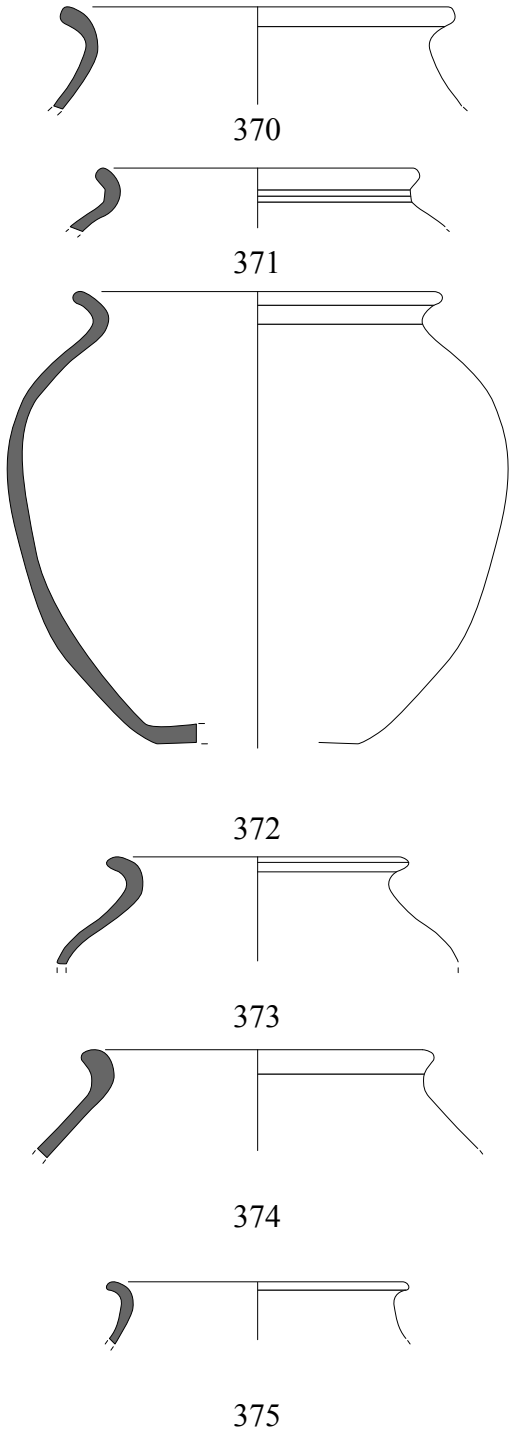

ANNEXE A
AMPHITHEATRE
Planche XLII

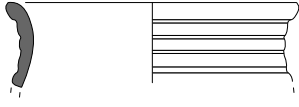

382



388

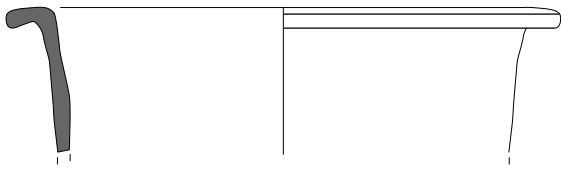

383

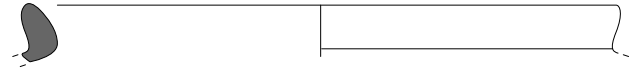

389

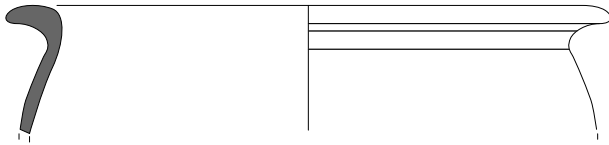

384

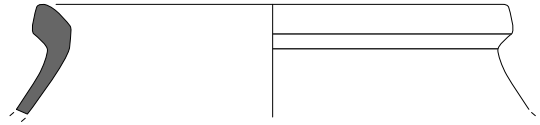

390

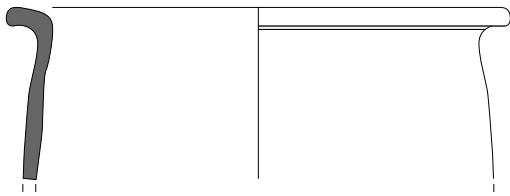

385

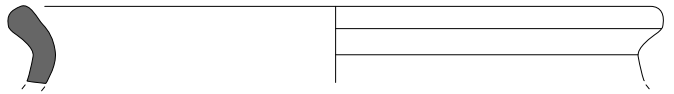

391

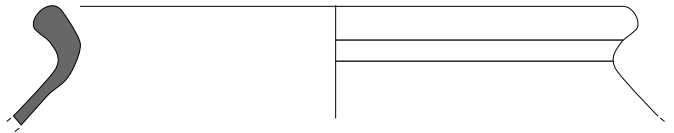

392

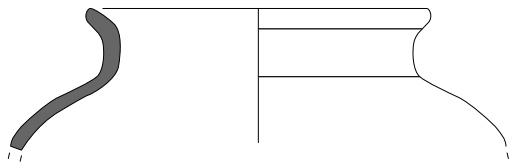

386

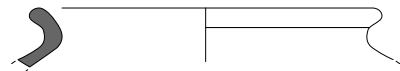

393

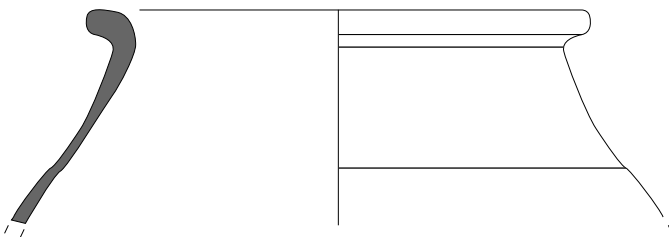

387

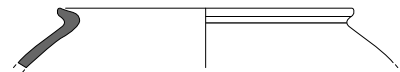

394

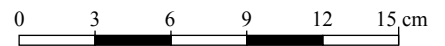

ANNEXE A
AMPHITHEATRE
Planche XLIII

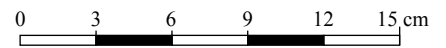
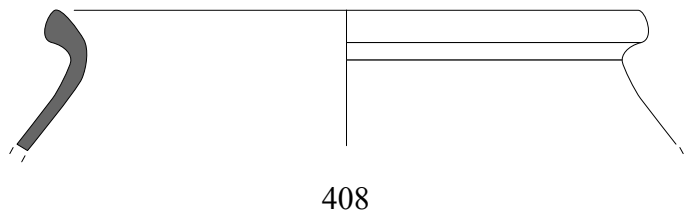
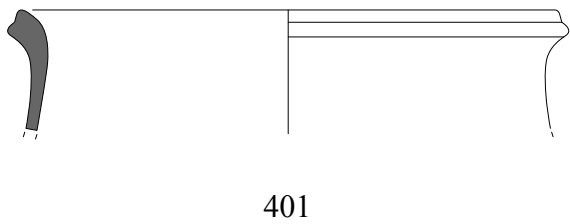
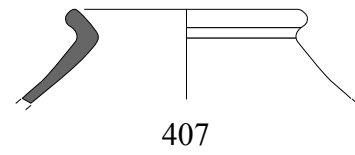
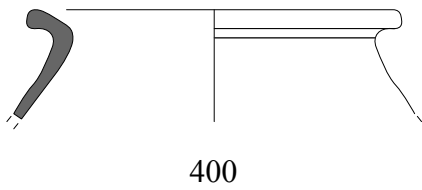
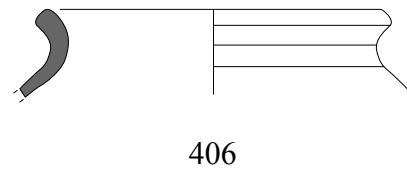
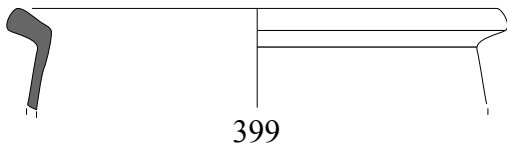
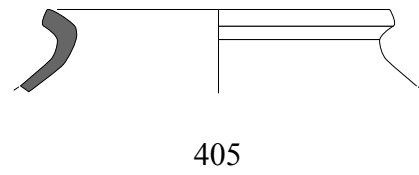
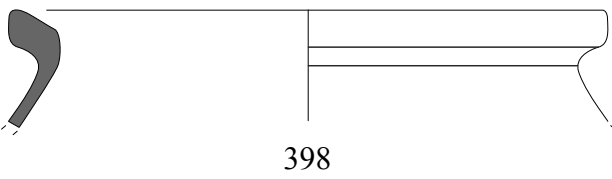
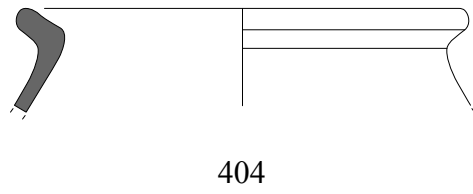
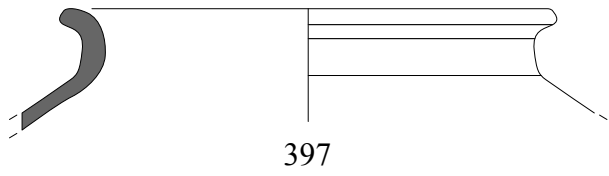
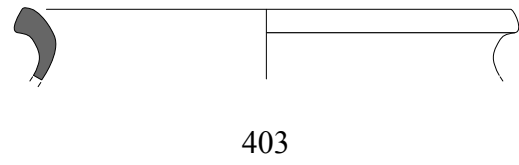
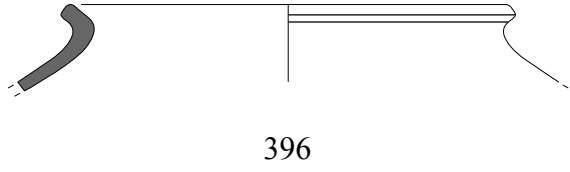
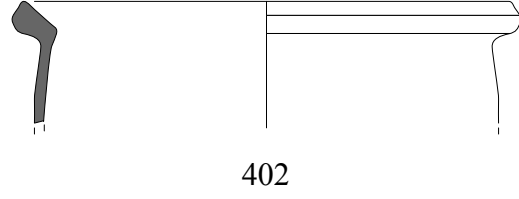
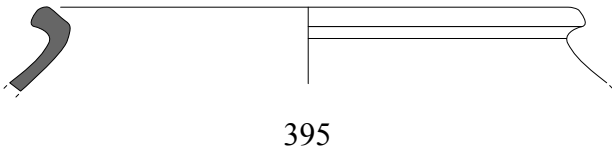

ANNEXE A
AMPHITHEATRE
Planche XLIV

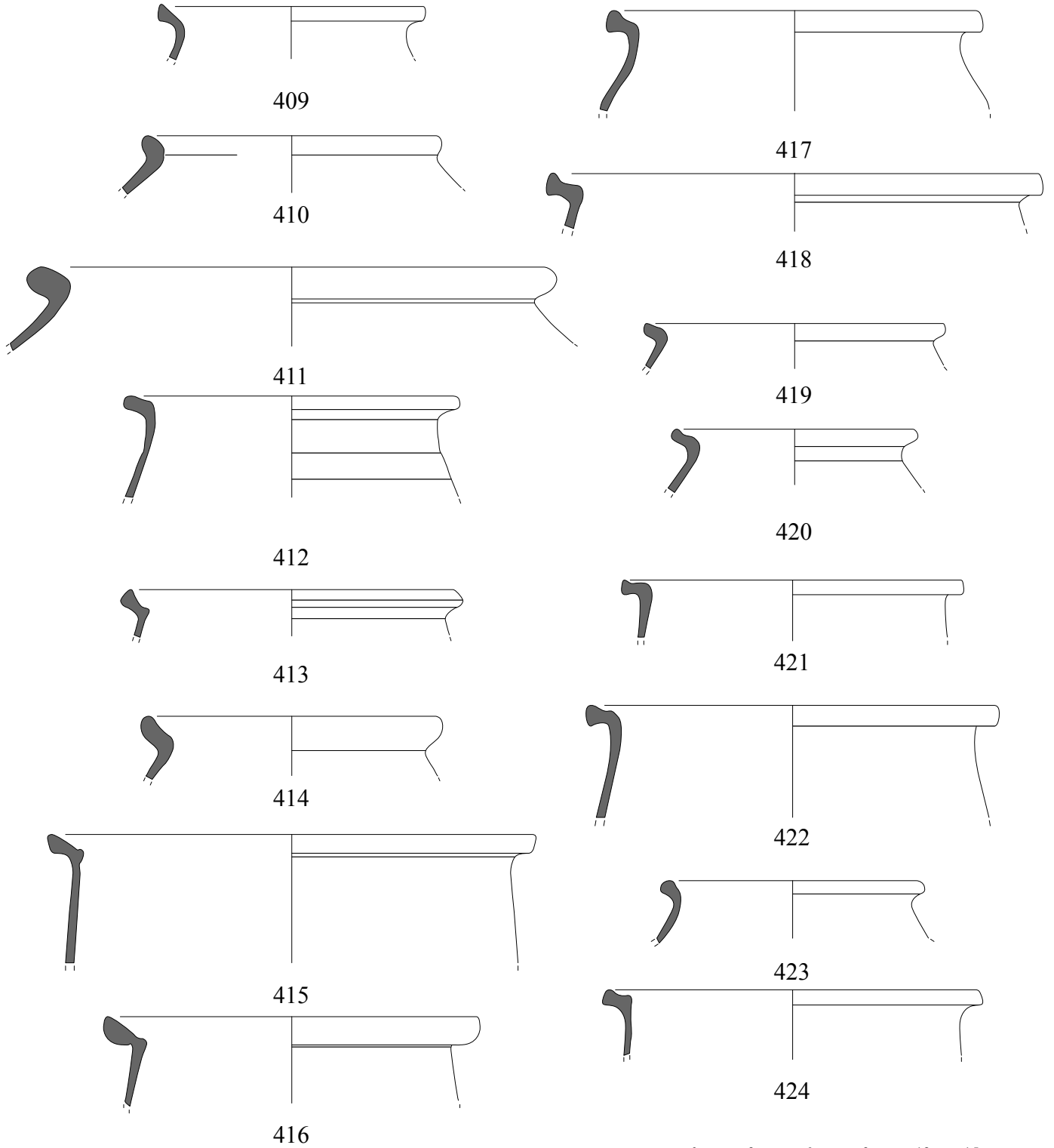

ANNEXE A
AMPHITHEATRE
Planche XLV

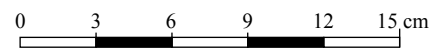
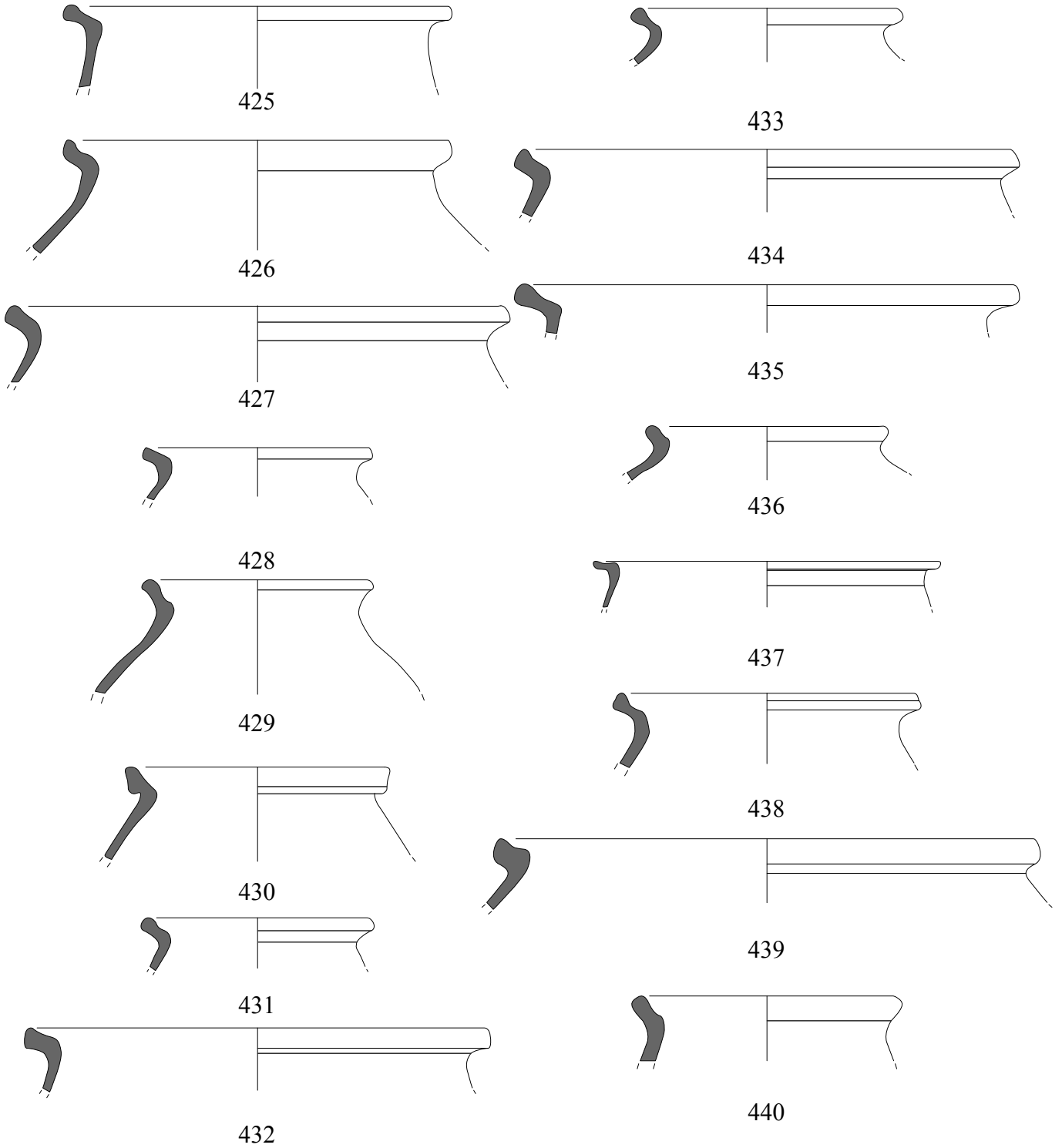

ANNEXE A
AMPHITHEATRE
Planche XLVI

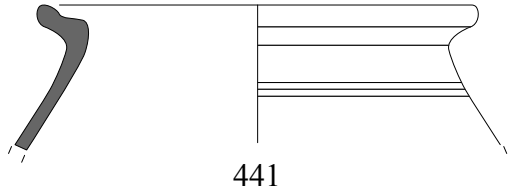

441

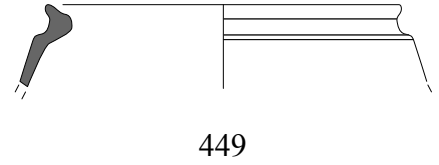

449

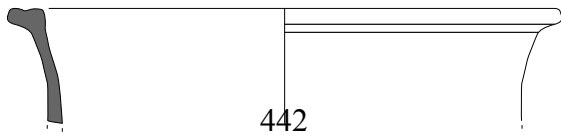

442



450

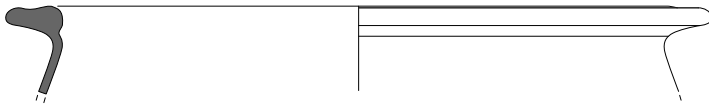

443

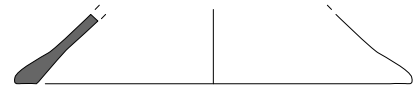

451

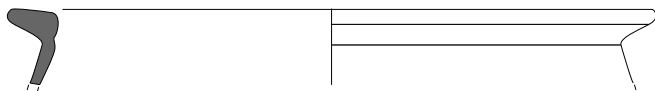

444



452

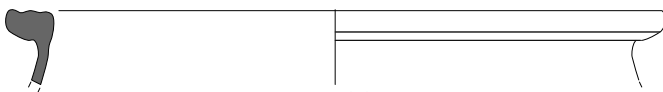

445



453

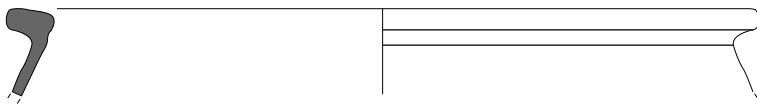

446

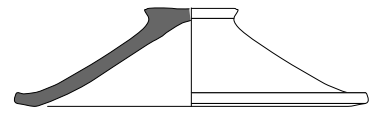

454

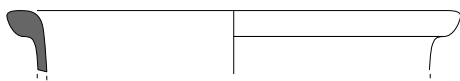

447

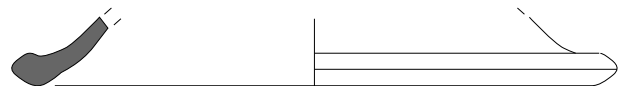

455

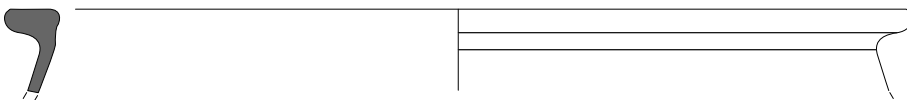

448



456

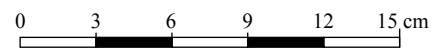

ANNEXE A
 AMPHITHEATRE
 Planche XLVII

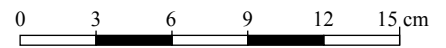
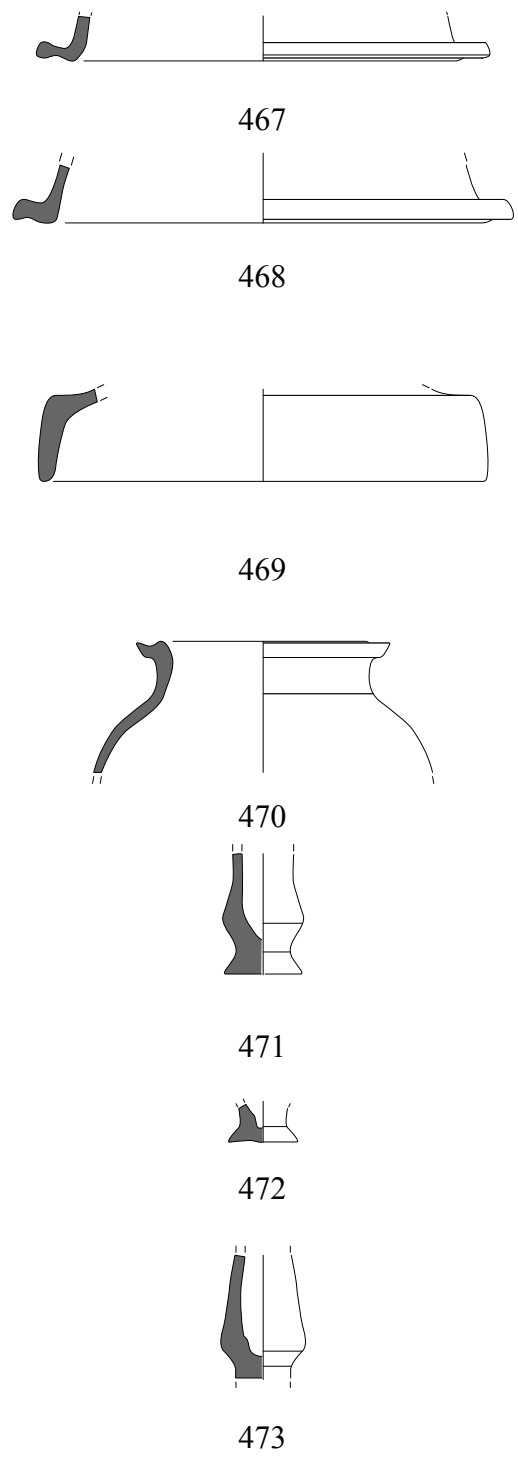
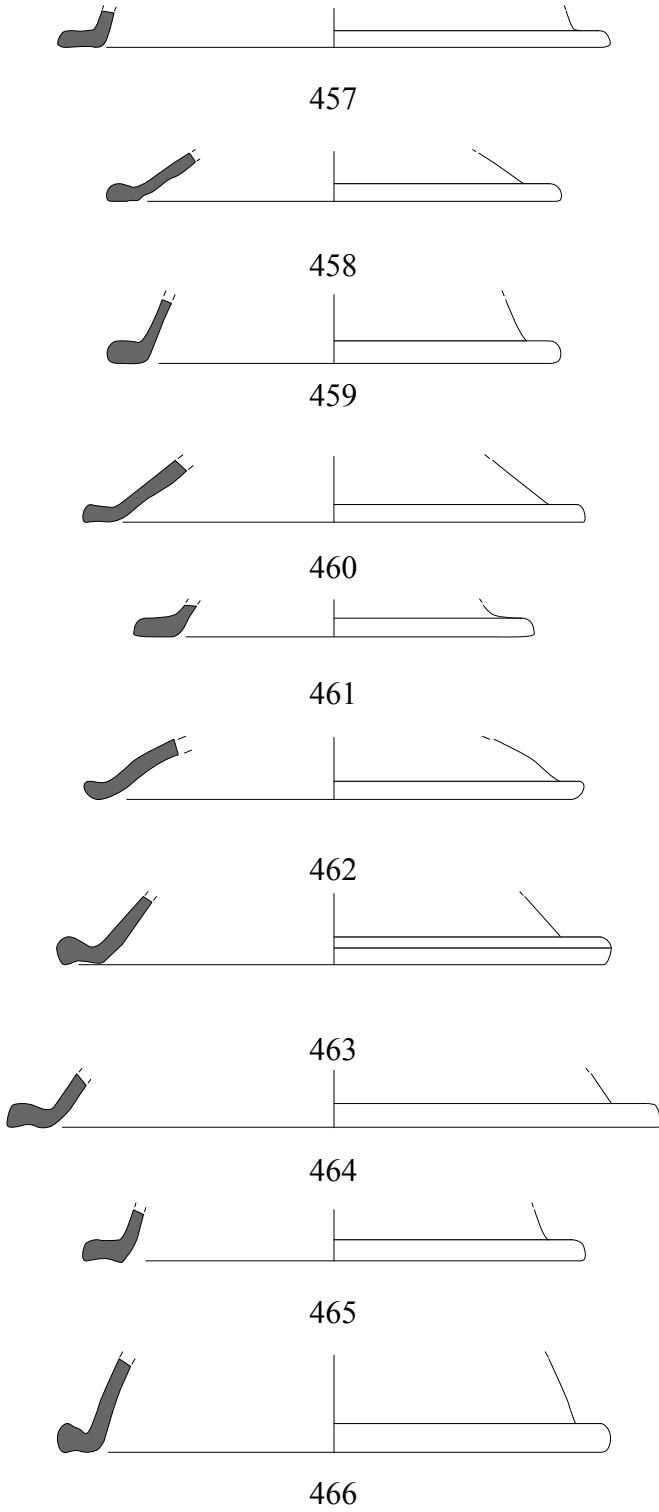

ANNEXE A
AMPHITHEATRE
Planche XLVIII

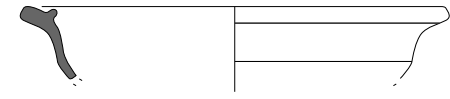

474

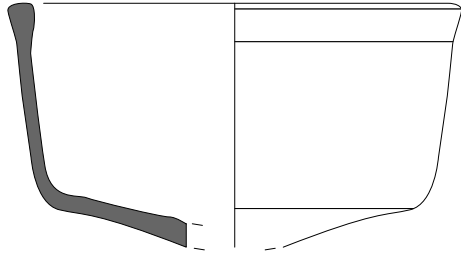

475

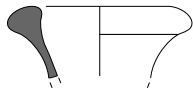

476

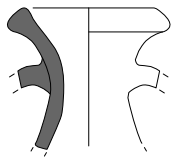

477

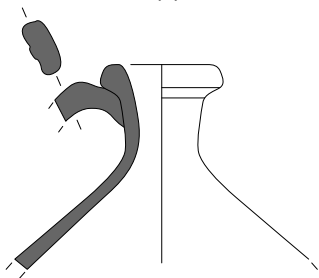

478



479



480

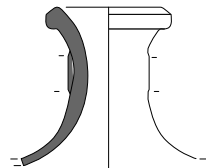

481

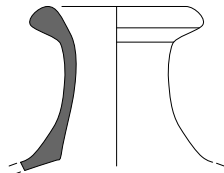

482

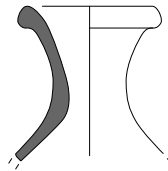

483

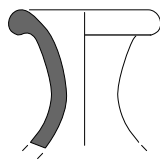

484

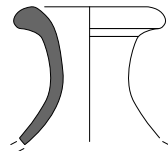

485

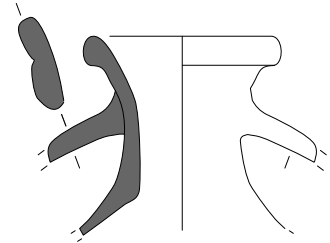

486

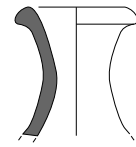

487

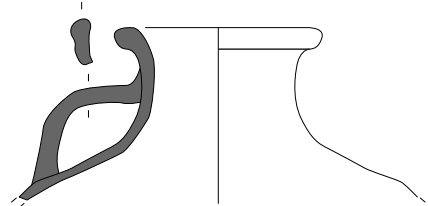

488

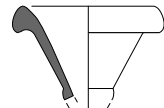

489

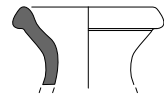

490

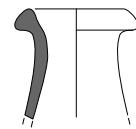

491

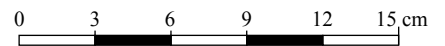

ANNEXE A
 AMPHITHEATRE
 Planche XLIX

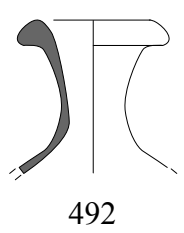

492

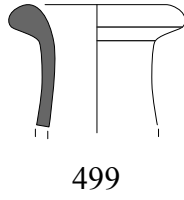

499

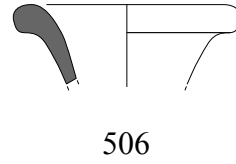

506

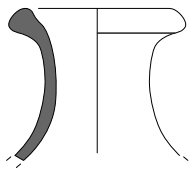

493

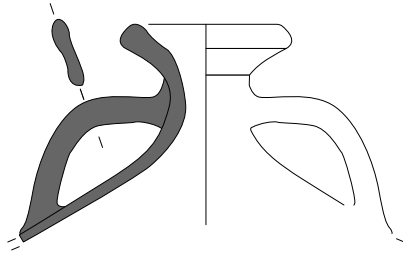

500

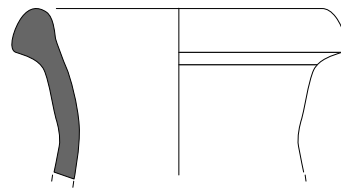

507

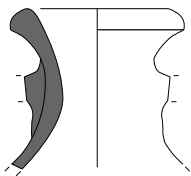

494

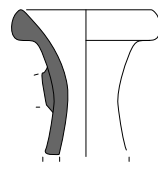

501



508



509

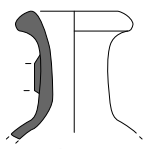

495



502

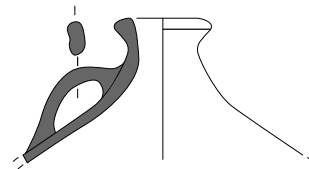

510

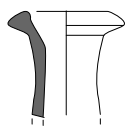

496

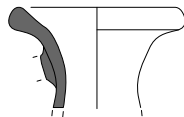

503

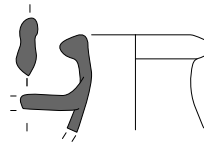

511

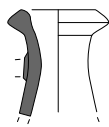

497

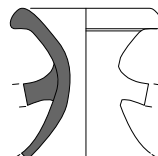

504



512

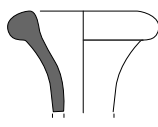

498

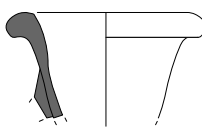

505

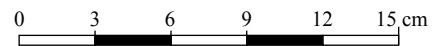

ANNEXE A
 AMPHITHEATRE

Planche LI

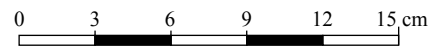
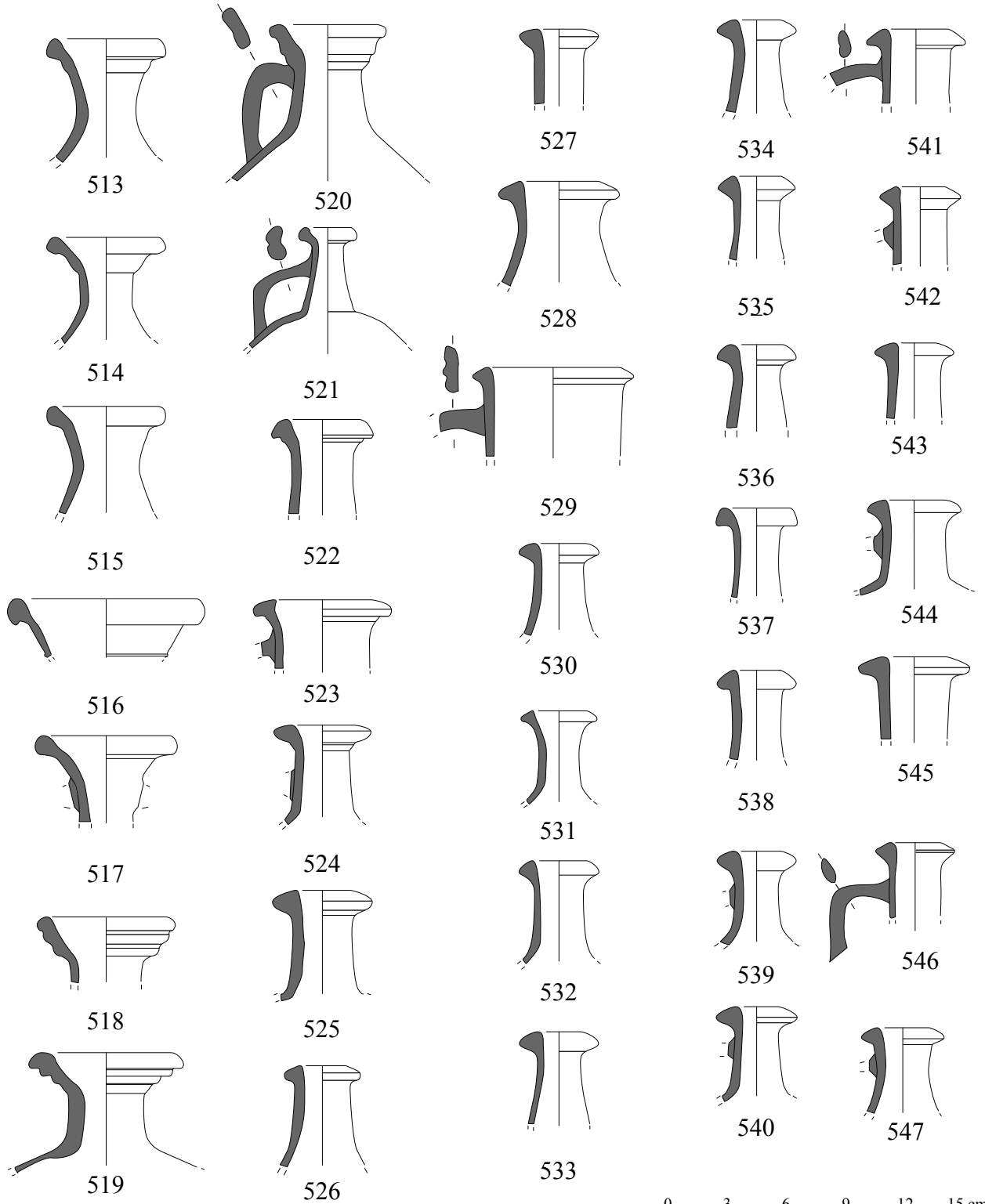

ANNEXE A
AMPHITHEATRE
Planche LII

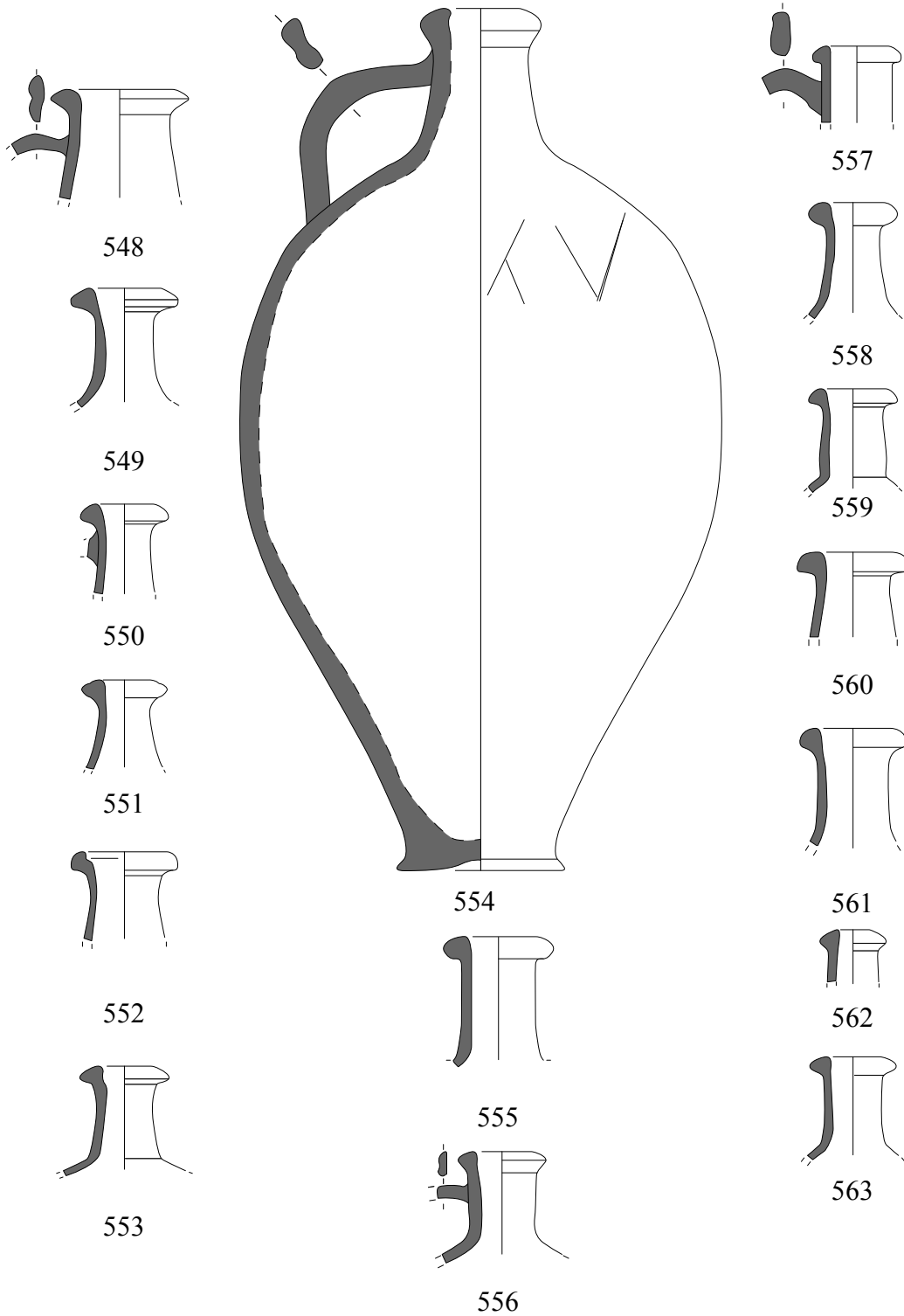

0 3 6 9 12 15 cm

ANNEXE A
 AMPHITHEATRE
 Planche LII

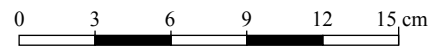
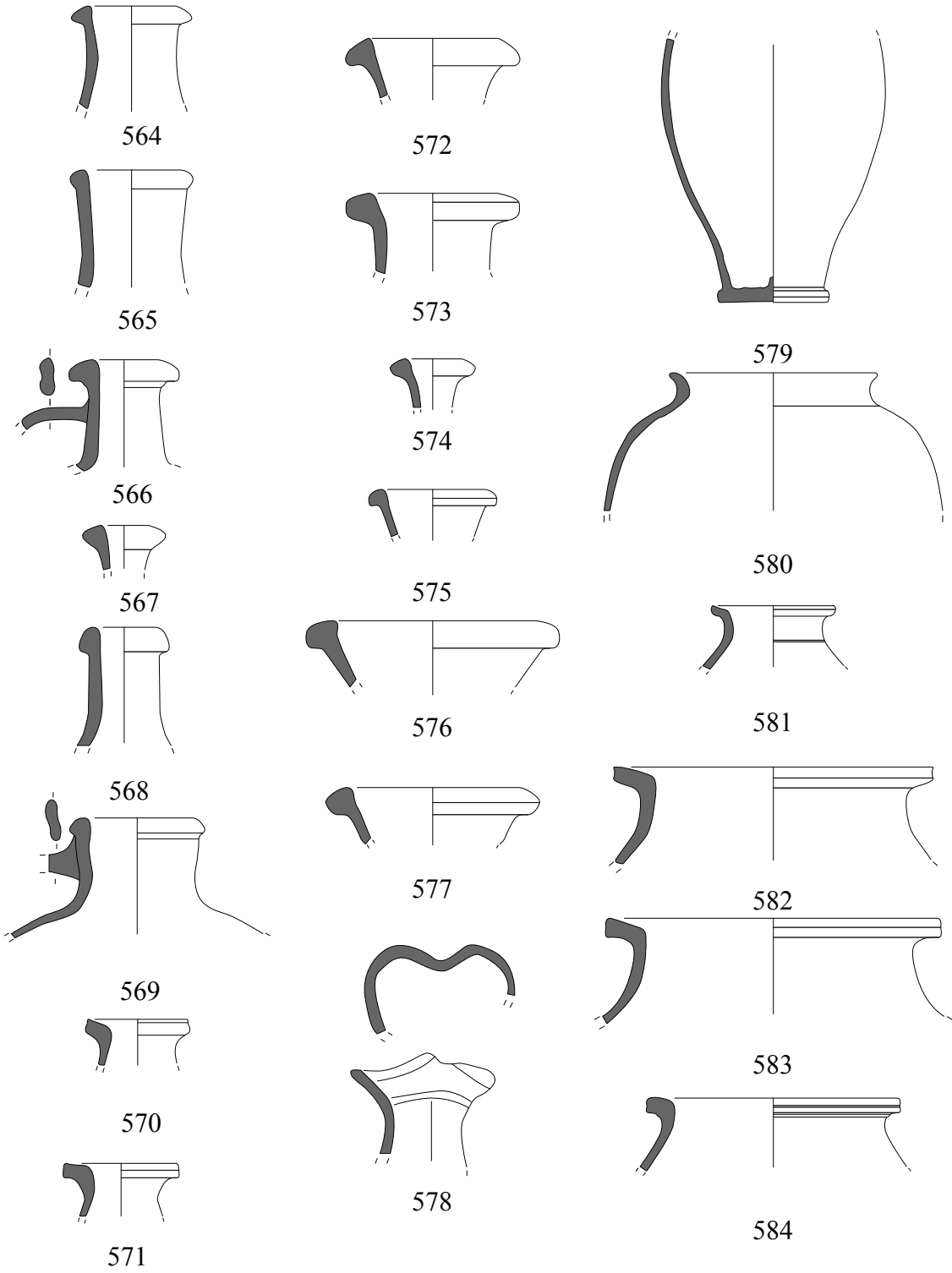

ANNEXE A
AMPHITHEATRE
Planche LIII

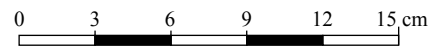
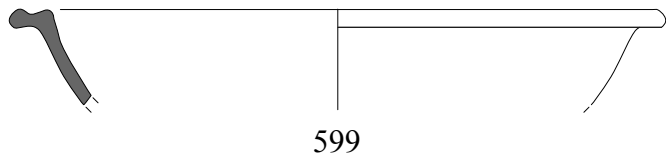
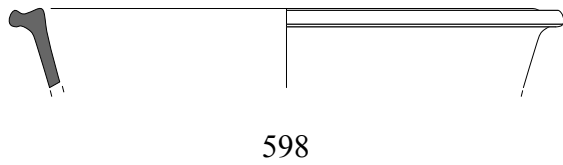
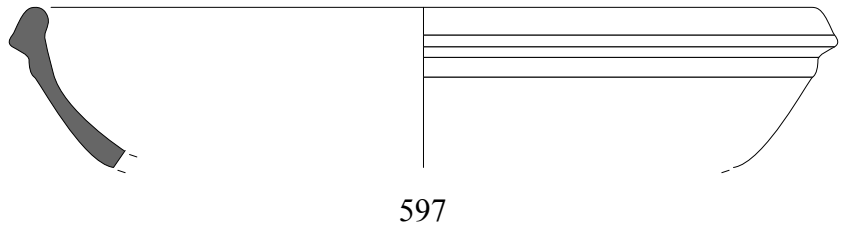
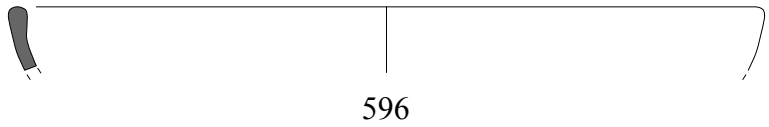
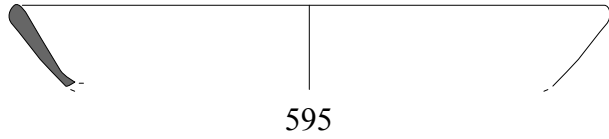
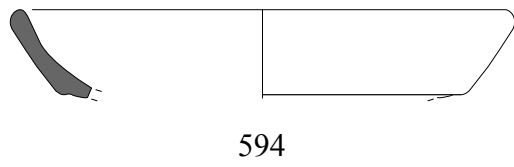
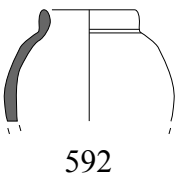
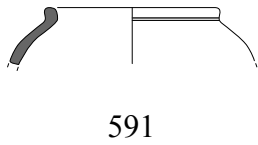
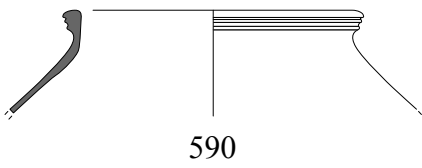
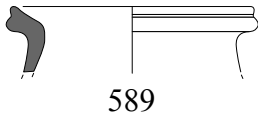
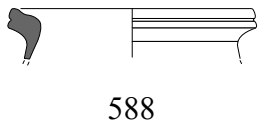
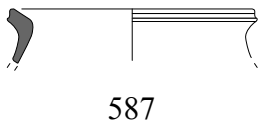
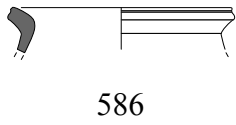
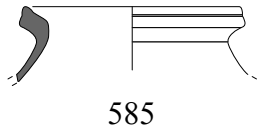
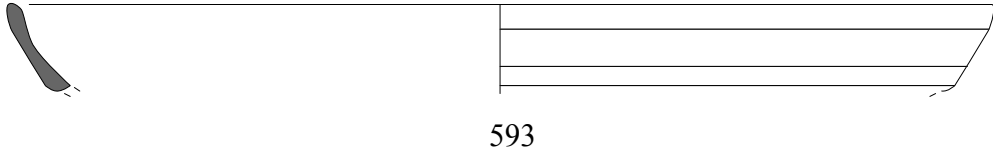

ANNEXE A
AMPHITHEATRE
Planche LIV

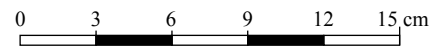
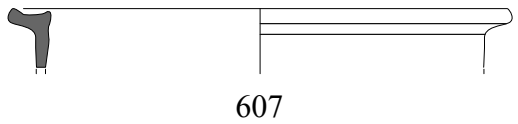
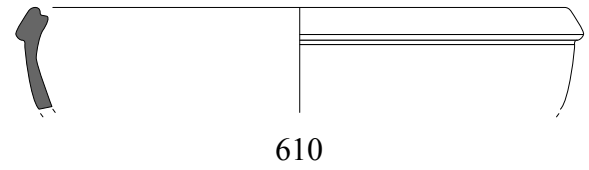
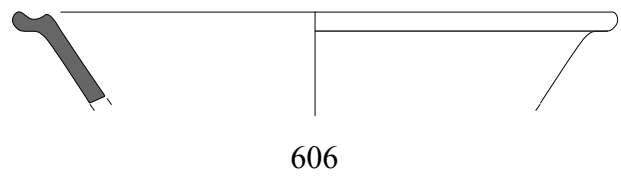
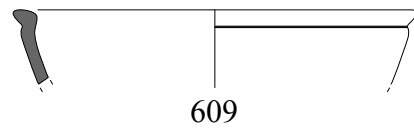
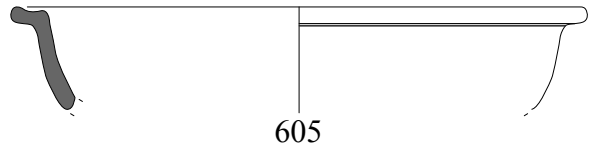
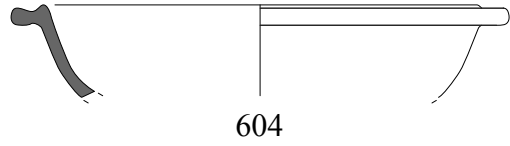
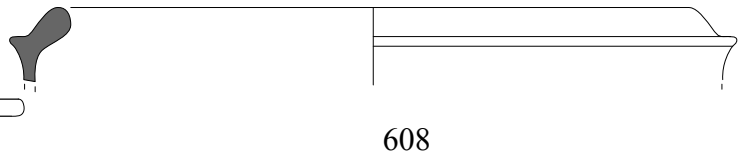
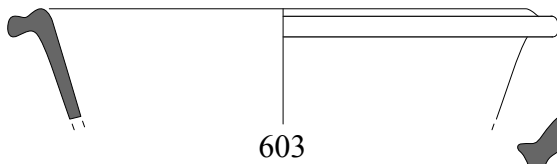
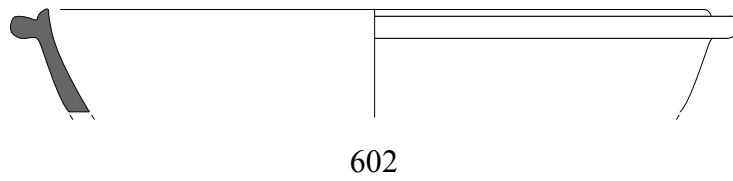
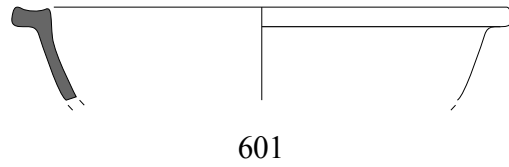
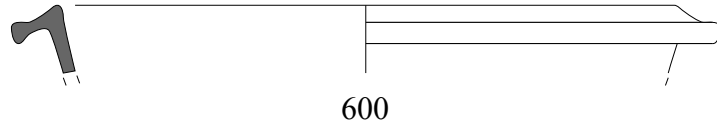

ANNEXE A
 AMPHITHEATRE
 Planche LV

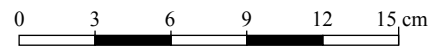
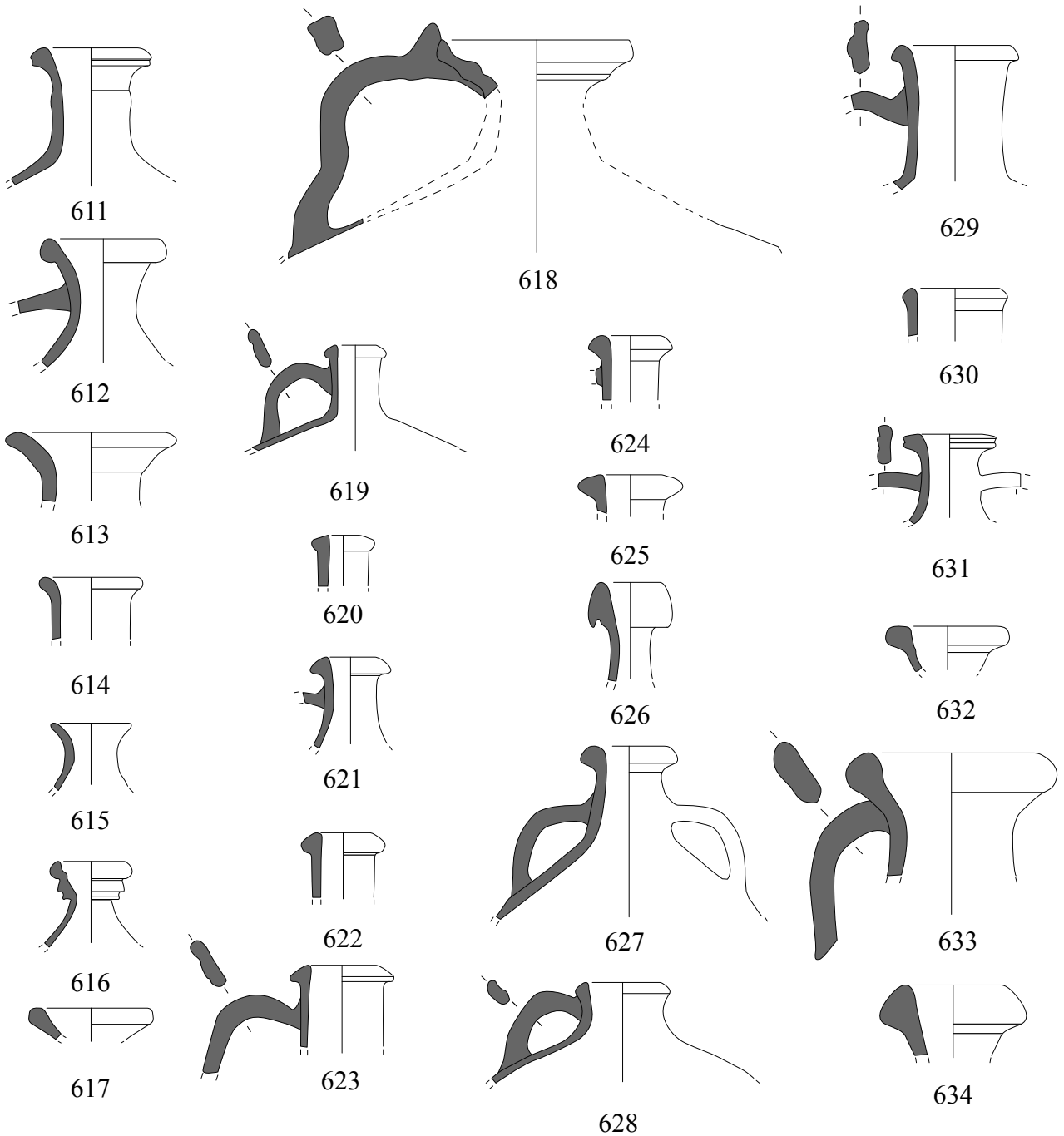

ANNEXE A
 AMPHITHEATRE
 Planche LVI

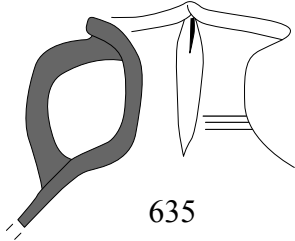
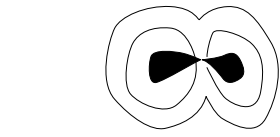

635

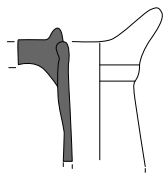

636

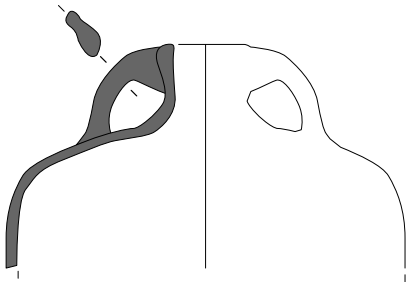

637

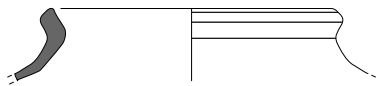

638

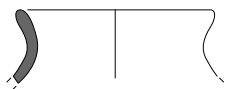

639

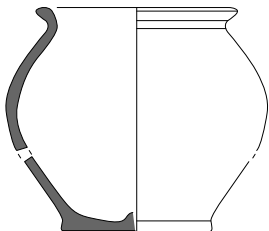

640

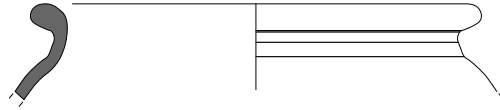

641



642

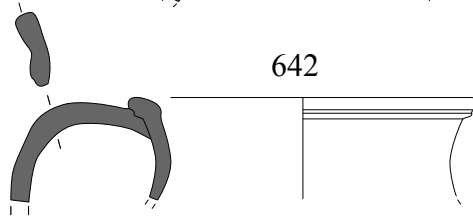

643

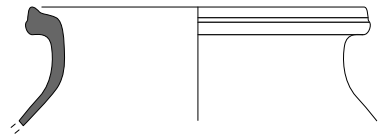

644



645



646

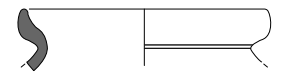

647



648

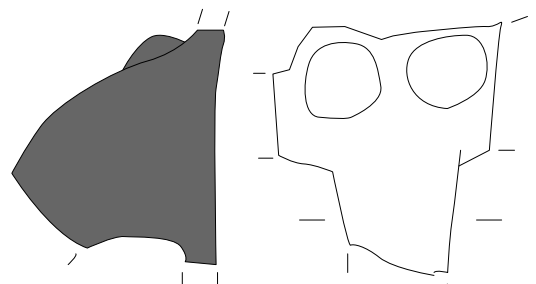

649

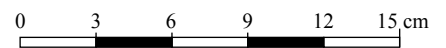
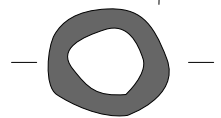

ANNEXE A
AMPHITHEATRE
Planche LVII

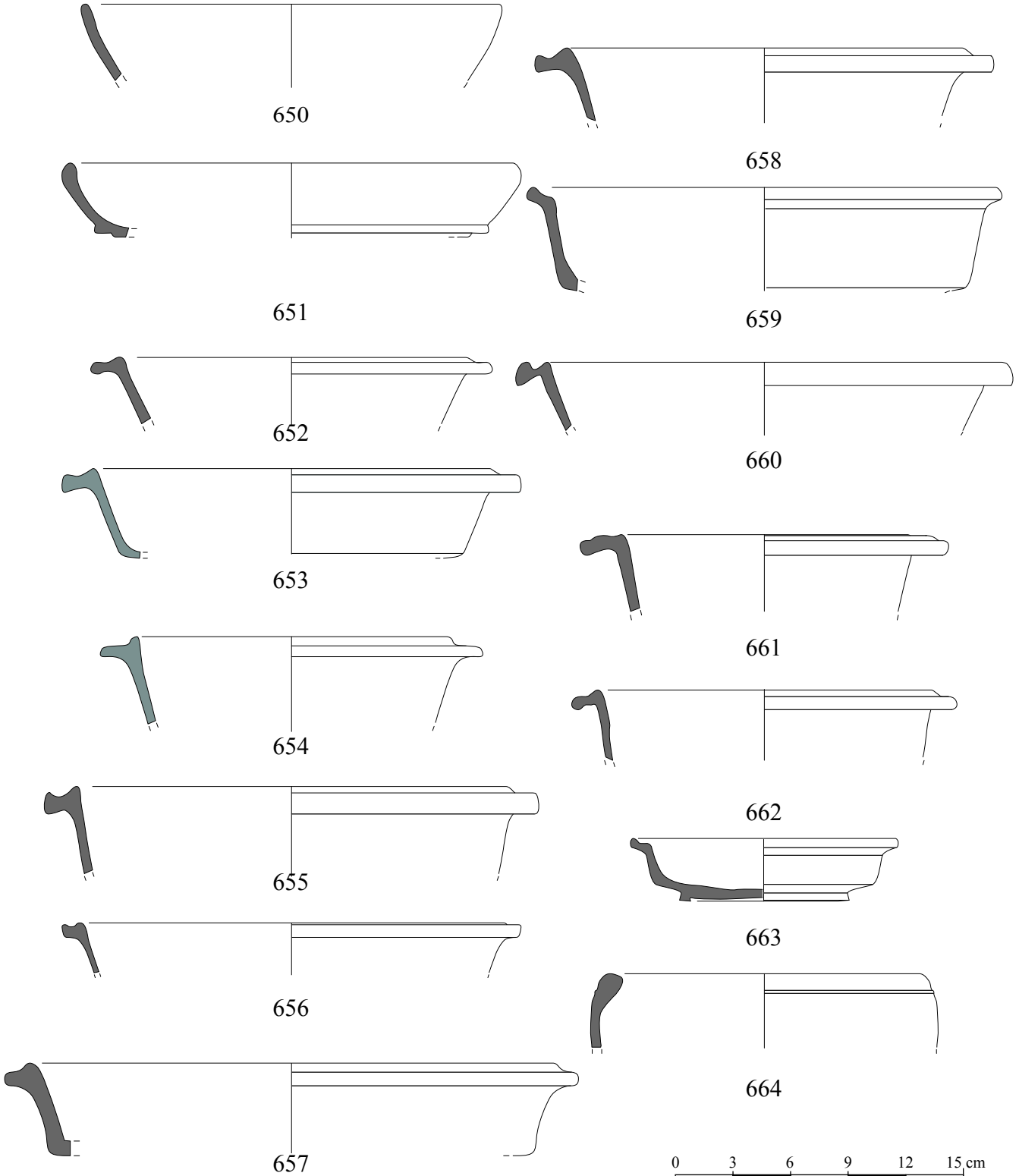

ANNEXE A
AMPHITHEATRE
Planche LVIII

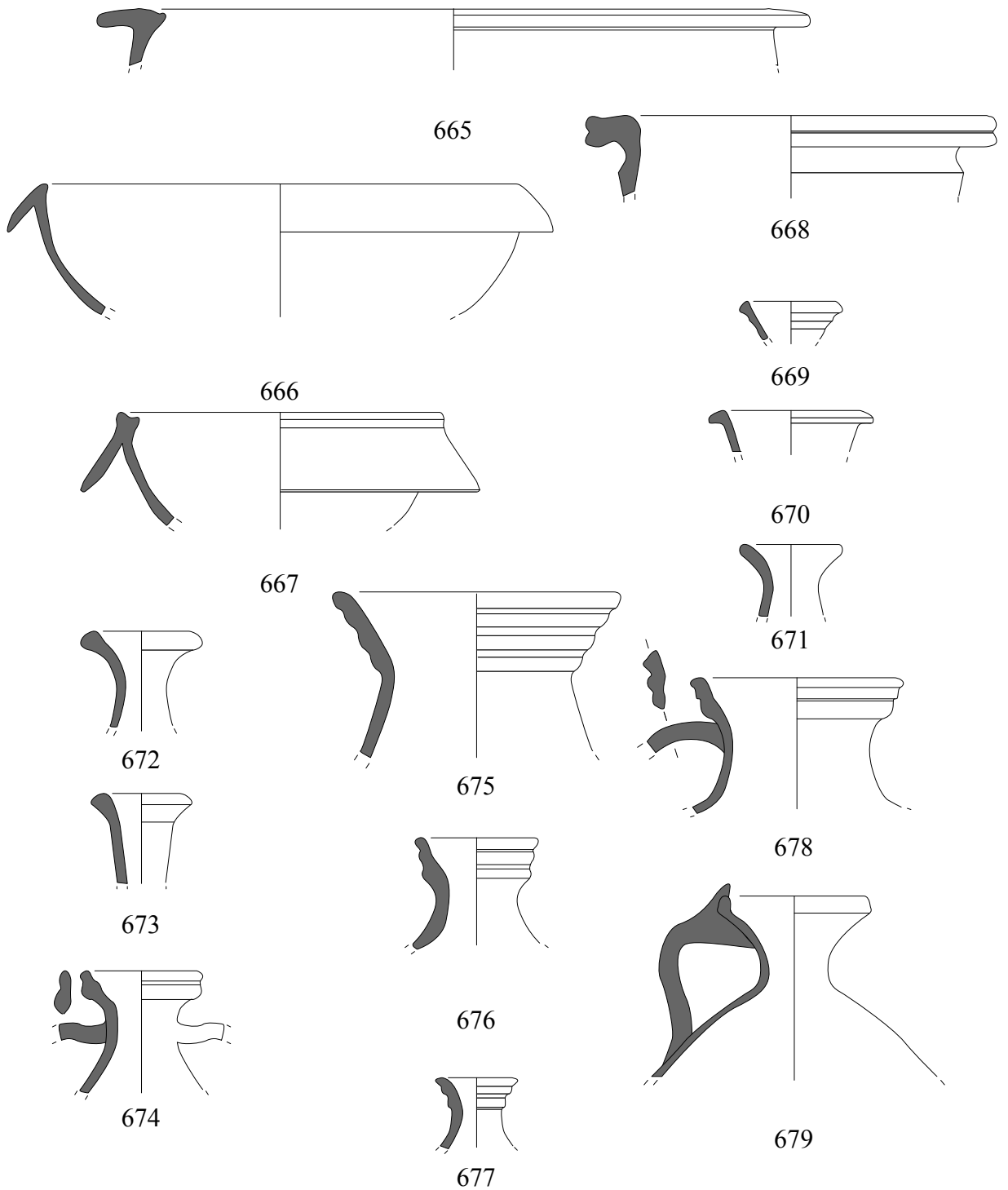

0 3 6 9 12 15 cm

ANNEXE A
AMPHITHEATRE
Planche LIX

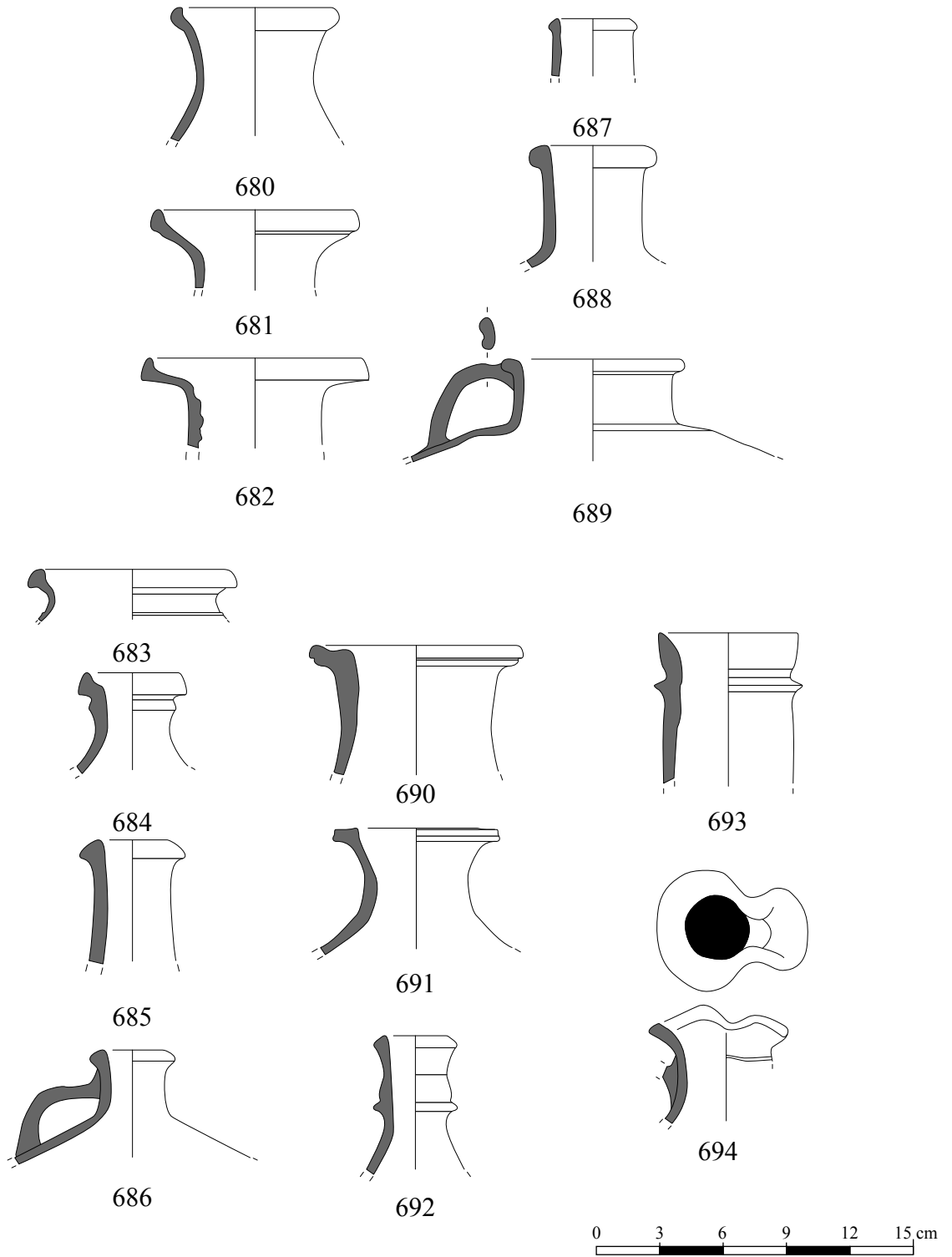

ANNEXE A
AMPHITHEATRE
Planche LX

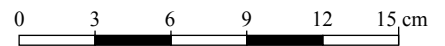
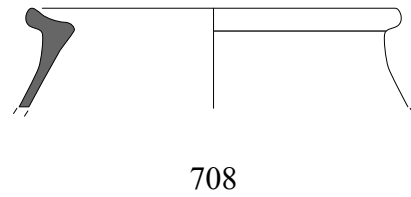
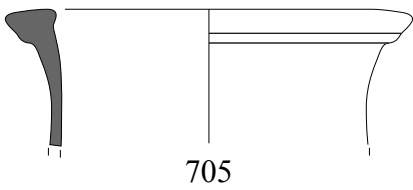
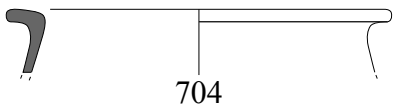
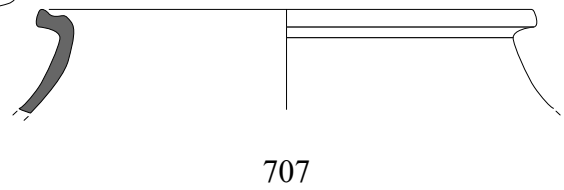
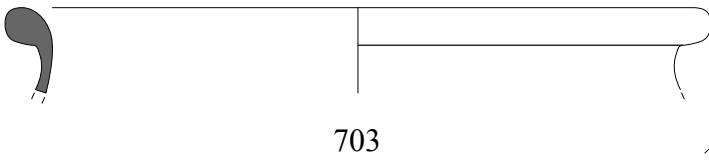
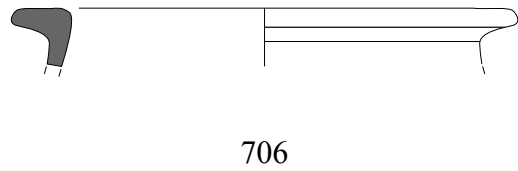
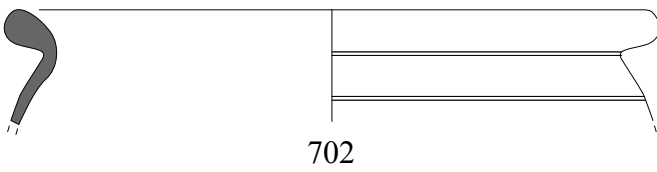
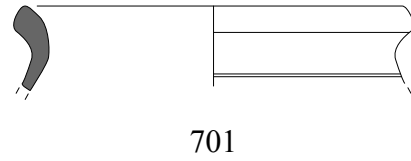
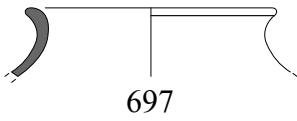
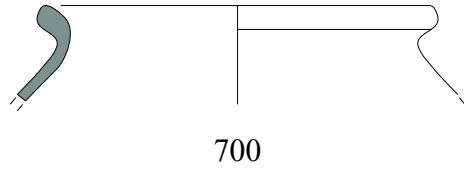
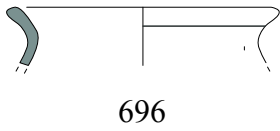
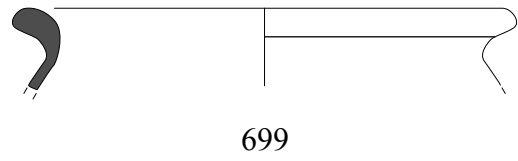
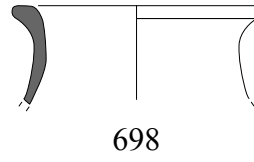
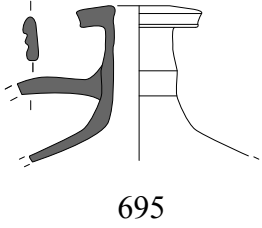

ANNEXE A
AMPHITHEATRE
Planche LXI

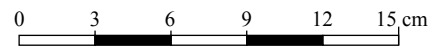
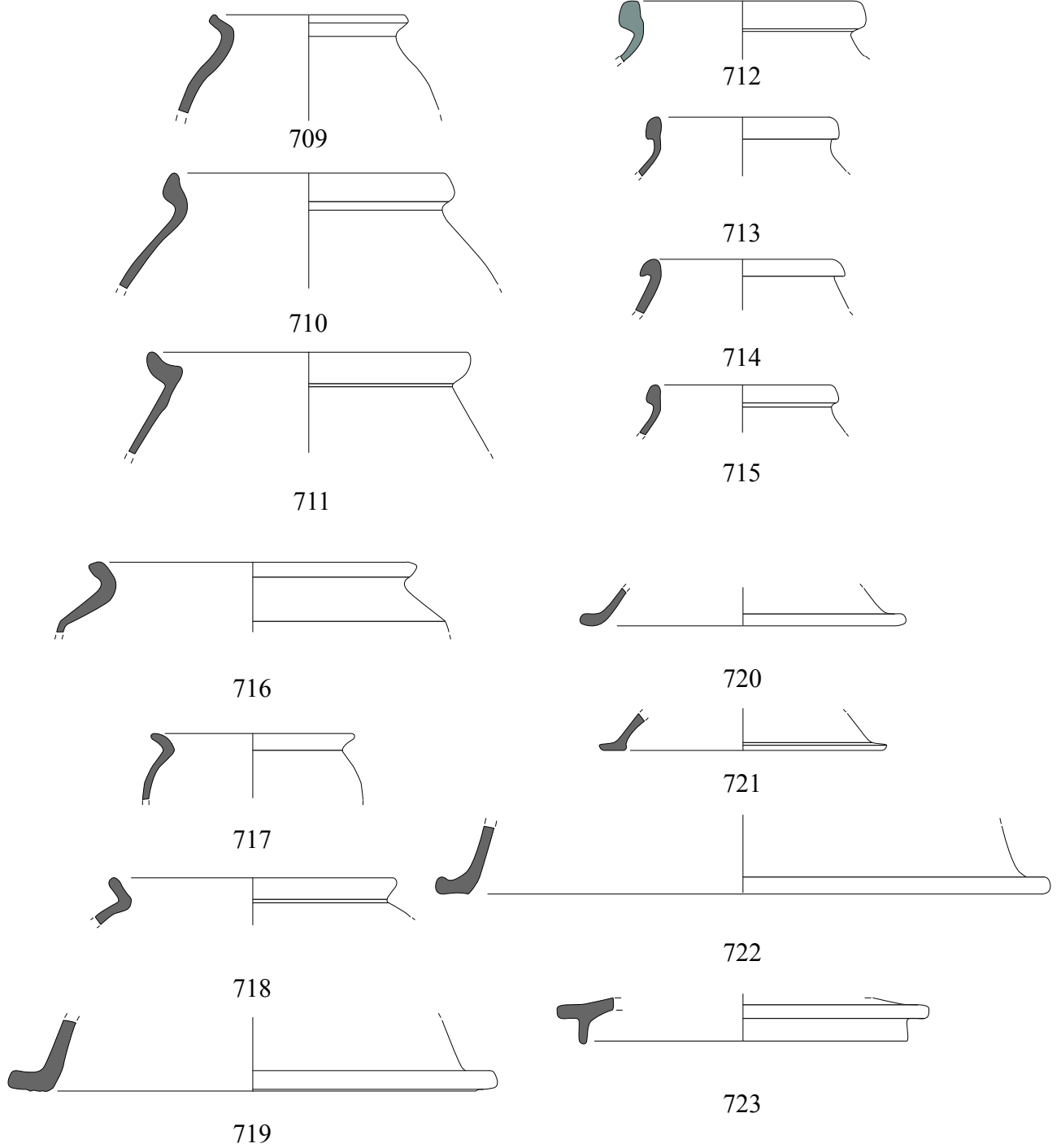

ANNEXE A
AMPHITHEATRE
Planche LXII

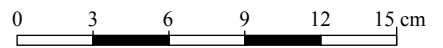
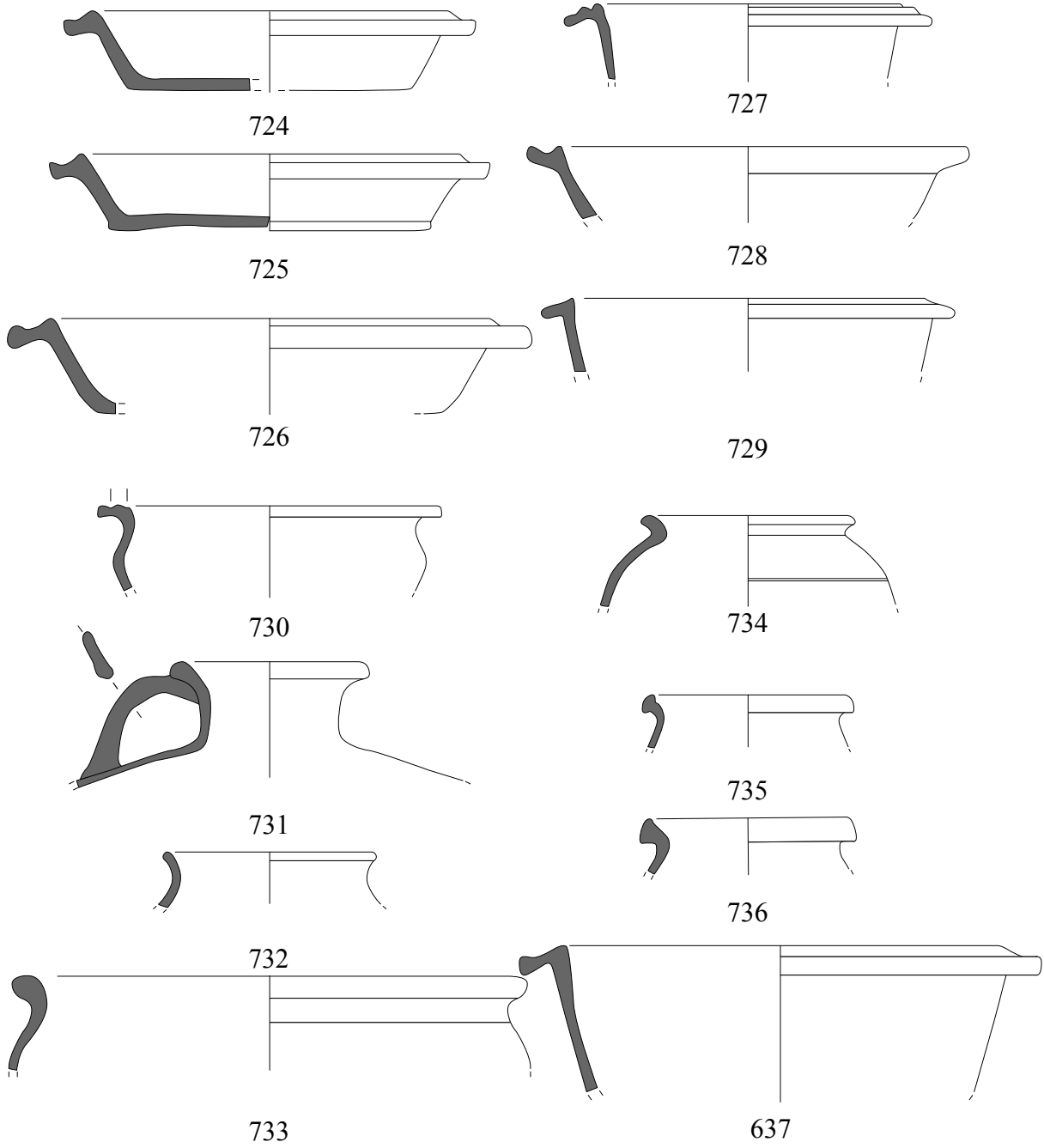

ANNEXE A
AMPHITHEATRE
Planche LXIII

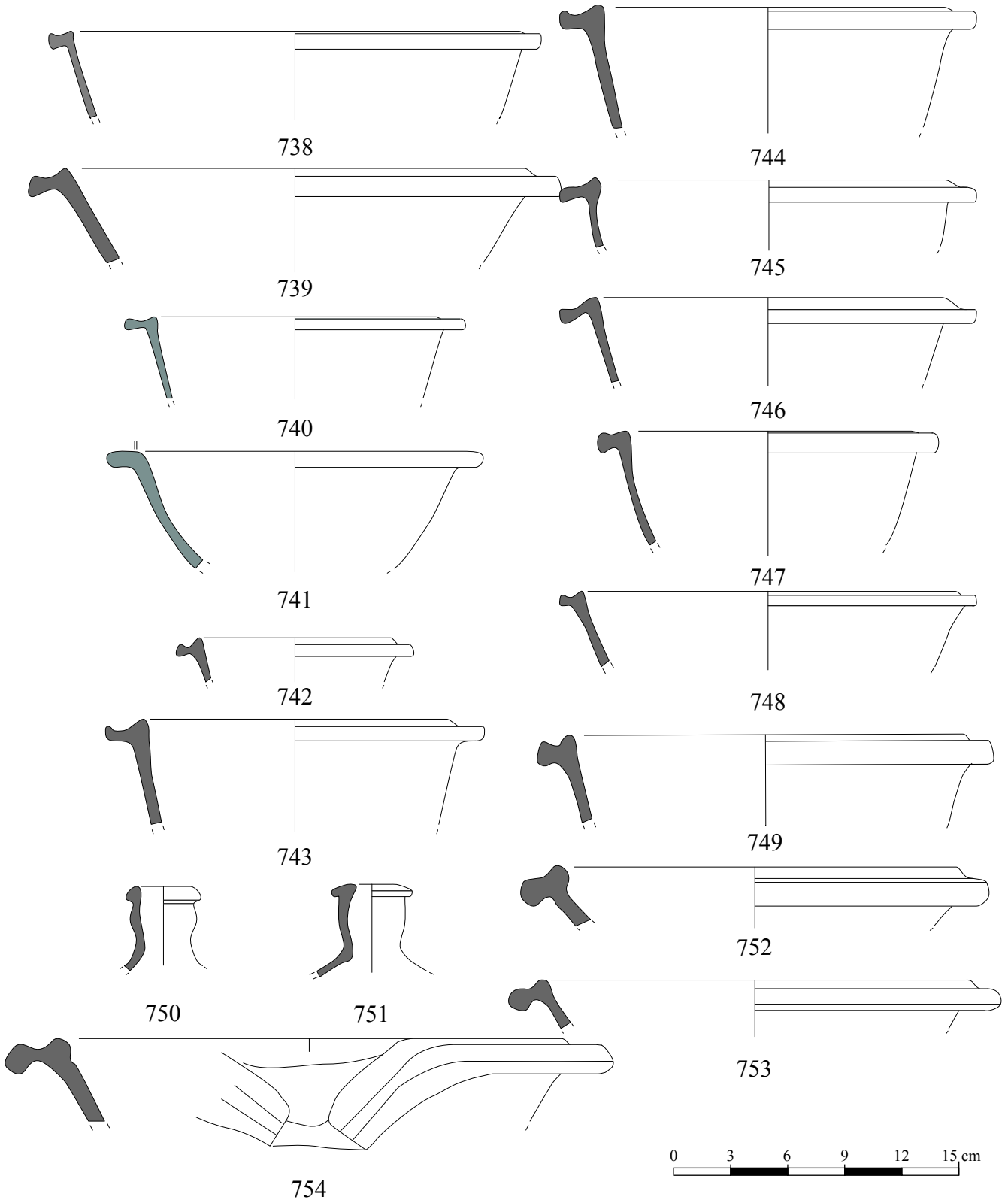

ANNEXE A
AMPHITHEATRE
Planche LXIV



755

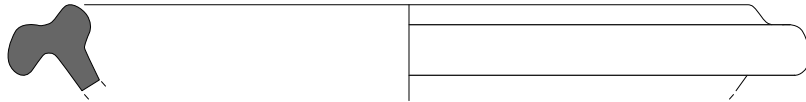

756

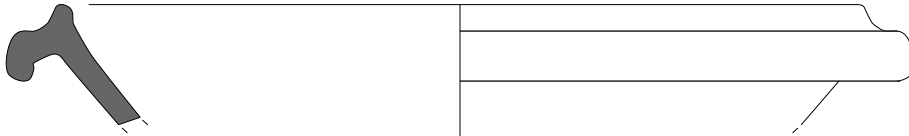

757

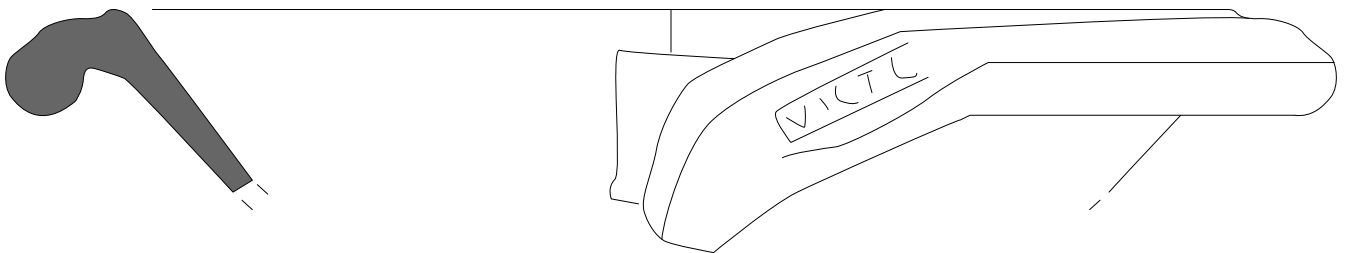

758

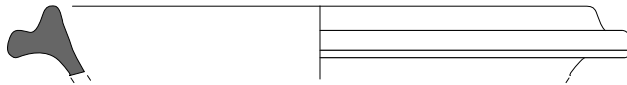

759

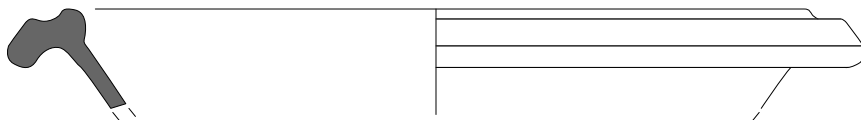

760

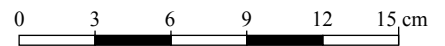

ANNEXE A
AMPHITHEATRE
Planche LXV

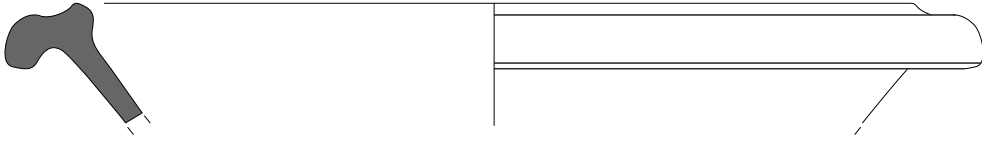

761

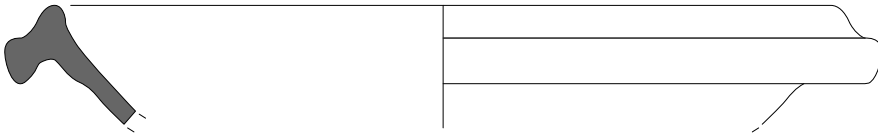

762

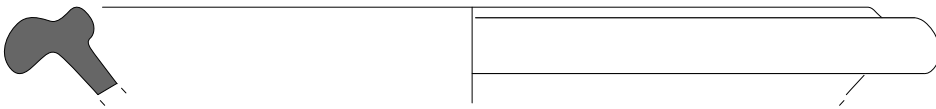

763

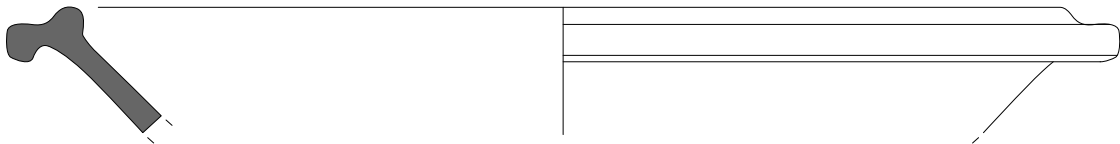

764

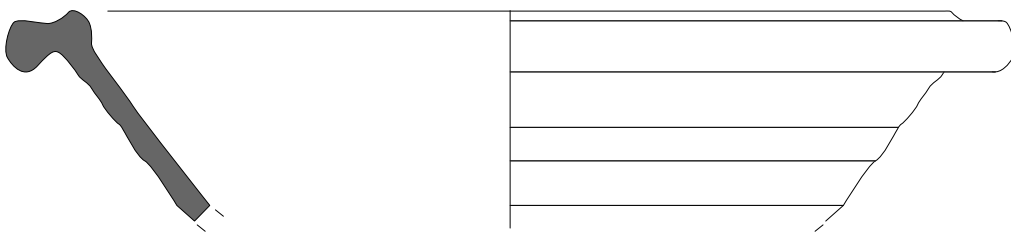

765

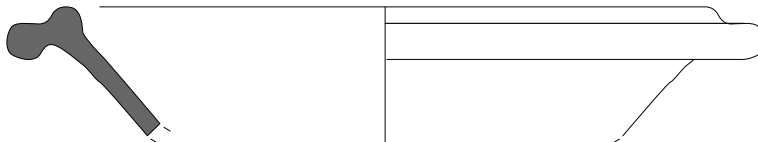

766

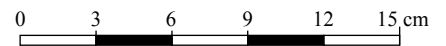

ANNEXE A
AMPHITHEATRE
Planche LXVI

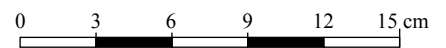
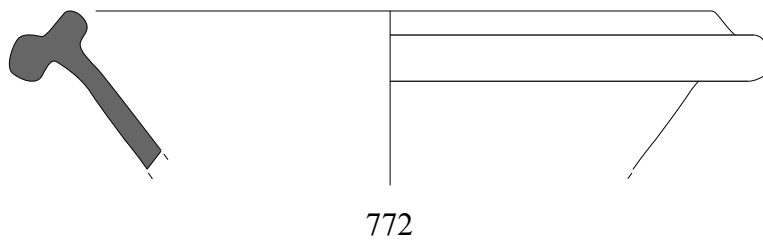
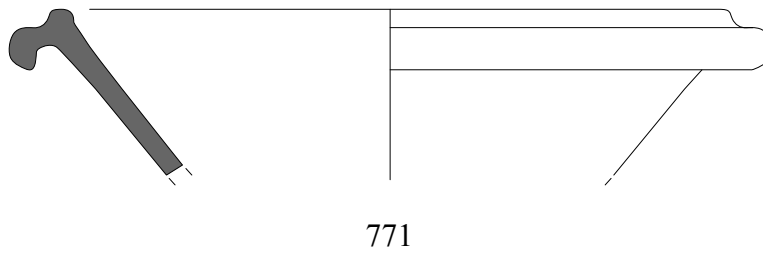
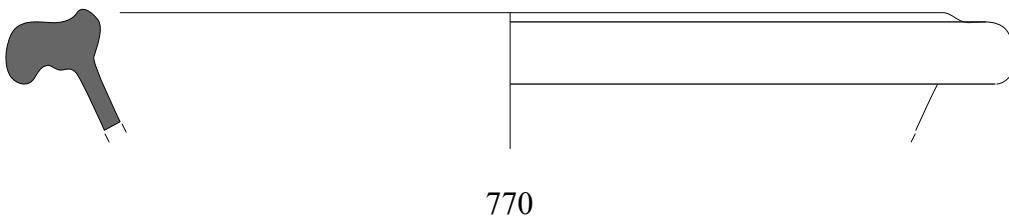
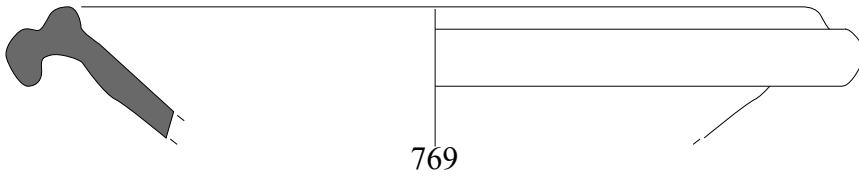
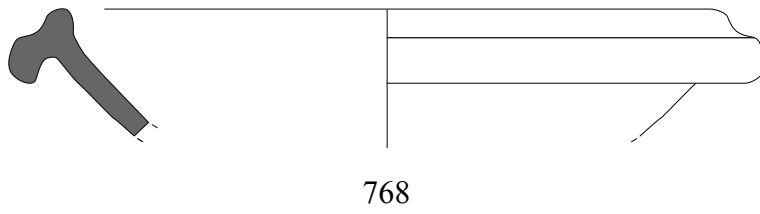
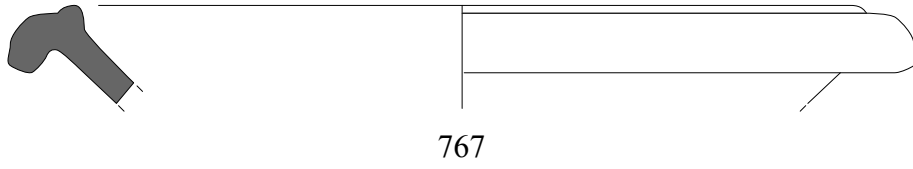

ANNEXE A
AMPHITHEATRE
Planche LXVII

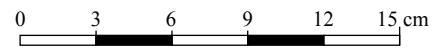
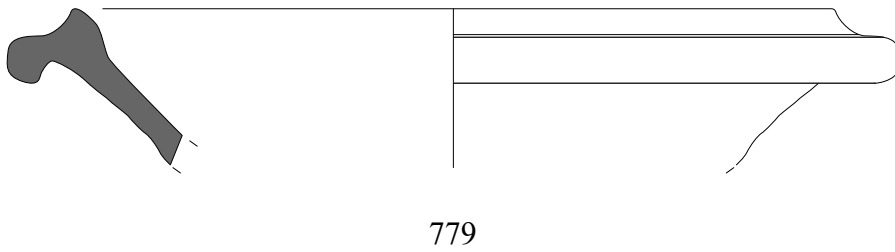
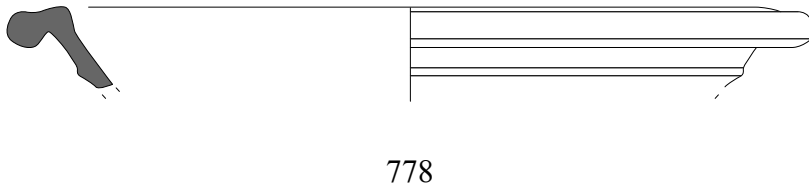
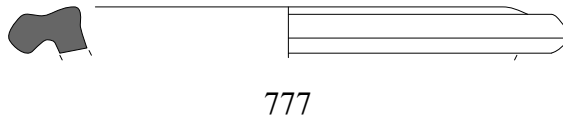
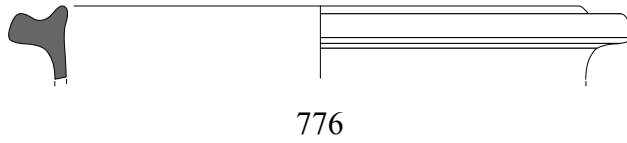
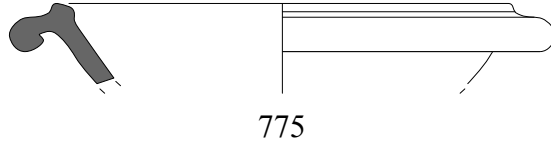
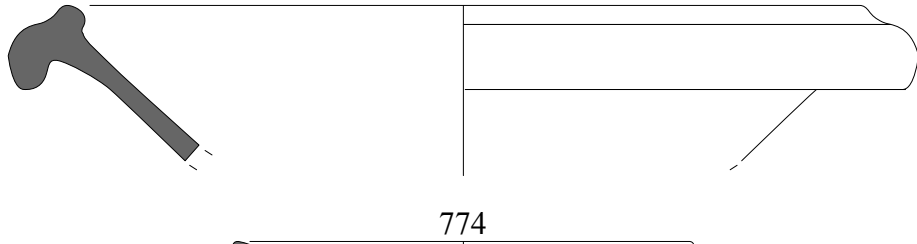
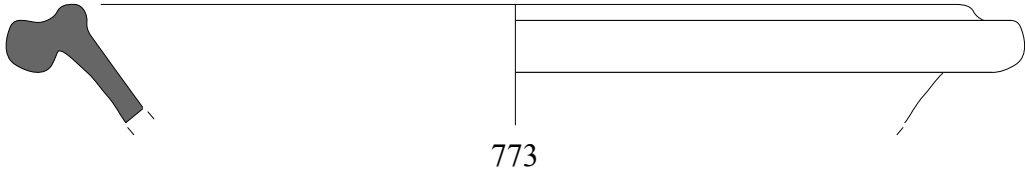

ANNEXE A
AMPHITHEATRE
Planche LXVIII

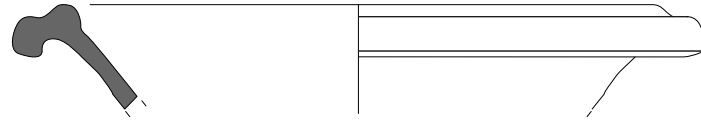

780

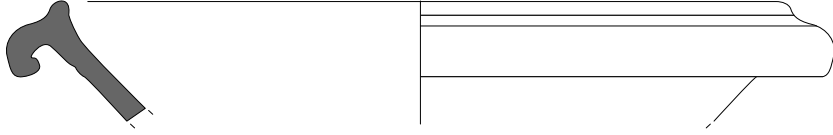

781

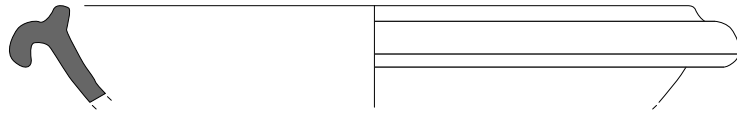

782

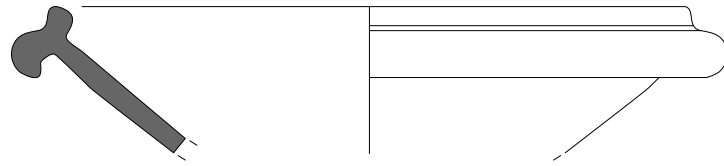

783

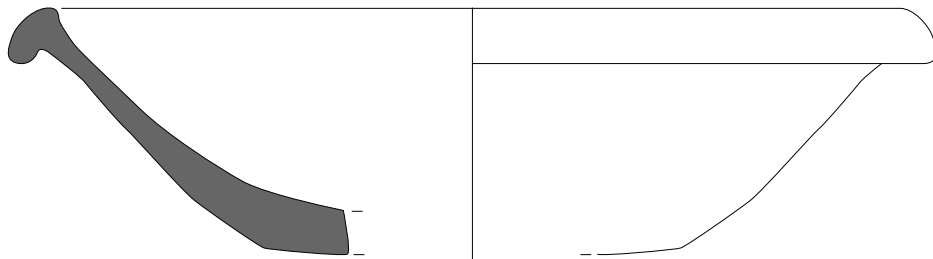

784

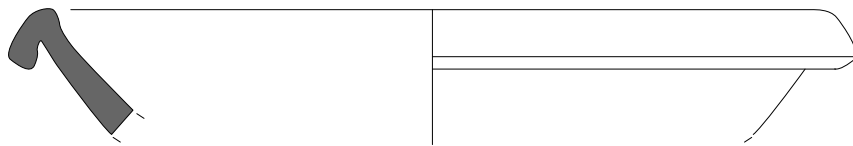

785

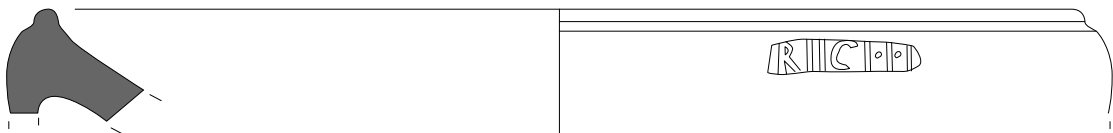

786

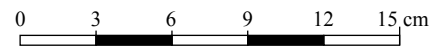

ANNEXE A
AMPHITHEATRE
Planche LXIX

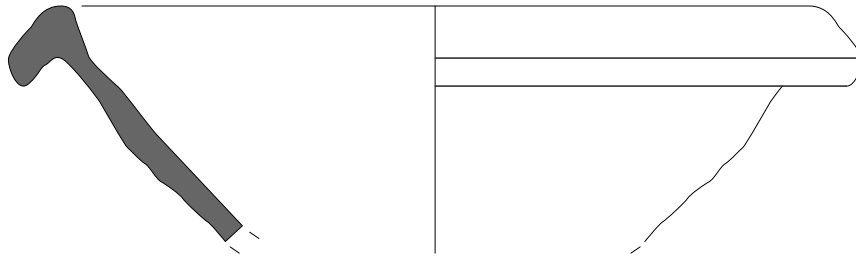

787

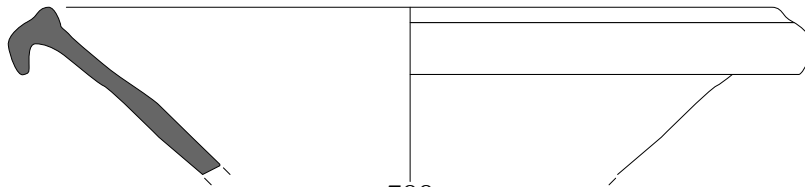

788

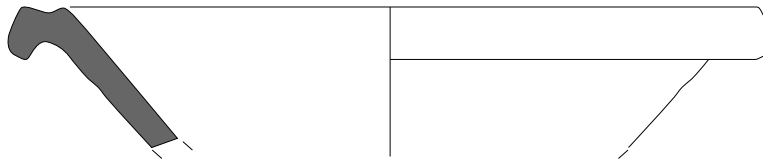

789

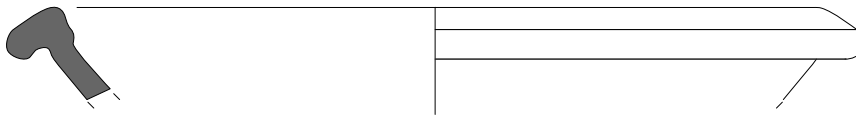

790

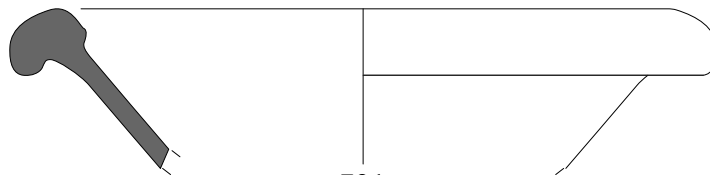

791

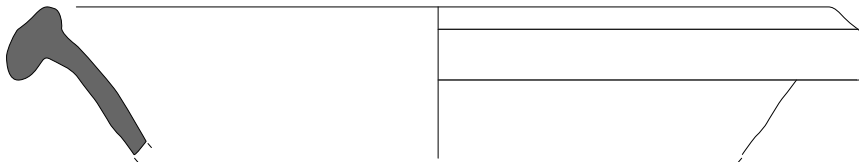

792

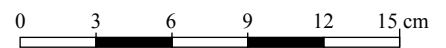

ANNEXE A
AMPHITHEATRE
Planche LXX

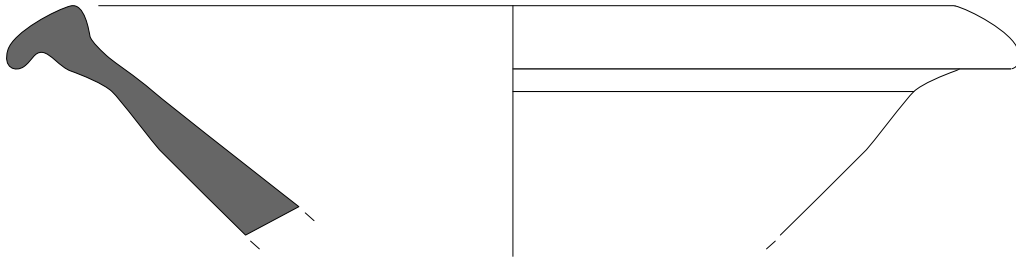

793

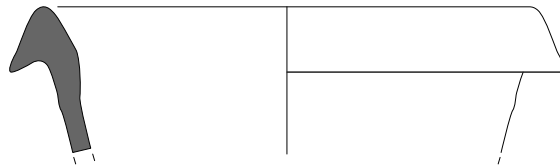

794

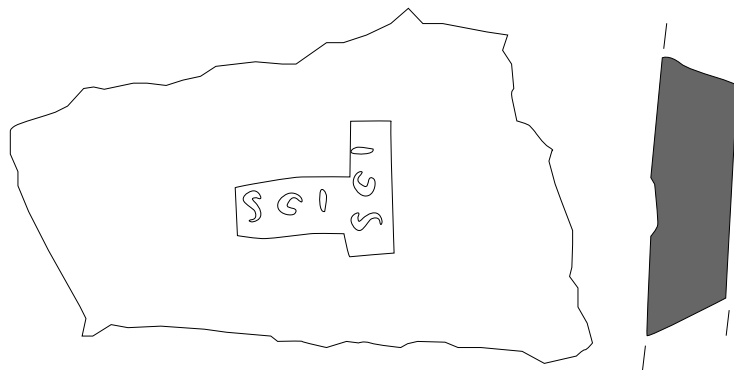

795

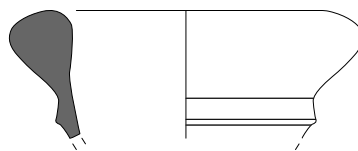

796

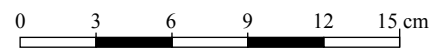

ANNEXE A
 AMPHITHEATRE
 Planche LXXI

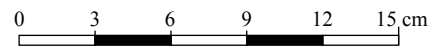
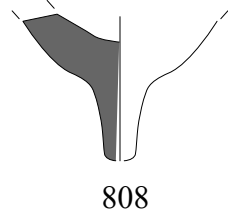
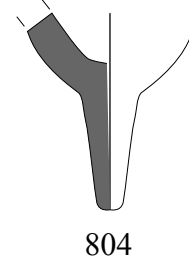
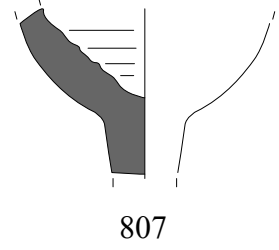
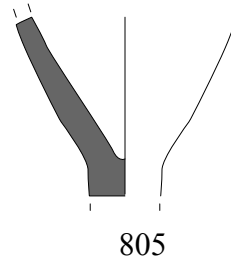
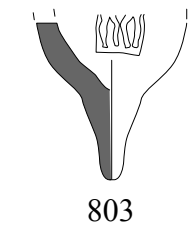
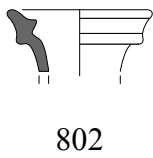
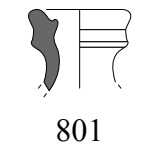
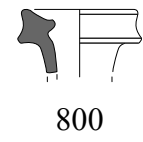
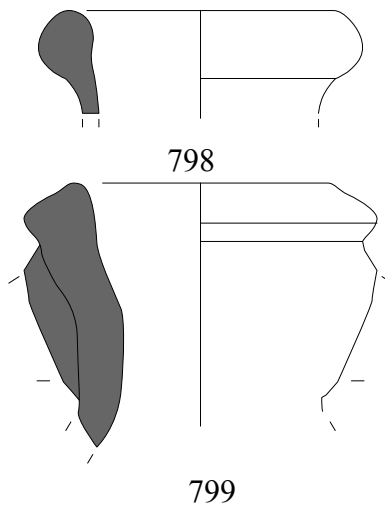
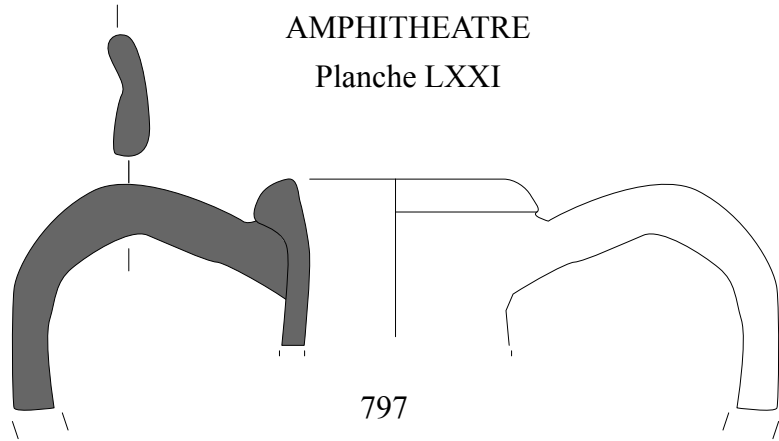

ANNEXE A
AMPHITHEATRE
Planche LXXII

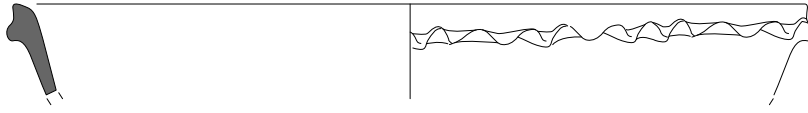

809

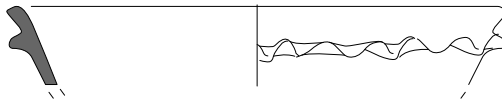

810

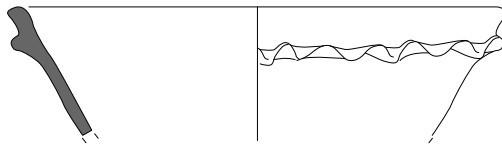

811

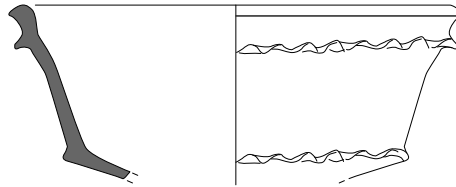

812

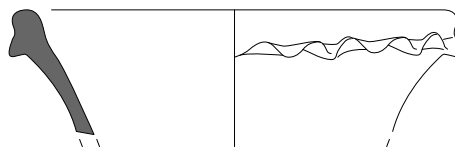

813

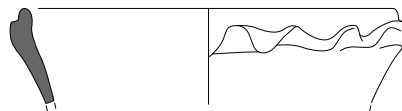

814

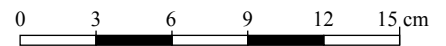

ANNEXE A
AMPHITHEATRE
Planche LXXIII

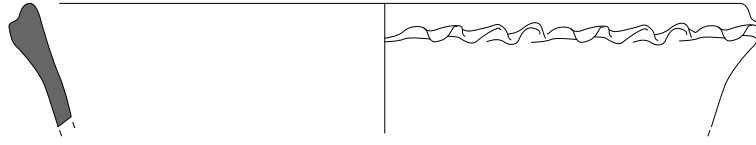

815

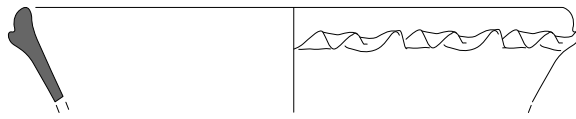

816

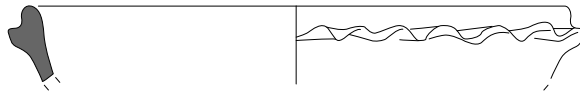

817

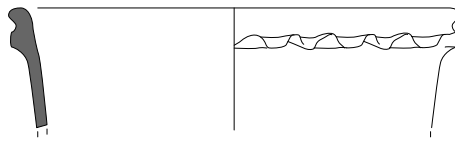

818

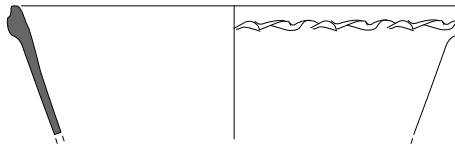

819

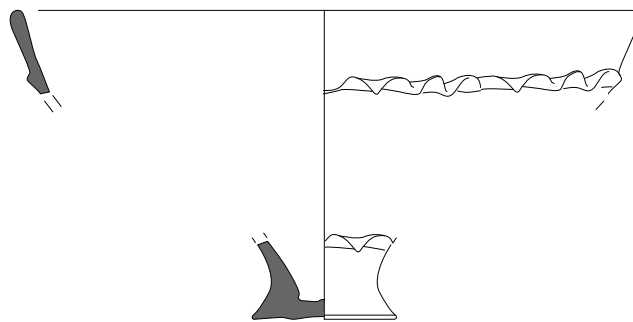

820

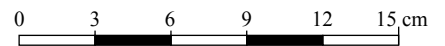

ANNEXE A
AMPHITHEATRE
Planche LXXIV

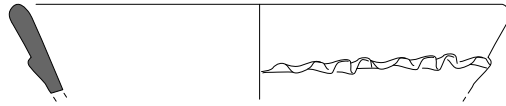

821

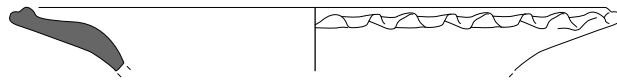

822

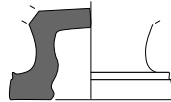

823

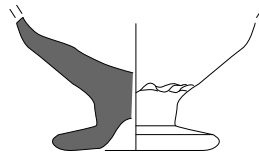

824

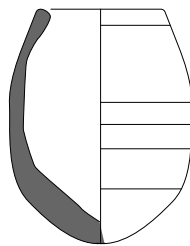

825

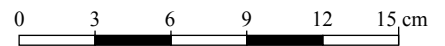

ANNEXE A
AMPHITHEATRE
OP 1992-1993
US 1001
Planche I



1001-90

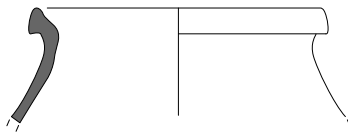

1001-107



1001-110

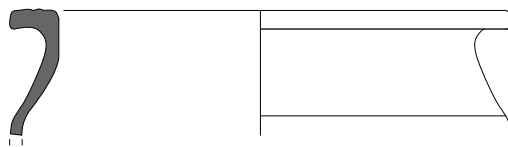

1001-106

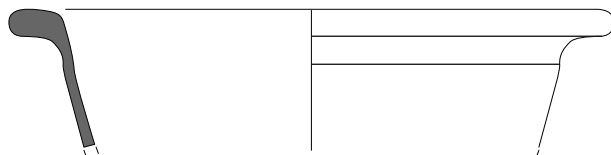

1001-113

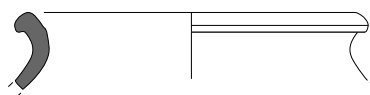

1001-108

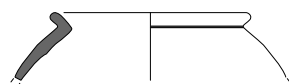

1001-109

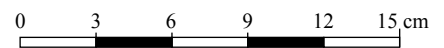

ANNEXE A
AMPHITHEATRE
OP 1992-1993
US 1002
Planche I

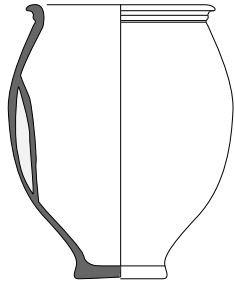

1

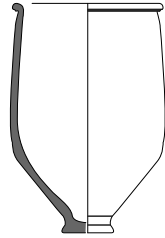

2

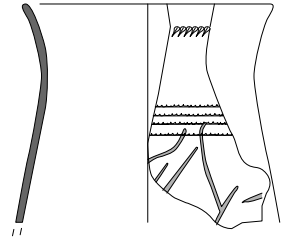

3

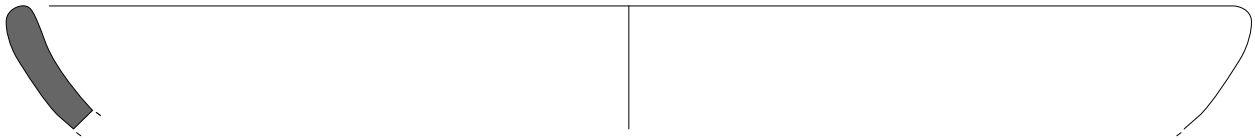

4

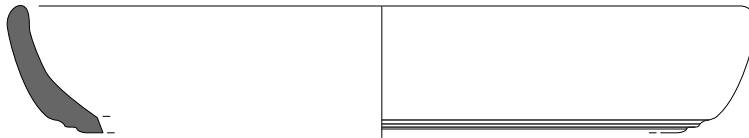

5

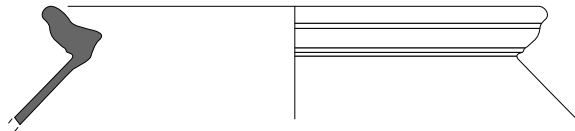

6

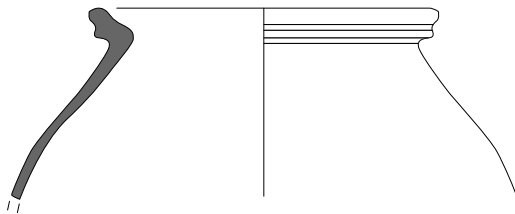

7

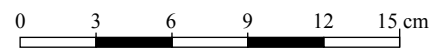

ANNEXE A
AMPHITHEATRE
OP 1992-1993
US 1002
Planche II

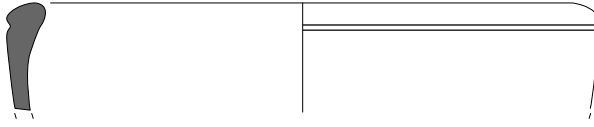

8

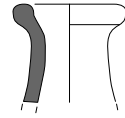

14

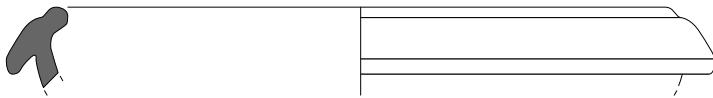

9

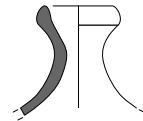

15

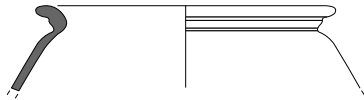

10

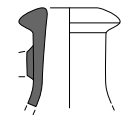

16

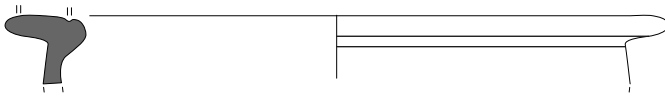

11

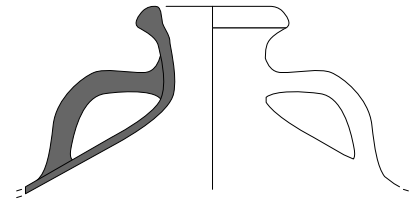

17

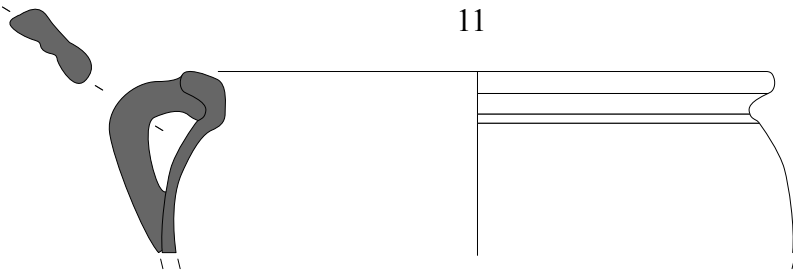

12

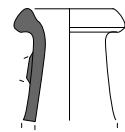

18

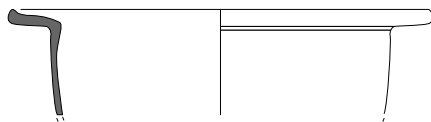

13

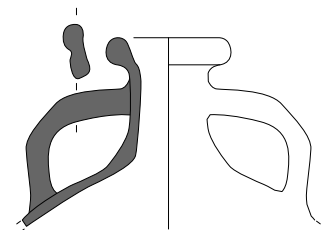

19

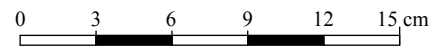

ANNEXE A
AMPHITHEATRE
OP 1992-1993
US 1002
Planche III

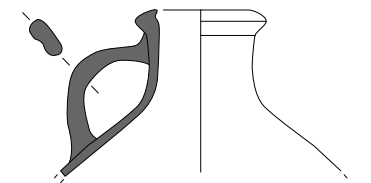

20

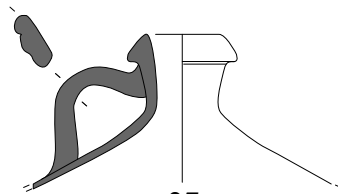

27

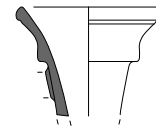

28

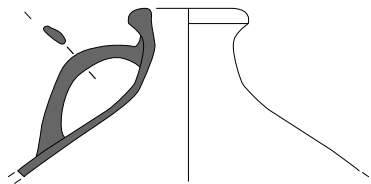

21

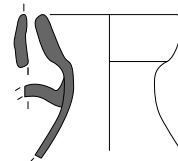

29

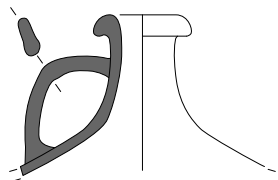

22

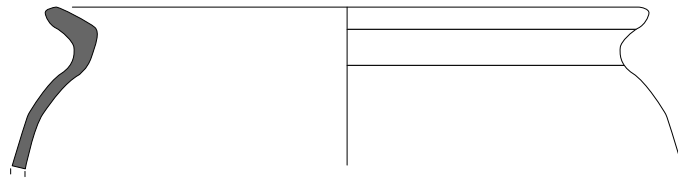

30

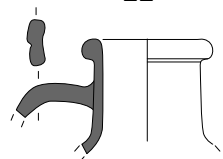

23

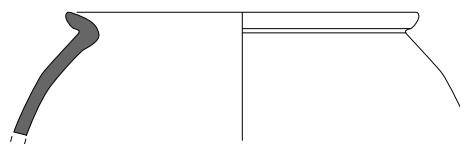

31

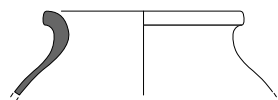

24

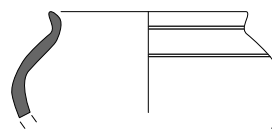

32

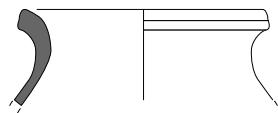

25

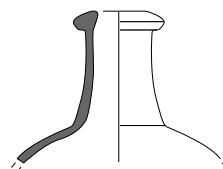

34

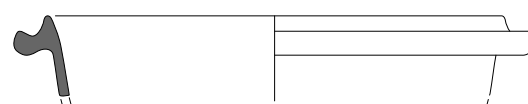

33

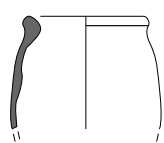

26



ANNEXE A
AMPHITHEATRE
OP 1992-1993
US 1002
Planche IV

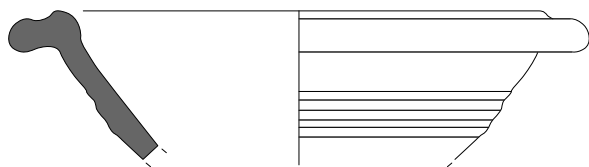

35

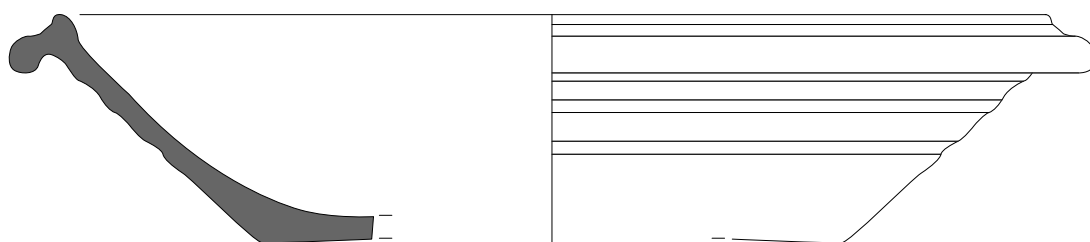

36



37

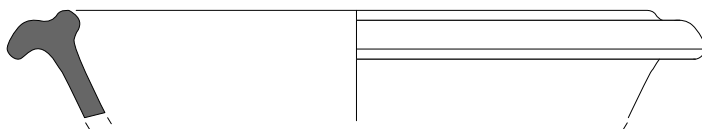

38

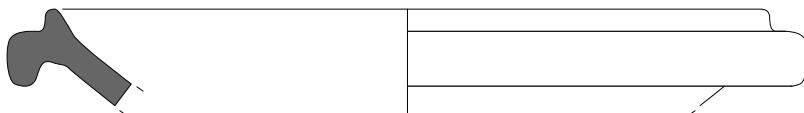

39



40



ANNEXE A
AMPHITHEATRE
OP 1992-1993
US 1002
Planche V

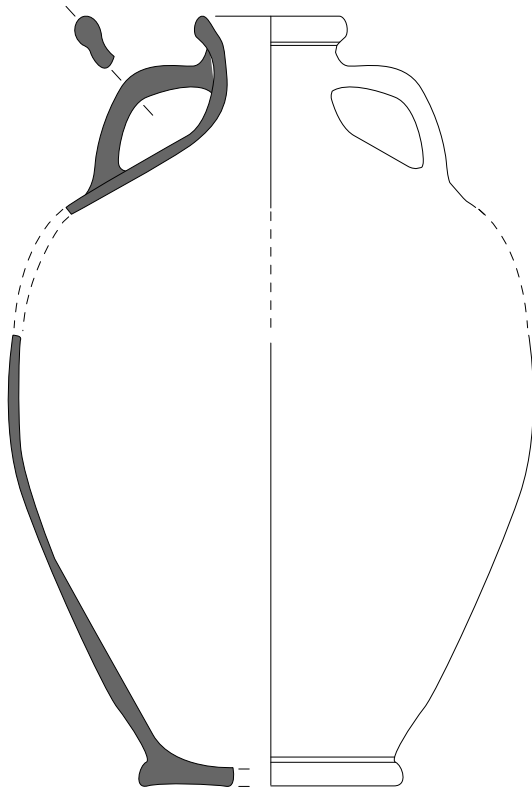

41

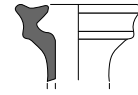

44

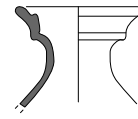

45

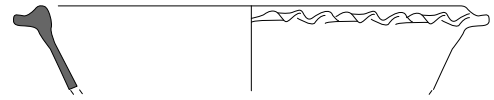

46

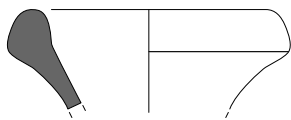

42

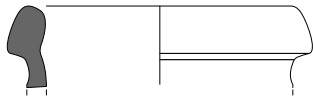

43

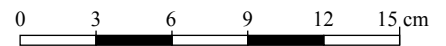

ANNEXE A
AMPHITHEATRE
OP 1992-1993
US 1002c
Planche VI

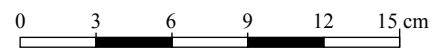
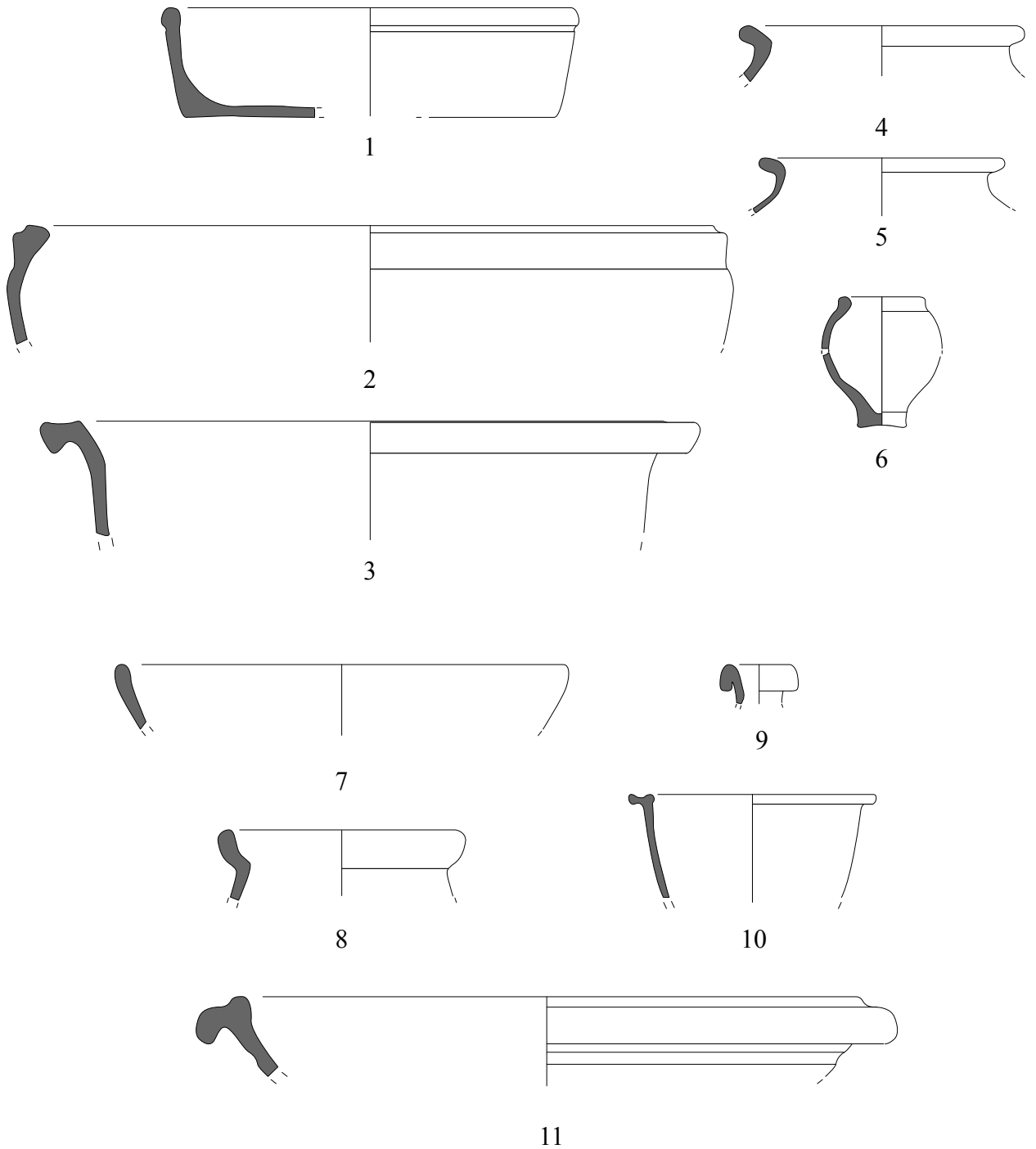

ANNEXE A
AMPHITHEATRE
OP 1992-1993
US 1003c
Planche VII

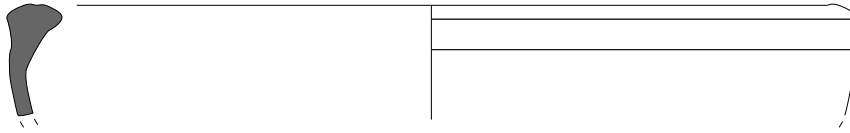

1

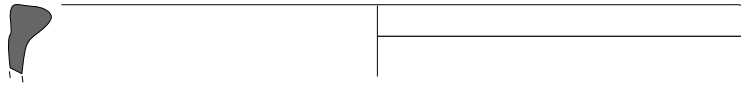

2

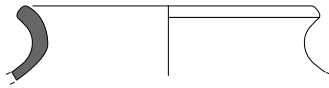

3

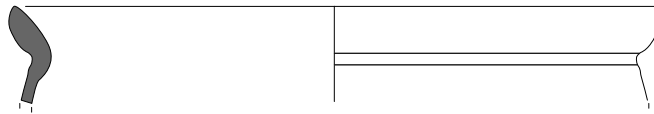

4

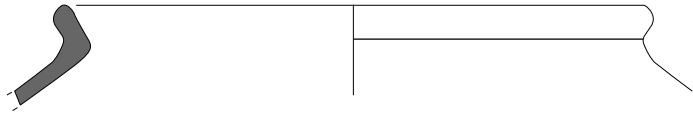

5

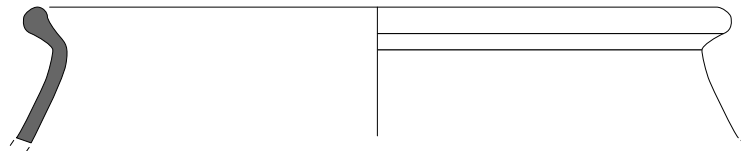

6

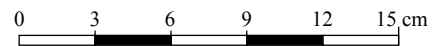

ANNEXE A
AMPHITHEATRE
OP 1992-1993
US 1004c
Planche VIII

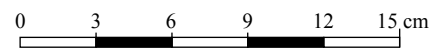
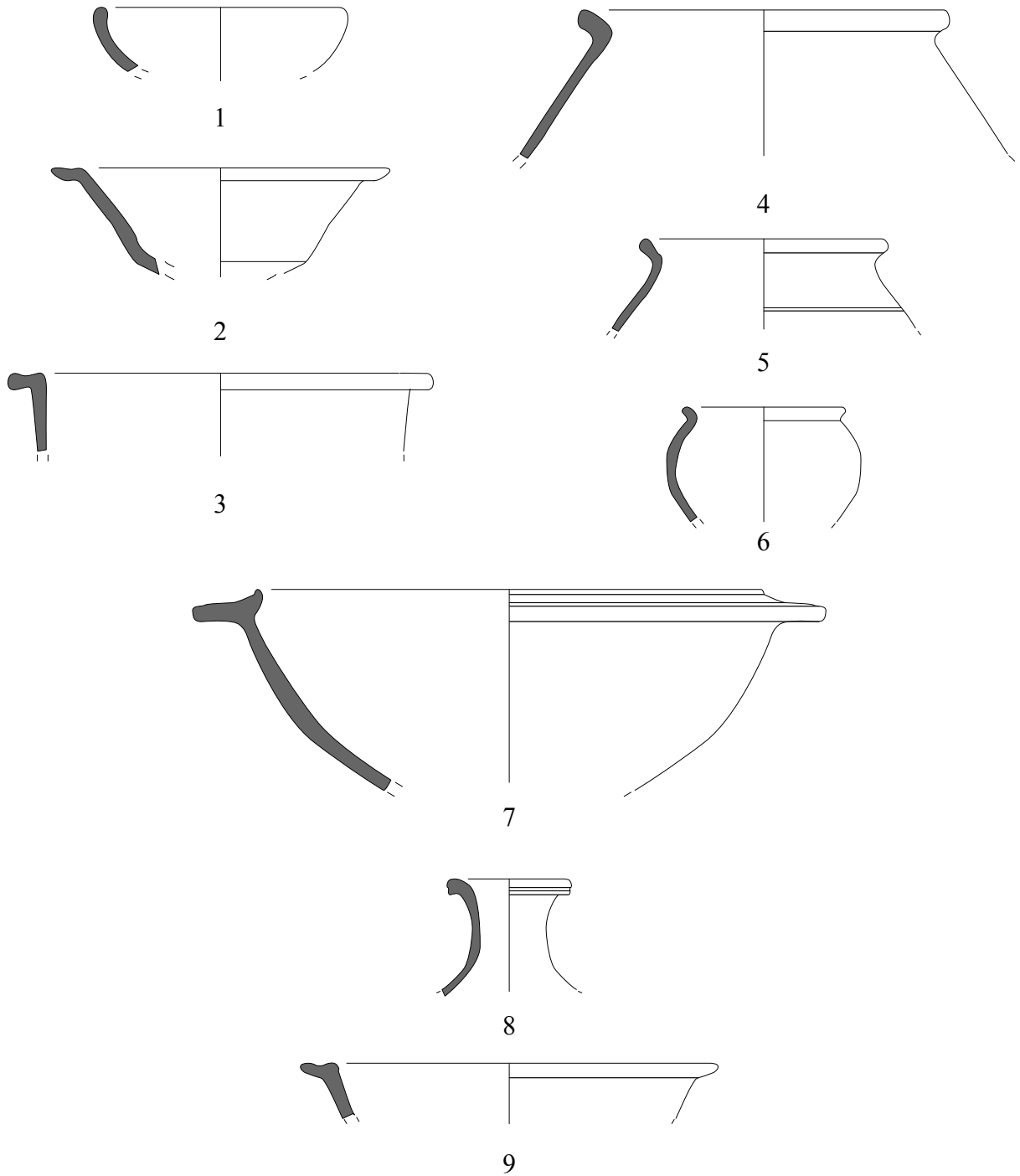

ANNEXE A
AMPHITHEATRE
OP 1992-1993

(issu de Feller 1997 p. 36-43)

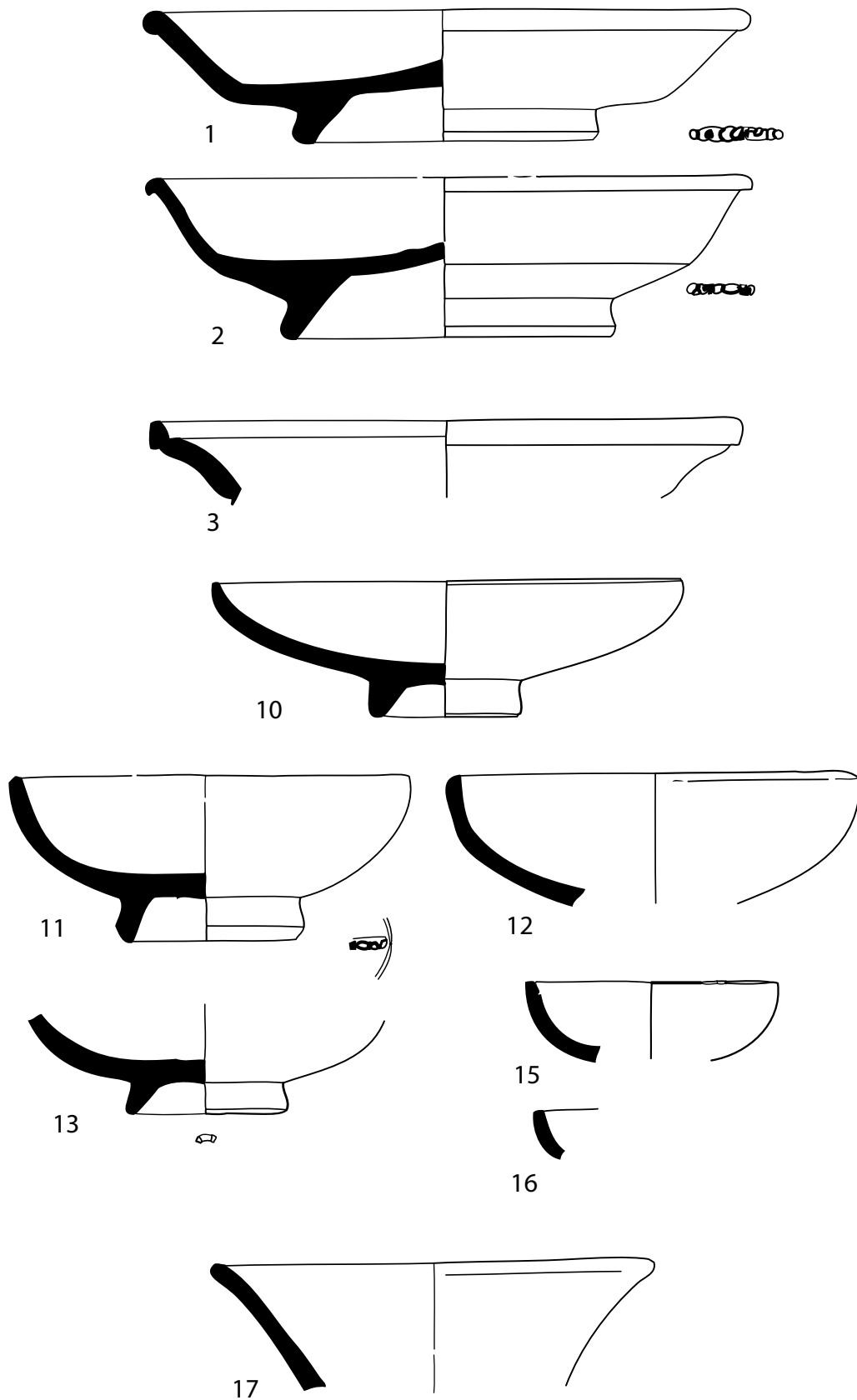

terre sigillée

ANNEXE A
AMPHITHEATRE

OP 1992-1993

(issu de Feller 1997 p. 36-43)

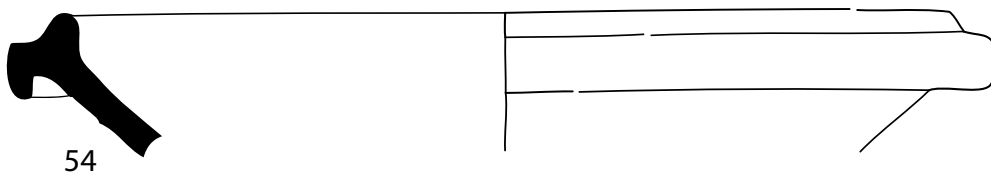
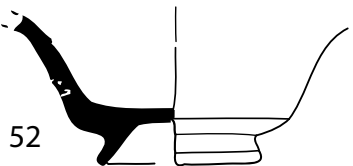
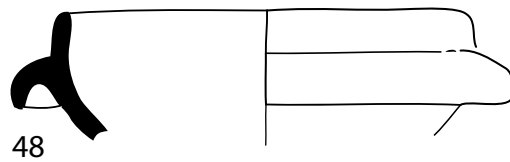
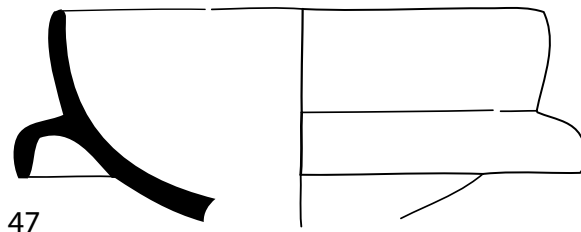
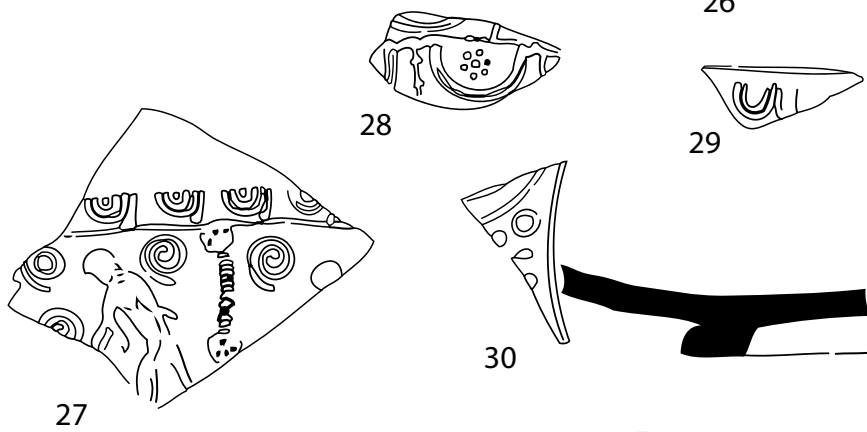
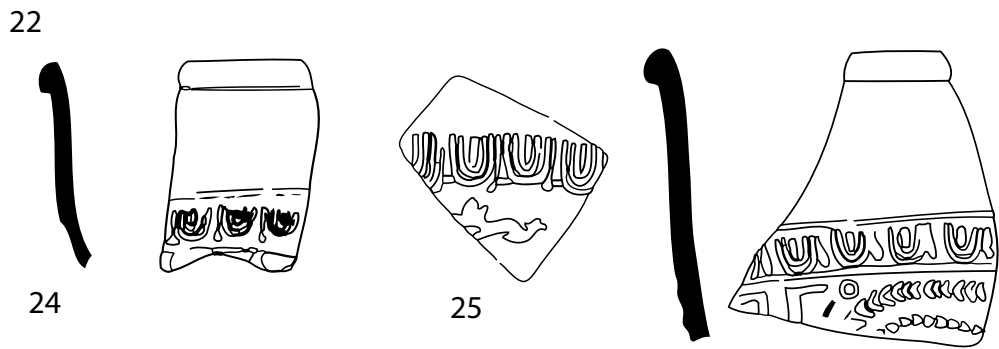
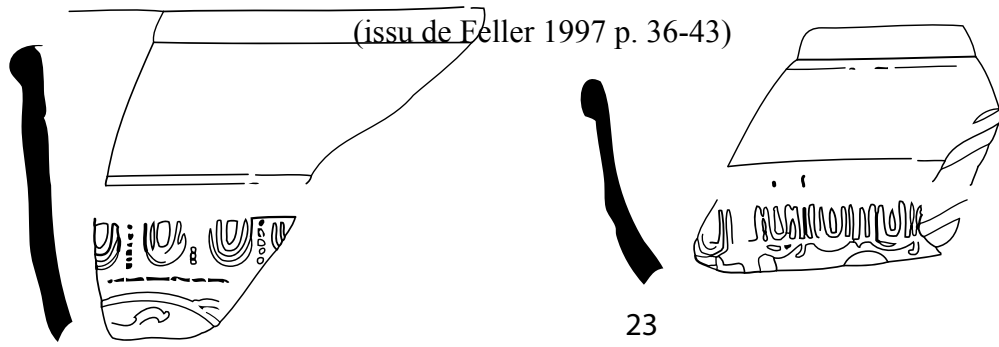

ANNEXE A
AMPHITHEATRE

OP 1992-1993

(issu de Feller 1997 p. 36-43)

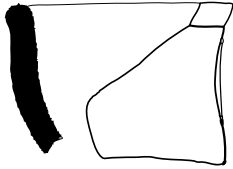

46

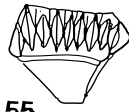

55



56

terre sigillée (suite)

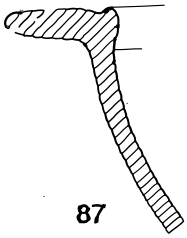

87

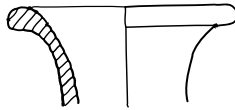

88

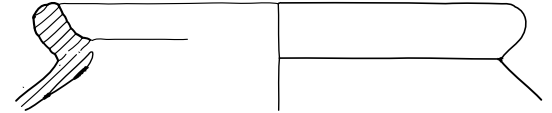

90

céramique gallo-belge

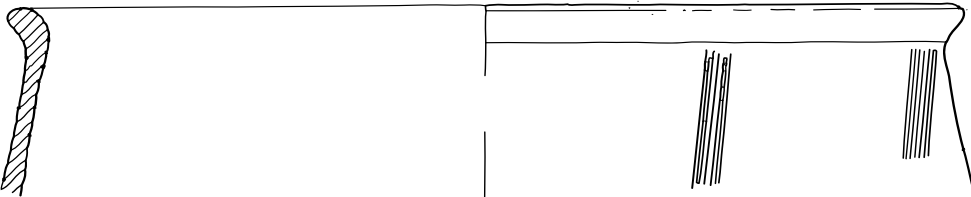

91

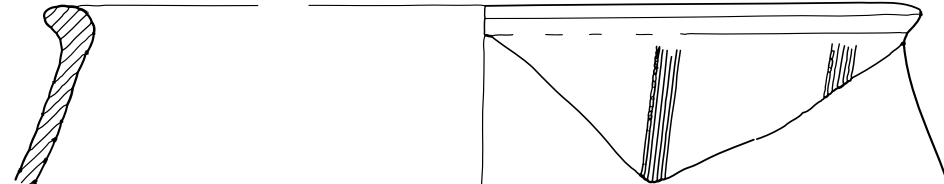

92

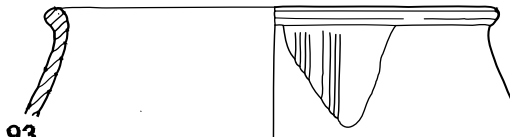

93



94

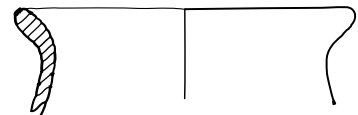

95

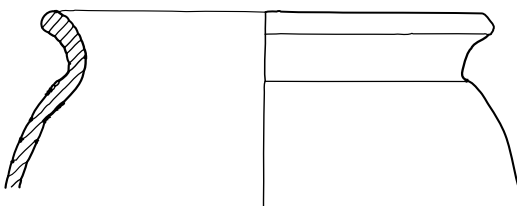

96

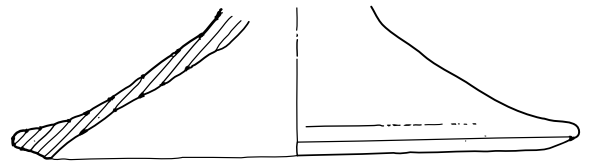

97

céramique commune sombre

ANNEXE A
AMPHITHEATRE

OP 1992-1993

(issu de Feller 1997 p. 36-43)

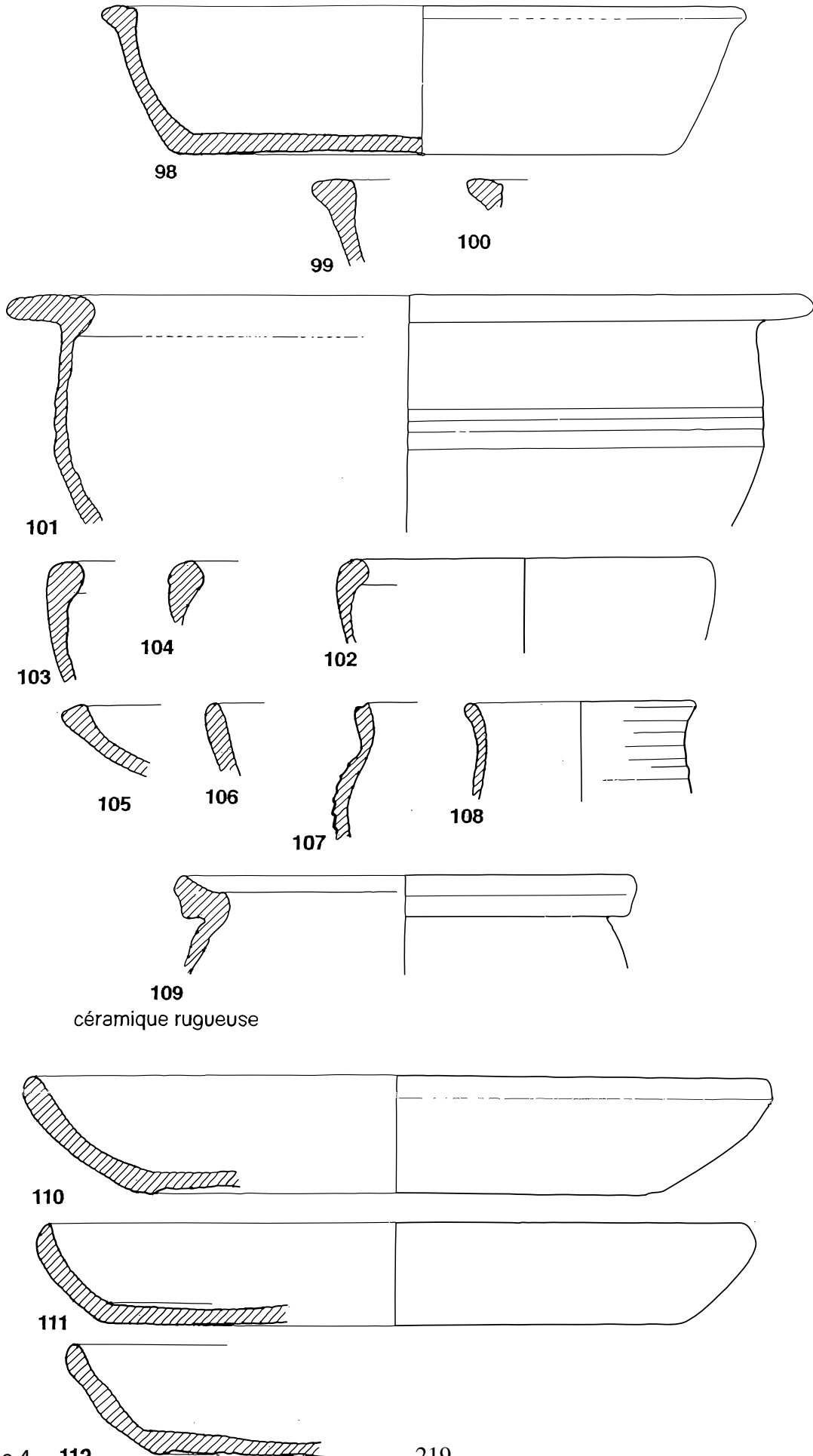

ANNEXE A
AMPHITHEATRE

OP 1992-1993

(issu de Feller 1997 p. 36-43)

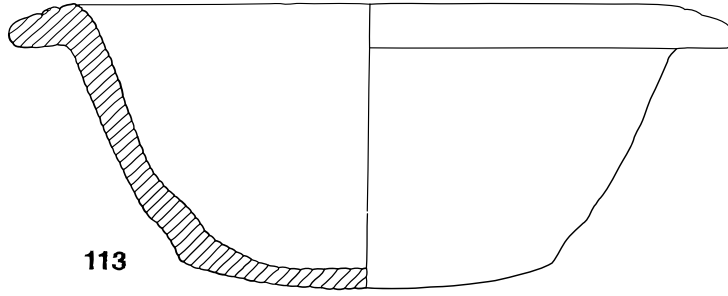

113

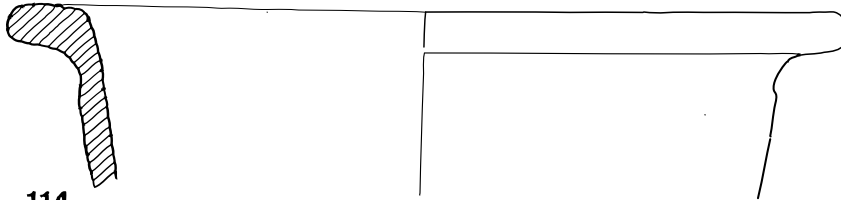

114

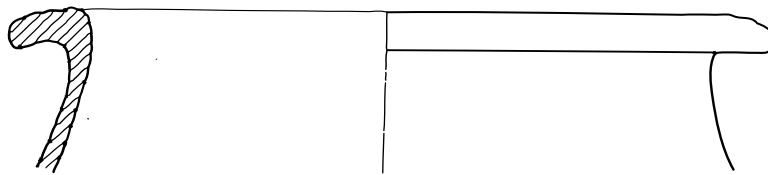

115

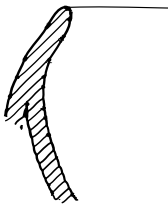

116

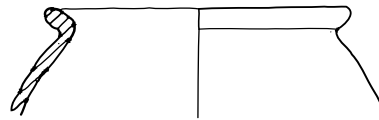

118

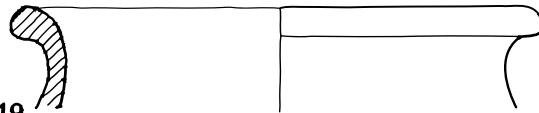

119

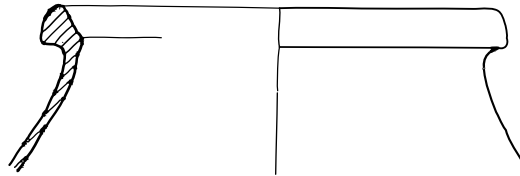

120

c ramique dor e

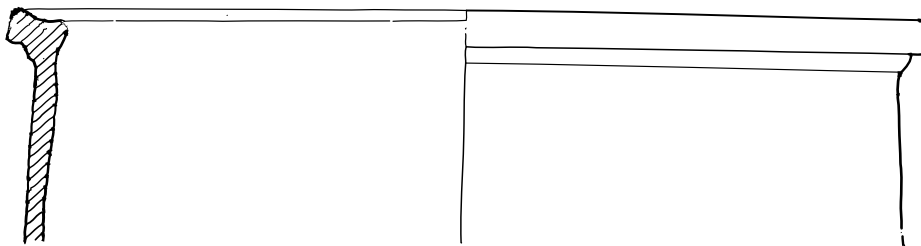

121

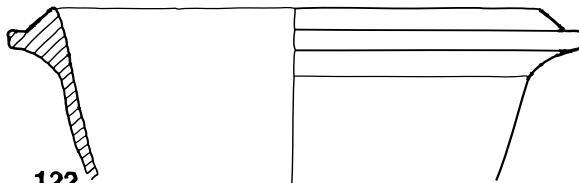

122

ANNEXE A
AMPHITHEATRE

OP 1992-1993

(issu de Feller 1997 p. 36-43)

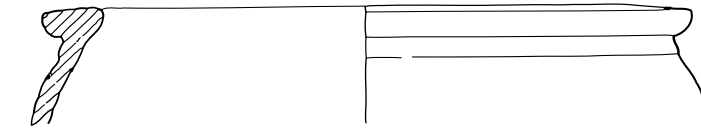

123

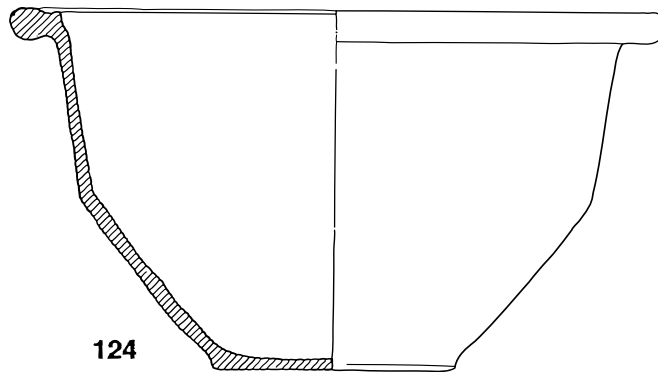

124

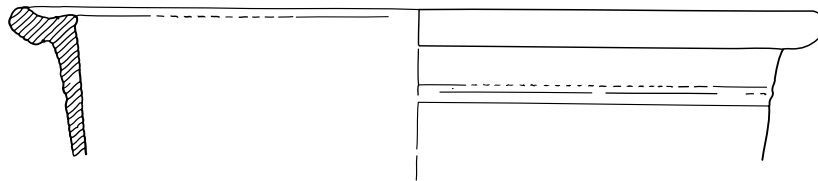

125

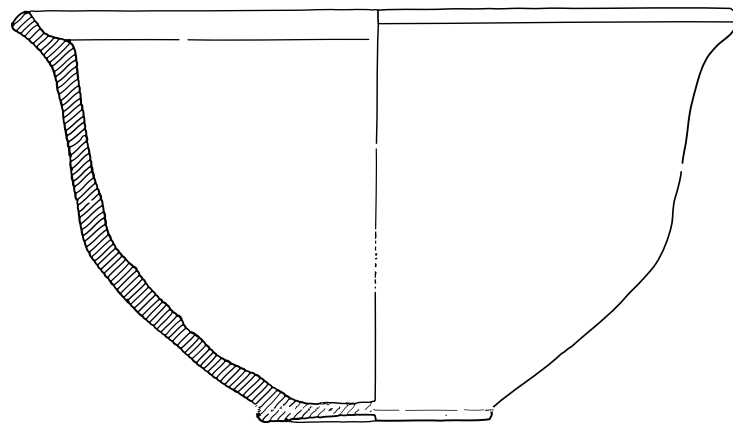

127

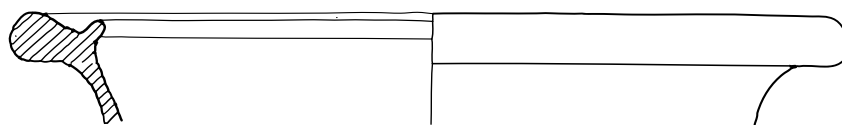

126

céramique à dégraissant coquillier

ANNEXE A
AMPHITHEATRE

OP 1992-1993

(issu de Feller 1997 p. 36-43)

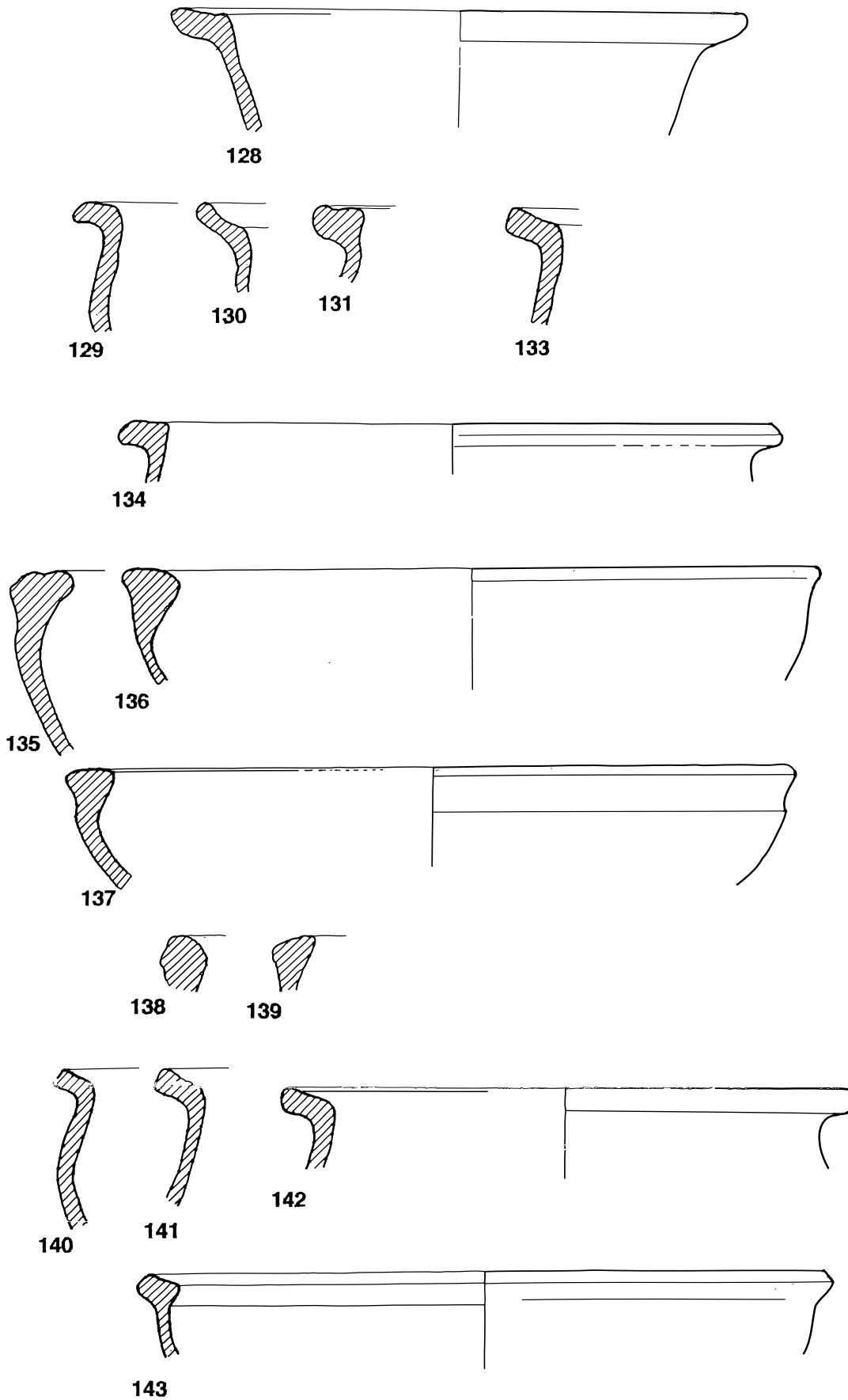

céramique à dégraissant coquillier (suite)

ANNEXE A
AMPHITHEATRE

OP 1992-1993

(issu de Feller 1997 p. 36-43)

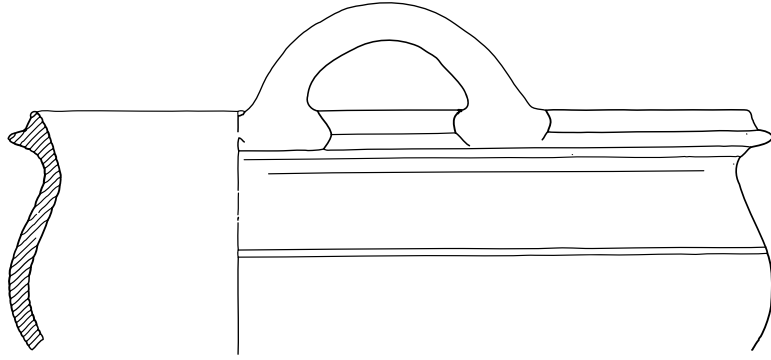

145

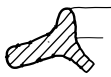

144

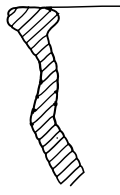

146



147



148

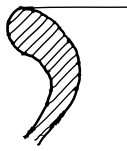

149



150



151



152

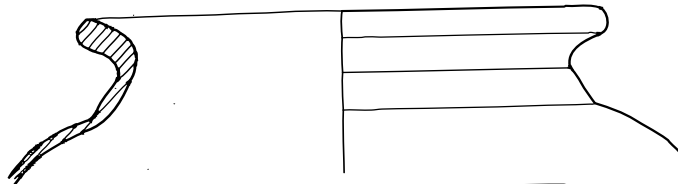

153

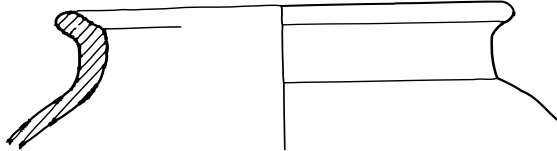

154

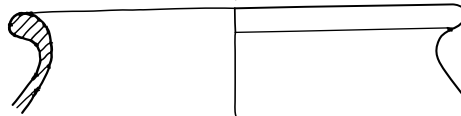

156

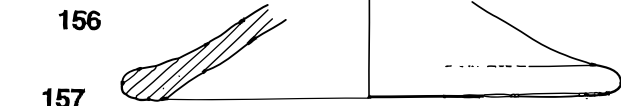

157

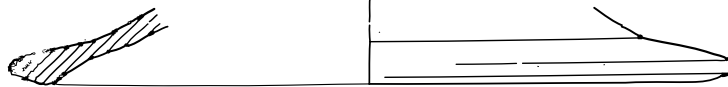

158

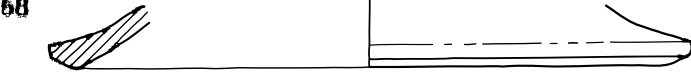

159



160

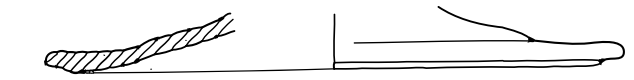

161



162

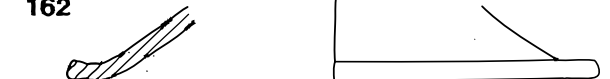

163

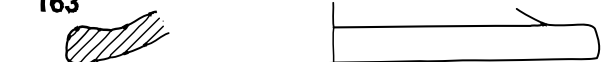

164



165



166

ANNEXE A
LA MALADIÈRE
Planche I

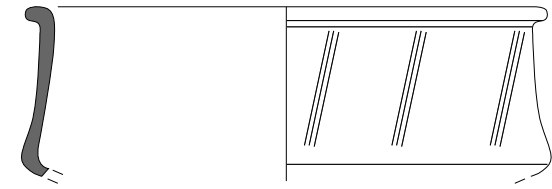

1

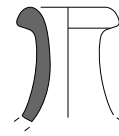

6

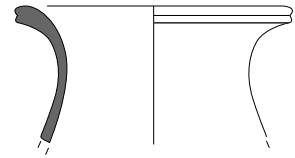

7

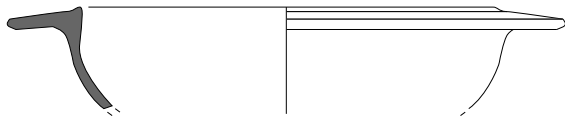

2

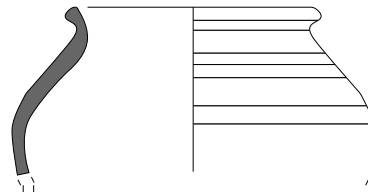

8

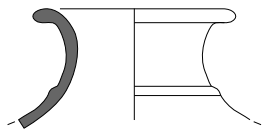

3

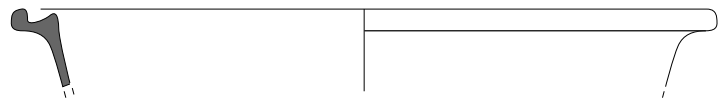

9

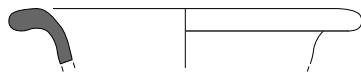

4

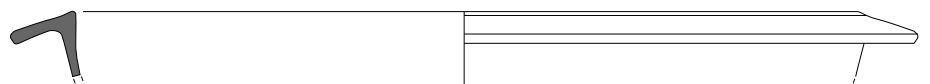

10

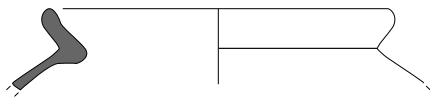

5

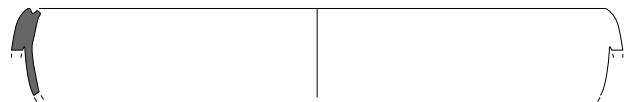

11

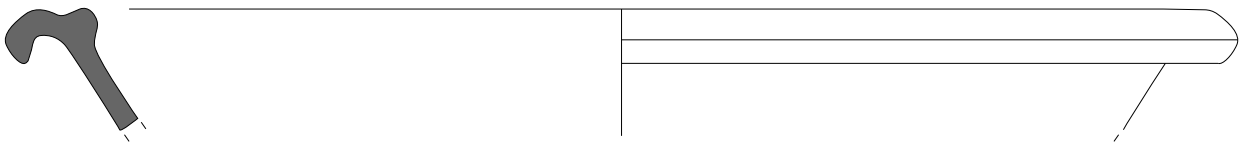

12

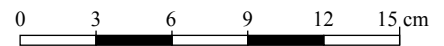

ANNEXE A
HANGAR POILPRES
Planche I

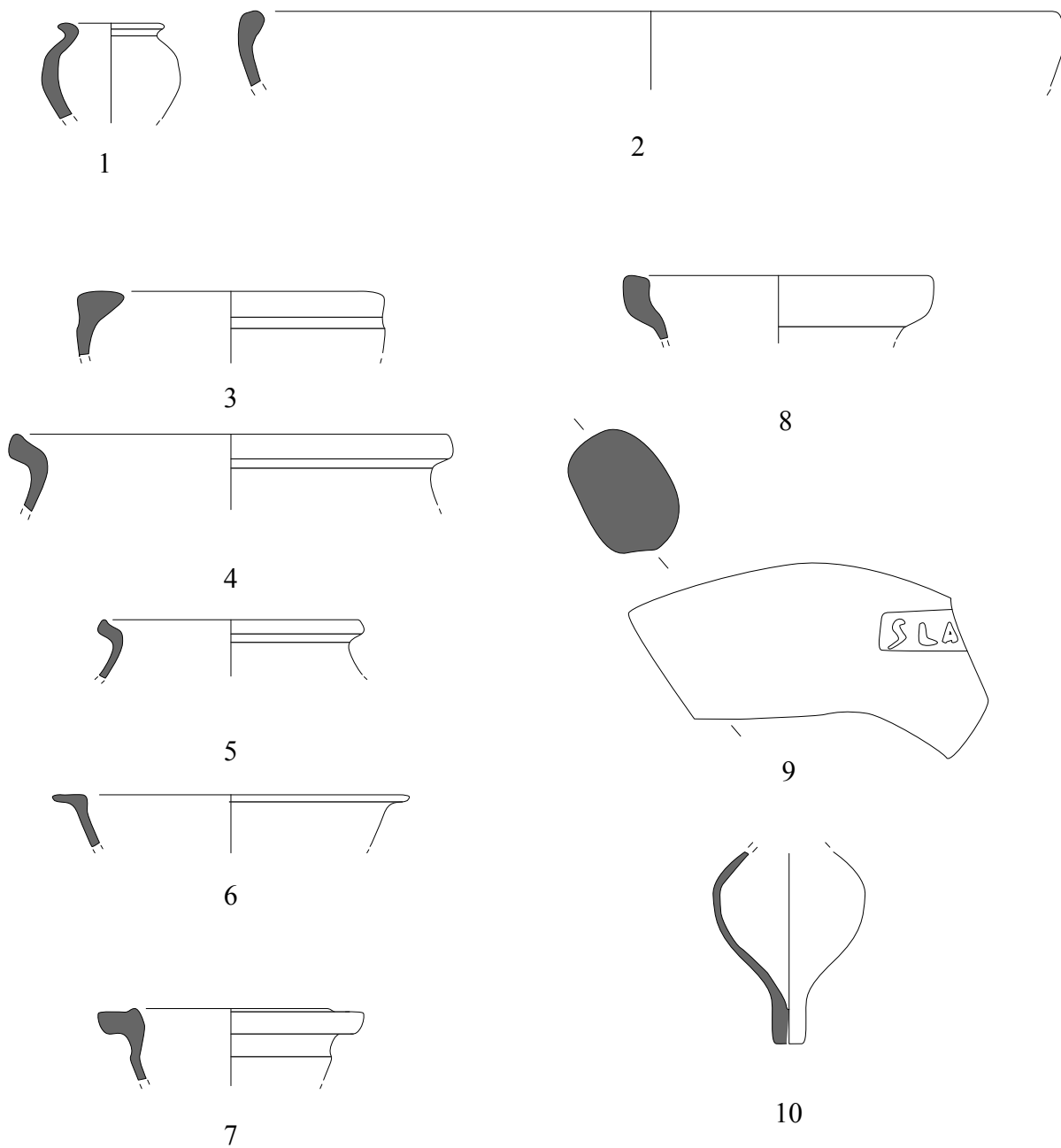

ANNEXE A
FOSSE DUSSEAUX

Planche I

ARTIALIS

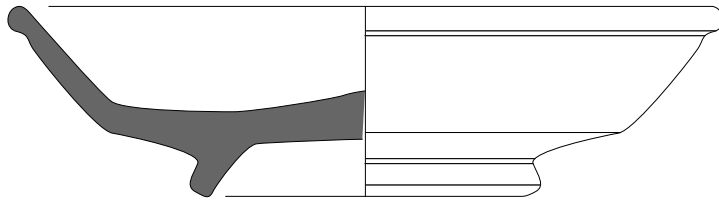

1

ARTIALIS

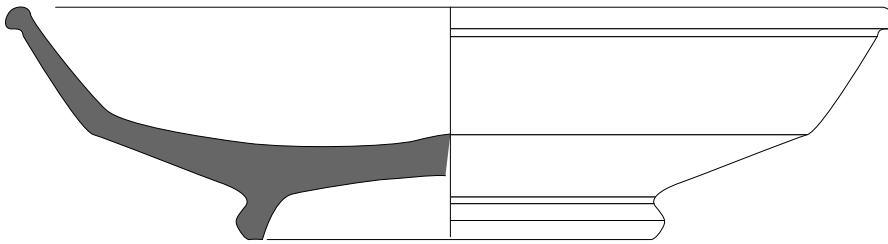

2

DOMATIM

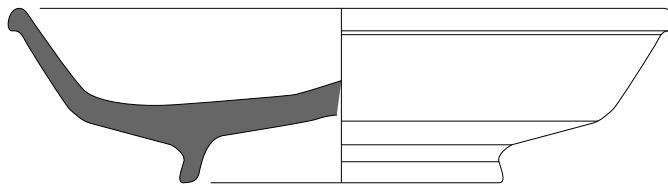

3

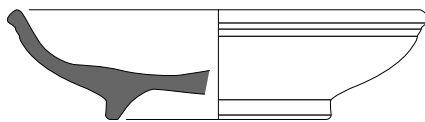

4

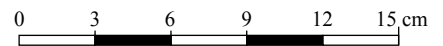

ANNEXE A
FOSSE DUSSEAUX
Planche II

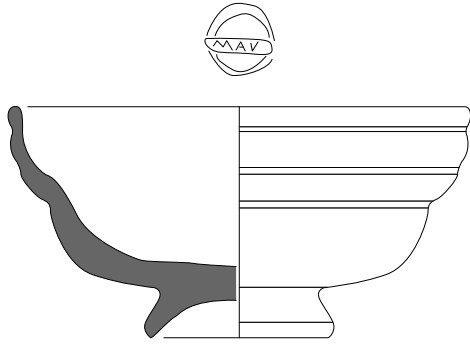

5

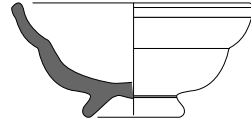

7

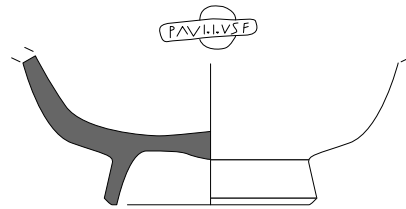

8

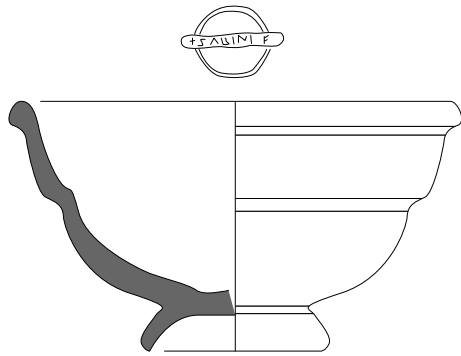

6

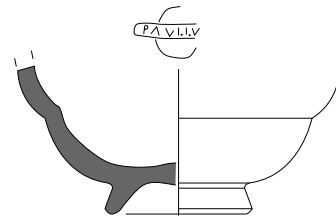

9

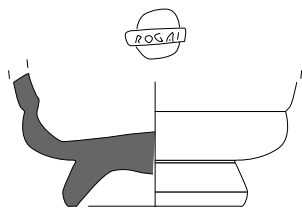

10

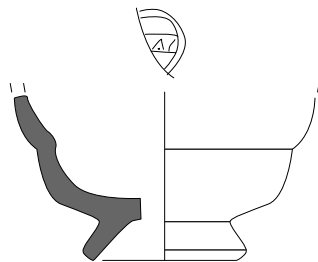

11

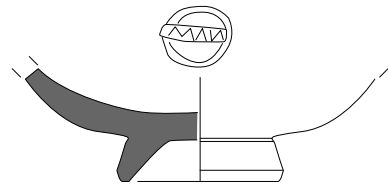

12

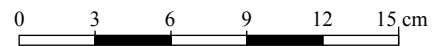

ANNEXE A
FOSSE DUSSEAUX
Planche III

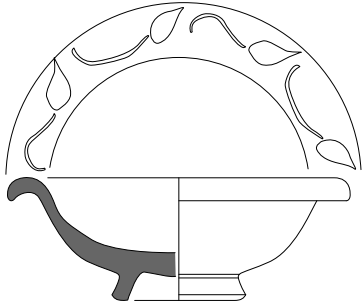

13

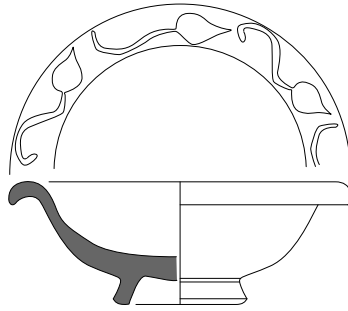

15

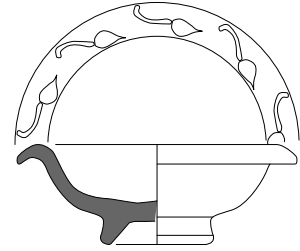

16

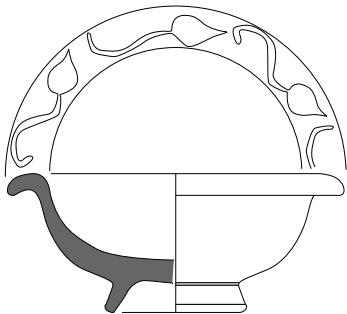

14



18

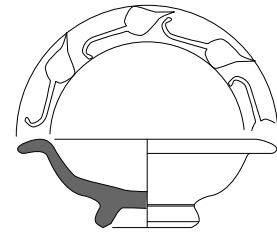

17



19

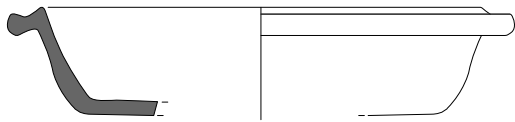

20

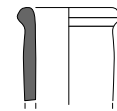

21

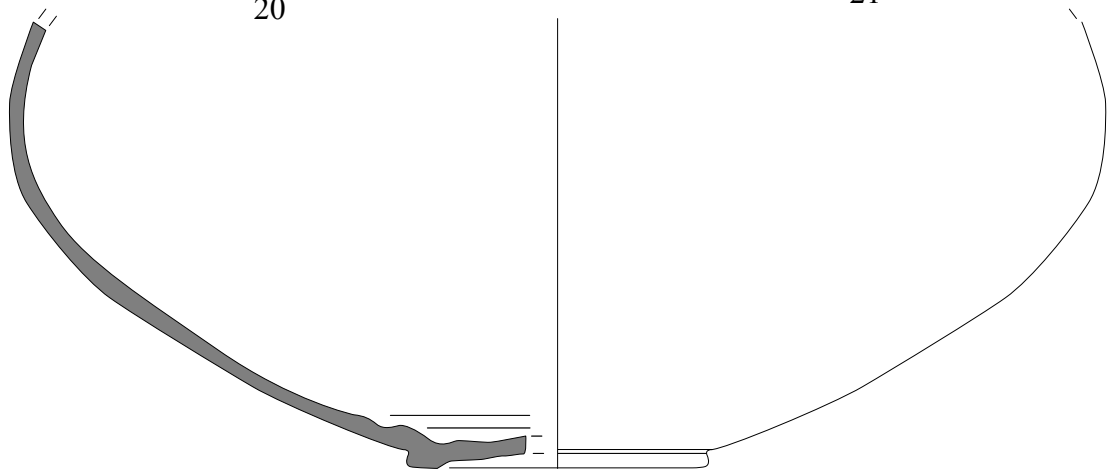

22

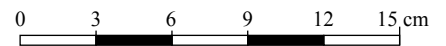

ANNEXE A
FOSSE DUSSEAUX
Planche IV

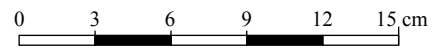
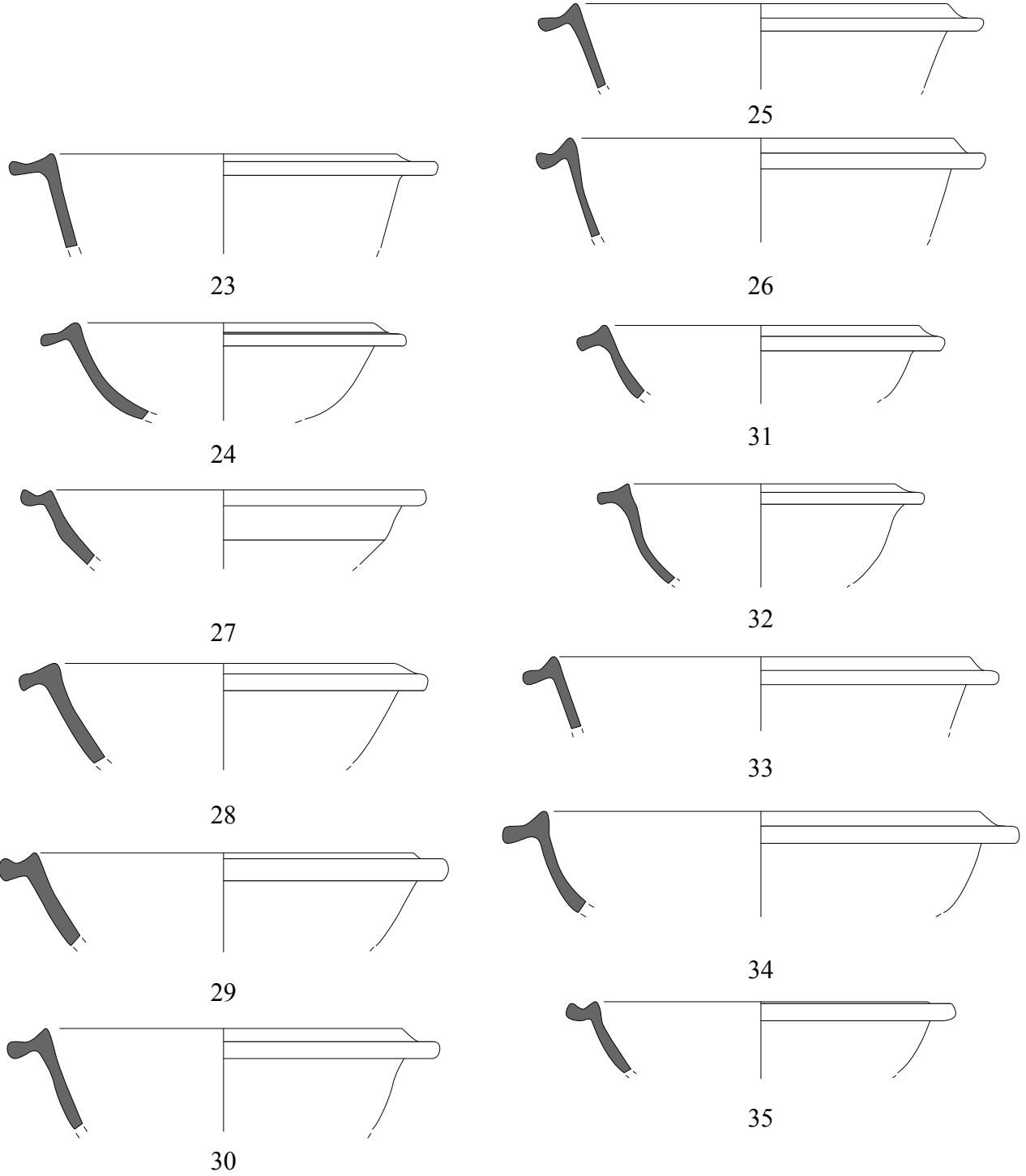

ANNEXE A
FOSSE DUSSEAUX
Planche V

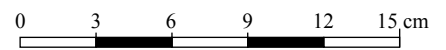
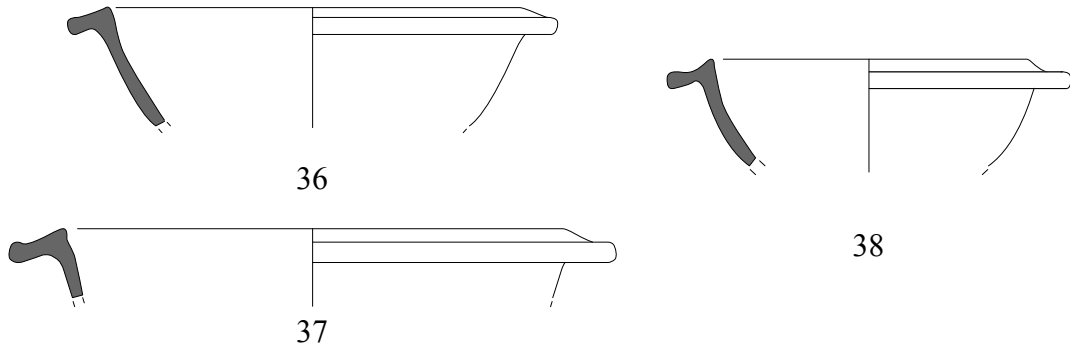

ANNEXE A
CITERNE ERNEST CHAUDRON
Planche I

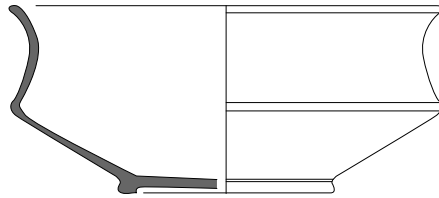

1

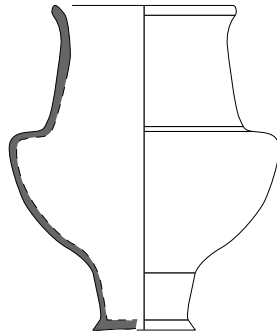

2

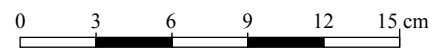

ANNEXE A
HORS CONTEXTE

Planche I

⊙FSEVED

1

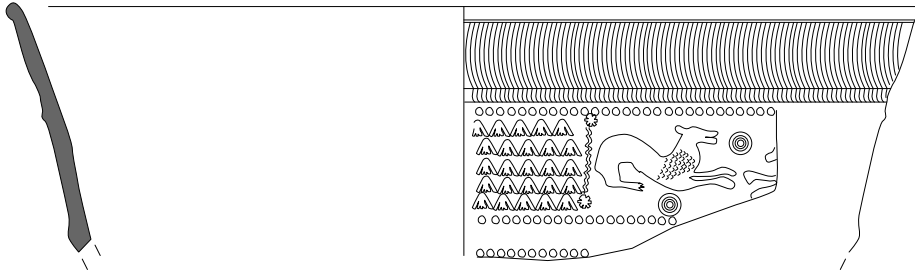

2

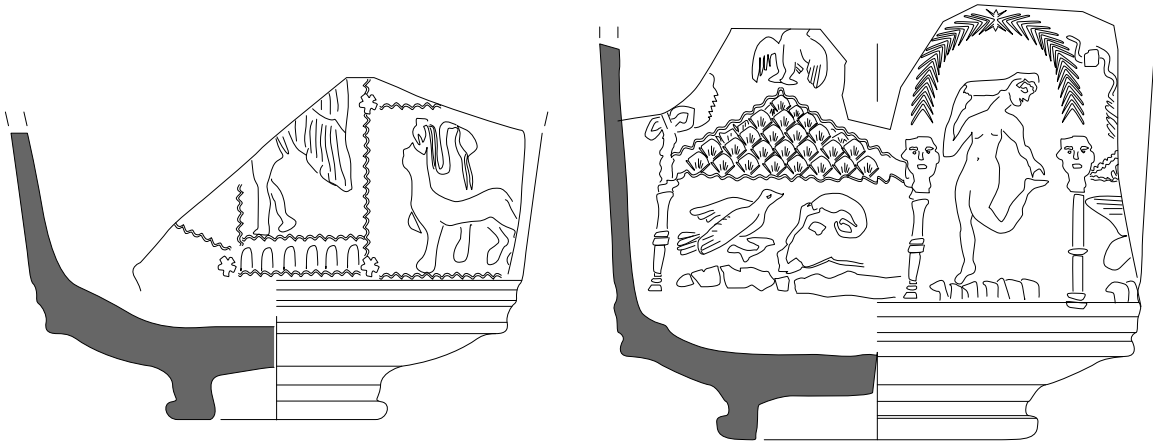

3

4

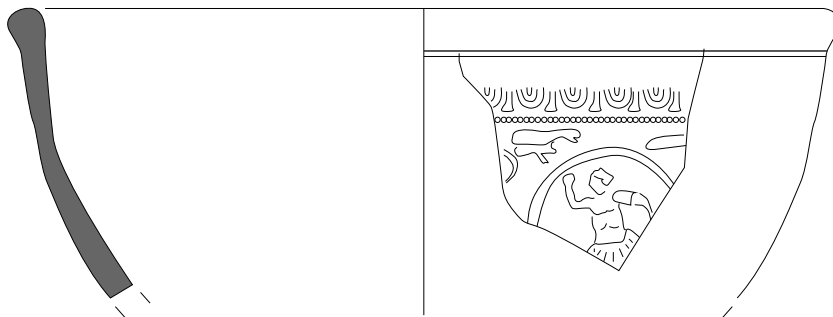

5

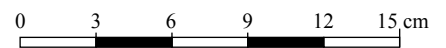

ANNEXE A
HORS CONTEXTE

Planche II

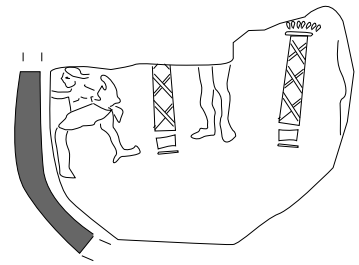
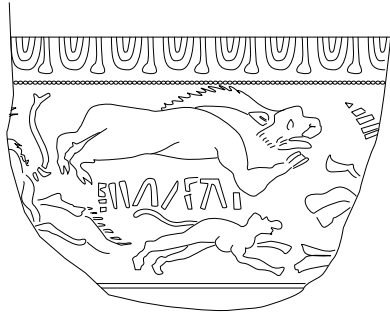

8

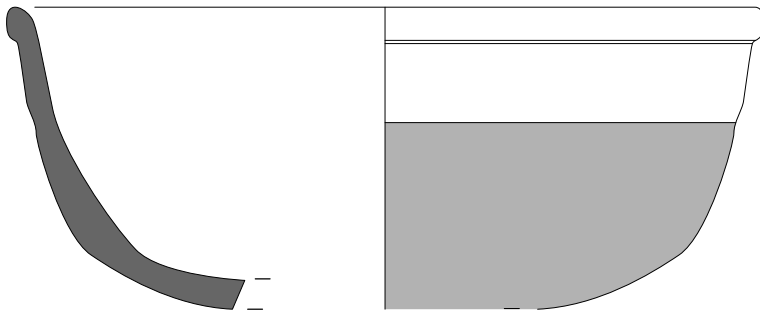

6

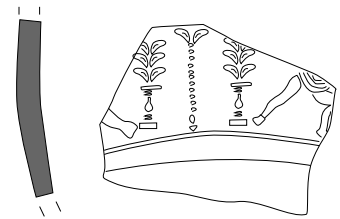

9

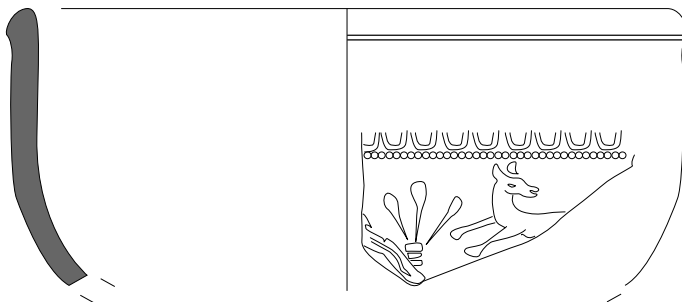

7

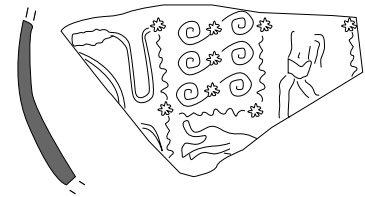

10

GENITOR

11

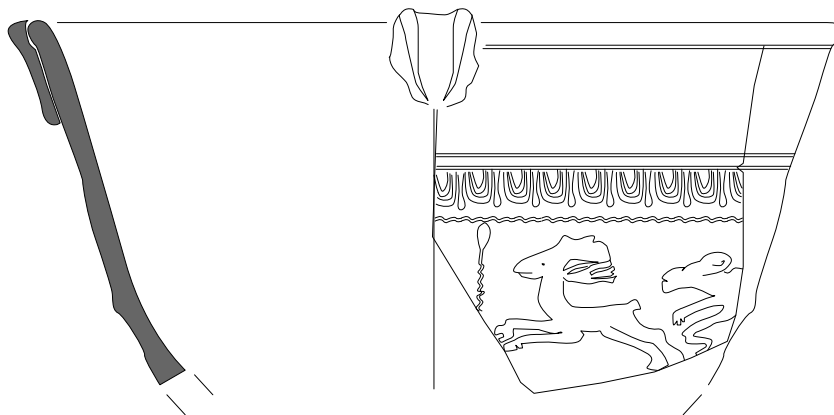

12

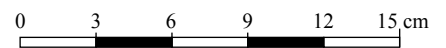

ANNEXE A
HORS CONTEXTE
Planche III

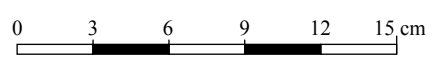
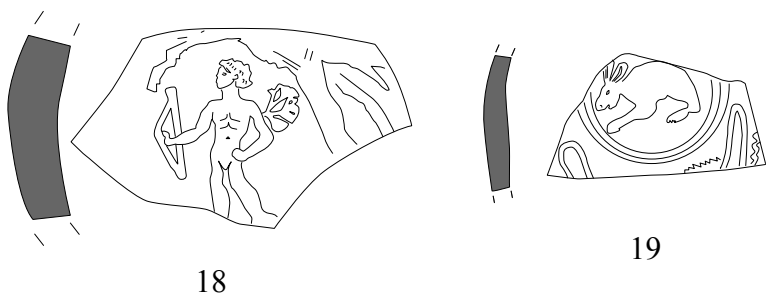
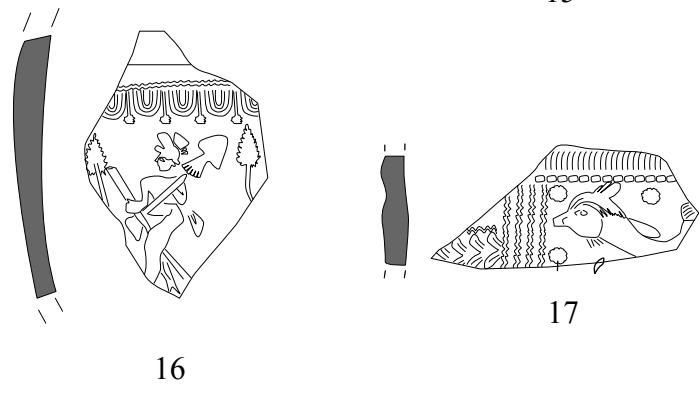
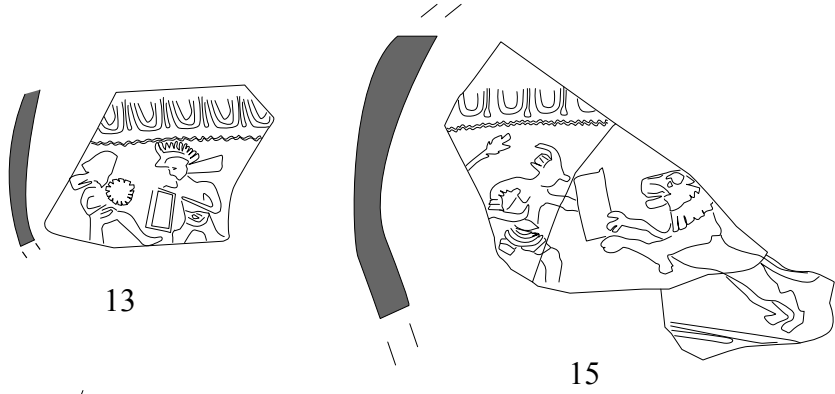
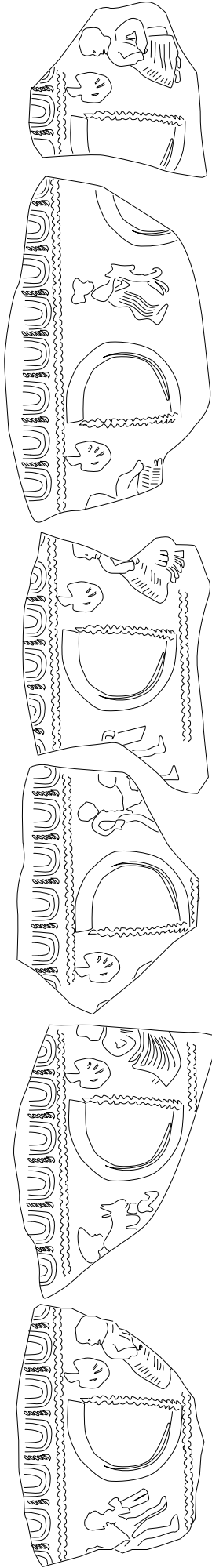

ANNEXE A
HORS CONTEXTE
Planche IV

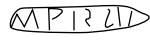

20

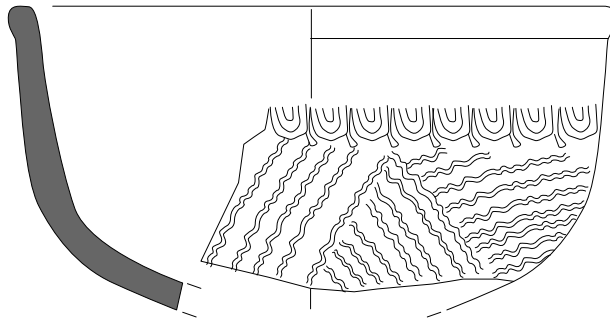

21

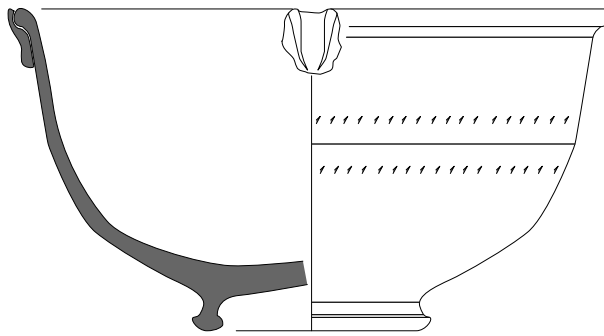

22

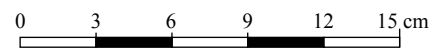

HORS CONTEXTE

Planche V

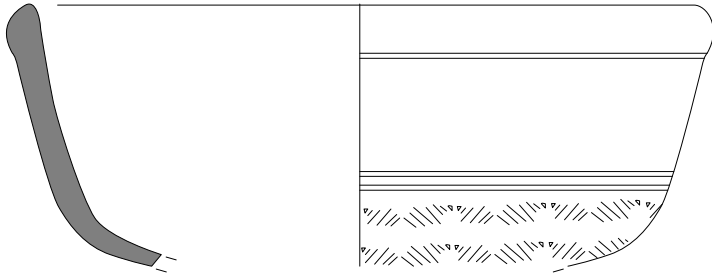

23

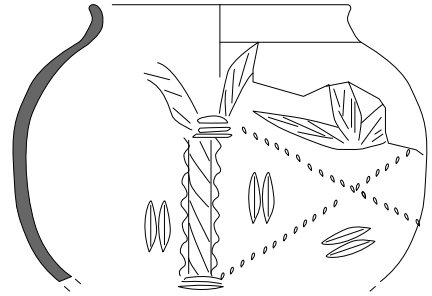

27

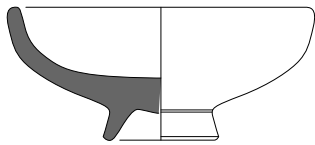

24

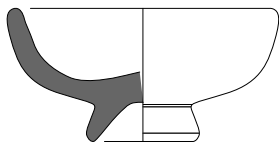

25

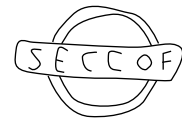

28



29

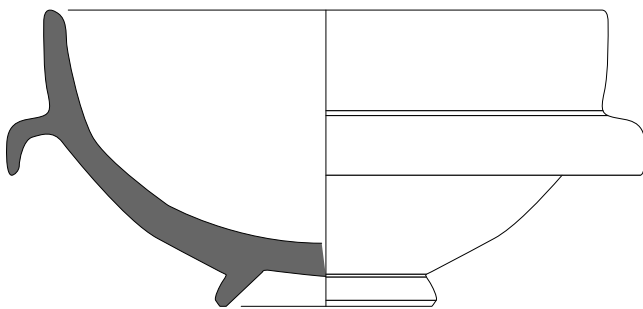

26

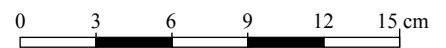

HORS CONTEXTE

Planche VI

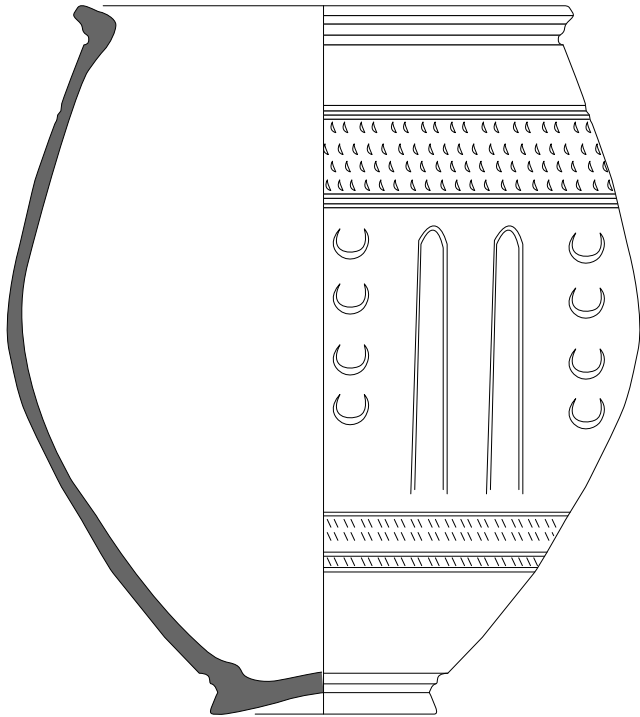

30

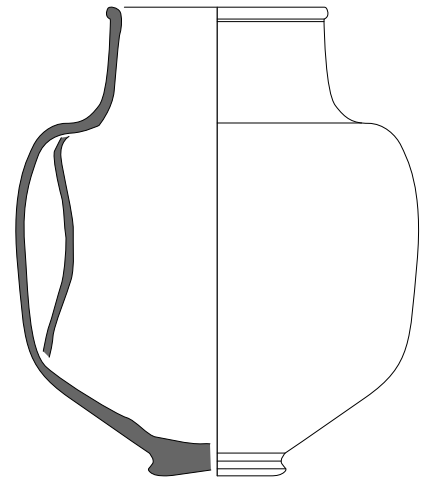

32

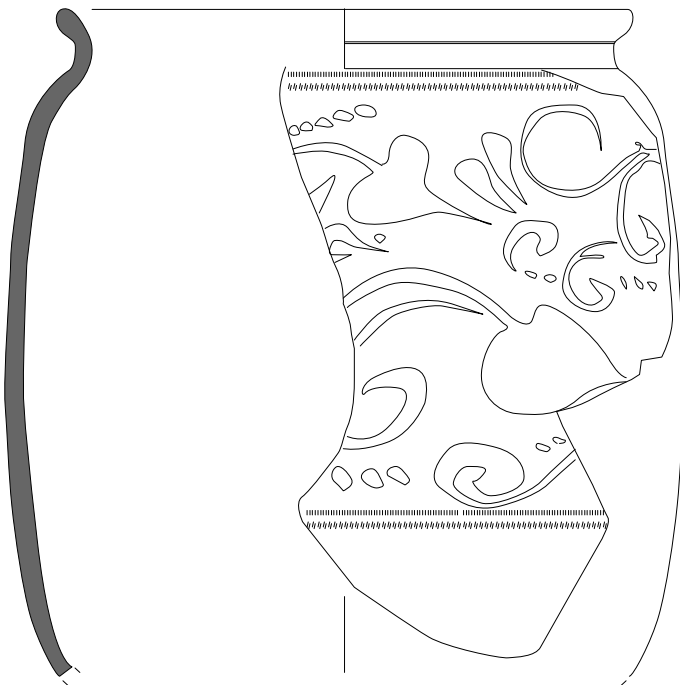

31

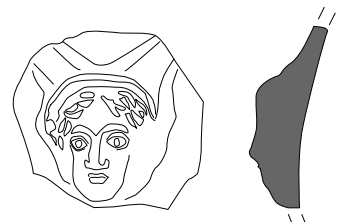

33

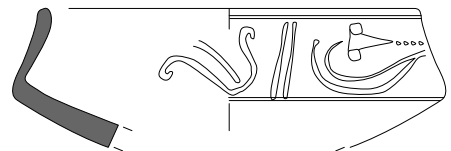

34

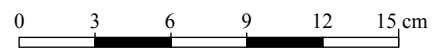

HORS CONTEXTE

Planche VII

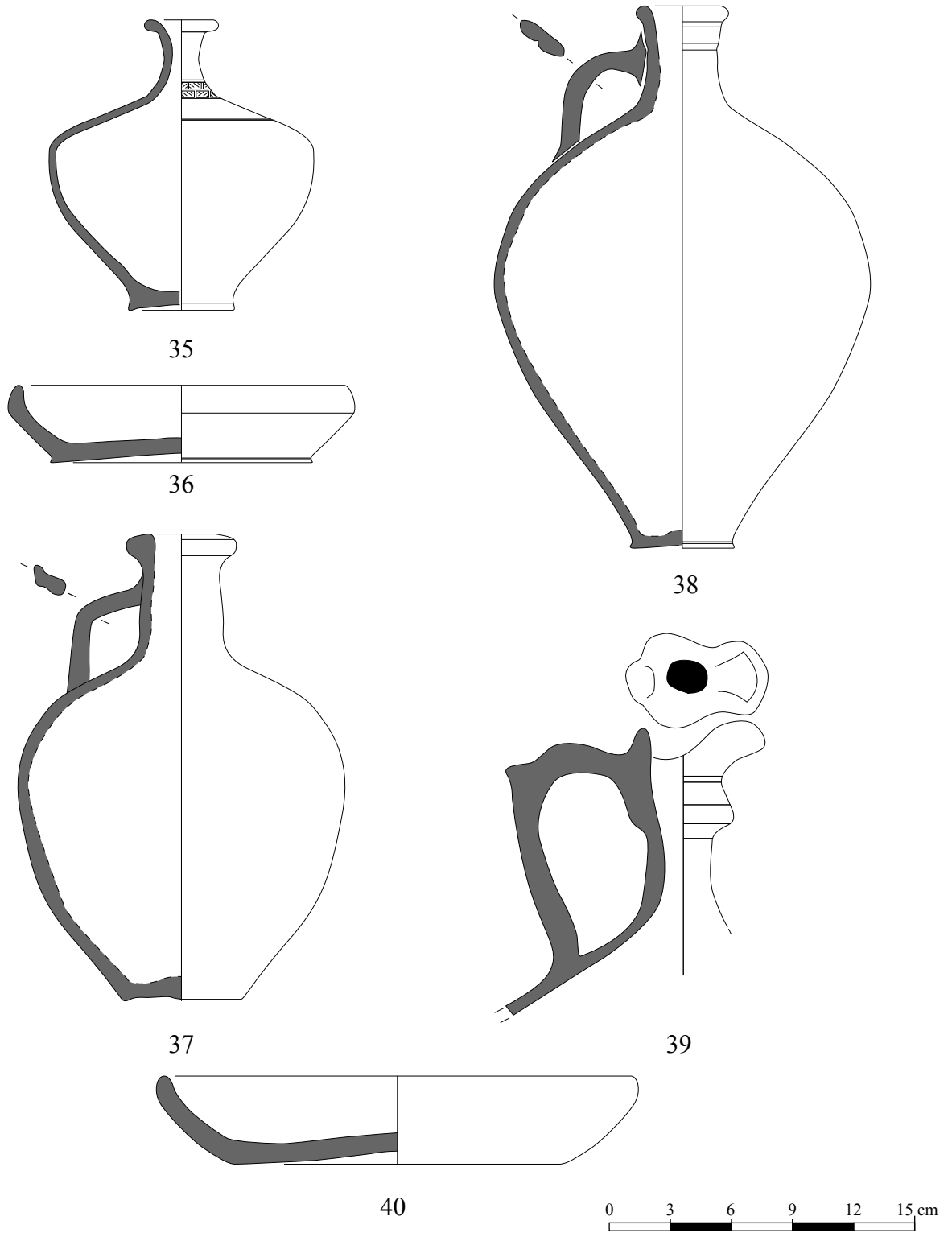

HORS CONTEXTE

Planche VIII

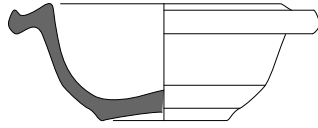

41

PWNF



42

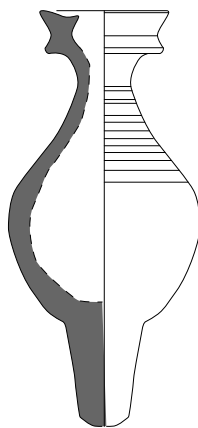

43

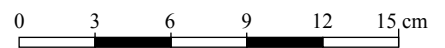

ANNEXE B : LES ROISES

| année | n° OA | Rayon | Caisse | n° ordre | Carré | Catégorie | Comptage | | | | | | Typologie | Desc. Typo. | Dessin | Planche | |
|-----------|----------|-------|--------|-------------|-----------------|-----------|----------|---|---|---|---|----|-----------|-------------|------------|---------|-----|
| | | | | | | | B | F | A | D | P | NR | | | | | NMI |
| 1977 | | 64-2 | 583 | 119 | F15 | TS SG | 1 | | | | | 1 | 1 | assiette | Drag. 15 | 1 | I |
| 1977 | 7823 | 63-2 | 553 | 37 | G13 | TS SG | 1 | | | | | 1 | 1 | assiette | Drag. 15 | 2 | I |
| 1983 | 7824 | 65-4 | 603 | 202 | H14 | TS SG | 1 | | | | | 1 | 1 | assiette | Drag. 15 | | |
| 1982 | 7823 | 64-5 | 1470 | 534 | H15-D15- D17 | TS SG | 1 | | | | | 1 | 1 | assiette | Drag. 15 | 3 | I |
| 1985 | | BAL | 1466 | 244 | Cave | TS SG | 2 | 2 | | | 1 | 5 | 1 | assiette | Drag. 15 | 4 | I |
| 1980 | | 66-4 | 1474 | 743 | E15III | TS SG | 1 | | | | | 11 | 1 | assiette | Drag. 15 | | |
| 1981 | | 66-4 | 1474 | 747 | G15-G16 | TS SG | | 1 | | | | 1 | 1 | assiette | Drag. 15 | | |
| 1980 | | 35-1 | 1441 | 245 | G16 | TS SG | 1 | | | | | 1 | 1 | assiette | Drag. 15 | | |
| 1983 | 7824 | 67-4 | 1469 | 497 | H14 | TS SG | 2 | | | | | 1 | 1 | assiette | Drag. 15 | | |
| 1983 | | 64-2 | 583 | 116 | H15 | TS SG | 1 | | | | | 1 | 1 | assiette | Drag. 15a | 5 | I |
| 1980 | 7803 | 32-1 | 1447 | 281 | F16 | TS SG | 2 | 4 | | | | 6 | 1 | assiette | Drag. 15a | 6 | I |
| 1980 | | 64-2 | 583 | 129 | F16 | TS SG | 7 | 2 | | | | 9 | 1 | assiette | Drag. 15a | 7 | I |
| 1980 | | 64-2 | 583 | 129 | F16 | TS SG | 1 | | | | | 1 | 1 | assiette | Drag. 15a | | |
| 1979 | | 64-2 | 583 | 118 | G17 | TS SG | | | | 1 | | 1 | 1 | assiette | Drag. 15a | 8 | I |
| 1980-1981 | 7803 | 32-1 | 1447 | 282 | F16-G16 | TS SG | 4 | | | | | 4 | 1 | assiette | Drag. 15b | 9 | I |
| 1983 | 7824 | 65-3 | 598 | 186 | H15 | TS SG | 1 | | | | | 1 | 1 | assiette | Drag. 15b2 | 10 | I |
| | | 28-2 | 30 | 20 | D14 | TS SG | 1 | | | | | 1 | 1 | assiette | Drag. 18b | | |
| 1983 | 7824 | 65-3 | 598 | 186 | H15 | TS SG | 1 | | | | | 1 | 1 | assiette | Drag. 18b | 11 | I |
| 1983 | 7824 | 65-3 | 598 | 186 | H15 | TS SG | 2 | | | | | 2 | 1 | assiette | Drag. 18b | 12 | I |
| 1977 | 7823 | 63-2 | 553 | 37 | G13 | TS SG | 1 | | | | | 1 | 1 | assiette | Drag. 18b | 13 | I |
| 1977 | 7823 | 63-2 | 553 | 37 | G13 | TS SG | 1 | | | | | 1 | 1 | assiette | Drag. 18b | 14 | I |
| 1982 | | 63-3 | 558 | 67 | H15 | TS SG | 1 | | | | | 1 | 1 | assiette | Drag. 18b | 15 | I |
| 1980 | | 66-4 | 1474 | 692 | D15 | TS SG | 1 | | | | | 1 | 1 | assiette | Drag. 18b | | |
| 1981 | | 63-2 | 555 | 55 | G15-G16 | TS SG | 1 | | | | | 1 | 1 | assiette | Drag. 18b | | |
| 1979 | | 35-1 | 1441 | 243 | G16 | TS SG | 1 | | | | | 1 | 1 | assiette | Drag. 18b | | |

ANNEXE B : LES ROISES

| année | n° OA | Rayon | Caisse | n° ordre | Carré | Catégorie | Comptage | | | | | | | Typologie | Desc. Typo. | Dessin | Planche |
|-------|----------|-------|--------|-------------|----------------------------|-----------|----------|---|---|---|---|----|-----|-----------|-------------|--------|---------|
| | | | | | | | B | F | A | D | P | NR | NMI | | | | |
| 1983 | 7824 | 65-4 | 603 | 202 | H14 | TS SG | 3 | | | | | 3 | 1 | assiette | Drag. 18b | | |
| 1983 | 7824 | 67-4 | 1469 | 513 | J16 | TS SG | 1 | | | | | 1 | 1 | assiette | Drag. 18b | | |
| 1984 | 7825 | 67-3 | 1467 | 407 | M10X | TS SG | 1 | | | | | 1 | 1 | assiette | Drag. 18b | | |
| 1984 | 7825 | 67-3 | 1467 | 404 | P8II | TS SG | 2 | | | | | 1 | 1 | assiette | Drag. 18b | | |
| 1984 | 7825 | 67-3 | 1467 | 373 | P8III | TS SG | 1 | | | | | 1 | 1 | assiette | Drag. 18b | | |
| 1984 | 7825 | 67-3 | 1467 | 365 | P7 | TS SG | 3 | 2 | | | 3 | 8 | 1 | assiette | Drag. 18b | | |
| 1980 | | 28-2 | 30 | 12 | G16 | TS SG | 1 | | | | | 1 | 1 | coupe | Drag. 27 | | |
| 1976 | 7823 | 63-2 | 553 | 40 | G12 | TS SG | 1 | | | 1 | | 2 | 1 | coupe | Drag. 29b | | |
| 1980 | | 66-4 | 1474 | 700 | E14a | TS SG | 2 | | | | | 2 | 1 | coupe | Drag. 29b | | |
| 1979 | 7803 | 32-1 | 1445 | 265 | G8-G16- G15-F15- F15 | TS SG | | | | 2 | | 2 | 1 | coupe | Drag. 29b | | |
| 1982 | | 63-3 | 558 | 67 | H15 | TS SG | 1 | | | | | 1 | 1 | coupe | Drag. 29b | | |
| 1982 | | 35-1 | 1443 | 250 | H16 | TS SG | | | | 3 | | 3 | 1 | coupe | Drag. 29b | | |
| 1984 | 7825 | 67-3 | 1467 | 378 | P8III | TS SG | | | | 1 | | 1 | 1 | coupe | Drag. 29b | | |
| 1979 | 7803 | 63-2 | 552 | 36 | G16 | TS SG | 1 | | 2 | | | 3 | 1 | coupe | Drag. 29b | | |
| | | 28-2 | 30 | 32 | M10 | TS SG | 1 | | | | 1 | 2 | 1 | coupe | Drag. 37 | 16 | I |
| 1984 | 7825 | 67-3 | 1467 | 399 | P8I | TS SG | 1 | | | | | 1 | 1 | coupe | Drag. 37 | | |
| 1984 | 7825 | 67-3 | 1467 | 405 | Q8III | TS SG | 1 | | | | | 1 | 1 | coupe | Drag. 37 | | |
| 1983 | 7824 | 65-3 | 598 | 186 | H15 | TS SG | 1 | | | | | 1 | 1 | coupe | Hermet 31 | 17 | I |
| 1982 | | 63-3 | 558 | 67 | H15 | TS SG | 1 | | | | | 1 | 1 | coupe | Hermet 31 | 18 | II |
| 1981 | | 67-3 | 1468 | 468 | F16 | TS SG | 3 | | | | | 3 | 1 | coupe | Ritt. 12 | 19 | II |
| 1984 | | 32-1 | 1446 | 273 | L11 | TS SG | 1 | | | | | 1 | 1 | coupe | Ritt. 12 | | |
| 1983 | | 33-1 | 1448 | 291 | H14 | TS SG | 2 | 3 | | | | 5 | 1 | coupelle | Drag. 22a | | |
| 1982 | | 28-5 | 1471 | 586 | H15 | TS SG | | 1 | | | | 1 | 1 | coupelle | Drag. 22a | | |
| 1984 | 7825 | 67-3 | 1467 | 376 | P7 | TS SG | 1 | | | | | 1 | 1 | coupelle | Drag. 22a | | |
| 1984 | 7825 | 65-5 | 606 | 206 | P8 | TS SG | 2 | | | | | 2 | 1 | coupelle | Drag. 22a | | |

ANNEXE B : LES ROISES

| année | n° OA | Rayon | Caisse | n° ordre | Carré | Catégorie | Comptage | | | | | | Typologie | Desc. Typo. | Dessin | Planche | |
|-------|----------|-------|--------|-------------|---------|-----------|----------|---|---|---|----|----|-----------|-------------|-------------|---------|-----|
| | | | | | | | B | F | A | D | P | NR | | | | | NMI |
| 1983 | 7824 | 65-4 | 603 | 202 | H14 | TS SG | 1 | | | | | 1 | 1 | coupelle | Drag. 24/25 | | |
| 1983 | 7824 | 66-3 | 1472 | 636 | H14 | TS SG | | 1 | | | 1 | 2 | 1 | coupelle | Drag. 24/25 | 20 | II |
| 1980 | | 66-4 | 1474 | 703 | F14 | TS SG | 1 | | | | | 1 | 1 | coupelle | Drag. 24/25 | | |
| 1979 | 7803 | 63-2 | 552 | 36 | G16 | TS SG | 2 | | | | | 2 | 1 | coupelle | Drag. 24/25 | | |
| 1980 | 7803 | 32-1 | 1447 | 285 | G16 | TS SG | 5 | | | 1 | | 6 | 1 | coupelle | Drag. 27 | 21 | II |
| 1982 | 7823 | 64-5 | 1470 | 549 | H15 | TS SG | | 1 | | | | 1 | 1 | coupelle | Drag. 27 | | |
| 1984 | | BAL | 1466 | 341 | M10X | TS SG | 1 | | | | | 1 | 1 | coupelle | Drag. 27 | 22 | II |
| 1981 | | 63-2 | 555 | 55 | G15-G16 | TS SG | 1 | | | | | 1 | 1 | coupelle | Drag. 27 | | |
| 1979 | | 32-1 | 1445 | 274 | G17 | TS SG | 2 | | | | | 2 | 1 | coupelle | Drag. 27 | | |
| 1983 | 7824 | 67-4 | 1469 | 485 | H15 | TS SG | | 1 | | | | 1 | 1 | coupelle | Drag. 27 | | |
| 1984 | 7825 | 66-4 | 1473 | 687 | M10XII | TS SG | 1 | | | | | 1 | 1 | coupelle | Drag. 27 | | |
| 1984 | 7825 | 67-3 | 1467 | 387 | P8III | TS SG | 1 | | | | | 1 | 1 | coupelle | Drag. 27 | | |
| 1983 | 7824 | 67-4 | 1469 | 506 | H14 | TS SG | 2 | | | | | 1 | 1 | coupelle | Drag. 27 | | |
| 1981 | | 67-3 | 1468 | 468 | F16 | TS SG | 4 | | | | | 4 | 1 | coupelle | Drag. 27b | 23 | II |
| 1981 | | 63-5 | 564 | 87 | H7 | TS SG | 1 | | | | | 1 | 1 | coupelle | Drag. 27b | | |
| 1981 | | 67-3 | 1468 | 422 | Cave | TS SG | 5 | 1 | | | 12 | 18 | 1 | coupelle | Drag. 27c | | |
| 1984 | | BAL | 1466 | 342 | M10 XI | TS SG | 1 | | | | | 1 | 1 | coupelle | Drag. 35 | 24 | II |
| 1981 | | 63-2 | 555 | 55 | G15-G16 | TS SG | 1 | | | | | 1 | 1 | coupelle | Drag. 35 | | |
| 1983 | 7824 | 67-4 | 1469 | 481 | H15 | TS SG | 1 | | | | | 1 | 1 | coupelle | Drag. 35 | | |
| 1984 | | 32-1 | 1446 | 273 | L11 | TS SG | 2 | | | | | 2 | 1 | coupelle | Drag. 35 | | |
| 1984 | | BAL | 1466 | 418 | M10X | TS SG | 1 | | | | | 1 | 1 | coupelle | Drag. 35 | | |
| 1984 | | 35-1 | 1443 | 251 | N9 | TS SG | 1 | | | | | 1 | 1 | coupelle | Drag. 35 | | |
| 1984 | 7825 | 67-3 | 1467 | 416 | P7 | TS SG | 1 | | | | | 1 | 1 | coupelle | Drag. 35 | | |
| 1984 | 7825 | 65-5 | 606 | 206 | P8 | TS SG | 1 | | | | | 1 | 1 | coupelle | Drag. 35 | | |
| 1984 | 7825 | 67-3 | 1467 | 354 | P8II | TS SG | 1 | | | | | 1 | 1 | coupelle | Drag. 35 | | |
| 1984 | 7825 | 67-3 | 1467 | 377 | P8III | TS SG | 1 | | | | | 1 | 1 | coupelle | Drag. 35 | | |

ANNEXE B : LES ROISES

| année | n° OA | Rayon | Caisse | n° ordre | Carré | Catégorie | Comptage | | | | | | Typologie | Desc. Typo. | Dessin | Planche | |
|-------|----------|-------|--------|-------------|-------------------------------------|-----------|----------|---|---|---|---|----|-----------|------------------------------|--------------------------|---------|-----|
| | | | | | | | B | F | A | D | P | NR | | | | | NMI |
| 1984 | 7825 | 67-3 | 1467 | 374 | P8IV | TS SG | 1 | | | | | 1 | 1 | coupelle | Drag. 35 | | |
| 1984 | 7825 | 66-4 | 1473 | 688 | M10IX | TS SG | 1 | | | | | 1 | 1 | coupelle | VernhetC1 ou Drag. 46 | | |
| | | 62-3 | 571 | 101 | sans n° | TS SG | 1 | | | | | 1 | 1 | tasse | Drag. 33c | 25 | II |
| 1984 | 7825 | 63-4 | 1467 | 394 | N9V | TS SG | 1 | | | | | 1 | 1 | mortier | Hermet 23 | 26 | II |
| 1984 | 7825 | 67-3 | 1467 | 397 | N9VII | TS SG | 1 | | | | | 1 | 1 | mortier | Hermet 23 | 27 | II |
| 1981 | | 66-3 | 1465 | 321 | H16 | TS SG | | | | 1 | | 1 | 1 | décor | | 28 | II |
| 1983 | | 64-2 | 583 | 116 | H15 | TS SG | | | | 1 | | 1 | | | | | |
| 1983 | 7824 | 66-3 | 1472 | 633 | H14 | TS SG | | 1 | | | | 1 | 1 | estampille [OFIC.PRIM...] | | 29 | III |
| 1984 | 7825 | 67-3 | 1467 | 413 | M10XII | TS SG | | 1 | | | | 1 | 1 | estampille [...VIMI] | | 30 | III |
| 1981 | | 66-3 | 1465 | 326 | H16 | TS SG | | 1 | | | | 1 | 1 | estampille [CELSI] | | 31 | III |
| 1979 | 7803 | 32-1 | 1445 | 265 | G8-G16- G15-F15- F15 | TS SG | | 1 | | | | 1 | 1 | estampille [...MIOI] | | 32 | III |
| | | 62-3 | 571 | 101 | sans n° | TS SG | | 1 | | | | 1 | 1 | estampille [OFIC.PRIM...] | | 33 | III |
| 1983 | 7824 | 65-3 | 598 | 186 | H15 | TS SG | | 1 | | | | 1 | | | | | |
| | | 64-4 | 590 | 147 | B21 ou E14 | TS SG | | | | | 1 | 1 | | | | | |
| 1982 | 7823 | 65-2 | 596 | 180 | C13 | TS SG | | | | | 2 | 2 | | | | | |
| 1982 | 7823 | 65-2 | 596 | 178 | C13-D13 | TS SG | | | | | 4 | 4 | | | | | |
| 1973 | | 64-3 | 586 | 140 | Croisement des deux tranchées | TS SG | | | | | 1 | 1 | | | | | |
| 1973 | | 64-3 | 586 | 139 | F | TS SG | | | | | 1 | 1 | | | | | |
| 1977 | | 64-2 | 583 | 113 | W | TS SG | | | | | 2 | 2 | | | | | |

ANNEXE B : LES ROISES

| année | n° OA | Rayon | Caisse | n° ordre | Carré | Catégorie | Comptage | | | | | | Typologie | Desc. Typo. | Dessin | Planche |
|-------|----------|-------|--------|-------------|---------|-----------|----------|---|---|---|----|----|-----------|-------------|--------|---------|
| | | | | | | | B | F | A | D | P | NR | | | | |
| 1975 | | 64.2 | 583 | 117 | Bode 5 | TS SG | | | | 2 | 3 | 5 | | | | |
| 1983 | 7824 | 65-4 | 604 | 204 | Cave | TS SG | | 2 | | | 7 | 9 | | | | |
| 1983 | 7824 | 65-4 | 604 | 204 | Cave | TS SG | | 1 | | | | 1 | | | | |
| 1981 | | 67-3 | 1468 | 423 | Cave | TS SG | | 1 | | | 6 | 7 | | | | |
| 1982 | 7823 | 64-5 | 1470 | 536 | E13-E14 | TS SG | | 1 | | | | 1 | | | | |
| 1981 | | 67-3 | 1468 | 463 | E15 | TS SG | | | | 1 | | 1 | | | | |
| | | 28-2 | 30 | 27 | F14 | TS SG | | | | | 1 | 1 | | | | |
| 1980 | | 64-2 | 583 | 129 | F16 | TS SG | | | | 1 | | 1 | | | | |
| | | 28-2 | 30 | 23 | F-G15 | TS SG | | | | | 2 | 2 | | | | |
| 1979 | | 63-5 | 564 | 84 | G12-G13 | TS SG | | | | | 4 | 4 | | | | |
| 1977 | | 64-2 | 583 | 122 | G13 | TS SG | | | | 1 | | 1 | | | | |
| 1977 | 7823 | 63-2 | 553 | 37 | G13 | TS SG | | 5 | | 1 | 53 | 59 | | | | |
| 1981 | | 66-3 | 1465 | 330 | G16-G15 | TS SG | | 1 | | | | 1 | | | | |
| 1983 | 7823 | 64-5 | 1470 | 560 | H15 | TS SG | | | | | 1 | 1 | | | | |
| 1982 | 7823 | 64-5 | 1470 | 568 | H15 | TS SG | | 1 | | | | 1 | | | | |
| 1982 | 7823 | 64-5 | 1470 | 546 | H15 | TS SG | | 1 | | | | 1 | | | | |
| 1981 | | 67-3 | 1468 | 474 | H16-G16 | TS SG | | | | 1 | | 1 | | | | |
| 1981 | | 67-3 | 1468 | 455 | H16 | TS SG | | | | 1 | | 1 | | | | |
| 1981 | | 67-3 | 1468 | 462 | H17 | TS SG | | | | 1 | | 1 | | | | |
| 1981 | | 67-3 | 1468 | 452 | H17 | TS SG | | | | | 1 | 1 | | | | |
| 1984 | | 63-4 | 563 | 82 | M10 | TS SG | | | | | 80 | 80 | | | | |
| 1984 | 7825 | 67-3 | 1467 | 357 | P8I | TS SG | | | | | 3 | 3 | | | | |
| | | 62-4 | 576 | 206 | Cave | TS SG | | | | | 1 | 1 | | | | |
| 1980 | | 66-4 | 1474 | 728 | E15III | TS SG | | 1 | | | | 1 | | | | |
| 1980 | | 63-3 | 559 | 168 | F16 | TS SG | | 3 | | | 40 | 43 | | | | |
| 1977 | | 63-2 | 555 | 53 | G14 | TS SG | | 3 | | | 15 | 18 | | | | |

ANNEXE B : LES ROISES

| année | n° OA | Rayon | Caisse | n° ordre | Carré | Catégorie | Comptage | | | | | | | Typologie | Desc. Typo. | Dessin | Planche |
|-------|----------|-------|--------|-------------|---------|-----------|----------|---|---|---|----|----|-----|-----------|-------------|--------|---------|
| | | | | | | | B | F | A | D | P | NR | NMI | | | | |
| 1977 | | 63-2 | 555 | 51 | G14-G15 | TS SG | | | | | 10 | 10 | | | | | |
| 1981 | | 63-2 | 555 | 55 | G15-G16 | TS SG | | | | | 7 | 7 | | | | | |
| 1979 | 7803 | 63-2 | 552 | 36 | G16 | TS SG | | | 3 | | 25 | 28 | | | | | |
| 1975 | 7782 | 65-3 | 600 | 197 | H13 | TS SG | | | | | 4 | 4 | | | | | |
| 1983 | 7824 | 67-4 | 1469 | 504 | H14 | TS SG | | 1 | | | | 1 | | | | | |
| 1983 | 7824 | 67-4 | 1469 | 498 | H14 | TS SG | | 1 | | | | 1 | | | | | |
| 1976 | | 63-3 | 558 | 68 | H15 | TS SG | | | | | 2 | 2 | | | | | |
| 1982 | | 63-3 | 558 | 67 | H15 | TS SG | | | | | 39 | 39 | | | | | |
| 1982 | | 33-1 | 1448 | 292 | H15 | TS SG | | 1 | | | | 1 | | | | | |
| 1983 | 7824 | 66-3 | 1472 | 629 | J16 | TS SG | | | | | 1 | 1 | | | | | |
| 1982 | | 63-3 | 556 | 58 | J16 | TS SG | | 1 | | | 16 | 17 | | | | | |
| 1975 | | 65-2 | 597 | 183 | K12 | TS SG | | | | | 5 | 5 | | | | | |
| 1983 | 7824 | 67-4 | 1469 | 510 | K14 | TS SG | | | | 1 | | 1 | | | | | |
| 1984 | 7825 | 65-5 | 608 | 208 | L11 | TS SG | | 4 | | | 14 | 18 | | | | | |
| 1984 | 7825 | 67-3 | 1467 | 409 | L11XIII | TS SG | | | | 1 | | 1 | | | | | |
| 1975 | 7782 | 63-2 | 554 | 50 | L13 | TS SG | | | | | 5 | 5 | | | | | |
| 1983 | | 62-3 | 570 | 99 | M02 | TS SG | | | | | 10 | 10 | | | | | |
| 1984 | | BAL | 1466 | 395 | M10 XI | TS SG | | | | | 2 | 2 | | | | | |
| 1984 | 7825 | 67-3 | 1467 | 417 | M10XII | TS SG | | 1 | | | | 1 | | | | | |
| 1984 | 7825 | 67-3 | 1467 | 412 | M10XII | TS SG | | | | | 2 | | | | | | |
| 1984 | 7825 | 67-3 | 1467 | 359 | M10XII | TS SG | | | | 1 | | 1 | | | | | |
| 1968 | | 43-3 | 1387 | 214 | Mur | TS SG | | | | | 6 | 6 | | | | | |
| 1984 | 7825 | 67-3 | 1467 | 369 | N9VII | TS SG | | | | 1 | | 1 | | | | | |
| 1984 | 7825 | 67-3 | 1467 | 398 | N9VII | TS SG | | | | | 3 | 3 | | | | | |
| 1984 | 7825 | 67-3 | 1467 | 396 | P7 | TS SG | | 1 | | | | 1 | | | | | |
| 1984 | 7825 | 67-3 | 1467 | 386 | P8 | TS SG | | | | | 1 | 1 | | | | | |

ANNEXE B : LES ROISES

| année | n° OA | Rayon | Caisse | n° ordre | Carré | Catégorie | Comptage | | | | | | | Typologie | Desc. Typo. | Dessin | Planche |
|-------|----------|-------|--------|-------------|----------------------------|-----------|----------|---|---|---|---|----|-----|-----------|-------------|--------|---------|
| | | | | | | | B | F | A | D | P | NR | NMI | | | | |
| 1984 | 7825 | 67-3 | 1467 | 354 | P8II | TS SG | | | | 2 | | 2 | | | | | |
| 1984 | 7825 | 66-4 | 1474 | 674 | P8II | TS SG | | 1 | | | | 1 | | | | | |
| 1984 | 7825 | 67-3 | 1467 | 381 | P8III | TS SG | | | | | 1 | 1 | | | | | |
| 1984 | 7825 | 67-3 | 1467 | 393 | P8III | TS SG | | | | 1 | | 1 | | | | | |
| 1984 | 7825 | 67-3 | 1467 | 351 | P8III | TS SG | | | | 1 | | 1 | | | | | |
| 1984 | 7825 | 67-3 | 1467 | 379 | P8III | TS SG | | 1 | | | | 1 | | | | | |
| 1984 | 7825 | 67-3 | 1467 | 366 | Q8III | TS SG | | | | | 2 | 2 | | | | | |
| | 7825 | 28-2 | 30 | 3 | Q8 IV | TS SG | | 1 | | | | 1 | | | | | |
| 1977 | 7823 | 63-2 | 553 | 37 | G13 | TS CG | 1 | | | | | 1 | 1 | coupe | Drag. 37 | 34 | III |
| 1977 | 7823 | 63-2 | 553 | 37 | G13 | TS CG | | | | 2 | 2 | 4 | | | | | |
| 1982 | 7823 | 64-5 | 1470 | 520 | J16-J17 | TS CG | | | 1 | | | 1 | | | | | |
| 1981 | | 67-3 | 1468 | 470 | D15 | TS CG | | | | 1 | | 1 | | | | | |
| 1983 | 7824 | 65-3 | 598 | 186 | H15 | TS GE | 2 | | | | | 2 | 1 | assiette | Drag. 18/31 | 35 | III |
| 1977 | 7823 | 63-2 | 553 | 37 | G13 | TS GE | 1 | | | | | 1 | 1 | assiette | Drag. 32 | 36 | III |
| 1975 | | 35-1 | 1444 | 426 | L13 | TS GE | 4 | | | | | 4 | 1 | assiette | Drag. 32 | | |
| 1983 | 7824 | 65-3 | 598 | 186 | H15 | TS GE | 1 | | | | | 1 | 1 | coupe | Drag. 37 | 37 | III |
| 1983 | 7824 | 65-4 | 604 | 204 | Cave | TS GE | 1 | | | | | 1 | 1 | coupe | Drag. 37 | | |
| 1980 | | 66-4 | 1474 | 702 | E14c | TS GE | 1 | | | | | 1 | 1 | coupe | Drag. 37 | | |
| 1979 | 7803 | 32-1 | 1445 | 265 | G8-G16- G15-F15- F15 | TS GE | 1 | | | 2 | | 3 | 1 | coupe | Drag. 37 | | |
| 1981 | | 63-2 | 555 | 55 | G15-G16 | TS GE | 1 | | | | | 1 | 1 | coupe | Drag. 37 | | |
| 1981 | | 63-2 | 555 | 55 | G15-G16 | TS GE | 1 | | | | | 1 | 1 | coupe | Drag. 37 | | |
| 1983 | 7824 | 65-4 | 603 | 202 | H14 | TS GE | 1 | | | | | 1 | 1 | coupe | Drag. 37 | | |
| 1983 | 7824 | 65-4 | 603 | 203 | H14-H15- J14-J15 | TS GE | 1 | | | | 3 | 4 | 1 | coupe | Drag. 37 | | |
| 1983 | 7824 | 65-3 | 598 | 186 | H15 | TS GE | 1 | | | | | 1 | 1 | coupe | Drag. 37 | | |

ANNEXE B : LES ROISES

| année | n° OA | Rayon | Caisse | n° ordre | Carré | Catégorie | Comptage | | | | | | | Typologie | Desc. Typo. | Dessin | Planche |
|-------|----------|-------|--------|-------------|---------|-----------|----------|---|---|---|----|----|-----|-----------|-------------|--------|---------|
| | | | | | | | B | F | A | D | P | NR | NMI | | | | |
| 1983 | 7824 | 67-4 | 1469 | 490 | J14 | TS GE | 1 | | | | 1 | 2 | 1 | coupe | Drag. 37 | | |
| 1983 | 7824 | 66-3 | 1472 | 641 | J14 | TS GE | 2 | 1 | | | | 2 | 1 | coupe | Drag. 37 | | |
| 1983 | 7824 | 33-1 | 1450 | 307 | J14 | TS GE | 5 | 2 | | | 6 | 13 | 1 | coupe | Drag. 37 | | |
| 1982 | | 33-1 | 1450 | 310 | Puits | TS GE | 1 | | | | | 1 | 1 | coupelle | Drag. 33 | 38 | III |
| 1977 | 7823 | 63-2 | 553 | 40 | G12 | TS GE | 1 | | | | | 1 | 1 | coupelle | Drag. 40 | 39 | III |
| 1983 | 7824 | 67-4 | 1469 | 482 | H15 | TS GE | | 2 | | | | 1 | 1 | mortier | Drag. 45 | | |
| 1983 | 7824 | 66-3 | 1472 | 607 | J14 | TS GE | | 1 | | | | 1 | 1 | mortier | Drag. 45 | | |
| 1983 | 7824 | 66-3 | 1472 | 606 | J14 | TS GE | | 1 | | | | 1 | 1 | mortier | Drag. 45 | | |
| 1983 | | 28-2 | 30 | 5 | J15 | TS GE | | | | | 1 | 1 | 1 | mortier | Drag. 45 | | |
| 1983 | 7824 | 66-3 | 1472 | 609 | J15 | TS GE | | 1 | | | | 1 | 1 | mortier | Drag. 45 | | |
| 1982 | | 34-1 | 1437 | 220 | J15 | TS GE | 2 | | | | | 2 | 1 | mortier | Drag. 45 | | |
| 1982 | | 28-5 | 1471 | 584 | J16-J17 | TS GE | 1 | | | | | 1 | 1 | mortier | Drag. 45 | | |
| 1983 | | 62-3 | 570 | 99 | M02 | TS GE | | | | | 1 | 1 | 1 | mortier | Drag. 45 | | |
| 1983 | 7824 | 65-3 | 598 | 186 | H15 | TS GE | | | | | 3 | 3 | | | | | |
| 1983 | | 62-3 | 570 | 99 | M02 | TS GE | | 3 | | | 2 | 5 | | | | | |
| 1983 | 7824 | 65-3 | 598 | 186 | H15 | TS GE | | | | 1 | | 1 | | | | | |
| 1976 | | 65-3 | 600 | 195 | H12 | TS GE | | | | | 10 | 10 | | | | | |
| 1983 | 7824 | 65-4 | 604 | 204 | Cave | TS AR | 1 | | | | | 1 | 1 | assiette | Drag. 18/31 | 40 | IV |
| 1983 | 7824 | 65-4 | 603 | 202 | H14 | TS AR | 1 | | | | | 1 | 1 | assiette | Drag. 18/31 | | |
| 1983 | | 62-3 | 570 | 99 | M02 | TS AR | 1 | | | | | 1 | 1 | assiette | Drag. 18/31 | | |
| 1977 | 7823 | 63-2 | 553 | 37 | G13 | TS AR | 1 | | | | | 1 | 1 | assiette | Drag. 32 | 41 | IV |
| 1981 | | 63-5 | 564 | 87 | H7 | TS AR | 1 | | | | | 1 | 1 | coupe | Drag. 37 | | |
| 1983 | 7824 | 65-4 | 604 | 204 | Cave | TS AR | 1 | | | | | 1 | 1 | coupe | Drag. 37 | 42 | IV |
| 1981 | | 67-3 | 1468 | 456 | E14 | TS AR | 1 | | | 1 | | 2 | 1 | coupe | Drag. 37 | 43 | IV |
| 1982 | | 63-3 | 559 | 78 | K16 | TS AR | 1 | | | | | 1 | 1 | coupe | Drag. 37 | 44 | IV |
| 1981 | | 67-3 | 1468 | 451 | D15 | TS AR | 1 | | | 2 | 1 | 4 | 1 | coupe | Drag. 37 | 45 | IV |

ANNEXE B : LES ROISES

| année | n° OA | Rayon | Caisse | n° ordre | Carré | Catégorie | Comptage | | | | | | | Typologie | Desc. Typo. | Dessin | Planche |
|-------|----------|-------|--------|-------------|---------|-----------|----------|---|---|---|---|----|-----|-----------|-------------|--------|---------|
| | | | | | | | B | F | A | D | P | NR | NMI | | | | |
| 1977 | 7823 | 63-2 | 553 | 46 | G12-G13 | TS AR | 1 | | | | | 1 | 1 | coupe | Drag. 37 | 46 | IV |
| 1982 | 7823 | 64-5 | 1470 | 554 | J16 | TS AR | 1 | | | | | 1 | 1 | coupe | Drag. 37 | 47 | IV |
| 1981 | | 67-3 | 1468 | 471 | H17 | TS AR | 1 | | | | | 1 | 1 | coupe | Drag. 37 | 48 | IV |
| 1976 | | 63-2 | 555 | 56 | G15 | TS AR | 2 | | | | | 2 | 1 | coupe | Drag. 37 | 49 | IV |
| 1977 | 7823 | 63-2 | 553 | 37 | G13 | TS AR | 1 | | | | | 1 | 1 | coupe | Drag. 37 | 50 | IV |
| 1977 | 7823 | 63-2 | 553 | 37 | G13 | TS AR | 2 | | | | | 2 | 1 | coupe | Drag. 37 | 51 | IV |
| 1977 | 7823 | 63-2 | 553 | 37 | G13 | TS AR | 2 | | | | | 2 | 1 | coupe | Drag. 37 | 52 | IV |
| 1977 | 7823 | 63-2 | 553 | 40 | G12 | TS AR | 1 | | | | | 1 | 1 | coupe | Drag. 37 | 53 | IV |
| 1983 | | 28-2 | 30 | 17 | H14 | TS AR | 1 | | | 1 | | 2 | 1 | coupe | Drag. 37 | 54 | V |
| 1983 | 7824 | 65-4 | 604 | 204 | Cave | TS AR | 1 | | | | | 1 | 1 | coupe | Drag. 37 | 55 | V |
| 1984 | 7825 | 65-5 | 606 | 206 | P8 | TS AR | 1 | | | | | 1 | 1 | coupe | Drag. 37 | | |
| 1982 | | 28-5 | 1471 | 591 | J16 | TS AR | 1 | | | | | 1 | 1 | coupe | Drag. 37 | | |
| 1982 | | 28-5 | 1471 | 578 | J16 | TS AR | 1 | | | | | 1 | 1 | coupe | Drag. 37 | | |
| 1982 | | 63-3 | 556 | 58 | J16 | TS AR | 1 | | | | | 1 | 1 | coupe | Drag. 37 | | |
| 1983 | | 66-3 | 1472 | 626 | K15 | TS AR | 1 | | | | | 1 | 1 | coupe | Drag. 37 | | |
| 1983 | | 62-3 | 570 | 99 | M02 | TS AR | 1 | | | | | 1 | 1 | coupe | Drag. 37 | | |
| 1983 | | 62-3 | 570 | 99 | M02 | TS AR | 1 | | | | | 1 | 1 | coupe | Drag. 37 | | |
| 1968 | | 43-3 | 1387 | 214 | Mur | TS AR | 1 | | | | | 1 | 1 | coupe | Drag. 37 | | |
| 1984 | 7825 | 67-3 | 1467 | 354 | P8II | TS AR | 1 | | | | | 1 | 1 | coupe | Drag. 37 | | |
| 1984 | 7825 | 65-4 | 602 | 200 | Q8 | TS AR | 2 | | | | | 2 | 1 | coupe | Drag. 37 | | |
| | | 5--2 | 1500 | 763 | sans n° | TS AR | 1 | | | | | 1 | 1 | coupe | Drag. 37 | | |
| | | 62-5 | 579 | 111 | sans n° | TS AR | 3 | 1 | | 4 | 4 | 12 | 1 | coupe | Drag. 37 | | |
| | | 62-3 | 571 | 101 | sans n° | TS AR | 1 | | | | | 1 | 1 | coupe | Drag. 37R | 56 | V |
| 1983 | | 62-3 | 570 | 99 | M02 | TS AR | 1 | | | | | 1 | 1 | coupe | Drag. 37 | | |
| 1983 | | 62-3 | 570 | 99 | M02 | TS AR | 1 | | | | | 1 | 1 | coupe | Drag. 37 | | |
| | | 62-3 | 571 | 101 | sans n° | TS AR | 3 | | | | | 3 | 1 | coupe | Drag. 38 | 57 | V |

ANNEXE B : LES ROISES

| année | n° OA | Rayon | Caisse | n° ordre | Carré | Catégorie | Comptage | | | | | | | Typologie | Desc. Typo. | Dessin | Planche |
|-------|----------|-------|--------|-------------|---------------|-----------|----------|---|---|---|----|----|-----|-----------|-------------|--------|---------|
| | | | | | | | B | F | A | D | P | NR | NMI | | | | |
| 1984 | 7825 | 67-3 | 1467 | 392 | N9VII | TS AR | 1 | | | | 3 | 4 | 1 | coupelle | Drag. 22a | | |
| 1984 | 7825 | 33-1 | 1449 | 302 | P8 51 | TS AR | 1 | | | | | 1 | 1 | coupelle | Drag. 22a | | |
| 1984 | 7825 | 67-3 | 1467 | 407 | M10X | TS AR | 1 | | | | | 1 | 1 | coupelle | Drag. 27 | | |
| 1976 | | 63-2 | 555 | 56 | G15 | TS AR | 1 | | | | | 1 | 1 | coupelle | Drag. 35 | 58 | V |
| 1976 | | 63-2 | 555 | 56 | G15 | TS AR | 1 | | | | | 1 | 1 | coupelle | Drag. 35 | | |
| 1982 | | 63-3 | 558 | 67 | H15 | TS AR | 2 | | | | | 2 | 1 | coupelle | Drag. 35 | | |
| 1983 | | 62-3 | 570 | 99 | M02 | TS AR | 6 | | | | | 6 | 1 | coupelle | Drag. 35 | | |
| | | 66-2 | 1506 | 770 | sans n° | TS AR | 1 | | | | | 1 | 1 | coupelle | Drag. 35 | | |
| | | 66-4 | 1511 | 774 | sans n° | TS AR | 1 | 1 | | | 14 | 16 | 1 | coupelle | Drag. 35 | | |
| 1982 | 7823 | 64-5 | 1470 | 556 | H15 | TS AR | 1 | 1 | | | | 2 | 1 | coupelle | Drag. 40 | 59 | V |
| 1982 | | BAL | 1466 | 338 | Puits | TS AR | 1 | | | | | 1 | 1 | coupelle | Drag. 40 | 60 | V |
| 1981 | | BAL | 1466 | 332 | Cave 1 | TS AR | 1 | | | | | 1 | 1 | coupelle | Drag. 40 | 61 | V |
| | | 62-3 | 571 | 101 | sans n° | TS AR | 1 | | | | | 1 | 1 | coupelle | Drag. 40 | 62 | V |
| 1977 | | 64-2 | 583 | 122 | G13 | TS AR | 1 | | | | | 1 | 1 | coupelle | Drag. 40 | 63 | V |
| 1982 | 7823 | 64-5 | 1470 | 557 | J16-J17 | TS AR | 1 | | | | | 1 | 1 | coupelle | Drag. 40 | 64 | V |
| 1982 | | 63-3 | 556 | 58 | J16 | TS AR | 1 | | | | | 1 | 1 | coupelle | Drag. 40 | 65 | V |
| 1976 | | 28-2 | 30 | 31 | H13 | TS AR | 4 | | | | 1 | 5 | 1 | coupelle | Drag. 40 | 66 | V |
| | | 64-2 | 1517 | 779 | sans n° | TS AR | 1 | | | | 1 | 2 | 1 | coupelle | Drag. 40 | | |
| 1981 | | BAL | 1466 | 340 | H17 ou M17 | TS AR | 1 | | | | | 1 | 1 | coupelle | Drag. 44 | 67 | V |
| 1982 | | 63-3 | 559 | 78 | K16 | TS AR | 1 | | | | | 1 | 1 | tasse | Drag. 33 | 68 | V |
| 1975 | 7782 | 63-2 | 554 | 49 | L12 | TS AR | 1 | | | | 6 | 7 | 1 | tasse | Drag. 33 | 69 | V |
| 1976 | | 63-2 | 555 | 56 | G15 | TS AR | 1 | | | | | 1 | 1 | tasse | Drag. 33 | 70 | VI |
| 1977 | | 33-1 | 1448 | 293 | G12-G13 | TS AR | 1 | | | | | 1 | 1 | tasse | Drag. 33 | | |
| 1983 | 7824 | 65-4 | 603 | 202 | H14 | TS AR | 1 | | | | | 1 | 1 | tasse | Drag. 33 | | |
| 1984 | 7825 | 65-4 | 602 | 200 | Q8 | TS AR | 1 | | | | | 1 | 1 | tasse | Drag. 33 | | |

ANNEXE B : LES ROISES

| année | n° OA | Rayon | Caisse | n° ordre | Carré | Catégorie | Comptage | | | | | | Typologie | Desc. Typo. | Dessin | Planche | |
|-------|----------|-------|--------|-------------|----------------------------|-----------|----------|---|---|----|----|----|-----------|--------------------------|----------|---------|-----|
| | | | | | | | B | F | A | D | P | NR | | | | | NMI |
| 1983 | | 28-2 | 30 | 8 | Cave | TS AR | 1 | | | | | 1 | 1 | mortier | Drag. 45 | 71 | VI |
| 1975 | | 62-3 | 571 | 102 | M11 | TS AR | 2 | | | | | 2 | 1 | mortier | Drag. 45 | 72 | VI |
| 1982 | 7823 | 64-5 | 1470 | 523 | H15 | TS AR | | 1 | | | | 1 | 1 | mortier | Drag. 45 | | |
| 1975 | 7782 | 33-1 | 1449 | 300 | H13 | TS AR | | | | 1 | | | 1 | mortier | Drag. 45 | | |
| 1983 | 7824 | 66-3 | 1472 | 603 | H15 | TS AR | | 2 | | | | 2 | 1 | mortier | Drag. 45 | | |
| 1983 | 7824 | 67-4 | 1469 | 482 | H15 | TS AR | | 2 | | | | 1 | 1 | mortier | Drag. 45 | | |
| 1983 | 7824 | 66-3 | 1472 | 607 | J14 | TS AR | | 1 | | | | 1 | 1 | mortier | Drag. 45 | | |
| 1983 | 7824 | 66-3 | 1472 | 606 | J14 | TS AR | | 1 | | | | 1 | 1 | mortier | Drag. 45 | | |
| 1983 | | 28-2 | 30 | 5 | J15 | TS AR | | | | 1 | | 1 | 1 | mortier | Drag. 45 | | |
| 1983 | 7824 | 66-3 | 1472 | 609 | J15 | TS AR | | 1 | | | | 1 | 1 | mortier | Drag. 45 | | |
| 1982 | | 34-1 | 1437 | 220 | J15 | TS AR | 2 | | | | | 2 | 1 | mortier | Drag. 45 | | |
| 1982 | | 28-5 | 1471 | 584 | J16-J17 | TS AR | 1 | | | | | 1 | 1 | mortier | Drag. 45 | | |
| 1983 | | 62-3 | 570 | 99 | M02 | TS AR | | | | 1 | | 1 | 1 | mortier | Drag. 45 | | |
| | | 62-3 | 571 | 101 | sans n° | TS AR | 1 | | | | | 1 | 1 | mortier | Drag. 45 | | |
| 1984 | 7825 | 67-3 | 1467 | 368 | P8II | TS AR | 1 | | | | | 1 | 1 | mortier | Curle 21 | | |
| 1981 | | BAL | 1466 | 339 | Cave | TS AR | | 1 | | | | 1 | 1 | gobelet | Dech. 72 | 73 | VI |
| 1982 | | 63-3 | 556 | 58 | J16 | TS AR | 1 | | | | | 1 | 1 | gobelet | | 74 | VI |
| | | 62-5 | 579 | 111 | sans n° | TS AR | | | | 22 | 22 | 1 | | | | | |
| 1982 | | 63-3 | 558 | 67 | H15 | TS AR | 1 | | | | | 1 | 1 | cruche | | 75 | VI |
| 1983 | 7824 | 65-4 | 604 | 204 | Cave | TS AR | 1 | | | | | 1 | 1 | | | 76 | VI |
| 1983 | 7824 | 66-3 | 1472 | 622 | K14 | TS AR | | 1 | | | | 1 | 1 | estampille [MARCE...] | | 77 | VI |
| 1979 | 7803 | 32-1 | 1445 | 265 | G8-G16- G15-F15- F15 | TS AR | | 1 | | | | 1 | 1 | estampille [IISVS] | | 78 | VI |
| 1981 | | 67-3 | 1468 | 461 | E14a | TS AR | | | | 1 | | 1 | 1 | | | 79 | VI |
| 1981 | | 67-3 | 1468 | 459 | E14d | TS AR | | | | 1 | | 1 | 1 | | | 80 | VII |

ANNEXE B : LES ROISES

| année | n° OA | Rayon | Caisse | n° ordre | Carré | Catégorie | Comptage | | | | | | | Typologie | Desc. Typo. | Dessin | Planche |
|-------|----------|-------|--------|-------------|---------------------|-----------|----------|---|---|----|----|----|-----|------------|-------------|--------|---------|
| | | | | | | | B | F | A | D | P | NR | NMI | | | | |
| 1981 | | 66-3 | 1465 | 327 | H17 | TS AR | | | | 1 | | 1 | 1 | | | 81 | VII |
| 1983 | 7803 | 32-1 | 1447 | 283 | J14-J15- H14-H15 | TS AR | | | | 1 | | 1 | | | | | |
| 1981 | | 66-3 | 1465 | 325 | D15 | TS AR | | | | 23 | | 23 | | A VOIR | | | |
| 1982 | 7823 | 64-5 | 1470 | 525 | C13 | TS AR | | | | 1 | | 1 | | | | | |
| 1982 | 7823 | 64.5 | 1470 | 527 | D13 | TS AR | | | | 1 | | 1 | | | | | |
| 1982 | 7823 | 64-5 | 1470 | 536 | E13-E14 | TS AR | | | | 1 | | 1 | | | | | |
| 1982 | 7823 | 64-5 | 1470 | 551 | J16-J17 | TS AR | | | 1 | | | 1 | | | | | |
| 1982 | 7823 | 64-5 | 1470 | 566 | J16 | TS AR | | | | 1 | | 1 | | | | | |
| 1982 | 7823 | 64-5 | 1470 | 538 | J16 | TS AR | | | | 1 | | 1 | | | | | |
| 1982 | 7823 | 64-5 | 1470 | 555 | J16 | TS AR | | | | 3 | | 3 | | | | | |
| 1982 | 7823 | 64-5 | 1470 | 567 | H15 | TS AR | | | | 1 | | 1 | | | | | |
| 1984 | | 3-1 | 1485 | 689 | 3 | TS AR | | 3 | | 4 | 28 | 35 | | | | | |
| 1977 | 7823 | 63-2 | 553 | 37 | G13 | TS AR | | 1 | | 4 | 14 | 19 | | | | | |
| 1977 | 7823 | 63-2 | 553 | 40 | G12 | TS AR | | | | | 9 | 9 | | TS AR TARD | | | |
| 1976 | | 64-2 | 583 | 121 | H13-H14 | TS AR | | | | 1 | | 1 | | TS AR TARD | | | |
| 1977 | | 64-2 | 583 | 113 | W | TS AR | | | | | 4 | 4 | | | | | |
| 1983 | 7824 | 65-4 | 604 | 204 | Cave | TS AR | | 3 | | | 35 | 38 | | | | | |
| 1973 | | 64-3 | 586 | 138 | C | TS AR | | | | | 4 | 4 | | | | | |
| 1982 | 7823 | 65-2 | 596 | 180 | C13 | TS AR | | | | | 15 | 15 | | | | | |
| 1984 | | 64-5 | 592 | 155 | D13 | TS AR | | | | | 16 | 16 | | | | | |
| 1980 | | 66-4 | 1474 | 730 | D14c | TS AR | | | | 1 | | 1 | | | | | |
| 1980 | | 66-4 | 1474 | 713 | D14d | TS AR | | 1 | | | | 1 | | | | | |
| 1981 | | 64-4 | 591 | 150 | E13 | TS AR | | | | | 16 | 16 | | | | | |
| 1980 | | 64-4 | 591 | 151 | E14 | TS AR | | 1 | | | 12 | 13 | | | | | |
| 1980 | | 66-4 | 1474 | 701 | E14c | TS AR | | | | | 1 | 1 | | | | | |

ANNEXE B : LES ROISES

| année | n° OA | Rayon | Caisse | n° ordre | Carré | Catégorie | Comptage | | | | | | | Typologie | Desc. Typo. | Dessin | Planche |
|-------|----------|-------|--------|-------------|-----------------|-----------|----------|---|---|---|----|----|-----|-----------|-------------|--------|---------|
| | | | | | | | B | F | A | D | P | NR | NMI | | | | |
| | | 28.2 | 30 | 29 | E15 | TS AR | | | | | 2 | 2 | | | | | |
| 1980 | | 66-4 | 1474 | 741 | E15b | TS AR | | | | | 4 | 4 | | | | | |
| 1980 | | 66-4 | 1474 | 742 | E15b | TS AR | | | | | 2 | 2 | | | | | |
| 1981 | | 64-4 | 591 | 149 | E15-F15 | TS AR | | | | | 1 | 1 | | | | | |
| 1981 | | 67-3 | 1468 | 450 | F14 | TS AR | | 1 | | | | 1 | | | | | |
| | | 3-1 | 1486 | 2 | F14 | TS AR | | | | | 1 | 1 | | | | | |
| 1977 | | 65-2 | 594 | 167 | F15 | TS AR | | | | | 15 | 15 | | | | | |
| 1981 | | 64-3 | 587 | 142 | F16 | TS AR | | | | | 7 | 7 | | | | | |
| | | 65-2 | 595 | 171 | F16-G16- G17 | TS AR | | | | | 1 | 1 | | | | | |
| | | 28-2 | 30 | 23 | F-G15 | TS AR | | | | | 4 | 4 | | | | | |
| 1977 | 7823 | 63-2 | 553 | 40 | G12 | TS AR | | | | 3 | 7 | 10 | | | | | |
| 1977 | 7823 | 63-2 | 553 | 40 | G12 | TS AR | | 1 | | | | 1 | | | | | |
| 1976 | 7823 | 63-2 | 553 | 40 | G12 | TS AR | | | | | 7 | 7 | | | | | |
| 1977 | 7823 | 63-2 | 553 | 46 | G12-G13 | TS AR | | | | | 4 | 4 | | | | | |
| 1979 | | 63-5 | 564 | 88 | G12-H12 | TS AR | | | | | 13 | 13 | | | | | |
| 1977 | | 64-2 | 583 | 122 | G13 | TS AR | | | | 1 | | 1 | | | | | |
| 1977 | | 33-1 | 1448 | 296 | G13 | TS AR | | 2 | | | | 2 | | | | | |
| 1976 | | 63-2 | 555 | 56 | G15 | TS AR | | | | | 39 | 39 | | | | | |
| 1979 | | 32-1 | 1445 | 267 | G15 | TS AR | | | | | 2 | 2 | | | | | |
| 1981 | | 63-2 | 555 | 55 | G15-G16 | TS AR | | | | | 10 | 10 | | | | | |
| 1980 | | 63-4 | 566 | 93 | G16 | TS AR | | | | | 21 | 21 | | | | | |
| 1981 | | 67-3 | 1468 | 458 | G16-H16 | TS AR | | | | 1 | | 1 | | | | | |
| 1981 | | 63-5 | 564 | 87 | H7 | TS AR | | | | | 13 | 13 | | | | | |
| 1976 | | 65-3 | 600 | 195 | H12 | TS AR | | | | | 8 | 8 | | | | | |
| 1975 | 7782 | 65-3 | 600 | 197 | H13 | TS AR | | | | | 18 | 18 | | | | | |

ANNEXE B : LES ROISES

| année | n° OA | Rayon | Caisse | n° ordre | Carré | Catégorie | Comptage | | | | | | Typologie | Desc. Typo. | Dessin | Planche |
|-----------------|----------|-------|--------|-------------|------------|-----------|----------|---|---|---|----|----|-----------|-------------|--------|---------|
| | | | | | | | B | F | A | D | P | NR | | | | |
| 1983 | 7824 | 65-4 | 603 | 202 | H14 | TS AR | | 3 | | | 12 | 15 | | | | |
| 1983 | 7824 | 67-4 | 1469 | 505 | H14 | TS AR | | 1 | | | | 1 | | | | |
| 1983 | 7824 | 67-4 | 1469 | 502 | H14 | TS AR | | | | | 1 | 1 | | | | |
| 1983 | 7824 | 67-4 | 1469 | 496 | H14 | TS AR | | 1 | | | | 1 | | | | |
| 1983 | 7824 | 65-3 | 598 | 186 | H15 | TS AR | | | | | 30 | 30 | | | | |
| 1982 | 7823 | 64-5 | 1470 | 539 | H15 | TS AR | | | | 1 | | 1 | | | | |
| 1982 | | 63-3 | 558 | 67 | H15 | TS AR | | | | | 4 | 4 | | | | |
| 1983 | 7824 | 65-3 | 598 | 186 | H15 | TS AR | | 3 | | | 13 | 16 | | | | |
| 1983 | 7824 | 67-4 | 1469 | 483 | H15 | TS AR | | 1 | | | | 1 | | | | |
| 1982 | | 28-5 | 1471 | 587 | H15 | TS AR | | 1 | | | 3 | 4 | | | | |
| 1981 | | 63-5 | 564 | 86 | H16 | TS AR | | | | | 4 | 4 | | | | |
| 1983 | 7824 | 66-3 | 1472 | 631 | H16 | TS AR | | | | | 1 | 1 | | | | |
| 1981 | | 67-3 | 1468 | 453 | H17 | TS AR | | | | 1 | | 1 | | | | |
| 1976/1977/19779 | | 63-4 | 561 | 80 | Hypocauste | TS AR | | | | | 23 | 23 | | | | |
| 1976 | | 63-3 | 557 | 65 | J13 | TS AR | | | | | 12 | 12 | | | | |
| 1983 | 7824 | 66-3 | 1472 | 640 | J14 | TS AR | | | | | 2 | 2 | | | | |
| 1982 | | 65-3 | 599 | 192 | J15 | TS AR | | | | | 34 | 34 | | | | |
| 1982 | 7823 | 64-5 | 1470 | 524 | J15-J16 | TS AR | | | | | 1 | 1 | | | | |
| 1982 | 7823 | 62-3 | 572 | 500 | J15-J16 | TS AR | | | | | 2 | 2 | | | | |
| 1982 | | 65-3 | 599 | 191 | J15-K15 | TS AR | | | | | 4 | 4 | | | | |
| 1982 | 7823 | 64-5 | 1470 | 563 | J16 | TS AR | | 1 | | | | 1 | | | | |
| 1982 | | 28-5 | 1471 | 585 | J16 | TS AR | | | | | 1 | 1 | | | | |
| 1982 | | 63-3 | 556 | 58 | J16 | TS AR | | | | | 27 | 27 | | | | |
| 1982 | 7823 | 64-5 | 1470 | 561 | J16-J17 | TS AR | | | | | 1 | 1 | | | | |
| 1982 | | 65-3 | 598 | 188 | J16-J17 | TS AR | | | | | 5 | 5 | | | | |
| 1974 | | 55-2 | 597 | 181 | K9 | TS AR | | | | | 3 | 3 | | | | |

ANNEXE B : LES ROISES

| année | n° OA | Rayon | Caisse | n° ordre | Carré | Catégorie | Comptage | | | | | | Typologie | Desc. Typo. | Dessin | Planche |
|-------|----------|-------|--------|-------------|--------|-----------|----------|---|---|---|-----|-----|-----------|-------------|--------|---------|
| | | | | | | | B | F | A | D | P | NR | | | | |
| 1975 | | 65-2 | 597 | 183 | K12 | TS AR | | | | | 12 | 12 | | | | |
| 1975 | | 63-3 | 559 | 73 | K13 | TS AR | | | | | 5 | 5 | | | | |
| 1983 | | 63-3 | 559 | 75 | K14 | TS AR | | | | | 12 | 12 | | | | |
| 1983 | 7824 | 67-4 | 1469 | 516 | K14 | TS AR | | | | | 1 | 1 | | | | |
| 1982 | | 63-3 | 559 | 602 | K15 | TS AR | | | | | 11 | 11 | | | | |
| 1982 | | 63-3 | 559 | 78 | K16 | TS AR | | | | | 7 | 7 | | | | |
| 1974 | 7816 | 63-2 | 554 | 48 | L11 | TS AR | | | | | 6 | 6 | | | | |
| 1984 | | 32-1 | 1446 | 273 | L11 | TS AR | | | | 1 | 2 | 3 | | | | |
| 1975 | 7782 | 63-2 | 554 | 50 | L13 | TS AR | | | | | 1 | 1 | | | | |
| 1983 | | 62-3 | 570 | 99 | M02 | TS AR | | 4 | | | 48 | 52 | | | | |
| 1984 | | 63-4 | 563 | 82 | M10 | TS AR | | | | | 14 | 14 | | | | |
| 1984 | | BAL | 1466 | 390 | M10 XI | TS AR | | | | | 1 | 1 | | | | |
| 1984 | 7825 | 67-3 | 1467 | 359 | M10XII | TS AR | | 1 | | 1 | 1 | 3 | | | | |
| 1968 | | 43-3 | 1387 | 214 | Mur | TS AR | | | | | 3 | 3 | | | | |
| 1984 | | 64-4 | 591 | 153 | N9 | TS AR | | | | | 124 | 124 | | | | |
| 1984 | 7825 | 67-3 | 1467 | 380 | N9V | TS AR | | | | | 1 | 1 | | | | |
| 1984 | 7825 | 67-3 | 1467 | 346 | N9V | TS AR | | | | | 1 | | | | | |
| 1984 | 7825 | 67-3 | 1467 | 347 | N9V | TS AR | | | | 1 | | 1 | | | | |
| 1984 | 7825 | 67-3 | 1467 | 401 | N9V | TS AR | | | | 1 | | 1 | | | | |
| 1984 | 7825 | 67-3 | 1467 | 360 | N9V | TS AR | | | | 1 | | 1 | | | | |
| 1984 | 7825 | 37-3 | 1467 | 353 | N9VII | TS AR | | | | 1 | | 1 | | | | |
| 1984 | 7825 | 34-1 | 1437 | 218 | P7 | TS AR | | 1 | | | | 1 | | | | |
| 1984 | 7825 | 67-3 | 1467 | 348 | P8III | TS AR | | | | | 3 | 3 | | | | |
| 1984 | 7825 | 67-3 | 1467 | 350 | P8III | TS AR | | | | | 1 | 1 | | | | |
| 1984 | 7825 | 65-4 | 602 | 200 | Q8 | TS AR | | 3 | | | 25 | 28 | | | | |
| 1984 | | 32-1 | 1445 | 278 | Q8 | TS AR | | 1 | | | 1 | 2 | | | | |

ANNEXE B : LES ROISES

| année | n° OA | Rayon | Caisse | n° ordre | Carré | Catégorie | Comptage | | | | | | | Typologie | Desc. Typo. | Dessin | Planche |
|-----------|----------|-------------------|---------|-------------|--------------------|-----------|----------|---|---|---|----|----|-----|-----------|-------------|--------|---------|
| | | | | | | | B | F | A | D | P | NR | NMI | | | | |
| 1984 | 7825 | 67-3 | 1467 | 402 | Q8 III et IV | TS AR | | 3 | | | | | | | | | |
| 1984 | 7825 | 67-3 | 1467 | 421 | Q8 IV | TS AR | | | | 1 | | 1 | | | | | |
| | | 62-4 | 575 | 47 | W | TS AR | | | | | 1 | 1 | | | | | |
| 1980 | | 63-4 | 562 | 81 | Wp | TS AR | | | | | 12 | 12 | | | | | |
| | | Musée Mosaïque | vitrine | | Inv.2009-0- 281 | EN AR | 3 | | | | | 3 | 1 | gobelet | Hees 2 | 82 | VII |
| 1977 | | 64-2 | 583 | 113 | W | EN AR | 1 | | | | | 1 | 1 | gobelet | Hees 2 | 83 | VII |
| 1984 | | 3-1 | 1485 | 689 | 3 | EN AR | 1 | | | | | 1 | 1 | gobelet | Hees 2 | 84 | VII |
| 1983 | 7824 | 65-4 | 604 | 204 | Cave | EN AR | 3 | | | | | 3 | 1 | gobelet | Hees 2 | 85 | VII |
| 1983 | 7824 | 65-4 | 604 | 204 | Cave | EN AR | 1 | | | | | 1 | 1 | gobelet | Hees 2 | 86 | VII |
| 1977 | 7823 | 63-2 | 553 | 40 | G12 | EN AR | 1 | | | | | 1 | 1 | gobelet | Hees 2 | 87 | VII |
| 1983 | 7824 | 65-4 | 604 | 204 | Cave | EN AR | 2 | | | | | 2 | 1 | gobelet | Hees 2 | 88 | VII |
| 1983 | | 64-2 | 583 | 125 | Cave | EN AR | 1 | | | | | 1 | 1 | gobelet | Hees 2 | 89 | VII |
| 1983 | 7824 | 65-4 | 604 | 204 | Cave | EN AR | 3 | | | | | 3 | 1 | gobelet | Hees 2 | 90 | VII |
| 1983 | 7824 | 65-4 | 604 | 204 | Cave | EN AR | 2 | | | | | 2 | 1 | gobelet | Hees 2 | 91 | VII |
| 1983 | 7824 | 65-4 | 604 | 204 | Cave | EN AR | 1 | | | | | 1 | 1 | gobelet | Hees 2 | 92 | VII |
| 1977 | 7823 | 63-2 | 553 | 37 | G13 | EN AR | 3 | | | | | 3 | 1 | gobelet | Hees 2 | 93 | VII |
| 1977 | 7823 | 63-2 | 553 | 37 | G13 | EN AR | 2 | | | | | 2 | 1 | gobelet | Hees 2 | 94 | VII |
| 1977 | 7823 | 63-2 | 553 | 37 | G13 | EN AR | 4 | | | | | 4 | 1 | gobelet | Hees 2 | 95 | VII |
| 1983 | 7824 | 34-1 | 1439 | 232 | Cave | EN AR | 1 | | | | 3 | 4 | 1 | gobelet | Hees 2 | 96 | VII |
| 1983 | 7824 | 34-1 | 1439 | 232 | Cave | EN AR | 2 | | | | | 2 | 1 | gobelet | Hees 2 | 97 | VII |
| | | 28-2 | 30 | 28 | C13 | EN AR | 1 | | | | | 1 | 1 | gobelet | Hees 2 | | |
| 1980-1982 | | 64-5 | 1671 | 783 | D13-D15 | EN AR | 4 | | | | | 4 | 1 | gobelet | Hees 2 | | |
| 1980 | | 64-4 | 591 | 151 | E14 | EN AR | 1 | | | | | 1 | 1 | gobelet | Hees 2 | | |
| 1980 | | 64-4 | 591 | 151 | E14 | EN AR | 1 | | | | | 1 | 1 | gobelet | Hees 2 | | |
| 1980 | | 66-4 | 1474 | 423 | E14c | EN AR | 2 | | | | 1 | 3 | 1 | gobelet | Hees 2 | | |

ANNEXE B : LES ROISES

| année | n° OA | Rayon | Caisse | n° ordre | Carré | Catégorie | Comptage | | | | | | Typologie | Desc. Typo. | Dessin | Planche | |
|-----------------|----------|-------|--------|-------------|------------|-----------|----------|---|---|---|----|----|-----------|-------------|--------|---------|-----|
| | | | | | | | B | F | A | D | P | NR | | | | | NMI |
| 1979 | | 63-5 | 564 | 84 | G12-G13 | EN AR | 2 | | | | | 2 | 1 | gobelet | Hees 2 | | |
| 1979 | | 63-5 | 564 | 88 | G12-H12 | EN AR | 1 | | | | | 1 | 1 | gobelet | Hees 2 | | |
| 1977 | | 63-2 | 555 | 52 | G13-G14 | EN AR | 1 | | | | | 1 | 1 | gobelet | Hees 2 | | |
| 1977 | | 63-2 | 555 | 53 | G14 | EN AR | 1 | | | | 12 | 13 | 1 | gobelet | Hees 2 | | |
| 1976 | | 63-2 | 555 | 56 | G15 | EN AR | 1 | | | | | 1 | 1 | gobelet | Hees 2 | | |
| 1976 | | 63-2 | 555 | 56 | G15 | EN AR | 1 | | | | | 1 | 1 | gobelet | Hees 2 | | |
| 1976 | | 63-2 | 555 | 56 | G15 | EN AR | 1 | | | | | 1 | 1 | gobelet | Hees 2 | | |
| | | 35-1 | 1443 | 253 | G16 | EN AR | 1 | | | | | 1 | 1 | gobelet | Hees 2 | | |
| 1983 | 7824 | 65-4 | 603 | 202 | H14 | EN AR | 1 | | | | | 1 | 1 | gobelet | Hees 2 | | |
| 1976/1977/19779 | | 63-4 | 561 | 80 | Hypocauste | EN AR | 1 | | | | | 1 | 1 | gobelet | Hees 2 | | |
| 1976/1977/19779 | | 63-4 | 561 | 80 | Hypocauste | EN AR | 1 | | | | | 1 | 1 | gobelet | Hees 2 | | |
| 1976/1977/19779 | | 63-4 | 561 | 80 | Hypocauste | EN AR | 1 | | | | | 1 | 1 | gobelet | Hees 2 | | |
| 1976 | | 63-3 | 557 | 65 | J13 | EN AR | 1 | | | | | 1 | 1 | gobelet | Hees 2 | | |
| 1976 | | 63-3 | 557 | 65 | J13 | EN AR | 1 | | | | | 1 | 1 | gobelet | Hees 2 | | |
| 1983 | 7824 | 66-3 | 1472 | 608 | J15 | EN AR | 1 | 1 | | | 2 | 4 | 1 | gobelet | Hees 2 | | |
| 1982 | | 28-5 | 1471 | 579 | J16 | EN AR | 1 | 1 | | | 9 | 11 | 1 | gobelet | Hees 2 | | |
| 1982 | | 63-3 | 556 | 58 | J16 | EN AR | 1 | | | | | 1 | 1 | gobelet | Hees 2 | | |
| 1982 | | 63-3 | 556 | 58 | J16 | EN AR | 1 | | | | | 1 | 1 | gobelet | Hees 2 | | |
| 1982 | | 63-3 | 556 | 58 | J16 | EN AR | 1 | | | | | 1 | 1 | gobelet | Hees 2 | | |
| 1968 | | 43-3 | 1387 | 214 | Mur | EN AR | 1 | | | | | 1 | 1 | gobelet | Hees 2 | | |
| 1984 | 7825 | 65-5 | 606 | 206 | P8 | EN AR | 1 | | | | | 1 | 1 | gobelet | Hees 2 | | |
| 1984 | 7825 | 65-5 | 606 | 206 | P8 | EN AR | 1 | | | | | 1 | 1 | gobelet | Hees 2 | | |
| 1984 | 7825 | 65-5 | 606 | 206 | P8 | EN AR | 1 | | | | | 1 | 1 | gobelet | Hees 2 | | |
| 1984 | 7825 | 65-5 | 606 | 206 | P8 | EN AR | 1 | | | | | 1 | 1 | gobelet | Hees 2 | | |
| 1984 | 7825 | 65-5 | 606 | 206 | P8 | EN AR | 1 | | | | | 1 | 1 | gobelet | Hees 2 | | |
| 1984 | 7825 | 67-3 | 1467 | 384 | P8III | EN AR | 1 | 1 | | | 8 | 10 | 1 | gobelet | Hees 2 | | |

ANNEXE B : LES ROISES

| année | n° OA | Rayon | Caisse | n° ordre | Carré | Catégorie | Comptage | | | | | | Typologie | Desc. Typo. | Dessin | Planche | |
|-----------|----------|-------|--------|-------------|-------------------------------------|-----------|----------|---|---|---|---|----|-----------|-------------|---------|---------|--------|
| | | | | | | | B | F | A | D | P | NR | | | | | NMI |
| 1984 | 7825 | 65-4 | 602 | 200 | Q8 | EN AR | 1 | | | 2 | | 3 | 1 | gobelet | Hees 2 | | |
| 1984 | 7825 | 65-4 | 602 | 200 | Q8 | EN AR | 1 | | | | | 3 | 4 | 1 | gobelet | Hees 2 | |
| | 7825 | 28-2 | 30 | 3 | Q8 IV | EN AR | | 1 | | | | 14 | 15 | 1 | gobelet | Hees 2 | |
| | | 27--2 | 1490 | 751 | sans n° | EN AR | 1 | | | | | | 1 | 1 | gobelet | Hees 2 | |
| | | 64-2 | 1518 | 781 | sans n° | EN AR | 3 | | | | | | 3 | 1 | gobelet | Hees 2 | |
| | | 64-2 | 1518 | 781 | sans n° | EN AR | 1 | | | | | | 1 | 1 | gobelet | Hees 2 | |
| | | 64-2 | 1518 | 781 | sans n° | EN AR | 2 | | | | | | 2 | 1 | gobelet | Hees 2 | |
| 1977 | 7823 | 63-2 | 553 | 46 | G12-G13 | EN AR | 2 | | | | | | 2 | 1 | gobelet | Hees 4 | 98 VII |
| 1984 | 7825 | 65-5 | 606 | 206 | P8 | EN AR | 1 | | | | | | 1 | 1 | gobelet | Hees 4 | |
| 1967 | | 27--2 | 1498 | 761 | sans n° | EN AR | | 2 | | | | | 2 | | | | |
| | | 64-2 | 1518 | 781 | sans n° | EN AR | | | | | | | 0 | | | | |
| | | 66-4 | 1511 | 774 | sans n° | EN AR | | 1 | | | | 3 | 4 | | | | |
| 1984 | | 3-1 | 1485 | 689 | 3 | EN AR | | | | | | 12 | 12 | | | | |
| 1973 | | 64-3 | 586 | 138 | C | EN AR | | | | | | 5 | 5 | | | | |
| 1982 | 7823 | 65-2 | 596 | 180 | C13 | EN AR | | | | | | 12 | 12 | | | | |
| 1983 | 7824 | 62-4 | 574 | 107 | Cave | EN AR | | 3 | | | | 52 | 55 | | | | |
| 1983 | 7824 | 65-4 | 604 | 204 | Cave | EN AR | | 3 | | | | 92 | 95 | | | | |
| 1983 | 7824 | 34-1 | 1439 | 232 | Cave | EN AR | | 3 | | | | 5 | 8 | | | | |
| 1981 | | 67-3 | 1468 | 440 | Cave | EN AR | | 1 | | | | | 1 | | | | |
| 1981 | | 67-3 | 1468 | 444 | Cave | EN AR | | 1 | | | | 11 | 12 | | | | |
| 1981 | | 67-3 | 1468 | 446 | Cave | EN AR | | 1 | | | | | 1 | | | | |
| 1973 | | 64-3 | 586 | 140 | Croisement des deux tranchées | EN AR | | | | | | 3 | 3 | | | | |
| 1980-1982 | | 64-5 | 1671 | 783 | D13-D15 | EN AR | | | | | | 13 | 13 | | | | |
| | | 28-2 | 30 | 20 | D14 | EN AR | | 2 | | | | | 2 | | | | |
| 1981 | | 67-3 | 1468 | 479 | E13 | EN AR | | | | | | 2 | 2 | | | | |

ANNEXE B : LES ROISES

| année | n° OA | Rayon | Caisse | n° ordre | Carré | Catégorie | Comptage | | | | | | | Typologie | Desc. Typo. | Dessin | Planche |
|-------|----------|-------|--------|-------------|--|-----------|----------|---|---|---|----|----|-----|-----------|-------------|--------|---------|
| | | | | | | | B | F | A | D | P | NR | NMI | | | | |
| 1981 | | 64-4 | 591 | 150 | E13 | EN AR | | | | | 14 | 14 | | | | | |
| 1976 | | 28-2 | 30 | 11 | J13-J14 | EN AR | | 2 | | | | 2 | | | | | |
| 1984 | 7825 | 28-2 | 30 | 21 | Q8 | EN AR | | 1 | | | | 1 | | | | | |
| 1982 | | 63-4 | 563 | 83 | E13-E14 | EN AR | | | | | 2 | 2 | | | | | |
| 1980 | | 66-4 | 1474 | 727 | E14c | EN AR | | | | | 1 | 1 | | | | | |
| 1980 | | 66-4 | 1474 | 719 | E14c | EN AR | | 1 | | | 1 | 2 | | | | | |
| 1980 | | 64-4 | 591 | 148 | E15 | EN AR | | | | | 7 | 7 | | | | | |
| 1973 | | 64.3 | 586 | 140 | Extrémité NW de la tranchée SE-NW côté voie close | EN AR | | | | | | 10 | 10 | | | | |
| 1982 | | 63-4 | 566 | 91 | F13 | EN AR | | | | | 4 | 4 | | | | | |
| 1977 | | 65-2 | 594 | 167 | F15 | EN AR | | 3 | | | 3 | 6 | | | | | |
| 1981 | | 65-2 | 594 | 166 | F15-G15 | EN AR | | | | | 6 | 6 | | | | | |
| 1977 | 7823 | 63-2 | 553 | 40 | G12 | EN AR | | | | | 9 | 9 | | | | | |
| 1976 | 7823 | 63-2 | 553 | 40 | G12 | EN AR | | | | | 8 | 8 | | | | | |
| 1977 | 7823 | 63-2 | 553 | 46 | G12-G13 | EN AR | | | | | 8 | 8 | | | | | |
| 1979 | | 63-5 | 564 | 84 | G12-G13 | EN AR | | | | | 15 | 15 | | | | | |
| 1979 | | 63-5 | 564 | 88 | G12-H12 | EN AR | | | | | 23 | 23 | | | | | |
| | 7823 | 63-2 | 553 | 45 | G12-H12 berme | EN AR | | | | | 6 | 6 | | | | | |
| 1977 | 7823 | 63-2 | 553 | 37 | G13 | EN AR | | 1 | | | 79 | 80 | | | | | |
| 1977 | | 63-2 | 555 | 52 | G13-G14 | EN AR | | 4 | | | 38 | 42 | | | | | |
| 1977 | | 63-2 | 555 | 51 | G14-G15 | EN AR | | | | | 3 | 3 | | | | | |
| | | 28-2 | 30 | 25 | G15-G16 | EN AR | | | | | 2 | 2 | | | | | |

ANNEXE B : LES ROISES

| année | n° OA | Rayon | Caisse | n° ordre | Carré | Catégorie | Comptage | | | | | | Typologie | Desc. Typo. | Dessin | Planche |
|-----------------|----------|-------|--------|-------------|------------|-----------|----------|---|---|---|-----|-----|-----------|-------------|--------|---------|
| | | | | | | | B | F | A | D | P | NR | | | | |
| 1979 | 7803 | 63-2 | 552 | 36 | G16 | EN AR | | 3 | | | 38 | 41 | | | | |
| 1979 | 7803 | 32-1 | 1445 | 268 | G16 | EN AR | | 2 | | | 1 | 3 | | | | |
| 1981 | | 63-5 | 564 | 87 | H7 | EN AR | | | | | 16 | 16 | | | | |
| 1983 | 7824 | 65-4 | 603 | 202 | H14 | EN AR | | 1 | | | 14 | 15 | | | | |
| 1982 | | 63-3 | 558 | 67 | H15 | EN AR | | | | | 7 | 7 | | | | |
| 1981 | | 63-5 | 564 | 86 | H16 | EN AR | | | | | 7 | 7 | | | | |
| 1976/1977/19779 | | 63-4 | 561 | 80 | Hypocauste | EN AR | | | | | 41 | 41 | | | | |
| 1976 | | 63-3 | 557 | 65 | J13 | EN AR | | 5 | | | 112 | 117 | | | | |
| 1982 | 7823 | 64-5 | 1470 | 558 | J16 | EN AR | | 1 | | | | 1 | | | | |
| 1982 | | 63-3 | 556 | 58 | J16 | EN AR | | 1 | | | 26 | 27 | | | | |
| 1974 | | 55-2 | 597 | 181 | K9 | EN AR | | | | | 3 | 3 | | | | |
| 1974 | | 55-2 | 597 | 182 | K10 | EN AR | | | | | 2 | 2 | | | | |
| 1975 | | 65-2 | 597 | 183 | K12 | EN AR | | 4 | | | 12 | 16 | | | | |
| 1975 | | 65-3 | 597 | 184 | K13 | EN AR | | | | | 18 | 18 | | | | |
| 1983 | | 63-3 | 559 | 75 | K14 | EN AR | | 3 | | | 6 | 9 | | | | |
| 1982 | | 63-3 | 559 | 602 | K15 | EN AR | | 3 | | | 17 | 20 | | | | |
| 1982 | | 63-3 | 559 | 78 | K16 | EN AR | | | | | 33 | 33 | | | | |
| 1975 | 7782 | 63-2 | 554 | 49 | L12 | EN AR | | | | | 8 | 8 | | | | |
| 1975 | 7782 | 63-2 | 554 | 50 | L13 | EN AR | | | | | 3 | 3 | | | | |
| 1984 | 7825 | 65-5 | 605 | 205 | M10 | EN AR | | 1 | | | 22 | 23 | | | | |
| 1984 | 7825 | 66-4 | 1474 | 670 | M10X | EN AR | | 1 | | | | 1 | | | | |
| 1968 | | 43-3 | 1387 | 214 | Mur | EN AR | | 1 | | | 5 | 6 | | | | |
| 1984 | 7825 | 34-1 | 1437 | 217 | N9 | EN AR | | | | | 6 | 6 | | | | |
| 1984 | 7825 | 65-5 | 607 | 207 | P7 | EN AR | | | | | 7 | 7 | | | | |
| 1984 | 7825 | 63-3 | 559 | 79 | P8 | EN AR | | | | | 20 | 20 | | | | |
| 1977 | | 64-4 | 589 | 46 | W | EN AR | | | | | 1 | 1 | | | | |

ANNEXE B : LES ROISES

| année | n° OA | Rayon | Caisse | n° ordre | Carré | Catégorie | Comptage | | | | | | | Typologie | Desc. Typo. | Dessin | Planche |
|-------|----------|-------|--------|-------------|--|-----------|----------|---|---|-----|-----|----|-----|-----------|---------------------------|--------|---------|
| | | | | | | | B | F | A | D | P | NR | NMI | | | | |
| | | 32-1 | 1445 | 277 | W | EN AR | | 1 | | | | 1 | | | | | |
| 1980 | | 63-4 | 562 | 81 | Wp | EN AR | | | | 14 | 14 | | | | | | |
| 1980 | | 64-4 | 591 | 151 | E14 | EN AR | | 3 | | 26 | 29 | | | | | | |
| | | 5--2 | 1500 | 763 | sans n° | EN AR | | | | 1 | 1 | | | | | | |
| 1973 | | 64-3 | 586 | 140 | Extrémité NW de la tranchée SE-NW côté voie close | EN TR | 1 | 1 | | | | 2 | 1 | gobelet | Hees 2 | 99 | VIII |
| 1974 | 7816 | 63-5 | 567 | 98 | M11 | EN TR | 1 | | | | | 1 | 1 | gobelet | Hees 2 | | |
| 1973 | | 64-3 | 586 | 138 | C | EN TR | | | | 3 | 3 | | | | | | |
| 1983 | 7824 | 65-4 | 604 | 204 | Cave | EN TR | | 4 | | 121 | 125 | | | | | | |
| 1983 | 7824 | 34-1 | 1439 | 232 | Cave | EN TR | | | | 4 | 4 | | | | | | |
| 1977 | 7823 | 63-2 | 553 | 40 | G12 | EN TR | | 3 | | 48 | 51 | | | | | | |
| 1982 | 7823 | 64-5 | 1470 | 530 | J15 | EN TR | | 1 | | | | 1 | | | | | |
| 1982 | 7823 | 64-5 | 1470 | 532 | K15 | EN TR | | 1 | | | | 1 | | | | | |
| 1983 | 7824 | 65-4 | 604 | 204 | Cave | EN COL | | | 1 | | | 1 | 1 | gobelet | | | |
| 1976 | | 63-3 | 557 | 65 | J13 | EN COL | 1 | | | | | 1 | 1 | gobelet | Höpken E24 ou Nied. 32 | | |
| 1984 | 7825 | 65-5 | 606 | 206 | P8 | EN COL | 1 | | | 1 | 2 | 1 | 1 | gobelet | Höpken E24 ou Nied. 32 | | |
| | | 64-2 | 1518 | 781 | sans n° | EN COL | 1 | | | | | 1 | 1 | gobelet | Hees 4 | 100 | VIII |
| 1983 | 7824 | 34-1 | 1439 | 232 | Cave | EN COL | | | | 1 | 1 | | | | | | |
| 1984 | 7825 | 67-3 | 1467 | 372 | N9VII | EN COL | | | 1 | | | 1 | | | | | |
| 1982 | 7823 | 64-5 | 1470 | 564 | J16 | EN LEZ | 1 | | | | | 1 | 1 | gobelet | Lezoux 331 | 101 | VIII |
| | | BAL | 1466 | 236 | sans n° | EN LEZ | 1 | | | | | 1 | 1 | gobelet | Lezoux 331 | 102 | VIII |

ANNEXE B : LES ROISES

| année | n° OA | Rayon | Caisse | n° ordre | Carré | Catégorie | Comptage | | | | | | | Typologie | Desc. Typo. | Dessin | Planche | |
|-------|----------|-------|--------|-------------|---------|-----------|----------|---|---|---|----|----|-----|-----------|-------------|-------------------------|---------|------|
| | | | | | | | B | F | A | D | P | NR | NMI | | | | | |
| 1983 | 7824 | 65-4 | 604 | 204 | Cave | MET AR | 1 | | | | | | 1 | 1 | gobelet | Symonds 1 / Nied. 33 | 103 | VIII |
| 1977 | 7823 | 63-2 | 553 | 40 | G12 | MET AR | 1 | | | | | | 1 | 1 | gobelet | Symonds 1 / Nied. 33 | 104 | VIII |
| 1981 | | 66-3 | 1465 | 324 | D15 | MET AR | 1 | | | | 10 | 11 | 1 | | gobelet | Symonds 1 / Nied. 33 | 105 | VIII |
| 1982 | 7823 | 64-5 | 1470 | 544 | J16-J17 | MET AR | 1 | | | | | | 1 | 1 | gobelet | Symonds 1 / Nied. 33 | 106 | VIII |
| 1981 | | 64-5 | 1671 | 785 | D15 | MET AR | 2 | | | | | | 2 | 1 | gobelet | Symonds 1 / Nied. 33 | | |
| 1980 | | 64-4 | 591 | 151 | E14 | MET AR | 1 | | | | | | 1 | 1 | gobelet | Symonds 1 / Nied. 33 | | |
| 1977 | | 65-2 | 594 | 167 | F15 | MET AR | 1 | 1 | | | 3 | 5 | 1 | | gobelet | Symonds 1 / Nied. 33 | | |
| | | 28-2 | 30 | 26 | F16-G16 | MET AR | 3 | | | | | | 3 | 1 | gobelet | Symonds 1 / Nied. 33 | | |
| 1977 | | 63-2 | 555 | 52 | G13-G14 | MET AR | 1 | | 2 | | 9 | 12 | 1 | | gobelet | Symonds 1 / Nied. 33 | | |
| 1976 | | 63-2 | 555 | 56 | G15 | MET AR | 1 | | | | | | 1 | 1 | gobelet | Symonds 1 / Nied. 33 | | |
| 1976 | | 63-2 | 555 | 56 | G15 | MET AR | 2 | | | | | | 2 | 1 | gobelet | Symonds 1 / Nied. 33 | | |
| 1981 | | 63-5 | 564 | 87 | H7 | MET AR | 1 | | | | | | 1 | 1 | gobelet | Symonds 1 / Nied. 33 | | |
| 1975 | | 34-1 | 1437 | 223 | H13 | MET AR | 3 | | | | | | 3 | 1 | gobelet | Symonds 1 / Nied. 33 | | |
| 1975 | | 34-1 | 1438 | 231 | H13 | MET AR | 2 | | | | 3 | 5 | 1 | | gobelet | Symonds 1 / Nied. 33 | | |
| 1983 | 7824 | 65-4 | 603 | 202 | H14 | MET AR | 1 | | | | | | 1 | 1 | gobelet | Symonds 1 / Nied. 33 | | |

ANNEXE B : LES ROISES

| année | n° OA | Rayon | Caisse | n° ordre | Carré | Catégorie | Comptage | | | | | | | Typologie | Desc. Typo. | Dessin | Planche | |
|-----------------|----------|-------|--------|-------------|------------|-----------|----------|---|---|---|---|----|-----|-----------|-------------|-------------------------|---------|--|
| | | | | | | | B | F | A | D | P | NR | NMI | | | | | |
| 1983 | 7824 | 65-4 | 603 | 202 | H14 | MET AR | 1 | | | | | | 1 | 1 | gobelet | Symonds 1 / Nied. 33 | | |
| 1983 | 7824 | 65-4 | 603 | 202 | H14 | MET AR | 1 | | | | | | 1 | 1 | gobelet | Symonds 1 / Nied. 33 | | |
| 1982 | | 63-3 | 558 | 67 | H15 | MET AR | 1 | | | | | | 1 | 1 | gobelet | Symonds 1 / Nied. 33 | | |
| 1982 | | 63-3 | 558 | 67 | H15 | MET AR | 1 | | | | | | 1 | 1 | gobelet | Symonds 1 / Nied. 33 | | |
| 1982 | | 63-3 | 558 | 67 | H15 | MET AR | 1 | | | | | | 1 | 1 | gobelet | Symonds 1 / Nied. 33 | | |
| 1981 | | 63-5 | 564 | 86 | H16 | MET AR | 1 | | | | | | 1 | 1 | gobelet | Symonds 1 / Nied. 33 | | |
| 1981 | | 63-5 | 564 | 86 | H16 | MET AR | 2 | | | | | | 2 | 1 | gobelet | Symonds 1 / Nied. 33 | | |
| 1981 | | 67-3 | 1468 | 475 | H17 | MET AR | 2 | | | | 3 | | 5 | 1 | gobelet | Symonds 1 / Nied. 33 | | |
| 1976/1977/19779 | | 63-4 | 561 | 80 | Hypocauste | MET AR | 1 | | | | | | 1 | 1 | gobelet | Symonds 1 / Nied. 33 | | |
| 1976/1977/19779 | | 63-4 | 561 | 80 | Hypocauste | MET AR | 1 | | | | | | 1 | 1 | gobelet | Symonds 1 / Nied. 33 | | |
| 1976 | | 63-3 | 557 | 65 | J13 | MET AR | 1 | | | | | | 1 | 1 | gobelet | Symonds 1 / Nied. 33 | | |
| 1976 | | 63-3 | 557 | 65 | J13 | MET AR | 1 | | | | | | 1 | 1 | gobelet | Symonds 1 / Nied. 33 | | |
| 1976 | | 63-3 | 557 | 65 | J13 | MET AR | 1 | | | | | | 1 | 1 | gobelet | Symonds 1 / Nied. 33 | | |
| 1976 | | 63-3 | 557 | 65 | J13 | MET AR | 1 | | | | | | 1 | 1 | gobelet | Symonds 1 / Nied. 33 | | |
| 1976 | | 63-3 | 557 | 65 | J13 | MET AR | 1 | | | | | | 1 | 1 | gobelet | Symonds 1 / Nied. 33 | | |

ANNEXE B : LES ROISES

| année | n° OA | Rayon | Caisse | n° ordre | Carré | Catégorie | Comptage | | | | | | | Typologie | Desc. Typo. | Dessin | Planche |
|-------|----------|-------|--------|-------------|---------|-----------|----------|---|---|---|-----|-----|-----|-----------|-------------------------|--------|---------|
| | | | | | | | B | F | A | D | P | NR | NMI | | | | |
| 1982 | | 65-3 | 599 | 192 | J15 | MET AR | 3 | 1 | | | 29 | 33 | 1 | gobelet | Symonds 1 / Nied. 33 | | |
| 1982 | | 63-3 | 556 | 58 | J16 | MET AR | 1 | | | | | 1 | 1 | gobelet | Symonds 1 / Nied. 33 | | |
| 1982 | | 63-3 | 556 | 58 | J16 | MET AR | 1 | | | | | 1 | 1 | gobelet | Symonds 1 / Nied. 33 | | |
| 1975 | | 65-2 | 597 | 183 | K12 | MET AR | 1 | 1 | | | 3 | 5 | 1 | gobelet | Symonds 1 / Nied. 33 | | |
| 1983 | | 63-3 | 559 | 75 | K14 | MET AR | 2 | | | | | 2 | 1 | gobelet | Symonds 1 / Nied. 33 | | |
| 1968 | | 43-3 | 1387 | 214 | Mur | MET AR | 2 | | | | | 2 | 1 | gobelet | Symonds 1 / Nied. 33 | | |
| 1984 | 7825 | 65-5 | 607 | 207 | P7 | MET AR | 1 | 1 | | | 3 | 5 | 1 | gobelet | Symonds 1 / Nied. 33 | | |
| 1982 | | BAL | 1466 | 333 | J16 | MET AR | 1 | | | | | 1 | 1 | gobelet | Chenet 335 | 107 | VIII |
| 1982 | 7823 | 65-2 | 596 | 180 | C13 | MET AR | | | | | 7 | 7 | | | | | |
| 1982 | 7823 | 65-2 | 596 | 178 | C13-D13 | MET AR | | | | | 6 | 6 | | | | | |
| 1980 | | 32-1 | 1445 | 270 | E15 | MET AR | | | | | 2 | 2 | | | | | |
| 1983 | 7824 | 65-4 | 604 | 204 | Cave | MET AR | | 4 | | | 112 | 116 | | | | | |
| 1983 | 7824 | 34-1 | 1439 | 232 | Cave | MET AR | | 1 | | | 6 | 7 | | | | | |
| 1981 | | 67-3 | 1468 | 441 | Cave | MET AR | | | | | 16 | 16 | | | | | |
| 1981 | | 67-3 | 1468 | 442 | Cave | MET AR | | | | | 12 | 12 | | | | | |

ANNEXE B : LES ROISES

| année | n° OA | Rayon | Caisse | n° ordre | Carré | Catégorie | Comptage | | | | | | | Typologie | Desc. Typo. | Dessin | Planche |
|-------|----------|-------|--------|-------------|--|-----------|----------|---|---|---|----|----|-----|-----------|-------------|--------|---------|
| | | | | | | | B | F | A | D | P | NR | NMI | | | | |
| 1981 | | 67-3 | 1468 | 449 | Cave | MET AR | | 1 | | | | | 1 | | | | |
| 1981 | | 67-3 | 1468 | 457 | Cave | MET AR | | | | | 7 | | 7 | | | | |
| 1973 | | 64-3 | 586 | 140 | Croisement des deux tranchées | MET AR | | | | | 20 | | 20 | | | | |
| 1981 | | 64-5 | 1671 | 785 | D15 | MET AR | | | | | 21 | | 21 | | | | |
| 1980 | | 64-4 | 591 | 151 | E14 | MET AR | | | | | 11 | | 11 | | | | |
| 1980 | | 66-4 | 1474 | 744 | E14d | MET AR | | | | | 1 | | 1 | | | | |
| 1973 | | 64-3 | 586 | 140 | Extrémité NW de la tranchée SE-NW côté voie close | MET AR | | | | | 3 | | 3 | | | | |
| 1973 | | 64-3 | 586 | 140 | Extrémité NW de la tranchée SE-NW côté voie close | MET AR | | 7 | | | | | 7 | | | | |
| 1977 | | 34-1 | 1438 | 229 | Fond de cave | MET AR | | 1 | | | | | 1 | | | | |
| 1977 | 7823 | 63-2 | 553 | 40 | G12 | MET AR | | | | | 11 | | 11 | | | | |
| 1976 | 7823 | 63-2 | 553 | 40 | G12 | MET AR | | | | | 5 | | 5 | | | | |

ANNEXE B : LES ROISES

| année | n° OA | Rayon | Caisse | n° ordre | Carré | Catégorie | Comptage | | | | | | Typologie | Desc. Typo. | Dessin | Planche |
|-----------------|----------|-------|--------|-------------|------------|-----------|----------|---|---|---|----|----|-----------|-------------|--------|---------|
| | | | | | | | B | F | A | D | P | NR | | | | |
| 1977 | 7823 | 63-2 | 553 | 46 | G12-G13 | MET AR | | | | | 12 | 12 | | | | |
| 1979 | | 63-5 | 564 | 84 | G12-G13 | MET AR | | | | | 24 | 24 | | | | |
| 1977 | 7823 | 63-2 | 553 | 37 | G13 | MET AR | | 2 | | | 50 | 52 | | | | |
| 1979 | | 32-1 | 1445 | 267 | G15 | MET AR | | 1 | | | | 1 | | | | |
| 1981 | | 63-5 | 564 | 87 | H7 | MET AR | | | | | 17 | 17 | | | | |
| 1976 | | 65-3 | 600 | 195 | H12 | MET AR | | | | | 9 | 9 | | | | |
| 1975 | | 28-2 | 30 | 13 | H13 | MET AR | | | | | 4 | 4 | | | | |
| 1975 | 7782 | 65-3 | 600 | 197 | H13 | MET AR | | 1 | | | 37 | 38 | | | | |
| 1983 | 7824 | 65-4 | 603 | 202 | H14 | MET AR | | 1 | | | 31 | 32 | | | | |
| 1982 | 7823 | 64-5 | 1470 | 559 | H15 | MET AR | | | | | 1 | 1 | | | | |
| 1982 | | 63-3 | 558 | 67 | H15 | MET AR | | 6 | | | 5 | 11 | | | | |
| 1981 | | 63-5 | 564 | 86 | H16 | MET AR | | | | | 26 | 26 | | | | |
| 1976/1977/19779 | | 63-4 | 561 | 80 | Hypocauste | MET AR | | | | | 20 | 20 | | | | |
| 1976 | | 63-3 | 557 | 65 | J13 | MET AR | | 2 | | | 41 | 43 | | | | |
| 1983 | 7824 | 67-4 | 1469 | 514 | J14 | MET AR | | 1 | | | 5 | 6 | | | | |

ANNEXE B : LES ROISES

| année | n° OA | Rayon | Caisse | n° ordre | Carré | Catégorie | Comptage | | | | | | | Typologie | Desc. Typo. | Dessin | Planche |
|-------|----------|-------|--------|-------------|---------|-----------|----------|---|---|---|----|----|-----|-----------|-------------|--------|---------|
| | | | | | | | B | F | A | D | P | NR | NMI | | | | |
| 1983 | 7824 | 66-3 | 1473 | 616 | J15 | MET AR | | 1 | | | 9 | 10 | | | | | |
| 1982 | | 34-1 | 1437 | 220 | J15 | MET AR | | 3 | | | | 3 | | | | | |
| 1982 | 7823 | 64-5 | 1470 | 562 | J16 | MET AR | | 1 | | | | 1 | | | | | |
| 1982 | | 63-3 | 556 | 58 | J16 | MET AR | | | | | 63 | 63 | | | | | |
| 1982 | | 63-3 | 559 | 602 | K15 | MET AR | | | | | 16 | 16 | | | | | |
| 1974 | 7816 | 63-2 | 554 | 48 | L11 | MET AR | | | | | 23 | 23 | | | | | |
| 1984 | 7825 | 65-5 | 608 | 208 | L11 | MET AR | | | | | 16 | 16 | | | | | |
| 1975 | 7782 | 63-2 | 554 | 49 | L12 | MET AR | | | | | 3 | 3 | | | | | |
| 1975 | 7782 | 63-2 | 554 | 50 | L13 | MET AR | | 1 | | | 2 | 3 | | | | | |
| 1984 | 7825 | 65-5 | 605 | 205 | M10 | MET AR | | | | | 3 | 3 | | | | | |
| 1974 | 7816 | 63-5 | 567 | 98 | M11 | MET AR | | 2 | | | | 2 | | | | | |
| | | 34-1 | 1438 | 230 | M13 | MET AR | | | | | 1 | 1 | | | | | |
| 1968 | | 43-3 | 1387 | 214 | Mur | MET AR | | 2 | | | 7 | 9 | | | | | |
| 1984 | 7825 | 63-3 | 559 | 79 | P8 | MET AR | | | | | 34 | 34 | | | | | |
| | | 64-2 | 1518 | 781 | sans n° | MET AR | | | | | | 0 | | | | | |

ANNEXE B : LES ROISES

| année | n° OA | Rayon | Caisse | n° ordre | Carré | Catégorie | Comptage | | | | | | | Typologie | Desc. Typo. | Dessin | Planche | |
|-------|----------|-------|--------|-------------|---------|-----------|----------|---|---|---|----|----|-----|-----------|-------------------------|-------------------------|---------|------|
| | | | | | | | B | F | A | D | P | NR | NMI | | | | | |
| | | 64-2 | 1517 | 779 | sans n° | MET AR | | | 4 | | 34 | 38 | | | | | | |
| | | 66-1 | 1515 | 778 | sans n° | MET AR | | 3 | | | 67 | 70 | | | | | | |
| | | 66-1 | 1510 | 773 | sans n° | MET AR | | | | | 27 | 27 | | | | | | |
| | | 66-4 | 1511 | 774 | sans n° | MET AR | | 1 | | | 37 | 38 | | | | | | |
| | | 67-4 | 1507 | 771 | sans n° | MET AR | | | | | 24 | 24 | | | | | | |
| 1983 | 7824 | 65-4 | 604 | 204 | Cave | MET TR | 1 | | | | | 1 | 1 | gobelet | Symonds 1 / Nied. 33 | 108 | VIII | |
| 1984 | 7825 | 67-3 | 1467 | 389 | N9VII | MET TR | 1 | | | | | 1 | 1 | gobelet | Symonds 1 / Nied. 33 | 109 | VIII | |
| 1977 | 7823 | 63-2 | 553 | 37 | G13 | MET TR | 2 | | | | | 2 | 1 | gobelet | Symonds 1 / Nied. 33 | 110 | VIII | |
| 1974 | 7803 | 32.1 | 1447 | 287 | K10 | MET TR | 2 | | | | | 2 | 1 | gobelet | Symonds 1 / Nied. 33 | 111 | VIII | |
| 1981 | | 66-3 | 1465 | 328 | H17 | MET TR | 2 | | | | 3 | 5 | 1 | gobelet | Symonds 1 / Nied. 33 | 112 | VIII | |
| 1983 | 7824 | 34-1 | 1439 | 232 | Cave | MET TR | 3 | | | | | | 3 | 1 | gobelet | Symonds 1 / Nied. 33 | 113 | VIII |
| 1979 | | 63-5 | 564 | 88 | G12-H12 | MET TR | 1 | | | | | | 1 | 1 | gobelet | Symonds 1 / Nied. 33 | | |
| 1979 | | 63-5 | 564 | 88 | G12-H12 | MET TR | 1 | | | | | | 1 | 1 | gobelet | Symonds 1 / Nied. 33 | | |
| 1981 | | 63-5 | 564 | 87 | H7 | MET TR | 1 | | | | | | 1 | 1 | gobelet | Symonds 1 / Nied. 33 | | |
| 1981 | | 63-5 | 564 | 87 | H7 | MET TR | 1 | | | | | | 1 | 1 | gobelet | Symonds 1 / Nied. 33 | | |

ANNEXE B : LES ROISES

| année | n° OA | Rayon | Caisse | n° ordre | Carré | Catégorie | Comptage | | | | | | Typologie | Desc. Typo. | Dessin | Planche | |
|-------|----------|-------|--------|-------------|---------|-----------|----------|---|---|---|-----|-----|-----------|-------------|----------------------------------|---------|------|
| | | | | | | | B | F | A | D | P | NR | | | | | NMI |
| 1981 | | 63-5 | 564 | 87 | H7 | MET TR | 1 | | | | | 1 | 1 | gobelet | Symonds 1 / Nied. 33 | | |
| 1981 | | 63-5 | 564 | 87 | H7 | MET TR | 1 | | | | | 1 | 1 | gobelet | Symonds 1 / Nied. 33 | | |
| 1981 | | 63-5 | 564 | 87 | H7 | MET TR | 1 | | | | | 1 | 1 | gobelet | Symonds 1 / Nied. 33 | | |
| 1981 | | 63-5 | 564 | 87 | H7 | MET TR | 1 | | | | | 1 | 1 | gobelet | Symonds 1 / Nied. 33 | | |
| 1981 | | 63-5 | 564 | 87 | H7 | MET TR | 1 | | | | | 1 | 1 | gobelet | Symonds 1 / Nied. 33 | | |
| 1975 | | 35-1 | 1443 | 257 | J13 | MET TR | 6 | | | | 10 | 16 | 1 | gobelet | Symonds 1 / Nied. 33 | | |
| 1975 | | 65-2 | 597 | 183 | K12 | MET TR | 1 | | | | 2 | 3 | 1 | gobelet | Symonds 1 / Nied. 33 | | |
| | | 62-3 | 571 | 101 | sans n° | MET TR | 1 | | | | | 1 | 1 | gobelet | Symonds 1 / Nied. 33 | | |
| 1983 | 7824 | 33-1 | 1450 | 308 | J14 | MET TR | 4 | 1 | | | 13 | 18 | 1 | gobelet | Symonds 1.2.1 / Nied. 33 | 114 | VIII |
| 1983 | 7824 | 65-4 | 604 | 204 | Cave | MET TR | 1 | | | | | 1 | 1 | gobelet | Symonds 2/Niederbieber 29 | 115 | VIII |
| 1983 | 7824 | 65-4 | 604 | 204 | Cave | MET TR | 1 | | | | | 1 | 1 | gobelet | Symonds 3a/Niederbieber 31 | 116 | VIII |
| 1983 | 7824 | 65-4 | 604 | 204 | Cave | MET TR | 1 | | | | | 1 | 1 | gobelet | Symonds 4 | 117 | IX |
| 1974 | | 35-1 | 1441 | 244 | L11 | MET TR | | | | | 1 | 1 | 1 | gobelet | Symonds 4 | | |
| 1977 | 7823 | 63-2 | 553 | 37 | G13 | MET TR | 3 | | | | | 3 | 1 | gobelet | | 118 | IX |
| 1982 | 7823 | 65-2 | 596 | 180 | C13 | MET TR | | | | | 3 | 3 | | | | | |
| 1983 | 7824 | 62-4 | 574 | 107 | Cave | MET TR | | 4 | | | 107 | 111 | | | | | |
| 1983 | 7824 | 65-4 | 604 | 204 | Cave | MET TR | | 1 | | | 146 | 147 | | | | | |

ANNEXE B : LES ROISES

| année | n° OA | Rayon | Caisse | n° ordre | Carré | Catégorie | Comptage | | | | | | | Typologie | Desc. Typo. | Dessin | Planche |
|-------|----------|-------|--------|-------------|---------|------------|----------|---|---|---|----|----|-----|-----------|-------------------------|--------|---------|
| | | | | | | | B | F | A | D | P | NR | NMI | | | | |
| 1980 | | 64-5 | 1671 | 784 | D14 | MET TR | | 1 | | | 1 | 2 | | | | | |
| 1980 | | 66-4 | 1474 | 707 | D14d | MET TR | | 1 | | | | 1 | | | | | |
| 1980 | | 66-4 | 1474 | 782 | E14a | MET TR | | | | | 2 | 2 | | | | | |
| 1977 | 7823 | 63-2 | 553 | 40 | G12 | MET TR | | | | | 5 | 5 | | | | | |
| 1979 | | 63-5 | 564 | 88 | G12-H12 | MET TR | | | | | 10 | 10 | | | | | |
| 1977 | 7823 | 63-2 | 553 | 37 | G13 | MET TR | | | | | 18 | 18 | | | | | |
| 1981 | | 63-5 | 564 | 87 | H7 | MET TR | | | | | 5 | 5 | | | | | |
| 1982 | | 35-1 | 1442 | 248 | H16 | MET TR | | | | | 2 | 2 | | | | | |
| 1981 | | 67-3 | 1468 | 472 | H17 | MET TR | | | | | 6 | 6 | | | | | |
| 1981 | | 67-3 | 1468 | 475 | H17 | MET TR | | | | | 5 | 5 | | | | | |
| 1983 | 7824 | 66-3 | 1473 | 618 | J15 | MET TR | | 1 | | | 4 | 5 | | | | | |
| 1974 | 7803 | 32-1 | 1447 | 284 | L11 | MET TR | | | | | 1 | 1 | | | | | |
| | | 64-2 | 1518 | 781 | sans n° | MET TR | | | | | | 0 | | | | | |
| | | 64-2 | 1517 | 779 | sans n° | MET TR | | | 2 | | 11 | 13 | | | | | |
| | | 66-1 | 1515 | 778 | sans n° | MET TR | | | | | 12 | 12 | | | | | |
| 1974 | | 28-2 | 30 | 6 | L11 | MET TR | | | | | 2 | 2 | | | | | |
| 1983 | 7824 | 65-4 | 604 | 204 | Cave | MET LEZ | 1 | | | | 4 | 5 | 1 | gobelet | Symonds 1 / Nied. 33 | 119 IX | |
| 1977 | 7823 | 63-2 | 553 | 40 | G12 | MET LEZ | | | | | 4 | 4 | | | | | |
| 1977 | 7823 | 63-2 | 553 | 37 | G13 | MET LEZ | | | | | 18 | 18 | | | | | |
| 1983 | 7824 | 34-1 | 1439 | 232 | Cave | MET LEZ | | | | | 8 | 8 | | | | | |
| 1982 | 7823 | 64-5 | 1470 | 564 | J16 | MET LEZ | | | | | 1 | 1 | | | | | |
| 1981 | | 63-5 | 564 | 87 | H7 | TN | 1 | | | | | 1 | 1 | assiette | TNA38 | 120 IX | |
| 1984 | 7825 | 65-4 | 602 | 200 | Q8 | TN | 1 | | | | | 1 | 1 | assiette | TNA41/43 | 121 IX | |

ANNEXE B : LES ROISES

| année | n° OA | Rayon | Caisse | n° ordre | Carré | Catégorie | Comptage | | | | | | Typologie | Desc. Typo. | Dessin | Planche | |
|-------|----------|-------|--------|-------------|---------|-----------|----------|---|---|---|---|----|-----------|-------------|----------|---------|-----|
| | | | | | | | B | F | A | D | P | NR | | | | | NMI |
| 1982 | | 65-3 | 599 | 192 | J15 | TN | 1 | | | | | 1 | 1 | assiette | TNA41/43 | 122 | IX |
| 1984 | | 3-1 | 1485 | 689 | 3 | TN | 1 | | | | | 1 | 1 | assiette | TNA41/43 | 123 | IX |
| 1977 | 7823 | 63-2 | 553 | 40 | G12 | TN | 1 | | | | | 1 | 1 | assiette | TNA41/43 | 124 | IX |
| 1977 | 7823 | 63-2 | 553 | 37 | G13 | TN | 1 | | | | | 1 | 1 | assiette | TNA41/43 | 125 | IX |
| 1976 | | 63-3 | 558 | 68 | H15 | TN | 1 | | | | | 1 | 1 | assiette | TNA41/43 | 126 | IX |
| 1984 | | 64-2 | 583 | 132 | N9 | TN | 1 | | | | | 1 | 1 | assiette | TNA41/43 | 127 | IX |
| 1976 | | 65-3 | 600 | 195 | H12 | TN | 1 | | | | | 1 | 1 | assiette | TNA41/43 | 128 | IX |
| 1976 | | 65-3 | 600 | 195 | H12 | TN | 1 | | | | | 1 | 1 | assiette | TNA41/43 | 129 | IX |
| 1983 | 7824 | 65-3 | 598 | 186 | H15 | TN | 1 | | | | | 1 | 1 | assiette | TNA41/43 | 130 | IX |
| 1976 | | 63-2 | 555 | 56 | G15 | TN | 1 | | | | | 1 | 1 | assiette | TNA41/43 | 131 | IX |
| 1983 | 7824 | 65-4 | 603 | 202 | H14 | TN | 1 | | | | | 1 | 1 | assiette | TNA41/43 | 132 | X |
| | | 67-4 | 1507 | 771 | sans n° | TN | 1 | | | | | 1 | 1 | assiette | TNA41/43 | 133 | X |
| 1979 | | 32-1 | 1445 | 274 | G17 | TN | 4 | | | | | 4 | 1 | bol | TNB1 | 134 | X |
| 1984 | 7825 | 66-4 | 1473 | 673 | P8II | TN | 3 | 1 | | | | 1 | 1 | bol | TNB1 | 135 | X |
| 1982 | | 63-3 | 556 | 58 | J16 | TN | 2 | | | | | 2 | 1 | bol | TNB1 | 136 | X |
| 1984 | 7825 | 65-5 | 606 | 206 | P8 | TN | 1 | | | | | 1 | 1 | bol | TNB1 | 137 | X |
| 1982 | | 63-3 | 558 | 67 | H15 | TN | 1 | | | | | 1 | 1 | bol | TNB1 | 138 | X |
| | | 67-4 | 1507 | 771 | sans n° | TN | 1 | | | | | 1 | 1 | bol | TNB1 | 139 | X |
| 1976 | | 28-2 | 30 | 11 | J13-J14 | TN | 1 | | | | | 1 | 1 | bol | TNB1 | | |
| 1983 | 7824 | 65-3 | 598 | 186 | H15 | TN | 1 | | | | | 1 | 1 | bol | TNB1 | 140 | X |
| 1983 | | 63-3 | 559 | 75 | K14 | TN | 1 | | | | | 1 | 1 | bol | TNB1.2 | 141 | X |
| 1976 | | 63-2 | 555 | 56 | G15 | TN | 1 | | | | | 1 | 1 | bol | TNB2.1 | 142 | X |
| 1976 | | 63-3 | 557 | 65 | J13 | TN | 1 | | | | | 1 | 1 | bol | TNB2.2 | 143 | X |
| 1983 | | 63-3 | 559 | 75 | K14 | TN | 1 | | | | | 1 | 1 | bol | TNB12 | 144 | X |
| 1980 | | 64-4 | 591 | 151 | E14 | TN | 2 | | | | | 2 | 1 | bol | TNB12 | 145 | X |
| | | 64-2 | 1518 | 781 | sans n° | TN | 1 | | | 1 | | 2 | 1 | bol | TNB14 | 146 | X |

ANNEXE B : LES ROISES

| année | n° OA | Rayon | Caisse | n° ordre | Carré | Catégorie | Comptage | | | | | | Typologie | Desc. Typo. | Dessin | Planche | |
|-------|----------|-------|--------|-------------|---------|-----------|----------|---|---|---|---|----|-----------|-------------|----------|---------|-----|
| | | | | | | | B | F | A | D | P | NR | | | | | NMI |
| | | 67-4 | 1507 | 771 | sans n° | TN | 1 | | | | | 1 | 1 | bol | TNB14 | 147 | X |
| | | 67-4 | 1507 | 771 | sans n° | TN | 1 | | | | | 1 | 1 | bol | TNB14 | 148 | X |
| 1982 | | 63-3 | 559 | 602 | K15 | TN | 1 | | | | | 1 | 1 | bol | TNB14 | 149 | XI |
| 1982 | | 28-2 | 30 | 7 | J16-J17 | TN | 2 | | | | | 2 | 1 | bol | TNB18 | 150 | XI |
| 1984 | 7825 | 65-5 | 606 | 206 | P8 | TN | 1 | | | | | 1 | 1 | bol | TNB33 | 151 | XI |
| 1977 | 7823 | 63-2 | 553 | 40 | G12 | TN | 1 | | | | | 1 | 1 | coupe | TNC1.2 | 152 | XI |
| 1982 | | 65-3 | 599 | 192 | J15 | TN | 1 | | | | | 1 | 1 | coupe | TNC16 | 153 | XI |
| 1982 | | 63-3 | 556 | 58 | J16 | TN | 1 | | | | | 1 | 1 | coupe | TNC16 | 154 | XI |
| 1983 | 7824 | 62-4 | 574 | 107 | Cave | TN | 1 | | | | | 1 | 1 | coupe | TNC.20.2 | 155 | XI |
| | | 64-2 | 583 | 120 | Q8 | TN | 2 | | | | | 2 | 1 | gobelet | TNG4 | 156 | XI |
| 1983 | 7824 | 65-4 | 603 | 202 | H14 | TN | 1 | | | | | 1 | 1 | bouteille | TNBT1 | 157 | XI |
| 1982 | | 63-3 | 558 | 67 | H15 | TN | 1 | | | | | 1 | 1 | bouteille | TNBT1.2 | 158 | XI |
| 1983 | 7824 | 67-4 | 1469 | 484 | H15 | TN | 1 | | | | | 1 | 1 | bouteille | TNBT1 | 159 | XI |
| 1984 | 7825 | 65-5 | 606 | 206 | P8 | TN | 1 | | | | | 1 | 1 | bouteille | TNBT1 | 160 | XI |
| 1984 | 7825 | 66-4 | 1473 | 680 | Q8 IV | TN | 1 | | | | | 1 | 1 | bouteille | TNBT1.3 | 161 | XI |
| 1983 | 7824 | 65-3 | 598 | 186 | H15 | TN | 2 | | | | | 2 | 1 | bouteille | TNBT1.3 | 162 | XI |
| 1982 | | 63-3 | 558 | 67 | H15 | TN | 1 | | | | | 1 | 1 | bouteille | TNBT4 | 163 | XI |
| 1977 | 7823 | 63-2 | 553 | 37 | G13 | TN | 3 | | | | | 3 | 1 | bouteille | TNBT6 | 164 | XI |
| 1981 | | 64-5 | 1671 | 785 | D15 | TN | 1 | | | | | 1 | 1 | bouteille | TNBT10 | 165 | XI |
| 1975 | | 65-2 | 597 | 183 | K12 | TN | 1 | | | | 3 | 4 | 1 | bouteille | TNBT10 | 166 | XII |
| 1983 | 7824 | 65-3 | 598 | 186 | H15 | TN | 1 | | | | | 1 | 1 | bouteille | TNBT10 | 167 | XII |
| 1984 | 7825 | 66-4 | 1473 | 682 | Q8 IV | TN | 1 | | | | | 1 | 1 | bouteille | TNBT11.2 | 168 | XII |
| 1976 | | 65-3 | 600 | 195 | H12 | TN | 1 | | | | | 1 | 1 | pot | TNP2 | 169 | XII |
| 1983 | 7824 | 65-4 | 603 | 202 | H14 | TN | 1 | | | | | 1 | 1 | pot | TNP2 | 170 | XII |
| 1976 | | 63-3 | 557 | 65 | J13 | TN | 1 | | | | | 1 | 1 | pot | TNP2 | 171 | XII |
| 1976 | | 63-3 | 557 | 65 | J13 | TN | 1 | | | | | 1 | 1 | pot | TNP2 | 172 | XII |

ANNEXE B : LES ROISES

| année | n° OA | Rayon | Caisse | n° ordre | Carré | Catégorie | Comptage | | | | | | | Typologie | Desc. Typo. | Dessin | Planche |
|-------|----------|-------|--------|-------------|---------|-----------|----------|---|---|---|---|----|-----|-----------|-------------|--------|---------|
| | | | | | | | B | F | A | D | P | NR | NMI | | | | |
| 1984 | 7825 | 65-5 | 606 | 206 | P8 | TN | 1 | | | | | 1 | 1 | pot | TNP2 | 173 | XII |
| 1979 | 7803 | 63-2 | 552 | 36 | G16 | TN | 1 | | | | | 1 | 1 | pot | TNP10 | 174 | XII |
| 1976 | | 65-3 | 600 | 195 | H12 | TN | 1 | | | | | 1 | 1 | pot | TNP10 | 175 | XII |
| 1983 | 7824 | 65-4 | 603 | 202 | H14 | TN | 1 | | | | | 1 | 1 | pot | TNP10 | 176 | XII |
| 1983 | 7824 | 65-4 | 603 | 202 | H14 | TN | 1 | | | | | 1 | 1 | pot | TNP10 | 177 | XII |
| 1982 | | 63-3 | 558 | 67 | H15 | TN | 1 | | | | | 1 | 1 | pot | TNP10 | 178 | XII |
| 1983 | | 35-1 | 1441 | 240 | H15 | TN | 1 | | | | | 1 | 1 | pot | TNP10 | 179 | XII |
| 1983 | | 63-3 | 559 | 75 | K14 | TN | 1 | | | | | 1 | 1 | pot | TNP10 | 180 | XII |
| 1982 | | 63-3 | 558 | 67 | H15 | TN | 1 | | | | | 1 | 1 | pot | TNP10 | 181 | XII |
| 1982 | | 63-3 | 558 | 67 | H15 | TN | 1 | | | | | 1 | 1 | pot | TNP10 | 182 | XII |
| | | 67-4 | 1507 | 771 | sans n° | TN | 1 | | | | | 1 | 1 | pot | TNP10 | 183 | XII |
| 1983 | 7824 | 65-3 | 598 | 186 | H15 | TN | 1 | | | | | 1 | 1 | pot | TNP10 | 184 | XII |
| 1980 | | 33-1 | 1448 | 294 | F14 | TN | 2 | | | | | 2 | 1 | pot | TNP10 | 185 | XIII |
| 1976 | | 63-2 | 555 | 56 | G15 | TN | 3 | | | | | 3 | 1 | pot | TNP10 | 186 | XIII |
| 1984 | 7825 | 34-1 | 1437 | 217 | N9 | TN | 1 | | | | | 1 | 1 | pot | TNP10 | 187 | XIII |
| 1980 | | 64-4 | 591 | 151 | E14 | TN | 1 | | | | | 1 | 1 | pot | TNP10 | 188 | XIII |
| 1983 | | 28-2 | 30 | 18 | H14/J16 | TN | 4 | | | | 6 | 10 | 1 | pot | TNP10 | 189 | XIII |
| 1984 | 7825 | 65-5 | 607 | 207 | P7 | TN | 1 | | | | | 1 | 1 | pot | TNP12 | 190 | XIII |
| 1979 | 7803 | 63-2 | 552 | 36 | G16 | TN | 1 | | | | | 1 | 1 | pot | TNP13 | 191 | XIII |
| 1979 | 7803 | 63-2 | 552 | 36 | G16 | TN | 1 | | | | | 1 | 1 | pot | TNP25 | 192 | XIII |
| 1981 | | 64-5 | 1671 | 785 | D15 | TN | 1 | | | | | 1 | 1 | pot | TNP26 | 193 | XIII |
| 1977 | 7823 | 63-2 | 553 | 37 | G13 | TN | 1 | | | | | 1 | 1 | pot | TNP32 | 194 | XIII |
| 1977 | | 63-2 | 555 | 52 | G13-G14 | TN | 1 | | | | | 1 | 1 | pot | TNP32 | 195 | XIII |
| 1976 | | 63-2 | 555 | 56 | G15 | TN | 5 | | | | | 5 | 1 | pot | TNP32 | 196 | XIII |
| 1976 | | 63-3 | 557 | 65 | J13 | TN | 1 | | | | | 1 | 1 | pot | TNP35 | 197 | XIII |
| 1977 | | 65-2 | 594 | 167 | F15 | TN | 1 | | | | | 1 | 1 | pot | TNP35 | 198 | XIII |

ANNEXE B : LES ROISES

| année | n° OA | Rayon | Caisse | n° ordre | Carré | Catégorie | Comptage | | | | | | Typologie | Desc. Typo. | Dessin | Planche | |
|-------|----------|-------|--------|-------------|---------|-----------|----------|---|---|---|----|----|-----------|-------------|----------|---------|------|
| | | | | | | | B | F | A | D | P | NR | | | | | NMI |
| 1976 | | 63-3 | 557 | 65 | J13 | TN | 1 | | | | | 1 | 1 | pot | TNP37 | 199 | XIII |
| | | 64-2 | 1518 | 781 | sans n° | TN | 1 | | | | | 1 | 1 | pot | TNP39.1 | 200 | XIII |
| 1977 | 7823 | 63-2 | 553 | 37 | G13 | TN | 2 | | | | | 2 | 1 | pot | TNP39.1 | 201 | XIII |
| 1980 | | 32-1 | 1445 | 271 | E14 | TN | 1 | | | | | 1 | 1 | pot | TNP40 | 202 | XIII |
| 1976 | | 63-3 | 557 | 65 | J13 | TN | 1 | | | | | 1 | 1 | pot | TNP40 | 203 | XIV |
| 1977 | | 65-2 | 594 | 167 | F15 | TN | 1 | | | | | 1 | 1 | pot | TNP42 | 204 | XIV |
| 1979 | 7803 | 35-1 | 1444 | 259 | G16 | TN | 1 | | | | | 1 | 1 | pot | TNP42 | 205 | XIV |
| 1983 | 7824 | 65-4 | 603 | 202 | H14 | TN | 1 | | | | | 1 | 1 | pot | TNP42 | 206 | XIV |
| 1976 | | 63-3 | 558 | 68 | H15 | TN | 1 | | | | | 1 | 1 | pot | TNP42 | 207 | XIV |
| 1983 | 7824 | 67-4 | 1469 | 512 | J16 | TN | 1 | | | | | 1 | 1 | pot | TNP51/54 | 208 | XIV |
| 1983 | 7824 | 65-3 | 598 | 186 | H15 | TN | 2 | | | | | 2 | 1 | pot | TNP51/54 | 209 | XIV |
| 1982 | | 65-3 | 599 | 192 | J15 | TN | 1 | | | | | 1 | 1 | pot | TNP51/54 | 210 | XIV |
| 1983 | 7824 | 65-4 | 603 | 202 | H14 | TN | 1 | | | | | 1 | 1 | pot | TNP51/54 | 211 | XIV |
| 1982 | | 63-3 | 558 | 67 | H15 | TN | 1 | | | | | 1 | 1 | pot | TNP51/54 | 212 | XIV |
| 1984 | 7825 | 65-5 | 606 | 206 | P8 | TN | 1 | | | | | 1 | 1 | pot | TNP51/54 | 213 | XIV |
| 1976 | | 63-2 | 555 | 56 | G15 | TN | 2 | | | | | 2 | 1 | pot | TNP51/54 | 214 | XIV |
| 1979 | 7803 | 63-2 | 552 | 36 | G16 | TN | 1 | | | | | 1 | 1 | pot | TNP51/54 | 215 | XIV |
| 1982 | 823 | 64-5 | 1470 | 522 | H15 | TN | 2 | | | | | 2 | 1 | pot | TNP51/54 | 216 | XIV |
| 1976 | | 63-3 | 557 | 65 | J13 | TN | 1 | | | | | 1 | 1 | pot | TNP51/54 | 217 | XIV |
| 1976 | | 63-3 | 557 | 65 | J13 | TN | 1 | | | | | 1 | 1 | pot | TNP51/54 | 218 | XIV |
| 1976 | | 63-3 | 557 | 65 | J13 | TN | 1 | | | | | 1 | 1 | pot | TNP51/54 | 219 | XV |
| | | 64-2 | 583 | 120 | Q8 | TN | 3 | | | | | 3 | 1 | pot | TNP51/54 | 220 | XV |
| 1980 | | 64-5 | 1671 | 784 | D14 | TN | 2 | | | | | 2 | 1 | pot | TNP51/54 | 221 | XV |
| 1976 | | 63-3 | 558 | 68 | H15 | TN | 1 | | | | | 1 | 1 | pot | TNP54.3 | 222 | XV |
| 1983 | 7824 | 65-4 | 604 | 204 | Cave | TN | | 2 | | | 62 | 64 | | | | | |
| 1984 | | 32-1 | 1446 | 273 | L11 | TN | | | | | 7 | 7 | | | | | |

ANNEXE B : LES ROISES

| année | n° OA | Rayon | Caisse | n° ordre | Carré | Catégorie | Comptage | | | | | | | Typologie | Desc. Typo. | Dessin | Planche |
|-----------|----------|-------|--------|-------------|--|-----------|----------|---|---|---|----|----|-----|-----------|-------------|--------|---------|
| | | | | | | | B | F | A | D | P | NR | NMI | | | | |
| | | 64-2 | 1518 | 781 | sans n° | TN | | | | | | 0 | | | | | |
| | | 66-1 | 1515 | 778 | sans n° | TN | | 1 | | | 41 | 42 | | | | | |
| | | 66-1 | 1510 | 773 | sans n° | TN | | | | | 18 | 18 | | | | | |
| | | 66-4 | 1511 | 774 | sans n° | TN | | | | | 26 | 26 | | | | | |
| | | 67-4 | 1507 | 771 | sans n° | TN | | | | | 19 | 19 | | | | | |
| 1984 | | 3-1 | 1485 | 689 | 3 | TN | | 1 | | | 1 | 2 | | | | | |
| 1973 | | 64-3 | 586 | 138 | C | TN | | | | | 4 | 4 | | | | | |
| 1982 | 7823 | 65-2 | 596 | 180 | C13 | TN | | | | | 10 | 10 | | | | | |
| 1982 | 7823 | 65-2 | 596 | 178 | C13-D13 | TN | | | | | 1 | 1 | | | | | |
| 1981 | | 67-3 | 1468 | 439 | Cave | TN | | | | | 2 | 2 | | | | | |
| 1980-1982 | | 64-5 | 1671 | 783 | D13-D15 | TN | | 1 | | | 16 | 17 | | | | | |
| 1980 | | 64-5 | 1671 | 784 | D14 | TN | | 3 | | | 60 | 63 | | | | | |
| 1981 | | 64-5 | 1671 | 785 | D15 | TN | | 1 | | | 23 | 24 | | | | | |
| 1981 | | 67-3 | 1468 | 480 | D15 | TN | | | | | 1 | 1 | | | | | |
| 1982 | | 63-4 | 563 | 83 | E13-E14 | TN | | 1 | | | | 1 | | | | | |
| 1980 | | 66-4 | 1474 | 725 | E14c | TN | | 1 | | | 1 | 2 | | | | | |
| 1973 | | 64-3 | 586 | 140 | Extrémité NW de la tranchée SE-NW côté voie close | TN | | | | | 5 | 5 | | | | | |
| 1982 | | 63-4 | 566 | 91 | F13 | TN | | | | | 3 | 3 | | | | | |
| 1980 | | 63-4 | 95 | 20 | F14 | TN | | | | | 12 | 12 | | | | | |
| 1979 | | 65-2 | 594 | 168 | F16 | TN | | | | | 65 | 65 | | | | | |
| | | 28-2 | 30 | 23 | F-G15 | TN | | | | | 1 | 1 | | | | | |
| 1976 | 7823 | 63-2 | 553 | 40 | G12 | TN | | | | | 16 | 16 | | | | | |

ANNEXE B : LES ROISES

| année | n° OA | Rayon | Caisse | n° ordre | Carré | Catégorie | Comptage | | | | | | Typologie | Desc. Typo. | Dessin | Planche |
|-----------------|----------|-------|--------|-------------|---------------------|-----------|----------|---|---|---|-----|-----|-----------|-------------|--------|---------|
| | | | | | | | B | F | A | D | P | NR | | | | |
| 1979 | | 63-5 | 564 | 84 | G12-G13 | TN | | | | | 7 | 7 | | | | |
| 1979 | | 63-5 | 564 | 88 | G12-H12 | TN | | | | | 39 | 39 | | | | |
| 1977 | 7823 | 63-2 | 553 | 37 | G13 | TN | | | | | 60 | 60 | | | | |
| 1977 | | 63-2 | 555 | 52 | G13-G14 | TN | | | | | 42 | 42 | | | | |
| 1977 | | 63-2 | 555 | 53 | G14 | TN | | 1 | | | 29 | 30 | | | | |
| 1977 | | 63-2 | 555 | 51 | G14-G15 | TN | | | | | 4 | 4 | | | | |
| 1976 | | 63-2 | 555 | 56 | G15 | TN | | 4 | | | 39 | 43 | | | | |
| 1976 | | 63-2 | 555 | 56 | G15 | TN | | 2 | | | | 2 | | | | |
| 1980 | | 63-4 | 566 | 93 | G16 | TN | | | | | 12 | 12 | | | | |
| 1979 | 7803 | 63-2 | 552 | 36 | G16 | TN | | 2 | 1 | | 146 | 149 | | | | |
| 1981 | | 63-5 | 564 | 87 | H7 | TN | | 5 | | | 74 | 79 | | | | |
| 1976 | | 65-3 | 600 | 195 | H12 | TN | | | | | 67 | 67 | | | | |
| 1975 | 7782 | 65-3 | 600 | 197 | H13 | TN | | 3 | | | 75 | 78 | | | | |
| 1975 | 7782 | 33-1 | 1449 | 300 | H13 | TN | | 1 | | 1 | 2 | | | | | |
| 1976 | | 65-4 | 603 | 201 | H13-H14 | TN | | 1 | | | 30 | 31 | | | | |
| 1983 | 7824 | 65-4 | 603 | 202 | H14 | TN | | | | | 12 | 12 | | | | |
| 1983 | 7824 | 65-4 | 603 | 202 | H14 | TN | | 3 | | | 84 | 87 | | | | |
| 1983 | 7824 | 65-4 | 603 | 203 | H14-H15- J14-J15 | TN | | | | | 31 | 31 | | | | |
| 1976 | | 63-3 | 558 | 68 | H15 | TN | | 7 | | | 34 | 41 | | | | |
| 1982 | | 63-3 | 558 | 67 | H15 | TN | | 8 | | | 170 | 178 | | | | |
| 1981 | | 63-5 | 564 | 86 | H16 | TN | | | | | 22 | 22 | | | | |
| 1983 | 7824 | 55-3 | 598 | 187 | H16 | TN | | 2 | | | 47 | 49 | | | | |
| 1982 | | 35-1 | 1442 | 248 | H16 | TN | | | | | 2 | 2 | | | | |
| 1976/1977/19779 | | 63-4 | 561 | 80 | Hypocauste | TN | | 3 | | | 33 | 36 | | | | |
| 1975 | 7782 | 65-3 | 599 | 189 | J12 | TN | | | | | 14 | 14 | | | | |

ANNEXE B : LES ROISES

| année | n° OA | Rayon | Caisse | n° ordre | Carré | Catégorie | Comptage | | | | | | | Typologie | Desc. Typo. | Dessin | Planche |
|-------|----------|-------|--------|-------------|---|-----------|----------|---|---|---|-----|-----|-----|-----------|-------------|--------|---------|
| | | | | | | | B | F | A | D | P | NR | NMI | | | | |
| 1976 | | 63-3 | 557 | 65 | J13 | TN | | 3 | | | 44 | 47 | | | | | |
| 1983 | 7824 | 67-4 | 1469 | 489 | J14 | TN | | 2 | | | | 2 | | | | | |
| 1982 | | 63-3 | 556 | 58 | J16 | TN | | 2 | | | 113 | 115 | | | | | |
| 1982 | | 34-1 | 1438 | 227 | J16 | TN | | 1 | | | | 1 | | | | | |
| 1975 | | 65-3 | 597 | 184 | K13 | TN | | | 1 | | 23 | 24 | | | | | |
| 1983 | | 63-3 | 559 | 75 | K14 | TN | | 3 | | | 83 | 86 | | | | | |
| 1982 | | 63-3 | 559 | 602 | K15 | TN | | | | | 34 | 34 | | | | | |
| 1982 | | 63-3 | 559 | 78 | K16 | TN | | | | | 47 | 47 | | | | | |
| 1974 | | 65-2 | 593 | 164 | L10 | TN | | | | | 6 | 6 | | | | | |
| 1974 | 7816 | 63-2 | 554 | 48 | L11 | TN | | | | | 6 | 6 | | | | | |
| 1984 | 7825 | 65-5 | 608 | 208 | L11 | TN | | | | | 67 | 67 | | | | | |
| 1984 | 7825 | 67-3 | 1467 | 43 | L11XIII | TN | | 3 | | | | 3 | | | | | |
| 1984 | 7825 | 65-5 | 605 | 205 | M10 | TN | | 2 | | | 97 | 99 | | | | | |
| 1974 | 7816 | 63-5 | 567 | 98 | M11 | TN | | | 1 | | 71 | 72 | | | | | |
| 1984 | 7825 | 65-5 | 607 | 207 | P7 | TN | | 1 | | | 77 | 78 | | | | | |
| 1984 | 7825 | 63-3 | 559 | 79 | P8 | TN | | | | | 358 | 358 | | | | | |
| 1984 | 7825 | 65-5 | 606 | 206 | P8 | TN | | 3 | | | 155 | 158 | | | | | |
| 1984 | 7825 | 63-5 | 565 | 90 | Q8 | TN | | 2 | | | 150 | 152 | | | | | |
| 1984 | | 33-1 | 1449 | 301 | Q8 | TN | | 1 | | | 1 | 2 | | | | | |
| 1973 | | 64-3 | 586 | 140 | Tranchée SW.NE Extrémité - -> amph | TN | | | | | 1 | 1 | | | | | |
| 1982 | | 63-3 | 558 | 67 | H15 | TN/DTN | 1 | | | | | 1 | 1 | bol | TN/DTN B1 | 223 | XV |
| 1979 | 7803 | 63-2 | 552 | 36 | G16 | TN/DTN | 1 | | | | | 1 | 1 | bol | TN/DTN B1 | 224 | XV |
| 1983 | 7824 | 65-3 | 598 | 186 | H15 | TN/DTN | 1 | | | | | 1 | 1 | bol | TN/DTN B1 | 225 | XV |
| 1983 | | 35-1 | 1441 | 240 | H15 | TN/DTN | 1 | | | | | 1 | 1 | bol | TN/DTN B1 | 226 | XV |

ANNEXE B : LES ROISES

| année | n° OA | Rayon | Caisse | n° ordre | Carré | Catégorie | Comptage | | | | | | Typologie | Desc. Typo. | Dessin | Planche | |
|-------|----------|-------|--------|-------------|-----------------|-----------|----------|---|---|----|----|----|-----------|-------------|------------|---------|-----|
| | | | | | | | B | F | A | D | P | NR | | | | | NMI |
| 1982 | | 63-3 | 558 | 67 | H15 | TN/DTN | 1 | | | | | 1 | 1 | bol | TN/DTN B1 | 227 | XV |
| 1982 | | 63-3 | 558 | 67 | H15 | TN/DTN | 2 | | | | | 2 | 1 | bol | TN/DTN B1 | 228 | XV |
| | | 27--2 | 1490 | 751 | sans n° | TN/DTN | 1 | | | 1 | | 2 | 1 | coupe | TN/DTN C1 | 229 | XV |
| 1982 | | 65-3 | 599 | 192 | J15 | TN/DTN | 1 | | | | | 1 | 1 | jatte | TN/DTN J1 | 230 | XV |
| 1976 | | 63-2 | 555 | 56 | G15 | TN/DTN | 1 | | | | | 1 | 1 | jatte | TN/DTN J1 | 231 | XV |
| 1977 | | 35-1 | 1443 | 252 | G14 | TN/DTN | 4 | | | | | 4 | 1 | jatte | TN/DTN J1 | 232 | XV |
| 1984 | 7825 | 65-5 | 606 | 206 | P8 | TN/DTN | 1 | | | | | 1 | 1 | bouteille | TN/DTN Bt2 | 233 | XV |
| 1980 | | 66-4 | 1474 | 716 | E15a | TN/DTN | 1 | | | | | 1 | 1 | pot | TN/DTN P2 | 234 | XVI |
| 1980 | | 64-4 | 591 | 151 | E14 | TN/DTN | | | | 30 | 30 | | | | | | |
| 1980 | | 64-4 | 591 | 148 | E15 | TN/DTN | | | | 50 | 50 | | | | | | |
| 1981 | | 67-3 | 1468 | 469 | E15-F15 | TN/DTN | | | | 2 | 2 | | | | | | |
| 1981 | | 64-3 | 587 | 144 | F15-F16 | TN/DTN | | | | 12 | 12 | | | | | | |
| 1981 | | 65-2 | 594 | 166 | F15-G15 | TN/DTN | | | | 25 | 25 | | | | | | |
| 1981 | | 64-3 | 587 | 142 | F16 | TN/DTN | | | | 21 | 21 | | | | | | |
| | | 65-2 | 595 | 171 | F16-G16- G17 | TN/DTN | | | | 3 | 3 | | | | | | |
| 1977 | | 33-1 | 1448 | 296 | G13 | TN/DTN | 2 | | | 5 | 7 | | | | | | |
| 1979 | 7803 | 32-1 | 1445 | 268 | G16 | TN/DTN | | 2 | | 5 | 7 | | | | | | |
| 1983 | 7824 | 67-4 | 1469 | 503 | H14 | TN/DTN | 1 | | | | 1 | | | | | | |
| 1983 | 7824 | 66-3 | 1472 | 637 | H14 | TN/DTN | 1 | | | 14 | 15 | | | | | | |
| 1983 | | 35-1 | 1441 | 242 | H17 | TN/DTN | 1 | | | | 1 | | | | | | |
| 1983 | 7824 | 66-3 | 1472 | 605 | J15 | TN/DTN | 1 | | | | 1 | | | | | | |
| 1982 | 7823 | 64-5 | 1470 | 525 | C13 | TN AR | | | 1 | | 1 | 1 | | | | | |
| 1982 | 7823 | 64-5 | 1470 | 553 | J16 | TN AR | | | 1 | | 1 | 1 | | | | | |
| 1982 | 7823 | 64-5 | 1470 | 552 | J16 | TN AR | | | 1 | | 1 | 1 | | | | | |
| 1982 | 7823 | 64-5 | 1470 | 543 | J16 | TN AR | | | 2 | | 2 | 1 | | | | | |

ANNEXE B : LES ROISES

| année | n° OA | Rayon | Caisse | n° ordre | Carré | Catégorie | Comptage | | | | | | Typologie | Desc. Typo. | Dessin | Planche |
|-------|----------|-------|--------|-------------|-----------------|-----------|----------|----|---|---|-----|-----|-----------|-------------|--------|---------|
| | | | | | | | B | F | A | D | P | NR | | | | |
| 1976 | | 64-2 | 583 | 121 | H13-H14 | TN AR | | | | 1 | | 1 | 1 | | | |
| 1980 | | 66-4 | 1474 | 694 | E15 | TN AR | | | | 2 | | 2 | | | | |
| 1980 | | 66-4 | 1474 | 745 | F14 | TN AR | | | | 2 | | 2 | | | | |
| 1977 | 7823 | 63-2 | 553 | 40 | G12 | TN AR | | 3 | | 1 | 28 | 32 | | | | |
| 1977 | 7823 | 63-2 | 553 | 37 | G13 | TN AR | | | 4 | | 28 | 32 | | | | |
| 1981 | | 67-3 | 1468 | 445 | H17 | TN AR | | | | 3 | | 3 | | | | |
| 1983 | 7824 | 62-4 | 574 | 107 | Cave | TN AR | | | | | 49 | 49 | | | | |
| 1980 | | 66-4 | 1474 | 742 | E15b | TN AR | | | | | 1 | 1 | | | | |
| 1977 | | 65-2 | 594 | 167 | F15 | TN AR | | 1 | | 2 | 37 | 40 | | | | |
| 1981 | | 67-3 | 1468 | 448 | F15-G15- F16 | TN AR | | 4 | | | | 4 | | | | |
| 1981 | | 64-3 | 585 | 136 | F15-G15- F16 | TN AR | | | | 1 | | 1 | | | | |
| 1976 | 7823 | 63-2 | 553 | 40 | G12 | TN AR | | | | 1 | | 1 | | | | |
| 1983 | 7824 | 65-3 | 598 | 186 | H15 | TN AR | | 10 | | | 120 | 130 | | | | |
| 1982 | | 28-5 | 1471 | 589 | H15 | TN AR | | | | | 2 | 2 | | | | |
| 1983 | 7824 | 67-4 | 1469 | 509 | J15 | TN AR | | | | | 1 | 1 | | | | |
| 1982 | | 65-3 | 599 | 192 | J15 | TN AR | | 3 | | | 80 | 83 | | | | |
| 1974 | | 63-3 | 559 | 72 | K11 | TN AR | | 1 | | | 4 | 5 | | | | |
| 1975 | | 65-2 | 597 | 183 | K12 | TN AR | | 3 | | | 10 | 13 | | | | |
| 1982 | 7823 | 64-5 | 1470 | 531 | K16 | TN AR | | | | 1 | | 1 | | | | |
| 1984 | 7825 | 67-3 | 1467 | 400 | N9V | TN AR | | | | 1 | | 1 | | | | |
| 1984 | 7825 | 65-4 | 602 | 200 | Q8 | TN AR | | | | | 4 | 4 | | | | |
| | | 27--2 | 1490 | 751 | sans n° | TN AR | | | | 1 | | 1 | | | | |
| | | 64-2 | 1518 | 781 | sans n° | TN AR | | | | | | 0 | | | | |
| 1975 | 7782 | 65-3 | 600 | 197 | H13 | TR | 1 | | | | | 1 | 1 | bol | TRB3 | 235 XVI |
| 1981 | | 63-5 | 564 | 87 | H7 | TR | 1 | | | | | 1 | 1 | coupe | TRC1 | 236 XVI |

ANNEXE B : LES ROISES

| année | n° OA | Rayon | Caisse | n° ordre | Carré | Catégorie | Comptage | | | | | | | Typologie | Desc. Typo. | Dessin | Planche |
|-------|----------|-------|--------|-------------|---------|-----------|----------|---|---|---|---|----|-----|------------|--------------|--------|---------|
| | | | | | | | B | F | A | D | P | NR | NMI | | | | |
| 1984 | 7825 | 67-3 | 1467 | 363 | M10 XI | TR | 2 | | | | | 2 | 1 | coupelle | TRC13 | 237 | XVI |
| 1983 | 7824 | 65-3 | 598 | 186 | H15 | TR | 1 | | | | | 1 | 1 | bouteille | TRBT1.3 | 238 | XVI |
| 1979 | 7803 | 63-2 | 552 | 36 | G16 | TR | 1 | | | | 7 | 8 | 1 | pot | TRP10 | 239 | XVI |
| 1979 | 7803 | 63-2 | 552 | 36 | G16 | TR | 1 | | | | | 1 | 1 | pot | TRP25 | 240 | XVI |
| 1981 | | 67-3 | 1468 | 480 | D15 | TR | 1 | | | | | 1 | 1 | pot | TRP31 | 241 | XVI |
| 1979 | | 63-5 | 564 | 84 | G12-G13 | TR | 1 | | | | | 1 | 1 | pot | TRP42 | 242 | XVI |
| 1975 | | 35-1 | 1443 | 254 | K12 | TR | | 1 | | | | 1 | 1 | estampille | | 243 | XVI |
| 1982 | | 64-5 | 1671 | 786 | D13 | TR | | | | | 4 | 4 | | | | | |
| 1980 | | 64-5 | 592 | 156 | D14 | TR | | | | | | 12 | 12 | | | | |
| 1979 | | 28-2 | 30 | 6 | F16 | TR | | | | | | 3 | 3 | | | | |
| 1980 | | 35-1 | 1441 | 245 | G16 | TR | | | | | | 1 | 1 | | | | |
| 1976 | | 65-3 | 600 | 195 | H12 | TR | | | | | | 6 | 6 | | | | |
| 1982 | | 63-3 | 558 | 67 | H15 | TR | | | | | | 6 | 6 | | | | |
| 1983 | 7824 | 65-3 | 598 | 186 | H15 | TR | | | | | | 4 | 4 | | | | |
| 1975 | | 35-1 | 1443 | 257 | J13 | TR | | | | | | 1 | 1 | | | | |
| 1975 | | 63-3 | 559 | 73 | K13 | TR | | | | | | 8 | 8 | | | | |
| 1984 | | 63-4 | 563 | 82 | M10 | TR | | | | | | 7 | 7 | | | | |
| 1984 | | 63-4 | 563 | 82 | M10 | TR | | | | | | 1 | 1 | | | | |
| 1984 | | 33-1 | 1449 | 301 | Q8 | TR | | | | | | 21 | 21 | | | | |
| 1983 | | 64-2 | 583 | 125 | Cave | VRP | 1 | | | | | 1 | 1 | plat | Goudineau 15 | 244 | XVI |
| 1983 | 7824 | 65-4 | 604 | 204 | Cave | VRP | 2 | | | | | 2 | 1 | plat | Goudineau 15 | 245 | XVI |
| 1980 | | 64-5 | 1671 | 784 | D14 | VRP | 1 | | | | | 1 | 1 | plat | Goudineau 15 | 246 | XVI |
| 1983 | | 62-3 | 570 | 99 | M02 | VRP | 1 | | | | | 1 | 1 | plat | Goudineau 15 | 247 | XVII |
| 1974 | 7816 | 63-5 | 567 | 98 | M11 | VRP | 3 | | | | | 3 | 1 | plat | Goudineau 17 | 248 | XVII |
| | | 67-4 | 1507 | 771 | sans n° | VRP | 1 | | | | | 1 | 1 | plat | Goudineau 17 | 249 | XVII |
| 1968 | | 43-3 | 1387 | 214 | Mur | VRP | 1 | | | | | 2 | 3 | plat | Goudineau 19 | 250 | XVII |

ANNEXE B : LES ROISES

| année | n° OA | Rayon | Caisse | n° ordre | Carré | Catégorie | Comptage | | | | | | Typologie | Desc. Typo. | Dessin | Planche | |
|-------|----------|-------|--------|-------------|---------|-----------|----------|---|---|----|----|----|-----------|-------------|--------------|---------|-------|
| | | | | | | | B | F | A | D | P | NR | | | | | NMI |
| | | 66-4 | 1511 | 774 | sans n° | VRP | 1 | | | | | 1 | 1 | plat | Goudineau 19 | 251 | XVII |
| | | 28-2 | 30 | 20 | D14 | VRP | | | | 2 | 2 | 1 | | plat | | | |
| 1984 | | 63-4 | 563 | 82 | M10 | VRP | 3 | | | | | 3 | 1 | plat | | | |
| 1984 | 7825 | 66-3 | 1473 | 666 | N9VII | VRP | 2 | | | | | 2 | 1 | couvercle | Goudineau 18 | 252 | XVII |
| 1984 | | 3-1 | 1485 | 689 | 3 | VRP | | | | 1 | 1 | | | | | | |
| 1983 | 7824 | 65-4 | 604 | 204 | Cave | VRP | | | | 7 | 7 | | | | | | |
| 1973 | | 64-3 | 586 | 139 | F | VRP | | | | 1 | 1 | | | | | | |
| 1979 | | 63-5 | 564 | 88 | G12-H12 | VRP | | | | 1 | 1 | | | | | | |
| 1977 | 7823 | 63-2 | 553 | 37 | G13 | VRP | | | | 8 | 8 | | | | | | |
| 1981 | | 63-5 | 564 | 87 | H7 | VRP | | | | 2 | 2 | | | | | | |
| 1974 | | 55-2 | 597 | 181 | K9 | VRP | | | | 2 | 2 | | | | | | |
| 1974 | 7816 | 63-2 | 554 | 48 | L11 | VRP | | | | 4 | 4 | | | | | | |
| 1983 | | 62-3 | 570 | 99 | M02 | VRP | | | | 4 | 4 | | | | | | |
| 1984 | | 63-4 | 563 | 82 | M10 | VRP | | | | 16 | 16 | | | | | | |
| 1980 | | 63-4 | 562 | 81 | Wp | VRP | | | | 5 | 5 | | | | | | |
| 1976 | | 64-2 | 583 | 121 | H13-H14 | RU UR | 1 | | | | | 1 | 1 | plat | Nied. 112 | 253 | XVII |
| 1976 | | 65-3 | 600 | 195 | H12 | RU UR | 1 | | | | | 1 | 1 | plat | Nied. 112 | 254 | XVII |
| 1976 | | 63-3 | 558 | 68 | H15 | RU UR | 1 | | | | | 1 | 1 | plat | Nied. 112 | 255 | XVII |
| 1984 | 7825 | 65-4 | 602 | 200 | Q8 | RU UR | 1 | | | | | 1 | 1 | plat | Nied. 113 | 256 | XVII |
| 1976 | | 63-3 | 558 | 68 | H15 | RU UR | 1 | | | | | 1 | 1 | jatte | Nied. 104 | 257 | XVII |
| 1982 | | 64-2 | 583 | 130 | K15 | RU UR | 1 | | | | | 1 | 1 | jatte | Nied. 104 | 258 | XVIII |
| 1976 | | 63-3 | 557 | 65 | J13 | RU UR | 1 | | | | | 1 | 1 | jatte | Nied. 104 | 259 | XVIII |
| 1976 | | 65-3 | 600 | 195 | H12 | RU UR | 1 | | | | | 1 | 1 | jatte | Nied. 104 | 260 | XVIII |
| 1982 | | 63-3 | 559 | 602 | K15 | RU UR | 1 | | | | | 1 | 1 | jatte | Nied. 104 | 261 | XVIII |
| | | 64-2 | 1518 | 781 | sans n° | RU UR | 1 | | | | | 1 | 1 | jatte | Nied. 104 | 262 | XVIII |
| | | 66-4 | 1511 | 774 | sans n° | RU UR | 1 | | | | | 1 | 1 | jatte | Nied. 104 | 263 | XVIII |

ANNEXE B : LES ROISES

| année | n° OA | Rayon | Caisse | n° ordre | Carré | Catégorie | Comptage | | | | | | Typologie | Desc. Typo. | Dessin | Planche | |
|-------|----------|-------|--------|-------------|---------|-----------|----------|---|---|---|----|----|-----------|-------------|------------|---------|-------|
| | | | | | | | B | F | A | D | P | NR | | | | | NMI |
| | | 67-4 | 1507 | 771 | sans n° | RU UR | 1 | | | | | 1 | 1 | jatte | Nied. 106 | 264 | XVIII |
| 1976 | | 64-2 | 583 | 121 | H13-H14 | RU UR | 1 | | | | | 1 | 1 | marmite | Nied. 89 | 265 | XVIII |
| 1983 | 7824 | 62-4 | 574 | 107 | Cave | RU UR | 2 | | | | | 2 | 1 | marmite | Nied. 89 | 266 | XVIII |
| 1983 | 7824 | 65-4 | 604 | 204 | Cave | RU UR | 3 | | | | | 3 | 1 | marmite | Nied. 89 | 267 | XVIII |
| 1976 | | 63-3 | 558 | 68 | H15 | RU UR | 1 | | | | | 1 | 1 | marmite | Nied. 89 | 268 | XVIII |
| 1976 | | 63-3 | 557 | 65 | J13 | RU UR | 1 | | | | | 1 | 1 | marmite | Nied. 89 | 269 | XVIII |
| 1976 | | 63-3 | 557 | 65 | J13 | RU UR | 1 | | | | | 1 | 1 | marmite | Nied. 89 | 270 | XVIII |
| 1974 | | 33-1 | 1449 | 305 | K9 | RU UR | 1 | | | | | 1 | 1 | marmite | Nied. 89 | 271 | XVIII |
| 1983 | 7824 | 65-3 | 598 | 186 | H15 | RU UR | 3 | | | | | 3 | 1 | pichet | Nied. 100b | 272 | XVIII |
| 1976 | | 32-1 | 1445 | 279 | H12 | RU UR | | 1 | | | | 1 | 1 | couvercle | Nied. 120 | 273 | XVIII |
| 1980 | | 66-4 | 1474 | 726 | D14c | RU UR | 1 | | | | 3 | 4 | 1 | couvercle | Nied. 120b | 274 | XVIII |
| 1983 | 7824 | 65-4 | 604 | 204 | Cave | RU UR | | | | | 7 | 7 | | | | | |
| 1983 | 7824 | 62-4 | 574 | 107 | Cave | RU UR | | | | | 4 | 4 | | | | | |
| 1980 | | 64-5 | 1671 | 784 | D14 | RU UR | | | | | 1 | 1 | | | | | |
| | | 28-2 | 30 | 23 | F-G15 | RU UR | | | | 2 | | 2 | | | | | |
| 1976 | | 65-3 | 600 | 195 | H12 | RU UR | | | | | 24 | 24 | | | | | |
| 1982 | | 65-3 | 599 | 192 | J15 | RU UR | | | | | 6 | 6 | | | | | |
| 1983 | 7824 | 67-4 | 1469 | 494 | K15 | RU UR | | 1 | | | 14 | 15 | | | | | |
| 1982 | | 63-3 | 559 | 602 | K15 | RU UR | | | | | 14 | 14 | | | | | |
| 1968 | | 43-3 | 1387 | 214 | Mur | RU UR | | | | | 4 | 4 | | | | | |
| 1984 | 7825 | 65-4 | 602 | 200 | Q8 | RU UR | | | | | 2 | 2 | | | | | |
| 1984 | | 3-1 | 1485 | 689 | 3 | RU Cl | | 2 | | | 7 | 9 | 1 | plat | Nied. 111a | 275 | XIX |
| | | 67-4 | 1507 | 771 | sans n° | RU Cl | 1 | | | | | 1 | 1 | plat | Nied. 113 | 276 | XIX |
| 1976 | | 63-2 | 555 | 56 | G15 | RU Cl | 1 | | | | | 1 | 1 | jatte | RU Cl J1 | 277 | XIX |
| 1981 | | 64-5 | 1671 | 785 | D15 | RU Cl | 1 | | | | | 1 | 1 | jatte | Nied. 104 | 278 | XIX |
| | | 67-4 | 1507 | 771 | sans n° | RU Cl | 1 | | | | | 1 | 1 | marmite | Nied. 87 | 279 | XIX |

ANNEXE B : LES ROISES

| année | n° OA | Rayon | Caisse | n° ordre | Carré | Catégorie | Comptage | | | | | | | Typologie | Desc. Typo. | Dessin | Planche |
|-------|----------|-------|--------|-------------|--|-----------|----------|---|---|---|----|----|-----|-----------|-------------|--------|---------|
| | | | | | | | B | F | A | D | P | NR | NMI | | | | |
| 1975 | 7782 | 65-3 | 600 | 197 | H13 | RU Cl | 1 | | | | | 1 | 1 | marmite | Nied. 89 | 280 | XIX |
| 1983 | 7824 | 65-3 | 598 | 186 | H15 | RU Cl | 1 | | | | | 1 | 1 | marmite | Nied. 89 | 281 | XIX |
| 1984 | | 3-1 | 1485 | 689 | 3 | RU Cl | 1 | | | | | 1 | 1 | marmite | Nied. 89 | 282 | XIX |
| 1984 | | 3-1 | 1485 | 689 | 3 | RU Cl | 1 | | | | | 1 | 1 | marmite | Nied. 89 | 283 | XIX |
| 1977 | 7823 | 63-2 | 553 | 46 | G12-G13 | RU Cl | 1 | | | | | 1 | 1 | marmite | Nied. 89 | 284 | XIX |
| | | 67-4 | 1507 | 771 | sans n° | RU Cl | 1 | | | | | 1 | 1 | marmite | Nied. 89 | 285 | XIX |
| | | 67-4 | 1507 | 771 | sans n° | RU Cl | 1 | | | | | 1 | 1 | marmite | Nied. 89 | 286 | XIX |
| | | 5--2 | 1500 | 763 | sans n° | RU Cl | 1 | | | | | 1 | 1 | marmite | Nied. 89 | 287 | XX |
| 1977 | 7823 | 63-2 | 553 | 40 | G12 | RU Cl | 1 | | | | | 1 | 1 | marmite | Nied. 89 | 288 | XX |
| 1982 | 7823 | 63-2 | 553 | 44 | C13 | RU Cl | 1 | | | | | 1 | 1 | marmite | Nied. 89 | 289 | XX |
| 1973 | | 64-3 | 586 | 140 | Extrémité NW de la tranchée SE-NW côté voie close | RU Cl | 1 | 1 | | | 5 | 7 | 1 | marmite | Nied. 89 | 290 | XX |
| 1977 | | 64-2 | 583 | 113 | W | RU Cl | 1 | | | | | 1 | 1 | marmite | Nied. 89 | 291 | XX |
| 1968 | | 43-3 | 1387 | 214 | Mur | RU Cl | | | | | 4 | 4 | 1 | pichet | Nied. 96 | 292 | XX |
| 1977 | 7823 | 63-2 | 553 | 37 | G13 | RU Cl | 1 | | | | | 1 | 1 | pot | RU Cl P2 | 293 | XX |
| 1982 | | 63-4 | 563 | 83 | E13-E14 | RU Cl | | 1 | | | | 1 | | | | | |
| 1981 | | 67-3 | 1468 | 425 | Cave | RU Cl | | 1 | | | 1 | 2 | | | | | |
| 1984 | | 63-4 | 563 | 82 | M10 | RU Cl | | | | | 13 | 13 | | | | | |
| | | 67-4 | 1507 | 771 | sans n° | RU Cl | | | | | 31 | 31 | | | | | |
| 1984 | | 3-1 | 1485 | 689 | 3 | RU Cl | | | | | 11 | 11 | | | | | |
| 1973 | | 64-3 | 586 | 138 | C | RU Cl | | | | | 15 | 15 | | | | | |
| 1982 | | 64-5 | 1671 | 786 | D13 | RU Cl | | | | | 7 | 7 | | | | | |
| 1982 | 7823 | 63-2 | 553 | 44 | C13 | RU Cl | | | | | 7 | 7 | | | | | |

ANNEXE B : LES ROISES

| année | n° OA | Rayon | Caisse | n° ordre | Carré | Catégorie | Comptage | | | | | | | Typologie | Desc. Typo. | Dessin | Planche |
|-------|----------|-------|--------|-------------|--|-----------|----------|---|---|---|----|----|-----|------------|-------------------|--------|---------|
| | | | | | | | B | F | A | D | P | NR | NMI | | | | |
| 1984 | | 64-3 | 586 | 139 | F | RU CI | | | | | 8 | 8 | | | | | |
| 1977 | 7823 | 63-2 | 553 | 46 | G12-G13 | RU CI | | | | | 5 | 5 | | | | | |
| 1977 | 7823 | 63-2 | 553 | 37 | G13 | RU CI | | | | | 41 | 41 | | | | | |
| 1984 | | 3-1 | 1485 | 689 | 3 | RU CI | 4 | | | | | 4 | | | | | |
| 1973 | | 64-3 | 586 | 140 | Extrémité NW de la tranchée SE-NW côté voie close | RU CI | | | | | 7 | 7 | | | | | |
| 1973 | | 64-3 | 586 | 140 | Extrémité SW de la grande tranchée | RU CI | | | | | 2 | 2 | | | | | |
| 1977 | 7823 | 63-2 | 553 | 40 | G12 | RU CI | | | | | 9 | 9 | | | | | |
| 1977 | 7823 | 63-2 | 553 | 37 | G13 | RU CI | | 2 | | | 18 | 20 | | | | | |
| | | 28-2 | 30 | 33 | H13 | RU CI | | | | | 2 | 2 | | | | | |
| 1983 | 7824 | 65-4 | 603 | 202 | H14 | RU CI | | | | | 12 | 12 | | | | | |
| 1982 | | 65-3 | 599 | 192 | J15 | RU CI | | 1 | | | | 1 | | | | | |
| 1983 | | 62-3 | 570 | 99 | M02 | RU CI | | | | | 78 | 78 | | | | | |
| 1984 | | 3-1 | 1485 | 689 | 3 | RU S | 2 | | | | 3 | 5 | 1 | marmite | Nied. 87 | 294 | XX |
| 1983 | 7824 | 65-3 | 598 | 186 | H15 | RU S | 1 | | | | | 1 | 1 | pot | Speicher 18a | 295 | XX |
| 1975 | 7782 | 65-3 | 600 | 197 | H13 | RUA | 1 | | | | | 1 | 1 | jatte | Deru Reims J13 | 296 | XX |
| 1974 | 7803 | 32-1 | 1447 | 288 | M11 | RUA | 1 | | | | | 1 | 1 | bouilloire | Deru Reims CR1 | 297 | XX |
| 1977 | 7823 | 63-2 | 553 | 40 | G12 | CB | 1 | | | | | 1 | 1 | plat | Reims A2 | 298 | XX |
| 1983 | | 63-3 | 559 | 75 | K14 | CB | 1 | | | | | 1 | 1 | plat | Reims A2 | 299 | XX |
| 1982 | | 65-3 | 599 | 192 | J15 | CB | 1 | | | | | 1 | 1 | plat | Reims A2 | 300 | XX |

ANNEXE B : LES ROISES

| année | n° OA | Rayon | Caisse | n° ordre | Carré | Catégorie | Comptage | | | | | | Typologie | Desc. Typo. | Dessin | Planche | |
|-----------------|----------|-------|--------|-------------|--|-----------|----------|---|---|---|---|----|-----------|-------------|-----------|---------|------|
| | | | | | | | B | F | A | D | P | NR | | | | | NMI |
| 1968 | | 43-3 | 1387 | 214 | Mur | CB | 1 | | | | | 1 | 1 | plat | Reims A2 | 301 | XXI |
| 1983 | | 28-2 | 30 | 5 | J15 | CB | 2 | | | | | 2 | 1 | plat | Reims A2 | 302 | XXI |
| 1977 | | 64-2 | 583 | 126 | G12 | CB | 2 | | | | | 2 | 1 | plat | Reims A4 | 303 | XXI |
| 1977 | 7823 | 63-2 | 553 | 37 | G13 | CB | 1 | | | | | 1 | 1 | plat | Reims A6 | 304 | XXI |
| 1983 | 7824 | 65-4 | 604 | 204 | Cave | CB | 3 | | | | | 3 | 1 | plat | Reims A6 | 305 | XXI |
| | | 64-2 | 583 | 120 | Q8 | CB | 1 | | | | | 1 | 1 | plat | Reims A6 | 306 | XXI |
| 1982 | | 63-3 | 556 | 58 | J16 | CB | 1 | | | | | 1 | 1 | plat | Reims A6 | 307 | XXI |
| 1984 | | 32-1 | 1446 | 273 | L11 | CB | 5 | | | | | 5 | 1 | plat | Reims A6 | 308 | XXI |
| 1976 | | 63-3 | 558 | 68 | H15 | CB | 1 | | | | | 1 | 1 | plat | Reims A7 | 309 | XXI |
| 1974 | | 55-2 | 597 | 181 | K9 | CB | 1 | | | | | 1 | 1 | plat | Reims A7 | 310 | XXI |
| 1983 | | 63-3 | 559 | 75 | K14 | CB | 2 | | | | | 2 | 1 | plat | Reims A7 | 311 | XXI |
| 1982 | | 63-3 | 556 | 58 | J16 | CB | 1 | | | | | 1 | 1 | plat | Reims A12 | 312 | XXI |
| 1982 | | 63-2 | 555 | 54 | F15-G15 | CB | 1 | | | | | 1 | 1 | jatte | Reims J4 | 313 | XXI |
| 1974 | | 55-2 | 597 | 182 | K10 | CB | 2 | | | | | 2 | 1 | jatte | Reims J9 | 314 | XXI |
| 1976/1977/19779 | | 63-4 | 561 | 80 | Hypocauste | CB | 1 | | | | | 1 | 1 | jatte | Reims J10 | 315 | XXI |
| 1983 | | 64-2 | 583 | 115 | K16 | CB | 1 | | | | | 1 | 1 | jatte | Reims J13 | 316 | XXI |
| 1983 | 7824 | 33-1 | 1450 | 309 | K14-15 | CB | 3 | | | | | 3 | 1 | jatte | Reims J30 | 317 | XXII |
| 1981 | | 63-5 | 564 | 87 | H7 | CB | 1 | | | | | 1 | 1 | jatte | Reims J38 | 318 | XXII |
| 1982 | | 63-3 | 559 | 602 | K15 | CB | 1 | | | | | 1 | 1 | jatte | Reims J38 | 319 | XXII |
| 1968 | | 43-3 | 1387 | 214 | Mur | CB | 2 | | | | | 2 | 1 | pot | Reims P7 | 320 | XXII |
| 1983 | 7824 | 62-4 | 574 | 107 | Cave | CB | 1 | | | | | 1 | 1 | pot | Reims P16 | 321 | XXII |
| 1973 | | 64-3 | 586 | 140 | Tranchée côté Roises extrémité gauche | CB | 2 | | | | | 2 | 1 | pot | Reims P16 | 322 | XXII |
| 1982 | 7823 | 64-5 | 1470 | 548 | J16-J17 | CB | 2 | | | | | 2 | 1 | pot | Reims P16 | 323 | XXII |
| 1981 | | 66-3 | 1465 | 324 | D15 | CB | 3 | | | | 4 | 7 | 1 | pot | Reims P16 | 324 | XXII |

ANNEXE B : LES ROISES

| année | n° OA | Rayon | Caisse | n° ordre | Carré | Catégorie | Comptage | | | | | | Typologie | Desc. Typo. | Dessin | Planche | |
|-----------------|----------|-------|--------|-------------|------------|-----------|----------|---|---|---|---|----|-----------|-------------|-----------|---------|-------|
| | | | | | | | B | F | A | D | P | NR | | | | | NMI |
| 1974 | 7816 | 63-5 | 567 | 98 | M11 | CB | 1 | | | | | 1 | 1 | pot | Reims P16 | 325 | XXII |
| 1983 | 7824 | 65-4 | 604 | 204 | Cave | CB | 3 | | | | | 3 | 1 | pot | Reims P16 | 326 | XXII |
| 1982 | | 65-3 | 599 | 192 | J15 | CB | 2 | | | | | 2 | 1 | pot | Reims P16 | 327 | XXII |
| | | 64-2 | 583 | 120 | Q8 | CB | 1 | | | | | 1 | 1 | pot | Reims P16 | 328 | XXII |
| 1977 | | 63-2 | 555 | 52 | G13-G14 | CB | 1 | | | | | 1 | 1 | pot | Reims P16 | 329 | XXII |
| 1981 | | 63-5 | 564 | 87 | H7 | CB | 1 | | | | | 1 | 1 | pot | Reims P16 | 330 | XXII |
| 1983 | | 63-3 | 559 | 75 | K14 | CB | 2 | | | | | 2 | 1 | pot | Reims P16 | 331 | XXII |
| 1983 | 7824 | 65-4 | 604 | 204 | Cave | CB | 3 | | | | | 3 | 1 | pot | Reims P16 | 332 | XXII |
| 1982 | | 63-3 | 559 | 602 | K15 | CB | 1 | | | | | 1 | 1 | pot | Reims P16 | 333 | XXII |
| 1977 | 7823 | 63-2 | 553 | 40 | G12 | CB | 3 | | | | | 3 | 1 | pot | Reims P16 | 334 | XXII |
| 1977 | 7823 | 63-2 | 553 | 37 | G13 | CB | 1 | | | | | 1 | 1 | pot | Reims P16 | 335 | XXIII |
| 1974 | | 28-2 | 30 | 16 | L10 | CB | 2 | | | | | 2 | 1 | pot | Reims P16 | 336 | XXIII |
| 1977 | | 33-1 | 1448 | 296 | G13 | CB | 1 | | | | | 1 | 1 | pot | Reims P16 | 337 | XXIII |
| 1983 | 7824 | 65-3 | 598 | 186 | H15 | CB | 4 | | | | | 4 | 1 | pot | Reims P16 | 338 | XXIII |
| 1976/1977/19779 | | 63-4 | 561 | 80 | Hypocauste | CB | 1 | | | | | 1 | 1 | pot | Reims P16 | 339 | XXIII |
| 1974 | 7816 | 63-5 | 567 | 98 | M11 | CB | 2 | | | | | 2 | 1 | pot | Reims P16 | 340 | XXIII |
| 1974 | 7816 | 63-5 | 567 | 98 | M11 | CB | 1 | | | | | 1 | 1 | pot | Reims P16 | 341 | XXIII |
| 1968 | | 43-3 | 1387 | 214 | Mur | CB | 1 | | | | | 1 | 1 | pot | Reims P16 | 342 | XXIII |
| 1975 | | 65-3 | 597 | 184 | K13 | CB | 1 | | | | | 1 | 1 | pot | Reims P16 | 343 | XXIII |
| 1983 | 7824 | 65-4 | 604 | 204 | Cave | CB | 1 | | | | | 1 | 1 | pot | Reims P16 | 344 | XXIV |
| 1983 | 7824 | 65-4 | 604 | 204 | Cave | CB | 3 | | | | | 3 | 1 | pot | Reims P16 | 345 | XXIV |
| 1981 | 7823 | 64-5 | 1470 | 535 | J15 | CB | 1 | | | | | 1 | 1 | pot | Reims P16 | 346 | XXIV |
| 1974 | 7816 | 63-2 | 554 | 48 | L11 | CB | 1 | | | | | 1 | 1 | pot | Reims P16 | 347 | XXIV |
| 1975 | 7782 | 63-2 | 554 | 49 | L12 | CB | 1 | | | 2 | | 3 | 1 | pot | Reims P16 | 348 | XXIV |
| 1974 | 7803 | 32-1 | 1447 | 288 | M11 | CB | 2 | | | | | 2 | 1 | pot | Reims P16 | 349 | XXIV |
| 1974 | | 64-2 | 583 | 128 | M11 | CB | 2 | | | | | 2 | 1 | pot | Reims P16 | 350 | XXIV |

ANNEXE B : LES ROISES

| année | n° OA | Rayon | Caisse | n° ordre | Carré | Catégorie | Comptage | | | | | | | Typologie | Desc. Typo. | Dessin | Planche |
|-------|----------|-------|--------|-------------|---|-----------|----------|---|---|---|----|----|-----|-----------|-------------|--------|---------|
| | | | | | | | B | F | A | D | P | NR | NMI | | | | |
| | | 62-3 | 571 | 101 | sans n° | CB | 2 | | | | 6 | 8 | 1 | pot | Reims P16 | 351 | XXIV |
| 1973 | | 64-3 | 586 | 140 | L / Tranchée NE-SW extrémité NE | CB | 5 | | | | | 5 | 1 | pot | Reims P16 | 352 | XXIV |
| 1976 | | 63-3 | 557 | 65 | J13 | CB | 1 | | | | | 1 | 1 | pot | Reims P16 | 353 | XXIV |
| 1976 | | 63-3 | 557 | 65 | J13 | CB | 1 | | | | | 1 | 1 | pot | Reims P16 | 354 | XXIV |
| 1984 | 7825 | 65-5 | 606 | 206 | P8 | CB | 1 | | | | | 1 | 1 | pot | Reims P16 | 355 | XXIV |
| 1974 | | 55-2 | 597 | 182 | K10 | CB | 1 | | | | | 1 | 1 | pot | Reims P16 | 356 | XXIV |
| 1982 | | 63-3 | 556 | 58 | J16 | CB | 1 | | | | | 1 | 1 | pot | Reims P16 | 357 | XXIV |
| 1974 | | 55-2 | 597 | 181 | K9 | CB | 1 | | | | | 1 | 1 | pot | Reims P16 | 358 | XXIV |
| 1982 | | 63-3 | 556 | 58 | J16 | CB | 1 | | | | | 1 | 1 | pot | Reims P16 | 359 | XXIV |
| 1980 | | 64-4 | 591 | 151 | E14 | CB | 2 | | | | | 2 | 1 | pot | Reims P19 | 360 | XXV |
| 1979 | 7803 | 35-1 | 1444 | 259 | G16 | CB | 3 | | | | 34 | 37 | 1 | pot | Reims P19 | 361 | XXV |
| 1983 | 7824 | 65-3 | 598 | 186 | H15 | CB | 1 | | | | | 1 | 1 | couvercle | Reims Cv1 | 362 | XXV |
| 1976 | | 64-2 | 583 | 121 | H13-H14 | CB | 1 | | | | | 1 | 1 | couvercle | Reims Cv2 | 363 | XXV |
| | | 64-2 | 1517 | 779 | sans n° | CB | 1 | | | | 16 | 17 | | | | | |
| 1974 | | 35-1 | 1441 | 246 | L10 | CB | 1 | | | | | 1 | | | | | |
| | | 64-2 | 1518 | 781 | sans n° | CB | | | | | | 0 | | | | | |
| | | 66-1 | 1510 | 773 | sans n° | CB | | | | | 20 | 20 | | | | | |
| | | 66-4 | 1511 | 774 | sans n° | CB | | | | | 14 | 14 | | | | | |
| 1974 | | 55-2 | 597 | 181 | K9 | CB | | | | | 3 | 3 | | | | | |
| 1974 | | 63-3 | 559 | 72 | K11 | CB | | | | | 4 | 4 | | | | | |
| 1975 | | 65-3 | 597 | 184 | K13 | CB | | | | | 8 | 8 | | | | | |
| 1982 | 7823 | 65-2 | 596 | 180 | C13 | CB | | | | | 11 | 11 | | | | | |
| 1982 | 7823 | 65-2 | 596 | 178 | C13-D13 | CB | | | | | 2 | 2 | | | | | |

ANNEXE B : LES ROISES

| année | n° OA | Rayon | Caisse | n° ordre | Carré | Catégorie | Comptage | | | | | | Typologie | Desc. Typo. | Dessin | Planche |
|-------|----------|-------|--------|-------------|-------------------------------------|-----------|----------|---|---|---|----|----|-----------|-------------|--------|---------|
| | | | | | | | B | F | A | D | P | NR | | | | |
| 1983 | 7824 | 62-4 | 574 | 107 | Cave | CB | | | | | 13 | 13 | | | | |
| 1983 | 7824 | 65-4 | 604 | 204 | Cave | CB | | 8 | | | 67 | 75 | | | | |
| 1981 | | 67-3 | 1468 | 443 | Cave | CB | | 2 | | | 11 | 13 | | | | |
| 1973 | | 64-3 | 586 | 140 | Croisement des deux tranchées | CB | | | | | 5 | 5 | | | | |
| 1980 | | 64-5 | 1671 | 784 | D14 | CB | | | | | 6 | 6 | | | | |
| 1977 | | 34-1 | 1437 | 224 | F15 | CB | | | | | 2 | 2 | | | | |
| 1981 | | 65-2 | 594 | 166 | F15-G15 | CB | | | | | 5 | 5 | | | | |
| 1981 | | 64-3 | 587 | 142 | F16 | CB | | | | | 6 | 6 | | | | |
| 1977 | 7823 | 63-2 | 553 | 40 | G12 | CB | | 2 | | | 17 | 19 | | | | |
| 1976 | 7823 | 63-2 | 553 | 40 | G12 | CB | | | | | 25 | 25 | | | | |
| 1979 | | 63-5 | 564 | 84 | G12-G13 | CB | | | | | 4 | 4 | | | | |
| 1977 | 7823 | 63-2 | 553 | 46 | G12-G13 | CB | | | | | 2 | 2 | | | | |
| 1979 | | 63-5 | 564 | 88 | G12-H12 | CB | | | | | 3 | 3 | | | | |
| 1977 | 7823 | 63-2 | 553 | 37 | G13 | CB | | | | | 11 | 11 | | | | |
| 1977 | | 63-2 | 555 | 52 | G13-G14 | CB | | | | | 17 | 17 | | | | |
| 1977 | | 63-2 | 555 | 53 | G14 | CB | | | | | 2 | 2 | | | | |
| 1977 | | 63-2 | 555 | 51 | G14-G15 | CB | | | | | 2 | 2 | | | | |
| 1976 | | 63-2 | 555 | 56 | G15 | CB | | 2 | | | 13 | 15 | | | | |
| 1979 | 7803 | 63-2 | 552 | 36 | G16 | CB | | | | | 6 | 6 | | | | |
| 1981 | | 63-5 | 564 | 87 | H7 | CB | | 1 | | | 23 | 24 | | | | |
| 1976 | | 65-3 | 600 | 195 | H12 | CB | | | | | 14 | 14 | | | | |
| 1975 | 7782 | 65-3 | 600 | 197 | H13 | CB | | | | | 20 | 20 | | | | |
| 1975 | 7782 | 33-1 | 1449 | 300 | H13 | CB | | | | | 2 | 2 | | | | |
| 1976 | | 64-2 | 583 | 121 | H13-H14 | CB | | | | | 3 | 3 | | | | |
| 1976 | | 65-4 | 603 | 201 | H13-H14 | CB | | | | | 11 | 11 | | | | |

ANNEXE B : LES ROISES

| année | n° OA | Rayon | Caisse | n° ordre | Carré | Catégorie | Comptage | | | | | | Typologie | Desc. Typo. | Dessin | Planche |
|-----------------|----------|-------|--------|-------------|---|-----------|----------|---|---|---|----|----|-----------|-------------|--------|---------|
| | | | | | | | B | F | A | D | P | NR | | | | |
| 1983 | 7824 | 65-4 | 603 | 203 | H14-H15- J14-J15 | CB | | | | | 5 | 5 | | | | |
| 1976 | | 63-3 | 558 | 68 | H15 | CB | | | | | 10 | 10 | | | | |
| 1982 | | 63-3 | 558 | 67 | H15 | CB | | 1 | | | 22 | 23 | | | | |
| 1983 | 7824 | 65-3 | 598 | 186 | H15 | CB | | | | | 12 | 12 | | | | |
| 1981 | | 63-5 | 564 | 86 | H16 | CB | | | | | 4 | 4 | | | | |
| 1983 | 7824 | 55-3 | 598 | 187 | H16 | CB | | | | | 6 | 6 | | | | |
| 1981 | | 67-3 | 1468 | 473 | H17 | CB | | 1 | | | | 1 | | | | |
| 1983 | | 35-1 | 1441 | 242 | H17 | CB | | 2 | | | 2 | 4 | | | | |
| 1976/1977/19779 | | 63-4 | 561 | 80 | Hypocauste | CB | | | | | 31 | 31 | | | | |
| 1976 | | 63-3 | 557 | 65 | J13 | CB | | 1 | | | 18 | 19 | | | | |
| 1982 | | 65-3 | 599 | 192 | J15 | CB | | | | | 60 | 60 | | | | |
| 1982 | | 63-3 | 556 | 58 | J16 | CB | | | | | 25 | 25 | | | | |
| 1983 | | 63-3 | 559 | 75 | K14 | CB | | 2 | | | 47 | 49 | | | | |
| 1982 | | 63-3 | 559 | 602 | K15 | CB | | | | | 12 | 12 | | | | |
| 1982 | | 63-3 | 559 | 78 | K16 | CB | | | | | 27 | 27 | | | | |
| 1973 | | 64-3 | 586 | 140 | L / Tranchée NE-SW extrémité NE | CB | | 1 | | | 71 | 72 | | | | |
| 1974 | 7803 | 32-1 | 1447 | 286 | L10 | CB | 1 | | | | | 1 | | | | |
| 1974 | | 65-2 | 593 | 164 | L10 | CB | | | | | 3 | 3 | | | | |
| 1974 | 7816 | 63-2 | 554 | 48 | L11 | CB | | | | | 19 | 19 | | | | |
| 1984 | 7825 | 65-5 | 608 | 208 | L11 | CB | | | | | 21 | 21 | | | | |
| 1984 | 7825 | 65-5 | 605 | 205 | M10 | CB | | | | | 18 | 18 | | | | |
| 1974 | 7816 | 63-5 | 567 | 98 | M11 | CB | | 5 | | | 34 | 39 | | | | |

ANNEXE B : LES ROISES

| année | n° OA | Rayon | Caisse | n° ordre | Carré | Catégorie | Comptage | | | | | | | Typologie | Desc. Typo. | Dessin | Planche | |
|-------|----------|-------|--------|-------------|---|-----------|----------|---|---|---|---|----|-----|-----------|-------------|---------------|---------|------|
| | | | | | | | B | F | A | D | P | NR | NMI | | | | | |
| 1968 | | 43-3 | 1387 | 214 | Mur | CB | | | | | 2 | 2 | | | | | | |
| 1984 | 7825 | 63-3 | 559 | 79 | P8 | CB | | | | | 3 | 3 | | | | | | |
| 1984 | 7825 | 65-5 | 606 | 206 | P8 | CB | | | | | 2 | 2 | | | | | | |
| 1984 | 7825 | 65-4 | 602 | 200 | Q8 | CB | | | | | 4 | 4 | | | | | | |
| 1973 | | 64-3 | 586 | 140 | Tranchée SE-NW à 2 m extrémité NW | CB | 2 | | | | | 37 | 39 | | | | | |
| 1979 | | 64-2 | 583 | 131 | G12-H12 descente de cave | Sb. Coq | 1 | | | | | | 1 | 1 | plat | Sb. Coq P11.1 | 364 | XXV |
| 1981 | | 63-5 | 564 | 87 | H7 | Sb. Coq | 1 | | | | | | 1 | 1 | plat | Sb. Coq P11.1 | 365 | XXV |
| 1974 | | 64-2 | 583 | 127 | L11 | Sb. Coq | 1 | | | | | | 1 | 1 | plat | Sb. Coq P11.1 | 366 | XXV |
| 1974 | 7803 | 32-1 | 1447 | 288 | M11 | Sb. Coq | 3 | 6 | | | | | 9 | 1 | plat | Sb. Coq P11.1 | 367 | XXV |
| 1984 | 7825 | 34-1 | 1437 | 219 | M10 | Sb. Coq | 1 | | | | | | 1 | 1 | plat | Sb. Coq P11.1 | 368 | XXV |
| 1975 | 7782 | 63-2 | 554 | 49 | L12 | Sb. Coq | 1 | | | | | | 1 | 1 | plat | Sb. Coq P11.2 | 369 | XXV |
| 1977 | | 64-2 | 583 | 126 | G12 | Sb. Coq | 1 | | | | | | 1 | 1 | plat | Sb. Coq P11.3 | 370 | XXV |
| 1977 | 7823 | 63-2 | 553 | 40 | G12 | Sb. Coq | 1 | | | | | | 1 | 1 | plat | Sb. Coq P11.3 | 371 | XXV |
| 1979 | | 63-5 | 564 | 88 | G12-H12 | Sb. Coq | 3 | | | | | | 3 | 1 | plat | Sb. Coq P11.3 | 372 | XXVI |
| 1976 | | 63-3 | 558 | 68 | H15 | Sb. Coq | 1 | | | | | | 1 | 1 | plat | Sb. Coq P11.3 | 373 | XXVI |
| 1976 | | 63-3 | 557 | 65 | J13 | Sb. Coq | 1 | | | | | | 1 | 1 | plat | Sb. Coq P11.3 | 374 | XXVI |
| 1983 | | 35-1 | 1441 | 240 | H15 | Sb. Coq | 1 | | | | | | 1 | 1 | plat | Sb. Coq P11.3 | 375 | XXVI |
| 1983 | | 66-3 | 1472 | 627 | K15 | Sb. Coq | 4 | | | | 8 | 12 | 1 | 1 | plat | Sb. Coq P11.3 | 376 | XXVI |
| 1984 | 7825 | 65-5 | 607 | 207 | P7 | Sb. Coq | 1 | | | | | | 1 | 1 | plat | Sb. Coq P11.3 | 377 | XXVI |
| 1982 | | 65-3 | 599 | 192 | J15 | Sb. Coq | 1 | | | | | | 1 | 1 | plat | Sb. Coq P12 | 378 | XXVI |
| 1982 | | 63-3 | 559 | 78 | K16 | Sb. Coq | 1 | | | | | | 1 | 1 | plat | Sb. Coq P12 | 379 | XXVI |

ANNEXE B : LES ROISES

| année | n° OA | Rayon | Caisse | n° ordre | Carré | Catégorie | Comptage | | | | | | Typologie | Desc. Typo. | Dessin | Planche | |
|-------|----------|-------|--------|-------------|--------------------------------|-----------|----------|---|---|---|----|----|-----------|-------------|--------------|---------|--------|
| | | | | | | | B | F | A | D | P | NR | | | | | NMI |
| | | 66-4 | 1511 | 774 | sans n° | Sb. Coq | 1 | | | | | 1 | 1 | plat | Sb. Coq Pl2 | 380 | XXVI |
| 1983 | | 35-1 | 1441 | 242 | H17 | Sb. Coq | 1 | | | | | 1 | 1 | plat | Sb. Coq Pl5 | 381 | XXVII |
| 1974 | | 64-2 | 583 | 127 | L11 | Sb. Coq | 1 | | | | | 1 | 1 | plat | Sb. Coq Pl6 | 382 | XXVII |
| 1982 | | 63-3 | 556 | 58 | J16 | Sb. Coq | 2 | | | | | 2 | 1 | jatte | Sb. Coq J1 | 383 | XXVII |
| 1983 | 7824 | 65-4 | 603 | 202 | H14 | Sb. Coq | 3 | | | | | 3 | 1 | jatte | Sb. Coq J1 | 384 | XXVII |
| 1982 | | 63-3 | 558 | 67 | H15 | Sb. Coq | 1 | | | | | 1 | 1 | jatte | Sb. Coq J1 | 385 | XXVII |
| 1984 | | 32-1 | 1446 | 273 | L11 | Sb. Coq | 1 | | | | | 1 | 1 | jatte | Sb. Coq J1 | 386 | XXVII |
| 1984 | 7825 | 65-5 | 606 | 206 | P8 | Sb. Coq | 1 | | | | | 1 | 1 | jatte | Sb. Coq J1 | 387 | XXVII |
| 1984 | 7825 | 67-3 | 1467 | 370 | P8I | Sb. Coq | 5 | 1 | | | 17 | 1 | 1 | jatte | Sb. Coq J1 | 388 | XXVII |
| 1984 | | 32-1 | 1445 | 278 | Q8 | Sb. Coq | 1 | | | | | 1 | 1 | jatte | Sb. Coq J1 | 389 | XXVIII |
| 1983 | 7824 | 65-3 | 598 | 186 | H15 | Sb. Coq | 4 | | | | | 4 | 1 | jatte | Sb. Coq J1 | 390 | XXVIII |
| 1982 | | 63-3 | 558 | 67 | H15 | Sb. Coq | 1 | | | | | 1 | 1 | jatte | Sb. Coq J1 | 391 | XXVIII |
| | | 64-2 | 1518 | 781 | sans n° | Sb. Coq | 1 | | | | | 1 | 1 | jatte | Sb. Coq J1 | 392 | XXVIII |
| 1981 | | 67-3 | 1468 | 466 | D15-E15 | Sb. Coq | 1 | | | | | 1 | 1 | jatte | Sb. Coq J2.1 | 393 | XXVIII |
| 1983 | | 64-2 | 583 | 125 | Cave | Sb. Coq | 1 | | | | | 1 | 1 | jatte | Sb. Coq J2.1 | 394 | XXVIII |
| 1979 | | 64-2 | 583 | 131 | G12-H12 descente de cave | Sb. Coq | 1 | | | | | 1 | 1 | jatte | Sb. Coq J2.2 | 395 | XXVIII |
| 1984 | | 64-2 | 583 | 132 | N9 | Sb. Coq | 2 | | | | | 2 | 1 | jatte | Sb. Coq J2.3 | 396 | XXVIII |
| 1977 | 7823 | 63-2 | 553 | 40 | G12 | Sb. Coq | 2 | | | | | 2 | 1 | jatte | Sb. Coq J2.3 | 397 | XXVIII |
| 1977 | | 64-2 | 583 | 126 | G12 | Sb. Coq | 1 | | | | 3 | 4 | 1 | jatte | Sb. Coq J2.3 | 398 | XXVIII |
| 1981 | | 63-5 | 564 | 87 | H7 | Sb. Coq | 1 | | | | | 1 | 1 | jatte | Sb. Coq J2.3 | 399 | XXVIII |
| 1982 | | 63-3 | 556 | 58 | J16 | Sb. Coq | 1 | | | | | 1 | 1 | jatte | Sb. Coq J2.3 | 400 | XXVIII |
| 1968 | | 43-3 | 1387 | 214 | Mur | Sb. Coq | 1 | | | | | 1 | 1 | jatte | Sb. Coq J2.3 | 401 | XXVIII |
| 1977 | | 64-2 | 583 | 113 | W | Sb. Coq | 1 | | | | 1 | 2 | 1 | jatte | Sb. Coq J2.3 | 402 | XXIX |
| 1982 | | 64-2 | 583 | 123 | J16 | Sb. Coq | 1 | | | | | 1 | 1 | jatte | Sb. Coq J2.3 | 403 | XXIX |
| | | 64-2 | 1518 | 781 | sans n° | Sb. Coq | 1 | | | | | 1 | 1 | jatte | Sb. Coq J2.3 | 404 | XXIX |

ANNEXE B : LES ROISES

| année | n° OA | Rayon | Caisse | n° ordre | Carré | Catégorie | Comptage | | | | | | Typologie | Desc. Typo. | Dessin | Planche | |
|-------|----------|-------|--------|-------------|---------|-----------|----------|---|---|---|---|----|-----------|-------------|----------------|---------|-------|
| | | | | | | | B | F | A | D | P | NR | | | | | NMI |
| | | 67-4 | 1507 | 771 | sans n° | Sb. Coq | 1 | | | | | 1 | 1 | jatte | Sb. Coq J2.3 | 405 | XXIX |
| | | 27--2 | 1490 | 751 | sans n° | Sb. Coq | 2 | | | | | 2 | 1 | jatte | Sb. Coq J2.3 | 406 | XXIX |
| | | 66-4 | 1511 | 774 | sans n° | Sb. Coq | 1 | | | | | 1 | 1 | jatte | Sb. Coq J2.3 | 407 | XXIX |
| | | 66-4 | 1511 | 774 | sans n° | Sb. Coq | 1 | | | | | 1 | 1 | jatte | Sb. Coq J2.3 | 408 | XXIX |
| 1983 | 7824 | 65-4 | 604 | 204 | Cave | Sb. Coq | 2 | | | | | 2 | 1 | jatte | Sb. Coq J3.1 | 409 | XXIX |
| 1977 | 7823 | 63-2 | 553 | 37 | G13 | Sb. Coq | 3 | | | | | 3 | 1 | jatte | Sb. Coq J4.2 | 410 | XXX |
| 1984 | 7825 | 65-5 | 606 | 206 | P8 | Sb. Coq | 1 | | | | | 1 | 1 | jatte | Sb. Coq J4.2 | 411 | XXX |
| | | 66-4 | 1511 | 774 | sans n° | Sb. Coq | 1 | | | | | 1 | 1 | jatte | Sb. Coq J5 | 412 | XXX |
| 1977 | | 64-2 | 583 | 126 | G12 | Sb. Coq | 1 | | | | | 1 | 1 | jatte | Sb. Coq J7 | 413 | XXX |
| 1982 | | 63-3 | 558 | 67 | H15 | Sb. Coq | 2 | | | | | 2 | 1 | jatte | Sb. Coq J8 | 414 | XXX |
| | | 66-4 | 1511 | 774 | sans n° | Sb. Coq | 1 | | | | | 1 | 1 | jatte | Sb. Coq J/M1 | 415 | XXX |
| 1977 | 7823 | 63-2 | 553 | 37 | G13 | Sb. Coq | 3 | | | | | 3 | 1 | jatte | Sb. Coq J/M2 | 416 | XXX |
| 1984 | | 3-1 | 1485 | 689 | 3 | Sb. Coq | 1 | | | | | 1 | 1 | jatte | Sb. Coq J/M2 | 417 | XXX |
| | | 66-4 | 1511 | 774 | sans n° | Sb. Coq | 1 | | | | | 1 | 1 | jatte | Sb. Coq J/M3.1 | 418 | XXX |
| 1974 | | 28-2 | 30 | 20 | M11 | Sb. Coq | 2 | | | | | 2 | 1 | marmite | Sb. Coq M1.1 | 419 | XXXI |
| 1974 | 7803 | 32-1 | 1447 | 288 | M11 | Sb. Coq | 1 | | | | | 1 | 1 | marmite | Sb. Coq M1.1 | 420 | XXXI |
| 1982 | | 28-5 | 1471 | 588 | J16 | Sb. Coq | 1 | 1 | | | 4 | 6 | 1 | marmite | Sb. Coq M1.1 | 421 | XXXI |
| | | 67-4 | 1507 | 771 | sans n° | Sb. Coq | 2 | | | | | 2 | 1 | marmite | Sb. Coq M1.1 | 422 | XXXI |
| 1982 | | 34-1 | 1438 | 227 | J16 | Sb. Coq | 2 | 2 | 1 | | 2 | 7 | 1 | marmite | Sb. Coq M1.2 | 423 | XXXI |
| 1982 | | 63-3 | 558 | 67 | H15 | Sb. Coq | 1 | | | | | 1 | 1 | pot | Sb. Coq P1.1 | 424 | XXXI |
| 1974 | | 55-2 | 597 | 181 | K9 | Sb. Coq | 1 | | | | | 1 | 1 | pot | Sb. Coq P1.1 | 425 | XXXI |
| 1984 | | 64-2 | 583 | 127 | L11 | Sb. Coq | 1 | | | | | 1 | 1 | pot | Sb. Coq P1.1 | 426 | XXXI |
| 1974 | | 64-2 | 583 | 128 | M11 | Sb. Coq | 4 | | | | | 4 | 1 | pot | Sb. Coq P1.1 | 427 | XXXI |
| 1984 | 7825 | 65-5 | 606 | 206 | P8 | Sb. Coq | 1 | | | | | 1 | 1 | pot | Sb. Coq P1.1 | 428 | XXXII |
| 1984 | 7825 | 65-5 | 606 | 206 | P8 | Sb. Coq | 1 | | | | | 1 | 1 | pot | Sb. Coq P1.1 | 429 | XXXII |
| 1974 | 7816 | 63-5 | 567 | 98 | M11 | Sb. Coq | 2 | | | | | 2 | 1 | pot | Sb. Coq P1.1 | 430 | XXXII |

ANNEXE B : LES ROISES

| année | n° OA | Rayon | Caisse | n° ordre | Carré | Catégorie | Comptage | | | | | | Typologie | Desc. Typo. | Dessin | Planche | |
|-------|----------|-------|--------|-------------|------------------|-----------|----------|---|---|---|---|----|-----------|-------------|--------------|---------|--------|
| | | | | | | | B | F | A | D | P | NR | | | | | NMI |
| 1982 | | 65-3 | 599 | 192 | J15 | Sb. Coq | 3 | | | | | 3 | 1 | pot | Sb. Coq P1.1 | 431 | XXXII |
| | | 64-2 | 1518 | 781 | sans n° | Sb. Coq | 1 | | | | | 1 | 1 | pot | Sb. Coq P1.1 | 432 | XXXII |
| 1977 | | 65-2 | 594 | 167 | F15 | Sb. Coq | 1 | | | | | 1 | 1 | pot | Sb. Coq P3 | 433 | XXXII |
| 1984 | 7825 | 65-5 | 606 | 206 | P8 | Sb. Coq | 1 | | | | | 1 | 1 | pot | Sb. Coq P3 | 434 | XXXII |
| 1982 | | 63-3 | 558 | 67 | H15 | Sb. Coq | 2 | | | | | 2 | 1 | pot | Sb. Coq P3 | 435 | XXXII |
| 1983 | 7824 | 65-3 | 598 | 186 | H15 | Sb. Coq | 1 | | | | | 1 | 1 | pot | Sb. Coq P3 | 436 | XXXII |
| 1976 | | 63-3 | 557 | 65 | J13 | Sb. Coq | 1 | | | | | 1 | 1 | pot | Sb. Coq P3 | 437 | XXXII |
| 1974 | | 55-2 | 597 | 182 | K10 | Sb. Coq | 1 | | | 2 | | 3 | 1 | pot | Sb. Coq P3 | 438 | XXXII |
| 1984 | 7825 | 65-5 | 607 | 207 | P7 | Sb. Coq | 1 | | | | | 1 | 1 | pot | Sb. Coq P3 | 439 | XXXII |
| 1980 | | 64-4 | 591 | 151 | E14 | Sb. Coq | 1 | | | | | 1 | 1 | pot | Sb. Coq P3 | 440 | XXXII |
| 1977 | | 65-2 | 594 | 167 | F15 | Sb. Coq | 1 | | | | | 1 | 1 | pot | Sb. Coq P3 | 441 | XXXII |
| 1982 | | 63-3 | 558 | 67 | H15 | Sb. Coq | 1 | | | | | 1 | 1 | pot | Sb. Coq P3 | 442 | XXXII |
| | 7823 | 63-2 | 553 | 45 | G12-G13 berme | Sb. Coq | 3 | | | | | 3 | 1 | pot | Sb. Coq P4 | 443 | XXXII |
| 1974 | | 64-2 | 583 | 128 | M11 | Sb. Coq | 1 | | | | | 1 | 1 | pot | Sb. Coq P4 | 444 | XXXII |
| | | 64-2 | 583 | 120 | Q8 | Sb. Coq | 1 | | | | | 1 | 1 | pot | Sb. Coq P4 | 445 | XXXII |
| 1975 | 7782 | 65-3 | 600 | 197 | H13 | Sb. Coq | 1 | | | | | 1 | 1 | pot | Sb. Coq P4 | 446 | XXXII |
| | | 66-4 | 1511 | 774 | sans n° | Sb. Coq | 1 | | | | | 1 | 1 | pot | Sb. Coq P4 | 447 | XXXII |
| 1977 | 7823 | 63-2 | 553 | 37 | G13 | Sb. Coq | 3 | | | | | 3 | 1 | pot | Sb. Coq P5.1 | 448 | XXXII |
| 1982 | | 28-5 | 1471 | 582 | Puits | Sb. Coq | 2 | 1 | | | 6 | 9 | 1 | pot | Sb. Coq P5.1 | 449 | XXXIII |
| | | 64-2 | 583 | 120 | Q8 | Sb. Coq | 1 | | | | 1 | 2 | 1 | pot | Sb. Coq P5.1 | 450 | XXXIII |
| 1977 | | 63-2 | 555 | 52 | G13-G14 | Sb. Coq | 1 | | | | | 1 | 1 | pot | Sb. Coq P5.2 | 451 | XXXIII |
| | | 66-4 | 1511 | 774 | sans n° | Sb. Coq | 1 | | | | | 1 | 1 | pot | Sb. Coq P5.2 | 452 | XXXIII |
| | | 64-2 | 1518 | 781 | sans n° | Sb. Coq | 1 | | | | | 1 | 1 | pot | Sb. Coq P5.3 | 453 | XXXIII |
| 1976 | | 63-3 | 557 | 65 | J13 | Sb. Coq | 1 | | | | | 1 | 1 | pot | Sb. Coq P5.3 | 454 | XXXIII |
| 1976 | | 63-3 | 558 | 68 | H15 | Sb. Coq | 1 | | | | | 1 | 1 | pot | Sb. Coq P5.3 | 455 | XXXIII |

ANNEXE B : LES ROISES

| année | n° OA | Rayon | Caisse | n° ordre | Carré | Catégorie | Comptage | | | | | | Typologie | Desc. Typo. | Dessin | Planche | | |
|-----------------|----------|-------|--------|-------------|--|-----------|----------|---|---|---|---|----|-----------|-------------|--------------|--------------|--------|-------|
| | | | | | | | B | F | A | D | P | NR | | | | | NMI | |
| 1977 | 7823 | 63-2 | 553 | 40 | G12 | Sb. Coq | 6 | | | | | 6 | 1 | pot | Sb. Coq P6.1 | 456 | XXXIII | |
| 1977 | | 35-1 | 1444 | 262 | G12 | Sb. Coq | 1 | | | | | 1 | 1 | pot | Sb. Coq P6.1 | 457 | XXXIII | |
| 1982 | | 63-3 | 556 | 58 | J16 | Sb. Coq | 2 | | | | | 2 | 1 | pot | Sb. Coq P6.1 | 458 | XXXIII | |
| 1975 | | 65-3 | 597 | 184 | K13 | Sb. Coq | 1 | | | | | 1 | 1 | pot | Sb. Coq P6.1 | 459 | XXXIII | |
| 1974 | | 64-2 | 583 | 127 | L11 | Sb. Coq | 3 | 1 | | | | 4 | 1 | pot | Sb. Coq P6.1 | 460 | XXXIII | |
| 1984 | | 64-2 | 583 | 127 | L11 | Sb. Coq | 3 | | | | | 3 | 1 | pot | Sb. Coq P6.1 | 461 | XXXIII | |
| 1984 | 7825 | 65-5 | 606 | 206 | P8 | Sb. Coq | 1 | | | | | 1 | 1 | pot | Sb. Coq P6.1 | 462 | XXXIII | |
| 1984 | 7825 | 65-5 | 606 | 206 | P8 | Sb. Coq | 1 | | | | | 1 | 1 | pot | Sb. Coq P6.1 | 463 | XXXIV | |
| 1984 | 7825 | 65-5 | 606 | 206 | P8 | Sb. Coq | 1 | | | | | 1 | 1 | pot | Sb. Coq P6.1 | 464 | XXXIV | |
| 1984 | 7825 | 65-5 | 606 | 206 | P8 | Sb. Coq | 1 | | | | | 1 | 1 | pot | Sb. Coq P6.1 | 465 | XXXIV | |
| 1983 | | 63-3 | 559 | 75 | K14 | Sb. Coq | 1 | | | | | 1 | 1 | pot | Sb. Coq P6.1 | 466 | XXXIV | |
| 1982 | | 63-3 | 559 | 78 | K16 | Sb. Coq | 1 | | | | | 1 | 1 | pot | Sb. Coq P6.1 | 467 | XXXIV | |
| 1982 | | 63-3 | 559 | 78 | K16 | Sb. Coq | 1 | | | | | 1 | 1 | pot | Sb. Coq P6.1 | 468 | XXXIV | |
| 1976/1977/19779 | | 63-4 | 561 | 80 | Hypocauste | Sb. Coq | 1 | | | | | 1 | 1 | pot | Sb. Coq P6.1 | 469 | XXXIV | |
| 1984 | | 3-1 | 1485 | 689 | 3 | Sb. Coq | 1 | | | | | 1 | 1 | pot | Sb. Coq P7.1 | 470 | XXXIV | |
| 1984 | | 3-1 | 1485 | 689 | 3 | Sb. Coq | 2 | | | | | 2 | 1 | pot | Sb. Coq P7.1 | 471 | XXXIV | |
| 1973 | | 64-3 | 586 | 140 | Extrémité NW de la tranchée SE-NW côté voie close | Sb. Coq | 1 | 1 | | | | 7 | 9 | 1 | pot | Sb. Coq P7.1 | 472 | XXXIV |
| 1976 | | 63-2 | 555 | 56 | G15 | Sb. Coq | 2 | | | | | 2 | 1 | pot | Sb. Coq P7.1 | 473 | XXXIV | |
| 1983 | 7824 | 65-4 | 603 | 202 | H14 | Sb. Coq | 1 | | | | | 1 | 1 | pot | Sb. Coq P7.1 | 474 | XXXIV | |
| 1974 | | 55-2 | 597 | 181 | K9 | Sb. Coq | 1 | | | | | 1 | 1 | pot | Sb. Coq P7.1 | 475 | XXXIV | |
| 1984 | | 64-2 | 583 | 132 | N9 | Sb. Coq | 1 | | | | | 1 | 1 | pot | Sb. Coq P7.1 | 476 | XXXIV | |
| 1984 | 7825 | 65-5 | 606 | 206 | P8 | Sb. Coq | 1 | | | | | 1 | 1 | pot | Sb. Coq P7.1 | 477 | XXXIV | |

ANNEXE B : LES ROISES

| année | n° OA | Rayon | Caisse | n° ordre | Carré | Catégorie | Comptage | | | | | | Typologie | Desc. Typo. | Dessin | Planche | |
|-------|----------|-------|--------|-------------|------------------|-----------|----------|---|---|---|---|----|-----------|-------------|--------------|---------|-------|
| | | | | | | | B | F | A | D | P | NR | | | | | NMI |
| 1984 | 7825 | 65-5 | 606 | 206 | P8 | Sb. Coq | 1 | | | | | 1 | 1 | pot | Sb. Coq P7.1 | 478 | XXXIV |
| 1984 | 7825 | 65-5 | 606 | 206 | P8 | Sb. Coq | 1 | | | | | 1 | 1 | pot | Sb. Coq P7.1 | 479 | XXXIV |
| 1976 | | 63-3 | 558 | 68 | H15 | Sb. Coq | 1 | | | | | 1 | 1 | pot | Sb. Coq P7.1 | 480 | XXXIV |
| 1977 | | 65-2 | 594 | 167 | F15 | Sb. Coq | 2 | | | | | 2 | 1 | pot | Sb. Coq P7.1 | 481 | XXXV |
| 1979 | | 33-1 | 1449 | 304 | G16 | Sb. Coq | 1 | | | | | 1 | 1 | pot | Sb. Coq P7.1 | 482 | XXXV |
| 1982 | | 65-3 | 599 | 192 | J15 | Sb. Coq | 1 | | | | | 1 | 1 | pot | Sb. Coq P7.1 | 483 | XXXV |
| | | 67-4 | 1507 | 771 | sans n° | Sb. Coq | 1 | | | | | 1 | 1 | pot | Sb. Coq P7.1 | 484 | XXXV |
| 1976 | | 63-2 | 555 | 56 | G15 | Sb. Coq | 1 | | | | | 1 | 1 | pot | Sb. Coq P7.3 | 485 | XXXV |
| 1975 | 7782 | 33-1 | 1449 | 300 | H13 | Sb. Coq | 1 | | | | | | 1 | pot | Sb. Coq P8 | 486 | XXXV |
| 1983 | 7824 | 65-4 | 603 | 202 | H14 | Sb. Coq | 3 | | | | | 3 | 1 | pot | Sb. Coq P8 | 487 | XXXV |
| 1976 | | 63-3 | 557 | 65 | J13 | Sb. Coq | 1 | | | | | 1 | 1 | pot | Sb. Coq P8 | 488 | XXXV |
| 1982 | | 63-3 | 556 | 58 | J16 | Sb. Coq | 1 | | | | | 1 | 1 | pot | Sb. Coq P8 | 489 | XXXV |
| 1984 | 7825 | 65-5 | 607 | 207 | P7 | Sb. Coq | 1 | | | | | 1 | 1 | pot | Sb. Coq P8 | 490 | XXXV |
| | | 67-4 | 1507 | 771 | sans n° | Sb. Coq | 1 | | | | | 1 | 1 | pot | Sb. Coq P8 | 491 | XXXV |
| 1983 | 7824 | 65-4 | 604 | 204 | Cave | Sb. Coq | 2 | | | | | 2 | 1 | pot | Sb. Coq P9.1 | 492 | XXXV |
| 1981 | | 63-5 | 564 | 87 | H7 | Sb. Coq | 1 | | | | | 1 | 1 | pot | Sb. Coq P9.1 | 493 | XXXV |
| 1983 | 7824 | 67-4 | 1469 | 493 | J14 | Sb. Coq | 1 | | | | | 1 | 1 | pot | Sb. Coq P9.1 | 494 | XXXV |
| 1982 | | 63-3 | 556 | 58 | J16 | Sb. Coq | 1 | | | | | 1 | 1 | pot | Sb. Coq P9.1 | 495 | XXXV |
| 1984 | 7825 | 65-5 | 607 | 207 | P7 | Sb. Coq | 1 | | | | | 1 | 1 | pot | Sb. Coq P9.1 | 496 | XXXV |
| 1983 | | 63-3 | 559 | 75 | K14 | Sb. Coq | 1 | | | | | 1 | 1 | pot | Sb. Coq P9.1 | 497 | XXXV |
| 1980 | | 32-1 | 1445 | 271 | E14 | Sb. Coq | 1 | | | | | 1 | 1 | pot | Sb. Coq P9.2 | 498 | XXXV |
| | 7823 | 63-2 | 553 | 45 | G12-G13 berme | Sb. Coq | 2 | | | | | 2 | 1 | pot | Sb. Coq P9.2 | 499 | XXXVI |
| 1977 | 7823 | 63-2 | 553 | 37 | G13 | Sb. Coq | 3 | | | | | 3 | 1 | pot | Sb. Coq P9.2 | 500 | XXXVI |
| 1975 | 7782 | 33-1 | 1449 | 300 | H13 | Sb. Coq | 2 | | | | | | 1 | pot | Sb. Coq P9.2 | 501 | XXXVI |
| 1975 | | 65-3 | 597 | 184 | K13 | Sb. Coq | 1 | | | | | 1 | 1 | pot | Sb. Coq P9.2 | 502 | XXXVI |

ANNEXE B : LES ROISES

| année | n° OA | Rayon | Caisse | n° ordre | Carré | Catégorie | Comptage | | | | | | Typologie | Desc. Typo. | Dessin | Planche | |
|-----------------|----------|-------|--------|-------------|------------|-----------|----------|---|---|---|-----|-----|-----------|-------------|---------------|---------|--------|
| | | | | | | | B | F | A | D | P | NR | | | | | NMI |
| 1983 | 7824 | 65-4 | 604 | 204 | Cave | Sb. Coq | 1 | | | | | 1 | 1 | pot | Sb. Coq P10.1 | 503 | XXXVI |
| 1982 | | 63-3 | 558 | 67 | H15 | Sb. Coq | 1 | | | | | 1 | 1 | pot | Sb. Coq P10.1 | 504 | XXXVI |
| 1983 | 7824 | 65-3 | 598 | 186 | H15 | Sb. Coq | 1 | | | | | 1 | 1 | pot | Sb. Coq P10.1 | 505 | XXXVI |
| 1984 | 7825 | 65-5 | 606 | 206 | P8 | Sb. Coq | 1 | | | | | 1 | 1 | pot | Sb. Coq P10.1 | 506 | XXXVI |
| | | 64-2 | 583 | 120 | Q8 | Sb. Coq | 2 | | | | | 2 | 1 | pot | Sb. Coq P10.1 | 507 | XXXVI |
| 1983 | 7824 | 65-3 | 598 | 186 | H15 | Sb. Coq | 1 | | | | | 1 | 1 | pot | Sb. Coq P10.2 | 508 | XXXVI |
| 1976 | | 63-3 | 558 | 68 | H15 | Sb. Coq | 1 | | | | | 1 | 1 | pot | Sb. Coq P10.2 | 509 | XXXVI |
| 1983 | 7824 | 62-4 | 574 | 107 | Cave | Sb. Coq | 3 | | | | | 3 | 1 | couvercle | Sb. Coq Cv1 | 510 | XXXVII |
| 1976 | | 63-2 | 555 | 56 | G15 | Sb. Coq | 1 | | | | | 1 | 1 | couvercle | Sb. Coq Cv1 | 511 | XXXVII |
| | | 64-2 | 1518 | 781 | sans n° | Sb. Coq | 1 | | | | | 1 | 1 | couvercle | Sb. Coq Cv1 | 512 | XXXVII |
| | | 27--2 | 1490 | 751 | sans n° | Sb. Coq | 1 | | | | | 1 | 1 | couvercle | Sb. Coq Cv1 | 513 | XXXVII |
| 1984 | 7825 | 65-5 | 606 | 206 | P8 | Sb. Coq | 1 | | | | | 1 | 1 | couvercle | Sb. Coq Cv2.2 | 514 | XXXVII |
| 1983 | 7824 | 65-4 | 604 | 204 | Cave | Sb. Coq | 1 | | | | | 1 | 1 | couvercle | Sb. Coq Cv3.1 | 515 | XXXVII |
| 1983 | 7824 | 65-4 | 603 | 202 | H14 | Sb. Coq | 1 | | | | | 1 | 1 | couvercle | Sb. Coq Cv3.1 | 516 | XXXVII |
| 1983 | 7824 | 65-3 | 598 | 186 | H15 | Sb. Coq | 2 | | | | | 2 | 1 | couvercle | Sb. Coq Cv3.1 | 517 | XXXVII |
| 1976/1977/19779 | | 63-4 | 561 | 80 | Hypocauste | Sb. Coq | 1 | | | | | 1 | 1 | couvercle | Sb. Coq Cv3.1 | 518 | XXXVII |
| 1974 | | 55-2 | 597 | 181 | K9 | Sb. Coq | 1 | | | | | 1 | 1 | couvercle | Sb. Coq Cv3.1 | 519 | XXXVII |
| 1968 | | 43-3 | 1387 | 214 | Mur | Sb. Coq | 1 | | | | | 1 | 1 | couvercle | Sb. Coq Cv3.1 | 520 | XXXVII |
| 1983 | 7824 | 65-4 | 604 | 204 | Cave | Sb. Coq | 1 | | | | | 1 | 1 | couvercle | Sb. Coq Cv3.2 | 521 | XXXVII |
| 1983 | 7824 | 65-4 | 604 | 204 | Cave | Sb. Coq | 1 | | | | | 1 | 1 | couvercle | Sb. Coq Cv4.1 | 522 | XXXVII |
| 1983 | 7824 | 65-4 | 604 | 204 | Cave | Sb. Coq | 1 | | | | | 1 | 1 | couvercle | Sb. Coq Cv4.1 | 523 | XXXVII |
| 1983 | 7824 | 65-4 | 604 | 204 | Cave | Sb. Coq | 1 | | | | | 1 | 1 | couvercle | Sb. Coq Cv4.1 | 524 | XXXVII |
| 1983 | 7824 | 65-4 | 604 | 204 | Cave | Sb. Coq | 1 | | | | | 1 | 1 | couvercle | Sb. Coq Cv4.1 | 525 | XXXVII |
| 1980 | | 64-4 | 591 | 151 | E14 | Sb. Coq | 1 | | | | | 1 | 1 | couvercle | Sb. Coq Cv4.1 | 526 | XXXVII |
| 1977 | 7823 | 63-2 | 553 | 40 | G12 | Sb. Coq | 1 | | | | | 1 | 1 | couvercle | Sb. Coq Cv4.1 | 527 | XXXVII |
| 1977 | 7823 | 63-2 | 553 | 37 | G13 | Sb. Coq | | 2 | 1 | | 146 | 149 | 1 | couvercle | Sb. Coq Cv4.1 | 528 | XXXVII |

ANNEXE B : LES ROISES

| année | n° OA | Rayon | Caisse | n° ordre | Carré | Catégorie | Comptage | | | | | | Typologie | Desc. Typo. | Dessin | Planche | |
|-------|----------|-------|--------|-------------|-------------|-----------|----------|---|---|---|----|----|-----------|--------------|---------------|---------|---------|
| | | | | | | | B | F | A | D | P | NR | | | | | NMI |
| 1977 | 7823 | 63-2 | 553 | 37 | G13 | Sb. Coq | 4 | | | | | 4 | 1 | couvercle | Sb. Coq Cv4.1 | 529 | XXXVIII |
| 1977 | | 63-2 | 555 | 52 | G13-G14 | Sb. Coq | 1 | | | | | 1 | 1 | couvercle | Sb. Coq Cv4.1 | 530 | XXXVIII |
| 1982 | | 63-3 | 558 | 67 | H15 | Sb. Coq | 1 | | | | | 1 | 1 | couvercle | Sb. Coq Cv4.1 | 531 | XXXVIII |
| 1982 | | 63-3 | 556 | 58 | J16 | Sb. Coq | 2 | | | | | 2 | 1 | couvercle | Sb. Coq Cv4.1 | 532 | XXXVIII |
| 1982 | | 63-3 | 556 | 58 | J16 | Sb. Coq | 1 | | | | | 1 | 1 | couvercle | Sb. Coq Cv4.1 | 533 | XXXVIII |
| 1983 | | 62-3 | 570 | 99 | M02 | Sb. Coq | 1 | | | | | 1 | 1 | couvercle | Sb. Coq Cv4.1 | 534 | XXXVIII |
| 1984 | 7825 | 65-5 | 606 | 206 | P8 | Sb. Coq | 1 | | | | | 1 | 1 | couvercle | Sb. Coq Cv4.1 | 535 | XXXVIII |
| 1983 | 7824 | 65-4 | 604 | 204 | Cave | Sb. Coq | 2 | | | | | 2 | 1 | couvercle | Sb. Coq Cv5 | 536 | XXXVIII |
| 1983 | 7824 | 65-4 | 604 | 204 | Cave | Sb. Coq | 2 | | | | | 2 | 1 | couvercle | Sb. Coq Cv5 | 537 | XXXVIII |
| 1976 | | 63-2 | 555 | 56 | G15 | Sb. Coq | 1 | | | | | 1 | 1 | couvercle | Sb. Coq Cv6.1 | 538 | XXXVIII |
| 1981 | | 66-3 | 1465 | 322 | Cave | Sb. Coq | 1 | | | | | 1 | 1 | couvercle | Sb. Coq Cv6.2 | 539 | XXXVIII |
| 1982 | | 33-1 | 1450 | 311 | J16 | Sb. Coq | | 1 | | | 10 | 11 | | | | | |
| 1981 | | 67-3 | 1468 | 424 | Cave | Sb. Coq | | 1 | | | | 1 | | fond percé ? | | | |
| | | 66-5 | 1498 | | sans n° | Sb. Coq | | 1 | | | | 1 | | fond percé ? | | | |
| | | 5--2 | 1500 | 763 | sans n° | Sb. Coq | | 2 | | | 4 | 6 | | | | | |
| | | 26--1 | 1488 | 691 | indéterminé | Sb. Coq | | 3 | | | 44 | 47 | | | | | |
| | | 3--3 | 1493 | 755 | sans n° | Sb. Coq | | | | | 15 | 15 | | | | | |
| | | 27--2 | 1495 | | sans n° | Sb. Coq | | | | | 50 | 50 | | | | | |
| | | 27--2 | 1490 | 751 | sans n° | Sb. Coq | | | | | 47 | 47 | | | | | |
| | | 36-4 | 1512 | | sans n° | Sb. Coq | | | | | 44 | 44 | | | | | |
| | | 64-2 | 1518 | 781 | sans n° | Sb. Coq | | | | | | 0 | | | | | |
| | | 64-2 | 1517 | 779 | sans n° | Sb. Coq | | | | | 22 | 22 | | | | | |
| | | 66-2 | 1506 | 770 | sans n° | Sb. Coq | | 3 | | | 14 | 17 | | | | | |
| | | 66-1 | 1515 | 778 | sans n° | Sb. Coq | | 4 | | | 54 | 58 | | | | | |
| | | 66-1 | 1510 | 773 | sans n° | Sb. Coq | | 3 | | | 23 | 26 | | | | | |
| | | 66-4 | 1511 | 774 | sans n° | Sb. Coq | | 3 | | | 59 | 62 | | | | | |

ANNEXE B : LES ROISES

| année | n° OA | Rayon | Caisse | n° ordre | Carré | Catégorie | Comptage | | | | | | Typologie | Desc. Typo. | Dessin | Planche |
|-----------|----------|-------|--------|-------------|---------|-----------|----------|---|---|---|-----|-----|-----------|-------------|--------|---------|
| | | | | | | | B | F | A | D | P | NR | | | | |
| | | 67-4 | 1507 | 771 | sans n° | Sb. Coq | | 1 | | | 56 | 57 | | | | |
| 1984 | | 3-1 | 1485 | 689 | 3 | Sb. Coq | | 2 | | | 33 | 35 | | | | |
| 1982 | 7823 | 65-2 | 596 | 180 | C13 | Sb. Coq | | | | | 21 | 21 | | | | |
| 1982 | 7823 | 65-2 | 596 | 178 | C13-D13 | Sb. Coq | | | | | 2 | 2 | | | | |
| 1983 | 7824 | 62-4 | 574 | 107 | Cave | Sb. Coq | | | | | 80 | 80 | | | | |
| 1983 | 7824 | 65-4 | 604 | 204 | Cave | Sb. Coq | | 7 | | | 102 | 109 | | | | |
| 1983 | 7824 | 34-1 | 1439 | 232 | Cave | Sb. Coq | | 4 | | | | 4 | | | | |
| 1981 | | 67-3 | 1468 | 437 | Cave | Sb. Coq | | 1 | | | | 1 | | | | |
| 1981 | | 67-3 | 1468 | 438 | Cave | Sb. Coq | | 1 | | | | 1 | | | | |
| | | 28-2 | 30 | 20 | D13 | Sb. Coq | | 2 | | | | 2 | | | | |
| 1984 | | 64-5 | 592 | 155 | D13 | Sb. Coq | | | | | 31 | 31 | | | | |
| 1980-1982 | | 64-5 | 1671 | 783 | D13-D15 | Sb. Coq | | | | | 20 | 20 | | | | |
| 1981 | | 64-5 | 1671 | 785 | D15 | Sb. Coq | | | | | 27 | 27 | | | | |
| 1981 | | 64-5 | 1671 | 785 | D15 | Sb. Coq | | | | | 3 | 3 | | | | |
| 1981 | | 65-4 | 592 | 157 | D15 | Sb. Coq | | | | | 19 | 19 | | | | |
| 1981 | | 67-3 | 1468 | 479 | E13 | Sb. Coq | | | | | 3 | 3 | | | | |
| 1981 | | 64-4 | 591 | 150 | E13 | Sb. Coq | | | | | 22 | 22 | | | | |
| 1980 | | 64-4 | 591 | 151 | E14 | Sb. Coq | | | | | 40 | 40 | | | | |
| 1981 | | 64-4 | 591 | 149 | E15-F15 | Sb. Coq | | | | | 2 | 2 | | | | |
| 1982 | | 63-4 | 566 | 91 | F13 | Sb. Coq | | | | | 10 | 10 | | | | |
| 1977 | | 65-2 | 594 | 167 | F15 | Sb. Coq | | 3 | | | 64 | 67 | | | | |
| 1981 | | 64-3 | 587 | 144 | F15-F16 | Sb. Coq | | | | | 21 | 21 | | | | |
| 1981 | | 65-2 | 594 | 166 | F15-G15 | Sb. Coq | | | | | 10 | 10 | | | | |
| 1979 | | 65-2 | 594 | 168 | F16 | Sb. Coq | | | | | 111 | 111 | | | | |
| 1977 | 7823 | 63-2 | 553 | 40 | G12 | Sb. Coq | | 2 | 1 | | 104 | 107 | | | | |
| 1976 | 7823 | 63-2 | 553 | 40 | G12 | Sb. Coq | | | | | 51 | 51 | | | | |

ANNEXE B : LES ROISES

| année | n° OA | Rayon | Caisse | n° ordre | Carré | Catégorie | Comptage | | | | | | | Typologie | Desc. Typo. | Dessin | Planche |
|-----------------|----------|-------|--------|-------------|---------------------|-----------|----------|---|---|---|-----|-----|-----|-----------|-------------|--------|---------|
| | | | | | | | B | F | A | D | P | NR | NMI | | | | |
| 1977 | 7823 | 63-2 | 553 | 46 | G12-G13 | Sb. Coq | | | | | 8 | 8 | | | | | |
| 1979 | | 63-5 | 564 | 84 | G12-G13 | Sb. Coq | | | | | 11 | 11 | | | | | |
| 1979 | | 63-5 | 564 | 88 | G12-H12 | Sb. Coq | | | | | 44 | 44 | | | | | |
| | 7823 | 63-2 | 553 | 45 | G12-H12 berme | Sb. Coq | | | | | 12 | 12 | | | | | |
| 1977 | | 63-2 | 555 | 52 | G13-G14 | Sb. Coq | 3 | 1 | | | 40 | 44 | | | | | |
| 1977 | | 63-2 | 555 | 53 | G14 | Sb. Coq | 1 | | | | 8 | 9 | | | | | |
| 1977 | | 63-2 | 555 | 51 | G14-G15 | Sb. Coq | 1 | | | | 12 | 13 | | | | | |
| 1976 | | 63-2 | 555 | 56 | G15 | Sb. Coq | | | | | 42 | 42 | | | | | |
| 1979 | 7803 | 63-2 | 552 | 36 | G16 | Sb. Coq | 2 | | | | 87 | 89 | | | | | |
| 1981 | | 63-5 | 564 | 87 | H7 | Sb. Coq | 2 | | | | 48 | 50 | | | | | |
| 1976 | | 65-3 | 600 | 195 | H12 | Sb. Coq | | | | | 21 | 21 | | | | | |
| 1975 | 7782 | 65-3 | 600 | 197 | H13 | Sb. Coq | | | | | 35 | 35 | | | | | |
| 1975 | 7782 | 33-1 | 1449 | 300 | H13 | Sb. Coq | 1 | | | | 12 | | | | | | |
| 1976 | | 65-4 | 603 | 201 | H13-H14 | Sb. Coq | 2 | | | | 68 | 70 | | | | | |
| 1983 | 7824 | 65-4 | 603 | 202 | H14 | Sb. Coq | 3 | | | | 48 | 51 | | | | | |
| 1983 | 7824 | 65-4 | 603 | 203 | H14-H15- J14-J15 | Sb. Coq | | | | | 12 | 12 | | | | | |
| 1976 | | 63-3 | 558 | 68 | H15 | Sb. Coq | 6 | | | | 33 | 39 | | | | | |
| 1982 | | 63-3 | 558 | 67 | H15 | Sb. Coq | 6 | | | | 88 | 94 | | | | | |
| 1983 | 7824 | 65-3 | 598 | 186 | H15 | Sb. Coq | 15 | | | | 127 | 142 | | | | | |
| 1981 | | 63-5 | 564 | 86 | H16 | Sb. Coq | | | | | 12 | 12 | | | | | |
| 1983 | 7824 | 55-3 | 598 | 187 | H16 | Sb. Coq | 3 | | | | 17 | 20 | | | | | |
| 1976/1977/19779 | | 63-4 | 561 | 80 | Hypocauste | Sb. Coq | 4 | | | | 81 | 85 | | | | | |
| 1975 | 7782 | 65-3 | 599 | 189 | J12 | Sb. Coq | | | | | 19 | 19 | | | | | |
| 1976 | | 63-3 | 557 | 65 | J13 | Sb. Coq | 3 | | | | 38 | 41 | | | | | |
| 1975 | | 35-1 | 1443 | 257 | J13 | Sb. Coq | 1 | | | | 1 | 2 | | | | | |

ANNEXE B : LES ROISES

| année | n° OA | Rayon | Caisse | n° ordre | Carré | Catégorie | Comptage | | | | | | Typologie | Desc. Typo. | Dessin | Planche |
|-------|----------|-------|--------|-------------|---------|-----------|----------|---|---|---|-----|-----|-----------|-------------|--------|---------|
| | | | | | | | B | F | A | D | P | NR | | | | |
| 1982 | | 65-3 | 599 | 192 | J15 | Sb. Coq | | 1 | | | 51 | 52 | | | | |
| 1982 | | 65-3 | 599 | 191 | J15-K15 | Sb. Coq | | | | | 5 | 5 | | | | |
| 1982 | | 63-3 | 556 | 58 | J16 | Sb. Coq | | 6 | 1 | | 117 | 124 | | | | |
| 1974 | | 55-2 | 597 | 181 | K9 | Sb. Coq | | | | | 15 | 15 | | | | |
| 1974 | | 63-3 | 559 | 72 | K11 | Sb. Coq | | | | | 10 | 10 | | | | |
| 1975 | | 63-3 | 559 | 73 | K13 | Sb. Coq | | | | | 1 | 1 | | | | |
| 1975 | | 65-3 | 597 | 184 | K13 | Sb. Coq | | | | | 9 | 9 | | | | |
| 1983 | | 63-3 | 559 | 75 | K14 | Sb. Coq | | 4 | | | 34 | 38 | | | | |
| 1983 | 7824 | 67-4 | 1469 | 515 | K14 | Sb. Coq | | 3 | | | 21 | 24 | | | | |
| 1983 | 7824 | 67-4 | 1469 | 511 | K14 | Sb. Coq | | | | | 1 | 1 | | | | |
| 1983 | 7824 | 66-3 | 1472 | 624 | K15 | Sb. Coq | | 1 | | | 6 | 7 | | | | |
| 1982 | | 63-3 | 559 | 602 | K15 | Sb. Coq | | 3 | | | 35 | 38 | | | | |
| 1982 | | 63-3 | 559 | 78 | K16 | Sb. Coq | | | | | 25 | 25 | | | | |
| 1974 | | 65-2 | 593 | 164 | L10 | Sb. Coq | | | | | 8 | 8 | | | | |
| 1974 | 7816 | 63-2 | 554 | 48 | L11 | Sb. Coq | | 2 | | | 44 | 46 | | | | |
| 1984 | 7825 | 65-5 | 608 | 208 | L11 | Sb. Coq | | 3 | | | 39 | 42 | | | | |
| 1984 | 7825 | 67-3 | 1467 | 409 | L11XIII | Sb. Coq | | 1 | | | | 1 | | | | |
| 1984 | 7825 | 67-3 | 1467 | 409 | L11XIII | Sb. Coq | | | | | 5 | 5 | | | | |
| 1975 | 7782 | 63-2 | 554 | 49 | L12 | Sb. Coq | | 1 | | | 7 | 8 | | | | |
| 1975 | 7782 | 63-2 | 554 | 50 | L13 | Sb. Coq | | | | | 2 | 2 | | | | |
| 1984 | 7825 | 65-5 | 605 | 205 | M10 | Sb. Coq | | 5 | | | 101 | 106 | | | | |
| 1974 | 7816 | 63-5 | 567 | 98 | M11 | Sb. Coq | | 2 | 1 | | 90 | 93 | | | | |
| 1968 | | 43-3 | 1387 | 214 | Mur | Sb. Coq | | | | | 18 | 18 | | | | |
| 1984 | 7825 | 34-1 | 1437 | 217 | N9 | Sb. Coq | | 1 | | | | 1 | | | | |
| 1984 | 7825 | 65-5 | 607 | 207 | P7 | Sb. Coq | | | | | 71 | 71 | | | | |
| 1984 | 7825 | 63-3 | 559 | 79 | P8 | Sb. Coq | | | | | 137 | 137 | | | | |

ANNEXE B : LES ROISES

| année | n° OA | Rayon | Caisse | n° ordre | Carré | Catégorie | Comptage | | | | | | | Typologie | Desc. Typo. | Dessin | Planche |
|-------|----------|-------|--------|-------------|--|-----------|----------|---|---|---|-----|-----|-----|-----------|--------------|--------|---------|
| | | | | | | | B | F | A | D | P | NR | NMI | | | | |
| 1984 | 7825 | 65-5 | 606 | 206 | P8 | Sb. Coq | | 4 | | | 140 | 144 | | | | | |
| 1984 | 7825 | 63-5 | 565 | 90 | Q8 | Sb. Coq | | 4 | | | 114 | 118 | | | | | |
| 1984 | 7825 | 65-4 | 602 | 200 | Q8 | Sb. Coq | | | | | 5 | 5 | | | | | |
| 1973 | | 64-3 | 586 | 140 | Tranchée côté Roises extrémité gauche | Sb. Coq | | | | | 1 | 1 | | | | | |
| 1973 | | 64-3 | 586 | 140 | Tranchée SE-NW à 2 m extrémité NW | Sb. Coq | | | | | 3 | 3 | | | | | |
| | | 32-1 | 1445 | 277 | W | Sb. Coq | | | 1 | | | 1 | | | | | |
| | | 64-2 | 583 | 120 | Q8 | Com. Sb | 1 | | | | | 1 | 1 | jatte | Com. Sb J1 | 540 | XXXIX |
| 1973 | | 64-3 | 586 | 140 | Extrémité NW de la tranchée SE-NW côté voie close | Com. Sb | 1 | | | | 1 | 2 | 1 | jatte | Com. Sb J2.1 | 541 | XXXIX |
| 1981 | | 67-3 | 1468 | 469 | E15-F15 | Com. Sb | 2 | | | | | 2 | 1 | jatte | Com. Sb J2.2 | 542 | XXXIX |
| 1981 | | 64-5 | 1671 | 785 | D15 | Com. Sb | | | | | 1 | 1 | 1 | jatte | Com. Sb J2.2 | 543 | XXXIX |
| 1977 | 7823 | 63-2 | 553 | 40 | G12 | Com. Sb | 1 | | | | | 1 | 1 | jatte | Com. Sb J3 | 544 | XXXIX |
| 1983 | 7824 | 65-4 | 603 | 202 | H14 | Com. Sb | 1 | | | | | 1 | 1 | jatte | Com. Sb J4 | 545 | XXXIX |
| | | 35-1 | 1444 | 261 | J16 | Com. Sb | 1 | | | | | 1 | 1 | jatte | Com. Sb J4 | 546 | XXXIX |
| 1973 | | 64-3 | 586 | 140 | Extrémité NW de la tranchée SE-NW | Com. Sb | 1 | | | | | 1 | 1 | jatte | Com. Sb J4 | 547 | XXXIX |

ANNEXE B : LES ROISES

| année | n° OA | Rayon | Caisse | n° ordre | Carré | Catégorie | Comptage | | | | | | | Typologie | Desc. Typo. | Dessin | Planche |
|-------|----------|-------|--------|-------------|---|-----------|----------|---|---|---|---|----|-----|-----------|--------------|--------|---------|
| | | | | | | | B | F | A | D | P | NR | NMI | | | | |
| | | | | | côté voie close | | | | | | | | | | | | |
| 1980 | | 66-4 | 1474 | 721 | E14c | Com. Sb | 1 | | | | | 1 | 1 | jatte | Com. Sb J5 | 548 | XXXIX |
| 1984 | 7825 | 65-5 | 606 | 206 | P8 | Com. Sb | 1 | | | | | 1 | 1 | bouteille | Com. Sb Bt1 | 549 | XXXIX |
| | | 64-2 | 1518 | 781 | sans n° | Com. Sb | 1 | | | | | 1 | 1 | bouteille | Com. Sb Bt2 | 550 | XXXIX |
| 1981 | | 64-5 | 1671 | 785 | D15 | Com. Sb | 1 | | | | | 1 | 1 | pot | Com. Sb P1.1 | 551 | XXXIX |
| 1974 | | 64-2 | 583 | 128 | M11 | Com. Sb | 1 | | | | | 1 | 1 | pot | Com. Sb P1.1 | 552 | XXXIX |
| 1983 | | 64-2 | 583 | 125 | Cave | Com. Sb | 1 | | | | | 1 | 1 | pot | Com. Sb P1.1 | 553 | XL |
| 1980 | | 64-5 | 1671 | 784 | D14 | Com. Sb | 1 | | | | | 1 | 1 | pot | Com. Sb P2 | 554 | XL |
| 1982 | | 64-2 | 583 | 112 | J15 | Com. Sb | 1 | | | | | 1 | 1 | pot | Com. Sb P2 | 555 | XL |
| | | 27--2 | 1490 | 751 | sans n° | Com. Sb | 3 | | | | | 3 | 1 | pot | Com. Sb P2 | 556 | XL |
| 1976 | | 64-2 | 583 | 121 | H13-H14 | Com. Sb | 1 | | | | | 1 | 1 | pot | Com. Sb P3.1 | 557 | XL |
| 1982 | | 63-3 | 558 | 67 | H15 | Com. Sb | 1 | | | | | 1 | 1 | pot | Com. Sb P3.1 | 558 | XL |
| 1983 | | 64-2 | 583 | 116 | H15 | Com. Sb | 1 | | | | | 1 | 1 | pot | Com. Sb P3.2 | 559 | XL |
| 1973 | | 64-3 | 586 | 140 | Grande tranchée côté Roises | Com. Sb | | 1 | | | | 30 | 31 | | | | |
| 1973 | | 64-3 | 586 | 140 | Tranchée SW.NE Extrémité - -> amph | Com. Sb | | | | | | 2 | 2 | | | | |
| 1982 | 7823 | 65-2 | 596 | 180 | C13 | Com. Sb | | | | | | 38 | 38 | | | | |
| 1977 | 7823 | 63-2 | 553 | 37 | G13 | Com. Sb | | | | | | 10 | 10 | | | | |
| 1977 | 7823 | 63-2 | 553 | 37 | G13 | Com. Sb | | 2 | | | | 25 | 27 | | | | |
| 1981 | | 67-3 | 1468 | 467 | D15-E15 | Com. Sb | | 1 | | | | | 1 | | | | |
| 1977 | 7823 | 63-2 | 553 | 40 | G12 | Com. Sb | | | | | | 5 | 5 | | | | |
| 1976 | 7823 | 63-2 | 553 | 40 | G12 | Com. Sb | | | | | | 15 | 15 | | | | |
| 1981 | | 63-5 | 564 | 86 | H16 | Com. Sb | | | | | | 13 | 13 | | | | |

ANNEXE B : LES ROISES

| année | n° OA | Rayon | Caisse | n° ordre | Carré | Catégorie | Comptage | | | | | | | Typologie | Desc. Typo. | Dessin | Planche | |
|-------|----------|-------|--------|-------------|---------|--------------|----------|---|---|---|---|----|-----|-----------|-------------|---------------|---------|----|
| | | | | | | | B | F | A | D | P | NR | NMI | | | | | |
| 1968 | | 43-3 | 1387 | 214 | Mur | Com. Cl 1 | 1 | | | | | | 1 | 1 | bol | Com. Cl B3 | 560 | XL |
| | | 66-4 | 1511 | 774 | sans n° | Com. Cl 1 | 1 | | | | | | 1 | 1 | bol | Com. Cl B2 | 561 | XL |
| | | 67-4 | 1507 | 771 | sans n° | Com. Cl 1 | 1 | | | | | | 1 | 1 | marmite | Com. Cl M1 | 562 | XL |
| 1984 | 7825 | 65-5 | 606 | 206 | P8 | Com. Cl 1 | 1 | | | | | | 1 | 1 | cruche | Com. Cl Cr1.1 | 563 | XL |
| 1977 | 7823 | 63-2 | 553 | 40 | G12 | Com. Cl 1 | 2 | | | | | | 2 | 1 | cruche | Com. Cl Cr1.1 | 564 | XL |
| 1983 | | 35-1 | 1441 | 240 | H15 | Com. Cl 1 | 1 | | 2 | | | | 3 | 1 | cruche | Com. Cl Cr1.1 | 565 | XL |
| 1983 | | 62-3 | 570 | 99 | M02 | Com. Cl 1 | 1 | | | | | | 1 | 1 | cruche | Com. Cl Cr1.1 | 566 | XL |
| | | 67-4 | 1507 | 771 | sans n° | Com. Cl 1 | 2 | | | | | | 2 | 1 | cruche | Com. Cl Cr1.1 | 567 | XL |
| | | 67-4 | 1507 | 771 | sans n° | Com. Cl 1 | 2 | | | | | | 2 | 1 | cruche | Com. Cl Cr1.1 | 568 | XL |
| 1979 | 7803 | 35-1 | 1444 | 259 | G16 | Com. Cl 1 | 1 | 1 | | | 5 | | 7 | 1 | cruche | Com. Cl Cr1.2 | 569 | XL |
| 1983 | | 62-3 | 570 | 99 | M02 | Com. Cl 1 | 2 | | | | | | 2 | 1 | cruche | Com. Cl Cr1.2 | 570 | XL |
| 1983 | | 62-3 | 570 | 99 | M02 | Com. Cl 1 | 1 | | | | | | 1 | 1 | cruche | Com. Cl Cr1.2 | 571 | XL |
| 1984 | 7825 | 65-5 | 607 | 207 | P7 | Com. Cl 1 | 1 | | | | | | 1 | 1 | cruche | Com. Cl Cr1.2 | 572 | XL |
| 1984 | 7825 | 65-4 | 602 | 200 | Q8 | Com. Cl 1 | 2 | | | | | | 2 | 1 | cruche | Com. Cl Cr1.2 | 573 | XL |
| | | 66-4 | 1511 | 774 | sans n° | Com. Cl 1 | 1 | | | | | | 1 | 1 | cruche | Com. Cl Cr2.1 | 574 | XL |

ANNEXE B : LES ROISES

| année | n° OA | Rayon | Caisse | n° ordre | Carré | Catégorie | Comptage | | | | | | | Typologie | Desc. Typo. | Dessin | Planche | |
|-------|----------|-------|--------|-------------|---------|--------------|----------|---|---|---|---|----|-----|-----------|-------------|---------------|---------|-----|
| | | | | | | | B | F | A | D | P | NR | NMI | | | | | |
| | | 66-4 | 1511 | 774 | sans n° | Com. Cl 1 | 1 | | | | | | 1 | 1 | cruche | Com. Cl Cr2.1 | 575 | XLI |
| | | 66-4 | 1511 | 774 | sans n° | Com. Cl 1 | 1 | | | | | | 1 | 1 | cruche | Com. Cl Cr2.1 | 576 | XLI |
| | | 66-4 | 1511 | 774 | sans n° | Com. Cl 1 | 1 | | | | | | 1 | 1 | cruche | Com. Cl Cr2.1 | 577 | XLI |
| | | 66-4 | 1511 | 774 | sans n° | Com. Cl 1 | 1 | | | | | | 1 | 1 | cruche | Com. Cl Cr2.1 | 578 | XLI |
| 1984 | 7825 | 65-4 | 602 | 200 | Q8 | Com. Cl 1 | 1 | | | | | | 1 | 1 | cruche | Com. Cl Cr3 | 579 | XLI |
| 1975 | 7782 | 65-3 | 600 | 197 | H13 | Com. Cl 1 | 1 | | | | | | 1 | 1 | cruche | Com. Cl Cr6.1 | 580 | XLI |
| 1973 | | 64-3 | 586 | 138 | C | Com. Cl 1 | 1 | | | | | | 1 | 1 | cruche | Com. Cl Cr6.1 | 581 | XLI |
| 1983 | | 62-3 | 570 | 99 | M02 | Com. Cl 1 | 2 | | | | | | 2 | 1 | cruche | Com. Cl Cr6.1 | 582 | XLI |
| 1983 | | 62-3 | 570 | 99 | M02 | Com. Cl 1 | 1 | | | | | | 1 | 1 | cruche | Com. Cl Cr6.1 | 583 | XLI |
| 1984 | 7825 | 65-5 | 607 | 207 | P7 | Com. Cl 1 | 1 | | | | | | 1 | 1 | cruche | Com. Cl Cr6.1 | 584 | XLI |
| 1984 | 7825 | 67-3 | 1467 | 388 | P8III | Com. Cl 1 | 1 | | | | | | 1 | 1 | cruche | Com. Cl Cr6.1 | 585 | XLI |
| 1984 | 7825 | 65-4 | 602 | 200 | Q8 | Com. Cl 1 | 1 | | | | | | 1 | 1 | cruche | Com. Cl Cr6.1 | 586 | XLI |
| 1984 | 7825 | 67-3 | 1467 | 406 | Q8 IV | Com. Cl 1 | 1 | | | | | | 1 | 1 | cruche | Com. Cl Cr6.1 | 587 | XLI |
| | | 5--2 | 1500 | 763 | sans n° | Com. Cl 1 | 1 | | | | | | 1 | 1 | cruche | Com. Cl Cr6.1 | 588 | XLI |
| | | 5--2 | 1500 | 763 | sans n° | Com. Cl 1 | 1 | | | | | | 1 | 1 | cruche | Com. Cl Cr6.1 | 589 | XLI |

ANNEXE B : LES ROISES

| année | n° OA | Rayon | Caisse | n° ordre | Carré | Catégorie | Comptage | | | | | | | Typologie | Desc. Typo. | Dessin | Planche | |
|-------|----------|-------|--------|-------------|---------|--------------|----------|---|---|---|---|----|-----|-----------|-------------|---------------|---------|-----|
| | | | | | | | B | F | A | D | P | NR | NMI | | | | | |
| | | 66-4 | 1511 | 774 | sans n° | Com. Cl 1 | 1 | | | | | | 1 | 1 | cruche | Com. Cl Cr6.1 | 590 | XLI |
| | | 5--2 | 1500 | 763 | sans n° | Com. Cl 1 | 1 | | | | | | 1 | 1 | cruche | Com. Cl Cr6.2 | 591 | XLI |
| | | 64-2 | 1518 | 781 | sans n° | Com. Cl 1 | 1 | | | | | | 1 | 1 | cruche | Com. Cl Cr6.2 | 592 | XLI |
| 1975 | 7782 | 65-3 | 600 | 197 | H13 | Com. Cl 1 | 1 | | | | | | 1 | 1 | cruche | Com. Cl Cr7.1 | 593 | XLI |
| 1984 | 7825 | 65-4 | 602 | 200 | Q8 | Com. Cl 1 | 2 | | | | | | 2 | 1 | cruche | Com. Cl Cr7.1 | 594 | XLI |
| 1984 | 7825 | 65-4 | 602 | 200 | Q8 | Com. Cl 1 | 1 | | | | | | 1 | 1 | cruche | Com. Cl Cr7.1 | 595 | XLI |
| 1984 | 7825 | 65-4 | 602 | 200 | Q8 | Com. Cl 1 | 2 | | | | | | 2 | 1 | cruche | Com. Cl Cr7.1 | 596 | XLI |
| | | 66-4 | 1511 | 774 | sans n° | Com. Cl 1 | 1 | | | | | | 1 | 1 | cruche | Com. Cl Cr7.1 | 597 | XLI |
| | | 5--2 | 1500 | 763 | sans n° | Com. Cl 1 | 1 | | | | | | 1 | 1 | cruche | Com. Cl Cr7.1 | 598 | XLI |
| | | 32-1 | 1446 | 280 | sans n° | Com. Cl 1 | 1 | | | | | | 1 | 1 | cruche | Com. Cl Cr7.2 | 599 | XLI |
| | | | | | | | | | | | | | | | | | | |
| | | | | | | | | | | | | | | | | | | |
| 1984 | 7825 | 65-5 | 607 | 207 | P7 | Com. Cl 1 | 1 | | | | | | 1 | 1 | cruche | Com. Cl Cr8 | 600 | XLI |
| 1981 | | 63-5 | 564 | 87 | H7 | Com. Cl 1 | 1 | | | | | | 1 | 1 | cruche | Com. Cl Cr8 | 601 | XLI |
| 1983 | | 62-3 | 570 | 99 | M02 | Com. Cl 1 | 3 | | | | | | 3 | 1 | cruche | Com. Cl Cr8 | 602 | XLI |
| | | 67-4 | 1507 | 771 | sans n° | Com. Cl 1 | 1 | | | | | | 1 | 1 | cruche | Com. Cl Cr8 | 603 | XLI |

ANNEXE B : LES ROISES

| année | n° OA | Rayon | Caisse | n° ordre | Carré | Catégorie | Comptage | | | | | | Typologie | Desc. Typo. | Dessin | Planche | |
|-------|----------|-------|--------|-------------|---------|--------------|----------|---|---|---|----|----|-----------|-------------|--------------|---------|------|
| | | | | | | | B | F | A | D | P | NR | | | | | NMI |
| 1984 | 7825 | 65-5 | 606 | 206 | P8 | Com. Cl 1 | 1 | | | | | 1 | 1 | cruche | Com. Cl Cr10 | 604 | XLI |
| 1974 | 7816 | 63-5 | 567 | 98 | M11 | Com. Cl 1 | 1 | | | | | 1 | 1 | cruche | Com. Cl Cr10 | | |
| 1983 | 7824 | 65-4 | 604 | 204 | Cave | Com. Cl 1 | 1 | | | | | 1 | 1 | cruche | Com. Cl Cr11 | 605 | XLI |
| 1968 | | 43-3 | 1387 | 214 | Mur | Com. Cl 1 | 1 | | | | | 1 | 1 | pot | Com. Cl P3 | 606 | XLII |
| 1982 | 7823 | 64-5 | 1470 | 545 | J16 | Com. Cl 1 | | 1 | | | | 1 | 1 | pot | Com. Cl Min | 607 | XLII |
| 1982 | | BAL | 1466 | 337 | Puits | Com. Cl 1 | 1 | | | | | 1 | 1 | pot | Com. Cl Min | 608 | XLII |
| 1979 | 7803 | 28-2 | 30 | 2 | sans n° | Com. Cl 1 | 4 | 2 | | | 13 | 19 | | | | | |
| | | 27--2 | 1495 | | sans n° | Com. Cl 1 | | | | | 29 | 29 | | | | | |
| | | 5--2 | 1500 | 763 | sans n° | Com. Cl 1 | | 8 | 2 | | 76 | 86 | | | | | |
| | | 3--3 | 1493 | 755 | sans n° | Com. Cl 1 | | | | | 18 | 18 | | | | | |
| | | 27--2 | 1490 | 751 | sans n° | Com. Cl 1 | | | | | 37 | 37 | | | | | |
| | | 64-2 | 1517 | 779 | sans n° | Com. Cl 1 | | 3 | | 1 | 26 | 30 | | | | | |
| | | 66-2 | 1506 | 770 | sans n° | Com. Cl 1 | | 2 | | | 20 | 22 | | | | | |
| | | 66-1 | 1510 | 773 | sans n° | Com. Cl 1 | | 2 | 1 | | 14 | 17 | | | | | |
| | | 66-4 | 1511 | 774 | sans n° | Com. Cl 1 | | 6 | | | 47 | 53 | | | | | |

ANNEXE B : LES ROISES

| année | n° OA | Rayon | Caisse | n° ordre | Carré | Catégorie | Comptage | | | | | | | Typologie | Desc. Typo. | Dessin | Planche |
|-------|----------|-------|--------|-------------|-------------------------------------|--------------|----------|---|---|---|-----|-----|-----|-----------|-------------|--------|---------|
| | | | | | | | B | F | A | D | P | NR | NMI | | | | |
| | | 67-4 | 1507 | 771 | sans n° | Com. Cl 1 | | 3 | | | 49 | 52 | | | | | |
| 1984 | 7825 | 65-5 | 607 | 207 | P7 | Com. Cl 1 | | 2 | | | 55 | 57 | | | | | |
| 1984 | 7825 | 65-5 | 606 | 206 | P8 | Com. Cl 1 | | 3 | 2 | | 230 | 235 | | | | | |
| 1976 | | 65-3 | 600 | 195 | H12 | Com. Cl 1 | | | | | 58 | 58 | | | | | |
| 1981 | | 63-5 | 564 | 86 | H16 | Com. Cl 1 | | 1 | | | 41 | 42 | | | | | |
| 1983 | 7824 | 67-4 | 1469 | 518 | K15 | Com. Cl 1 | | 3 | | | | 3 | | | | | |
| 1984 | | 3-1 | 1485 | 689 | 3 | Com. Cl 1 | | 4 | 1 | | 22 | 27 | | | | | |
| 1973 | | 64-3 | 586 | 138 | C | Com. Cl 1 | | | | | 5 | 5 | | | | | |
| 1983 | 7824 | 62-4 | 574 | 107 | Cave | Com. Cl 1 | | 1 | | | 20 | 21 | | | | | |
| 1981 | | 66-3 | 1465 | 329 | Cave | Com. Cl 1 | | 3 | | | 8 | 11 | | | | | |
| 1973 | | 64-3 | 586 | 140 | Croisement des deux tranchées | Com. Cl 1 | | | | | 7 | 7 | | | | | |
| 1982 | | 64-5 | 1671 | 786 | D13 | Com. Cl 1 | | | | | 37 | 37 | | | | | |
| 1980 | | 64-5 | 1671 | 784 | D14 | Com. Cl 1 | | 1 | | | 15 | 16 | | | | | |
| | | 28-2 | 30 | 20 | D14 | Com. Cl 1 | | 2 | | | | 2 | | | | | |
| 1981 | | 64-5 | 1671 | 785 | D15 | Com. Cl 1 | | 1 | | | | 1 | | | | | |

ANNEXE B : LES ROISES

| année | n° OA | Rayon | Caisse | n° ordre | Carré | Catégorie | Comptage | | | | | | | Typologie | Desc. Typo. | Dessin | Planche |
|-------|----------|-------|--------|-------------|---------|--------------|----------|---|---|---|----|----|-----|-----------|-------------|--------|---------|
| | | | | | | | B | F | A | D | P | NR | NMI | | | | |
| 1980 | | 64-4 | 591 | 148 | E15 | Com. Cl 1 | | | | | 27 | 27 | | | | | |
| 1981 | | 64-3 | 587 | 142 | F16 | Com. Cl 1 | | | | | 24 | 24 | | | | | |
| 1977 | 7823 | 63-2 | 553 | 40 | G12 | Com. Cl 1 | | 2 | | 3 | 5 | 10 | | | | | |
| 1979 | | 63-5 | 564 | 88 | G12-H12 | Com. Cl 1 | | | | | 12 | 12 | | | | | |
| 1977 | | 63-2 | 555 | 51 | G14-G15 | Com. Cl 1 | | | | | 7 | 7 | | | | | |
| 1976 | | 63-2 | 555 | 56 | G15 | Com. Cl 1 | | | 1 | | 22 | 23 | | | | | |
| 1981 | | 63-2 | 555 | 55 | G15-G16 | Com. Cl 1 | | | | | 12 | 12 | | | | | |
| 1980 | | 28-2 | 30 | 12 | G16 | Com. Cl 1 | | | | | 1 | 1 | | | | | |
| 1979 | 7803 | 63-2 | 552 | 36 | G16 | Com. Cl 1 | | | 2 | | 14 | 16 | | | | | |
| 1976 | | 65-3 | 600 | 195 | H12 | Com. Cl 1 | | | | | 2 | 2 | | | | | |
| 1975 | 7782 | 65-3 | 600 | 197 | H13 | Com. Cl 1 | | 1 | 1 | | 25 | 27 | | | | | |
| 1983 | 7824 | 65-4 | 603 | 202 | H14 | Com. Cl 1 | | 1 | 1 | | 12 | 14 | | | | | |
| 1983 | 7824 | 67-4 | 1469 | 500 | H14 | Com. Cl 1 | | 1 | | | | 1 | | | | | |
| 1983 | 7824 | 65-3 | 598 | 186 | H15 | Com. Cl 1 | | 2 | 3 | | 12 | 17 | | | | | |
| 1983 | 7824 | 66-3 | 1472 | 612 | H15 | Com. Cl 1 | | | 1 | | | 1 | | | | | |

ANNEXE B : LES ROISES

| année | n° OA | Rayon | Caisse | n° ordre | Carré | Catégorie | Comptage | | | | | | | Typologie | Desc. Typo. | Dessin | Planche |
|-----------------|----------|-------|--------|-------------|------------|--------------|----------|---|---|---|----|----|-----|-----------|-------------|--------|---------|
| | | | | | | | B | F | A | D | P | NR | NMI | | | | |
| 1976/1977/19779 | | 63-4 | 561 | 80 | Hypocauste | Com. Cl 1 | | | | | 18 | 18 | | | | | |
| 1976 | | 63-3 | 557 | 65 | J13 | Com. Cl 1 | | | | | 24 | 24 | | | | | |
| 1975 | | 35-1 | 1443 | 257 | J13 | Com. Cl 1 | | | | | 6 | 6 | | | | | |
| 1983 | 7803 | 32-1 | 1447 | 289 | J14 | Com. Cl 1 | | 2 | | | 1 | 3 | | | | | |
| 1982 | | 65-3 | 599 | 192 | J15 | Com. Cl 1 | | | | | 24 | 24 | | | | | |
| 1982 | 7823 | 64-5 | 1470 | 524 | J15-J16 | Com. Cl 1 | | | 1 | | | 1 | | | | | |
| 1982 | | 63-3 | 556 | 58 | J16 | Com. Cl 1 | | 2 | 2 | | 36 | 40 | | | | | |
| 1982 | | 34-1 | 1438 | 227 | J16 | Com. Cl 1 | | | | | 7 | 7 | | | | | |
| 1974 | | 55-2 | 597 | 182 | K10 | Com. Cl 1 | | | | | 3 | 3 | | | | | |
| 1974 | | 28-2 | 30 | 15 | K11 | Com. Cl 1 | | 2 | | | | 2 | | | | | |
| 1974 | | 63-3 | 559 | 72 | K11 | Com. Cl 1 | | | 1 | | 4 | 5 | | | | | |
| 1975 | | 35-1 | 1443 | 256 | K13 | Com. Cl 1 | | 1 | | | 4 | 5 | | | | | |
| 1982 | | 63-3 | 559 | 602 | K15 | Com. Cl 1 | | 1 | 1 | | 14 | 16 | | | | | |
| 1974 | 7816 | 63-2 | 554 | 47 | L10 | Com. Cl 1 | | | | | 14 | 14 | | | | | |
| 1974 | 7816 | 63-2 | 554 | 48 | L11 | Com. Cl 1 | | | 1 | | 48 | 49 | | | | | |

ANNEXE B : LES ROISES

| année | n° OA | Rayon | Caisse | n° ordre | Carré | Catégorie | Comptage | | | | | | | Typologie | Desc. Typo. | Dessin | Planche |
|-------|----------|-------|--------|-------------|----------------------------|--------------|--------------|----|---|---|-----|-----|-----|-----------|-------------|--------|---------|
| | | | | | | | B | F | A | D | P | NR | NMI | | | | |
| 1984 | 7825 | 65-5 | 608 | 208 | L11 | Com. Cl 1 | | 2 | 1 | | 55 | 58 | | | | | |
| 1984 | 7825 | 66-4 | 1474 | 447 | L11XIII | Com. Cl 1 | | 2 | | | | 2 | | | | | |
| 1975 | 7782 | 63-2 | 554 | 49 | L12 | Com. Cl 1 | | | | 3 | 3 | | | | | | |
| 1983 | | 62-3 | 570 | 99 | M02 | Com. Cl 1 | | 13 | 9 | | 206 | 228 | | | | | |
| | | 28-2 | 30 | 32 | M10 | Com. Cl 1 | | 1 | | | 2 | 3 | | | | | |
| 1984 | | 63-4 | 563 | 82 | M10 | Com. Cl 1 | | | | | 140 | 140 | | | | | |
| 1984 | 7825 | 66-4 | 1474 | 671 | M10X | Com. Cl 1 | | 1 | | | | 1 | | | | | |
| 1984 | 7825 | 65-5 | 607 | 207 | P7 | Com. Cl 1 | | 3 | | | 68 | 71 | | | | | |
| | 7825 | 1983 | 66-4 | 1473 | 644 | P7 | Com. Cl 1 | | 2 | | 14 | 16 | | | | | |
| 1984 | 7825 | 65-5 | 606 | 206 | P8 | Com. Cl 1 | | 1 | | | 78 | 79 | | | | | |
| 1984 | 7825 | 66-4 | 1474 | 676 | P8III | Com. Cl 1 | | 1 | | | | 1 | | | | | |
| 1984 | 7825 | 65-4 | 602 | 200 | Q8 | Com. Cl 1 | | 4 | 6 | | 123 | 133 | | | | | |
| 1984 | 7825 | 66-4 | 1473 | 684 | Q8 | Com. Cl 1 | | | 1 | | | 1 | | | | | |
| 1984 | 7825 | 67-3 | 1467 | 419 | Q8III | Com. Cl 1 | | | 1 | | 4 | 5 | | | | | |
| 1973 | | 64-3 | 586 | 140 | Tranchée SE-NW à 2 m | Com. Cl 1 | | | | | 4 | 4 | | | | | |

ANNEXE B : LES ROISES

| année | n° OA | Rayon | Caisse | n° ordre | Carré | Catégorie | Comptage | | | | | | | Typologie | Desc. Typo. | Dessin | Planche |
|-------|----------|-------|--------|-------------|-----------------|--------------|----------|---|---|---|---|----|-----|-----------|---------------|--------|---------|
| | | | | | | | B | F | A | D | P | NR | NMI | | | | |
| | | | | | extrémité NW | | | | | | | | | | | | |
| 1984 | 7825 | 65-5 | 606 | 206 | P8 | Com. Cl 2 | 1 | | | | | 1 | 1 | plat | Com. Cl P13 | 609 | XLII |
| 1979 | | 32-1 | 1446 | 276 | G15 | Com. Cl 2 | 1 | 1 | | | | | 1 | bol | Com. Cl B3 | 610 | XLII |
| 1984 | 7825 | 65-5 | 606 | 206 | P8 | Com. Cl 2 | 1 | | | | | 1 | 1 | bol | Com. Cl B7 | 611 | XLII |
| 1975 | 7782 | 63-2 | 554 | 49 | L12 | Com. Cl 2 | 1 | | 1 | | 4 | 6 | 1 | bol | Com. Cl B4 | 612 | XLII |
| 1984 | | 64-2 | 583 | 132 | N9 | Com. Cl 2 | 2 | | | | | 2 | 1 | bol | Com. Cl B4 | 613 | XLII |
| 1976 | 7823 | 63-2 | 553 | 40 | G12 | Com. Cl 2 | 1 | | | | | 1 | 1 | marmite | Com. Cl M1 | 614 | XLII |
| 1977 | 7823 | 63-2 | 553 | 37 | G13 | Com. Cl 2 | 2 | | | | | 2 | 1 | cruche | Com. Cl Cr1.1 | 615 | XLII |
| 1984 | 7825 | 65-5 | 606 | 206 | P8 | Com. Cl 2 | 1 | | | | 3 | 4 | 1 | cruche | Com. Cl Cr1.1 | 616 | XLII |
| 1981 | | 63-2 | 555 | 55 | G15-G16 | Com. Cl 2 | 1 | | | | | 1 | 1 | cruche | Com. Cl Cr1.1 | 617 | XLII |
| 1976 | | 63-3 | 558 | 68 | H15 | Com. Cl 2 | 1 | | | | | 1 | 1 | cruche | Com. Cl Cr1.1 | 618 | XLII |
| 1984 | 7825 | 65-5 | 606 | 206 | P8 | Com. Cl 2 | 1 | | | | | 1 | 1 | cruche | Com. Cl Cr1.1 | 619 | XLII |
| 1982 | | 64-5 | 1671 | 786 | D13 | Com. Cl 2 | 5 | | | | | 5 | 1 | cruche | Com. Cl Cr1.2 | 620 | XLII |
| 1981 | | 63-5 | 564 | 87 | H7 | Com. Cl 2 | 1 | | | | | 1 | 1 | cruche | Com. Cl Cr1.2 | 621 | XLII |
| 1981 | | 63-5 | 564 | 87 | H7 | Com. Cl 2 | 1 | | | | | 1 | 1 | cruche | Com. Cl Cr1.2 | 622 | XLII |

ANNEXE B : LES ROISES

| année | n° OA | Rayon | Caisse | n° ordre | Carré | Catégorie | Comptage | | | | | | | Typologie | Desc. Typo. | Dessin | Planche | |
|-------|----------|-------|--------|-------------|---------|--------------|----------|---|---|---|---|----|-----|-----------|-------------|---------------|---------|-------|
| | | | | | | | B | F | A | D | P | NR | NMI | | | | | |
| 1976 | | 63-3 | 558 | 68 | H15 | Com. Cl 2 | 1 | | | | | | 1 | 1 | cruche | Com. Cl Cr1.2 | 623 | XLII |
| 1984 | 7825 | 65-4 | 602 | 200 | Q8 | Com. Cl 2 | 1 | | | | | | 1 | 1 | cruche | Com. Cl Cr1.2 | 624 | XLII |
| 1979 | 7803 | 63-2 | 552 | 36 | G16 | Com. Cl 2 | 1 | | | | | | 1 | 1 | cruche | Com. Cl Cr2.1 | 625 | XLII |
| 1984 | 7825 | 65-5 | 606 | 206 | P8 | Com. Cl 2 | 1 | | | | | | 1 | 1 | cruche | Com. Cl Cr2.1 | 626 | XLII |
| 1984 | 7825 | 65-5 | 606 | 206 | P8 | Com. Cl 2 | 1 | | | | | | 1 | 1 | cruche | Com. Cl Cr2.1 | 627 | XLII |
| 1982 | | 63-3 | 558 | 67 | H15 | Com. Cl 2 | 2 | | | | | | 2 | 1 | cruche | Com. Cl Cr2.1 | 628 | XLIII |
| 1984 | 7825 | 65-5 | 606 | 206 | P8 | Com. Cl 2 | 1 | | | | | | 1 | 1 | cruche | Com. Cl Cr3 | 629 | XLIII |
| 1984 | 7825 | 65-4 | 602 | 200 | Q8 | Com. Cl 2 | 1 | | | | | | 1 | 1 | cruche | Com. Cl Cr3 | 630 | XLIII |
| 1984 | 7825 | 65-5 | 606 | 206 | P8 | Com. Cl 2 | 1 | | | | | | 1 | 1 | cruche | Com. Cl Cr3 | 631 | XLIII |
| | | 66-4 | 1511 | 774 | sans n° | Com. Cl 2 | 1 | | | | | | 1 | 1 | cruche | Com. Cl Cr4.2 | 632 | XLIII |
| | | 67-4 | 1507 | 771 | sans n° | Com. Cl 2 | 1 | | | | | | 1 | 1 | cruche | Com. Cl Cr4.2 | 633 | XLIII |
| 1983 | | 62-3 | 570 | 99 | M02 | Com. Cl 2 | 1 | | | | | | 1 | 1 | cruche | Com. Cl Cr4.3 | 634 | XLIII |
| 1983 | 7824 | 65-4 | 604 | 204 | Cave | Com. Cl 2 | 1 | | | | | | 1 | 1 | cruche | Com. Cl Cr6.1 | 635 | XLIII |
| 1983 | 7824 | 65-4 | 604 | 204 | Cave | Com. Cl 2 | 1 | | | | | | 1 | 1 | cruche | Com. Cl Cr6.1 | 636 | XLIII |
| 1984 | 7825 | 65-5 | 606 | 206 | P8 | Com. Cl 2 | 1 | | | | | | 1 | 1 | cruche | Com. Cl Cr6.1 | 637 | XLIII |

ANNEXE B : LES ROISES

| année | n° OA | Rayon | Caisse | n° ordre | Carré | Catégorie | Comptage | | | | | | | Typologie | Desc. Typo. | Dessin | Planche | |
|-------|----------|-------|--------|-------------|------------------|--------------|----------|---|---|---|---|----|-----|-----------|-------------|---------------|---------|-------|
| | | | | | | | B | F | A | D | P | NR | NMI | | | | | |
| 1982 | 7823 | 63-2 | 553 | 44 | C13 | Com. Cl 2 | 1 | | | | | | 1 | 1 | cruche | Com. Cl Cr6.3 | 638 | XLIII |
| 1984 | 7825 | 66-4 | 1473 | 683 | Q8III | Com. Cl 2 | 1 | | | | | | 1 | 1 | cruche | Com. Cl Cr6.4 | 639 | XLIII |
| 1979 | 7803 | 63-2 | 552 | 36 | G16 | Com. Cl 2 | 1 | | | | | | 1 | 1 | cruche | Com. Cl Cr7.1 | 640 | XLIII |
| | 7823 | 63-2 | 553 | 45 | G12-G13 berme | Com. Cl 2 | 1 | | | | | | 1 | 1 | cruche | Com. Cl Cr7.1 | 641 | XLIII |
| 1984 | | 64-2 | 583 | 132 | N9 | Com. Cl 2 | 1 | | | | | | 1 | 1 | cruche | Com. Cl Cr8 | 642 | XLIII |
| 1984 | 7825 | 65-5 | 606 | 206 | P8 | Com. Cl 2 | 1 | | | | | | 1 | 1 | cruche | Com. Cl Cr8 | 643 | XLIII |
| 1984 | 7825 | 65-5 | 606 | 206 | P8 | Com. Cl 2 | 1 | | | | | | 1 | 1 | cruche | Com. Cl Cr9 | 644 | XLIII |
| 1974 | 7816 | 63-5 | 567 | 98 | M11 | Com. Cl 2 | 1 | | | | | | 1 | 1 | cruche | Com. Cl Cr10 | 645 | XLIII |
| 1974 | | 55-2 | 597 | 181 | K9 | Com. Cl 2 | 1 | | | | | | 1 | 1 | pot | Com. Cl P1.1 | 646 | XLIII |
| | | 64-2 | 583 | 120 | Q8 | Com. Cl 2 | 4 | | | | | | 4 | 1 | pot | Com. Cl P1.1 | 647 | XLIII |
| | | 5--2 | 1500 | 763 | sans n° | Com. Cl 2 | 1 | | | | | | 1 | 1 | pot | Com. Cl P2 | 648 | XLIII |
| 1974 | | 55-2 | 597 | 181 | K9 | Com. Cl 2 | 1 | | | | | | 1 | 1 | pot | Com. Cl P5.1 | 649 | XLIII |
| 1984 | 7825 | 65-5 | 606 | 206 | P8 | Com. Cl 2 | 1 | | | | | | 1 | 1 | pot | Com. Cl P5.1 | 650 | XLIV |
| 1983 | | 62-3 | 570 | 99 | M02 | Com. Cl 2 | 1 | | | | | | 1 | 1 | pot | Com. Cl P5.1 | 651 | XLIV |
| 1984 | | 3-1 | 1485 | 689 | 3 | Com. Cl 2 | 2 | 2 | | | 8 | 12 | 1 | 1 | pot | Com. Cl P5.2 | 652 | XLIV |

ANNEXE B : LES ROISES

| année | n° OA | Rayon | Caisse | n° ordre | Carré | Catégorie | Comptage | | | | | | Typologie | Desc. Typo. | Dessin | Planche | |
|-------|----------|-------|--------|-------------|-------------|--------------|----------|---|---|---|---|----|-----------|-------------|--------------|---------|------|
| | | | | | | | B | F | A | D | P | NR | | | | | NMI |
| 1982 | | 64-2 | 583 | 112 | J15 | Com. Cl 2 | 1 | | | | | 1 | 1 | pot | Com. Cl P5.2 | 653 | XLIV |
| 1982 | | 63-3 | 556 | 58 | J16 | Com. Cl 2 | 1 | | | | | 1 | 1 | pot | Com. Cl P6.1 | 654 | XLIV |
| | | 62-3 | 571 | 101 | sans n° | Com. Cl 2 | 1 | | | | | 1 | 1 | pot | Com. Cl P6.1 | 655 | XLIV |
| 1976 | 7823 | 63-2 | 553 | 40 | G12 | Com. Cl 2 | 1 | | | | | 1 | 1 | pot | Com. Cl P6.3 | 656 | XLIV |
| | | 62-3 | 571 | 101 | sans n° | Com. Cl 2 | 1 | | | | | 1 | 1 | pot | Com. Cl P7.2 | 657 | XLIV |
| 1984 | | 32-1 | 1445 | 278 | Q8 | Com. Cl 2 | 1 | | | | | 1 | 1 | pot | Com. Cl P8 | 658 | XLIV |
| 1982 | | 63-3 | 558 | 67 | H15 | Com. Cl 2 | 1 | | | | | 1 | 1 | pot | Com. Cl P9 | 659 | XLIV |
| 1983 | 7824 | 67-4 | 1469 | 491 | J14 | Com. Cl 2 | 1 | | | | | 1 | 1 | pot | Com. Cl P9 | 660 | XLIV |
| 1982 | | 63-3 | 559 | 602 | K15 | Com. Cl 2 | 1 | | | | | 1 | 1 | pot | Com. Cl P10 | 661 | XLIV |
| 1984 | 7825 | 65-4 | 602 | 200 | Q8 | Com. Cl 2 | 1 | | | | | 1 | 1 | couvercle | Com. Cl Cv3 | 662 | XLIV |
| 1984 | | BAL | 1466 | 414 | M10IX | Com. Cl 2 | | | | | 1 | 1 | 1 | graffiti | | 663 | XLIV |
| | | 36-4 | 1512 | | sans n° | Com. Cl 2 | | | | | | 87 | 87 | | | | |
| | | 5--2 | 1500 | 763 | sans n° | Com. Cl 2 | | 2 | 1 | | | 60 | 63 | | | | |
| | | 26--1 | 1488 | 691 | indéterminé | Com. Cl 2 | 1 | | | | | 27 | 28 | | | | |
| | | 3--3 | 1493 | 755 | sans n° | Com. Cl 2 | | 1 | | | | 20 | 21 | | | | |

ANNEXE B : LES ROISES

| année | n° OA | Rayon | Caisse | n° ordre | Carré | Catégorie | Comptage | | | | | | | Typologie | Desc. Typo. | Dessin | Planche |
|-------|----------|-------|--------|-------------|--|--------------|----------|---|---|---|-----|-----|-----|-----------|-------------|--------|---------|
| | | | | | | | B | F | A | D | P | NR | NMI | | | | |
| | | 66-1 | 1510 | 773 | sans n° | Com. Cl 2 | | | | | 10 | 10 | | | | | |
| | | 66-4 | 1511 | 774 | sans n° | Com. Cl 2 | | | | | 37 | 37 | | | | | |
| 1979 | | 63-5 | 564 | 84 | G12-G13 | Com. Cl 2 | | | | | 29 | 29 | | | | | |
| 1977 | 7823 | 63-2 | 553 | 37 | G13 | Com. Cl 2 | | | 3 | | 103 | 106 | | | | | |
| 1981 | | 63-5 | 564 | 87 | H7 | Com. Cl 2 | | 5 | | | 67 | 72 | | | | | |
| 1984 | | 33-1 | 1449 | 301 | Q8 | Com. Cl 2 | | | | | 4 | 4 | | | | | |
| 1984 | | 3-1 | 1485 | 689 | 3 | Com. Cl 2 | | 2 | | | 9 | 11 | | | | | |
| 1982 | 7823 | 63-2 | 553 | 44 | C13 | Com. Cl 2 | | | 2 | | 39 | 41 | | | | | |
| 1982 | | 64-5 | 1671 | 786 | D13 | Com. Cl 2 | | | | | 12 | 12 | | | | | |
| 1973 | | 64-3 | 586 | 140 | Extrémité NW de la tranchée SE-NW côté voie close | Com. Cl 2 | | | | | 12 | 12 | | | | | |
| 1984 | | 64-3 | 586 | 139 | F | Com. Cl 2 | | 2 | | | 6 | 8 | | | | | |
| 1977 | 7823 | 63-2 | 553 | 40 | G12 | Com. Cl 2 | | 3 | | | 45 | 48 | | | | | |
| 1976 | 7823 | 63-2 | 553 | 40 | G12 | Com. Cl 2 | | 1 | 2 | | 70 | 73 | | | | | |

ANNEXE B : LES ROISES

| année | n° OA | Rayon | Caisse | n° ordre | Carré | Catégorie | Comptage | | | | | | | Typologie | Desc. Typo. | Dessin | Planche |
|-------|----------|-------|--------|-------------|-----------------|--------------|----------|----|---|---|-----|-----|-----|-----------|-------------|--------|---------|
| | | | | | | | B | F | A | D | P | NR | NMI | | | | |
| 1977 | 7823 | 63-2 | 553 | 37 | G13 | Com. Cl 2 | | 7 | | | 111 | 118 | | | | | |
| 1983 | 7824 | 65-4 | 603 | 202 | H14 | Com. Cl 2 | | 1 | | | 37 | 38 | | | | | |
| | | 28-2 | 30 | 32 | M10 | Com. Cl 2 | | | | | 2 | 2 | | | | | |
| 1984 | | 63-4 | 563 | 82 | M10 | Com. Cl 2 | | | | | 175 | 175 | | | | | |
| 1984 | 7825 | 65-4 | 602 | 200 | Q8 | Com. Cl 2 | | 1 | 2 | | 98 | 101 | | | | | |
| 1984 | | 3-1 | 1485 | 689 | 3 | Com. Cl 2 | | 2 | 1 | | 1 | 4 | | | | | |
| 1983 | 7824 | 62-4 | 574 | 107 | Cave | Com. Cl 2 | | 2 | 1 | | 120 | 123 | | | | | |
| 1983 | 7824 | 65-4 | 604 | 204 | Cave | Com. Cl 2 | | 11 | 2 | | 121 | 134 | | | | | |
| 1981 | | 67-3 | 1468 | 460 | D15 | Com. Cl 2 | | | | | 1 | 1 | | | | | |
| 1981 | | 64-5 | 1671 | 785 | D15 | Com. Cl 2 | | | | | 14 | 14 | | | | | |
| 1981 | | 65-4 | 592 | 157 | D15 | Com. Cl 2 | | | | | 13 | 13 | | | | | |
| 1980 | | 62-5 | 578 | 110 | D13-D14- D15 | Com. Cl 2 | | | | | 5 | 5 | | | | | |
| 1982 | | 64-4 | 591 | 152 | D13-D14- D15 | Com. Cl 2 | | | | | 12 | 12 | | | | | |
| 1981 | | 67-3 | 1468 | 479 | E13 | Com. Cl 2 | | | | | 4 | 4 | | | | | |
| 1980 | | 64-4 | 591 | 151 | E14 | Com. Cl 2 | | | | | 45 | 45 | | | | | |

ANNEXE B : LES ROISES

| année | n° OA | Rayon | Caisse | n° ordre | Carré | Catégorie | Comptage | | | | | | Typologie | Desc. Typo. | Dessin | Planche |
|-------|----------|-------|--------|-------------|---------|--------------|----------|---|---|---|----|----|-----------|-------------|--------|---------|
| | | | | | | | B | F | A | D | P | NR | | | | |
| 1981 | | 67-3 | 1468 | 469 | E15-F15 | Com. Cl 2 | | | | | 2 | 2 | | | | |
| 1981 | | 67-3 | 1468 | 464 | F13 | Com. Cl 2 | | 2 | | | | 2 | | | | |
| 1982 | | 63-4 | 566 | 91 | F13 | Com. Cl 2 | | | | | 8 | 8 | | | | |
| 1977 | | 65-2 | 594 | 167 | F15 | Com. Cl 2 | | 3 | 3 | | 57 | 63 | | | | |
| 1981 | | 64-3 | 587 | 144 | F15-F16 | Com. Cl 2 | | | | | 16 | 16 | | | | |
| 1982 | | 28-2 | 30 | 14 | F15-G15 | Com. Cl 2 | | | 1 | | | 1 | | | | |
| 1981 | | 65-2 | 594 | 166 | F15-G15 | Com. Cl 2 | | | | | 36 | 36 | | | | |
| 1981 | | 64-3 | 587 | 142 | F16 | Com. Cl 2 | | | | | 12 | 12 | | | | |
| 1979 | | 65-2 | 594 | 168 | F16 | Com. Cl 2 | | | | | 87 | 87 | | | | |
| 1981 | | 66-3 | 1465 | 331 | F16-G16 | Com. Cl 2 | | | 1 | | 21 | 22 | | | | |
| 1981 | | 64-3 | 587 | 143 | F16-G16 | Com. Cl 2 | | | 4 | | 22 | 26 | | | | |
| 1981 | | 66-3 | 1465 | 323 | F15-G15 | Com. Cl 2 | | | | | 8 | 8 | | | | |
| 1979 | | 63-5 | 564 | 88 | G12-H12 | Com. Cl 2 | | 2 | 2 | | 89 | 93 | | | | |
| 1977 | | 63-2 | 555 | 52 | G13-G14 | Com. Cl 2 | | | | | 14 | 14 | | | | |
| 1977 | | 63-2 | 555 | 53 | G14 | Com. Cl 2 | | 3 | | | 30 | 33 | | | | |

ANNEXE B : LES ROISES

| année | n° OA | Rayon | Caisse | n° ordre | Carré | Catégorie | Comptage | | | | | | Typologie | Desc. Typo. | Dessin | Planche |
|-------|----------|-------|--------|-------------|---------------------|--------------|----------|---|---|---|-----|-----|-----------|-------------|--------|---------|
| | | | | | | | B | F | A | D | P | NR | | | | |
| 1977 | | 63-2 | 555 | 51 | G14-G15 | Com. Cl 2 | | | | | 16 | 16 | | | | |
| 1976 | | 63-2 | 555 | 56 | G15 | Com. Cl 2 | | | | | 25 | 25 | | | | |
| 1981 | | 63-2 | 555 | 55 | G15-G16 | Com. Cl 2 | | | | | 18 | 18 | | | | |
| 1979 | 7803 | 63-2 | 552 | 36 | G16 | Com. Cl 2 | | | | | 54 | 54 | | | | |
| 1979 | 7803 | 32-1 | 1445 | 268 | G16 | Com. Cl 2 | | | | | 2 | 2 | | | | |
| 1975 | 7782 | 65-3 | 600 | 197 | H13 | Com. Cl 2 | | | | | 31 | 31 | | | | |
| 1976 | | 65-4 | 603 | 201 | H13-H14 | Com. Cl 2 | | 3 | 1 | | 78 | 82 | | | | |
| 1983 | 7824 | 65-4 | 603 | 202 | H14 | Com. Cl 2 | | 2 | 3 | | 57 | 62 | | | | |
| 1983 | 7824 | 65-4 | 603 | 203 | H14-H15- J14-J15 | Com. Cl 2 | | | | | 26 | 26 | | | | |
| 1982 | 7823 | 64-5 | 1470 | 521 | H15 | Com. Cl 2 | | 1 | | | | 1 | | | | |
| 1976 | | 63-3 | 558 | 68 | H15 | Com. Cl 2 | | | | | 21 | 21 | | | | |
| 1982 | | 63-3 | 558 | 67 | H15 | Com. Cl 2 | | 8 | | 5 | 36 | 49 | | | | |
| 1983 | 7824 | 65-3 | 598 | 186 | H15 | Com. Cl 2 | | 3 | 2 | | 107 | 112 | | | | |
| 1982 | | 33-1 | 1448 | 292 | H15 | Com. Cl 2 | | 1 | | | | 1 | | | | |
| 1983 | | 35-1 | 1441 | 241 | H16 | Com. Cl 2 | | | | | 1 | 1 | | | | |

ANNEXE B : LES ROISES

| année | n° OA | Rayon | Caisse | n° ordre | Carré | Catégorie | Comptage | | | | | | | Typologie | Desc. Typo. | Dessin | Planche |
|-------|----------|-------|--------|-------------|---------|--------------|----------|---|---|---|-----|-----|-----|-----------|-------------|--------|---------|
| | | | | | | | B | F | A | D | P | NR | NMI | | | | |
| 1975 | 7782 | 65-3 | 599 | 189 | J12 | Com. Cl 2 | | | | | 19 | 19 | | | | | |
| 1976 | | 63-3 | 557 | 65 | J13 | Com. Cl 2 | | 4 | | | 140 | 144 | | | | | |
| 1983 | 7824 | 67-4 | 1469 | 517 | J15 | Com. Cl 2 | | | | | 16 | 16 | | | | | |
| 1982 | | 65-3 | 599 | 192 | J15 | Com. Cl 2 | | | | | 97 | 97 | | | | | |
| 1982 | | 66-4 | 1474 | 693 | J15-J16 | Com. Cl 2 | | | | | 6 | 6 | | | | | |
| 1982 | | 28-5 | 1471 | 576 | J16 | Com. Cl 2 | | 1 | | | 1 | 2 | | | | | |
| 1982 | | 63-3 | 556 | 58 | J16 | Com. Cl 2 | | | | | 41 | 41 | | | | | |
| 1975 | | 65-2 | 597 | 183 | K12 | Com. Cl 2 | | | | | 14 | 14 | | | | | |
| 1982 | | 63-3 | 559 | 602 | K15 | Com. Cl 2 | | 2 | 1 | | 81 | 84 | | | | | |
| 1982 | | 63-3 | 559 | 78 | K16 | Com. Cl 2 | | | | | 26 | 26 | | | | | |
| 1974 | 7816 | 63-2 | 554 | 47 | L10 | Com. Cl 2 | | | | | 170 | 170 | | | | | |
| 1974 | 7816 | 63-2 | 554 | 48 | L11 | Com. Cl 2 | | | 2 | | 54 | 56 | | | | | |
| 1984 | 7825 | 67-3 | 1467 | 410 | L11XIII | Com. Cl 2 | | | | | 7 | 7 | | | | | |
| 1983 | | 62-3 | 570 | 99 | M02 | Com. Cl 2 | | 6 | 2 | | 212 | 220 | | | | | |
| 1974 | 7816 | 63-5 | 567 | 98 | M11 | Com. Cl 2 | | 3 | 2 | | 73 | 78 | | | | | |

ANNEXE B : LES ROISES

| année | n° OA | Rayon | Caisse | n° ordre | Carré | Catégorie | Comptage | | | | | | | Typologie | Desc. Typo. | Dessin | Planche |
|-----------------|----------|-------|--------|-------------|------------|--------------|----------|---|---|---|-----|-----|-----|-----------|---------------|--------|---------|
| | | | | | | | B | F | A | D | P | NR | NMI | | | | |
| 1968 | | 43-3 | 1387 | 214 | Mur | Com. Cl 2 | | 1 | 1 | | 46 | 48 | | | | | |
| 1984 | 7825 | 65-5 | 607 | 207 | P7 | Com. Cl 2 | | 2 | 1 | | 59 | 62 | | | | | |
| 1984 | 7825 | 65-5 | 606 | 206 | P8 | Com. Cl 2 | | 2 | | | 148 | 150 | | | | | |
| 1984 | 7825 | 65-4 | 602 | 200 | Q8 | Com. Cl 2 | | 5 | 4 | | 122 | 131 | | | | | |
| 1980 | | 63-4 | 562 | 81 | Wp | Com. Cl 2 | | | | | 39 | 39 | | | | | |
| 1980 | | 33-1 | 1448 | 285 | Wp | Com. Cl 2 | | 1 | | | | 1 | | | | | |
| 1981 | | 64-4 | 591 | 150 | E13 | Com. Cl 2 | | | | | 29 | 29 | | | | | |
| 1976/1977/19779 | | 63-4 | 561 | 80 | Hypocauste | Com. Cl 2 | | | | | 45 | 45 | | | | | |
| 1976/1977/19779 | | 62-3 | 573 | 89 | Hypocauste | Com. Cl 2 | | | | | 2 | 2 | | | | | |
| 1983 | 7824 | 66-3 | 1472 | 617 | J15 | Com. Cl 2 | | 1 | | | | 1 | | | | | |
| 1980 | | 66-4 | 1474 | 734 | E14d | Com. Cl 2 | | | | | 2 | 2 | | | | | |
| 1984 | 7825 | 66-3 | 1473 | 667 | N9VII | Com. Cl 2 | | | | | 1 | 1 | | | | | |
| 1980 | | 66-4 | 1474 | 732 | E14c | Com. Cl 3 | 2 | | | | | 2 | 1 | plat | Com. Cl P11.1 | 664 | XLIV |
| 1983 | | 62-3 | 570 | 99 | M02 | Com. Cl 3 | 1 | | | | | 1 | 1 | plat | Com. Cl P11.1 | 665 | XLIV |
| 1976 | | 64-2 | 583 | 121 | H13-H14 | Com. Cl 3 | 1 | | | | | 1 | 1 | plat | Com. Cl P11.3 | 666 | XLIV |

ANNEXE B : LES ROISES

| année | n° OA | Rayon | Caisse | n° ordre | Carré | Catégorie | Comptage | | | | | | | Typologie | Desc. Typo. | Dessin | Planche | |
|-------|----------|-------|--------|-------------|---------|--------------|----------|---|---|---|----|----|-----|-----------|-------------|---------------|---------|-----|
| | | | | | | | B | F | A | D | P | NR | NMI | | | | | |
| 1979 | 7803 | 63-2 | 552 | 36 | G16 | Com. Cl 3 | 1 | | | | | | 1 | 1 | plat | Com. Cl P12.2 | 667 | XLV |
| | | 67-4 | 1507 | 771 | sans n° | Com. Cl 3 | 1 | | | | | | 1 | 1 | bol | Com. Cl B1 | 668 | XLV |
| | | 66-4 | 1511 | 774 | sans n° | Com. Cl 3 | 1 | | | | | | 1 | 1 | bol | Com. Cl B4 | 669 | XLV |
| 1984 | | 64-3 | 586 | 139 | F | Com. Cl 3 | 1 | | | | | | 1 | 1 | marmite | Com. Cl M1 | 670 | XLV |
| 1984 | | 64-3 | 586 | 139 | F | Com. Cl 3 | 2 | | | | | | 2 | 1 | jatte | Com. Cl J2 | 671 | XLV |
| 1984 | 7825 | 65-5 | 606 | 206 | P8 | Com. Cl 3 | 1 | | | | 11 | 12 | 1 | 1 | cruche | Com. Cl Cr1.1 | 672 | XLV |
| 1977 | | 35-1 | 1444 | 262 | G12 | Com. Cl 3 | 1 | | | | | | 1 | 1 | cruche | Com. Cl Cr4.1 | 673 | XLV |
| 1968 | | 43-3 | 1387 | 214 | Mur | Com. Cl 3 | 1 | | | | | | 1 | 1 | cruche | Com. Cl Cr4.1 | 674 | XLV |
| 1983 | | 35-1 | 1441 | 242 | H17 | Com. Cl 3 | 1 | | | | | | 1 | 1 | cruche | Com. Cl Cr4.2 | 675 | XLV |
| | | 66-4 | 1511 | 774 | sans n° | Com. Cl 3 | 1 | | | | | | 1 | 1 | cruche | Com. Cl Cr4.2 | 676 | XLV |
| | | 67-4 | 1507 | 771 | sans n° | Com. Cl 3 | 1 | | | | | | 1 | 1 | cruche | Com. Cl Cr4.2 | 677 | XLV |
| 1984 | | 3-1 | 1485 | 689 | 3 | Com. Cl 3 | 6 | | 1 | | | | 7 | 1 | cruche | Com. Cl Cr5 | 678 | XLV |
| 1984 | | 3-1 | 1485 | 689 | 3 | Com. Cl 3 | 2 | | | | | | 2 | 1 | cruche | Com. Cl Cr5 | 679 | XLV |
| 1976 | | 64-2 | 583 | 124 | G15 | Com. Cl 3 | 1 | | | | | | 1 | 1 | cruche | Com. Cl Cr5 | 680 | XLV |
| 1984 | 7825 | 65-5 | 606 | 206 | P8 | Com. Cl 3 | 1 | | | | 5 | 6 | 1 | 1 | cruche | Com. Cl Cr5 | 681 | XLV |

ANNEXE B : LES ROISES

| année | n° OA | Rayon | Caisse | n° ordre | Carré | Catégorie | Comptage | | | | | | | Typologie | Desc. Typo. | Dessin | Planche | |
|-------|----------|-------|--------|-------------|---------|--------------|----------|---|---|---|----|----|-----|-----------|-------------|---------------|---------|------|
| | | | | | | | B | F | A | D | P | NR | NMI | | | | | |
| | | 67-4 | 1507 | 771 | sans n° | Com. Cl 3 | 1 | | | | | | 1 | 1 | cruche | Com. Cl Cr6.1 | 682 | XLV |
| 1982 | | 63-3 | 558 | 67 | H15 | Com. Cl 3 | 2 | | | | | | 2 | 1 | cruche | Com. Cl Cr6.3 | 683 | XLV |
| | | 36-4 | 1512 | | sans n° | Com. Cl 3 | 1 | | | | | | 1 | 1 | cruche | Com. Cl Cr6.3 | 684 | XLV |
| 1982 | | 63-3 | 558 | 67 | H15 | Com. Cl 3 | 1 | | | | | | 1 | 1 | cruche | Com. Cl Cr7.1 | 685 | XLV |
| 1984 | 7825 | 67-3 | 1467 | 345 | P8III | Com. Cl 3 | 1 | | | | 12 | 13 | | 1 | cruche | Com. Cl Cr7.1 | 686 | XLV |
| 1984 | 7825 | 66-4 | 1473 | 678 | M10XII | Com. Cl 3 | 1 | | | | | | 1 | 1 | cruche | Com. Cl Cr7.1 | 687 | XLVI |
| 1974 | 7816 | 63-5 | 567 | 98 | M11 | Com. Cl 3 | 2 | | | | | | 2 | 1 | cruche | Com. Cl Cr7.1 | 688 | XLVI |
| | | 5--2 | 1500 | 763 | sans n° | Com. Cl 3 | 1 | | | | | | 1 | 1 | cruche | Com. Cl Cr7.1 | 689 | XLVI |
| 1982 | | 63-3 | 558 | 67 | H15 | Com. Cl 3 | 1 | | | | | | 1 | 1 | cruche | Com. Cl Cr7.2 | 690 | XLVI |
| | | | | | | | | | | | | | | | | | | |
| | | | | | | | | | | | | | | | | | | |
| 1977 | | 64-2 | 583 | 113 | W | Com. Cl 3 | 1 | | | | | | 1 | 1 | cruche | Com. Cl Cr8 | 691 | XLVI |
| 1984 | 7825 | 34-1 | 1437 | 218 | P7 | Com. Cl 3 | 2 | | | | | | 2 | 1 | cruche | Com. Cl Cr8 | 692 | XLVI |
| | | 67-4 | 1507 | 771 | sans n° | Com. Cl 3 | 1 | | | | | | 1 | 1 | cruche | Com. Cl Cr8 | 693 | XLVI |
| 1977 | 7823 | 63-2 | 553 | 40 | G12 | Com. Cl 3 | 1 | | | | | | 1 | 1 | cruche | Com. Cl Cr10 | 694 | XLVI |
| 1979 | 7803 | 63-2 | 552 | 36 | G16 | Com. Cl 3 | 1 | | | | | | 1 | 1 | cruche | Com. Cl Cr10 | 695 | XLVI |

ANNEXE B : LES ROISES

| année | n° OA | Rayon | Caisse | n° ordre | Carré | Catégorie | Comptage | | | | | | Typologie | Desc. Typo. | Dessin | Planche | |
|-------|----------|-------|--------|-------------|------------------|--------------|----------|---|---|---|----|----|-----------|-------------|--------------|---------|------|
| | | | | | | | B | F | A | D | P | NR | | | | | NMI |
| | 7823 | 63-2 | 553 | 45 | G12-G13 berme | Com. Cl 3 | 1 | | | | | 1 | 1 | pot | Com. Cl P3 | 696 | XLVI |
| | | 67-4 | 1507 | 771 | sans n° | Com. Cl 3 | 1 | | | | | 1 | 1 | pot | Com. Cl P6.1 | 697 | XLVI |
| 1974 | 7816 | 63-5 | 567 | 98 | M11 | Com. Cl 3 | 2 | | | | | 2 | 1 | pot | Com. Cl P5.1 | 698 | XLVI |
| | | 5--2 | 1500 | 763 | sans n° | Com. Cl 3 | 1 | | | | | 1 | 1 | pot | Com. Cl P5.1 | 699 | XLVI |
| 1976 | | 64-2 | 583 | 121 | H13-H14 | Com. Cl 3 | 1 | | | | | 1 | 1 | pot | Com. Cl P5.2 | 700 | XLVI |
| 1976 | | 63-3 | 558 | 68 | H15 | Com. Cl 3 | 1 | | | | | 1 | 1 | pot | Com. Cl P7.1 | 701 | XLVI |
| 1983 | 7824 | 65-3 | 598 | 186 | H15 | Com. Cl 3 | 2 | | | | | 2 | 1 | pot | Com. Cl P7.1 | 702 | XLVI |
| 1984 | | 64-3 | 586 | 139 | F | Com. Cl 3 | 1 | | | | | 1 | 1 | pot | Com. Cl P8 | 703 | XLVI |
| | | 34-1 | 1440 | 237 | K16 | Com. Cl 3 | 1 | | | | | 1 | 1 | pot | Com. Cl P8 | 704 | XLVI |
| 1983 | | 62-3 | 570 | 99 | M02 | Com. Cl 3 | 1 | | | | | 1 | 1 | pot | Com. Cl P8 | 705 | XLVI |
| 1982 | | 63-3 | 558 | 67 | H15 | Com. Cl 3 | 1 | | | | | 1 | 1 | pot | Com. Cl P8 | 706 | XLVI |
| | 7823 | 63-2 | 553 | 45 | G12-G13 berme | Com. Cl 3 | 1 | | | | | 1 | 1 | couvercle | Com. Cl Cv2 | 707 | XLVI |
| 1982 | | 63-3 | 558 | 67 | H15 | Com. Cl 3 | 1 | | | | | 1 | 1 | couvercle | Com. Cl Cv2 | 708 | XLVI |
| | | 5--2 | 1500 | 763 | sans n° | Com. Cl 3 | | 1 | | | | 1 | | | | | |
| | | 27--2 | 1496 | | sans n° | Com. Cl 3 | | | | | 45 | 45 | | | | | |

ANNEXE B : LES ROISES

| année | n° OA | Rayon | Caisse | n° ordre | Carré | Catégorie | Comptage | | | | | | Typologie | Desc. Typo. | Dessin | Planche |
|-------|----------|-------|--------|-------------|-------------|--------------|----------|---|---|---|----|----|-----------|-------------|--------|---------|
| | | | | | | | B | F | A | D | P | NR | | | | |
| | | 5--2 | 1500 | 763 | sans n° | Com. Cl 3 | | 3 | | | 10 | 13 | | | | |
| | | 5--2 | 1500 | 763 | sans n° | Com. Cl 3 | | 2 | | | 40 | 42 | | | | |
| | | 5--2 | 1500 | 763 | sans n° | Com. Cl 3 | | 3 | 2 | | 56 | 61 | | | | |
| | | 26--1 | 1488 | 691 | indéterminé | Com. Cl 3 | 3 | | | | 34 | 37 | | | | |
| | | 3--3 | 1493 | 755 | sans n° | Com. Cl 3 | | | | | 11 | 11 | | | | |
| | | 27--2 | 1490 | 751 | sans n° | Com. Cl 3 | | | | | 22 | 22 | | | | |
| | | 66-4 | 1511 | 774 | sans n° | Com. Cl 3 | | 1 | | | 12 | 13 | | | | |
| | | 67-4 | 1507 | 771 | sans n° | Com. Cl 3 | | | | | 37 | 37 | | | | |
| 1974 | 7816 | 63-2 | 554 | 47 | L10 | Com. Cl 3 | | | | | 28 | 28 | | | | |
| 1973 | | 64-3 | 586 | 139 | F | Com. Cl 3 | | 2 | | | | 2 | | | | |
| 1977 | 7823 | 63-2 | 553 | 40 | G12 | Com. Cl 3 | | | | | 11 | 11 | | | | |
| 1976 | 7823 | 63-2 | 553 | 40 | G12 | Com. Cl 3 | | | | | 53 | 53 | | | | |
| 1976 | 7823 | 63-2 | 553 | 40 | G12 | Com. Cl 3 | | 1 | | | | 1 | | | | |
| 1983 | | 64-2 | 583 | 115 | K16 | Com. Cl 3 | | | | | 12 | 12 | | | | |
| 1975 | 7782 | 65-3 | 599 | 189 | J12 | Com. Cl 3 | | | | | 21 | 21 | | | | |

ANNEXE B : LES ROISES

| année | n° OA | Rayon | Caisse | n° ordre | Carré | Catégorie | Comptage | | | | | | | Typologie | Desc. Typo. | Dessin | Planche |
|-------|----------|-------|--------|-------------|--|--------------|----------|---|---|---|----|----|-----|-----------|-------------|--------|---------|
| | | | | | | | B | F | A | D | P | NR | NMI | | | | |
| 1984 | | 3-1 | 1485 | 689 | 3 | Com. Cl 3 | | | 1 | | 5 | 6 | | | | | |
| 1973 | | 64-3 | 586 | 138 | C | Com. Cl 3 | | | | | 28 | 28 | | | | | |
| 1983 | 7824 | 62-4 | 574 | 107 | Cave | Com. Cl 3 | | | | | 46 | 46 | | | | | |
| 1973 | | 64-3 | 586 | 140 | Croisement des deux tranchées | Com. Cl 3 | | | | | 25 | 25 | | | | | |
| 1982 | | 64-5 | 1671 | 786 | D13 | Com. Cl 3 | | | | | 17 | 17 | | | | | |
| 1980 | | 64-5 | 592 | 156 | D14 | Com. Cl 3 | | | | | 19 | 19 | | | | | |
| 1981 | | 66-3 | 1465 | 324 | D15 | Com. Cl 3 | | | | | 1 | 1 | | | | | |
| 1980 | | 64-4 | 591 | 151 | E14 | Com. Cl 3 | | | | | 31 | 31 | | | | | |
| 1980 | | 64-4 | 591 | 148 | E15 | Com. Cl 3 | | | | | 31 | 31 | | | | | |
| 1973 | | 64-3 | 586 | 140 | Extrémité NW de la tranchée SE-NW côté voie close | Com. Cl 3 | | | | | 35 | 35 | | | | | |
| 1980 | | 63-4 | 95 | 20 | F14 | Com. Cl 3 | | | | | 29 | 29 | | | | | |
| 1981 | | 64-3 | 587 | 144 | F15-F16 | Com. Cl 3 | | | | | 14 | 14 | | | | | |
| 1981 | | 64-3 | 587 | 142 | F16 | Com. Cl 3 | | | | | 17 | 17 | | | | | |

ANNEXE B : LES ROISES

| année | n° OA | Rayon | Caisse | n° ordre | Carré | Catégorie | Comptage | | | | | | | Typologie | Desc. Typo. | Dessin | Planche |
|-------|----------|-------|--------|-------------|------------------|--------------|----------|---|---|---|-----|-----|-----|-----------|-------------|--------|---------|
| | | | | | | | B | F | A | D | P | NR | NMI | | | | |
| 1979 | | 32-1 | 1445 | 266 | F16 | Com. Cl 3 | | | 1 | | 3 | 4 | | | | | |
| 1981 | | 67-3 | 1468 | 465 | F16-G16 | Com. Cl 3 | | | | | 1 | 1 | | | | | |
| 1981 | | 64-3 | 587 | 143 | F16-G16 | Com. Cl 3 | | | 5 | | 19 | 24 | | | | | |
| 1977 | 7823 | 63-2 | 553 | 40 | G12 | Com. Cl 3 | | 1 | | | 50 | 51 | | | | | |
| 1976 | 7823 | 63-2 | 553 | 40 | G12 | Com. Cl 3 | | | 3 | | 32 | 35 | | | | | |
| 1977 | 7823 | 63-2 | 553 | 46 | G12-G13 | Com. Cl 3 | | | | | 7 | 7 | | | | | |
| | 7823 | 63-2 | 553 | 45 | G12-H12 berme | Com. Cl 3 | | | | | 19 | 19 | | | | | |
| 1977 | 7823 | 63-2 | 553 | 37 | G13 | Com. Cl 3 | | 2 | | | 101 | 103 | | | | | |
| 1980 | | 63-4 | 566 | 93 | G16 | Com. Cl 3 | | | | | 14 | 14 | | | | | |
| 1979 | 7803 | 63-2 | 552 | 36 | G16 | Com. Cl 3 | | 2 | | | 47 | 49 | | | | | |
| | | 28-2 | 30 | 34 | H13-H14 | Com. Cl 3 | | | | | 2 | 2 | | | | | |
| 1976 | | 63-3 | 558 | 68 | H15 | Com. Cl 3 | | | | | 24 | 24 | | | | | |
| 1982 | | 63-3 | 558 | 67 | H15 | Com. Cl 3 | | 5 | 5 | | 25 | 35 | | | | | |
| 1983 | | 35-1 | 1441 | 242 | H17 | Com. Cl 3 | | | | | 2 | 2 | | | | | |
| 1976 | | 63-3 | 557 | 65 | J13 | Com. Cl 3 | | 2 | | | 20 | 22 | | | | | |

ANNEXE B : LES ROISES

| année | n° OA | Rayon | Caisse | n° ordre | Carré | Catégorie | Comptage | | | | | | | Typologie | Desc. Typo. | Dessin | Planche |
|-------|----------|-------|--------|-------------|--|--------------|----------|---|---|---|----|----|-----|-----------|-------------|--------|---------|
| | | | | | | | B | F | A | D | P | NR | NMI | | | | |
| 1982 | 7823 | 64-5 | 1470 | 550 | J16 | Com. Cl 3 | | | | | 2 | 2 | | | | | |
| 1982 | | 63-3 | 556 | 58 | J16 | Com. Cl 3 | | | | | 51 | 51 | | | | | |
| 1982 | | 34-1 | 1438 | 227 | J16 | Com. Cl 3 | | | 1 | | 1 | 2 | | | | | |
| 1974 | | 63-3 | 559 | 72 | K11 | Com. Cl 3 | | | | | 7 | 7 | | | | | |
| 1983 | | 63-3 | 559 | 75 | K14 | Com. Cl 3 | | 1 | 2 | | 5 | 8 | | | | | |
| 1982 | | 63-3 | 559 | 602 | K15 | Com. Cl 3 | | | | | 19 | 19 | | | | | |
| 1982 | | 63-3 | 559 | 78 | K16 | Com. Cl 3 | | | | | 34 | 34 | | | | | |
| 1983 | | 62-3 | 570 | 99 | M02 | Com. Cl 3 | | 1 | | | 50 | 51 | | | | | |
| 1974 | 7816 | 63-5 | 567 | 98 | M11 | Com. Cl 3 | | 1 | 7 | | 81 | 89 | | | | | |
| 1984 | 7825 | 67-3 | 1467 | 357 | P8I | Com. Cl 3 | | | | | 11 | 11 | | | | | |
| 1973 | | 64-3 | 586 | 140 | Tranchée côté Roises extrémité gauche | Com. Cl 3 | | | | | 3 | 3 | | | | | |
| 1973 | | 64-3 | 586 | 140 | Tranchée SE-NW à 2 m extrémité NW | Com. Cl 3 | | | | | 3 | 3 | | | | | |
| 1973 | | 64-3 | 586 | 140 | Tranchée SW.NE | Com. Cl 3 | | | | | 6 | 6 | | | | | |

ANNEXE B : LES ROISES

| année | n° OA | Rayon | Caisse | n° ordre | Carré | Catégorie | Comptage | | | | | | | Typologie | Desc. Typo. | Dessin | Planche |
|-------|----------|-------|--------|-------------|------------------------|------------------|----------|---|---|---|-----|-----|-----|-----------|---------------|--------|---------|
| | | | | | | | B | F | A | D | P | NR | NMI | | | | |
| | | | | | Extrémité - -> amph | | | | | | | | | | | | |
| 1980 | | 63-4 | 562 | 81 | Wp | Com. Cl 3 | | | | | 51 | 51 | | | | | |
| 1979 | 7803 | 63-2 | 552 | 36 | G16 | Com. Cl 3 | | 1 | | | 38 | 39 | | | | | |
| 1983 | 7824 | 65-3 | 598 | 186 | H15 | Com. Cl 3 | | 3 | 1 | | 97 | 101 | | | | | |
| 1984 | | 63-4 | 563 | 82 | M10 | Com. Cl 3 | | | | | 341 | 341 | | | | | |
| 1975 | 7782 | 65-3 | 600 | 197 | H13 | Com. Cl 3 | | 1 | | | 1 | 2 | | | | | |
| 1984 | 7825 | 67-3 | 1467 | 362 | M10X | Com. Cl 3 | | | | | 1 | 1 | | | | | |
| 1983 | | 62-3 | 570 | 99 | M02 | Com. Cl dorée | 1 | | | | | 1 | 1 | plat | Com. Cl P13 | 709 | XLVI |
| | | 27--2 | 1490 | 751 | sans n° | Com. Cl dorée | 1 | | | | | 1 | 1 | plat | Com. Cl P13 | 710 | XLVI |
| | | 67-4 | 1507 | 771 | sans n° | Com. Cl dorée | 1 | | | | | 1 | 1 | plat | Com. Cl P13 | 711 | XLVI |
| 1983 | | 62-3 | 570 | 99 | M02 | Com. Cl dorée | 6 | | | | | 6 | 1 | plat | Com. Cl P16 | 712 | XLVI |
| | | 5--2 | 1500 | 763 | sans n° | Com. Cl dorée | 1 | | | | | 1 | 1 | bol | Com. Cl B1 | 713 | XLVII |
| | | 5--2 | 1500 | 763 | sans n° | Com. Cl dorée | 1 | | | | | 1 | 1 | bol | Com. Cl B4 | 714 | XLVII |
| | | 27--2 | 1490 | 751 | sans n° | Com. Cl dorée | 2 | | | | | 2 | 1 | bol | Com. Cl B6.2 | 715 | XLVII |
| 1983 | | 64-2 | 583 | 125 | Cave | Com. Cl dorée | 1 | | | | | 1 | 1 | cruche | Com. Cl Cr7.2 | 716 | XLVII |

ANNEXE B : LES ROISES

| année | n° OA | Rayon | Caisse | n° ordre | Carré | Catégorie | Comptage | | | | | | | Typologie | Desc. Typo. | Dessin | Planche |
|-------|----------|-------|--------|-------------|---------------------------------------|---------------|----------|---|---|---|----|----|-----|-----------|---------------|--------|---------|
| | | | | | | | B | F | A | D | P | NR | NMI | | | | |
| 1982 | | 33-1 | 1448 | 292 | H15 | Com. Cl dorée | 2 | | | | 3 | 5 | 1 | pot | Com. Cl P2 | 717 | XLVII |
| 1973 | | 64-3 | 586 | 140 | Croisement des deux tranchées | Com. Cl dorée | 1 | | | | | 1 | 1 | pot | Com. Cl P2 | 718 | XLVII |
| 1983 | | 62-3 | 570 | 99 | M02 | Com. Cl dorée | 1 | | | | | 1 | 1 | pot | Com. Cl P2 | 719 | XLVII |
| 1983 | | 62-3 | 570 | 99 | M02 | Com. Cl dorée | 1 | | | | | 1 | 1 | pot | Com. Cl P2 | 720 | XLVII |
| 1983 | | 62-3 | 570 | 99 | M02 | Com. Cl dorée | 1 | | | | | 1 | 1 | pot | Com. Cl P2 | 721 | XLVII |
| | | 64-2 | 1518 | 781 | sans n° | Com. Cl dorée | 1 | | | | | 1 | 1 | pot | Com. Cl P2 | 722 | XLVII |
| 1983 | | 62-3 | 570 | 99 | M02 | Com. Cl dorée | 3 | | | | | 3 | 1 | pot | Com. Cl P6.1 | 723 | XLVII |
| 1983 | | 62-3 | 570 | 99 | M02 | Com. Cl dorée | 1 | | | | | 1 | 1 | pot | Com. Cl P6.1 | 724 | XLVII |
| | | 27--2 | 1490 | 751 | sans n° | Com. Cl dorée | 1 | | | | | 1 | 1 | couvercle | Com. Cl Cv3 | 725 | XLVII |
| 1984 | | 3-1 | 1485 | 689 | 3 | Com. Cl dorée | | | | | 1 | 1 | | | | | |
| 1983 | | 62-3 | 570 | 99 | M02 | Com. Cl dorée | | | | | 90 | 90 | | | | | |
| 1977 | | 64-2 | 583 | 113 | W | Cl. Eng. | 1 | | | | | 1 | 1 | plat | Com. Cl P12.2 | 726 | XLVIII |
| 1984 | 7825 | 67-3 | 1467 | 371 | M10 XI | Cl. Eng. | 1 | | | | | 1 | 1 | pot | Com. Cl P1 | 727 | XLVIII |
| 1982 | 7823 | 64-5 | 1470 | 547 | J16 | Cl. Eng. | 1 | | | | | 1 | 1 | pot | Com. Cl P5.1 | 728 | XLVIII |
| 1973 | | 64-3 | 586 | 140 | Tranchée côté Roises extrémité gauche | Cl. Eng. | | | | | | 2 | 2 | | | | |

ANNEXE B : LES ROISES

| année | n° OA | Rayon | Caisse | n° ordre | Carré | Catégorie | Comptage | | | | | | | Typologie | Desc. Typo. | Dessin | Planche |
|-------|----------|-------|--------|-------------|-------------------------------------|------------------|----------|---|---|---|----|----|-----|-----------|---------------|--------|---------|
| | | | | | | | B | F | A | D | P | NR | NMI | | | | |
| 1973 | | 64-3 | 586 | 140 | Croisement des deux tranchées | Cl. Eng. | | | | | 2 | 2 | | | | | |
| 1982 | 7823 | 64-5 | 1470 | 537 | H15 | Cl. Eng. | | | | 4 | | 4 | | | | | |
| 1982 | 7823 | 64-5 | 1470 | 541 | J16-J17 | Cl. Eng. | | | 1 | | | 1 | | | | | |
| 1977 | | 65-2 | 594 | 167 | F15 | Cl. Eng. | | 1 | 1 | | 10 | 12 | | | | | |
| 1977 | | 63-2 | 555 | 53 | G14 | Cl. Eng. | | 2 | | | 24 | 26 | | | | | |
| 1979 | 7803 | 63-2 | 552 | 36 | G16 | Cl. Eng. | | | | | 25 | 25 | | | | | |
| 1983 | 7824 | 65-3 | 598 | 186 | H15 | Cl. Eng. | | 1 | | | 3 | 4 | | | | | |
| 1974 | 7816 | 63-2 | 554 | 48 | L11 | Cl. Eng. | | 1 | | | 61 | 62 | | | | | |
| 1984 | | 63-4 | 563 | 82 | M10 | Cl. Eng. | | | | | 2 | 2 | | | | | |
| 1977 | 7823 | 63-2 | 553 | 37 | G13 | Cl. Eng. | | | | | 10 | 10 | | | | | |
| 1983 | 7824 | 66-3 | 1472 | 630 | H14 | Com. Cl Grand | 1 | | | | | 1 | 1 | cruche | Com. Cl Cr7.3 | 729 | XLIII |
| 1983 | 7824 | 66-3 | 1472 | 638 | J15 | Com. Cl Grand | 1 | | | | | 1 | 1 | cruche | Com. Cl Cr7.3 | 730 | XLIII |
| 1983 | | 62-3 | 570 | 99 | M02 | Com. Cl Grand | 1 | | 1 | | | 2 | 1 | cruche | Com. Cl Cr7.3 | 731 | XLIII |
| 1979 | 7803 | 35-1 | 1444 | 259 | G16 | Com. Cl Grand | 3 | | | | 4 | 7 | 1 | cruche | Com. Cl Cr7.3 | 732 | XLIII |
| 1977 | | 64-2 | 583 | 113 | W | Com. Cl Grand | 1 | | | | | 1 | 1 | cruche | Com. Cl Cr7.3 | 733 | XLIII |
| | | 66-4 | 1511 | 774 | sans n° | Com. Cl Grand | 1 | | | | | 1 | 1 | cruche | Com. Cl Cr7.3 | 734 | XLIII |
| 1984 | | 66-4 | 1474 | 729 | E15III | Mo | 2 | | | | | 2 | 1 | mortier | Mo1.1 | 735 | XLVIII |
| 1984 | | 3-1 | 1485 | 689 | 3 | Mo | 1 | | | | 4 | 5 | 1 | mortier | Mo1.1 | 736 | XLVIII |
| | | 66-4 | 1511 | 774 | sans n° | Mo | 1 | | | | | 1 | 1 | mortier | Mo1.1 | 737 | XLVIII |
| | | 27--2 | 1490 | 751 | sans n° | Mo | 3 | | | | | 3 | 1 | mortier | Mo1.1 | 738 | XLIX |
| | | 67-4 | 1507 | 771 | sans n° | Mo | 1 | | | | | 1 | 1 | mortier | Mo1.1 | 739 | XLIX |

ANNEXE B : LES ROISES

| année | n° OA | Rayon | Caisse | n° ordre | Carré | Catégorie | Comptage | | | | | | Typologie | Desc. Typo. | Dessin | Planche | |
|-------|----------|-------|--------|-------------|--------------------------------|-----------|----------|---|---|----|----|----|-----------|-------------|--------|---------|------|
| | | | | | | | B | F | A | D | P | NR | | | | | NMI |
| | | 5--2 | 1500 | 763 | sans n° | Mo | | 3 | | | 25 | 28 | 1 | mortier | Mo1.1 | 740 | XLIX |
| | | 67-4 | 1507 | 771 | sans n° | Mo | 1 | | | | | 1 | 1 | mortier | Mo1.1 | 741 | XLIX |
| | | 5--2 | 1500 | 763 | sans n° | Mo | 1 | | | | | 1 | 1 | mortier | Mo1.1 | 742 | XLIX |
| 1984 | | 33-1 | 1451 | 213 | D15.08 | Mo | 7 | 1 | | | 2 | 10 | 1 | mortier | Mo1.2 | 743 | XLIX |
| 1979 | | 64-2 | 583 | 131 | G12-H12 descente de cave | Mo | 1 | | | | | 1 | 1 | mortier | Mo1.3 | 744 | L |
| | | 27--2 | 1490 | 751 | sans n° | Mo | 1 | | | | | 1 | 1 | mortier | Mo1.3 | 745 | L |
| | | 5--2 | 1500 | 763 | sans n° | Mo | 2 | | | | | 2 | 1 | mortier | Mo1.3 | 746 | L |
| 1983 | 7824 | 65-4 | 603 | 202 | H14 | Mo | 1 | | | | | 1 | 1 | mortier | Mo2 | 747 | L |
| | | 32-1 | 1445 | 277 | W | Mo | 1 | | | | | 1 | 1 | mortier | Mo3.1 | 748 | L |
| 1974 | 7816 | 63-2 | 554 | 48 | L11 | Mo | 1 | | | | | 1 | 1 | mortier | Mo3.2 | 749 | L |
| 1976 | | 64-2 | 583 | 124 | G15 | Mo | 1 | | | | | 1 | 1 | mortier | Mo4.1 | 750 | LI |
| 1979 | | 64-2 | 583 | 131 | G12-H12 descente de cave | Mo | 1 | | | | | 1 | 1 | mortier | Mo4.2 | 751 | LI |
| 1983 | | 62-3 | 570 | 99 | M02 | Mo | 2 | | | | | 2 | 1 | mortier | Mo4.2 | 752 | LI |
| 1977 | | 63-2 | 555 | 52 | G13-G14 | Mo | 1 | | | 10 | 11 | 1 | 1 | mortier | Mo5 | 753 | LI |
| 1977 | 7823 | 63-2 | 553 | 40 | G12 | Mo | 1 | | | 1 | 2 | 1 | 1 | mortier | | | |
| 1977 | 7823 | 63-2 | 553 | 40 | G12 | Mo | 1 | | | | | 1 | 1 | mortier | | | |
| | | 64-2 | 583 | 120 | Q8 | Mo | 1 | | | | | 1 | 1 | mortier | | | |
| | | 3--3 | 1493 | 755 | sans n° | Mo | | | | 4 | 4 | | | | | | |
| | | 66-2 | 1506 | 770 | sans n° | Mo | | 1 | | 2 | 3 | | | | | | |
| | | 66-1 | 1510 | 773 | sans n° | Mo | | 1 | | 2 | 3 | | | | | | |
| 1982 | | 64-5 | 1671 | 786 | D13 | Mo | | | | 1 | 1 | | | | | | |
| 1977 | | 64-2 | 583 | 126 | G12 | Mo | | | | 1 | 1 | | | | | | |
| 1982 | 7823 | 63-2 | 553 | 44 | C13 | Mo | | | | 2 | 2 | | | | | | |

ANNEXE B : LES ROISES

| année | n° OA | Rayon | Caisse | n° ordre | Carré | Catégorie | Comptage | | | | | | Typologie | Desc. Typo. | Dessin | Planche | |
|-------|----------|-------|--------|-------------|---------|-----------|----------|---|---|---|----|----|-----------|-------------|------------|---------|------|
| | | | | | | | B | F | A | D | P | NR | | | | | NMI |
| 1983 | 7824 | 65-4 | 604 | 204 | Cave | Mo | | | | | 1 | 1 | | | | | |
| 1973 | | 64-3 | 586 | 139 | F | Mo | | | | | 12 | 12 | | | | | |
| 1977 | | 64-2 | 583 | 126 | G12 | Mo | | | | | 1 | 1 | | | | | |
| 1982 | | 63-3 | 556 | 58 | J16 | Mo | | 1 | | | | 1 | | | | | |
| 1982 | | 32-1 | 1445 | 269 | J16 | Mo | | | | | 1 | 1 | | | | | |
| 1984 | | 63-4 | 563 | 82 | M10 | Mo | | | | | 40 | 40 | | | | | |
| 1979 | 7803 | 63-2 | 552 | 36 | G16 | Mo | | 1 | | | | 1 | | | | | |
| 1983 | 7824 | 66-3 | 1472 | 614 | H15 | Do | 2 | | | | | 2 | 1 | dolium | Do1 | 754 | LI |
| 1982 | | 28-5 | 1471 | 580 | H15 | Do | 1 | | | | | 1 | 1 | dolium | Do1 | 755 | LI |
| 1983 | 7824 | 67-4 | 1469 | 508 | J15 | Do | | 1 | | | | 1 | | | | | |
| 1979 | 7803 | 63-2 | 552 | 36 | G16 | Amp. | 2 | | | | | 2 | 1 | amphore | Dressel 20 | 756 | LII |
| 1982 | | 35-1 | 1443 | 250 | H16 | Amp. | 1 | | | | | 1 | 1 | amphore | Dressel 20 | 757 | LII |
| 1984 | 7825 | 65-4 | 602 | 200 | Q8 | Amp. | 1 | | | | 30 | 31 | 1 | amphore | Dressel 20 | 758 | LII |
| 1984 | | 3-1 | 1485 | 689 | 3 | Amp. | 2 | | | | 20 | 22 | 1 | amphore | Dressel 20 | 759 | LII |
| 1982 | | 63-3 | 558 | 67 | H15 | Amp. | 1 | | | | | 1 | 1 | amphore | Dressel 20 | 760 | LII |
| 1968 | | 43-3 | 1387 | 214 | Mur | Amp. | 1 | | | | 4 | 5 | 1 | amphore | Dressel 20 | 761 | LII |
| 1982 | | 65-3 | 599 | 192 | J15 | Amp. | 1 | | | | | 1 | 1 | amphore | Dressel 20 | 762 | LII |
| 1967 | | 27--2 | 1498 | 761 | sans n° | Amp. | 1 | | | | 32 | 33 | 1 | amphore | Dressel 20 | 763 | LII |
| 1983 | 7824 | 65-4 | 604 | 204 | Cave | Amp. | 2 | | 1 | | | 3 | 1 | amphore | Dressel 20 | 764 | LII |
| | 1984 | 66-4 | 1473 | 668 | N9V | Amp. | | 1 | | | | 1 | 1 | amphore | Dressel 20 | 765 | LII |
| 1983 | 7824 | 65-3 | 598 | 186 | H15 | Amp. | | 1 | 1 | | 7 | 9 | 1 | amphore | Gauloise 4 | | |
| 1981 | | 29-1 | 3 | 1 | Cave | Amp. | 1 | 6 | 2 | | 46 | 55 | 1 | amphore | Gauloise 4 | 766 | LII |
| 1974 | | 55-2 | 597 | 182 | K10 | Amp. | 1 | | | | | 1 | 1 | amphore | Gauloise 4 | 767 | LIII |
| | | 5--2 | 1500 | 763 | sans n° | Amp. | 1 | | | | 6 | 7 | 1 | amphore | Gauloise 4 | 768 | LIII |
| 1983 | | 63-3 | 559 | 75 | K14 | Amp. | 2 | | 1 | | 3 | 6 | 1 | amphore | Gauloise 4 | 769 | LIII |
| 1976 | | 63-2 | 555 | 56 | G15 | Amp. | 1 | | | | 9 | 10 | 1 | amphore | Gauloise 4 | 770 | LIII |

ANNEXE B : LES ROISES

| année | n° OA | Rayon | Caisse | n° ordre | Carré | Catégorie | Comptage | | | | | | Typologie | Desc. Typo. | Dessin | Planche | |
|-------|----------|-------|--------|-------------|---------------|-----------|----------|---|---|---|----|----|-----------|-------------|---------------------------|---------|------|
| | | | | | | | B | F | A | D | P | NR | | | | | NMI |
| | | 28-2 | 30 | 34 | H13-H14 | Amp. | 1 | | | | | 1 | 1 | amphore | Gauloise 4 | 771 | LIII |
| 1983 | 7824 | 3-3 | 1419 | 215 | Cave | Amp. | 1 | | | | | 1 | 1 | amphore | Gauloise 4 | 772 | LIII |
| 1983 | 7824 | 3-3 | 1419 | 215 | Cave | Amp. | 1 | | 1 | | 2 | 4 | 1 | amphore | Gauloise 4 | 773 | LIII |
| | 7824 | 67-4 | 1469 | 488 | H15 | Amp. | 1 | | | | | 1 | 1 | amphore | à huile Tunisie | 774 | LIII |
| 1983 | 7824 | 65-3 | 598 | 186 | H15 | Amp. | 1 | | | | 2 | 3 | 1 | amphore | à huile Tunisie | 775 | LIII |
| 1974 | | 55-2 | 597 | 181 | K9 | Amp. | 1 | | | | | 1 | 1 | amphore | Dressel 2/4 orientale | 776 | LIII |
| 1984 | 7825 | 28-2 | 30 | 21 | Q8 | Amp. | | | 2 | | | 2 | 1 | amphore | Dressel 2/4 orientale | | |
| | | 66-4 | 1511 | 774 | sans n° | Amp. | 1 | | | | | 1 | 1 | amphore | cnidienne A- ORI Mau38 | 777 | LIII |
| | | 27--2 | 1490 | 751 | sans n° | Amp. | | | | | 24 | 24 | | | | | |
| | | 36-4 | 1512 | | sans n° | Amp. | | | | | 25 | 25 | | | | | |
| | | 66-4 | 1511 | 774 | sans n° | Amp. | | | | | 4 | 4 | | | | | |
| | | 66-4 | 1513 | | sans n° | Amp. | | | | | | 17 | | | | | |
| | | 67-5 | 1503 | | sans n° | Amp. | | | | | | 13 | | | | | |
| | | 67-5 | 1504 | | sans n° | Amp. | | | | | | 20 | | | | | |
| | | 64-4 | 590 | 147 | B21 ou E14 | Amp. | | | | | 37 | 37 | | | | | |
| 1981 | 7803 | 63-5 | 564 | 89 | Cave | Amp. | | | 1 | | 5 | 6 | | | | | |
| 1980 | | 64-5 | 1671 | 784 | D14 | Amp. | | | | | 3 | 3 | | | | | |
| 1973 | | 64-3 | 586 | 140 | | Amp. | | | | | 20 | 20 | | | | | |
| 1979 | | 65-2 | 594 | 168 | F16 | Amp. | | | | | 34 | 34 | | | | | |
| 1977 | 7823 | 63-2 | 553 | 37 | G13 | Amp. | | | | | 6 | 6 | | | | | |
| 1979 | 7803 | 63-2 | 552 | 36 | G16 | Amp. | | | 1 | | 89 | 90 | | | | | |
| 1983 | 7824 | 65-4 | 603 | 202 | H14 | Amp. | | | | | 5 | 5 | | | | | |
| 1982 | | 63-3 | 558 | 67 | H15 | Amp. | | | | | 6 | 6 | | | | | |

ANNEXE B : LES ROISES

| année | n° OA | Rayon | Caisse | n° ordre | Carré | Catégorie | Comptage | | | | | | Typologie | Desc. Typo. | Dessin | Planche |
|-------|----------|-------|--------|-------------|--|-----------|----------|---|---|-----|---|-----|-----------|-------------|--------|---------|
| | | | | | | | B | F | A | D | P | NR | | | | |
| 1983 | 7824 | 66-3 | 1472 | 634 | H16 | Amp. | | | 1 | | | 1 | | | | |
| 1983 | 7824 | 66-3 | 1473 | 619 | J15 | Amp. | | | | 3 | | 3 | | | | |
| 1974 | | 55-2 | 597 | 181 | K9 | Amp. | | | | 27 | | 27 | | | | |
| 1974 | | 55-2 | 597 | 182 | K10 | Amp. | | | | 21 | | 21 | | | | |
| 1984 | | 63-4 | 563 | 82 | M10 | Amp. | | | | 13 | | 13 | | | | |
| 1974 | 7816 | 63-5 | 567 | 98 | M11 | Amp. | | | | 35 | | 35 | | | | |
| 1984 | 7825 | 66-4 | 1474 | 643 | P7 | Amp. | | | 1 | | | 1 | | | | |
| 1973 | | 64-3 | 586 | 140 | Tranchée côté Roises extrémité gauche | Amp. | | | | | | 6 | | 6 | | |
| 1983 | 7824 | 62-4 | 574 | 107 | Cave | Amp. | | | | 6 | | 6 | | | | |
| 1983 | 7824 | 65-4 | 604 | 204 | Cave | Amp. | | | | 4 | | 4 | | | | |
| 1981 | | 63-5 | 564 | 87 | H7 | Amp. | | | | 6 | | 6 | | | | |
| 1981 | | 67-3 | 1468 | 476 | H16 | Amp. | | 1 | 1 | 1 | | 3 | | | | |
| 1973 | | 64-3 | 586 | 140 | Tranchée côté Roises extrémité gauche | Amp. | | | | | | 2 | | 2 | | |
| 1983 | 7824 | 55-3 | 598 | 187 | H16 | Amp. | | | | 5 | | 5 | | | | |
| 1982 | | 63-3 | 556 | 58 | J16 | Amp. | | | | 38 | | 38 | | | | |
| | | 34-1 | 1440 | 239 | J16 | Amp. | | | | 2 | | 2 | | | | |
| 1984 | | 63-4 | 563 | 82 | M10 | Amp. | | | | 13 | | 13 | | | | |
| 1984 | 7825 | 63-3 | 559 | 79 | P8 | Amp. | | | | 351 | | 351 | | | | |
| 1977 | | 64-3 | 585 | 137 | W | Amp. | | | | 21 | | 21 | | | | |
| 1984 | 7825 | 66-4 | 1474 | 677 | M10IX | Amp. | | | | 2 | | 2 | | | | |
| | 1984 | 66-4 | 1473 | 669 | N9V | Amp. | | | | 2 | | 2 | | | | |

ANNEXE B : LES ROISES

| année | n° OA | Rayon | Caisse | n° ordre | Carré | Catégorie | Comptage | | | | | | | Typologie | Desc. Typo. | Dessin | Planche |
|-----------------|----------|-------|--------|-------------|------------|--------------|----------|---|---|---|----|----|-----|--------------|--------------|--------|---------|
| | | | | | | | B | F | A | D | P | NR | NMI | | | | |
| 1979 | 7803 | 35-1 | 1444 | 259 | G16 | Amp. | | | | | 4 | 4 | | | | | |
| 1984 | 7825 | 63-3 | 559 | 79 | P8 | Amp. | | | 1 | | 42 | 43 | | | | | |
| 1976 | | 63-3 | 557 | 65 | J13 | Amp. | | | | | 55 | 55 | | | | | |
| 1983 | 7824 | 66-3 | 1472 | 628 | J14 | Amp. | | | | | 4 | 4 | | | | | |
| 1975 | 7782 | 65-3 | 600 | 197 | H13 | Amp. | | 1 | | | 6 | 7 | | | | | |
| 1981 | | 67-3 | 1468 | 436 | Cave | Amp. | | | | | 2 | 2 | | | | | |
| | | 28-2 | 30 | 27 | F14 | Amp. | | | | | 3 | 3 | | | | | |
| 1976/1977/19779 | | 63-4 | 561 | 80 | Hypocauste | Amp. | | | | | 5 | 5 | | | | | |
| 1983 | 7824 | 66-3 | 1472 | 639 | J14 | Amp. | | | | | 8 | 8 | | | | | |
| 1982 | | 65-3 | 599 | 192 | J15 | Amp. | | | | | 4 | 4 | | | | | |
| 1982 | 7823 | 64-5 | 1470 | 532 | K15 | Amp. | | | 1 | | | 1 | | | | | |
| 1982 | | 63-3 | 559 | 602 | K15 | Amp. | | | | | 28 | 28 | | | | | |
| 1974 | 7816 | 63-2 | 554 | 48 | L11 | Amp. | | | 1 | | 1 | 2 | | | | | |
| 1983 | 7824 | 65-4 | 604 | 204 | Cave | Ampho. | 1 | | | | | 1 | 1 | amphorisque | Ampho3 | 778 | LIII |
| | | 66-4 | 1511 | 774 | sans n° | Ampho. | | 1 | | | | 1 | 1 | amphorisque | Ampho fond 2 | 779 | LIII |
| | | 67-4 | 1507 | 771 | sans n° | Ampho. | | | | | 2 | 2 | 1 | amphorisque | | | |
| 1982 | 7823 | 64-5 | 1470 | 565 | J16 | Bp1 | 1 | | | | 2 | 3 | 1 | brûle-parfum | Bp1 | 781 | LIV |
| 1984 | 7825 | 34-1 | 1437 | 217 | N9 | Bp1 | 1 | | | | | 1 | 1 | brûle-parfum | Bp2 | 782 | LIV |
| 1974 | 7816 | 63-5 | 567 | 98 | M11 | Bp1 | 1 | | | | | 1 | 1 | brûle-parfum | Bp2 | 783 | LIV |
| 1974 | 7816 | 63-2 | 554 | 48 | L11 | Bp1 | | 1 | | | | 1 | 1 | brûle-parfum | Bp fond 5 | 784 | LIV |
| | | 67-4 | 1507 | 771 | sans n° | Bp1 | | | | | 1 | 1 | 1 | brûle-parfum | | | |
| 1980-1982 | | 64-5 | 1671 | 783 | D13-D15 | Post-antique | | | | | 1 | 1 | | | | | |
| 1983 | | | 1675 | 788 | G83-H13.48 | Post-antique | | | | | 2 | 2 | | | | | |
| 1982 | | | 1675 | 787 | G82 | Post-antique | | | | | 6 | 6 | | | | | |

ANNEXE B : LES ROISES

| année | n° OA | Rayon | Caisse | n° ordre | Carré | Catégorie | Comptage | | | | | | Typologie | Desc. Typo. | Dessin | Planche |
|-------|----------|-------|--------|-------------|-------|--------------|----------|---|---|---|---|----|-----------|-------------|--------|---------|
| | | | | | | | B | F | A | D | P | NR | | | | |
| | | 33-1 | 1449 | 303 | K12 | Post-antique | | | | | 1 | 1 | | | | |

ANNEXE B : RUE DE L'AMPHITHÉÂTRE – SECTEUR 1

| année | n° OA | Rayon | Caisse | n° ordre | structure | US | Catégorie | Comptage | | | | | | Typologie | Desc. Typo. | Dessin | Planche | |
|-------|----------|-------|--------|-------------|-----------------|-----|--------------------|----------|---|---|---|----|----|-----------|-------------|----------|-------------------------|-----|
| | | | | | | | | B | F | A | D | P | NR | | | | | NMI |
| 1998 | 332 8 | 22.2 | 6735 | | Remblai | 003 | EN | | | | | 2 | 2 | 1 | | | | |
| 1998 | 332 8 | 22.2 | 6735 | | Remblai | 003 | TN/DTN | | 1 | | | | 1 | 1 | | | | |
| 1998 | 332 8 | 22.2 | 6735 | | Remblai | 003 | CB | | 1 | | | | 1 | 1 | | | | |
| 1998 | 332 8 | 22.2 | 6735 | | Remblai | 003 | Sb. Coq | | | | | 3 | 3 | 1 | | | | |
| 1998 | 332 8 | 22.2 | 6735 | | Remblai | 003 | Com. Cl 3 | | | | | 10 | 10 | 1 | | | | |
| 1998 | 332 8 | 22.3 | 4832 | | Remblai | 005 | TN | 1 | | | | 10 | 11 | 1 | bol | TNB1 | 005.1 | I |
| 1998 | 332 8 | 22.3 | 4832 | | Remblai | 005 | Sb. Coq | | | | | 1 | 1 | 1 | | | | |
| 1998 | 332 8 | 22.3 | 4832 | | Remblai | 005 | Com. Cl | | 1 | | | | 1 | 1 | | | | |
| 1998 | 332 8 | 22.3 | 4832 | | Puisard 1030 | 013 | TN | 1 | | | | 2 | 3 | 1 | bol | TNB1 | | |
| 1998 | 332 8 | 22.3 | 4832 | | Puisard 1030 | 013 | Sb. Coq | | | | | 1 | 1 | 1 | | | | |
| 1998 | 332 8 | 22.3 | 4832 | | Puisard 1030 | 013 | faïence blanche | | | | | 1 | 1 | 1 | | | | |
| 1998 | 332 8 | 22.3 | 4832 | 4 | Couche 1014 | 014 | TS SG | 4 | 1 | | | 7 | 12 | 1 | coupe | Drag. 35 | Rapport Pl 1 n°89 | |
| 1998 | 332 8 | 22.3 | 4832 | 4 | Couche 1014 | 014 | TN | 1 | | | | | 1 | 1 | assiette | TNA41/43 | 014.1 | I |
| 1998 | 332 8 | 22.3 | 4832 | 4 | Couche 1014 | 014 | TN | 1 | | | | | 1 | 1 | assiette | TNA41/43 | 014.2 | I |
| 1998 | 332 8 | 22.3 | 4832 | 4 | Couche 1014 | 014 | TN | 1 | | | | | 1 | 1 | assiette | TNA1 | | |

ANNEXE B : RUE DE L'AMPHITHÉÂTRE – SECTEUR 1

| année | n° OA | Rayon | Caisse | n° ordre | structure | US | Catégorie | Comptage | | | | | | Typologie | Desc. Typo. | Dessin | Planche | |
|-------|----------|-------|--------|-------------|----------------|-----|-----------|----------|---|---|---|---------|-----|-----------|-------------|---------------|---------|-----|
| | | | | | | | | B | F | A | D | P | NR | | | | | NMI |
| 1998 | 332 8 | 22.3 | 4832 | 4 | Couche 1014 | 014 | TN | 1 | | 1 | | 4 | 6 | 1 | bol | TNB1 | | |
| 1998 | 332 8 | 22.3 | 4832 | | Couche 1014 | 014 | TN | | 5 | | | 12 2 | 127 | 0 | | | | |
| 1998 | 332 8 | 22.3 | 4832 | 4 | Couche 1014 | 014 | TN | 1 | | | | | 1 | 1 | bol | TNB1.2 | 014.3 | I |
| 1998 | 332 8 | 22.3 | 4832 | 4 | Couche 1014 | 014 | TN | 3 | | | | | 3 | 1 | pot | TNP3/4 | | |
| 1998 | 332 8 | 22.3 | 4832 | 4 | Couche 1014 | 014 | TN | 6 | | | | | 6 | 1 | pot | TNP10 | 014.4 | I |
| 1998 | 332 8 | 22.3 | 4832 | 4 | Couche 1014 | 014 | TN | 3 | | | | | 3 | 1 | pot | P51/54 | 014.5 | I |
| 1998 | 332 8 | 22.3 | 4832 | 4 | Couche 1014 | 014 | TR | 1 | | | | | 1 | 1 | calice | TRKL15 | 014.6 | I |
| 1998 | 332 8 | 22.3 | 4832 | | Couche 1014 | 014 | RU S | 1 | | | | | 1 | 1 | jatte | Nied.106 | 014.7 | I |
| 1998 | 332 8 | 22.3 | 4832 | | Couche 1014 | 014 | RU Cl | | | | | 16 | 16 | 1 | | | | |
| 1998 | 332 8 | 22.3 | 4832 | 4 | Couche 1014 | 014 | Sb. Coq | | 3 | | | 53 | 56 | 0 | | | | |
| 1998 | 332 8 | 22.3 | 4832 | 4 | Couche 1014 | 014 | Sb. Coq | 4 | | | | | 4 | 1 | jatte | Sb. Coq J1 | 014.8 | I |
| 1998 | 332 8 | 22.3 | 4832 | | Couche 1014 | 014 | Sb. Coq | 5 | | | | | 5 | 1 | couvercle | Sb. Coq Cv2.1 | 014.9 | I |
| 1998 | 332 8 | 22.3 | 4832 | | Couche 1014 | 014 | Com. Cl | | 1 | 2 | | 10 5 | 108 | 0 | | | | |
| 1998 | 332 8 | 22.3 | 4832 | 8 | Couche 1014 | 014 | Com. Cl 2 | 3 | 2 | | | | 5 | 1 | cruche | Com. Cl Cr7.1 | 014.10 | I |
| 1998 | 332 8 | 22.3 | 4832 | | Coupe 26 | 019 | Com. Cl | | | | | 3 | 3 | 1 | | | | |
| 1998 | 332 | 22.3 | 4832 | | Coupe 25 | 021 | TS SG | | | | | 1 | 1 | 1 | coupe | Drag. 37 | | |

ANNEXE B : RUE DE L'AMPHITHÉÂTRE – SECTEUR 1

| année | n° OA | Rayon | Caisse | n° ordre | structure | US | Catégorie | Comptage | | | | | | Typologie | Desc. Typo. | Dessin | Planche | |
|-------|----------|-------|--------|-------------|---------------|------------|-----------|----------|---|---|---|---|----|-----------|-------------|--------------|-------------|-----|
| | | | | | | | | B | F | A | D | P | NR | | | | | NMI |
| | 8 | | | | | | | | | | | | | | | | | |
| 1998 | 332 8 | 22.3 | 4832 | | Coupe 25 | 021 | TS SG | 1 | | | | | 1 | 1 | coupe | Drag. 27 | | |
| 1998 | 332 8 | 22.3 | 4832 | | Coupe 25 | 021 | TN | | | | | 3 | 3 | 1 | pot | TNP54 | | |
| 1998 | 332 8 | 22.3 | 4832 | 3 | Coupe 25 | 021 | Sb. Coq | 2 | | | | 2 | 4 | 1 | pot | Sb. Coq P6.1 | 021.1 | I |
| 1998 | 332 8 | 22.3 | 4832 | | Coupe 25 | 021 | Com. Cl | | | | | 1 | 1 | 1 | | | | |
| 1998 | 332 8 | 22.2 | 6735 | | Foyer 1001 | 100 1 | TN | | 2 | | | 1 | 3 | 1 | | | | |
| 1998 | 332 8 | 22.7 | 6732 | | | 100 7 | TN/DTN | | | | | 2 | 2 | 1 | | | | |
| 1998 | 332 8 | 22.6 | 6733 | | | 100 7 | Sb. Coq | 3 | | | | 8 | 11 | 1 | | | | |
| 1998 | 332 8 | 22.5 | 6734 | | | 100 7 | Com. Cl | | | | | 4 | 4 | 1 | | | | |
| 1998 | 332 8 | 22.4 | 6735 | | | 100 7 | Amp. | | | | | 1 | 1 | 1 | | | | |
| 1998 | 332 8 | 22.3 | 4832 | | Cave 1 | Cav e 1 | TS GE | | 1 | | | | 1 | 1 | mortier | Drag. 45 | | |
| 1998 | 332 8 | 22.4 | 4832 | | Cave 1 | Cav e 1 | EN AR | 1 | | | | | 1 | 1 | gobelet | Hees 2 | | |
| 1998 | 332 8 | 22.5 | 4832 | | Cave 1 | Cav e 1 | MET AR | | | | | 4 | 4 | 1 | | | | |
| 1998 | 332 8 | 22.6 | 4832 | 3 | Cave 1 | Cav e 1 | Sb. Coq | 1 | | | | | 1 | 1 | pot | Sb. Coq P6.1 | Cave1. 1 | I |
| 1998 | 332 8 | 22.7 | 4832 | | Cave 1 | Cav e 1 | Com. Cl | | | | | 2 | 2 | 1 | | | | |

ANNEXE B : RUE DE L'AMPHITHÉÂTRE – SECTEUR 2

| année | n° OA | Rayon | Caisse | n° ordre | structure | US | Catégorie | Comptage | | | | | | | Typologie | Desc. Typo. | Dessin | Planche |
|-------|-------|-------|--------|----------|-----------|---------------|-----------|----------|---|---|---|----|----|-----|-----------|-------------|--------|---------|
| | | | | | | | | B | F | A | D | P | NR | NMI | | | | |
| 1998 | 3328 | 22.3 | 6736 | | Décapage | 2000/200 1 | TS SG | | | | | 1 | 1 | 1 | | | | |
| 1998 | 3328 | 22.2 | 6737 | | Décapage | 2000/200 1 | TN/DTN | | | | | 2 | 2 | 1 | | | | |
| 1998 | 3328 | 22.1 | 6738 | | Décapage | 2000/200 1 | Sb. Coq | | 1 | | | | 1 | 1 | | | | |
| 1998 | 3328 | 22.0 | 6739 | | Décapage | 2000/200 1 | Com. Cl | | | | | 2 | 2 | 1 | | | | |
| 1998 | 3328 | 22.1 | 6740 | | Décapage | 2000/200 1 | Amp. | | | | | 1 | 1 | 1 | | | | |
| 1998 | 3328 | 22.2 | 6741 | | Cave 2 | 2004 | Com. Cl | | 2 | | | | 2 | 1 | | | | |
| 1998 | 3328 | 22.3 | 6742 | | Cave 2 | 2005 | TN/DTN | | | | | 1 | 1 | 1 | | | | |
| 1998 | 3328 | 22.3 | 6727 | | Cave 2 | 2009 | TS SG | 7 | 1 | | | 1 | 9 | 1 | coupe | Curle 11b | | |
| 1998 | 3328 | 22.3 | 6727 | | Cave 2 | 2009 | TS SG | 1 | | | | | 1 | 1 | plat | Drag. 18b | | |
| 1998 | 3328 | 22.3 | 6727 | | Cave 2 | 2009 | TN | 1 | | | | | 1 | 1 | pot | TNP54 | | |
| 1998 | 3328 | 22.3 | 6727 | | Cave 2 | 2009 | Sb. Coq | 1 | 1 | | | 10 | 12 | 1 | | | | |
| 1998 | 3328 | 22.3 | 6727 | | Cave 2 | 2009 | Com. Cl | | | | | 4 | 4 | 1 | | | | |

ANNEXE B : RUE DE L'AMPHITHÉÂTRE – SECTEUR 3

| année | n° OA | Rayon | Caisse | n° ordre | structure | US | Catégorie | Comptage | | | | | | Typologie | Desc. Typo. | Dessin | Planche | | |
|-------|-------|-------|--------|----------|--------------|------|-----------|----------|---|---|---|---|-----|-----------|-------------|-----------|---------------|--------|----|
| | | | | | | | | B | F | A | D | P | NR | | | | | NMI | |
| 1998 | 3328 | 22.3 | 4832 | | Fosse 3005 | 006 | TS SG | | | | 1 | | 1 | 1 | coupe | Drag. 37 | | | |
| 1998 | 3328 | 22.3 | 4832 | 23 | Fosse 3005 | 006 | TN | 1 | | | | | 1 | 2 | 1 | bol | TNB37 | 006.1 | II |
| 1998 | 3328 | 22.3 | 6727 | | Citerne 3008 | 008 | TS AR | 2 | | | | | 2 | 4 | 1 | coupe | Drag. 37 | | |
| 1998 | 3328 | 22.3 | 6727 | | Citerne 3008 | 008 | Com. Cl | | 3 | | | | 13 | 16 | 1 | | | | |
| 1998 | 3328 | 22.2 | 6735 | | Citerne 3008 | 3008 | TS | 1 | | | | | 1 | 2 | 1 | coupe | Drag. 37 | | |
| 1998 | 3328 | 22.2 | 6735 | | Citerne 3008 | 3008 | TS SG | 1 | | | | | | 1 | 1 | coupe | Drag. 37 | | |
| 1998 | 3328 | 22.2 | 6735 | | Citerne 3008 | 3008 | TS AR | 1 | | | | | 4 | 5 | 1 | coupe | Drag. 37 | | |
| 1998 | 3328 | 22.2 | 6735 | | Citerne 3008 | 3008 | TS AR | 1 | | | | | | 1 | 1 | coupe | Drag. 37 | | |
| 1998 | 3328 | 22.2 | 6735 | | Citerne 3008 | 3008 | TS AR | 1 | | | | | | 1 | 1 | coupe | Drag. 37 | | |
| 1998 | 3328 | 22.2 | 6735 | | Citerne 3008 | 3008 | TS AR | 1 | | | | | 4 | 5 | 1 | coupe | Drag. 40 | | |
| 1998 | 3328 | 22.2 | 6735 | | Citerne 3008 | 3008 | TS AR | 1 | | | | | | 1 | 1 | mortier | Drag. 45 | | |
| 1998 | 3328 | 22.2 | 6735 | | Citerne 3008 | 3008 | TS AR | 1 | | | | | | 1 | 1 | mortier | Drag. 45 | | |
| 1998 | 3328 | 22.2 | 6735 | | Citerne 3008 | 3008 | EN | 0 | 1 | | | | 30 | 31 | 0 | | | | |
| 1998 | 3328 | 22.2 | 6735 | | Citerne 3008 | 3008 | EN | 2 | | | | | | 2 | 1 | gobelet | Hees 2 | | |
| 1998 | 3328 | 22.2 | 6735 | | Citerne 3008 | 3008 | EN | 1 | | | | | | 1 | 1 | gobelet | Hees 2 | | |
| 1998 | 3328 | 22.2 | 6735 | | Citerne 3008 | 3008 | EN AR | 1 | | | | | | 1 | 1 | gobelet | Hees 2 | | |
| 1998 | 3328 | 22.2 | 6735 | | Citerne 3008 | 3008 | EN AR | 1 | | | | | | 1 | 1 | gobelet | Hees 2 | | |
| 1998 | 3328 | 22.2 | 6735 | | Citerne 3008 | 3008 | EN AR | 1 | | | | | | 1 | 1 | gobelet | Hees 2 | | |
| 1998 | 3328 | 22.2 | 6735 | | Citerne 3008 | 3008 | TN | 5 | | | | | 18 | 23 | 1 | bouteille | TNBT1 | | |
| 1998 | 3328 | 22.2 | 6735 | | Citerne 3008 | 3008 | RU Cl | 1 | | | | | 4 | 5 | 1 | | | | |
| 1998 | 3328 | 22.2 | 6735 | | Citerne 3008 | 3008 | RU S | | | | | | 3 | 3 | 1 | | | | |
| 1998 | 3328 | 22.2 | 6735 | 4 | Citerne 3008 | 3008 | Sb. Coq | | | | | | 11 | 11 | 0 | | | | |
| 1998 | 3328 | 22.2 | 6735 | 4 | Citerne 3008 | 3008 | Sb. Coq | 2 | 2 | 2 | | | | 6 | 1 | poëlon | | | |
| 1998 | 3328 | 22.2 | 6735 | | Citerne 3008 | 3008 | Com. Cl | | 3 | 6 | | | 134 | 143 | 0 | | | | |
| 1998 | 3328 | 22.2 | 6735 | 34 | Citerne 3008 | 3008 | Com. Cl 1 | 1 | | | | | | 1 | 1 | cruche | Com. Cl Cr3 | 3008.1 | II |
| 1998 | 3328 | 22.2 | 6735 | 32 | Citerne 3008 | 3008 | Com. Cl 1 | 1 | 1 | | | | 2 | 4 | 1 | cruche | Com. Cl Cr9 | 3008.2 | II |
| 1998 | 3328 | 22.2 | 6735 | 33 | Citerne 3008 | 3008 | Com. Cl 2 | 2 | | | | | | 2 | 1 | cruche | Com. Cl Cr1.1 | 3008.3 | II |

ANNEXE B : RUE DE L'AMPHITHÉÂTRE – SECTEUR 3

| année | n° OA | Rayon | Caisse | n° ordre | structure | US | Catégorie | Comptage | | | | | | Typologie | Desc. Typo. | Dessin | Planche | |
|-------|-------|-------|--------|----------|--------------|------|---------------|----------|---|---|---|----|----|-----------|--------------|---------------|---------|-----|
| | | | | | | | | B | F | A | D | P | NR | | | | | NMI |
| 1998 | 3328 | 22.2 | 6735 | 11 | Citerne 3008 | 3008 | Com. Cl 3 | 2 | | | | 2 | 1 | pot | Com. Cl P1.2 | 3008.4 | II | |
| 1998 | 3328 | 22.2 | 6735 | 4 | Citerne 3008 | 3008 | Com. Cl dorée | 6 | | | | 8 | 14 | 1 | pot | Com. Cl P2 | 3008.5 | II |
| 1998 | 3328 | 22.2 | 6735 | 31 | Citerne 3008 | 3008 | Mo | 2 | | | | 2 | 1 | mortier | Mo3.2 | 3008.6 | II | |
| 1998 | 3328 | 22.2 | 6735 | | Citerne 3008 | 3008 | Amp. | | | | | 8 | 8 | 1 | | | | |
| 1998 | 3328 | 22.5 | 1353 | | Citerne 3008 | 3021 | TS | | | | 1 | | 1 | 1 | coupe | Drag. 37 | | |
| 1998 | 3328 | 22.5 | 1353 | | Citerne 3008 | 3021 | TS SG | | | | | 5 | 5 | 1 | | | | |
| 1998 | 3328 | 22.5 | 1353 | | Citerne 3008 | 3021 | TS AR | | | | 3 | | 3 | 1 | coupe | Drag. 37 | | |
| 1998 | 3328 | 22.5 | 1353 | | Citerne 3008 | 3021 | EN | | 4 | | | 21 | 25 | 1 | | | | |
| 1998 | 3328 | 22.5 | 1353 | | Citerne 3008 | 3021 | MET | | | | | 4 | 4 | 0 | | | | |
| 1998 | 3328 | 22.5 | 1353 | | Citerne 3008 | 3021 | MET AR | | | | | 2 | 2 | 1 | | | | |
| 1998 | 3328 | 22.5 | 1353 | | Citerne 3008 | 3021 | TN | 1 | | | | 17 | 18 | 1 | | | | |
| 1998 | 3328 | 22.5 | 1353 | 3 | Citerne 3008 | 3021 | VRP | 1 | | | | | 1 | 1 | plat | Goudineau 15 | 3021.1 | III |
| 1998 | 3328 | 22.5 | 1353 | | Citerne 3008 | 3021 | Sb. Coq | | 3 | | | 12 | 15 | 0 | | | | |
| 1998 | 3328 | 22.5 | 1353 | 3 | Citerne 3008 | 3021 | Sb. Coq | 1 | | | | | 1 | 1 | plat | Sb. Coq P13 | 3021.2 | III |
| 1998 | 3328 | 22.5 | 1353 | 3 | Citerne 3008 | 3021 | Sb. Coq | 1 | | | | | 1 | 1 | pot | Sb. Coq P2 | 3021.3 | III |
| 1998 | 3328 | 22.5 | 1353 | 3 | Citerne 3008 | 3021 | Sb. Coq | 1 | | | | | 1 | 1 | pot | Sb. Coq P9.2 | 3021.4 | III |
| 1998 | 3328 | 22.5 | 1353 | 3 | Citerne 3008 | 3021 | Sb. Coq | 2 | | | | | 2 | 1 | couvercle | Sb. Coq Cv3.1 | 3021.5 | III |
| 1998 | 3328 | 22.5 | 1353 | 3 | Citerne 3008 | 3021 | Sb. Coq | 1 | | | | | 1 | 1 | couvercle | Sb. Coq Cv5 | 3021.6 | III |
| 1998 | 3328 | 22.5 | 1353 | | Citerne 3008 | 3021 | Com. Cl | | 2 | | | 31 | 33 | 1 | | | | |
| 1998 | 3328 | 22.5 | 1353 | 3 | Citerne 3008 | 3021 | Com. Cl dorée | 1 | | | | | 1 | 1 | plat | Com. Cl P12 | 3021.7 | III |
| 1998 | 3328 | 22.5 | 1353 | | Citerne 3008 | 3021 | Amp. | | 1 | | | 17 | 18 | 1 | | | | |
| 1998 | 3328 | 22.2 | 6735 | | Citerne 3008 | 3022 | EN | | | | | 2 | 2 | 1 | | | | |
| 1998 | 3328 | 22.2 | 6735 | | Citerne 3008 | 3022 | MET AR | | | | | 2 | 2 | 1 | | | | |
| 1998 | 3328 | 22.2 | 6735 | 2 | Citerne 3008 | 3022 | TN | 1 | | | | | 1 | 1 | pot | TNP32 | 3022.1 | III |
| 1998 | 3328 | 22.2 | 6735 | | Citerne 3008 | 3022 | RU Cl | | | | | 1 | 1 | 1 | | | | |
| 1998 | 3328 | 22.2 | 6735 | 3 | Citerne 3008 | 3022 | Sb. Coq | 1 | | | | | 1 | 1 | pot | Sb. Coq P7.1 | 3022.2 | III |

ANNEXE B : RUE DE L'AMPHITHÉÂTRE – SECTEUR 3

| année | n° OA | Rayon | Caisse | n° ordre | structure | US | Catégorie | Comptage | | | | | | Typologie | Desc. Typo. | Dessin | Planche |
|-------|-------|-------|--------|----------|--------------|------|---------------|----------|---|---|---|---|----|-----------|-------------|---------------|-----------|
| | | | | | | | | B | F | A | D | P | NR | | | | |
| 1998 | 3328 | 22.2 | 6735 | | Citerne 3008 | 3022 | Com. Cl | | | | | 3 | 3 | 1 | | | |
| 1998 | 3328 | 22.2 | 6735 | | Citerne 3008 | 3022 | Com. Cl dorée | | | | | 6 | 6 | 1 | | | |
| 1998 | 3328 | 22.3 | 4844 | | Citerne 3008 | 3026 | TS GE | | 1 | | | | 1 | 1 | | | |
| 1998 | 3328 | 22.3 | 4844 | | Citerne 3008 | 3026 | TS AR | 1 | | | | 2 | 3 | 1 | coupe | Drag. 37 | |
| 1998 | 3328 | 22.3 | 4844 | | Citerne 3008 | 3026 | TN/DTN | | | | | 2 | 2 | 1 | | | |
| 1998 | 3328 | 22.3 | 4844 | | Citerne 3008 | 3026 | Sb. Coq | | 1 | | | | 1 | 1 | | | |
| 1998 | 3328 | 22.3 | 4844 | | Citerne 3008 | 3026 | Com. Cl | | | | | 2 | 2 | 1 | | | |
| 1998 | 3328 | 22.4 | 4831 | | Citerne 3008 | 3040 | TS | | 1 | | | | 1 | 1 | | | |
| 1998 | 3328 | 22.4 | 4831 | | Citerne 3008 | 3040 | TN/DTN | | | | | 1 | 1 | 1 | | | |
| 1998 | 3328 | 22.4 | 4831 | | Citerne 3008 | 3040 | Sb. Coq | | | | | 1 | 1 | 1 | | | |
| 1998 | 3328 | 22.4 | 4831 | | Citerne 3008 | 3040 | Amp. | | | | | 1 | 1 | 1 | | | |
| 1998 | 3328 | 22.3 | 4832 | | Cave 3 | 010 | TS SG | | | | | 1 | 1 | 1 | | | |
| 1998 | 3328 | 22.3 | 4832 | | Cave 3 | 010 | TS AR | | | | | 1 | 1 | 1 | coupe | Drag. 37 | |
| 1998 | 3328 | 22.3 | 4832 | 20 | Cave 3 | 010 | CB | 1 | | | | | 1 | 1 | pot | Reims P16 | 010.1 IV |
| 1998 | 3328 | 22.3 | 4832 | | Cave 3 | 010 | Sb. Coq | | | | | 1 | 1 | 1 | | | |
| 1998 | 3328 | 22.3 | 4832 | | Cave 3 | 010 | Com. Cl | | | | | 1 | 1 | 1 | | | |
| 1998 | 3328 | 22.3 | 4832 | | Cave 3 | 011 | TS SG | | | | | 1 | 1 | 1 | coupe | Drag. 27 | |
| 1998 | 3328 | 22.3 | 4832 | | Cave 3 | 011 | TS GE | | 1 | | | 5 | 6 | 1 | | | |
| 1998 | 3328 | 22.3 | 4832 | | Cave 3 | 011 | EN | | | | | 1 | 1 | 1 | | | |
| 1998 | 3328 | 22.3 | 4832 | | Cave 3 | 011 | MET AR | 3 | | | | 2 | 5 | 1 | gobelet | Nied. 33 | |
| 1998 | 3328 | 22.3 | 4832 | | Cave 3 | 011 | TN | | | | | 3 | 3 | 1 | | | |
| 1998 | 3328 | 22.3 | 4832 | | Cave 3 | 011 | TR | | | | | 1 | 1 | 1 | | | |
| 1998 | 3328 | 22.3 | 4832 | | Cave 3 | 011 | Com. Cl | | | | | 5 | 5 | 1 | | | |
| 1998 | 3328 | 22.3 | 4832 | | Cave 3 | 011 | Amp. | | | | | 1 | 1 | 1 | | | |
| 1998 | 3328 | 22.3 | 4832 | | Cave 3 | 011 | faïence brune | | | | | 1 | 1 | 1 | | | |
| 1998 | 3328 | 22.3 | 4844 | | Cave 3 | 3030 | MET AR | 2 | | | | 1 | 3 | 1 | gobelet | Nied. 33 | |
| 1998 | 3328 | 22.3 | 4844 | 145 | Cave 3 | 3030 | CB | 1 | | | | 3 | 4 | 1 | plat | Chossenot 679 | 3030.1 IV |

ANNEXE B : RUE DE L'AMPHITHÉÂTRE – SECTEUR 3

| année | n° OA | Rayon | Caisse | n° ordre | structure | US | Catégorie | Comptage | | | | | | Typologie | Desc. Typo. | Dessin | Planche | | |
|-------|-------|-------|--------|----------|-----------|------|-----------|----------|---|---|---|----|----|-----------|-------------|---------------|------------|--------|----|
| | | | | | | | | B | F | A | D | P | NR | | | | | NMI | |
| 1998 | 3328 | 22.4 | 4831 | | Cave 3 | 3033 | EN AR | 1 | | | | 9 | 10 | 1 | gobelet | Hees 2 | | | |
| 1998 | 3328 | 22.4 | 4831 | | Cave 3 | 3033 | EN AR | 1 | | | | | 1 | 1 | gobelet | Hees 2 | | | |
| 1998 | 3328 | 22.4 | 4831 | | Cave 3 | 3033 | MET AR | 1 | | | | 5 | 6 | 1 | gobelet | Nied. 33 | | | |
| 1998 | 3328 | 22.4 | 4831 | | Cave 3 | 3033 | TN | | | | | 5 | 5 | 1 | | | | | |
| 1998 | 3328 | 22.4 | 4831 | | Cave 3 | 3033 | VRP CG | | 1 | | | | | 1 | 1 | | | | |
| 1998 | 3328 | 22.4 | 4831 | | Cave 3 | 3033 | CB | | 2 | | | | | 2 | 1 | | | | |
| 1998 | 3328 | 22.4 | 4831 | | Cave 3 | 3033 | Com. Cl | | | | | 2 | 2 | 1 | | | | | |
| 1998 | 3328 | 22.4 | 4831 | | Cave 3 | 3034 | TS GE | | | | | 1 | 1 | 1 | | | | | |
| 1998 | 3328 | 22.4 | 4831 | | Cave 3 | 3034 | TS AR | | 4 | | | 1 | 5 | 1 | coupe | Drag. 35 | | | |
| 1998 | 3328 | 22.4 | 4831 | | Cave 3 | 3034 | MET AR | | 1 | | | 2 | 3 | 1 | | | | | |
| 1998 | 3328 | 22.4 | 4831 | | Cave 3 | 3034 | TN | 1 | | | | | | 1 | 1 | pot | TNP4.1 | | |
| 1998 | 3328 | 22.4 | 4831 | | Cave 3 | 3034 | VRP CG | | 1 | | | | | 1 | 1 | | | | |
| 1998 | 3328 | 22.4 | 4831 | 4 | Cave 3 | 3034 | Sb. Coq | 3 | | | | 4 | 7 | 1 | pot | Sb. Coq P10.2 | 3034.1 | IV | |
| 1998 | 3328 | 22.4 | 4831 | 4 | Cave 3 | 3034 | Com. Cl 3 | 1 | | | | 4 | 5 | 1 | pot | Com. Cl P2 | 3034.2 | IV | |
| 1998 | 3328 | 22.4 | 4831 | | Cave 3 | 3035 | TS GE | 1 | | | | | | 1 | 1 | | | | |
| 1998 | 3328 | 22.4 | 4831 | | Cave 3 | 3035 | EN | | | | | 2 | 2 | 1 | | | | | |
| 1998 | 3328 | 22.4 | 4831 | | Cave 3 | 3035 | MET | | | | | 1 | 1 | 1 | | | | | |
| 1998 | 3328 | 22.4 | 4831 | | Cave 3 | 3035 | TN | | | | | 1 | 1 | 1 | | | | | |
| 1998 | 3328 | 22.4 | 4831 | 3 | Cave 3 | 3035 | Sb. Coq | 1 | | | | | | 1 | 1 | jatte | Sb. Coq J6 | 3035.1 | IV |
| 1998 | 3328 | 22.4 | 4831 | | Cave 3 | 3035 | Com. Cl | | | | | 1 | 1 | 1 | | | | | |
| 1998 | 3328 | 22.4 | 4831 | | Cave 3 | 3035 | Amp. | | | | | 2 | 2 | 1 | | | | | |
| 1998 | 3328 | 22.4 | 4831 | | Cave 3 | 3036 | EN | | | | | 4 | 4 | 1 | | | | | |
| 1998 | 3328 | 22.4 | 4831 | | Cave 3 | 3036 | TN | | 1 | | | 2 | 3 | 1 | | | | | |
| 1998 | 3328 | 22.4 | 4831 | | Cave 3 | 3036 | Sb. Coq | | 1 | | | | | 1 | 1 | | | | |
| 1998 | 3328 | 22.4 | 4831 | | Cave 3 | 3036 | Com. Cl | 1 | | | | 1 | 2 | 1 | | | | | |
| 1998 | 3328 | 22.4 | 4831 | | Cave 3 | 3044 | TS GE | | | | | 1 | 1 | 1 | | | | | |
| 1998 | 3328 | 22.4 | 4831 | | Cave 3 | 3044 | EN AR | 3 | 1 | | | 32 | 36 | 1 | gobelet | Hees 2 | | | |

ANNEXE B : RUE DE L'AMPHITHÉÂTRE – SECTEUR 3

| année | n° OA | Rayon | Caisse | n° ordre | structure | US | Catégorie | Comptage | | | | | | Typologie | Desc. Typo. | Dessin | Planche | |
|-------|-------|-------|--------|----------|------------|------|-----------|----------|---|---|---|----|----|-----------|-------------|---------------|---------|-----|
| | | | | | | | | B | F | A | D | P | NR | | | | | NMI |
| 1998 | 3328 | 22.4 | 4831 | | Cave 3 | 3044 | Sb. Coq | | | | | 0 | 1 | | | | | |
| 1998 | 3328 | 22.4 | 4831 | | Cave 3 | 3044 | Com. Cl | | | | | 3 | 3 | 1 | | | | |
| 1998 | 3328 | 22.4 | 4831 | | | 3003 | TS SG | | | | | 2 | 2 | 1 | | | | |
| 1998 | 3328 | 22.4 | 4831 | | | 3003 | EN | | 3 | | | 27 | 30 | 1 | | | | |
| 1998 | 3328 | 22.4 | 4831 | 2 | | 3003 | Sb. Coq | 1 | | | | 11 | 12 | 1 | pot | Sb. Coq P6.1 | 3003.1 | IV |
| 1998 | 3328 | 22.4 | 4831 | 2 | | 3003 | Com. Cl 2 | 1 | | | | | 1 | 1 | pot | Com. Cl P5.2 | 3003.2 | IV |
| 1998 | 3328 | 22.4 | 4831 | | | 3003 | Com. Cl 2 | | 2 | | | 18 | 20 | 0 | | | | |
| 1998 | 3328 | 22.4 | 4831 | | | 3003 | Amp. | | | | | 2 | 2 | 1 | | | | |
| 1998 | 3328 | 22.2 | 6735 | | Fosse 3005 | 3006 | TS | | | 1 | | 3 | 4 | 1 | coupe | Drag. 37 | | |
| 1998 | 3328 | 22.2 | 6735 | | Fosse 3005 | 3006 | TS SG | 1 | | | | | 1 | 1 | plat | Drag. 18b | | |
| 1998 | 3328 | 22.2 | 6735 | | Fosse 3005 | 3006 | TS SG | 1 | | | | | 1 | 1 | plat | Drag. 15b1 | | |
| 1998 | 3328 | 22.2 | 6735 | | Fosse 3005 | 3006 | TS SG | 1 | | 1 | | 3 | 5 | 1 | coupe | Vernhet F2 | | |
| 1998 | 3328 | 22.2 | 6735 | | Fosse 3005 | 3006 | TS SG | 1 | | | | | 1 | 1 | coupe | Vernhet A1 | | |
| 1998 | 3328 | 22.2 | 6735 | | Fosse 3005 | 3006 | TS SG | 1 | | | | | 1 | 1 | coupe | Drag. 37 | | |
| 1998 | 3328 | 22.2 | 6735 | | Fosse 3005 | 3006 | TS SG | 1 | | | | | 1 | 1 | coupe | Drag. 37 | | |
| 1998 | 3328 | 22.2 | 6735 | | Fosse 3005 | 3006 | TS SG | 1 | | | | | 1 | 1 | coupe | Drag. 27 | | |
| 1998 | 3328 | 22.2 | 6735 | | Fosse 3005 | 3006 | TS GE | 1 | | | | | 1 | 1 | | | | |
| 1998 | 3328 | 22.2 | 6735 | | Fosse 3005 | 3006 | TS AR | | 2 | | | 2 | 4 | 1 | | | | |
| 1998 | 3328 | 22.2 | 6735 | | Fosse 3005 | 3006 | EN | 1 | | | | 2 | 3 | 1 | | | | |
| 1998 | 3328 | 22.2 | 6735 | | Fosse 3005 | 3006 | TN | | 2 | | | | 2 | 1 | | | | |
| 1998 | 3328 | 22.2 | 6735 | | Fosse 3005 | 3006 | TN/DTN | 1 | 2 | | | 2 | 5 | 1 | | | | |
| 1998 | 3328 | 22.2 | 6735 | | Fosse 3005 | 3006 | TR | | 3 | | | | 3 | 1 | | | | |
| 1998 | 3328 | 22.2 | 6735 | 3 | Fosse 3005 | 3006 | Sb. Coq | 1 | | | | | 1 | 1 | jatte | Sb. Coq J7 | 3006.1 | IV |
| 1998 | 3328 | 22.2 | 6735 | 3 | Fosse 3005 | 3006 | Sb. Coq | 1 | | | | | 1 | 1 | pot | Sb. Coq P1.1 | 3006.2 | IV |
| 1998 | 3328 | 22.2 | 6735 | 3 | Fosse 3005 | 3006 | Sb. Coq | 1 | 1 | | | | 2 | 1 | pot | Sb. Coq P6.1 | 3006.3 | IV |
| 1998 | 3328 | 22.2 | 6735 | 3 | Fosse 3005 | 3006 | Sb. Coq | 1 | | | | | 1 | 1 | pot | Sb. Coq P9.2 | 3006.4 | IV |
| 1998 | 3328 | 22.2 | 6735 | 3 | Fosse 3005 | 3006 | Sb. Coq | 1 | | | | | 1 | 1 | couvercle | Sb. Coq Cv4.2 | 3006.5 | IV |

ANNEXE B : RUE DE L'AMPHITHÉÂTRE – SECTEUR 3

| année | n° OA | Rayon | Caisse | n° ordre | structure | US | Catégorie | Comptage | | | | | | Typologie | Desc. Typo. | Dessin | Planche | |
|-------|-------|-------|--------|----------|------------|------|-----------|----------|---|---|---|----|----|-----------|-------------|---------------|---------|-----|
| | | | | | | | | B | F | A | D | P | NR | | | | | NMI |
| 1998 | 3328 | 22.2 | 6735 | 14 | Fosse 3005 | 3006 | Com. Cl 1 | 4 | 1 | | | | 5 | 1 | cruche | Com. Cl Cr6.1 | 3006.6 | IV |
| 1998 | 3328 | 22.2 | 6735 | 3 | Fosse 3005 | 3006 | Com. Cl 2 | 1 | | | | | 1 | 1 | pot | Com. Cl P4.1 | 3006.7 | IV |
| 1998 | 3328 | 22.2 | 6735 | 3 | Fosse 3005 | 3006 | Com. Cl 2 | 1 | | | | | 1 | 1 | pot | Com. Cl P4.1 | 3006.8 | IV |
| 1998 | 3328 | 22.2 | 6735 | 29 | Fosse 3005 | 3006 | Mo | 1 | | | | | 1 | 1 | mortier | Mo2 | 3006.9 | IV |
| 1998 | 3328 | 22.2 | 6735 | 28 | Fosse 3005 | 3006 | Amp. | 1 | | | | | 1 | 1 | amphore | Dressel 20 | 3006.10 | IV |
| 1998 | 3328 | 22.4 | 4831 | | Drain 3004 | 3007 | TS SG | 1 | | | | | 1 | 1 | assiette | Drag. 18b | | |
| 1998 | 3328 | 22.4 | 4831 | | Drain 3004 | 3007 | TS SG | 2 | | | | | 2 | 1 | assiette | Vernhet A1 | | |
| 1998 | 3328 | 22.4 | 4831 | | Drain 3004 | 3007 | TS SG | 1 | | | | | 1 | 1 | coupe | Drag. 37 | | |
| 1998 | 3328 | 22.4 | 4831 | | Drain 3004 | 3007 | EN | | | | | 2 | 2 | 1 | | | | |
| 1998 | 3328 | 22.4 | 4831 | 10 | Drain 3004 | 3007 | TN | 1 | | | | 19 | 20 | 1 | pot | TNP10 | 3007.1 | V |
| 1998 | 3328 | 22.4 | 4831 | | Drain 3004 | 3007 | TR | 1 | | | | 1 | 2 | 1 | calice | | | |
| 1998 | 3328 | 22.4 | 4831 | | Drain 3004 | 3007 | RU Cl | | 2 | | | 1 | 3 | 1 | | | | |
| 1998 | 3328 | 22.4 | 4831 | 4 | Drain 3004 | 3007 | Sb. Coq | 1 | | | | 8 | 9 | 1 | jatte | Sb. Coq J1 | 3007.2 | V |
| 1998 | 3328 | 22.4 | 4831 | 4 | Drain 3004 | 3007 | Sb. Coq | 1 | | | | | 1 | 1 | pot | Sb. Coq P5.1 | 3007.3 | V |
| 1998 | 3328 | 22.4 | 4831 | | Drain 3004 | 3007 | Com. Cl | | 1 | 2 | | 14 | 17 | 1 | | | | |
| 1998 | 3328 | 22.4 | 4831 | | Drain 3004 | 3007 | Amp. | 1 | | | | 5 | 6 | 1 | | | | |
| 1998 | 3328 | 22.2 | 6735 | | | 3025 | TS GE | | | | | 1 | 1 | 1 | | | | |
| 1998 | 3328 | 22.2 | 6735 | | | 3025 | EN | | | | | 1 | 1 | 1 | | | | |
| 1998 | 3328 | 22.2 | 6735 | | | 3025 | TN/DTN | | | | | 1 | 1 | 1 | | | | |
| 1998 | 3328 | 22.2 | 6735 | | | 3025 | Sb. Coq | | | | | 1 | 1 | 1 | | | | |
| 1998 | 3328 | 22.2 | 6735 | | | 3025 | Com. Cl | | | | | 1 | 1 | 1 | | | | |
| 1998 | 3328 | 22.4 | 4831 | | Fosse | 3048 | TS SG | 2 | | | | 2 | 4 | 1 | plat | Drag. 18b | | |
| 1998 | 3328 | 22.4 | 4831 | | Fosse | 3048 | TS GE | | | | | 2 | 2 | 1 | coupe | Drag. 37 | | |
| 1998 | 3328 | 22.4 | 4831 | | Fosse | 3048 | EN | | | | | 2 | 2 | 1 | | | | |
| 1998 | 3328 | 22.4 | 4831 | | Fosse | 3048 | MET | | | | | 1 | 1 | 1 | | | | |
| 1998 | 3328 | 22.4 | 4831 | | Fosse | 3048 | PLB | | | | | 1 | 1 | 1 | | | | |
| 1998 | 3328 | 22.4 | 4831 | | Fosse | 3048 | TN | 3 | 1 | | | 14 | 18 | 1 | bol | TNB27.2 | | |

ANNEXE B : RUE DE L'AMPHITHÉÂTRE – SECTEUR 3

| année | n° OA | Rayon | Caisse | n° ordre | structure | US | Catégorie | Comptage | | | | | | Typologie | Desc. Typo. | Dessin | Planche | |
|-------|-------|-------|--------|----------|-----------|------|-----------|----------|---|---|---|---|----|-----------|---------------|--------------|---------|-----|
| | | | | | | | | B | F | A | D | P | NR | | | | | NMI |
| 1998 | 3328 | 22.4 | 4831 | 2 | Fosse | 3048 | TR | 1 | | | | 1 | 1 | assiette | A16.1 | 3048.1 | V | |
| 1998 | 3328 | 22.4 | 4831 | 12 | Fosse | 3048 | Sb. Coq | 1 | | | | 4 | 5 | plat | Sb. Coq P11.3 | 3048.2 | V | |
| 1998 | 3328 | 22.4 | 4831 | | Fosse | 3048 | Com. Cl | | | | | 2 | 2 | | | | | |
| 1998 | 3328 | 22.4 | 4831 | | Epandage | 3049 | TS SG | 1 | | | | | 1 | 1 | plat | Drag. 18b | | |
| 1998 | 3328 | 22.4 | 4831 | | Epandage | 3049 | TS SG | 1 | 2 | | | | 1 | 4 | coupe | Drag. 27 | | |
| 1998 | 3328 | 22.4 | 4831 | | Epandage | 3049 | TS GE | 1 | | | | | 1 | 1 | coupe | Drag. 37 | | |
| 1998 | 3328 | 22.4 | 4831 | | Epandage | 3049 | TS AR | 1 | | | | | 1 | 1 | coupe | Drag. 33 | | |
| 1998 | 3328 | 22.4 | 4831 | | Epandage | 3049 | MET AR | | | | | | 1 | 1 | | | | |
| 1998 | 3328 | 22.4 | 4831 | | Epandage | 3049 | TN | 2 | 6 | | | | 10 | 18 | | | | |
| 1998 | 3328 | 22.4 | 4831 | 9 | Epandage | 3049 | Sb. Coq | 3 | | | | | 6 | 9 | jatte | Sb. Coq J2.2 | 3049.1 | V |
| 1998 | 3328 | 22.4 | 4831 | | Epandage | 3049 | Com. Cl | | | | | | 6 | 6 | | | | |
| 1998 | 3328 | 22.4 | 4831 | | Epandage | 3049 | Amp. | | | 1 | | | | 1 | | | | |

ANNEXE B : RUE DE L'AMPHITHÉÂTRE – SECTEUR 4

| année | n° OA | Rayon | Caisse | n° ordre | structure | US | Catégorie | Comptage | | | | | | Typologie | Desc. Typo. | Dessin | Planche |
|-------|-------|-------|--------|----------|-----------|------|-----------|----------|---|---|---|---|----|-----------|-------------|--------|-----------|
| | | | | | | | | B | F | A | D | P | NR | | | | |
| 1998 | 3328 | 22.3 | 6727 | | Pièce 4 | 4007 | TS SG | | | | | 1 | 1 | 1 | | | |
| 1998 | 3328 | 22.3 | 6727 | | Pièce 4 | 4007 | TS AR | | | | | 1 | 1 | 1 | | | |
| 1998 | 3328 | 22.3 | 6727 | 1 | Pièce 4 | 4007 | TN | 1 | 1 | | | 2 | 4 | 1 | coupelle | TNC5 | 4007.1 VI |
| 1998 | 3328 | 22.3 | 6727 | | Pièce 4 | 4007 | Sb. Coq | | | | | 1 | 1 | 1 | | | |
| 1998 | 3328 | 22.3 | 6727 | | Pièce 4 | 4007 | Com. Cl | | | | | 5 | 5 | 1 | | | |

ANNEXE B : RUE DE L'AMPHITHÉÂTRE – SECTEUR 5

| année | n° OA | Rayon | Caisse | n° ordre | structure | US | Catégorie | Comptage | | | | | | Typologie | Desc. Typo. | Dessin | Planche | |
|-------|-------|-------|--------|----------|-----------|------|-----------|----------|---|---|---|---|----|-----------|-------------|--------|---------|-----|
| | | | | | | | | B | F | A | D | P | NR | | | | | NMI |
| 1998 | 3328 | 22.3 | 6727 | | Décapage | 5000 | Sb. Coq | | 1 | | | | 1 | 1 | | | | |
| 1998 | 3328 | 22.3 | 6727 | 5 | Nettoyage | 5001 | TN | 1 | | | | 6 | 7 | 1 | calice | TNKL15 | 5001.1 | VII |
| 1998 | 3328 | 22.3 | 6727 | | Nettoyage | 5001 | Sb. Coq | | | | | 2 | 2 | 1 | | | | |
| 1998 | 3328 | 22.3 | 6727 | | Nettoyage | 5001 | Com. Cl | | | | | 1 | 1 | 1 | | | | |
| 1998 | 3328 | 22.3 | 6727 | | | 5004 | EN | | | | | 1 | 1 | 1 | | | | |
| 1998 | 3328 | 22.3 | 6727 | | | 5004 | TN/DTN | | | | | 1 | 1 | 1 | | | | |
| 1998 | 3328 | 22.3 | 6727 | | | 5004 | RU Cl | | | | | 1 | 1 | 1 | | | | |
| 1998 | 3328 | 22.3 | 6727 | | | 5004 | Sb. Coq | | | | | 2 | 2 | 1 | | | | |
| 1998 | 3328 | 22.3 | 6727 | | | 5004 | Com. Cl | | 1 | | | 3 | 4 | 1 | | | | |
| 1998 | 3328 | 22.3 | 6727 | | Remblai | 5007 | TN/DTN | | | | | 3 | 3 | 1 | | | | |
| 1998 | 3328 | 22.3 | 6727 | | Remblai | 5007 | Sb. Coq | 2 | | | | | 2 | 1 | | | | |

ANNEXE B : RUE DE L'AMPHITHÉÂTRE – SECTEUR 6

| année | n° OA | Rayon | Caisse | n° ordre | structure | US | Catégorie | Comptage | | | | | | Typologie | Desc. Typo. | Dessin | Planche | |
|-------|-------|-------|--------|----------|-----------|------|---------------|----------|---|---|---|----|----|-----------|-------------|---------------|---------|------|
| | | | | | | | | B | F | A | D | P | NR | | | | | NMI |
| 1998 | 3328 | 22.3 | 6727 | | Décapage | 6000 | TS | | 1 | | | | 1 | 0 | | | | |
| 1998 | 3328 | 22.3 | 6727 | | Décapage | 6000 | TS SG | 1 | 4 | | | | 5 | 1 | | | | |
| 1998 | 3328 | 22.3 | 6727 | | Décapage | 6000 | Com. Cl dorée | 1 | | | | | 1 | 1 | | | | |
| 1998 | 3328 | 22.5 | 1353 | | Cave 6 | 6005 | TS SG | | | | 2 | 2 | 1 | | | | | |
| 1998 | 3328 | 22.5 | 1353 | | Cave 6 | 6005 | TS AR | 1 | | | | | 1 | 1 | coupe | Drag. 37 | | |
| 1998 | 3328 | 22.5 | 1353 | | Cave 6 | 6005 | EN | | 2 | | | | 2 | 1 | | | | |
| 1998 | 3328 | 22.5 | 1353 | | Cave 6 | 6005 | TN | | 1 | | | 37 | 38 | 0 | | | | |
| 1998 | 3328 | 22.5 | 1353 | | Cave 6 | 6005 | TN | 2 | | | | | 2 | 1 | bol | TNB1 | | |
| 1998 | 3328 | 22.5 | 1353 | | Cave 6 | 6005 | TN | 2 | | | | | 2 | 1 | bol | TNB1 | | |
| 1998 | 3328 | 22.5 | 1353 | | Cave 6 | 6005 | TN | 2 | | | | | 2 | 1 | bol | TNB1 | | |
| 1998 | 3328 | 22.5 | 1353 | | Cave 6 | 6005 | TN | 2 | | | | | 2 | 1 | pot | TNP41 | | |
| 1998 | 3328 | 22.5 | 1353 | | Cave 6 | 6005 | TN | 1 | | | | | 1 | 1 | pot | TNP54 | | |
| 1998 | 3328 | 22.5 | 1353 | | Cave 6 | 6005 | TN | 1 | | | | | 1 | 1 | pot | TNP54 | | |
| 1998 | 3328 | 22.5 | 1353 | | Cave 6 | 6005 | VRP | | | | | 1 | 1 | 1 | | | | |
| 1998 | 3328 | 22.5 | 1353 | 15 | Cave 6 | 6005 | Sb. Coq | 1 | | | | | 1 | 1 | couvercle | Sb. Coq Cv3.1 | 6005.1 | VIII |
| 1998 | 3328 | 22.5 | 1353 | 9 | Cave 6 | 6005 | Com. Cl | 2 | 3 | | | 51 | 56 | 1 | cruche | Com. Cl Cr6.2 | 6005.2 | VIII |
| 1998 | 3328 | 22.5 | 1353 | 1 | Cave 6 | 6005 | Mo | 1 | | | | | 1 | 1 | mortier | Mo3.1 | 6005.3 | VIII |
| 1998 | 3328 | 22.5 | 1353 | | Cave 6 | 6005 | Amp. | | | | | 3 | 3 | 1 | | | | |
| 1998 | 3328 | 22.5 | 1353 | | Cave 6 | 6062 | TS AR | 1 | | | | | 1 | 1 | coupelle | Drag. 40 | | |
| 1998 | 3328 | 22.5 | 1353 | | Cave 6 | 6062 | TS AR | 1 | | | | | 1 | 1 | coupe | Drag. 32 | | |
| 1998 | 3328 | 22.5 | 1353 | | Cave 6 | 6062 | TS AR | 5 | | | | | 5 | 1 | coupe | Drag. 37 | | |
| 1998 | 3328 | 22.5 | 1353 | | Cave 6 | 6062 | TS AR | | 1 | | | 9 | 10 | 0 | | | | |
| 1998 | 3328 | 22.5 | 1353 | | Cave 6 | 6062 | EN | | | | | 3 | 3 | 1 | | | | |
| 1998 | 3328 | 22.5 | 1353 | | Cave 6 | 6062 | MET AR | | 2 | | | 20 | 22 | 0 | | | | |

ANNEXE B : RUE DE L'AMPHITHÉÂTRE – SECTEUR 6

| année | n° OA | Rayon | Caisse | n° ordre | structure | US | Catégorie | Comptage | | | | | | Typologie | Desc. Typo. | Dessin | Planche | |
|-------|-------|-------|--------|----------|-----------|------|-----------|----------|--------|---|---|----|----|-----------|-------------|------------------|---------|------|
| | | | | | | | | B | F | A | D | P | NR | | | | | NMI |
| 1998 | 3328 | 22.5 | 1353 | | Cave 6 | 6062 | MET AR | 2 | | | | | 2 | 1 | gobelet | Nied. 33 | | |
| 1998 | 3328 | 22.5 | 1353 | | Cave 6 | 6062 | MET AR | 2 | | | | | 2 | 1 | gobelet | Nied. 33 | | |
| 1998 | 3328 | 22.5 | 1353 | | Cave 6 | 6062 | MET AR | 4 | | | | | 4 | 1 | gobelet | Nied. 33 | | |
| 1998 | 3328 | 22.5 | 1353 | | Cave 6 | 6062 | MET TR | 1 | | | | | 1 | 1 | | | | |
| 1998 | 3328 | 22.5 | 1353 | | Cave 6 | 6062 | TN/DTN | 1 | | | | 7 | 8 | 1 | | | | |
| 1998 | 3328 | 22.5 | 1353 | 200 | Cave 6 | 6062 | VRP CG | 1 2 | 4 0 | | | 2 | 54 | 1 | plat | Gounideau 19 | 6062.1 | VIII |
| 1998 | 3328 | 22.5 | 1353 | 200 | Cave 6 | 6062 | VRP R | 4 | | | | 10 | 14 | 1 | plat | Goudineau 15 | 6062.2 | VIII |
| 1998 | 3328 | 22.5 | 1353 | 1 | Cave 6 | 6062 | RU UR | 1 | | | | 4 | 5 | 1 | plat | Nied. 112 | 6062.3 | VIII |
| 1998 | 3328 | 22.5 | 1353 | | Cave 6 | 6062 | RU CI | 1 | | | | | 1 | 1 | plat | PL2 | | |
| 1998 | 3328 | 22.5 | 1353 | | Cave 6 | 6062 | CB | | 3 | | | 28 | 31 | 0 | | | | |
| 1998 | 3328 | 22.5 | 1353 | 1 | Cave 6 | 6062 | CB | 1 | | | | | 1 | 1 | plat | Reims A12 | 6062.4 | VIII |
| 1998 | 3328 | 22.5 | 1353 | 200 | Cave 6 | 6062 | CB | 3 | | | | | 3 | 1 | pot | Reims P16 | 6062.5 | VIII |
| 1998 | 3328 | 22.5 | 1353 | 200 | Cave 6 | 6062 | Sb. Coq | 1 | | | | 15 | 16 | 1 | couvercle | Sb. Coq Cv2.1 | 6062.6 | VIII |
| 1998 | 3328 | 22.5 | 1353 | | Cave 6 | 6062 | Com. Cl | | | 2 | | 31 | 33 | 0 | | | | |
| 1998 | 3328 | 22.5 | 1353 | | Cave 6 | 6062 | Com. Cl 2 | 2 | | | | | 2 | 1 | pot | Com. Cl P4.2 | 6062.7 | IX |
| 1998 | 3328 | 22.5 | 1353 | 200 | Cave 6 | 6062 | Com. Cl 3 | 5 | 2 | | | 3 | 10 | 1 | pot | Com. Cl P4.1 | 6062.8 | IX |
| 1998 | 3328 | 22.3 | 4844 | | Cave 6 | 6064 | EN | 5 | | | | 4 | 9 | 1 | | | | |
| 1998 | 3328 | 22.3 | 4844 | | Cave 6 | 6064 | MET AR | | | | | 2 | 2 | 1 | gobelet | Nied. 33 | | |
| 1998 | 3328 | 22.3 | 4844 | | Cave 6 | 6064 | TN | | | | | 3 | 3 | 1 | assiette | TNA41/43 | | |
| 1998 | 3328 | 22.3 | 4844 | | Cave 6 | 6064 | RU CI | | | | | 16 | 16 | 1 | | | | |
| 1998 | 3328 | 22.3 | 4844 | 3 | Cave 6 | 6064 | CB | 1 | 1 | | | 2 | 4 | 1 | plat | Reims A6 | 6064.1 | IX |
| 1998 | 3328 | 22.3 | 4844 | | Cave 6 | 6064 | Com. Cl | | 1 | | | 3 | 4 | 1 | | | | |
| 1998 | 3328 | 22.5 | 1353 | | Cave 6 | 6065 | EN | | | | | 47 | 47 | 1 | | | | |

ANNEXE B : RUE DE L'AMPHITHÉÂTRE – SECTEUR 6

| année | n° OA | Rayon | Caisse | n° ordre | structure | US | Catégorie | Comptage | | | | | | Typologie | Desc. Typo. | Dessin | Planche |
|-------|-------|-------|--------|----------|---------------|------|------------------|----------|---|---|---|----|----|-----------|-------------|------------------|-----------|
| | | | | | | | | B | F | A | D | P | NR | | | | |
| 1998 | 3328 | 22.5 | 1353 | | Cave 6 | 6065 | MET | 6 | | | | 26 | 32 | 0 | | | |
| 1998 | 3328 | 22.5 | 1353 | | Cave 6 | 6065 | MET AR | | | | | 1 | 1 | 1 | | | |
| 1998 | 3328 | 22.5 | 1353 | 3 | Cave 6 | 6065 | VRP | 1 | | | | | 1 | 1 | plat | Goudineau 15 | 6065.1 IX |
| 1998 | 3328 | 22.5 | 1353 | 3 | Cave 6 | 6065 | Sb. Coq | 1 | | | | | 1 | 1 | couvercle | Sb. Coq Cv6.1 | 6065.2 IX |
| 1998 | 3328 | 22.5 | 1353 | | Cave 6 | 6065 | Com. Cl | 1 | | | | | 1 | 1 | jatte | | |
| 1998 | 3328 | 22.3 | 4844 | | Cave 6 | 6068 | Sb. Coq | 1 | | | | | 1 | 1 | | | |
| 1998 | 3328 | 22.3 | 4844 | | Cave 6 | 6068 | Com. Cl | | | | | 2 | 2 | 1 | | | |
| 1998 | 3328 | 22.3 | 4844 | | Cave 6 | 6068 | Com. Cl dorée | 1 | | | | | | 1 | 1 | jatte | |
| 1998 | 3328 | 22.3 | 4844 | | Drain 6007 | 6009 | TN/DTN | | | | | 4 | 4 | 1 | | | |
| 1998 | 3328 | 22.3 | 4844 | | Drain 6007 | 6009 | RU Cl | | | | | 1 | 1 | 1 | | | |
| 1998 | 3328 | 22.3 | 4844 | | Drain 6007 | 6009 | Sb. Coq | 2 | | | | 1 | 3 | 1 | | | |
| 1998 | 3328 | 22.3 | 4844 | | Drain 6007 | 6009 | Com. Cl | | | | | 4 | 4 | 1 | | | |
| 1998 | 3328 | 22.3 | 4844 | | | 6018 | MET AR | | | | | 3 | 3 | 1 | | | |
| 1998 | 3328 | 22.3 | 4844 | | | 6018 | Sb. Coq | | | | | 2 | 2 | 1 | | | |
| 1998 | 3328 | 22.3 | 4844 | | | 6018 | Com. Cl | | | | | 2 | 2 | 1 | | | |
| 1998 | 3328 | 22.5 | 4786 | | Puits 6017 | 6019 | TS CG | 1 | | | | | 1 | 1 | | | |
| 1998 | 3328 | 22.5 | 4786 | | Puits 6017 | 6019 | TS GE | | | | | 1 | 1 | 1 | | | |
| 1998 | 3328 | 22.5 | 4786 | | Puits 6017 | 6019 | EN | | 1 | | | 6 | 7 | 1 | | | |
| 1998 | 3328 | 22.5 | 4786 | | Puits 6017 | 6019 | MET | | | | | 4 | 4 | 1 | | | |
| 1998 | 3328 | 22.5 | 4786 | | Puits 6017 | 6019 | MET AR | | | | | 1 | 1 | 1 | | | |
| 1998 | 3328 | 22.5 | 4786 | | Puits 6017 | 6019 | TN/DTN | | 1 | | | 7 | 8 | 1 | | | |
| 1998 | 3328 | 22.5 | 4786 | | Puits 6017 | 6019 | CB | | | | | 5 | 5 | 1 | | | |

ANNEXE B : RUE DE L'AMPHITHÉÂTRE – SECTEUR 6

| année | n° OA | Rayon | Caisse | n° ordre | structure | US | Catégorie | Comptage | | | | | | Typologie | Desc. Typo. | Dessin | Planche | |
|-------|-------|-------|--------|----------|-----------------|------|-----------|----------|--------|---|---|----|----|-----------|-------------|------------------|---------|-----|
| | | | | | | | | B | F | A | D | P | NR | | | | | NMI |
| 1998 | 3328 | 22.5 | 4786 | 3 | Puits 6017 | 6019 | Sb. Coq | 1 | | | | | 1 | 1 | plat | Sb. Coq P11.2 | 6019.1 | IX |
| 1998 | 3328 | 22.5 | 4786 | 3 | Puits 6017 | 6019 | Sb. Coq | 2 | | | | 3 | 5 | 1 | pot | Sb. Coq P6.1 | 6019.2 | IX |
| 1998 | 3328 | 22.5 | 4786 | | Puits 6017 | 6019 | Com. Cl | | | | | 14 | 14 | 1 | | | | |
| 1998 | 3328 | 22.2 | 6735 | | Citerne 6043 | 6021 | TS | | | | | 1 | 1 | 1 | coupe | Drag. 37 | | |
| 1998 | 3328 | 22.2 | 6735 | | Citerne 6043 | 6021 | TS AR | | | | | 1 | 1 | 1 | mortier | Drag. 45 | | |
| 1998 | 3328 | 22.2 | 6735 | | Citerne 6043 | 6021 | MET AR | | | | | 2 | 2 | 1 | | | | |
| 1998 | 3328 | 22.2 | 6735 | | Citerne 6043 | 6021 | Sb. Coq | | | | | 4 | 4 | 1 | | | | |
| 1998 | 3328 | 22.2 | 6735 | | Citerne 6043 | 6021 | Com. Cl | | 1 | | | 2 | 3 | 1 | | | | |
| 1998 | 3328 | 22.2 | 6735 | 4 | Citerne 6043 | 6021 | Amp. | 1 | | | | | 1 | 1 | amphore | Dressel 8 | 6021.1 | IX |
| 1998 | 3328 | 22.5 | 4786 | | Citerne 6043 | 6022 | TS | 1 | | | | | 1 | 1 | coupe | Drag. 32 | | |
| 1998 | 3328 | 22.5 | 4786 | | Citerne 6043 | 6022 | TS AR | 1 | | | | | 1 | 1 | coupe | Drag. 37 | | |
| 1998 | 3328 | 22.5 | 4786 | | Citerne 6043 | 6022 | TS AR | | | | | 1 | 1 | 1 | coupe | Drag. 37 | | |
| 1998 | 3328 | 22.5 | 4786 | | Citerne 6043 | 6022 | EN | | | | | 2 | 2 | 1 | | | | |
| 1998 | 3328 | 22.5 | 4786 | | Citerne 6043 | 6022 | MET AR | | 1 0 | | | 85 | 95 | 1 | | | | |
| 1998 | 3328 | 22.5 | 4786 | | Citerne 6043 | 6022 | MET AR | 1 | | | | | 1 | 1 | gobelet | Nied. 33 | | |
| 1998 | 3328 | 22.5 | 4786 | | Citerne 6043 | 6022 | MET AR | 1 | | | | | 1 | 1 | gobelet | Nied. 33 | | |
| 1998 | 3328 | 22.5 | 4786 | | Citerne | 6022 | MET AR | 1 | | | | | 1 | 1 | gobelet | Nied. 33 | | |

ANNEXE B : RUE DE L'AMPHITHÉÂTRE – SECTEUR 6

| année | n° OA | Rayon | Caisse | n° ordre | structure | US | Catégorie | Comptage | | | | | | Typologie | Desc. Typo. | Dessin | Planche | |
|-------|-------|-------|--------|----------|-----------------|------|-----------|----------|---|---|---|----|----|-----------|-------------|------------------|---------|-----|
| | | | | | | | | B | F | A | D | P | NR | | | | | NMI |
| | | | | | 6043 | | | | | | | | | | | | | |
| 1998 | 3328 | 22.5 | 4786 | | Citerne 6043 | 6022 | MET AR | 1 | | | | | 1 | 1 | gobelet | Nied. 33 | | |
| 1998 | 3328 | 22.5 | 4786 | | Citerne 6043 | 6022 | MET AR | 1 | | | | | 1 | 1 | gobelet | Nied. 33 | | |
| 1998 | 3328 | 22.5 | 4786 | | Citerne 6043 | 6022 | MET AR | 1 | | | | | 1 | 1 | gobelet | Nied. 33 | | |
| 1998 | 3328 | 22.5 | 4786 | | Citerne 6043 | 6022 | MET AR | 1 | | | | | 1 | 1 | gobelet | Nied. 33 | | |
| 1998 | 3328 | 22.5 | 4786 | | Citerne 6043 | 6022 | MET TR | 4 | | | | | 4 | 1 | | | | |
| 1998 | 3328 | 22.5 | 4786 | | Citerne 6043 | 6022 | TN | | 1 | | | 1 | 2 | 1 | | | | |
| 1998 | 3328 | 22.5 | 4786 | 1 | Citerne 6043 | 6022 | RU UR | 1 | | 1 | | | 1 | 1 | pot | Nied. 89 | 6022.1 | X |
| 1998 | 3328 | 22.5 | 4786 | 1 | Citerne 6043 | 6022 | RU UR | 1 | | | | | 1 | 1 | pot | Nied. 89 | 6022.2 | X |
| 1998 | 3358 | 22.5 | 4786 | | Citerne 6043 | 6022 | CB | | | | | | | 1 | | | | |
| 1998 | 3328 | 22.5 | 4786 | 3 | Citerne 6043 | 6022 | Sb. Coq | 1 | | | | 16 | 17 | 1 | plat | Sb. Coq P11.1 | 6022.3 | X |
| 1998 | 3328 | 22.5 | 4786 | 3 | Citerne 6043 | 6022 | Sb. Coq | 1 | | | | | 1 | 1 | pot | Sb. Coq P4 | 6022.4 | X |
| 1998 | 3328 | 22.5 | 4786 | | Citerne 6043 | 6022 | Com. Cl | | 1 | | | 39 | 40 | 1 | | | | |
| 1998 | 3328 | 22.5 | 4786 | | Citerne 6043 | 6022 | Amp. | | | | | 1 | 1 | 1 | | | | |
| 1998 | 3328 | 22.2 | 6744 | | Citerne 6043 | 6023 | TS AR | | | | | 2 | 2 | 1 | | | | |
| 1998 | 3328 | 22.2 | 6744 | | Citerne 6043 | 6025 | TS GE | | | | | 1 | 1 | 1 | | | | |
| 1998 | 3328 | 22.2 | 6744 | | Citerne | 6025 | TN/DTN | | | | | 1 | 1 | 1 | | | | |

ANNEXE B : RUE DE L'AMPHITHÉÂTRE – SECTEUR 6

| année | n° OA | Rayon | Caisse | n° ordre | structure | US | Catégorie | Comptage | | | | | | Typologie | Desc. Typo. | Dessin | Planche | |
|-------|-------|-------|--------|----------|-----------------|------|-----------|----------|---|---|---|----|----|-----------|-------------|------------------|---------|-----|
| | | | | | | | | B | F | A | D | P | NR | | | | | NMI |
| | | | | | 6043 | | | | | | | | | | | | | |
| 1998 | 3328 | 22.2 | 6744 | | Citerne 6043 | 6025 | EN | 1 | 1 | | | 34 | 36 | 1 | | | | |
| 1998 | 3328 | 22.2 | 6744 | | Citerne 6043 | 6025 | MET AR | 9 | 1 | | | 42 | 52 | 1 | gobelet | Nied. 33 | | |
| 1998 | 3328 | 22.2 | 6744 | | Citerne 6043 | 6025 | MET AR | 1 | | | | | 1 | 1 | gobelet | Nied. 33 | | |
| 1998 | 3328 | 22.2 | 6744 | | Citerne 6043 | 6025 | MET AR | 1 | | | | | 1 | 1 | gobelet | Nied. 33 | | |
| 1998 | 3328 | 22.2 | 6744 | | Citerne 6043 | 6025 | MET TR | 6 | 1 | | | 27 | 34 | 1 | gobelet | Nied. 33 | | |
| 1998 | 3328 | 22.2 | 6744 | 5 | Citerne 6043 | 6025 | Sb. Coq | 2 | | | | 6 | 8 | 1 | couvercle | Sb. Coq Cv3.1 | 6025.1 | X |
| 1998 | 3328 | 22.2 | 6744 | 5 | Citerne 6043 | 6025 | Sb. Coq | 2 | | | | | 2 | 1 | couvercle | Sb. Coq Cv4.1 | 6025.2 | X |
| 1998 | 3328 | 22.2 | 6744 | 3 | Citerne 6043 | 6025 | Com. Cl 2 | 1 | | | | | 1 | 1 | cruche | Com. Cl Cr6.1 | 6025.3 | X |
| 1998 | 3328 | 22.2 | 6744 | | Citerne 6043 | 6025 | Com. Cl | | | | | 78 | 78 | 0 | | | | |
| 1998 | 3328 | 22.2 | 6744 | | Citerne 6043 | 6025 | Amp. | | 3 | | | | 3 | 1 | | | | |
| 1998 | 3328 | 22.2 | 6744 | | | 6024 | TS | | | | | 2 | 2 | 1 | coupe | Drag. 37 | | |
| 1998 | 3328 | 22.2 | 6744 | | | 6024 | TS | | | | | 1 | 1 | 1 | coupe | Drag. 37 | | |
| 1998 | 3328 | 22.2 | 6744 | | | 6024 | TS AR | 1 | | | | | 1 | 1 | coupe | Drag. 40 | | |
| 1998 | 3328 | 22.2 | 6744 | | | 6024 | TS AR | 1 | | | | 1 | 2 | 1 | coupe | Drag. 37 | | |
| 1998 | 3328 | 22.2 | 6744 | | | 6024 | TS AR | 1 | | | | | 1 | 1 | coupe | Curle 21 | | |
| 1998 | 3328 | 22.2 | 6744 | | | 6024 | MET AR | 1 | 2 | | | 14 | 17 | 1 | gobelet | Nied. 33 | | |
| 1998 | 3328 | 22.2 | 6744 | | | 6024 | MET TR | | | | | 6 | 6 | 1 | | | | |
| 1998 | 3328 | 22.2 | 6744 | 3 | | 6024 | VRP | 2 | | | | 4 | 6 | 1 | plat | Goudineau 15 | 6024.1 | X |

ANNEXE B : RUE DE L'AMPHITHÉÂTRE – SECTEUR 6

| année | n° OA | Rayon | Caisse | n° ordre | structure | US | Catégorie | Comptage | | | | | | Typologie | Desc. Typo. | Dessin | Planche | |
|-------|-------|-------|--------|----------|-----------|------|-----------|----------|---|---|---|----|----|-----------|-------------|------------------|---------|-----|
| | | | | | | | | B | F | A | D | P | NR | | | | | NMI |
| 1998 | 3328 | 22.2 | 6744 | 3 | | 6024 | Sb. Coq | 1 | | | | 8 | 9 | 1 | couvercle | | 6024.2 | X |
| 1998 | 3328 | 22.2 | 6744 | 3 | | 6024 | Sb. Coq | 1 | | | | | 1 | 1 | couvercle | Sb. Coq Cv4.1 | 6024.3 | X |
| 1998 | 3328 | 22.2 | 6744 | | | 6024 | Com. Sb | | | | | 3 | 3 | 1 | | | | |
| 1998 | 3328 | 22.2 | 6744 | | | 6024 | Com. Cl | | 2 | | | 20 | 22 | 1 | | | | |
| 1998 | 3328 | 22.2 | 6744 | 4 | | 6024 | Mo | 1 | | | | 1 | 2 | 1 | mortier | Mo3.1 | 6024.4 | XI |
| 1998 | 3328 | 22.2 | 6744 | | | 6024 | Amp. | | | | | 1 | 1 | 1 | | | | |
| 1998 | 3328 | 22.3 | 4844 | | Coupe 25 | 6026 | TS SG | 1 | | | | | 1 | 1 | coupe | Drag. 37 | | |
| 1998 | 3328 | 22.3 | 4844 | | Coupe 25 | 6026 | TS SG | 1 | | | | 4 | 5 | 1 | coupe | Drag. 37 | | |
| 1998 | 3328 | 22.3 | 4844 | | Coupe 25 | 6026 | MET AR | | | | | 1 | 1 | 1 | | | | |
| 1998 | 3328 | 22.3 | 4844 | | Coupe 25 | 6026 | TN | 1 | 2 | | | 8 | 11 | 1 | bol | TNB1 | | |
| 1998 | 3328 | 22.3 | 4844 | | Coupe 25 | 6026 | Sb. Coq | | | | | 5 | 5 | 1 | | | | |
| 1998 | 3328 | 22.3 | 4844 | 8 | Coupe 25 | 6026 | Com. Cl 3 | 1 | | | | 10 | 11 | 1 | plat | Com. Cl P11.3 | 6026.1 | XI |
| 1998 | 3328 | 22.3 | 4844 | | Coupe 25 | 6026 | Amp. | | | | | 1 | 1 | 1 | | | | |
| 1998 | 3328 | 22.3 | 4844 | | Coupe 25 | 6028 | TS SG | | 1 | | | | 1 | 1 | | | | |
| 1998 | 3328 | 22.3 | 4844 | | Coupe 25 | 6028 | TN/DTN | | | | | 1 | 1 | 1 | | | | |
| 1998 | 3328 | 22.3 | 4844 | 2 | Coupe 25 | 6028 | TR | 1 | | | | 1 | 2 | 1 | calice | TRK16 | 6028.1 | XI |
| 1998 | 3328 | 22.3 | 4844 | 3 | Coupe 25 | 6028 | Sb. Coq | 1 | | | | | 1 | 1 | couvercle | | 6028.2 | XI |
| 1998 | 3328 | 22.3 | 4844 | | Coupe 25 | 6028 | Com. Cl | | | | | 3 | 3 | 1 | | | | |
| 1998 | 3328 | 22.3 | 4832 | 2 | Coupe 25 | 6030 | Sb. Coq | 1 | | | | 1 | 2 | 1 | pot | Sb. Coq P9.1 | 6030.1 | XI |
| 1998 | 3328 | 22.3 | 4832 | 1 | Coupe 25 | 6030 | Com. Cl | | | | | 1 | 1 | 1 | | | | |
| 1998 | 3328 | 22.3 | 4832 | | Coupe 26 | 6035 | Com. Cl | | | | | 6 | 6 | 1 | bouteille | | | |
| 1998 | 3328 | 22.5 | 1353 | | Coupe 32 | 6045 | TS | | 2 | | | 1 | 3 | 0 | | | | |
| 1998 | 3328 | 22.5 | 1353 | | Coupe 32 | 6045 | TS SG | 1 | | | | | 1 | 1 | plat | indét. | | |
| 1998 | 3328 | 22.5 | 1353 | | Coupe 32 | 6045 | TS SG | 1 | | | | | 1 | 1 | plat | Drag. 15b1 | | |
| 1998 | 3328 | 22.5 | 1353 | | Coupe 32 | 6045 | TS SG | 1 | 1 | | | 8 | 10 | 1 | coupe | Drag. 37 | | |

ANNEXE B : RUE DE L'AMPHITHÉÂTRE – SECTEUR 6

| année | n° OA | Rayon | Caisse | n° ordre | structure | US | Catégorie | Comptage | | | | | | Typologie | Desc. Typo. | Dessin | Planche | |
|-------|-------|-------|--------|----------|-----------|------|---------------|----------|---|---|---|----|----|-----------|-------------|---------------|---------|-----|
| | | | | | | | | B | F | A | D | P | NR | | | | | NMI |
| 1998 | 3328 | 22.5 | 1353 | | Coupe 32 | 6045 | TS SG | 1 | | | | | 1 | 1 | coupe | Drag. 37 | | |
| 1998 | 3328 | 22.5 | 1353 | | Coupe 32 | 6045 | TS SG | 1 | | | | | 1 | 1 | coupe | VernhA1 | | |
| 1998 | 3328 | 22.5 | 1353 | | Coupe 32 | 6045 | EN | | 1 | | | 1 | 2 | 1 | | | | |
| 1998 | 3328 | 22.5 | 1353 | | Coupe 32 | 6045 | TN | | 7 | | | 28 | 35 | 0 | | | | |
| 1998 | 3328 | 22.5 | 1353 | | Coupe 32 | 6045 | TN | 1 | | | | | 1 | 1 | assiette | TNA41/43 | | |
| 1998 | 3328 | 22.5 | 1353 | | Coupe 32 | 6045 | TN | 1 | | | | | 1 | 1 | assiette | TNA41/43 | | |
| 1998 | 3328 | 22.5 | 1353 | | Coupe 32 | 6045 | TN | 1 | | | | | 1 | 1 | bol | TNB1 | | |
| 1998 | 3328 | 22.5 | 1353 | | Coupe 32 | 6045 | TN | 1 | | | | | 1 | 1 | pot | TNP46 | | |
| 1998 | 3328 | 22.5 | 1353 | | Coupe 32 | 6045 | TR | 1 | | | | 2 | 3 | 1 | calice | TRKL15 | | |
| 1998 | 3328 | 22.5 | 1353 | | Coupe 32 | 6045 | Sb. Coq | | | | | 14 | 14 | 0 | | | | |
| 1998 | 3328 | 22.5 | 1353 | 3 | Coupe 32 | 6045 | Sb. Coq | 2 | | | | | 2 | 1 | couvercle | Sb. Coq Cv1 | 6045.1 | XI |
| 1998 | 3328 | 22.5 | 1353 | 3 | Coupe 32 | 6045 | Sb. Coq | 2 | | | | | 2 | 1 | couvercle | Sb. Coq Cv4.1 | 6045.2 | XI |
| 1998 | 3328 | 22.5 | 1353 | 3 | Coupe 32 | 6045 | Sb. Coq | 2 | | | | | 2 | 1 | couvercle | Sb. Coq Cv4.2 | 6045.3 | XI |
| 1998 | 3328 | 22.5 | 1353 | 32 | Coupe 32 | 6045 | Com. Cl 2 | | | | | 71 | 71 | 1 | | | | |
| 1998 | 3328 | 22.5 | 1353 | 23 | Coupe 32 | 6045 | Com. Cl 1 | 1 | | 1 | | | 2 | 1 | cruche | Com. Cl Cr7.2 | 6045.4 | XII |
| 1998 | 3328 | 22.5 | 1353 | | Coupe 32 | 6045 | Com. Cl dorée | | | | | 1 | 1 | 1 | | | | |
| 1998 | 3328 | 22.5 | 1353 | | Coupe 32 | 6045 | Amp. | | | | | 5 | 5 | 1 | | | | |
| 1998 | 3328 | 22.5 | 4786 | | Coupe 32 | 6047 | TN | | | | 1 | | 1 | 1 | | | | |
| 1998 | 3328 | 22.5 | 4786 | | Coupe 32 | 6047 | TN/DTN | | | | | 2 | 2 | 1 | | | | |
| 1998 | 3328 | 22.5 | 4786 | | Coupe 32 | 6047 | RU Cl | | | | | 2 | 2 | 1 | | | | |
| 1998 | 3328 | 22.5 | 4786 | | Coupe 32 | 6047 | Sb. Coq | | | | | 1 | 1 | 1 | | | | |
| 1998 | 3328 | 22.5 | 4786 | | Coupe 32 | 6047 | Com. Cl | | | | | 1 | 1 | 1 | | | | |
| 1998 | 3328 | 22.5 | 4786 | | Coupe 33 | 6049 | TS CG | | | | | 1 | 1 | 1 | | | | |
| 1998 | 3328 | 22.5 | 4786 | | Coupe 33 | 6049 | TN | 2 | | | | | 2 | 1 | | | | |

ANNEXE B : RUE DE L' AMPHITHÉÂTRE – SECTEUR 6

| année | n° OA | Rayon | Caisse | n° ordre | structure | US | Catégorie | Comptage | | | | | | Typologie | Desc. Typo. | Dessin | Planche |
|-------|-------|-------|--------|----------|--------------|------|-----------|----------|---|---|---|----|----|-----------|-------------|------------|--------------------|
| | | | | | | | | B | F | A | D | P | NR | | | | |
| 1998 | 3328 | 22.5 | 4786 | | Coupe 33 | 6051 | TS AR | 1 | | | | | 1 | 1 | plat | Drag. 31 | |
| 1998 | 3328 | 22.5 | 4786 | | Latrine 6072 | 6056 | TS | 1 | | | 3 | | 4 | 1 | coupe | Drag. 37 | Rapport Pl 2 n°72 |
| 1998 | 3328 | 22.5 | 4786 | | Latrine 6072 | 6056 | TS SG | 5 | | | | | 5 | 1 | plat | Drag. 18b | Rapport Pl 2 n°67 |
| 1998 | 3328 | 22.5 | 4786 | | Latrine 6072 | 6056 | TS SG | 1 | | | | 2 | 3 | 1 | coupe | Drag. 27 | |
| 1998 | 3328 | 22.5 | 4786 | | Latrine 6072 | 6056 | TS SG | 4 | | | | | 4 | 1 | coupe | Drag. 27 | |
| 1998 | 3328 | 22.5 | 4786 | | Latrine 6072 | 6056 | TS CG | 2 | 4 | | | 2 | 8 | 1 | plat | Drag. 18 | Rapport Pl 2 n°74 |
| 1998 | 3328 | 22.5 | 4786 | | Latrine 6072 | 6056 | TS CG | 1 | | | | | 1 | 1 | coupe | Drag. 33 | Rapport Pl 2 n°39 |
| 1998 | 3328 | 22.5 | 4786 | | Latrine 6072 | 6056 | TS GE | 1 | | | | | 1 | 1 | plat | Drag. 18 | Rapport Pl 2 n°75 |
| 1998 | 3328 | 22.5 | 4786 | | Latrine 6072 | 6056 | EN | 5 | 2 | | | 20 | 27 | 1 | gobelet | Hees 2 | Rapport Pl 2 n°153 |
| 1998 | 3328 | 22.5 | 4786 | | Latrine 6072 | 6056 | EN MOS | 2 | | | | | 2 | 1 | gobelet | Hees 2 | Rapport Pl 2 n°175 |
| 1998 | 3328 | 22.5 | 4786 | | Latrine 6072 | 6056 | TN | 3 | 3 | | | 20 | 26 | 1 | pot | TNP54 | Rapport Pl 2 n°130 |
| 1998 | 3328 | 22.5 | 4786 | | Latrine 6072 | 6056 | RU CI | 6 | 5 | | | | 11 | 1 | plat | Nied. 110a | Rapport Pl 2 n°214 |

ANNEXE B : RUE DE L' AMPHITHÉÂTRE – SECTEUR 6

| année | n° OA | Rayon | Caisse | n° ordre | structure | US | Catégorie | Comptage | | | | | | Typologie | Desc. Typo. | Dessin | Planche |
|-------|-------|-------|--------|----------|-----------------|------|-----------|----------|---|---|---|---------|-----|-----------|-------------|------------------|-------------------------|
| | | | | | | | | B | F | A | D | P | NR | | | | |
| 1998 | 3328 | 22.5 | 4786 | | Latrine 6072 | 6056 | Sb. Coq | | 3 | | | 27 | 30 | 0 | | | |
| 1998 | 3328 | 22.5 | 4786 | 100 | Latrine 6072 | 6056 | Sb. Coq | 2 | | | | | 2 | 1 | pot | Sb. Coq P9.2 | 6056.1 XII |
| 1998 | 3328 | 22.5 | 4786 | 100 | Latrine 6072 | 6056 | Sb. Coq | 2 | | | | | 2 | 1 | pot | Sb. Coq P9.2 | 6056.2 XII |
| 1998 | 3328 | 22.5 | 4786 | 100 | Latrine 6072 | 6056 | Sb. Coq | 1 | | | | | 1 | 1 | couvercle | | 6056.3 XII |
| 1998 | 3328 | 22.5 | 4786 | | Latrine 6072 | 6056 | Com. Cl | | 5 | 3 | | 19 7 | 205 | 0 | | | |
| 1998 | 3328 | 22.5 | 4786 | 13 | Latrine 6072 | 6056 | Com. Cl 1 | 1 | | | | | 1 | 1 | cruche | Com. Cl Cr1.1 | 6056.4 XII |
| 1998 | 3328 | 22.5 | 4786 | 25 | Latrine 6072 | 6056 | Com. Cl 1 | 1 | | | | | 1 | 1 | cruche | Com. Cl Cr1.2 | 6056.5 XII |
| 1998 | 3328 | 22.5 | 4786 | 22 | Latrine 6072 | 6056 | Com. Cl 1 | 1 | | | | | 1 | 1 | cruche | Com. Cl Cr2.1 | 6056.6 XII |
| 1998 | 3328 | 22.5 | 4786 | 36 | Latrine 6072 | 6056 | Com. Cl 2 | 2 | | | | | 2 | 1 | cruche | Com. Cl Cr2.1 | 6056.7 XII |
| 1998 | 3328 | 22.5 | 4786 | 26 | Latrine 6072 | 6056 | Com. Cl 2 | 1 | | | | | 1 | 1 | cruche | Com. Cl Cr8 | 6056.8 XIII |
| 1998 | 3328 | 22.5 | 4786 | 27 | Latrine 6072 | 6056 | Mo | 1 | | | | | 1 | 1 | mortier | Mo2 | 6056.9 XIII |
| 1998 | 3328 | 22.5 | 4786 | 25 | Latrine 6072 | 6056 | Amp. | 1 | 2 | 2 | | 59 | 64 | 1 | amphore | Beltran II A | 6056.1 0 XIII |
| 1998 | 3328 | 22.5 | 4786 | | Latrine 6072 | 6057 | TS SG | 4 | 1 | | | 2 | 7 | 1 | coupelle | Drag. 27 | Rapport Pl 2 n°50 |
| 1998 | 3328 | 22.5 | 4786 | | Latrine 6072 | 6057 | Sb. Coq | | | | | 1 | 1 | 1 | | | |
| 1998 | 3328 | 22.5 | 4786 | | Latrine 6072 | 6057 | Com. Cl | | 1 | | | 16 | 17 | 1 | | | |

ANNEXE B : RUE DE L'AMPHITHÉÂTRE – SECTEUR 7

| année | n° OA | Rayon | Caisse | n° ordre | structure | US | Catégorie | Comptage | | | | | | | Typologie | Desc. Typo. | Dessin | Planche |
|-------|-------|-------|--------|----------|------------|------|-----------|----------|---|---|---|---|----|-----|-----------|---------------|--------|---------|
| | | | | | | | | B | F | A | D | P | NR | NMI | | | | |
| 1998 | 3328 | 22.4 | 4801 | | Décapage | 7000 | EN | 1 | | | | | 1 | 1 | gobelet | Hees 2 | | |
| 1998 | 3328 | 22.4 | 4801 | | Décapage | 7000 | MET | | 1 | | | | 1 | 1 | | | | |
| 1998 | 3328 | 22.4 | 4801 | | Décapage | 7000 | TR | 1 | | | | | 1 | 1 | bol | TRB1 | 7000.1 | XIV |
| 1998 | 3328 | 22.4 | 4801 | 2 | Décapage | 7000 | Com. Cl 2 | | | | | 2 | 2 | 1 | | | | |
| 1998 | 3328 | 22.4 | 4801 | | Décapage | 7000 | Amp. | | | | | 1 | 1 | 1 | | | | |
| 1998 | 3328 | 22.4 | 4801 | 1 | Puits 7003 | 7001 | Com. Cl 1 | 1 | | | | 1 | 2 | 1 | cruche | Com. Cl Cr1.1 | 7001.1 | XIV |
| 1998 | 3328 | 22.4 | 4801 | | Cave 7 | 7007 | TS | | 1 | | | 7 | 8 | 0 | | | | |
| 1998 | 3328 | 22.4 | 4801 | | Cave 7 | 7007 | TS GE | | | | | 2 | 2 | 1 | | | | |
| 1998 | 3328 | 22.4 | 4801 | | Cave 7 | 7007 | TS AR | 1 | 2 | | | 1 | 4 | 1 | coupe | Drag. 37 | | |
| 1998 | 3328 | 22.4 | 4801 | | Cave 7 | 7007 | TS AR | 1 | | | | | 1 | 1 | mortier | Drag. 45 | | |
| 1998 | 3328 | 22.4 | 4801 | | Cave 7 | 7007 | EN AR | 1 | | | | 1 | 2 | 1 | gobelet | Hees 2 | | |
| 1998 | 3328 | 22.4 | 4801 | | Cave 7 | 7007 | MET | | | | | 5 | 5 | 0 | | | | |
| 1998 | 3328 | 22.4 | 4801 | | Cave 7 | 7007 | MET AR | | | | | 7 | 7 | 1 | | | | |
| 1998 | 3328 | 22.4 | 4801 | | Cave 7 | 7007 | TN/DTN | | | | | 1 | 1 | 1 | | | | |
| 1998 | 3328 | 22.4 | 4801 | | Cave 7 | 7007 | TR | | | | | 6 | 6 | 1 | | | | |
| 1998 | 3328 | 22.4 | 4801 | | Cave 7 | 7007 | VRP | | | | | 2 | 2 | 1 | | | | |
| 1998 | 3328 | 22.4 | 4801 | 4 | Cave 7 | 7007 | Sb. Coq | 1 | | | | | 1 | 1 | couvercle | Sb. Coq Cv6.1 | 7007.1 | XIV |
| 1998 | 3328 | 22.4 | 4801 | 1 | Cave 7 | 7007 | Com. Cl 2 | 1 | 1 | | | 1 | 3 | 1 | cruche | Com. Cl Cr1.1 | 7007.2 | XIV |
| 1998 | 3328 | 22.4 | 4801 | | Cave 7 | 7007 | Amp. | | | 1 | | 1 | 2 | 1 | | | | |
| 1998 | 3328 | 22.4 | 4801 | | Cave 7 | 7010 | TS | 1 | | | | | 1 | 1 | plat | Drag. 18 | | |
| 1998 | 3328 | 22.4 | 4801 | | Cave 7 | 7010 | TS GE | 2 | | | | 4 | 6 | 1 | mortier | Drag. 45 | | |
| 1998 | 3328 | 22.4 | 4801 | | Cave 7 | 7010 | EN AR | 1 | 1 | | | 5 | 7 | 1 | gobelet | Hees 2 | | |
| 1998 | 3328 | 22.4 | 4801 | | Cave 7 | 7010 | EN AR | 1 | | | | | 1 | 1 | gobelet | Hees 2 | | |
| 1998 | 3328 | 22.4 | 4801 | | Cave 7 | 7010 | MET AR | | | | | 8 | 8 | 1 | | | | |
| 1998 | 3328 | 22.4 | 4801 | | Cave 7 | 7010 | TN/DTN | | | | | 1 | 1 | 1 | | | | |
| 1998 | 3328 | 22.4 | 4801 | | Cave 7 | 7010 | CB | | | | | 1 | 1 | 1 | | | | |
| 1998 | 3328 | 22.4 | 4801 | 3 | Cave 7 | 7010 | Sb. Coq | 2 | | | | 1 | 3 | 1 | couvercle | Sb. Coq Cv3.1 | 7010.1 | XIV |

ANNEXE B : RUE DE L'AMPHITHÉÂTRE – SECTEUR 7

| année | n° OA | Rayon | Caisse | n° ordre | structure | US | Catégorie | Comptage | | | | | | | Typologie | Desc. Typo. | Dessin | Planche |
|-------|-------|-------|--------|----------|----------------|------|-----------|----------|---|---|---|----|----|---------|-----------|---------------|--------|---------|
| | | | | | | | | B | F | A | D | P | NR | NMI | | | | |
| 1998 | 3328 | 22.4 | 4801 | | Cave 7 | 7010 | Com. Cl | | | 1 | | 5 | 6 | 1 | | | | |
| 1998 | 3328 | 22.4 | 4801 | | Cave 7 | 7020 | EN AR | 6 | 4 | | | 32 | 42 | 1 | gobelet | Hees 2 | | |
| 1998 | 3328 | 22.4 | 4801 | | Cave 7 | 7020 | EN AR | 5 | | | | 5 | 1 | gobelet | Hees 2 | | | |
| 1998 | 3328 | 22.4 | 4801 | 3 | Cave 7 | 7020 | Sb. Coq | 1 | | | | 1 | 2 | 1 | pot | Sb. Coq P1.1 | 7020.1 | XIV |
| 1998 | 3328 | 22.4 | 4801 | | Cave 7 | 7020 | Com. Cl | | | | | 5 | 5 | 1 | | | | |
| 1998 | 3328 | 22.4 | 4801 | 3 | Cave 7 | 7021 | EN AR | 1 | | | | 1 | 1 | 1 | gobelet | Hees 2 | 7021.1 | XIV |
| 1998 | 3328 | 22.4 | 4801 | 3 | Cave 7 | 7021 | EN AR | 4 | 1 | | | 5 | 10 | 1 | gobelet | Hees 2 | 7021.2 | XIV |
| 1998 | 3328 | 22.4 | 4801 | | Drain cave 7 | 7011 | TS AR | 1 | | | | 4 | 5 | 1 | coupe | Drag. 37 | | |
| 1998 | 3328 | 22.4 | 4801 | | Drain cave 7 | 7011 | EN | 1 | | | | 27 | 28 | 1 | | | | |
| 1998 | 3328 | 22.4 | 4801 | | Drain cave 7 | 7011 | MET | | 2 | | | 1 | 3 | 0 | | | | |
| 1998 | 3328 | 22.4 | 4801 | | Drain cave 7 | 7011 | MET AR | 1 | | | | 18 | 19 | 1 | gobelet | Nied. 33 | | |
| 1998 | 3328 | 22.4 | 4801 | | Drain cave 7 | 7011 | TN/DTN | | | | | 6 | 6 | 1 | | | | |
| 1998 | 3328 | 22.4 | 4801 | 5 | Drain cave 7 | 7011 | Sb. Coq | 1 | | | | 1 | 1 | 1 | bouteille | Sb. Coq Bt1.1 | 7011.1 | XIV |
| 1998 | 3328 | 22.4 | 4801 | 5 | Drain cave 7 | 7011 | Sb. Coq | 1 | | | | 1 | 1 | 1 | pot | Sb. Coq P5.3 | 7011.2 | XIV |
| 1998 | 3328 | 22.4 | 4801 | 5 | Drain cave 7 | 7011 | Sb. Coq | 1 | | | | 1 | 1 | 1 | couvercle | Sb. Coq Cv2.1 | 7011.3 | XV |
| 1998 | 3328 | 22.4 | 4801 | 5 | Drain cave 7 | 7011 | Sb. Coq | 1 | | | | 1 | 1 | 1 | couvercle | Sb. Coq Cv3.1 | 7011.4 | XV |
| 1998 | 3328 | 22.4 | 4801 | 4 | Drain cave 7 | 7011 | Com. Cl 2 | 1 | 1 | | | 6 | 8 | 1 | cruche | Com. Cl Cr1.1 | 7011.5 | XV |
| 1998 | 3328 | 22.4 | 4801 | | Puisard cave 7 | 7012 | TS GE | | | | | 2 | 2 | 1 | coupe | Drag. 37 | | |
| 1998 | 3328 | 22.4 | 4801 | | Puisard cave 7 | 7012 | EN AR | 1 | 2 | | | 23 | 26 | 1 | gobelet | Hees 2 | | |
| 1998 | 3328 | 22.4 | 4801 | | Puisard cave 7 | 7012 | TN | 3 | 1 | | | 4 | 1 | 1 | bol | TNB18 | 7012.1 | XV |
| 1998 | 3328 | 22.4 | 4801 | 3 | Puisard cave 7 | 7012 | Sb. Coq | 1 | | | | 3 | 4 | 1 | couvercle | Sb. Coq Cv5 | 7012.2 | XV |
| 1998 | 3328 | 22.4 | 4801 | | Puisard cave 7 | 7012 | Com. Cl | | | | | 13 | 13 | 1 | | | | |

ANNEXE B : RUE DE L'AMPHITHÉÂTRE – SECTEUR 8

| année | n° OA | Rayon | Caisse | n° ordre | structure | US | Catégorie | Comptage | | | | | | | Typologie | Desc. Typo. | Dessin | Planche |
|-------|-------|-------|--------|----------|-----------|------|-----------|----------|---|---|---|---|----|-----|-----------|-------------|--------|---------|
| | | | | | | | | B | F | A | D | P | NR | NMI | | | | |
| 1998 | 3328 | 22.3 | 6727 | | Cave 8 | 023 | TS GE | | 1 | | | 1 | 2 | 1 | | | | |
| 1998 | 3328 | 22.3 | 6727 | | Cave 8 | 023 | EN AR | 1 | | | | 2 | 3 | 1 | gobelet | Hees 2 | | |
| 1998 | 3328 | 22.3 | 6727 | | Cave 8 | 023 | TN | | | | | 3 | 3 | 1 | | | | |
| 1998 | 3328 | 22.3 | 6727 | | Cave 8 | 023 | Sb. Coq | | | | | 6 | 6 | 1 | | | | |
| 1998 | 3328 | 22.4 | 4801 | | Remblai | 8004 | TS SG | | | | | 1 | 1 | 1 | | | | |
| 1998 | 3328 | 22.4 | 4801 | | Remblai | 8004 | TN/DTN | 1 | | | | 7 | 8 | 1 | | | | |
| 1998 | 3328 | 22.4 | 4801 | | Remblai | 8004 | Sb. Coq | | | | | 1 | 1 | 1 | | | | |
| 1998 | 3328 | 22.4 | 4801 | | Remblai | 8004 | Com. Cl | | | | | 4 | 4 | 1 | | | | |
| 1998 | 3328 | 22.4 | 4801 | | Remblai | 8004 | Amp. | | | | | 1 | 1 | 1 | | | | |

ANNEXE B : RUE DE L'AMPHITHÉÂTRE – SECTEUR 9

| année | n° OA | Rayon | Caisse | n° ordre | structure | US | Catégorie | Comptage | | | | | | Typologie | Desc. Typo. | Dessin | Planche | |
|-------|-------|-------|--------|----------|---------------|------|-----------|----------|---|---|---|----|----|-----------|-------------|---------------|---------|-----|
| | | | | | | | | B | F | A | D | P | NR | | | | | NMI |
| 1998 | 3328 | 22.3 | 6727 | | Cave 9 | 9008 | TS GE | 1 | | | | 1 | 1 | coupe | Drag. 37 | | | |
| 1998 | 3328 | 22.3 | 6727 | | Cave 9 | 9008 | EN | | | | | 1 | 1 | | | | | |
| 1998 | 3328 | 22.3 | 6727 | | Cave 9 | 9008 | TN/DTN | | | | | 11 | 11 | 1 | | | | |
| 1998 | 3328 | 22.3 | 6727 | | Cave 9 | 9008 | RU CI | | | | | 1 | 1 | 1 | | | | |
| 1998 | 3328 | 22.3 | 6727 | 3 | Cave 9 | 9008 | Sb. Coq | 6 | 1 | | | 20 | 27 | 1 | pot | Sb. Coq P5.1 | 9008.1 | XVI |
| 1998 | 3328 | 22.3 | 6727 | | Cave 9 | 9008 | Com. CI | | | | | 3 | 3 | 1 | | | | |
| 1998 | 3328 | 22.3 | 6727 | | Couche occup. | 9010 | TS | 1 | | | | 0 | 1 | 1 | coupe | Drag. 37 | | |
| 1998 | 3328 | 22.3 | 6727 | | Couche occup. | 9010 | TS SG | | 2 | | | 2 | 4 | 1 | | | | |
| 1998 | 3328 | 22.3 | 6727 | | Couche occup. | 9010 | TS GE | | | | | 2 | 2 | 1 | | | | |
| 1998 | 3328 | 22.3 | 6727 | | Couche occup. | 9010 | EN | | | | | 1 | 1 | 1 | | | | |
| 1998 | 3328 | 22.3 | 6727 | | Couche occup. | 9010 | MET | | | | | 3 | 3 | 1 | | | | |
| 1998 | 3328 | 22.3 | 6727 | 1 | Couche occup. | 9010 | TN | 1 | | | | 6 | 7 | 1 | pot | TNP10 | 9010.1 | XVI |
| 1998 | 3328 | 22.3 | 6727 | | Couche occup. | 9010 | CB | | 1 | | | 4 | 5 | 1 | | | | |
| 1998 | 3328 | 22.3 | 6727 | | Couche occup. | 9010 | Sb. Coq | | 3 | | | 19 | 22 | 0 | | | | |
| 1998 | 3328 | 22.3 | 6727 | 3 | Couche occup. | 9010 | Sb. Coq | 1 | | | | | 1 | 1 | plat | Sb. Coq P14 | 9010.2 | XVI |
| 1998 | 3328 | 22.3 | 6727 | 3 | Couche occup. | 9010 | Sb. Coq | 2 | | | | | 2 | 1 | pot | Sb. Coq P7.1 | 9010.3 | XVI |
| 1998 | 3328 | 22.3 | 6727 | 3 | Couche occup. | 9010 | Sb. Coq | 1 | | | | | 1 | 1 | pot | Sb. Coq P10.3 | 9010.4 | XVI |
| 1998 | 3328 | 22.3 | 6727 | 3 | Couche occup. | 9010 | Sb. Coq | 1 | | | | | 1 | 1 | couvercle | Sb. Coq Cv3.1 | 9010.5 | XVI |
| 1998 | 3328 | 22.3 | 6727 | | Couche occup. | 9010 | Com. CI | | | | | 8 | 8 | 1 | | | | |
| 1998 | 3328 | 22.3 | 6727 | | Couche occup. | 9010 | Amp. | | | | | 1 | 1 | 1 | | | | |

ANNEXE B : RUE DE L'AMPHITHÉÂTRE – SECTEUR 10

| année | n° OA | Rayon | Caisse | n° ordre | structure | US | Catégorie | Comptage | | | | | | Typologie | Desc. Typo. | Dessin | Planche | |
|-------|-------|-------|--------|----------|---------------|-------|-----------|----------|---|---|---|---|----|-----------|-------------|-------------|----------|--------------------|
| | | | | | | | | B | F | A | D | P | NR | | | | | NMI |
| 1998 | 3328 | 22.2 | 6741 | | Coupe 5 | 10004 | Com. Cl | | | | | 1 | 1 | 1 | | | | |
| 1998 | 3328 | 22.2 | 6741 | | Coupe 5 | 10007 | TS SG | | | | | 1 | 1 | 1 | | | | |
| 1998 | 3328 | 22.2 | 6741 | | Coupe 5 | 10010 | Com. Cl | | | | | 1 | 1 | 1 | | | | |
| 1998 | 3328 | 22.5 | 1353 | | Citerne 10009 | 10022 | TS | | 1 | 1 | | | | 2 | 0 | | | |
| 1998 | 3328 | 22.5 | 1353 | 4 | Citerne 10009 | 10022 | TS GE | 1 | 1 | | | | | 2 | 1 | coupe | Drag. 43 | Rapport Pl 3 n°15 |
| 1998 | 3328 | 22.5 | 1353 | 4 | Citerne 10009 | 10022 | TS GE | | 1 | | | | 1 | 1 | coupe | Drag. 37 | | Rapport Pl 3 n°26 |
| 1998 | 3328 | 22.5 | 1353 | | Citerne 10009 | 10022 | MET AR | | 1 | | | 5 | 6 | 0 | | | | |
| 1998 | 3328 | 22.5 | 1353 | 4 | Citerne 10009 | 10022 | MET AR | 1 | | | | | 1 | 1 | gobelet | Nied. 33 | 10022. 1 | XVII |
| 1998 | 3328 | 22.5 | 1353 | 4 | Citerne 10009 | 10022 | MET AR | 2 | | | | | 2 | 1 | gobelet | Nied. 33 | | Rapport Pl 3 n°170 |
| 1998 | 3328 | 22.5 | 1353 | | Citerne 10009 | 10022 | TN/DTN | | | | | 1 | 1 | 1 | | | | |
| 1998 | 3328 | 22.5 | 1353 | 4 | Citerne 10009 | 10022 | RU UR | 1 | | | | | 1 | 1 | plat | Nied. 112 | 10022. 2 | XVII |
| 1998 | 3328 | 22.5 | 1353 | | Citerne 10009 | 10022 | CB | | 1 | | | 1 | 2 | 1 | | | | |
| 1998 | 3328 | 22.5 | 1353 | | Citerne 10009 | 10022 | Sb. Coq | | 1 | | | 5 | 6 | 0 | | | | |
| 1998 | 3328 | 22.5 | 1353 | 4 | Citerne 10009 | 10022 | Sb. Coq | 2 | | | | | 2 | 1 | plat | Sb. Coq Pl3 | 10022. 3 | XVII |
| 1998 | 3328 | 22.5 | 1353 | 4 | Citerne 10009 | 10022 | Sb. Coq | 1 | | | | | 1 | 1 | pot | Sb. Coq P3 | 10022. 4 | XVII |
| 1998 | 3328 | 22.5 | 1353 | | Citerne 10009 | 10022 | Com. Cl | | | | | 3 | 3 | 1 | | | | |

ANNEXE B : RUE DE L'AMPHITHÉÂTRE – SECTEUR 10

| année | n° OA | Rayon | Caisse | n° ordre | structure | US | Catégorie | Comptage | | | | | | Typologie | Desc. Typo. | Dessin | Planche | | |
|-------|-------|-------|--------|----------|------------------|-------|-----------|----------|---|---|---|---|----|-----------|-------------|---------|-----------------|---------------------------|------|
| | | | | | | | | B | F | A | D | P | NR | | | | | NMI | |
| 1998 | 3328 | 22.5 | 1353 | 17 | Citerne 10009 | 10022 | Mo | 1 | | | | | | 1 | 1 | mortier | Mo3.2 | 10022. 5 | XVII |
| 1998 | 3328 | 22.2 | 6735 | | Citerne 10009 | 10023 | TS SG | | 1 | | | | | 1 | 1 | | | | |
| 1998 | 3328 | 22.2 | 6735 | | Citerne 10009 | 10023 | TS GE | | | | | | 1 | 1 | 1 | | | | |
| 1998 | 3328 | 22.2 | 6735 | | Citerne 10009 | 10023 | EN | | | | | | 1 | 1 | 1 | | | | |
| 1998 | 3328 | 22.2 | 6735 | | Citerne 10009 | 10023 | MET AR | 1 | | | | | 2 | 3 | 1 | gobelet | Nied. 33 | 10023. 1 | XVII |
| 1998 | 3328 | 22.2 | 6735 | 3 | Citerne 10009 | 10023 | TN | 1 | | | | | | 1 | 1 | pot | TNP10 | 10023. 2 | XVII |
| 1998 | 3328 | 22.2 | 6735 | 3 | Citerne 10009 | 10023 | TN | 1 | | | | | | 1 | 1 | calice | TNKL 22 | Rapport Pl 3 n°202 | |
| 1998 | 3328 | 22.2 | 6735 | 3 | Citerne 10009 | 10023 | CB | 1 | | | | | | 1 | 1 | plat | Reims A6 | 10023. 3 | XVII |
| 1998 | 3328 | 22.2 | 6735 | 3 | Citerne 10009 | 10023 | CB | 1 | | | | | | 1 | 1 | jatte | Reims J40 | Rapport Pl. 3 n°144 | |
| 1998 | 3328 | 22.2 | 6735 | | Citerne 10009 | 10023 | Sb. Coq | | | | | | 3 | 3 | 0 | | | | |
| 1998 | 3328 | 22.2 | 6735 | 3 | Citerne 10009 | 10023 | Sb. Coq | 1 | | | | | | 1 | 1 | pot | Sb. Coq P5.1 | 10023. 4 | XVII |
| 1998 | 3328 | 22.2 | 6735 | 3 | Citerne 10009 | 10023 | Sb. Coq | 1 | | | | | | 1 | 1 | pot | Sb. Coq P6.3 | 10023. 5 | XVII |
| 1998 | 3328 | 22.2 | 6735 | 5 | Citerne 10009 | 10023 | Com. Cl | | | | | | 5 | 5 | 0 | | | | |
| 1998 | 3328 | 22.2 | 6735 | | Citerne 10009 | 10023 | Com. Cl 3 | 1 | | | | | | 1 | 1 | pot | Com. Cl P4.1 | 10023. 6 | XVII |
| 1998 | 3328 | 22.2 | 6735 | 1 | Citerne 10009 | 10023 | Mo | 1 | | | | | | 1 | 1 | mortier | Mo1.2 | 10023. 7 | XVII |

ANNEXE B : RUE DE L'AMPHITHÉÂTRE – SECTEUR 10

| année | n° OA | Rayon | Caisse | n° ordre | structure | US | Catégorie | Comptage | | | | | | Typologie | Desc. Typo. | Dessin | Planche |
|-------|-------|-------|--------|----------|------------------|-------|-----------|----------|---|---|---|---|----|-----------|-------------|----------|-------------------------|
| | | | | | | | | B | F | A | D | P | NR | | | | |
| 1998 | 3328 | 22.2 | 6735 | | Citerne 10009 | 10027 | TS GE | | 2 | | | 6 | 8 | 0 | | | |
| 1998 | 3328 | 22.2 | 6735 | | Citerne 10009 | 10027 | TS GE | 1 | | | | | 1 | 1 | coupe | Drag. 38 | Rapport Pl 3 n°2 |
| 1998 | 3328 | 22.2 | 6735 | | Citerne 10009 | 10027 | TS GE | | | | 1 | | 1 | 1 | coupe | Drag. 37 | Rapport Pl 3 n°13 |
| 1998 | 3328 | 22.2 | 6735 | | Citerne 10009 | 10027 | TS GE | 1 | | | | | 1 | 1 | coupe | Drag. 40 | Rapport Pl 3 n°14 |
| 1998 | 3328 | 22.2 | 6735 | | Citerne 10009 | 10027 | TS GE | 1 | | | | | 1 | 1 | coupe | Drag. 37 | Rapport Pl 3 n°16 |
| 1998 | 3328 | 22.2 | 6735 | | Citerne 10009 | 10027 | TS GE | 1 | | | | | 1 | 1 | coupe | Drag. 37 | Rapport Pl 3 n°18 |
| 1998 | 3328 | 22.2 | 6735 | | Citerne 10009 | 10027 | TS GE | 1 | | | | | 1 | 1 | coupe | Drag. 37 | Rapport Pl 3 n°19 |
| 1998 | 3328 | 22.2 | 6735 | | Citerne 10009 | 10027 | TS AR | | 3 | | | 1 | 4 | 0 | | | |
| 1998 | 3328 | 22.2 | 6735 | | Citerne 10009 | 10027 | TS AR | 1 | | | | | 1 | 1 | coupe | Drag. 37 | Rapport Pl 3 n°73 |
| 1998 | 3328 | 22.2 | 6735 | | Citerne 10009 | 10027 | TS AR | 1 | | | | | 1 | 1 | coupe | Drag. 37 | Rapport Pl 3 n°58 |
| 1998 | 3328 | 22.2 | 6735 | | Citerne 10009 | 10027 | TS AR | 4 | | | | | 4 | 1 | mortier | Drag. 45 | Rapport Pl 3 n°81 |
| 1998 | 3328 | 22.2 | 6735 | | Citerne | 10027 | EN AR | 1 | | | | | 1 | 1 | gobelet | Hees 2 | 10027. XVIII |

ANNEXE B : RUE DE L'AMPHITHÉÂTRE – SECTEUR 10

| année | n° OA | Rayon | Caisse | n° ordre | structure | US | Catégorie | Comptage | | | | | | Typologie | Desc. Typo. | Dessin | Planche | |
|-------|-------|-------|--------|----------|------------------|-------|-----------|----------|---|---|---|----|----|-----------|-------------|-----------|--------------------------|-------|
| | | | | | | | | B | F | A | D | P | NR | | | | | NMI |
| | | | | | 10009 | | | | | | | | | | 1 | | | |
| 1998 | 3328 | 22.2 | 6735 | | Citerne 10009 | 10027 | EN AR | 1 | 1 | | | 16 | 18 | 1 | gobelet | Hees 2 | Rapport Pl 3 n°189 | |
| 1998 | 3328 | 22.2 | 6735 | | Citerne 10009 | 10027 | MET | | | | | 3 | 3 | 1 | | | | |
| 1998 | 3328 | 22.2 | 6735 | | Citerne 10009 | 10027 | MET AR | | 4 | | | 42 | 46 | 0 | | | | |
| 1998 | 3328 | 22.2 | 6735 | 4 | Citerne 10009 | 10027 | MET AR | 2 | | | | | 2 | 1 | gobelet | Nied. 33 | | |
| 1998 | 3328 | 22.2 | 6735 | 4 | Citerne 10009 | 10027 | MET AR | 1 | | | | | 1 | 1 | gobelet | Nied. 33 | 10027. 2 | XVIII |
| 1998 | 3328 | 22.2 | 6735 | 4 | Citerne 10009 | 10027 | MET AR | 1 | | | | | 1 | 1 | gobelet | Nied. 33 | | |
| 1998 | 3328 | 22.2 | 6735 | | Citerne 10009 | 10027 | MET TR | | | | | 3 | 3 | 1 | | | | |
| 1998 | 3328 | 22.2 | 6735 | | Citerne 10009 | 10027 | TN/DTN | | | | | 9 | 9 | 1 | | | | |
| 1998 | 3328 | 22.2 | 6735 | 4 | Citerne 10009 | 10027 | RU UR | 1 | | | | 1 | 2 | 1 | jatte | Nied. 104 | 10027. 3 | XVIII |
| 1998 | 3328 | 22.2 | 6735 | 4 | Citerne 10009 | 10027 | RU UR | 2 | | | | | 2 | 1 | jatte | Nied. 104 | 10027. 4 | XVIII |
| 1998 | 3328 | 22.2 | 6735 | 4 | Citerne 10009 | 10027 | RU UR | 2 | | | | | 2 | 1 | plat | Nied. 112 | 10027. 5 | XVIII |
| 1998 | 3328 | 22.2 | 6735 | 4 | Citerne 10009 | 10027 | RU UR | 2 | | | | 12 | 14 | 1 | jatte | Nied. 104 | 10027. 6 | XVIII |
| 1998 | 3328 | 22.2 | 6735 | | Citerne 10009 | 10027 | RU S | | | | | 1 | 1 | 1 | | | | |
| 1998 | 3328 | 22.2 | 6735 | | Citerne 10009 | 10027 | CB | | 1 | | | 10 | 11 | 0 | | | | |
| 1998 | 3328 | 22.2 | 6735 | 4 | Citerne 10009 | 10027 | CB | 1 | | | | | 1 | 1 | jatte | Reims J4 | 10027. 7 | XVIII |

ANNEXE B : RUE DE L'AMPHITHÉÂTRE – SECTEUR 10

| année | n° OA | Rayon | Caisse | n° ordre | structure | US | Catégorie | Comptage | | | | | | Typologie | Desc. Typo. | Dessin | Planche | |
|-------|-------|-------|--------|----------|------------------|-------|-----------|----------|---|---|---|----|----|-----------|-------------|------------------|--------------|-------|
| | | | | | | | | B | F | A | D | P | NR | | | | | NMI |
| 1998 | 3328 | 22.2 | 6735 | 4 | Citerne 10009 | 10027 | CB | 1 | | | | | 1 | 1 | jatte | Reims J4 | 10027. 8 | XVIII |
| 1998 | 3328 | 22.2 | 6735 | 4 | Citerne 10009 | 10027 | CB | 1 | | | | | 1 | 1 | pot | Reims P16 | 10027. 9 | XVIII |
| 1998 | 3328 | 22.2 | 6735 | 4 | Citerne 10009 | 10027 | CB | 1 | | | | | 1 | 1 | pot | Reims P16 | 10027. 10 | XVIII |
| 1998 | 3328 | 22.2 | 6735 | | Citerne 10009 | 10027 | Sb. Coq | | 1 | | | 12 | 13 | 0 | | | | |
| 1998 | 3328 | 22.2 | 6735 | 4 | Citerne 10009 | 10027 | Sb. Coq | 1 | | | | | 1 | 1 | plat | Sb. Coq P11.1 | 10027. 11 | XVIII |
| 1998 | 3328 | 22.2 | 6735 | 4 | Citerne 10009 | 10027 | Sb. Coq | 2 | | | | | 2 | 1 | plat | Sb. Coq P14 | 10027. 12 | XVIII |
| 1998 | 3328 | 22.2 | 6735 | 4 | Citerne 10009 | 10027 | Sb. Coq | 2 | | | | | 2 | 1 | pot | Sb. Coq P3 | 10027. 13 | XVIII |
| 1998 | 3328 | 22.2 | 6735 | 4 | Citerne 10009 | 10027 | Sb. Coq | 1 | | | | | 1 | 1 | couvercle | Sb. Coq Cv3.1 | 10027. 14 | XVIII |
| 1998 | 3328 | 22.2 | 6735 | 4 | Citerne 10009 | 10027 | Sb. Coq | 1 | | | | | 1 | 1 | couvercle | Sb. Coq Cv5 | 10027. 15 | XIX |
| 1998 | 3328 | 22.2 | 6735 | 10 | Citerne 10009 | 10027 | Com. Cl 2 | 1 | | | | | 1 | 1 | couvercle | Com. Cl Cv1 | 10027. 16 | XIX |
| 1998 | 3328 | 22.2 | 6735 | 57 | Citerne 10009 | 10027 | Com. Cl 2 | 6 | | | | | 6 | 1 | cruche | Com. Cl Cr2.2 | 10027. 17 | XIX |
| 1998 | 3328 | 22.2 | 6735 | 55 | Citerne 10009 | 10027 | Com. Cl 2 | 4 | | | | | 4 | 1 | cruche | | 10027. 18 | XIX |
| 1998 | 3328 | 22.2 | 6735 | 4 | Citerne 10009 | 10027 | Com. Cl 3 | 2 | | | | | 2 | 1 | plat | Com. Cl P11.3 | 10027. 19 | XIX |
| 1998 | 3328 | 22.2 | 6735 | | Citerne 10009 | 10027 | Com. Cl | | 3 | 3 | | 62 | 68 | 0 | | | | |
| 1998 | 3328 | 22.2 | 6735 | 50 | Citerne 10009 | 10027 | Amp. | 5 | | | | | 5 | 1 | amphore | Speicher 29 | 10027. 20 | XIX |
| 1998 | 3328 | 22.2 | 6735 | 54 | Citerne 10009 | 10027 | Amp. | 1 | | 1 | | 11 | 13 | 1 | amphore | Gauloise 4 | 10027. 21 | XIX |

ANNEXE B : RUE DE L'AMPHITHÉÂTRE – SECTEUR 10

| année | n° OA | Rayon | Caisse | n° ordre | structure | US | Catégorie | Comptage | | | | | | Typologie | Desc. Typo. | Dessin | Planche |
|-------|-------|-------|--------|----------|-------------------|-------|-----------|----------|---|---|---|---|----|-----------|-------------|--------|---------|
| | | | | | | | | B | F | A | D | P | NR | | | | |
| 1998 | 3328 | 22.2 | 6735 | | Couche occupation | 10026 | Sb. Coq | | | | | 1 | 1 | 1 | | | |
| 1998 | 3328 | 22.2 | 6735 | | Couche occupation | 10026 | CB | | | | | 1 | 1 | 1 | | | |
| 1998 | 3328 | 22.2 | 6735 | | Couche occupation | 10026 | Com. Cl | | | | | 4 | 4 | 1 | | | |

ANNEXE B : RUE DE L' AMPHITHÉÂTRE - DÉCAPAGE

| année | n° OA | Rayon | Caisse | n° ordre | structure | US | Catégorie | Comptage | | | | | | | Typologie | Desc. Typo. | Dessin | Planche |
|-------|-------|-------|--------|----------|-----------|-----|-----------|----------|---|---|---|----|----|-----|-----------|-------------|--------|---------|
| | | | | | | | | B | F | A | D | P | NR | NMI | | | | |
| 1998 | 3328 | 22.2 | 6735 | | Décapage | 001 | TS SG | | 2 | | | | 2 | 1 | | | | |
| 1998 | 3328 | 22.2 | 6735 | 23 | Décapage | 001 | TN | 1 | | | | | 1 | 1 | bol | TNB1.4 | 001.1 | XX |
| 1998 | 3328 | 22.2 | 6735 | 23 | Décapage | 001 | TN | 1 | 2 | | | 21 | 24 | 1 | bol | TNB1 | 001.2 | XX |
| 1998 | 3328 | 22.2 | 6735 | | Décapage | 001 | TN | 1 | | | | | 1 | 1 | bol | TNB1 | | |
| 1998 | 3328 | 22.2 | 6735 | | Décapage | 001 | RU Cl | | | | | 1 | 1 | 1 | | | | |
| 1998 | 3328 | 22.2 | 6735 | | Décapage | 001 | Sb. Coq | | | | | 1 | 1 | 1 | | | | |
| 1998 | 3328 | 22.2 | 6735 | | Décapage | 001 | Com. Cl | | | 1 | | 11 | 12 | 1 | | | | |
| 1998 | 3328 | 22.2 | 6735 | 10 | Décapage | 001 | Mo | 1 | | | | | 1 | 1 | mortier | Mo6 | 001.3 | XX |
| 1998 | 3328 | 22.2 | 6735 | | Décapage | 001 | Amp. | | | | | 1 | 1 | 1 | | | | |

ANNEXE B : RUE DE L'AMPHITHÉÂTRE – SONDAGE 2

| année | n° OA | Rayon | Caisse | n° ordre | structure | US | Catégorie | Comptage | | | | | | | Typologie | Desc. Typo. | Dessin | Planche |
|-------|-------|-------|--------|----------|-----------|------------|-----------|----------|---|---|---|---|----|-----|-----------|--------------|--------|---------|
| | | | | | | | | B | F | A | D | P | NR | NMI | | | | |
| 1998 | 3328 | 22.2 | 6735 | | S2 | S2/R. cave | TS | 1 | | | | | 1 | 1 | coupe | Drag. 44 | | |
| 1998 | 3328 | 22.2 | 6735 | | S2 | S2/R. cave | TS | | | | | 1 | 1 | 1 | coupe | Drag. 37 | | |
| 1998 | 3328 | 22.2 | 6735 | | S2 | S2/R. cave | TS GE | 1 | | | | | 1 | 1 | coupe | Drag. 37 | | |
| 1998 | 3328 | 22.2 | 6735 | | S2 | S2/R. cave | TS AR | | | | | 1 | 1 | 1 | | | | |
| 1998 | 3328 | 22.2 | 6735 | | S2 | S2/R. cave | EN AR | 1 | | | | 1 | 2 | 1 | gobelet | Hees 2 | | |
| 1998 | 3328 | 22.2 | 6735 | | S2 | S2/R. cave | EN AR | 2 | | | | | 2 | 1 | gobelet | Hees 2 | | |
| 1998 | 3328 | 22.2 | 6735 | | S2 | S2/R. cave | MET AR | 1 | 2 | | | 5 | 8 | 1 | gobelet | Nied. 33 | | |
| 1998 | 3328 | 22.2 | 6735 | | S2 | S2/R. cave | MET TR | | | | | 1 | 1 | 1 | | | | |
| 1998 | 3328 | 22.2 | 6735 | | S2 | S2/R. cave | TN/DTN | | | | | 2 | 2 | 1 | | | | |
| 1998 | 3328 | 22.2 | 6735 | 13 | S2 | S2/R. cave | RU UR | 1 | | | | 1 | 2 | 1 | jatte | Nied. 104 | S2.1 | XXI |
| 1998 | 3328 | 22.2 | 6735 | | S2 | S2/R. cave | RU Cl | | | | | 1 | 1 | 1 | | | | |
| 1998 | 3328 | 22.2 | 6735 | 13 | S2 | S2/R. cave | CB | 1 | | | | 2 | 3 | 1 | plat | Reims A1 | S2.2 | XXI |
| 1998 | 3328 | 22.2 | 6735 | 5 | S2 | S2/R. cave | Sb. Coq | 1 | | | | | 1 | 1 | pot | Sb. Coq P9.2 | S2.3 | XXI |
| 1998 | 3328 | 22.2 | 6735 | 5 | S2 | S2/R. cave | Sb. Coq | 1 | | | | | 1 | 1 | couvercle | Sb. Coq Cv5 | S2.4 | XXI |
| 1998 | 3328 | 22.2 | 6735 | 1 | S2 | S2/R. cave | Mo | 3 | | | | | 3 | 1 | mortier | Mo1.2 | S2.5 | XXI |
| 1998 | 3328 | 22.2 | 6735 | 1 | S2 | S2/R. cave | Amp. | 1 | | | | | 1 | 1 | amphore | Dressel 20 | S2.6 | XXI |

ANNEXE B : RUE DE L'AMPHITHÉÂTRE – SONDAGE 3

| année | n° OA | Rayon | Caisse | n° ordre | structure | US | Catégorie | Comptage | | | | | | | Typologie | Desc. Typo. | Dessin | Planche |
|-------|-------|-------|--------|----------|-----------|---------------|-----------|----------|---|---|---|----|----|-----|-----------|------------------|--------|---------|
| | | | | | | | | B | F | A | D | P | NR | NMI | | | | |
| 1998 | 3328 | 22.2 | 6744 | | S3 | S3/fosse arg. | MET AR | | | | | 4 | 4 | 1 | | | | |
| 1998 | 3328 | 22.2 | 6744 | | S3 | S3/fosse arg. | TN/DTN | | | | | 1 | 1 | 1 | | | | |
| 1998 | 3328 | 22.2 | 6744 | | S3 | S3/fosse arg. | RU UR | | 1 | | | | 1 | 1 | | | | |
| 1998 | 3328 | 22.2 | 6744 | 7 | S3 | S3/fosse arg. | Sb. Coq | 1 | | | | 1 | 2 | 1 | jatte | Sb. Coq J/M1 | S3.1 | XXII |
| 1998 | 3328 | 22.2 | 6744 | | S3 | S3/fosse arg. | Com. Cl | | | | | 3 | 3 | 1 | | | | |
| 1998 | 3328 | 22.2 | 6735 | | S3 | S3,piégeage | TS SG | 1 | | | | | 1 | 1 | assiette | Drag. 16 | | |
| 1998 | 3328 | 22.2 | 6735 | | S3 | S3,piégeage | TS SG | 1 | | | | | 1 | 1 | assiette | Drag. 18 | | |
| 1998 | 3328 | 22.2 | 6735 | | S3 | S3,piégeage | TS SG | 1 | | | | | 1 | 1 | coupe | Vernhet A1 | | |
| 1998 | 3328 | 22.2 | 6735 | | S3 | S3,piégeage | TS SG | 1 | | | | | 1 | 1 | coupe | Vernhet A1 | | |
| 1998 | 3328 | 22.2 | 6735 | | S3 | S3,piégeage | TS SG | 1 | | | | | 1 | 1 | coupe | Vernhet A1 | | |
| 1998 | 3328 | 22.2 | 6735 | | S3 | S3,piégeage | TS SG | 1 | | | | | 1 | 1 | coupe | Vernhet A1 | | |
| 1998 | 3328 | 22.2 | 6735 | | S3 | S3,piégeage | TS GE | 1 | | | | | 1 | 1 | coupe | Drag. 37 | | |
| 1998 | 3328 | 22.2 | 6735 | | S3 | S3,piégeage | TN/DTN | | 2 | | | 48 | 50 | 0 | | | | |
| 1998 | 3328 | 22.2 | 6735 | 5 | S3 | S3,piégeage | TN | 2 | | | | | 2 | 1 | bol | TNB1 | S3p.1 | XXII |
| 1998 | 3328 | 22.2 | 6735 | 5 | S3 | S3,piégeage | TN | 1 | | | | | 1 | 1 | bol | TNB1 | S3p.2 | XXII |
| 1998 | 3328 | 22.2 | 6735 | 5 | S3 | S3,piégeage | TN | 1 | | | | | 1 | 1 | bol | TNB1 | S3p.3 | XXII |
| 1998 | 3328 | 22.2 | 6735 | | S3 | S3,piégeage | TR | | | | | 1 | 1 | 1 | | | | |
| 1998 | 3328 | 22.2 | 6735 | | S3 | S3,piégeage | RU Cl | | | | | 2 | 2 | 1 | | | | |
| 1998 | 3328 | 22.2 | 6735 | 7 | S3 | S3,piégeage | Sb. Coq | 1 | | | | | 1 | 1 | jatte | Sb. Coq J2.2 | S3p.4 | XXII |
| 1998 | 3328 | 22.2 | 6735 | 7 | S3 | S3,piégeage | Sb. Coq | 1 | | | | 6 | 7 | 1 | pot | Sb. Coq P5.1 | S3p.5 | XXII |
| 1998 | 3328 | 22.2 | 6735 | 2 | S3 | S3,piégeage | Com. Cl 2 | 1 | | | | 15 | 16 | 1 | cruche | Com. Cl Cr1.1 | S3p.6 | XXII |
| 1998 | 3328 | 22.2 | 6735 | 4 | S3 | S3,piégeage | Do | 1 | | | | | 1 | 1 | dolium | Do1 | S3p.7 | XXII |
| 1998 | 3328 | 22.2 | 6735 | | S3 | S3,piégeage | Amp. | | | 1 | | | 1 | 1 | | | | |

ANNEXE B : RUE DE L'AMPHITHÉÂTRE – SONDAGE 4

| année | n° OA | Rayon | Caisse | n° ordre | structure | US | Catégorie | Comptage | | | | | | Typologie | Desc. Typo. | Dessin | Planche |
|-------|-------|-------|--------|----------|-----------|----------------|-----------|----------|---|---|---|---|----|-----------|-------------|--------|---------|
| | | | | | | | | B | F | A | D | P | NR | | | | |
| 1998 | 3328 | 22.2 | 6735 | | S4 | S4/micro piég. | TN/DTN | | | | | 1 | 1 | 1 | | | |
| 1998 | 3328 | 22.2 | 6735 | | S4 | S4/micro piég. | Com. Cl | | | 1 | | 2 | 3 | 1 | | | |

ANNEXE B : RUE DE L'AMPHITHÉÂTRE – SONDAGE 5

| année | n° OA | Rayon | Caisse | n° ordre | structure | US | Catégorie | Comptage | | | | | | | Typologie | Desc. Typo. | Dessin | Planche |
|-------|-------|-------|--------|----------|-----------|------------|---------------|----------|---|---|---|---|----|-----|-----------|----------------|--------|---------|
| | | | | | | | | B | F | A | D | P | NR | NMI | | | | |
| 1998 | 3328 | 22.2 | 6735 | | S5 | S5/R. cave | TS | 1 | | | | | 1 | 1 | plat | Drag. 31/LudSb | | |
| 1998 | 3328 | 22.2 | 6735 | | S5 | S5/R. cave | TS AR | | | | | 2 | 2 | 1 | coupe | Drag. 37 | | |
| 1998 | 3328 | 22.2 | 6735 | | S5 | S5/R. cave | MET TR | | | | | 1 | 1 | 1 | | | | |
| 1998 | 3328 | 22.2 | 6735 | | S5 | S5/R. cave | TN/DTN | | | | | 1 | 1 | 1 | | | | |
| 1998 | 3328 | 22.2 | 6735 | | S5 | S5/R. cave | CB | | 1 | 1 | | 1 | 3 | 1 | | | | |
| 1998 | 3328 | 22.2 | 6735 | | S5 | S5/R. cave | Sb. Coq | | | | | 1 | 1 | 1 | | | | |
| 1998 | 3328 | 22.2 | 6735 | 3 | S5 | S5/R. cave | Com. Cl 2 | 1 | | | | | 1 | 1 | plat | Com. Cl P11.2 | S5.1 | XXIII |
| 1998 | 3328 | 22.2 | 6735 | 3 | S5 | S5/R. cave | Com. Cl 2 | 1 | | | | | 1 | 1 | bol | Com. Cl B3 | S5.2 | XXIII |
| 1998 | 3328 | 22.2 | 6735 | | S5 | Cave 5 | TS GE | 1 | 1 | | | 1 | 3 | 1 | coupe | Drag. 37 | | |
| 1998 | 3328 | 22.2 | 6735 | | S5 | Cave 5 | EN | 1 | 2 | | | 5 | 8 | 1 | gobelet | Hees 2 | | |
| 1998 | 3328 | 22.2 | 6735 | | S5 | Cave 5 | MET AR | 1 | | | | | 1 | 1 | gobelet | Nied. 33 | | |
| 1998 | 3328 | 22.2 | 6735 | | S5 | Cave 5 | Sb. Coq | | | | | 2 | 2 | 1 | | | | |
| 1998 | 3328 | 22.2 | 6735 | | S5 | Cave 5 | Com. Cl dorée | 1 | | | | | 1 | 1 | | | | |
| 1998 | 3328 | 22.2 | 6735 | | S5 | Cave 5 | Mo | 1 | | | | | 1 | 1 | | | | |
| 1998 | 3328 | 22.2 | 6735 | | S5 | Cave 5 | Amp. | | | 1 | | 5 | 5 | 1 | | | | |

ANNEXE B : RUE DE L'AMPHITHÉÂTRE – SONDAGE 6

| année | n° OA | Rayon | Caisse | n° ordre | structure | US | Catégorie | Comptage | | | | | | | Typologie | Desc. Typo. | Dessin | Planche |
|-------|-------|-------|--------|----------|-----------|------------|-----------|----------|---|---|---|---|----|-----|-----------|---------------|--------|---------|
| | | | | | | | | B | F | A | D | P | NR | NMI | | | | |
| 1998 | 3328 | 22.2 | 6735 | | S6 | S6/R. cave | EN | | | | | 1 | 1 | 1 | | | | |
| 1998 | 3328 | 22.2 | 6735 | 2 | S6 | S6/R. cave | Sb. Coq | 1 | | | | | 1 | 1 | plat | Sb. Coq P11.1 | S6.1 | XXIV |
| 1998 | 3328 | 22.2 | 6735 | | S6 | S6/R. cave | Com. Cl | | | 1 | | 2 | 3 | 1 | | | | |
| 1998 | 3328 | 22.2 | 6735 | | S6 | S6,NIV OCC | TS SG | | | | | 1 | 1 | 1 | | | | |
| 1998 | 3328 | 22.2 | 6735 | | S6 | S6,NIV OCC | EN | | | | | 5 | 5 | 1 | | | | |
| 1998 | 3328 | 22.2 | 6735 | | S6 | S6,NIV OCC | Com. Cl | | | | | 2 | 2 | 1 | | | | |

ANNEXE B : PUITES CHAMPS DU CARRÉ

| année | Rayon | Caisse | n° ordre | Catégorie | Comptage | | | | | | Typologie | Desc. Typo. | Dessin | Planche |
|-------|-------|--------|----------|-----------|----------|---|---|---|---|----|-----------|-------------|--------|---------|
| | | | | | B | F | A | D | P | NR | | | | |
| | 54-3 | 459 | | Com. Cl 1 | | 1 | | | | 1 | 1 | | | |
| | 54-3 | 459 | | Mo | | | | | 1 | 1 | 1 | | | |

ANNEXE B : PUIITS DAINVILLE

| année | Rayon | Caisse | n° ordre | Catégorie | Comptage | | | | | | | Typologie | Desc. Typo. | Dessin | Planche |
|-------|-------|--------|----------|-----------|----------|---|---|---|---|----|-----|-----------|--------------|--------|---------|
| | | | | | B | F | A | D | P | NR | NMI | | | | |
| | 60-4 | 560 | | Com. Sb | 1 | | | | | 1 | 1 | pot | Com. Sb P1.1 | 1 | I |

ANNEXE B : Puits des Roises

| année | Rayon | Caisse | n° ordre | Catégorie | Comptage | | | | | | | Typologie | Desc. Typo. | Dessin | Planche | |
|-------|-------|--------|----------|-----------|----------|---|---|---|---|----|-----|-----------|-------------|--------|---------|--|
| | | | | | B | F | A | D | P | NR | NMI | | | | | |
| | 35-2 | 95 | | Amp. | | | 1 | | | | 1 | 1 | | | | |

ANNEXE B : PUIITS DUSSEAUX

| année | Rayon | Caisse | n° ordre | Catégorie | Comptage | | | | | | | Typologie | Desc. Typo. | Dessin | Planche | |
|-------|-------|--------|----------|-----------|----------|---|---|---|----|-----|-----|--------------------|-------------|--------------|---------|----|
| | | | | | B | F | A | D | P | NR | NMI | | | | | |
| | 32-3 | 71 | 1 | TS SG | | 1 | | | 3 | 4 | | | | | | |
| | 57-3 | 488 | | TS SG | 1 | | | | | 1 | 1 | coupe | Drag. 29b | 1 | I | |
| | 57-3 | 488 | | TS SG | 1 | | | | | 1 | 1 | coupelle | Drag. 24/25 | 2 | I | |
| | 57-3 | 488 | | TS SG | 2 | | | | | 2 | 1 | assiette | Drag. 18 | 3 | I | |
| | 57-3 | 488 | | TS SG | 1 | | | | | 1 | 1 | assiette | Drag. 18 | 4 | I | |
| | 57-3 | 488 | | TS SG | 1 | | | | | 1 | 1 | assiette | Drag. 17b | 5 | I | |
| | 57-3 | 488 | | TS SG | 1 | | | | | 1 | 1 | coupe | Ritt. 12 | 6 | I | |
| | 57-3 | 488 | | TS SG | 13 | 5 | | | 16 | 34 | 1 | coupe | Ritt. 12 | 7 | II | |
| | 32-3 | 71 | 1 | TS AR | | 2 | | | | 2 | 1 | | | | | |
| 1981 | 61-2 | 538 | | EN AR | | 2 | | | | 3 | 5 | 1 | | | | |
| | 32-3 | 71 | 1 | TN | 1 | | | | | 1 | 1 | coupe | TNC13 | 8 | II | |
| | 57-3 | 488 | | TN | 2 | | | | | 2 | 1 | pot | TNP2.1 | 9 | II | |
| | 32-3 | 71 | 1 | TN | 1 | | | | | 1 | 1 | pot | TNP10 | 10 | II | |
| | 32-3 | 71 | 1 | TN | | 1 | | | | 8 | 9 | 1 | | | | |
| 1981 | 61-2 | 538 | | TN | | | | | | 12 | 12 | | | | | |
| | 57-3 | 488 | | TN AR | | | | 7 | 11 | 18 | 1 | décor à la molette | | | | |
| | 57-3 | 488 | | TR | | 1 | | | | 8 | 9 | | | | | |
| | 32-3 | 71 | 1 | RU S | | | | | | 1 | 1 | 1 | | | | |
| | 32-3 | 71 | 1 | Sb. Coq | 2 | | | | | 2 | 1 | jatte | | 11 | II | |
| | 32-3 | 71 | 1 | Sb. Coq | | | 1 | | | 6 | 7 | 1 | | | | |
| | 57-3 | 488 | | Sb. Coq | | | | | | 5 | 5 | | | | | |
| 1981 | 61-2 | 538 | | Com. Cl 1 | | | | | | 214 | 214 | 1 | | | | |
| 1981 | 61-2 | 538 | | Com. Cl 1 | | 1 | | | | 8 | 9 | | | | | |
| | 57-3 | 488 | | Com. Cl 1 | | 1 | | | | 7 | 8 | | | | | |
| | 32-3 | 71 | 1 | Com. Cl 2 | 1 | | | | | 1 | 2 | 1 | cruche | Com. Cl Cr10 | 12 | II |
| 1981 | 61-2 | 538 | | Com. Cl 2 | | | | | | 31 | 31 | | | | | |

ANNEXE B : PUIITS DUSSEAUX

| année | Rayon | Caisse | n° ordre | Catégorie | Comptage | | | | | | Typologie | Desc. Typo. | Dessin | Planche | |
|-------|-------|--------|----------|---------------|----------|---|---|---|----|----|-----------|-------------|---------------|---------|-----|
| | | | | | B | F | A | D | P | NR | | | | | NMI |
| | 57-3 | 488 | | Com. Cl 2 | 1 | | | | | 1 | 1 | cruche | Com. Cl Cr7.1 | 13 | II |
| | 57-3 | 488 | | Com. Cl 2 | 1 | | | | | 1 | 1 | cruche | Com. Cl Cr3 | 14 | II |
| | 32-3 | 71 | 1 | Com. Cl dorée | 3 | | | | | 3 | 1 | pot | Com. Cl P7.1 | 15 | II |
| | 32-3 | 71 | 1 | Cl. Eng. | | 1 | | | 21 | 22 | 1 | | | | |
| 1981 | 61-2 | 538 | | Cl. Eng. | | | | | 25 | 25 | | | | | |
| | 57-3 | 488 | | Cl. Eng. | | 1 | | | 14 | 15 | | | | | |
| | 57-3 | 488 | | Amp. | | | | | 5 | 5 | 1 | | | | |
| | 57-3 | 488 | | Amp. | | | | | 12 | 12 | | | | | |

ANNEXE B : PUITES MEYER

| année | Rayon | Caisse | n° ordre | Catégorie | Comptage | | | | | | | Typologie | Desc. Typo. | Dessin | Planche |
|-------|-------|--------|----------|---------------|----------|---|---|---|----|----|-----|-----------|--------------|--------|---------|
| | | | | | B | F | A | D | P | NR | NMI | | | | |
| 1969 | 54-4 | 463 | | TS AR | | | | | 2 | 2 | 1 | tasse | Drag. 33 | 1 | I |
| 1969 | 54-4 | 463 | | TS AR | | | | 1 | | 1 | | | | | |
| 1969 | 54-4 | 463 | | TS AR | 1 | | | | | 1 | | | | | |
| 1969 | 54-4 | 462 | 2 | EN AR | | | | | 3 | 3 | | | | | |
| 1969 | 54-4 | 463 | | EN AR | 1 | 1 | | | | 7 | 1 | gobelet | Hees 2 | | |
| 1969 | 54-4 | 462 | 2 | MET AR | | | | | 3 | 3 | 1 | | | | |
| 1969 | 54-4 | 463 | | MET AR | | 2 | | | | 2 | | | | | |
| 1969 | 54-4 | 462 | 2 | TN | 1 | | | | | 1 | 1 | pot | TNP10 | 2 | I |
| 1969 | 54-4 | 462 | 2 | TN | | 2 | | | | 2 | | | | | |
| 1969 | 54-4 | 463 | | VRP | | 2 | | | | 2 | 1 | | | | |
| 1969 | 54-4 | 463 | | RU UR | 1 | | | | | 1 | 1 | marmite | Nied. 89 | 3 | I |
| 1969 | 54-4 | 463 | | RU Cl | 1 | | | | | 1 | 1 | | | | |
| 1969 | 54-4 | 462 | 2 | CB | | 1 | | | 1 | 2 | | | | | |
| 1969 | 54-4 | 463 | | CB | | 2 | | | 5 | 7 | | | | | |
| 1969 | 54-4 | 463 | | CB | 1 | | | | | 1 | 1 | pot | Reims P16 | 4 | I |
| 1969 | 54-4 | 462 | 2 | Sb. Coq | | 1 | | | 2 | 3 | | | | | |
| 1969 | 54-4 | 463 | | Sb. Coq | 3 | | | | | 3 | 1 | pot | Sb. Coq P7.1 | 5 | I |
| 1969 | 54-4 | 463 | | Com. Cl | 1 | | | | | 1 | | | | | |
| 1969 | 54-4 | 462 | 2 | Com. Cl 1 | | | | | 2 | 2 | | | | | |
| 1969 | 54-4 | 463 | | Com. Cl 1 | | | | | 7 | 7 | | | | | |
| 1969 | 54-4 | 462 | 2 | Com. Cl 2 | 1 | | | | | 1 | 1 | pot | Com. Cl P5.1 | 6 | I |
| 1969 | 54-4 | 462 | 2 | Com. Cl 2 | | | | | 12 | 12 | | | | | |
| 1969 | 54-4 | 463 | 2 | Com. Cl 2 | | | | | 16 | 16 | | | | | |
| 1969 | 54-4 | 463 | | Com. Cl dorée | 2 | | | | | 2 | 1 | bol | Com. Cl B6.1 | 7 | I |
| 1969 | 54-4 | 462 | 2 | Mo | 1 | | | | | 1 | 1 | mortier | Mo1.1 | 8 | I |
| 1969 | 54-4 | 462 | 2 | Mo | 1 | | | | | 1 | 1 | mortier | Mo1.2 | 9 | I |

ANNEXE B : PUIITS MEYER

| année | Rayon | Caisse | n° ordre | Catégorie | Comptage | | | | | | | Typologie | Desc. Typo. | Dessin | Planche | |
|-------|-------|--------|----------|-----------|----------|---|---|---|---|----|-----|-----------|-------------|--------|---------|---|
| | | | | | B | F | A | D | P | NR | NMI | | | | | |
| 1969 | 54-4 | 462 | 2 | Mo | 1 | | | | | | 1 | 1 | mortier | Mo4.3 | 10 | I |

ANNEXE B : PUITES MORLOT

| année | Rayon | Caisse | n° ordre | Catégorie | Comptage | | | | | | | Typologie | Desc. Typo. | Dessin | Planche |
|-------|-------|--------|----------|-----------|----------|---|---|---|----|----|-----|-----------|-----------------------|--------|---------|
| | | | | | B | F | A | D | P | NR | NMI | | | | |
| 1981 | 54-5 | 465 | | TS SG | | 1 | | | 17 | 18 | | | | | |
| 1981 | 54-5 | 465 | | TS SG | 2 | | | | | 2 | 1 | coupe | Drag. 37 | 1 | I |
| 1981 | 54-5 | 465 | | TS SG | | 1 | | | | 1 | 1 | | estampille [MO...] | 2 | I |
| 1981 | 54-5 | 465 | | TS AR | | | | | 5 | 5 | 1 | | | | |
| 1981 | 54-5 | 465 | | EN AR | | 1 | | | 8 | 9 | | | | | |
| 1981 | 54-5 | 465 | | EN AR | 1 | | | | | 1 | 1 | gobelet | Hees 2 | | |
| 1981 | 54-5 | 465 | | EN AR | 2 | | | | | 2 | 1 | gobelet | Hees 2 | | |
| 1981 | 54-5 | 465 | | MET AR | | 1 | | | 7 | 8 | 1 | | | | |
| 1981 | 54-5 | 465 | | TN | | 1 | 1 | | 24 | 26 | | | | | |
| 1981 | 54-5 | 465 | | TN | 2 | | | | | 2 | 1 | bouteille | BT2.3 | 3 | I |
| 1981 | 54-5 | 465 | | Sb. Coq | | 2 | | | 10 | 12 | | | | | |
| 1981 | 54-5 | 465 | | Sb. Coq | 3 | | | | | 3 | 1 | jatte | Sb. Coq J7 | 4 | I |
| 1981 | 54-5 | 465 | | Sb. Coq | 1 | | | | | 1 | 1 | jatte | Sb. Coq J7 | 5 | I |
| 1981 | 54-5 | 465 | | Sb. Coq | 1 | | | | | 1 | 1 | pot | Sb. Coq P6.1 | 6 | I |
| 1981 | 54-5 | 465 | | Sb. Coq | 1 | | | | | 1 | 1 | pot | Sb. Coq P7.1 | 7 | I |
| 1981 | 54-5 | 465 | | Sb. Coq | 2 | | | | | 2 | 1 | couvercle | Sb. Coq Cv4.1 | 8 | I |
| 1981 | 54-5 | 465 | | Cl. Eng. | | 1 | 2 | | 50 | 53 | 1 | | | | |
| 1981 | 54-5 | 465 | | Do | 2 | | | | | 2 | 1 | dolium | Do2 | 9 | I |
| 1981 | 54-5 | 465 | | Amp. | 1 | | | | 20 | 21 | 1 | amphore | Dressel 20 | 10 | I |
| 1981 | 54-5 | 465 | | Amp. | 2 | 2 | 1 | | 25 | 30 | 1 | amphore | Dressel 2/4 | 11 | I |
| 1981 | 54-5 | 465 | | Amp. | | | | | 7 | 7 | | | | | |

ANNEXE B : PUIITS MOSER

| année | Rayon | Caisse | n° ordre | Catégorie | Comptage | | | | | | Typologie | Desc. Typo. | Dessin | Planche | |
|-------|-------|--------|----------|-----------|----------|---|---|---|----|----|-----------|-------------|-------------------------|---------|-----|
| | | | | | B | F | A | D | P | NR | | | | | NMI |
| | 37-4 | 148 | 2 | TS SG | 1 | | | | 1 | 2 | 1 | coupe | Drag. 35 | | |
| | 37-4 | 149 | 1 | TS SG | | 1 | | | | 1 | 1 | | estampille [ATTICVS] | 1 | I |
| 1980 | 60-5 | 534 | | TS CG | | | | | 1 | 1 | 1 | | | | |
| | 37-4 | 149 | 1 | TS AR | 1 | | | | | 1 | 1 | coupe | Drag. 37R | 2 | I |
| 1979 | 60-3 | 527 | | TS AR | 1 | | | | | 1 | 1 | coupe | Drag. 37 | 3 | I |
| | 37-4 | 149 | 1 | TS AR | 1 | | | | | 1 | 1 | coupelle | Drag. 40 | 4 | I |
| 1980 | 60-5 | 534 | | TS AR | 1 | | | | | 1 | 1 | tasse | Drag. 33 | 5 | I |
| | 37-4 | 149 | 1 | TS AR | | 3 | | | 6 | 9 | | | | | |
| 1979 | 60-3 | 527 | | TS AR | | 1 | | | 18 | 19 | | | | | |
| | 60-4 | 529 | | TS AR | | | | | 22 | 22 | | | | | |
| 1980 | 60-5 | 534 | | TS AR | | 1 | | | 10 | 11 | | | | | |
| | 37-4 | 149 | 1 | EN AR | | 2 | | | | 2 | 1 | | | | |
| 1979 | 60-3 | 527 | | EN COL | | | | | 1 | 1 | 1 | | | | |
| | 60-4 | 529 | | EN COL | | 1 | | | | 1 | | | | | |
| 1979 | 60-3 | 527 | | MET AR | | | | | 6 | 6 | 1 | | | | |
| 1980 | 60-5 | 534 | | MET AR | | 1 | | | 15 | 16 | | | | | |
| 1979 | 60-3 | 527 | | MET TR | | | | | 3 | 3 | | | | | |
| 1980 | 60-5 | 534 | | MET TR | | | | | 6 | 6 | | | | | |
| 1980 | 60-5 | 534 | | MET TR | 1 | | | | | 1 | 1 | | | | |
| 1980 | 60-5 | 534 | | TN | | | | | 12 | 12 | | | | | |
| 1980 | 60-5 | 534 | | TN | 1 | | | | | 1 | 1 | pot | TNP51/54 | 6 | I |
| | 60-4 | 529 | | TN | 2 | | | | | 2 | 1 | pot | TNP51/54 | 7 | I |
| 1980 | 60-5 | 534 | | TN | | | | 1 | | 1 | | | | | |
| 1979 | 60-3 | 527 | | TN AR | | | | | 4 | 4 | 1 | | | | |
| | 60-4 | 529 | | TN AR | | 2 | | | 18 | 20 | | | | | |
| | 37-4 | 148 | 2 | TN AR | | | | | 3 | 3 | | | | | |

ANNEXE B : PUIITS MOSER

| année | Rayon | Caisse | n° ordre | Catégorie | Comptage | | | | | | Typologie | Desc. Typo. | Dessin | Planche |
|-------|-------|--------|----------|-----------|----------|---|---|---|----|----|-----------|-------------|---------------|---------|
| | | | | | B | F | A | D | P | NR | | | | |
| | 37-4 | 149 | 1 | TR | | | | | 4 | 4 | 1 | | | |
| | 60-4 | 529 | | RU UR | | | | | 13 | 13 | | | | |
| 1980 | 60-5 | 534 | | RU UR | 1 | | | | | 1 | 1 | marmite | Nied. 89 | 8 I |
| 1980 | 60-5 | 534 | | RU CI | | 1 | | | | 1 | | | | |
| 1980 | 60-5 | 534 | | RU CI | | 1 | | | | 1 | | | | |
| | 60-4 | 529 | | RU S | | | | | 1 | 1 | 1 | | | |
| 1980 | 60-5 | 534 | | CB | 1 | | | | | 1 | 1 | plat | Deru Reims A1 | 9 I |
| 1980 | 60-5 | 534 | | CB | 1 | | | | | 1 | 1 | jatte | Reims J10 | 10 I |
| | 60-4 | 529 | | CB | 1 | | | | | 1 | 1 | pot | Reims P17 | 11 I |
| | 60-4 | 529 | | CB | 1 | | | | | 1 | 1 | pot | Reims P16 | 12 I |
| 1980 | 60-5 | 534 | | CB | 2 | | | | | 2 | 1 | pot | Reims P16 | 13 I |
| 1980 | 60-5 | 534 | | CB | 1 | | | | | 1 | 1 | pot | Reims P16 | 14 I |
| | 60-4 | 529 | | CB | 1 | | | | | 1 | 1 | pot | Reims P16 | 15 I |
| | 37-4 | 149 | 1 | CB | | | | | 1 | 1 | | | | |
| 1979 | 60-3 | 527 | | CB | | | | | 5 | 5 | | | | |
| | 60-4 | 529 | | CB | | | | | 23 | 23 | | | | |
| 1980 | 60-5 | 534 | | CB | | 1 | | | 10 | 11 | | | | |
| 1980 | 60-5 | 534 | | Sb. Coq | 2 | | | | | 2 | 1 | jatte | Sb. Coq J5 | 16 II |
| | 60-4 | 529 | | Sb. Coq | 1 | | | | | 1 | 1 | jatte | Sb. Coq J6 | 17 II |
| 1980 | 60-5 | 534 | | Sb. Coq | 1 | | | | | 1 | 1 | pot | Sb. Coq P3 | 18 II |
| 1980 | 60-5 | 534 | | Sb. Coq | 1 | | | | | 1 | 1 | pot | Sb. Coq P5.1 | 19 II |
| | 60-4 | 529 | | Sb. Coq | 1 | | | | | 1 | 1 | couvercle | Sb. Coq Cv1 | 20 II |
| | 60-4 | 529 | | Sb. Coq | 2 | | | | | 2 | 1 | couvercle | Sb. Coq Cv5 | 21 II |
| | 37-4 | 149 | 1 | Sb. Coq | | | | | 3 | 3 | | | | |
| | 60-4 | 529 | | Sb. Coq | | | | | 34 | 34 | | | | |
| 1980 | 60-5 | 534 | | Sb. Coq | | 3 | | | 9 | 12 | | | | |
| | 37-4 | 148 | 2 | Sb. Coq | | 6 | | | | 6 | | | | |

ANNEXE B : PUIITS MOSER

| année | Rayon | Caisse | n° ordre | Catégorie | Comptage | | | | | | Typologie | Desc. Typo. | Dessin | Planche |
|-------|-------|--------|----------|---------------|----------|---|---|---|----|----|-----------|-------------|---------------|---------|
| | | | | | B | F | A | D | P | NR | | | | |
| 1979 | 60-3 | 527 | | Com. Sb | | | | 8 | | 8 | | | | |
| 1979 | 60-3 | 527 | | Com. Sb | 1 | | | | | 1 | 1 | pot | Com. Sb P1.2 | 22 II |
| | 60-4 | 529 | | Com. Cl 1 | 1 | | | | | 1 | 1 | cruche | Com. Cl Cr4.1 | 23 II |
| 1980 | 60-5 | 534 | | Com. Cl 1 | 1 | | | | | 1 | 1 | cruche | Com. Cl Cr4.1 | 24 II |
| 1979 | 60-3 | 527 | | Com. Cl 1 | | 2 | | | 4 | 6 | | | | |
| | 60-4 | 529 | | Com. Cl 1 | | 4 | 2 | | | 6 | | | | |
| 1980 | 60-5 | 534 | | Com. Cl 1 | | | 2 | | 9 | 11 | | | | |
| | 37-4 | 148 | 2 | Com. Cl 1 | | 1 | | | 4 | 5 | | | | |
| | 37-4 | 149 | 1 | Com. Cl 2 | | 1 | | | 20 | 21 | 1 | | | |
| 1979 | 60-3 | 527 | | Com. Cl 2 | | | | | 18 | 18 | | | | |
| 1980 | 60-5 | 534 | | Com. Cl 2 | | 1 | | | 5 | 6 | | | | |
| 1980 | 60-5 | 534 | | Com. Cl dorée | | | | | 2 | 2 | 1 | | | |
| | 37-4 | 149 | 1 | Amp. | | | | | 1 | 1 | 1 | | | |
| 1979 | 60-3 | 527 | | Amp. | | | | | 2 | 2 | | | | |
| 1980 | 60-5 | 534 | | Amp. | | | | | 35 | 35 | | | | |
| 1980 | 60-5 | 534 | | Amp. | | | | | 5 | 5 | | | | |

ANNEXE B : Puits MOUGEL

| année | Rayon | Caisse | n° ordre | Catégorie | Comptage | | | | | | | Typologie | Desc. Typo. | Dessin | Planche |
|-------|-------|--------|----------|-----------|----------|---|---|---|---|----|-----|-----------|----------------|--------|---------|
| | | | | | B | F | A | D | P | NR | NMI | | | | |
| | 32-5 | 80 | | Com. C1 1 | | 1 | | | | 1 | 1 | | | | |

ANNEXE B : PUITTS CHAMPE MARGUERITE

| année | Rayon | Caisse | n° ordre | Catégorie | Comptage | | | | | | | Typologie | Desc. Typo. | Dessin | Planche |
|-------|-------|--------|----------|-----------|----------|---|---|---|----|----|-----|-----------|--------------|--------|---------|
| | | | | | B | F | A | D | P | NR | NMI | | | | |
| 1957 | 37-2 | 138 | 1 | TS AR | | | | | 6 | 6 | | | | | |
| 1957 | 37-2 | 138 | 1 | TS AR | | 1 | | | | 1 | 1 | coupe | Drag. 37 | 1 | I |
| 1957 | 57-4 | 490 | | TS AR | 1 | | | | | 1 | 1 | coupe | Drag. 37 | 2 | I |
| 1957 | 57-4 | 490 | | TS AR | | | | 1 | | 1 | 1 | coupe | Drag. 37 | 3 | I |
| 1957 | 57-4 | 490 | | EN AR | | 2 | | | | 2 | 1 | | | | |
| 1964 | 57-4 | 490 | | MET AR | | 1 | | | | 1 | 1 | | | | |
| 1957 | 57-4 | 490 | | TN | | | | 1 | | 1 | 1 | gobelet | TNG3 | 4 | II |
| 1957 | 37-2 | 138 | 1 | TN | 1 | | | | | 1 | 1 | pot | TNP12 | 5 | II |
| 1957 | 37-2 | 138 | 1 | TN AR | | | | | 5 | 5 | 1 | | | | |
| 1957 | 37-2 | 138 | 1 | Sb. Coq | 1 | | | | | 1 | 1 | jatte | Sb. Coq J2.3 | 6 | II |
| 1964 | 57-4 | 490 | | Com. Cl 1 | | 1 | | | | 1 | 1 | | | | |
| 1957 | 37-2 | 138 | 1 | Amp. | | | | | 24 | 24 | 1 | | | | |

ANNEXE B : PUIXS AUX TABLETTES

| année | Rayon | Caisse | n° ordre | Catégorie | Comptage | | | | | | | Typologie | Desc. Typo. | Dessin | Planche |
|-----------|-------------------|---------|----------|-----------|----------|---|---|---|----|----|-----|----------------------|-------------|--------|---------|
| | | | | | B | F | A | D | P | NR | NMI | | | | |
| 1967-1968 | 53-2 | 432 | | TS SG | | 1 | | | 40 | 41 | 0 | | | | |
| 1967-1968 | 53-2 | 432 | | TS SG | 8 | | | | | 8 | 1 | coupe | Drag. 35 | | |
| 1967-1968 | 53-2 | 432 | | TS AR | | | | | 93 | 93 | 0 | | | | |
| 1967-1968 | 53-2 | 432 | | TS AR | 8 | 1 | | | 1 | 10 | 1 | coupe | Drag. 37 | 1 | I |
| 1967-1968 | 53-4 | 441 | | EN AR | 5 | | | | | 5 | 1 | gobelet | Hees 2 | 2 | I |
| 1967-1968 | 53-4 | 441 | | MET AR | | 1 | | | | 1 | 1 | gobelet | Nied. 33 | 3 | I |
| 1967-1968 | 53-4 | 441 | | MET AR | | 1 | | | | 1 | 1 | gobelet | Nied. 33 | 4 | I |
| 1967-1968 | 53-4 | 441 | | MET AR | | 1 | | | | 1 | 1 | gobelet | Nied. 33 | 5 | I |
| 1967-1968 | 53-4 | 441 | | MET AR | | 1 | | | | 1 | 1 | gobelet | Nied. 33 | 6 | I |
| 1967-1968 | 53-4 | 441 | | MET AR | 1 | | | | 2 | 3 | 1 | gobelet | Nied. 33 | 7 | I |
| 1967-1968 | 53-4 | 441 | | MET AR | | 2 | | | 17 | 19 | 0 | | | | |
| 1967-1968 | 53-4 | 441 | | MET TR | 3 | | | | 15 | 18 | 1 | gobelet | Symonds 2 | 8 | I |
| 1967-1968 | 53-4 | 441 | | MET TR | | | | 1 | | 1 | 1 | décor à la barbotine | | 9 | II |
| 1967-1968 | 53-4 | 441 | | MET TR | | 3 | | | | 3 | 1 | gobelet | Nied. 33 | 10 | II |
| 1967-1968 | Musée Mosaïque | Vitrine | | MET AR | 1 | | | | 3 | | 1 | gobelet | Nied. 33 | | |
| 1967-1968 | 53-4 | 441 | | MET TR | | 1 | | | | 1 | 0 | | | | |

ANNEXE B : PUIXS AUX TABLETTES

| année | Rayon | Caisse | n° ordre | Catégorie | Comptage | | | | | | | Typologie | Desc. Typo. | Dessin | Planche |
|-----------|-------|--------|----------|-----------|----------|---|---|----|-----|-----|-----|---------------------------------|-------------|--------|---------|
| | | | | | B | F | A | D | P | NR | NMI | | | | |
| 1967-1968 | 53-4 | 441 | | MET TR | | | | | 22 | 22 | 0 | | | | |
| 1967-1968 | 53-2 | 433 | | TN | 1 | | | | | 1 | 1 | assiette | TNA43 | 11 | II |
| 1967-1968 | 53-2 | 433 | | TN | 1 | | | | | 1 | 1 | assiette | TNA24 | 12 | II |
| 1967-1968 | 53-2 | 433 | | TN | 1 | | | | | 1 | 1 | bol | TNB1 | 13 | II |
| 1967-1968 | 53-2 | 433 | 2 | TN | | 1 | | | 17 | 18 | 1 | pot | TNP7.3 | 14 | II |
| 1967-1968 | 53-2 | 433 | | TN | 1 | | | | | 1 | 1 | pot | TNP28 | 15 | II |
| 1967-1968 | 53-2 | 433 | | TN | 1 | | | | | 1 | 1 | pot | TNP42 | 16 | II |
| 1967-1968 | 53-2 | 433 | | TN | 1 | | | | | 1 | 1 | pot | TNP42 | 17 | II |
| 1967-1968 | 53-2 | 433 | 2 | TN | | | | 11 | | 11 | 0 | | | | |
| 1967-1968 | 53-2 | 433 | 5 | TN | | | | | 8 | 8 | 0 | | | | |
| 1967-1968 | 53-2 | 433 | | TN | | 4 | | | 221 | 225 | 0 | | | | |
| 1967-1968 | 52-3 | 423 | 4 | TR | | 3 | | | 9 | 12 | 1 | fond de gobelet passé au feu | | | |
| 1967-1968 | 52-3 | 423 | 6 | RU CI | 1 | | | | | 1 | 1 | plat | Nied. 111a | 18 | II |
| 1967-1968 | 52-3 | 423 | 6 | RU CI | 1 | | | | | 1 | 1 | plat | Nied. 113 | 19 | II |
| 1967-1968 | 52-3 | 423 | 6 | RU CI | 1 | | | | | 1 | 1 | marmite | Nied. 89 | 20 | II |
| 1967-1968 | 52-3 | 423 | 6 | RU CI | 1 | | | | | 1 | 1 | cruche | Nied. 98 | 21 | II |

ANNEXE B : PUIXS AUX TABLETTES

| année | Rayon | Caisse | n° ordre | Catégorie | Comptage | | | | | | | Typologie | Desc. Typo. | Dessin | Planche |
|-----------|-------|--------|----------|-----------|----------|---|---|---|----|----|-----|----------------|---------------|--------|---------|
| | | | | | B | F | A | D | P | NR | NMI | | | | |
| 1967-1968 | 52-3 | 423 | 6 | RU Cl | | 5 | | | 33 | 38 | 0 | | | | |
| 1967-1968 | 53-2 | 433 | 1 | CB | 1 | 2 | | | 8 | 11 | 1 | pot | Reims P16 | 22 | III |
| 1967-1968 | 53-2 | 433 | 1 | CB | 3 | | | | | 3 | 1 | pot | Reims P16 | 23 | III |
| 1967-1968 | 53-2 | 433 | 1 | CB | 3 | | | | 3 | 6 | 1 | pot | Reims P16 | 24 | III |
| 1967-1968 | 53-2 | 433 | 1 | CB | 2 | | | | 6 | 8 | 1 | pot | Reims P16 | 25 | III |
| 1967-1968 | 53-2 | 433 | 1 | CB | | 1 | | | | | | un fond percé | | | |
| 1967-1968 | 53-2 | 433 | 3 | CB | | | | | 35 | 35 | 0 | | | | |
| 1967-1968 | 53-2 | 436 | | Sb. Coq | 9 | 1 | | | 14 | 24 | 1 | jatte | Sb. Coq J2.3 | 26 | III |
| 1967-1968 | 53-2 | 436 | | Sb. Coq | 2 | | | | 7 | 9 | 1 | pot | Sb. Coq P6.3 | 27 | III |
| 1967-1968 | 52-3 | 423 | 4 | Com. Sb | 2 | | | | | 2 | 1 | bol | Com. Sb B1 | 28 | III |
| 1967-1968 | 53-2 | 436 | | Com. Sb | 4 | 1 | | | 38 | 43 | 1 | pot | Com. Sb P1.1 | 29 | III |
| 1967-1968 | 53-2 | 433 | 5 | Com. Sb | | | | | 8 | 8 | 0 | | | | |
| 1967-1968 | 53-2 | 433 | 5 | Com. Sb | | 1 | | | | | 1 | 0 | | | |
| 1967-1968 | 52-3 | 423 | 4 | Com. Cl 2 | 1 | | | | | 1 | 1 | plat | Com. Cl P12.1 | 30 | IV |
| 1967-1968 | 52-3 | 423 | 2 | Com. Cl 2 | 1 | | | | | 1 | 1 | cruche | Com. Cl Cr6.1 | 31 | IV |
| 1967-1968 | 52-3 | 423 | 4 | Com. Cl 3 | | 3 | | | 8 | 11 | 0 | fond de cruche | | | |

ANNEXE B : PUIXS AUX TABLETTES

| année | Rayon | Caisse | n° ordre | Catégorie | Comptage | | | | | | | Typologie | Desc. Typo. | Dessin | Planche |
|-----------|-------|--------|----------|-----------|----------|---|---|---|-----|-----|-----|----------------|--------------|--------|---------|
| | | | | | B | F | A | D | P | NR | NMI | | | | |
| 1967-1968 | 52-3 | 423 | 4 | Com. C13 | | 5 | | | 4 | 9 | 0 | fond de cruche | | | |
| 1967-1968 | 52-3 | 423 | 5 | Com. C13 | 1 | | | | | 1 | 1 | pot | Com. C1 P3.1 | 32 | IV |
| 1967-1968 | 52-3 | 423 | 1 | Com. C12 | | 5 | 1 | | 150 | 156 | 0 | | | | |
| 1967-1968 | 52-3 | 423 | 5 | Com. C13 | | 5 | 1 | | 128 | 134 | 0 | | | | |
| 1967-1968 | 52-3 | 423 | 4 | Com. C12 | | 1 | | | 106 | 107 | 0 | | | | |

ANNEXE B : Puits Chemin HLM

| année | Rayon | Caisse | n° ordre | Catégorie | Comptage | | | | | | Typologie | Desc. Typo. | Dessin | Planche |
|-------|-------|--------|----------|-----------|----------|---|---|---|---|----|-----------|-------------|--------------|---------|
| | | | | | B | F | A | D | P | NR | | | | |
| 1969 | 55-4 | 450 | 1 | TS SG | | | | | 3 | 3 | | | | |
| 1969 | 55-4 | 450 | 1 | TS SG | 1 | | | | | 1 | 1 | assiette | Drag. 18 | 1 I |
| 1969 | 55-4 | 450 | 1 | TS SG | 1 | | | | | 1 | 1 | coupelle | Drag. 22a | 2 I |
| 1969 | 55-4 | 450 | 1 | TS SG | 1 | | | | | 1 | 1 | coupelle | Drag. 22a | 3 I |
| 1969 | 55-4 | 451 | | Sb. Coq | 1 | | | | | 1 | 1 | pot | Sb. Coq P1.1 | 4 I |

ANNEXE B : PUIITS PERRIN

| année | Rayon | Caisse | n° ordre | Catégorie | Comptage | | | | | | Typologie | Desc. Typo. | Dessin | Planche | |
|-------|-------|--------|----------|-----------|----------|---|---|---|----|----|-----------|-------------|---------------|---------|-----|
| | | | | | B | F | A | D | P | NR | | | | | NMI |
| 1970 | 37-4 | 148 | 1 | TS CG | | | | 1 | | 1 | 1 | | décor | 1 | I |
| 1970 | 37-4 | 148 | 1 | TS AR | | 1 | | | 10 | 11 | | | | | |
| 1970 | 37-4 | 148 | 1 | TS AR | 1 | | | | | 1 | 1 | coupe | Drag. 37 | 2 | I |
| 1970 | 37-4 | 148 | 1 | EN AR | 1 | | | | | 1 | 1 | gobelet | Hees 2 | 3 | I |
| 1970 | 37-4 | 148 | 1 | EN AR | 1 | | | | | 1 | 1 | gobelet | Hees 2 | 4 | I |
| 1970 | 57-5 | 497 | 2 | EN AR | 3 | | | | | 3 | 1 | gobelet | Hees 2 | 5 | I |
| 1970 | 57-5 | 497 | 2 | EN AR | 1 | | | | | 1 | 1 | gobelet | Hees 2 | 6 | I |
| 1970 | 37-4 | 148 | 1 | EN AR | | | | | 6 | 6 | | | | | |
| 1970 | 57-5 | 497 | 2 | EN AR | | | | | 29 | 29 | | | | | |
| 1970 | 37-4 | 148 | 1 | MET TR | 1 | | | | | 1 | 1 | gobelet | Nied. 31 | 7 | I |
| 1970 | 37-4 | 148 | 1 | TN AR | | | | | 4 | 4 | | | | | |
| 1970 | 37-4 | 148 | 1 | TN AR | 1 | | | | | 1 | 1 | coupe | TNC3.2 | 8 | I |
| 1970 | 37-4 | 148 | 1 | TN AR | 1 | | | | | 1 | 1 | pot | TNP47 | 9 | I |
| 1970 | 37-4 | 148 | 1 | VRP | | | 1 | | | | 1 | | | | |
| 1970 | 37-4 | 148 | 1 | VRP | 1 | | | | | 1 | 1 | assiette | Goudineau 15 | 10 | I |
| 1970 | 37-4 | 148 | 1 | RU | | | 1 | | | 1 | 1 | | | | |
| 1970 | 37-4 | 148 | 1 | RU UR | | | | | 1 | 1 | 1 | | | | |
| 1970 | 37-4 | 148 | 1 | CB | 1 | | | | | 1 | 1 | pot | Reims P16 | 11 | I |
| 1970 | 37-4 | 148 | 1 | CB | 2 | | | | | 2 | 1 | pot | Reims P16 | 12 | I |
| 1970 | 37-4 | 148 | 1 | CB | | | | | 3 | 3 | | | | | |
| 1970 | 37-4 | 148 | 1 | Sb. Coq | 1 | | | | | 1 | 1 | jatte | Sb. Coq J/M2 | 13 | I |
| 1970 | 37-4 | 148 | 1 | Sb. Coq | 1 | | | | | 1 | 1 | pot | Sb. Coq P1.2 | 14 | I |
| 1970 | 37-4 | 148 | 1 | Sb. Coq | 1 | | | | | 1 | 1 | pot | Sb. Coq P5.1 | 15 | I |
| 1970 | 37-4 | 148 | 1 | Sb. Coq | 1 | | | | | 1 | 1 | couvercle | Sb. Coq Cv4.1 | 16 | II |
| 1970 | 37-4 | 148 | 1 | Sb. Coq | 1 | | | | | 1 | 1 | couvercle | Sb. Coq Cv5 | 17 | II |
| 1970 | 37-4 | 148 | 1 | Sb. Coq | | 1 | | | 1 | 2 | | | | | |
| 1970 | 37-4 | 148 | 1 | Com. Cl 1 | | | | 4 | | 4 | | | | | |

ANNEXE B : PUIITS PERRIN

| année | Rayon | Caisse | n° ordre | Catégorie | Comptage | | | | | | Typologie | Desc. Typo. | Dessin | Planche | |
|-------|-------|--------|----------|---------------|----------|---|---|---|----|----|-----------|--------------|--------------------|---------|-----|
| | | | | | B | F | A | D | P | NR | | | | | NMI |
| 1970 | 37-4 | 148 | 1 | Com. Cl 2 | 2 | | | | | 2 | 1 | bol | Com. Cl B8 | 18 | II |
| 1970 | 37-4 | 148 | 1 | Com. Cl 2 | 1 | | | | | 1 | 1 | cruche | Com. Cl Cr6.1 | 19 | II |
| 1970 | 37-4 | 148 | 1 | Com. Cl dorée | | | 4 | | 15 | 19 | 1 | | trou dans la panse | | |
| 1970 | 57-5 | 497 | 2 | Cl. Eng. | 1 | | | | | 1 | 1 | cruche | Com. Cl Cr6.2 | 20 | II |
| 1970 | 37-4 | 148 | 1 | Mo | 1 | | | | | 1 | 1 | mortier | Mo3.2 | 21 | II |
| 1970 | 37-4 | 148 | 1 | Amp. | | | | 4 | | 4 | 1 | | | | |
| 1970 | 37-4 | 148 | 1 | Bp 1 | 1 | | | | | 1 | 1 | brûle-parfum | Bp1 | 22 | II |

ANNEXE B : Puits LOULOU, RUE DE L'AMPHITHÉÂTRE

| année | Rayon | Caisse | n° ordre | Catégorie | Comptage | | | | | | | Typologie | Desc. Typo. | Dessin | Planche |
|-------|-------|--------|----------|-----------|----------|---|---|---|---|----|-----|-----------|-------------|--------|---------|
| | | | | | B | F | A | D | P | NR | NMI | | | | |
| | 59-5 | 510 | | TS SG | | 2 | | | 3 | 5 | | | | | |
| | 59-5 | 510 | | TS SG | 1 | | | | | 1 | 1 | assiette | Hermet 2 | 1 | I |
| | 59-5 | 510 | | TS SG | 1 | | | | | 1 | 1 | assiette | Drag. 15 | 2 | I |
| | 59-5 | 510 | | TN | | | | | 7 | 7 | 1 | | | | |
| | 59-5 | 510 | | TN | 1 | | | | | 1 | 1 | bol | TNB35 | 3 | I |
| | 59-5 | 510 | | TR | | | | | 5 | 5 | 1 | | | | |
| | 59-5 | 510 | | Sb. Coq | | | | | 1 | 1 | 1 | | | | |
| | 59-5 | 510 | | Com. Cl 1 | | | 1 | | 2 | 3 | 1 | | | | |

ANNEXE B : PUIITS PIERRAT

| année | Rayon | Caisse | n° ordre | Catégorie | Comptage | | | | | | Typologie | Desc. Typo. | Dessin | Planche |
|-------|-------|--------|----------|-----------|----------|---|---|---|---|----|-----------|-------------|-------------|---------|
| | | | | | B | F | A | D | P | NR | | | | |
| | 60-2 | 525 | | TS AR | | 1 | | | | 1 | 1 | | | |
| | 60-2 | 525 | | EN AR | 1 | | | | | 1 | 1 | gobelet | Hees 2 | 1 I |
| | 60-2 | 525 | | TN | 1 | | | | | 1 | 1 | bol | TNB18 | 2 I |
| | 60-2 | 525 | | Sb. Coq | | 1 | | | | 1 | | | | |
| | 60-2 | 525 | | Sb. Coq | 1 | | | | | 1 | 1 | couvercle | Sb. Coq Cv5 | 3 I |
| | 60-2 | 525 | | Com. Cl 1 | | | | | 8 | 8 | 1 | | | |

ANNEXE B : PUIITS PIZZAGALLI

| Site | année | Rayon | Caisse | n° ordre | Catégorie | Comptage | | | | | | Typologie | Desc. Typo. | Dessin | Planche | |
|---------------------|-------|-------|--------|-------------|-----------|----------|---|---|---|----|----|-----------|-------------|-----------|---------|-----|
| | | | | | | B | F | A | D | P | NR | | | | | NMI |
| Puits Pizzagalli | | 57-1 | 469 | | TS SG | 1 | | | | | 1 | 1 | assiette | Drag. 18 | 1 | I |
| Puits Pizzagalli | | 57-1 | 469 | | TS SG | 1 | | | | | 1 | 1 | bol | Drag. 33c | 2 | I |
| Puits Pizzagalli | | 56-2 | 471 | | TS SG | 1 | | | | | 1 | 1 | coupe | Drag. 35 | | |
| Puits Pizzagalli | | 57-1 | 469 | | TS SG | | 1 | | | | 1 | 1 | coupe | Curle 11b | 3 | I |
| Puits Pizzagalli | | 57-1 | 469 | | TS SG | 1 | | | | | 1 | 1 | coupe | Ritt. 9b | 4 | I |
| Puits Pizzagalli | | 57-1 | 469 | | TS SG | 2 | | | | | 2 | 1 | coupelle | Drag. 46 | 5 | I |
| Puits Pizzagalli | | 57-1 | 469 | | TS SG | 1 | | | | | 1 | 1 | coupelle | Drag. 27 | | |
| Puits Pizzagalli | | 57-1 | 469 | | TS SG | 1 | | | | | 1 | 1 | coupelle | Drag. 22b | 6 | I |
| Puits Pizzagalli | | 57-1 | 469 | | TS SG | | 1 | | | | 1 | 1 | estampille | | 7 | I |
| Puits Pizzagalli | | 57-1 | 469 | | TS SG | | 4 | | | 34 | 38 | | | | | |
| Puits Pizzagalli | | 59-3 | 1623 | | TS SG | | | | | 3 | 3 | | | | | |
| Puits Pizzagalli | | 57-1 | 469 | | TS GE | 3 | | | | | 3 | 1 | tasse | Drag. 33 | 8 | I |
| Puits Pizzagalli | | 57-1 | 469 | | TS GE | 1 | | | | | 1 | 1 | coupe | Drag. 37 | 9 | I |
| Puits Pizzagalli | | 57-1 | 469 | | TS GE | 3 | | | | 1 | 4 | 1 | coupe | Drag. 37R | 10 | I |
| Puits Pizzagalli | | 56-2 | 471 | | TS AR | 1 | | | | | 1 | 1 | assiette | Drag. 32 | 11 | II |

ANNEXE B : PUIITS PIZZAGALLI

| Site | année | Rayon | Caisse | n° ordre | Catégorie | Comptage | | | | | | Typologie | Desc. Typo. | Dessin | Planche | |
|---------------------|-------|-------|--------|-------------|-----------|----------|---|---|---|---|----|-----------|-------------|----------|---------|-----|
| | | | | | | B | F | A | D | P | NR | | | | | NMI |
| Puits Pizzagalli | | 56-2 | 471 | | TS AR | 1 | | | | | 1 | 1 | coupe | Drag. 40 | 12 | II |
| Puits Pizzagalli | | 56-2 | 471 | | TS AR | 1 | | | | | 1 | 1 | coupe | Drag. 37 | 13 | II |
| Puits Pizzagalli | 1978 | 56-4 | 477 | | TS AR | 2 | | | 3 | | 5 | 1 | coupe | Drag. 37 | 14 | II |
| Puits Pizzagalli | 1978 | 56-4 | 477 | | TS AR | 4 | 1 | | 5 | | 10 | 1 | coupe | Drag. 37 | 15 | II |
| Puits Pizzagalli | | 37-4 | 149 | 1 | TS AR | 1 | | | | | 1 | | coupe | Drag. 37 | 16 | III |
| Puits Pizzagalli | | 57-1 | 469 | | TS AR | 1 | | | | | 1 | 1 | coupelle | Drag. 46 | 17 | III |
| Puits Pizzagalli | | 56-2 | 471 | | TS AR | | 1 | | | | 1 | 1 | mortier | | | |
| Puits Pizzagalli | 1978 | 56-4 | 477 | | TS AR | | | | 1 | | 1 | 1 | décor | | 18 | III |
| Puits Pizzagalli | 1978 | 56-4 | 477 | | TS AR | | | | 1 | | 1 | 1 | décor | | 19 | III |
| Puits Pizzagalli | 1978 | 56-4 | 477 | | TS AR | | | | 1 | | 1 | 1 | décor | | 20 | III |
| Puits Pizzagalli | 1978 | 56-4 | 477 | | TS AR | | | | 1 | | 1 | 1 | décor | | 21 | III |
| Puits Pizzagalli | | 59-3 | 1623 | | TS AR | | 1 | | | | 1 | 1 | décor | | 22 | III |
| Puits Pizzagalli | | 59-3 | 1623 | | TS AR | | 1 | | | | 1 | 1 | décor | | 23 | III |
| Puits Pizzagalli | | 59-3 | 1623 | | TS AR | | | | 2 | | 2 | 1 | décor | | 24 | IV |
| Puits Pizzagalli | | 59-3 | 1623 | | TS AR | | 3 | | | | 3 | 1 | décor | | 25 | IV |

ANNEXE B : PUIITS PIZZAGALLI

| Site | année | Rayon | Caisse | n° ordre | Catégorie | Comptage | | | | | | Typologie | Desc. Typo. | Dessin | Planche | |
|---------------------|-------|-------|--------|-------------|-----------|----------|---|---|---|----|----|-----------|-------------|----------|---------|-----|
| | | | | | | B | F | A | D | P | NR | | | | | NMI |
| Puits Pizzagalli | | 59-3 | 1623 | | TS AR | | | | 1 | | 1 | 1 | décor | | 26 | IV |
| Puits Pizzagalli | | 59-3 | 1623 | | TS AR | | | | 1 | | 1 | 1 | décor | | 27 | IV |
| Puits Pizzagalli | 1977 | 36-4 | 131 | 1 | TS AR | | | | | 1 | 1 | | | | | |
| Puits Pizzagalli | | 56-2 | 471 | | TS AR | | | | | 9 | 9 | | | | | |
| Puits Pizzagalli | | 37-4 | 149 | 1 | TS AR | | | | | 4 | 4 | | | | | |
| Puits Pizzagalli | | 57-1 | 469 | | EN AR | 4 | 1 | | | 5 | 10 | 1 | gobelet | Hees 2 | 28 | IV |
| Puits Pizzagalli | | 59-3 | 1623 | | EN AR | | 1 | | | | 1 | 1 | gobelet | | 29 | IV |
| Puits Pizzagalli | | 37-4 | 149 | 1 | EN AR | | | | | 7 | 7 | | | | | |
| Puits Pizzagalli | | 56-2 | 471 | | MET AR | 1 | | | | | 1 | 1 | gobelet | Nied. 31 | 30 | IV |
| Puits Pizzagalli | | 56-2 | 471 | | MET AR | 1 | | | | | 1 | 1 | gobelet | Nied. 33 | 31 | IV |
| Puits Pizzagalli | | 56-2 | 471 | | MET AR | | | | | 25 | 25 | | | | | |
| Puits Pizzagalli | | 37-4 | 149 | 1 | MET AR | | 2 | | | 2 | 4 | | | | | |
| Puits Pizzagalli | | 56-2 | 471 | | MET TR | 1 | | | | | 1 | 1 | gobelet | Nied. 31 | 32 | IV |
| Puits Pizzagalli | | 56-2 | 471 | | MET TR | | | | | 5 | 5 | | | | | |
| Puits Pizzagalli | | 37-4 | 149 | 1 | MET TR | | | | | 2 | 2 | | | | | |

ANNEXE B : PUIITS PIZZAGALLI

| Site | année | Rayon | Caisse | n° ordre | Catégorie | Comptage | | | | | | Typologie | Desc. Typo. | Dessin | Planche | |
|---------------------|-------|-------|--------|-------------|-----------|----------|---|---|---|---|----|-----------|-------------|--------------|---------|-----|
| | | | | | | B | F | A | D | P | NR | | | | | NMI |
| Puits Pizzagalli | | 56-2 | 471 | | TN | 1 | | | | | 1 | 1 | pot | TNP35 | 33 | IV |
| Puits Pizzagalli | | 57-1 | 469 | | TN | | | | | 1 | 1 | 1 | décor | | 34 | IV |
| Puits Pizzagalli | | 56-2 | 471 | | TN | | | | | 5 | 5 | | | | | |
| Puits Pizzagalli | | 56-2 | 471 | | TN | | | | | 2 | 2 | | | | | |
| Puits Pizzagalli | | 57-1 | 469 | | TN | | 1 | | | | 1 | | | | | |
| Puits Pizzagalli | | 57-1 | 469 | | TN | | 1 | | | | 1 | | | | | |
| Puits Pizzagalli | | 37-4 | 149 | 1 | TN | | | | | 4 | 4 | | | | | |
| Puits Pizzagalli | | 57-1 | 469 | | TR | | | | 3 | | 3 | 1 | décor | | | |
| Puits Pizzagalli | | 37-4 | 149 | 1 | TR | | | | | 3 | 3 | | | | | |
| Puits Pizzagalli | | 57-1 | 469 | | VRP | 2 | 1 | | | 4 | 7 | 1 | plat | Goudineau 15 | 35 | V |
| Puits Pizzagalli | | 59-3 | 1623 | | VRP | 1 | | | | 2 | 3 | 1 | plat | Goudineau 15 | 36 | V |
| Puits Pizzagalli | | 57-1 | 469 | | VRP | 1 | | | | 1 | 2 | 1 | couvercle | Goudineau 18 | 37 | V |
| Puits Pizzagalli | | 56-2 | 471 | | VRP | | | | | 2 | 2 | | | | | |
| Puits Pizzagalli | | 56-3 | 475 | | VRP | | 1 | | | | 1 | | | | | |
| Puits Pizzagalli | | 56-2 | 471 | | RU UR | | | | | 2 | 2 | 1 | | | | |

ANNEXE B : PUIITS PIZZAGALLI

| Site | année | Rayon | Caisse | n° ordre | Catégorie | Comptage | | | | | | Typologie | Desc. Typo. | Dessin | Planche | |
|---------------------|-------|-------|--------|-------------|-----------|----------|---|---|---|----|----|-----------|-------------|-------------------------------|---------|-----|
| | | | | | | B | F | A | D | P | NR | | | | | NMI |
| Puits Pizzagalli | | 59-3 | 1623 | | RU S | 1 | | | | | 1 | 1 | pot | Loeschke 1929 tafel X n°26 | 38 | V |
| Puits Pizzagalli | | 56-2 | 471 | | CB | | | | | 10 | 10 | | | | | |
| Puits Pizzagalli | | 56-2 | 471 | | CB | 4 | | | | | 4 | 1 | pot | Reims P16 | 39 | V |
| Puits Pizzagalli | | 57-1 | 469 | | CB | 1 | | | | | 1 | 1 | pot | Reims P16 | | |
| Puits Pizzagalli | | 37-4 | 149 | 1 | CB | | | | | 6 | 6 | | | | | |
| Puits Pizzagalli | 1978 | 56-3 | 474 | | Sb. Coq | 1 | | | | | 1 | 1 | plat | Sb. Coq P13 | 40 | V |
| Puits Pizzagalli | 1978 | 56-3 | 474 | | Sb. Coq | 1 | | | | | 1 | 1 | plat | Sb. Coq P14 | 41 | V |
| Puits Pizzagalli | 1978 | 56-3 | 474 | | Sb. Coq | 1 | | | | | 1 | 1 | jatte | Sb. Coq J1 | 42 | V |
| Puits Pizzagalli | 1978 | 56-3 | 474 | | Sb. Coq | 1 | | | | | 1 | 1 | jatte | Sb. Coq J2.1 | 43 | V |
| Puits Pizzagalli | 1978 | 56-3 | 474 | | Sb. Coq | 4 | | | | | 4 | 1 | jatte | Sb. Coq J2.3 | 44 | VI |
| Puits Pizzagalli | 1978 | 56-3 | 474 | | Sb. Coq | 1 | | | | | 1 | 1 | jatte | Sb. Coq J2.3 | 45 | VI |
| Puits Pizzagalli | 1978 | 56-3 | 474 | | Sb. Coq | 2 | | | | | 2 | 1 | jatte | Sb. Coq J2.3 | 46 | VI |
| Puits Pizzagalli | 1978 | 56-3 | 474 | | Sb. Coq | 1 | | | | | 1 | 1 | jatte | Sb. Coq J2.3 | 47 | VI |
| Puits Pizzagalli | 1978 | 56-3 | 474 | | Sb. Coq | 2 | | | | | 2 | 1 | jatte | Sb. Coq J2.3 | 48 | VI |
| Puits Pizzagalli | 1978 | 56-3 | 474 | | Sb. Coq | 2 | | | | | 2 | 1 | jatte | Sb. Coq J2.3 | 49 | VI |

ANNEXE B : PUIITS PIZZAGALLI

| Site | année | Rayon | Caisse | n° ordre | Catégorie | Comptage | | | | | | Typologie | Desc. Typo. | Dessin | Planche | |
|---------------------|-------|-------|--------|-------------|-----------|----------|---|---|---|---|----|-----------|-------------|-------------------|---------|------|
| | | | | | | B | F | A | D | P | NR | | | | | NMI |
| Puits Pizzagalli | 1978 | 56-3 | 474 | | Sb. Coq | 1 | | | | | 1 | 1 | jatte | Sb. Coq J2.3 | 50 | VI |
| Puits Pizzagalli | 1978 | 56-3 | 474 | | Sb. Coq | 1 | | | | | 1 | 1 | jatte | Sb. Coq J2.3 | 51 | VI |
| Puits Pizzagalli | 1978 | 56-3 | 474 | | Sb. Coq | 2 | | | | | 2 | 1 | jatte | Sb. Coq J4.2 | 52 | VI |
| Puits Pizzagalli | 1978 | 56-3 | 474 | | Sb. Coq | 7 | | | | | 7 | 1 | jatte | Sb. Coq J4.2 | 53 | VII |
| Puits Pizzagalli | 1978 | 56-3 | 474 | | Sb. Coq | 1 | | | | | 1 | 1 | jatte | Sb. Coq J4.2 | 54 | VII |
| Puits Pizzagalli | | 37-4 | 149 | 1 | Sb. Coq | 1 | | | | | 1 | | jatte | Sb. Coq J4.2 | 55 | VII |
| Puits Pizzagalli | 1978 | 56-3 | 474 | | Sb. Coq | 7 | | | | | 7 | 1 | jatte | Sb. Coq J6 | 56 | VII |
| Puits Pizzagalli | 1978 | 56-3 | 474 | | Sb. Coq | 4 | | | | | 4 | 1 | jatte | Sb. Coq J6 | 57 | VII |
| Puits Pizzagalli | 1978 | 56-3 | 474 | | Sb. Coq | 3 | | | | | 3 | 1 | jatte | Sb. Coq J/M1 | 58 | VII |
| Puits Pizzagalli | 1978 | 56-3 | 474 | | Sb. Coq | 1 | | | | | 1 | 1 | jatte | Sb. Coq J/M1 | 59 | VIII |
| Puits Pizzagalli | 1978 | 56-3 | 474 | | Sb. Coq | 2 | | | | | 2 | 1 | jatte | Sb. Coq J/M1 | 60 | VIII |
| Puits Pizzagalli | 1978 | 56-3 | 474 | | Sb. Coq | 1 | | | | | 1 | 1 | jatte | Sb. Coq J/M2 | 61 | VIII |
| Puits Pizzagalli | 1978 | 56-3 | 474 | | Sb. Coq | 4 | | | | | 4 | 1 | jatte | Sb. Coq J/M3.1 | 62 | VIII |
| Puits Pizzagalli | 1978 | 56-3 | 474 | | Sb. Coq | 2 | | | | | 2 | 1 | jatte | Sb. Coq J/M5 | 63 | VIII |
| Puits Pizzagalli | 1978 | 56-3 | 474 | | Sb. Coq | 3 | | | | | 3 | 1 | pot | Sb. Coq P3 | 64 | VIII |

ANNEXE B : PUIITS PIZZAGALLI

| Site | année | Rayon | Caisse | n° ordre | Catégorie | Comptage | | | | | | Typologie | Desc. Typo. | Dessin | Planche | |
|---------------------|-------|-------|--------|-------------|-----------|----------|---|---|---|---|----|-----------|-------------|--------------|---------|-----|
| | | | | | | B | F | A | D | P | NR | | | | | NMI |
| Puits Pizzagalli | 1978 | 56-3 | 474 | | Sb. Coq | 1 | | | | | 1 | 1 | pot | Sb. Coq P4 | 65 | IX |
| Puits Pizzagalli | 1978 | 56-3 | 474 | | Sb. Coq | 2 | | | | | 2 | 1 | pot | Sb. Coq P5.1 | 66 | IX |
| Puits Pizzagalli | 1978 | 56-3 | 474 | | Sb. Coq | 4 | | | | | 4 | 1 | pot | Sb. Coq P6.1 | 67 | IX |
| Puits Pizzagalli | 1978 | 56-3 | 474 | | Sb. Coq | 3 | | | | | 3 | 1 | pot | Sb. Coq P6.1 | 68 | IX |
| Puits Pizzagalli | 1978 | 56-3 | 474 | | Sb. Coq | 5 | | | | | 5 | 1 | pot | Sb. Coq P6.1 | 69 | IX |
| Puits Pizzagalli | | 56-2 | 471 | | Sb. Coq | 1 | | | | | 1 | 1 | pot | Sb. Coq P6.1 | 70 | IX |
| Puits Pizzagalli | 1978 | 56-3 | 474 | | Sb. Coq | 4 | | | | | 4 | 1 | pot | Sb. Coq P6.2 | 71 | IX |
| Puits Pizzagalli | 1978 | 56-3 | 474 | | Sb. Coq | 2 | | | | | 2 | 1 | pot | Sb. Coq P7.1 | 72 | IX |
| Puits Pizzagalli | 1978 | 56-3 | 474 | | Sb. Coq | 2 | | | | | 2 | 1 | pot | Sb. Coq P7.1 | 73 | IX |
| Puits Pizzagalli | 1978 | 56-3 | 474 | | Sb. Coq | 1 | | | | | 1 | 1 | pot | Sb. Coq P7.1 | 74 | IX |
| Puits Pizzagalli | 1978 | 56-3 | 474 | | Sb. Coq | 2 | | | | | 2 | 1 | pot | Sb. Coq P7.1 | 75 | X |
| Puits Pizzagalli | 1978 | 56-3 | 474 | | Sb. Coq | 1 | | | | | 1 | 1 | pot | Sb. Coq P7.1 | 76 | X |
| Puits Pizzagalli | 1978 | 56-3 | 474 | | Sb. Coq | 1 | | | | | 1 | 1 | pot | Sb. Coq P7.1 | 77 | X |
| Puits Pizzagalli | 1978 | 56-3 | 474 | | Sb. Coq | 2 | | | | | 2 | 1 | pot | Sb. Coq P7.2 | 78 | X |
| Puits Pizzagalli | 1978 | 56-3 | 474 | | Sb. Coq | 2 | | | | | 2 | 1 | pot | Sb. Coq P9.1 | 79 | X |

ANNEXE B : PUIITS PIZZAGALLI

| Site | année | Rayon | Caisse | n° ordre | Catégorie | Comptage | | | | | | Typologie | Desc. Typo. | Dessin | Planche | |
|---------------------|-------|-------|--------|-------------|-----------|----------|---|---|---|---|----|-----------|-------------|---------------|---------|-----|
| | | | | | | B | F | A | D | P | NR | | | | | NMI |
| Puits Pizzagalli | | 56-5 | 480 | | Sb. Coq | 1 | | | | | 1 | 1 | couvercle | Sb. Coq Cv1 | 80 | X |
| Puits Pizzagalli | | 56-5 | 480 | | Sb. Coq | 1 | | | | | 1 | 1 | couvercle | Sb. Coq Cv1 | 81 | X |
| Puits Pizzagalli | | 56-5 | 480 | | Sb. Coq | 1 | | | | | 1 | 1 | couvercle | Sb. Coq Cv1 | 82 | X |
| Puits Pizzagalli | 1978 | 56-3 | 474 | | Sb. Coq | 1 | | | | | 1 | 1 | couvercle | Sb. Coq Cv2.1 | 83 | X |
| Puits Pizzagalli | | 56-5 | 480 | | Sb. Coq | 3 | | | | | 3 | 1 | couvercle | Sb. Coq Cv2.3 | 84 | X |
| Puits Pizzagalli | | 56-5 | 480 | | Sb. Coq | 1 | | | | | 1 | 1 | couvercle | Sb. Coq Cv2.3 | 85 | X |
| Puits Pizzagalli | | 56-5 | 480 | | Sb. Coq | 2 | | | | | 2 | 1 | couvercle | Sb. Coq Cv2.3 | 86 | X |
| Puits Pizzagalli | | 56-5 | 480 | | Sb. Coq | 4 | | | | | 4 | 1 | couvercle | Sb. Coq Cv2.3 | 87 | X |
| Puits Pizzagalli | | 56-5 | 480 | | Sb. Coq | 2 | | | | | 2 | 1 | couvercle | Sb. Coq Cv3.1 | 88 | X |
| Puits Pizzagalli | | 56-5 | 480 | | Sb. Coq | 1 | | | | | 1 | 1 | couvercle | Sb. Coq Cv3.1 | 89 | X |
| Puits Pizzagalli | | 56-5 | 480 | | Sb. Coq | 1 | | | | | 1 | 1 | couvercle | Sb. Coq Cv3.1 | 90 | XI |
| Puits Pizzagalli | | 56-5 | 480 | | Sb. Coq | 1 | | | | | 1 | 1 | couvercle | Sb. Coq Cv3.1 | 91 | XI |
| Puits Pizzagalli | | 56-5 | 480 | | Sb. Coq | 1 | | | | | 1 | 1 | couvercle | Sb. Coq Cv3.1 | 92 | XI |
| Puits Pizzagalli | | 56-5 | 480 | | Sb. Coq | 1 | | | | | 1 | 1 | couvercle | Sb. Coq Cv3.1 | 93 | XI |
| Puits Pizzagalli | | 56-5 | 480 | | Sb. Coq | 1 | | | | | 1 | 1 | couvercle | Sb. Coq Cv3.1 | 94 | XI |

ANNEXE B : PUITES PIZZAGALLI

| Site | année | Rayon | Caisse | n° ordre | Catégorie | Comptage | | | | | | Typologie | Desc. Typo. | Dessin | Planche | |
|------------------|-------|-------|--------|-------------|--------------|----------|----|---|---|-----|-----|-----------|-------------|---------------|---------|-----|
| | | | | | | B | F | A | D | P | NR | | | | | NMI |
| Puits Pizzagalli | | 56-5 | 480 | | Sb. Coq | 3 | | | | | 3 | 1 | couvercle | Sb. Coq Cv3.1 | 95 | XI |
| Puits Pizzagalli | | 56-5 | 480 | | Sb. Coq | 14 | 1 | | | | 15 | 1 | couvercle | Sb. Coq Cv3.1 | 96 | XI |
| Puits Pizzagalli | | 56-5 | 480 | | Sb. Coq | 1 | | | | | 1 | 1 | couvercle | Sb. Coq Cv4.2 | 97 | XI |
| Puits Pizzagalli | | 56-5 | 480 | | Sb. Coq | 1 | | | | | 1 | 1 | couvercle | Sb. Coq Cv4.2 | 98 | XI |
| Puits Pizzagalli | 1977 | 36-4 | 131 | 1 | Sb. Coq | | 3 | | | 22 | 25 | | | | | |
| Puits Pizzagalli | 1978 | 56-3 | 474 | | Sb. Coq | | 35 | 2 | | 13 | 50 | | | | | |
| Puits Pizzagalli | | 56-2 | 471 | | Sb. Coq | | | | | 5 | 5 | | | | | |
| Puits Pizzagalli | | 56-5 | 480 | | Sb. Coq | | 5 | | | 359 | 364 | | | | | |
| Puits Pizzagalli | | 59-3 | 1623 | | Sb. Coq | | | | | 3 | 3 | | | | | |
| Puits Pizzagalli | | 37-4 | 149 | 1 | Sb. Coq | | | | | 7 | 7 | | | | | |
| Puits Pizzagalli | | 56-2 | 471 | | Com. Sb | 1 | | | | | 1 | 1 | pot | Com. Sb P1.2 | 99 | XII |
| Puits Pizzagalli | 1978 | 56-3 | 474 | | Com. Sb | 4 | | | | | 4 | 1 | pot | Com. Sb P2 | 100 | XII |
| Puits Pizzagalli | | 57-1 | 469 | | Com. Sb | | 5 | | | | 5 | | | | | |
| Puits Pizzagalli | | 56-4 | 478 | | Com. Cl 1 | 1 | | | | | 1 | 1 | cruche | Com. Cl Cr1.1 | 101 | XII |
| Puits Pizzagalli | | 56-4 | 478 | | Com. Cl 1 | 1 | | | | | 1 | 1 | cruche | Com. Cl Cr1.2 | 102 | XII |

ANNEXE B : PUIITS PIZZAGALLI

| Site | année | Rayon | Caisse | n° ordre | Catégorie | Comptage | | | | | | Typologie | Desc. Typo. | Dessin | Planche | |
|------------------|-------|-------|--------|-------------|-----------|----------|---|---|---|----|----|-----------|-------------|---------------|---------|-----|
| | | | | | | B | F | A | D | P | NR | | | | | NMI |
| Puits Pizzagalli | | 56-4 | 478 | | Com. Cl 1 | 1 | | | | | 1 | 1 | cruche | Com. Cl Cr1.2 | 103 | XII |
| Puits Pizzagalli | | 56-4 | 478 | | Com. Cl 1 | 2 | | | | | 2 | 1 | cruche | Com. Cl Cr1.2 | 104 | XII |
| Puits Pizzagalli | | 56-4 | 478 | | Com. Cl 1 | 1 | | | | | 1 | 1 | cruche | Com. Cl Cr4.1 | 105 | XII |
| Puits Pizzagalli | | 59-3 | 1623 | | Com. Cl 1 | 1 | | | | | 1 | 1 | cruche | Com. Cl Cr6.1 | 106 | XII |
| Puits Pizzagalli | | 56-4 | 478 | | Com. Cl 1 | 1 | | | | | 1 | 1 | cruche | Com. Cl Cr6.1 | 107 | XII |
| Puits Pizzagalli | | 56-4 | 478 | | Com. Cl 1 | 1 | | | | | 1 | 1 | cruche | Com. Cl Cr6.1 | 108 | XII |
| Puits Pizzagalli | | 56-4 | 478 | | Com. Cl 1 | 1 | | | | | 1 | 1 | cruche | Com. Cl Cr6.2 | 109 | XII |
| Puits Pizzagalli | | 56-4 | 478 | | Com. Cl 1 | 1 | | | | | 1 | 1 | cruche | Com. Cl Cr6.2 | 110 | XII |
| Puits Pizzagalli | | 59-3 | 1623 | | Com. Cl 1 | 1 | | | | | 1 | 1 | cruche | Com. Cl Cr10 | 111 | XII |
| Puits Pizzagalli | | 56-4 | 478 | | Com. Cl 1 | 1 | | | | | 1 | 1 | cruche | Com. Cl Cr10 | 112 | XII |
| Puits Pizzagalli | | 56-4 | 478 | | Com. Cl 1 | 1 | | | | | 1 | 1 | cruche | Com. Cl Cr15 | 113 | XII |
| Puits Pizzagalli | | 56-4 | 478 | | Com. Cl 1 | 1 | | | | | 1 | 1 | pot | Com. Cl P5.2 | 114 | XII |
| Puits Pizzagalli | | | BAL | | Com. Cl 1 | 1 | | | | | 1 | 1 | pot | Com. Cl PMin1 | 115 | XII |
| Puits Pizzagalli | | 56-2 | 471 | | Com. Cl 1 | | | | | 2 | 2 | | | | | |
| Puits Pizzagalli | | 56-2 | 471 | | Com. Cl 1 | | 3 | | | 23 | 26 | | | | | |

ANNEXE B : Puits PIZZAGALLI

| Site | année | Rayon | Caisse | n° ordre | Catégorie | Comptage | | | | | | Typologie | Desc. Typo. | Dessin | Planche |
|------------------|-------|-------|--------|-------------|---------------|----------|---|---|---|-----|-----|-----------|-------------|--------------|----------|
| | | | | | | B | F | A | D | P | NR | | | | |
| Puits Pizzagalli | | 57-1 | 469 | | Com. Cl 1 | | 7 | | | 70 | 77 | | | | |
| Puits Pizzagalli | | 59-3 | 1623 | | Com. Cl 1 | | 1 | 1 | | 43 | 45 | | | | |
| Puits Pizzagalli | | 59-3 | 1623 | | Com. Cl 1 | | 4 | | | 41 | 45 | | | | |
| Puits Pizzagalli | | 59-3 | 1623 | | Com. Cl 1 | | 3 | 1 | | 7 | 11 | | | | |
| Puits Pizzagalli | | 59-3 | 1623 | | Com. Cl 2 | 1 | | | | | 1 | 1 | pot | Com. Cl P5.2 | 116 XII |
| Puits Pizzagalli | | 56-3 | 475 | | Com. Cl 2 | 1 | | | | | 1 | 1 | pot | Com. Cl P5.2 | 117 XII |
| Puits Pizzagalli | | 57-1 | 469 | | Com. Cl 2 | 3 | | | | | 3 | 1 | couvercle | Com. Cl Cv3 | 118 XII |
| Puits Pizzagalli | | 59-3 | 1623 | | Com. Cl 2 | | 1 | 3 | | 300 | 304 | | | | |
| Puits Pizzagalli | | 56-2 | 471 | | Com. Cl 2 | | 1 | | | 17 | 18 | | | | |
| Puits Pizzagalli | | 56-3 | 475 | | Com. Cl 2 | | | | | 3 | 3 | | | | |
| Puits Pizzagalli | | 37-4 | 149 | 1 | Com. Cl 2 | | 2 | | | 16 | 18 | | | | |
| Puits Pizzagalli | | 37-4 | 149 | 1 | Com. Cl 3 | 1 | | | | | 1 | | | | |
| Puits Pizzagalli | | 56-2 | 471 | | Com. Cl 3 | | | | | 16 | 16 | | | | |
| Puits Pizzagalli | | 57-1 | 469 | | Com. Cl 3 | | | | | 1 | 1 | 1 | graffiti | | 119 XIII |
| Puits Pizzagalli | | 56-3 | 475 | | Com. Cl dorée | 1 | | | | | 1 | 1 | plat | Com. Cl P13 | 120 XIII |

ANNEXE B : PUIITS PIZZAGALLI

| Site | année | Rayon | Caisse | n° ordre | Catégorie | Comptage | | | | | | Typologie | Desc. Typo. | Dessin | Planche | |
|---------------------|-------|-------|--------|-------------|------------------|----------|---|---|---|----|----|-----------|-------------|---------------|---------|------|
| | | | | | | B | F | A | D | P | NR | | | | | NMI |
| Puits Pizzagalli | | 56-3 | 475 | | Com. Cl dorée | 1 | | | | | 1 | 1 | plat | Com. Cl P13 | 121 | XIII |
| Puits Pizzagalli | | 56-3 | 475 | | Com. Cl dorée | 3 | | | | | 3 | 1 | plat | Com. Cl P13 | 122 | XIII |
| Puits Pizzagalli | | 56-3 | 475 | | Com. Cl dorée | 1 | | | | | 1 | 1 | plat | Com. Cl P13 | 123 | XIII |
| Puits Pizzagalli | | 56-3 | 475 | | Com. Cl dorée | 2 | | | | | 2 | 1 | plat | Com. Cl P13 | | |
| Puits Pizzagalli | | 56-3 | 475 | | Com. Cl dorée | 1 | | | | | 1 | 1 | plat | Com. Cl P13 | | |
| Puits Pizzagalli | | 56-3 | 475 | | Com. Cl dorée | 1 | | | | | 1 | 1 | plat | Com. Cl P13 | 124 | XIV |
| Puits Pizzagalli | | 56-3 | 475 | | Com. Cl dorée | 1 | | | | | 1 | 1 | plat | Com. Cl P13 | 125 | XIV |
| Puits Pizzagalli | | 56-3 | 475 | | Com. Cl dorée | 5 | | | | | 5 | 1 | plat | Com. Cl P13 | 126 | XIV |
| Puits Pizzagalli | | 56-3 | 475 | | Com. Cl dorée | 3 | | | | | 3 | 1 | plat | Com. Cl P14 | 127 | XIV |
| Puits Pizzagalli | | 56-3 | 475 | | Com. Cl dorée | 1 | | | | | 1 | 1 | plat | Com. Cl P14 | 128 | XIV |
| Puits Pizzagalli | | 56-3 | 475 | | Com. Cl dorée | 5 | | | | | 5 | 1 | bol | Com. Cl B6.2 | 129 | XIV |
| Puits Pizzagalli | | 56-3 | 475 | | Com. Cl dorée | 1 | | | | | 1 | 1 | bol | Com. Cl B6.2 | 130 | XIV |
| Puits Pizzagalli | | 56-3 | 475 | | Com. Cl dorée | 1 | | | | | 1 | 1 | marmite | Com. Cl M1 | 131 | XIV |
| Puits Pizzagalli | | 56-3 | 475 | | Com. Cl dorée | 1 | | | | | 1 | 1 | cruche | Com. Cl Cr4.2 | 132 | XIV |
| Puits Pizzagalli | | 57-1 | 469 | | Com. Cl dorée | 3 | 5 | 2 | | 81 | 91 | 1 | cruche | Com. Cl Cr15 | 133 | XIV |

ANNEXE B : Puits PIZZAGALLI

| Site | année | Rayon | Caisse | n° ordre | Catégorie | Comptage | | | | | | Typologie | Desc. Typo. | Dessin | Planche | |
|------------------|-------|-------|--------|-------------|---------------|----------|---|---|---|----|----|-----------|-------------|--------------|---------|-----|
| | | | | | | B | F | A | D | P | NR | | | | | NMI |
| Puits Pizzagalli | | 56-3 | 475 | | Com. Cl dorée | 2 | 1 | | | 1 | 4 | 1 | pot | Com. Cl P6.1 | 134 | XIV |
| Puits Pizzagalli | | 56-3 | 475 | | Com. Cl dorée | 1 | | | | | 1 | 1 | pot | Com. Cl P6.1 | 135 | XV |
| Puits Pizzagalli | | 56-3 | 475 | | Com. Cl dorée | 1 | | | | | 1 | 1 | pot | Com. Cl P6.1 | 136 | XV |
| Puits Pizzagalli | | 56-3 | 475 | | Com. Cl dorée | 1 | | | | | 1 | 1 | pot | Com. Cl P6.1 | 137 | XV |
| Puits Pizzagalli | | 56-3 | 475 | | Com. Cl dorée | 2 | | | | | 2 | 1 | pot | Com. Cl P6.1 | 138 | XV |
| Puits Pizzagalli | | 56-3 | 475 | | Com. Cl dorée | 1 | | | | | 1 | 1 | pot | Com. Cl P6.1 | 139 | XV |
| Puits Pizzagalli | | 56-3 | 475 | | Com. Cl dorée | 1 | | | | | 1 | 1 | pot | Com. Cl P6.1 | 140 | XV |
| Puits Pizzagalli | | 56-3 | 475 | | Com. Cl dorée | 3 | | | | | 3 | 1 | pot | Com. Cl P6.2 | 141 | XV |
| Puits Pizzagalli | | 56-3 | 475 | | Com. Cl dorée | 1 | | | | | 1 | 1 | pot | Com. Cl P6.2 | 142 | XV |
| Puits Pizzagalli | | 56-2 | 471 | | Com. Cl dorée | | | | | 2 | 2 | | | | | |
| Puits Pizzagalli | | 56-3 | 475 | | Com. Cl dorée | | | | | 27 | 27 | | | | | |
| Puits Pizzagalli | | 56-3 | 475 | | Com. Cl dorée | | | | | 25 | 25 | | | | | |
| Puits Pizzagalli | | 56-3 | 475 | | Com. Cl dorée | | 6 | | | 6 | 12 | | | | | |
| Puits Pizzagalli | | 56-3 | 475 | | Com. Cl dorée | | 5 | | | 8 | 13 | | | | | |
| Puits Pizzagalli | | 56-3 | 475 | | Com. Cl dorée | | 7 | | | | 7 | | | | | |

ANNEXE B : Puits PIZZAGALLI

| Site | année | Rayon | Caisse | n° ordre | Catégorie | Comptage | | | | | | Typologie | Desc. Typo. | Dessin | Planche |
|------------------|-------|-------|--------|-------------|---------------|----------|---|---|---|----|----|-----------|-------------|---------------|----------|
| | | | | | | B | F | A | D | P | NR | | | | |
| Puits Pizzagalli | | 56-3 | 475 | | Com. Cl dorée | | 6 | | | 20 | 26 | | | | |
| Puits Pizzagalli | | 56-3 | 475 | | Com. Cl dorée | | 1 | | | | 1 | | | | |
| Puits Pizzagalli | | 56-3 | 475 | | Cl. Eng. | 1 | | | | 3 | 4 | | | | |
| Puits Pizzagalli | | 37-4 | 149 | 1 | Cl. Eng. | 1 | | | | | 1 | 1 | cruche | Com. Cl Cr2.1 | 143 XV |
| Puits Pizzagalli | | 56-3 | 475 | | Com. Cl Grand | 1 | | | | | 1 | 1 | bol | Com. Cl B5 | 144 XV |
| Puits Pizzagalli | | 56-3 | 475 | | Com. Cl Grand | 2 | | | | | 2 | 1 | bol | Com. Cl B5 | 145 XV |
| Puits Pizzagalli | | 56-3 | 475 | | Com. Cl Grand | 2 | | | | | 2 | 1 | bol | Com. Cl B5 | 146 XV |
| Puits Pizzagalli | | 56-3 | 475 | | Com. Cl Grand | 1 | | | | | 1 | 1 | bol | Com. Cl B5 | 147 XVI |
| Puits Pizzagalli | | 56-3 | 475 | | Com. Cl Grand | 1 | | | | | 1 | 1 | bol | Com. Cl B5 | 148 XVI |
| Puits Pizzagalli | | 57-1 | 469 | | Com. Cl Grand | 1 | 2 | | | 40 | 43 | 1 | bol | Com. Cl B5 | 149 XVI |
| Puits Pizzagalli | | 56-3 | 475 | | Com. Cl Grand | 1 | | | | | 1 | 1 | cruche | Com. Cl Cr7.3 | 150 XVI |
| Puits Pizzagalli | 1977 | 36-4 | 131 | 1 | Mo | 2 | 1 | | | | 3 | 1 | mortier | Mo1.1 | 151 XVI |
| Puits Pizzagalli | | 56-3 | 475 | | Mo | 1 | | | | 3 | 4 | 1 | mortier | Mo1.1 | 152 XVI |
| Puits Pizzagalli | | 56-3 | 475 | | Mo | 1 | | | | | 1 | 1 | mortier | Mo1.1 | 153 XVII |
| Puits Pizzagalli | | 56-3 | 475 | | Mo | 4 | | | | 10 | 14 | 1 | mortier | Mo1.1 | 154 XVII |

ANNEXE B : PUIITS PIZZAGALLI

| Site | année | Rayon | Caisse | n° ordre | Catégorie | Comptage | | | | | | | Typologie | Desc. Typo. | Dessin | Planche |
|---------------------|-------|-------------------|---------|-------------|-----------|----------|---|---|---|---|----|-----|-------------|--------------|--------|---------|
| | | | | | | B | F | A | D | P | NR | NMI | | | | |
| Puits Pizzagalli | | 56-3 | 475 | | Mo | 4 | | | | 2 | 6 | 1 | mortier | Mo3 | 155 | XVII |
| Puits Pizzagalli | | 56-3 | 475 | | Mo | | | | | 3 | 3 | 1 | mortier | | | |
| Puits Pizzagalli | | 56-3 | 475 | | Mo | | | | | 2 | 2 | 1 | mortier | | | |
| Puits Pizzagalli | | 56-3 | 475 | | Mo | | 1 | | | 2 | 3 | 1 | mortier | | | |
| Puits Pizzagalli | | 56-2 | 471 | | Mo | 1 | | | | | 1 | | | | | |
| Puits Pizzagalli | | 56-3 | 475 | | Mo | | 1 | | | | 1 | | | | | |
| Puits Pizzagalli | | 57-1 | 469 | | Mo | | | | | 4 | 4 | | | | | |
| Puits Pizzagalli | | 56-5 | 251 | | Amp. | | | | | | 58 | 1 | amphore | Dressel 20 | | |
| Puits Pizzagalli | | 58-1 | 252 | | Amp. | | | | | | 60 | 1 | amphore | Gauloise 4 | | |
| Puits Pizzagalli | | Musée Mosaïque | vitrine | | Amp. | 1 | | | | | 1 | 1 | amphore | Dressel 43 | 156 | XVII |
| Puits Pizzagalli | | 56-2 | 471 | | Amp. | | | | | 2 | 2 | | | | | |
| Puits Pizzagalli | | 56-2 | 471 | | Amp. | | | | | 8 | 8 | | | | | |
| Puits Pizzagalli | | 56-2 | 471 | | Amp. | | | | | 2 | 2 | | | | | |
| Puits Pizzagalli | | 57-1 | 469 | | Ampho. | | 1 | | | | 1 | 1 | amphorisque | Ampho fond 1 | 157 | XVII |
| Puits Pizzagalli | | 57-1 | 469 | | Ampho. | | 1 | | | 2 | 3 | 1 | amphorisque | Ampho fond 2 | 158 | XVII |

ANNEXE B : PUIITS PIZZAGALLI

| Site | année | Rayon | Caisse | n° ordre | Catégorie | Comptage | | | | | | | Typologie | Desc. Typo. | Dessin | Planche |
|---------------------|-------|-------|--------|-------------|-----------------|----------|----|---|---|----|----|-----|---------------------|-------------|--------|---------|
| | | | | | | B | F | A | D | P | NR | NMI | | | | |
| Puits Pizzagalli | 1977 | 36-4 | 131 | 1 | Bp1 | 5 | | | | 3 | 8 | 1 | brûle-parfum | Bp1 | 159 | XVIII |
| Puits Pizzagalli | 1977 | 36-4 | 131 | 1 | Bp1 | | 1 | | | 4 | 5 | 1 | brûle-parfum | Bp fond 3 | 160 | XVIII |
| Puits Pizzagalli | | 56-4 | 478 | | Creuset | | 24 | | | 10 | 34 | 1 | creuset | | | |
| Puits Pizzagalli | | 57-1 | 469 | | Lampe | | | | 1 | | | 1 | lampe à huile | | 161 | XVIII |
| Puits Pizzagalli | | 57-1 | 469 | | Lampe | 1 | | | | | | 1 | lampe à huile | | | |
| Puits Pizzagalli | | | BAL | | Pomme de pin | 1 | | | | | | 1 | vase phytomorphe | | 162 | XIX |
| Puits Pizzagalli | | | BAL | | Pomme de pin | 1 | | | | | | 1 | vase phytomorphe | | 163 | XIX |
| Puits Pizzagalli | | | BAL | | TB Allier | | | | | 1 | 1 | 1 | édicule | | | |
| Puits Pizzagalli | | | BAL | | TB Allier | | | | | 1 | 1 | 1 | édicule | | 164 | XX |
| Puits Pizzagalli | | | BAL | | TB Allier | | | | | 1 | 1 | 1 | acrotère | | 165 | XX |
| Puits Pizzagalli | | | BAL | | TB Allier | | | | | 10 | 10 | 1 | cheval | | | |

ANNEXE B : Puits POILPRÈS

| année | Rayon | Caisse | n° ordre | Catégorie | Comptage | | | | | | | Typologie | Desc. Typo. | Dessin | Planche |
|-------|-------|--------|----------|-----------|----------|---|---|---|---|----|-----|-----------|----------------|--------|---------|
| | | | | | B | F | A | D | P | NR | NMI | | | | |
| | 54-3 | 461 | | Com. C12 | | 1 | | | 8 | 9 | 1 | | | | |

ANNEXE B : PUIITS RUE DE LA CHAPELLE

| année | Rayon | Caisse | n° ordre | Catégorie | Comptage | | | | | | | Typologie | Desc. Typo. | Dessin | Planche | |
|-------|-------|--------|----------|-----------|----------|---|---|---|-----|-----|-----|-----------|------------------|--------|---------|--|
| | | | | | B | F | A | D | P | NR | NMI | | | | | |
| 1975 | 57-4 | 493 | 2 | EN AR | | | | | 140 | 140 | | | | | | |
| 1975 | 57-4 | 493 | 2 | EN AR | 1 | | | | | 1 | 1 | gobelet | Hees 2 | 1 | I | |
| 1975 | 57-4 | 493 | 2 | EN AR | 1 | | | | | 1 | 1 | gobelet | Hees 2 | 2 | I | |
| 1975 | 57-4 | 493 | 2 | EN AR | 2 | | | | | 2 | 1 | gobelet | Hees 2 | 3 | I | |
| 1975 | 57-4 | 493 | 2 | EN AR | 3 | | | | | 3 | 1 | gobelet | Hees 2 | 4 | I | |
| 1975 | 57-4 | 493 | 2 | EN AR | 2 | | | | | 2 | 1 | gobelet | Hees 2 | 5 | I | |
| 1975 | 57-4 | 493 | 2 | EN AR | 2 | | | | | 2 | 1 | gobelet | Hees 2 | 6 | I | |
| 1975 | 57-4 | 493 | 2 | EN AR | 6 | | | | | 6 | 1 | gobelet | Hees 2 | 7 | I | |
| 1975 | 57-4 | 492 | 1 | EN AR | | | | | 2 | 2 | | | | | | |
| 1975 | 57-4 | 493 | 2 | EN TR | | | | 1 | | 1 | 1 | | décor de lunules | | | |
| 1975 | 57-4 | 492 | 1 | TN | | | | | 3 | 3 | 1 | | | | | |
| | | BAL | | TR | 1 | | | | | 1 | 1 | gobelet | | 8 | I | |
| 1975 | 57-4 | 493 | 2 | Sb. Coq | 1 | | | | | 1 | 1 | jatte | Sb. Coq J1 | 9 | I | |
| 1975 | 57-4 | 493 | 2 | Sb. Coq | 1 | | | | | 1 | 1 | jatte | Sb. Coq J1 | 10 | I | |
| 1975 | 57-4 | 493 | 2 | Sb. Coq | 1 | | | | | 1 | 1 | jatte | Sb. Coq J1 | 11 | I | |
| 1975 | 57-4 | 493 | 2 | Sb. Coq | 2 | | | | | 2 | 1 | jatte | Sb. Coq J1 | | | |
| 1975 | 57-4 | 493 | 2 | Sb. Coq | 2 | | | | | 2 | 1 | jatte | Sb. Coq J2.1 | 12 | I | |
| 1975 | 57-4 | 493 | 2 | Sb. Coq | 3 | | | | | 3 | 1 | jatte | Sb. Coq J2.3 | 13 | I | |
| 1975 | 57-4 | 493 | 2 | Sb. Coq | 3 | | | | | 3 | 1 | jatte | Sb. Coq J2.3 | 14 | I | |
| 1975 | 57-4 | 493 | 2 | Sb. Coq | 2 | | | | | 2 | 1 | jatte | Sb. Coq J6 | 15 | II | |
| 1975 | 57-4 | 493 | 2 | Sb. Coq | 2 | | | | | 2 | 1 | jatte | Sb. Coq J6 | 16 | II | |
| 1975 | 57-4 | 493 | 2 | Sb. Coq | 4 | | | | | 4 | 1 | jatte | Sb. Coq J/M4 | 17 | II | |
| 1975 | 57-4 | 493 | 2 | Sb. Coq | 2 | | | | | 2 | 1 | pot | Sb. Coq P3 | 18 | II | |
| 1975 | 57-4 | 493 | 2 | Sb. Coq | 1 | | | | | 1 | 1 | pot | Sb. Coq P6.1 | 19 | II | |
| 1975 | 57-4 | 493 | 2 | Sb. Coq | 2 | | | | | 2 | 1 | pot | Sb. Coq P6.1 | 20 | II | |
| 1975 | 57-4 | 493 | 2 | Sb. Coq | 3 | | | | | 3 | 1 | pot | Sb. Coq P7.1 | 21 | II | |

ANNEXE B : PUITTS RUE DE LA CHAPELLE

| année | Rayon | Caisse | n° ordre | Catégorie | Comptage | | | | | | | Typologie | Desc. Typo. | Dessin | Planche |
|-------|-------|--------|----------|---------------|----------|----|---|---|-----|-----|-----|-----------|---------------|--------|---------|
| | | | | | B | F | A | D | P | NR | NMI | | | | |
| 1975 | 57-4 | 493 | 2 | Sb. Coq | 2 | | | | | 2 | 1 | pot | Sb. Coq P7.1 | 22 | II |
| 1975 | 57-4 | 493 | 2 | Sb. Coq | 3 | | | | | 3 | 1 | pot | Sb. Coq P7.1 | 23 | II |
| 1975 | 57-4 | 493 | 2 | Sb. Coq | 2 | | | | | 2 | 1 | pot | Sb. Coq P10.1 | 24 | III |
| 1975 | 57-4 | 493 | 2 | Sb. Coq | 1 | | | | | 1 | 1 | couvercle | Sb. Coq Cv5 | 25 | III |
| 1975 | 57-4 | 493 | 2 | Sb. Coq | 1 | | | | | 1 | 1 | couvercle | Sb. Coq Cv5 | 26 | III |
| 1975 | 57-4 | 493 | 2 | Sb. Coq | | 28 | | | 285 | 313 | | | | | |
| 1975 | 57-4 | 492 | 1 | Sb. Coq | | | | | 4 | 4 | | | | | |
| 1975 | 57-4 | 492 | 1 | Com. Cl 1 | | 1 | 1 | | 8 | 10 | 1 | | | | |
| 1975 | 57-4 | 493 | 2 | Com. Cl dorée | 2 | | | | | 2 | 1 | plat | Com. Cl P15 | 27 | III |

ANNEXE B : PUIITS SCHNEIDER BERTRAND

| année | Rayon | Caisse | n° ordre | Catégorie | Comptage | | | | | | | Typologie | Desc. Typo. | Dessin | Planche |
|-------|-------|--------|----------|-----------|----------|---|---|---|---|----|-----|-----------|------------------|--------|---------|
| | | | | | B | F | A | D | P | NR | NMI | | | | |
| | 32-3 | 71 | 1 | TS SG | | | | | 1 | 1 | 1 | | | | |
| | 32-3 | 71 | 1 | TN | | 1 | | | | 1 | 1 | | | | |
| | 32-3 | 71 | 1 | Com. Cl 1 | 1 | | | | | 1 | 1 | cruche | Com. Cl Cr6.1 | 1 | I |

ANNEXE B : PUIITS SPINDLER

| année | Rayon | Caisse | n° ordre | Catégorie | Comptage | | | | | | | Typologie | Desc. Typo. | Dessin | Planche | |
|-------|-------|--------|----------|-----------|----------|---|---|---|---|-----|-----|-----------|-------------|------------------------|---------|---|
| | | | | | B | F | A | D | P | NR | NMI | | | | | |
| 1979 | 52-2 | 420 | 2 | TS SG | | 1 | | | | 1 | 2 | 1 | | | | |
| 1979 | 52-2 | 420 | 1 | TS AR | 3 | | | | | | 3 | 1 | coupe | Drag. 37 | 1 | I |
| 1979 | 52-2 | 420 | 1 | TS AR | 3 | | | | | | 3 | 1 | coupe | Drag. 37 | 2 | I |
| 1979 | 52-2 | 420 | 1 | TS AR | 4 | | | | | | 4 | 1 | coupe | Drag. 38 | 3 | I |
| 1979 | 52-2 | 420 | 1 | TS AR | 3 | | | | | | 3 | 1 | coupelle | Drag. 40 | 4 | I |
| 1979 | 52-2 | 420 | 1 | TS AR | 3 | | | | | | 3 | 1 | tasse | Drag. 33 | 5 | I |
| 1979 | 52-2 | 420 | 1 | TS AR | 1 | | | | | | 1 | 1 | cruche | | 6 | I |
| 1979 | 52-2 | 420 | 2 | TS AR | | | | | | 11 | 11 | 1 | mortier | Drag. 45 | | |
| 1979 | 52-2 | 420 | 2 | TS AR | | 3 | | | | 48 | 51 | 0 | | | | |
| 1979 | 52-2 | 420 | 1 | TS AR | | | | 2 | | | 2 | 1 | | | | |
| 1979 | 52-2 | 420 | 1 | TS AR | | | | 2 | | | 2 | 1 | gobelet | Déch. 72 | | |
| 1979 | 52-2 | 420 | 1 | TS AR | | | | 1 | | | 1 | 1 | | décor à la molette | | |
| 1979 | 52-2 | 420 | 1 | TS AR | | | | 1 | | | 1 | 1 | | décor à la molette | | |
| 1979 | 52-2 | 420 | 1 | TS AR | | | | 1 | | | 1 | 1 | | décor à la molette | | |
| 1979 | 52-2 | 420 | 1 | TS AR | | | | 1 | | | 1 | 1 | | décor à la molette | | |
| 1979 | 52-2 | 420 | 2 | EN AR | 1 | | | | | | 1 | 1 | gobelet | Hees 2 | | |
| 1979 | 52-2 | 420 | 5 | MET AR | | 9 | | | | 212 | 221 | 0 | | | | |
| 1979 | 52-2 | 420 | 5 | MET AR | 3 | | | | | | 3 | 1 | gobelet | Nied. 33 | 7 | I |
| 1979 | 52-2 | 420 | 5 | MET AR | 3 | | | | | | 3 | 1 | gobelet | Nied. 33 | 8 | I |
| 1979 | 52-2 | 420 | 5 | MET AR | 2 | | | | | 4 | 6 | 1 | gobelet | Nied. 33 | 9 | I |
| 1979 | 52-2 | 420 | 5 | MET AR | 2 | | | | | | 2 | 1 | gobelet | Nied. 33 | 10 | I |
| 1979 | 52-2 | 420 | 5 | MET AR | 1 | | | 1 | | | 2 | 1 | gobelet | Nied. 33 | 11 | I |
| 1979 | 52-2 | 420 | 5 | MET AR | 1 | | | | | | 1 | 1 | gobelet | Nied. 31, grafitte "M" | 12 | I |
| 1979 | 52-2 | 420 | 5 | MET TR | | | | | | 8 | 8 | 0 | | | | |
| 1979 | 52-2 | 420 | 5 | MET TR | 1 | | | | | | 1 | 1 | gobelet | Nied. 35 | 13 | I |
| 1979 | 52-2 | 420 | 5 | MET TR | 1 | | | | | | 1 | 1 | gobelet | Nied. 33 | 14 | I |

ANNEXE B : PUIITS SPINDLER

| année | Rayon | Caisse | n° ordre | Catégorie | Comptage | | | | | | | Typologie | Desc. Typo. | Dessin | Planche |
|-------|-------------------|---------|----------|-----------|----------|---|---|---|----|----|-----|--------------------|---------------------------------|--------|---------|
| | | | | | B | F | A | D | P | NR | NMI | | | | |
| | musée mosaïque | vitrine | | MET TR | 1 | | | | | 1 | 1 | | décor à la barbotine blanche | 15 | I |
| 1979 | 52-2 | 420 | 2 | TN | 1 | | | | | 1 | 1 | assiette | A20.1 | 16 | II |
| 1979 | 52-2 | 420 | 2 | VRP | 1 | | | | 1 | 2 | 1 | plat | Goudineau 15 | 17 | II |
| 1979 | 52-2 | 420 | 2 | RU UR | 1 | | | | | 1 | 1 | marmite | Nied. 89 | 18 | II |
| 1979 | 52-2 | 420 | 2 | RU M | | | | | 3 | 3 | 1 | | | | |
| 1979 | 52-2 | 420 | 3 | CB | 2 | | | | | 2 | 1 | plat | Reims A6 | 19 | II |
| 1979 | 52-2 | 420 | 3 | CB | 1 | | | | | 1 | 1 | plat | Reims A6 | 20 | II |
| 1979 | 52-2 | 420 | 3 | CB | | | 1 | | | 1 | 1 | jatte | Reims J40 | | |
| 1979 | 52-2 | 420 | 3 | CB | 3 | | | | | 3 | 1 | pot | Reims P16 | 21 | II |
| 1979 | 52-2 | 420 | 3 | CB | 3 | | | | | 3 | 1 | pot | Reims P16 | 22 | II |
| 1979 | 52-2 | 420 | 3 | CB | 2 | | | | | 2 | 1 | pot | Reims P16 | 23 | II |
| 1979 | 52-2 | 420 | 3 | CB | | 3 | | | 51 | 54 | 0 | | | | |
| 1979 | 52-2 | 420 | 3 | CB | | | | | 87 | 87 | 0 | | | | |
| 1979 | 52-2 | 420 | 4 | Sb. Coq | 1 | | | | | 1 | 1 | plat | Sb. Coq P11.3 | 24 | II |
| 1979 | 52-2 | 420 | 4 | Sb. Coq | 1 | | | | | 1 | 1 | jatte | Sb. Coq J2.1 | 25 | II |
| 1979 | 52-2 | 420 | 4 | Sb. Coq | 1 | | | | | 1 | 1 | jatte | Sb. Coq J2.1 | 26 | II |
| 1979 | 52-2 | 420 | 4 | Sb. Coq | 2 | | | | | 2 | 1 | pot | Sb. Coq P10.1 | 27 | II |
| 1979 | 52-2 | 420 | 4 | Sb. Coq | | 4 | | | 47 | 51 | 0 | | | | |
| 1979 | 52-2 | 420 | 2 | Com. Sb | | | | | 8 | 8 | 0 | | | | |
| 1979 | 52-2 | 420 | 2 | Com. Sb | | | | 1 | | 1 | 1 | décor de picots | | 28 | II |
| 1979 | 52-2 | 420 | 2 | Com. Cl 2 | 1 | | | | | 1 | 1 | cruche | Com. Cl Cr6.3 | 29 | II |
| 1979 | 52-2 | 420 | 2 | Com. Cl 3 | 1 | | | | | 1 | 1 | cruche | Com. Cl Cr2.2 | 30 | II |
| 1979 | 37-5 | 151 | 1 | Com. Cl | 1 | | | | 18 | 19 | 1 | pot | Com. Cl P2 | 31 | II |
| 1979 | 52-2 | 420 | 2 | Com. Cl | | | | | 29 | 29 | 0 | | | | |
| 1979 | 52-2 | 420 | 2 | Com. Cl | | | | | 21 | 21 | 0 | | | | |

ANNEXE B : PUIITS SPINDLER

| année | Rayon | Caisse | n° ordre | Catégorie | Comptage | | | | | | | Typologie | Desc. Typo. | Dessin | Planche | |
|-------|-------|--------|----------|---------------|----------|---|---|---|---|----|-----|-----------|-------------|--------|---------|--|
| | | | | | B | F | A | D | P | NR | NMI | | | | | |
| 1979 | 52-2 | 420 | 2 | Com. Cl dorée | | | | | | 2 | 2 | 1 | | | | |

ANNEXE B : PUIITS TANG

| année | Rayon | Caisse | n° ordre | Catégorie | Comptage | | | | | | Typologie | Desc. Typo. | Dessin | Planche | |
|-------|-------|--------|----------|-----------|----------|---|---|---|---|----|-----------|-------------|--------|---------|-----|
| | | | | | B | F | A | D | P | NR | | | | | NMI |
| | 54-4 | 464 | | TS AR | | | | 1 | | | 1 | décor | | 1 | I |
| | 54-4 | 464 | | TR | 1 | | | | | | 1 | assiette | A54.1 | 2 | I |

ANNEXE B : PUITES INCONNUS

| année | Rayon | Caisse | n° ordre | Catégorie | Comptage | | | | | | | Typologie | Desc. Typo. | Dessin | Planche |
|-------|-------|--------|----------|---------------|----------|---|---|---|----|----|-----|-----------|---------------|--------|---------|
| | | | | | B | F | A | D | P | NR | NMI | | | | |
| | 58-3 | 468 | | TS AR | | | | | 2 | 2 | | | | | |
| | 58-3 | 468 | | MET AR | | | | | 31 | 31 | | | | | |
| | 54-2 | 458 | | TN | | | | | 14 | 14 | | | | | |
| | 58-3 | 468 | | TN | | | | | 27 | 27 | | | | | |
| 1967 | 37-4 | 148 | 1 | RUA | 1 | 1 | | | | 2 | 1 | jatte | Reims J7 | 1 | I |
| 1967 | 37-4 | 148 | 1 | CB | 1 | | | | | 1 | 1 | plat | Reims A9 | 2 | II |
| | 54-2 | 458 | | Sb. Coq | | | | | 25 | 25 | | | | | |
| 1967 | 37-4 | 148 | 1 | Com. Cl 1 | | 1 | | | | 1 | 1 | | | | |
| | 37-4 | 147 | 29 | Com. Cl 1 | 1 | | | | | 1 | 1 | cruche | Com. Cl Cr1.1 | 3 | I |
| | 37-4 | 147 | 29 | Com. Cl 1 | 2 | | | | 1 | 3 | 1 | pot | Com. Cl P6.1 | 4 | I |
| | 54-2 | 458 | | Com. Cl 1 | | | | | 12 | 12 | | | | | |
| | 58-3 | 468 | | Com. Cl 1 | | | | | 15 | 15 | | | | | |
| | 37-4 | 147 | 29 | Com. Cl 2 | 1 | | | | | 1 | 1 | cruche | Com. Cl Cr1.1 | 5 | I |
| | 37-4 | 147 | 29 | Com. Cl 3 | 1 | | | | | 1 | 1 | cruche | Com. Cl Cr5 | 6 | I |
| | 37-4 | 147 | 29 | Com. Cl 2 | 1 | | | | | 1 | 1 | pot | Com. Cl P5.2 | 7 | I |
| | 37-4 | 147 | 29 | Com. Cl 2 | 1 | | | | | 1 | 1 | pot | Com. Cl P6.1 | 8 | I |
| | 61-3 | 541 | | Com. Cl 3 | | | | | 12 | 12 | | | | | |
| | 37-4 | 147 | 29 | Com. Cl Grand | 3 | | | | | 3 | 1 | bol | Com. Cl B5 | 9 | II |
| | 37-4 | 147 | 29 | Mo | 1 | | | | | 1 | 1 | mortier | Mo1.1 | 10 | II |
| | 37-4 | 147 | 29 | Amp. | 1 | | | | | 1 | 1 | amphore | Dressel 20 | 11 | II |

ANNEXE B : AMPHITHÉÂTRE

| année | n° OA | Rayon | Caisse | n° ordre | US | Catégorie | Comptage | | | | | | Typologie | Desc. Typo. | Dessin | Planche | |
|------------|-------|-------|--------|----------|---------|-----------|----------|---|---|---|---|----|-----------|-------------|----------|---------|-----|
| | | | | | | | B | F | A | D | P | NR | | | | | NMI |
| | | 14--1 | 938 | | | TS SG | 1 | | | | | 1 | 1 | assiette | Drag. 15 | | |
| | | 41-2 | 195 | | | TS SG | 1 | | | | | 1 | 1 | assiette | Drag. 18 | | |
| | | 41-2 | 198 | | | TS SG | 1 | | | | | 1 | 1 | assiette | Drag. 18 | | |
| | | 41-3 | 213 | | | TS SG | 1 | | | | | 1 | 1 | assiette | Drag. 18 | | |
| | | 41-3 | 213 | | | TS SG | 1 | | | | | 1 | 1 | assiette | Drag. 18 | | |
| | | 15--4 | 914 | | | TS SG | 1 | | | | | 1 | 1 | assiette | Drag. 18 | | |
| | | 15--4 | 914 | | | TS SG | 1 | | | | | 1 | 1 | assiette | Drag. 18 | | |
| 1966-67-68 | | 39-2 | 155 | | S43 | TS SG | 1 | | | | | 1 | 1 | coupe | Drag. 37 | 1 | I |
| 1966-67-68 | | 39-2 | 155 | | S43 | TS SG | 1 | | | | | 1 | 1 | coupe | Drag. 37 | 2 | I |
| 1966 | | 19--1 | 1035 | | | TS SG | 1 | | | | | 1 | 1 | coupe | Drag. 27 | | |
| 1968 | | 14--2 | 919 | | | TS SG | 1 | | | | | 1 | 1 | coupe | Drag. 37 | | |
| 1968 | | 14--2 | 919 | | | TS SG | 1 | | | | | 1 | 1 | coupe | Drag. 37 | | |
| 1968 | | 14--2 | 919 | | | TS SG | 1 | | | | | 1 | 1 | coupe | Drag. 37 | | |
| 1968 | | 14--2 | 919 | | | TS SG | 1 | | | | | 1 | 1 | coupe | Drag. 37 | | |
| 1968 | | 14--2 | 919 | | | TS SG | 1 | | | | | 1 | 1 | coupe | Drag. 37 | | |
| 1968 | | 14--2 | 919 | | | TS SG | 1 | | | | | 1 | 1 | coupe | Drag. 37 | | |
| 1968 | | 14--2 | 919 | | | TS SG | 1 | | | | | 1 | 1 | coupe | Drag. 37 | | |
| 1968 | | 41-2 | 195 | | | TS SG | 1 | | | | | 1 | 1 | coupe | Drag. 37 | | |
| 1968 | | 14--2 | 919 | | | TS SG | 1 | | | | | 1 | 1 | coupelle | | 3 | I |
| | | 29-2 | 9 | | salle 2 | TS SG | 3 | | | | | 3 | 1 | coupelle | Drag. 35 | | |
| | | 29-2 | 9 | | salle 2 | TS SG | 1 | | | | | 1 | 1 | coupelle | Drag. 35 | | |
| | | 29-2 | 9 | | | TS SG | 1 | | 1 | | | 2 | 1 | coupelle | Drag. 35 | | |
| | | 41-2 | 195 | | | TS SG | 1 | | | | | 1 | 1 | coupelle | Drag. 35 | | |
| | | 41-2 | 195 | | | TS SG | 1 | | | | | 1 | 1 | coupelle | Drag. 35 | | |
| | | 41-2 | 198 | | | TS SG | 3 | | | | | 3 | 1 | coupelle | Drag. 35 | | |

ANNEXE B : AMPHITHÉÂTRE

| année | n° OA | Rayon | Caisse | n° ordre | US | Catégorie | Comptage | | | | | | Typologie | Desc. Typo. | Dessin | Planche | |
|-------|-------|-------|--------|----------|---------|-----------|----------|---|---|---|---|----|-----------|-------------|----------|---------|-----|
| | | | | | | | B | F | A | D | P | NR | | | | | NMI |
| | | 41-2 | 198 | | | TS SG | 2 | | | | | 2 | 1 | coupelle | Drag. 35 | | |
| | | 41-2 | 198 | | | TS SG | | | | 1 | | 1 | 1 | coupelle | Drag. 35 | | |
| 1979 | | 14--1 | 918 | | | TS SG | | 1 | | | 1 | 2 | 1 | coupelle | Drag. 35 | | |
| | | 41-3 | 213 | | | TS SG | 1 | | | | | 1 | 1 | coupelle | Drag. 35 | | |
| | | 41-3 | 213 | | | TS SG | 2 | | | | | 2 | 1 | coupelle | Drag. 35 | | |
| | | 42-5 | 266 | | | TS SG | 1 | | | 1 | 9 | 11 | 1 | coupelle | Drag. 35 | | |
| 1967 | | 40-2 | 191 | | | TS SG | 1 | | | | | 1 | 1 | coupelle | Drag. 35 | | |
| | | 41-2 | 195 | | | TS SG | 1 | | | | | 1 | 1 | coupelle | Drag. 40 | | |
| | | 29-2 | 9 | | salle 2 | TS SG | 1 | | | | | 1 | 1 | coupelle | Drag. 40 | | |
| | | 29-2 | 9 | | salle 2 | TS SG | 1 | | | | | 1 | 1 | coupelle | Drag. 40 | | |
| | | 29-2 | 9 | | salle 2 | TS SG | 1 | | | | | 1 | 1 | coupelle | Drag. 40 | | |
| 1968 | | 14--2 | 919 | | | TS SG | 1 | | | | | 1 | 1 | coupelle | Drag. 40 | | |
| 1968 | | 14--2 | 919 | | | TS SG | 1 | | | | | 1 | 1 | coupelle | Drag. 40 | | |
| 1968 | | 14--2 | 919 | | | TS SG | 1 | | | | | 1 | 1 | coupelle | Drag. 40 | | |
| 1968 | | 14--2 | 919 | | | TS SG | 1 | | | | | 1 | 1 | coupelle | Drag. 40 | | |
| 1968 | | 14--2 | 919 | | | TS SG | 1 | | | | | 1 | 1 | coupelle | Drag. 40 | | |
| 1968 | | 14--2 | 919 | | | TS SG | 1 | | | | | 1 | 1 | tasse | Drag. 33 | | |
| 1968 | | 14--2 | 919 | | | TS SG | 1 | | | | | 1 | 1 | tasse | Drag. 33 | | |
| 1968 | | 14--2 | 919 | | | TS SG | 1 | | | | | 1 | 1 | tasse | Drag. 33 | | |
| 1968 | | 14--2 | 919 | | | TS SG | 1 | | | | | 1 | 1 | tasse | Drag. 33 | | |
| | | 41-3 | 213 | | | TS SG | 1 | | | | | 1 | 1 | tasse | Drag. 33 | | |
| 1968 | | 14--2 | 919 | | | TS SG | | | | | 2 | 2 | 1 | mortier | Curle 21 | | |
| 1968 | | 14--2 | 919 | | | TS SG | 1 | | | | | 1 | 1 | mortier | Curle 21 | | |
| 1968 | | 14--2 | 919 | | | TS SG | 1 | | | | | 1 | 1 | mortier | Drag. 45 | | |
| | | 41-2 | 195 | | | TS SG | 1 | | | | | 1 | 1 | mortier | Drag. 45 | | |

ANNEXE B : AMPHITHÉÂTRE

| année | n° OA | Rayon | Caisse | n° ordre | US | Catégorie | Comptage | | | | | | Typologie | Desc. Typo. | Dessin | Planche |
|------------|----------|-------|--------|-------------|-----|-----------|----------|---|---|---|----|----|-----------|-------------------------------|---------------|---------|
| | | | | | | | B | F | A | D | P | NR | | | | |
| 1966-67-68 | | 39-2 | 155 | | S43 | TS SG | | | | 1 | | 1 | 1 | décor | | 4 I |
| 1966-67-68 | | 39-2 | 155 | | S43 | TS SG | | | | 1 | | 1 | 1 | décor | | 5 I |
| 1966-67-68 | | 39-2 | 155 | | | TS SG | | 1 | | | | 1 | 1 | estampille [...IMI] | | 6 I |
| 1966-67-68 | | 39-2 | 155 | | S34 | TS SG | | 1 | | | | 1 | 1 | estampille [LIPVCA] | | 7 I |
| | | 16--1 | 974 | | | TS SG | | 1 | | | | 1 | 1 | estampille [MONTANU] | graffiti [AD] | 8 I |
| 1966-67-68 | | 39-2 | 155 | | | TS SG | | 1 | | | | 1 | 1 | estampille [OF.ALBANI] | | 9 II |
| | | 14--1 | 938 | | | TS SG | | 1 | | | | 1 | 1 | estampille [OFMONIVF] | | 10 II |
| 1966-67-68 | | 39-2 | 155 | | | TS SG | | 1 | | | | 1 | 1 | estampille [TRIIIVOF] | | 11 II |
| 1966-67-68 | | 39-2 | 155 | | | TS SG | | 1 | | | | 1 | 1 | estampille [VIKI] | | 12 II |
| | | BAL | | | | TS SG | | 1 | | | | 1 | 1 | estampille rosace | | 13 II |
| 1966-67-68 | | 39-2 | 155 | | S32 | TS SG | | | | 2 | | 2 | 1 | graffiti BIATI | | |
| 1968 | | 14--2 | 919 | | | TS SG | | 3 | | | 71 | 74 | | | | |
| 1965-1968 | | 41-2 | 197 | | | TS SG | | 9 | | 5 | 3 | 61 | 3 | | | |
| | | 14--1 | 938 | | | TS SG | | | | 5 | | 5 | | | | |
| | | 14--1 | 938 | | | TS SG | | | | 1 | | 1 | | | | |
| | | 14--1 | 938 | | | TS SG | | | | 1 | | 1 | | | | |

ANNEXE B : AMPHITHÉÂTRE

| année | n° OA | Rayon | Caisse | n° ordre | US | Catégorie | Comptage | | | | | | Typologie | Desc. Typo. | Dessin | Planche |
|-------|----------|-------|--------|-------------|--------------------|-----------|----------|---|---|---|----|----|-----------|-------------|--------|---------|
| | | | | | | | B | F | A | D | P | NR | | | | |
| 1989 | | 34-3 | 115 | | 4NC3 | TS SG | | | | | 16 | 16 | | | | |
| 1989 | | 34-4 | 119 | | 2NA8.5 | TS SG | | | | | 8 | 8 | | | | |
| 1989 | | 34-5 | 123 | | MCIII couche 23 | TS SG | | 1 | | | 3 | 4 | | | | |
| 1989 | | 34-5 | 125 | | 5SD8 | TS SG | | | | | 4 | 4 | | | | |
| 1989 | | 37-5 | 137 | | ND3 ST4 | TS SG | | | | | 11 | 11 | | | | |
| | | 39-3 | 161 | | | TS SG | | | | | 16 | 16 | | | | |
| | | 29-2 | 9 | | salle 2 | TS SG | | 4 | | | 5 | 9 | | | | |
| | | 29-2 | 9 | | salle 2 | TS SG | | 1 | | | | 1 | | | | |
| | | 29-2 | 9 | | | TS SG | | | | 1 | 1 | 2 | | | | |
| | | 40-2 | 191 | | | TS SG | | | | 1 | | 1 | | | | |
| | | 41-2 | 195 | | | TS SG | | 2 | | | | 2 | | | | |
| | | 41-2 | 195 | | | TS SG | | 1 | | | | 1 | | | | |
| | | 41-2 | 195 | | | TS SG | | | | | 5 | 5 | | | | |
| | | 41-2 | 195 | | | TS SG | | | | | 1 | 1 | | | | |
| | | 41-2 | 195 | | | TS SG | 1 | | | | | 1 | | | | |
| | | 41-2 | 195 | | | TS SG | | | | | 11 | 11 | | | | |
| | | 41-2 | 195 | | | TS SG | | 5 | | | 1 | 6 | | | | |
| | | 41-2 | 195 | | | TS SG | | | | | 1 | 1 | | | | |
| | | 41-2 | 195 | | | TS SG | | | | | 1 | 1 | | | | |
| | | 41-2 | 195 | | | TS SG | | | | | 1 | 1 | | | | |
| | | 41-2 | 195 | | | TS SG | | | | | 1 | 1 | | | | |
| | | 41-2 | 195 | | | TS SG | | | | | 1 | 1 | | | | |
| | | 41-2 | 195 | | | TS SG | | | | | 1 | 1 | | | | |
| | | 41-2 | 195 | | | TS SG | | | | | 1 | 1 | | | | |
| | | 41-2 | 195 | | | TS SG | | | | | 1 | 1 | | | | |
| | | 41-2 | 195 | | | TS SG | | | | | 1 | 1 | | | | |

ANNEXE B : AMPHITHÉÂTRE

| année | n° OA | Rayon | Caisse | n° ordre | US | Catégorie | Comptage | | | | | | Typologie | Desc. Typo. | Dessin | Planche |
|---------|----------|--------|--------|-------------|----|-----------|----------|---|---|---|----|----|-----------|-------------|--------|---------|
| | | | | | | | B | F | A | D | P | NR | | | | |
| | | 41-2 | 198 | | | TS SG | | | | | 2 | 2 | | | | |
| 1979 | | 15--3 | 907 | | | TS SG | | | | | 2 | 2 | | | | |
| 1979 | | 14--1 | 918 | | | TS SG | | | | 1 | | 1 | | | | |
| | | 41-3 | 213 | | | TS SG | 5 | | | | 26 | 31 | | | | |
| | | 41-3 | 213 | | | TS SG | | | | | 8 | 8 | | | | |
| | | 41-3 | 213 | | | TS SG | | | | | 2 | 2 | | | | |
| | | 41-3 | 213 | | | TS SG | | | | | 1 | 1 | | | | |
| | | 41-3 | 213 | | | TS SG | 4 | | | | 23 | 27 | | | | |
| | | 41-3 | 213 | | | TS SG | | | | | 2 | 2 | | | | |
| | | 41-3 | 213 | | | TS SG | | | | 1 | 6 | 7 | | | | |
| | | 41-3 | 213 | | | TS SG | | | | 1 | 7 | 8 | | | | |
| | | 41-3 | 213 | | | TS SG | | 1 | | | 8 | 9 | | | | |
| | | 41-3 | 213 | | | TS SG | | | | | 7 | 7 | | | | |
| | | 41-3 | 213 | | | TS SG | | | | | 8 | 8 | | | | |
| | | 41-3 | 213 | | | TS SG | | | | | 5 | 5 | | | | |
| | | 41-3 | 213 | | | TS SG | | | | 1 | 3 | 4 | | | | |
| | | 41-3 | 213 | | | TS SG | 1 | | | | | 22 | | | | |
| | | 41-3 | 213 | | | TS SG | 1 | 4 | | | | 1 | | | | |
| | | 41-3 | 213 | | | TS SG | | | | | 1 | 1 | | | | |
| | | 42-3 | 252 | | | TS SG | | 1 | | | | 1 | | | | |
| | | 42-3 | 252 | | | TS SG | | 1 | | | | 1 | | | | |
| | | 15--03 | 903 | | | TS SG | | | | | 1 | 1 | | | | |
| | | 15--3 | 907 | | | TS SG | | 1 | | 1 | 1 | 3 | | | | |
| 1965/66 | | 15--4 | 914 | | | TS SG | | 4 | | 1 | 4 | 9 | | | | |
| | | 14--1 | 938 | | | TS SG | | | | 8 | 39 | 47 | | | | |

ANNEXE B : AMPHITHÉÂTRE

| année | n° OA | Rayon | Caisse | n° ordre | US | Catégorie | Comptage | | | | | | Typologie | Desc. Typo. | Dessin | Planche | |
|----------------|----------|-------|--------|-------------|-----|-----------|----------|---|---|---|---|----|-----------|-------------|-------------|---------|-----|
| | | | | | | | B | F | A | D | P | NR | | | | | NMI |
| | | 14--1 | 938 | | | TS SG | 1 | | | | | 1 | | | | | |
| | | 14--1 | 938 | | | TS SG | 1 | | | | | 1 | | | | | |
| | | 14--1 | 938 | | | TS SG | 1 | | | | | 1 | | | | | |
| | | 14--1 | 938 | | | TS SG | 1 | | | | | 1 | | | | | |
| | | 14--1 | 938 | | | TS SG | | | | | 1 | 1 | | | | | |
| | | 14--1 | 938 | | | TS SG | | | | | 1 | 1 | | | | | |
| 1966-67- 68 | | 39-2 | 155 | | S43 | TS CG | 1 | | | | | 1 | 1 | coupe | Drag. 37 | 14 | II |
| 1965 | | 41-2 | 205 | | | TS GE | 1 | | | | | 1 | 1 | assiette | Drag. 18/31 | | |
| | | 41-3 | 213 | | | TS GE | 1 | | | | | 1 | 1 | assiette | Drag. 18/31 | | |
| 1966 | | 19--1 | 1035 | | | TS GE | 2 | 2 | | | | 4 | 1 | coupe | Drag. 27 | | |
| 1968 | | 40-2 | 192 | | | TS GE | 1 | | | | | 1 | 1 | coupe | Drag. 37 | | |
| 1968 | | 40-2 | 192 | | | TS GE | 1 | | | | | 1 | 1 | coupe | Drag. 37 | | |
| 1968 | | 40-2 | 192 | | | TS GE | 1 | | | | | 1 | 1 | coupe | Drag. 37 | | |
| 1968 | | 40-2 | 192 | | | TS GE | 1 | | | | | 1 | 1 | coupe | Drag. 37 | | |
| 1968 | | 15--4 | 947 | | | TS GE | 3 | 1 | | | | 4 | 1 | coupe | Drag. 37 | | |
| 1966 | | 19--2 | 1073 | | | TS GE | 1 | | | | | 1 | 1 | coupe | Drag. 37 | | |
| 1966 | | 19--1 | 1035 | | | TS GE | 2 | | | | | 2 | 1 | coupe | Drag. 37 | | |
| 1966 | | 19--1 | 1035 | | | TS GE | 1 | 1 | | | | 2 | 1 | coupe | Drag. 37 | | |
| | | 17--2 | 1024 | | | TS GE | 1 | | | | 1 | 2 | 1 | coupe | Drag. 37 | | |
| | | 17--2 | 992 | | | TS GE | 1 | | | | | 1 | 1 | coupe | Drag. 37 | | |
| | | 17--2 | 992 | | | TS GE | 1 | | | | | 1 | 1 | coupe | Drag. 37 | | |
| | | 17--2 | 992 | | | TS GE | 1 | | | | | 1 | 1 | coupe | Drag. 37 | | |
| | | 17--2 | 992 | | | TS GE | 1 | | | | | 1 | 1 | coupe | Drag. 37 | | |
| | | 17--2 | 992 | | | TS GE | 1 | | | | | 1 | 1 | coupe | Drag. 37 | | |
| | | 17--2 | 992 | | | TS GE | 1 | | | | | 1 | 1 | coupe | Drag. 37 | | |

ANNEXE B : AMPHITHÉÂTRE

| année | n° OA | Rayon | Caisse | n° ordre | US | Catégorie | Comptage | | | | | | Typologie | Desc. Typo. | Dessin | Planche | |
|---------------|----------|-------|--------|-------------|----|-----------|----------|---|---|---|----|----|-----------|-------------|----------|---------|-----|
| | | | | | | | B | F | A | D | P | NR | | | | | NMI |
| | | 17--2 | 992 | | | TS GE | 1 | | | | | 1 | 1 | coupe | Drag. 37 | | |
| | | 17--2 | 992 | | | TS GE | 1 | | | | | 1 | 1 | coupe | Drag. 37 | | |
| | | 21--3 | 1162 | | | TS GE | 1 | | | | | 1 | 1 | coupe | Drag. 37 | 15 | II |
| 1968 | | 40-2 | 192 | | | TS GE | 3 | | | | | 3 | 1 | coupe | Drag. 37 | | |
| 1989 | | 69-4 | 668 | | | TS GE | | 1 | | 3 | | 4 | 1 | coupe | Drag. 37 | 16 | III |
| 1978 | | 15--2 | 905 | | | TS GE | 1 | | | | | 1 | 1 | coupe | Drag. 37 | | |
| 1978 | | 15--2 | 905 | | | TS GE | 1 | | | | | 1 | 1 | coupe | Drag. 37 | | |
| 1979 | | 15--3 | 907 | | | TS GE | 1 | | | | | 1 | 1 | coupe | Drag. 37 | | |
| | | 19--1 | 1035 | | | TS GE | 1 | | | | | 1 | 1 | coupe | Drag. 38 | 17 | III |
| 1989 | | 69-4 | 668 | | | TS GE | 1 | | | | | 1 | 1 | coupe | Drag. 38 | 18 | III |
| | | 17--2 | 992 | | | TS GE | 1 | | | | | 1 | 1 | coupelle | Drag. 27 | | |
| 1966 | | 42-2 | 244 | | | TS GE | 1 | | | | | 1 | 1 | coupelle | Drag. 27 | | |
| | | 41-3 | 213 | | | TS GE | 1 | | | | | 1 | 1 | coupelle | Drag. 27 | | |
| | | 41-3 | 213 | | | TS GE | 1 | | | | | 1 | 1 | coupelle | Drag. 27 | | |
| | | 17--2 | 992 | | | TS GE | 1 | | | | | 1 | 1 | coupelle | Drag. 35 | | |
| | | 17--2 | 992 | | | TS GE | 1 | | | | | 1 | 1 | coupelle | Drag. 35 | | |
| | | 17--2 | 992 | | | TS GE | 1 | | | | | 1 | 1 | coupelle | Drag. 35 | | |
| 1967 | | 43-2 | 228 | | | TS GE | 1 | | | | | 1 | 1 | coupelle | Drag. 35 | | |
| 1978 | | 15--2 | 905 | | | TS GE | 4 | 2 | | | 53 | 59 | 1 | coupelle | Drag. 35 | | |
| | | 41-2 | 195 | | | TS GE | 1 | | | | | 1 | 1 | coupelle | Drag. 35 | | |
| 1989 | | 69-4 | 668 | | | TS GE | 3 | 1 | | | | 4 | 1 | coupelle | Drag. 40 | 19 | III |
| | | 45-3 | 305 | | | TS GE | 1 | | | | 11 | 12 | 1 | coupelle | Drag. 40 | | |
| 1966 | | 18--4 | 1099 | | | TS GE | 1 | | | | | 1 | 1 | coupelle | Drag. 40 | | |
| | | 17--4 | 1031 | | | TS GE | 1 | 1 | | | 4 | 6 | 1 | coupelle | Drag. 46 | 20 | III |
| 1965- 1968 | | 41-2 | 197 | | | TS GE | 2 | 1 | | | | 3 | 1 | coupelle | Drag. 46 | 21 | III |

ANNEXE B : AMPHITHÉÂTRE

| année | n° OA | Rayon | Caisse | n° ordre | US | Catégorie | Comptage | | | | | | Typologie | Desc. Typo. | Dessin | Planche | |
|-------|----------|-------|--------|-------------|----|-----------|----------|---|---|--------|----|----|-----------|--------------------------------|----------|---------|-----|
| | | | | | | | B | F | A | D | P | NR | | | | | NMI |
| | | 17--2 | 992 | | | TS GE | 1 | | | | | 1 | 1 | coupelle | Lud. Oc | | |
| | | 17--2 | 992 | | | TS GE | 1 | | | | | 1 | 1 | tasse | Drag. 33 | | |
| 1979 | | 15--3 | 907 | | | TS GE | 1 | | | | | 1 | 1 | tasse | Drag. 33 | | |
| | | 19--1 | 1035 | | | TS GE | 1 | | | | | 1 | 1 | mortier | Curle 21 | | |
| 1979 | | 15--3 | 907 | | | TS GE | 1 | | | | | 1 | 1 | mortier | Curle 21 | | |
| 1968 | | 15--4 | 947 | | | TS GE | 2 | | | | | 2 | 1 | mortier | Drag. 45 | | |
| 1968 | | 20--3 | 1148 | | | TS GE | 1 | | | | 5 | 6 | 1 | mortier | Drag. 45 | | |
| 1969 | | 20--3 | 1146 | | | TS GE | 1 | 3 | | | 4 | 8 | 1 | mortier | Drag. 45 | | |
| | | 41-2 | 197 | | | TS GE | | 1 | | | | 1 | 1 | estampille [CONG...] | | 22 | III |
| | | BAL | | | | TS GE | | 1 | | | | 1 | 1 | estampille [TITURI MANU] | | 23 | III |
| | | 44--4 | 286 | | | TS GE | | | | | 3 | 3 | | | | | |
| | | 44--4 | 290 | | | TS GE | | 1 | | 2 4 | 3 | 28 | | | | | |
| | | 45-2 | 298 | | | TS GE | | 1 | | | | 1 | | | | | |
| | | 44-1 | 1609 | | | TS GE | | 2 | | | | 2 | | | | | |
| 1966 | | 17--4 | 1032 | | | TS GE | | | | | 1 | 1 | | | | | |
| 1969 | | 16--2 | 1003 | | | TS GE | | 1 | | | 1 | 2 | | | | | |
| 1968 | | 15--3 | 943 | | | TS GE | | | | | 4 | 4 | | | | | |
| 1964 | | 18--1 | 1049 | | | TS GE | | 1 | | | | 1 | | | | | |
| 1966 | | 19--5 | 1084 | | | TS GE | | 2 | | | | 2 | | | | | |
| | | 19--4 | 1064 | | | TS GE | | 1 | | | 4 | 5 | | | | | |
| 1968 | | 16--3 | 1012 | | | TS GE | | 2 | | | 3 | 5 | | | | | |
| 1968 | | 16--3 | 1012 | | | TS GE | | 1 | | | 6 | 7 | | | | | |
| 1966 | | 19--1 | 1035 | | | TS GE | | 9 | | | 17 | 26 | | | | | |

ANNEXE B : AMPHITHÉÂTRE

| année | n° OA | Rayon | Caisse | n° ordre | US | Catégorie | Comptage | | | | | | Typologie | Desc. Typo. | Dessin | Planche | |
|-------|----------|-------|--------|-------------|----|-----------|----------|--------|---|--------|----|---------|-----------|-------------|-------------|---------|-----|
| | | | | | | | B | F | A | D | P | NR | | | | | NMI |
| 1974 | | 18--3 | 1057 | | | TS GE | | 4 | | | 12 | 16 | | | | | |
| | | 17--2 | 1024 | | | TS GE | | 1 0 | | | 28 | 38 | | | | | |
| 1966 | | 16--5 | 1019 | | | TS GE | | 1 | | | 6 | 7 | | | | | |
| | | 20--2 | 1142 | | | TS GE | | 3 | | | 41 | 44 | | | | | |
| 1969 | | 20--3 | 1146 | | | TS GE | | | | | 29 | 29 | | | | | |
| 1969 | | 20--2 | 1140 | | | TS GE | | 3 | | | 4 | 7 | | | | | |
| | | 41-1 | 1583 | | | TS GE | | | | | 7 | 7 | | | | | |
| | | 42-1 | 1602 | | | TS GE | | | | | 22 | 22 | | | | | |
| | | 42-1 | 1462 | | | TS GE | | | | | 14 | 14 | | | | | |
| | | 17--2 | 992 | | | TS GE | | 1 3 | | 1 6 | 74 | 10 3 | | | | | |
| | | 20--3 | 1148 | | | TS GE | | 1 | | | | 1 | | | | | |
| | | 16--2 | 978 | | | TS GE | 1 1 | 1 4 | | 3 9 | | 64 | | | | | |
| | | 21--1 | 1127 | | | TS GE | 1 7 | 1 6 | | 6 9 | | 10 2 | | | | | |
| | | 39-1 | 1547 | | | TS GE | 9 | 1 5 | | 3 7 | | 61 | | | | | |
| | | 41-2 | 198 | | | TS GE | | | | | 1 | 1 | | | | | |
| | | 41-2 | 198 | | | TS GE | | | 1 | | | 1 | | | | | |
| 1966 | | 19--2 | 1073 | | | TS AR | 3 | | | | | 3 | 1 | assiette | Drag. 18/31 | | |
| | | 16--1 | 974 | | | TS AR | 4 | 1 | | | | 5 | 1 | assiette | Drag. 18/31 | 24 | IV |
| | | 17--2 | 992 | | | TS AR | 1 | | | | | 1 | 1 | assiette | Drag. 18/31 | | |
| 1989 | | 36-2 | 124 | | | TS AR | 1 | | | | | 1 | 1 | assiette | Drag. 18/31 | | |
| 1989 | | 36-2 | 124 | | | TS AR | 1 | | | | | 1 | 1 | assiette | Drag. 18/31 | | |
| 1989 | | 36-2 | 124 | | | TS AR | 1 | | | | | 1 | 1 | assiette | Drag. 18/31 | | |
| 1967 | | 43-2 | 228 | | | TS AR | 1 | | | | | 1 | 1 | assiette | Drag. 18/31 | | |

ANNEXE B : AMPHITHÉÂTRE

| année | n° OA | Rayon | Caisse | n° ordre | US | Catégorie | Comptage | | | | | | Typologie | Desc. Typo. | Dessin | Planche | |
|-------|----------|-------|--------|-------------|-------|-----------|----------|---|---|---|----|----|-----------|-------------|-------------|---------|-----|
| | | | | | | | B | F | A | D | P | NR | | | | | NMI |
| 1967 | | 43-2 | 228 | | | TS AR | 1 | | | | | 1 | 1 | assiette | Drag. 18/31 | | |
| 1967 | | 43-2 | 228 | | | TS AR | 1 | | | | | 1 | 1 | assiette | Drag. 18/31 | | |
| 1966 | | 14--3 | 960 | | | TS AR | | 1 | | | | 1 | 1 | assiette | Drag. 18/31 | 25 | IV |
| 1966 | | 14--3 | 960 | | | TS AR | 1 | | | | | 1 | 1 | assiette | Drag. 18/31 | | |
| 1964 | | 14--2 | 951 | | | TS AR | 1 | | | | | 1 | 1 | assiette | Drag. 18/31 | | |
| 1964 | | 14--2 | 951 | | | TS AR | 1 | | | | | 1 | 1 | assiette | Drag. 18/31 | | |
| | | 41-2 | 195 | | | TS AR | 2 | | | | | 2 | 1 | assiette | Drag. 18/31 | | |
| | | 41-3 | 213 | | | TS AR | 2 | | | | | 2 | 1 | assiette | Drag. 18/31 | | |
| | | 41-3 | 213 | | | TS AR | 1 | | | | | 1 | 1 | assiette | Drag. 18/31 | | |
| | | 15--4 | 914 | | | TS AR | 1 | | | | | 1 | 1 | assiette | Drag. 18/31 | | |
| | | 14--1 | 938 | | | TS AR | 1 | | | | | 1 | 1 | assiette | Drag. 18/31 | | |
| | | 14--1 | 938 | | | TS AR | 1 | | | | | 1 | 1 | assiette | Drag. 18/31 | | |
| 1989 | | 36-2 | 126 | | 3CNA9 | TS AR | 9 | 6 | | | 11 | 26 | 1 | assiette | Curle 15 | 26 | IV |
| | | 43-1 | 1573 | | | TS AR | 1 | | | | | 1 | 1 | assiette | Drag. 32 | 27 | IV |
| | | 16--1 | 976 | | | TS AR | 1 | | | | | 1 | 1 | coupe | Drag. 33 | | |
| | | 15--4 | 914 | | | TS AR | 1 | | | | | 1 | 1 | coupe | Drag. 33 | | |
| | | 20--2 | 1142 | | | TS AR | 1 | 1 | | | 4 | 6 | 1 | coupe | Drag. 35 | | |
| 1964 | | 14--2 | 951 | | | TS AR | 1 | | | | | 1 | 1 | coupe | Drag. 37 | | |
| | | 17--2 | 1024 | | | TS AR | 2 | | | | | 2 | 1 | coupe | Drag. 37 | | |
| | | 17--2 | 1024 | | | TS AR | 1 | | | | | 1 | 1 | coupe | Drag. 37 | | |
| | | 17--2 | 992 | | | TS AR | 1 | | | | | 1 | 1 | coupe | Drag. 37 | | |
| | | 18--2 | 1087 | | | TS AR | 1 | | | | | 1 | 1 | coupe | Drag. 37 | | |
| 1989 | | 36-2 | 124 | | | TS AR | 1 | | | | | 1 | 1 | coupe | Drag. 37 | | |
| 1989 | | 36-2 | 124 | | | TS AR | 1 | | | | | 1 | 1 | coupe | Drag. 37 | | |
| 1968 | | 40-2 | 192 | | | TS AR | 1 | | | | | 1 | 1 | coupe | Drag. 37 | | |
| 1968 | | 40-2 | 192 | | | TS AR | 1 | | | | | 1 | 1 | coupe | Drag. 37 | | |

ANNEXE B : AMPHITHÉÂTRE

| année | n° OA | Rayon | Caisse | n° ordre | US | Catégorie | Comptage | | | | | | Typologie | Desc. Typo. | Dessin | Planche | |
|-----------|-------|---------------------|---------|-----------------|----|-----------|----------|---|---|---|---|----|-----------|-------------|------------|---------|-----|
| | | | | | | | B | F | A | D | P | NR | | | | | NMI |
| 1968 | | 40-2 | 192 | | | TS AR | 1 | | | | | 1 | 1 | coupe | Drag. 37 | | |
| 1965-1968 | | 41-2 | 197 | | | TS AR | 4 | | | | 3 | 7 | 1 | coupe | Drag. 37 | | |
| 1989 | | 69-4 | 668 | | | TS AR | 1 | | | | | 1 | 1 | coupe | Drag. 37 | | |
| 1989 | | 69-4 | 668 | | | TS AR | 1 | | | | | 1 | 1 | coupe | Drag. 37 | | |
| 1964 | | 14--2 | 951 | | | TS AR | 1 | | | | | 1 | 1 | coupe | Drag. 37 | | |
| 1964 | | 14--2 | 951 | | | TS AR | 1 | | | | | 1 | 1 | coupe | Drag. 37 | | |
| 1964 | | 14--2 | 951 | | | TS AR | 1 | | | | | 1 | 1 | coupe | Drag. 37 | | |
| 1964 | | 14--2 | 951 | | | TS AR | 1 | | | | | 1 | 1 | coupe | Drag. 37 | | |
| | | 41-3 | 213 | | | TS AR | 1 | | | | | 1 | 1 | coupe | Drag. 37 | | |
| | | 15--4 | 914 | | | TS AR | 1 | | | | | 1 | 1 | coupe | Drag. 37 | | |
| | | 15--4 | 914 | | | TS AR | 1 | | | | | 1 | 1 | coupe | Drag. 37 | | |
| | | 14--1 | 938 | | | TS AR | 1 | | | | | 1 | 1 | coupe | Drag. 37 | | |
| | | 21--2 | 1130 | | | TS AR | 1 | | | | | 1 | 1 | coupe | Drag. 37R | | |
| 1965-1968 | | 41-2 | 197 | | | TS AR | 1 | | | | | 1 | 1 | coupe | Drag. 37R | 28 | V |
| 1989 | | 36-2 | 124 | | | TS AR | 3 | 1 | | | 1 | 5 | 1 | coupe | Drag. 37R | 29 | V |
| | | 43-1 | 1573 | | | TS AR | 1 | | | | | 1 | 1 | coupe | Drag. 37R | 30 | V |
| | | Musée Amphi théâtre | vitrine | Inv.2 009-0-906 | | TS AR | 4 | 1 | | | | 5 | 1 | coupe | Drag. 37R | | |
| | | 17--2 | 992 | | | TS AR | 3 | | | | | 3 | 1 | coupe | Drag. 38 | | |
| | | 14--5 | 967 | | | TS AR | 1 | 1 | | | 4 | 6 | 1 | coupe | Chenet 326 | 31 | V |
| 1968 | | 14--2 | 919 | | | TS AR | 2 | | | | | 2 | 1 | coupe | Chenet 317 | 32 | V |
| 1965-1968 | | 41-2 | 197 | | | TS AR | 1 | | | | | 1 | 1 | coupelle | Drag. 27 | 33 | V |

ANNEXE B : AMPHITHÉÂTRE

| année | n° OA | Rayon | Caisse | n° ordre | US | Catégorie | Comptage | | | | | | Typologie | Desc. Typo. | Dessin | Planche | |
|---------------|----------|-------|--------|-------------|----|-----------|----------|---|---|---|----|----|-----------|-------------|----------|---------|-----|
| | | | | | | | B | F | A | D | P | NR | | | | | NMI |
| 1965- 1968 | | 41-2 | 197 | | | TS AR | 2 | 2 | | | 2 | 6 | 1 | coupelle | Drag. 27 | 34 | V |
| 1965- 1968 | | 41-2 | 197 | | | TS AR | 2 | | | | | 2 | 1 | coupelle | Drag. 27 | | |
| | | 16--1 | 974 | | | TS AR | 3 | 2 | | | | 5 | 1 | coupelle | Drag. 27 | 35 | V |
| | | 16--1 | 974 | | | TS AR | | 1 | | | | 1 | 1 | coupelle | Drag. 27 | 36 | V |
| 1966 | | 19--2 | 1073 | | | TS AR | 1 | | | | | 1 | 1 | coupelle | Drag. 35 | | |
| | | 17--2 | 1024 | | | TS AR | 1 | 1 | | | | 2 | 1 | coupelle | Drag. 35 | | |
| 1989 | | 36-2 | 124 | | | TS AR | 1 | | | | | 1 | 1 | coupelle | Drag. 35 | | |
| 1979 | | 15--3 | 907 | | | TS AR | 3 | | | | | 3 | 1 | coupelle | Drag. 35 | | |
| | | 15--4 | 914 | | | TS AR | 1 | | | | | 1 | 1 | coupelle | Drag. 35 | | |
| | | 14--1 | 938 | | | TS AR | 5 | | | | | 5 | 1 | coupelle | Drag. 35 | | |
| | | 14--1 | 938 | | | TS AR | 1 | | | | | 1 | 1 | coupelle | Drag. 35 | | |
| 1966 | | 42-2 | 244 | | | TS AR | 1 | | | | 4 | 5 | 1 | coupelle | Drag. 35 | | |
| | | 41-2 | 195 | | | TS AR | | | | 3 | | 3 | 1 | coupelle | Drag. 35 | | |
| | | 41-3 | 213 | | | TS AR | | | | | 1 | 1 | 1 | coupelle | Drag. 35 | | |
| 1964 | | 14--2 | 951 | | | TS AR | | | | | 15 | 15 | 1 | coupelle | Drag. 35 | | |
| 1964 | | 14--2 | 951 | | | TS AR | 1 | | | | | 1 | 1 | coupelle | Drag. 40 | | |
| 1967 | | 43-2 | 228 | | | TS AR | 1 | | | | | 1 | 1 | coupelle | Drag. 40 | | |
| | | 14--1 | 938 | | | TS AR | 1 | | | | | 1 | 1 | coupelle | Drag. 40 | | |
| | | BAL | | | | TS AR | 2 | | | | | 2 | 1 | coupelle | Drag. 40 | | |
| 1989 | | 36-2 | 124 | | | TS AR | 1 | | | | | 1 | 1 | coupelle | Drag. 40 | | |
| | | BAL | | | | TS AR | 2 | 1 | | | 4 | 7 | 1 | tasse | Drag. 33 | 37 | V |
| | | 16--1 | 974 | | | TS AR | | 1 | | | | 1 | 1 | tasse | Drag. 33 | 38 | VI |
| | | 43-1 | 1573 | | | TS AR | 1 | | | | | 1 | 1 | tasse | Drag. 33 | 39 | VI |
| | | 41-2 | 197 | | | TS AR | 1 | | | | | 1 | 1 | tasse | Drag. 33 | 40 | VI |
| | | 15--4 | 914 | | | TS AR | 1 | | | | | 1 | 1 | tasse | Drag. 46 | | |

ANNEXE B : AMPHITHÉÂTRE

| année | n° OA | Rayon | Caisse | n° ordre | US | Catégorie | Comptage | | | | | | Typologie | Desc. Typo. | Dessin | Planche | |
|------------|-------|-------|--------|----------|----------|-----------|----------|---|---|---|---|----|-----------|--------------------------------|----------|---------|-----|
| | | | | | | | B | F | A | D | P | NR | | | | | NMI |
| 1966 | | 14--2 | 922 | | | TS AR | 2 | | | | | 2 | 1 | mortier | Curle 21 | | |
| | | 43-1 | 1573 | | | TS AR | 1 | | | | | 1 | 1 | mortier | Curle 21 | 41 | VI |
| 1966 | | 17--4 | 1031 | | | TS AR | | 1 | | | | 1 | 1 | mortier | Drag. 45 | | |
| | | 39-1 | 1549 | | | TS AR | 2 | | | | 3 | 5 | 1 | mortier | Drag. 45 | | |
| | | 41-2 | 198 | | | TS AR | 1 | | | | | 1 | 1 | mortier | Drag. 45 | | |
| 1966-67-68 | | 39-2 | 155 | | S34 | TS AR | 1 | | | | | 1 | 1 | mortier | Drag. 45 | 42 | VI |
| | | 43-1 | 1581 | | | TS AR | 1 | | | | | 1 | 1 | mortier | Drag. 45 | | |
| | | 15--4 | 914 | | | TS AR | 1 | | | | | 1 | 1 | mortier | Drag. 45 | | |
| | | 15--3 | 909 | | couche 7 | TS AR | | | | | 2 | 2 | 1 | mortier | Drag. 45 | | |
| 1968 | | 40-2 | 192 | | | TS AR | 1 | | | | | 1 | 1 | gobelet | Déch. 72 | 43 | VI |
| | | BAL | | | | TS AR | | | | 1 | | 1 | 1 | gobelet | | 44 | VI |
| | | 16--1 | 974 | | | TS AR | | | | 1 | | 1 | 1 | décor | | 45 | VI |
| | | 20--3 | 1146 | | | TS AR | 1 | | | | | 1 | 1 | décor | | 46 | VI |
| | | BAL | | | | TS AR | | 1 | | | | 1 | 1 | estampille [VERECVOV] | | 47 | VII |
| | | 16--1 | 974 | | | TS AR | | 1 | | | | 1 | 1 | estampille [IIANINVS] | | 48 | VII |
| | | 16--1 | 974 | | | TS AR | | | | 3 | | 3 | 1 | estampille [MARCELL USF] | | 49 | VII |
| | | 41-2 | 197 | | | TS AR | | 1 | | | | 1 | 1 | estampille [SECCOF] | | 50 | VII |
| | | 16--1 | 974 | | | TS AR | | | | | | 2 | 1 | estampille [TAVRIN...] | | 51 | VII |
| | | 16--1 | 974 | | | TS AR | | | | | | 1 | 1 | estampille [TOCCA.F] | | 52 | VII |

ANNEXE B : AMPHITHÉÂTRE

| année | n° OA | Rayon | Caisse | n° ordre | US | Catégorie | Comptage | | | | | | Typologie | Desc. Typo. | Dessin | Planche | |
|----------------|----------|-------|--------|-------------|-----|-----------|----------|--------|---|--------|----|----|-----------|-----------------------|--------|---------|-----|
| | | | | | | | B | F | A | D | P | NR | | | | | NMI |
| | | BAL | | | | TS AR | | 1 | | | | 1 | 1 | estampille TOCA | | 53 | VII |
| 1966-67- 68 | | 39-2 | 155 | | S43 | TS AR | | 1 | | | | 1 | 1 | graffiti | | | |
| 1966-67- 68 | | 39-2 | 155 | | S43 | TS AR | | 1 | | | | 1 | 1 | graffiti DN | | 54 | VII |
| | | 43-1 | 1573 | | | TS AR | | | | 1 | | 1 | | décor a la molette | | | |
| | | | 1547 | | | TS AR | | | | | 4 | 4 | | décor a la molette | | | |
| 1978 | | 15--2 | 905 | | | TS AR | | | | 4 | 16 | 20 | | | | | |
| | | 19--2 | 1073 | | | TS AR | | | | 2 | | 2 | | | | | |
| | | 21--1 | 1127 | | | TS AR | | 1 2 | | | 87 | 99 | | | | | |
| | | 20--1 | 1112 | | | TS AR | | | | 2 3 | | 23 | | | | | |
| | | 44--3 | 279 | | | TS AR | | | | | 1 | 1 | | | | | |
| 1979 | | 15--3 | 907 | | | TS AR | | | | 1 | 1 | 2 | | | | | |
| 1964 | | 14--2 | 951 | | | TS AR | | 5 | | | 52 | 57 | | | | | |
| 1968 | | 40-2 | 192 | | | TS AR | | | 1 | | | 1 | | | | | |
| 1989 | | 36-2 | 124 | | | TS AR | | | | | 2 | 2 | | | | | |
| 1989 | | 36-2 | 124 | | | TS AR | | | | 5 | 5 | 10 | | | | | |
| 1989 | | 36-2 | 124 | | | TS AR | 3 | | | | 1 | 4 | | | | | |
| 1966-67- 68 | | 39-2 | 155 | | | TS AR | | | | 1 | | 1 | | | | | |
| | | 15--4 | 912 | | | TS AR | | 1 | | | 3 | 4 | | | | | |
| | | 14--1 | 917 | | | TS AR | | | | | 3 | 3 | | | | | |
| | | 15--1 | 936 | | | TS AR | | | 1 | | | 1 | | | | | |
| | | 14--1 | 937 | | | TS AR | | 1 | | | | 1 | | | | | |

ANNEXE B : AMPHITHÉÂTRE

| année | n° OA | Rayon | Caisse | n° ordre | US | Catégorie | Comptage | | | | | | Typologie | Desc. Typo. | Dessin | Planche |
|-------|-------|-------|--------|----------|--|-----------|----------|---|---|---|----|----|-----------|-------------|--------|---------|
| | | | | | | | B | F | A | D | P | NR | | | | |
| | | 18--3 | 1093 | | | TS AR | | | | | 6 | 6 | | | | |
| | | 12--4 | 1362 | | | TS AR | | 2 | | | | 2 | | | | |
| | | 44-1 | 1595 | | | TS AR | | | | | 24 | 24 | | | | |
| | | 20--1 | 114 | | | TS AR | | | | | 1 | 1 | | | | |
| | | 20--2 | 1145 | | | TS AR | | | | | 19 | 19 | | | | |
| 1966 | | 21--1 | 1157 | | | TS AR | | | | | 3 | 3 | | | | |
| 1966 | | 21--1 | 1155 | | | TS AR | | | | | 3 | 3 | | | | |
| 1966 | | 21--2 | 1160 | | | TS AR | | 2 | | | 4 | 6 | | | | |
| | | 26--1 | 1487 | | | TS AR | | 1 | | | 3 | 4 | | | | |
| | | 31--4 | 1620 | | | TS AR | | | | | 4 | 4 | | | | |
| 1966 | | 16--3 | 1010 | | | TS AR | | | | | 10 | 10 | | | | |
| | | 16--1 | 974 | | | TS AR | | 7 | | | | 7 | | | | |
| 1990 | 967 | 47-4 | 1666 | 3 | NA3 | TS AR | | | | | 17 | 17 | | | | |
| 1990 | 967 | 47-4 | 1666 | 1 | NA2b couche 1 canal à l'est de la fosse | TS AR | | | | | 12 | 12 | | | | |
| 1990 | 967 | 47-4 | 1666 | 7 | coupe 2 couche verdâtre au dessus de la couche grise | TS AR | | | | | 8 | 8 | | | | |
| 1968 | | 20--3 | 1148 | | | TS AR | | | | | 17 | 17 | | | | |
| 1963 | | 20--3 | 1147 | | | TS AR | | | | | 3 | 3 | | | | |
| 1968 | | 20--2 | 1144 | | | TS AR | | 4 | | | 14 | 18 | | | | |
| | | 41-1 | 1574 | | | TS AR | | 1 | | | 27 | 28 | | | | |
| | | 41-1 | 1584 | | | TS AR | | | | | 36 | 36 | | | | |
| | | 42-1 | 1463 | | | TS AR | | 1 | | | 8 | 9 | | | | |

ANNEXE B : AMPHITHÉÂTRE

| année | n° OA | Rayon | Caisse | n° ordre | US | Catégorie | Comptage | | | | | | Typologie | Desc. Typo. | Dessin | Planche |
|-------|----------|-------|--------|-------------|----|-----------|----------|---|---|--------|----|----|-----------|-------------|--------|---------|
| | | | | | | | B | F | A | D | P | NR | | | | |
| | | 36-1 | 1539 | | | TS AR | | 1 | | | 4 | 5 | | | | |
| 1964 | | 16--3 | 1013 | | | TS AR | | | | 2 8 | | 28 | | | | |
| | | 45-2 | 299 | | | TS AR | | | | | 3 | 3 | | | | |
| 1966 | | 19--2 | 1073 | | | TS AR | | 8 | | | 15 | 23 | | | | |
| | | 28--4 | 1603 | | | TS AR | | 5 | | 6 | 84 | 95 | | | | |
| | | 47-3 | 1654 | | | TS AR | | 4 | | | 17 | 21 | | | | |
| | | 38-3 | 1632 | | | TS AR | | 3 | | | 12 | 15 | | | | |
| | | 38-3 | 1633 | | | TS AR | | | | | 4 | 4 | | | | |
| 1989 | | 36-2 | 124 | | | TS AR | | 1 | | | | 1 | | | | |
| 1989 | | 36-2 | 124 | | | TS AR | | | | | 1 | 1 | | | | |
| 1989 | | 36-2 | 124 | | | TS AR | | | | | 1 | 1 | | | | |
| | | 41-2 | 197 | | | TS AR | | 1 | | | | 1 | | | | |
| | | 41-2 | 197 | | | TS AR | | | | | 1 | 1 | | | | |
| 1967 | | 43-2 | 228 | | | TS AR | | 1 | | | | 1 | | | | |
| 1967 | | 43-2 | 228 | | | TS AR | 1 | 1 | | | | 2 | | | | |
| 1967 | | 43-2 | 228 | | | TS AR | | 1 | | | | 1 | | | | |
| 1967 | | 43-2 | 228 | | | TS AR | | 1 | | | | 1 | | | | |
| 1967 | | 43-2 | 228 | | | TS AR | | | | | 13 | 13 | | | | |
| 1967 | | 43-2 | 228 | | | TS AR | | 1 | | | 8 | 9 | | | | |
| 1967 | | 43-2 | 228 | | | TS AR | | 1 | | | | 1 | | | | |
| 1967 | | 43-2 | 228 | | | TS AR | | 1 | | | | 1 | | | | |
| 1966 | | 42-2 | 244 | | | TS AR | 1 | | | | | 1 | | | | |
| 1968 | | 44-2 | 269 | | | TS AR | | | | | 2 | 2 | | | | |
| 1966 | | 15--4 | 950 | | | TS AR | | | | | 1 | 1 | | | | |

ANNEXE B : AMPHITHÉÂTRE

| année | n° OA | Rayon | Caisse | n° ordre | US | Catégorie | Comptage | | | | | | Typologie | Desc. Typo. | Dessin | Planche |
|-------|-------|-------------|--------|----------|----------------------|-----------|----------|---|---|---|----|----|-----------|-------------|--------|---------|
| | | | | | | | B | F | A | D | P | NR | | | | |
| 1966 | | 15--4 | 950 | | | TS AR | | 1 | | 1 | 5 | 7 | | | | |
| 1966 | | 14--3 | 960 | | | TS AR | | 3 | | 1 | 1 | 5 | | | | |
| 1964 | | 14--2 | 951 | | | TS AR | | 3 | | | 12 | 15 | | | | |
| 1964 | | 14--2 | 951 | | | TS AR | 1 | | | | | 1 | | | | |
| 1964 | | 14--2 | 951 | | | TS AR | | | | | 15 | 15 | | | | |
| 1964 | | 14--2 | 951 | | | TS AR | | | | | 1 | 1 | | | | |
| 1964 | | 14--2 | 951 | | | TS AR | | | | 9 | 10 | 19 | | | | |
| 1979 | | 15--3 | 907 | | | TS AR | | | | | 45 | 45 | | | | |
| | | 35-4 | 101 | | | TS AR | | | | | 15 | 15 | | | | |
| | | 39-1 | 1547 | | | TS AR | | 3 | | 9 | | 14 | | | | |
| | | 35-4 | 103 | | | TS AR | | 2 | | 6 | 14 | 2 | | | | |
| 1989 | | 34-2 | 110 | | NA2 structure 3 | TS AR | | | | | 1 | 1 | | | | |
| 1989 | | 34-2 | 111 | | ND3 structure 4.1 | TS AR | | | | | 1 | 1 | | | | |
| 1989 | | 34-5 | 123 | | 5NC3 | TS AR | | | | | 1 | 1 | | | | |
| 1989 | | 36-2 | 124 | | | TS AR | 1 | | | | | 1 | | | | |
| 1968 | | 42-3 | 253 | | | TS AR | | | | | 3 | 3 | | | | |
| | | 16- févr | 978 | | | TS AR | | | | 1 | 5 | 15 | | | | |
| 1978 | | 15--2 | 905 | | | TS AR | | | | | 6 | 6 | | | | |
| | | 41-2 | 195 | | | TS AR | 2 | | | | | 2 | | | | |
| | | 41-2 | 195 | | | TS AR | 2 | | | | | 2 | | | | |
| | | 41-2 | 195 | | | TS AR | | | | 4 | | 4 | | | | |
| | | 41-3 | 213 | | | TS AR | | | | | 2 | 2 | | | | |
| | | 41-3 | 213 | | | TS AR | | | | | 2 | 2 | | | | |

ANNEXE B : AMPHITHÉÂTRE

| année | n° OA | Rayon | Caisse | n° ordre | US | Catégorie | Comptage | | | | | | Typologie | Desc. Typo. | Dessin | Planche |
|-------|----------|-------|--------|-------------|----------|-----------|----------|---|---|---|----|----|-----------|-------------|--------|---------|
| | | | | | | | B | F | A | D | P | NR | | | | |
| | | 41-3 | 213 | | | TS AR | 2 | | | | 3 | 5 | | | | |
| | | 41-3 | 213 | | | TS AR | | | | 4 | | 4 | | | | |
| | | 41-3 | 213 | | | TS AR | 1 | | | | | 1 | | | | |
| | | 41-3 | 213 | | | TS AR | 1 | | | | | 1 | | | | |
| | | 41-3 | 213 | | | TS AR | 1 | | | | | 1 | | | | |
| | | 41-3 | 213 | | | TS AR | 1 | | | | | 1 | | | | |
| | | 41-3 | 213 | | | TS AR | | | | | 1 | 1 | | | | |
| | | 41-3 | 213 | | | TS AR | | 1 | | | | 1 | | | | |
| | | 41-3 | 213 | | | TS AR | | | | | 3 | 3 | | | | |
| | | 41-3 | 213 | | | TS AR | | | | | 2 | 2 | | | | |
| | | 41-3 | 213 | | | TS AR | | | | | 3 | 3 | | | | |
| | | 41-3 | 213 | | | TS AR | 1 | | | | | 1 | | | | |
| | | 41-3 | 213 | | | TS AR | 1 | | | | | 1 | | | | |
| | | 41-3 | 213 | | | TS AR | | 1 | | | | 1 | | | | |
| | | 41-3 | 213 | | | TS AR | 1 | | | | | 1 | | | | |
| | | 41-3 | 213 | | | TS AR | 1 | | | | | 1 | | | | |
| | | 42-3 | 252 | | | TS AR | | 2 | | | 9 | 11 | | | | |
| | | 42-3 | 252 | | | TS AR | | 3 | | | 25 | 28 | | | | |
| | | 42-3 | 252 | | | TS AR | | 2 | | | 0 | 2 | | | | |
| | | 42-3 | 252 | | | TS AR | | | | 1 | | 1 | | | | |
| | | 15--3 | 907 | | couche 3 | TS AR | | 1 | | | 2 | 3 | | | | |
| | | 15--3 | 907 | | | TS AR | | | | | 11 | 11 | | | | |
| 1979 | | 15--3 | 907 | | | TS AR | | 1 | | | | 1 | | | | |
| 1979 | | 15--3 | 907 | | | TS AR | | | | 3 | 8 | 11 | | | | |
| | | 15--4 | 914 | | | TS AR | | 1 | | 1 | | 2 | | | | |
| | | 14--1 | 938 | | | TS AR | | | | | 1 | 1 | | | | |

ANNEXE B : AMPHITHÉÂTRE

| année | n° OA | Rayon | Caisse | n° ordre | US | Catégorie | Comptage | | | | | | Typologie | Desc. Typo. | Dessin | Planche | |
|-------|-------|---------------------------|---------|------------------------|----------|-----------|----------|---|---|---|----|----|-----------|-------------|--------|---------|-----|
| | | | | | | | B | F | A | D | P | NR | | | | | NMI |
| | | 14--1 | 938 | | | TS AR | | 2 | | 2 | 17 | 21 | | | | | |
| | | 15--3 | 909 | | couche 7 | TS AR | | 1 | | 3 | 7 | 11 | | | | | |
| | | 15--3 | 909 | | couche 7 | TS AR | | | | | 3 | 3 | | | | | |
| | | Musée Mosaï que | vitrine | Inv.2 009- 0-273 | | TS AR | | | | | | 3 | | | | | |
| 1989 | | 34-5 | 123 | | 3CNA9 | EN AR | 5 | 3 | | | 15 | 23 | 1 | gobelet | Hees 2 | 55 | VII |
| | | 38-1 | 1546 | | | EN AR | 1 | | | | | 1 | 1 | gobelet | Hees 2 | 56 | VII |
| | | Musée Amphi théâtre | vitrine | Inv.2 009- 0-913 | | EN AR | 1 | 1 | 3 | | | 5 | 1 | gobelet | Hees 2 | | |
| | | 42-3 | 252 | | | EN AR | 6 | | | | | 6 | 1 | gobelet | Hees 2 | | |
| | | 42-3 | 252 | | | EN AR | 2 | | | | 1 | 3 | 1 | gobelet | Hees 2 | | |
| | | 42-3 | 252 | | | EN AR | 2 | | | | | 2 | 1 | gobelet | Hees 2 | | |
| | | 40-2 | 189 | | | EN AR | 1 | | | | | 1 | 1 | gobelet | Hees 2 | | |
| | | 40-2 | 189 | | | EN AR | 1 | | | | | 1 | 1 | gobelet | Hees 2 | | |
| | | 14--1 | 938 | | | EN AR | 4 | | | | | 4 | 1 | gobelet | Hees 2 | | |
| 1989 | | 34-3 | 115 | | 4NE3 | EN AR | 1 | | | | | 1 | 1 | gobelet | Hees 2 | | |
| 1989 | | 34-4 | 116 | | | EN AR | | 1 | | | 3 | 4 | 1 | gobelet | Hees 2 | | |
| 1989 | | 34-5 | 123 | | 5NC3 | EN AR | 6 | | | | 28 | 34 | 1 | gobelet | Hees 2 | | |
| 1989 | | 34-5 | 125 | | | EN AR | 3 | | | | | 3 | 1 | gobelet | Hees 2 | | |
| 1989 | | 34-5 | 125 | | | EN AR | 1 0 | | | | | 10 | 1 | gobelet | Hees 2 | | |
| 1989 | | 34-5 | 125 | | 27SD8 | EN AR | 8 | | | | 11 | 19 | 1 | gobelet | Hees 2 | | |
| | | 15--2 | 939 | | | EN AR | 1 | | | | | 1 | 1 | gobelet | Hees 2 | | |
| | | 15--2 | 939 | | | EN AR | 1 | | | | | 1 | 1 | gobelet | Hees 2 | | |
| | | 18--3 | 1093 | | | EN AR | 1 | | | | | 1 | 1 | gobelet | Hees 2 | | |

ANNEXE B : AMPHITHÉÂTRE

| année | n° OA | Rayon | Caisse | n° ordre | US | Catégorie | Comptage | | | | | | Typologie | Desc. Typo. | Dessin | Planche | |
|-------|----------|-------|--------|-------------|-------------------------|-----------|----------|---|---|---|----|----|-----------|-------------|--------|---------|-----|
| | | | | | | | B | F | A | D | P | NR | | | | | NMI |
| | | 14--3 | 961 | | | EN AR | 1 | | | | | 1 | 1 | gobelet | Hees 2 | | |
| | | 14--3 | 961 | | | EN AR | 1 | | | | | 1 | 1 | gobelet | Hees 2 | | |
| | | 14--3 | 961 | | | EN AR | 1 | | | | | 1 | 1 | gobelet | Hees 2 | | |
| 1966 | | 17--1 | 1020 | | | EN AR | 5 | | | | 12 | 17 | 1 | gobelet | Hees 2 | | |
| 1966 | | 17--1 | 1020 | | | EN AR | 3 | | | | 9 | 12 | 1 | gobelet | Hees 2 | | |
| 1966 | | 17--4 | 1032 | | | EN AR | 1 | | | | 21 | 22 | 1 | gobelet | Hees 2 | | |
| | | 37-1 | 1532 | | | EN AR | 3 | | | | 4 | 7 | 1 | gobelet | Hees 2 | | |
| | | 37-1 | 1534 | | | EN AR | 1 | 3 | | | 5 | 9 | 1 | gobelet | Hees 2 | | |
| 1968 | | 39-5 | 166 | | | EN AR | 1 | | | | | 1 | 1 | gobelet | Hees 2 | | |
| 1968 | | 39-5 | 166 | | | EN AR | 1 | | | | | 1 | 1 | gobelet | Hees 2 | | |
| 1968 | | 39-5 | 166 | | | EN AR | 1 | | | | | 1 | 1 | gobelet | Hees 2 | | |
| 1968 | | 39-5 | 166 | | | EN AR | 1 | | | | | 1 | 1 | gobelet | Hees 2 | | |
| 1968 | | 39-5 | 166 | | | EN AR | 1 | | | | | 1 | 1 | gobelet | Hees 2 | | |
| 1968 | | 39-5 | 166 | | | EN AR | 1 | | | | | 1 | 1 | gobelet | Hees 2 | | |
| 1966 | | 42-2 | 244 | | | EN AR | 1 | | | | | 1 | 1 | gobelet | Hees 2 | | |
| 1966 | | 42-2 | 244 | | | EN AR | 1 | | | | | 1 | 1 | gobelet | Hees 2 | | |
| 1965 | | 42-3 | 257 | | amphithéâtre e dépôt | EN AR | 1 | | | | | 1 | 1 | gobelet | Hees 2 | | |
| 1968 | | 44-2 | 269 | | | EN AR | 1 | | | | | 1 | 1 | gobelet | Hees 2 | | |
| 1978 | | 15--2 | 905 | | | EN AR | 2 | | | | | 2 | 1 | gobelet | Hees 2 | | |
| 1978 | | 15--2 | 905 | | | EN AR | 1 | | | | | 1 | 1 | gobelet | Hees 2 | | |
| 1978 | | 15--2 | 905 | | | EN AR | 1 | | | | | 1 | 1 | gobelet | Hees 2 | | |
| 1978 | | 15--2 | 905 | | | EN AR | 1 | | | | | 1 | 1 | gobelet | Hees 2 | | |
| 1978 | | 15--2 | 905 | | | EN AR | 1 | | | | | 1 | 1 | gobelet | Hees 2 | | |
| 1978 | | 15--2 | 905 | | | EN AR | 1 | | | | | 1 | 1 | gobelet | Hees 2 | | |

ANNEXE B : AMPHITHÉÂTRE

| année | n° OA | Rayon | Caisse | n° ordre | US | Catégorie | Comptage | | | | | | Typologie | Desc. Typo. | Dessin | Planche | |
|-------|----------|-------|--------|-------------|----------|-----------|----------|---|---|---|---|----|-----------|-------------|--------|---------|-----|
| | | | | | | | B | F | A | D | P | NR | | | | | NMI |
| 1978 | | 15--2 | 905 | | | EN AR | 1 | | | | | 1 | 1 | gobelet | Hees 2 | | |
| 1966 | | 14--3 | 960 | | | EN AR | 1 | | | | | 1 | 1 | gobelet | Hees 2 | | |
| 1966 | | 14--3 | 960 | | | EN AR | 1 | | | | | 1 | 1 | gobelet | Hees 2 | | |
| 1966 | | 14--3 | 960 | | | EN AR | 3 | | | | | 3 | 1 | gobelet | Hees 2 | | |
| 1966 | | 14--3 | 960 | | | EN AR | 1 | | | | | 1 | 1 | gobelet | Hees 2 | | |
| | | 29-2 | 9 | | salle 2 | EN AR | 1 | | | | | 1 | 1 | gobelet | Hees 2 | | |
| | | 29-2 | 9 | | salle 2 | EN AR | 1 | | | | | 1 | 1 | gobelet | Hees 2 | | |
| | | 29-2 | 9 | | salle 2 | EN AR | 1 | | | | | 1 | 1 | gobelet | Hees 2 | | |
| 1967 | | 40-2 | 191 | | | EN AR | 1 | | | | | 1 | 1 | gobelet | Hees 2 | | |
| 1967 | | 40-2 | 191 | | | EN AR | 1 | | | | | 1 | 1 | gobelet | Hees 2 | | |
| | | 41-2 | 198 | | | EN AR | 1 | | | | | 1 | 1 | gobelet | Hees 2 | | |
| | | 42-3 | 255 | | | EN AR | 2 8 | | | | | 28 | 1 | gobelet | Hees 2 | | |
| | | 42-3 | 255 | | | EN AR | 1 5 | | | | | 15 | 1 | gobelet | Hees 2 | | |
| | | 15--3 | 907 | | couche 4 | EN AR | 1 | | | | | 1 | 1 | gobelet | Hees 2 | | |
| | | 15--3 | 907 | | couche 3 | EN AR | 1 | | | | | 1 | 1 | gobelet | Hees 2 | | |
| 1979 | | 15--3 | 907 | | | EN AR | 2 | | | | | 2 | 1 | gobelet | Hees 2 | | |
| | | 14--1 | 938 | | | EN AR | 2 | | | | | 2 | 1 | gobelet | Hees 2 | | |
| 1968 | | 42-3 | 253 | | | EN AR | 1 | | | | | 1 | 1 | gobelet | Hees 2 | | |
| 1966 | | 14--2 | 922 | | | EN AR | 1 | | | | | 1 | 1 | gobelet | Hees 2 | | |
| 1966 | | 14--2 | 922 | | | EN AR | 1 | | | | | 1 | 1 | gobelet | Hees 2 | | |
| 1966 | | 14--2 | 922 | | | EN AR | 1 | | | | | 1 | 1 | gobelet | Hees 2 | | |
| 1966 | | 14--2 | 922 | | | EN AR | 1 | | | | | 1 | 1 | gobelet | Hees 2 | | |
| 1964 | | 14--2 | 951 | | | EN AR | 1 | | | | | 1 | 1 | gobelet | Hees 2 | | |
| | | 29-2 | 9 | | | EN AR | 1 | | | | | 1 | 1 | gobelet | Hees 2 | | |
| | | 29-2 | 9 | | | EN AR | 1 | | | | | 1 | 1 | gobelet | Hees 2 | | |

ANNEXE B : AMPHITHÉÂTRE

| année | n° OA | Rayon | Caisse | n° ordre | US | Catégorie | Comptage | | | | | | Typologie | Desc. Typo. | Dessin | Planche | |
|------------|----------|-------|--------|-------------|---------------------------------|-----------|----------|---|---|---|----|----|-----------|-------------|--------|---------|-----|
| | | | | | | | B | F | A | D | P | NR | | | | | NMI |
| | | 42-2 | 245 | | | EN AR | 2 | | | | | 2 | 1 | gobelet | Hees 2 | | |
| | | 42-2 | 245 | | | EN AR | 3 | | | | | 3 | 1 | gobelet | Hees 2 | | |
| | | 15--3 | 909 | | couche 7 | EN AR | 6 | | | | | 6 | 1 | gobelet | Hees 2 | | |
| 1964 | | 14--2 | 951 | | | EN AR | 1 | | | | | 1 | 1 | gobelet | Hees 2 | | |
| 1964 | | 14--2 | 951 | | | EN AR | 1 | | | | | 1 | 1 | gobelet | Hees 2 | | |
| 1964 | | 14--2 | 951 | | | EN AR | 1 | | | | | 1 | 1 | gobelet | Hees 2 | | |
| 1964 | | 14--2 | 951 | | | EN AR | | 7 | | | 61 | 68 | 1 | gobelet | Hees 2 | | |
| 1979 | | 15--3 | 907 | | | EN AR | 5 | | | | | 5 | | gobelet | Hees 2 | | |
| 1964 | | 14--2 | 951 | | | EN AR | 1 | | | | | 1 | 1 | gobelet | Hees 2 | | |
| 1964 | | 14--2 | 951 | | | EN AR | 1 | | | | | 1 | 1 | gobelet | Hees 2 | | |
| 1964 | | 14--2 | 951 | | | EN AR | 1 | | | | | 1 | 1 | gobelet | Hees 2 | | |
| 1968 | | 40-2 | 192 | | | EN AR | 1 | | | | | 1 | 1 | gobelet | Hees 4 | | |
| 1966-67-68 | | 39-2 | 155 | | | EN AR | | | | | 1 | 1 | 1 | graffiti | | | |
| | | 38-1 | 1554 | | | EN AR | | | | | 3 | 3 | | | | | |
| 1964 | | 14--2 | 951 | | | EN AR | 1 | | | | | 1 | | | | | |
| 1964 | | 14--2 | 951 | | | EN AR | | 1 | | | | 1 | | | | | |
| | | 41-2 | 198 | | | EN AR | | | | | 4 | 4 | | | | | |
| | | 42-2 | 250 | | | EN AR | | 1 | | | | 1 | | | | | |
| | | 42-3 | 268 | | | EN AR | | 2 | | | | 2 | | | | | |
| 1989 | | 34-2 | 110 | | NA3 structure 2 | EN AR | | 1 | | | 9 | 10 | | | | | |
| 1989 | | 34-2 | 110 | | NA2 structure 3 | EN AR | | | | | 4 | 4 | | | | | |
| 1989 | | 34-2 | 111 | | ND3 structure 4 niveau 10 | EN AR | | | | | 3 | 3 | | | | | |

ANNEXE B : AMPHITHÉÂTRE

| année | n° OA | Rayon | Caisse | n° ordre | US | Catégorie | Comptage | | | | | | Typologie | Desc. Typo. | Dessin | Planche |
|-------|----------|-------|--------|-------------|--------------------------|-----------|----------|---|---|---|----|----|-----------|-------------|--------|---------|
| | | | | | | | B | F | A | D | P | NR | | | | |
| 1989 | | 34-2 | 111 | | ND3 structure 4.11 | EN AR | | | | | 3 | 3 | | | | |
| 1989 | | 34-2 | 111 | | ND3 structure 4.14 | EN AR | | | | | 1 | 1 | | | | |
| 1989 | | 34-3 | 113 | | 5NE3 | EN AR | | | | | 3 | 3 | | | | |
| 1989 | | 34-3 | 115 | | 4NC3 | EN AR | | 1 | | | 3 | 4 | | | | |
| 1989 | | 34-4 | 118 | | 3CNA9 | EN AR | | | | | 2 | 2 | | | | |
| 1989 | | 34-4 | 118 | | 3CNA8 | EN AR | | | | | 5 | 5 | | | | |
| 1989 | | 34-5 | 123 | | MCIII couche 23 | EN AR | | | | | 5 | 5 | | | | |
| 1989 | | 34-5 | 125 | | 5SD8 | EN AR | | | | | 2 | 2 | | | | |
| 1989 | | 34-5 | 125 | | | EN AR | | 3 | | | 27 | 30 | | | | |
| 1989 | | 36-2 | 128 | | 4NA3 | EN AR | | | | | 4 | 4 | | | | |
| 1989 | | 37-5 | 137 | | ND3 ST4 | EN AR | | | | | 20 | 20 | | | | |
| 1989 | | 37-5 | 136 | | 5ND3 | EN AR | | | | | 34 | 34 | | | | |
| | | 39-3 | 158 | | | EN AR | | | | | 17 | 17 | | | | |
| | | 39-3 | 161 | | | EN AR | | | | | 21 | 21 | | | | |
| | | 44--4 | 310 | | | EN AR | | | | | 31 | 31 | | | | |
| | | 45-3 | 303 | | | EN AR | | | | | 16 | 16 | | | | |
| | | 44-1 | 1606 | | | EN AR | | 2 | | | | 2 | | | | |
| | | 20--2 | 1145 | | | EN AR | | | | | 28 | 28 | | | | |
| 1966 | | 21--1 | 1157 | | | EN AR | | 1 | | | | 1 | | | | |
| 1966 | | 21--1 | 1155 | | | EN AR | | 1 | | | 14 | 15 | | | | |
| 1966 | | 21--2 | 1160 | | | EN AR | | | | | 4 | 4 | | | | |
| | | 46-2 | 1479 | | | EN AR | | | | | 21 | 21 | | | | |

ANNEXE B : AMPHITHÉÂTRE

| année | n° OA | Rayon | Caisse | n° ordre | US | Catégorie | Comptage | | | | | | Typologie | Desc. Typo. | Dessin | Planche |
|-------|----------|-------|--------|-------------|-----------------|-----------|----------|---|---|---|----|----|-----------|-------------|--------|---------|
| | | | | | | | B | F | A | D | P | NR | | | | |
| 1966 | | 17--4 | 1031 | | | EN AR | | | | | 4 | 4 | | | | |
| 1964 | | 18--1 | 1049 | | | EN AR | | 1 | | | | 1 | | | | |
| 1966 | | 18--4 | 1099 | | | EN AR | | 3 | | | 18 | 21 | | | | |
| | | 44-2 | 270 | | | EN AR | | 1 | | | 31 | 32 | | | | |
| 1990 | 967 | 47-4 | 1666 | 2 | NA3a | EN AR | | | | | 21 | 21 | | | | |
| 1990 | 967 | 47-4 | 1666 | 9 | NG1 couche 1 | EN AR | | | | | 6 | 6 | | | | |
| | | 20--2 | 1142 | | | EN AR | | | | | 13 | 13 | | | | |
| | | 41-1 | 1565 | | | EN AR | | | | | 17 | 17 | | | | |
| | | 41-1 | 1574 | | | EN AR | | | | | 22 | 22 | | | | |
| | | 41-1 | 1583 | | | EN AR | | | | | 12 | 12 | | | | |
| | | 41-1 | 1584 | | | EN AR | | | | | 11 | 11 | | | | |
| | | 42-1 | 1602 | | | EN AR | | 1 | | | 9 | 10 | | | | |
| | | 42-1 | 1462 | | | EN AR | | | | | 7 | 7 | | | | |
| | | 42-1 | 1572 | | | EN AR | | | | | 13 | 13 | | | | |
| | | 42-1 | 1569 | | | EN AR | | | | | 8 | 8 | | | | |
| | | 45-3 | 309 | | | EN AR | | 1 | | | 6 | 7 | | | | |
| | | 36-1 | 1535 | | | EN AR | | 2 | | | 1 | 3 | | | | |
| | | 28--4 | 1603 | | | EN AR | | | | | 24 | 24 | | | | |
| | | 47-3 | 1654 | | | EN AR | | 1 | | | 11 | 12 | | | | |
| | | 38-3 | 1632 | | | EN AR | | 1 | | | 16 | 17 | | | | |
| | | 38-3 | 1633 | | | EN AR | | | | | 17 | 17 | | | | |
| 1989 | | 36-2 | 124 | | | EN AR | | | | | 3 | 3 | | | | |
| 1989 | | 36-2 | 124 | | | EN AR | | | | | 4 | 4 | | | | |
| 1989 | | 36-2 | 124 | | | EN AR | | | | | 3 | 3 | | | | |
| 1968 | | 39-5 | 166 | | | EN AR | | 2 | | | | 2 | | | | |

ANNEXE B : AMPHITHÉÂTRE

| année | n° OA | Rayon | Caisse | n° ordre | US | Catégorie | Comptage | | | | | | Typologie | Desc. Typo. | Dessin | Planche |
|-------|----------|-------|--------|-------------|----------|-----------|----------|---|---|---|----|----|-----------|-------------|--------|---------|
| | | | | | | | B | F | A | D | P | NR | | | | |
| 1968 | | 40-2 | 192 | | | EN AR | | | | | 5 | 5 | | | | |
| 1968 | | 44-2 | 269 | | | EN AR | | 1 | | | 19 | 20 | | | | |
| 1978 | | 15--2 | 905 | | | EN AR | | 5 | | | 4 | 9 | | | | |
| 1966 | | 15--4 | 950 | | | EN AR | | | | | 7 | 7 | | | | |
| 1966 | | 14--3 | 960 | | | EN AR | | 3 | | | | 3 | | | | |
| | | 29-2 | 9 | | salle 2 | EN AR | | 1 | | | 6 | 7 | | | | |
| | | 29-2 | 9 | | | EN AR | | | | | 1 | 1 | | | | |
| | | 29-2 | 9 | | | EN AR | | 1 | | | 3 | 4 | | | | |
| | | 29-2 | 9 | | | EN AR | 1 | | | | | 1 | | | | |
| | | 29-2 | 9 | | | EN AR | | 1 | | | | 1 | | | | |
| | | 29-2 | 9 | | | EN AR | | | | | 1 | 1 | | | | |
| | | 40-2 | 186 | | | EN AR | | | | | 1 | 1 | | | | |
| | | 40-2 | 186 | | | EN AR | | | | | 1 | 1 | | | | |
| 1967 | | 40-2 | 191 | | | EN AR | | | | | 13 | 13 | | | | |
| | | 42-2 | 245 | | | EN AR | | | | | 12 | 12 | | | | |
| | | 42-3 | 268 | | | EN AR | | 2 | | | 29 | 31 | | | | |
| | | 42-3 | 268 | | | EN AR | | 4 | | | 1 | 5 | | | | |
| | | 42-3 | 268 | | | EN AR | 5 | 6 | | | | 56 | | | | |
| | | 42-5 | 266 | | | EN AR | | | | | 25 | 25 | | | | |
| | | 42-5 | 266 | | | EN AR | 4 | | | | | 4 | | | | |
| | | 15--3 | 907 | | couche 4 | EN AR | | 1 | | | 5 | 6 | | | | |
| | | 15--3 | 907 | | couche 3 | EN AR | | | | | 4 | 4 | | | | |
| 1979 | | 15--3 | 907 | | | EN AR | 3 | | | | | 3 | | | | |
| 1979 | | 15--3 | 907 | | | EN AR | | | 1 | | 4 | 5 | | | | |
| 1979 | | 15--3 | 907 | | | EN AR | | | | | 2 | 2 | | | | |
| 1979 | | 15--3 | 907 | | | EN AR | | | | | 2 | 2 | | | | |

ANNEXE B : AMPHITHÉÂTRE

| année | n° OA | Rayon | Caisse | n° ordre | US | Catégorie | Comptage | | | | | | Typologie | Desc. Typo. | Dessin | Planche | |
|-------|----------|--------|--------|-------------|----------|-----------|----------|---|---|---|----|----|-----------|-------------|------------|---------|-----|
| | | | | | | | B | F | A | D | P | NR | | | | | NMI |
| 1979 | | 15--3 | 907 | | | EN AR | | | | | 9 | 9 | | | | | |
| | | 14--1 | 938 | | | EN AR | | | | | 43 | 43 | | | | | |
| | | 15--3 | 909 | | couche 7 | EN AR | | 3 | | | 23 | 26 | | | | | |
| 1989 | | 34-3 | 115 | | | EN TR | | | | 3 | | 3 | 1 | gobelet | Hees 4 | | |
| | | 15--3 | 909 | | couche 8 | EN TR | 1 | 1 | | | | 2 | 1 | gobelet | Hees 4 | | |
| | | 41-1 | 1584 | | | EN TR | | | | | 1 | 1 | | | | | |
| | | 41-3 | 213 | | | EN TR | 1 | | | | | 1 | | | | | |
| 1989 | | 34-3 | 115 | | 4SC3 | EN COL | 1 | 1 | | | 11 | 13 | 1 | gobelet | Hofheim 26 | 57 | VII |
| 1990 | | | 1651 | | fosse 3 | EN COL | 1 | | | | | 1 | 1 | gobelet | Nied. 32 | 58 | VII |
| 1966 | | 14--2 | 922 | | | EN COL | 1 | | | | | 1 | 1 | gobelet | Hees 2 | | |
| 1979 | | 15--3 | 907 | | | EN COL | | | | | 1 | 1 | | | | | |
| | | 15--3 | 909 | | couche 7 | EN COL | | | | | 1 | 1 | | | | | |
| | | 15--01 | 901 | | | MET | | | | | 2 | 2 | 1 | | | | |
| | | 18--2 | 1087 | | | MET | | | | | 14 | 14 | | | | | |
| | | 42-3 | 268 | | | MET | | 1 | | | | 1 | | | | | |
| 1979 | | 15--3 | 907 | | | MET | | 1 | | | 3 | 4 | | | | | |
| 1979 | | 15--3 | 907 | | | MET | | | | | 3 | 3 | | | | | |
| 1979 | | 15--3 | 907 | | | MET | | | | | 3 | 3 | | | | | |
| 1979 | | 15--3 | 907 | | | MET | | 1 | | | | 1 | | | | | |
| 1979 | | 14--1 | 918 | | | MET | | 1 | | | 2 | 3 | | | | | |
| | | 14--1 | 938 | | | MET | | | | 5 | 16 | 21 | | | | | |
| 1966 | | 14--2 | 922 | | | MET AR | 1 | | | | | 1 | 1 | gobelet | Nied. 31 | | |
| | | 44-1 | 1609 | | | MET AR | 3 | 2 | | | | 5 | 1 | gobelet | Nied. 31 | | |
| | | 31--4 | 1617 | | | MET AR | 1 | | | | 6 | 7 | 1 | gobelet | Nied. 33 | | |
| 1968 | | 15--4 | 947 | | | MET AR | 1 | | | | | 1 | 1 | gobelet | Nied. 33 | | |
| 1966 | | 14--2 | 922 | | | MET AR | 1 | | | | | 1 | 1 | gobelet | Nied. 33 | | |

ANNEXE B : AMPHITHÉÂTRE

| année | n° OA | Rayon | Caisse | n° ordre | US | Catégorie | Comptage | | | | | | Typologie | Desc. Typo. | Dessin | Planche | |
|-------|----------|-------|--------|-------------|-------------------------|-----------|----------|---|---|---|----|----|-----------|-------------|----------|---------|------|
| | | | | | | | B | F | A | D | P | NR | | | | | NMI |
| 1966 | | 14--2 | 922 | | | MET AR | 1 | | | | | 1 | 1 | gobelet | Nied. 33 | | |
| | | 14--4 | 964 | | | MET AR | | 2 | | | | 2 | | | | | |
| 1966 | | 16--3 | 1010 | | | MET AR | | 1 | | | 3 | 4 | | | | | |
| 1969 | | 16--2 | 1003 | | | MET AR | | | | | 7 | 7 | | | | | |
| 1969 | | 20--2 | 1140 | | | MET AR | | 2 | | | 12 | 14 | | | | | |
| | | 41-1 | 1583 | | | MET AR | | | | | 17 | 17 | | | | | |
| | | 42-1 | 1572 | | | MET AR | | | | | 21 | 21 | | | | | |
| | | 42-1 | 1569 | | | MET AR | | | | | 18 | 18 | | | | | |
| 1967 | | 43-2 | 228 | | | MET AR | | | | | 2 | 2 | | | | | |
| 1966 | | 14--2 | 922 | | | MET TR | 1 | | | | | 1 | 1 | gobelet | Nied. 31 | | |
| 1966 | | 14--2 | 922 | | | MET TR | 1 | | | | | 1 | 1 | gobelet | Nied. 31 | | |
| 1966 | | 14--2 | 922 | | | MET TR | 1 | | | | | 1 | 1 | gobelet | Nied. 31 | | |
| 1966 | | 14--2 | 922 | | | MET TR | 1 | | | | | 1 | 1 | gobelet | Nied. 31 | | |
| 1966 | | 14--2 | 922 | | | MET TR | 1 | | | | | 1 | 1 | gobelet | Nied. 31 | | |
| 1966 | | 14--2 | 922 | | | MET TR | 1 | | | | | 1 | 1 | gobelet | Nied. 31 | | |
| | | 41-2 | 198 | | | MET TR | 1 | | | | | 1 | 1 | gobelet | Nied. 31 | | |
| | | 14--3 | 963 | | | MET TR | | | | | 2 | 2 | | | | | |
| | | 41-2 | 195 | | | MET TR | | | 1 | | | 1 | | | | | |
| | | 41-2 | 198 | | | MET TR | | | | | 2 | 2 | | | | | |
| | | 40-2 | 186 | | | TN | 1 | | | | | 1 | 1 | assiette | TNA14 | 59 | VIII |
| 1966 | | 42-2 | 247 | | Amphithéâtre e dépôt | TN | 1 | | | | | 1 | 1 | assiette | TNA39 | 60 | VIII |
| | | 41-2 | 195 | | | TN | 3 | | | | 24 | 27 | 1 | assiette | TNA41/43 | 61 | VIII |
| 1966 | | 42-2 | 247 | | Amphithéâtre e dépôt | TN | 1 | | | | | 1 | 1 | assiette | TNA41/43 | 62 | VIII |

ANNEXE B : AMPHITHÉÂTRE

| année | n° OA | Rayon | Caisse | n° ordre | US | Catégorie | Comptage | | | | | | Typologie | Desc. Typo. | Dessin | Planche | |
|-------|-------|-------|--------|----------|-------------------------|-----------|----------|---|---|---|---|----|-----------|-------------|----------|---------|------|
| | | | | | | | B | F | A | D | P | NR | | | | | NMI |
| 1966 | | 42-2 | 247 | | Amphithéâtre e dépôt | TN | 1 | | | | | 1 | 1 | assiette | TNA41/43 | 63 | VIII |
| 1989 | | 34-3 | 115 | | | TN | 2 | | | | | 2 | 1 | assiette | TNA41/43 | 64 | VIII |
| 1966 | | 42-2 | 247 | | Amphithéâtre e dépôt | TN | 1 | | | | | 1 | 1 | assiette | TNA44.3 | 65 | VIII |
| 1966 | | 42-2 | 247 | | Amphithéâtre e dépôt | TN | 1 | | | | | 1 | 1 | bol | TNB1 | 66 | VIII |
| 1966 | | 42-2 | 247 | | Amphithéâtre e dépôt | TN | 1 | | | | | 1 | 1 | bol | TNB1 | 67 | VIII |
| 1966 | | 42-2 | 247 | | Amphithéâtre e dépôt | TN | 1 | | | | | 1 | 1 | bol | TNB1 | 68 | VIII |
| 1966 | | 42-2 | 247 | | Amphithéâtre e dépôt | TN | 1 | | | | | 1 | 1 | bol | TNB1 | 69 | VIII |
| | | 29-2 | 9 | | | TN | 1 | | | | | 1 | 1 | bol | TNB1 | 70 | VIII |
| 1967 | | 42-2 | 246 | | | TN | 1 | | | | | 1 | 1 | bol | TNB1 | 71 | VIII |
| 1967 | | 42-2 | 246 | | Amphithéâtre e dépôt | TN | 1 | | | | | 1 | 1 | bol | TNB1 | 72 | VIII |
| 1966 | | 42-2 | 247 | | Amphithéâtre e dépôt | TN | 1 | | | | | 1 | 1 | bol | TNB14 | 73 | IX |
| 1989 | | 34-3 | 115 | | | TN | 5 | | | | 6 | 11 | 1 | bol | TNB14 | 74 | IX |
| | | 38-1 | 1546 | | | TN | 1 | | | | | 1 | 1 | bol | TNB14 | 75 | IX |
| | | 38-1 | 1546 | | | TN | 1 | | | | | 1 | 1 | bol | TNB14 | 76 | IX |
| | | 20--4 | 1149 | | | TN | 1 | | | | | 1 | 1 | bol | TNB14 | 77 | IX |
| 1966 | | 42-2 | 247 | | Amphithéâtre e dépôt | TN | 1 | | | | | 1 | 1 | bol | TNB14 | 78 | IX |
| 1966 | | 42-2 | 247 | | Amphithéâtre e dépôt | TN | 1 | | | | | 1 | 1 | bol | TNB14 | 79 | IX |
| | | 41-2 | 195 | | | TN | 8 | | | | 5 | 13 | 1 | bol | TNB14 | 80 | IX |
| 1966 | | 14--3 | 960 | | | TN | 1 | | | | | 1 | 1 | bol | TNB18 | 81 | IX |

ANNEXE B : AMPHITHÉÂTRE

| année | n° OA | Rayon | Caisse | n° ordre | US | Catégorie | Comptage | | | | | | Typologie | Desc. Typo. | Dessin | Planche | |
|------------|-------|-------|--------|----------|-------------------------|-----------|----------|---|---|---|---|----|-----------|-------------|---------|---------|-----|
| | | | | | | | B | F | A | D | P | NR | | | | | NMI |
| | | 41-2 | 195 | | | TN | 1 | | | | | 1 | 1 | bol | TNB38 | 82 | IX |
| 1966-67-68 | | 39-2 | 155 | | | TN | 1 | 1 | | | 7 | 9 | 1 | bol | TNB38 | 83 | IX |
| | | 37-1 | 1530 | | | TN | 1 | | | | | 1 | 1 | bol | TNB38 | 84 | IX |
| 1966 | | 42-2 | 247 | | Amphithéâtre e dépôt | TN | 1 | | | | | 1 | 1 | bouteille | TNBT1 | 85 | X |
| 1967 | | 42-2 | 246 | | | TN | 1 | | | | | 1 | 1 | bouteille | TNBT4 | 86 | X |
| 1966 | | 42-2 | 247 | | Amphithéâtre e dépôt | TN | 1 | | | | | 1 | 1 | bouteille | TNBT4 | 87 | X |
| 1966 | | 42-2 | 247 | | Amphithéâtre e dépôt | TN | 1 | | | | | 1 | 1 | bouteille | TNBT4 | 88 | X |
| 1965 | | 42-4 | 261 | | | TN | 1 | | | | | 1 | 1 | bouteille | TNBT6.2 | 89 | X |
| 1966 | | 42-2 | 247 | | Amphithéâtre e dépôt | TN | 1 | | | | | 1 | 1 | pot | TNP2 | 90 | X |
| | | 41-2 | 195 | | | TN | 1 | | | | | 1 | 1 | pot | TNP2.2 | 91 | X |
| 1966 | | 42-2 | 247 | | Amphithéâtre e dépôt | TN | 1 | | | | | 1 | 1 | pot | TNP10 | 92 | X |
| 1966 | | 42-2 | 247 | | Amphithéâtre e dépôt | TN | 1 | | | | | 1 | 1 | pot | TNP10 | 93 | X |
| 1966 | | 14--3 | 960 | | | TN | 1 | | | | | 1 | 1 | pot | TNP10 | 94 | X |
| | | 18--2 | 1086 | | | TN | 1 | | | | | 1 | 1 | pot | TNP10 | 95 | X |
| 1966 | | 42-2 | 247 | | Amphithéâtre e dépôt | TN | 1 | | | | | 1 | 1 | pot | TNP10 | 96 | X |
| 1966 | | 42-2 | 247 | | Amphithéâtre e dépôt | TN | 1 | | | | | 1 | 1 | pot | TNP10 | 97 | X |
| 1978 | | 15--2 | 905 | | | TN | 4 | | | | 3 | 7 | 1 | pot | TNP10 | 98 | X |
| 1966 | | 14--2 | 922 | | | TN | 1 | | | | | 1 | 1 | pot | TNP10 | 99 | X |
| 1966 | | 14--2 | 922 | | | TN | 1 | | | | | 1 | 1 | pot | TNP10 | 100 | XI |
| | | 42-2 | 245 | | | TN | 1 | | | | | 1 | 1 | pot | TNP10 | 101 | XI |

ANNEXE B : AMPHITHÉÂTRE

| année | n° OA | Rayon | Caisse | n° ordre | US | Catégorie | Comptage | | | | | | Typologie | Desc. Typo. | Dessin | Planche | |
|-------|-------|-------|--------|----------|-------------------------|-----------|----------|---|---|---|---|----|-----------|-------------|----------|---------|-----|
| | | | | | | | B | F | A | D | P | NR | | | | | NMI |
| | | 42-2 | 245 | | | TN | 1 | | | | | 1 | 1 | pot | TNP10 | 102 | XI |
| 1979 | | 15--3 | 907 | | | TN | 1 | | | | | 1 | 1 | pot | TNP10 | 103 | XI |
| 1966 | | 42-2 | 247 | | Amphithéâtre e dépôt | TN | 1 | | | | | 1 | 1 | pot | TNP12.1 | 104 | XI |
| | | 13--4 | 947 | | | TN | 1 | | | | | 1 | 1 | pot | TNP26 | 105 | XI |
| 1966 | | 42-2 | 247 | | Amphithéâtre e dépôt | TN | 1 | | | | | 1 | 1 | pot | TNP26 | 106 | XI |
| | | 41-2 | 195 | | | TN | 1 | | | | | 1 | 1 | pot | TNP26 | 107 | XI |
| | | 18--1 | 1054 | | | TN | 1 | | | | | 1 | 1 | pot | TNP32 | 108 | XI |
| 1966 | | 42-2 | 247 | | Amphithéâtre e dépôt | TN | 1 | | | | | 1 | 1 | pot | TNP32 | 109 | XI |
| 1966 | | 42-2 | 247 | | Amphithéâtre e dépôt | TN | 1 | | | | | 1 | 1 | pot | TNP32 | 110 | XI |
| 1966 | | 14--2 | 922 | | | TN | 1 | | | | | 1 | 1 | pot | TNP32 | 111 | XI |
| | | 42-5 | 266 | | | TN | 2 | | | | 2 | 4 | 1 | pot | TNP32 | 112 | XI |
| 1989 | | 36-2 | 124 | | | TN | 1 | | | | | 1 | 1 | pot | TNP34 | 113 | XI |
| | | 41-2 | 195 | | | TN | 1 | | | | | 1 | 1 | pot | TNP40 | 114 | XI |
| | | 16--5 | 1019 | | | TN | 1 | | | | | 1 | 1 | pot | TNP51/54 | 115 | XI |
| 1966 | | 42-2 | 247 | | Amphithéâtre e dépôt | TN | 1 | | | | | 1 | 1 | pot | TNP51/54 | 116 | XI |
| 1966 | | 42-2 | 247 | | Amphithéâtre e dépôt | TN | 1 | | | | | 1 | 1 | pot | TNP51/54 | 117 | XII |
| 1966 | | 42-2 | 247 | | Amphithéâtre e dépôt | TN | 1 | | | | | 1 | 1 | pot | TNP51/54 | 118 | XII |
| 1966 | | 42-2 | 247 | | Amphithéâtre e dépôt | TN | 1 | | | | | 1 | 1 | pot | TNP51/54 | 119 | XII |
| 1966 | | 42-2 | 247 | | Amphithéâtre e dépôt | TN | 1 | | | | | 1 | 1 | pot | TNP55 | 120 | XII |

ANNEXE B : AMPHITHÉÂTRE

| année | n° OA | Rayon | Caisse | n° ordre | US | Catégorie | Comptage | | | | | | Typologie | Desc. Typo. | Dessin | Planche | |
|----------------|----------|--------|--------|-------------|--------------------------|-----------|----------|---|---|---|----|----|-----------|-------------|--------|---------|-----|
| | | | | | | | B | F | A | D | P | NR | | | | | NMI |
| 1966 | | 42-2 | 247 | | Amphithéâtre dépôtoir | TN | 1 | | | | | 1 | 1 | pot | TNP55 | 121 | XII |
| 1966-67- 68 | | 39-2 | 155 | | | TN | | 1 | | | | 1 | 1 | estampille | | 122 | XII |
| 1989 | | 69-4 | 668 | | | TN | | 1 | | | | 1 | 1 | estampille | | 123 | XII |
| 1968 | | 14--2 | 919 | | | TN | | | | | 1 | 1 | | | | | |
| 1968 | | 14--2 | 919 | | | TN | | | | | 1 | 1 | | | | | |
| | | 41-2 | 195 | | | TN | | | 1 | | | 1 | | | | | |
| | | 42-2 | 245 | | | TN | | | 2 | | | 2 | | | | | |
| | | 35-4 | 101 | | | TN | | | | | 2 | 2 | | | | | |
| | | 35-4 | 102 | | | TN | | | | | 3 | 3 | | | | | |
| | | 35-5 | 105 | | | TN | | | | | 7 | 7 | | | | | |
| 1989 | | 34-2 | 111 | | ND3 structure 4.11 | TN | | | | | 1 | 1 | | | | | |
| 1989 | | 34-2 | 112 | | coup IV | TN | | | | | 3 | 3 | | | | | |
| 1989 | | 34-3 | 115 | | 4NE3 | TN | | | | | 3 | 3 | | | | | |
| 1989 | | 34-5 | 125 | | 5SD8 | TN | | | | | 3 | 3 | | | | | |
| 1989 | | 36-2 | 127 | | | TN | | | | | 2 | 2 | | | | | |
| | | 39-3 | 158 | | | TN | | | | | 10 | 10 | | | | | |
| | | 39-4 | 162 | | | TN | | | | | 6 | 6 | | | | | |
| | | 15--02 | 906 | | | TN | | | | | 3 | 3 | | | | | |
| | | 15--3 | 910 | | | TN | | | | | 5 | 5 | | | | | |
| | | 14--2 | 955 | | | TN | | | | | 4 | 4 | | | | | |
| | | 14--2 | 954 | | | TN | | | | | 20 | 20 | | | | | |
| | | 14--2 | 954 | | | TN | | | | | 14 | 14 | | | | | |
| | | 17--1 | 1027 | | | TN | | | | | 12 | 12 | | | | | |

ANNEXE B : AMPHITHÉÂTRE

| année | n° OA | Rayon | Caisse | n° ordre | US | Catégorie | Comptage | | | | | | Typologie | Desc. Typo. | Dessin | Planche |
|-------|----------|-------|--------|-------------|----|-----------|----------|---|---|---|----|----|-----------|-------------|--------|---------|
| | | | | | | | B | F | A | D | P | NR | | | | |
| | | 14--3 | 961 | | | TN | | | | | 17 | 17 | | | | |
| | | 14--3 | 963 | | | TN | | | | | 2 | 2 | | | | |
| | | 14--4 | 964 | | | TN | | | | | 12 | 12 | | | | |
| | | 14--5 | 968 | | | TN | | | | | 3 | 3 | | | | |
| | | 12--4 | 1362 | | | TN | | 2 | | | 13 | 15 | | | | |
| | | 44--2 | 274 | | | TN | | 3 | | | 39 | 42 | | | | |
| | | 44--3 | 279 | | | TN | | 1 | | | 12 | 13 | | | | |
| | | 45-2 | 301 | | | TN | | | | | 3 | 3 | | | | |
| | | 45-2 | 295 | | | TN | | | | | 12 | 12 | | | | |
| | | 44-1 | 1595 | | | TN | | | | | 25 | 25 | | | | |
| | | 43-1 | 1586 | | | TN | | | | | 21 | 21 | | | | |
| | | 20--1 | 1115 | | | TN | | 1 | | | | 1 | | | | |
| | | 20--1 | 114 | | | TN | | | | | 1 | 1 | | | | |
| | | 20--1 | 1111 | | | TN | | | | | 2 | 2 | | | | |
| | | 20--2 | 1145 | | | TN | | | | | 17 | 17 | | | | |
| 1966 | | 21--1 | 1146 | | | TN | | | 2 | | | 2 | | | | |
| 1966 | | 21--1 | 1157 | | | TN | | | | | 4 | 4 | | | | |
| 1965 | | 21--1 | 1126 | | | TN | | | | | 27 | 27 | | | | |
| 1966 | | 21--2 | 1160 | | | TN | | | | | 27 | 27 | | | | |
| | | 31--4 | 1617 | | | TN | | | | | 20 | 20 | | | | |
| | | 46-2 | 1479 | | | TN | | | | | 10 | 10 | | | | |
| | | 38-1 | 1545 | | | TN | | | | | 2 | 2 | | | | |
| | | 38-1 | 1553 | | | TN | | | | | 3 | 3 | | | | |
| | | 39-1 | 1561 | | | TN | | | | | 22 | 22 | | | | |
| 1968 | | 15--3 | 943 | | | TN | | 1 | | | 6 | 7 | | | | |
| 1968 | | 15--4 | 947 | | | TN | | | | | 27 | 27 | | | | |

ANNEXE B : AMPHITHÉÂTRE

| année | n° OA | Rayon | Caisse | n° ordre | US | Catégorie | Comptage | | | | | | Typologie | Desc. Typo. | Dessin | Planche |
|-------|----------|-------|--------|-------------|--|-----------|----------|---|---|---|----|----|-----------|-------------|--------|---------|
| | | | | | | | B | F | A | D | P | NR | | | | |
| 1966 | | 19--5 | 1084 | | | TN | | 1 | | | 5 | 6 | | | | |
| 1966 | | 19--3 | 1078 | | | TN | | | | | 15 | 15 | | | | |
| 1966 | | 18--2 | 1086 | | | TN | | 2 | | | 7 | 9 | | | | |
| 1966 | | 16--5 | 1019 | | | TN | | | | | 8 | 8 | | | | |
| 1990 | 967 | 47-4 | 1666 | 10 | NG1 couche 1 | TN | | | | | 6 | 6 | | | | |
| 1990 | 967 | 47-4 | 1666 | 7 | NA3 b couche 1 | TN | | | | | 6 | 6 | | | | |
| 1990 | 967 | 47-4 | 1666 | 7 | NG1 couche 1 | TN | | | | | 17 | 17 | | | | |
| 1990 | 967 | 47-4 | 1666 | 3 | coupe 2 couche verdâtre au dessus de la couche grise | TN | | | | | 4 | 4 | | | | |
| 1990 | 967 | 47-4 | 1666 | 5 | NEO couche 1 | TN | | | | | 10 | 10 | | | | |
| | | 20--2 | 1142 | | | TN | | | | | 21 | 21 | | | | |
| 1969 | | 20--3 | 1146 | | | TN | | | | | 41 | 41 | | | | |
| | | 14--5 | 967 | | | TN | | | | | 5 | 5 | | | | |
| | | | | | | TN | | | | | 23 | 23 | | | | |
| | | 42-1 | 1602 | | | TN | | | | | 41 | 41 | | | | |
| | | 42-1 | 1464 | | | TN | | 1 | | | 34 | 35 | | | | |
| | | 42-1 | 1463 | | | TN | | | | | 27 | 27 | | | | |
| | | 42-1 | 1568 | | | TN | | 1 | | | 12 | 13 | | | | |
| | | 42-1 | 1567 | | | TN | | | | | 33 | 33 | | | | |
| | | 42-1 | 1572 | | | TN | | | | | 47 | 47 | | | | |
| | | 45-3 | 309 | | | TN | | 1 | | | 21 | 22 | | | | |

ANNEXE B : AMPHITHÉÂTRE

| année | n° OA | Rayon | Caisse | n° ordre | US | Catégorie | Comptage | | | | | | Typologie | Desc. Typo. | Dessin | Planche |
|-------|-------|-------|--------|----------|-------------------------|-----------|----------|---|---|---|----|----|-----------|-------------|--------|---------|
| | | | | | | | B | F | A | D | P | NR | | | | |
| | | 36-2 | 1529 | | | TN | | | | | 3 | 3 | | | | |
| | | 38-3 | 1558 | | | TN | | | | | 1 | 1 | | | | |
| | | 46-3 | 1480 | | | TN | | 1 | | | 38 | 40 | | | | |
| | | 38-1 | 1546 | | | TN | | 1 | | | | 1 | | | | |
| | | 28--4 | 1603 | | | TN | | | | | 9 | 9 | | | | |
| | | 47-3 | 1654 | | | TN | | | | | 11 | 11 | | | | |
| | | 38-3 | 1632 | | | TN | | | | | 16 | 16 | | | | |
| | | 38-3 | 1633 | | | TN | | | | | 12 | 12 | | | | |
| 1989 | | 36-2 | 124 | | | TN | | | | | 1 | 1 | | | | |
| 1989 | | 36-2 | 124 | | | TN | | | | | 1 | 1 | | | | |
| 1968 | | 42-3 | 253 | | | TN | 1 | | | | | 1 | | | | |
| 1968 | | 42-3 | 253 | | | TN | | 1 | | | 6 | 7 | | | | |
| 1965 | | 42-4 | 261 | | | TN | | 1 | | | | 1 | | | | |
| 1965 | | 42-4 | 261 | | | TN | | 1 | | | | 1 | | | | |
| 1965 | | 42-4 | 261 | | | TN | | | | 5 | 23 | 23 | | | | |
| 1965 | | 42-3 | 257 | | amphithéâtre e dépôt | TN | | | | | 1 | 1 | | | | |
| 1968 | | 44-2 | 269 | | | TN | | 1 | | | | 1 | | | | |
| 1968 | | 44-2 | 269 | | | TN | | 2 | | | 14 | 16 | | | | |
| 1978 | | 15--2 | 905 | | | TN | | | | 1 | 4 | 9 | 23 | | | |
| 1978 | | 15--2 | 905 | | | TN | 1 | | | | | 1 | | | | |
| 1978 | | 15--2 | 905 | | | TN | | | | 3 | 25 | 28 | | | | |
| 1966 | | 14--2 | 922 | | | TN | | 1 | | | | 1 | | | | |
| 1966 | | 14--2 | 922 | | | TN | | 9 | 1 | 1 | 12 | 13 | | | | |
| | | | | | | | | | | | 5 | 6 | | | | |

ANNEXE B : AMPHITHÉÂTRE

| année | n° OA | Rayon | Caisse | n° ordre | US | Catégorie | Comptage | | | | | | Typologie | Desc. Typo. | Dessin | Planche |
|-------|----------|-------|--------|-------------|---------|-----------|----------|---|---|---|----|----|-----------|-------------|--------|---------|
| | | | | | | | B | F | A | D | P | NR | | | | |
| 1966 | | 14--3 | 960 | | | TN | | 1 | | 2 | 7 | 10 | | | | |
| 1964 | | 14--2 | 951 | | | TN | | 1 | | | 22 | 23 | | | | |
| | | 29-2 | 9 | | salle 2 | TN | | 2 | | | 8 | 10 | | | | |
| | | 29-2 | 9 | | | TN | | | | | 3 | 3 | | | | |
| 1967 | | 40-2 | 191 | | | TN | | | | | 6 | 6 | | | | |
| | | 41-2 | 195 | | | TN | | | | | 1 | 1 | | | | |
| | | 41-2 | 195 | | | TN | | | | | 1 | 1 | | | | |
| | | 41-2 | 195 | | | TN | | | | | 1 | 1 | | | | |
| | | 41-2 | 195 | | | TN | | | | | 1 | 1 | | | | |
| | | 41-2 | 195 | | | TN | | | | | 1 | 1 | | | | |
| | | 41-2 | 195 | | | TN | | | | | 1 | 1 | | | | |
| | | 41-2 | 195 | | | TN | | | | 2 | | 2 | | | | |
| | | 41-2 | 195 | | | TN | | 1 | | | | 1 | | | | |
| | | 41-2 | 195 | | | TN | 1 | | | | 1 | 2 | | | | |
| | | 41-2 | 195 | | | TN | | | | | 1 | 1 | | | | |
| | | 41-2 | 195 | | | TN | | | | | 1 | 1 | | | | |
| | | 41-2 | 195 | | | TN | | | | | 2 | 2 | | | | |
| | | 41-2 | 195 | | | TN | 1 | | | | | 1 | | | | |
| | | 41-2 | 195 | | | TN | | | | | 1 | 1 | | | | |
| | | 41-2 | 195 | | | TN | | | | | 1 | 1 | | | | |
| | | 41-2 | 195 | | | TN | | | | | 1 | 1 | | | | |
| | | 41-3 | 213 | | | TN | | | | | 20 | 20 | | | | |
| | | 42-3 | 268 | | | TN | 2 | | | | | 2 | | | | |
| | | 42-5 | 266 | | | TN | | | | | 6 | 6 | | | | |
| 1979 | | 15--3 | 907 | | | TN | | 1 | | 1 | 4 | 6 | | | | |
| 1979 | | 15--3 | 907 | | | TN | | | | | 1 | 1 | | | | |

ANNEXE B : AMPHITHÉÂTRE

| année | n° OA | Rayon | Caisse | n° ordre | US | Catégorie | Comptage | | | | | | Typologie | Desc. Typo. | Dessin | Planche | |
|-------|-------|-------|--------|----------|-------------------------|-----------|----------|---|---|---|----|----|-----------|-------------|-------------------|---------|------|
| | | | | | | | B | F | A | D | P | NR | | | | | NMI |
| 1979 | | 15--3 | 907 | | | TN | | 1 | | 7 | 5 | 13 | | | | | |
| 1979 | | 15--3 | 907 | | | TN | | 1 | | 5 | 4 | 10 | | | | | |
| 1979 | | 15--3 | 907 | | | TN | | | | | 14 | 14 | | | | | |
| 1979 | | 15--3 | 907 | | | TN | | | | 1 | 15 | 16 | | | | | |
| | | 14--1 | 938 | | | TN | | | | 1 | 33 | 34 | | | | | |
| | | 15--3 | 909 | | couche 7 | TN | | | | | 6 | 6 | | | | | |
| 1966 | | 42-2 | 247 | | Amphithéâtre e dépôt | TN/DTN | 1 | | | | | 1 | 1 | bol | TN/DTN B1 | 124 | XII |
| 1979 | | 14--1 | 918 | | | TN/DTN | 1 | | | | | 1 | 1 | bouteille | TN/DTN Bt1 | 125 | XII |
| 1966 | | 42-2 | 247 | | Amphithéâtre e dépôt | TN/DTN | 1 | | | | | 1 | 1 | pot | TN/DTN P1 | 126 | XII |
| 1966 | | 42-2 | 247 | | Amphithéâtre e dépôt | TN/DTN | 1 | | | | | 1 | 1 | pot | TN/DTN P1 | 127 | XII |
| | | 29-2 | 9 | | | TN/DTN | 1 | | | | | 1 | 1 | pot | TN/DTN P1 | 128 | XII |
| 1968 | | 39-5 | 166 | | | TN/DTN | | | | | 1 | 1 | | | | | |
| 1968 | | 14--2 | 919 | | | TN/DTN | | | | | 2 | 2 | | | | | |
| 1968 | | 40-2 | 192 | | | TN AR | 1 | | | | | 1 | 1 | bol | Deru AR TNB1.1 | 129 | XII |
| 1966 | | 42-2 | 247 | | Amphithéâtre e dépôt | TN AR | 1 | | | | | 1 | 1 | bol | Deru ARB3.7 | 130 | XII |
| | | 20--2 | 1144 | | | TN AR | 1 | | | | | 1 | 1 | bol | Deru ARTNB3.9 | 131 | XII |
| | | 41-2 | 198 | | | TN AR | 1 | | | | | 1 | 1 | coupelle | Drag. 35 | | |
| | | 43-1 | 1573 | | | TN AR | 1 | | | | | 1 | 1 | pot | Deru ARTNP4.1 | 132 | XIII |
| 1966 | | 42-2 | 247 | | Amphithéâtre e dépôt | TN AR | 1 | | | | | 1 | 1 | pot | Deru ARTNP4.2 | 133 | XIII |
| 1966 | | 42-2 | 247 | | Amphithéâtre e dépôt | TN AR | 1 | | | | | 1 | 1 | pot | Deru ARTNP4.2 | 134 | XIII |

ANNEXE B : AMPHITHÉÂTRE

| année | n° OA | Rayon | Caisse | n° ordre | US | Catégorie | Comptage | | | | | | Typologie | Desc. Typo. | Dessin | Planche | |
|-------|-------|-------|--------|----------|--------------------|-----------|----------|---|---|---|----|----|-----------|-------------|---------------|---------|------|
| | | | | | | | B | F | A | D | P | NR | | | | | NMI |
| | | 17--4 | 1032 | | | TN AR | 1 | | | | | 1 | 1 | pot | Deru ARTNP5.3 | 135 | XIII |
| | | 20--4 | 1149 | | | TN AR | 1 | | | | | 1 | 1 | pot | Deru ARTNP5.3 | 136 | XIII |
| 1966 | | 42-2 | 247 | | Amphithéâtre dépôt | TN AR | 1 | | | | | 1 | 1 | pot | Deru ARTNP5.6 | 137 | XIII |
| | | 21--2 | 1130 | | | TN AR | 1 | | | | | 1 | 1 | pot | TNP42 | 138 | XIII |
| 1968 | | 40-2 | 192 | | | TN AR | | 1 | | 9 | 10 | 20 | | | | | |
| 1967 | | 42-2 | 246 | | amphithéâtre dépôt | TN AR | 1 | | | | | | 1 | | | | |
| 1965 | | 42-2 | 247 | | Amphithéâtre dépôt | TN AR | | | | | 10 | 10 | | | | | |
| 1966 | | 17--1 | 1020 | | | TN AR | | | | 1 | 3 | 79 | 92 | | | | |
| 1966 | | 17--4 | 1031 | | | TN AR | | 1 | | 1 | 11 | 13 | | | | | |
| | | 21--1 | 1156 | | | TN AR | | | | | | 2 | 2 | | | | |
| 1990 | 967 | 38-3 | 1631 | 1 | couche 1 NE2 | TN AR | | | | 4 | 47 | 51 | | | | | |
| 1968 | | 20--2 | 1144 | | | TN AR | | | | | 33 | 33 | | | | | |
| | | 42-1 | 1569 | | | TN AR | | | | | 21 | 21 | | | | | |
| | | 38-1 | 1546 | | | TN AR | | 4 | | | 47 | 51 | | | | | |
| 1973 | | 16--4 | 1016 | | | TN AR | | | | 4 | | 4 | | | | | |
| 1967 | | 42-2 | 246 | | | TN AR | | 3 | | | 2 | 5 | | | | | |
| 1967 | | 42-2 | 246 | | amphithéâtre dépôt | TN AR | | 7 | | | 13 | 21 | | | | | |
| 1966 | | 42-2 | 244 | | | TN AR | | 3 | | | 7 | 0 | | | | | |
| 1966 | | 42-2 | 244 | | | TN AR | | 1 | | | | 1 | | | | | |
| 1965 | | 42-2 | 247 | | Amphithéâtre dépôt | TN AR | | 1 | | | | 1 | | | | | |

ANNEXE B : AMPHITHÉÂTRE

| année | n° OA | Rayon | Caisse | n° ordre | US | Catégorie | Comptage | | | | | | Typologie | Desc. Typo. | Dessin | Planche | |
|----------------|-------|-------|--------|----------|-------------------------|-----------|----------|---|---|---|----|----|-----------|-------------|--------------|---------|------|
| | | | | | | | B | F | A | D | P | NR | | | | | NMI |
| 1965 | | 42-2 | 247 | | Amphithéâtre e dépôt | TN AR | | 1 | | | | 1 | | | | | |
| 1965 | | 42-2 | 247 | | Amphithéâtre e dépôt | TN AR | | 1 | | | | 1 | | | | | |
| | | 41-2 | 195 | | | TN AR | | | | 5 | | 5 | | | | | |
| | | 41-2 | 195 | | | TN AR | 8 | | | | 26 | 34 | | | | | |
| | | 41-2 | 198 | | | TN AR | | 1 | | | 1 | 2 | | | | | |
| | | 15--3 | 909 | | couche 8 | TN AR | | 1 | 1 | | | 2 | | | | | |
| | | 15--3 | 909 | | | TR | 1 | | | | | 1 | 1 | coupe | TRC8 | 139 | XIII |
| | | 19--2 | 1071 | | | VRP | 1 | | | | | 1 | 1 | plat | Goudineau 15 | 140 | XIV |
| | | 36-1 | 1539 | | | VRP | 1 | | | | | 1 | 1 | plat | Goudineau 15 | 141 | XIV |
| 1965 | | 42-3 | 257 | | amphithéâtre e dépôt | VRP | 1 | | | | | 1 | 1 | plat | Goudineau 15 | 142 | XIV |
| | | 42-3 | 255 | | | VRP | 1 | | | | | 1 | 1 | plat | Goudineau 15 | 143 | XIV |
| 1989 | | 34-3 | 115 | | | VRP | 1 | | | | | 1 | 1 | plat | Goudineau 16 | 144 | XIV |
| | | 43-1 | 1586 | | | VRP | 1 | | | | | 1 | 1 | plat | Goudineau 16 | 145 | XIV |
| | | 16--3 | 1013 | | | VRP | 1 | | | | | 1 | 1 | plat | Goudineau 16 | 146 | XIV |
| | | 37-1 | 1532 | | | VRP | 1 | | | | | 1 | 1 | plat | Goudineau 16 | 147 | XV |
| | | 42-2 | 245 | | | VRP | 2 | | | | | 2 | 1 | plat | Goudineau 16 | 148 | XV |
| | | 42-3 | 255 | | | VRP | 1 | | | | | 1 | 1 | plat | Goudineau 16 | 149 | XV |
| | | 42-3 | 255 | | | VRP | 1 | | | | | 1 | 1 | plat | Goudineau 16 | 150 | XV |
| | | 42-3 | 252 | | | VRP | 1 | | | | | 1 | 1 | plat | Goudineau 16 | 151 | XV |
| | | 42-3 | 252 | | | VRP | 1 | | | | | 1 | 1 | plat | Goudineau 16 | 152 | XV |
| 1966-67- 68 | | 39-2 | 155 | | | VRP | 2 | | | | 3 | 5 | 1 | plat | Goudineau 17 | 153 | XVI |
| | | 42-2 | 245 | | | VRP | | | | | 3 | 3 | 1 | plat | Goudineau 17 | 154 | XVI |
| 1966 | | 42-2 | 244 | | | VRP | 1 | 1 | | | 5 | 7 | 1 | plat | Goudineau 17 | 155 | XVI |

ANNEXE B : AMPHITHÉÂTRE

| année | n° OA | Rayon | Caisse | n° ordre | US | Catégorie | Comptage | | | | | | Typologie | Desc. Typo. | Dessin | Planche | |
|-------|----------|-------|--------|-------------|--------------------------|-----------|----------|---|---|---|----|----|-----------|-------------|--------------|---------|-----|
| | | | | | | | B | F | A | D | P | NR | | | | | NMI |
| 1966 | | 15--4 | 950 | | | VRP | 1 | | | | | 1 | 1 | plat | Goudineau 17 | 156 | XVI |
| 1965 | | 42-3 | 257 | | amphithéâtre dépotoir | VRP | 1 | | | | | 1 | 1 | couvercle | Goudineau 18 | 157 | XVI |
| | | 42-3 | 252 | | | VRP | 2 | | | | | 2 | 1 | couvercle | Goudineau 18 | 158 | XVI |
| 1968 | | 14--2 | 919 | | | VRP | | 1 | | | | 1 | 1 | graffiti | | | |
| 1979 | | 14--1 | 918 | | | VRP | | | | 1 | | 1 | | | | | |
| 1989 | | 34-3 | 115 | | 4NC3 | VRP | | 1 | | | 4 | 5 | | | | | |
| | | 14--3 | 963 | | | VRP | | | | | 2 | 2 | | | | | |
| 1966 | | 21--2 | 1160 | | | VRP | | | | | 1 | 1 | | | | | |
| | | 30--3 | 1619 | | | VRP | | | | | 21 | 21 | | | | | |
| | | 45-3 | 306 | | | VRP | | 1 | | | | 1 | | | | | |
| | | 38-1 | 1554 | | | VRP | | | | | 1 | 1 | | | | | |
| | | 19--4 | 1064 | | | VRP | | 1 | | | | 1 | | | | | |
| 1968 | | 16--3 | 1012 | | | VRP | | 1 | | | 2 | 3 | | | | | |
| | | 44-2 | 270 | | | VRP | | 2 | | | 12 | 14 | | | | | |
| | | 37-1 | 1532 | | | VRP | | | | | 5 | 5 | | | | | |
| | | 36-1 | 1539 | | | VRP | 5 | 6 | | | 10 | 21 | | | | | |
| | | 43-1 | 1586 | | | VRP | | | | | 6 | 6 | | | | | |
| 1968 | | 39-5 | 166 | | | VRP | | | | | 1 | 1 | | | | | |
| 1966 | | 42-2 | 244 | | | VRP | | 1 | | | | 1 | | | | | |
| 1968 | | 42-3 | 253 | | | VRP | | 1 | | | 3 | 4 | | | | | |
| 1968 | | 14--2 | 919 | | | VRP | | | | | 1 | 1 | | | | | |
| 1966 | | 15--4 | 950 | | | VRP | | 1 | | | | 1 | | | | | |
| 1966 | | 15--4 | 950 | | | VRP | | 1 | | | | 1 | | | | | |
| 1966 | | 15--4 | 950 | | | VRP | | | | | 2 | 2 | | | | | |
| 1967 | | 40-2 | 191 | | | VRP | | | | | 2 | 2 | | | | | |

ANNEXE B : AMPHITHÉÂTRE

| année | n° OA | Rayon | Caisse | n° ordre | US | Catégorie | Comptage | | | | | | Typologie | Desc. Typo. | Dessin | Planche | |
|-------|----------|-------|--------|-------------|---------|-----------|----------|---|---|---|----|----|-----------|-------------|------------|---------|-------|
| | | | | | | | B | F | A | D | P | NR | | | | | NMI |
| | | 42-2 | 245 | | | VRP | 1 | | | | | 1 | | | | | |
| | | 42-3 | 255 | | | VRP | | 1 | | | 15 | 16 | | | | | |
| | | 42-3 | 255 | | | VRP | | 1 | | | | 1 | | | | | |
| | | 42-3 | 255 | | | VRP | | 1 | | | | 1 | | | | | |
| | | 42-3 | 255 | | | VRP | | 1 | | | | 1 | | | | | |
| | | 42-3 | 252 | | | VRP | | 1 | | | | 1 | | | | | |
| | | 42-5 | 266 | | | VRP | | | | | 5 | 5 | | | | | |
| 1979 | | 15--3 | 907 | | | VRP | 1 | | | | 1 | 2 | | | | | |
| 1979 | | 15--3 | 907 | | | VRP | | | | | 7 | 7 | | | | | |
| 1979 | | 15--3 | 907 | | | VRP | | 1 | | | | 1 | | | | | |
| 1979 | | 15--3 | 907 | | | VRP | | | | | 1 | 1 | | | | | |
| 1979 | | 14--1 | 918 | | | VRP | | 1 | | | | 1 | | | | | |
| | | 15--4 | 914 | | | VRP | | 1 | | 1 | 2 | 4 | | | | | |
| | | 15--4 | 914 | | | VRP | 1 | | | | | 1 | | | | | |
| | | 45-3 | 302 | | | RU UR | 3 | 1 | | | 3 | 7 | 1 | plat | Nied. 110a | 159 | XVII |
| | | 37-1 | 1534 | | | RU UR | 1 | | | | | 1 | 1 | plat | Nied. 110a | 160 | XVII |
| 1989 | | 34-4 | 120 | | | RU UR | 8 | 4 | | | | 12 | 1 | plat | Nied. 115 | 161 | XVII |
| 1989 | | 34-5 | 123 | | 5NC3 | RU UR | 1 | | | | | 1 | 1 | plat | Nied. 104 | 162 | XVII |
| | | 20--2 | 1140 | | | RU UR | 1 | | | | | 1 | 1 | jatte | Nied. 104 | 163 | XVII |
| 1965 | | 42-3 | 257 | | | RU UR | 2 | | | | | 2 | 1 | jatte | Nied. 104 | 164 | XVII |
| | | 41-2 | 195 | | | RU UR | 1 | | | | | 1 | 1 | jatte | Nied. 104 | 165 | XVII |
| 1968 | | 14--2 | 919 | | | RU UR | 1 | | | | | 1 | 1 | marmite | Nied. 89 | 166 | XVIII |
| 1989 | | 37-5 | 137 | | ND3 ST4 | RU UR | | | | | 10 | 10 | | | | | |
| | | 29-2 | 9 | | | RU UR | | 1 | | | | 1 | | | | | |
| 1967 | | 40-2 | 191 | | | RU UR | | | | | 2 | 2 | | | | | |
| | | 41-2 | 195 | | | RU UR | | | | 1 | | 1 | | | | | |

ANNEXE B : AMPHITHÉÂTRE

| année | n° OA | Rayon | Caisse | n° ordre | US | Catégorie | Comptage | | | | | | Typologie | Desc. Typo. | Dessin | Planche | |
|----------------|----------|-------|--------|-------------|-----------------------|-----------|----------|---|---|---|---|----|-----------|-------------|------------|---------|-------|
| | | | | | | | B | F | A | D | P | NR | | | | | NMI |
| | | 42-3 | 255 | | | RU UR | | | | | 1 | 1 | | | | | |
| 1965 | | 42-3 | 257 | | amphithéâtre dépôt | RU CI | 2 | | | | | 2 | 1 | plat | RU CI P11 | 167 | XVIII |
| | | 42-3 | 255 | | | RU CI | 1 | | | | | 1 | 1 | plat | Nied. 111a | 168 | XVIII |
| | | 18--2 | 1086 | | | RU CI | 1 | | | | | 1 | 1 | plat | Nied. 111a | 169 | XVIII |
| | | 21--2 | 1159 | | | RU CI | 1 | | | | | 1 | 1 | plat | Nied. 111a | 170 | XVIII |
| | | 37-1 | 1534 | | | RU CI | 1 | | | | | 1 | 1 | plat | Nied. 111a | 171 | XVIII |
| | | 37-1 | 1532 | | | RU CI | 2 | | | | | 2 | 1 | plat | Nied. 111a | 172 | XVIII |
| | | 36-1 | 1538 | | | RU CI | 1 | | | | | 1 | 1 | plat | Nied. 111a | 173 | XVIII |
| 1965 | | 42-3 | 257 | | amphithéâtre dépôt | RU CI | 2 | | | | | 2 | 1 | plat | Nied. 113 | 174 | XVIII |
| 1989 | | 34-4 | 120 | | | RU CI | 2 | 1 | | | 9 | 12 | 1 | jatte | Nied. 104 | 175 | XVIII |
| 1968 | | 39-5 | 166 | | | RU CI | 1 | | | | | 1 | 1 | jatte | Nied. 104 | 176 | XVIII |
| 1966 | | 14--3 | 960 | | | RU CI | | | | | 1 | 1 | 1 | jatte | Nied. 104 | 177 | XVIII |
| 1966-67- 68 | | 39-2 | 155 | | | RU CI | 1 | | | | | 1 | 1 | jatte | RU CI J1 | 178 | XVIII |
| 1968 | | 44-2 | 269 | | | RU CI | 1 | | | | | 1 | 1 | jatte | RU CI J1 | 179 | XVIII |
| 1966-67- 68 | | 39-2 | 155 | | | RU CI | 1 | | | | | 1 | 1 | jatte | RU CI J2 | 180 | XIX |
| 1989 | | 36-2 | 126 | | | RU CI | 3 | | | | | 3 | 1 | marmite | RU CI M1 | 181 | XIX |
| | | 29-2 | 9 | | | RU CI | 1 | | | | | 1 | 1 | marmite | Nied. 89 | 182 | XIX |
| | | 42-2 | 245 | | | RU CI | 1 | | | | | 1 | 1 | marmite | Nied. 89 | 183 | XIX |
| | | 17--3 | 1033 | | | RU CI | 1 | | | | | 1 | 1 | marmite | Nied. 89 | 184 | XIX |
| | | 43-1 | 1586 | | | RU CI | 1 | | | | | 1 | 1 | marmite | Nied. 89 | 185 | XIX |
| | | 18--1 | 1054 | | | RU CI | 1 | | | | | 1 | 1 | marmite | Nied. 89 | 186 | XIX |
| | | 13--4 | 947 | | | RU CI | 1 | | | | | 1 | 1 | marmite | Nied. 89 | 187 | XIX |
| | | 42-1 | 1572 | | | RU CI | 1 | | | | | 1 | 1 | marmite | Nied. 89 | 188 | XIX |

ANNEXE B : AMPHITHÉÂTRE

| année | n° OA | Rayon | Caisse | n° ordre | US | Catégorie | Comptage | | | | | | Typologie | Desc. Typo. | Dessin | Planche | |
|-------|-------|-------|--------|----------|-------------------------|-----------|----------|---|---|---|----|----|-----------|-------------|------------|---------|-----|
| | | | | | | | B | F | A | D | P | NR | | | | | NMI |
| | | 37-2 | 1560 | | | RU CI | 1 | | | | | 1 | 1 | marmite | Nied. 89 | 189 | XIX |
| | | 37-1 | 1532 | | | RU CI | 1 | | | | | 1 | 1 | marmite | Nied. 89 | 190 | XIX |
| | | 12--5 | 1360 | | | RU CI | 1 | | | | | 1 | 1 | marmite | Nied. 89 | 191 | XIX |
| | | 36-1 | 1538 | | | RU CI | 1 | | | | | 1 | 1 | marmite | Nied. 89 | 192 | XIX |
| | | 36-1 | 1538 | | | RU CI | 1 | | | | | 1 | 1 | marmite | Nied. 89 | 193 | XIX |
| 1964 | | 14--2 | 951 | | | RU CI | 7 | | | | | 7 | 1 | marmite | Nied. 89 | 194 | XIX |
| 1965 | | 42-3 | 257 | | amphithéâtre e dépôt | RU CI | 2 | | | | | 2 | 1 | pot | RU CI P1 | 195 | XIX |
| | | 36-1 | 1538 | | | RU CI | 1 | | | | | 1 | 1 | pot | RU CI P3 | 196 | XX |
| 1989 | | 34-4 | 120 | | | RU CI | 4 | 1 | | | 2 | 7 | 1 | couvercle | Nied. 120a | 197 | XX |
| 1964 | | 14--2 | 951 | | | RU CI | 1 | | | | | 1 | | | | | |
| 1989 | | 34-2 | 111 | | ND3 structure 4.4 | RU CI | | 4 | | | 51 | 55 | | | | | |
| 1989 | | 34-2 | 111 | | ND3 structure 4.4 | RU CI | 9 | 8 | | | 6 | 23 | | | | | |
| 1989 | | 34-4 | 116 | | | RU CI | 9 | 1 | | | 3 | 13 | | | | | |
| 1989 | | 34-4 | 118 | | 3CNA9 | RU CI | | | | | 4 | 4 | | | | | |
| | | 45-3 | 305 | | | RU CI | | | | | 1 | 1 | | | | | |
| | | 43-1 | 1586 | | | RU CI | | | | | 14 | 14 | | | | | |
| 1966 | | 21--1 | 1157 | | | RU CI | | 1 | | | | 1 | | | | | |
| 1966 | | 18--4 | 1099 | | | RU CI | | 1 | | | 3 | 4 | | | | | |
| | | 44-2 | 270 | | | RU CI | | | | | 14 | 14 | | | | | |
| 1989 | | 36-2 | 124 | | | RU CI | | | | | 1 | 1 | | | | | |
| 1965 | | 42-3 | 257 | | amphithéâtre e dépôt | RU CI | | 1 | | | | 1 | | | | | |
| 1965 | | 42-3 | 257 | | amphithéâtre e dépôt | RU CI | | | | | 2 | 2 | | | | | |

ANNEXE B : AMPHITHÉÂTRE

| année | n° OA | Rayon | Caisse | n° ordre | US | Catégorie | Comptage | | | | | | Typologie | Desc. Typo. | Dessin | Planche |
|-------|----------|-------|--------|-------------|-----------------------|-----------|----------|---|---|---|----|----|-----------|-------------|--------|---------|
| | | | | | | | B | F | A | D | P | NR | | | | |
| 1965 | | 42-3 | 257 | | amphithéâtre dépôt | RU CI | | | | | 1 | 1 | | | | |
| 1965 | | 42-3 | 257 | | amphithéâtre dépôt | RU CI | | | | | 1 | 1 | | | | |
| 1965 | | 42-3 | 257 | | amphithéâtre dépôt | RU CI | | | | | 1 | 1 | | | | |
| 1965 | | 42-3 | 257 | | amphithéâtre dépôt | RU CI | | | | | 1 | 1 | | | | |
| 1968 | | 14--2 | 919 | | | RU CI | | | | | 1 | 1 | | | | |
| 1966 | | 15--4 | 950 | | | RU CI | | 2 | | | 10 | 12 | | | | |
| 1966 | | 14--3 | 960 | | | RU CI | | | | | 1 | 1 | | | | |
| 1966 | | 14--3 | 960 | | | RU CI | | | | | 1 | 1 | | | | |
| 1966 | | 14--3 | 960 | | | RU CI | | | | | 1 | 1 | | | | |
| 1966 | | 14--3 | 960 | | | RU CI | | 1 | 1 | | 2 | 4 | | | | |
| 1964 | | 14--2 | 951 | | | RU CI | | | | | 1 | 1 | | | | |
| 1964 | | 14--2 | 951 | | | RU CI | | 2 | | | 39 | 41 | | | | |
| | | 29-2 | 9 | | | RU CI | | | | | 1 | 1 | | | | |
| | | 42-3 | 252 | | | RU CI | | | | | 1 | 1 | | | | |
| | | 42-5 | 266 | | | RU CI | | | | | 1 | 1 | | | | |
| | | 42-5 | 266 | | | RU CI | | | | | 2 | 2 | | | | |
| 1979 | | 15--3 | 907 | | | RU CI | | 1 | | | 1 | 2 | | | | |
| 1979 | | 15--3 | 907 | | | RU CI | | 1 | | | | 1 | | | | |
| 1979 | | 15--3 | 907 | | | RU CI | 1 | | | | | 1 | | | | |
| 1979 | | 15--3 | 907 | | | RU CI | | 1 | | | | 1 | | | | |
| 1979 | | 15--3 | 907 | | | RU CI | | 1 | | | 3 | 4 | | | | |
| | | 41-2 | 195 | | | RU CI | | 1 | | | | 1 | | | | |
| | | 45-3 | 305 | | | RU CI | | | | | 4 | 4 | | | | |

ANNEXE B : AMPHITHÉÂTRE

| année | n° OA | Rayon | Caisse | n° ordre | US | Catégorie | Comptage | | | | | | Typologie | Desc. Typo. | Dessin | Planche | |
|-------|----------|-------|--------|-------------|-----------|-----------|----------|---|---|---|----|----|-----------|-------------|----------|---------|-----|
| | | | | | | | B | F | A | D | P | NR | | | | | NMI |
| | | 19--4 | 1064 | | | RU CI | | | | | 2 | 2 | | | | | |
| 1966 | | 18--2 | 1086 | | | RU CI | | | | | 7 | 7 | | | | | |
| 1990 | 967 | 47-4 | 1666 | 1 | NA3a fond | RU CI | | | | | 4 | 4 | | | | | |
| 1969 | | 20--2 | 1140 | | | RU CI | | 1 | | | | 1 | | | | | |
| 1968 | | 20--2 | 1144 | | | RU CI | | | | | 15 | 15 | | | | | |
| | | | | | | RU CI | | 1 | | | 12 | 13 | | | | | |
| | | 41-1 | 1583 | | | RU CI | | | | | 14 | 14 | | | | | |
| | | 42-1 | 1572 | | | RU CI | | | | | 14 | 14 | | | | | |
| | | 37-1 | 1532 | | | RU CI | | 1 | | | 11 | 12 | | | | | |
| | | 36-1 | 1538 | | | RU CI | | 1 | | | 17 | 18 | | | | | |
| | | 36-2 | 1529 | | | RU CI | | | | | 11 | 11 | | | | | |
| | | 37-1 | 1534 | | | RU CI | | | | | 27 | 27 | | | | | |
| | | 28--4 | 1603 | | | RU CI | | | | | 14 | 14 | | | | | |
| | | 47-3 | 1654 | | | RU CI | | | | | 7 | 7 | | | | | |
| | | 38-3 | 1632 | | | RU CI | | | | | 15 | 15 | | | | | |
| 1968 | | 44-2 | 269 | | | RU CI | | 2 | | | 14 | 16 | | | | | |
| | | 41-2 | 195 | | | RU CI | | | | | 1 | 1 | | | | | |
| | | 42-2 | 250 | | | RU CI | | 1 | | | | 1 | | | | | |
| | | 42-3 | 268 | | | RU CI | | | | | 2 | 2 | | | | | |
| | | 42-5 | 264 | | | RU CI | | | | | 1 | 1 | | | | | |
| | | 42-5 | 266 | | | RU CI | | | | | 1 | 1 | | | | | |
| 1964 | | 14--2 | 951 | | | RU CI | 5 | | | | 43 | 48 | | | | | |
| 1965 | | 42-3 | 257 | | | RU S | 1 | | | | | 1 | 1 | marmite | Nied. 89 | 198 | XX |
| | | 42-3 | 252 | | | RU S | 1 | | | | | 1 | 1 | marmite | Nied. 89 | 199 | XX |
| | | 39-1 | 1555 | | | RU S | 1 | | | | | 1 | 1 | pot | Nied. 96 | 200 | XX |

ANNEXE B : AMPHITHÉÂTRE

| année | n° OA | Rayon | Caisse | n° ordre | US | Catégorie | Comptage | | | | | | Typologie | Desc. Typo. | Dessin | Planche | | |
|-------|----------|-------|--------|-------------|----|-----------|----------|---|---|---|----|----|-----------|------------------|----------------------|-------------------------------------|-----|-----|
| | | | | | | | B | F | A | D | P | NR | | | | | NMI | |
| | | 19--4 | 1064 | | | RU S | | | | 1 | | 1 | 1 | décor de cercles | | | | |
| | | 16--3 | 1013 | | | RUA | 2 | | | | | 2 | 1 | jatte | Deru Reims J1 | 201 | XX | |
| 1990 | 967 | 38--3 | 1631 | | 5 | RUA | 3 | | | | 61 | 64 | 1 | jatte | Deru Reims J1 | 202 | XX | |
| | | 45-4 | 283 | | | RUA | 1 | | | | | | 1 | 1 | jatte | Deru Reims J1 | 203 | XX |
| | | 12--5 | 1360 | | | RUA | 1 | | | | | | 1 | 1 | jatte | Deru Reims J4 | 204 | XX |
| 1966 | | 15--4 | 950 | | | RUA | 1 | | | | | | 1 | 1 | jatte | Deru Reims J11 | 205 | XX |
| | | 41-1 | 1583 | | | RUA | 1 | | | | | | 1 | 1 | jatte | Deru Reims J13 | 206 | XX |
| 1989 | | 34-4 | 116 | | | RUA | 4 | | | | 3 | 7 | 1 | jatte | Deru Reims J14 | 207 | XX | |
| | | 37-2 | 1560 | | | RUA | 1 | | | | | | 1 | 1 | pot | Deru Reims P8 | 208 | XXI |
| | | 36-1 | 1538 | | | RUA | 1 | | | | | | 1 | 1 | pot | Deru Reims p.248 fig. 155 n°2 | 209 | XXI |
| 1966 | | 14--3 | 960 | | | RU M | | | | 1 | 1 | 2 | 1 | décor | rosaces estampées | 210 | XXI | |
| 1968 | | 44-2 | 269 | | | CB | 1 | | | | | | 1 | 1 | plat | Reims A2 | 211 | XXI |
| 1968 | | 14--2 | 919 | | | CB | 1 | | | | | | 1 | 1 | plat | Reims A4 | 212 | XXI |
| | | 37-2 | 1560 | | | CB | 1 | | | | | | 1 | 1 | plat | Reims A6 | 213 | XXI |
| | | 37-1 | 1532 | | | CB | 1 | | | | | | 1 | 1 | plat | Reims A6 | 214 | XXI |
| | | 36-1 | 1538 | | | CB | 1 | | | | | | 1 | 1 | plat | Reims A9 | 215 | XXI |
| 1989 | | 34-4 | 120 | | | CB | 1 | | | | | | 1 | 1 | plat | Reims A11 | 216 | XXI |
| | | 43-1 | 1573 | | | CB | 1 | | | | | | 1 | 1 | plat | Reims A12 | 217 | XXI |
| 1966 | | 15--4 | 950 | | | CB | 1 | | | | | | 1 | 1 | plat | Reims A12 | 218 | XXI |
| 1968 | | 14--2 | 919 | | | CB | 1 | | | | | | 1 | 1 | jatte | Reims J2 | 219 | XXI |
| 1979 | | 15--3 | 907 | | | CB | 1 | | | | | | 1 | 1 | jatte | Reims J6 | 220 | XXI |
| | | 45-3 | 307 | | | CB | | | | | 1 | 1 | 1 | 1 | jatte | Reims J9 | | |
| 1979 | | 14--1 | 918 | | | CB | 1 | | | | | | 1 | 1 | jatte | Reims J13 | 221 | XXI |

ANNEXE B : AMPHITHÉÂTRE

| année | n° OA | Rayon | Caisse | n° ordre | US | Catégorie | Comptage | | | | | | Typologie | Desc. Typo. | Dessin | Planche | |
|------------|----------|-------|--------|-------------|---------|-----------|----------|---|---|---|----|----|-----------|-------------|-----------|---------|------|
| | | | | | | | B | F | A | D | P | NR | | | | | NMI |
| | | 21--4 | 1165 | | | CB | 1 | | | | | 1 | 1 | jatte | Reims J13 | 222 | XXI |
| 1989 | | 37-5 | 137 | | ND3 ST4 | CB | 5 | | | | 38 | 43 | 1 | jatte | Reims J20 | 223 | XXII |
| 1966-67-68 | | 39-2 | 155 | | | CB | 1 | | | | | 1 | 1 | jatte | Reims J26 | 224 | XXII |
| | | 45-3 | 307 | | | CB | 1 | | | | | 1 | 1 | pot | Reims P1 | 225 | XXII |
| | | 16--2 | 1003 | | | CB | 3 | | | | | 3 | 1 | pot | Reims P7 | 226 | XXII |
| | | 21--3 | 1162 | | | CB | 1 | | | | | 1 | 1 | pot | Reims P7 | 227 | XXII |
| 1968 | | 14--2 | 919 | | | CB | 1 | | | | | 1 | 1 | pot | Reims P8 | 228 | XXII |
| | | 37-1 | 1532 | | | CB | 1 | | | | | 1 | 1 | pot | Reims P12 | 229 | XXII |
| | | 13--4 | 947 | | | CB | 1 | | | | | 1 | 1 | pot | Reims P16 | 230 | XXII |
| 1968 | | 14--2 | 919 | | | CB | 1 | | | | | 1 | 1 | pot | Reims P16 | 231 | XXII |
| 1968 | | 14--2 | 919 | | | CB | 1 | | | | | 1 | 1 | pot | Reims P16 | 232 | XXII |
| 1968 | | 14--2 | 919 | | | CB | 1 | | | | | 1 | 1 | pot | Reims P16 | 233 | XXII |
| | | 16--2 | 1003 | | | CB | 1 | | | | | 1 | 1 | pot | Reims P16 | 234 | XXII |
| | | 43-1 | 1573 | | | CB | 1 | | | | | 1 | 1 | pot | Reims P16 | 235 | XXII |
| | | 43-1 | 1573 | | | CB | 1 | | | | | 1 | 1 | pot | Reims P16 | 236 | XXII |
| 1966-67-68 | | 39-2 | 155 | | | CB | 1 | | | | | 1 | 1 | pot | Reims P16 | 237 | XXII |
| 1966-67-68 | | 39-2 | 155 | | | CB | 1 | | | | | 1 | 1 | couvercle | Reims Cv6 | 238 | XXII |
| | | 18--2 | 1087 | | | CB | | | | | 3 | 3 | | | | | |
| | | 14--5 | 968 | | | CB | | | | | 1 | 1 | | | | | |
| | | 20--1 | 1111 | | | CB | | | | | 3 | 3 | | | | | |
| | | 20--2 | 1145 | | | CB | | | | | 14 | 14 | | | | | |
| 1965 | | 21--1 | 1126 | | | CB | | | | | 3 | 3 | | | | | |
| | | 31--4 | 1617 | | | CB | | | | | 13 | 13 | | | | | |
| 1969 | | 16--2 | 1003 | | | CB | | 2 | | | 19 | 21 | | | | | |

ANNEXE B : AMPHITHÉÂTRE

| année | n° OA | Rayon | Caisse | n° ordre | US | Catégorie | Comptage | | | | | | Typologie | Desc. Typo. | Dessin | Planche | |
|-------|----------|-------|--------|-------------|------------------------------|-----------|----------|---|---|---|----|----|-----------|-------------|---------------|---------|-------|
| | | | | | | | B | F | A | D | P | NR | | | | | NMI |
| 1966 | | 18--2 | 1090 | | | CB | | 1 | | | | 1 | | | | | |
| 1966 | | 19--3 | 1078 | | | CB | | | | | 6 | 6 | | | | | |
| 1974 | | 18--3 | 1057 | | | CB | | | | | 2 | 2 | | | | | |
| | | 20--2 | 1142 | | | CB | | | | | 12 | 12 | | | | | |
| | | | | | | CB | | | | | 12 | 12 | | | | | |
| | | 36-1 | 1535 | | | CB | | | | | 1 | 1 | | | | | |
| | | 39-1 | 1549 | | | CB | | | | | 1 | 1 | | | | | |
| 1973 | | 16--4 | 1016 | | | CB | | | | | 3 | 3 | | | | | |
| 1968 | | 14--2 | 919 | | | CB | | | | | 1 | 1 | | | | | |
| 1968 | | 14--2 | 919 | | | CB | | | | | 1 | 1 | | | | | |
| 1968 | | 14--2 | 919 | | | CB | | | | | 1 | 1 | | | | | |
| 1968 | | 14--2 | 919 | | | CB | | | | | 1 | 1 | | | | | |
| 1968 | | 14--2 | 919 | | | CB | | | | | 66 | 66 | | | | | |
| 1979 | | 15--3 | 907 | | | CB | | | | | 1 | 1 | | | | | |
| 1979 | | 15--3 | 907 | | | CB | | | | | 7 | 7 | | | | | |
| 1979 | | 15--3 | 907 | | | CB | | | | | 2 | 2 | | | | | |
| 1979 | | 15--3 | 907 | | | CB | | 1 | | | | 1 | | | | | |
| 1979 | | 15--3 | 907 | | | CB | | | | | 2 | 2 | | | | | |
| 1979 | | 14--1 | 918 | | | CB | | 1 | | | 1 | 2 | | | | | |
| | | 14--1 | 938 | | | CB | | | | | 1 | 1 | | | | | |
| 1989 | | 34-2 | 111 | | NE3 structure 4- 15-18 | Sb. Coq | 4 | | | | 15 | 19 | 1 | plat | Sb. Coq P11.1 | 239 | XXIII |
| | | 18--3 | 1092 | | | Sb. Coq | 1 | | | | | 1 | 1 | plat | Sb. Coq P11.1 | 240 | XXIII |
| | | 20--4 | 1149 | | | Sb. Coq | 1 | | | | | 1 | 1 | plat | Sb. Coq P11.2 | 241 | XXIII |
| 1978 | | 15--2 | 905 | | | Sb. Coq | 1 | | | | 1 | 2 | 1 | plat | Sb. Coq P11.2 | 242 | XXIII |

ANNEXE B : AMPHITHÉÂTRE

| année | n° OA | Rayon | Caisse | n° ordre | US | Catégorie | Comptage | | | | | | Typologie | Desc. Typo. | Dessin | Planche | |
|----------------|----------|-------|--------|-------------|---------------------------------|-----------|----------|---|---|---|----|----|-----------|-------------|--------------|---------|-------|
| | | | | | | | B | F | A | D | P | NR | | | | | NMI |
| 1966 | | 42-2 | 244 | | | Sb. Coq | 1 | | | | | 1 | 1 | plat | Sb. Coq Pl2 | 243 | XXIII |
| 1966 | | 42-2 | 244 | | | Sb. Coq | 1 | | | | | 1 | 1 | plat | Sb. Coq Pl2 | 244 | XXIII |
| 1989 | | 34-2 | 111 | | ND3 structure 4 niveau 10 | Sb. Coq | 1 | | | | 19 | 20 | 1 | plat | Sb. Coq Pl2 | 245 | XXIV |
| 1989 | | 37-5 | 137 | | ND3 ST4 | Sb. Coq | 9 | | | | | 9 | 1 | plat | Sb. Coq Pl2 | 246 | XXIV |
| 1966-67- 68 | | 39-2 | 155 | | | Sb. Coq | 1 | | | | | 1 | 1 | plat | Sb. Coq Pl2 | 247 | XXIV |
| | | 13--4 | 947 | | | Sb. Coq | 1 | | | | | 1 | 1 | plat | Sb. Coq Pl2 | 248 | XXIV |
| | | 16--3 | 1013 | | | Sb. Coq | 1 | | | | | 1 | 1 | plat | Sb. Coq Pl2 | 249 | XXIV |
| | | 42-1 | 1572 | | | Sb. Coq | 1 | | | | | 1 | 1 | plat | Sb. Coq Pl2 | 250 | XXIV |
| | | 36-1 | 1529 | | | Sb. Coq | 1 | | | | | 1 | 1 | plat | Sb. Coq Pl2 | 251 | XXIV |
| 1979 | | 14--1 | 918 | | | Sb. Coq | 1 | | | | | 1 | 1 | plat | Sb. Coq Pl2 | 252 | XXV |
| 1989 | | 37-5 | 137 | | ND3 ST4 | Sb. Coq | 1 | | | | | 1 | 1 | plat | Sb. Coq Pl2 | 253 | XXV |
| 1979 | | 14--1 | 918 | | | Sb. Coq | 1 | | | | | 1 | 1 | plat | Sb. Coq Pl3 | 254 | XXV |
| 1989 | | 36-2 | 128 | | 4NA3 | Sb. Coq | 1 | 1 | | | 27 | 29 | 1 | plat | Sb. Coq Pl3 | 255 | XXV |
| 1989 | | 37-5 | 136 | | 5ND3 | Sb. Coq | 2 | | | | | 2 | 1 | plat | Sb. Coq Pl3 | 256 | XXV |
| | | 20--4 | 1149 | | | Sb. Coq | 1 | | | | | 1 | 1 | plat | Sb. Coq Pl3 | 257 | XXV |
| | | 41-1 | 1574 | | | Sb. Coq | 1 | | | | | 1 | 1 | plat | Sb. Coq Pl3 | 258 | XXV |
| | | 44-1 | 1595 | | | Sb. Coq | 1 | | | | | 1 | 1 | jatte | Sb. Coq J1 | 259 | XXV |
| 1966 | | 42-2 | 244 | | | Sb. Coq | 1 | | | | | 1 | 1 | jatte | Sb. Coq J1 | 260 | XXVI |
| 1965 | | 42-3 | 257 | | | Sb. Coq | 1 | | | | | 1 | 1 | jatte | Sb. Coq J1 | 261 | XXVI |
| 1966 | | 42-2 | 244 | | | Sb. Coq | 1 | | | | | 1 | 1 | jatte | Sb. Coq J1 | 262 | XXVI |
| 1989 | | 34-3 | 113 | | ND3 structure 4- 7B-7C | Sb. Coq | 1 | | | | | 1 | 1 | jatte | Sb. Coq J2.1 | 263 | XXVI |
| 1989 | | 34-3 | 113 | | ND3 structure 4.6 | Sb. Coq | 5 | | | | 6 | 11 | 1 | jatte | Sb. Coq J2.1 | 264 | XXVI |

ANNEXE B : AMPHITHÉÂTRE

| année | n° OA | Rayon | Caisse | n° ordre | US | Catégorie | Comptage | | | | | | Typologie | Desc. Typo. | Dessin | Planche | |
|----------------|----------|-------|--------|-------------|--------------------------|-----------|----------|---|---|---|----|----|-----------|-------------|--------------|---------|--------|
| | | | | | | | B | F | A | D | P | NR | | | | | NMI |
| 1989 | | 34-3 | 113 | | ND3 structure 4.6 | Sb. Coq | 2 | | | | 17 | 19 | 1 | jatte | Sb. Coq J2.1 | 265 | XXVI |
| 1989 | | 34-3 | 113 | | ND3 structure 4.6 | Sb. Coq | 1 | | | | | 1 | 1 | jatte | Sb. Coq J2.1 | 266 | XXVI |
| 1989 | | 36-2 | 126 | | SD3 ST4 | Sb. Coq | 2 | | | | | 2 | 1 | jatte | Sb. Coq J2.1 | 267 | XXVI |
| | | 44-1 | 1605 | | | Sb. Coq | 1 | | | | | 1 | 1 | jatte | Sb. Coq J2.1 | 268 | XXVI |
| | | 21--2 | 1159 | | | Sb. Coq | 1 | | | | | 1 | 1 | jatte | Sb. Coq J2.1 | 269 | XXVI |
| 1966 | | 14--3 | 960 | | | Sb. Coq | 1 | | | | | 1 | 1 | jatte | Sb. Coq J2.1 | 270 | XXVI |
| | | 42-2 | 245 | | | Sb. Coq | 1 | | | | | 1 | 1 | jatte | Sb. Coq J2.1 | 271 | XXVI |
| 1989 | | 34-3 | 115 | | 4NC3 | Sb. Coq | 9 | | | | | 9 | 1 | jatte | Sb. Coq J2.2 | 272 | XXVI |
| 1968 | | 42-3 | 253 | | | Sb. Coq | 1 | | | | | 1 | 1 | jatte | Sb. Coq J2.2 | 273 | XXVII |
| 1968 | | 42-3 | 253 | | | Sb. Coq | 1 | | | | | 1 | 1 | jatte | Sb. Coq J2.2 | 274 | XXVII |
| 1989 | | 34-2 | 111 | | ND3 structure 4.9B | Sb. Coq | 1 | | | | | 1 | 1 | jatte | Sb. Coq J2.3 | 275 | XXVII |
| 1989 | | 34-5 | 123 | | 5NC3 | Sb. Coq | 1 | | | | | 1 | 1 | jatte | Sb. Coq J2.3 | 276 | XXVII |
| 1989 | | 34-5 | 123 | | 5NC3 | Sb. Coq | 1 | | | | | 1 | 1 | jatte | Sb. Coq J2.3 | 277 | XXVII |
| 1989 | | 37-5 | 137 | | ND3 ST4 | Sb. Coq | 3 | | | | | 3 | 1 | jatte | Sb. Coq J2.3 | 278 | XXVII |
| 1989 | | 37-5 | 137 | | ND3 ST4 | Sb. Coq | 1 | | | | | 1 | 1 | jatte | Sb. Coq J2.3 | 279 | XXVII |
| 1989 | | 37-5 | 137 | | ND3 ST4 | Sb. Coq | 2 | | | | | 2 | 1 | jatte | Sb. Coq J2.3 | 280 | XXVII |
| 1966-67- 68 | | 39-2 | 155 | | | Sb. Coq | 1 | | | | | 1 | 1 | jatte | Sb. Coq J2.3 | 281 | XXVII |
| 1966-67- 68 | | 39-2 | 155 | | | Sb. Coq | 1 | | | | | 1 | 1 | jatte | Sb. Coq J2.3 | 282 | XXVII |
| | | 18--2 | 1086 | | | Sb. Coq | 1 | | | | | 1 | 1 | jatte | Sb. Coq J2.3 | 283 | XXVII |
| | | 18--1 | 1054 | | | Sb. Coq | 1 | | | | | 1 | 1 | jatte | Sb. Coq J2.3 | 284 | XXVII |
| | | 19--3 | 1078 | | | Sb. Coq | 1 | | | | | 1 | 1 | jatte | Sb. Coq J2.3 | 285 | XXVIII |
| | | 21--4 | 1165 | | | Sb. Coq | 1 | | | | | 1 | 1 | jatte | Sb. Coq J2.3 | 286 | XXVIII |

ANNEXE B : AMPHITHÉÂTRE

| année | n° OA | Rayon | Caisse | n° ordre | US | Catégorie | Comptage | | | | | | Typologie | Desc. Typo. | Dessin | Planche | |
|-------|----------|-------|--------|-------------|----|-----------|----------|---|---|---|---|----|-----------|-------------|--------------|---------|--------|
| | | | | | | | B | F | A | D | P | NR | | | | | NMI |
| | | 21--4 | 1165 | | | Sb. Coq | 1 | | | | | 1 | 1 | jatte | Sb. Coq J2.3 | 287 | XXVIII |
| | | 21--4 | 1165 | | | Sb. Coq | 1 | | | | | 1 | 1 | jatte | Sb. Coq J2.3 | 288 | XXVIII |
| | | 41-1 | 1584 | | | Sb. Coq | 1 | | | | | 1 | 1 | jatte | Sb. Coq J2.3 | 289 | XXVIII |
| | | 41-1 | 1583 | | | Sb. Coq | 1 | | | | | 1 | 1 | jatte | Sb. Coq J2.3 | 290 | XXVIII |
| | | 41-1 | 1583 | | | Sb. Coq | 1 | | | | | 1 | 1 | jatte | Sb. Coq J2.3 | 291 | XXVIII |
| | | 42-1 | 1572 | | | Sb. Coq | 1 | | | | | 1 | 1 | jatte | Sb. Coq J2.3 | 292 | XXVIII |
| | | 20--2 | 1144 | | | Sb. Coq | 1 | | | | | 1 | 1 | jatte | Sb. Coq J2.3 | 293 | XXIX |
| | | 36-1 | 1529 | | | Sb. Coq | 1 | | | | | 1 | 1 | jatte | Sb. Coq J2.3 | 294 | XXIX |
| | | 36-1 | 1529 | | | Sb. Coq | 1 | | | | | 1 | 1 | jatte | Sb. Coq J2.3 | 295 | XXIX |
| | | 21--2 | 1130 | | | Sb. Coq | 1 | | | | | 1 | 1 | jatte | Sb. Coq J2.3 | 296 | XXIX |
| | | 37-1 | 1533 | | | Sb. Coq | 1 | | | | | 1 | 1 | jatte | Sb. Coq J2.3 | 297 | XXIX |
| | | 16--4 | 1016 | | | Sb. Coq | 1 | | | | | 1 | 1 | jatte | Sb. Coq J2.3 | 298 | XXIX |
| 1989 | | 36-2 | 124 | | | Sb. Coq | 3 | | | | | 3 | 1 | jatte | Sb. Coq J2.3 | 299 | XXX |
| 1989 | | 36-2 | 124 | | | Sb. Coq | 2 | | | | | 2 | 1 | jatte | Sb. Coq J2.3 | 300 | XXX |
| 1968 | | 42-3 | 253 | | | Sb. Coq | 2 | | | | | 2 | 1 | jatte | Sb. Coq J2.3 | 301 | XXX |
| 1968 | | 42-3 | 253 | | | Sb. Coq | 1 | | | | | 1 | 1 | jatte | Sb. Coq J2.3 | 302 | XXX |
| 1968 | | 14--2 | 919 | | | Sb. Coq | 1 | | | | | 1 | 1 | jatte | Sb. Coq J2.3 | 303 | XXX |
| 1966 | | 14--3 | 960 | | | Sb. Coq | 1 | | | | | 1 | 1 | jatte | Sb. Coq J2.3 | 304 | XXX |
| 1967 | | 40-2 | 191 | | | Sb. Coq | 1 | | | | | 1 | 1 | jatte | Sb. Coq J2.3 | 305 | XXX |
| | | 42-3 | 252 | | | Sb. Coq | 1 | | | | | 11 | 1 | jatte | Sb. Coq J2.3 | 306 | XXX |
| | | 14--1 | 938 | | | Sb. Coq | 7 | | | | | 7 | 1 | jatte | Sb. Coq J2.3 | 307 | XXXI |
| 1979 | | 14--1 | 918 | | | Sb. Coq | 1 | | | 7 | | 8 | 1 | jatte | Sb. Coq J2.3 | 308 | XXXI |
| | | 15--3 | 909 | | | Sb. Coq | 1 | | | | | 1 | 1 | jatte | Sb. Coq J2.3 | 309 | XXXI |
| | | 37-1 | 1530 | | | Sb. Coq | 1 | | | | | 1 | 1 | jatte | Sb. Coq J2.3 | 310 | XXXI |

ANNEXE B : AMPHITHÉÂTRE

| année | n° OA | Rayon | Caisse | n° ordre | US | Catégorie | Comptage | | | | | | Typologie | Desc. Typo. | Dessin | Planche | |
|------------|-------|--------------------|---------|--------------------------------|--------------------------|-----------|----------|---|---|---|---|----|-----------|-------------|--------------|---------|--------|
| | | | | | | | B | F | A | D | P | NR | | | | | NMI |
| | | Musée Amphithéâtre | vitrine | inv.20 09-0- 756- 758 | | Sb. Coq | 1 | | | | | 1 | 1 | jatte | Sb. Coq J2.3 | 311 | XXXI |
| 1966-67-68 | | 39-2 | 155 | | | Sb. Coq | 1 | | | | | 1 | 1 | jatte | Sb. Coq J3.2 | 312 | XXXI |
| | | 37-1 | 1530 | | | Sb. Coq | 6 | | | | 3 | 9 | 1 | jatte | Sb. Coq J3.3 | 313 | XXXI |
| | | Musée Amphithéâtre | vitrine | inv.20 09-0- 756- 758 | | Sb. Coq | 1 | | | | | 1 | 1 | jatte | Sb. Coq J4.1 | 314 | XXXI |
| 1989 | | 34-2 | 111 | | ND3 structure 4.1 | Sb. Coq | 1 | 1 | | | 4 | 6 | 1 | jatte | Sb. Coq J4.2 | 315 | XXXI |
| 1989 | | 34-2 | 111 | | ND3 structure 4.9B | Sb. Coq | 3 | | | | | 3 | 1 | jatte | Sb. Coq J4.2 | 316 | XXXII |
| 1989 | | 34-4 | 116 | | | Sb. Coq | 1 5 | 1 | | | 4 | 20 | 1 | jatte | Sb. Coq J4.2 | 317 | XXXII |
| 1989 | | 36-2 | 126 | | ST4 8A | Sb. Coq | 5 | | | | 9 | 14 | 1 | jatte | Sb. Coq J4.2 | 318 | XXXII |
| 1989 | | 36-2 | 126 | | ND3 ST4 | Sb. Coq | 4 | | | | | 4 | 1 | jatte | Sb. Coq J4.2 | 319 | XXXII |
| 1989 | | 37-5 | 136 | | 5ND3 | Sb. Coq | 2 | | | | | 2 | 1 | jatte | Sb. Coq J4.2 | 320 | XXXIII |
| | | 18--2 | 1090 | | | Sb. Coq | 1 | | | | | 1 | 1 | jatte | Sb. Coq J4.2 | 321 | XXXIII |
| | | 16--5 | 1019 | | | Sb. Coq | 1 | | | | | 1 | 1 | jatte | Sb. Coq J4.2 | 322 | XXXIII |
| | | 21--2 | 1159 | | | Sb. Coq | 1 | | | | | 1 | 1 | jatte | Sb. Coq J4.2 | 323 | XXXIII |
| | | 37-1 | 1534 | | | Sb. Coq | 1 | | | | | 1 | 1 | jatte | Sb. Coq J4.2 | 324 | XXXIII |
| | | 16--4 | 1016 | | | Sb. Coq | 1 4 | | | | | 14 | 1 | jatte | Sb. Coq J4.2 | 325 | XXXIII |
| | | 42-5 | 266 | | | Sb. Coq | 1 | | | | | 1 | 1 | jatte | Sb. Coq J4.2 | 326 | XXXIV |
| | | 37-1 | 1530 | | | Sb. Coq | 1 | | | | | 1 | 1 | jatte | Sb. Coq J4.2 | 327 | XXXIV |

ANNEXE B : AMPHITHÉÂTRE

| année | n° OA | Rayon | Caisse | n° ordre | US | Catégorie | Comptage | | | | | | Typologie | Desc. Typo. | Dessin | Planche | |
|------------|-------|--------------------|---------|--------------------|---------|-----------|----------|---|---|---|---|----|-----------|-------------|--------------|---------|--------|
| | | | | | | | B | F | A | D | P | NR | | | | | NMI |
| | | Musée Amphithéâtre | vitrine | inv.2009-0-756-758 | | Sb. Coq | 1 | | | | | 1 | 1 | jatte | Sb. Coq J4.3 | 328 | XXXIV |
| | | Musée Amphithéâtre | vitrine | inv.2009-0-756-758 | | Sb. Coq | 1 | | | | | 1 | 1 | jatte | Sb. Coq J4.4 | 329 | XXXIV |
| | | 18--2 | 1090 | | | Sb. Coq | 2 | | | | | 2 | 1 | jatte | Sb. Coq J5 | 330 | XXXIV |
| | | 18--2 | 1090 | | | Sb. Coq | 1 | | | | | 1 | 1 | jatte | Sb. Coq J5 | 331 | XXXV |
| | | 17--4 | 1032 | | | Sb. Coq | 1 | | | | | 1 | 1 | jatte | Sb. Coq J5 | 332 | XXXV |
| | | 21--2 | 1159 | | | Sb. Coq | 1 | | | | | 1 | 1 | jatte | Sb. Coq J5 | 333 | XXXV |
| 1966 | | 42-2 | 244 | | | Sb. Coq | 1 | | | | | 1 | 1 | jatte | Sb. Coq J5 | 334 | XXXV |
| | | 37-1 | 1530 | | | Sb. Coq | 1 | | | | | 1 | 1 | jatte | Sb. Coq J5 | 335 | XXXV |
| 1966-67-68 | | 39-2 | 155 | | | Sb. Coq | 1 | | | | | 1 | 1 | jatte | Sb. Coq J/M1 | 336 | XXXV |
| | | 43-1 | 1582 | | | Sb. Coq | 1 | | | | | 1 | 1 | jatte | Sb. Coq J/M1 | 337 | XXXV |
| | | 21--2 | 1130 | | | Sb. Coq | 1 | | | | | 1 | 1 | jatte | Sb. Coq J/M1 | 338 | XXXVI |
| 1989 | | 34-2 | 112 | | 5NC3 | Sb. Coq | 3 | | | | | 3 | 1 | jatte | Sb. Coq J/M1 | 339 | XXXVI |
| | | 37-1 | 1533 | | | Sb. Coq | 4 | | | | | 4 | 1 | jatte | Sb. Coq J/M1 | 340 | XXXVI |
| | | 42-2 | 245 | | | Sb. Coq | 1 | | | | | 1 | 1 | jatte | Sb. Coq J/M1 | 341 | XXXVI |
| 1989 | | 34-2 | 112 | | 5NE3 | Sb. Coq | 9 | | | | | 9 | 1 | jatte | Sb. Coq J/M2 | 342 | XXXVI |
| 1989 | | 34-2 | 112 | | 5NE3 | Sb. Coq | 2 | | | | | 2 | 1 | jatte | Sb. Coq J/M2 | 343 | XXXVI |
| 1989 | | 34-2 | 112 | | 5NE3 | Sb. Coq | 9 | | | | | 9 | 1 | jatte | Sb. Coq J/M2 | 344 | XXXVI |
| 1989 | | 34-2 | 112 | | 5NE3 | Sb. Coq | 1 | | | | | 1 | 1 | jatte | Sb. Coq J/M2 | 345 | XXXVII |
| 1989 | | 34-2 | 112 | | 5NE3 | Sb. Coq | 1 | | | | | 1 | 1 | jatte | Sb. Coq J/M2 | 346 | XXXVII |
| 1989 | | 34-4 | 116 | | | Sb. Coq | 9 | 1 | | | 5 | 15 | 1 | jatte | Sb. Coq J/M2 | 347 | XXXVII |
| 1989 | | 37-5 | 137 | | ND3 ST4 | Sb. Coq | 3 | | | | | 3 | 1 | jatte | Sb. Coq J/M2 | 348 | XXXVII |

ANNEXE B : AMPHITHÉÂTRE

| année | n° OA | Rayon | Caisse | n° ordre | US | Catégorie | Comptage | | | | | | Typologie | Desc. Typo. | Dessin | Planche | |
|-------|----------|-------|--------|-------------|---------|-----------|----------|---|---|---|----|----|-----------|-------------|----------------|---------|-------------|
| | | | | | | | B | F | A | D | P | NR | | | | | NMI |
| 1989 | | 37-5 | 137 | | ND3 ST4 | Sb. Coq | 2 | | | | | 2 | 1 | jatte | Sb. Coq J/M2 | 349 | XXXVII |
| 1989 | | 37-5 | 137 | | ND3 ST4 | Sb. Coq | 2 | | | | | 2 | 1 | jatte | Sb. Coq J/M2 | 350 | XXXVII |
| 1989 | | 37-5 | 136 | | 5ND3 | Sb. Coq | 1 | | | | | 1 | 1 | jatte | Sb. Coq J/M2 | 351 | XXXVII I |
| 1989 | | 37-5 | 136 | | 5ND3 | Sb. Coq | 2 | | | | | 2 | 1 | jatte | Sb. Coq J/M2 | 352 | XXXVII I |
| | | 13--4 | 947 | | | Sb. Coq | 1 | | | | | 1 | 1 | jatte | Sb. Coq J/M2 | 353 | XXXVII I |
| | | 18--3 | 1092 | | | Sb. Coq | 1 | | | | | 1 | 1 | jatte | Sb. Coq J/M2 | 354 | XXXVII I |
| | | 41-1 | 1583 | | | Sb. Coq | 1 | | | | | 1 | 1 | jatte | Sb. Coq J/M2 | 355 | XXXVII I |
| | | 21--2 | 1159 | | | Sb. Coq | 1 | | | | | 1 | 1 | jatte | Sb. Coq J/M2 | 356 | XXXVII I |
| | | 21--2 | 1159 | | | Sb. Coq | 1 | | | | | 1 | 1 | jatte | Sb. Coq J/M2 | 357 | XXXVII I |
| | | 39-1 | 1555 | | | Sb. Coq | 1 | | | | | 1 | 1 | jatte | Sb. Coq J/M2 | 358 | XXXIX |
| | | 21--2 | 1130 | | | Sb. Coq | 1 | | | | | 1 | 1 | jatte | Sb. Coq J/M2 | 359 | XXXIX |
| | | 16--4 | 1016 | | | Sb. Coq | 4 | | | | | 4 | 1 | jatte | Sb. Coq J/M2 | 360 | XXXIX |
| | | 37-1 | 1532 | | | Sb. Coq | 2 | | | | | 2 | 1 | jatte | Sb. Coq J/M2 | 361 | XXXIX |
| | | 19--4 | 1064 | | | Sb. Coq | 1 | | | | | 1 | 1 | jatte | Sb. Coq J/M3.2 | 362 | XXXIX |
| 1966 | | 14--3 | 960 | | | Sb. Coq | | 1 | | | | 1 | 1 | jatte | Sb. Coq J/M3.2 | 363 | XL |
| | | 37-1 | 1534 | | | Sb. Coq | | | 1 | | | 1 | 1 | jatte | Sb. Coq J/M3.2 | | |
| 1989 | | 34-2 | 112 | | 5NE3 | Sb. Coq | | 4 | 1 | | 32 | 37 | 1 | jatte | Sb. Coq J/M3.2 | | |
| 1979 | | 15--3 | 907 | | | Sb. Coq | | | 1 | | | 1 | 1 | jatte | Sb. Coq J/M3.2 | | |
| | | 36-1 | 1529 | | | Sb. Coq | 1 | | | | | 1 | 1 | jatte | Sb. Coq J/M3.2 | 364 | XL |
| | | 42-1 | 1567 | | | Sb. Coq | 1 | | | | | 1 | 1 | jatte | Sb. Coq J/M4 | 365 | XL |
| 1989 | | 36-2 | 124 | | | Sb. Coq | 2 | | | | | 2 | 1 | jatte | Sb. Coq J/M4 | 366 | XL |

ANNEXE B : AMPHITHÉÂTRE

| année | n° OA | Rayon | Caisse | n° ordre | US | Catégorie | Comptage | | | | | | Typologie | Desc. Typo. | Dessin | Planche | |
|----------------|----------|-------|--------|-------------|--------------------------|-----------|----------|---|---|---|----|----|-----------|-------------|---------------|---------|------|
| | | | | | | | B | F | A | D | P | NR | | | | | NMI |
| | | 20--4 | 1149 | | | Sb. Coq | 1 | | | | | 1 | 1 | bouteille | Sb. Coq Bt1.1 | 367 | XL |
| | | 20--4 | 1149 | | | Sb. Coq | 1 | | | | | 1 | 1 | bouteille | Sb. Coq Bt1.1 | 368 | XL |
| | | 18--1 | 1054 | | | Sb. Coq | 1 | | | | | 1 | 1 | bouteille | Sb. Coq Bt1.2 | 369 | XL |
| | | 18--3 | 1092 | | | Sb. Coq | 1 | | | | | 1 | 1 | pot | Sb. Coq P1.1 | 370 | XLI |
| 1989 | | 34-2 | 111 | | ND3 structure 4.14 | Sb. Coq | 1 | | | | 12 | 13 | 1 | pot | Sb. Coq P1.1 | 371 | XLI |
| 1989 | | 34-4 | 116 | | | Sb. Coq | 3 | 1 | | | 19 | 23 | 1 | pot | Sb. Coq P1.1 | 372 | XLI |
| 1989 | | 34-4 | 120 | | | Sb. Coq | 4 | 6 | | | 7 | 17 | 1 | pot | Sb. Coq P1.1 | 373 | XLI |
| 1989 | | 37-5 | 136 | | 5ND3 | Sb. Coq | 1 | | | | | 1 | 1 | pot | Sb. Coq P1.1 | 374 | XLI |
| 1966-67- 68 | | 39-2 | 155 | | | Sb. Coq | 1 | | | | | 1 | 1 | pot | Sb. Coq P1.1 | 375 | XLI |
| | | 41-1 | 1584 | | | Sb. Coq | 1 | | | | | 1 | 1 | pot | Sb. Coq P1.1 | 376 | XLI |
| | | 37-1 | 1532 | | | Sb. Coq | 2 | | | | | 2 | 1 | pot | Sb. Coq P1.1 | 377 | XLI |
| 1989 | | 36-2 | 124 | | | Sb. Coq | 2 | | | | | 2 | 1 | pot | Sb. Coq P1.1 | 378 | XLI |
| | | 42-2 | 245 | | | Sb. Coq | 2 | | | | | 2 | 1 | pot | Sb. Coq P1.1 | 379 | XLI |
| | | 42-3 | 252 | | | Sb. Coq | 1 | | | | | 1 | 1 | pot | Sb. Coq P1.1 | 380 | XLI |
| | | 15--3 | 909 | | couche 7 | Sb. Coq | 1 | | | | | 1 | 1 | pot | Sb. Coq P1.1 | 381 | XLI |
| 1989 | | 34-4 | 120 | | | Sb. Coq | 3 | | | | | 3 | 1 | pot | Sb. Coq P2 | 382 | XLII |
| 1989 | | 34-3 | 115 | | 4SC3 | Sb. Coq | 1 | 1 | | | 9 | 11 | 1 | pot | Sb. Coq P3 | 383 | XLII |
| 1989 | | 37-5 | 137 | | ND3 ST4 | Sb. Coq | 5 | | | | | 5 | 1 | pot | Sb. Coq P3 | 384 | XLII |
| | | 29-2 | 9 | | salle 2 | Sb. Coq | 1 | | | | | 1 | 1 | pot | Sb. Coq P3 | 385 | XLII |
| 1989 | | 34-2 | 110 | | NA3 structure 2 | Sb. Coq | 4 | | | | | 4 | 1 | pot | Sb. Coq P4 | 386 | XLII |
| | | 37-1 | 1534 | | | Sb. Coq | 1 | | | | | 1 | 1 | pot | Sb. Coq P5.1 | 387 | XLII |
| | | 20--4 | 1149 | | | Sb. Coq | 1 | | | | | 1 | 1 | pot | Sb. Coq P5.1 | 388 | XLII |
| 1968 | | 14--2 | 919 | | | Sb. Coq | 1 | | | | | 1 | 1 | pot | Sb. Coq P5.1 | 389 | XLII |

ANNEXE B : AMPHITHÉÂTRE

| année | n° OA | Rayon | Caisse | n° ordre | US | Catégorie | Comptage | | | | | | Typologie | Desc. Typo. | Dessin | Planche | |
|----------------|----------|-------|--------|-------------|----------|-----------|----------|---|---|---|----|----|-----------|-------------|--------------|---------|-------|
| | | | | | | | B | F | A | D | P | NR | | | | | NMI |
| | | 42-3 | 252 | | | Sb. Coq | 1 2 | | | | | 12 | 1 | pot | Sb. Coq P5.1 | 390 | XLII |
| | | 42-3 | 252 | | | Sb. Coq | 1 | | | | | 1 | 1 | pot | Sb. Coq P5.1 | 391 | XLII |
| | | 42-5 | 266 | | | Sb. Coq | 1 | | | | | 1 | 1 | pot | Sb. Coq P5.1 | 392 | XLII |
| | | 15--3 | 909 | | couche 7 | Sb. Coq | 2 | | | | | 2 | 1 | pot | Sb. Coq P5.1 | 393 | XLII |
| | | 41-2 | 198 | | | Sb. Coq | 1 | | | | | 1 | 1 | pot | Sb. Coq P5.1 | 394 | XLII |
| | | 29-2 | 9 | | salle 2 | Sb. Coq | 1 | | | | | 1 | 1 | pot | Sb. Coq P6.1 | 395 | XLIII |
| 1989 | | 36-2 | 128 | | 4NA3 | Sb. Coq | 1 | | | | | 1 | 1 | pot | Sb. Coq P6.1 | 396 | XLIII |
| 1966-67- 68 | | 39-2 | 155 | | | Sb. Coq | 1 | | | | | 1 | 1 | pot | Sb. Coq P6.1 | 397 | XLIII |
| | | 19--2 | 1071 | | | Sb. Coq | 1 | | | | | 1 | 1 | pot | Sb. Coq P6.1 | 398 | XLIII |
| | | 44-3 | 281 | | | Sb. Coq | 1 | | | | | 1 | 1 | pot | Sb. Coq P6.1 | 399 | XLIII |
| | | 44-3 | 281 | | | Sb. Coq | 2 | | | | | 2 | 1 | pot | Sb. Coq P6.1 | 400 | XLIII |
| | | 16--3 | 1013 | | | Sb. Coq | 1 | | | | | 1 | 1 | pot | Sb. Coq P6.1 | 401 | XLIII |
| | | 18--3 | 1092 | | | Sb. Coq | 1 | | | | | 1 | 1 | pot | Sb. Coq P6.1 | 402 | XLIII |
| | | 41-1 | 1574 | | | Sb. Coq | 1 | | | | | 1 | 1 | pot | Sb. Coq P6.1 | 403 | XLIII |
| 1968 | | 42-3 | 253 | | | Sb. Coq | 1 | | | | | 1 | 1 | pot | Sb. Coq P6.1 | 404 | XLIII |
| 1968 | | 42-3 | 253 | | | Sb. Coq | 1 | | | | | 1 | 1 | pot | Sb. Coq P6.1 | 405 | XLIII |
| 1966 | | 15--4 | 950 | | | Sb. Coq | 1 | | | | | 1 | 1 | pot | Sb. Coq P6.1 | 406 | XLIII |
| 1967 | | 40-2 | 191 | | | Sb. Coq | 1 | | | | | 1 | 1 | pot | Sb. Coq P6.1 | 407 | XLIII |
| | | 42-2 | 245 | | | Sb. Coq | 1 | | | | | 1 | 1 | pot | Sb. Coq P6.1 | 408 | XLIII |
| | | 42-3 | 252 | | | Sb. Coq | 1 | | | | | 1 | 1 | pot | Sb. Coq P6.1 | 409 | XLIV |
| | | 42-3 | 252 | | | Sb. Coq | 1 | | | | | 1 | 1 | pot | Sb. Coq P6.1 | 410 | XLIV |
| | | 29-2 | 9 | | salle 2 | Sb. Coq | 1 | | | | | 1 | 1 | pot | Sb. Coq P6.1 | 411 | XLIV |
| | | 37-1 | 1530 | | | Sb. Coq | 1 | | | | | 1 | 1 | pot | Sb. Coq P6.1 | 412 | XLIV |
| 1989 | | 34-2 | 112 | | 5NE3 | Sb. Coq | 1 | | | | | 1 | 1 | pot | Sb. Coq P7.1 | 413 | XLIV |
| 1989 | | 34-5 | 123 | | 5NC3 | Sb. Coq | 1 | 3 | | | 34 | 38 | 1 | pot | Sb. Coq P7.1 | 414 | XLIV |

ANNEXE B : AMPHITHÉÂTRE

| année | n° OA | Rayon | Caisse | n° ordre | US | Catégorie | Comptage | | | | | | Typologie | Desc. Typo. | Dessin | Planche | |
|-------|----------|-------|--------|-------------|---------|-----------|----------|---|---|---|---|----|-----------|-------------|--------------|---------|------|
| | | | | | | | B | F | A | D | P | NR | | | | | NMI |
| 1989 | | 34-5 | 125 | | NE3 ST4 | Sb. Coq | 3 | 1 | | | 5 | 9 | 1 | pot | Sb. Coq P7.1 | 415 | XLIV |
| 1989 | | 37-5 | 136 | | 5ND3 | Sb. Coq | 3 | | | | | 3 | 1 | pot | Sb. Coq P7.1 | 416 | XLIV |
| | | 44-1 | 1609 | | | Sb. Coq | 1 | | | | | 1 | 1 | pot | Sb. Coq P7.1 | 417 | XLIV |
| | | 13--4 | 947 | | | Sb. Coq | 1 | | | | | 1 | 1 | pot | Sb. Coq P7.1 | 418 | XLIV |
| | | 13--4 | 947 | | | Sb. Coq | 1 | | | | | 1 | 1 | pot | Sb. Coq P7.1 | 419 | XLIV |
| | | 45-3 | 302 | | | Sb. Coq | 1 | | | | | 1 | 1 | pot | Sb. Coq P7.1 | 420 | XLIV |
| | | 45-3 | 302 | | | Sb. Coq | 1 | | | | | 1 | 1 | pot | Sb. Coq P7.1 | 421 | XLIV |
| | | 45-3 | 302 | | | Sb. Coq | 1 | | | | | 1 | 1 | pot | Sb. Coq P7.1 | 422 | XLIV |
| | | 42-1 | 1572 | | | Sb. Coq | 1 | | | | | 1 | 1 | pot | Sb. Coq P7.1 | 423 | XLIV |
| | | 42-1 | 1572 | | | Sb. Coq | 1 | | | | | 1 | 1 | pot | Sb. Coq P7.1 | 424 | XLIV |
| | | 42-1 | 1567 | | | Sb. Coq | 1 | | | | | 1 | 1 | pot | Sb. Coq P7.1 | 425 | XLV |
| | | 36-1 | 1529 | | | Sb. Coq | 1 | | | | | 1 | 1 | pot | Sb. Coq P7.1 | 426 | XLV |
| | | 39-1 | 1555 | | | Sb. Coq | 1 | | | | | 1 | 1 | pot | Sb. Coq P7.1 | 427 | XLV |
| | | 39-1 | 1555 | | | Sb. Coq | 1 | | | | | 1 | 1 | pot | Sb. Coq P7.1 | 428 | XLV |
| | | 21--2 | 1130 | | | Sb. Coq | 1 | | | | | 1 | 1 | pot | Sb. Coq P7.1 | 429 | XLV |
| | | 20--3 | 1146 | | | Sb. Coq | 1 | | | | | 1 | 1 | pot | Sb. Coq P7.1 | 430 | XLV |
| 1989 | | 36-2 | 124 | | | Sb. Coq | 2 | | | | | 2 | 1 | pot | Sb. Coq P7.1 | 431 | XLV |
| 1968 | | 42-3 | 253 | | | Sb. Coq | 1 | | | | | 1 | 1 | pot | Sb. Coq P7.1 | 432 | XLV |
| 1968 | | 42-3 | 253 | | | Sb. Coq | 1 | | | | | 1 | 1 | pot | Sb. Coq P7.1 | 433 | XLV |
| 1968 | | 44-2 | 269 | | | Sb. Coq | 1 | | | | | 1 | 1 | pot | Sb. Coq P7.1 | 434 | XLV |
| 1968 | | 14--2 | 919 | | | Sb. Coq | 1 | | | | | 1 | 1 | pot | Sb. Coq P7.1 | 435 | XLV |
| | | 40-2 | 189 | | | Sb. Coq | 1 | | | | | 1 | 1 | pot | Sb. Coq P7.1 | 436 | XLV |
| | | 42-3 | 268 | | | Sb. Coq | 1 | | | | | 1 | 1 | pot | Sb. Coq P7.1 | 437 | XLV |
| | | 14--1 | 938 | | | Sb. Coq | 1 | | | | | 1 | 1 | pot | Sb. Coq P7.1 | 438 | XLV |
| | | 29-2 | 9 | | salle 2 | Sb. Coq | 1 | | | | | 1 | 1 | pot | Sb. Coq P7.1 | 439 | XLV |
| | | 15--3 | 909 | | | Sb. Coq | 1 | | | | | 1 | 1 | pot | Sb. Coq P7.1 | 440 | XLV |

ANNEXE B : AMPHITHÉÂTRE

| année | n° OA | Rayon | Caisse | n° ordre | US | Catégorie | Comptage | | | | | | Typologie | Desc. Typo. | Dessin | Planche | |
|------------|----------|-------|--------|-------------|--------------------------|-----------|----------|---|---|---|---|----|-----------|-------------|---------------|---------|-------|
| | | | | | | | B | F | A | D | P | NR | | | | | NMI |
| 1966-67-68 | | 39-2 | 155 | | | Sb. Coq | 2 | | | | | 2 | 1 | pot | Sb. Coq P7.2 | 441 | XLVI |
| 1989 | | 34-2 | 111 | | ND3 structure 4.9B | Sb. Coq | 2 | | | | | 2 | 1 | pot | Sb. Coq P10.1 | 442 | XLVI |
| 1989 | | 34-2 | 112 | | 5NE3 | Sb. Coq | 1 | | | | | 1 | 1 | pot | Sb. Coq P10.1 | 443 | XLVI |
| | | 18--2 | 1090 | | | Sb. Coq | 1 | | | | | 1 | 1 | pot | Sb. Coq P10.1 | 444 | XLVI |
| | | 16--3 | 1013 | | | Sb. Coq | 1 | | | | | 1 | 1 | pot | Sb. Coq P10.1 | 445 | XLVI |
| | | 16--5 | 1019 | | | Sb. Coq | 1 | | | | | 1 | 1 | pot | Sb. Coq P10.1 | 446 | XLVI |
| | | 18--3 | 1092 | | | Sb. Coq | 1 | | | | | 1 | 1 | pot | Sb. Coq P10.1 | 447 | XLVI |
| | | 21--2 | 1159 | | | Sb. Coq | 1 | | | | | 1 | 1 | pot | Sb. Coq P10.1 | 448 | XLVI |
| 1979 | | 15--3 | 907 | | | Sb. Coq | 1 | | | | | 1 | 1 | pot | Sb. Coq P11 | 449 | XLVI |
| 1989 | | 34-5 | 123 | | 5NC3 | Sb. Coq | 1 | | | | | 1 | 1 | couvercle | Sb. Coq Cv1 | 450 | XLVI |
| 1968 | | 39-5 | 166 | | | Sb. Coq | 1 | | | | | 1 | 1 | couvercle | Sb. Coq Cv1 | 451 | XLVI |
| 1968 | | 42-3 | 253 | | | Sb. Coq | 1 | | | | | 1 | 1 | couvercle | Sb. Coq Cv1 | 452 | XLVI |
| | | 42-3 | 252 | | | Sb. Coq | 2 | | | | | 2 | 1 | couvercle | Sb. Coq Cv1 | 453 | XLVI |
| 1966-67-68 | | 39-2 | 155 | | | Sb. Coq | 1 | | | | | 1 | 1 | couvercle | Sb. Coq Cv2.3 | 454 | XLVI |
| 1965 | | 42-3 | 257 | | amphithéâtre e dépôt | Sb. Coq | 1 | | | | | 1 | 1 | couvercle | Sb. Coq Cv2.3 | 455 | XLVI |
| | | 42-2 | 245 | | | Sb. Coq | 1 | | | | | 1 | 1 | couvercle | Sb. Coq Cv3.1 | 456 | XLVI |
| | | 42-2 | 245 | | | Sb. Coq | 1 | | | | | 1 | 1 | couvercle | Sb. Coq Cv3.1 | 457 | XLVII |
| | | 42-3 | 252 | | | Sb. Coq | 1 | | | | | 1 | 1 | couvercle | Sb. Coq Cv3.1 | 458 | XLVII |
| | | 42-5 | 264 | | | Sb. Coq | 1 | | | | | 1 | 1 | couvercle | Sb. Coq Cv3.1 | 459 | XLVII |
| | | 42-5 | 266 | | | Sb. Coq | 1 | | | | | 1 | 1 | couvercle | Sb. Coq Cv3.1 | 460 | XLVII |
| | | 41-2 | 198 | | | Sb. Coq | 1 | | | | | 1 | 1 | couvercle | Sb. Coq Cv3.1 | 461 | XLVII |
| | | 19--4 | 1064 | | | Sb. Coq | 1 | | | | | 1 | 1 | couvercle | Sb. Coq Cv3.2 | 462 | XLVII |

ANNEXE B : AMPHITHÉÂTRE

| année | n° OA | Rayon | Caisse | n° ordre | US | Catégorie | Comptage | | | | | | Typologie | Desc. Typo. | Dessin | Planche | |
|----------------|----------|-------|--------|-------------|--------------------------|-----------|----------|---|---|---|----|----|-----------|-------------|---------------|---------|-------|
| | | | | | | | B | F | A | D | P | NR | | | | | NMI |
| 1989 | | 34-3 | 113 | | ND3 structure 4.4 | Sb. Coq | 1 | | | | 20 | 21 | 1 | couvercle | Sb. Coq Cv4.1 | 463 | XLVII |
| 1989 | | 36-2 | 124 | | | Sb. Coq | 2 | | | | | 2 | 1 | couvercle | Sb. Coq Cv4.1 | 464 | XLVII |
| 1966 | | 42-2 | 244 | | | Sb. Coq | 1 | | | | | 1 | 1 | couvercle | Sb. Coq Cv4.1 | 465 | XLVII |
| 1968 | | 42-3 | 253 | | | Sb. Coq | 1 | | | | | 1 | 1 | couvercle | Sb. Coq Cv4.1 | 466 | XLVII |
| | | 42-3 | 252 | | | Sb. Coq | 1 | | | | | 1 | 1 | couvercle | Sb. Coq Cv4.1 | 467 | XLVII |
| | | 42-5 | 266 | | | Sb. Coq | 1 | | | | | 1 | 1 | couvercle | Sb. Coq Cv4.1 | 468 | XLVII |
| 1966-67- 68 | | 39-2 | 155 | | | Sb. Coq | 1 | | | | | 1 | 1 | couvercle | Sb. Coq Cv6.1 | 469 | XLVII |
| 1966-67- 68 | | 39-2 | 155 | | | Sb. Coq | | 1 | | | | 1 | 1 | couvercle | | | |
| | | 37-1 | 1534 | | | Sb. Coq | | 6 | | | | 6 | 1 | faisselle | | | |
| 1968 | | 40-2 | 192 | | | Sb. Coq | | 1 | | | | 1 | | fond percé | | | |
| 1966-67- 68 | | 39-2 | 155 | | | Sb. Coq | | | | 1 | 1 | 2 | 1 | graffiti M | | | |
| | | 35-4 | 101 | | | Sb. Coq | | 1 | | | 31 | 32 | | | | | |
| | | 35-4 | 102 | | | Sb. Coq | | | | | 4 | 4 | | | | | |
| | | 35-4 | 103 | | | Sb. Coq | | | | | 45 | 45 | | | | | |
| | | 35-4 | 104 | | | Sb. Coq | | 3 | | | 12 | 15 | | | | | |
| | | 35-5 | 105 | | | Sb. Coq | | | | | 21 | 21 | | | | | |
| 1989 | | 34-2 | 110 | | NA3 structure 2 | Sb. Coq | | 3 | | | 17 | 20 | | | | | |
| 1989 | | 34-2 | 110 | | NA2 structure 3 | Sb. Coq | | 2 | | | 21 | 23 | | | | | |
| 1989 | | 34-2 | 111 | | ND3 structure 4.11 | Sb. Coq | | | | | 13 | 13 | | | | | |

ANNEXE B : AMPHITHÉÂTRE

| année | n° OA | Rayon | Caisse | n° ordre | US | Catégorie | Comptage | | | | | | Typologie | Desc. Typo. | Dessin | Planche |
|-------|----------|-------|--------|-------------|---------------------------------|-----------|----------|--------|---|---|---------|---------|-----------|-------------|--------|---------|
| | | | | | | | B | F | A | D | P | NR | | | | |
| 1989 | | 34-3 | 113 | | ND3 structure 4- 7B-7C | Sb. Coq | | 3 | | | 29 | 32 | | | | |
| 1989 | | 34-3 | 113 | | 5NE3 | Sb. Coq | | | | | 13 | 13 | | | | |
| 1989 | | 34-3 | 115 | | 4NC3 | Sb. Coq | | 3 | | | 47 | 50 | | | | |
| 1989 | | 34-3 | 115 | | 4NE3 | Sb. Coq | | | | | 11 | 11 | | | | |
| 1989 | | 34-4 | 116 | | | Sb. Coq | | 7 | | | 12 | 19 | | | | |
| 1989 | | 34-4 | 118 | | 3CSD7 | Sb. Coq | | 3 | | | 9 | 12 | | | | |
| 1989 | | 34-4 | 118 | | 3CNA9 | Sb. Coq | | 1 | | | 11 | 12 | | | | |
| 1989 | | 34-4 | 118 | | 3CSB8 | Sb. Coq | | | | | 3 | 3 | | | | |
| 1989 | | 34-4 | 118 | | section sud sommel che 13 | Sb. Coq | | | | | 12 | 12 | | | | |
| 1989 | | 34-4 | 118 | | 3CNA8 | Sb. Coq | | | | | 17 | 17 | | | | |
| 1989 | | 34-4 | 118 | | 3CNB9 | Sb. Coq | | | | | 7 | 7 | | | | |
| 1989 | | 34-4 | 118 | | 3CSA8 | Sb. Coq | | | | | 18 | 18 | | | | |
| 1989 | | 34-5 | 123 | | MCIII couche 23 | Sb. Coq | | | | | 18 | 18 | | | | |
| 1989 | | 34-5 | 125 | | NE3 structure 4 | Sb. Coq | | | | | 6 | 6 | | | | |
| 1989 | | 34-5 | 125 | | 5SD8 | Sb. Coq | | 1 | | | 15 | 16 | | | | |
| 1989 | | 34-5 | 125 | | SD8 | Sb. Coq | | 1 | | | 21 | 22 | | | | |
| 1989 | | 36-2 | 128 | | 5NA2 | Sb. Coq | | 2 | | | 22 | 24 | | | | |
| 1989 | | 36-2 | 129 | | 2SC3 | Sb. Coq | | | | | 10 | 10 | | | | |
| 1989 | | 37-5 | 137 | | ND3 ST4 | Sb. Coq | | 2 4 | | | 23 3 | 25 7 | | | | |
| 1989 | | 37-5 | 136 | | 5ND3 | Sb. Coq | | 3 | | | 11 2 | 11 5 | | | | |

ANNEXE B : AMPHITHÉÂTRE

| année | n° OA | Rayon | Caisse | n° ordre | US | Catégorie | Comptage | | | | | | Typologie | Desc. Typo. | Dessin | Planche |
|-------|----------|--------|--------|-------------|----|-----------|----------|--------|---|---|----|-----|-----------|-------------|--------|---------|
| | | | | | | | B | F | A | D | P | NR | | | | |
| | | 39-2 | 156 | | | Sb. Coq | | | | | 16 | 16 | | | | |
| | | 39-3 | 158 | | | Sb. Coq | | 2 | | | 68 | 70 | | | | |
| | | 39-3 | 159 | | | Sb. Coq | | 3 | | | 87 | 90 | | | | |
| | | 39-3 | 161 | | | Sb. Coq | | 4 | | | 96 | 100 | | | | |
| | | 39-3 | 1390 | | | Sb. Coq | | | | | 55 | 55 | | | | |
| | | 39-4 | 162 | | | Sb. Coq | | | | | 37 | 37 | | | | |
| | | 39-4 | 165 | | | Sb. Coq | | 2 | | | 26 | 28 | | | | |
| | | 38-2 | 172 | | | Sb. Coq | | | | | 57 | 57 | | | | |
| | | 38-2 | 173 | | | Sb. Coq | | 1 | | | 41 | 42 | | | | |
| | | 38-2 | 178 | | | Sb. Coq | | 2 | | | 27 | 29 | | | | |
| | | 38-2 | 179 | | | Sb. Coq | | | | | 36 | 36 | | | | |
| | | 15--02 | 906 | | | Sb. Coq | | | | | 10 | 10 | | | | |
| | | 15--3 | 910 | | | Sb. Coq | | 1 | | | 12 | 13 | | | | |
| | | 14--2 | 955 | | | Sb. Coq | | | | | 17 | 17 | | | | |
| | | 14--2 | 920 | | | Sb. Coq | | | | | 2 | 2 | | | | |
| | | 14--2 | 954 | | | Sb. Coq | | | | | 17 | 17 | | | | |
| | | 18--3 | 1093 | | | Sb. Coq | | | | | 19 | 19 | | | | |
| | | 17--1 | 1027 | | | Sb. Coq | | 4 | | | | 4 | | | | |
| | | 14--3 | 961 | | | Sb. Coq | | 6 | | | 20 | 26 | | | | |
| | | 14--4 | 964 | | | Sb. Coq | | 1 | | | 6 | 7 | | | | |
| | | 12--2 | 1356 | | | Sb. Coq | | 2 | | | | 2 | | | | |
| | | 44--3 | 278 | | | Sb. Coq | | 1 2 | | | 54 | 66 | | | | |
| | | 44--4 | 284 | | | Sb. Coq | | | | | 24 | 24 | | | | |
| | | 44--4 | 286 | | | Sb. Coq | | 1 | | | 15 | 16 | | | | |
| | | 44--4 | 285 | | | Sb. Coq | | | | | 12 | 12 | | | | |

ANNEXE B : AMPHITHÉÂTRE

| année | n° OA | Rayon | Caisse | n° ordre | US | Catégorie | Comptage | | | | | | Typologie | Desc. Typo. | Dessin | Planche |
|-------|----------|-------|--------|-------------|----|-----------|----------|--------|---|---|---------|---------|-----------|-------------|--------|---------|
| | | | | | | | B | F | A | D | P | NR | | | | |
| | | 44--4 | 310 | | | Sb. Coq | | | | | 24 | 24 | | | | |
| | | 45-2 | 295 | | | Sb. Coq | | 3 | | | 18 | 21 | | | | |
| | | 45-2 | 298 | | | Sb. Coq | | 1 | | | 15 | 16 | | | | |
| | | 45-3 | 308 | | | Sb. Coq | | 2 | | | 12 | 14 | | | | |
| | | 45-3 | 303 | | | Sb. Coq | | 1 | | | 43 | 44 | | | | |
| | | 45-3 | 305 | | | Sb. Coq | | | | | 14 | 14 | | | | |
| | | 44-1 | 1605 | | | Sb. Coq | | | | | 12 | 12 | | | | |
| | | 44-1 | 1597 | | | Sb. Coq | | | | | 23 | 23 | | | | |
| | | 44-1 | 1595 | | | Sb. Coq | | 2 | | | 37 | 39 | | | | |
| | | 44-1 | 1611 | | | Sb. Coq | | 1 8 | | | 78 | 96 | | | | |
| | | 44-1 | 1609 | | | Sb. Coq | | | | | 15 4 | 15 4 | | | | |
| | | 44-1 | 1606 | | | Sb. Coq | | 1 | | | 26 | 27 | | | | |
| | | 20--1 | 1115 | | | Sb. Coq | | | | | 10 | 10 | | | | |
| | | 20--1 | 1111 | | | Sb. Coq | | | | | 20 | 20 | | | | |
| | | 20--2 | 1145 | | | Sb. Coq | | 3 | | | 56 | 59 | | | | |
| 1966 | | 21--1 | 1146 | | | Sb. Coq | | | | | 5 | 5 | | | | |
| 1965 | | 21--1 | 1126 | | | Sb. Coq | | | | | 12 | 12 | | | | |
| 1966 | | 21--1 | 1155 | | | Sb. Coq | | | | | 54 | 54 | | | | |
| 1968 | | 21--2 | 1158 | | | Sb. Coq | | | | | 3 | 3 | | | | |
| 1966 | | 21--2 | 1160 | | | Sb. Coq | | | | | 38 | 38 | | | | |
| | | 26--1 | 1487 | | | Sb. Coq | | | | | 3 | 3 | | | | |
| | | 31--4 | 1617 | | | Sb. Coq | | 2 | | | 47 | 49 | | | | |
| | | 31--4 | 1620 | | | Sb. Coq | | | | | 3 | 3 | | | | |
| | | 20--2 | 1141 | | | Sb. Coq | | 1 | | | 14 | 15 | | | | |

ANNEXE B : AMPHITHÉÂTRE

| année | n° OA | Rayon | Caisse | n° ordre | US | Catégorie | Comptage | | | | | | Typologie | Desc. Typo. | Dessin | Planche |
|-------|----------|-------|--------|-------------|----|-----------|----------|---|---|---|---------|---------|-----------|-------------|--------|---------|
| | | | | | | | B | F | A | D | P | NR | | | | |
| | | 45-3 | 304 | | | Sb. Coq | | 3 | | | 14 7 | 15 0 | | | | |
| | | 45-3 | 305 | | | Sb. Coq | | | | | 19 | 19 | | | | |
| 1966 | | 45-3 | 306 | | | Sb. Coq | | | | | 59 | 59 | | | | |
| | | 36-1 | 1542 | | | Sb. Coq | | | | | 71 | 71 | | | | |
| | | 38-1 | 1554 | | | Sb. Coq | | | | | 36 | 36 | | | | |
| | | 38-1 | 1553 | | | Sb. Coq | | 2 | | | 34 | 36 | | | | |
| | | 38-1 | 1551 | | | Sb. Coq | | | | | 3 | 3 | | | | |
| | | 39-1 | 1557 | | | Sb. Coq | | | | | 68 | 68 | | | | |
| | | 39-1 | 1561 | | | Sb. Coq | | | | | 37 | 37 | | | | |
| 1966 | | 17--1 | 1020 | | | Sb. Coq | | 2 | | | 14 | 16 | | | | |
| 1966 | | 17--4 | 1032 | | | Sb. Coq | | | | | 87 | 87 | | | | |
| 1969 | | 16--2 | 1003 | | | Sb. Coq | | | | | 3 | 3 | | | | |
| 1966 | | 17--4 | 1031 | | | Sb. Coq | | 2 | | | 7 | 9 | | | | |
| 1968 | | 15--4 | 947 | | | Sb. Coq | | | | | 34 | 34 | | | | |
| 1966 | | 18--1 | 1054 | | | Sb. Coq | | 3 | | | 3 | 6 | | | | |
| 1966 | | 18--4 | 1099 | | | Sb. Coq | | 1 | | | | 1 | | | | |
| 1966 | | 18--2 | 1090 | | | Sb. Coq | | 3 | | | 72 | 75 | | | | |
| 1966 | | 19--5 | 1084 | | | Sb. Coq | | | | | 9 | 9 | | | | |
| | | 19--4 | 1064 | | | Sb. Coq | | | | | 4 | 4 | | | | |
| | | 18--3 | 1092 | | | Sb. Coq | | 1 | | | 87 | 88 | | | | |
| 1967 | | 45-3 | 302 | | | Sb. Coq | | 1 | | | 49 | 50 | | | | |
| 1968 | | 16--3 | 1012 | | | Sb. Coq | | 2 | | | 82 | 84 | | | | |
| 1966 | | 19--3 | 1078 | | | Sb. Coq | | 3 | | | 78 | 81 | | | | |
| 1966 | | 18--2 | 1086 | | | Sb. Coq | | 1 | | | 19 | 20 | | | | |
| 1974 | | 18--3 | 1057 | | | Sb. Coq | | | | | 21 | 21 | | | | |

ANNEXE B : AMPHITHÉÂTRE

| année | n° OA | Rayon | Caisse | n° ordre | US | Catégorie | Comptage | | | | | | Typologie | Desc. Typo. | Dessin | Planche |
|-------|----------|-------|--------|-------------|---|-----------|----------|--------|---|---|----|----|-----------|-------------|--------|---------|
| | | | | | | | B | F | A | D | P | NR | | | | |
| 1966 | | 16--5 | 1019 | | | Sb. Coq | | | | | 39 | 39 | | | | |
| | | 21--1 | 1156 | | | Sb. Coq | | | | | 5 | 5 | | | | |
| | | 44-2 | 270 | | | Sb. Coq | | 4 | | | 91 | 95 | | | | |
| 1990 | 967 | 38-3 | 1631 | 4 | couche 1 NE2 | Sb. Coq | | 6 | | | 23 | 24 | | | | |
| 1990 | 967 | 38-3 | 1631 | 1 | fosse 3 | Sb. Coq | | 1 0 | | | 35 | 45 | | | | |
| 1990 | 967 | 47-4 | 1666 | 11 | couche verdâtre au dessus de couche grise | Sb. Coq | | | | | 5 | 5 | | | | |
| 1990 | 967 | 47-4 | 1666 | 4 | NA3a | Sb. Coq | | | | | 8 | 8 | | | | |
| 1990 | 967 | 47-4 | 1666 | 4 | NG2 tout le long de la coupe et au- dessus | Sb. Coq | | | | | 4 | 4 | | | | |
| 1990 | 967 | 47-4 | 1666 | 3 | NA3a couche 8 | Sb. Coq | | | | | 4 | 4 | | | | |
| 1990 | 967 | 47-4 | 1666 | 8 | NEO couche 1 | Sb. Coq | | | | | 30 | 30 | | | | |
| 1990 | 967 | 47-4 | 1666 | 4 | NA3a fond | Sb. Coq | | | | | 12 | 12 | | | | |
| 1990 | 967 | 47-4 | 1666 | 5 | NG1 couche 1 | Sb. Coq | | | | | 11 | 11 | | | | |
| 1990 | 967 | 47-4 | 1666 | 8 | NA3a | Sb. Coq | | | | | 20 | 20 | | | | |
| | | 20--2 | 1142 | | | Sb. Coq | | | | | 97 | 97 | | | | |
| | | | | | | Sb. Coq | | 2 | | | 24 | 26 | | | | |
| 1969 | | 20--3 | 1146 | | | Sb. Coq | | | | | 14 | 14 | | | | |
| 1969 | | 20--2 | 1140 | | | Sb. Coq | | | | | 17 | 17 | | | | |

ANNEXE B : AMPHITHÉÂTRE

| année | n° OA | Rayon | Caisse | n° ordre | US | Catégorie | Comptage | | | | | | Typologie | Desc. Typo. | Dessin | Planche |
|-------|----------|-------|--------|-------------|----|-----------|----------|---|---|---|----|----|-----------|-------------|--------|---------|
| | | | | | | | B | F | A | D | P | NR | | | | |
| | | 14--5 | 967 | | | Sb. Coq | | | | | 14 | 14 | | | | |
| 1968 | | 20--2 | 1144 | | | Sb. Coq | | 2 | | | 47 | 49 | | | | |
| | | 21--4 | 1166 | | | Sb. Coq | | | | | 22 | 22 | | | | |
| | | | | | | Sb. Coq | | 3 | | | 4 | 7 | | | | |
| | | 41-1 | 1565 | | | Sb. Coq | | 2 | | | 67 | 69 | | | | |
| | | 41-1 | 1574 | | | Sb. Coq | | 3 | | | 39 | 42 | | | | |
| | | 41-1 | 1583 | | | Sb. Coq | | 3 | | | 84 | 87 | | | | |
| | | 41-1 | 1584 | | | Sb. Coq | | | | | 74 | 74 | | | | |
| | | 42-1 | 1602 | | | Sb. Coq | | | | | 10 | 10 | | | | |
| | | 42-1 | 1462 | | | Sb. Coq | | 2 | | | 4 | 4 | | | | |
| | | 42-1 | 1464 | | | Sb. Coq | | | | | 77 | 79 | | | | |
| | | 42-1 | 1463 | | | Sb. Coq | | 4 | | | 17 | 17 | | | | |
| | | 42-1 | 1463 | | | Sb. Coq | | 1 | | | 0 | 4 | | | | |
| | | 42-1 | 1568 | | | Sb. Coq | | | | | 67 | 68 | | | | |
| | | 42-1 | 1567 | | | Sb. Coq | | 1 | | | 14 | 14 | | | | |
| | | 42-1 | 1567 | | | Sb. Coq | | 2 | | | 1 | 2 | | | | |
| | | 42-1 | 1572 | | | Sb. Coq | | | | | 79 | 81 | | | | |
| | | 42-1 | 1572 | | | Sb. Coq | | 5 | | | 24 | 25 | | | | |
| | | 42-1 | 1569 | | | Sb. Coq | | 3 | | | 9 | 4 | | | | |
| | | 45-3 | 307 | | | Sb. Coq | | | | | 94 | 97 | | | | |
| | | 37-1 | 1532 | | | Sb. Coq | | | | | 4 | 4 | | | | |
| | | 37-1 | 1532 | | | Sb. Coq | | | | | 17 | 17 | | | | |
| | | 37-1 | 1533 | | | Sb. Coq | | | | | 8 | 8 | | | | |
| | | 36-2 | 1529 | | | Sb. Coq | | | | | 27 | 27 | | | | |
| | | 39-1 | 1549 | | | Sb. Coq | | | | | 11 | 11 | | | | |
| | | 37-1 | 1534 | | | Sb. Coq | | | | | 44 | 44 | | | | |
| 1973 | | 16--4 | 1016 | | | Sb. Coq | | 3 | | | 49 | 52 | | | | |

ANNEXE B : AMPHITHÉÂTRE

| année | n° OA | Rayon | Caisse | n° ordre | US | Catégorie | Comptage | | | | | | Typologie | Desc. Typo. | Dessin | Planche |
|-------|----------|---------------------|--------|-------------|----|-----------|----------|--------|---|---|---------|---------|-----------|-------------|--------|---------|
| | | | | | | | B | F | A | D | P | NR | | | | |
| | | 37-1 | 1530 | | | Sb. Coq | | 1 7 | | | 49 | 66 | | | | |
| | | en face de 21 | 1373 | | | Sb. Coq | | | | | 28 7 | 28 7 | | | | |
| | | en face de 21 | 1377 | | | Sb. Coq | | | | | 38 8 | 38 8 | | | | |
| | | 28--4 | 1603 | | | Sb. Coq | | 1 8 | | | 18 7 | 20 5 | | | | |
| | | 47-3 | 1654 | | | Sb. Coq | | 3 | | | 76 | 79 | | | | |
| | | 38-3 | 1632 | | | Sb. Coq | | | | | 13 7 | 13 7 | | | | |
| | | 38-3 | 1633 | | | Sb. Coq | | 5 | | | 38 | 43 | | | | |
| | | 47-5 | 1655 | | | Sb. Coq | | | | | 14 7 | 14 7 | | | | |
| 1989 | | 36-2 | 124 | | | Sb. Coq | | | | | 3 | 3 | | | | |
| 1989 | | 36-2 | 124 | | | Sb. Coq | | | | | 1 | 1 | | | | |
| 1989 | | 36-2 | 124 | | | Sb. Coq | | 1 | | | 4 | 5 | | | | |
| 1989 | | 36-2 | 124 | | | Sb. Coq | | 1 | | | | 1 | | | | |
| 1989 | | 36-2 | 124 | | | Sb. Coq | | 1 | | | | 1 | | | | |
| 1989 | | 36-2 | 124 | | | Sb. Coq | | | | | 41 | 41 | | | | |
| 1989 | | 36-2 | 124 | | | Sb. Coq | | 1 | | | | 1 | | | | |
| 1989 | | 36-2 | 124 | | | Sb. Coq | | 1 | | | | 1 | | | | |
| 1989 | | 36-2 | 124 | | | Sb. Coq | | 6 | | | 47 | 53 | | | | |
| 1989 | | 36-2 | 124 | | | Sb. Coq | | 1 | | | | 1 | | | | |
| 1989 | | 36-2 | 124 | | | Sb. Coq | | 1 | | | | 1 | | | | |
| 1989 | | 36-2 | 124 | | | Sb. Coq | | | | | 17 | 17 | | | | |

ANNEXE B : AMPHITHÉÂTRE

| année | n° OA | Rayon | Caisse | n° ordre | US | Catégorie | Comptage | | | | | | Typologie | Desc. Typo. | Dessin | Planche |
|-------|----------|-------|--------|-------------|----|-----------|----------|---|---|---|----|----|-----------|-------------|--------|---------|
| | | | | | | | B | F | A | D | P | NR | | | | |
| 1968 | | 39-5 | 166 | | | Sb. Coq | | 1 | | | | 1 | | | | |
| 1968 | | 39-5 | 166 | | | Sb. Coq | | 1 | | | | 1 | | | | |
| 1968 | | 39-5 | 166 | | | Sb. Coq | | 1 | | | | 1 | | | | |
| 1968 | | 39-5 | 166 | | | Sb. Coq | | 1 | | | | 1 | | | | |
| 1968 | | 39-5 | 166 | | | Sb. Coq | | 1 | | | | 1 | | | | |
| 1968 | | 39-5 | 166 | | | Sb. Coq | | | | | 1 | 1 | | | | |
| 1968 | | 39-5 | 166 | | | Sb. Coq | | 8 | | | | 8 | | | | |
| 1968 | | 42-3 | 253 | | | Sb. Coq | 1 | | | | | 1 | | | | |
| 1968 | | 42-3 | 253 | | | Sb. Coq | | | | | 1 | 1 | | | | |
| 1968 | | 42-3 | 253 | | | Sb. Coq | 1 | | | | | 1 | | | | |
| 1968 | | 42-3 | 253 | | | Sb. Coq | 1 | | | | | 1 | | | | |
| 1968 | | 42-3 | 253 | | | Sb. Coq | 1 | | | | | 1 | | | | |
| 1968 | | 42-3 | 253 | | | Sb. Coq | 1 | | | | | 1 | | | | |
| 1968 | | 42-3 | 253 | | | Sb. Coq | 1 | | | | | 1 | | | | |
| 1968 | | 42-3 | 253 | | | Sb. Coq | 1 | | | | | 1 | | | | |
| 1968 | | 42-3 | 253 | | | Sb. Coq | 1 | | | | | 1 | | | | |
| 1968 | | 42-3 | 253 | | | Sb. Coq | 1 | | | | | 1 | | | | |
| 1968 | | 42-3 | 253 | | | Sb. Coq | 1 | | | | | 1 | | | | |
| 1968 | | 42-3 | 253 | | | Sb. Coq | 1 | | | | | 1 | | | | |
| 1968 | | 42-3 | 253 | | | Sb. Coq | 1 | | | | | 1 | | | | |
| 1968 | | 42-3 | 253 | | | Sb. Coq | 1 | | | | | 1 | | | | |
| 1968 | | 42-3 | 253 | | | Sb. Coq | 1 | | | | | 1 | | | | |
| 1968 | | 42-3 | 253 | | | Sb. Coq | | 1 | | | 75 | 87 | | | | |
| 1968 | | 44-2 | 269 | | | Sb. Coq | | 1 | | | | 1 | | | | |
| 1968 | | 44-2 | 269 | | | Sb. Coq | | 1 | | | | 1 | | | | |

ANNEXE B : AMPHITHÉÂTRE

| année | n° OA | Rayon | Caisse | n° ordre | US | Catégorie | Comptage | | | | | | Typologie | Desc. Typo. | Dessin | Planche |
|-------|----------|-------|--------|-------------|----|-----------|----------|---|---|---|----|----|-----------|-------------|--------|---------|
| | | | | | | | B | F | A | D | P | NR | | | | |
| 1968 | | 44-2 | 269 | | | Sb. Coq | | 1 | | | | 1 | | | | |
| 1968 | | 44-2 | 269 | | | Sb. Coq | | | | | 1 | 1 | | | | |
| 1968 | | 44-2 | 269 | | | Sb. Coq | | | | | 1 | 1 | | | | |
| 1968 | | 44-2 | 269 | | | Sb. Coq | | | | | 1 | 1 | | | | |
| 1968 | | 44-2 | 269 | | | Sb. Coq | | | | | 1 | 1 | | | | |
| 1968 | | 44-2 | 269 | | | Sb. Coq | | | | | 1 | 1 | | | | |
| 1968 | | 44-2 | 269 | | | Sb. Coq | | | | | 1 | 1 | | | | |
| 1968 | | 44-2 | 269 | | | Sb. Coq | | 1 | | | | 1 | | | | |
| 1968 | | 44-2 | 269 | | | Sb. Coq | | 1 | | | | 1 | | | | |
| 1968 | | 44-2 | 269 | | | Sb. Coq | | | | | 1 | 1 | | | | |
| 1968 | | 44-2 | 269 | | | Sb. Coq | | | | | 1 | 1 | | | | |
| 1968 | | 44-2 | 269 | | | Sb. Coq | | 2 | 1 | | 79 | 82 | | | | |
| 1978 | | 15--2 | 905 | | | Sb. Coq | | | | | 1 | 1 | | | | |
| 1978 | | 15--2 | 905 | | | Sb. Coq | | | | | 1 | 1 | | | | |
| 1978 | | 15--2 | 905 | | | Sb. Coq | | | | | 1 | 1 | | | | |
| 1978 | | 15--2 | 905 | | | Sb. Coq | | | | | 1 | 1 | | | | |
| 1978 | | 15--2 | 905 | | | Sb. Coq | | | | | 1 | 1 | | | | |
| 1978 | | 15--2 | 905 | | | Sb. Coq | | 2 | | | 63 | 65 | | | | |
| 1968 | | 14--2 | 919 | | | Sb. Coq | | | | | 1 | 1 | | | | |
| 1968 | | 14--2 | 919 | | | Sb. Coq | | | | | 2 | 2 | | | | |
| 1966 | | 15--4 | 950 | | | Sb. Coq | | | | | 6 | 6 | | | | |
| 1966 | | 14--3 | 960 | | | Sb. Coq | | 1 | | | | 1 | | | | |
| 1966 | | 14--3 | 960 | | | Sb. Coq | | | | | 1 | 1 | | | | |
| 1966 | | 14--3 | 960 | | | Sb. Coq | | | | | 1 | 1 | | | | |
| 1966 | | 14--3 | 960 | | | Sb. Coq | | 2 | | | 22 | 24 | | | | |

ANNEXE B : AMPHITHÉÂTRE

| année | n° OA | Rayon | Caisse | n° ordre | US | Catégorie | Comptage | | | | | | Typologie | Desc. Typo. | Dessin | Planche |
|-------|----------|-------|--------|-------------|---------|-----------|----------|---|---|---|----|----|-----------|-------------|--------|---------|
| | | | | | | | B | F | A | D | P | NR | | | | |
| 1964 | | 14--2 | 951 | | | Sb. Coq | | 2 | | | 8 | 10 | | | | |
| 1964 | | 14--2 | 951 | | | Sb. Coq | 1 | | | | | 1 | | | | |
| 1964 | | 14--2 | 951 | | | Sb. Coq | 1 | | | | | 1 | | | | |
| 1964 | | 14--2 | 951 | | | Sb. Coq | 1 | | | | | 1 | | | | |
| 1964 | | 14--2 | 951 | | | Sb. Coq | 1 | | | | | 1 | | | | |
| 1964 | | 14--2 | 951 | | | Sb. Coq | 1 | | | | | 1 | | | | |
| | | 29-2 | 9 | | salle 2 | Sb. Coq | | 1 | | | | 1 | | | | |
| | | 29-2 | 9 | | salle 2 | Sb. Coq | | 1 | | | 21 | 22 | | | | |
| | | 29-2 | 9 | | salle 2 | Sb. Coq | | 4 | | | 8 | 12 | | | | |
| | | 29-2 | 9 | | salle 2 | Sb. Coq | | | | | 1 | 1 | | | | |
| | | 29-2 | 9 | | salle 2 | Sb. Coq | | | | | 1 | 1 | | | | |
| | | 29-2 | 9 | | salle 2 | Sb. Coq | | | | | 1 | 1 | | | | |
| | | 29-2 | 9 | | salle 2 | Sb. Coq | | | | | 1 | 1 | | | | |
| | | 29-2 | 9 | | salle 2 | Sb. Coq | | | | | 1 | 1 | | | | |
| | | 29-2 | 9 | | | Sb. Coq | | | | | 2 | 2 | | | | |
| | | 40-2 | 186 | | | Sb. Coq | | | | | 1 | 1 | | | | |
| 1967 | | 40-2 | 191 | | | Sb. Coq | | | | | 1 | 1 | | | | |
| 1967 | | 40-2 | 191 | | | Sb. Coq | | | | | 1 | 1 | | | | |
| 1967 | | 40-2 | 191 | | | Sb. Coq | | | | | 1 | 1 | | | | |
| 1967 | | 40-2 | 191 | | | Sb. Coq | | | | | 1 | 1 | | | | |
| 1967 | | 40-2 | 191 | | | Sb. Coq | | | | | 1 | 1 | | | | |
| 1967 | | 40-2 | 191 | | | Sb. Coq | | | | | 25 | 25 | | | | |
| | | 40-2 | 189 | | | Sb. Coq | | | | | 1 | 1 | | | | |
| | | 40-2 | 189 | | | Sb. Coq | | | | | 1 | 1 | | | | |
| | | 40-2 | 189 | | | Sb. Coq | | | | | 1 | 1 | | | | |

ANNEXE B : AMPHITHÉÂTRE

| année | n° OA | Rayon | Caisse | n° ordre | US | Catégorie | Comptage | | | | | | Typologie | Desc. Typo. | Dessin | Planche |
|-------|----------|-------|--------|-------------|----|-----------|----------|---|---|---|----|----|-----------|-------------|--------|---------|
| | | | | | | | B | F | A | D | P | NR | | | | |
| | | 40-2 | 189 | | | Sb. Coq | | | | | 1 | 1 | | | | |
| | | 40-2 | 189 | | | Sb. Coq | | | | | 1 | 1 | | | | |
| | | 40-2 | 189 | | | Sb. Coq | | | | | 1 | 1 | | | | |
| | | 40-2 | 189 | | | Sb. Coq | | | | | 1 | 1 | | | | |
| | | 40-2 | 189 | | | Sb. Coq | | | | | 1 | 1 | | | | |
| | | 40-2 | 189 | | | Sb. Coq | | | | | 1 | 1 | | | | |
| | | 40-2 | 189 | | | Sb. Coq | | | | | 1 | 1 | | | | |
| | | 40-2 | 189 | | | Sb. Coq | | | | | 1 | 1 | | | | |
| | | 41-2 | 198 | | | Sb. Coq | | | | | 1 | 1 | | | | |
| | | 41-2 | 198 | | | Sb. Coq | | | | | 2 | 2 | | | | |
| | | 41-2 | 198 | | | Sb. Coq | | | | | 1 | 1 | | | | |
| | | 42-2 | 245 | | | Sb. Coq | | 3 | | | 18 | 21 | | | | |
| | | 42-2 | 245 | | | Sb. Coq | | 2 | | | | 2 | | | | |
| | | 42-2 | 245 | | | Sb. Coq | 8 | | | | | 8 | | | | |
| | | 42-2 | 250 | | | Sb. Coq | | 2 | | | | 2 | | | | |
| | | 42-3 | 252 | | | Sb. Coq | | | | | 17 | 17 | | | | |
| | | 42-3 | 252 | | | Sb. Coq | 1 | | | | | 1 | | | | |
| | | 42-3 | 252 | | | Sb. Coq | | 1 | | | | 1 | | | | |
| | | 42-3 | 252 | | | Sb. Coq | | | | | 2 | 2 | | | | |
| | | 42-3 | 252 | | | Sb. Coq | | 6 | | | 2 | 8 | | | | |
| | | 42-3 | 252 | | | Sb. Coq | | | | | 1 | 1 | | | | |
| | | 42-3 | 252 | | | Sb. Coq | | | | | 1 | 1 | | | | |
| | | 42-3 | 252 | | | Sb. Coq | | | | | 1 | 1 | | | | |
| | | 42-3 | 252 | | | Sb. Coq | | | | | 1 | 1 | | | | |
| | | 42-3 | 252 | | | Sb. Coq | | | | | 1 | 1 | | | | |
| | | 42-3 | 252 | | | Sb. Coq | | 1 | | | | 1 | | | | |
| | | 42-3 | 252 | | | Sb. Coq | | 1 | | | | 1 | | | | |

ANNEXE B : AMPHITHÉÂTRE

| année | n° OA | Rayon | Caisse | n° ordre | US | Catégorie | Comptage | | | | | | Typologie | Desc. Typo. | Dessin | Planche | |
|-------|----------|-------|--------|-------------|----------|-----------|----------|--------|---|---|----|----|-----------|-------------|--------------|---------|-------|
| | | | | | | | B | F | A | D | P | NR | | | | | NMI |
| 1979 | | 15--3 | 907 | | | Sb. Coq | | | | | 1 | 1 | | | | | |
| 1979 | | 15--3 | 907 | | | Sb. Coq | | | | | 1 | 1 | | | | | |
| 1979 | | 15--3 | 907 | | | Sb. Coq | | | | | 1 | 1 | | | | | |
| 1979 | | 15--3 | 907 | | | Sb. Coq | | | | | 1 | 1 | | | | | |
| 1979 | | 15--3 | 907 | | | Sb. Coq | | | | | 2 | 2 | | | | | |
| 1979 | | 15--3 | 907 | | | Sb. Coq | | | | | 6 | 6 | | | | | |
| 1979 | | 15--3 | 907 | | | Sb. Coq | 1 | | | | | 1 | | | | | |
| 1979 | | 15--3 | 907 | | | Sb. Coq | | 3 | | | 13 | 16 | | | | | |
| 1979 | | 15--3 | 907 | | | Sb. Coq | | 2 0 | | | | 20 | | | | | |
| 1979 | | 15--3 | 907 | | | Sb. Coq | | | | | 16 | 16 | | | | | |
| 1979 | | 15--3 | 907 | | | Sb. Coq | | | | | 1 | 1 | | | | | |
| 1979 | | 15--3 | 907 | | | Sb. Coq | | | | | 7 | 7 | | | | | |
| 1979 | | 15--3 | 907 | | | Sb. Coq | | 1 | | | 1 | 2 | | | | | |
| 1979 | | 14--1 | 918 | | | Sb. Coq | | | | | 2 | 2 | | | | | |
| 1979 | | 14--1 | 918 | | | Sb. Coq | | 1 | | | | 1 | | | | | |
| | | 14--1 | 938 | | | Sb. Coq | | 1 | | | 25 | 26 | | | | | |
| | | 15--3 | 909 | | couche 7 | Sb. Coq | | 3 | | | 5 | 8 | | | | | |
| | | 15--3 | 909 | | couche 7 | Sb. Coq | | 1 | | | 8 | 9 | | | | | |
| | | 15--3 | 909 | | couche 7 | Sb. Coq | | 1 | | | | 1 | | | | | |
| | | 15--3 | 909 | | couche 8 | Sb. Coq | | 2 | | | 11 | 13 | | | | | |
| | | 17--3 | 996 | | | Com. Sb | 1 | | | | | 1 | 1 | pot | Com. Sb P4 | 470 | XLVII |
| 1966 | | 16--3 | 1010 | | | Com. Sb | | 1 | | | | 1 | 1 | pot | Com. Sb PMin | 471 | XLVII |
| 1966 | | 16--3 | 1010 | | | Com. Sb | | 1 | | | | 1 | 1 | pot | Com. Sb PMin | 472 | XLVII |
| | | 18--1 | 1049 | | | Com. Sb | | 1 | | | | 1 | 1 | pot | Com. Sb PMin | | |
| | | 37-1 | 1530 | | | Com. Sb | | 1 | | | | 1 | 1 | pot | Com. Sb PMin | 473 | XLVII |

ANNEXE B : AMPHITHÉÂTRE

| année | n° OA | Rayon | Caisse | n° ordre | US | Catégorie | Comptage | | | | | | Typologie | Desc. Typo. | Dessin | Planche |
|-------|----------|--------|--------|-------------|----------|-----------|----------|---|---|---|----|----|-----------|-------------|--------|---------|
| | | | | | | | B | F | A | D | P | NR | | | | |
| | | 19--4 | 1064 | | | Com. Sb | | 1 | | | | 1 | 1 | faisselle | | |
| | | 29-2 | 9 | | salle 2 | Com. Sb | | | | | 1 | 1 | | | | |
| | | 29-2 | 9 | | salle 2 | Com. Sb | 1 | | | | | 1 | | | | |
| | | 29-2 | 9 | | | Com. Sb | | | | | 3 | 3 | | | | |
| | | 40-2 | 186 | | | Com. Sb | | | | | 1 | 1 | | | | |
| | | 42-3 | 252 | | | Com. Sb | | | | | 6 | 6 | | | | |
| | | 42-3 | 268 | | | Com. Sb | | | | | 8 | 8 | | | | |
| | | 15--03 | 903 | | | Com. Sb | | | | | 1 | 1 | | | | |
| 1979 | | 15--3 | 907 | | | Com. Sb | 1 | | | | | 1 | | | | |
| 1979 | | 15--3 | 907 | | | Com. Sb | | | | | 1 | 1 | | | | |
| 1979 | | 15--3 | 907 | | | Com. Sb | | 3 | | | 2 | 5 | | | | |
| 1979 | | 15--3 | 907 | | | Com. Sb | | | | | 4 | 4 | | | | |
| 1979 | | 15--3 | 907 | | | Com. Sb | | | | | 13 | 13 | | | | |
| | | 15--3 | 909 | | couche 7 | Com. Sb | | | | | 1 | 1 | | | | |
| | | 15--3 | 909 | | | Com. Sb | | 1 | | | | 1 | | | | |
| | | 15--3 | 909 | | | Com. Sb | | 1 | | | | 1 | | | | |
| | | 14--1 | 917 | | | Com. Cl | | | 1 | | 12 | 13 | | | | |
| | | 14--3 | 925 | | | Com. Cl | | | | | 2 | 2 | | | | |
| | | 45-2 | 298 | | | Com. Cl | | | | | 12 | 12 | | | | |
| 1966 | | 21--2 | 1160 | | | Com. Cl | | | | | 53 | 53 | | | | |
| | | 31--4 | 1617 | | | Com. Cl | | | | | 34 | 34 | | | | |
| | | 39-1 | 1561 | | | Com. Cl | | | | | 31 | 31 | | | | |
| 1966 | | 18--4 | 1099 | | | Com. Cl | | | | | 14 | 14 | | | | |
| 1966 | | 19--3 | 1078 | | | Com. Cl | | | | | 78 | 78 | | | | |
| | | 41-1 | 1574 | | | Com. Cl | | 2 | | | 67 | 69 | | | | |
| | | 42-1 | 1602 | | | Com. Cl | | | 2 | | 39 | 41 | | | | |

ANNEXE B : AMPHITHÉÂTRE

| année | n° OA | Rayon | Caisse | n° ordre | US | Catégorie | Comptage | | | | | | Typologie | Desc. Typo. | Dessin | Planche |
|------------|-------|---------------|--------|----------|------------|-----------|----------|---|---|---|---------|---------|-----------|---------------|--------|---------|
| | | | | | | | B | F | A | D | P | NR | | | | |
| | | 42-3 | 252 | | | Com. Cl | | | | | 36 | 36 | | | | |
| | | 15--3 | 907 | | sondage | Com. Cl | | | | | 1 | 1 | | | | |
| | | 45-3 | 303 | | | Com. Cl | | 1 | | | 12 | 13 | | | | |
| | | 36-1 | 1539 | | | Com. Cl | | 1 | | | 3 | 4 | | | | |
| | | en face de 21 | 1373 | | | Com. Cl | | | | | 14 7 | 14 7 | | | | |
| 1965 | | 42-3 | 257 | | | Com. Cl 1 | 1 | | | | 1 | 1 | plat | Com. Cl Pl3 | 474 | XLVIII |
| 1989 | | 34-4 | 120 | | | Com. Cl 1 | 6 | | | | 4 | 10 | bol | Com. Cl B1 | 475 | XLVIII |
| | | 41-2 | 195 | | | Com. Cl 1 | 1 | | | | 1 | 1 | cruche | Com. Cl Cr1.1 | 476 | XLVIII |
| 1966 | | 42-2 | 244 | | | Com. Cl 1 | 1 | | | | 1 | 1 | cruche | Com. Cl Cr1.1 | 477 | XLVIII |
| 1989 | | 36-2 | 127 | | ND3 ST4-9A | Com. Cl 1 | 1 | | 1 | | 2 | 1 | cruche | Com. Cl Cr1.1 | 478 | XLVIII |
| 1966-67-68 | | 39-2 | 155 | | | Com. Cl 1 | 1 | | | | 1 | 1 | cruche | Com. Cl Cr1.1 | 479 | XLVIII |
| 1966-67-68 | | 39-2 | 155 | | | Com. Cl 1 | 1 | | | | 1 | 1 | cruche | Com. Cl Cr1.1 | 480 | XLVIII |
| 1966-67-68 | | 39-2 | 155 | | | Com. Cl 1 | 1 | | | | 1 | 1 | cruche | Com. Cl Cr1.1 | 481 | XLVIII |
| | | 17--4 | 1032 | | | Com. Cl 1 | 1 | | | | 1 | 1 | cruche | Com. Cl Cr1.1 | 482 | XLVIII |
| | | 20--2 | 1144 | | | Com. Cl 1 | 1 | | | | 1 | 1 | cruche | Com. Cl Cr1.1 | 483 | XLVIII |
| | | 20--3 | 1147 | | | Com. Cl 1 | 1 | | | | 1 | 1 | cruche | Com. Cl Cr1.1 | 484 | XLVIII |
| | | 41-1 | 1565 | | | Com. Cl 1 | 1 | | | | 1 | 1 | cruche | Com. Cl Cr1.1 | 485 | XLVIII |
| | | 39-1 | 1549 | | | Com. Cl 1 | 1 | | | | 1 | 1 | cruche | Com. Cl Cr1.1 | 486 | XLVIII |
| | | 37-1 | 1533 | | | Com. Cl 1 | 1 | | | | 1 | 1 | cruche | Com. Cl Cr1.1 | 487 | XLVIII |
| | | 45-4 | 283 | | | Com. Cl 1 | 1 | | | | 1 | 1 | cruche | Com. Cl Cr1.1 | 488 | XLVIII |
| | | 45-4 | 283 | | | Com. Cl 1 | 1 | | | | 1 | 1 | cruche | Com. Cl Cr1.1 | 489 | XLVIII |
| | | 16--3 | 1013 | | | Com. Cl 1 | 1 | | | | 1 | 1 | cruche | Com. Cl Cr1.1 | 490 | XLVIII |

ANNEXE B : AMPHITHÉÂTRE

| année | n° OA | Rayon | Caisse | n° ordre | US | Catégorie | Comptage | | | | | | Typologie | Desc. Typo. | Dessin | Planche | |
|-------|----------|-------|--------|-------------|----|-----------|----------|---|---|---|---|----|-----------|-------------|---------------|---------|--------|
| | | | | | | | B | F | A | D | P | NR | | | | | NMI |
| | | 16--3 | 1013 | | | Com. Cl 1 | 1 | | | | | 1 | 1 | cruche | Com. Cl Cr1.1 | 491 | XLVIII |
| | | 16--3 | 1013 | | | Com. Cl 1 | 1 | | | | | 1 | 1 | cruche | Com. Cl Cr1.1 | 492 | XLIX |
| | | 16--3 | 1013 | | | Com. Cl 1 | 1 | | | | | 1 | 1 | cruche | Com. Cl Cr1.1 | 493 | XLIX |
| 1965 | | 41-2 | 205 | | | Com. Cl 1 | 1 | | | | | 1 | 1 | cruche | Com. Cl Cr1.1 | 494 | XLIX |
| 1965 | | 41-2 | 205 | | | Com. Cl 1 | 1 | | | | | 1 | 1 | cruche | Com. Cl Cr1.1 | 495 | XLIX |
| 1965 | | 41-2 | 205 | | | Com. Cl 1 | 1 | | | | | 1 | 1 | cruche | Com. Cl Cr1.1 | 496 | XLIX |
| 1965 | | 41-2 | 205 | | | Com. Cl 1 | 1 | | | | | 1 | 1 | cruche | Com. Cl Cr1.1 | 497 | XLIX |
| 1965 | | 41-2 | 205 | | | Com. Cl 1 | 1 | | | | | 1 | 1 | cruche | Com. Cl Cr1.1 | 498 | XLIX |
| 1965 | | 41-2 | 205 | | | Com. Cl 1 | 1 | | | | | 1 | 1 | cruche | Com. Cl Cr1.1 | 499 | XLIX |
| 1965 | | 41-2 | 205 | | | Com. Cl 1 | 1 | | | | | 1 | 1 | cruche | Com. Cl Cr1.1 | 500 | XLIX |
| 1965 | | 41-2 | 205 | | | Com. Cl 1 | 1 | | | | | 1 | 1 | cruche | Com. Cl Cr1.1 | 501 | XLIX |
| 1965 | | 41-2 | 205 | | | Com. Cl 1 | 1 | | | | | 1 | 1 | cruche | Com. Cl Cr1.1 | 502 | XLIX |
| 1967 | | 40-2 | 191 | | | Com. Cl 1 | 1 | | | | | 1 | 1 | cruche | Com. Cl Cr1.1 | 503 | XLIX |
| | | 41-2 | 198 | | | Com. Cl 1 | 1 | | | | | 1 | 1 | cruche | Com. Cl Cr1.1 | 504 | XLIX |
| | | 42-5 | 264 | | | Com. Cl 1 | 1 | | | | | 1 | 1 | cruche | Com. Cl Cr1.1 | 505 | XLIX |
| | | 42-5 | 264 | | | Com. Cl 1 | 1 | | | | | 1 | 1 | cruche | Com. Cl Cr1.1 | 506 | XLIX |
| | | 42-5 | 264 | | | Com. Cl 1 | 1 | | | | | 1 | 1 | cruche | Com. Cl Cr1.1 | 507 | XLIX |
| | | 42-5 | 264 | | | Com. Cl 1 | 1 | | | | | 1 | 1 | cruche | Com. Cl Cr1.1 | 508 | XLIX |
| 1979 | | 15--3 | 907 | | | Com. Cl 1 | 1 | | | | | 1 | 1 | cruche | Com. Cl Cr1.1 | 509 | XLIX |
| | | 44-1 | 1605 | | | Com. Cl 1 | 1 | | | | | 1 | 1 | cruche | Com. Cl Cr1.1 | 510 | XLIX |
| | | 44-3 | 281 | | | Com. Cl 1 | 1 | | | | | 1 | 1 | cruche | Com. Cl Cr1.1 | 511 | XLIX |
| | | 44-1 | 1597 | | | Com. Cl 1 | 1 | | | | | 1 | 1 | cruche | Com. Cl Cr1.2 | 512 | XLIX |
| | | 20--4 | 1149 | | | Com. Cl 1 | 1 | | | | | 1 | 1 | cruche | Com. Cl Cr1.2 | 513 | L |
| | | 45-4 | 283 | | | Com. Cl 1 | 1 | | | | | 1 | 1 | cruche | Com. Cl Cr1.2 | 514 | L |
| | | 16--3 | 1013 | | | Com. Cl 1 | 1 | | | | | 1 | 1 | cruche | Com. Cl Cr1.2 | 515 | L |
| 1968 | | 42-3 | 253 | | | Com. Cl 1 | 1 | | | | | 1 | 1 | cruche | Com. Cl Cr1.2 | 516 | L |

ANNEXE B : AMPHITHÉÂTRE

| année | n° OA | Rayon | Caisse | n° ordre | US | Catégorie | Comptage | | | | | | Typologie | Desc. Typo. | Dessin | Planche | |
|------------|----------|-------|--------|-------------|------|-----------|----------|---|---|---|---|----|-----------|-------------|---------------|---------|-----|
| | | | | | | | B | F | A | D | P | NR | | | | | NMI |
| | | 42-5 | 264 | | | Com. Cl 1 | 1 | | | | | 1 | 1 | cruche | Com. Cl Cr1.2 | 517 | L |
| 1966-67-68 | | 39-2 | 155 | | | Com. Cl 1 | 1 | | | | | 1 | 1 | cruche | Com. Cl Cr3 | 518 | L |
| | | 17--1 | 1023 | | | Com. Cl 1 | 1 | | | | | 1 | 1 | cruche | Com. Cl Cr3 | 519 | L |
| | | 45-4 | 283 | | | Com. Cl 1 | 1 | | | | | 1 | 1 | cruche | Com. Cl Cr3 | 520 | L |
| | | 17--3 | 1033 | | | Com. Cl 1 | 1 | | | | | 1 | 1 | cruche | Com. Cl Cr4 | 521 | L |
| | | 16--5 | 1019 | | | Com. Cl 1 | 1 | | | | | 1 | 1 | cruche | Com. Cl Cr5 | 522 | L |
| | | 42-5 | 264 | | | Com. Cl 1 | 1 | | | | | 1 | 1 | cruche | Com. Cl Cr5 | 523 | L |
| 1989 | | 34-5 | 121 | | 5ND3 | Com. Cl 1 | 1 | | | | | 1 | 1 | cruche | Com. Cl Cr6.1 | 524 | L |
| | | 43-1 | 1582 | | | Com. Cl 1 | 1 | | | | | 1 | 1 | cruche | Com. Cl Cr6.1 | 525 | L |
| | | 17--1 | 1023 | | | Com. Cl 1 | 1 | | | | | 1 | 1 | cruche | Com. Cl Cr6.1 | 526 | L |
| | | 16--5 | 1019 | | | Com. Cl 1 | 1 | | | | | 1 | 1 | cruche | Com. Cl Cr6.1 | 527 | L |
| | | 18--3 | 1092 | | | Com. Cl 1 | 1 | | | | | 1 | 1 | cruche | Com. Cl Cr6.1 | 528 | L |
| | | 41-1 | 1583 | | | Com. Cl 1 | 1 | | | | | 1 | 1 | cruche | Com. Cl Cr6.1 | 529 | L |
| | | 45-3 | 309 | | | Com. Cl 1 | 1 | | | | | 1 | 1 | cruche | Com. Cl Cr6.1 | 530 | L |
| | | 45-4 | 283 | | | Com. Cl 1 | 1 | | | | | 1 | 1 | cruche | Com. Cl Cr6.1 | 531 | L |
| | | 45-4 | 283 | | | Com. Cl 1 | 1 | | | | | 1 | 1 | cruche | Com. Cl Cr6.1 | 532 | L |
| | | 45-4 | 283 | | | Com. Cl 1 | 1 | | | | | 1 | 1 | cruche | Com. Cl Cr6.1 | 533 | L |
| | | 45-4 | 283 | | | Com. Cl 1 | 1 | | | | | 1 | 1 | cruche | Com. Cl Cr6.1 | 534 | L |
| | | 45-4 | 283 | | | Com. Cl 1 | 1 | | | | | 1 | 1 | cruche | Com. Cl Cr6.1 | 535 | L |
| | | 16--3 | 1013 | | | Com. Cl 1 | 1 | | | | | 1 | 1 | cruche | Com. Cl Cr6.1 | 536 | L |
| | | 16--3 | 1013 | | | Com. Cl 1 | 1 | | | | | 1 | 1 | cruche | Com. Cl Cr6.1 | 537 | L |
| | | 16--3 | 1013 | | | Com. Cl 1 | 1 | | | | | 1 | 1 | cruche | Com. Cl Cr6.1 | 538 | L |
| 1965 | | 41-2 | 205 | | | Com. Cl 1 | 1 | | | | | 1 | 1 | cruche | Com. Cl Cr6.1 | 539 | L |
| 1965 | | 41-2 | 205 | | | Com. Cl 1 | 1 | | | | | 1 | 1 | cruche | Com. Cl Cr6.1 | 540 | L |
| 1965 | | 41-2 | 205 | | | Com. Cl 1 | 1 | | | | | 1 | 1 | cruche | Com. Cl Cr6.1 | 541 | L |

ANNEXE B : AMPHITHÉÂTRE

| année | n° OA | Rayon | Caisse | n° ordre | US | Catégorie | Comptage | | | | | | Typologie | Desc. Typo. | Dessin | Planche | |
|------------|----------|---------------------------|---------|------------------------|------------|-----------|----------|---|---|---|---|----|-----------|-------------|---------------|---------|-----|
| | | | | | | | B | F | A | D | P | NR | | | | | NMI |
| 1965 | | 41-2 | 205 | | | Com. Cl 1 | 1 | | | | | 1 | 1 | cruche | Com. Cl Cr6.1 | 542 | L |
| 1965 | | 41-2 | 205 | | | Com. Cl 1 | 1 | | | | | 1 | 1 | cruche | Com. Cl Cr6.1 | 543 | L |
| 1965 | | 41-2 | 205 | | | Com. Cl 1 | 1 | | | | | 1 | 1 | cruche | Com. Cl Cr6.1 | 544 | L |
| 1965 | | 41-2 | 205 | | | Com. Cl 1 | 1 | | | | | 1 | 1 | cruche | Com. Cl Cr6.1 | 545 | L |
| 1965 | | 41-2 | 205 | | | Com. Cl 1 | 2 | | | | | 2 | 1 | cruche | Com. Cl Cr6.1 | 546 | L |
| 1966 | | 42-2 | 244 | | | Com. Cl 1 | 1 | | | | | 1 | 1 | cruche | Com. Cl Cr6.1 | 547 | L |
| | | 29-2 | 9 | | salle 2 | Com. Cl 1 | 1 | | | | | 1 | 1 | cruche | Com. Cl Cr6.1 | 548 | LI |
| | | 42-5 | 264 | | | Com. Cl 1 | 1 | | | | | 1 | 1 | cruche | Com. Cl Cr6.1 | 549 | LI |
| | | 42-5 | 264 | | | Com. Cl 1 | 1 | | | | | 1 | 1 | cruche | Com. Cl Cr6.1 | 550 | LI |
| 1965 | | 41-2 | 205 | | | Com. Cl 1 | 1 | | | | | 1 | 1 | cruche | Com. Cl Cr6.1 | 551 | LI |
| 1989 | | 34-5 | 121 | | ST4-9B-ND3 | Com. Cl 1 | 1 | | | | | 1 | 1 | cruche | Com. Cl Cr6.2 | 552 | LI |
| 1966-67-68 | | 39-2 | 155 | | | Com. Cl 1 | 1 | | | | | 1 | 1 | cruche | Com. Cl Cr6.2 | 553 | LI |
| | | Musée Amphi théâtre | vitrine | Inv.2 009- 0-915 | | Com. Cl 1 | | | 1 | | | 1 | 1 | cruche | Com. Cl Cr6.2 | 554 | LI |
| | | 20--4 | 1149 | | | Com. Cl 1 | 1 | | | | | 1 | 1 | cruche | Com. Cl Cr7.1 | 555 | LI |
| | | 20--4 | 1149 | | | Com. Cl 1 | 1 | | | | | 1 | 1 | cruche | Com. Cl Cr7.1 | 556 | LI |
| | | 36-1 | 1538 | | | Com. Cl 1 | 1 | | | | | 1 | 1 | cruche | Com. Cl Cr7.1 | 557 | LI |
| | | 16--3 | 1013 | | | Com. Cl 1 | 1 | | | | | 1 | 1 | cruche | Com. Cl Cr7.1 | 558 | LI |
| | | 16--3 | 1013 | | | Com. Cl 1 | 1 | | | | | 1 | 1 | cruche | Com. Cl Cr7.1 | 559 | LI |
| | | 16--3 | 1013 | | | Com. Cl 1 | 1 | | | | | 1 | 1 | cruche | Com. Cl Cr7.1 | 560 | LI |
| | | 16--3 | 1013 | | | Com. Cl 1 | 1 | | | | | 1 | 1 | cruche | Com. Cl Cr7.1 | 561 | LI |
| 1968 | | 39-5 | 166 | | | Com. Cl 1 | 1 | | | | | 1 | 1 | cruche | Com. Cl Cr7.1 | 562 | LI |
| 1965 | | 41-2 | 205 | | | Com. Cl 1 | 1 | | | | | 1 | 1 | cruche | Com. Cl Cr7.1 | 563 | LI |
| 1965 | | 41-2 | 205 | | | Com. Cl 1 | 1 | | | | | 1 | 1 | cruche | Com. Cl Cr7.1 | 564 | LII |

ANNEXE B : AMPHITHÉÂTRE

| année | n° OA | Rayon | Caisse | n° ordre | US | Catégorie | Comptage | | | | | | Typologie | Desc. Typo. | Dessin | Planche | |
|------------|----------|-------|--------|-------------|---------|-----------|----------|---|---|---|----|----|-----------|-------------|---------------|---------|------|
| | | | | | | | B | F | A | D | P | NR | | | | | NMI |
| 1965 | | 41-2 | 205 | | | Com. Cl 1 | 1 | | | | | 1 | 1 | cruche | Com. Cl Cr7.1 | 565 | LII |
| 1965 | | 41-2 | 205 | | | Com. Cl 1 | 1 | | | | | 1 | 1 | cruche | Com. Cl Cr7.1 | 566 | LII |
| 1965 | | 41-2 | 205 | | | Com. Cl 1 | 1 | | | | | 1 | 1 | cruche | Com. Cl Cr7.1 | 567 | LII |
| | | 18--3 | 1092 | | | Com. Cl 1 | 1 | | | | | 1 | 1 | cruche | Com. Cl Cr7.1 | 568 | LII |
| | | 41-1 | 1583 | | | Com. Cl 1 | 1 | | | | | 1 | 1 | cruche | Com. Cl Cr7.3 | 569 | LII |
| | | 36-1 | 1529 | | | Com. Cl 1 | 1 | | | | | 1 | 1 | cruche | Com. Cl Cr8 | 570 | LII |
| 1965 | | 41-2 | 205 | | | Com. Cl 1 | 1 | | | | | 1 | 1 | cruche | Com. Cl Cr8 | 571 | LII |
| | | 18--3 | 1092 | | | Com. Cl 1 | 1 | | | | | 1 | 1 | cruche | Com. Cl Cr10 | 572 | LII |
| 1965 | | 41-2 | 205 | | | Com. Cl 1 | 1 | | | | | 1 | 1 | cruche | Com. Cl Cr10 | 573 | LII |
| 1965 | | 41-2 | 205 | | | Com. Cl 1 | 1 | | | | | 1 | 1 | cruche | Com. Cl Cr10 | 574 | LII |
| 1965 | | 41-2 | 205 | | | Com. Cl 1 | 1 | | | | | 1 | 1 | cruche | Com. Cl Cr10 | 575 | LII |
| 1965 | | 41-2 | 205 | | | Com. Cl 1 | 1 | | | | | 1 | 1 | cruche | Com. Cl Cr10 | 576 | LII |
| | | 40-2 | 189 | | | Com. Cl 1 | 1 | | | | | 1 | 1 | cruche | Com. Cl Cr10 | 577 | LII |
| 1966-67-68 | | 39-2 | 155 | | | Com. Cl 1 | 1 | | | | | 1 | 1 | cruche | Com. Cl Cr15 | 578 | LII |
| 1989 | | 34-4 | 120 | | | Com. Cl 1 | | 3 | | | 11 | 14 | 1 | fond | | 579 | LII |
| 1964 | | 14--2 | 951 | | | Com. Cl 1 | 1 | | | | | 1 | 1 | pot | Com. Cl P1.1 | 580 | LII |
| | | 29-2 | 9 | | salle 2 | Com. Cl 1 | 1 | 1 | | | 2 | 4 | 1 | pot | Com. Cl P4.1 | 581 | LII |
| | | 18--2 | 1086 | | | Com. Cl 1 | 1 | | | | | 1 | 1 | pot | Com. Cl P4.1 | 582 | LII |
| | | 17--1 | 1023 | | | Com. Cl 1 | 1 | | | | | 1 | 1 | pot | Com. Cl P4.1 | 583 | LII |
| | | 37-2 | 1560 | | | Com. Cl 1 | 1 | | | | | 1 | 1 | pot | Com. Cl P4.1 | 584 | LII |
| 1965 | | 41-2 | 205 | | | Com. Cl 1 | 1 | | | | | 1 | 1 | pot | Com. Cl P4.1 | 585 | LIII |
| 1965 | | 41-2 | 205 | | | Com. Cl 1 | 1 | | | | | 1 | 1 | pot | Com. Cl P4.1 | 586 | LIII |
| 1965 | | 41-2 | 205 | | | Com. Cl 1 | 1 | | | | | 1 | 1 | pot | Com. Cl P4.1 | 587 | LIII |
| 1965 | | 41-2 | 205 | | | Com. Cl 1 | 1 | | | | | 1 | 1 | pot | Com. Cl P4.1 | 588 | LIII |
| | | 42-5 | 264 | | | Com. Cl 1 | 1 | | | | | 1 | 1 | pot | Com. Cl P5.2 | 589 | LIII |

ANNEXE B : AMPHITHÉÂTRE

| année | n° OA | Rayon | Caisse | n° ordre | US | Catégorie | Comptage | | | | | | Typologie | Desc. Typo. | Dessin | Planche | |
|-------|----------|-------|--------|-------------|---------------------------------|-----------|----------|---|---|---|---|----|-----------|-------------|---------------|---------|------|
| | | | | | | | B | F | A | D | P | NR | | | | | NMI |
| | | 16--3 | 1013 | | | Com. Cl 1 | 1 | | | | | 1 | 1 | pot | Com. Cl P6.2 | 590 | LIII |
| 1965 | | 41-2 | 205 | | | Com. Cl 1 | 1 | | | | | 1 | 1 | pot | Com. Cl P7.2 | 591 | LIII |
| | | 37-1 | 1534 | | | Com. Cl 1 | 1 | | | | | 1 | 1 | pot | Com. Cl PMin1 | 592 | LIII |
| 1989 | | 34-5 | 121 | | 5ND3 | Com. Cl 1 | | 1 | | | | 1 | | | | | |
| | | 35-4 | 101 | | | Com. Cl 1 | | 2 | 1 | | | 25 | 28 | | | | |
| | | 35-4 | 102 | | | Com. Cl 1 | | | | | | 34 | 34 | | | | |
| 1965 | | 41-2 | 205 | | | Com. Cl 1 | | 1 | | | | | 1 | | | | |
| | | 35-4 | 103 | | | Com. Cl 1 | | | | | | 29 | 29 | | | | |
| | | 35-5 | 105 | | | Com. Cl 1 | | | | | | 41 | 41 | | | | |
| 1989 | | 34-2 | 110 | | NA3 structure 2 | Com. Cl 1 | | 2 | | | | 31 | 33 | | | | |
| 1989 | | 34-2 | 110 | | NA2 structure 3 | Com. Cl 1 | | | | | | 9 | 9 | | | | |
| 1989 | | 34-2 | 111 | | ND3 structure 4.1 | Com. Cl 1 | | | | | | 6 | 6 | | | | |
| 1989 | | 34-2 | 111 | | ND3 structure 4 niveau 10 | Com. Cl 1 | | | | | | 10 | 10 | | | | |
| 1989 | | 34-2 | 111 | | ND3 structure 4.9B | Com. Cl 1 | | 1 | | | | 30 | 31 | | | | |
| 1989 | | 34-3 | 113 | | ND3 structure 4- 7B-7C | Com. Cl 1 | | | | | | 12 | 12 | | | | |
| 1989 | | 34-3 | 113 | | 2A7 étage 2 | Com. Cl 1 | | 1 | | | | 4 | 5 | | | | |
| 1989 | | 34-3 | 113 | | 5NE3 | Com. Cl 1 | | | | | | 5 | 5 | | | | |
| 1989 | | 34-3 | 115 | | 4NC3 | Com. Cl 1 | | 1 | | | | 12 | 13 | | | | |
| 1989 | | 34-4 | 118 | | 3CNA9 | Com. Cl 1 | | | | | | 2 | 2 | | | | |
| 1989 | | 34-4 | 118 | | 3CSB8 | Com. Cl 1 | | | | | | 8 | 8 | | | | |

ANNEXE B : AMPHITHÉÂTRE

| année | n° OA | Rayon | Caisse | n° ordre | US | Catégorie | Comptage | | | | | | Typologie | Desc. Typo. | Dessin | Planche |
|------------|----------|--------|--------|-------------|---------|-----------|----------|---|---|---|----|----|-----------|-------------|--------|---------|
| | | | | | | | B | F | A | D | P | NR | | | | |
| 1989 | | 34-4 | 118 | | 3CSA8 | Com. Cl 1 | | 1 | | | 9 | 10 | | | | |
| 1989 | | 34-5 | 121 | | | Com. Cl 1 | | 5 | | | 9 | 14 | | | | |
| 1989 | | 34-5 | 123 | | 5NC3 | Com. Cl 1 | | | 1 | | 17 | 18 | | | | |
| 1989 | | 34-5 | 125 | | 5SD8 | Com. Cl 1 | | 2 | | | 9 | 11 | | | | |
| 1989 | | 34-5 | 125 | | NE3 ST4 | Com. Cl 1 | | | 1 | | 17 | 18 | | | | |
| 1989 | | 36-2 | 127 | | | Com. Cl 1 | | 4 | | | 13 | 17 | | | | |
| 1989 | | 36-2 | 128 | | 4NA3 | Com. Cl 1 | | | | | 8 | 8 | | | | |
| 1989 | | 36-2 | 129 | | 2SC3 | Com. Cl 1 | | | | | 3 | 3 | | | | |
| 1989 | | 37-5 | 137 | | ND3 ST4 | Com. Cl 1 | | 3 | 2 | | 45 | 50 | | | | |
| 1989 | | 37-5 | 136 | | 5ND3 | Com. Cl 1 | | 1 | | | 23 | 24 | | | | |
| | | 39-2 | 156 | | | Com. Cl 1 | | | 1 | | 11 | 12 | | | | |
| | | 39-3 | 158 | | | Com. Cl 1 | | 1 | | | 39 | 40 | | | | |
| | | 39-3 | 161 | | | Com. Cl 1 | | | | | 51 | 51 | | | | |
| | | 39-3 | 1390 | | | Com. Cl 1 | | 1 | | | 18 | 19 | | | | |
| | | 39-4 | 165 | | | Com. Cl 1 | | | | | 10 | 10 | | | | |
| | | 38-2 | 178 | | | Com. Cl 1 | | | | | 34 | 34 | | | | |
| 1966-67-68 | | 39-2 | 155 | | | Com. Cl 1 | | 1 | | | | 1 | | | | |
| | | 15--02 | 906 | | | Com. Cl 1 | | | | | 15 | 15 | | | | |
| | | 15--4 | 912 | | | Com. Cl 1 | | | 1 | | | 1 | | | | |
| | | 14--2 | 955 | | | Com. Cl 1 | | | | | 14 | 14 | | | | |
| | | 14--2 | 920 | | | Com. Cl 1 | | 1 | | | | 1 | | | | |
| | | 15--1 | 936 | | | Com. Cl 1 | | 1 | | | 2 | 3 | | | | |
| | | 14--2 | 953 | | | Com. Cl 1 | | 1 | | | 3 | 4 | | | | |
| | | 14--2 | 954 | | | Com. Cl 1 | | | | | 25 | 25 | | | | |
| | | 17--1 | 1027 | | | Com. Cl 1 | | 1 | | | | 1 | | | | |

ANNEXE B : AMPHITHÉÂTRE

| année | n° OA | Rayon | Caisse | n° ordre | US | Catégorie | Comptage | | | | | | Typologie | Desc. Typo. | Dessin | Planche |
|-------|----------|-------|--------|-------------|----|-----------|----------|---|---|---|----|----|-----------|-------------|--------|---------|
| | | | | | | | B | F | A | D | P | NR | | | | |
| | | 18--2 | 1088 | | | Com. Cl 1 | | 2 | | | | 2 | | | | |
| | | 12--2 | 1356 | | | Com. Cl 1 | | 1 | | | | 1 | | | | |
| | | 44--4 | 284 | | | Com. Cl 1 | | 1 | | | | 1 | | | | |
| | | 44--4 | 285 | | | Com. Cl 1 | | | | | 21 | 21 | | | | |
| | | 44--4 | 310 | | | Com. Cl 1 | | 1 | | | 13 | 14 | | | | |
| | | 45-2 | 301 | | | Com. Cl 1 | | | 1 | | 17 | 18 | | | | |
| | | 45-2 | 295 | | | Com. Cl 1 | | | | | 20 | 20 | | | | |
| | | 45-3 | 308 | | | Com. Cl 1 | | | | | 20 | 20 | | | | |
| | | 45-3 | 305 | | | Com. Cl 1 | | | | | 18 | 18 | | | | |
| | | 44-1 | 1605 | | | Com. Cl 1 | | | | | 41 | 41 | | | | |
| | | 44-1 | 1597 | | | Com. Cl 1 | | | | | 12 | 12 | | | | |
| | | 44-1 | 1595 | | | Com. Cl 1 | | | | | 13 | 13 | | | | |
| | | 44-1 | 1606 | | | Com. Cl 1 | | | | | 9 | 9 | | | | |
| | | 43-1 | 1586 | | | Com. Cl 1 | | | | | 24 | 24 | | | | |
| | | 20--1 | 1115 | | | Com. Cl 1 | | | | | 1 | 1 | | | | |
| | | 20--2 | 1145 | | | Com. Cl 1 | | | 2 | | 87 | 89 | | | | |
| 1966 | | 21--1 | 1157 | | | Com. Cl 1 | | | | | 12 | 12 | | | | |
| 1965 | | 21--1 | 1126 | | | Com. Cl 1 | | | | | 21 | 21 | | | | |
| 1966 | | 21--1 | 1155 | | | Com. Cl 1 | | | | | 47 | 47 | | | | |
| 1968 | | 21--2 | 1158 | | | Com. Cl 1 | | | | | 10 | 10 | | | | |
| 1966 | | 21--3 | 1163 | | | Com. Cl 1 | | | 5 | | 61 | 66 | | | | |
| | | 26--1 | 1487 | | | Com. Cl 1 | | | | | 4 | 4 | | | | |
| | | 30--3 | 1619 | | | Com. Cl 1 | | | | | 17 | 17 | | | | |
| | | 31--4 | 1620 | | | Com. Cl 1 | | | | | 12 | 12 | | | | |
| | | 46-1 | 1476 | | | Com. Cl 1 | | | | | 19 | 19 | | | | |
| | | 45-3 | 305 | | | Com. Cl 1 | | | | | 12 | 12 | | | | |

ANNEXE B : AMPHITHÉÂTRE

| année | n° OA | Rayon | Caisse | n° ordre | US | Catégorie | Comptage | | | | | | Typologie | Desc. Typo. | Dessin | Planche |
|-------|----------|-------|--------|-------------|---------------------|-----------|----------|---|---|---|----|----|-----------|-------------|--------|---------|
| | | | | | | | B | F | A | D | P | NR | | | | |
| | | 36-1 | 1542 | | | Com. Cl 1 | | | | | 3 | 3 | | | | |
| | | 38-1 | 1545 | | | Com. Cl 1 | | | | | 13 | 13 | | | | |
| | | 38-1 | 1554 | | | Com. Cl 1 | | | | | 4 | 4 | | | | |
| | | 38-1 | 1553 | | | Com. Cl 1 | | | | | 7 | 7 | | | | |
| 1966 | | 17--1 | 1020 | | | Com. Cl 1 | | 1 | | | 11 | 12 | | | | |
| 1966 | | 17--4 | 1032 | | | Com. Cl 1 | | 1 | 1 | | 31 | 33 | | | | |
| 1966 | | 17--1 | 1023 | | | Com. Cl 1 | | 7 | 3 | | 67 | 77 | | | | |
| 1968 | | 15--3 | 943 | | | Com. Cl 1 | | 1 | 1 | | 2 | 4 | | | | |
| 1966 | | 17--4 | 1031 | | | Com. Cl 1 | | 1 | 2 | | 12 | 15 | | | | |
| 1966 | | 19--5 | 1084 | | | Com. Cl 1 | | | | | 14 | 14 | | | | |
| | | 18--3 | 1092 | | | Com. Cl 1 | | 1 | 2 | | 59 | 62 | | | | |
| 1967 | | 45-3 | 302 | | | Com. Cl 1 | | | 2 | | 37 | 39 | | | | |
| 1968 | | 16--3 | 1012 | | | Com. Cl 1 | | | | | 4 | 4 | | | | |
| 1966 | | 18--2 | 1086 | | | Com. Cl 1 | | 4 | | | 38 | 42 | | | | |
| 1966 | | 16--5 | 1019 | | | Com. Cl 1 | | 2 | 1 | | 58 | 61 | | | | |
| | | 44-2 | 270 | | | Com. Cl 1 | | 3 | 1 | | 37 | 41 | | | | |
| 1990 | 967 | 47-4 | 1666 | | NA3 couche 1 bis | Com. Cl 1 | | | | | 1 | 1 | | | | |
| 1990 | 967 | 47-4 | 1666 | 4 | NA3 | Com. Cl 1 | | | | | 31 | 31 | | | | |
| 1990 | 967 | 47-4 | 1666 | 6 | NA3b couche 1 | Com. Cl 1 | | | | | 7 | 7 | | | | |
| 1990 | 967 | 47-4 | 1666 | 2 | NA3 couche 1 bis | Com. Cl 1 | | | | | 5 | 5 | | | | |
| 1990 | 967 | 47-4 | 1666 | 5 | NA3 | Com. Cl 1 | | | | | 9 | 9 | | | | |
| 1990 | 967 | 47-4 | 1666 | 4 | NG1 couche 1 | Com. Cl 1 | | | | | 10 | 10 | | | | |
| | | 20--2 | 1142 | | | Com. Cl 1 | | 3 | 2 | | 21 | 26 | | | | |

ANNEXE B : AMPHITHÉÂTRE

| année | n° OA | Rayon | Caisse | n° ordre | US | Catégorie | Comptage | | | | | | Typologie | Desc. Typo. | Dessin | Planche |
|-------|----------|-------|--------|-------------|----|-----------|----------|---|---|---|----|-----|-----------|-------------|--------|---------|
| | | | | | | | B | F | A | D | P | NR | | | | |
| 1968 | | 20--3 | 1148 | | | Com. Cl 1 | | | | | 37 | 37 | | | | |
| | | 20--3 | 1148 | | | Com. Cl 1 | | 3 | | | | 3 | | | | |
| 1963 | | 20--3 | 1147 | | | Com. Cl 1 | | 2 | 1 | | 12 | 15 | | | | |
| 1969 | | 20--3 | 1146 | | | Com. Cl 1 | | 3 | | | 64 | 67 | | | | |
| | | 14--5 | 967 | | | Com. Cl 1 | | | | | 3 | 3 | | | | |
| 1968 | | 20--2 | 1144 | | | Com. Cl 1 | | | | | 26 | 26 | | | | |
| | | 21--4 | 1166 | | | Com. Cl 1 | | | | | 17 | 17 | | | | |
| 1966 | | 21--4 | 1166 | | | Com. Cl 1 | | 2 | 1 | | 1 | 4 | | | | |
| | | 21--4 | 1166 | | | Com. Cl 1 | | | | | 5 | 5 | | | | |
| | | 41-1 | 1565 | | | Com. Cl 1 | | 1 | | | 24 | 25 | | | | |
| | | 41-1 | 1583 | | | Com. Cl 1 | | 1 | 3 | | 97 | 101 | | | | |
| | | 41-1 | 1584 | | | Com. Cl 1 | | 1 | | | 65 | 66 | | | | |
| | | 42-1 | 1464 | | | Com. Cl 1 | | 1 | | | 61 | 62 | | | | |
| | | 42-1 | 1463 | | | Com. Cl 1 | | 2 | 1 | | 38 | 41 | | | | |
| | | 42-1 | 1568 | | | Com. Cl 1 | | 1 | | | 42 | 43 | | | | |
| | | 42-1 | 1567 | | | Com. Cl 1 | | 1 | 1 | | 88 | 90 | | | | |
| | | 42-1 | 1569 | | | Com. Cl 1 | | | 2 | | 66 | 68 | | | | |
| | | 45-3 | 309 | | | Com. Cl 1 | | 1 | 1 | | 21 | 23 | | | | |
| | | 36-1 | 1535 | | | Com. Cl 1 | | 1 | 2 | | 31 | 34 | | | | |
| | | 45-3 | 307 | | | Com. Cl 1 | | | | | 3 | 3 | | | | |
| | | 37-1 | 1532 | | | Com. Cl 1 | | 1 | | | 8 | 9 | | | | |
| | | 37-1 | 1533 | | | Com. Cl 1 | | | 1 | | 12 | 13 | | | | |
| | | 36-1 | 1538 | | | Com. Cl 1 | | 7 | 2 | | 31 | 40 | | | | |
| | | 36-2 | 1529 | | | Com. Cl 1 | | 1 | | | 18 | 19 | | | | |
| | | 39-1 | 1549 | | | Com. Cl 1 | | 3 | | | 5 | 8 | | | | |

ANNEXE B : AMPHITHÉÂTRE

| année | n° OA | Rayon | Caisse | n° ordre | US | Catégorie | Comptage | | | | | | Typologie | Desc. Typo. | Dessin | Planche |
|-------|----------|-------|--------|-------------|----|-----------|----------|--------|---|---|---------|---------|-----------|-------------|--------|---------|
| | | | | | | | B | F | A | D | P | NR | | | | |
| 1967 | | 45-4 | 283 | | | Com. Cl 1 | | 3 | | | 37 | 40 | | | | |
| | | 37-2 | 1560 | | | Com. Cl 1 | | 4 | 4 | | 79 | 87 | | | | |
| | | 46-3 | 1480 | | | Com. Cl 1 | | 2 4 | 7 | | 33 1 | 36 2 | | | | |
| 1964 | | 16--3 | 1013 | | | Com. Cl 1 | | 2 | 1 | | 14 | 17 | | | | |
| | | 28--4 | 1603 | | | Com. Cl 1 | | | | | 55 | 55 | | | | |
| | | 47-3 | 1654 | | | Com. Cl 1 | | | | | 38 | 38 | | | | |
| | | 38-3 | 1633 | | | Com. Cl 1 | | | | | 25 | 25 | | | | |
| | | 31-2 | 1596 | | | Com. Cl 1 | | | | | 39 | 39 | | | | |
| 1989 | | 36-2 | 124 | | | Com. Cl 1 | | | | | 28 | 28 | | | | |
| 1989 | | 36-2 | 124 | | | Com. Cl 1 | | | | | 9 | 9 | | | | |
| 1989 | | 36-2 | 124 | | | Com. Cl 1 | | | | | 1 | 1 | | | | |
| 1968 | | 39-5 | 166 | | | Com. Cl 1 | | | | | 1 | 1 | | | | |
| 1968 | | 39-5 | 166 | | | Com. Cl 1 | | | | | 1 | 1 | | | | |
| 1968 | | 39-5 | 166 | | | Com. Cl 1 | | 3 | 4 | | | 7 | | | | |
| 1965 | | 41-2 | 205 | | | Com. Cl 1 | | | | | 1 | 1 | | | | |
| 1965 | | 41-2 | 205 | | | Com. Cl 1 | | | | | 1 | 1 | | | | |
| 1965 | | 41-2 | 205 | | | Com. Cl 1 | | | | | 1 | 1 | | | | |
| 1965 | | 41-2 | 205 | | | Com. Cl 1 | | | | | 2 | 2 | | | | |
| 1965 | | 41-2 | 205 | | | Com. Cl 1 | | | | | 1 | 1 | | | | |
| 1965 | | 41-2 | 205 | | | Com. Cl 1 | | | | | 1 | 1 | | | | |
| 1965 | | 41-2 | 205 | | | Com. Cl 1 | | | | | 2 | 2 | | | | |
| 1965 | | 41-2 | 205 | | | Com. Cl 1 | | | | | 1 | 1 | | | | |
| 1965 | | 41-2 | 205 | | | Com. Cl 1 | | | | | 2 | 2 | | | | |
| 1965 | | 41-2 | 205 | | | Com. Cl 1 | | | | | 1 | 1 | | | | |
| 1965 | | 41-2 | 205 | | | Com. Cl 1 | | | | | 1 | 1 | | | | |

ANNEXE B : AMPHITHÉÂTRE

| année | n° OA | Rayon | Caisse | n° ordre | US | Catégorie | Comptage | | | | | | Typologie | Desc. Typo. | Dessin | Planche |
|-------|----------|-------|--------|-------------|-------------------------|-----------|----------|---|---|---|----|-----|-----------|-------------|--------|---------|
| | | | | | | | B | F | A | D | P | NR | | | | |
| 1965 | | 41-2 | 205 | | | Com. Cl 1 | | | | | 1 | 1 | | | | |
| 1965 | | 41-2 | 205 | | | Com. Cl 1 | | | | | 1 | 1 | | | | |
| 1965 | | 41-2 | 205 | | | Com. Cl 1 | | | | | 1 | 1 | | | | |
| 1965 | | 41-2 | 205 | | | Com. Cl 1 | | | | | 1 | 1 | | | | |
| 1965 | | 41-2 | 205 | | | Com. Cl 1 | | | | | 1 | 1 | | | | |
| 1965 | | 41-2 | 205 | | | Com. Cl 1 | | | | | 1 | 1 | | | | |
| 1965 | | 41-2 | 205 | | | Com. Cl 1 | | | | | 1 | 1 | | | | |
| 1965 | | 41-2 | 205 | | | Com. Cl 1 | | | | | 1 | 1 | | | | |
| 1965 | | 41-2 | 205 | | | Com. Cl 1 | | | | | 1 | 1 | | | | |
| 1965 | | 42-2 | 248 | | Amphithéâtre e dépôt | Com. Cl 1 | | | | | 67 | 67 | | | | |
| 1968 | | 42-3 | 253 | | | Com. Cl 1 | | | | | 2 | 2 | | | | |
| 1968 | | 42-3 | 253 | | | Com. Cl 1 | 1 | | | | | 1 | | | | |
| 1968 | | 42-3 | 253 | | | Com. Cl 1 | 1 | | | | | 1 | | | | |
| 1968 | | 42-3 | 253 | | | Com. Cl 1 | | 2 | | | 10 | 12 | | | | |
| 1965 | | 42-3 | 257 | | | Com. Cl 1 | | | | | 1 | 1 | | | | |
| 1965 | | 42-3 | 257 | | amphithéâtre e dépôt | Com. Cl 1 | | | | | 1 | 1 | | | | |
| 1968 | | 44-2 | 269 | | | Com. Cl 1 | | 1 | | | | 1 | | | | |
| 1968 | | 44-2 | 269 | | | Com. Cl 1 | | | 1 | | | 1 | | | | |
| 1968 | | 44-2 | 269 | | | Com. Cl 1 | | 1 | | | | 1 | | | | |
| 1968 | | 44-2 | 269 | | | Com. Cl 1 | | 4 | 3 | | 63 | 70 | | | | |
| 1989 | | 69-4 | 668 | | | Com. Cl 1 | | | | | 1 | 1 | | | | |
| 1978 | | 15--2 | 905 | | | Com. Cl 1 | | 1 | | | 44 | 45 | | | | |
| 1966 | | 15--4 | 950 | | | Com. Cl 1 | | 9 | 3 | | 93 | 105 | | | | |
| 1966 | | 15--4 | 950 | | | Com. Cl 1 | | | | | 1 | 1 | | | | |

ANNEXE B : AMPHITHÉÂTRE

| année | n° OA | Rayon | Caisse | n° ordre | US | Catégorie | Comptage | | | | | | Typologie | Desc. Typo. | Dessin | Planche |
|-------|----------|-------|--------|-------------|---------|-----------|----------|---|---|---|----|----|-----------|-------------|--------|---------|
| | | | | | | | B | F | A | D | P | NR | | | | |
| 1966 | | 14--3 | 960 | | | Com. Cl 1 | | 1 | | | | 1 | | | | |
| 1964 | | 14--2 | 951 | | | Com. Cl 1 | | | | | 3 | 3 | | | | |
| 1964 | | 14--2 | 951 | | | Com. Cl 1 | 1 | | | | | 1 | | | | |
| 1964 | | 14--2 | 951 | | | Com. Cl 1 | | | | | 2 | 2 | | | | |
| | | 29-2 | 9 | | salle 2 | Com. Cl 1 | | | 2 | 2 | | 4 | | | | |
| | | 29-2 | 9 | | salle 2 | Com. Cl 1 | 1 | | | | | 1 | | | | |
| | | 29-2 | 9 | | salle 2 | Com. Cl 1 | 1 | | | | | 1 | | | | |
| | | 29-2 | 9 | | salle 2 | Com. Cl 1 | | 1 | | | 8 | 9 | | | | |
| | | 29-2 | 9 | | salle 2 | Com. Cl 1 | 1 | | | | | 1 | | | | |
| | | 29-2 | 9 | | | Com. Cl 1 | | 3 | | | 34 | 37 | | | | |
| | | 29-2 | 9 | | | Com. Cl 1 | | 4 | 3 | | 67 | 74 | | | | |
| | | 29-2 | 9 | | | Com. Cl 1 | | 1 | | | | 1 | | | | |
| | | 29-2 | 9 | | | Com. Cl 1 | | 1 | | | | 1 | | | | |
| | | 40-2 | 186 | | | Com. Cl 1 | | | | | 1 | 1 | | | | |
| | | 40-2 | 186 | | | Com. Cl 1 | | | | | 1 | 1 | | | | |
| 1967 | | 40-2 | 191 | | | Com. Cl 1 | | 3 | | | 22 | 25 | | | | |
| | | 40-2 | 189 | | | Com. Cl 1 | | | | | 1 | 1 | | | | |
| | | 41-2 | 195 | | | Com. Cl 1 | | 1 | | | | 1 | | | | |
| | | 41-2 | 198 | | | Com. Cl 1 | | 3 | | | | 3 | | | | |
| | | 41-2 | 198 | | | Com. Cl 1 | | | 2 | | | 2 | | | | |
| | | 41-2 | 198 | | | Com. Cl 1 | | | | | 4 | 4 | | | | |
| | | 42-2 | 245 | | | Com. Cl 1 | | 4 | 4 | | 57 | 65 | | | | |
| | | 42-2 | 245 | | | Com. Cl 1 | | | | | 1 | 1 | | | | |
| | | 42-2 | 245 | | | Com. Cl 1 | 1 | | | | | 1 | | | | |
| | | 42-2 | 245 | | | Com. Cl 1 | 1 | | | | | 1 | | | | |
| | | 42-2 | 245 | | | Com. Cl 1 | 1 | | | | | 1 | | | | |

ANNEXE B : AMPHITHÉÂTRE

| année | n° OA | Rayon | Caisse | n° ordre | US | Catégorie | Comptage | | | | | | Typologie | Desc. Typo. | Dessin | Planche |
|-------|----------|-------|--------|-------------|----|-----------|----------|--------|--------|---|----|----|-----------|-------------|--------|---------|
| | | | | | | | B | F | A | D | P | NR | | | | |
| | | 42-2 | 245 | | | Com. Cl 1 | 1 | | | | | 1 | | | | |
| | | 42-2 | 245 | | | Com. Cl 1 | 1 | | | | | 1 | | | | |
| | | 42-2 | 250 | | | Com. Cl 1 | | 5 | | | | 5 | | | | |
| | | 42-3 | 252 | | | Com. Cl 1 | | 1 | 3 | | 90 | 94 | | | | |
| | | 42-3 | 252 | | | Com. Cl 1 | 1 | | | | | 1 | | | | |
| | | 42-3 | 255 | | | Com. Cl 1 | | 1 | | | | 1 | | | | |
| | | 42-3 | 252 | | | Com. Cl 1 | | | | | 55 | 55 | | | | |
| | | 42-3 | 268 | | | Com. Cl 1 | | 1 | | | 8 | 9 | | | | |
| | | 42-5 | 264 | | | Com. Cl 1 | | 3 6 | 1 6 | | | 52 | | | | |
| | | 42-5 | 264 | | | Com. Cl 1 | | | | | 1 | 1 | | | | |
| | | 42-5 | 264 | | | Com. Cl 1 | | | | | 1 | 1 | | | | |
| | | 42-5 | 264 | | | Com. Cl 1 | | | | | 1 | 1 | | | | |
| | | 42-5 | 264 | | | Com. Cl 1 | | | | | 1 | 1 | | | | |
| | | 42-5 | 264 | | | Com. Cl 1 | | | | | 1 | 1 | | | | |
| | | 42-5 | 264 | | | Com. Cl 1 | | | | | 1 | 1 | | | | |
| | | 42-5 | 264 | | | Com. Cl 1 | | | | | 1 | 1 | | | | |
| | | 42-5 | 264 | | | Com. Cl 1 | | | | | 1 | 1 | | | | |
| | | 42-5 | 264 | | | Com. Cl 1 | | | | | 22 | 22 | | | | |
| | | 42-5 | 264 | | | Com. Cl 1 | | | | | 4 | 4 | | | | |
| | | 42-5 | 266 | | | Com. Cl 1 | | 4 | 1 | | 14 | 14 | | | | |
| 1979 | | 15--3 | 907 | | | Com. Cl 1 | | 1 | 3 | | 3 | 7 | | | | |
| 1979 | | 15--3 | 907 | | | Com. Cl 1 | | | | | 1 | 1 | | | | |
| 1979 | | 15--3 | 907 | | | Com. Cl 1 | | 1 | | | | 1 | | | | |
| 1979 | | 15--3 | 907 | | | Com. Cl 1 | | 1 | | | | 1 | | | | |

ANNEXE B : AMPHITHÉÂTRE

| année | n° OA | Rayon | Caisse | n° ordre | US | Catégorie | Comptage | | | | | | Typologie | Desc. Typo. | Dessin | Planche | |
|-------|----------|-------|--------|-------------|------------------------|-----------|----------|---|---|---|----|----|-----------|-------------|---------------|---------|------|
| | | | | | | | B | F | A | D | P | NR | | | | | NMI |
| 1979 | | 15--3 | 907 | | | Com. Cl 1 | | | 1 | | | 1 | | | | | |
| 1979 | | 15--3 | 907 | | | Com. Cl 1 | | 1 | 3 | | 5 | 9 | | | | | |
| 1979 | | 15--3 | 907 | | | Com. Cl 1 | | 1 | | | | 1 | | | | | |
| 1979 | | 15--3 | 907 | | | Com. Cl 1 | | 1 | | | | 1 | | | | | |
| 1979 | | 15--3 | 907 | | | Com. Cl 1 | | 1 | | | | 1 | | | | | |
| 1979 | | 15--3 | 907 | | | Com. Cl 1 | | | | | 5 | 5 | | | | | |
| 1979 | | 15--3 | 907 | | | Com. Cl 1 | | 1 | | | 1 | 2 | | | | | |
| 1979 | | 14--1 | 918 | | | Com. Cl 1 | | | | | 2 | 2 | | | | | |
| | | 14--1 | 938 | | | Com. Cl 1 | | 1 | | | 5 | 6 | | | | | |
| | | 15--3 | 909 | | couche 7 | Com. Cl 1 | | 3 | 1 | | 22 | 26 | | | | | |
| | | 15--3 | 909 | | | Com. Cl 1 | | 1 | | | | 1 | | | | | |
| | | 15--3 | 909 | | | Com. Cl 1 | | 1 | | | | 1 | | | | | |
| | | 15--3 | 909 | | | Com. Cl 1 | | | | | 1 | 1 | | | | | |
| 1989 | | 34-2 | 110 | | NA3 structure 2 | Com. Cl 2 | 1 | | | | | 1 | 1 | plat | Com. Cl P11.1 | 593 | LIII |
| 1989 | | 34-3 | 115 | | | Com. Cl 2 | 3 | | | | | 3 | 1 | plat | Com. Cl P11.1 | 594 | LIII |
| | | 41-1 | 1584 | | | Com. Cl 2 | 3 | | | | | 3 | 1 | plat | Com. Cl P11.1 | 595 | LIII |
| | | 29-2 | 9 | | salle 2 | Com. Cl 2 | 1 | | | | | 1 | 1 | plat | Com. Cl P11.1 | 596 | LIII |
| | | 29-2 | 9 | | | Com. Cl 2 | 1 | | | | | 1 | 1 | plat | Com. Cl P11.3 | 597 | LIII |
| 1989 | | 36-2 | 124 | | | Com. Cl 2 | 1 | | | | | 1 | 1 | plat | Com. Cl P13 | 598 | LIII |
| 1968 | | 39-5 | 166 | | | Com. Cl 2 | 1 | | | | | 1 | 1 | plat | Com. Cl P13 | 599 | LIII |
| 1965 | | 42-3 | 257 | | amphithéâtr e dépôt | Com. Cl 2 | 1 | | | | | 1 | 1 | plat | Com. Cl P13 | 600 | LIV |
| 1965 | | 42-3 | 257 | | amphithéâtr e dépôt | Com. Cl 2 | 1 | | | | | 1 | 1 | plat | Com. Cl P13 | 601 | LIV |
| | | 29-2 | 9 | | | Com. Cl 2 | 1 | | | | | 1 | 1 | plat | Com. Cl P13 | 602 | LIV |
| 1967 | | 40-2 | 191 | | | Com. Cl 2 | 1 | | | | | 1 | 1 | plat | Com. Cl P13 | 603 | LIV |

ANNEXE B : AMPHITHÉÂTRE

| année | n° OA | Rayon | Caisse | n° ordre | US | Catégorie | Comptage | | | | | | Typologie | Desc. Typo. | Dessin | Planche | |
|------------|-------|--------|--------|----------|---------|-----------|----------|---|---|---|----|----|-----------|-------------|---------------|---------|-----|
| | | | | | | | B | F | A | D | P | NR | | | | | NMI |
| | | 41-2 | 198 | | | Com. Cl 2 | 1 | | | | | 1 | 1 | plat | Com. Cl Pl3 | 604 | LIV |
| | | 41-2 | 198 | | | Com. Cl 2 | 1 | | | | | 1 | 1 | plat | Com. Cl Pl3 | 605 | LIV |
| | | 41-2 | 198 | | | Com. Cl 2 | 1 | | | | | 1 | 1 | plat | Com. Cl Pl3 | 606 | LIV |
| 1968 | | 39-5 | 166 | | | Com. Cl 2 | 1 | | | | | 1 | 1 | plat | Com. Cl Pl7 | 607 | LIV |
| | | 13--4 | 947 | | | Com. Cl 2 | 1 | | | | | 1 | 1 | bol | Com. Cl B2 | 608 | LIV |
| | | 41-2 | 198 | | | Com. Cl 2 | 1 | | | | | 11 | 1 | bol | Com. Cl B4 | 609 | LIV |
| 1968 | | 39-5 | 166 | | | Com. Cl 2 | 1 | | | | | 1 | 1 | bol | Com. Cl B7 | 610 | LIV |
| 1978 | | 19--3 | 1042 | | | Com. Cl 2 | 2 | 2 | | | 50 | 54 | 1 | cruche | Com. Cl Cr1.2 | 611 | LV |
| | | 44-1 | 1606 | | | Com. Cl 2 | 1 | | | | | 1 | 1 | cruche | Com. Cl Cr1.2 | 612 | LV |
| 1966 | | 15--4 | 950 | | | Com. Cl 2 | 1 | | | | | 1 | 1 | cruche | Com. Cl Cr1.2 | 613 | LV |
| | | 29-2 | 9 | | salle 2 | Com. Cl 2 | 1 | | | | | 1 | 1 | cruche | Com. Cl Cr1.2 | 614 | LV |
| | | 15--03 | 903 | | | Com. Cl 2 | 1 | | | | | 1 | 1 | cruche | Com. Cl Cr1.2 | 615 | LV |
| 1989 | | 34-5 | 121 | | NE3 ST4 | Com. Cl 2 | 1 | | | | 1 | 2 | 1 | cruche | Com. Cl Cr3 | 616 | LV |
| 1967 | | 40-2 | 191 | | | Com. Cl 2 | 1 | | | | | 1 | 1 | cruche | Com. Cl Cr3 | 617 | LV |
| 1966 | | 14--3 | 960 | | | Com. Cl 2 | 1 | | | | | 1 | 1 | cruche | Com. Cl Cr4.2 | 618 | LV |
| | | 26--1 | 1487 | | | Com. Cl 2 | | | 1 | | | 1 | 1 | cruche | Com. Cl Cr4.2 | | |
| | | 18--2 | 1088 | | | Com. Cl 2 | 1 | | | | | 1 | 1 | cruche | Com. Cl Cr6.1 | 619 | LV |
| | | 36-1 | 1538 | | | Com. Cl 2 | 1 | | | | | 1 | 1 | cruche | Com. Cl Cr6.1 | 620 | LV |
| 1965 | | 41-2 | 205 | | | Com. Cl 2 | 1 | | | | | 1 | 1 | cruche | Com. Cl Cr6.1 | 621 | LV |
| | | 29-2 | 9 | | | Com. Cl 2 | 1 | | | | | 1 | 1 | cruche | Com. Cl Cr6.1 | 622 | LV |
| 1967 | | 40-2 | 191 | | | Com. Cl 2 | 1 | | | | | 1 | 1 | cruche | Com. Cl Cr6.1 | 623 | LV |
| | | 41-2 | 198 | | | Com. Cl 2 | 1 | | | | | 1 | 1 | cruche | Com. Cl Cr6.1 | 624 | LV |
| | | 41-2 | 198 | | | Com. Cl 2 | 1 | | | | | 1 | 1 | cruche | Com. Cl Cr6.1 | 625 | LV |
| | | 16--3 | 1013 | | | Com. Cl 2 | 1 | | | | | 1 | 1 | cruche | Com. Cl Cr6.3 | 626 | LV |
| 1966-67-68 | | 39-2 | 155 | | | Com. Cl 2 | 1 | | | | | 1 | 1 | cruche | Com. Cl Cr7.1 | 627 | LV |

ANNEXE B : AMPHITHÉÂTRE

| année | n° OA | Rayon | Caisse | n° ordre | US | Catégorie | Comptage | | | | | | Typologie | Desc. Typo. | Dessin | Planche | |
|----------------|----------|--------|--------|-------------|-----|-----------|----------|---|---|---|---|----|-----------|--------------------|---------------|---------|-----|
| | | | | | | | B | F | A | D | P | NR | | | | | NMI |
| | | 36-1 | 1535 | | | Com. Cl 2 | 1 | | | | | 1 | 1 | cruche | Com. Cl Cr7.1 | 628 | LV |
| | | 16--3 | 1013 | | | Com. Cl 2 | 1 | | | | | 1 | 1 | cruche | Com. Cl Cr7.1 | 629 | LV |
| 1989 | | 36-2 | 124 | | | Com. Cl 2 | 1 | | | | | 1 | 1 | cruche | Com. Cl Cr7.1 | 630 | LV |
| | | 44-1 | 1605 | | | Com. Cl 2 | 1 | | | | | 1 | 1 | cruche | Com. Cl Cr8 | 631 | LV |
| 1965 | | 41-2 | 205 | | | Com. Cl 2 | 1 | | | | | 1 | 1 | cruche | Com. Cl Cr10 | 632 | LV |
| 1966 | | 42-2 | 244 | | | Com. Cl 2 | 2 | | | | | 2 | 1 | cruche | Com. Cl Cr10 | 633 | LV |
| 1965 | | 41-2 | 205 | | | Com. Cl 2 | 1 | | | | | 1 | 1 | cruche | Com. Cl Cr10 | 634 | LV |
| 1966 | | 14--3 | 960 | | | Com. Cl 2 | 1 | | | | | 1 | 1 | cruche | Com. Cl Cr15 | 635 | LVI |
| | | 19--1 | 1035 | | | Com. Cl 2 | 1 | | | | | 1 | 1 | cruche | Com. Cl Cr16 | 636 | LVI |
| | | 37-1 | 1530 | | | Com. Cl 2 | 5 | | | | | 5 | 1 | cruche- amphore | | 637 | LVI |
| 1989 | | 36-2 | 124 | | | Com. Cl 2 | 1 | | | | | 1 | 1 | pot | Com. Cl P1.1 | 638 | LVI |
| 1966 | | 15--4 | 950 | | | Com. Cl 2 | 1 | | | | | 1 | 1 | pot | Com. Cl P1.1 | 639 | LVI |
| 1989 | | 34-4 | 116 | | | Com. Cl 2 | 1 | 2 | | | | 3 | 1 | pot | Com. Cl P2 | 640 | LVI |
| 1968 | | 44-2 | 269 | | | Com. Cl 2 | 2 | | | | | 2 | 1 | pot | Com. Cl P2 | 641 | LVI |
| 1966 | | 15--4 | 950 | | | Com. Cl 2 | 1 | | | | | 1 | 1 | pot | Com. Cl P2 | 642 | LVI |
| 1966 | | 14--3 | 960 | | | Com. Cl 2 | 1 | | | | | 1 | 1 | pot | Com. Cl P4.2 | 643 | LVI |
| | | 44-1 | 1597 | | | Com. Cl 2 | 1 | | | | | 1 | 1 | pot | Com. Cl P5.2 | 644 | LVI |
| 1966 | | 42-2 | 244 | | | Com. Cl 2 | 1 | | | | | 1 | 1 | pot | Com. Cl P5.2 | 645 | LVI |
| 1966 | | 14--3 | 960 | | | Com. Cl 2 | 1 | | | | | 1 | 1 | pot | Com. Cl P6.3 | 646 | LVI |
| 1966 | | 15--4 | 950 | | | Com. Cl 2 | 1 | | | | | 1 | 1 | pot | Com. Cl P7.1 | 647 | LVI |
| | | 41-2 | 195 | | | Com. Cl 2 | 1 | | | | | 1 | 1 | couvercle | Com. Cl Cv2 | 648 | LVI |
| | | 15--03 | 903 | | | Com. Cl 2 | | | | 1 | | 1 | 1 | | | 649 | LVI |
| 1966-67- 68 | | 39-2 | 155 | | | Com. Cl 2 | | 1 | | | 1 | 2 | 1 | | | | |
| 1966-67- 68 | | 39-2 | 155 | | S34 | Com. Cl 2 | | | | 1 | | 1 | 1 | | | | |

ANNEXE B : AMPHITHÉÂTRE

| année | n° OA | Rayon | Caisse | n° ordre | US | Catégorie | Comptage | | | | | | Typologie | Desc. Typo. | Dessin | Planche |
|------------|----------|-------|--------|-------------|------------------------------|-----------|----------|---|---|---|----|----|-----------|-------------|--------|---------|
| | | | | | | | B | F | A | D | P | NR | | | | |
| 1966-67-68 | | 39-2 | 155 | | | Com. Cl 2 | | | | | 1 | 1 | | | | |
| 1966-67-68 | | 39-2 | 155 | | | Com. Cl 2 | | 1 | | | | 1 | 1 | | | |
| 1966-67-68 | | 39-2 | 155 | | | Com. Cl 2 | | 1 | | | | 1 | 1 | | | |
| 1968 | | 40-2 | 192 | | | Com. Cl 2 | | | 1 | | | 1 | | | | |
| | | 35-4 | 102 | | | Com. Cl 2 | | | | | 24 | 24 | | | | |
| | | 35-5 | 105 | | | Com. Cl 2 | | | | | 23 | 23 | | | | |
| 1989 | | 34-2 | 111 | | ND3 structure 4.14 | Com. Cl 2 | | 1 | | | 3 | 4 | | | | |
| 1989 | | 34-2 | 111 | | ND3 structure 4.9B | Com. Cl 2 | | 1 | | | 12 | 13 | | | | |
| 1989 | | 34-3 | 113 | | ND3 structure 4- 7B-7C | Com. Cl 2 | | | | | 6 | 6 | | | | |
| 1989 | | 34-3 | 113 | | 2A7 étage 2 | Com. Cl 2 | | | | | 6 | 6 | | | | |
| 1989 | | 34-3 | 115 | | 4NC3 | Com. Cl 2 | | | 2 | | 24 | 26 | | | | |
| 1989 | | 34-3 | 115 | | 4NE3 | Com. Cl 2 | | | 1 | | 4 | 5 | | | | |
| 1989 | | 34-5 | 123 | | 5NC3 | Com. Cl 2 | | | | | 21 | 21 | | | | |
| 1989 | | 34-5 | 125 | | SD8 | Com. Cl 2 | | | | | 19 | 19 | | | | |
| 1989 | | 36-2 | 128 | | 5NA2 | Com. Cl 2 | | | | | 7 | 7 | | | | |
| 1989 | | 36-2 | 129 | | 2SC3 | Com. Cl 2 | | | | | 9 | 9 | | | | |
| 1989 | | 37-5 | 137 | | ND3 ST4 | Com. Cl 2 | | | | | 21 | 21 | | | | |
| 1989 | | 37-5 | 136 | | 5ND3 | Com. Cl 2 | | | | | 19 | 19 | | | | |
| | | 39-2 | 156 | | | Com. Cl 2 | | | | | 3 | 3 | | | | |
| | | 39-3 | 161 | | | Com. Cl 2 | | | 1 | | 14 | 15 | | | | |

ANNEXE B : AMPHITHÉÂTRE

| année | n° OA | Rayon | Caisse | n° ordre | US | Catégorie | Comptage | | | | | | Typologie | Desc. Typo. | Dessin | Planche |
|-------|----------|-------|--------|-------------|----|-----------|----------|---|---|---|----|----|-----------|-------------|--------|---------|
| | | | | | | | B | F | A | D | P | NR | | | | |
| | | 38-2 | 178 | | | Com. Cl 2 | | 1 | | | 12 | 13 | | | | |
| | | 15--3 | 910 | | | Com. Cl 2 | | 1 | | | 3 | 4 | | | | |
| | | 15--1 | 936 | | | Com. Cl 2 | | | | | 19 | 19 | | | | |
| | | 14--2 | 955 | | | Com. Cl 2 | | | | | 3 | 3 | | | | |
| | | 14--1 | 937 | | | Com. Cl 2 | | | | | 12 | 12 | | | | |
| | | 14--2 | 954 | | | Com. Cl 2 | | | | | 16 | 16 | | | | |
| | | 14--2 | 954 | | | Com. Cl 2 | | | | | 16 | 16 | | | | |
| | | 14--3 | 961 | | | Com. Cl 2 | | | 1 | | | 1 | | | | |
| | | 14--3 | 963 | | | Com. Cl 2 | | | | | 22 | 22 | | | | |
| | | 14--5 | 968 | | | Com. Cl 2 | | | | | 4 | 4 | | | | |
| | | 12--5 | 1358 | | | Com. Cl 2 | | | | | 10 | 10 | | | | |
| | | 12--2 | 1356 | | | Com. Cl 2 | | | | | 12 | 12 | | | | |
| | | 44--4 | 284 | | | Com. Cl 2 | | 1 | | | 16 | 17 | | | | |
| | | 44--4 | 286 | | | Com. Cl 2 | | 2 | | | | 2 | | | | |
| | | 45-2 | 301 | | | Com. Cl 2 | | | | | 27 | 27 | | | | |
| | | 44-1 | 1597 | | | Com. Cl 2 | | | | | 35 | 35 | | | | |
| | | 44-1 | 1595 | | | Com. Cl 2 | | | | | 14 | 14 | | | | |
| | | 44-1 | 1609 | | | Com. Cl 2 | | | | | 3 | 3 | | | | |
| | | 44-1 | 1606 | | | Com. Cl 2 | | | | | 10 | 10 | | | | |
| | | 20--2 | 1145 | | | Com. Cl 2 | | 1 | | | 69 | 70 | | | | |
| 1966 | | 21--1 | 1146 | | | Com. Cl 2 | | | 1 | | 2 | 3 | | | | |
| 1966 | | 21--1 | 1157 | | | Com. Cl 2 | | | | | 14 | 14 | | | | |
| 1965 | | 21--1 | 1126 | | | Com. Cl 2 | | | | | 17 | 17 | | | | |
| 1966 | | 21--1 | 1155 | | | Com. Cl 2 | | | | | 97 | 97 | | | | |
| | | 46-2 | 1479 | | | Com. Cl 2 | | | | | 33 | 33 | | | | |
| | | 46-1 | 1476 | | | Com. Cl 2 | | 1 | | | | 1 | | | | |

ANNEXE B : AMPHITHÉÂTRE

| année | n° OA | Rayon | Caisse | n° ordre | US | Catégorie | Comptage | | | | | | Typologie | Desc. Typo. | Dessin | Planche |
|-------|----------|-------|--------|-------------|------------------|-----------|----------|---|---|---|----|----|-----------|-------------|--------|---------|
| | | | | | | | B | F | A | D | P | NR | | | | |
| | | 20--2 | 1141 | | | Com. Cl 2 | | | | | 3 | 3 | | | | |
| | | 45-3 | 305 | | | Com. Cl 2 | | | | | 24 | 24 | | | | |
| | | 36-1 | 1542 | | | Com. Cl 2 | | 1 | | | 17 | 18 | | | | |
| | | 38-1 | 1545 | | | Com. Cl 2 | | 1 | | | 9 | 10 | | | | |
| | | 38-1 | 1554 | | | Com. Cl 2 | | 1 | | | 10 | 11 | | | | |
| | | 38-1 | 1551 | | | Com. Cl 2 | | 2 | | | | 2 | | | | |
| 1966 | | 17--1 | 1020 | | | Com. Cl 2 | | 1 | | | 4 | 5 | | | | |
| 1966 | | 17--4 | 1032 | | | Com. Cl 2 | | 2 | 1 | | 14 | 17 | | | | |
| 1966 | | 17--1 | 1023 | | | Com. Cl 2 | | 1 | | | 9 | 10 | | | | |
| 1969 | | 16--2 | 1003 | | | Com. Cl 2 | | 1 | | | 22 | 23 | | | | |
| 1968 | | 15--3 | 943 | | | Com. Cl 2 | | | | | 10 | 10 | | | | |
| 1966 | | 17--4 | 1031 | | | Com. Cl 2 | | | | | 19 | 19 | | | | |
| 1968 | | 15--4 | 947 | | | Com. Cl 2 | | 2 | 1 | | 14 | 17 | | | | |
| 1966 | | 19--5 | 1084 | | | Com. Cl 2 | | 1 | | | 8 | 9 | | | | |
| | | 19--4 | 1064 | | | Com. Cl 2 | | 2 | | | 3 | 5 | | | | |
| | | 18--3 | 1092 | | | Com. Cl 2 | | 3 | | | 41 | 44 | | | | |
| 1968 | | 16--3 | 1012 | | | Com. Cl 2 | | 1 | | | 11 | 12 | | | | |
| 1966 | | 18--2 | 1086 | | | Com. Cl 2 | | | | | 14 | 14 | | | | |
| 1974 | | 18--3 | 1057 | | | Com. Cl 2 | | | | | 18 | 18 | | | | |
| 1966 | | 16--5 | 1019 | | | Com. Cl 2 | | 3 | | | 34 | 37 | | | | |
| | | 21--1 | 1156 | | | Com. Cl 2 | | 1 | | | 2 | 3 | | | | |
| 1990 | 967 | 47-4 | 1666 | 3 | NA3b couche 1 | Com. Cl 2 | | | | | 16 | 16 | | | | |
| 1990 | 967 | 47-4 | 1666 | 7 | NA3a | Com. Cl 2 | | | | | 78 | 78 | | | | |
| 1990 | 967 | 47-4 | 1666 | 5 | NA3a | Com. Cl 2 | | | | | 48 | 48 | | | | |
| | | 20--2 | 1142 | | | Com. Cl 2 | | | | | 14 | 14 | | | | |

ANNEXE B : AMPHITHÉÂTRE

| année | n° OA | Rayon | Caisse | n° ordre | US | Catégorie | Comptage | | | | | | Typologie | Desc. Typo. | Dessin | Planche |
|-------|----------|-------|--------|-------------|----|-----------|----------|---|---|---|----|----|-----------|-------------|--------|---------|
| | | | | | | | B | F | A | D | P | NR | | | | |
| 1968 | | 20--3 | 1148 | | | Com. Cl 2 | | | | | 12 | 12 | | | | |
| 1969 | | 20--3 | 1146 | | | Com. Cl 2 | | | 1 | | 31 | 32 | | | | |
| 1969 | | 20--2 | 1140 | | | Com. Cl 2 | | | | | 3 | 3 | | | | |
| 1968 | | 20--2 | 1144 | | | Com. Cl 2 | | 6 | | | 64 | 70 | | | | |
| | | 21--4 | 1166 | | | Com. Cl 2 | | | | | 31 | 31 | | | | |
| 1966 | | | | | | Com. Cl 2 | | 1 | | | 4 | 5 | | | | |
| | | 41-1 | 1583 | | | Com. Cl 2 | | | | | 31 | 31 | | | | |
| | | 42-1 | 1462 | | | Com. Cl 2 | | | 1 | | 37 | 38 | | | | |
| | | 42-1 | 1568 | | | Com. Cl 2 | | | 2 | | 39 | 41 | | | | |
| | | 42-1 | 1569 | | | Com. Cl 2 | | 3 | 1 | | 37 | 41 | | | | |
| | | 45-3 | 309 | | | Com. Cl 2 | | | | | 17 | 17 | | | | |
| | | 36-1 | 1535 | | | Com. Cl 2 | | 3 | | | 17 | 20 | | | | |
| | | 45-3 | 307 | | | Com. Cl 2 | | | | | 5 | 5 | | | | |
| | | 37-1 | 1533 | | | Com. Cl 2 | | | | | 13 | 13 | | | | |
| | | 36-2 | 1529 | | | Com. Cl 2 | | | | | 12 | 12 | | | | |
| | | 37-2 | 1560 | | | Com. Cl 2 | | 1 | 2 | | 55 | 58 | | | | |
| | | 37-1 | 1530 | | | Com. Cl 2 | | 2 | | | 37 | 58 | | | | |
| | | 28--4 | 1603 | | | Com. Cl 2 | | 3 | | | 28 | 31 | | | | |
| | | 47-3 | 1654 | | | Com. Cl 2 | | | | | 47 | 47 | | | | |
| | | 38-3 | 1632 | | | Com. Cl 2 | | 3 | | | 19 | 22 | | | | |
| | | 31-2 | 1596 | | | Com. Cl 2 | | 6 | | | 47 | 53 | | | | |
| 1989 | | 36-2 | 124 | | | Com. Cl 2 | | | | | 4 | 4 | | | | |
| 1989 | | 36-2 | 124 | | | Com. Cl 2 | | | | | 6 | 6 | | | | |
| 1989 | | 36-2 | 124 | | | Com. Cl 2 | | | | | 3 | 3 | | | | |
| 1968 | | 39-5 | 166 | | | Com. Cl 2 | | | | | 1 | 1 | | | | |

ANNEXE B : AMPHITHÉÂTRE

| année | n° OA | Rayon | Caisse | n° ordre | US | Catégorie | Comptage | | | | | | Typologie | Desc. Typo. | Dessin | Planche |
|-------|----------|-------|--------|-------------|-----------------------|-----------|----------|---|---|---|----|----|-----------|-------------|--------|---------|
| | | | | | | | B | F | A | D | P | NR | | | | |
| 1968 | | 39-5 | 166 | | | Com. Cl 2 | 1 | | | | | 1 | | | | |
| 1968 | | 39-5 | 166 | | | Com. Cl 2 | | 4 | | | | 4 | | | | |
| 1965 | | 41-2 | 205 | | | Com. Cl 2 | | | | | 1 | 1 | | | | |
| 1965 | | 41-2 | 205 | | | Com. Cl 2 | | | | | 1 | 1 | | | | |
| 1966 | | 42-2 | 244 | | | Com. Cl 2 | | 1 | | | 5 | 6 | | | | |
| 1968 | | 42-3 | 253 | | | Com. Cl 2 | | 1 | | | 3 | 4 | | | | |
| 1965 | | 42-3 | 257 | | amphithéâtre dépôt | Com. Cl 2 | | | | | 1 | 1 | | | | |
| 1965 | | 42-3 | 257 | | amphithéâtre dépôt | Com. Cl 2 | | | | | 1 | 1 | | | | |
| 1968 | | 44-2 | 269 | | | Com. Cl 2 | | | 1 | | | 1 | | | | |
| 1968 | | 44-2 | 269 | | | Com. Cl 2 | | 1 | 1 | | 17 | 19 | | | | |
| 1966 | | 15--4 | 950 | | | Com. Cl 2 | | 3 | 2 | | 47 | 52 | | | | |
| 1966 | | 15--4 | 950 | | | Com. Cl 2 | | | | | 2 | 2 | | | | |
| 1966 | | 15--4 | 950 | | | Com. Cl 2 | | | | | 1 | 1 | | | | |
| 1966 | | 15--4 | 950 | | | Com. Cl 2 | | | | | 1 | 1 | | | | |
| 1966 | | 15--4 | 950 | | | Com. Cl 2 | | | | | 1 | 1 | | | | |
| 1966 | | 15--4 | 950 | | | Com. Cl 2 | | | | | 1 | 1 | | | | |
| 1966 | | 14--3 | 960 | | | Com. Cl 2 | | | | 3 | | 3 | | | | |
| 1964 | | 14--2 | 951 | | | Com. Cl 2 | 1 | | | | | 1 | | | | |
| | | 29-2 | 9 | | salle 2 | Com. Cl 2 | 1 | | | | | 1 | | | | |
| | | 29-2 | 9 | | salle 2 | Com. Cl 2 | | 3 | 1 | | | 4 | | | | |
| | | 29-2 | 9 | | salle 2 | Com. Cl 2 | | | | | 1 | 1 | | | | |
| | | 29-2 | 9 | | salle 2 | Com. Cl 2 | | | | | 8 | 8 | | | | |
| | | 29-2 | 9 | | salle 2 | Com. Cl 2 | | | | | 1 | 1 | | | | |
| | | 29-2 | 9 | | | Com. Cl 2 | | 1 | 1 | | 25 | 27 | | | | |
| | | 29-2 | 9 | | | Com. Cl 2 | | 1 | | | | 1 | | | | |

ANNEXE B : AMPHITHÉÂTRE

| année | n° OA | Rayon | Caisse | n° ordre | US | Catégorie | Comptage | | | | | | Typologie | Desc. Typo. | Dessin | Planche |
|-------|----------|--------|--------|-------------|----|-----------|----------|---|---|---|----|----|-----------|-------------|--------|---------|
| | | | | | | | B | F | A | D | P | NR | | | | |
| | | 40-2 | 186 | | | Com. Cl 2 | | | | | 1 | 1 | | | | |
| 1967 | | 40-2 | 191 | | | Com. Cl 2 | | 3 | | | 80 | 83 | | | | |
| 1967 | | 40-2 | 191 | | | Com. Cl 2 | | | | 6 | | 6 | | | | |
| 1967 | | 40-2 | 191 | | | Com. Cl 2 | | | | | 1 | 1 | | | | |
| 1967 | | 40-2 | 191 | | | Com. Cl 2 | | | | | 1 | 1 | | | | |
| | | 41-2 | 195 | | | Com. Cl 2 | | | | 2 | | 2 | | | | |
| | | 41-2 | 198 | | | Com. Cl 2 | | 1 | | | | 1 | | | | |
| | | 41-2 | 198 | | | Com. Cl 2 | | | | | 1 | 1 | | | | |
| | | 41-2 | 198 | | | Com. Cl 2 | | | 1 | | 3 | 4 | | | | |
| | | 42-2 | 250 | | | Com. Cl 2 | | 1 | | | | 18 | | | | |
| | | 42-2 | 250 | | | Com. Cl 2 | 1 | | | | | 1 | | | | |
| | | 42-2 | 250 | | | Com. Cl 2 | | 2 | | | | 2 | | | | |
| | | 42-3 | 252 | | | Com. Cl 2 | | | | | 7 | 7 | | | | |
| | | 42-3 | 252 | | | Com. Cl 2 | | | 1 | | | 1 | | | | |
| | | 42-3 | 252 | | | Com. Cl 2 | 1 | | | | | 1 | | | | |
| | | 42-3 | 252 | | | Com. Cl 2 | | | 2 | | 3 | 5 | | | | |
| | | 42-3 | 252 | | | Com. Cl 2 | 1 | | | | | 1 | | | | |
| | | 42-3 | 268 | | | Com. Cl 2 | | | | | 2 | 2 | | | | |
| | | 42-5 | 264 | | | Com. Cl 2 | | 1 | | | 13 | 14 | | | | |
| | | 42-5 | 266 | | | Com. Cl 2 | | | | | 15 | 15 | | | | |
| | | 42-5 | 266 | | | Com. Cl 2 | | 4 | | | 2 | 6 | | | | |
| | | 42-5 | 266 | | | Com. Cl 2 | | 1 | | | 1 | 2 | | | | |
| | | 15--03 | 903 | | | Com. Cl 2 | | 3 | | | 1 | 4 | | | | |
| | | 15--03 | 903 | | | Com. Cl 2 | | | 1 | | | 1 | | | | |
| | | 15--03 | 903 | | | Com. Cl 2 | | | | | 1 | 1 | | | | |
| | | 15--03 | 903 | | | Com. Cl 2 | | | | | 1 | 1 | | | | |

ANNEXE B : AMPHITHÉÂTRE

| année | n° OA | Rayon | Caisse | n° ordre | US | Catégorie | Comptage | | | | | | Typologie | Desc. Typo. | Dessin | Planche | |
|----------------|----------|-------|--------|-------------|-------------------------|-----------|----------|---|---|---|----|----|-----------|-------------|---------------|---------|------|
| | | | | | | | B | F | A | D | P | NR | | | | | NMI |
| 1979 | | 15--3 | 907 | | | Com. Cl 2 | | 2 | | | 1 | 3 | | | | | |
| 1979 | | 15--3 | 907 | | | Com. Cl 2 | | 4 | | | | 4 | | | | | |
| 1979 | | 15--3 | 907 | | | Com. Cl 2 | | 1 | | 1 | 13 | 15 | | | | | |
| 1979 | | 15--3 | 907 | | | Com. Cl 2 | | | | | 2 | 2 | | | | | |
| 1979 | | 15--3 | 907 | | | Com. Cl 2 | | | 1 | | 16 | 17 | | | | | |
| | | 14--1 | 938 | | | Com. Cl 2 | | | | | 16 | 16 | | | | | |
| | | 15--3 | 909 | | couche 7 | Com. Cl 2 | | | 1 | | 16 | 17 | | | | | |
| | | 15--3 | 909 | | couche 8 | Com. Cl 2 | | 1 | | | 12 | 13 | | | | | |
| 1965 | | 42-3 | 257 | | amphithéâtre e dépôt | Com. Cl 3 | 1 | | | | | 1 | 1 | plat | Com. Cl P11.1 | 650 | LVII |
| 1966-67- 68 | | 39-2 | 155 | | | Com. Cl 3 | 1 | | | | | 1 | 1 | plat | Com. Cl P12.1 | 651 | LVII |
| | | 37-2 | 1560 | | | Com. Cl 3 | 1 | | | | | 1 | 1 | plat | Com. Cl P13 | 652 | LVII |
| | | 12--5 | 1360 | | | Com. Cl 3 | 1 | | | | | 1 | 1 | plat | Com. Cl P13 | 653 | LVII |
| | | 12--5 | 1360 | | | Com. Cl 3 | 1 | | | | | 1 | 1 | plat | Com. Cl P13 | 654 | LVII |
| | | 18--2 | 1086 | | | Com. Cl 3 | 1 | | | | | 1 | 1 | plat | Com. Cl P13 | 655 | LVII |
| 1965 | | 42-3 | 257 | | amphithéâtre e dépôt | Com. Cl 3 | 1 | | | | | 1 | 1 | plat | Com. Cl P13 | 656 | LVII |
| 1965 | | 42-3 | 257 | | amphithéâtre e dépôt | Com. Cl 3 | 1 | | | | | 1 | 1 | plat | Com. Cl P13 | 657 | LVII |
| 1965 | | 42-3 | 257 | | amphithéâtre e dépôt | Com. Cl 3 | 1 | | | | | 1 | 1 | plat | Com. Cl P13 | 658 | LVII |
| | | 40-2 | 189 | | | Com. Cl 3 | 1 | | | | | 1 | 1 | plat | Com. Cl P13 | 659 | LVII |
| | | 41-2 | 198 | | | Com. Cl 3 | 1 | | | | | 1 | 1 | plat | Com. Cl P13 | 660 | LVII |
| 1966 | | 15--4 | 950 | | | Com. Cl 3 | 1 | | | | | 1 | 1 | plat | Com. Cl P15 | 661 | LVII |
| 1966 | | 14--3 | 960 | | | Com. Cl 3 | 1 | | | | | 1 | 1 | plat | Com. Cl P15 | 662 | LVII |
| 1966-67- 68 | | 39-2 | 155 | | | Com. Cl 3 | 1 | | | | | 1 | 1 | plat | Com. Cl P17 | 663 | LVII |

ANNEXE B : AMPHITHÉÂTRE

| année | n° OA | Rayon | Caisse | n° ordre | US | Catégorie | Comptage | | | | | | Typologie | Desc. Typo. | Dessin | Planche | |
|------------|-------|-------|--------|----------|-----------------------|-----------|----------|---|---|---|---|----|-----------|-------------|---------------|---------|-------|
| | | | | | | | B | F | A | D | P | NR | | | | | NMI |
| | | 37-2 | 1560 | | | Com. Cl 3 | 1 | | | | | 1 | 1 | bol | Com. Cl B1 | 664 | LVII |
| 1968 | | 44-2 | 269 | | | Com. Cl 3 | 1 | | | | | 1 | 1 | bol | Com. Cl B3 | 665 | LVIII |
| 1966-67-68 | | 39-2 | 155 | | | Com. Cl 3 | 1 | | | | | 1 | 1 | bol | Com. Cl B6.2 | 666 | LVIII |
| 1966 | | 15--4 | 950 | | | Com. Cl 3 | 1 | | | | | 1 | 1 | bol | Com. Cl B6.3 | 667 | LVIII |
| 1965 | | 42-3 | 257 | | amphithéâtre dépôt | Com. Cl 3 | 1 | | | | | 1 | 1 | marmite | Com. Cl M2 | 668 | LVIII |
| | | 17--4 | 1031 | | | Com. Cl 3 | 1 | | | | | 1 | 1 | cruche | Com. Cl Cr1.1 | 669 | LVIII |
| | | 41-1 | 1584 | | | Com. Cl 3 | 1 | | | | | 1 | 1 | cruche | Com. Cl Cr1.1 | 670 | LVIII |
| | | 20--4 | 1149 | | | Com. Cl 3 | 1 | | | | | 1 | 1 | cruche | Com. Cl Cr1.1 | 671 | LVIII |
| | | 36-1 | 1538 | | | Com. Cl 3 | 1 | | | | | 1 | 1 | cruche | Com. Cl Cr1.1 | 672 | LVIII |
| | | 42-5 | 266 | | | Com. Cl 3 | 1 | | | | | 1 | 1 | cruche | Com. Cl Cr1.1 | 673 | LVIII |
| 1966-67-68 | | 39-2 | 155 | | | Com. Cl 3 | 1 | | | | | 1 | 1 | cruche | Com. Cl Cr3 | 674 | LVIII |
| | | 36-1 | 1529 | | | Com. Cl 3 | 1 | | | | | 1 | 1 | cruche | Com. Cl Cr3 | 675 | LVIII |
| 1964 | | 14--2 | 951 | | | Com. Cl 3 | 2 | | | | | 2 | 1 | cruche | Com. Cl Cr3 | 676 | LVIII |
| | | 40-2 | 189 | | | Com. Cl 3 | 1 | | | | | 1 | 1 | cruche | Com. Cl Cr3 | 677 | LVIII |
| | | 43-1 | 1573 | | | Com. Cl 3 | 1 | | | | | 1 | 1 | cruche | Com. Cl Cr3 | 678 | LVIII |
| 1966-67-68 | | 39-2 | 155 | | | Com. Cl 3 | 1 | | | | | 1 | 1 | cruche | Com. Cl Cr4.2 | 679 | LVIII |
| | | 18--1 | 1049 | | | Com. Cl 3 | 1 | | | | | 1 | 1 | cruche | Com. Cl Cr4.2 | 680 | LIX |
| | | 12--5 | 1360 | | | Com. Cl 3 | 1 | | | | | 1 | 1 | cruche | Com. Cl Cr4.2 | 681 | LIX |
| | | 36-1 | 1538 | | | Com. Cl 3 | 1 | | | | | 1 | 1 | cruche | Com. Cl Cr4.2 | 682 | LIX |
| | | 17--4 | 1032 | | | Com. Cl 3 | 2 | | | | | 2 | 1 | cruche | Com. Cl Cr5 | 683 | LIX |
| | | 36-1 | 1538 | | | Com. Cl 3 | 1 | | | | | 1 | 1 | cruche | Com. Cl Cr5 | 684 | LIX |
| | | 44-1 | 1609 | | | Com. Cl 3 | 1 | | | | | 1 | 1 | cruche | Com. Cl Cr6.1 | 685 | LIX |
| | | 17--4 | 1031 | | | Com. Cl 3 | 1 | | | | | 1 | 1 | cruche | Com. Cl Cr6.1 | 686 | LIX |

ANNEXE B : AMPHITHÉÂTRE

| année | n° OA | Rayon | Caisse | n° ordre | US | Catégorie | Comptage | | | | | | Typologie | Desc. Typo. | Dessin | Planche | |
|-------|----------|-------|--------|-------------|------------------------|-----------|----------|---|---|---|---|----|-----------|-------------|---------------|---------|-----|
| | | | | | | | B | F | A | D | P | NR | | | | | NMI |
| | | 21--4 | 1166 | | | Com. Cl 3 | 1 | | | | | 1 | 1 | cruche | Com. Cl Cr6.1 | 687 | LIX |
| | | 17--4 | 1031 | | | Com. Cl 3 | 1 | | | | | 1 | 1 | cruche | Com. Cl Cr7.1 | 688 | LIX |
| | | 41-1 | 1584 | | | Com. Cl 3 | 1 | | | | | 1 | 1 | cruche | Com. Cl Cr7.1 | 689 | LIX |
| | | 21--4 | 1166 | | | Com. Cl 3 | 1 | | | | | 1 | 1 | cruche | Com. Cl Cr8 | 690 | LIX |
| | | 20--4 | 1149 | | | Com. Cl 3 | 1 | | | | | 1 | 1 | cruche | Com. Cl Cr8 | 691 | LIX |
| | | 21--4 | 1166 | | | Com. Cl 3 | 1 | | | | | 1 | 1 | cruche | Com. Cl Cr12 | 692 | LIX |
| | | 42-1 | 1567 | | | Com. Cl 3 | 1 | | | | | 1 | 1 | cruche | Com. Cl Cr13 | 693 | LIX |
| | | 16--3 | 995 | | | Com. Cl 3 | 1 | | | | | 1 | 1 | cruche | Com. Cl Cr15 | 694 | LIX |
| | | 42-1 | 1567 | | | Com. Cl 3 | 1 | | | | | 1 | 1 | cruche | Com. Cl Cr16 | 695 | LX |
| | | 12--5 | 1360 | | | Com. Cl 3 | 1 | | | | | 1 | 1 | pot | Com. Cl P1.1 | 696 | LX |
| | | 40-2 | 189 | | | Com. Cl 3 | 1 | | | | | 1 | 1 | pot | Com. Cl P1.1 | 697 | LX |
| 1979 | | 14--1 | 918 | | | Com. Cl 3 | 1 | | | | | 1 | 1 | pot | Com. Cl P1.1 | 698 | LX |
| | | 41-1 | 1574 | | | Com. Cl 3 | 1 | | | | | 1 | 1 | pot | Com. Cl P2 | 699 | LX |
| | | 12--5 | 1360 | | | Com. Cl 3 | 1 | | | | | 1 | 1 | pot | Com. Cl P2 | 700 | LX |
| 1979 | | 15--3 | 907 | | | Com. Cl 3 | 1 | | | | | 1 | 1 | pot | Com. Cl P2 | 701 | LX |
| | | 44-1 | 1609 | | | Com. Cl 3 | 1 | | | | | 1 | 1 | pot | Com. Cl P3 | 702 | LX |
| | | 37-2 | 1560 | | | Com. Cl 3 | 1 | | | | | 1 | 1 | pot | Com. Cl P3 | 703 | LX |
| 1965 | | 42-3 | 257 | | | Com. Cl 3 | 1 | | | | | 1 | 1 | pot | Com. Cl P5.1 | 704 | LX |
| 1965 | | 42-3 | 257 | | amphithéâtr e dépôt | Com. Cl 3 | 1 | | | | | 1 | 1 | pot | Com. Cl P5.1 | 705 | LX |
| 1965 | | 42-3 | 257 | | amphithéâtr e dépôt | Com. Cl 3 | 1 | | | | | 1 | 1 | pot | Com. Cl P5.1 | 706 | LX |
| | | 17--4 | 1031 | | | Com. Cl 3 | 1 | | | | | 1 | 1 | pot | Com. Cl P6.1 | 707 | LX |
| | | 41-1 | 1574 | | | Com. Cl 3 | 1 | | | | | 1 | 1 | pot | Com. Cl P6.1 | 708 | LX |
| 1965 | | 42-3 | 257 | | amphithéâtr e dépôt | Com. Cl 3 | 1 | | | | | 1 | 1 | pot | Com. Cl P6.1 | 709 | LXI |

ANNEXE B : AMPHITHÉÂTRE

| année | n° OA | Rayon | Caisse | n° ordre | US | Catégorie | Comptage | | | | | | Typologie | Desc. Typo. | Dessin | Planche | |
|-------|----------|-------|--------|-------------|-------------------------|-----------|----------|---|---|---|----|----|-----------|-------------------------------|--------------|---------|-----|
| | | | | | | | B | F | A | D | P | NR | | | | | NMI |
| 1965 | | 42-3 | 257 | | amphithéâtre e dépôt | Com. Cl 3 | 1 | | | | | 1 | 1 | pot | Com. Cl P6.1 | 710 | LXI |
| 1966 | | 14--3 | 960 | | | Com. Cl 3 | 1 | | | | | 1 | 1 | pot | Com. Cl P6.1 | 711 | LXI |
| | | 12--5 | 1360 | | | Com. Cl 3 | 1 | | | | | 1 | 1 | pot | Com. Cl P6.3 | 712 | LXI |
| 1965 | | 42-3 | 257 | | | Com. Cl 3 | 1 | | | | | 1 | 1 | pot | Com. Cl P6.3 | 713 | LXI |
| 1965 | | 42-3 | 257 | | amphithéâtre e dépôt | Com. Cl 3 | 1 | | | | | 1 | 1 | pot | Com. Cl P6.3 | 714 | LXI |
| | | 40-2 | 189 | | | Com. Cl 3 | 1 | | | | | 1 | 1 | pot | Com. Cl P6.3 | 715 | LXI |
| | | 37-2 | 1560 | | | Com. Cl 3 | 1 | | | | | 1 | 1 | pot | Com. Cl P7.1 | 716 | LXI |
| 1966 | | 14--3 | 960 | | | Com. Cl 3 | 1 | | | | | 1 | 1 | pot | Com. Cl P7.1 | 717 | LXI |
| | | 15--3 | 909 | | couche 7 | Com. Cl 3 | 1 | | | | | 1 | 1 | pot | Com. Cl P7.1 | 718 | LXI |
| 1968 | | 39-5 | 166 | | | Com. Cl 3 | 1 | | | | | 1 | 1 | couvercle | Com. Cl Cv2 | 719 | LXI |
| 1965 | | 42-3 | 257 | | amphithéâtre e dépôt | Com. Cl 3 | 1 | | | | | 1 | 1 | couvercle | Com. Cl Cv2 | 720 | LXI |
| 1966 | | 15--4 | 950 | | | Com. Cl 3 | 1 | | | | | 1 | 1 | couvercle | Com. Cl Cv2 | 721 | LXI |
| | | 29-2 | 9 | | | Com. Cl 3 | | 1 | 2 | | 7 | 10 | 1 | couvercle | Com. Cl Cv2 | 722 | LXI |
| | | 41-1 | 1574 | | | Com. Cl 3 | 1 | | | | | 1 | 1 | couvercle | Com. Cl Cv4 | 723 | LXI |
| 1974 | | 18--3 | 1057 | | | Com. Cl 3 | | | | | | 1 | 1 | panse perforée de trous | | | |
| | | 41-1 | 1584 | | | Com. Cl 3 | | | | | | 1 | 1 | | | | |
| | | 42-3 | 252 | | | Com. Cl 3 | | | 1 | | | | 1 | | | | |
| | | 35-4 | 101 | | | Com. Cl 3 | | | 1 | | 12 | 13 | | | | | |
| | | 35-4 | 103 | | | Com. Cl 3 | | | | | 37 | 37 | | | | | |
| | | 35-4 | 104 | | | Com. Cl 3 | | | | | 36 | 36 | | | | | |
| | | 35-5 | 105 | | | Com. Cl 3 | | | | | 37 | 37 | | | | | |
| 1989 | | 34-2 | 110 | | NA3 structure 2 | Com. Cl 3 | | | | | | 4 | 4 | | | | |

ANNEXE B : AMPHITHÉÂTRE

| année | n° OA | Rayon | Caisse | n° ordre | US | Catégorie | Comptage | | | | | | Typologie | Desc. Typo. | Dessin | Planche |
|----------------|----------|-------|--------|-------------|------------------------------|-----------|----------|---|--------|---|----|----|-----------|-------------|--------|---------|
| | | | | | | | B | F | A | D | P | NR | | | | |
| 1989 | | 34-2 | 111 | | ND3 structure 4.11 | Com. Cl 3 | | | | | 7 | 7 | | | | |
| 1989 | | 34-2 | 112 | | coup IV | Com. Cl 3 | | | | | 2 | 2 | | | | |
| 1989 | | 34-3 | 113 | | ND3 structure 4- 7B-7C | Com. Cl 3 | | | | | 10 | 10 | | | | |
| 1989 | | 36-2 | 128 | | 5NA2 | Com. Cl 3 | | | | | 14 | 14 | | | | |
| 1989 | | 36-2 | 128 | | 4NA3 | Com. Cl 3 | | | 1 | | 5 | 6 | | | | |
| 1989 | | 37-5 | 137 | | ND3 ST4 | Com. Cl 3 | | | | | 14 | 14 | | | | |
| 1989 | | 37-5 | 136 | | 5ND3 | Com. Cl 3 | | | | | 5 | 5 | | | | |
| | | 39-3 | 1390 | | | Com. Cl 3 | | | | | 9 | 9 | | | | |
| 1966-67- 68 | | 39-2 | 155 | | | Com. Cl 3 | | | 1 | | | 1 | | | | |
| 1966-67- 68 | | 39-2 | 155 | | | Com. Cl 3 | | | 1 | | | 1 | | | | |
| | | 15--1 | 936 | | | Com. Cl 3 | | | | | 14 | 14 | | | | |
| | | 14--2 | 955 | | | Com. Cl 3 | | | | | 21 | 21 | | | | |
| | | 14--1 | 937 | | | Com. Cl 3 | | | | | 24 | 24 | | | | |
| | | 14--2 | 954 | | | Com. Cl 3 | | | | | 4 | 4 | | | | |
| | | 12--4 | 1362 | | | Com. Cl 3 | | | 3 | | | 3 | | | | |
| | | 44--4 | 286 | | | Com. Cl 3 | | | | | 24 | 24 | | | | |
| | | 43-1 | 1585 | | | Com. Cl 3 | | | 1 3 | | | 13 | | | | |
| | | 43-1 | 1586 | | | Com. Cl 3 | | | | | 79 | 79 | | | | |
| | | 20--1 | 1115 | | | Com. Cl 3 | | | 1 | | 3 | 4 | | | | |
| 1968 | | 21--2 | 1158 | | | Com. Cl 3 | | | 1 | | | 1 | | | | |
| | | 21--3 | 1163 | | | Com. Cl 3 | | | | | 74 | 74 | | | | |

ANNEXE B : AMPHITHÉÂTRE

| année | n° OA | Rayon | Caisse | n° ordre | US | Catégorie | Comptage | | | | | | Typologie | Desc. Typo. | Dessin | Planche |
|-------|----------|-------|--------|-------------|-----------------|-----------|----------|---|---|---|---------|---------|-----------|-------------|--------|---------|
| | | | | | | | B | F | A | D | P | NR | | | | |
| | | 46-2 | 1479 | | | Com. Cl 3 | | | | | 17 | 17 | | | | |
| | | 38-1 | 1553 | | | Com. Cl 3 | | | | | 9 | 9 | | | | |
| 1968 | | 15--4 | 947 | | | Com. Cl 3 | | 1 | | | 9 | 10 | | | | |
| | | 18--3 | 1092 | | | Com. Cl 3 | | 1 | | | 14 | 15 | | | | |
| 1967 | | 45-3 | 302 | | | Com. Cl 3 | | 2 | | | 79 | 81 | | | | |
| 1990 | 967 | 38-3 | 1631 | 5 | couche 1 NE2 | Com. Cl 3 | | 1 | | | 52 | 53 | | | | |
| 1990 | 967 | 47-4 | 1666 | 1 | NA3 couche 8 | Com. Cl 3 | | | | | 10 | 10 | | | | |
| | | 20--2 | 1142 | | | Com. Cl 3 | | 2 | | | 12 | 14 | | | | |
| 1968 | | 20--3 | 1148 | | | Com. Cl 3 | | | | | 14 | 14 | | | | |
| | | 41-1 | 1565 | | | Com. Cl 3 | | | 1 | | 33 | 34 | | | | |
| | | 42-1 | 1464 | | | Com. Cl 3 | | | | | 15 | 15 | | | | |
| | | 36-1 | 1535 | | | Com. Cl 3 | | | 1 | | 11 | 12 | | | | |
| | | 36-1 | 1538 | | | Com. Cl 3 | | 2 | 1 | | 18 | 21 | | | | |
| | | 38-3 | 1558 | | | Com. Cl 3 | | | 1 | | 3 | 4 | | | | |
| | | 37-2 | 1560 | | | Com. Cl 3 | | 3 | 1 | | 67 | 71 | | | | |
| | | 39-1 | 1555 | | | Com. Cl 3 | | | | | 61 | 61 | | | | |
| | | 47-5 | 1655 | | | Com. Cl 3 | | | | | 3 | 3 | | | | |
| | | 31-2 | 1596 | | | Com. Cl 3 | | 1 | | | 16 1 | 16 2 | | | | |
| 1989 | | 36-2 | 124 | | | Com. Cl 3 | | 1 | | | 9 | 10 | | | | |
| 1968 | | 39-5 | 166 | | | Com. Cl 3 | | | | | 1 | 1 | | | | |
| 1966 | | 42-2 | 244 | | | Com. Cl 3 | 1 | | | | | 1 | | | | |
| 1968 | | 42-3 | 253 | | | Com. Cl 3 | | 1 | | | 10 | 11 | | | | |
| 1965 | | 42-3 | 257 | | | Com. Cl 3 | | | | | 1 | 1 | | | | |
| 1965 | | 42-3 | 257 | | | Com. Cl 3 | | | | | 1 | 1 | | | | |

ANNEXE B : AMPHITHÉÂTRE

| année | n° OA | Rayon | Caisse | n° ordre | US | Catégorie | Comptage | | | | | | Typologie | Desc. Typo. | Dessin | Planche |
|-------|----------|-------|--------|-------------|--------------------------|-----------|----------|---|---|---|----|----|-----------|-------------|--------|---------|
| | | | | | | | B | F | A | D | P | NR | | | | |
| 1965 | | 42-3 | 257 | | amphithéâtre et dépôt | Com. Cl 3 | | | | | 2 | 2 | | | | |
| 1965 | | 42-3 | 257 | | amphithéâtre et dépôt | Com. Cl 3 | | | | | 1 | 1 | | | | |
| 1965 | | 42-3 | 257 | | amphithéâtre et dépôt | Com. Cl 3 | | | | | 1 | 1 | | | | |
| 1965 | | 42-3 | 257 | | amphithéâtre et dépôt | Com. Cl 3 | | | | | 1 | 1 | | | | |
| 1965 | | 42-3 | 257 | | amphithéâtre et dépôt | Com. Cl 3 | | | | | 1 | 1 | | | | |
| 1965 | | 42-3 | 257 | | amphithéâtre et dépôt | Com. Cl 3 | | | | | 1 | 1 | | | | |
| 1965 | | 42-3 | 257 | | amphithéâtre et dépôt | Com. Cl 3 | | | | | 2 | 2 | | | | |
| 1965 | | 42-3 | 257 | | amphithéâtre et dépôt | Com. Cl 3 | | | | | 1 | 1 | | | | |
| 1965 | | 42-3 | 257 | | amphithéâtre et dépôt | Com. Cl 3 | | | | | 1 | 1 | | | | |
| 1965 | | 42-3 | 257 | | amphithéâtre et dépôt | Com. Cl 3 | | | | | 1 | 1 | | | | |
| 1968 | | 44-2 | 269 | | | Com. Cl 3 | | 1 | | | | 1 | | | | |
| 1968 | | 44-2 | 269 | | | Com. Cl 3 | | 3 | 1 | | 25 | 29 | | | | |
| 1978 | | 15--2 | 905 | | | Com. Cl 3 | | | | | 1 | 1 | | | | |
| 1978 | | 15--2 | 905 | | | Com. Cl 3 | | | | | 1 | 1 | | | | |
| 1978 | | 15--2 | 905 | | | Com. Cl 3 | | | | | 1 | 1 | | | | |
| 1978 | | 15--2 | 905 | | | Com. Cl 3 | | | | | 1 | 1 | | | | |
| 1978 | | 15--2 | 905 | | | Com. Cl 3 | | | | | 1 | 1 | | | | |
| 1978 | | 15--2 | 905 | | | Com. Cl 3 | 1 | 1 | | | 14 | 26 | | | | |

ANNEXE B : AMPHITHÉÂTRE

| année | n° OA | Rayon | Caisse | n° ordre | US | Catégorie | Comptage | | | | | | Typologie | Desc. Typo. | Dessin | Planche |
|-------|----------|-------|--------|-------------|---------|-----------|----------|---|---|---|----|----|-----------|-------------|--------|---------|
| | | | | | | | B | F | A | D | P | NR | | | | |
| 1966 | | 15--4 | 950 | | | Com. Cl 3 | | 3 | 1 | | 58 | 62 | | | | |
| 1966 | | 15--4 | 950 | | | Com. Cl 3 | | | | | 1 | 1 | | | | |
| 1966 | | 15--4 | 950 | | | Com. Cl 3 | | | | | 1 | 1 | | | | |
| 1966 | | 15--4 | 950 | | | Com. Cl 3 | | | | | 1 | 1 | | | | |
| 1966 | | 15--4 | 950 | | | Com. Cl 3 | | | | | 1 | 1 | | | | |
| 1966 | | 14--2 | 922 | | | Com. Cl 3 | 1 | | | | | 1 | | | | |
| 1966 | | 14--3 | 960 | | | Com. Cl 3 | | 8 | | | 8 | 16 | | | | |
| 1964 | | 14--2 | 951 | | | Com. Cl 3 | | 1 | | | 5 | 6 | | | | |
| 1964 | | 14--2 | 951 | | | Com. Cl 3 | 1 | | | | | 1 | | | | |
| 1964 | | 14--2 | 951 | | | Com. Cl 3 | 1 | | | | | 1 | | | | |
| 1964 | | 14--2 | 951 | | | Com. Cl 3 | 3 | | | | 9 | 12 | | | | |
| 1964 | | 14--2 | 951 | | | Com. Cl 3 | | 2 | | | 96 | 98 | | | | |
| | | 29-2 | 9 | | salle 2 | Com. Cl 3 | | 1 | | | 9 | 10 | | | | |
| | | 29-2 | 9 | | salle 2 | Com. Cl 3 | | | | | 1 | 1 | | | | |
| | | 29-2 | 9 | | | Com. Cl 3 | | | | | 1 | 1 | | | | |
| | | 29-2 | 9 | | | Com. Cl 3 | | | | | 1 | 1 | | | | |
| | | 29-2 | 9 | | | Com. Cl 3 | | | | | 1 | 1 | | | | |
| | | 40-2 | 186 | | | Com. Cl 3 | | | | | 1 | 1 | | | | |
| 1967 | | 40-2 | 191 | | | Com. Cl 3 | | 2 | | | 26 | 28 | | | | |
| | | 40-2 | 189 | | | Com. Cl 3 | | | | | 1 | 1 | | | | |
| | | 40-2 | 189 | | | Com. Cl 3 | | | | | 1 | 1 | | | | |
| | | 41-2 | 198 | | | Com. Cl 3 | 3 | | | | | 3 | | | | |
| | | 41-2 | 198 | | | Com. Cl 3 | | | 1 | | 11 | 12 | | | | |
| | | 42-2 | 250 | | | Com. Cl 3 | | 3 | | | 4 | 34 | | | | |
| | | 42-3 | 252 | | | Com. Cl 3 | | 1 | | | | 1 | | | | |

ANNEXE B : AMPHITHÉÂTRE

| année | n° OA | Rayon | Caisse | n° ordre | US | Catégorie | Comptage | | | | | | Typologie | Desc. Typo. | Dessin | Planche | |
|-------|----------|--------|--------|-------------|----------|---------------|----------|---|---|---|----|----|-----------|-------------|-------------|---------|------|
| | | | | | | | B | F | A | D | P | NR | | | | | NMI |
| | | 42-3 | 252 | | | Com. Cl 3 | | 2 | 2 | | | 4 | | | | | |
| | | 42-3 | 252 | | | Com. Cl 3 | | 1 | | | | 1 | | | | | |
| | | 42-3 | 252 | | | Com. Cl 3 | 1 | | | | | 1 | | | | | |
| | | 42-3 | 252 | | | Com. Cl 3 | 1 | | | | | 1 | | | | | |
| | | 42-3 | 252 | | | Com. Cl 3 | 1 | | | | | 1 | | | | | |
| | | 42-3 | 252 | | | Com. Cl 3 | 1 | | | | | 1 | | | | | |
| | | 42-3 | 252 | | | Com. Cl 3 | 4 | | | | | 4 | | | | | |
| | | 42-5 | 266 | | | Com. Cl 3 | | | | | 38 | 38 | | | | | |
| | | 15--03 | 903 | | | Com. Cl 3 | | | | | 1 | 1 | | | | | |
| 1979 | | 15--3 | 907 | | | Com. Cl 3 | | 2 | 2 | | 4 | 8 | | | | | |
| 1979 | | 15--3 | 907 | | | Com. Cl 3 | | 6 | | | 12 | 18 | | | | | |
| 1979 | | 15--3 | 907 | | | Com. Cl 3 | | | | | 15 | 15 | | | | | |
| 1979 | | 15--3 | 907 | | | Com. Cl 3 | | 1 | | | 38 | 39 | | | | | |
| 1979 | | 14--1 | 918 | | | Com. Cl 3 | | | | | 2 | 2 | | | | | |
| | | 14--1 | 938 | | | Com. Cl 3 | | | | | 6 | 6 | | | | | |
| | | 15--3 | 909 | | couche 8 | Com. Cl 3 | | | | | 10 | 10 | | | | | |
| | | 44-3 | 281 | | | Com. Cl dorée | 3 | | | | | 3 | 1 | plat | Com. Cl P13 | 724 | LXII |
| | | 44-3 | 281 | | | Com. Cl dorée | 4 | | | | | 4 | 1 | plat | Com. Cl P13 | 725 | LXII |
| | | 36-1 | 1529 | | | Com. Cl dorée | 1 | | | | | 1 | 1 | plat | Com. Cl P13 | 726 | LXII |
| | | 16--3 | 1013 | | | Com. Cl dorée | 1 | | | | | 1 | 1 | plat | Com. Cl P15 | 727 | LXII |
| | | 45-3 | 307 | | | Com. Cl dorée | 1 | | | | | 1 | 1 | plat | Com. Cl P17 | 738 | LXII |
| 1964 | | 14--2 | 951 | | | Com. Cl dorée | 1 | | | | | 1 | 1 | bol | Com. Cl B3 | 729 | LXII |

ANNEXE B : AMPHITHÉÂTRE

| année | n° OA | Rayon | Caisse | n° ordre | US | Catégorie | Comptage | | | | | | Typologie | Desc. Typo. | Dessin | Planche | |
|-------|-------|-------|--------|----------|--------------------|---------------|----------|---|---|---|----|----|-----------|-------------|---------------|---------|------|
| | | | | | | | B | F | A | D | P | NR | | | | | NMI |
| | | 39-1 | 1549 | | | Com. Cl dorée | 1 | | | | | 1 | 1 | marmite | Com. Cl M1 | 730 | LXII |
| 1978 | | 15--2 | 905 | | | Com. Cl dorée | 1 | | | | 1 | 1 | | cruche | Com. Cl Cr1.1 | 731 | LXII |
| 1966 | | 15--4 | 950 | | | Com. Cl dorée | 1 | | | | | 1 | 1 | pot | Com. Cl P1.1 | 732 | LXII |
| | | 16--3 | 1013 | | | Com. Cl dorée | 1 | | | | | 1 | 1 | pot | Com. Cl P2 | 733 | LXII |
| | | 16--3 | 1013 | | | Com. Cl dorée | 1 | | | | | 1 | 1 | pot | Com. Cl P2 | 734 | LXII |
| | | 41-1 | 1584 | | | Com. Cl dorée | 1 | | | | | 1 | 1 | pot | Com. Cl P6.1 | 735 | LXII |
| | | 39-1 | 1555 | | | Com. Cl dorée | 1 | | | | | 1 | 1 | pot | Com. Cl P6.1 | 736 | LXII |
| 1990 | 967 | 47-4 | 1666 | 1 | NA3 | Com. Cl dorée | | | | | 5 | 5 | | | | | |
| | | 41-1 | 1584 | | | Com. Cl dorée | | 2 | | | 24 | 26 | | | | | |
| | | 37-1 | 1532 | | | Com. Cl dorée | | | | | 3 | 3 | | | | | |
| | | 37-1 | 1534 | | | Com. Cl dorée | | | | | 12 | 12 | | | | | |
| 1968 | | 14--2 | 919 | | | Com. Cl dorée | | | | | 1 | 1 | | | | | |
| 1964 | | 14--2 | 951 | | | Com. Cl dorée | 2 | | | | 1 | 3 | | | | | |
| | | 15--3 | 909 | | couche 8 | Com. Cl dorée | | | | | 1 | 1 | | | | | |
| | | 37-1 | 1533 | | | Cl. Eng. | | | | | 1 | 1 | 1 | | | | |
| 1965 | | 42-3 | 257 | | amphithéâtre dépôt | Cl. Eng. | | | | | 1 | 1 | | | | | |

ANNEXE B : AMPHITHÉÂTRE

| année | n° OA | Rayon | Caisse | n° ordre | US | Catégorie | Comptage | | | | | | Typologie | Desc. Typo. | Dessin | Planche | |
|-------|----------|-------|--------|-------------|--------------------------|------------------|----------|---|---|---|---|----|-----------|-------------|---------------|---------|-------|
| | | | | | | | B | F | A | D | P | NR | | | | | NMI |
| 1965 | | 42-3 | 257 | | amphithéâtre dépôtoir | Cl. Eng. | | | | | 1 | 1 | | | | | |
| 1968 | | 14--2 | 919 | | | Cl. Eng. | | | | | 1 | 1 | | | | | |
| 1968 | | 14--2 | 919 | | | Cl. Eng. | | | | | 1 | 1 | | | | | |
| 1968 | | 14--2 | 919 | | | Cl. Eng. | | | | | 1 | 1 | | | | | |
| 1968 | | 14--2 | 919 | | | Cl. Eng. | | | | | 1 | 1 | | | | | |
| 1965 | | 42-3 | 257 | | amphithéâtre dépôtoir | Com. Cl Grand | 1 | | | | | 1 | 1 | bol | Com. Cl B5 | 737 | LXII |
| 1968 | | 44-2 | 269 | | | Com. Cl Grand | 1 | | | | | 1 | 1 | bol | Com. Cl B5 | 738 | LXIII |
| | | 37-1 | 1534 | | | Com. Cl Grand | 1 | | | | | 1 | 1 | bol | Com. Cl B5 | 739 | LVIII |
| | | 12--5 | 1360 | | | Com. Cl Grand | 1 | | | | | 1 | 1 | bol | Com. Cl B5 | 740 | LVIII |
| | | 12--5 | 1360 | | | Com. Cl Grand | 1 | | | | | 1 | 1 | bol | Com. Cl B5 | 741 | LVIII |
| 1965 | | 42-3 | 257 | | amphithéâtre dépôtoir | Com. Cl Grand | 1 | | | | | 1 | 1 | bol | Com. Cl B5 | 742 | LVIII |
| 1965 | | 42-3 | 257 | | amphithéâtre dépôtoir | Com. Cl Grand | 3 | | | | | 3 | 1 | bol | Com. Cl B5 | 743 | LVIII |
| 1965 | | 42-3 | 257 | | amphithéâtre dépôtoir | Com. Cl Grand | 1 | | | | | 1 | 1 | bol | Com. Cl B5 | 744 | LVIII |
| 1965 | | 42-3 | 257 | | amphithéâtre dépôtoir | Com. Cl Grand | 1 | | | | | 1 | 1 | bol | Com. Cl B5 | 745 | LVIII |
| 1965 | | 42-3 | 257 | | amphithéâtre dépôtoir | Com. Cl Grand | 1 | | | | | 1 | 1 | bol | Com. Cl B5 | 746 | LVIII |
| | | 41-1 | 1574 | | | Com. Cl Grand | 1 | | | | | 1 | 1 | cruche | Com. Cl Cr7.3 | 747 | LVIII |
| | | 36-1 | 1538 | | | Com. Cl Grand | 1 | | | | | 1 | 1 | cruche | Com. Cl Cr7.3 | 748 | LVIII |

ANNEXE B : AMPHITHÉÂTRE

| année | n° OA | Rayon | Caisse | n° ordre | US | Catégorie | Comptage | | | | | | Typologie | Desc. Typo. | Dessin | Planche | |
|----------------|----------|-------|--------|-------------|------|------------------|----------|---|---|---|---|----|-----------|-------------|------------|---------|-------|
| | | | | | | | B | F | A | D | P | NR | | | | | NMI |
| 1964 | | 14--2 | 951 | | | Com. Cl Grand | 1 | | | | | 1 | 1 | bol | Com. Cl B5 | 749 | LVIII |
| | | 39-1 | 1549 | | | Com. Cl Grand | 1 | | | | | 1 | 1 | bol | Com. Cl B5 | 750 | LVIII |
| | | 39-1 | 1555 | | | Com. Cl Grand | 1 | | | | | 1 | 1 | bol | Com. Cl B5 | 751 | LVIII |
| 1966 | | 15--4 | 950 | | | Mo | 1 | | | | | 1 | 1 | mortier | Mo1.1 | 752 | LXIII |
| | | 41-2 | 198 | | | Mo | 1 | | | | | 1 | 1 | mortier | Mo1.1 | 753 | LXIII |
| 1966 | | 14--3 | 960 | | | Mo | 1 | | | | | 1 | 1 | mortier | Mo1.1 | 754 | LXIII |
| | | 42-5 | 264 | | | Mo | 1 | | | | | 1 | 1 | mortier | Mo1.1 | 755 | LXIV |
| 1989 | | 34-5 | 123 | | 5NC3 | Mo | 1 | | | | | 1 | 1 | mortier | Mo1.1 | 756 | LXIV |
| 1989 | | 36-2 | 128 | | 4NA3 | Mo | 1 | | | | | 1 | 1 | mortier | Mo1.1 | 757 | LXIV |
| 1966-67- 68 | | 39-2 | 155 | | | Mo | 1 | | | | | 1 | 1 | mortier | Mo1.1 | 758 | LXIV |
| 1966-67- 68 | | 39-2 | 155 | | | Mo | 1 | | | | | 1 | 1 | mortier | Mo1.1 | 759 | LXIV |
| 1966-67- 68 | | 39-2 | 155 | | | Mo | 2 | | | | | 2 | 1 | mortier | Mo1.1 | 760 | LXIV |
| | | 19--2 | 1071 | | | Mo | 1 | | | | | 1 | 1 | mortier | Mo1.1 | 761 | LXV |
| | | 19--2 | 1071 | | | Mo | 1 | | | | | 1 | 1 | mortier | Mo1.1 | 762 | LXV |
| | | 19--2 | 1071 | | | Mo | 1 | | | | | 1 | 1 | mortier | Mo1.1 | 763 | LXV |
| | | 13--4 | 947 | | | Mo | 1 | | | | | 1 | 1 | mortier | Mo1.1 | 764 | LXV |
| | | 17--1 | 1023 | | | Mo | 1 | | | | | 1 | 1 | mortier | Mo1.1 | 765 | LXV |
| | | 36-3 | 1559 | | | Mo | 1 | | | | | 1 | 1 | mortier | Mo1.1 | 766 | LXV |
| | | 36-3 | 1559 | | | Mo | 1 | | | | | 1 | 1 | mortier | Mo1.1 | 767 | LXVI |
| | | 41-1 | 1574 | | | Mo | 1 | | | | | 1 | 1 | mortier | Mo1.1 | 768 | LXVI |
| | | 41-1 | 1574 | | | Mo | 1 | | | | | 1 | 1 | mortier | Mo1.1 | 769 | LXVI |
| | | 37-1 | 1532 | | | Mo | 1 | | | | | 1 | 1 | mortier | Mo1.1 | 770 | LXVI |

ANNEXE B : AMPHITHÉÂTRE

| année | n° OA | Rayon | Caisse | n° ordre | US | Catégorie | Comptage | | | | | | Typologie | Desc. Typo. | Dessin | Planche | |
|----------------|----------|-------|--------|-------------|----------|-----------|----------|---|---|---|---|----|-----------|-------------|--------|---------|--------|
| | | | | | | | B | F | A | D | P | NR | | | | | NMI |
| | | 12--5 | 1360 | | | Mo | 1 | | | | | 1 | 1 | mortier | Mo1.1 | 771 | LXVI |
| | | 45-4 | 283 | | | Mo | 1 | | | | | 1 | 1 | mortier | Mo1.1 | 772 | LXVI |
| | | 20--3 | 1148 | | | Mo | 1 | | | | | 1 | 1 | mortier | Mo1.1 | 773 | LXVII |
| | | 42-2 | 245 | | | Mo | 2 | | | | | 2 | 1 | mortier | Mo1.1 | 774 | LXVII |
| | | 42-2 | 245 | | | Mo | 2 | | | | | 2 | 1 | mortier | Mo1.1 | 775 | LXVII |
| | | 42-5 | 264 | | | Mo | 1 | | | | | 1 | 1 | mortier | Mo1.1 | 776 | LXVII |
| | | 42-5 | 264 | | | Mo | 1 | | | | | 1 | 1 | mortier | Mo1.1 | 777 | LXVII |
| | | 42-5 | 264 | | | Mo | 1 | | | | | 1 | 1 | mortier | Mo1.1 | 778 | LXVII |
| 1979 | | 15--3 | 907 | | | Mo | | | | | 1 | 1 | 1 | mortier | Mo1.1 | | |
| | | 15--3 | 909 | | couche 7 | Mo | 2 | | | | | 2 | 1 | mortier | Mo1.1 | 779 | LXVII |
| | | 42-5 | 264 | | | Mo | 1 | | | | | 1 | 1 | mortier | Mo1.1 | 780 | LXVIII |
| 1966 | | 15--4 | 950 | | | Mo | 1 | | | | | 1 | 1 | mortier | Mo2 | 781 | LXVIII |
| 1966 | | 15--4 | 950 | | | Mo | 1 | | | | | 1 | 1 | mortier | Mo2 | 782 | LXVIII |
| | | 42-5 | 266 | | | Mo | 1 | | | | | 1 | 1 | mortier | Mo2 | 783 | LXVIII |
| | | 37-1 | 1530 | | | Mo | 3 | | | | | 3 | 1 | mortier | Mo3.1 | 784 | LXVIII |
| 1967 | | 40-2 | 191 | | | Mo | 1 | | | | | 1 | 1 | mortier | Mo3.2 | 785 | LXVIII |
| 1966-67- 68 | | 39-2 | 155 | | | Mo | 2 | | | | | 2 | 1 | mortier | Mo3.2 | 786 | LXVIII |
| 1966-67- 68 | | 39-2 | 155 | | | Mo | 3 | | | | | 3 | 1 | mortier | Mo3.2 | 787 | LXIX |
| | | 45-3 | 302 | | | Mo | 2 | | | 4 | 6 | 1 | 1 | mortier | Mo3.2 | 788 | LXIX |
| | | 37-1 | 1534 | | | Mo | 1 | | | | | 1 | 1 | mortier | Mo3.2 | 789 | LXIX |
| | | 36-1 | 1535 | | | Mo | 1 | | | | | 1 | 1 | mortier | Mo3.2 | 790 | LXIX |
| | | 41-1 | 1574 | | | Mo | 1 | | | | | 1 | 1 | mortier | Mo3.2 | 791 | LXIX |
| | | 29-2 | 9 | | | Mo | 1 | | | | | 1 | 1 | mortier | Mo3.2 | 792 | LXIX |
| | | 15--3 | 909 | | couche 7 | Mo | 1 | | | | | 1 | 1 | mortier | Mo3.2 | 793 | LXX |

ANNEXE B : AMPHITHÉÂTRE

| année | n° OA | Rayon | Caisse | n° ordre | US | Catégorie | Comptage | | | | | | Typologie | Desc. Typo. | Dessin | Planche |
|-------|----------|-------|--------|-------------|------------------------------|-----------|----------|---|---|---|----|----|-----------|-------------|--------|---------|
| | | | | | | | B | F | A | D | P | NR | | | | |
| 1989 | | 34-3 | 113 | | ND3 structure 4- 7B-7C | Mo | | | | | 1 | 1 | | | | |
| | | 18--2 | 1088 | | | Mo | | | | | 3 | 3 | | | | |
| 1968 | | 21--2 | 1158 | | | Mo | | | | | 2 | 2 | | | | |
| | | 30--3 | 1619 | | | Mo | | | | | 19 | 19 | | | | |
| | | 31--4 | 1571 | | | Mo | | | | | 11 | 11 | | | | |
| | | 38-1 | 1551 | | | Mo | | | | | 2 | 2 | | | | |
| 1966 | | 17--4 | 1032 | | | Mo | | | | | 2 | 2 | | | | |
| 1966 | | 17--1 | 1023 | | | Mo | | | | | 4 | 4 | | | | |
| 1967 | | 45-3 | 302 | | | Mo | | 1 | | | 3 | 4 | | | | |
| | | 41-1 | 1574 | | | Mo | | | | | 36 | 36 | | | | |
| | | 42-1 | 1569 | | | Mo | | 2 | | | 29 | 31 | | | | |
| | | 45-3 | 309 | | | Mo | | 3 | | | 18 | 21 | | | | |
| | | 36-1 | 1535 | | | Mo | | 1 | | | 24 | 25 | | | | |
| | | 37-1 | 1532 | | | Mo | | | | | 7 | 7 | | | | |
| | | 37-1 | 1533 | | | Mo | | 1 | | | 4 | 5 | | | | |
| | | 39-1 | 1549 | | | Mo | | | | | 4 | 4 | | | | |
| 1967 | | 45-4 | 283 | | | Mo | | 5 | | | 21 | 26 | | | | |
| | | 38-3 | 1558 | | | Mo | | | | | 4 | 4 | | | | |
| | | 36-3 | 1559 | | | Mo | | 9 | | | 18 | 27 | | | | |
| 1968 | | 42-3 | 253 | | | Mo | | | | | 1 | 1 | | | | |
| 1964 | | 14--2 | 951 | | | Mo | | | | | 2 | 2 | | | | |
| | | 29-2 | 9 | | | Mo | | 1 | | | | 1 | | | | |
| | | 40-2 | 189 | | | Mo | | | | | 1 | 1 | | | | |
| | | 41-2 | 195 | | | Mo | | | | | 1 | 1 | | | | |
| | | 42-5 | 264 | | | Mo | | | | | 1 | 1 | | | | |

ANNEXE B : AMPHITHÉÂTRE

| année | n° OA | Rayon | Caisse | n° ordre | US | Catégorie | Comptage | | | | | | Typologie | Desc. Typo. | Dessin | Planche | |
|------------|----------|--------|--------|-------------|-----------------------|-----------|----------|---|---|---|----|----|-----------|-------------|-------------|---------|------|
| | | | | | | | B | F | A | D | P | NR | | | | | NMI |
| | | 42-5 | 266 | | | Mo | | | | | 3 | 3 | | | | | |
| | | 42-5 | 266 | | | Mo | | | | | 1 | 1 | | | | | |
| | | 15--03 | 903 | | | Mo | 1 | | | | | 1 | | | | | |
| 1979 | | 15--3 | 907 | | | Mo | 1 | | | | | 1 | | | | | |
| | | 15--3 | 909 | | couche 7 | Mo | | | | | 6 | 6 | | | | | |
| | | 15--3 | 909 | | couche 7 | Mo | | | | | 1 | 1 | | | | | |
| | | 15--3 | 909 | | | Mo | | | | | 1 | 1 | | | | | |
| | | 42-5 | 266 | | | Amp. | 1 | | | | | 1 | 1 | amphore | Beltran IIA | 794 | LXX |
| | | 20--2 | 1145 | | | Amp. | 1 | | | | | 1 | 1 | amphore | dressel 20 | | |
| 1968 | | 21--2 | 1158 | | | Amp. | 1 | | | | 17 | 18 | 1 | amphore | Dressel 20 | | |
| | | 30--3 | 1622 | | | Amp. | 1 | | | | 12 | 13 | 1 | amphore | Dressel 20 | | |
| | | 31--4 | 1575 | | | Amp. | | 1 | 2 | | 49 | 52 | 1 | amphore | Dressel 20 | | |
| 1968 | | 15--3 | 943 | | | Amp. | | | 1 | | 4 | 5 | 1 | amphore | Dressel 20 | | |
| 1967 | | 16--2 | 979 | | | Amp. | | | 1 | | 57 | 58 | 1 | amphore | Dressel 20 | | |
| | | 21--4 | 1166 | | | Amp. | 1 | | | | 9 | 10 | 1 | amphore | Dressel 20 | | |
| | | 37-1 | 1533 | | | Amp. | 1 | | | | | 1 | 1 | amphore | Dressel 20 | | |
| | | 31-2 | 1596 | | | Amp. | 2 | | 3 | | 19 | 24 | 1 | amphore | Dressel 20 | | |
| 1967 | | 15--1 | 904 | | Amphithéâtre -cloaque | Amp. | | | | | 1 | 1 | 1 | amphore | Dressel 20 | 795 | LXX |
| 1966 | | 14--3 | 960 | | | Amp. | | | | | 1 | 1 | 1 | amphore | Dressel 20 | | |
| 1979 | | 15--3 | 907 | | | Amp. | | | | | 2 | 2 | 1 | amphore | Dressel 20 | | |
| | | 15--3 | 909 | | couche 8 | Amp. | | | | | 9 | 9 | 1 | amphore | Dressel 20 | | |
| 1966-67-68 | | 39-2 | 155 | | | Amp. | 1 | | | | | 1 | 1 | amphore | Gauloise 4 | 796 | LXX |
| 1966 | | 18--2 | 1086 | | | Amp. | 1 | 1 | | | 4 | 6 | 1 | amphore | Gauloise 4 | | |
| | | 16--5 | 1019 | | | Amp. | 1 | | | | | 1 | 1 | amphore | Gauloise 4 | 797 | LXXI |
| | | 41-2 | 198 | | | Amp. | 1 | | | | | 1 | 1 | amphore | Gauloise 4 | 798 | LXXI |

ANNEXE B : AMPHITHÉÂTRE

| année | n° OA | Rayon | Caisse | n° ordre | US | Catégorie | Comptage | | | | | | Typologie | Desc. Typo. | Dessin | Planche | |
|-------|----------|-------|--------|-------------|------|-----------|----------|---|---|----|----|----|-----------|-------------|--------------|---------|------|
| | | | | | | | B | F | A | D | P | NR | | | | | NMI |
| 1979 | | 14--1 | 918 | | | Amp. | 1 | | | | | 1 | 1 | amphore | Gauloise 4 | 799 | LXXI |
| 1966 | | 42-2 | 244 | | | Amp. | 1 | | | | 5 | 6 | 1 | amphorisque | Ampho1 | 800 | LXXI |
| 1965 | | 41-2 | 205 | | | Amp. | 1 | | | | | 1 | 1 | amphorisque | Ampho1 | 801 | LXXI |
| | | 37-2 | 1560 | | | Amp. | 1 | | | | | 1 | 1 | amphorisque | Ampho1 | 802 | LXXI |
| | | 17--1 | 1023 | | | Amp. | 1 | | | | | 1 | 1 | amphorisque | Ampho fond 1 | 803 | LXXI |
| | | 42-5 | 264 | | | Amp. | 1 | | | | | 1 | 1 | amphorisque | Ampho fond 1 | 804 | LXXI |
| | | 36-1 | 1539 | | | Amp. | | 1 | | | | 1 | 1 | amphorisque | Ampho fond 1 | 805 | LXXI |
| | | 36-1 | 1539 | | | Amp. | | 1 | | | | 1 | 1 | amphorisque | Ampho fond 1 | 806 | LXXI |
| | | 41-1 | 1565 | | | Amp. | 1 | | | | | 1 | 1 | amphorisque | Ampho fond 2 | 807 | LXXI |
| | | 45-3 | 309 | | | Amp. | | 2 | | | | 2 | 1 | amphorisque | Ampho fond 2 | 808 | LXXI |
| | | 37-1 | 1533 | | | Amp. | | | | | 1 | 1 | 1 | amphorique | | | |
| 1966 | | 18--2 | 1086 | | | Amp. | | | | | 1 | 1 | 1 | amphorisque | | | |
| | | 45-4 | 283 | | | Amp. | | 1 | | | | 1 | 1 | amphorique | | | |
| | | 44--4 | 290 | | | Amp. | | 1 | | | | 1 | 1 | amphorisque | | | |
| 1966 | | 17--4 | 1031 | | | Amp. | | | | | 1 | 1 | 1 | amphorisque | | | |
| | | 35-5 | 106 | | | Amp. | | | 1 | 35 | 36 | | | | | | |
| 1989 | | 37-5 | 136 | | 5ND3 | Amp. | | | | 10 | 10 | | | | | | |
| | | 15--4 | 912 | | | Amp. | | | | 20 | 20 | | | | | | |
| | | 15--2 | 939 | | | Amp. | | | | 15 | 15 | | | | | | |
| | | 15--2 | 942 | | | Amp. | | | | 1 | 1 | | | | | | |
| | | 16--1 | 973 | | | Amp. | | | | 2 | 2 | | | | | | |
| | | 18--3 | 1093 | | | Amp. | | | | 8 | 8 | | | | | | |
| | | 18--2 | 1088 | | | Amp. | | | | 2 | 2 | | | | | | |
| | | 14--5 | 966 | | | Amp. | | | | 2 | 2 | | | | | | |
| | | 45-2 | 301 | | | Amp. | | | | 1 | 1 | | | | | | |
| | | 45-3 | 308 | | | Amp. | | | | 3 | 3 | | | | | | |

ANNEXE B : AMPHITHÉÂTRE

| année | n° OA | Rayon | Caisse | n° ordre | US | Catégorie | Comptage | | | | | | Typologie | Desc. Typo. | Dessin | Planche |
|-------|----------|-------|--------|-------------|----|-----------|----------|---|---|---|----|----|-----------|-------------|--------|---------|
| | | | | | | | B | F | A | D | P | NR | | | | |
| | | 44-1 | 1605 | | | Amp. | | | | | 50 | 50 | | | | |
| | | 44-1 | 1597 | | | Amp. | | | | | 19 | 19 | | | | |
| | | 44-1 | 1606 | | | Amp. | | | | | 26 | 26 | | | | |
| | | 43-1 | 1586 | | | Amp. | | | | | 19 | 19 | | | | |
| | | 20--1 | 1115 | | | Amp. | | | | | 2 | 2 | | | | |
| | | 20--1 | 1111 | | | Amp. | | | | | 1 | 1 | | | | |
| 1966 | | 21--1 | 1146 | | | Amp. | | | | | 3 | 3 | | | | |
| 1966 | | 21--1 | 1157 | | | Amp. | | | | | 3 | 3 | | | | |
| 1966 | | 21--1 | 1155 | | | Amp. | | | | | 12 | 12 | | | | |
| 1966 | | 21--1 | 1125 | | | Amp. | | | | | 43 | 43 | | | | |
| 1966 | | 21--2 | 1160 | | | Amp. | | | | | 14 | 14 | | | | |
| | | 30--3 | 1619 | | | Amp. | | | 1 | | 41 | 42 | | | | |
| | | 31--4 | 1571 | | | Amp. | | | 1 | | 43 | 44 | | | | |
| | | 46-2 | 1479 | | | Amp. | | | | | 9 | 9 | | | | |
| | | 46-1 | 1476 | | | Amp. | | | | | 8 | 8 | | | | |
| | | 45-3 | 305 | | | Amp. | | | | | 1 | 1 | | | | |
| | | 45-3 | 306 | | | Amp. | | | | | 3 | 3 | | | | |
| | | 38-1 | 1554 | | | Amp. | | | | | 1 | 1 | | | | |
| | | 38-1 | 1553 | | | Amp. | | | | | 10 | 10 | | | | |
| | | 38-1 | 1551 | | | Amp. | | | | | 14 | 14 | | | | |
| | | 38-1 | 1552 | | | Amp. | | | | | 58 | 58 | | | | |
| 1966 | | 17--4 | 1032 | | | Amp. | | | | | 3 | 3 | | | | |
| 1966 | | 19--5 | 1084 | | | Amp. | | | | | 3 | 3 | | | | |
| | | 19--4 | 1064 | | | Amp. | | | | | 5 | 5 | | | | |
| 1967 | | 45-3 | 302 | | | Amp. | | | | | 1 | 1 | | | | |
| 1968 | | 16--3 | 1012 | | | Amp. | | | | | 3 | 3 | | | | |

ANNEXE B : AMPHITHÉÂTRE

| année | n° OA | Rayon | Caisse | n° ordre | US | Catégorie | Comptage | | | | | | Typologie | Desc. Typo. | Dessin | Planche |
|-------|----------|-------|--------|-------------|--|-----------|----------|---|---|---|----|----|-----------|-------------|--------|---------|
| | | | | | | | B | F | A | D | P | NR | | | | |
| 1966 | | 16--5 | 1019 | | | Amp. | | 2 | 1 | | 19 | 22 | | | | |
| | | 21--1 | 1156 | | | Amp. | | | | | 3 | 3 | | | | |
| 1990 | 967 | 38-3 | 1631 | 2 | couche 1 NE2 | Amp. | | | | | 5 | 5 | | | | |
| 1990 | 967 | 47-4 | 1666 | 1 | NA3 couche 1 bis | Amp. | | | | | 2 | 2 | | | | |
| 1990 | 967 | 47-4 | 1666 | 2 | coupe 2 au- dessus de la couche grise verte | Amp. | | | | | 3 | 3 | | | | |
| | | 20--2 | 1142 | | | Amp. | | | | | 1 | 1 | | | | |
| | | 20--2 | 1142 | | | Amp. | | | | | 3 | 3 | | | | |
| | | | | | | Amp. | | | | | 2 | 2 | | | | |
| 1963 | | 20--3 | 1147 | | | Amp. | | | | | 21 | 21 | | | | |
| 1969 | | 20--3 | 1146 | | | Amp. | | | | | 17 | 17 | | | | |
| | | | | | | Amp. | | | | | 10 | 10 | | | | |
| | | 41-1 | 1565 | | | Amp. | | | | | 34 | 34 | | | | |
| | | 41-1 | 1574 | | | Amp. | | | | | 25 | 25 | | | | |
| | | 42-1 | 1567 | | | Amp. | | | | | 65 | 65 | | | | |
| | | 42-1 | 1569 | | | Amp. | | | | | 30 | 30 | | | | |
| | | 45-3 | 309 | | | Amp. | | | | | 5 | 5 | | | | |
| | | 36-1 | 1535 | | | Amp. | | | 1 | | 4 | 5 | | | | |
| | | 39-1 | 1549 | | | Amp. | | | | | 5 | 5 | | | | |
| | | 38-3 | 1558 | | | Amp. | | | | | 7 | 7 | | | | |
| | | 47-5 | 1655 | | | Amp. | | | | | 5 | 5 | | | | |
| 1989 | | 36-2 | 124 | | | Amp. | | | | | 3 | 3 | | | | |
| 1968 | | 39-5 | 166 | | | Amp. | | | | | 1 | 1 | | | | |

ANNEXE B : AMPHITHÉÂTRE

| année | n° OA | Rayon | Caisse | n° ordre | US | Catégorie | Comptage | | | | | | Typologie | Desc. Typo. | Dessin | Planche | |
|----------------|----------|-------|--------|-------------|----------|-----------|----------|---|---|---|----|----|-----------|--------------|--------|---------|--------|
| | | | | | | | B | F | A | D | P | NR | | | | | NMI |
| 1968 | | 42-3 | 253 | | | Amp. | | | | | 2 | 2 | | | | | |
| 1968 | | 42-3 | 253 | | | Amp. | | | | | 1 | 1 | | | | | |
| 1968 | | 44-2 | 269 | | | Amp. | | | | | 4 | 4 | | | | | |
| 1967 | | 40-2 | 191 | | | Amp. | | 1 | | | | 1 | | | | | |
| | | 41-2 | 198 | | | Amp. | 4 | | | | | 4 | | | | | |
| | | 41-2 | 198 | | | Amp. | | | 1 | | 67 | 68 | | | | | |
| | | 42-2 | 250 | | | Amp. | 1 | | | | | 1 | | | | | |
| | | 42-5 | 264 | | | Amp. | | | | | 1 | 1 | | | | | |
| | | 42-5 | 266 | | | Amp. | | | | | 1 | 1 | | | | | |
| | | 42-5 | 266 | | | Amp. | | | | | 1 | 1 | | | | | |
| 1979 | | 15--3 | 907 | | | Amp. | | | | | 1 | 1 | | | | | |
| | | 15--4 | 914 | | | Amp. | | | | | 20 | 20 | | | | | |
| | | 15--3 | 909 | | couche 7 | Amp. | | | | | 9 | 9 | | | | | |
| | | 37-1 | 1534 | | | Amp. | | | 1 | | | 1 | | | | | |
| | | 16--3 | 1013 | | | Bp 1 | 1 | | | | | 1 | 1 | brûle-parfum | Bp1 | 809 | LXXII |
| | | 16--3 | 1013 | | | Bp 1 | 1 | | | | | 1 | 1 | brûle-parfum | Bp1 | 810 | LXXII |
| | | 16--3 | 1013 | | | Bp 1 | 1 | | | | | 1 | 1 | brûle-parfum | Bp1 | 811 | LXXII |
| | | 37-1 | 1530 | | | Bp 1 | 4 | | | | | 4 | 1 | brûle-parfum | Bp1 | 812 | LXXII |
| | | 16--3 | 1013 | | | Bp 1 | 1 | | | | | 1 | 1 | brûle-parfum | Bp1 | 813 | LXXII |
| 1968 | | 44-2 | 269 | | | Bp 1 | 1 | | | | | 1 | 1 | brûle parfum | Bp1 | 814 | LXXII |
| | | 29-2 | 9 | | salle 2 | Bp 1 | 1 | | | | | 1 | 1 | brûle parfum | Bp1 | 815 | LXXIII |
| | | 42-5 | 266 | | | Bp 1 | 1 | | | | | 1 | 1 | brûle parfum | Bp1 | 816 | LXXIII |
| 1989 | | 34-5 | 121 | | 5NC3 | Bp 1 | 1 | | | | | 1 | 1 | brûle-parfum | Bp1 | 817 | LXXIII |
| 1966-67- 68 | | 39-2 | 155 | | | Bp 1 | 1 | | | | | 1 | 1 | brûle-parfum | Bp1 | 818 | LXXIII |
| | | 42-1 | 1567 | | | Bp 3 | 1 | | | | | 1 | 1 | brûle-parfum | Bp1 | 819 | LXXIII |

ANNEXE B : AMPHITHÉÂTRE

| année | n° OA | Rayon | Caisse | n° ordre | US | Catégorie | Comptage | | | | | | Typologie | Desc. Typo. | Dessin | Planche | |
|------------|-------|-------|--------|----------|---------|--------------|----------|---|---|---|---|----|-----------|--------------|-----------|---------|--------|
| | | | | | | | B | F | A | D | P | NR | | | | | NMI |
| | | 45-3 | 302 | | | Bp 2 | 1 | | | | | 1 | 1 | brûle-parfum | Bp2 | 820 | LXXIII |
| 1967 | | 40-2 | 191 | | | Bp 2 | 1 | | | | | 1 | 1 | brûle parfum | Bp2 | 821 | LXXIV |
| 1966-67-68 | | 39-2 | 155 | | | Bp 1 | 1 | | | | | 1 | 1 | brûle-parfum | Bp3 | 822 | LXXIV |
| | | 43-1 | 1582 | | | Bp 2 | | 1 | | | | 1 | 1 | brûle-parfum | Bp fond 4 | 823 | LXXIV |
| | | 41-1 | 1584 | | | Bp 3 | | 1 | | | | 1 | 1 | brûle-parfum | Bp fond 2 | 824 | LXXIV |
| 1966-67-68 | | 39-2 | 155 | | | Creuset | 1 | 1 | | | 1 | 3 | 1 | creuset | | 825 | LXXIV |
| 1966-67-68 | | 39-2 | 155 | | | Creuset | | 2 | | | | 2 | 1 | creuset | | | |
| | | 15--4 | 912 | | | post-antique | | | | | 4 | 4 | 1 | | | | |
| 1965 | | 21--1 | 1126 | | | post-antique | | | | | 1 | 1 | | | | | |
| | | 19--2 | 1076 | | | post-antique | 1 | | | | | 1 | | | | | |
| 1966 | | 17--4 | 1032 | | | post-antique | 1 | | | | 1 | 2 | | | | | |
| 1966 | | 42-2 | 244 | | | post-antique | 1 | | | | | 1 | | | | | |
| 1965 | | 42-3 | 257 | | | post-antique | | 1 | | | | 1 | | | | | |
| | | 29-2 | 9 | | salle 2 | post-antique | 1 | | | | | 1 | | | | | |
| 1979 | | 15--3 | 907 | | | post-antique | | | | | 3 | 3 | | | | | |
| | | BAL | | | | TB Allier | | | | | 1 | 1 | | figurine | | | |
| 1966-67-68 | | 39-2 | 155 | | | Lampe | 1 | | | | | 1 | | | | | |

ANNEXE B : AMPHITHÉÂTRE

| année | n° OA | Rayon | Caisse | n° ordre | US | Catégorie | Comptage | | | | | | Typologie | Desc. Typo. | Dessin | Planche |
|----------------|----------|-------|--------|-------------|----|-----------|----------|---|---|---|---|----|-----------|-------------|--------|---------|
| | | | | | | | B | F | A | D | P | NR | | | | |
| 1966-67- 68 | | 39-2 | 155 | | | Lampe | 1 | | | | | 1 | | | | |
| 1966-67- 68 | | 39-2 | 155 | | | Lampe | 1 | | | | | 1 | | | | |
| | | 43-1 | 1573 | | | Lampe | 1 | | | | | 1 | | | | |

ANNEXE B : OPÉRATION DE SURVEILLANCE DE L'AMPHITHÉÂTRE (1992-1993)

| année | n° OA | Rayon | Caisse | US | Catégorie | Comptage | | | | | | Typologie | Desc. Typo. | Dessin | Planche | |
|-----------|-------|-------|--------|------|-----------|----------|---|---|----|----|----|-----------|--------------|----------|---------|-----|
| | | | | | | B | F | A | D | P | NR | | | | | NMI |
| 1992-1993 | 1195 | 45-2 | 1647 | 1002 | EN AR | 1 | | | | | 1 | 1 | gobelet | Hees 2 | | |
| 1992-1993 | 1195 | 45-2 | 1647 | 1002 | EN AR | 1 | | | | | 1 | 1 | gobelet | Hees 2 | | |
| 1992-1993 | 1195 | 45-2 | 1647 | 1002 | EN AR | 2 | 1 | | | | 3 | 1 | gobelet | Hees 2 | 1 | I |
| 1992-1993 | 1195 | 45-2 | 1647 | 1002 | EN AR | 5 | | | | | 5 | 1 | gobelet | Hees 2 | | |
| 1992-1993 | 1195 | 45-2 | 1647 | 1002 | EN AR | 1 | | | | | 1 | 1 | gobelet | Hees 2 | | |
| 1992-1993 | 1195 | 45-2 | 1647 | 1002 | EN AR | 2 | | | | | 2 | 1 | gobelet | Hees 2 | | |
| 1992-1993 | 1195 | 45-2 | 1647 | 1002 | EN AR | 1 | | | | | 1 | 1 | gobelet | Hees 2 | | |
| 1992-1993 | 1195 | 45-2 | 1647 | 1002 | EN AR | 4 | 1 | | | | 5 | 1 | gobelet | Hees 2 | | |
| 1992-1993 | 1195 | 45-2 | 1647 | 1002 | EN AR | 1 | 1 | | | | 2 | 1 | gobelet | Hees 2 | 2 | I |
| 1992-1993 | 1195 | 45-2 | 1647 | 1002 | EN AR | | 6 | | | 84 | 90 | | | | | |
| 1992-1993 | 1195 | 45-2 | 1647 | 1002 | MET | 1 | | | | | 1 | 1 | gobelet | ? | 3 | I |
| 1992-1993 | 1195 | 61-3 | 1644 | 1002 | TN AR | | 1 | 1 | 40 | 42 | 1 | | | | | |
| 1992-1993 | 1195 | 47-2 | 1636 | 1002 | VRP | 3 | 3 | | 4 | 10 | 1 | plat | Goudineau 16 | 4 | I | |
| 1992-1993 | 1195 | 47-2 | 1636 | 1002 | VRP | 1 | | | 3 | 4 | 1 | plat | Goudineau 19 | 5 | I | |
| 1992-1993 | 1195 | 61-3 | 1644 | 1002 | RU UR | 2 | | | | | 2 | 1 | marmite | Nied. 89 | 6 | I |
| 1992-1993 | 1195 | 61-3 | 1644 | 1002 | RU UR | 4 | | | | | 4 | 1 | marmite | Nied. 89 | 7 | I |

ANNEXE B : OPÉRATION DE SURVEILLANCE DE L'AMPHITHÉÂTRE (1992-1993)

| année | n° OA | Rayon | Caisse | US | Catégorie | Comptage | | | | | | Typologie | Desc. Typo. | Dessin | Planche | |
|-----------|-------|-------|--------|------|-----------|----------|---|---|---|-----|-----|-----------|-------------|---------------|---------|-----|
| | | | | | | B | F | A | D | P | NR | | | | | NMI |
| 1992-1993 | 1195 | 61-3 | 1644 | 1002 | RU Cl | 2 | | | | | 2 | 1 | jatte | Nied. 104 | 8 | II |
| 1992-1993 | 1195 | 61-3 | 1644 | 1002 | RU Cl | 2 | | | | | 2 | 1 | jatte | RU Cl J3 | 9 | II |
| 1992-1993 | 1195 | 61-3 | 1644 | 1002 | RU Cl | 1 | | | | | 1 | 1 | marmite | Nied. 89 | 10 | II |
| 1992-1993 | 1195 | 61-3 | 1644 | 1002 | RU Cl | | 1 | | | 34 | 35 | | | | | |
| 1992-1993 | 1195 | 61-3 | 1644 | 1002 | RUA | 2 | | | | | 2 | 1 | jatte | Deru Reims J5 | 11 | II |
| 1992-1993 | 1195 | 61-3 | 1644 | 1002 | CB | | | | | 1 | 1 | 1 | | | | |
| 1992-1993 | 1195 | 47-2 | 1636 | 1002 | Sb. Coq | 2 | | | | | 2 | 1 | pot | Sb. Coq P6.2 | 12 | II |
| 1992-1993 | 1195 | 61-3 | 1644 | 1002 | Sb. Coq | | | | | 2 | 2 | | | | | |
| 1992-1993 | 1195 | 61-3 | 1644 | 1002 | Com. Cl 1 | | 4 | 5 | | 182 | 191 | 1 | | | | |
| 1992-1993 | 1195 | 61-3 | 1644 | 1002 | Com. Cl 1 | 1 | | | | | 1 | 1 | bol | Com. Cl B6 | 13 | II |
| 1992-1993 | 1195 | 47-2 | 1636 | 1002 | Com. Cl 1 | 1 | | | | | 1 | 1 | cruche | Com. Cl Cr1.1 | 14 | II |
| 1992-1993 | 1195 | 61-3 | 1644 | 1002 | Com. Cl 1 | 1 | | | | | 1 | 1 | cruche | Com. Cl Cr4.2 | 15 | II |
| 1992-1993 | 1195 | 61-3 | 1644 | 1002 | Com. Cl 1 | 1 | | | | | 1 | 1 | cruche | Com. Cl Cr6.1 | 16 | II |
| 1992-1993 | 1195 | 47-2 | 1636 | 1002 | Com. Cl 1 | 1 | | | | | 1 | 1 | cruche | Com. Cl Cr6.1 | 17 | II |
| 1992-1993 | 1195 | 61-3 | 1644 | 1002 | Com. Cl 1 | 1 | | 1 | | | 2 | 1 | cruche | Com. Cl Cr6.2 | 18 | II |
| 1992-1993 | 1195 | 61-3 | 1644 | 1002 | Com. Cl 1 | 1 | | | | | 1 | 1 | cruche | Com. Cl Cr6.2 | 19 | II |

ANNEXE B : OPÉRATION DE SURVEILLANCE DE L'AMPHITHÉÂTRE (1992-1993)

| année | n° OA | Rayon | Caisse | US | Catégorie | Comptage | | | | | | Typologie | Desc. Typo. | Dessin | Planche | |
|-----------|-------|-------|--------|------|---------------|----------|----|---|---|----|-----|-----------|-------------|---------------|---------|-----|
| | | | | | | B | F | A | D | P | NR | | | | | NMI |
| 1992-1993 | 1195 | 47-2 | 1636 | 1002 | Com. Cl 1 | 1 | | | | | 1 | 1 | cruche | Com. Cl Cr6.2 | 20 | III |
| 1992-1993 | 1195 | 47-2 | 1636 | 1002 | Com. Cl 1 | 1 | | | | | 1 | 1 | cruche | Com. Cl Cr6.2 | 21 | III |
| 1992-1993 | 1195 | 47-2 | 1636 | 1002 | Com. Cl 1 | 1 | | | | | 1 | 1 | cruche | Com. Cl Cr7.1 | 22 | III |
| 1992-1993 | 1195 | 61-3 | 1644 | 1002 | Com. Cl 1 | 1 | | | | | 1 | 1 | cruche | Com. Cl Cr7.2 | 23 | III |
| 1992-1993 | 1195 | 61-3 | 1644 | 1002 | Com. Cl 1 | 2 | | | | | 2 | 1 | pot | Com. Cl P4.1 | 24 | III |
| 1992-1993 | 1195 | 61-3 | 1644 | 1002 | Com. Cl 1 | 3 | | | | | 3 | 1 | pot | Com. Cl P4.1 | 25 | III |
| 1992-1993 | 1195 | 61-3 | 1644 | 1002 | Com. Cl 1 | 1 | | | | | 1 | 1 | pot | Com. Cl PMin1 | 26 | III |
| 1992-1993 | 1195 | 47-2 | 1636 | 1002 | Com. Cl 2 | 1 | | | | | 1 | 1 | cruche | Com. Cl Cr6.3 | 27 | III |
| 1992-1993 | 1195 | 61-3 | 1644 | 1002 | Com. Cl 3 | | 12 | 2 | | 94 | 108 | 1 | | | | |
| 1992-1993 | 1195 | 61-3 | 1644 | 1002 | Com. Cl 3 | 1 | | | | | 1 | 1 | cruche | Com. Cl Cr2.1 | 28 | III |
| 1992-1993 | 1195 | 47-2 | 1636 | 1002 | Com. Cl 3 | 1 | | | | | 1 | 1 | cruche | Com. Cl Cr2.1 | 29 | III |
| 1992-1993 | 1195 | 47-2 | 1636 | 1002 | Com. Cl dorée | 3 | | | | | 3 | 1 | pot | Com. Cl P4.1 | 30 | III |
| 1992-1993 | 1195 | 47-2 | 1636 | 1002 | Com. Cl dorée | 1 | | | | | 1 | 1 | pot | Com. Cl P8 | 31 | III |
| 1992-1993 | 1195 | 47-2 | 1636 | 1002 | Com. Cl dorée | 1 | | | | | 1 | 1 | pot | Com. Cl P8 | 32 | III |
| 1992-1993 | 1195 | 61-3 | 1644 | 1002 | Com. Cl Grand | 2 | | | | | 2 | 1 | bol | Com. Cl B5 | 33 | III |
| 1992-1993 | 1195 | 47-2 | 1636 | 1002 | Com. Cl Grand | 1 | | | | | 1 | 1 | cruche | Com. Cl Cr7.3 | 34 | III |

ANNEXE B : OPÉRATION DE SURVEILLANCE DE L'AMPHITHÉÂTRE (1992-1993)

| année | n° OA | Rayon | Caisse | US | Catégorie | Comptage | | | | | | | Typologie | Desc. Typo. | Dessin | Planche |
|-----------|-------|-------|--------|-----------|-----------|----------|---|---|---|----|----|-----|--------------|-------------|--------|---------|
| | | | | | | B | F | A | D | P | NR | NMI | | | | |
| 1992-1993 | 1195 | 61-3 | 1644 | 1002 | Mo | | | | | 15 | 15 | 1 | mortier | Mo1.1 | 35 | IV |
| 1992-1993 | 1195 | 61-3 | 1644 | 1002 | Mo | 3 | | | | | 3 | 1 | mortier | Mo1.1 | 36 | IV |
| 1992-1993 | 1195 | 61-3 | 1644 | 1002 | Mo | 1 | | | | | 1 | 1 | mortier | Mo1.1 | 37 | IV |
| 1992-1993 | 1195 | 61-3 | 1644 | 1002 | Mo | 1 | | | | | 1 | 1 | mortier | Mo1.1 | 38 | IV |
| 1992-1993 | 1195 | 61-3 | 1644 | 1002 | Mo | 1 | | | | | 1 | 1 | mortier | Mo1.2 | 39 | IV |
| 1992-1993 | 1195 | 61-3 | 1644 | 1002 | Mo | 1 | | | | | 1 | 1 | estampille | | 40 | IV |
| 1992-1993 | 1195 | 61-3 | 1644 | 1002 | Amp. | 1 | 1 | | | 47 | 49 | 1 | amphore | Gauloise 4 | 41 | V |
| 1992-1993 | 1195 | 61-3 | 1644 | 1002 | Amp. | 1 | | | | | 1 | 1 | amphore | Gauloise 4 | 42 | V |
| 1992-1993 | 1195 | 61-3 | 1644 | 1002 | Amp. | 1 | | | | | 1 | 1 | amphore | Dressel 2/4 | 43 | V |
| 1992-1993 | 1195 | 61-3 | 1644 | 1002 | Amp. | | | 1 | | | 1 | | amphore | Dressel 20 | | |
| 1992-1993 | 1195 | 61-3 | 1644 | 1002 | Amp. | | | 1 | | | 1 | | | | | |
| 1992-1993 | 1195 | 47-2 | 1636 | 1002 | Ampho. | 1 | | | | | 1 | 1 | amphorisque | Ampho2 | 44 | V |
| 1992-1993 | 1195 | 47-2 | 1636 | 1002 | Ampho. | 1 | | | | | 1 | 1 | amphorisque | Ampho4 | 45 | V |
| 1992-1993 | 1195 | 61-3 | 1644 | 1002 | Bp 1 | 1 | | | | | 1 | 1 | brûle-parfum | Bp1 | 46 | V |
| 1992/93 | | | 1646 | 1002 c | TS SG | 1 | | | | | 1 | | | | | |
| 1992/93 | | | 1646 | 1002 c | TS SG | | | | 1 | | 1 | | | | | |

ANNEXE B : OPÉRATION DE SURVEILLANCE DE L'AMPHITHÉÂTRE (1992-1993)

| année | n° OA | Rayon | Caisse | US | Catégorie | Comptage | | | | | | Typologie | Desc. Typo. | Dessin | Planche | |
|---------|-------|-------|--------|-----------|-----------|----------|---|---|---|----|----|-----------|-------------|----------|---------|-----|
| | | | | | | B | F | A | D | P | NR | | | | | NMI |
| 1992/93 | | | 1646 | 1002 c | TS SG | 1 | | | | | 1 | 1 | coupelle | Drag. 35 | | |
| 1992/93 | | | 1646 | 1002 c | TS SG | | 1 | | | | 1 | | | | | |
| 1992/93 | | | 1646 | 1002 c | EN AR | 1 | | | | | 1 | 1 | gobelet | Hees 2 | | |
| 1992/93 | | | 1646 | 1002 c | EN AR | 1 | | | | | 1 | 1 | gobelet | Hees 2 | | |
| 1992/93 | | | 1646 | 1002 c | EN AR | 1 | | | | | 1 | 1 | gobelet | Hees 2 | | |
| 1992/93 | | | 1646 | 1002 c | EN AR | 1 | | | | | 1 | 1 | gobelet | Hees 2 | | |
| 1992/93 | | | 1646 | 1002 c | EN AR | 1 | | | | | 1 | 1 | gobelet | Hees 2 | | |
| 1992/93 | | | 1646 | 1002 c | EN AR | 1 | | | | | 1 | 1 | gobelet | Hees 2 | | |
| 1992/93 | | | 1646 | 1002 c | EN AR | 1 | | | | | 1 | 1 | gobelet | Hees 2 | | |
| 1992/93 | | | 1646 | 1002 c | EN AR | 1 | | | | | 1 | 1 | gobelet | Hees 2 | | |
| 1992/93 | | | 1646 | 1002 c | EN AR | 1 | | | | | 1 | 1 | gobelet | Hees 2 | | |
| 1992/93 | | | 1646 | 1002 c | EN AR | 1 | | | | | 1 | 1 | gobelet | Hees 2 | | |
| 1992/93 | | | 1646 | 1002 c | EN AR | 1 | | | | | 1 | 1 | gobelet | Hees 2 | | |
| 1992/93 | | | 1646 | 1002 c | EN AR | 1 | | | | | 1 | 1 | gobelet | Hees 2 | | |
| 1992/93 | | | 1646 | 1002 c | EN AR | | 2 | | | 17 | 19 | | | | | |

ANNEXE B : OPÉRATION DE SURVEILLANCE DE L'AMPHITHÉÂTRE (1992-1993)

| année | n° OA | Rayon | Caisse | US | Catégorie | Comptage | | | | | | Typologie | Desc. Typo. | Dessin | Planche |
|---------|-------|-------|--------|-----------|-----------|----------|---|---|---|----|----|-----------|-------------|-----------------|---------|
| | | | | | | B | F | A | D | P | NR | | | | |
| 1992/93 | | | 1646 | 1002 c | MET | | | | | 3 | 3 | | | | |
| 1992/93 | | | 1646 | 1002 c | MET | 1 | | | | | 1 | 1 | gobelet | Nied.31 | |
| 1992/93 | | | 1646 | 1002 c | VRP | | 1 | | | | 1 | 1 | | | |
| 1992/93 | | | 1646 | 1002 c | VRP | | | | | 1 | 1 | | | | |
| 1992/93 | | | 1646 | 1002 c | RU CI | | | | | 3 | 3 | | | | |
| 1992/93 | | | 1646 | 1002 c | RU CI | 1 | | | | | 1 | | | | |
| 1992/93 | | | 1646 | 1002 c | RU CI | | 1 | | | | 1 | 1 | | | |
| 1992/93 | | | 1646 | 1002 c | RU S | 4 | | | | | 4 | 1 | plat | S33 | 1 VI |
| 1992/93 | | | 1646 | 1002 c | CB | | | | | 1 | 1 | 1 | | | |
| 1992/93 | | | 1646 | 1002 c | Sb. Coq | 1 | | | | | 1 | 1 | jatte | Sb. Coq J5 | 2 VI |
| 1992/93 | | | 1646 | 1002 c | Sb. Coq | 1 | | | | | 1 | 1 | jatte | Sb. Coq J/M2 | 3 VI |
| 1992/93 | | | 1646 | 1002 c | Sb. Coq | 1 | | | | | 1 | 1 | pot | Sb. Coq P6.1 | 4 VI |
| 1992/93 | | | 1646 | 1002 c | Sb. Coq | 1 | | | | | 1 | 1 | pot | Sb. Coq P6.1 | 5 VI |
| 1992/93 | | | 1646 | 1002 c | Sb. Coq | | 8 | | | 50 | 58 | | | | |
| 1992/93 | | | 1646 | 1002 c | Sb. Coq | | 1 | | | | 1 | | | | |
| 1992/93 | | | 1646 | 1002 c | Sb. Coq | | 1 | | | | 1 | | | | |

ANNEXE B : OPÉRATION DE SURVEILLANCE DE L'AMPHITHÉÂTRE (1992-1993)

| année | n° OA | Rayon | Caisse | US | Catégorie | Comptage | | | | | | | Typologie | Desc. Typo. | Dessin | Planche |
|---------|-------|-------|--------|-----------|-----------|----------|---|---|---|----|----|-----|-----------|------------------|--------|---------|
| | | | | | | B | F | A | D | P | NR | NMI | | | | |
| 1992/93 | | | 1646 | 1002 c | Sb. Coq | | 1 | | | | 1 | | | | | |
| 1992/93 | | | 1646 | 1002 c | Com. Sb | | 1 | | | 24 | 25 | 1 | | | | |
| 1992/93 | | | 1646 | 1002 c | Com. Cl 1 | | 3 | 3 | | 27 | 33 | | | | | |
| 1992/93 | | | 1646 | 1002 c | Com. Cl 1 | 1 | 1 | | | | 2 | 1 | pot | Com. Cl PMin1 | 6 | VI |
| 1992/93 | | | 1646 | 1002 c | Com. Cl 2 | 1 | | | | | 1 | 1 | plat | Com. Cl P11.1 | 7 | VI |
| 1992/93 | | | 1646 | 1002 c | Com. Cl 2 | 2 | | | | | 2 | 1 | pot | Com. Cl P6.2 | 8 | VI |
| 1992/93 | | | 1646 | 1002 c | Com. Cl 2 | | 2 | | | 11 | 13 | | | | | |
| 1992/93 | | | 1646 | 1002 c | Com. Cl 3 | | 3 | | | 24 | 27 | | | | | |
| 1992/93 | | | 1646 | 1002 c | Com. Cl 3 | | 1 | | | | 1 | | | | | |
| 1992/93 | | | 1646 | 1002 c | Com. Cl 3 | 1 | | | | | 1 | 1 | cruche | Com. Cl Cr4.1 | 9 | VI |
| 1992/93 | | | 1646 | 1002 c | Com. Cl 3 | | 1 | | | | 1 | | | | | |
| 1992/93 | | | 1646 | 1002 c | Com. Cl 3 | 4 | | | | | 4 | 1 | bol | Com. Cl B5 | 10 | VI |
| 1992/93 | | | 1646 | 1002 c | Mo | 1 | 1 | | | | 2 | 1 | mortier | Mo1.1 | 11 | VI |
| 1992/93 | | | 1646 | 1002 c | Mo | | 1 | | | | 1 | | | | | |
| 1992/93 | | | 1646 | 1002 c | Amp. | | | | | 1 | 1 | 1 | | | | |

ANNEXE B : OPÉRATION DE SURVEILLANCE DE L'AMPHITHÉÂTRE (1992-1993)

| année | n° OA | Rayon | Caisse | US | Catégorie | Comptage | | | | | | Typologie | Desc. Typo. | Dessin | Planche | |
|---------------|-------|-------|--------|------------|-----------|----------|---|---|---|----|----|-----------|-------------|---------------|---------|------|
| | | | | | | B | F | A | D | P | NR | | | | | NMI |
| 1992/93 | | | 1646 | 1002 c | Amp. | | | | | 5 | 5 | | | | | |
| 1992- 1993 | 1195 | 47-2 | 1636 | 1003- C | Sb. Coq | 1 | | | | | 1 | 1 | jatte | Sb. Coq J4.2 | 1 | VII |
| 1992- 1993 | 1195 | 47-2 | 1636 | 1003- C | Sb. Coq | 1 | | | | | 1 | 1 | jatte | Sb. Coq J4.2 | 2 | VII |
| 1992- 1993 | 1195 | 47-2 | 1636 | 1003- C | Sb. Coq | 2 | | | | | 2 | 1 | pot | Sb. Coq P1.1 | 3 | VII |
| 1992- 1993 | 1195 | 47-2 | 1636 | 1003- C | Sb. Coq | 1 | | | | | 1 | 1 | pot | Sb. Coq P5.2 | 4 | VII |
| 1992- 1993 | 1195 | 47-2 | 1636 | 1003- C | Sb. Coq | 3 | | | | | 3 | 1 | pot | Sb. Coq P6.1 | 5 | VII |
| 1992- 1993 | 1195 | 47-2 | 1636 | 1003- C | Sb. Coq | 3 | | | | | 3 | 1 | pot | Sb. Coq P7.1 | 6 | VII |
| 1992- 1993 | 1195 | 47-2 | 1636 | 1003- C | Sb. Coq | | 4 | | | 82 | 86 | | | | | |
| 1992/93 | | | 1646 | 1004 c | TS AR | 1 | | | | | 1 | 1 | assiette | Drag. 18/31 | | |
| 1992/93 | | | 1646 | 1004 c | TS AR | 2 | | | | | 2 | 1 | coupe | Drag. 37R | | |
| 1992/93 | | | 1646 | 1004 c | TS AR | | 1 | | | 1 | 2 | | | | | |
| 1992/93 | | | 1646 | 1004 c | EN AR | 1 | | | | | 1 | 1 | gobelet | Hees 2 | | |
| 1992/93 | | | 1646 | 1004 c | RU Cl | | | | | 1 | 1 | 1 | | | | |
| 1992/93 | | | 1646 | 1004 c | Sb. Coq | 1 | | | | | 1 | 1 | plat | Sb. Coq P11.1 | 1 | VIII |
| 1992/93 | | | 1646 | 1004 c | Sb. Coq | 1 | | | | | 1 | 1 | jatte | Sb. Coq J2.3 | 2 | VIII |
| 1992/93 | | | 1646 | 1004 c | Sb. Coq | 1 | | | | | 1 | 1 | jatte | Sb. Coq J/M2 | 3 | VIII |

ANNEXE B : OPÉRATION DE SURVEILLANCE DE L'AMPHITHÉÂTRE (1992-1993)

| année | n° OA | Rayon | Caisse | US | Catégorie | Comptage | | | | | | Typologie | Desc. Typo. | Dessin | Planche | |
|---------|-------|-------|--------|-----------|---------------|----------|---|---|---|----|----|-----------|-------------|------------------|---------|------|
| | | | | | | B | F | A | D | P | NR | | | | | NMI |
| 1992/93 | | | 1646 | 1004 c | Sb. Coq | 1 | | | | | 1 | 1 | pot | Sb. Coq P6.1 | 4 | VIII |
| 1992/93 | | | 1646 | 1004 c | Sb. Coq | 1 | | | | | 1 | 1 | pot | Sb. Coq P7.1 | 5 | VIII |
| 1992/93 | | | 1646 | 1004 c | Sb. Coq | 2 | 1 | | | 19 | 22 | | | | | |
| 1992/93 | | | 1646 | 1004 c | Sb. Coq | | 1 | | | 1 | 2 | | | | | |
| 1992/93 | | | 1646 | 1004 c | Com. Cl 1 | 1 | | | | 2 | 3 | 1 | pot | Com. Cl PMin1 | 6 | VIII |
| 1992/93 | | | 1646 | 1004 c | Com. Cl 1 | 1 | | | | 2 | 3 | | | | | |
| 1992/93 | | | 1646 | 1004 c | Com. Cl 1 | | 1 | | | 8 | 9 | | | | | |
| 1992/93 | | | 1646 | 1004 c | Com. Cl 1 | | 1 | | | 10 | 11 | | | | | |
| 1992/93 | | | 1646 | 1004 c | Com. Cl 2 | 2 | | | | 1 | 3 | 1 | bol | Com. Cl B3 | 7 | VIII |
| 1992/93 | | | 1646 | 1004 c | Com. Cl 2 | | | | | 4 | 4 | | | | | |
| 1992/93 | | | 1646 | 1004 c | Com. Cl 2 | | | | | 1 | 1 | | | | | |
| 1992/93 | | | 1646 | 1004 c | Com. Cl 3 | 1 | | | | | 1 | 1 | cruche | Com. Cl Cr1.1 | 8 | VIII |
| 1992/93 | | | 1646 | 1004 c | Com. Cl 3 | | | | | 7 | 7 | | | | | |
| 1992/93 | | | 1646 | 1004 c | Com. Cl dorée | 1 | | | | | 1 | 1 | bol | Com. Cl B4 | 9 | VIII |
| 1992/93 | | | 1646 | 1004 c | Mo | | | | | 1 | 1 | 1 | | | | |
| 1992/93 | | | 1646 | 1004 c | Mo | | 1 | | | | 1 | | | | | |

ANNEXE B : OPÉRATION DE SURVEILLANCE DE L'AMPHITHÉÂTRE (1992-1993)

| année | n° OA | Rayon | Caisse | US | Catégorie | Comptage | | | | | | | Typologie | Desc. Typo. | Dessin | Planche |
|-----------|-------|-------|--------|-----------|-----------|----------|---|---|---|---|----|-----|-----------|-------------|--------|----------------|
| | | | | | | B | F | A | D | P | NR | NMI | | | | |
| 1992/93 | | | 1646 | 1004 c | Amp. | | | | | 1 | 1 | 1 | | | | |
| 1992-1993 | | | | 1001 | TS | 1 | | | | | 1 | 1 | assiette | Drag. 18/31 | 1 | Annexe D Pl. I |
| 1992-1993 | | | | 1001 | TS | 1 | | | | | 1 | 1 | assiette | Drag. 18/31 | 2 | Annexe D Pl. I |
| 1992-1993 | | | | 1001 | TS | 1 | | | | | 1 | 1 | assiette | Drag. 18/31 | | |
| 1992-1993 | | | | 1001 | TS | 1 | | | | | 1 | 1 | assiette | Drag. 18/31 | | |
| 1992-1993 | | | | 1001 | TS | 1 | | | | | 1 | 1 | assiette | Drag. 18/31 | | |
| 1992-1993 | | | | 1001 | TS | 1 | | | | | 1 | 1 | assiette | Drag. 18/31 | | |
| 1992-1993 | | | | 1001 | TS | | | | 1 | | 1 | 1 | coupe | Drag. 27 | | |
| 1992-1993 | | | | 1001 | TS | 2 | | | | | 2 | 1 | coupe | Drag. 27 | | |
| 1992-1993 | | | | 1001 | TS | | 1 | | | | 1 | 1 | coupe | Drag. 32/40 | 13 | Annexe D Pl. I |
| 1992-1993 | | | | 1001 | TS | 1 | | | | | 1 | 1 | coupe | Drag. 32/40 | | |
| 1992-1993 | | | | 1001 | TS | 1 | | | | | 1 | 1 | coupe | Drag. 32/40 | 15 | Annexe D Pl. I |
| 1992-1993 | | | | 1001 | TS | 1 | | | | | 1 | 1 | coupe | Drag. 32/40 | 16 | Annexe D Pl. I |
| 1992-1993 | | | | 1001 | TS | 1 | | | | | 1 | 1 | coupe | Drag. 33 | | |
| 1992-1993 | | | | 1001 | TS | 1 | | | | | 1 | 1 | coupe | Drag. 33 | | |
| 1992-1993 | | | | 1001 | TS | 1 | | | | | 1 | 1 | coupe | Drag. 33 | | |

ANNEXE B : OPÉRATION DE SURVEILLANCE DE L'AMPHITHÉÂTRE (1992-1993)

| année | n° OA | Rayon | Caisse | US | Catégorie | Comptage | | | | | | Typologie | Desc. Typo. | Dessin | Planche | |
|-----------|-------|-------|--------|------|-----------|----------|---|---|---|---|----|-----------|-------------------|---------------|---------|------------------|
| | | | | | | B | F | A | D | P | NR | | | | | NMI |
| 1992-1993 | | | | 1001 | TS | 1 | | | | | 1 | 1 | coupe | Drag. 37 | 22 | Annexe D Pl. II |
| 1992-1993 | | | | 1001 | TS | 1 | | | | | 1 | 1 | coupe | Drag. 37 | | |
| 1992-1993 | | | | 1001 | TS | 1 | | | | | 1 | 1 | coupe | Drag. 37 | | |
| 1992-1993 | | | | 1001 | TS | 1 | | | | | 1 | 1 | coupe | Drag. 37 | | |
| 1992-1993 | | | | 1001 | TS | 1 | | | | | 1 | 1 | coupe | Drag. 37 | | |
| 1992-1993 | | | | 1001 | TS | | | | | 1 | 1 | 1 | coupe | Drag. 37 | 46 | Annexe D Pl. III |
| 1992-1993 | | | | 1001 | TS | | 1 | | | | 1 | 1 | coupe | Drag. 46 | 52 | I Annexe D Pl. I |
| 1992-1993 | | | | 1001 | TS | | | | | 1 | 1 | 1 | coupe | Drag. 38 | | |
| 1992-1993 | | | | 1001 | TS | | | | | 1 | 1 | 1 | pot | Déchelette 72 | 55 | Annexe D Pl. III |
| 1992-1993 | | | | 1001 | TS | | | | | 2 | 2 | 1 | gourde | | 56 | Annexe D Pl. III |
| 1992-1993 | | | | 1001 | TS | | 1 | | | | 1 | 1 | estampille VINDVS | | | |
| 1992-1993 | | | | 1001 | TS AR | 1 | | | | | 1 | 1 | assiette | Curle 15 | 7 | Annexe D Pl. I |
| 1992-1993 | | | | 1001 | TS AR | | | | | | 4 | 1 | coupe | Drag. 32/40 | 10 | Annexe D Pl. I |
| 1992-1993 | | | | 1001 | TS AR | | | | | | 9 | 1 | coupe | Drag. 32/40 | 11 | Annexe D Pl. I |

ANNEXE B : OPÉRATION DE SURVEILLANCE DE L'AMPHITHÉÂTRE (1992-1993)

| année | n° OA | Rayon | Caisse | US | Catégorie | Comptage | | | | | | Typologie | Desc. Typo. | Dessin | Planche | |
|-----------|-------|-------|--------|------|-----------|----------|---|---|---|---|----|-----------|-------------|-------------|---------|-----------------|
| | | | | | | B | F | A | D | P | NR | | | | | NMI |
| 1992-1993 | | | | 1001 | TS AR | | | | | | 1 | 1 | coupe | Drag. 32/40 | 12 | Annexe D Pl. I |
| 1992-1993 | | | | 1001 | TS AR | 2 | | | | | 2 | 1 | coupe | Drag. 33 | 17 | Annexe D Pl. I |
| 1992-1993 | | | | 1001 | TS AR | | | | | 1 | 1 | 1 | coupe | Drag. 36 | | |
| 1992-1993 | | | | 1001 | TS AR | 3 | | | | | 3 | 1 | coupe | Drag. 37 | 23 | Annexe D Pl. II |
| 1992-1993 | | | | 1001 | TS AR | 2 | | | | | 2 | 1 | coupe | Drag. 37 | 24 | Annexe D Pl. II |
| 1992-1993 | | | | 1001 | TS AR | 1 | | | | | 1 | 1 | coupe | Drag. 37 | 25 | Annexe D Pl. II |
| 1992-1993 | | | | 1001 | TS AR | 1 | | | | | 1 | 1 | coupe | Drag. 37 | 26 | Annexe D Pl. II |
| 1992-1993 | | | | 1001 | TS AR | 1 | | | | | 1 | 1 | coupe | Drag. 37 | 27 | Annexe D Pl. II |
| 1992-1993 | | | | 1001 | TS AR | 1 | | | | | 1 | 1 | coupe | Drag. 37 | 28 | Annexe D Pl. II |
| 1992-1993 | | | | 1001 | TS AR | 1 | | | | | 1 | 1 | coupe | Drag. 37 | 29 | Annexe D Pl. II |
| 1992-1993 | | | | 1001 | TS AR | 1 | | | | | 1 | 1 | coupe | Drag. 37 | 30 | Annexe D Pl. II |
| 1992-1993 | | | | 1001 | TS AR | 1 | | | | | 1 | 1 | coupe | Drag. 37 | | |
| 1992-1993 | | | | 1001 | TS AR | 1 | | | | | 1 | 1 | coupe | Drag. 37 | | |
| 1992-1993 | | | | 1001 | TS AR | | | | | 1 | 1 | 1 | coupe | Drag. 37 | | |
| 1992-1993 | | | | 1001 | TS AR | | | | | 1 | 1 | 1 | coupe | Drag. 37 | | |
| 1992-1993 | | | | 1001 | TS AR | | | | | 1 | 1 | 1 | coupe | Drag. 37 | | |

ANNEXE B : OPÉRATION DE SURVEILLANCE DE L'AMPHITHÉÂTRE (1992-1993)

| année | n° OA | Rayon | Caisse | US | Catégorie | Comptage | | | | | | Typologie | Desc. Typo. | Dessin | Planche | |
|-----------|-------|-------|--------|------|-----------|----------|---|---|---|---|----|-----------|-------------|----------|---------|-----------------|
| | | | | | | B | F | A | D | P | NR | | | | | NMI |
| 1992-1993 | | | | 1001 | TS AR | | | | | 1 | 1 | 1 | coupe | Drag. 37 | | |
| 1992-1993 | | | | 1001 | TS AR | | | | | 1 | 1 | 1 | coupe | Drag. 37 | | |
| 1992-1993 | | | | 1001 | TS AR | | | | | 1 | 1 | 1 | coupe | Drag. 37 | | |
| 1992-1993 | | | | 1001 | TS AR | | | | | 1 | 1 | 1 | coupe | Drag. 37 | | |
| 1992-1993 | | | | 1001 | TS AR | | | | | 1 | 1 | 1 | coupe | Drag. 37 | | |
| 1992-1993 | | | | 1001 | TS AR | | | | | 1 | 1 | 1 | coupe | Drag. 37 | | |
| 1992-1993 | | | | 1001 | TS AR | 1 | | | | | 1 | 1 | coupe | Drag. 44 | 47 | Annexe D Pl. II |
| 1992-1993 | | | | 1001 | TS AR | 1 | | | | | 1 | 1 | coupe | Drag. 44 | 48 | Annexe D Pl. II |
| 1992-1993 | | | | 1001 | TS AR | | 1 | | | | 1 | 1 | coupe | Drag. 44 | | |
| 1992-1993 | | | | 1001 | TS AR | | 1 | | | | 1 | 1 | coupe | Drag. 44 | | |
| 1992-1993 | | | | 1001 | TS AR | | 1 | | | | 1 | 1 | coupe | Drag. 44 | | |
| 1992-1993 | | | | 1001 | TS AR | 1 | | | | | 1 | 1 | mortier | Curle 21 | 54 | Annexe D Pl. II |
| 1992-1993 | | | | 1001 | EN | 1 | | | | | 1 | 1 | gobelet | Hees 2 | | |
| 1992-1993 | | | | 1001 | EN | 1 | | | | | 1 | 1 | gobelet | Hees 2 | | |
| 1992-1993 | | | | 1001 | EN | 1 | | | | | 1 | 1 | gobelet | Hees 2 | | |
| 1992-1993 | | | | 1001 | EN | 1 | | | | | 1 | 1 | gobelet | Hees 2 | | |

ANNEXE B : OPÉRATION DE SURVEILLANCE DE L'AMPHITHÉÂTRE (1992-1993)

| année | n° OA | Rayon | Caisse | US | Catégorie | Comptage | | | | | | Typologie | Desc. Typo. | Dessin | Planche | |
|-----------|-------|-------|--------|------|-----------|----------|---|---|---|---|----|-----------|-------------|-----------|---------|-----|
| | | | | | | B | F | A | D | P | NR | | | | | NMI |
| 1992-1993 | | | | 1001 | EN | 1 | | | | | 1 | 1 | gobelet | Hees 2 | | |
| 1992-1993 | | | | 1001 | EN | 1 | | | | | 1 | 1 | gobelet | Hees 2 | | |
| 1992-1993 | | | | 1001 | EN | 1 | | | | | 1 | 1 | gobelet | Hees 2 | | |
| 1992-1993 | | | | 1001 | EN | 1 | | | | | 1 | 1 | gobelet | Hees 2 | | |
| 1992-1993 | | | | 1001 | EN | 1 | | | | | 1 | 1 | gobelet | Hees 2 | | |
| 1992-1993 | | | | 1001 | EN | 1 | | | | | 1 | 1 | gobelet | Hees 2 | | |
| 1992-1993 | | | | 1001 | EN | 1 | | | | | 1 | 1 | gobelet | Stuart 16 | | |
| 1992-1993 | | | | 1001 | EN | 1 | | | | | 1 | 1 | gobelet | Hees 4 | | |
| 1992-1993 | | | | 1001 | EN AR | 1 | | | | | 1 | 1 | gobelet | Hees 2 | | |
| 1992-1993 | | | | 1001 | EN AR | 1 | | | | | 1 | 1 | gobelet | Hees 2 | | |
| 1992-1993 | | | | 1001 | EN AR | 1 | | | | | 1 | 1 | gobelet | Hees 2 | | |
| 1992-1993 | | | | 1001 | EN AR | 1 | | | | | 1 | 1 | gobelet | Hees 2 | | |
| 1992-1993 | | | | 1001 | EN AR | 1 | | | | | 1 | 1 | gobelet | Hees 2 | | |
| 1992-1993 | | | | 1001 | EN AR | 1 | | | | | 1 | 1 | gobelet | Hees 2 | | |
| 1992-1993 | | | | 1001 | EN AR | 1 | | | | | 1 | 1 | gobelet | Hees 2 | | |

ANNEXE B : OPÉRATION DE SURVEILLANCE DE L'AMPHITHÉÂTRE (1992-1993)

| année | n° OA | Rayon | Caisse | US | Catégorie | Comptage | | | | | | | Typologie | Desc. Typo. | Dessin | Planche |
|-----------|-------|-------|--------|------|-----------|----------|---|---|---|---|----|-----|-----------|--------------|--------|------------------|
| | | | | | | B | F | A | D | P | NR | NMI | | | | |
| 1992-1993 | | | | 1001 | EN AR | 1 | | | | | 1 | 1 | gobelet | Hees 2 | | |
| 1992-1993 | | | | 1001 | EN AR | 1 | | | | | 1 | 1 | gobelet | Hees 2 | | |
| 1992-1993 | | | | 1001 | EN AR | 1 | | | | | 1 | 1 | gobelet | Hees 2 | | |
| 1992-1993 | | | | 1001 | EN AR | 1 | | | | | 1 | 1 | gobelet | Hees 2 | | |
| 1992-1993 | | | | 1001 | EN AR | 1 | | | | | 1 | 1 | gobelet | Hees 2 | | |
| 1992-1993 | | | | 1001 | EN AR | 1 | | | | | 1 | 1 | gobelet | Hees 2 | | |
| 1992-1993 | | | | 1001 | EN AR | 1 | | | | | 1 | 1 | gobelet | Hees 2 | | |
| 1992-1993 | | | | 1001 | EN AR | 1 | | | | | 1 | 1 | gobelet | Hees 2 | | |
| 1992-1993 | | | | 1001 | EN AR | 1 | | | | | 1 | 1 | gobelet | Hees 2 | | |
| 1992-1993 | | | | 1001 | EN AR | 1 | | | | | 1 | 1 | gobelet | Hees 2 | | |
| 1992-1993 | | | | 1001 | TN | 1 | | | | | 1 | 1 | coupe | Hofheim 128 | 87 | Annexe D Pl. III |
| 1992-1993 | | | | 1001 | TN | 2 | | | | | 2 | 1 | bouteille | TNBT4 | 88 | Annexe D Pl. III |
| 1992-1993 | | | | 1001 | TN | 1 | | | | | 1 | 1 | bouteille | | | |
| 1992-1993 | | | | 1001 | TN | 1 | | | | | 1 | 1 | pot | Hofheim 114 | 90 | Annexe D Pl. III |
| 1992-1993 | | | | 1001 | VRP | | | | | | 5 | 1 | plat | Goudineau 19 | 110 | Annexe D Pl. IV |

ANNEXE B : OPÉRATION DE SURVEILLANCE DE L'AMPHITHÉÂTRE (1992-1993)

| année | n° OA | Rayon | Caisse | US | Catégorie | Comptage | | | | | | | Typologie | Desc. Typo. | Dessin | Planche |
|-----------|-------|-------|--------|------|-----------|----------|---|---|---|---|----|-----|-----------|---------------|--------|-------------------|
| | | | | | | B | F | A | D | P | NR | NMI | | | | |
| 1992-1993 | | | | 1001 | VRP | | | | | | 3 | 1 | plat | Goudineau 19 | 111 | Annexe D Pl. IV |
| 1992-1993 | | | | 1001 | VRP | | | | | | 2 | 1 | plat | Goudineau 19 | 112 | Annexe D Pl. IV |
| 1992-1993 | | | | 1001 | Sb. Coq | 1 | | | | | 1 | 1 | plat | Sb. Coq P11.1 | 147 | Annexe D Pl. VIII |
| 1992-1993 | | | | 1001 | Sb. Coq | 1 | | | | | 1 | 1 | plat | Sb. Coq P12 | 148 | Annexe D Pl. VIII |
| 1992-1993 | | | | 1001 | Sb. Coq | | | | | | 32 | 1 | jatte | Sb. Coq J2.1 | 124 | Annexe D Pl. VI |
| 1992-1993 | | | | 1001 | Sb. Coq | 3 | | | | | 3 | 1 | jatte | Sb. Coq J2.3 | 125 | Annexe D Pl. VI |
| 1992-1993 | | | | 1001 | Sb. Coq | 1 | | | | | 7 | 1 | jatte | Sb. Coq J2.3 | 126 | Annexe D Pl. VI |
| 1992-1993 | | | | 1001 | Sb. Coq | | | | | | 7 | 1 | jatte | Sb. Coq J2.2 | 127 | Annexe D Pl. VI |
| 1992-1993 | | | | 1001 | Sb. Coq | 1 | | | | | 1 | 1 | jatte | Sb. Coq J2.1 | 128 | Annexe D Pl. VII |
| 1992-1993 | | | | 1001 | Sb. Coq | 1 | | | | | 1 | 1 | jatte | Sb. Coq J2.1 | 129 | Annexe D Pl. VII |

ANNEXE B : OPÉRATION DE SURVEILLANCE DE L'AMPHITHÉÂTRE (1992-1993)

| année | n° OA | Rayon | Caisse | US | Catégorie | Comptage | | | | | | Typologie | Desc. Typo. | Dessin | Planche | |
|-----------|-------|-------|--------|------|-----------|----------|---|---|---|---|----|-----------|-------------|---------------|---------|------------------|
| | | | | | | B | F | A | D | P | NR | | | | | NMI |
| 1992-1993 | | | | 1001 | Sb. Coq | 1 | | | | | 1 | 1 | pot | Sb. Coq P7.1 | 130 | Annexe D Pl. VII |
| 1992-1993 | | | | 1001 | Sb. Coq | 1 | | | | | 1 | 1 | jatte | Sb. Coq J2.1 | 131 | Annexe D Pl. VII |
| 1992-1993 | | | | 1001 | Sb. Coq | 1 | | | | | 1 | 1 | jatte | | | |
| 1992-1993 | | | | 1001 | Sb. Coq | 1 | | | | | 1 | 1 | jatte | Sb. Coq J2.2 | 133 | Annexe D Pl. VII |
| 1992-1993 | | | | 1001 | Sb. Coq | 1 | | | | | 1 | 1 | jatte | Sb. Coq J2.1 | 134 | Annexe D Pl. VII |
| 1992-1993 | | | | 1001 | Sb. Coq | 1 | | | | | 1 | 1 | plat | Sb. Coq P12 | 135 | Annexe D Pl. VII |
| 1992-1993 | | | | 1001 | Sb. Coq | 1 | | | | | 1 | 1 | jatte | Sb. Coq J1 | 136 | Annexe D Pl. VII |
| 1992-1993 | | | | 1001 | Sb. Coq | 1 | | | | | 1 | 1 | jatte | Sb. Coq J1 | 137 | Annexe D Pl. VII |
| 1992-1993 | | | | 1001 | Sb. Coq | 1 | | | | | 1 | 1 | plat | Sb. Coq P12 | 138 | Annexe D Pl. VII |
| 1992-1993 | | | | 1001 | Sb. Coq | 1 | | | | | 1 | 1 | plat | Sb. Coq P11.2 | 139 | Annexe D Pl. VII |
| 1992-1993 | | | | 1001 | Sb. Coq | 1 | | | | | 1 | 1 | pot | Sb. Coq P7.1 | 140 | Annexe D Pl. VII |

ANNEXE B : OPÉRATION DE SURVEILLANCE DE L'AMPHITHÉÂTRE (1992-1993)

| année | n° OA | Rayon | Caisse | US | Catégorie | Comptage | | | | | | Typologie | Desc. Typo. | Dessin | Planche | |
|-----------|-------|-------|--------|------|-----------|----------|---|---|---|---|----|-----------|-------------|--------------|---------|-------------------|
| | | | | | | B | F | A | D | P | NR | | | | | NMI |
| 1992-1993 | | | | 1001 | Sb. Coq | 1 | | | | | 1 | 1 | pot | Sb. Coq P7.1 | 141 | Annexe D Pl. VII |
| 1992-1993 | | | | 1001 | Sb. Coq | 1 | | | | | 1 | 1 | pot | Sb. Coq P8 | 142 | Annexe D Pl. VII |
| 1992-1993 | | | | 1001 | Sb. Coq | 10 | | | | | 10 | 1 | jatte | Sb. Coq J2.2 | 143 | Annexe D Pl. VII |
| 1992-1993 | | | | 1001 | Sb. Coq | 1 | | | | | 1 | 1 | jatte | Sb. Coq J3.1 | 144 | Annexe D Pl. VIII |
| 1992-1993 | | | | 1001 | Sb. Coq | 6 | | | | | 6 | 1 | marmite | Sb. Coq M1.2 | 145 | Annexe D Pl. VIII |
| 1992-1993 | | | | 1001 | Sb. Coq | 1 | | | | | 1 | 1 | jatte | Sb. Coq J/M2 | 146 | Annexe D Pl. VIII |
| 1992-1993 | | | | 1001 | Sb. Coq | 1 | | | | | 1 | 1 | pot | Sb. Coq P1.1 | 149 | Annexe D Pl. VIII |
| 1992-1993 | | | | 1001 | Sb. Coq | 1 | | | | | 1 | 1 | pot | Sb. Coq P6.1 | 150 | Annexe D Pl. VIII |
| 1992-1993 | | | | 1001 | Sb. Coq | 1 | | | | | 1 | 1 | pot | Sb. Coq P6.1 | 151 | Annexe D Pl. VIII |
| 1992-1993 | | | | 1001 | Sb. Coq | 1 | | | | | 1 | 1 | pot | Sb. Coq P6.1 | 152 | Annexe D Pl. VIII |

ANNEXE B : OPÉRATION DE SURVEILLANCE DE L'AMPHITHÉÂTRE (1992-1993)

| année | n° OA | Rayon | Caisse | US | Catégorie | Comptage | | | | | | Typologie | Desc. Typo. | Dessin | Planche | |
|-----------|-------|-------|--------|------|-----------|----------|---|---|---|---|----|-----------|-------------|---------------|---------|-------------------|
| | | | | | | B | F | A | D | P | NR | | | | | NMI |
| 1992-1993 | | | | 1001 | Sb. Coq | 1 | | | | | 1 | 1 | pot | Sb. Coq P1.1 | 153 | Annexe D Pl. VIII |
| 1992-1993 | | | | 1001 | Sb. Coq | 1 | | | | | 1 | 1 | pot | Sb. Coq P1.1 | 154 | Annexe D Pl. VIII |
| 1992-1993 | | | | 1001 | Sb. Coq | 1 | | | | | 1 | 1 | pot | Sb. Coq P3 | 155 | Annexe D Pl. VIII |
| 1992-1993 | | | | 1001 | Sb. Coq | 1 | | | | | 1 | 1 | pot | | | |
| 1992-1993 | | | | 1001 | Sb. Coq | 1 | | | | | 1 | 1 | couvercle | Sb. Coq Cv2.3 | 158 | Annexe D Pl. VIII |
| 1992-1993 | | | | 1001 | Sb. Coq | 1 | | | | | 1 | 1 | couvercle | Sb. Coq Cv2.3 | 159 | Annexe D Pl. VIII |
| 1992-1993 | | | | 1001 | Sb. Coq | 1 | | | | | 1 | 1 | couvercle | Sb. Coq Cv3.1 | 160 | Annexe D Pl. VIII |
| 1992-1993 | | | | 1001 | Sb. Coq | 1 | | | | | 1 | 1 | couvercle | Sb. Coq Cv2.3 | 161 | Annexe D Pl. VIII |
| 1992-1993 | | | | 1001 | Sb. Coq | 1 | | | | | 1 | 1 | couvercle | Sb. Coq Cv1 | 162 | Annexe D Pl. VIII |
| 1992-1993 | | | | 1001 | Sb. Coq | 1 | | | | | 1 | 1 | couvercle | Sb. Coq Cv3.1 | 163 | Annexe D Pl. VIII |
| 1992-1993 | | | | 1001 | Sb. Coq | 1 | | | | | 1 | 1 | couvercle | Sb. Coq Cv3.2 | 164 | Annexe D Pl. VIII |

ANNEXE B : OPÉRATION DE SURVEILLANCE DE L'AMPHITHÉÂTRE (1992-1993)

| année | n° OA | Rayon | Caisse | US | Catégorie | Comptage | | | | | | Typologie | Desc. Typo. | Dessin | Planche | |
|-----------|-------|-------|--------|------|---------------|----------|---|---|---|---|----|-----------|-------------|---------------|---------|-------------------|
| | | | | | | B | F | A | D | P | NR | | | | | NMI |
| 1992-1993 | | | | 1001 | Sb. Coq | 1 | | | | | 1 | 1 | couvercle | Sb. Coq Cv4.2 | 165 | Annexe D Pl. VIII |
| 1992-1993 | | | | 1001 | Sb. Coq | 1 | | | | | 1 | 1 | couvercle | Sb. Coq Cv2.2 | 166 | Annexe D Pl. VIII |
| 1992-1993 | | | | 1001 | Sb. Coq | 1 | | | | | 1 | 1 | couvercle | Sb. Coq Cv3.1 | 156 | Annexe D Pl. VIII |
| 1992-1993 | | | | 1001 | Sb. Coq | 1 | | | | | 1 | 1 | couvercle | Sb. Coq Cv3.1 | 157 | Annexe D Pl. VIII |
| 1992-1993 | | | | 1001 | Com. Cl | 1 | | | | | 1 | 1 | bol | Com. Cl B4 | 121 | Annexe D Pl. V |
| 1992-1993 | | | | 1001 | Com. Cl | 1 | | | | | 1 | 1 | bol | Com. Cl B5 | 122 | Annexe D Pl. V |
| 1992-1993 | | | | 1001 | Com. Cl | 1 | | | | | 1 | 1 | pot | Com. Cl P5.1 | 123 | Annexe D Pl. VI |
| 1992-1993 | | | | 1001 | Com. Cl dorée | 1 | | | | | 1 | 1 | bol | Com. Cl B5 | 113 | Annexe D Pl. V |
| 1992-1993 | | | | 1001 | Com. Cl dorée | 1 | | | | | 1 | 1 | bol | Com. Cl B4 | 114 | Annexe D Pl. V |
| 1992-1993 | | | | 1001 | Com. Cl dorée | 2 | | | | | 2 | 1 | pot | Com. Cl P2 | 115 | Annexe D Pl. V |
| 1992-1993 | | | | 1001 | Com. Cl dorée | 1 | | | | | 1 | 1 | bol | Com. Cl B6.2 | 116 | Annexe D Pl. V |
| 1992-1993 | | | | 1001 | Com. Cl dorée | 1 | | | | | 1 | 1 | bol | | | |
| 1992-1993 | | | | 1001 | Com. Cl dorée | 1 | | | | | 1 | 1 | pot | Com. Cl P2 | 118 | Annexe D Pl. V |

ANNEXE B : OPÉRATION DE SURVEILLANCE DE L'AMPHITHÉÂTRE (1992-1993)

| année | n° OA | Rayon | Caisse | US | Catégorie | Comptage | | | | | | Typologie | Desc. Typo. | Dessin | Planche | |
|-----------|-------|-------|--------|------|---------------|----------|---|---|---|---|----|-----------|-------------|--------------|---------|----------------|
| | | | | | | B | F | A | D | P | NR | | | | | NMI |
| 1992-1993 | | | | 1001 | Com. Cl dorée | 2 | | | | | 2 | 1 | pot | Com. Cl P2 | 115 | Annexe D Pl. V |
| 1992-1993 | | | | 1001 | Com. Cl dorée | 1 | | | | | 1 | 1 | pot | Com. Cl P2 | 119 | Annexe D Pl. V |
| 1992-1993 | | | | 1001 | Com. Cl dorée | 1 | | | | | 1 | 1 | pot | Com. Cl P6.2 | 120 | Annexe D Pl. V |

ANNEXE B : LA MALADIÈRE

| Rayon | Caisse | n° ordre | US | Catégorie | Comptage | | | | | | Typologie | Desc. Typo. | Dessin | Planche |
|-------|--------------|----------|--------------------------|-----------|----------|---|---|---|---|----|-----------|-------------|----------|---------|
| | | | | | B | F | A | D | P | NR | | | | |
| BAL | n°2010-0-24 | | prospection P Duveaux | TS SG | | | | | 7 | 7 | 1 | | | |
| BAL | n°2010-0-63 | | prospection P Duveaux | TS SG | | | | | 1 | 1 | | | | |
| BAL | n°2010-0-70 | | prospection P Duveaux | TS SG | | 1 | | | | 1 | | | | |
| BAL | n°2010-0-132 | lot 3 | prospection P Duveaux | TS SG | | 1 | | | | 1 | | | | |
| BAL | n°2010-0-62 | | prospection P Duveaux | TS SG | | 1 | | | | 1 | | | | |
| BAL | n°2010-0-69 | | prospection P Duveaux | TS SG | | 1 | | | | 1 | | | | |
| BAL | n°2010-0-66 | | prospection P Duveaux | TS GE | 1 | | | | | 1 | 1 | coupe | Drag. 37 | |
| BAL | n°2010-0-509 | lot 3 | prospection P Duveaux | TS GE | | 1 | | | 6 | 7 | | | | |
| BAL | n°2010-0-72 | lot 3 | prospection P Duveaux | TS GE | | | | 1 | | 1 | | | | |
| BAL | n°2010-0-94 | | prospection P Duveaux | TS AR | 1 | | | | | 1 | 1 | coupe | Drag. 37 | |
| BAL | n°2010-0-68 | | prospection P Duveaux | TS AR | | 1 | | | | 1 | | | | |
| BAL | n°2010-0-64 | | prospection P Duveaux | TS AR | | | | | 1 | 1 | | | | |
| BAL | n°2010-0-65 | | prospection P Duveaux | TS AR | | | | | 3 | 3 | | | | |
| BAL | n°2010-0-133 | lot 3 | prospection P Duveaux | TS AR | | | | 1 | | 1 | | | | |
| BAL | n°2010-0-71 | | prospection P Duveaux | TS AR | | 1 | | | | 1 | | | | |
| BAL | n°2010-0-67 | | prospection P Duveaux | TS AR | | | | 1 | 2 | 3 | | | | |

ANNEXE B : LA MALADIÈRE

| Rayon | Caisse | n° ordre | US | Catégorie | Comptage | | | | | | Typologie | Desc. Typo. | Dessin | Planche | |
|-------|--------------|----------|--------------------------|-----------|----------|---|---|---|----|----|-----------|-------------|--------|---------|-----|
| | | | | | B | F | A | D | P | NR | | | | | NMI |
| BAL | n°2010-0-504 | | prospection P Duveaux | EN AR | 3 | 1 | | | 10 | 14 | 1 | gobelet | Hees 2 | | |
| BAL | n°2010-0-76 | | prospection P Duveaux | EN AR | | | | | 3 | 3 | | | | | |
| BAL | n°2010-0-21 | | prospection P Duveaux | EN AR | | | | | 1 | 1 | | | | | |
| BAL | n°2010-0-30 | | prospection P Duveaux | EN AR | | 1 | | | | 1 | | | | | |
| BAL | n°2010-0-27 | | prospection P Duveaux | EN AR | | 1 | | | | 1 | | | | | |
| BAL | n°2010-0-33 | | prospection P Duveaux | EN AR | | 1 | | | | 1 | | | | | |
| BAL | n°2010-0-36 | | prospection P Duveaux | EN AR | | | | | 36 | 36 | | | | | |
| BAL | n°2010-0-31 | | prospection P Duveaux | EN AR | | 1 | | | | 1 | | | | | |
| BAL | n°2010-0-26 | | prospection P Duveaux | EN AR | | 1 | | | | 1 | | | | | |
| BAL | n°2009/0/505 | | | MET AR | | | | 1 | | 1 | 1 | | | | |
| BAL | n°2009/0/505 | | | MET AR | | | | | 1 | 1 | | | | | |
| BAL | n°2010-0-50 | | | TN | 1 | | | | | 1 | 1 | bol | TNB14 | 1 | I |
| BAL | n°2010/0/49 | | | TN | 2 | | | | | 2 | 1 | bol | TNB1 | 2 | I |
| BAL | n°2010/0/37 | | | TN | 1 | | | | | 1 | 1 | bouteille | TNBT4 | 3 | I |
| BAL | n°2010/0/54 | | | TN | 1 | | | | | 1 | 1 | bouteille | TNBT4 | 4 | I |
| BAL | n°2010/0/48 | | | TN | 1 | | | | | 1 | 1 | pot | TNP10 | 5 | I |
| BAL | n°2010-0-59 | lot 3 | prospection P Duveaux | TN | | | | | 34 | 34 | | | | | |
| BAL | n°2010-0-57 | | prospection P Duveaux | TN | | | | | 15 | 15 | | | | | |
| BAL | n°2010-0-41 | | prospection P Duveaux | TN | | 1 | | | | 1 | | | | | |

ANNEXE B : LA MALADIÈRE

| Rayon | Caisse | n° ordre | US | Catégorie | Comptage | | | | | | Typologie | Desc. Typo. | Dessin | Planche |
|-------|--------------|----------|--------------------------|-----------|----------|---|---|---|---|----|-----------|-------------|--------|---------|
| | | | | | B | F | A | D | P | NR | | | | |
| BAL | n°2010-0-38 | | prospection P Duveaux | TN | | | 1 | | | 1 | | | | |
| BAL | n°2010-0-506 | | prospection P Duveaux | TN | | | | | 8 | 8 | | | | |
| BAL | n°2010-0-35 | | prospection P Duveaux | TN | | | | | 3 | 3 | | | | |
| BAL | n°2010-0-32 | | prospection P Duveaux | TN | | 1 | | | | 1 | | | | |
| BAL | n°2010-0-51 | | prospection P Duveaux | TN | | | | | 1 | 1 | | | | |
| BAL | n°2010-0-29 | | prospection P Duveaux | TN | | 1 | | | | 1 | | | | |
| BAL | n°2010-0-52 | | prospection P Duveaux | TN | | 1 | | | | 1 | | | | |
| BAL | n°2010-0-42 | | prospection P Duveaux | TN | | 1 | | | | 1 | | | | |
| BAL | n°2010-0-55 | | prospection P Duveaux | TN | | | | | 1 | 1 | | | | |
| BAL | n°2010-0-40 | | prospection P Duveaux | TN | | 1 | | | | 1 | | | | |
| BAL | n°2010-0-56 | | prospection P Duveaux | TN | | 1 | | | | 1 | | | | |
| BAL | n°2010-0-47 | | prospection P Duveaux | TN | | 1 | | | | 1 | | | | |
| BAL | n°2010-0-44 | | prospection P Duveaux | TN | | 1 | | | | 1 | | | | |
| BAL | n°2010-0-53 | | prospection P Duveaux | TN | | 1 | | | | 1 | | | | |
| BAL | n°2010-0-61 | | prospection P Duveaux | TN | | | | | 1 | 1 | | | | |
| BAL | n°2009/0/505 | | | TN | | | | | 3 | 3 | | | | |

ANNEXE B : LA MALADIÈRE

| Rayon | Caisse | n° ordre | US | Catégorie | Comptage | | | | | | | Typologie | Desc. Typo. | Dessin | Planche |
|-------|--------------|----------|-----------------------|-----------|----------|---|---|---|----|----|-----|-----------|---------------|--------|---------|
| | | | | | B | F | A | D | P | NR | NMI | | | | |
| BAL | n°2010-0-58 | lot 3 | prospection P Duveaux | TN AR | | | | 4 | 27 | 31 | 1 | | | | |
| BAL | n°2010-0-43 | | prospection P Duveaux | TN AR | | 1 | | | | 1 | | | | | |
| BAL | n°2010-0-28 | | prospection P Duveaux | TN AR | | | | | 1 | 1 | | | | | |
| BAL | n°2010-0-78 | lot 3 | prospection P Duveaux | CB | | | | | 6 | 6 | 1 | | | | |
| BAL | n°2010-0-79 | | prospection P Duveaux | CB | | 1 | | | | 1 | | | | | |
| BAL | n°2010-0-34 | | prospection P Duveaux | CB | | | | | 1 | 1 | | | | | |
| BAL | n°2010-0-509 | | prospection P Duveaux | CB | | | | | 2 | 2 | | | | | |
| BAL | n°2010-0-82 | lot 3 | prospection P Duveaux | Sb. Coq | | 1 | | | | 1 | 1 | | | | |
| BAL | n°2010-0-81 | lot 3 | prospection P Duveaux | Sb. Coq | | | | | 10 | 10 | | | | | |
| BAL | n°2010-0-80 | | prospection P Duveaux | Sb. Coq | | | | | 10 | 10 | | | | | |
| BAL | n°2010-0-60 | | prospection P Duveaux | Sb. Coq | | | | | 1 | 1 | | | | | |
| BAL | n°2010-0-45 | | prospection P Duveaux | Sb. Coq | | 1 | | | | 1 | | | | | |
| BAL | n°2010/0/14 | | | Com. Cl 1 | 1 | | | | | 1 | 1 | cruche | Com. Cl Cr1.1 | 6 | I |
| BAL | n°2010/0/19 | | | Com. Cl 1 | 1 | | | | | 1 | 1 | cruche | Com. Cl Cr2.1 | 7 | I |
| BAL | n°2010-0-13 | lot 3 | prospection P Duveaux | Com. Cl 1 | | 1 | | | | 1 | | | | | |
| BAL | n°2010-0-15 | | prospection P Duveaux | Com. Cl 1 | | | | | 3 | 3 | | | | | |

ANNEXE B : LA MALADIÈRE

| Rayon | Caisse | n° ordre | US | Catégorie | Comptage | | | | | | Typologie | Desc. Typo. | Dessin | Planche | |
|-------|---------------|----------|--------------------------|------------------|----------|---|---|---|---|----|-----------|-------------|-------------|---------|-----|
| | | | | | B | F | A | D | P | NR | | | | | NMI |
| BAL | n°2010-0-16 | | prospection P Duveaux | Com. Cl 1 | | | | | 1 | 1 | | | | | |
| BAL | n°2010-0-17 | | prospection P Duveaux | Com. Cl 1 | | 1 | | | | 1 | | | | | |
| BAL | n°2010-0-18 | | prospection P Duveaux | Com. Cl 1 | | 1 | | | | 1 | | | | | |
| BAL | n°2009/0/503 | | | Com. Cl 1 | | | | | 8 | 8 | | | | | |
| BAL | n°2010-0-86 | | prospection P Duveaux | Com. Cl 2 | | 1 | | | | 1 | 1 | | | | |
| BAL | n°2010-0-84 | | prospection P Duveaux | Com. Cl 2 | | 1 | | | | 1 | | | | | |
| BAL | n°2010-0-87 | | prospection P Duveaux | Com. Cl 2 | | | | | 2 | 2 | | | | | |
| BAL | n°2010-0-22 | | prospection P Duveaux | Com. Cl 2 | | | | | 1 | 1 | | | | | |
| BAL | n°2009/0/1031 | | | Com. Cl 3 | 2 | 3 | | | 3 | 8 | 1 | pot | Com. Cl P2 | 8 | I |
| BAL | n°2010-0-88 | lot 3 | prospection P Duveaux | Com. Cl 3 | | | | | 6 | 6 | | | | | |
| BAL | n°2010-0-93 | | prospection P Duveaux | Com. Cl 3 | | | | | 3 | 3 | | | | | |
| BAL | n°2010-0-77 | | prospection P Duveaux | Com. Cl 3 | | | | | 1 | 1 | | | | | |
| BAL | n°2010-0-23 | | prospection P Duveaux | Com. Cl 3 | | | | | 3 | 3 | | | | | |
| BAL | n°2010-0-20 | | prospection P Duveaux | Com. Cl 3 | | | | | 1 | 1 | | | | | |
| BAL | n°2009/0/503 | | | Com. Cl 3 | | | | | 7 | 7 | | | | | |
| BAL | n°2010/0/89 | | | Com. Cl dorée | 1 | | | | | 1 | 1 | plat | Com. Cl P13 | 9 | I |
| BAL | n°2010/0/89 | | | Com. Cl dorée | 1 | | | | 4 | 5 | 1 | bol | Com. Cl B3 | 10 | I |

ANNEXE B : LA MALADIÈRE

| Rayon | Caisse | n° ordre | US | Catégorie | Comptage | | | | | | Typologie | Desc. Typo. | Dessin | Planche | |
|-------|--------------|----------|-----------------------|---------------|----------|---|---|---|---|----|-----------|-------------|--------------|---------|-----|
| | | | | | B | F | A | D | P | NR | | | | | NMI |
| BAL | n°2010/0/89 | | | Com. Cl dorée | 1 | | | | | 1 | 1 | bol | Com. Cl B6.3 | 11 | I |
| BAL | n°2010/0/85 | | | Mo | 1 | | | | | 1 | 1 | mortier | Mo1.1 | 12 | I |
| BAL | n°2010-0-3 | lot 3 | prospection P Duveaux | Amp. | | | | | 2 | 2 | | | | | |
| BAL | n°2010-0-1 | lot 3 | prospection P Duveaux | Amp. | | | | | 7 | 7 | | | | | |
| BAL | n°2010-0-2 | lot 3 | prospection P Duveaux | Amp. | | | | | 4 | 4 | | | | | |
| BAL | n°2010-0-83 | lot 3 | prospection P Duveaux | Amp. | | | | | 7 | 7 | | | | | |
| BAL | n°2010-0-7 | | prospection P Duveaux | Amp. | | | | | 2 | 2 | | | | | |
| BAL | n°2010-0-8 | | prospection P Duveaux | Amp. | | | 1 | | | 1 | | | | | |
| BAL | n°2010-0-25 | | prospection P Duveaux | Amp. | | | | | 6 | 6 | | | | | |
| BAL | n°2010-0-6 | | prospection P Duveaux | Amp. | | | | | 2 | 2 | | | | | |
| BAL | n°2010-0-5 | | prospection P Duveaux | Amp. | | | | | 1 | 1 | | | | | |
| BAL | n°2010-0-4 | | prospection P Duveaux | Amp. | | | | | 1 | 1 | | | | | |
| BAL | n°2009/0/512 | | | Amp. | | | 5 | | | 5 | 1 | | | | |

ANNEXE B : HANGAR POILPRÉS

| n° OA | Rayon | Caisse | n° ordre | Catégorie | Comptage | | | | | | Typologie | Desc. Typo. | Dessin | Planché | | |
|---|-------|------------------|----------|-----------|----------|---|---|---|----|----|-----------|-------------|----------|----------|-----|--|
| | | | | | B | F | A | D | P | NR | | | | | NMI | |
| | | 2009/0/502 | | TS SG | 1 | | | | | | 1 | 1 | coupelle | Drag. 35 | | |
| Prospection P. Duveaux "habitat nord-est" | BAL | n°2010-0-158 | lot n°7 | TS SG | | 1 | | | | | 1 | | | | | |
| Prospection P. Duveaux "habitat nord-est" | BAL | n°inv:2010-0-162 | lot n°7 | TS SG | | | | 1 | | | 1 | | | | | |
| Prospection P. Duveaux "habitat nord-est" | BAL | n°inv:2010-0-381 | lot n°5 | TS SG | | | | | 8 | 8 | | | | | | |
| Prospection P. Duveaux "habitat nord-est" | BAL | n°inv:2010-0-382 | lot n°5 | TS SG | | 3 | | | | | 3 | | | | | |
| Prospection P. Duveaux "habitat nord-est" | BAL | n°2010-0-269 | | TS SG | | 5 | | | | | 5 | | | | | |
| | | 2009/0/502 | | TS SG | | | | | 19 | 19 | | | | | | |
| Prospection P. Duveaux "habitat nord-est" | BAL | n°inv:2010-0-157 | lot n°7 | TS AR | 1 | | | | 1 | 2 | 1 | coupe | Drag. 37 | | | |
| | | 2010/0/380 | | TS AR | | | | | 14 | 14 | 1 | coupe | Drag. 37 | | | |
| | | 2009/0/502 | | TS AR | 1 | | | | | 1 | 1 | coupelle | Drag. 27 | | | |
| Prospection P. Duveaux "habitat nord-est" | | n°2010/0/156 | | TS AR | 1 | | | | | 1 | 1 | mortier | Drag. 45 | | | |
| | | 2009/0/502 | | TS AR | | 1 | | | | 1 | 1 | mortier | Curle 21 | | | |
| | | 2010/0/160 | | TS AR | | | | 1 | | 1 | | décor | | | | |
| Prospection P. Duveaux "habitat nord-est" | BAL | n°inv:2010-0-268 | | TS AR | | | | | 57 | 57 | | | | | | |
| Prospection P. Duveaux "habitat nord-est" | BAL | n°inv:2010-0-419 | lot n°5 | TS AR | | 3 | | | 50 | 53 | | | | | | |
| Prospection P. Duveaux "habitat nord-est" | BAL | n°2010-0-163 | lot n°7 | TS AR | | | | 1 | | 1 | | | | | | |
| Prospection P. Duveaux "habitat nord-est" | BAL | n°inv:2010-0-375 | lot n°5 | EN AR | | 4 | | | | 4 | | | | | | |

ANNEXE B : HANGAR POILPRÉS

| n° OA | Rayon | Caisse | n° ordre | Catégorie | Comptage | | | | | | | Typologie | Desc. Typo. | Dessin | Planche |
|---|-------|-------------------|----------|-----------|----------|---|---|---|----|-----|------|-----------|-------------|--------|---------|
| | | | | | B | F | A | D | P | N R | NM I | | | | |
| Prospection P. Duveaux "habitat nord-est" | BAL | n°inv:2010-0-406 | lot n°5 | EN AR | | 2 | | | | | 2 | | | | |
| Prospection P. Duveaux "habitat nord-est" | BAL | n°inv:2010-0-377 | lot n°5 | EN AR | | | | | 62 | 62 | | | | | |
| Prospection P. Duveaux "habitat nord-est" | BAL | n°inv:2010-0-165 | lot n°7 | EN AR | | | | | 5 | 5 | | | | | |
| Prospection P. Duveaux "habitat nord-est" | BAL | n°inv:2010-0-505 | | EN AR | | 1 | | | 11 | 12 | | | | | |
| Prospection P. Duveaux "habitat nord-est" | BAL | n°inv:2010-0-376 | lot n°5 | EN AR | | 5 | | | | 5 | 1 | gobelet | Hees 2 | | |
| Prospection P. Duveaux "habitat nord-est" | BAL | n°2010-0-164 | lot n°7 | EN AR | 1 | | | | | 1 | 1 | gobelet | Hees 2 | | |
| Prospection P. Duveaux "habitat nord-est" | BAL | n°inv:2010-0-770 | lot n°21 | MET | | | | | 3 | 3 | | | | | |
| Prospection P. Duveaux "habitat nord-est" | BAL | n°inv:2009-0-507 | lot n°3 | MET AR | | | | | 1 | 1 | 1 | | | | |
| Prospection P. Duveaux "habitat nord-est" | BAL | n°inv:2010-00-388 | lot n°5 | MET AR | | | | | 5 | 5 | | | | | |
| Prospection P. Duveaux "habitat nord-est" | BAL | n°inv:2010-0-413 | lot n°5 | TN | | 6 | | | | 6 | | | | | |
| Prospection P. Duveaux "habitat nord-est" | BAL | n°inv:2010-0-505 | | TN | | 2 | | | 7 | 9 | | | | | |
| Prospection P. Duveaux "habitat nord-est" | BAL | n°inv:2010-0-378 | lot n°5 | TN | | | | | 11 | 11 | | | | | |
| Prospection P. Duveaux "habitat nord-est" | BAL | n°2010-0-379 | lot n°5 | TN | 1 | 1 | | | 1 | 3 | 1 | | | | |
| | | 2010/0/167 | | TR | | | | | 3 | 3 | 1 | décor | | | |
| | | 2010/0/166 | | TR | | | | | 1 | 1 | 1 | décor | | | |
| Prospection P. Duveaux "habitat nord-est" | BAL | n°inv:2010-0-385 | lot n°5 | RU Cl | | 1 | | | | 1 | | | | | |

ANNEXE B : HANGAR POILPRÉS

| n° OA | Rayon | Caisse | n° ordre | Catégorie | Comptage | | | | | | | Typologie | Desc. Typo. | Dessin | Planche | |
|---|-------|------------------|----------|-----------|----------|---|---|---|---|-----|------|-----------|-------------|---------------|---------|---|
| | | | | | B | F | A | D | P | N R | NM I | | | | | |
| | | n°2010/0/510 | | RU Cl | 1 | | | | | | 1 | 1 | pot | Nied. 117 | 1 | I |
| Prospection P. Duveaux "habitat nord-est" | BAL | n°inv:2010-0-383 | lot n°5 | CB | | | | | | 21 | 21 | 1 | | | | |
| Prospection P. Duveaux "habitat nord-est" | BAL | n°inv:2010-0-168 | lot n°7 | CB | | 2 | | | | | 2 | | | | | |
| | | 2009/0/508 | | Sb. Coq | 1 | | | | | | 1 | 1 | plat | Sb. Coq P11.1 | 2 | I |
| | | 2009/0/508 | | Sb. Coq | 1 | | | | | | 1 | 1 | plat | Sb. Coq P12 | 3 | I |
| | | n°2010/0/403 | | Sb. Coq | | | 1 | | | | 1 | 1 | marmite | Sb. Coq M1.2 | | |
| | | 2009/0/508 | | Sb. Coq | 3 | | | | | | 3 | 1 | pot | Sb. Coq P7.1 | 4 | I |
| | | 2009/0/508 | | Sb. Coq | 1 | | | | | | 1 | 1 | pot | Sb. Coq P7.1 | 5 | I |
| Prospection P. Duveaux "habitat nord-est" | BAL | n°inv:2010-0-402 | lot n°5 | Sb. Coq | | | | | | 27 | 27 | | | | | |
| Prospection P. Duveaux "habitat nord-est" | BAL | n°inv:2010-0-300 | lot n°5 | Sb. Coq | | 8 | | | | | 8 | | | | | |
| | | 2009/0/508 | | Sb. Coq | | 1 | | | | 14 | 15 | | | | | |
| Prospection P. Duveaux "habitat nord-est" | BAL | n°inv:2010-0-391 | lot n°5 | Com. Cl 1 | | | 1 | | | | 1 | 1 | | | | |
| Prospection P. Duveaux "habitat nord-est" | BAL | n°2010-0-414 | lot n°5 | Com. Cl 1 | | | | | | 8 | 8 | | | | | |
| Prospection P. Duveaux "habitat nord-est" | BAL | n°inv:2010-0-415 | lot n°5 | Com. Cl 2 | | | 2 | | | | 2 | 1 | | | | |
| Prospection P. Duveaux "habitat nord-est" | BAL | n°inv:2010-0-387 | lot n°5 | Com. Cl 2 | | 1 | | | | | 1 | | | | | |
| Prospection P. Duveaux "habitat nord-est" | BAL | n°inv:2010-0-424 | lot n°5 | Com. Cl 2 | | 2 | | | | 17 | 19 | | | | | |
| Prospection P. Duveaux "habitat nord-est" | BAL | n°inv:2010-0-386 | lot n°5 | Com. Cl 2 | | | | | | 99 | 99 | | | | | |

ANNEXE B : HANGAR POILPRÉS

| n° OA | Rayon | Caisse | n° ordre | Catégorie | Comptage | | | | | | | Typologie | Desc. Typo. | Dessin | Planche |
|---|-------|------------------|----------|-----------|----------|---|---|---|---|-----|------|-----------|-------------|--------------|---------|
| | | | | | B | F | A | D | P | N R | NM I | | | | |
| Prospection P. Duveaux "habitat nord-est" | BAL | n°inv:2010-0-505 | | Com. Cl 2 | | | | | | 10 | 10 | | | | |
| Prospection P. Duveaux "habitat nord-est" | BAL | n°2010-0-390 | lot n°5 | Com. Cl 2 | | | | | | 2 | 2 | | | | |
| | | n°2010/0/404 | | Com. Cl 3 | 1 | | | | | | 1 | 1 | bol | Com. Cl B4 | 6 I |
| | | n°2010/0/404 | | Com. Cl 3 | 1 | | | | | | 1 | 1 | marmite | Com. Cl M2 | 7 I |
| | | n°2010/0/404 | | Com. Cl 3 | 1 | | | | | | 1 | 1 | pot | Com. Cl P6.1 | 8 I |
| Prospection P. Duveaux "habitat nord-est" | BAL | n°inv:2010-0-505 | | Com. Cl 3 | | | | | | 9 | 9 | | | | |
| Prospection P. Duveaux "habitat nord-est" | | n°2010/0/405 | | Com. Cl 3 | | | | | | 1 | 1 | | | | |
| Prospection P. Duveaux "habitat nord-est" | BAL | n°inv:2010-0-392 | lot n°5 | Mo | | | | | | 1 | 1 | 1 | | | |
| Prospection P. Duveaux "habitat nord-est" | BAL | n°inv:2010-0-407 | lot n°5 | Mo | | 2 | | | | | 2 | | | | |
| Prospection P. Duveaux "habitat nord-est" | BAL | n°inv:2010-0-389 | lot n°5 | Mo | | | | | | 4 | 4 | | | | |
| Prospection P. Duveaux "habitat nord-est" | BAL | n°inv:2010-0-394 | lot n°5 | Amp. | | | | | | 1 | 1 | | | | |
| Prospection P. Duveaux "habitat nord-est" | BAL | n°inv:2010-0-505 | | Amp. | | | | | | 6 | 6 | | | | |
| Prospection P. Duveaux "habitat nord-est" | | n°2010/0/313 | | Amp. | 1 | | | | | | 1 | 1 | amphore | Dressel 20 | |
| | | 2009/0/511 | | Amp. | | | 1 | | | | 1 | 1 | estampille | [SCI] | 9 I |
| | | 2009/0/513 | | Ampho. | | 1 | | | | | 1 | 1 | amphorisque | Ampho fond 3 | 10 I |

ANNEXE B : FOSSE DUSSEAUX

| année | Rayon | Caisse | n° ordre | Catégorie | Comptage | | | | | | | Typologie | Desc. Typo. | Dessin | Planche |
|-------|-------|--------|----------|-----------|----------|---|---|---|----|----|-----|-----------|-------------|--------|---------|
| | | | | | B | F | A | D | P | NR | NMI | | | | |
| 1973 | 69-3 | 664 | 209 | TS SG | 1 | 2 | | | | 3 | 1 | assiette | Curle 15 | | |
| 1973 | 69-3 | 664 | 209 | TS SG | 3 | | | | | 3 | 1 | assiette | Curle 15 | | |
| 1973 | | BAL | | TS SG | 1 | | | | | 1 | 1 | assiette | Drag. 18 | 1 | I |
| 1973 | | BAL | | TS SG | 6 | | | | 3 | 9 | 1 | assiette | Drag. 18 | 2 | I |
| 1973 | 69-3 | 664 | 209 | TS SG | 7 | 6 | | | 9 | 22 | 1 | assiette | Drag. 18 | | |
| 1973 | 69-3 | 664 | 209 | TS SG | 2 | 2 | | | | 4 | 1 | assiette | Drag. 18 | 4 | I |
| 1973 | 69-3 | 664 | 209 | TS SG | 3 | 1 | | | | 4 | 1 | assiette | Drag. 18 | 3 | I |
| 1973 | 69-3 | 664 | 209 | TS SG | | 1 | | | | 1 | 1 | assiette | Drag. 18 | | |
| 1973 | 69-3 | 664 | 209 | TS SG | 3 | | | | | 3 | 1 | assiette | Drag. 18 | | |
| 1973 | 69-3 | 664 | 209 | TS SG | 2 | | | | | 2 | 1 | assiette | Drag. 18 | | |
| 1973 | 69-3 | 664 | 209 | TS SG | 7 | | | | 1 | 8 | 1 | assiette | Drag. 18 | | |
| 1973 | 69-3 | 664 | 209 | TS SG | 6 | | | | | 6 | 1 | assiette | Drag. 18 | | |
| 1973 | 69-3 | 664 | 209 | TS SG | 4 | | | | | 4 | 1 | assiette | Drag. 18 | | |
| 1973 | 69-3 | 664 | 209 | TS SG | 8 | | | | | 8 | 1 | assiette | Drag. 18 | | |
| 1973 | 69-3 | 664 | 209 | TS SG | 5 | | | | | 5 | 1 | assiette | Drag. 18 | | |
| 1973 | 69-3 | 664 | 209 | TS SG | 1 | | | 2 | | 3 | 1 | coupe | Drag. 37 | | |
| 1973 | 69-3 | 664 | 209 | TS SG | | | | 2 | | 2 | 1 | coupe | Drag. 37 | | |
| 1973 | 69-3 | 664 | 209 | TS SG | | | | 1 | | 1 | 1 | coupe | Drag. 37 | | |
| 1973 | | BAL | | TS SG | 2 | | | | | 2 | 1 | coupelle | Drag. 27 | 5 | II |
| 1973 | | BAL | | TS SG | 3 | 1 | | | 1 | 5 | 1 | coupelle | Drag. 27 | 6 | II |
| 1973 | 69-3 | 664 | 209 | TS SG | 17 | | | | 11 | 28 | 1 | coupelle | Drag. 27 | | |
| 1973 | 69-3 | 664 | 209 | TS SG | 8 | 2 | | | | 10 | 1 | coupelle | Drag. 27 | | |
| 1973 | 69-3 | 664 | 209 | TS SG | 2 | 1 | | | 2 | 5 | 1 | coupelle | Drag. 27 | 7 | II |
| 1973 | 69-3 | 664 | 209 | TS SG | | 2 | | | 2 | 4 | 1 | coupelle | Drag. 27 | 8 | II |
| 1973 | 69-3 | 664 | 209 | TS SG | | 1 | | | | 1 | 1 | coupelle | Drag. 27 | 9 | II |
| 1973 | 69-3 | 664 | 209 | TS SG | | 1 | | | 1 | 2 | 1 | coupelle | Drag. 27 | 10 | II |
| 1973 | 69-3 | 664 | 209 | TS SG | | 1 | | | | 1 | 1 | coupelle | Drag. 27 | 11 | II |

ANNEXE B : FOSSE DUSSEAUX

| année | Rayon | Caisse | n° ordre | Catégorie | Comptage | | | | | | | Typologie | Desc. Typo. | Dessin | Planche |
|-------|-------|--------|----------|-----------|----------|----|---|---|----|----|-----|-----------|-------------|--------|---------|
| | | | | | B | F | A | D | P | NR | NMI | | | | |
| 1973 | 69-3 | 664 | 209 | TS SG | | 1 | | | | 1 | 1 | coupelle | Drag. 27 | 12 | II |
| 1973 | 69-3 | 664 | 209 | TS SG | 4 | | | | | 4 | 1 | coupelle | Drag. 27 | | |
| 1973 | 69-3 | 664 | 209 | TS SG | 2 | | | | | 2 | 1 | coupelle | Drag. 27 | | |
| 1973 | 69-3 | 664 | 209 | TS SG | 1 | | | | 1 | 2 | 1 | coupelle | Drag. 27 | | |
| 1973 | 69-3 | 664 | 209 | TS SG | 1 | | | | | 1 | 1 | coupelle | Drag. 27 | | |
| 1973 | 69-3 | 664 | 209 | TS SG | 1 | | | | | 1 | 1 | coupelle | Drag. 27 | | |
| 1973 | 69-3 | 664 | 209 | TS SG | 1 | | | | | 1 | 1 | coupelle | Drag. 27 | | |
| 1973 | 69-3 | 664 | 209 | TS SG | 3 | | | | | 3 | 1 | coupelle | Drag. 27 | | |
| 1973 | 69-3 | 664 | 209 | TS SG | 2 | | | | | 2 | 1 | coupelle | Drag. 27 | | |
| 1973 | 69-3 | 664 | 209 | TS SG | 2 | 1 | | | | 3 | 1 | coupelle | Drag. 27 | | |
| 1973 | 69-3 | 664 | 209 | TS SG | 5 | 1 | | | 10 | 16 | 1 | coupelle | Drag. 35 | | |
| 1973 | 69-3 | 664 | 209 | TS SG | 4 | 1 | | | | 5 | 1 | coupelle | Drag. 35 | 13 | III |
| 1973 | 69-3 | 664 | 209 | TS SG | 1 | | | | | 1 | 1 | coupelle | Drag. 35 | 14 | III |
| 1973 | 69-3 | 664 | 209 | TS SG | 3 | 1 | | | | 4 | 1 | coupelle | Drag. 35 | 15 | III |
| 1973 | 69-3 | 664 | 209 | TS SG | 2 | 1 | | | | 3 | 1 | coupelle | Drag. 35 | 16 | III |
| 1973 | 69-3 | 664 | 209 | TS SG | 1 | | | | | 1 | 1 | coupelle | Drag. 35 | 17 | III |
| 1973 | 69-3 | 664 | 209 | TS SG | 3 | | | | | 3 | 1 | coupelle | Drag. 35 | | |
| 1973 | 69-3 | 664 | 209 | TS SG | 2 | | | | | 2 | 1 | coupelle | Drag. 35 | | |
| 1973 | 69-3 | 664 | 209 | TS SG | 1 | | | | | 1 | 1 | coupelle | Drag. 35 | | |
| 1973 | 69-3 | 664 | 209 | TS SG | 2 | | | | | 2 | 1 | coupelle | Drag. 35 | | |
| 1973 | 69-3 | 664 | 209 | TS SG | 2 | | | | | 2 | 1 | coupelle | Drag. 35 | | |
| 1973 | 69-3 | 664 | 209 | TS SG | | | | | 57 | 57 | | | | | |
| 1973 | 69-3 | 664 | 209 | TS SG | | | | | 10 | 10 | | | | | |
| 1973 | 69-3 | 664 | 209 | TS SG | | | | | 31 | 31 | | | | | |
| 1973 | 69-3 | 664 | 209 | TS SG | | 29 | | | 12 | 41 | | | | | |
| 1973 | 69-3 | 664 | 209 | TS AR | 2 | | | | | 2 | 1 | assiette | Drag. 18/31 | | |
| 1973 | 69-3 | 664 | 209 | TS AR | 7 | | | | | 7 | 1 | assiette | Drag. 18/31 | | |

ANNEXE B : FOSSE DUSSEAUX

| année | Rayon | Caisse | n° ordre | Catégorie | Comptage | | | | | | | Typologie | Desc. Typo. | Dessin | Planche |
|-------|--------------------|---------|-----------------|-----------|----------|---|---|---|----|----|-----|-----------|---------------|--------|---------|
| | | | | | B | F | A | D | P | NR | NMI | | | | |
| 1973 | 69-3 | 665 | 211 | TS AR | 3 | 1 | | | | 4 | 1 | assiette | Drag. 18/31 | | |
| 1973 | musée amphithéâtre | vitrine | Inv. 2009-0-335 | TS AR | | 3 | | | | | 1 | coupe | Drag. 37 | | |
| 1973 | 69-3 | 664 | 209 | TS AR | 2 | | | | 1 | 3 | 1 | coupelle | Drag. 27 | | |
| 1973 | 69-3 | 664 | 209 | TS AR | 5 | 2 | | | 3 | 10 | 1 | coupelle | Drag. 35 | | |
| 1973 | 69-3 | 664 | 209 | TS AR | 2 | 1 | | | | 3 | 1 | coupelle | Drag. 35 | | |
| 1973 | 69-3 | 664 | 209 | TS AR | 1 | 1 | | | | 2 | 1 | coupelle | Drag. 35 | | |
| 1973 | 69-3 | 664 | 209 | TS AR | 6 | | | | | 6 | 1 | coupelle | Drag. 35 | | |
| 1973 | 69-3 | 664 | 209 | TS AR | 3 | | | | | 3 | 1 | coupelle | Drag. 35 | | |
| 1973 | 69-3 | 664 | 209 | TS AR | 1 | 2 | | | | 3 | 1 | coupelle | Drag. 35 | | |
| 1973 | 69-3 | 665 | 211 | TS AR | 1 | 1 | | | | 2 | 1 | coupelle | Drag. 35 | | |
| 1973 | 69-3 | 664 | 209 | TS AR | | 1 | | | | 1 | | | | | |
| 1973 | 69-3 | 665 | 211 | TS AR | | 3 | | | | 3 | | | | | |
| 1973 | 69-3 | 664 | 209 | EN AR | | 2 | | | 39 | 41 | | | | | |
| 1973 | 69-3 | 664 | 209 | EN AR | 2 | 1 | | | | 3 | 1 | gobelet | Hees 2 | | |
| 1973 | 69-3 | 664 | 209 | EN AR | 2 | | | | | 2 | 1 | gobelet | Hees 2 | | |
| 1973 | 69-3 | 664 | 209 | EN | | | | 1 | | 1 | 1 | décor | | | |
| 1973 | 69-3 | 664 | 209 | EN LYON | 1 | | | | | 1 | 1 | gobelet | type 13.1 | 18 | III |
| 1973 | 69-3 | 664 | 209 | MET AR | | | | | 1 | 1 | | | | | |
| 1973 | 69-3 | 664 | 209 | MET AR | 1 | | | | | 1 | 1 | gobelet | Nied. 33 | | |
| 1973 | 69-3 | 664 | 209 | MET | | | | 1 | | 1 | 1 | décor | | | |
| 1973 | 69-3 | 664 | 209 | MET AR | | 1 | | | | 1 | | | | | |
| 1973 | 69-3 | 664 | 209 | VRP | 4 | | | | 1 | 5 | 1 | couvercle | Goudineau 18 | 19 | III |
| 1973 | 69-3 | 665 | 211 | Com. Cl 3 | 9 | | | | | 9 | 1 | plat | Com. Cl P13 | 20 | III |
| 1973 | 69-3 | 665 | 211 | Com. Cl 3 | 1 | | | | | 1 | 1 | cruche | Com. Cl Cr7.1 | 21 | III |
| 1973 | 69-3 | 665 | 211 | Com. Cl 3 | 2 | | | | 10 | 12 | 1 | fond | | 22 | III |
| 1973 | 69-3 | 664 | 209 | Com. Cl 3 | | | | | 5 | 5 | | | | | |
| 1973 | 69-3 | 665 | 211 | Com. Cl 3 | | 7 | | | 70 | 77 | 1 | | | | |

ANNEXE B : FOSSE DUSSEAUX

| année | Rayon | Caisse | n° ordre | Catégorie | Comptage | | | | | | | Typologie | Desc. Typo. | Dessin | Planche |
|-------|-------|--------|----------|---------------|----------|---|---|---|---|----|-----|-----------|-------------|--------|---------|
| | | | | | B | F | A | D | P | NR | NMI | | | | |
| 1973 | 69-3 | 664 | 209 | Cl. Eng. | | | | | 1 | 1 | 1 | | | | |
| 1973 | 69-3 | 665 | 211 | Com. Cl Grand | 4 | | | | | 4 | 1 | bol | Com. Cl B5 | 23 | IV |
| 1973 | 69-3 | 665 | 211 | Com. Cl Grand | 2 | | | | | 2 | 1 | bol | Com. Cl B5 | 24 | IV |
| 1973 | 69-3 | 665 | 211 | Com. Cl Grand | 1 | | | | | 1 | 1 | bol | Com. Cl B5 | 25 | IV |
| 1973 | 69-3 | 665 | 211 | Com. Cl Grand | 2 | | | | | 2 | 1 | bol | Com. Cl B5 | 26 | IV |
| 1973 | 69-3 | 665 | 211 | Com. Cl Grand | 1 | | | | | 1 | 1 | bol | Com. Cl B5 | 27 | IV |
| 1973 | 69-3 | 665 | 211 | Com. Cl Grand | 1 | | | | | 1 | 1 | bol | Com. Cl B5 | 28 | IV |
| 1973 | 69-3 | 665 | 211 | Com. Cl Grand | 2 | | | | | 2 | 1 | bol | Com. Cl B5 | 29 | IV |
| 1973 | 69-3 | 665 | 211 | Com. Cl Grand | 3 | | | | | 3 | 1 | bol | Com. Cl B5 | 30 | IV |
| 1973 | 69-3 | 665 | 211 | Com. Cl Grand | 1 | | | | | 1 | 1 | bol | Com. Cl B5 | 31 | IV |
| 1973 | 69-3 | 665 | 211 | Com. Cl Grand | 1 | | | | | 1 | 1 | bol | Com. Cl B5 | 32 | IV |
| 1973 | 69-3 | 665 | 211 | Com. Cl Grand | 1 | | | | | 1 | 1 | bol | Com. Cl B5 | 33 | IV |
| 1973 | 69-3 | 665 | 211 | Com. Cl Grand | 1 | | | | | 1 | 1 | bol | Com. Cl B5 | 34 | IV |
| 1973 | 69-3 | 665 | 211 | Com. Cl Grand | 1 | | | | | 1 | 1 | bol | Com. Cl B5 | 35 | IV |
| 1973 | 69-3 | 665 | 211 | Com. Cl Grand | 1 | | | | | 1 | 1 | bol | Com. Cl B5 | 36 | V |
| 1973 | 69-3 | 665 | 211 | Com. Cl Grand | 1 | | | | | 1 | 1 | bol | Com. Cl B5 | 37 | V |
| 1973 | 69-3 | 665 | 211 | Com. Cl Grand | 1 | | | | | 1 | 1 | bol | Com. Cl B5 | 38 | V |

ANNEXE B : CITERNE ERNEST CHAUDRON

| Caisse | Catégorie | Comptage | | | | | | | Typologie | Desc. Typo. | Dessin | Planche |
|--------|-----------|----------|---|---|---|---|----|-----|-----------|--------------------------|--------|---------|
| | | B | F | A | D | P | NR | NMI | | | | |
| BAL | TN | 1 | | | | | 1 | 1 | bol | TNB15 | 1 | I |
| BAL | FRB | 1 | | | | | 1 | 1 | gobelet | Deru Reims G2/Chenet 341 | 2 | I |

ANNEXE B : HORS CONTEXTE

| Rayon | Caisse | infos | Catégorie | Comptage | | | | | | | Typologie | Desc. Typo. | Dessin | Planche | |
|----------------|-------------------|--|-----------|----------|---|---|---|---|----|-----|-----------|--------------------------|-----------|---------|----|
| | | | | B | F | A | D | P | NR | NMI | | | | | |
| Musée Epinal | boîte R204 | R2015-2-778 | TS SG | 2 | | | | | | 2 | 1 | assiette | Drag. 18 | 1 | I |
| Musée Epinal | vitrine 2 salle 1 | | TS SG | 1 | | | | | | 1 | 1 | coupe | Drag. 29b | 2 | I |
| Musée Epinal | boîte R195 | R2015-2-181 | TS SG | | 1 | | | | | 1 | 1 | estampille [IVCVNDVS] | | | |
| Musée Epinal | vitrine 2 salle 1 | noté "Grand 26 mai 1890" | TS CG | | 4 | | | 6 | 10 | | 1 | coupe | Drag. 30 | 3 | I |
| Musée Epinal | vitrine 1 salle 1 | noté "vase trouvé à Grand en janvier 1901" | TS CG | 1 | 1 | | | 5 | 7 | | 1 | coupe | Drag. 30 | 4 | I |
| BAL | | Dons Musée Besançon | TS CG | 1 | | | | | | 1 | 1 | coupe | Drag. 37 | 5 | I |
| BAL | | Dons Musée Besançon | TS CG | 1 | | | | | | 1 | 1 | coupe | Drag. 37 | | |
| BAL | | Dons Musée Besançon | TS CG | 1 | | | | | | 1 | 1 | coupe | Drag. 37 | 6 | II |
| BAL | | Dons Musée Besançon | TS CG | 1 | | | | | | 1 | 1 | coupe | Drag. 37 | 7 | II |
| BAL | | Dons Musée Besançon | TS CG | | | | 1 | | | 1 | 1 | décor | | 8 | II |
| BAL | | Dons Musée Besançon | TS CG | | | | 1 | | | 1 | 1 | décor | | 9 | II |
| BAL | | Dons Musée Besançon | TS CG | | | | 1 | | | 1 | 1 | décor | | 10 | II |
| BAL | | Lot 26 | TS CG | | 2 | | | | | 2 | 1 | estampille [GENITOR] | | 11 | II |
| BAL | | | TS GE | 1 | | | | | | 1 | 1 | coupe | Drag. 37 | | |
| BAL | | Lot JPB | TS GE | 1 | | | | | | 1 | 1 | coupe | Drag. 37 | | |
| BAL | | Lot JPB | TS GE | 1 | | | | | | 1 | 1 | coupe | Drag. 37 | | |
| BAL | | Lot JPB | TS GE | 1 | | | | | | 1 | 1 | coupe | Drag. 37 | | |
| BAL | | Dons Musée Besançon | TS GE | | | | 1 | | | 1 | 1 | coupe | Drag. 37 | | |
| BAL | | Dons Musée Besançon | TS GE | 1 | | | | | | 1 | 1 | coupe | Drag. 37 | | |
| Musée Mosaïque | vitrine | Inv.2009-0-907 | TS GE | 1 | | | | | | 1 | 1 | coupe | Drag. 37 | | |

ANNEXE B : HORS CONTEXTE

| Rayon | Caisse | infos | Catégorie | Comptage | | | | | | | Typologie | Desc. Typo. | Dessin | Planche | |
|----------------|-------------------|---------------------|-----------|----------|---|---|---|---|----|-----|-----------|-------------|----------|---------|-----|
| | | | | B | F | A | D | P | NR | NMI | | | | | |
| Musée Mosaique | vitrine | Inv.2009-0-909 | TS GE | 1 | | | | | | 1 | 1 | coupe | Drag. 37 | | |
| Musée Mosaique | vitrine | Inv.2009-0-911 | TS GE | 1 | | | | | | 1 | 1 | coupe | Drag. 37 | | |
| Musée Epinal | vitrine 2 salle 1 | noté "123 Grand" | TS GE | 1 | | | | | | 1 | 1 | coupe | Drag. 37 | 12 | II |
| Musée Epinal | boîte R195 | R 2015-2-189 | TS GE | 1 | | | | | | 1 | 1 | coupe | Drag. 37 | | |
| Musée Epinal | boîte R195 | L-IV-D-599 | TS GE | 3 | 2 | | | 1 | | 6 | 1 | coupe | Drag. 37 | | |
| Musée Epinal | boîte R195 | R2015-2-195 | TS GE | | 1 | | | | | 1 | 1 | coupe | Drag. 37 | | |
| Musée Epinal | boîte R195 | R2015-2-192 | TS GE | 1 | | | | | | 1 | 1 | coupe | Drag. 37 | | |
| Musée Epinal | boîte R195 | R2015-2-185 | TS GE | | | | | 1 | | 1 | 1 | coupe | Drag. 37 | | |
| Musée Epinal | boîte R195 | R2015-2-182 | TS GE | 1 | | | | | | 1 | 1 | coupe | Drag. 37 | | |
| Musée Epinal | boîte R195 | R2015-2-179 | TS GE | 1 | | | | 6 | | 7 | 1 | coupe | Drag. 37 | | |
| Musée Epinal | boîte R195 | L-IV-D-832 | TS GE | 1 | 2 | | | 4 | | 7 | 1 | coupe | Drag. 37 | | |
| BAL | | Lot 15 | TS GE | | | | | 3 | | 3 | 1 | coupelle | Drag. 35 | | |
| BAL | | Lot JPB | TS GE | 1 | | | | | | 1 | 1 | coupelle | Drag. 27 | | |
| BAL | | Lot JPB | TS GE | 1 | | | | | | 1 | 1 | coupelle | Drag. 27 | | |
| BAL | | Lot JPB | TS GE | 1 | | | | | | 1 | 1 | coupelle | Drag. 27 | | |
| BAL | | Lot 26 | TS GE | | | | | 1 | | 1 | 1 | décor | | | |
| BAL | | Lot 26 | TS GE | 1 | | | | | | 1 | 1 | décor | | 13 | III |
| BAL | | Dons Musée Besançon | TS GE | | | | 6 | | | 6 | 1 | décor | | 14 | III |

ANNEXE B : HORS CONTEXTE

| Rayon | Caisse | infos | Catégorie | Comptage | | | | | | | Typologie | Desc. Typo. | Dessin | Planche |
|--------------|-------------------|-------------------|-----------|----------|---|---|---|----|----|-----|-----------|-------------|--------|---------|
| | | | | B | F | A | D | P | NR | NMI | | | | |
| BAL | | Lot 26 | TS GE | | | | 3 | | 3 | 1 | décor | | 15 | III |
| Musée Epinal | boîte R195 | R2015-2-193 | TS GE | | | | | 1 | 1 | 1 | décor | | | |
| Musée Epinal | boîte R195 | R2015-2-197 | TS GE | | | | | 1 | 1 | 1 | décor | | | |
| Musée Epinal | boîte R195 | R2015-2-196 | TS GE | | | | | 1 | 1 | 1 | décor | | | |
| Musée Epinal | boîte R195 | R2015-2-184 | TS GE | | | | | 1 | 1 | 1 | décor | | | |
| Musée Epinal | boîte R195 | R2015-2-187 | TS GE | | | | | 1 | 1 | 1 | décor | | | |
| BAL | | Lot 26 | TS GE | | | | | 2 | 2 | | | | 16 | III |
| BAL | | Lot 26 | TS GE | 1 | | | | | 1 | | | | | |
| BAL | | Lot 26 | TS GE | | 1 | | | | 1 | | | | | |
| BAL | | Lot 26 | TS GE | 1 | | | | | 1 | | | | | |
| BAL | | Lot 15 | TS GE | | | | | 3 | 3 | | | | | |
| BAL | | Lot JPB | TS GE | | 4 | | 6 | 13 | 23 | | | | | |
| Musée Epinal | vitrine 2 salle 1 | noté "Grand 1893" | TS GE | | | | 1 | | 1 | 1 | décor | | 17 | III |
| Musée Epinal | vitrine 2 salle 1 | | TS GE | | | | 1 | | 1 | 1 | décor | | 18 | III |
| Musée Epinal | vitrine 2 salle 1 | | TS GE | | | | 1 | | 1 | 1 | décor | | 19 | III |
| Musée Epinal | boîte R195 | R2015-2-191 | TS GE | | | | | 1 | 1 | 1 | | | | |
| Musée Epinal | boîte R195 | R2015-2-186 | TS GE | | | | | 1 | 1 | 1 | | | | |
| Musée Epinal | boîte R195 | R2015-2-175 | TS GE | | 1 | | | | 1 | 1 | | | | |
| BAL | | Lot 26 | TS AR | 5 | | | | | 5 | 1 | assiette | Drag. 18/31 | 20 | IV |

ANNEXE B : HORS CONTEXTE

| Rayon | Caisse | infos | Catégorie | Comptage | | | | | | | Typologie | Desc. Typo. | Dessin | Planche | |
|--------------|-------------------|--------------------------|-----------|----------|---|---|---|----|----|-----|-----------|-------------|-----------|---------|----|
| | | | | B | F | A | D | P | NR | NMI | | | | | |
| Musée Epinal | vitrine 2 salle 1 | noté "Grand avril 1899" | TS AR | 1 | | | | | | 1 | 1 | coupe | Drag. 37 | 21 | IV |
| Musée Epinal | boîte R195 | R2015-2-176 | TS AR | 1 | | | | | | 1 | 1 | coupe | Drag. 37 | | |
| Musée Epinal | boîte R195 | R2015-2-190 | TS AR | | | | | 4 | 4 | | 1 | coupe | Drag. 37 | | |
| Musée Epinal | boîte R195 | R2015-2-183 | TS AR | 1 | | | | | | 1 | 1 | coupe | Drag. 37 | | |
| Musée Epinal | boîte R195 | R2015-2-178 | TS AR | 3 | | | | | | 3 | 1 | coupe | Drag. 37 | | |
| Musée Epinal | boîte R204 | R2015-2-779 | TS AR | 7 | 1 | | | 10 | 18 | | 1 | coupe | Drag. 37 | 22 | IV |
| Musée Epinal | boîte R204 | R2015-2-614 | TS AR | 1 | | | | | | 1 | 1 | coupe | Drag. 37 | | |
| Musée Epinal | vitrine 2 salle 1 | | TS AR | 1 | | | | | | 1 | 1 | coupe | Drag. 37R | 23 | V |
| Musée Epinal | boîte R195 | R2015-2-177 | TS AR | 3 | 1 | | | | | 4 | 1 | coupe | Drag. 37R | | |
| Musée Epinal | vitrine 2 salle 1 | | TS AR | 1 | | | | | | 1 | 1 | coupelle | Drag. 40 | 24 | V |
| Musée Epinal | vitrine 2 salle 1 | | TS AR | 1 | | | | | | 1 | 1 | coupelle | Drag. 40 | | |
| Musée Epinal | vitrine 2 salle 1 | | TS AR | 1 | | | | | | 1 | 1 | coupelle | Drag. 40 | 25 | V |
| Musée Epinal | vitrine 2 salle 1 | "trouvé à Grand en 1899" | TS AR | 1 | | | | | | 1 | 1 | mortier | Drag. 45 | | |
| Musée Epinal | boîte R195 | C-473 (10) | TS AR | 1 | | | | | | 1 | 1 | mortier | Drag. 45 | | |
| Musée Epinal | boîte R150 | R2014-2-615 | TS AR | | | | | 1 | 1 | | 1 | mortier | Drag. 45 | | |
| Musée Epinal | boîte R204 | | TS AR | 1 | | | | | | 1 | 1 | mortier | Drag. 38 | 26 | V |

ANNEXE B : HORS CONTEXTE

| Rayon | Caisse | infos | Catégorie | Comptage | | | | | | Typologie | Desc. Typo. | Dessin | Planche | |
|--------------|-------------------|----------------|-----------|----------|---|---|---|---|----|-----------|---------------------|----------|---------|-----|
| | | | | B | F | A | D | P | NR | | | | | NMI |
| Musée Epinal | vitrine 2 salle 1 | | TS AR | 4 | | | | 5 | 9 | 1 | gobelet | Déch. 72 | 27 | V |
| Musée Epinal | boîte R195 | R-2015-2-159 | TS AR | 6 | 2 | | | 3 | 11 | 1 | gobelet | | | |
| Musée Epinal | boîte R195 | R2015-2-194 | TS AR | | | | | 1 | 1 | 1 | décor | | | |
| Musée Epinal | boîte R195 | R2015-2-198 | TS AR | | | | | 1 | 1 | 1 | décor | | | |
| Musée Epinal | boîte R204 | R2015-2-781 | TS AR | | | | | 1 | 1 | 1 | décor | | | |
| Musée Epinal | boîte R204 | R2015-2-616 | TS AR | | | | | 1 | 1 | 1 | décor | | | |
| Musée Epinal | boîte R204 | R2015-2-617 | TS AR | | | | | 1 | 1 | 1 | décor | | | |
| Musée Epinal | boîte R150 | L-IV-D-824 | TS AR | | 1 | | | | 1 | 1 | estampille [SECCOF] | | 28 | V |
| Musée Epinal | boîte R150 | L-IV-D-829 (1) | TS AR | | 1 | | | | 1 | 1 | estampille [SECCOF] | | 29 | V |
| BAL | | Lot 15 | TS AR | | | | | 2 | 2 | | | | | |
| Musée Epinal | boîte R195 | R2015-2-173 | TS AR | | | | | 1 | 1 | 1 | | | | |
| Musée Epinal | boîte R195 | R2015-2-172 | TS AR | | | | | 1 | 1 | 1 | | | | |
| BAL | | Lot JPB | TS AR | | | | | 3 | 3 | | | | | |
| Musée Epinal | boîte R204 | R2015-2-780 | EN AR | 1 | | | | 2 | 3 | 1 | gobelet | Hees 2 | | |
| Musée Epinal | boîte R204 | R2015-2-613 | EN COL | | | | | 1 | 1 | 1 | décor | | | |
| Musée Epinal | boîte R204 | R2015-2-621 | EN COL | | | | | 2 | 2 | 1 | décor | | | |
| Musée Epinal | boîte R204 | R2015-2-622 | EN ALSACE | 2 | 1 | | | 5 | 8 | 1 | gobelet | Hees 2 | 30 | VI |

ANNEXE B : HORS CONTEXTE

| Rayon | Caisse | infos | Catégorie | Comptage | | | | | | | Typologie | Desc. Typo. | Dessin | Planche |
|----------------|-------------------|----------------------------|-----------|----------|---|---|---|---|----|-----|------------------------------|-------------|--------|---------|
| | | | | B | F | A | D | P | NR | NMI | | | | |
| Musée Epinal | vitrine 1 salle 1 | noté "D. IV.D 322 Grand" | MET AR | 1 | | | | 4 | 5 | 1 | gobelet | Nied. 29 | 31 | VI |
| BAL | | Lot JPB | MET AR | 1 | | | | | 1 | 1 | gobelet | Nied. 31 | | |
| Musée Mosaïque | vitrine | Inv.2009-0-912 | MET AR | 3 | 2 | | | 6 | 11 | 1 | gobelet | Nied. 31 | | |
| Musée Epinal | vitrine 1 salle 1 | noté "Grand 24 avril 1881" | MET AR | 1 | | | | | 1 | 1 | gobelet | Nied. 33 | 32 | VI |
| Musée Epinal | boîte R150 | R2014-2-612 | MET AR | | 1 | | | | 1 | 1 | | | | |
| Musée Mosaïque | vitrine | Inv.2009-0-714 | MET TR | | | | 1 | | 1 | 1 | décor de tête du dieu HERMES | | 33 | VI |
| | | | MET TR | 1 | | | | | 1 | 1 | | | | |
| Musée Epinal | boîte R204 | R2015-2-618 | MET LEZ | 1 | | | | | 1 | 1 | coupelle | Bet 302 | 34 | VI |
| Musée Epinal | boîte R204 | R2015-2-619 | PLB | | | | | 1 | 1 | 1 | décor | | | |
| Musée Epinal | boîte R150 | R2014-2-613 | TN | | | | | 1 | 1 | 1 | | | | |
| Musée Mosaïque | vitrine | Inv.2009-0-914 | TN AR | 1 | | | | | 1 | 1 | bouteille | TNBT10 | 35 | VII |
| Musée Epinal | boîte R204 | R2015-2-782 | TN AR | | | | | 1 | 1 | 1 | décor | | | |
| Musée Epinal | boîte R204 | R2015-2-620 | TN AR | | | | | 1 | 1 | 1 | décor | | | |
| Musée Epinal | boîte R204 | R2015-2-615 | TN AR | | | | | 1 | 1 | 1 | décor | | | |
| Musée Epinal | boîte R204 | R2015-2-616 | TN AR | | | | | 1 | 1 | 1 | décor | | | |

ANNEXE B : HORS CONTEXTE

| Rayon | Caisse | infos | Catégorie | Comptage | | | | | | | Typologie | Desc. Typo. | Dessin | Planche |
|------------------|-------------------|------------------------------|---------------|----------|---|---|---|----|----|-----|-----------|---------------|--------|---------|
| | | | | B | F | A | D | P | NR | NMI | | | | |
| Musée Epinal | boîte R195 | R2015-2-151 | TR | | | | | 1 | 1 | 1 | décor | | | |
| Musée Epinal | boîte R195 | R2015-2-152 | TR | | | | | 1 | 1 | 1 | décor | | | |
| Musée Epinal | vitrine 1 salle 1 | noté "Grand 29 avril 1887" | CB | 1 | | | | | 1 | 1 | plat | Reims A8 | 36 | VII |
| BAL | | Lot JPB | Sb. Coq | | | | | 1 | 1 | | | | | |
| Musée Epinal | boîte R195 | R-2015-2-158 | Sb. Coq | | 1 | | | | 1 | 1 | | | | |
| BAL | | Lot JPB | Com. Sb | | 2 | | | 20 | 22 | | | | | |
| BAL | | Lot JPB | Com. Sb | 2 | | | | | 2 | | | | | |
| BAL | | Lot JPB | Com. Sb | 1 | | | | | 1 | | | | | |
| Musée Mosaique | vitrine | Inv.2009-0-916 | Com. Cl 1 | 1 | | | | | 1 | 1 | cruche | Com. Cl Cr7.1 | 37 | VII |
| Musée du Barrois | | | Com. Cl 1 | | | | | | 1 | 1 | cruche | | | |
| Musée Epinal | vitrine 1 salle 1 | noté "Grand 1899" | Com. Cl 3 | 1 | 1 | | | 2 | 4 | 1 | cruche | Com. Cl Cr2.1 | 38 | VII |
| Musée Epinal | boîte R204 | R2015-2-787 | Com. Cl 3 | 1 | | | | | 1 | 1 | cruche | Com. Cl Cr7.1 | 39 | VII |
| Musée Epinal | vitrine 1 salle 1 | noté "Grand 29 juillet 1899" | Com. Cl dorée | 2 | | | | | 2 | 1 | plat | Com. Cl P11.2 | 40 | VII |
| Musée Mosaique | vitrine | | Com. Cl Grand | 1 | | | | | 1 | 1 | bol | Com. Cl B5 | 41 | VIII |
| BAL | | Lot JPB | Com. Cl dorée | | | | | 1 | 1 | | | | | |
| BAL | | Prospection P. Duveaux lot 4 | Amp. | | | 1 | | 5 | 6 | | | | | |

ANNEXE B : HORS CONTEXTE

| Rayon | Caisse | infos | Catégorie | Comptage | | | | | | Typologie | Desc. Typo. | Dessin | Planche | |
|--------------|----------------------|------------------------------|-----------|----------|---|---|---|---|----|-----------|-------------|--------------------|---------|------|
| | | | | B | F | A | D | P | NR | | | | | NMI |
| Musée Epinal | vitrine 1 salle 1 | | Amp. | | | 1 | | | 1 | 1 | amphore | avec estampille | 42 | VIII |
| Musée Epinal | boîte R150 | R2014-2-914 | Amp. | | 1 | | | | 1 | 1 | amphore | Dressel 20 | | |
| Musée Epinal | vitrine 1 salle 1 | noté "Grand 24 juillet 1899" | Ampho. | 1 | | | | | 1 | 1 | amphorisque | Ampho1 | 41 | VIII |

ANNEXE C : CARRÉS DE FOUILLE DES ROISES

| Carré | Année | Action | Description | Structures mises au jour | Céramique | Mobilier en association |
|------------|-------|---|--|--------------------------|-----------|-------------------------|
| 3 | 1984 | Ouverture de carrés P8 I et III ? | P8: Les niveaux de ce carré ont été perturbés par une tranchée moderne. Dans la partie occidentale (I et IV) un sol bétonné reposant sur un hérisson s'affaisse légèrement vers le sud ouest. A une profondeur de 0,68m on trouve l'horizon de marne gris-verdâtre évoqué pour P7. Dans la partie orientale, la couche d'humus recouvre un éboulis situé à -0,43m s'appuyant sur un niveau d'argile de couleur verte qui repose sur un second éboulis à -0,70m au dessus de l'argile en place. Dans l'angle sud-est de P8 on a trouvé des dalles et des fragments de pierre, pareilles que celles de l'angle NO du carré N9 V. | | | |
| B21 ou E14 | | | | | | |
| Bode 5 | 1975 | | | | | |
| C | 1973 | | | | | |
| C13 | 1982 | Explorer la voie nord-sud en C13, D13 avec sondage en E12 | L'aire de circulation et le mur nord-sud (C13, D13 E12): Poursuivre le dégagement du mur nord sud trouvé en E13 et délimiter l'aire dégagée de direction parallèle située à l'ouest. C13 : absence de substructions du mur nord sud dont les moellons ont été arrachés et dont il ne subsistait que le fantôme. Le terrain a été fortement remanié à cet endroit. | | | |
| C13-D13 | 1982 | Explorer la voie nord-sud en C13, D13 avec sondage en E12 | L'aire de circulation et le mur nord-sud (C13, D13 E12): D13 : le cailloutis s'appuie sur une couche d'argile recouvrant le banc calcaire. Un foyer constitué de pierres calcinées mélangées à de l'argile vient s'appuyer contre le parement oriental de ce mur. | | | |

ANNEXE C : CARRÉS DE FOUILLE DES ROISES

| Carré | Année | Action | Description | Structures mises au jour | Céramique | Mobilier en association |
|-------|-------|---|---|--------------------------|--|-------------------------|
| cave | 1981 | fouille de la cave E 14 F 14 parallèlement au dégagement de l'aire de passage nord sud en E13 et F 13 | De dimensions extérieures de 3m sur 3m10 et de 4.50 à 4m80 et profond de 1m70. Le mur ouest présente à son extrémité, là où commence l'escalier un raccordement net avec le mur I qui se poursuit en F14. L'accès se faisait-il par une trappe donnant dans la pièce située à l'étage supérieur. Un soupirail située dans le mur ouest et débouchant sur le passage nord sur est la seule source de lumière. Le sol de la cave est un pavage relativement homogène constitué de pierres de dimension moyenne. | | <p>Une cruche de terre commune rouge archéologiquement complète trouvée écrasée sur place au pied de l'escalier (ROI 81080460). Une anse d'amphore estampillée découverte dans l'angle sud-est au niveau le plus bas dans l'argile verte (ROI 810812130). Elle provient d'une amphore à panse globuleuse de type ibérique. La marque est « G.ANTONI QUIETI » et provient de la région de Séville (cf. M. H. Callender Roman Amphorae p. 90) il semblerait que ce soit le seul exemple connu à Grand coté proche de la voie de la commercialisation définie par Callender.</p> <p>Deux tessons d'une poterie à paroi fine à décor excisé sur le massif maçonné (ROI 81081233). Un fond de vase en céramique sigillée avec une fin d'estampille (Roi 841808103).</p> | |

ANNEXE C : CARRÉS DE FOUILLE DES ROISES

| Carré | Année | Action | Description | Structures mises au jour | Céramique | Mobilier en association |
|-------------------|-------|---|---|--------------------------|-----------|---|
| cave | 1983 | fouille de la cave repérée en 1982 débordant sur les 4 carrés J14, J15, K14 et K15. | Les dimensions intérieures sont de 4,15m sur 4m et 1,40m de profondeur. Dans l'angle sud-ouest se trouve un escalier descendant du sud vers le nord sur 1m50 par une seule volée de 6 marches avant d'arriver à un palier de 0,60m limité vers le nord par un chambranle dont les traces témoignent de l'existence d'une porte au bas de l'escalier à l'entrée de la cave. Les marches de celui-ci sont constituées de deux assises de moellons plus ou moins régulièrement disposées sur un niveau d'argile aménagée. Les murs sont construits dans un appareil réduit de petits moellons régulièrement disposés. Deux soupiraux sur les murs ouest et nord sont construits en embrasure de 1,40m (mur o) et 1,20m (mur N) à l'intérieure de la cave. Orientés de biais. Vers le sud-ouest pour celui du mur ouest et le nord ouest pour celui du mur nord. Ils déterminent ainsi deux sources d'éclairage qui bénéficient d'une exposition optimale. Une niche est voisine au soupirail sur le mur nord. Un graffiti d'origine douteuse a été trouvé en avant de celle-ci. D'une profondeur de 0,25m pour une largeur de 0,70m cette niche trouve son vis-à-vis sur le mur sud avec une seconde niche 0,25m de profondeur et 0,60 m de largeur. Enfin sur le mur ouest, une troisième niche de dimensions plus importantes (0,35m sur 1,10m) est située au croisement des faisceaux d'éclairage provenant des deux soupiraux. Le sol de la cave est constitué d'un pavage homogène à base de moellons réguliers en chassés dans l'argile grise à une profondeur de 1,50m par rapport au niveau antique. Une rigole large entre 0,10 et 0,20m court le long des murs de la cave. On remarque un système de drainage dans le quart nord-ouest de la pièce qui rejoint la rigole au centre du mur occidental. Une stèle mise au jour sur le sol de cette cave. Le muret tardif se poursuit vers le nord dans les carrés H, J et K14 et vient perturber le sommet des assises des murs sud et nord de la cave à une distance de 0,50m et 0,40m du mur ouest notamment pour ce qui concerne le soupirail du mur nord dont le sommet n'a pu être étudié ni sa relation avec l'aire de circulation de direction est-ouest. | | | Une statue en ronde-bosse représentant Hermès en calcaire tendre de la région a été retrouvée au niveau de la 5ème marche mêlée à des débris divers + 1 lampe à huile |
| cave | 1985 | | | | | |
| cave 1 | 1981 | | correspond très certainement à la cave de 1981 | | | |
| Cave B | | | | | | |
| Cave J16 27/67 | | | | | | |
| Croisement | 1973 | | | | | |

ANNEXE C : CARRÉS DE FOUILLE DES ROISES

| Carré | Année | Action | Description | Structures mises au jour | Céramique | Mobilier en association |
|--------------------|-----------|---|--|--------------------------|-----------|---|
| des deux tranchées | | | | | | |
| D13 | 1982 | Explorer la voie nord-sud en C13, D13 avec sondage en E12 | L'aire de circulation et le mur nord-sud (C13, D13 E12) : Poursuivre le dégagement du mur nord sud trouvé en E13 et délimiter l'aire dégagée de direction parallèle située à l'ouest. D13 : le cailloutis s'appuie sur une couche d'argile recouvrant le banc calcaire. Un foyer constitué de pierres calcinées mélangées à de l'argile vient s'appuyer contre le parement oriental de ce mur. | | | |
| D14 | 1980 | la mise en place de trois nouveaux carrés de 5x5m E14, E15 et D14 situés au sud des précédents. | Il est aussi traversé par le mur grossier. L'est du mur sous un amoncellement de pierres tendres on trouve de nombreuses traces d'incendie puis un sol formé d'un cailloutis. A l'ouest les dalles sont plus rares. | | | Ce carré est peut être riche en petit mobilier malgré la découverte de 4 monnaies de Néron, Hadrien, Gallien et Constantin. |
| D14a | | | | | | |
| D14b | | | | | | |
| D14c | | | | | | |
| D14d | | | | | | |
| D15 | 1981 | ouverture d'un triangle en D15 | Continuité du mur en E15 orienté nord sud. Sol en dessous de terre noire. | | | |
| D13-D15 | 1980-1982 | | | | | |
| D15-E15 | 1981 | | | | | |

ANNEXE C : CARRÉS DE FOUILLE DES ROISES

| Carré | Année | Action | Description | Structures mises au jour | Céramique | Mobilier en association |
|---------------------|-------|---|---|--------------------------|-----------|-------------------------|
| D13- D14- D15 | 1980 | | | | | |
| D15 08 | | | | | | |
| E12 | 1982 | Explorer la voie nord-sud en C13, D13 avec sondage en E12 | | | | |
| E13 | 1981 | du passage nord sud à l'ouest du bâtiment oriental (E13 F13) | aire de passage nord sud en E13 et F13 en parallèle de la fouille de la cave E14/F14, Mise au jour d'un cailloutis en surface | cailloutis | | |
| E13 | 1982 | Poursuivre le dégagement du mur nord sud trouvé en E13 et délimiter l'aire dégagée de direction parallèle située à l'ouest. | | mur | | |

ANNEXE C : CARRÉS DE FOUILLE DES ROISES

| Carré | Année | Action | Description | Structures mises au jour | Céramique | Mobilier en association |
|---------|-------|---|---|--------------------------|-----------|-------------------------|
| E14 | 1980 | ouverture du carré | dans le secteur de la seconde habitation, situé au sud des précédents, carré de 5x5m. Il est traversé en son milieu par un mur nord-sud qui croise au centre du carré un mur orienté est-ouest. De mauvaise qualité, le premier n'est conservé que sur deux assises, la limite Est est mal définie. Le second est mieux appareillé, un parement vient s'adosser sur sa paroi nord qui va former un angle avec autre orienté nord sud à l'est du carré. Le parement nord-sud dans sa partie nord semble s'effondrer vers l'ouest ce qui laisse supposer qu'une pièce, une cave peut-être se situe à cet endroit. De plus cette zone est pauvre en tessons. Dans la partie sud de nombreux tessons de sigillée, de poterie commune, d'outils en fer, une monnaie, deux rivets de bronze, des objets en os, aiguille, charnière. | mur NS, mur EO | | |
| E14 | 1981 | fouille d'une cave E 14/F14, parallèlement au dégagement de l'aire de passage nord sud en E13 et F 13 | voir cave de 1981 | cave | | |
| E14a | 1981 | | | | | |
| E14d | 1981 | | | | | |
| E13-E14 | 1982 | | | | | |

ANNEXE C : CARRÉS DE FOUILLE DES ROISES

| Carré | Année | Action | Description | Structures mises au jour | Céramique | Mobilier en association |
|---------|-------|---|--|--|-----------|-------------------------|
| E15 | 1980 | la mise en place de trois nouveaux carrés de 5x5m E14, E15 et D14 situés au sud des précédents. | Trois murs ont été dégagés : Un mur nord sud prolongement de celui trouvé en G15 et F15 qui s'adosse à un mur est ouest qui est le prolongement du mur est-ouest de E14, et un autre mur orienté nord-sud, décalé vers l'est rejoint le mur est ouest formant un angle droit. Le reste du carré est occupé par un éboulis compact de mortier de moellons et de pierres tendres. Sous cet ensemble, se trouve la couche de destruction avec des traces d'incendie reposant sur le sol antique formé de glaise damé très compacte. Elle est riche en petit mobilier. | Quatre salles sont délimitées par ces murs : Salle nord est commune avec F15 et F16 et se prolongeant en E16/Salle nord ouest commune avec E14, F14 et F15/Salle sud ouest commune avec E14, D14 et D15/Salle sud est se prolongeant en D15 et D16 | | |
| E15 | 1981 | | | | | |
| E15-F15 | 1981 | fouilles de la berme E15-F15 | A l'ouest du mur nord-sur sous la couche de terre noire apparait directement l'argile. A l'est de ce mur, sous la terre noire qui descend, on rencontre une sorte de pavage. | | | |
| E15a | | | | | | |
| E15b | | | | | | |
| E15III | | | | | | |

ANNEXE C : CARRÉS DE FOUILLE DES ROISES

| Carré | Année | Action | Description | Structures mises au jour | Céramique | Mobilier en association |
|---|-------|--|--|--------------------------|-----------|-------------------------|
| Extrémité NW de la tranchée SE-NW côté voie close | 1973 | | | | | |
| Extrémité SW de la grande tranchée | 1973 | | | | | |
| F | 1973 | | | | | |
| F13 | 1981 | du passage nord sud à l'ouest du bâtiment oriental (E13 F13) | aire de passage nord sud en E13 et F13 en parallèle de la fouille de la cave E14/F14. Sol I : empierrement à 0,25m de profondeur/ Sol II : caniveau en zone 2 pierres plus grosses et polie. On peut supposer que le cailloutis central et ouest est en fait du remblai destiné à niveler la voie. Après démontage du caniveau un alignement de pierres perpendiculaire au mur de la cave. | | | |
| F14 | 1979 | L'exploration dans le prolongement du carré F14 | | | | |
| F14 | 1980 | reprise du carré | Le mur grossièrement construit vu en E14. Sur sa paroi apparait un autre mur direction nord-sud parallèle à celui découvert en E15, F15 et G15. A l'est des traces d'un foyer et à l'ouest l'éboulis qui a probablement servi à combler la cave. Pour le mur de direction nord sud a été découvert un hérisson, les assises, les tranchées de fondation. | | | |

ANNEXE C : CARRÉS DE FOUILLE DES ROISES

| Carré | Année | Action | Description | Structures mises au jour | Céramique | Mobilier en association |
|--------------|-------|---|---|--------------------------|---|-------------------------|
| F14 | 1981 | fouille d'une cave E 14/F14, parallèlement au dégagement de l'aire de passage nord sud en E13 et F 13 | voir cave de 1981 | cave | | |
| F15 | 1977 | ouverture du carré (mais dans rapport 1979) | Un mur en G15, F15 (photo 3) orienté nord-sud, parallèle au mur de G14 et relié à celui-ci par un mur est-ouest perpendiculaire. C'est sûrement une pièce. De 0 à 0,15 m : l'humus / De 0,15 à 0,40 : une couche d'éboulis, moellons, mortier, pierres tendres, tessons de céramiques (photo 2)/De 0,40 à 0,70m : une couche d'incendie, des murs sur trois assises, du petit mobilier en abondance, surtout au pied du mur./A 0,70m : le sol vierge. | | Photo 32 12 juillet F15 signature MI OF/gallo-belge inscription VI/ tesson sigillée 1er s. début 2ème s. F15 4.6. 13 juillet tesson sigillée 1er s. début 2ème s. | |
| F15-F16 | | | | | | |
| F15-G15 | | | | | | |
| F15-G15-F16 | | | | | | |
| F-G 15 | | | | | | |
| Fond de cave | | | | | | |
| G | | | | | | |
| G 12 | 1976 | | | | | |
| G 12 | 1977 | | | | | |

ANNEXE C : CARRÉS DE FOUILLE DES ROISES

| Carré | Année | Action | Description | Structures mises au jour | Céramique | Mobilier en association |
|-------------|-------|---|---|---|---|-------------------------|
| G 12 - G 13 | 1977 | | | | | |
| G 12 - G 13 | 1979 | | | | | |
| G 12 - G 13 | | Cave fond et puits | | | | |
| G 12 - H 12 | | | | | | |
| G 13 | 1977 | | | | | |
| G 14 | 1979 | prolongement du carré | Un mur en G15, F15 (photo 3) orienté nord-sud, parallèle au mur de G14 et relié à celui-ci par un mur est-ouest perpendiculaire. C'est sûrement une pièce/De 0 à 0,15 m : l'humus/ De 0,15 à 0,40 : une couche d'éboulis, moellons, mortier, pierres tendres, tessons de céramiques (photo 2)/De 0,40 à 0,70m : une couche d'incendie, des murs sur trois assises, du petit mobilier en abondance, surtout au pied du mur./A 0,70m : le sol vierge. | | | |
| G 15 | 1976 | ouverture du carré (mais dans rapport 1979) | Un mur en G15, F15 (photo 3) orienté nord-sud, parallèle au mur de G14 et relié à celui-ci par un mur est-ouest perpendiculaire. C'est sûrement une pièce/De 0 à 0,15 m : l'humus/ De 0,15 à 0,40 : une couche d'éboulis, moellons, mortier, pierres tendres, tessons de céramiques (photo 2)/De 0,40 à 0,70m : une couche d'incendie, des murs sur trois assises, du petit mobilier en abondance, surtout au pied du mur./A 0,70m : le sol vierge. Des dalles de pierres tendres (photo 5) ont été trouvées et doivent correspondre aux restes de toiture. Un élément de gouttière en pierre tendre marqué « X » au centre du carré G15 et un élément de conduite en fer dans la paroi W de G16. | Deux périodes d'occupation :de 50 à 150 apr. J.-C /la seconde fin III début IV s. | Drag. 29 sigillée sud-gauloise | |
| G 15 - G16 | | | | | | |
| G 16 | 1979 | ouverture du carré | A l'est en G16, un autre mur nord-sud (photo 4) semble être relié à celui de G15 par un mur est-ouest dont on ne voit que l'amorce dans la paroi N du carré G16. La largeur de ces murs est de 0,60m. ils sont inversés sur trois ou quatre assises, entre 0,35 et 0,40m. De 0 à 0,15 m : l'humus/De 0,15 à 0,40 : une couche d'éboulis, moellons, mortier, pierres tendres, tessons de céramiques (photo 2)/De 0,40 à 0,70m : une couche d'incendie, des murs sur trois assises, du petit mobilier en abondance, surtout au pied du mur/A 0,70m : le sol vierge. | | estampille sur terre noire (photo 34)/estampille PISTUS (photo 35)/fond de Drag. 27 avec graffiti OF ALBANI (photo 36)/ fragment de | |

ANNEXE C : CARRÉS DE FOUILLE DES ROISES

| Carré | Année | Action | Description | Structures mises au jour | Céramique | Mobilier en association |
|---------------------------------|-------|--|---|--------------------------|--|-------------------------|
| | | | | | Drag.15-17 (photo 37)/rebords gros mortier/ estampille B II CC | |
| G 16 | 1980 | reprise de la fouille du carré et approfondissement par des sondages | Peut-être un drain d'écoulement, car un amas de pierres sous l'éboulis de 1979, il est restreint en longueur (0,60m) et il se poursuit sous la berme vers l'ouest et vers l'est au-delà de la fosse et peu après il s'interrompt. Sous cet amalgame on trouve des tessons, ce qui laisse supposer que cette structure existait à l'époque d'occupation. Interprétation : Nous sommes dans un bâtiment dont les murs sont orientés nord sur et perpendiculairement est ouest. Ils délimitent une grande salle à l'ouest (8 sur 7m). Dans l'angle sud ouest de cette salle, une cave a été déterminée. Le mur grossier qui traverse cette salle semble plus tardif. Au nord de cette salle et dans son prolongement se trouve une autre pièce (5,50m sur 7m). A l'est on a certainement deux autres salles de moindre largeur (3,25m) contigües aux précédentes. Au sud de ce bâtiment peut-être une aire de circulation. | | | |
| G16 | 1981 | | | | | |
| G 16 - G 15 | | | | | | |
| G 16 - H 16 | | | | | | |
| G 17 | 1979 | | | | | |
| G 8 - G 16 - G 15 - F 16 - F 15 | | | | | | |
| G 82 | | | | | | |
| G 83 H13.4 8 | | | | | | |
| G13/G 14 | | | | | | |
| G14/G 15 | | | | | | |

ANNEXE C : CARRÉS DE FOUILLE DES ROISES

| Carré | Année | Action | Description | Structures mises au jour | Céramique | Mobilier en association |
|-------------------------|-------|---|---|--------------------------|-----------|-------------------------|
| G16 Triang le F16 | 1980 | reprise de la fouille du triangle et approfondissement par des sondages | Un élément de mur nord sud part du milieu de la berme nord et s'interrompt au centre du triangle. Le niveau du sol vierge est à 0,78m. Un mur de refend est ouest a été découvert dans l'angle nord est il devait être le prolongement du mur est ouest de G15. | | | |
| G16 Triang le F16 | 1981 | élimination des bermes | Le hérisson du mur de l'extrémité est de direction nord sud a été dégagé. | | | |
| H7?? | | | | | | |
| H 11 | | | | | | |
| H 12 | 1979 | | Voir cave de 1979 /De 0 à 0,15 m : l'humus/ De 0,15 à 0,40 : une couche d'éboulis, moellons, mortier, pierres tendres, tessons de céramiques (photo 2)/De 0,40 à 0,70m : une couche d'incendie, des murs sur trois assises, du petit mobilier en abondance, surtout au pied du mur./A 0,70m : le sol vierge. | | | |
| H 12 - G 12 | 1979 | | voir rapport sur cave(dossier séparé) | | | |
| H 13 | | | une cavité profonde d'1,60 m. Au fond, des blocs calcaires et de la glaise rouge. Circulaire à l'origine, mais au nord, le périmètre a été rompu et ce puits a été comblé avec des moellons pour servir d'assise au carneau sud-est de l'hypocauste prolongé. Deux niveaux sont visible, le comblement de la cavité s'est faite après avoir démoli la partie nord et on utilisé ce remblai pour asseoir le prolongement rectangulaire de l'hypocauste primitif. Dans la glaise entre les assises de la cavité, de nombreux éclats de sigillées très brillantes et très mince, certainement précoces ainsi qu'un as d'Agrippa. | | | |
| H 13 - H 14 | | | | | | |

ANNEXE C : CARRÉS DE FOUILLE DES ROISES

| Carré | Année | Action | Description | Structures mises au jour | Céramique | Mobilier en association |
|------------------------------------|-------|-------------------------|--|--------------------------|---|-------------------------|
| H 14 | 1983 | ouverture du carré | Mur est-ouest en H14 et H15 : hérisson de direction est-ouest prolongeant l'amorce du mur. Ce mur constituait la paroi nord d'une salle de 7 sur 5,5m. Le mur est décalé d'environ 10 cm vers le nord par rapport au hérisson, cad à l'extérieur de la salle, aucun tesson mais des fragments d'os. A l'intérieur de la salle au dessus de cette argile se trouve un sol composé de chaux et de pierres plates. Cette dernière couche contenait des tessons de céramiques et des cendres. Un peu au-dessous du niveau des assises supérieures en places (0,20m) de l'angle maçonné ouest, l'existence d'un massif de pierres posées de chant, avec des traces de foyer et une grande quantité de pierres plates en calcaire tendre. La présence de quelques tessons et d'un col d'amphore. La présence d'un semblant de structure débordant sur le hérisson antique comprenant des traces de foyer peut expliquer la destruction de la paroi est ouest de la salle par une réutilisation de l'espace à une époque tardive qu'il est difficile de situer. | | | |
| H 14 - H 15 - J 14 - J 15 | | | | | | |
| H 14 et J 16 | | | | | | |
| H 15 | 1979 | ouverture du carré | De 0 à 0,15 m : l'humus/ De 0,15 à 0,40 : une couche d'éboulis, moellons, mortier, pierres tendres, tessons de céramiques (photo 2)/De 0,40 à 0,70m : une couche d'incendie, des murs sur trois assises, du petit mobilier en abondance, surtout au pied du mur./A 0,70m : le sol vierge. | | | |
| H 16 | 1981 | ouverture du carré | Un sol constitué d'un hérisson et le prolongement du mur sur 2 m, et à l'est un éboulis. | | | |
| H 16 - G 16 | | | | | | |
| H 17 | | ouverture du demi-carré | Sol constitué d'un cailloutis assez grossier, très riche en petit mobilier. | | Sous une pierre une clé placée dans une coupe brisée mais presque complète contenue elle-même dans une autre coupe dans le même état. Cette disposition fait penser à une cachette. | |

ANNEXE C : CARRÉS DE FOUILLE DES ROISES

| Carré | Année | Action | Description | Structures mises au jour | Céramique | Mobilier en association |
|---------------|-------|--------------------|---|--------------------------|-----------|-------------------------|
| Hypoc auste | | | Le plan de l'hypocauste a la forme d'un trapèze dont la grande base est le mur est de 3,35m, le mur ouest de 3,18m et les autres murs 2,60m. Ces murs sont de très bonne qualité d'une largeur moyenne de 0,50m, ils s'élèvent bien droit sur 6 assises (0,80m) et sont recouverts d'un enduit à base de mortier sur lequel on peut voir les traces des pilettes plaquées et collées contre les parois. 5 rangées d'orientation nord-sud. L'entrée du <i>praefurnium</i> large de 0,65m est ouverte dans le milieu du mur ouest de l'hypocauste. | hypocauste | | |
| J 12 | 1975 | | Sur la rive ouest, se tenait le <i>praefurnium</i> , dont le fond par sa couleur rouge attestait encore le souvenir du feu qui y avait brûlé. Le corridor étroit débouche dans le <i>praefurnium</i> par deux marches, le fond est à 0,90 m de profondeur. L'ensemble comporte donc deux rectangle dont le second a été ajouté au premier par démolition de la rive sud de celui-ci. Cinq carnaux évacuent la fumée en J12 un assemblage de pierres tendres calcinées, sorte de foyer a été trouvé à peu de distance au sud d'une substruction rectangulaire recouverte de cendres. En bas la glaise vierge rougeâtre puis au niveau supérieur du bloc de pierre qui est à droite une épaisse couche de cendres recouverte par la couche de démolition à base de mortier blanchâtre enfin 0,30 m d'humus. Il doit s'agir d'une cuisine. Au nord de J12, en K12, on peut se demander s'il n'y a pas eu une sorte de resserre à bois de forme trapézoïdale. | | | |
| J 13 | 1975 | | Dans la partie sud de K13, deux sortes de conduits ménagés dans l'épaisseur du mur qui débouchaient sur un béton passablement dégradé, mais sur ce dernier demeurait l'assise d'une pilette d'hypocauste. Le long de J13 dans un axe nord-sud se trouve un mur perpendiculaire à celui est-ouest de K13, l'assise supérieure du parement qui a glissé vers la droite et le blocage du mur sous le jalon. Sous J13 se trouve un hypocauste à deux niveaux, l'un Constantin attesté par les monnaies et la céramique tardive et un autre bien antérieur. Le plan : à partir d'un rectangle primitif de 2,10m x 1,50 m s'allonge vers le sud un autre rectangle postérieur de 1,05 m x 1,15 m. | | | |
| J 13 - J 14 | 1976 | | | | | |
| J 14 | 1983 | ouverture du carré | Les structures nord sud de l'ouest H14, J14, K14 : entre la berme ouest et le mur sud nord prolongé par la paroi ouest de la cave, une rigole a été mise au jour. la cave repérée en 1982 débordant sur les 4 carrés J14, J15, K14 et K15: | | | |
| J 14 - J 15 - | 1983 | | | | | |

ANNEXE C : CARRÉS DE FOUILLE DES ROISES

| Carré | Année | Action | Description | Structures mises au jour | Céramique | Mobilier en association |
|----------------|-------|--------------------|---|--------------------------|-----------|-------------------------|
| H 14 - H 15 | | | | | | |
| J 15 | 1982 | ouverture du carré | J15-J16 : puits et fosse. Agrandissement du carré par une bande d'une largeur d'un mètre correspondant à la berme J16-J17 vers l'ouest. Ensemble de structures dégagées sur un rectangle de 8 x 4m. Un premier mur 140° est sur 2 m. sa direction est discordante avec celle des autres. Un autre mur a été mis au jour à l'ouest du demi-carré J15. Un muret de pierres sèches dans l'axe de la berme J15-J16 sans fondation coupe diamétralement un puits au dessus. Un puits large d'1m20 dans le carré J16 et sa moitié ouest disparaît sous la berme J15-J16 est constitué d'assises régulières. Les pierres sont recouvertes d'un enduit noirâtre. Son fond est constitué d'une argile grisâtre compacte. Un cailloutis entoure la margelle et semble se poursuivre de l'autre côté. Dans l'angle sud-est du carré J16 le mur NO SE s'appuie sur une structure rectangulaire (1m30 sur 1m20). Son appareil n'est pas constitué d'assises régulières et les pierres sont recouvertes d'un enduit noirâtre. Peut-être une citerne. Dans la partie nord-est du carré J16 un trou de poteau certainement en relation avec ceux trouvés en K15 et K16. | | | |
| J 15 - J 16 | 1982 | ouverture du carré | J15-J16 : puits et fosse. Agrandissement du carré par une bande d'une largeur d'un mètre correspondant à la berme J16-J17 vers l'ouest. Ensemble de structures dégagées sur un rectangle de 8 x 4m. Un premier mur 140° est sur 2 m. sa direction est discordante avec celle des autres. Un autre mur a été mis au jour à l'ouest du demi-carré J15. Un muret de pierres sèches dans l'axe de la berme J15-J16 sans fondation coupe diamétralement un puits au dessus. Un puits large d'1m20 dans le carré J16 et sa moitié ouest disparaît sous la berme J15-J16 est constitué d'assises régulières. Les pierres sont recouvertes d'un enduit noirâtre. Son fond est constitué d'une argile grisâtre compacte. Un cailloutis entoure la margelle et semble se poursuivre de l'autre côté. Dans l'angle sud-est du carré J16 le mur NO SE s'appuie sur une structure rectangulaire (1m30 sur 1m20). Son appareil n'est pas constitué d'assises régulières et les pierres sont recouvertes d'un enduit noirâtre. Peut-être une citerne. Dans la partie nord-est du carré J16 un trou de poteau certainement en relation avec ceux trouvés en K15 et K16. | | | |

ANNEXE C : CARRÉS DE FOUILLE DES ROISES

| Carré | Année | Action | Description | Structures mises au jour | Céramique | Mobilier en association |
|---------------------------|-------|-----------------------|---|--------------------------|---|-------------------------|
| J 15 - J 16 - Puits | 1982 | ouverture du carré | J15-J16 : puits et fosse. Agrandissement du carré par une bande d'une largeur d'un mètre correspondant à la berme J16-J17 vers l'ouest. Ensemble de structures dégagées sur un rectangle de 8 x 4m. Un premier mur 140° est sur 2 m. sa direction est discordante avec celle des autres. Un autre mur a été mis au jour à l'ouest du demi-carré J15. Un muret de pierres sèches dans l'axe de la berme J15-J16 sans fondation coupe diamétralement un puits au dessus. Un puits large d'1m20 dans le carré J16 et sa moitié ouest disparaît sous la berme J15-J16 est constitué d'assises régulières. Les pierres sont recouvertes d'un enduit noirâtre. Son fond est constitué d'une argile grisâtre compacte. Un cailloutis entoure la margelle et semble se poursuivre de l'autre côté. Dans l'angle sud-est du carré J16 le mur NO SE s'appuie sur une structure rectangulaire (1m30 sur 1m20). Son appareil n'est pas constitué d'assises régulières et les pierres sont recouvertes d'un enduit noirâtre. Peut-être une citerne. Dans la partie nord-est du carré J16 un trou de poteau certainement en relation avec ceux trouvés en K15 et K16. | | | |
| J 15 - K 15 | 1982 | ouverture du carré | K 15 : dans l'angle sud-ouest comportant un seul parement face au sud présente un décrochement de 0,30m vers le nord. Il pourrait correspondre à un soupirail ou à une niche de cave qui a été comblée. Des pierres alignées forment une rigole au centre du carré et d'un trou de poteau dans l'angle nord-ouest. Le reste est recouvert d'un sol de qualité inégale constitué de plusieurs niveaux. | | | |
| J 16 | 1982 | ouverture du carré | J15-J16 : puits et fosse. Agrandissement du carré par une bande d'une largeur d'un mètre correspondant à la berme J16-J17 vers l'ouest. Ensemble de structures dégagées sur un rectangle de 8 x 4m. Un premier mur 140° est sur 2 m. sa direction est discordante avec celle des autres. Un autre mur a été mis au jour à l'ouest du demi-carré J15. Un muret de pierres sèches dans l'axe de la berme J15-J16 sans fondation coupe diamétralement un puits au dessus. Un puits large d'1m20 dans le carré J16 et sa moitié ouest disparaît sous la berme J15-J16 est constitué d'assises régulières. Les pierres sont recouvertes d'un enduit noirâtre. Son fond est constitué d'une argile grisâtre compacte. Un cailloutis entoure la margelle et semble se poursuivre de l'autre côté. Dans l'angle sud-est du carré J16 le mur NO SE s'appuie sur une structure rectangulaire (1m30 sur 1m20). Son appareil n'est pas constitué d'assises régulières et les pierres sont recouvertes d'un enduit noirâtre. Peut-être une citerne. Dans la partie nord-est du carré J16 un trou de poteau certainement en relation avec ceux trouvés en K15 et K16. | | ROI 820727181 en J16 (celui de la vitrine) vase à dépression entier en métallescente | |
| J 16 - J 17 | 1982 | ouverture du carré | berme J16-J17 vers l'ouest (voir J15-J16) | | | |

ANNEXE C : CARRÉS DE FOUILLE DES ROISES

| Carré | Année | Action | Description | Structures mises au jour | Céramique | Mobilier en association |
|-------|-------|--------|---|--------------------------|---|---|
| K 9 | 1974 | ? | En K9, K10 et K11 a été trouvée la fondation d'un mur parallèle à la ligne des trois noyers, laquelle fondation était orientée selon un axe de 72° est 252° ouest. Ce mur est très dégradé et il n'en reste que la première assise (photo 11, 12, 13). On voit la dégradation du mur suit la pente du terrain en allant d'ouest en est, trois assises sont descendues, le mortier est visible sur la photo 9. Au nord de ce mur, les carrés K9, K10 K11 sont constitués d'une infinité de petits moellons, la glaise jaunâtre mêlée de petit cailloux qui constitue le sol vierge. | | 178 tessons dont 7 cols et 1 fond trouvés sur le sol des carrés K9, K10, K11, L10, L11 avec une proportion plus élevée dans ces deux derniers carrés. | La série des carrés K a produit peu de céramiques mais un grand nombre de clous. Ce qui est intéressant avec un certain nombre de tessons de gallo-belges et de sigillée c'est qu'ils portent des traces de mortier, ils ont donc été réutilisés pour enrichir un béton postérieur. |
| K 10 | 1974 | ? | En K9, K10 et K11 a été trouvée la fondation d'un mur parallèle à la ligne des trois noyers, laquelle fondation était orientée selon un axe de 72° est 252° ouest. Ce mur est très dégradé et il n'en reste que la première assise (photo 11, 12, 13). On voit la dégradation du mur suit la pente du terrain en allant d'ouest en est, trois assises sont descendues, le mortier est visible sur la photo 9. En K10, ce mur présente une sorte d'ouverture d'une largeur de 1,20 m (photo 26), il n'y avait plus de moellons au même niveau que l'assise encore existante, est-ce une porte ? Au nord de ce mur, les carrés K9, K10 K11 sont constitués d'une infinité de petits moellons, la glaise jaunâtre mêlée de petit cailloux qui constitue le sol vierge. On note la présence de cendres abondantes en K10 entre le mur et le tas de déblais, ce qui permettrait de penser à une destruction par incendie. Beaucoup de tessons provenant de dolia ou de cruche assez grossières ont été trouvés à cet endroit (planche 1). Dans la zone N des carré K10 et K11 sur presque toute la longueur est-ouest et sur une largeur d'environ 1m, les vestiges de l'effondrement du petit édifice quadrangulaire de M11, cad, un amoncellement de moellons de construction mêlés à de la terre et du mortier. | | 178 tessons dont 7 cols et 1 fond trouvés sur le sol des carrés K9, K10, K11, L10, L11 avec une proportion plus élevée dans ces deux derniers carrés. | La série des carrés K a produit peu de céramiques mais un grand nombre de clous. Ce qui est intéressant avec un certain nombre de tessons de gallo-belges et de sigillée c'est qu'ils portent des traces de mortier, ils ont donc été réutilisés pour enrichir un béton postérieur. |

ANNEXE C : CARRÉS DE FOUILLE DES ROISES

| Carré | Année | Action | Description | Structures mises au jour | Céramique | Mobilier en association |
|-------|-------|------------------------------------|--|--------------------------|---|---|
| K 11 | 1974 | ? | En K9, K10 et K11 a été trouvée la fondation d'un mur parallèle à la ligne des trois noyers, laquelle fondation était orientée selon un axe de 72° est 252° ouest. Ce mur est très dégradé et il n'en reste que la première assise (photo 11, 12, 13). On voit la dégradation du mur suit la pente du terrain en allant d'ouest en est, trois assises sont descendues, le mortier est visible sur la photo 9. A l'extrémité e de ce mur en K11, un autre mur part à 90° vers le sud (photo 26), d'autre part à l'extrémité W la situation est plus confuse avec un angle symétrique à celui du côté est, mais un second mur plus large que le premier vient s'installer sur le précédent et pas tout à fait dans le même axe. Il s'agit de deux ouvrages différents. L'existence d'un poteau de bois au milieu des moellons à 2 m de l'extrémité W de K9 et à 0,20 m au nord du mur semble indiquer qu'il s'agit d'une construction assez récente, peut-être une fosse d'inclusion provoquée par l'édification d'un auvent à bestiaux. Entre la fondation du mur et le tas de déblais en K11 découverte de deux petites clés (photo 46), une rouelle en bronze (photo 55) et un boutoir de sanglier. Cet espace était rempli de mortier et de terre.les moellons du mur sont ajustés correctement et joints par du mortier jaunâtre. La face sud du mur (à l'intérieur du bâtiment) a peut-être été tapissée d'un revêtement de dalles en pierres tendres (photo 31). Le sol intérieur semble très abimé. Dans la zone N des carré K10 et K11 sur presque toute la longueur est-ouest et sur une largeur d'environ 1m, les vestiges de l'effondrement du petit édifice quadrangulaire de M11, cad, un amoncellement de moellons de construction mêlés à de la terre et du mortier. | | 178 tessons dont 7 cols et 1 fond trouvés sur le sol des carrés K9, K10, K11, L10, L11 avec une proportion plus élevée dans ces deux derniers carrés. | La série des carrés K a produit peu de céramiques mais un grand nombre de clous. Ce qui est intéressant avec un certain nombre de tessons de gallo-belges et de sigillée c'est qu'ils portent des traces de mortier, ils ont donc été réutilisés pour enrichir un béton postérieur. |
| K 12 | 1975 | sondages pour rejoindre K12 et K13 | . Au nord de J12, en K12, on peut se demander s'il n'y a pas eu une sorte de resserre à bois de forme trapézoïdale. | | | La série des carrés K a produit peu de céramiques mais un grand nombre de clous. Ce qui est intéressant avec un certain nombre de tessons de gallo-belges et de sigillée c'est qu'ils portent des traces de mortier, ils ont donc été réutilisés pour enrichir un béton postérieur. |

ANNEXE C : CARRÉS DE FOUILLE DES ROISES

| Carré | Année | Action | Description | Structures mises au jour | Céramique | Mobilier en association |
|-------|-------|------------------------------------|---|--------------------------|-----------|---|
| K 13 | 1975 | sondages pour rejoindre K12 et K13 | Dans la partie sud de K13, deux sortes de conduits ménagés dans l'épaisseur du mur qui débouchaient sur un béton passablement dégradé, mais sur ce dernier demeurait l'assise d'une pilette d'hypocauste. Le long de J13 dans un axe nord-sud se trouve un mur perpendiculaire à celui est-ouest de K13, l'assise supérieure du parement qui a glissé vers la droite et le blocage du mur sous le jalon. Sous J13 se trouve un hypocauste à deux niveaux, l'un Constantin attesté par les monnaies et la céramique tardive et un autre bien antérieur. Le plan : à partir d'un rectangle primitif de 2,10m x 1,50 m s'allonge vers le sud un autre rectangle postérieur de 1,05 m x 1,15 m. | | | La série des carrés K a produit peu de céramiques mais un grand nombre de clous. Ce qui est intéressant avec un certain nombre de tessons de gallo-belges et de sigillée c'est qu'ils portent des traces de mortier, ils ont donc été réutilisés pour enrichir un béton postérieur. |
| K 14 | 1975 | | Le carré K14 est aussi dénué de substruction mais il contient beaucoup de fragments de dalles en pierre tendre. | | | La série des carrés K a produit peu de céramiques mais un grand nombre de clous. Ce qui est intéressant avec un certain nombre de tessons de gallo-belges et de sigillée c'est qu'ils portent des traces de mortier, ils ont donc été réutilisés pour enrichir un béton postérieur. |

ANNEXE C : CARRÉS DE FOUILLE DES ROISES

| Carré | Année | Action | Description | Structures mises au jour | Céramique | Mobilier en association |
|----------------|-------|--------------------|---|--------------------------|-----------|---|
| K 14 - K 15 | 1982 | | | | | La série des carrés K a produit peu de céramiques mais un grand nombre de clous. Ce qui est intéressant avec un certain nombre de tessons de gallo-belges et de sigillée c'est qu'ils portent des traces de mortier, ils ont donc été réutilisés pour enrichir un béton postérieur. |
| K 15 | 1982 | ouverture du carré | K 15 : dans l'angle sud-ouest comportant un seul parement face au sud présente un décrochement de 0,30m vers le nord. Il pourrait correspondre à un soupirail ou à une niche de cave qui a été comblée. Des pierres alignées forment une rigole au centre du carré et d'un trou de poteau dans l'angle nord-ouest. Le reste est recouvert d'un sol de qualité inégale constitué de plusieurs niveaux. | | | La série des carrés K a produit peu de céramiques mais un grand nombre de clous. Ce qui est intéressant avec un certain nombre de tessons de gallo-belges et de sigillée c'est qu'ils portent des traces de mortier, ils ont donc été réutilisés pour enrichir un béton postérieur. |
| K15 | 1983 | | | | | |
| K 16 | 1982 | ouverture du carré | Un cailloutis présentant toutes les caractéristiques d'une voie de passage et une assise dont les trois moellons constituent le prolongement du mur nord ouest sud est en J16. | | | La série des carrés K a produit peu de céramiques mais un grand nombre de clous. Ce qui est intéressant avec un |

ANNEXE C : CARRÉS DE FOUILLE DES ROISES

| Carré | Année | Action | Description | Structures mises au jour | Céramique | Mobilier en association |
|-------|-------|--------|--|--------------------------|---|---|
| | | | | | | certain nombre de tessons de gallo-belges et de sigillée c'est qu'ils portent des traces de mortier, ils ont donc été réutilisés pour enrichir un béton postérieur. |
| L 10 | 1974 | | Dans la zone N des carré K10 et K11 sur presque toute la longueur est-ouest et sur une largeur d'environ 1m, les vestiges de l'effondrement du petit édifice quadrangulaire de M11, cad, un amoncellement de moellons de construction mêlés à de la terre et du mortier. La couche s'épaissie encore en L11 (photo 10) et que partie est de L10. La couche de destruction atteignait presque 0,50m d'épaisseur au pied du petit bâtiment quadrangulaire. Celui-ci se serait donc effondré à la première moitié du IVème s. (10 monnaies de Constantin et son fils Constant : 306-342). | | 178 tessons dont 7 cols et 1 fond trouvés sur le sol des carrés K9, K10, K11, L10, L11 avec une proportion plus élevée dans ces deux derniers carrés. | |
| L 11 | 1974 | | Dans la zone N des carré K10 et K11 sur presque toute la longueur est-ouest et sur une largeur d'environ 1m, les vestiges de l'effondrement du petit édifice quadrangulaire de M11, cad, un amoncellement de moellons de construction mêlés à de la terre et du mortier. La couche s'épaissie encore en L11 (photo 10) et que partie est de L10. La couche de destruction atteignait presque 0,50m d'épaisseur au pied du petit bâtiment quadrangulaire. Celui-ci se serait donc effondré à la première moitié du IVème s. (10 monnaies de Constantin et son fils Constant : 306-342). Lors du dégagement du petit édifice en M11, le mur sud déborde d'un mètre sur le carré L11. L'humus a été décapé (photo 14) et on a retrouvé les angles intérieurs au sud-est et au nord-est. En revanche le mur sud d'interrompt à environ 1m de l'angle sud-est comme si il y avait eu une ouverture. Au nord, le mur est tellement dégradé que même la fondation n'apparaît plus et à l'ouest il n'y a plus rien (problème de labours). Le seul côté est a pu être reconnu entièrement et mesure 3,25m. L'éboulis était le plus épais au pied du mur sud (photo 5). De nombreux fragments de tuiles et des restes de revêtement mural de couleurs variées ont été retrouvés à l'extérieur comme à l'intérieur du bâtiment tout comme les débris de dalles en pierre tendre. Dans l'éboulis et à l'intérieur du bâtiment on a retrouvé une abondance de clous : 148 en L11 (dont une vingtaine de clous de chaussure) et 101 en M11. A l'intérieur du petit bâtiment, on a trouvé une grande quantité de céramiques, plusieurs boudoirs de sangliers, des coquilles | | 178 tessons dont 7 cols et 1 fond trouvés sur le sol des carrés K9, K10, K11, L10, L11 avec une proportion plus élevée dans ces deux derniers carrés. | |

ANNEXE C : CARRÉS DE FOUILLE DES ROISES

| Carré | Année | Action | Description | Structures mises au jour | Céramique | Mobilier en association |
|--------------|-------|----------------------------|---|--------------------------|--------------------------------|-------------------------|
| | | | d'huitres, des os, une ramure de cerfs. Peut-être s'agit-il d'un petit local de stockage. Ce bâtiment était bien couvert de tuiles, il possédait à l'intérieur des revêtements en enduits peints : couleur jaune, rouge et crème, et un revêtement de plâtre portant des dessins géométriques tracés à la gouge en forme de carrés (photo 44). Le sol présentait un conglomérat de plâtre et de tessons qui provenait très probablement de la décomposition mural. Il semble s'être effondré par l'effet de la vétusté. | | | |
| L 11 XIII | 1984 | ouverture du carré | Un sondage 1974 avait mis en évidence une substructure d'un petit bâtiment quadrangulaire. La fouille en profondeur de cette année a permis de faire apparaître le prolongement vers l'est du mur septentrional de la petite pièce carrée est ouest ainsi que l'extension de ce bâtiment. Le hérisson de fondation qui forme une semelle débordant vers l'intérieur de la salle dégagée en 74 ne constitue qu'une assise reposant sur l'argile vierge. | | | |
| L 12 | 1975 | étendre les investigations | Les carrés L12 et L13 n'ont rien livré d'intéressant, en L13 une trainée de moellons grossiers qui pourrait être le résultat d'un éboulement et de nombreux clous Les carrés L12 et L13 révèlent un sol fait de glaise damée avec des moellons enchâssés dans cette glaise. | | 150 fgts de céramiques en L12. | |
| L 13 | 1975 | étendre les investigations | Les carrés L12 et L13 n'ont rien livré d'intéressant, en L13 une trainée de moellons grossiers qui pourrait être le résultat d'un éboulement et de nombreux clous Les carrés L12 et L13 révèlent un sol fait de glaise damée avec des moellons enchâssés dans cette glaise. | | | |
| M 02 | | | | | | |

ANNEXE C : CARRÉS DE FOUILLE DES ROISES

| Carré | Année | Action | Description | Structures mises au jour | Céramique | Mobilier en association |
|----------|-------|--------------------|--|--------------------------|-----------|-------------------------|
| M 10 | 1984 | ouverture du carré | La partie orientale est bouleversée par la présence d'une tranchée moderne nord sud. Elle interrompt le hérisson d'un mur est ouest parallèle aux structures dégagées en 1974. Ce hérisson est surmonté par une structure orientée nord sud comprenant une assise en place de pierres sèches et limitant à l'est un éboulis dont la composition évoque un mur basculé d'un seul tenant vers l'ouest. Sous cet éboulis on note la présence d'un niveau riche en tessons, mobiliers, fragments, enduits peints, au dessus de l'argile naturelle. | hérisson mur EO, | | |
| M 10 IX | 1984 | ouverture du carré | La partie orientale est bouleversée par la présence d'une tranchée moderne nord sud. Elle interrompt le hérisson d'un mur est ouest parallèle aux structures dégagées en 1974. Ce hérisson est surmonté par une structure orientée nord sud comprenant une assise en place de pierres sèches et limitant à l'est un éboulis dont la composition évoque un mur basculé d'un seul tenant vers l'ouest. Sous cet éboulis on note la présence d'un niveau riche en tessons, mobiliers, fragments, enduits peints, au dessus de l'argile naturelle. | | | |
| M 10 X | 1984 | ouverture du carré | La partie orientale est bouleversée par la présence d'une tranchée moderne nord sud. Elle interrompt le hérisson d'un mur est ouest parallèle aux structures dégagées en 1974. Ce hérisson est surmonté par une structure orientée nord sud comprenant une assise en place de pierres sèches et limitant à l'est un éboulis dont la composition évoque un mur basculé d'un seul tenant vers l'ouest. Sous cet éboulis on note la présence d'un niveau riche en tessons, mobiliers, fragments, enduits peints, au dessus de l'argile naturelle. | | | |
| M 10 XI | 1984 | ouverture du carré | La partie orientale est bouleversée par la présence d'une tranchée moderne nord sud. Elle interrompt le hérisson d'un mur est ouest parallèle aux structures dégagées en 1974. Ce hérisson est surmonté par une structure orientée nord sud comprenant une assise en place de pierres sèches et limitant à l'est un éboulis dont la composition évoque un mur basculé d'un seul tenant vers l'ouest. Sous cet éboulis on note la présence d'un niveau riche en tessons, mobiliers, fragments, enduits peints, au dessus de l'argile naturelle. | | | |
| M 10 XII | 1984 | ouverture du carré | La partie orientale est bouleversée par la présence d'une tranchée moderne nord sud. Elle interrompt le hérisson d'un mur est ouest parallèle aux structures dégagées en 1974. Ce hérisson est surmonté par une structure orientée nord sud comprenant une assise en place de pierres sèches et limitant à l'est un éboulis dont la composition évoque un mur basculé d'un seul tenant vers l'ouest. Sous cet éboulis on note la présence d'un niveau riche en tessons, mobiliers, fragments, enduits peints, au dessus de l'argile naturelle. | | | |

ANNEXE C : CARRÉS DE FOUILLE DES ROISES

| Carré | Année | Action | Description | Structures mises au jour | Céramique | Mobilier en association |
|-------|-------|--------|---|--------------------------|--|-------------------------|
| M 11 | 1974 | | <p>Dans la zone N des carré K10 et K11 sur presque toute la longueur est-ouest et sur une largeur d'environ 1m, les vestiges de l'effondrement du petit édifice quadrangulaire de M11, cad, un amoncellement de moellons de construction mêlés à de la terre et du mortier. La couche s'épaissit encore en L11 (photo 10) et que partie est de L10. La couche de destruction atteignait presque 0,50m d'épaisseur au pied du petit bâtiment quadrangulaire. Celui-ci se serait donc effondré à la première moitié du IVème s. (10 monnaies de Constantin et son fils Constant : 306-342). Lors du dégagement du petit édifice en M11, le mur sud déborde d'un mètre sur le carré L11. L'humus a été décapé (photo 14) et on a retrouvé les angles intérieurs au sud-est et au nord-est. En revanche le mur sud d'interrompt à environ 1m de l'angle sud-est comme si il y avait eu une ouverture. Au nord, le mur est tellement dégradé que même la fondation n'apparaît plus et à l'ouest il n'y a plus rien (problème de labours). Le seul côté est a pu être reconnu entièrement et mesure 3,25m. L'éboulis était le plus épais au pied du mur sud (photo 5). De nombreux fragments de tuiles et des restes de revêtement mural de couleurs variées ont été retrouvés à l'extérieur comme à l'intérieur du bâtiment tout comme les débris de dalles en pierre tendre. Dans l'éboulis et à l'intérieur du bâtiment on a retrouvé une abondance de clous : 148 en L11 (dont une vingtaine de clous de chaussure) et 101 en M11. A l'intérieur du petit bâtiment, on a trouvé une grande quantité de céramiques, plusieurs boutoirs de sangliers, des coquilles d'huitres, des os, une ramure de cerfs. Peut-être s'agit-il d'un petit local de stockage. Ce bâtiment était bien couvert de tuiles, il possédait à l'intérieur des revêtements en enduits peints : couleur jaune, rouge et crème, et un revêtement de plâtre portant des dessins géométriques tracés à la gouge en forme de carrés (photo 44). Le sol présentait un conglomérat de plâtre et de tessons qui provenait très probablement de la décomposition mural. Il semble s'être effondré par l'effet de la vétusté.</p> | | <p>152 tessons dont 2 cols, 1 fond et 1 anse viennent du carré M11. Petits vases ovoïdes à granulation (procédé dit « Griesbewurf ») : 605 tessons en dehors de M 11+ 551 tessons dans le carré M11 : Cette énorme quantité de tessons ne doit tout de même pas faire illusions la plupart sont très petits (2 ou 3 cm²) si bien que le nombre de vases dont ils proviennent est probablement au bout du compte réduit à une trentaine. Néanmoins une fois de plus, le petit bâtiment quadrangulaire en recelait à lui seul presque autant que tout le reste de la fouille. La qualité n'est malheureusement pas très bonne, l'engobe bleuté est peu tenace lors du lavage, les cassures rarement franches interdisent les reconstitutions de quelques envergure. Certains tessons portent des incisions ou des encoches, probablement faites par une molette.</p> | |

ANNEXE C : CARRÉS DE FOUILLE DES ROISES

| Carré | Année | Action | Description | Structures mises au jour | Céramique | Mobilier en association |
|---------|-------|--------------------|--|--------------------------|-----------|-------------------------|
| M 13 | | | | | | |
| Mur | | | | | | |
| N 9 | 1984 | ouverture du carré | Une importante couche de moellons mortier mobilier divers. Sous ce niveau de destruction dans l'angle nord ouest de N9 V on a retrouvé les mêmes dalles de couverture qu'en P8 III. Sur le reste de la zone fouillée, le sol est riche en charbon de bois, os, clous et poterie commune. | | | |
| N 9 V | 1984 | ouverture du carré | Une importante couche de moellons mortier mobilier divers. Sous ce niveau de destruction dans l'angle nord ouest de N9 V on a retrouvé les mêmes dalles de couverture qu'en P8 III. Sur le reste de la zone fouillée, le sol est riche en charbon de bois, os, clous et poterie commune. | | | |
| N 9 VII | 1984 | ouverture du carré | Une importante couche de moellons mortier mobilier divers. Sous ce niveau de destruction dans l'angle nord ouest de N9 V on a retrouvé les mêmes dalles de couverture qu'en P8 III. Sur le reste de la zone fouillée, le sol est riche en charbon de bois, os, clous et poterie commune. | | | |
| P 7 | 1984 | ouverture du carré | Cailloutis formant sol le long du mur oriental de la salle voisine de l'hypocauste/ Trou de poteau de la clôture de ce mur orienté nord sud/Cailloutis limité au nord par des pierres de calage d'un module important/Sol formé d'un mélange de terre damée et de mortier reposant sur un hérisson dans lequel figuraient des éléments de dalles posées de chant/Couche constituée d'un mélange d'argile de couleur ocre de terre de cailloux, contenant de nombreux tessons de céramique commune blanche et de sigillée (fin Ier, début IIème) a noter la continuation) -0,30m par rapport au niveau de référence NW de la lentille de marne gris-verdâtre mise en évidence dans le carré P8 I à une profondeur plus importante/Ces niveaux reposent sur une couche importante d'argiles rapportées d'origines diverses/Une couche de gros cailloux parmi lesquels un fragment d'assiette sigillée (Claude Flavien)/Argile en place à -0,65m | | | |
| P 8 | 1984 | ouverture du carré | Les niveaux de ce carré ont été perturbés par une tranchée moderne. Dans la partie occidentale (I et IV) un sol bétonné reposant sur un hérisson s'affaisse légèrement vers le sud ouest. A une profondeur de 0,68m on trouve l'horizon de marne gris-verdâtre évoqué pour P7. Dans la partie orientale, la couche d'humus recouvre un éboulis situé à -0,43m s'appuyant sur un niveau d'argile de couleur verte qui repose sur un second éboulis à -0,70m au dessus de l'argile en place. Dans l'angle sud-est de P8 on a trouvé des dalles et des fragments de pierre, pareilles que celles de l'angle NO du carré N9 V. | | | |
| P 8 51 | | | | | | |

ANNEXE C : CARRÉS DE FOUILLE DES ROISES

| Carré | Année | Action | Description | Structures mises au jour | Céramique | Mobilier en association |
|----------------|-------|--------------------|--|--------------------------|-----------|-------------------------|
| P 8 I | 1984 | ouverture du carré | Les niveaux de ce carré ont été perturbés par une tranchée moderne. Dans la partie occidentale (I et IV) un sol bétonné reposant sur un hérisson s'affaisse légèrement vers le sud ouest. A une profondeur de 0,68m on trouve l'horizon de marne gris-verdâtre évoqué pour P7. Dans la partie orientale, la couche d'humus recouvre un éboulis situé à -0,43m s'appuyant sur un niveau d'argile de couleur verte qui repose sur un second éboulis à -0,70m au dessus de l'argile en place. Dans l'angle sud-est de P8 on a trouvé des dalles et des fragments de pierre, pareilles que celles de l'angle NO du carré N9 V. | | | |
| P 8 II | 1984 | ouverture du carré | Les niveaux de ce carré ont été perturbés par une tranchée moderne. Dans la partie occidentale (I et IV) un sol bétonné reposant sur un hérisson s'affaisse légèrement vers le sud ouest. A une profondeur de 0,68m on trouve l'horizon de marne gris-verdâtre évoqué pour P7. Dans la partie orientale, la couche d'humus recouvre un éboulis situé à -0,43m s'appuyant sur un niveau d'argile de couleur verte qui repose sur un second éboulis à -0,70m au dessus de l'argile en place. Dans l'angle sud-est de P8 on a trouvé des dalles et des fragments de pierre, pareilles que celles de l'angle NO du carré N9 V. | | | |
| P 8 II - P 8 I | 1984 | ouverture du carré | Les niveaux de ce carré ont été perturbés par une tranchée moderne. Dans la partie occidentale (I et IV) un sol bétonné reposant sur un hérisson s'affaisse légèrement vers le sud ouest. A une profondeur de 0,68m on trouve l'horizon de marne gris-verdâtre évoqué pour P7. Dans la partie orientale, la couche d'humus recouvre un éboulis situé à -0,43m s'appuyant sur un niveau d'argile de couleur verte qui repose sur un second éboulis à -0,70m au dessus de l'argile en place. Dans l'angle sud-est de P8 on a trouvé des dalles et des fragments de pierre, pareilles que celles de l'angle NO du carré N9 V. | | | |
| P 8 III | 1984 | ouverture du carré | Les niveaux de ce carré ont été perturbés par une tranchée moderne. Dans la partie occidentale (I et IV) un sol bétonné reposant sur un hérisson s'affaisse légèrement vers le sud ouest. A une profondeur de 0,68m on trouve l'horizon de marne gris-verdâtre évoqué pour P7. Dans la partie orientale, la couche d'humus recouvre un éboulis situé à -0,43m s'appuyant sur un niveau d'argile de couleur verte qui repose sur un second éboulis à -0,70m au dessus de l'argile en place. Dans l'angle sud-est de P8 on a trouvé des dalles et des fragments de pierre, pareilles que celles de l'angle NO du carré N9 V. | | | |
| P 8 IV | 1984 | ouverture du carré | Les niveaux de ce carré ont été perturbés par une tranchée moderne. Dans la partie occidentale (I et IV) un sol bétonné reposant sur un hérisson s'affaisse légèrement vers le sud ouest. A une profondeur de 0,68m on trouve l'horizon de marne gris-verdâtre évoqué pour P7. Dans la partie orientale, la couche d'humus recouvre un éboulis situé à -0,43m s'appuyant sur un niveau d'argile de couleur verte qui | | | |

ANNEXE C : CARRÉS DE FOUILLE DES ROISES

| Carré | Année | Action | Description | Structures mises au jour | Céramique | Mobilier en association |
|------------------|-------|--------------------|---|--------------------------|---|-------------------------|
| | | | repose sur un second éboulis à -0,70m au dessus de l'argile en place. Dans l'angle sud-est de P8 on a trouvé des dalles et des fragments de pierre, pareilles que celles de l'angle NO du carré N9 V. | | | |
| Puits | 1975 | | En H13, une cavité profonde d'1,60 m. Au fond, des blocs calcaires et de la glaise rouge. Circulaire à l'origine, mais au nord, le périmètre a été rompu et ce puits a été comblé avec des moellons pour servir d'assise au carneau sud-est de l'hypocauste prolongé. Deux niveaux sont visible, le comblement de la cavité s'est faite après avoir démoli la partie nord et on utilisé ce remblai pour asseoir le prolongement rectangulaire de l'hypocauste primitif. Dans la glaise entre les assises de la cavité, de nombreux éclats de sigillées très brillantes et très mince, certainement précoces ainsi qu'un as d'Agrippa. | | La précocité de l'occupation de ce site serait ainsi à mettre en rapport avec le remplissage des puits découverts sous la rue des Roises, dont l'un avait fourni un ensemble de céramiques ponctuel de 40/50 apr. J.-C. | |
| Q 8 | 1984 | ouverture du carré | Au nord d'une tranchée moderne est ouest, parallèle à celle rencontrée en P8, un cailloutis formant sol apparait dans la berme est-ouest. | | | |
| Q 8 III | 1984 | ouverture du carré | Au nord d'une tranchée moderne est ouest, parallèle à celle rencontrée en P8, un cailloutis formant sol apparait dans la berme est-ouest. | | | |
| Q 8 III et IV | 1984 | ouverture du carré | Au nord d'une tranchée moderne est ouest, parallèle à celle rencontrée en P8, un cailloutis formant sol apparait dans la berme est-ouest. | | | |
| Q 8 IV | 1984 | ouverture du carré | Au nord d'une tranchée moderne est ouest, parallèle à celle rencontrée en P8, un cailloutis formant sol apparait dans la berme est-ouest. | | | |
| SN | | | | | | |
| W | 1974 | | A l'extrémité e de ce mur en K11, un autre mur part à 90% vers le sud (photo 26), d'autre part à l'extrémité W la situation est plus confuse avec un angle symétrique à celui du côté est, mais un second mur plus large que le premier vient s'installer sur le précédent et pas tout à fait dans le même axe. Il s'agit de deux ouvrages différents. L'existence d'un poteau de bois au milieu des moellons à 2 m de l'extrémité W de K9 et à 0,20 m au nord du mur semble indiquer qu'il s'agit d'une construction assez récente, peut-être une fosse d'inclusion provoquée par l'édification d'un auvent à bestiaux. | | | |
| W ou F 16 - G 16 | | | | | | |
| Wp | | | | | | |

AMPHITHEATRE – CAISSES NON TRAITÉES

| Rayon | Caisse | Catégorie |
|-------|--------|--|
| 14-3 | 952 | Amp., Com. Cl, EN AR, TS, Sb. Coq, TN |
| 14-4 | 962 | Amp., Sb. Coq, Com. Cl |
| 14-4 | 928 | Com. Cl, Post-antique |
| 15-2 | 941 | Amp., Com. Cl, Sb. Coq |
| 15-2 | 944 | Com. Cl 1, Com. Cl 3, EN AR, Sb. Coq, Mo |
| 15-3 | 945 | Amp., Sb. Coq, TN, Com. Cl |
| 14-3 | 956 | Com. Cl, TN, TS, Amp. |
| 16-2 | 957 | Amp., Mo, TN, VRP, Com. Cl 1 |
| 16-1 | 969 | CB, TS, Mo, Com. Cl |
| 16-1 | 970 | TN, TS, EN AR, Com. Cl |
| 16-1 | 972 | Mo, CB, Com. Cl, Sb. Coq |
| 16-1 | 971 | TS, Sb. Coq, Com. Cl |
| 16-1 | 975 | Amp. |
| 16-1 | 980 | Com. Cl, CB, EN AR |
| 16-1 | 1004 | TS, EN AR, CB |
| 16-1 | 1005 | Sb. Coq |
| 16-3 | 1007 | RU, TS, Sb. Coq, Com. Cl |
| 16-3 | 1004 | MET, TS, Com. Cl, Mo |
| 16-3 | 1015 | EN AR, Com. Cl, TN |
| 16-3 | 1017 | Com. Cl |
| 16-5 | 1018 | TS |
| 17-1 | 988 | Com. Cl, TS, TN, Mo, Amp., Sb. Coq |
| 17-1 | 989 | TS |
| 17-2 | 1025 | Mo, EN AR, Amp. |
| 17-3 | 1029 | Amp., Com. Cl 1, Sb. Coq |
| 17-3 | 997 | Amp., TN |
| 17-2 | 1026 | Sb. Coq |
| 17-2 | 1027 | Sb. Coq |
| 17-3 | 1030 | Com. Cl 1, TN, Sb. Coq |
| 19-1 | 1034 | TS |
| 19-1 | 1036 | Amp., Mo, TS, Sb. Coq |
| 19-1 | 1038 | TS, Mo, Sb. Coq |
| 19-2 | 1072 | Sb. Coq, Amp., Com. Cl, TN |
| 19-2 | 1074 | TS, Com. Cl, Sb. Coq |

AMPHITHEATRE – CAISSES NON TRAITÉES

| Rayon | Caisse | Catégorie |
|-------|--------|--|
| 19-2 | 1076 | Com. Cl, Sb. Coq, Amp. |
| 19-2 | 1075 | Sb. Coq |
| 19-3 | 1042 | Sb. Coq |
| 19-3 | 1077 | Sb. Coq, Com. Cl |
| 19-4 | 1081 | TS, Sb. Coq, Com. Cl |
| 19-4 | 1080 | TN, Amp., Com. Cl |
| 19-5 | 1083 | EN AR, TS, Sb. Coq, TN |
| 19-5 | 1082 | Sb. Coq, Com. Cl 1 |
| 19-5 | 1046 | Amp., Mo, EN |
| 19-5 | 1046 | EN |
| 18-1 | 1050 | TN, Com. Cl 1, Sb. Coq |
| 18-1 | 1052 | Com. Cl, TS, Sb. Coq |
| 18-1 | 1051 | EN AR, Sb. Coq, Amp. |
| 18-2 | 1085 | CB, TN, Sb. Coq, Com. Cl 2, TS |
| 18-3 | 1091 | Amp., TS, TN |
| 18-4 | 1096 | Sb. Coq, TS, Com. Cl |
| 18-4 | 1095 | TS, Sb. Coq |
| 18-4 | 1094 | Sb. Coq, TS, Com. Cl |
| 18-5 | 1097 | Amp. |
| 18-5 | 1098 | Com. Cl, Amp. |
| 4-2 | 1607 | Com. Cl 1, Com. Cl 2, Amp. |
| 12-2 | 1354 | Sb. Coq, TS, TN, Com. Cl 2 |
| 12-2 | 1355 | Amp., Com. Cl 1, TN, Sb. Coq, EN AR, TS |
| 12-2 | 1364 | Sb. Coq, TS GE, TN, Com. Cl 2, Com. Cl 3 |
| 12-4 | 1363 | TN, Com. Cl |
| 13-2 | 1365 | TN, CB, TS, Amp., Com. Cl |
| 16-3 | 1007 | Sb. Coq, TN, Com. Cl |
| 16-4 | 1014 | MET TR, MET AR, Sb. Coq, CB, TN, Com. Cl 1 |
| 30-2 | 1615 | Sb. Coq, CB, TN |
| 31-3 | 1612 | Com. Cl 1, Com. Cl 2, Com. Cl 3, Sb. Coq |
| 31-4 | 1566 | Com. Cl 2, Com. Cl 3, Mo, Amp. |
| 31-4 | 1621 | Sb. Coq, Com. Cl, EN AR, TS |
| 34-5 | 1638 | Com. Cl, Sb. Coq, TS, EN |
| 69-2 | 1616 | Sb. Coq, TN, Com. Cl 2, Com. Cl 1, Com. Cl 3 |

AMPHITHEATRE – CAISSES NON TRAITÉES

| Rayon | Caisse | Catégorie |
|-------|--------|--|
| 61-5 | 1667 | Sb. Coq, Com. Cl, TN, EN |
| 44-2 | 270 | RU, VRP, EN, Sb Coq, Com. Cl 1 |
| 44-2 | 271 | EN AR, Com. Cl 1, Com. Cl 3, TN, Sb. Coq |
| 44-2 | 272 | Com. Cl 1 |
| 44-2 | 273 | Com. Cl 1, Com. Cl 2, Sb. Coq, EN AR |
| 44-2 | 275 | Amp., Sb. Coq, Com. Cl 1, EN |
| 44-3 | 277 | Amp., Mo, Com. Cl 1, Com. Cl 2, EN AR, Sb. Coq |
| 44-3 | 280 | Com. Cl 1, Com. Cl 2, Com. Cl 3, TN, EN, Sb. Coq |
| 44-3 | 282 | Com. Cl 1, Com. Cl 3, Sb. Coq |
| 44-4 | 287 | Com. Cl 1, Com. Cl 2 |
| 44-4 | 288 | Sb. Coq, TN, Com. Cl 2 |
| 44-4 | 289 | Sb. Coq, Com. Cl 1, Com. Cl 2, TN |
| 44-5 | 291 | Com. Cl, Sb. Coq, TN |
| 44-5 | 292 | Com. Cl, Sb. Coq, TN |
| 44-5 | 293 | Com. Cl, Sb. Coq, TN |
| 44-5 | 294 | Com. Cl, Sb. Coq, TN |
| 45-2 | 300 | Sb. Coq, TN, Com. Cl |
| 45-2 | 296 | Sb. Coq, TN, Com. Cl, EN |
| 45-2 | 297 | Sb. Coq, TN, Com. Cl, EN |
| 45-2 | 295 | Sb. Coq, TN, Com. Cl |
| 44-1 | 1604 | Amp., Com. Cl 1, Com. Cl 2, Sb. Coq, TN |
| 43-1 | 1582 | Com. Cl 1, Com. Cl 2, TN, Sb. Coq |
| 43-1 | 1581 | Com. Cl, Sb. Coq |
| 20-2 | 1143 | CB, Com. Cl, Amp. |
| 20-2 | 1142 | MET AR, Com. Cl, TN, Sb. Coq |
| 46-3 | 1481 | Com. Cl, Amp., EN AR, TN |
| 46-1 | 1477 | TS |
| 46-1 | 1475 | Amp., Com. Cl |
| 47-1 | 1478 | Com. Cl, EN AR, Amp. |
| 32-5 | 1648 | Sb. Coq |
| 32-5 | 1640 | Sb. Coq |
| 34-1 | 1641 | Sb. Coq |
| 34-1 | 1642 | Sb. Coq |
| 36-1 | 1536 | Amp., Com. Cl 3, TN, Sb. Coq, Mo |

AMPHITHEATRE – CAISSES NON TRAITÉES

| Rayon | Caisse | Catégorie |
|-------|--------|-----------------------------------|
| 36-3 | 1562 | MET AR, Sb. Coq, TN |
| 45-4 | 311 | Sb. Coq |
| 45-4 | 312 | Com. Cl, Sb. Coq, TN |
| 45-4 | 313 | Com. Cl, Sb. Coq, TN |
| 45-5 | 314 | Sb. Coq, Com. Cl |
| 45-5 | 315 | Sb. Coq, Com. Cl |
| 45-5 | 316 | Sb. Coq, Com. Cl |
| 45-5 | 317 | Sb. Coq, Com. Cl |
| 30-3 | 1618 | Amp., Com. Cl, Mo |
| 30-3 | 1613 | TN, Com. Cl, Amp. |
| 21-3 | 1161 | Com. Cl, Sb. Coq, Mo, TN |
| 21-4 | 1164 | Amp. |
| 21-5 | 1167 | Amp., Com. Cl, Sb. Coq |
| 21-5 | 1168 | Amp., Com. Cl, Sb. Coq |
| 21-5 | 1169 | Amp., Com. Cl, Sb. Coq |
| 21-2 | 1128 | Com. Cl, Amp., Mo |
| 36-1 | 1537 | RU Cl, Sb. Coq, Com. Cl |
| 36-1 | 1543 | Com. Cl |
| 36-1 | 1544 | Com. Cl 1, Com. Cl 2, CB, Sb. Coq |
| 37-1 | 1531 | Com. Cl 2, Sb. Coq |
| 46-3 | 1482 | Com. Cl, Sb. Coq, TS, EN |
| 20-4 | 1150 | Com. Cl, Sb. Coq, EN |
| 20-4 | 1151 | Com. Cl, Sb. Coq |
| 20-5 | 1152 | Com. Cl, Sb. Coq |
| 20-5 | 1153 | Com. Cl, Sb. Coq |
| 20-5 | 1154 | Com. Cl, Sb. Coq, EN |
| 39-1 | 1548 | Sb. Coq, Com. Cl, TN |
| 39-1 | 1564 | TN, TS, Com. Cl 2, Mo, TN |
| 40-1 | 1460 | Com. Cl, TN, EN, Sb. Coq |
| 40-1 | 1461 | Com. Cl, TN, EN, Sb. Coq |
| 40-1 | 1458 | Com. Cl, TN, EN, Sb. Coq |
| 40-1 | 1459 | Com. Cl, TN, EN, Sb. Coq |
| 17-3 | 996 | Sb. Coq, Com. Cl, TN, TS |
| 19-1 | 1037 | Com. Cl, TS, Sb. Coq |

AMPHITHEATRE – CAISSES NON TRAITÉES

| Rayon | Caisse | Catégorie |
|-------|--------|--------------------------------|
| 20-1 | 1010 | Sb. Coq, TN, Com. Cl |
| 20-1 | 1013 | Com. Cl |
| 17-3 | 1008 | TS, Sb. Coq, Com. Cl, TN, Amp. |
| 17-1 | 998 | TS, Sb. Coq, Com. Cl, TN, Amp. |

ANNEXE E : TABLEAUX DE RÉPARTITION DE LA CÉRAMIQUE AU SEIN DU CORPUS

| Site | NR | NMI |
|------------------------|------|-----|
| Les Roises | 1748 | 198 |
| Rue de l'amphithéâtre | 315 | 135 |
| Puits Dusseaux | 47 | 8 |
| Puits Meyer | 4 | 1 |
| Puits Morlot | 26 | 3 |
| Puits Moser | 69 | 7 |
| Puits Champ Marguerite | 9 | 3 |
| Puits aux tablettes | 152 | 2 |
| Puits Chemin HLM | 6 | 3 |
| Puits Perrin | 13 | 2 |
| Puits Loulou | 7 | 2 |
| Puits Pierrat | 1 | 1 |
| Puits Pizzagalli | 107 | 29 |
| Puits Schneider | 1 | 1 |
| Puits Spindler | 89 | 14 |
| Puits Tang | 1 | 1 |
| Puits inconnus | 2 | 1 |
| Amphithéâtre | 3227 | 217 |
| OP 92 | 9 | 3 |
| Maladière | 32 | 3 |
| Hangar Poilpré | 169 | 6 |
| Fosse Dusseaux | 395 | 60 |
| HS | 204 | 78 |
| Total | 6633 | 778 |

Tableau de répartition de la céramique sigillée

| Site | NR | NMI |
|--------------------------|------|-----|
| Les Roises | 1308 | 64 |
| Rue de l'Amphithéâtre | 463 | 52 |
| Puits Dusseaux | 5 | 1 |
| Puits Meyer | 10 | 1 |
| Puits Morlot | 12 | 2 |
| Puits Moser | 4 | 2 |
| Puits Champ Marguerite | 2 | 1 |
| Puits aux tablettes | 5 | 1 |
| Puits Perrin | 41 | 4 |
| Puits Pierrat | 1 | 1 |
| Puits Pizzagalli | 18 | 2 |
| Puits Rue de la Chapelle | 160 | 8 |
| Puits Spindler | 1 | 1 |
| Amphithéâtre | 1568 | 85 |
| OP 92 | 144 | 23 |
| Maladière | 59 | 1 |
| Hangar Poilpré | 91 | 2 |
| Fosse Dusseaux | 48 | 4 |
| HS | 14 | 4 |
| Total | 3954 | 259 |

Tableau de répartition de la céramique à paroi fine engobée

ANNEXE E : TABLEAUX DE RÉPARTITION DE LA CÉRAMIQUE AU SEIN DU CORPUS

| Site | NR | NMI |
|------------------------|------|-----|
| Les Roises | 1508 | 63 |
| Rue de l'Amphithéâtre | 455 | 54 |
| Puits Meyer | 5 | 1 |
| Puits Morlot | 8 | 1 |
| Puits Moser | 32 | 2 |
| Puits Champ Marguerite | 1 | 1 |
| Puits aux tablettes | 71 | 8 |
| Puits Perrin | 1 | 1 |
| Puits Pizzagalli | 39 | 3 |
| Puits Spindler | 247 | 7 |
| Puits inconnus | 31 | 1 |
| Amphithéâtre | 166 | 15 |
| OP 92 | 5 | 2 |
| Maladière | 2 | 1 |
| Poilpré | 9 | 1 |
| Fosse Dusseaux | 3 | 2 |
| HS | 22 | 8 |
| Total | 2605 | 171 |

Tableau de répartition de la céramique à paroi fine métallescente

| Site | NR | NMI |
|-----------------------|----|-----|
| Rue de l'Amphithéâtre | 1 | 1 |
| Puits Pizzagalli | 2 | 2 |
| HS | 1 | 1 |
| Total | 4 | 4 |

Tableau de répartition de la céramique plombifère

| Site | NR | NMI |
|-------------------------|----|-----|
| Citerne Ernest Chaudron | 1 | 1 |

Tableau de répartition de la céramique fine sombre de Reims

ANNEXE E : TABLEAUX DE RÉPARTITION DE LA CÉRAMIQUE AU SEIN DU CORPUS

| Site | NR | NMI |
|--------------------------|------|-----|
| Les Roises | 3716 | 130 |
| Rue de l'Amphithéâtre | 628 | 92 |
| Puits Dainville | 1 | 1 |
| Puits Dusseaux | 57 | 7 |
| Puits Meyer | 3 | 1 |
| Puits Morlot | 28 | 1 |
| Puits Moser | 47 | 3 |
| Puits Champ Marguerite | 7 | 3 |
| Puits aux tablettes | 280 | 8 |
| Puits Perrin | 7 | 3 |
| Puits Loulou | 13 | 3 |
| Puits Pierrat | 1 | 1 |
| Puits Pizzagalli | 21 | 3 |
| Puits Rue de la Chapelle | 4 | 2 |
| Puits Schneider | 1 | 1 |
| Puits Spindler | 1 | 1 |
| Puits Tang | 1 | 1 |
| Puits inconnus | 41 | 1 |
| Amphithéâtre | 2744 | 82 |
| OP 92 | 42 | 1 |
| Maladière | 116 | 6 |
| Hangar Poilpré | 134 | 3 |
| Citerne Ernest Chaudron | 1 | 1 |
| HS | 8 | 8 |
| Total | 7902 | 363 |

Tableau de répartition de la céramique gallo-belge

| Site | NR | NMI |
|-----------------------|-----|-----|
| Les Roises | 71 | 11 |
| Rue de l'Amphithéâtre | 81 | 9 |
| Puits Meyer | 2 | 1 |
| Puits Perrin | 2 | 1 |
| Puits Pizzagalli | 15 | 3 |
| Puits Spindler | 2 | 1 |
| Amphithéâtre | 172 | 20 |
| OP 92 | 16 | 3 |
| Fosse Dusseaux | 5 | 1 |
| Total | 366 | 50 |

Tableau de répartition de la céramique à vernis rouge pompéien

| Site | NR | NMI |
|-----------------------|------|-----|
| Les Roises | 429 | 45 |
| Rue de l'amphithéâtre | 98 | 27 |
| Puits Dusseaux | 1 | 1 |
| Puits Meyer | 2 | 2 |
| Puits Moser | 18 | 3 |
| Puits aux tablettes | 42 | 4 |
| Puits Perrin | 2 | 2 |
| Puits Pizzagalli | 3 | 2 |
| Puits Spindler | 4 | 2 |
| Puits inconnus | 2 | 1 |
| Amphithéâtre | 649 | 53 |
| OP 92 | 58 | 9 |
| Hangar Poilpré | 2 | 1 |
| Total | 1310 | 152 |

Tableau de répartition de la céramique rugueuse

ANNEXE E : TABLEAUX DE RÉPARTITION DE LA CÉRAMIQUE AU SEIN DU CORPUS

| Site | NR | NMI |
|-----------------------|------|-----|
| Les Roises | 1050 | 66 |
| Rue de l'Amphithéâtre | 86 | 22 |
| Puits Meyer | 10 | 1 |
| Puits Moser | 47 | 6 |
| Puits aux tablettes | 64 | 4 |
| Puits Perrin | 6 | 2 |
| Puits Pizzagalli | 21 | 2 |
| Puits Spindler | 153 | 6 |
| Puits inconnus | 1 | 1 |
| Amphithéâtre | 256 | 29 |
| OP 92 | 2 | 2 |
| Maladière | 10 | 1 |
| Hangar Poilpré | 23 | 1 |
| HS | 1 | 1 |
| Total | 1730 | 144 |

Tableau de répartition de la céramique craquelée bleutée

| Site | NR | NMI |
|--------------------------|-------|-----|
| Les Roises | 3822 | 176 |
| Rue de l'Amphithéâtre | 465 | 100 |
| Puits Dusseaux | 12 | 1 |
| Puits Meyer | 6 | 1 |
| Puits Morlot | 20 | 5 |
| Puits Moser | 63 | 6 |
| Puits Champ Marguerite | 1 | 1 |
| Puits aux tablettes | 33 | 2 |
| Puits Chemin HLM | 1 | 1 |
| Puits Perrin | 6 | 5 |
| Puits Loulou | 1 | 1 |
| Puits Pierrat | 2 | 1 |
| Puits Pizzagalli | 585 | 58 |
| Puits Rue de la Chapelle | 353 | 18 |
| Puits Spindler | 56 | 4 |
| Puits inconnus | 25 | 1 |
| Amphithéâtre | 8822 | 237 |
| OP 92 | 195 | 16 |
| Maladière | 23 | 1 |
| Hangar Poilpré | 57 | 5 |
| HS | 2 | 1 |
| Total | 14550 | 641 |

Tableau de répartition de la céramique sombre à dégraissant coquillier

ANNEXE E : TABLEAUX DE RÉPARTITION DE LA CÉRAMIQUE AU SEIN DU CORPUS

| Site | NR | NMI |
|-----------------------|-----|-----|
| Les Roises | 166 | 20 |
| Rue de l'Amphithéâtre | 3 | 1 |
| Puits Moser | 8 | 1 |
| Puits aux tablettes | 54 | 2 |
| Puits Pizzagalli | 10 | 2 |
| Puits Spindler | 9 | 1 |
| Amphithéâtre | 54 | 6 |
| OP 92 | 25 | 1 |
| HS | 25 | 1 |
| Total | 354 | 35 |

Tableau de répartition de la céramique commune sombre

| Site | NR | | NMI |
|--------------------------|-------|-------|-----|
| Les Roises | 8353 | 35,4 | 176 |
| Rue de l'Amphithéâtre | 1242 | 31,0 | 96 |
| Puits Champ du carré | 1 | 50,0 | 1 |
| Puits Dusseaux | 328 | 70,2 | 5 |
| Puits Meyer | 41 | 47,7 | 2 |
| Puits Morlot | 53 | 25,6 | 1 |
| Puits Moser | 77 | 18,9 | 4 |
| Puits Mougél | 1 | 100,0 | 1 |
| Puits Champ Marguerite | 1 | 2,2 | 1 |
| Puits aux tablettes | 420 | 37,5 | 3 |
| Puits Perrin | 27 | 24,3 | 5 |
| Puits Loulou | 3 | 12,5 | 1 |
| Puits Pierrat | 8 | 61,5 | 1 |
| Puits Pizzagalli | 891 | 46,0 | 52 |
| Puits Poilpré | 9 | 100,0 | 1 |
| Puits Rue de la Chapelle | 12 | 2,3 | 2 |
| Puits Schneider | 1 | 33,3 | 1 |
| Puits Spindler | 73 | 11,5 | 4 |
| Puits inconnus | 51 | 32,9 | 8 |
| Amphithéâtre | 9481 | 33,1 | 285 |
| OP 92 | 457 | 43,8 | 33 |
| Maladière | 58 | 17,1 | 7 |
| Hangar Poilpré | 155 | 23,6 | 5 |
| Fosse Dusseaux | 130 | 22,4 | 21 |
| HS | 11 | 3,7 | 6 |
| Total | 21884 | | 722 |

Tableau de répartition de la céramique commune claire

ANNEXE E : TABLEAUX DE RÉPARTITION DE LA CÉRAMIQUE AU SEIN DU CORPUS

| Site | NR | NMI |
|-----------------------|-----|-----|
| Les Roises | 149 | 22 |
| Rue de l'Amphithéâtre | 14 | 10 |
| Puits Champ du carré | 1 | 1 |
| Puits Meyer | 3 | 3 |
| Puits Perrin | 1 | 1 |
| Puits Pizzagalli | 42 | 8 |
| Puits inconnus | 1 | 1 |
| Amphithéâtre | 312 | 43 |
| OP 92 | 27 | 8 |
| Maladière | 1 | 1 |
| Hangar Poilpré | 7 | 1 |
| Total | 558 | 99 |

Tableau de répartition des mortiers

| Site | NR | NMI |
|-----------------------|----|-----|
| Les Roises | 4 | 2 |
| Rue de l'Amphithéâtre | 1 | 1 |
| Puits Morlot | 2 | 1 |

Tableau de répartition des dolia

| Site | NR | NMI |
|------------------------|------|-----|
| Les Roises | 1240 | 24 |
| Rue de l'Amphithéâtre | 152 | 29 |
| Puits des Roises | 1 | 1 |
| Puits Dusseaux | 17 | 1 |
| Puits Morlot | 58 | 2 |
| Puits Moser | 43 | 1 |
| Puits Champ Marguerite | 24 | 1 |
| Puits Perrin | 4 | 1 |
| Puits Pizzagalli | 131 | 3 |
| Puits inconnus | 1 | 1 |
| Amphithéâtre | 1092 | 19 |
| OP 92 | 60 | 5 |
| Maladière | 38 | 1 |
| Hangar Poilpré | 9 | 2 |
| HS | 8 | 2 |
| Total | 2878 | 93 |

Tableau de répartition des amphores

ANNEXE E : TABLEAUX DE RÉPARTITION DE LA CÉRAMIQUE AU SEIN DU CORPUS

| Site | NR | NMI |
|------------------|----|-----|
| Les Roises | 4 | 3 |
| Puits Pizzagalli | 4 | 2 |
| Amphithéâtre | 20 | 14 |
| OP 92 | 2 | 2 |
| Hangar Poilpré | 1 | 1 |
| HS | 1 | 1 |
| Total | 32 | 23 |

Tableau de répartition des amphorisques

| Site | NR | NMI |
|------------------|----|-----|
| Les Roises | 7 | 5 |
| Puits Perrin | 1 | 1 |
| Puits Pizzagalli | 13 | 2 |
| Amphithéâtre | 19 | 16 |
| OP 92 | 1 | 1 |
| Total | 41 | 25 |

Tableau de répartition des brûle-parfums

| Site | NR | NMI |
|------------------|----|-----|
| Amphithéâtre | 5 | 2 |
| Puits Pizzagalli | 34 | 1 |

Tableau de répartition des creusets

Annexe E : Tableau descriptif des sites par critère

| site/lots | | nature du site | année de fouilles | méthode de fouille | Informations de fouille | auteur de l'étude | NR | NR en % | NMI | NMI en % | catégorie |
|------------------------------|---------------------------------|----------------|-------------------|---------------------------------|-------------------------|----------------------------|-------|---------|-----|----------|-----------|
| Les Roises | | habitat | 1973-1984 | sondages/fouilles par carroyage | partiel | Samantha Dub | 22923 | 22,39 | 873 | 11,17 | D |
| | Les Roises - cave A | habitat | 1981 | fouilles par carroyage | oui | Samantha Dub | 170 | 0,17 | 11 | 0,14 | D |
| | Les Roises - cave B1+hypocauste | habitat | 1976 | fouilles par carroyage | oui | Samantha Dub | 411 | 0,40 | 60 | 0,77 | C |
| | Les Roises - cave B2 | habitat | 1983-1985 | fouilles par carroyage | oui | Samantha Dub | 81 | 0,08 | 61 | 0,78 | C |
| Rue de l'Amphithéâtre | | habitat | 1998 | fouilles stratigraphiques | oui | Marc Feller / Samantha Dub | 4006 | 3,91 | 630 | 8,06 | A |
| Puits Champs du carré | | puits | | non renseigné | non | Samantha Dub | 2 | 0,00 | 2 | 0,03 | D |
| Puits Dainville | | puits | | non renseigné | non | Samantha Dub | 1 | 0,00 | 1 | 0,01 | D |
| Puits des Roises | | puits | | non renseigné | non | Samantha Dub | 1 | 0,00 | 1 | 0,01 | D |
| Puits Dusseaux | | puits | 1981 | non renseigné | non | Samantha Dub | 467 | 0,46 | 24 | 0,31 | D |
| Puits Meyer | | puits | 1969 | non renseigné | non | Samantha Dub | 86 | 0,08 | 14 | 0,18 | D |
| Puits Morlot | | puits | 1981 | non renseigné | non | Samantha Dub | 207 | 0,20 | 16 | 0,20 | D |
| Puits Moser | | puits | 1978-1980 | non renseigné | non | Samantha Dub | 409 | 0,40 | 36 | 0,46 | C |
| Puits Mougel | | puits | | non renseigné | non | Samantha Dub | 1 | 0,00 | 1 | 0,01 | D |

Annexe E : Tableau descriptif des sites par critère

| site/lots | nature du site | année de fouilles | méthode de fouille | Informations de fouille | auteur de l'étude | NR | NR en % | NMI | NMI en % | catégorie | |
|--|----------------|-------------------|--------------------|---------------------------|-------------------|-------------|---------|------|----------|-----------|---|
| Puits n°34 Champ des marguerites | puits | 1957/1964 | non renseigné | non | Samantha Dub | 45 | 0,04 | 11 | 0,14 | D | |
| Puits n°77 aux tablettes | puits | 1967-1968 | non renseigné | oui | Samantha Dub | 1121 | 1,09 | 35 | 0,45 | C | |
| Puits n°125 Chemin HLM | puits | 1969 | non renseigné | non | Samantha Dub | 7 | 0,01 | 4 | 0,05 | D | |
| Puits n°126 Perrin | puits | 1970 | non renseigné | oui | Samantha Dub | 110 | 0,11 | 25 | 0,32 | D | |
| Puits n°139 Loulou rue de l'amphithéâtre | puits | | non renseigné | non | Samantha Dub | 24 | 0,02 | 7 | 0,09 | D | |
| Puits Pierrat | puits | | non renseigné | non | Samantha Dub | 13 | 0,01 | 5 | 0,06 | D | |
| Puits Pizzagalli | puits | 1977 | non renseigné | non | Samantha Dub | 1951 | 1,91 | 180 | 2,30 | C | |
| Puits Poilprès | puits | | non renseigné | non | Samantha Dub | 9 | 0,01 | 1 | 0,01 | D | |
| Puits Rue de la Chapelle | puits | 1975 | non renseigné | non | Samantha Dub | 529 | 0,52 | 31 | 0,40 | C | |
| Puits Schneider Bertrand "carrefour rue de la chapelle" | puits | | non renseigné | non | Samantha Dub | 3 | 0,00 | 3 | 0,04 | D | |
| Puits Spindler | puits | 1979 | non renseigné | non | Samantha Dub | 637 | 0,62 | 43 | 0,55 | C | |
| Puits Tang | puits | | non renseigné | non | Samantha Dub | 2 | 0,00 | 2 | 0,03 | D | |
| Puits inconnus | puits | | non renseigné | non | Samantha Dub | 153 | 0,15 | 13 | 0,17 | D | |
| Amphithéâtre | amphithéâtre | | divers | oui | Samantha Dub | 28606 | 27,94 | 1124 | 14,39 | D | |
| | US 1001 | amphithéâtre | 1992-1993 | fouilles stratigraphiques | oui | Marc Feller | 243 | 0,24 | 167 | 2,14 | B |

Annexe E : Tableau descriptif des sites par critère

| site/lots | | nature du site | année de fouilles | méthode de fouille | Informations de fouille | auteur de l'étude | NR | NR en % | NMI | NMI en % | catégorie |
|----------------------------------|---------------------|----------------|-------------------|---------------------------|-------------------------|--------------------|--------|---------|------|----------|-----------|
| Amphithéâtre - OP 1992/93 | US 1002, 1003, 1004 | amphithéâtre | 1992-1993 | fouilles stratigraphiques | oui | Samantha Dub | 1051 | 1,03 | 105 | 1,34 | A |
| La Maladière | | habitat | 1967 | sondages et prospection | non | Samantha Dub | 339 | 0,33 | 16 | 0,20 | D |
| Hangar Poilpré | | fosse-dépotoir | 1973 | prospection | oui | Samantha Dub | 657 | 0,64 | 21 | 0,27 | D |
| Fosse Dusseaux | | funéraire | 1973 | | oui | Samantha Dub | 581 | 0,57 | 87 | 1,11 | B |
| Citerne Ernest Chaudron | | citerne | | | non | Samantha Dub | 2 | 0,00 | 2 | 0,03 | D |
| La Fontainotte | | habitat | 2011 | fouilles stratigraphiques | oui | Cécile Pilard-Jude | 12875 | 12,57 | 1165 | 14,91 | B |
| Rue du Ruisseau | | espace public | 2010-2015 | fouilles stratigraphiques | oui | Marion Legagneux | 24383 | 23,81 | 2926 | 37,45 | B |
| Hors stratigraphie | | indéterminé | | non renseigné | non | Samantha Dub | 293 | 0,29 | 110 | 1,41 | D |
| Total | | | | | | | 102399 | 100 | 7813 | 100 | |

ANNEXE E : TABLEAU DES DONNÉES NUMÉRIQUES PAR PHASE

| Catégorie céramique | Catégorie sites | Phase ant. | | Phase Ia | | Phase Ib | | Ant- Ia-Ib | | Phase Ib-IIa | | Phase IIa | | Phase IIb | | Phase IIa-IIb | | Phase IIb-IIc | | Phase IIc | | Phase II | | phase III | |
|------------------------|--------------------|------------|-----------|------------|------------|-----------|-----------|------------|-----------|--------------|----------|------------|-----------|------------|-----------|---------------|-----------|---------------|-----------|-----------|-----------|-----------|-----------|------------|-----------|
| | | NR | NMI | NR | NMI | NR | NMI | NR | NMI | NR | NMI | NR | NMI | NR | NMI | NR | NMI | NR | NMI | NR | NMI | NR | NMI | NR | NMI |
| TSSG | A | | | | | 11 | 3 | | | | | | | 4 | 1 | 9 | 5 | | | | | | | | |
| | B | 190 | 26 | 860 | 185 | 60 | 14 | | | | | 20 | 5 | 10 | 3 | | | 91 | 14 | 10 | 2 | | | 167 | 23 |
| | C | | | | | | | 347 | 48 | | | | | 8 | 4 | 51 | 9 | 49 | 1 | | | 2 | 1 | | |
| Total | | 190 | 26 | 860 | 185 | 71 | 17 | 347 | 48 | 0 | 0 | 20 | 5 | 22 | 8 | 60 | 14 | 140 | 15 | 10 | 2 | 2 | 1 | 167 | 23 |
| TSCG | A | | | | | 9 | 2 | | | | | | | | | | | | | | | | | | |
| | B | | | 10 | 3 | | | | | | | 2 | 2 | | | | | 14 | 1 | 9 | 2 | | | 129 | 17 |
| | C | | | | | | | | | | | | 1 | 1 | | | | | | | | | | | |
| Total | | 0 | 0 | 10 | 3 | 9 | 2 | 0 | 0 | 0 | 0 | 2 | 2 | 1 | 1 | 0 | 0 | 14 | 1 | 9 | 2 | 0 | 0 | 129 | 17 |
| TSGE | A | | | | | 2 | 2 | | | | | | | | | 40 | 19 | | | | | | | | |
| | B | | | 3 | 3 | 6 | 3 | | | | | 100 | 24 | 233 | 60 | | | 14 | 5 | 24 | 2 | | | 219 | 24 |
| | C | | | | | | | 49 | 12 | | | | | 3 | 2 | 8 | 3 | | | | | | | | |
| Total | | 0 | 0 | 3 | 3 | 8 | 5 | 49 | 12 | 0 | 0 | 100 | 24 | 236 | 62 | 48 | 22 | 14 | 5 | 24 | 2 | 0 | 0 | 219 | 24 |
| TSAR | A | | | | | 10 | 4 | | | | | | | | | 72 | 24 | | | | | | | | |
| | B | | | | | | | | | | | | | | | | | | | | | | | | |
| | C | | | | | | | | | | | | 72 | 10 | 48 | 17 | 103 | 1 | | | | 87 | 13 | | |
| Total | | 0 | 0 | 0 | 0 | 10 | 4 | 0 | 0 | 0 | 0 | 0 | 0 | 72 | 10 | 120 | 41 | 103 | 1 | 0 | 0 | 87 | 13 | 0 | 0 |
| EN | A | | | | | | | | | | | | | | | 194 | 14 | | | | | | | | |
| | B | | | 6 | 1 | 29 | 1 | | | | | 54 | 8 | 223 | 34 | | | | | | | | | | |
| | C | | | | | | | 1 | 1 | | | | | | | | | | | | | | | | |
| Total | | 0 | 0 | 6 | 1 | 29 | 1 | 1 | 1 | 0 | 0 | 54 | 8 | 223 | 34 | 194 | 14 | 0 | 0 | 0 | 0 | 0 | 0 | 0 | 0 |
| EN AR | A | | | | | 1 | 1 | | | | | | | 144 | 23 | 164 | 17 | | | | | | | | |
| | B | | | 9 | 3 | 1 | 1 | | | | | | | | | | | 52 | 6 | 79 | 11 | | | 183 | 16 |
| | C | | | | | | | 46 | 2 | 159 | 7 | | | 24 | 15 | 18 | 2 | 5 | 1 | | | 1 | 1 | | |
| Total | | 0 | 0 | 9 | 3 | 2 | 2 | 46 | 2 | 159 | 7 | 0 | 0 | 168 | 38 | 182 | 19 | 57 | 7 | 79 | 11 | 1 | 1 | 183 | 16 |
| EN TR | B | | | | | | | | | | | | | | | | | | 5 | 1 | | | | 66 | 5 |
| | C | | | | | | | | | 1 | 1 | | | 2 | 1 | | | | | | | | | | |
| Total | | 0 | 0 | 0 | 0 | 0 | 0 | 0 | 0 | 1 | 1 | 0 | 0 | 2 | 1 | 0 | 0 | 0 | 0 | 5 | 1 | 0 | 0 | 66 | 5 |
| EN COL | C | | | | | | | | | | | | 4 | 2 | | | | | | | | | | | |
| Total | | 0 | 0 | 0 | 0 | 0 | 0 | 0 | 0 | 0 | 0 | 0 | 0 | 4 | 2 | 0 | 0 | 0 | 0 | 0 | 0 | 0 | 0 | 0 | 0 |
| EN LEZ | B | | | 10 | 2 | | | | | | | | | | | | | 1 | 1 | 1 | 1 | | | 16 | 3 |

ANNEXE E : TABLEAU DES DONNÉES NUMÉRIQUES PAR PHASE

| Catégorie céramique | Catégorie sites | Phase ant. | | Phase Ia | | Phase Ib | | Ant- Ia-Ib | | Phase Ib-IIa | | Phase IIa | | Phase IIb | | Phase IIa-IIb | | Phase IIb-IIc | | Phase IIc | | Phase II | | phase III | |
|------------------------|--------------------|------------|-----------|-------------|------------|------------|-----------|------------|----------|--------------|----------|------------|-----------|------------|-----------|---------------|-----------|---------------|-----------|-----------|----------|------------|----------|------------|-----------|
| | | NR | NMI | NR | NMI | NR | NMI | NR | NMI | NR | NMI | NR | NMI | NR | NMI | NR | NMI | NR | NMI | NR | NMI | NR | NMI | NR | NMI |
| Total | | 0 | 0 | 10 | 2 | 0 | 0 | 0 | 0 | 0 | 0 | 0 | 0 | 0 | 0 | 0 | 0 | 1 | 1 | 1 | 1 | 0 | 0 | 16 | 3 |
| EN MOS | A | | | | | 2 | 1 | | | | | | | | | | | | | | | | | | |
| Total | | 0 | 0 | 0 | 0 | 2 | 1 | 0 | 0 | 0 | 0 | 0 | 0 | 0 | 0 | 0 | 0 | 0 | 0 | 0 | 0 | 0 | 0 | 0 | 0 |
| EN LYON | B | 2 | 2 | 28 | 6 | | | | | | | | | | | | | | | | | | | | |
| | C | | | | | | | 1 | 1 | | | | | | | | | | | | | | | | |
| Total | | 2 | 2 | 28 | 6 | 0 | 0 | 1 | 1 | 0 | 0 | 0 | 0 | 0 | 0 | 0 | 0 | 0 | 0 | 0 | 0 | 0 | 0 | 0 | 0 |
| MET | A | | | | | | | | | | | | 5 | 2 | 48 | 2 | | | | | | | | | |
| | B | | | | | | | | | | | 1 | 1 | 727 | 58 | | | | | | | | | | |
| Total | | 0 | 0 | 0 | 0 | 0 | 0 | 0 | 0 | 0 | 0 | 1 | 1 | 732 | 60 | 48 | 2 | 0 | 0 | 0 | 0 | 0 | 0 | 0 | 0 |
| MET AR | A | | | | | 1 | 1 | | | | | | | | | 312 | 33 | | | | | | | | |
| | B | | | 10 | 1 | | | | | | | | | | | | | 7 | 2 | 21 | 2 | | | 490 | 37 |
| | C | | | | | | | 3 | 2 | | | | | 31 | 5 | 31 | 2 | 26 | 5 | | | 237 | 5 | | |
| Total | | 0 | 0 | 10 | 1 | 1 | 1 | 3 | 2 | 0 | 0 | 0 | 0 | 31 | 5 | 343 | 35 | 33 | 7 | 21 | 2 | 237 | 5 | 490 | 37 |
| MET TR | A | | | | | | | | | | | | | | | 42 | 4 | | | | | | | | |
| | B | | | 4 | 1 | | | | | | | | | | | | | 6 | 2 | 24 | 1 | | | 141 | 6 |
| | C | | | | | | | | | | | | | 21 | 8 | 8 | 1 | 45 | 3 | | | 10 | 2 | | |
| Total | | 0 | 0 | 4 | 1 | 0 | 0 | 0 | 0 | 0 | 0 | 0 | 0 | 21 | 8 | 50 | 5 | 51 | 5 | 24 | 1 | 10 | 2 | 141 | 6 |
| MET LEZ | B | | | | | | | | | | | | | | | | | | | 1 | 1 | | | 15 | 3 |
| | C | | | | | | | | | | | | | 2 | 2 | | | | | | | | | | |
| Total | | 0 | 0 | 0 | 0 | 0 | 0 | 0 | 0 | 0 | 0 | 0 | 0 | 2 | 2 | 0 | 0 | 0 | 0 | 1 | 1 | 0 | 0 | 15 | 3 |
| PLB | B | 2 | 2 | 33 | 7 | | | | | | | | | | | | | | | | | | | | |
| Total | | 2 | 2 | 33 | 7 | 0 | 0 | 0 | 0 | 0 | 0 | 0 | 0 | 0 | 0 | 0 | 0 | 0 | 0 | 0 | 0 | 0 | 0 | 0 | 0 |
| TN | A | | | | | 285 | 29 | | | | | | | | | 66 | 13 | | | | | | | | |
| | B | 122 | 16 | 1229 | 100 | 188 | 17 | | | | | 365 | 31 | 459 | 19 | | | 121 | 6 | 85 | 8 | | | 121 | 20 |
| | C | | | | | | | | | 3 | 1 | | | 30 | 2 | 15 | 2 | 267 | 6 | | | 1 | 1 | | |
| Total | | 122 | 16 | 1229 | 100 | 473 | 46 | 0 | 0 | 3 | 1 | 365 | 31 | 489 | 21 | 81 | 15 | 388 | 12 | 85 | 8 | 1 | 1 | 121 | 20 |
| TN AR | A | | | | | | | | | | | | | 42 | 1 | | | | | | | | | | |
| | C | | | | | | | | | | | | | 37 | 8 | | | | | | | | | | |
| Total | | 0 | 0 | 0 | 0 | 0 | 0 | 0 | 0 | 0 | 0 | 0 | 0 | 79 | 9 | 0 | 0 | 0 | 0 | 0 | 0 | 0 | 0 | 0 | 0 |

ANNEXE E : TABLEAU DES DONNÉES NUMÉRIQUES PAR PHASE

| Catégorie céramique | Catégorie sites | Phase ant. | | Phase Ia | | Phase Ib | | Ant- Ia-Ib | | Phase Ib-IIa | | Phase IIa | | Phase IIb | | Phase IIa-IIb | | Phase IIb-IIc | | Phase IIc | | Phase II | | phase III | |
|------------------------|--------------------|------------|----------|-----------|-----------|-----------|----------|------------|----------|--------------|----------|-----------|----------|------------|-----------|---------------|-----------|---------------|----------|-----------|----------|----------|----------|-----------|-----------|
| | | NR | NMI | NR | NMI | NR | NMI | NR | NMI | NR | NMI | NR | NMI | NR | NMI | NR | NMI | NR | NMI | NR | NMI | NR | NMI | NR | NMI |
| TN/DTN | A | | | | | | | | | | | | | | | 30 | 9 | | | | | | | | |
| | C | | | | | | | | | | | | | | | | | 1 | 1 | | | | | | |
| Total | | 0 | 0 | 0 | 0 | 0 | 0 | 0 | 0 | 0 | 0 | 0 | 0 | 0 | 0 | 30 | 9 | 1 | 1 | 0 | 0 | 0 | 0 | 0 | 0 |
| TR | A | | | | | 9 | 4 | | | | | | | | | 7 | 2 | | | | | | | | |
| | B | 2 | 1 | 67 | 14 | 1 | 1 | | | | | 7 | 1 | | | | | 13 | 4 | 2 | 1 | | | 17 | 6 |
| | C | | | | | | | | | 1 | 1 | | | 5 | 2 | 6 | 1 | 12 | 1 | | | | | | |
| Total | | 2 | 1 | 67 | 14 | 10 | 5 | 0 | 0 | 1 | 1 | 7 | 1 | 5 | 2 | 13 | 3 | 25 | 5 | 2 | 1 | 0 | 0 | 17 | 6 |
| VRP | A | | | | | 1 | 1 | | | | | | | 16 | 3 | 74 | 7 | | | | | | | | |
| | B | | | | | 2 | 1 | | | | | 20 | 4 | 159 | 29 | | | 1 | 1 | 3 | 1 | | | 1 | 1 |
| | C | | | | | | | 5 | 1 | | | | | 1 | 1 | 15 | 3 | | | | | 2 | 1 | | |
| Total | | 0 | 0 | 0 | 0 | 3 | 2 | 5 | 1 | 0 | 0 | 20 | 4 | 176 | 33 | 89 | 10 | 1 | 1 | 3 | 1 | 2 | 1 | 1 | 1 |
| RU UR | A | | | | | | | | | | | | | 6 | 2 | | | | | | | | | | |
| | B | | | | | | | | | | | | | 49 | 11 | | | | | | | | | | |
| | C | | | | | | | | | | | | | 8 | 5 | 2 | 1 | | | | | 1 | 1 | | |
| Total | | 0 | 0 | 0 | 0 | 0 | 0 | 0 | 0 | 0 | 0 | 0 | 0 | 63 | 18 | 2 | 1 | 0 | 0 | 0 | 0 | 1 | 1 | 0 | 0 |
| RU CI | A | | | | | 29 | 3 | | | | | | | 45 | 4 | 23 | 4 | | | | | | | | |
| | B | | | 5 | 1 | 28 | 2 | | | | | | | 102 | 11 | | | | | 6 | 2 | | | 53 | 13 |
| | C | | | | | | | | | | | | | 16 | 2 | | | 42 | 4 | | | | | | |
| Total | | 0 | 0 | 5 | 1 | 57 | 5 | 0 | 0 | 0 | 0 | 0 | 0 | 163 | 17 | 23 | 4 | 42 | 4 | 6 | 2 | 0 | 0 | 53 | 13 |
| RU S | A | | | | | 1 | 1 | | | | | | | 4 | 1 | 4 | 2 | | | | | | | | |
| | C | | | | | | | | | | | | | | | 1 | 1 | | | | | | | | |
| Total | | 0 | 0 | 0 | 0 | 1 | 1 | 0 | 0 | 0 | 0 | 0 | 0 | 4 | 1 | 5 | 3 | 0 | 0 | 0 | 0 | 0 | 0 | 0 | 0 |
| RUA | A | | | | | | | | | | | | | 2 | 1 | | | | | | | | | | |
| Total | | 0 | 0 | 0 | 0 | 0 | 0 | 0 | 0 | 0 | 0 | 0 | 0 | 2 | 1 | 0 | 0 | 0 | 0 | 0 | 0 | 0 | 0 | 0 | 0 |
| RUM | C | | | | | | | | | | | | | | | | | | | | | 3 | 1 | | |
| Total | | 0 | 0 | 0 | 0 | 0 | 0 | 0 | 0 | 0 | 0 | 0 | 0 | 0 | 0 | 0 | 0 | 0 | 0 | 0 | 0 | 3 | 1 | 0 | 0 |
| CB | A | | | | | | | | | | | | | 2 | 2 | 68 | 16 | | | | | | | | |
| | B | | | | | | | | | | | | | 614 | 57 | | | | | | | | | | |
| | C | | | | | | | | | | | | | 65 | 17 | 21 | 2 | 64 | 4 | | | 153 | 6 | | |

ANNEXE E : TABLEAU DES DONNÉES NUMÉRIQUES PAR PHASE

| Catégorie céramique | Catégorie sites | Phase ant. | | Phase Ia | | Phase Ib | | Ant- Ia-Ib | | Phase Ib-IIa | | Phase IIa | | Phase IIb | | Phase IIa-IIb | | Phase IIb-IIc | | Phase IIc | | Phase II | | phase III | |
|------------------------|--------------------|------------|-----------|-------------|-----------|------------|-----------|------------|----------|--------------|-----------|-------------|-----------|-------------|------------|---------------|-----------|---------------|-----------|-------------|-----------|------------|----------|-------------|-----------|
| | | NR | NMI | NR | NMI | NR | NMI | NR | NMI | NR | NMI | NR | NMI | NR | NMI | NR | NMI | NR | NMI | NR | NMI | NR | NMI | NR | NMI |
| Total | | 0 | 0 | 0 | 0 | 0 | 0 | 0 | 0 | 0 | 0 | 0 | 0 | 681 | 76 | 89 | 18 | 64 | 4 | 0 | 0 | 153 | 6 | 0 | 0 |
| Sb. Coq | A | | | | | 280 | 36 | | | | | | | 69 | 5 | 150 | 40 | | | | | | | | |
| | B | 15 | 2 | 658 | 69 | 149 | 14 | | | | 621 | 74 | 779 | 110 | | | 122 | 18 | 179 | 14 | | | 382 | 49 | |
| | C | | | | | | | | | 353 | 18 | | | 98 | 32 | 585 | 58 | 33 | 2 | | | 56 | 4 | | |
| Total | | 15 | 2 | 658 | 69 | 429 | 50 | 0 | 0 | 353 | 18 | 621 | 74 | 946 | 147 | 735 | 98 | 155 | 20 | 179 | 14 | 56 | 4 | 382 | 49 |
| Com. Sb | A | | | | | | | | | | | | | 25 | 1 | | | | | | | | | | |
| | B | 9 | 2 | 384 | 26 | 24 | 1 | | | | 1 | 1 | 56 | 6 | | | 96 | 8 | 89 | 5 | | | 433 | 22 | |
| | C | | | | | | | | | | | | 12 | 3 | 10 | 2 | 54 | 2 | | | | | | | |
| Total | | 9 | 2 | 384 | 26 | 24 | 1 | 0 | 0 | 0 | 0 | 1 | 1 | 93 | 10 | 10 | 2 | 150 | 10 | 89 | 5 | 0 | 0 | 433 | 22 |
| Com. Cl | A | | | | | 398 | 10 | | | | | | | | | 474 | 20 | | | | | | | | |
| | B | 52 | 13 | 1787 | 69 | 226 | 7 | | | | 1069 | 38 | 2093 | 54 | | | 480 | 32 | 2625 | 54 | | | 3400 | 91 | |
| | C | | | | | | | | | 10 | 1 | | | | | | | | | | 69 | 1 | | | |
| Total | | 52 | 13 | 1787 | 69 | 624 | 17 | 0 | 0 | 10 | 1 | 1069 | 38 | 2093 | 54 | 474 | 20 | 480 | 32 | 2625 | 54 | 69 | 1 | 3400 | 91 |
| Com. Cl 1 | A | | | | | 36 | 6 | | | | | | | 245 | 17 | 5 | 2 | | | | | | | | |
| | C | | | | | | | | | | | | | 38 | 5 | 222 | 15 | | | | | | | | |
| | Total | 0 | 0 | 0 | 0 | 36 | 6 | 0 | 0 | 0 | 0 | 0 | 0 | 283 | 22 | 227 | 17 | 0 | 0 | 0 | 0 | 0 | 0 | 0 | 0 |
| Com. Cl 2 | A | | | | | 86 | 7 | | | | | | | 19 | 4 | 27 | 8 | | | | | | | | |
| | C | | | | | | | | | | | | | 56 | 6 | 349 | 4 | 265 | 2 | | | 1 | 1 | | |
| | Total | 0 | 0 | 0 | 0 | 86 | 7 | 0 | 0 | 0 | 0 | 0 | 0 | 75 | 10 | 376 | 12 | 265 | 2 | 0 | 0 | 1 | 1 | 0 | 0 |
| Com. Cl 3 | A | | | | | 19 | 2 | | | | | | | 145 | 5 | 20 | 5 | | | | | | | | |
| | C | | | | | | | 105 | 4 | | | | | 9 | 3 | 18 | 1 | 155 | 1 | | | 1 | 1 | | |
| | Total | 0 | 0 | 0 | 0 | 19 | 2 | 105 | 4 | 0 | 0 | 0 | 0 | 154 | 8 | 38 | 6 | 155 | 1 | 0 | 0 | 1 | 1 | 0 | 0 |
| Com. Cl dorée | A | | | | | 1 | 1 | | | | | | | 5 | 3 | 22 | 4 | | | | | | | | |
| | B | | | 8 | 2 | 1 | 1 | | | | | 43 | 13 | 73 | 17 | | | | | | | | | | |
| | C | | | | | | | | | 2 | 1 | | | 3 | 2 | 297 | 31 | | | | | 2 | 1 | | |
| Total | 0 | 0 | 8 | 2 | 2 | 2 | 0 | 0 | 2 | 1 | 43 | 13 | 81 | 22 | 319 | 35 | 0 | 0 | 0 | 0 | 2 | 1 | 0 | 0 | |
| Cl. Eng. | B | | | 30 | 10 | | | 1 | 1 | | | | | | | | | | 15 | 2 | | | 104 | 6 | |
| | C | | | | | | | | | | | | | | | 5 | 1 | | | | | | | | |
| Total | | 0 | 0 | 30 | 10 | 0 | 0 | 1 | 1 | 0 | 0 | 0 | 0 | 0 | 0 | 5 | 1 | 0 | 0 | 15 | 2 | 0 | 0 | 104 | 6 |

ANNEXE E : TABLEAU DES DONNÉES NUMÉRIQUES PAR PHASE

| Catégorie céramique | Catégorie sites | Phase ant. | | Phase Ia | | Phase Ib | | Ant- Ia-Ib | | Phase Ib-IIa | | Phase IIa | | Phase IIb | | Phase IIa-IIb | | Phase IIb-IIc | | Phase IIc | | Phase II | | phase III | |
|------------------------|--------------------|------------|----------|-----------|-----------|-----------|----------|------------|-----------|--------------|----------|------------|----------|------------|-----------|---------------|-----------|---------------|----------|------------|----------|----------|----------|------------|----------|
| | | NR | NMI | NR | NMI | NR | NMI | NR | NMI | NR | NMI | NR | NMI | NR | NMI | NR | NMI | NR | NMI | NR | NMI | NR | NMI | NR | NMI |
| Com. Cl Grand | C | | | | | | | 24 | 16 | | | | | | | | | | | | | | | | |
| Total | | 0 | 0 | 0 | 0 | 0 | 0 | 24 | 16 | 0 | 0 | 0 | 0 | 0 | 0 | 0 | 0 | 0 | 0 | 0 | 0 | 0 | 0 | 0 | 0 |
| Mo | A | | | | | 5 | 4 | | | | | | | 25 | 7 | 4 | 3 | | | | | | | | |
| | B | | | 1 | 1 | 2 | 1 | | | | | 34 | 9 | 89 | 22 | | | | 1 | 1 | | | 21 | 3 | |
| | C | | | | | | | | | | | | | 7 | 5 | 42 | 8 | | | | | | | | |
| Total | | 0 | 0 | 1 | 1 | 7 | 5 | 0 | 0 | 0 | 0 | 34 | 9 | 121 | 34 | 46 | 11 | 0 | 0 | 1 | 1 | 0 | 0 | 21 | 3 |
| Amp | A | | | | | 75 | 6 | | | | | | | 61 | 5 | 55 | 11 | | | | | | | | |
| | B | | | 52 | 13 | 21 | 3 | | | | | 156 | 5 | 302 | 9 | | | 24 | 4 | 105 | 3 | | | 109 | 8 |
| | C | | | | | | | | | | | | | 49 | 5 | 132 | 3 | | | | | | | | |
| Total | | 0 | 0 | 52 | 13 | 96 | 9 | 0 | 0 | 0 | 0 | 156 | 5 | 412 | 19 | 187 | 14 | 24 | 4 | 105 | 3 | 0 | 0 | 109 | 8 |
| Ampho | | | | | | | | | | | | | | 2 | 2 | | | | | | | | | | |
| | | | | | | | | | | | | | | 1 | 1 | 2 | 2 | | | | | | | | |
| Total | | 0 | 0 | 0 | 0 | 0 | 0 | 0 | 0 | 0 | 0 | 0 | 0 | 3 | 3 | 2 | 2 | 0 | 0 | 0 | 0 | 0 | 0 | 0 | 0 |
| Bp | A | | | | | | | | | | | | | 1 | 1 | | | | | | | | | | |
| | C | | | | | | | | | | | | | | | 13 | 2 | | | | | | | | |
| Total | | 0 | 0 | 0 | 0 | 0 | 0 | 0 | 0 | 0 | 0 | 0 | 0 | 1 | 1 | 13 | 2 | 0 | 0 | 0 | 0 | 0 | 0 | 0 | 0 |

ANNEXE F : TABLEAU DE RÉPARTITION DES FORMES AU SEIN DES CATÉGORIES FONCTIONNELLES

| Catégorie fonctionnelle | Forme | Catégorie céramique | | | | | | | | | | | | | | Total | | | |
|----------------------------|-------------|---------------------|-----|-----|-----|-----|-----|-----|-----|---------|---------|---------|----|----|-----|-------|------|------|------|
| | | TS | EN | MET | FRB | GB | VRP | RU | CB | Sb. Coq | Com. Sb | Com. Cl | Mo | Do | Amp | | | | |
| Présentation, consommation | Liquide | gobelet | 7 | 24 | 30 | 1 | 5 | | | | | | | | | | 67 | 443 | 1200 |
| | | coupe | | | 1 | | | | | | | | | | | | 1 | | |
| | | tasse | 6 | | | | | | | | | | | | | | 6 | | |
| | | calice | | | | | 5 | | | | | | | | | | 5 | | |
| | | cruche | 3 | | | | | | 1 | | | 334 | | | | | 338 | | |
| | | bouteille | | | | | 22 | | | | | | | | | | 22 | | |
| | | bouilloire | | | | | | | 1 | | | | | | | | 1 | | |
| | | pichet | | | | | | | 3 | | | | | | | | 3 | | |
| | | pot à boire | | | | | 117 | | | | | | | | | | 117 | | |
| | Solide | assiette | 114 | | | | 32 | | | | | | | | | | 146 | 757 | |
| coupe/coupelle | | 461 | | | | 8 | | | | | | | | | | 469 | | | |
| bol | | | | | | 70 | | | | | 72 | | | | | 142 | | | |
| Cuisine | Préparation | mortier | 59 | | | | | | | | | | 88 | | | 147 | 147 | 1150 | |
| | Cuisson | plat | | | | | 36 | 25 | 33 | 54 | | 65 | | | | 213 | 1003 | | |
| | | jatte | | | | | | | 37 | 19 | 201 | 9 | | | | 266 | | | |
| | | pot | | | | | | | 8 | 75 | 237 | 18 | | | | 338 | | | |
| | | couvercle | | | | | | 5 | 3 | 3 | 103 | | 12 | | | 126 | | | |
| marmite | | | | | | | 47 | | 6 | | 7 | | | | 60 | | | | |
| Stockage | dolium | | | | | | | | | | | | 4 | | 4 | 135 | | | |
| | pot | | | | | | | | | | 131 | | | | 131 | | | | |
| Transport | amphore | | | | | | | | | | | | | 60 | 60 | 60 | | | |
| Total | | 650 | 24 | 31 | 1 | 259 | 41 | 125 | 130 | 601 | 27 | 621 | 88 | 4 | 60 | 2662 | | | |

ANNEXE F : TABLEAU DE RÉPARTITION DES CATÉGORIES FONCTIONNELLES PAR CATÉGORIE

| Catégorie fonctionnelle | | TS | EN | MET | FRB | GB | VRP | RU | CB | Sb. Coq | Com. Sb | Com. Cl | Mo | Do | Amp | total |
|----------------------------|-------------|-----|----|-----|-----|-----|-----|-----|-----|---------|---------|---------|----|----|-----|-------|
| Présentation, consommation | Liquide | 16 | 24 | 31 | 1 | 149 | | 5 | | | | 334 | | | | 560 |
| | Solide | 575 | | | | 110 | | | | | | 72 | | | | 757 |
| Cuisine | Préparation | 59 | | | | | | | | | | | 88 | | | 147 |
| | Cuisson | | | | | | 41 | 120 | 130 | 601 | 27 | 84 | | | | 1003 |
| Stockage | | | | | | | | | | | | 131 | | 4 | | 135 |
| Transport | | | | | | | | | | | | | | | 60 | 60 |
| Total | | 650 | 24 | 31 | 1 | 259 | 41 | 125 | 130 | 601 | 27 | 621 | 88 | 4 | 60 | 2662 |

ANNEXE F : TABLEAU DE RÉPARTITION DES CATÉGORIES FONCTIONNELLES PAR PHASE

| Catégorie fonctionnelle | | phase antérieure | phase Ia | phase Ib | Ant- Ia- Ib | phase Ib-IIa | phase IIa | phase IIb | Phase IIa-IIb | Phase IIb-IIc | phase IIc | Phase IIa – IIb –IIc | phase III | Total |
|-------------------------------|-------------|---------------------|-------------|-------------|----------------|-----------------|--------------|--------------|------------------|------------------|--------------|----------------------------|--------------|-------|
| Présentation, consommation | Liquide | 10 | 14 | 38 | 5 | 8 | 76 | 176 | 82 | 19 | 41 | 14 | 30 | 513 |
| | Solide | 29 | 111 | 64 | 76 | | 106 | 75 | 56 | 6 | 2 | 5 | 18 | 548 |
| Cuisine | Préparation | | | 3 | | | 9 | 36 | 13 | | | 1 | 5 | 67 |
| | Cuisson | 2 | 15 | 41 | 1 | 20 | 100 | 291 | 132 | 36 | 15 | 11 | 58 | 722 |
| Stockage | | | 1 | | | | 7 | 10 | 13 | | | 1 | | 32 |
| Transport | | | | 2 | | | 3 | 16 | 12 | | | | 4 | 37 |
| Total | | 41 | 141 | 148 | 82 | 28 | 301 | 604 | 308 | 61 | 58 | 32 | 115 | 1919 |

ANNEXE F : TABLEAU DE RÉPARTITION DES FORMES PAR PHASE

| Catégorie fonctionnelle | | Forme | phase antérieure | phase Ia | phase Ib | Ant-Ia-Ib | phase Ib-IIa | phase IIa | phase IIb | Phase IIa-IIb | Phase IIb-IIc | phase IIc | Phase IIa – IIb –IIc | phase III | | |
|----------------------------|-------------|-------------|------------------|----------|----------|-----------|--------------|-----------|-----------|---------------|---------------|-----------|----------------------|-----------|----|---|
| Présentation, consommation | Liquide | gobelet | 2 | 2 | 4 | 4 | 8 | 38 | 126 | 48 | 13 | 11 | 10 | 10 | | |
| | | coupe | | | | | | | 2 | | | | | 1 | | |
| | | tasse | | | | | | | 1 | 1 | | | | 1 | 2 | |
| | | calice | | 1 | 3 | | | 1 | 1 | 1 | | 30 | | | | |
| | | cruche | 4 | 2 | 11 | 1 | | 21 | 35 | 26 | 2 | | | 3 | 12 | |
| | | bouteille | 3 | | | | | 2 | 1 | 2 | | | | | 1 | |
| | | bouilloire | | | | | | | | | | | | | | |
| | | pichet | | | | | | | | | 1 | | | | | 1 |
| | | pot à boire | 1 | 9 | 20 | | | 14 | 10 | 3 | 4 | | | | | 3 |
| | Solide | assiette | 3 | 14 | 18 | 18 | | 14 | 15 | 4 | 2 | 2 | | 1 | 2 | |
| coupe/coupelle | | 26 | 94 | 31 | 42 | | 70 | 58 | 50 | 3 | | | 4 | 16 | | |
| bol | | | 3 | 15 | 16 | | 22 | 2 | 2 | 1 | | | | | | |
| Cuisine | Préparation | mortier | | | 3 | | | 9 | 36 | 13 | | | | 1 | 5 | |
| | Cuisson | plat | | 2 | 3 | | 1 | 20 | 93 | 36 | 6 | | | 4 | 5 | |
| | | jatte | | 3 | 12 | | 10 | 24 | 71 | 30 | 4 | 1 | | 2 | 8 | |
| | | pot | 1 | 10 | 13 | | 7 | 44 | 105 | 32 | 13 | 9 | | 3 | 7 | |
| | | couvercle | 1 | | 8 | 1 | 2 | 11 | 15 | 33 | 4 | 2 | | 1 | 24 | |
| | | marmite | | | 1 | | | 1 | 7 | 1 | 9 | 3 | | 1 | 14 | |
| Stockage | dolium | | 1 | | | | | | | | | | | | | |
| | pot | | | 4 | | | 7 | 10 | 13 | | | | 1 | | | |
| Transport | | | | 2 | | | 3 | 16 | 12 | | | | | 4 | | |

TABLE DES MATIÈRES

| | | |
|------|--|-----|
| 1 | ANNEXE A : PLANCHES DE DESSINS | 1 |
| 1.1 | Les Roises | 1 |
| 1.2 | Rue de l' Amphithéâtre | 55 |
| 1.3 | Puits Dainville | 84 |
| 1.4 | Puits Dusseaux | 85 |
| 1.5 | Puits Meyer | 87 |
| 1.6 | Puits Morlot | 88 |
| 1.7 | Puits Moser | 89 |
| 1.8 | Puits Champe Marguerite | 91 |
| 1.9 | Puits aux tablettes | 93 |
| 1.10 | Puits Chemin HLM | 99 |
| 1.11 | Puits Perrin | 100 |
| 1.12 | Puits Loulou | 102 |
| 1.13 | Puits Pierrat | 103 |
| 1.14 | Puits Pizzagalli | 104 |
| 1.15 | Puits Rue de la Chapelle | 124 |
| 1.16 | Puits Scheider | 127 |
| 1.17 | Puits Spindler | 128 |
| 1.18 | Puits Tang | 130 |
| 1.19 | Puits inconnus | 131 |
| 1.20 | Amphithéâtre | 136 |
| 1.21 | Opération de surveillance de l' Amphithéâtre (1992-1993) | 207 |
| 1.22 | La Maladière | 224 |
| 1.23 | Hangar Poilprès | 225 |
| 1.24 | Fosse Dusseaux | 226 |
| 1.25 | Citerne Ernest Chaudron | 231 |
| 1.26 | Hors Contexte | 232 |
| 2 | ANNEXE B : INVENTAIRES CÉRAMIQUES | 241 |
| 2.1 | Les Roises | 241 |
| 2.2 | La Rue de l' Amphithéâtre | 337 |
| 2.3 | Puits Champs du carré | 376 |
| 2.4 | Puits Dainville | 377 |
| 2.5 | Puits des Roises | 378 |

| | | |
|------|---|-----|
| 2.6 | Puits Dusseaux | 379 |
| 2.7 | Puits Meyer..... | 381 |
| 2.8 | Puits Morlot..... | 383 |
| 2.9 | Puits Moser..... | 384 |
| 2.10 | Puits Mougel..... | 387 |
| 2.11 | Puits Champe Marguerite | 388 |
| 2.12 | Puits aux tablettes | 389 |
| 2.13 | Puits Chemin HLM | 393 |
| 2.14 | Puits Perrin | 394 |
| 2.15 | Puits Loulou | 396 |
| 2.16 | Puits Pierrat | 397 |
| 2.17 | Puits Pizzagalli | 398 |
| 2.18 | Puits Poilprès..... | 414 |
| 2.19 | Puits Rue de la Chapelle..... | 415 |
| 2.20 | Puits Schneider | 417 |
| 2.21 | Puits Spindler | 418 |
| 2.22 | Puits Tang..... | 421 |
| 2.23 | Puits inconnus..... | 422 |
| 2.24 | Amphithéâtre | 423 |
| 2.25 | Opération de surveillance de l'Amphithéâtre (1992-1993)..... | 539 |
| 2.26 | La Maladière..... | 560 |
| 2.27 | Hangar Poilprès | 566 |
| 2.28 | Fosse Dusseaux | 570 |
| 2.29 | Citerne Ernest Chaudron | 574 |
| 2.30 | Hors contexte..... | 575 |
| 3 | ANNEXE C : CARRÉS DE FOUILLE DES ROISES..... | 583 |
| 4 | ANNEXE D : LISTE DES CAISSES NON TRAITÉES DE L'AMPHITHÉÂTRE..... | 611 |
| 5 | ANNEXE E : DONNÉES LIÉES AU CHAPITRE III | 617 |
| 5.1 | Tableaux de répartition des céramiques au sein du corpus | 617 |
| 5.2 | Tableau descriptif des sites par critère | 625 |
| 5.3 | Tableau des données numériques par phase | 629 |
| 6 | ANNEXE F : DONNÉES LIÉES AU CHAPITRE IV | 635 |
| 6.1 | Tableau de répartition des formes au sein des catégories fonctionnelles | 635 |
| 6.2 | Tableau de répartition des catégories fonctionnelles par catégorie | 636 |
| 6.3 | Tableau de répartition des catégories fonctionnelles par phase..... | 637 |
| 6.4 | Tableau de répartition des formes par phase | 638 |