



HAL
open science

Machine health check methodology to help maintenance in operational condition : application to machine tool from its kinematic monitoring

Thomas Laloix

► To cite this version:

Thomas Laloix. Machine health check methodology to help maintenance in operational condition : application to machine tool from its kinematic monitoring. Automatic. Université de Lorraine, 2018. English. NNT : 2018LORR0291 . tel-02096015

HAL Id: tel-02096015

<https://hal.univ-lorraine.fr/tel-02096015>

Submitted on 11 Apr 2019

HAL is a multi-disciplinary open access archive for the deposit and dissemination of scientific research documents, whether they are published or not. The documents may come from teaching and research institutions in France or abroad, or from public or private research centers.

L'archive ouverte pluridisciplinaire **HAL**, est destinée au dépôt et à la diffusion de documents scientifiques de niveau recherche, publiés ou non, émanant des établissements d'enseignement et de recherche français ou étrangers, des laboratoires publics ou privés.



AVERTISSEMENT

Ce document est le fruit d'un long travail approuvé par le jury de soutenance et mis à disposition de l'ensemble de la communauté universitaire élargie.

Il est soumis à la propriété intellectuelle de l'auteur. Ceci implique une obligation de citation et de référencement lors de l'utilisation de ce document.

D'autre part, toute contrefaçon, plagiat, reproduction illicite encourt une poursuite pénale.

Contact : ddoc-theses-contact@univ-lorraine.fr

LIENS

Code de la Propriété Intellectuelle. articles L 122. 4

Code de la Propriété Intellectuelle. articles L 335.2- L 335.10

http://www.cfcopies.com/V2/leg/leg_droi.php

<http://www.culture.gouv.fr/culture/infos-pratiques/droits/protection.htm>

THÈSE

Présentée pour l'obtention du

Doctorat de l'Université de Lorraine

en Automatique, Traitement du Signal et des Images, Génie Informatique

par **Thomas LALOIX**

Méthodologie d'élaboration d'un bilan de santé de machines de production pour aider à la prise de décision en exploitation :

Application à un centre d'usinage à partir de la surveillance des composants de sa cinématique

Soutenue publiquement le 11 décembre 2018

Présidente

Véronique CARRE-MENETRIER Professeur, CReSTIC, Université de Reims Champagne-Ardennes

Rapporteurs :

Daniel BRISSAUD Professeur, G-SCOP, Grenoble INP
François PERES Professeur, ENIT-LGP, École Nationale d'Ingénieurs de Tarbes,
Toulouse INP

Examineurs :

Brigitte MORELLO Maître de Conférences HDR, FEMTO-ST, Université de Bourgogne Franche Comté

Kamel FETTIH Expert Performance des moyens, RENAULT SAS
Éric ROMAGNE Référent sénior Performance machines, RENAULT SAS
Benoit IUNG Professeur, CRAN, Université de Lorraine

(directeur de thèse)

Alexandre VOISIN Maître de Conférences, CRAN, Université de Lorraine

(co-directeur de thèse)

Invités :

Jean GOUTIERRE Expert Leader Maintenance 4.0, RENAULT SAS
Alexandre DER-MADIROSSIAN Chef de Département Ingénierie Maintenance & Performance des Moyens, RENAULT SAS

**Machine health check methodology to help
maintenance in operational condition:**

application to machine tool from its kinematic
monitoring

Acknowledgements

Writing the acknowledgements of a PhD thesis appears to be a special exercise. Conventional but such important and wholehearted. It is the moment to express all the gratitude to the people who contributed, supported and guided the peregrination of this long and fabulous adventure. These people who, thanks to their confidence, kindness and knowledge, participated to the completion of this book and the work it contains.

First and foremost, I would like to express my deep gratitude and thanks to my two PhD supervisors, Benoit Iung and Alexandre Voisin. The complementarity of your two points of view has been an incredible richness to raise mine. My sincere thanks for your kind guidance, the spread of your knowledge, and constructive support. You have not only influenced the PhD thesis content, but also deeply influenced me as a PhD student.

I would like to sincerely thank Eric Romagne and Kamel Fettih to take me under their wings, in Cléon plant and in Renault Technocentre. Thank you for your confidence and indefectible support. Thank you for the way you challenged me leading to constantly improvement our project and vision, discussions after discussions, presentation after presentation. A team with a strong tie is born. “We are doom to succeed” or “The fool didn’t know it was impossible, so he did it” was the motto (thank you Eric, I will surely keep it in mind for a very long time!).

I would like to address my acknowledgement to my PhD committee members, Ms. Véronique Carre-Menetrier, Mr. Daniel Brissaud, Mr. François Peres, Ms. Brigitte Morello, Mr. Jean Goutierre and Mr. Alexandre Der-Madirossian for their evaluation of my PhD work, for their appreciation and interesting insight to complete and enrich the PhD contributions.

I am grateful to Jean Goutierre for accepting me within the maintenance department of Renault Group, Olivier Mourglia within his eminent strategic expertise area and Denys Videau for providing me optimal working conditions.

This adventure has been shared and enriched by many colleagues and friend at Renault, in Guyancourt and Cléon, and at CRAN, in Nancy. Special thank for a guy who participated in the birth of some thesis contributions and who has always kept abreast of the evolution of this thesis, Florian. It was a real pleasure to work with you. Thank you for your involvement and your indefectible friendship. Thank you to the colleagues in Cléon’s office, David and Emmanuel. Collince, Dorine, Sarah, Charia, Quentin thank you for sharing your PhD journeys along mine! David, Guillaume, Jaouher, Mathias, Dominique, Stephane, Christophe, Jacky, Clement, Jerome, Zineb, Eric, Theo, Morgan, Marc thank you for the team spirit and your friendship.

Special thanks to the person which stand at the basis of this PhD journey, François. If you had not given my name to Benoit as PhD candidate, this unique experience would never have happened. Thank you to the professor, to the man and to the friend.

Finally, I would like to warmly thank my family.

My parents.

My brother, Mathieu, I love you (so much).

Laury, my love. I am impatient to embrace this fascinating new challenge of being a father.

To our very soon newborn baby.

Abstract

This PhD work has been initiated by Renault, in collaboration with Nancy Research Centre in Automatic Control (CRAN), with the aim to propose the foundation of a generic PHM-based methodology leading to machine health check regarding machine-product joint consideration and facing industrial requirements. The proposed PHM-based methodology is structured in five steps. The two first steps are developed in this PhD work and constitute the major contributions. The first originality represents the formalization of machine-product relationship knowledge based on the extension of well-known functioning/dysfunctioning analysis methods. The formalization is materialized by means of meta-modelling based on UML (Unified Modelling Language). This contribution leads to the identification of relevant parameters to be monitored, from component up to machine level. These parameters serve as a basis of the machine health check elaboration. The second major originality of the thesis aims at the definition of health check elaboration principles from the previously identified monitoring parameters and formalized system knowledge. Elaboration of such health indicators is based on Choquet integral as aggregation method. Such method raises the issue of parameter (capacity) identification. In this way, it is proposed a global optimization model of capacity identification according to system multi-level, by the use of Genetic Algorithms. Both contributions are developed with the objective to be generic (not only oriented on a specific class of equipment), according to industrial needs. The feasibility and the interests of such approach are shown on the case of machine tool located in RENAULT Cléon Factory.

Key words: Maintenance, Prognostics and Health Management, Health check, knowledge formalization

Table of content

General introduction	15
Chapter 1 Towards an operational health check of industrial systems	21
1.1. Introduction	21
1.2. From Renault Cléon use case... towards a generalization as industrial problem statement.	22
1.2.1. Machine tool as a research object	22
1.2.2. Manufacturing quality issue	24
1.2.3. Automated relationship between product and machine requirement: a gap to fill....	27
1.3. From industrial problem statement to scientific positioning	30
1.3.1. “Factory of the Future” initiative	30
1.3.2. PHM concepts as key-enabler to face machine-product relationship consideration.	33
1.3.2.1. PHM concepts, methodologies and standards: a maintenance perspective	33
1.3.2.2. Initiatives for integrated machine and product consideration	43
1.4. Global roadmap for Manufacturing System Prognostics and Health Management	44
1.4.1. Manufacturing system Prognostics and Health Management framework for machine- product joint consideration.....	44
1.5. Conclusion	47
Chapter 2 From system knowledge structuration to relevant parameters identification for health monitoring	49
2.1. Introduction.....	49
2.2. Current approaches for relevant parameter monitoring	50
2.2.1. Identification of monitoring parameters: current approaches	50
2.2.1.1. Rule of thumb	50
2.2.1.2. Dysfunctional analysis for monitoring parameters identification.....	53
2.2.1.3. Combined approaches for monitoring parameters identification.....	55
2.2.2. Integrated method for monitoring parameter identification in join machine-product consideration.....	56

2.2.2.1.	Functional analysis.....	57
2.2.2.2.	Dysfunctional analysis	59
2.2.2.3.	Dysfunctional causal relationship	59
2.2.2.4.	Dysfunctional causal relationship quantification.....	61
2.2.2.5.	Identification of monitoring parameters	61
2.3.	Proposal of a meta-model to support monitoring parameter selection for health indicator definition	63
2.3.1.	Meta-modelling formalization	64
2.3.2.	Knowledge concepts of functional analysis.....	67
2.3.3.	Knowledge concepts of dysfunctional analysis	70
2.4.	Instantiation of meta-model to different manufacturing system application classes	77
2.4.1.	Reference model definition.....	77
2.4.2.	Instantiation phases	79
2.4.3.	Machine tool reference model.....	80
2.5.	Conclusion	85
Chapter 3	From machine monitored parameters to health check elaboration	87
3.1.	Introduction.....	87
3.2.	Health check in the decision-making process	88
3.2.1.	Sensors and monitored parameters.....	90
3.2.2.	Performance and degradation indicators.....	91
3.2.3.	Health indicator definition	94
3.2.4.	Health check and related Key Performance Indicators (KPI) in PHM framework...	95
3.3.	Methods for health check elaboration	97
3.3.1.	Methods for commensurable monitored parameters.....	97
3.3.2.	Method to combine indicators to provide performance, dysfunctional and health indicators at every level of the system	101
3.3.2.1.	Aggregation functions.....	101
3.3.2.2.	Choquet integral and associated capacities	103
3.3.2.3.	Capacities identification.....	106
3.3.2.4.	Genetic Algorithms.....	107

3.4.	Proposal of Choquet Integral-based health indicator elaboration for manufacturing system health check	110
3.4.1.	Extension of relative entropy histogram for monitored parameters commensurability	110
3.4.2.	Proposal of global identification of Choquet Integral capacities	111
3.4.2.1.	Local vs. “chained” computation	111
3.4.2.2.	Genetic Algorithm construction for global capacities identification	113
3.5.	Case study: local optimization vs. global optimization.....	114
3.6.	Conclusion	119
Chapter 4	Health check elaboration for machine tool	121
4.1.	Introduction.....	121
4.2.	Machine tool application case within Renault industrial context	121
4.2.1.	From cylinder-blocks design requirements.....	122
4.2.2.	... to GROB BZ560 machining process.....	123
4.2.3.	GROB BZ560 machine tool working principles.....	124
4.3.	From the functional and dysfunctional knowledge to monitoring parameter selection ..	125
4.3.1.	From system knowledge and monitoring parameters selection... ..	125
4.3.2.	...to the definition of a data acquisition platform structure	136
4.4.	From monitoring parameters to machine health check elaboration	140
4.4.1.	Health check construction.....	140
4.4.2.	Health check elaboration.....	142
4.5.	Conclusion	145
	General conclusion and perspectives	147
	Bibliography of the author.....	151
	Bibliography	153
	Résumé en français.....	165
	Appendices	173
	Appendix A: Given capacities for local vs. global optimization approach.....	173
	Appendix B: Expert dataset for capacities identification.....	174

Table of figure

<i>Figure 1: PHM Framework proposal for industrial application</i>	20
<i>Figure 2: GROB BZ560 machine tool</i>	22
<i>Figure 3: GROB BZ560 machine tool kinematic</i>	24
<i>Figure 4: Renault engine cylinder-block</i>	24
<i>Figure 5: Sub-processes and heuristic quality control (Ament & Goch, 2001)</i>	25
<i>Figure 6: Gap between machine effectors and machine movement requirements</i>	29
<i>Figure 7: The FoF roadmap framework</i>	31
<i>Figure 8: PHM steps illustrated by (Atamuradov, Medjaher, Dersin, Lamoureux, & Zerhouni, 2017)</i>	33
<i>Figure 9: Data processing block diagram for open CM&D information architecture from ISO13374-2</i>	35
<i>Figure 10: OSA-CBM architecture (Lebold and Thurson, 2001)</i>	36
<i>Figure 11: Sequential modules of CBM systems (Bengtsson, 2004)</i>	37
<i>Figure 12: PHM system operational view (IEEE, 2017)</i>	38
<i>Figure 13: Essential steps for a PHM system (Das et al., 2011)</i>	40
<i>Figure 14: General PHM development process (a) and essential PHM processes (b) (Vogl, Weiss, et al., 2016)</i>	40
<i>Figure 15: 5S approach for systematic PHM design and implementation (J. Lee et al., 2014)</i>	42
<i>Figure 16; Information flow between each step of the WEAR methodology (Adams et al., 2017)</i>	43
<i>Figure 17: Proposed PHM methodology with contributions</i>	47
<i>Figure 18: Realized ball screw drive with integrated sensory pins (Möhring & Bertram, 2012)</i>	51
<i>Figure 19: Methodology for monitoring parameter identification</i>	56
<i>Figure 20: Knowledge formalization, illustrated by (Medina-Oliva et al., 2012)</i>	58
<i>Figure 21: Fourth-levels of the MDA approach (Atkinson & Kühne, 2003)</i>	65
<i>Figure 22: x and y classes association</i>	66
<i>Figure 23: Extract of the meta-model related functional concepts of knowledge</i>	69
<i>Figure 24: Extract of the meta-model related dysfunctional concepts of knowledge</i>	71
<i>Figure 25: Extract of meta-model related on monitoring concepts of knowledge</i>	74
<i>Figure 26: Extract of meta-model related on contextual concepts of knowledge</i>	74
<i>Figure 27: Extract of meta-model related on health indicator elaboration concepts of knowledge</i>	76
<i>Figure 28: Meta-model instantiation framework</i>	77
<i>Figure 29: Linear and ball-screw drive mechanisms (Altintas et al., 2011)</i>	78
<i>Figure 30: Necessary manufacturing system knowledge to support health indicator elaboration</i>	80
<i>Figure 31: Extract of Machine tool reference model related on functional aspects</i>	82

<i>Figure 32: Extract of machine tool reference model related on dysfunctional aspects.....</i>	<i>84</i>
<i>Figure 33: Synthetic overview of system health check.....</i>	<i>89</i>
<i>Figure 34: Health check illustration.....</i>	<i>95</i>
<i>Figure 35: Functional process of information transformation for health check elaboration</i>	<i>97</i>
<i>Figure 36: Classification scheme for fault detection and diagnostics methods (Katipamula & Brambley, 2005).....</i>	<i>99</i>
<i>Figure 37: Histogram deviation type I</i>	<i>99</i>
<i>Figure 38: Histogram deviation type II</i>	<i>99</i>
<i>Figure 39: Digraph example</i>	<i>105</i>
<i>Figure 40: Ad hoc system structure</i>	<i>112</i>
<i>Figure 41: NQE contribution by abstraction level for experiment 2, Table 12.....</i>	<i>117</i>
<i>Figure 42: NQE contribution of every element of the system for experiment 2, Table 12.....</i>	<i>117</i>
<i>Figure 43: Comparison of QE and NQE contributions for experiment 2, Table 12.....</i>	<i>118</i>
<i>Figure 44: Machine tool BZ560 kinematic</i>	<i>124</i>
<i>Figure 45: Sectional view of a motor spindle (Abele et al., 2010)</i>	<i>125</i>
<i>Figure 46: Ball-screw drive mechanism, adapted from (Altintas et al., 2011).....</i>	<i>126</i>
<i>Figure 47: Rotative axis (axes B'), from GROB documentation</i>	<i>126</i>
<i>Figure 48: Synthesis of monitoring parameters for machine tool</i>	<i>138</i>
<i>Figure 49: Data acquisition platform flows</i>	<i>139</i>
<i>Figure 50: GROB BZ560 health check structure.....</i>	<i>143</i>
<i>Figure 51: Proposed PHM methodology with contributions.....</i>	<i>147</i>
<i>Figure 52: Relationship between workpiece, machine movements and machine effectors requirements</i>	<i>148</i>

List of tables

<i>Table 1: Examples of parameters for PHM applications (Cheng et al., 2010)</i>	52
<i>Table 2: Causality relation typology</i>	60
<i>Table 3: Criticality quantification proposal</i>	61
<i>Table 4: Cardinality and associated syntax</i>	66
<i>Table 5: Capacities example</i>	104
<i>Table 6: Experiment results</i>	106
<i>Table 7: Values of parameters</i>	109
<i>Table 8: Value of capacities learned by Genetic algorithm</i>	109
<i>Table 9: Set of variation for experiment parameters</i>	115
<i>Table 10: Approximation error for 100 points</i>	115
<i>Table 11: Approximation error for 50 points</i>	116
<i>Table 12: Approximation error for 20 points</i>	116
<i>Table 13: Quality characteristics related to machining operations</i>	122
<i>Table 14: Process information of the diesel engine cylinder block</i>	123
<i>Table 15: Extract of GROB BZ560 constituting functions, input and output flows</i>	129
<i>Table 16: Extract of GROB BZ560 constituting sub-systems functional and performance requirements</i>	129
<i>Table 17: Quality deviation causes at GROB BZ560 sub-system level - extract</i>	133
<i>Table 18: Dysfunctional causality relationship from GROB BZ560 component level for axis X</i>	134
<i>Table 19: Identification of monitoring parameters of GROB BZ560 machine tool</i>	135
<i>Table 20: Identification of performance and degradation indicators of GROB BZ560 machine tool</i>	136
<i>Table 21: GROB BZ560-related performance, degradation and health indicators</i>	141
<i>Table 22: GROB BZ560 health check KPI</i>	141
<i>Table 23: GROB BZ 560 indicators</i>	144
<i>Table 24: Set of parameters for GROB BZ 560 capacities identification</i>	144
<i>Table 25: NQE for linear axis-based health check</i>	145
<i>Table 26: Indicators relations related to motor (A21), bearings (A23), guides (A26) and axis X (A2)</i>	174
<i>Table 27: Indicators relations related to motor (A31), bearings (A33), nut (A35), guides (A36) and axis Y (A3)</i>	175
<i>Table 28: Indicators relations related to motor (A41'), bearings (A43'), guides (A46') and axis Z (A4')</i>	175
<i>Table 29: Indicators relations related to motor (A41''), bearings (A43''), nut (A45''), guides (A46'') and axis Z (A4'')</i>	176

Table 30: Indicators relations related to axis X (A2), axis Y (A3), axis Z (A4'), axis Z (A4'') and GROB BZ560 (A0)..... 176

General introduction

Industrial system performances are a key lever for manufacturing enterprises (even more so for globalised ones) to face economic issues. It is particularly significant in the context of “Factory of the Future” paradigm (Industry 4.0) where competitiveness is increased with emergence of key technologies and enablers (Vaidya, Ambad, & Bhosle, 2018; Zhong, Xu, Klotz, & Newman, 2017). The term “Factory of the Future” appears in the end of the 20th century consecutive to strong advances being made in computer and communications technology and the associated strides in information management, interpretation, and control (Welber, 1986). Indeed, nowadays, the development of technologies from industry (principally in Information and Communication Technology domain) guided and supported by concepts, methods and tools coming from research field (e.g. cyber-physical systems, IoT manufacturing systems, cloud manufacturing, cloud computing, etc.) enables the transformation of traditional organization of industrial enterprise towards “Factory of the Future” paradigm. This (r)evolution shall lead to a flexible, smart and reconfigurable industrial process ensuring the improvement of product and service quality and increase of productivity (Zhong et al., 2017). Whereas the 3rd industrial revolution represented automation phases of industrial systems and development of IT and computers for controlling industrial systems and led to an important increase of system complexity, the 4th shall lead to intelligent systems thanks to digital transformation (Vaidya et al., 2018). It is assumed that it will improve industrial system control and process optimisation, enable efficient decision making and lead to an increase of companies’ benefits. “Factory of the Future” does not only address the increase of industrial system performances but also product traceability, process reconfiguration ability, information systems interoperability, etc. and by the way proposes a new level of organisation and control over the global value chain of product life cycle. In this way, better overall resource efficiency and effectiveness is also a component of “Factory of the Future” paradigm. As highlighted in prospective report (Brissaud, Frein, & Rocchi, 2013) on future production systems elaborated by French scientists and supported by ANR¹, orientations of the “Factory of the Future” are multiples. The domains cover societal and technological aspects, respectively e.g. human skill management, collaborative organisation, participative innovation, and manufacturing systems energy efficiency, manufacturing systems performances optimisation and control, supply chain optimisation. From these orientations, **the thesis addresses manufacturing system performance optimisation and control**. Nevertheless, beside availability of some technological solutions, extensive issues remain to be faced for “Factory of the Future” to be operational in industrial context.

To reach “Factory of the Future” objectives in development of advancing manufacturing systems, innovative discipline and field of research emerged. For example, considered as an

¹ French National Research Agency, <http://www.agence-nationale-recherche.fr/en/>

evolutionary step in condition-based maintenance (CBM), **Prognostics and Health Management (PHM)** gain in popularity since around fifteen years. The finality of PHM concepts is to assess the current and future health state of a system on the basis of past, present and future information in relation with its environmental, operational and usage condition (J. Lee et al., 2014; Zio, 2012). It corresponds to the same foundation as Predictive Maintenance. Based on information coming from manufacturing systems and its environment, it aims to provide to decision makers relevant indicators to pilot and maintain manufacturing production and equipment. So, PHM development leads the transition from the widely used “*fail and fix*” maintenance strategy towards “*predict and prevent*” one (Iung, Véron, Suhner, & Muller, 2005; J. Lee, Ni, Djurdjanovic, Qiu, & Liao, 2006). To promote, structure and ease PHM deployment, standards have been developed by the PHM community. One of the most common is the OSA-CBM (Lebold, Reichard, Hejda, Bezdicek, & Thurston, 2002). Elaborated by industrial and scientific members, OSA-CBM served as basis for the ISO-13374 standard (Condition Monitoring and Diagnostics of Machines) functional specification and is released under the MIMOSA² agreement. OSA-CBM architecture is composed of seven functional layers corresponding to (i) data acquisition, (ii) data manipulation, (iii) condition monitor, (iv) health assessment, (v) prognostics, (vi) decision support, (vii) human interface. On this basis, some works proposed to extract essential steps to develop prognostic and health management applications (Das et al., 2011; Sheppard, Kaufman, & Wilmering, 2009). As consequences of the implementation of such system, manufacturing companies are entitled to expect an increase of machine availability and performance rate.

Nevertheless, despite extensive work in this field, the quality issue of manufacturing product is not really addressed by the use of current PHM approaches since they are machine or component oriented. Product quality concern results mainly on properties deviation control. In manufacturing companies, these later are widely tackled with a posteriori control policy, e.g. Statistics Process Control (SPC). In recent years, advanced initiatives in this field are more proactive through online quality monitoring (Colledani, Yemane, & Tognetti, 2016) and improvement of measurement systems (Villeta, Maria Rubio, Luis Valencia, & Angel Sebastian, 2012). So, an interesting way is to anticipate deviation of product quality rather than suffer it. These deviations result from a conjunction of machine performance, process parameters and workpiece material deviation (Mori, Fujishima, Komatsu, Zhao, & Liu, 2008). Process parameters are generally specified by simulation and validation by field experimentation, while workpiece material conformity is the responsibility of supplier’s quality assurance. Only the machine performance is not fully under control, mainly due to the evolution of its operational context, and the degradation of its components. A way of investigation to face this issue refers to the monitoring of machine kinematic to prevent its degradation and the impact it might have on the manufactured product quality.

² Machinery Information Management Open Standard Alliance (<http://www.mimosa.org/mimosa/>)

Thus, a major scientific challenge addressed by the thesis is to define an integrated approach, in PHM framework, in order to provide relevant indicators at process level to control both product and machine performances deviations based on machine degradation monitoring.

Such vision is in line with the one the car manufacturer, Renault, intends to develop in consistence with “Factory of the Future” context. Indeed, despite maintenance policy efforts, it is observed unexpected machine degradations and break down, and unexpected and uncontrolled deviation of workpiece quality, as well. A relationship between both phenomenon (i.e. machine degradation and product quality deviation) has been established without convincing solution supported by conventional approaches (mainly periodic maintenance actions). **This thesis is built on this industrial challenge.** Initiated by Renault, in collaboration with Nancy Research Centre in Automatic Control (CRAN) as academic partner, the objective is to propose the foundation of a generic methodology leading to machine health check regarding machine-product joint consideration and facing industrial requirements (e.g. easy to understand, to handle, to develop, to deploy, to scale up). The present work benefits from a CIFRE agreement (industrial and academic partnership convention), under the supervision of ANRT³. The field of application corresponds to a Renault plant, located in Cléon (Normandie, France), where are produced engines and gearboxes for the whole Renault group. Manufacturing systems are mainly composed **by machine tools, which correspond to the class of application of the thesis.** Thus, the **research object of the thesis is a GROB BZ560 dual-spindle machine tool**, manufacturing engine cylinder-block. Such class of application (machine tool) is widely present in Renault plants, denoting an important potential of deployment of the methodology in all the worldwide.

Within this generic methodology, the thesis first originality is the formalization of machine-product relationship knowledge based on the extension of well-known functioning/dysfunctioning methods. The formalization is materialized by means of meta-modelling based on UML (Unified Modelling Language). This knowledge capitalisation is founded on concept modelling extracted from principles supported by system theory, FMECA⁴ and HAZOP⁵ methods. This contribution leads to the identification of relevant parameters to be monitored, from component up to machine level. These parameters serve as a basis to contribute to machine health check elaboration considering the joint machine-product relationship. The second major originality of the thesis aims at the definition of health indicator elaboration from the previously identified monitoring parameters. Elaboration of such health indicators is based on fusion/aggregation methods such as Choquet integral. Among them, three main classes are identified, related to machine performances, to machine degradation and finally to machine

³ National Association of Research and Technology, <http://www.anrt.asso.fr/en>

⁴ FMECA : Failure Mode, Effects and Criticality Analysis

⁵ HAZard and OPerability study

mission. Both contributions are developed with the objective to be generic (not only oriented on a specific class of equipment), according to industrial needs.

With regard to these main originalities, the thesis is structured into four chapters.

The first chapter introduces the Renault industrial problem statement in the framework of “Factory of the Future” and Renault roadmap. From this framework and roadmap emerge industrial challenges in decision-making for maintenance management, particularly the dual consideration of manufacturing system performance and the quality of product it delivers. Such industrial challenges lead to identify industrial questions (e.g. how to link machine degradation with product quality deviation?). Some of the industrial questions are selected as industrial issues to be faced by the thesis contributions. The dual manufacturing system performance and product quality consideration is investigated towards emerging approaches, such as PHM. The state of the art highlights some limits in relation to the industrial issues. These limits contribute to identify scientific issues to be faced to handle the industrial challenges in a generic way. The industrial and scientific issues are positioned on a machine tool, application case within this thesis. The global contribution lies in a PHM-based approach constructed on the joint consideration of manufacturing system performance and product quality relationship. The approach is structured in 5 steps (see Figure 1) in order to achieve the industrial challenges previously identified. The 2 first steps address scientific issues leading to key enabler for industrial questions. The proposed approach aims to be adaptable to other manufacturing applications such as stamping press (validation step is in progress and is not presented in this thesis). Among this 5 steps methodology, the two first steps are developed in next chapters and constitute the thesis major contributions.

The second chapter addresses the first step of the methodology representing the knowledge formalization. In this way, the relationship between manufacturing system and the product is formalized in a generic way by a knowledge meta-modelling. Based on functional and dysfunctional concepts, the meta-model integrates causality relationships between machine degradation and product quality deviation. Such knowledge capitalisation is founded on concepts modelling extracted from generic methodology such as FMECA and HAZOP but enhanced to consider the link between product properties and manufacturing system behavior. Formalization knowledge concepts is performed in UML thanks to the use of MEGA⁶ tool and aims to offer a high degree of genericity allowing the use of wide industrial application classes. The meta-model has been developed in order to be compliant with the MIMOSA standards. It corresponds to a partial generic model dedicated to manufacturing system application class. The meta-model plays a central role in the structuration of the knowledge for the identification of relevant parameters in link with sensor to be monitored, in the way to elaborate health indicators representing machine health check. The meta-model validation is performed by

⁶ <http://www.mega.com/en/product/hopex>

instantiation on an application class on a limited perimeter, to face Renault issues (machine tool). With respect to the application case, a reference model (from the meta-model) has been proposed for machine tool class. By means of meta-model instantiation, the reference model eases the industrial deployment and the reuse of the common knowledge of systems for an application class. Industrial interest has been demonstrated by the ability of the meta-model to be instantiated.

The third chapter proposes, in continuity with Chapter 2, to establish a typology of relevant indicators for machine health check, considering the joint machine-product relationship. Based on clarification of the concepts of system health check, the health check consideration is oriented towards the machine tool application case. In this way, machine health check corresponds to a set of health indicators in relation with functional and dysfunctional system features according to a dedicated context, as found in the literature. The manufacturing consideration led us to propose two classes of indicators: performance indicators and degradation indicators. Both are decontextualized and commensurable with each other. Indicator classes correspond to functional aspect of the machine and degradation state of the machine. In line with the proposed methodology, principles of indicator elaboration are introduced, based on monitoring parameters identified in step1. Performance and degradation indicators are combined by means of aggregation operator to compute machine health indicators at all levels of the system to structure the system health check. In this way, the concepts of horizontal aggregation and vertical aggregation are introduced. The Choquet integral is selected since it is a generalisation of well-known aggregation operators (e.g. mean, OWA) and thanks to its ability to handle interaction between indicators. System health check is guided with a dual orientation: machine-oriented (i.e. machine condition) and mission-oriented (i.e. product quality). Another originality of this chapter results in the proposition of a global optimisation approach for Choquet Integral capacities identification, by the use of genetic algorithms. The resulting health indicators could be then proposed to prognostic process to estimate their future trend and finally the machine remaining useful life.

The last chapter (Chapter 4) illustrates the application of the thesis contributions on a GROB BZ560 machine tool in industrial environment imposed by the Renault context. It starts with the methodology from knowledge formalization to health indicator elaboration, through machine tool monitoring, data collection, storage, etc. The generated health indicators constitute a relevant machine health check, considering both machine and product aspects. Encountered problems in the implementation in shop floor and benefits are highlighted.

Finally, the overall research results are discussed in a general conclusion, and, as a foundation stone of predictive maintenance in RENAULT-NISSAN alliance, scientific and industrial perspectives are sketched for further methodological developments for PHM framework elaboration in industrial context considering the joint machine-product relationship.

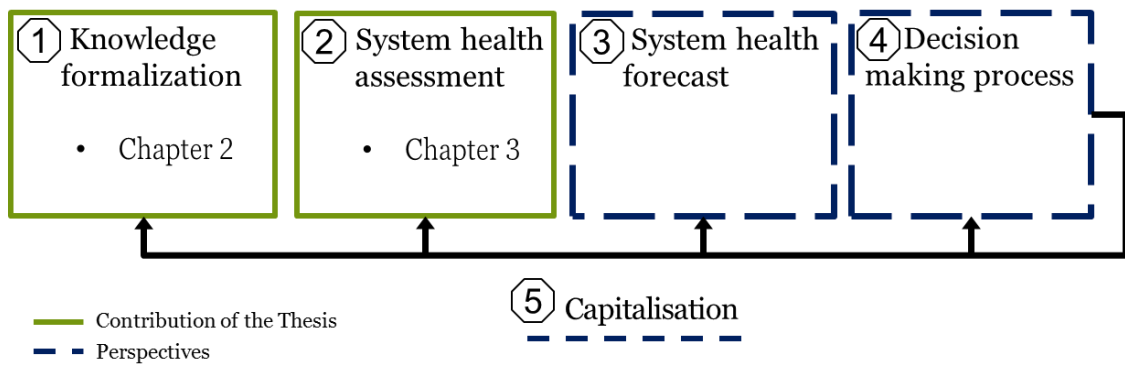

Figure 1: PHM Framework proposal for industrial application

Chapter 1 Towards an operational health check of industrial systems

1.1. Introduction

The first chapter underlines the Renault industrial problem statement in the framework of “Factory of the Future”, in accordance with Renault roadmap. The industrial problem statement emerges from a concrete use case, materialized by a machine tool GROB BZ560 located in Renault Cléon factory, and is presented in the next section. It addresses the challenge of dual consideration between manufacturing system performance and the quality of product it is delivering, in the framework of predictive maintenance. The industrial problem statement is then declined in some axes related to sub-problems in link with methodological issues. These axes are materialized by five independent and sequential industrial issues, from the monitoring step until the anticipative decision making. This section ends with a second issue to be faced: the gap to fill in the engineering chain of product life cycle (from product design to its production). This gap regards the lack in formalization of the influences of machine effectors performances and degradations on product quality.

Then, the consistence of the scientific positioning of industrial problem statement is demonstrated, in section 1.3, in the framework of “Factory of the Future”. The dual manufacturing system performance/degradation and product quality consideration is investigated towards PHM by the review of PHM standards and methodologies. This state of the art highlights some limits in relation to the industrial issues, particularly facing the product consideration, contributing to the statement of a research question.

Finally, the chapter concludes in section 1.4 with a PHM-based approach constructed on the joint consideration of manufacturing system performance and product quality relationship, to face the research question. The approach is structured in 5 steps, respectively addressing dedicated scientific issues, in order to achieve the industrial challenges previously identified. The proposed approach aims to be adaptable to various kind of manufacturing system. Among this 5 steps methodology, the two first steps are developed in next chapters and constitute the thesis major contributions.

1.2. From Renault Cléon use case... towards a generalization as industrial problem statement

1.2.1. Machine tool as a research object

This thesis work is positioned in manufacturing context, toward an application case represented by a machine tool. The research object of the thesis is a GROB BZ560 dual spindle and five-axis machine tool, presented in Figure 2, whose tool kinematic is depicted Figure 3. The machine tool is located in Renault Cléon factory⁷, which has been founded in 1958. It is a powertrain factory ensuring the production of gearboxes and engines (gasoline, fuel and electric) for all Renault vehicles. The plant also provides engines and gearboxes to Dacia, Renault Samsung Motor, Nissan, General Motors, Fiat and Daimler. The considered machine tool is situated in a process line in parallel with five similar machines which perform the same process. Corresponding machining operations are dedicated to the faces and holes of engine cylinder-block (Figure 4). This type of cylinder-block belongs to gasoline engine category and delivers 130hp⁸ up to 160hp. Workpieces are supplied in machine tools by means of a conveyor. Each of these five machine tool machines two cylinder-blocks simultaneously. Several types of cylinder-blocks are able to be machined on a same machine tool. The type depends on engine generation (gen1 and gen2) and production customer (e.g. Renault, Nissan, Daimler).



Figure 2: GROB BZ560 machine tool

⁷ <https://group.renault.com/en/our-company/locations/our-industrial-locations/cleon-plant-2/>

⁸ hp : horsepower

Each machining cycle takes about seven minutes. The related machining operations are milling, drilling, threading and boring machining operations. The whole machining operations use between fifteen and twenty cutting tools per workpiece. The machining process aims to ensure the cylinder-block quality requirements.

The machined cylinder-block quality is defined in terms of dimension, geometry and surface roughness. The quality requirements of the machined workpiece represent up to 350 characteristics to be measured. The machined workpiece quality control is ensured by means of Statistical Process Control (SPC) policy thanks to control chart. A sample is taken every 150 to 300 workpieces for quality control, depending the characteristics to be controlled. When quality deviation is detected, some actions are performed, empirically, to restore the workpiece quality under control. These actions can represent the reconfiguration of process, machine parameters, or cutting tool replacement. When these latter are not sufficient to ensure product quality, maintenance actions are achieved; usually, with some difficulties to address the real machine degradation root causes which lead to the product deviation.

To sustain machine performance, a slot dedicated to preventive maintenance is planned on a weekly basis, based on the preventive maintenance plan, without really consideration of the real machine state. This slot is about four to eight hours but can be skipped in accordance with production constraints. Corrective maintenance actions are required as well, due to machine failure or unsatisfactory product quality. **Today, the number and time of corrective maintenance actions are significantly superior to preventive one.** Production and maintenance actions ensuring machine tool performance are based on a posteriori information related to product quality deviation or machine break down. A mean to anticipate machine performance decrease and degradation is to provide to maintenance and production team, from the operators up to the managers, information related to machine state.

Actual production line performance is measured by the quantity of correct machined workpiece per production team, per day and per week. The quantity of non-quality and machine down time duration, down time cost, etc. are also considered. Thus, product quality is a fundamental requirement on this machine.

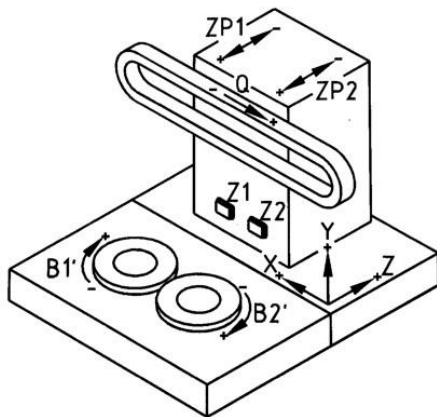

Figure 3: GROB BZ560 machine tool kinematic

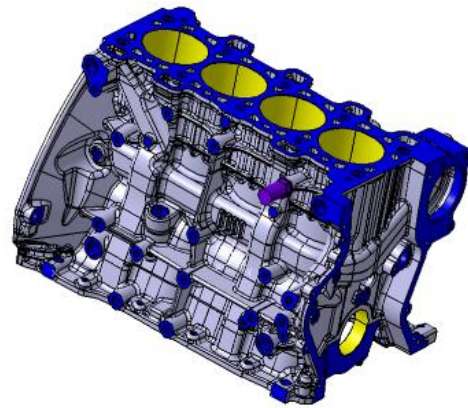

Figure 4: Renault engine cylinder-block

1.2.2. Manufacturing quality issue

In generalized way, the product quality control is performed by statistical approaches, e.g. statistical process control (SPC) or statistical quality control (SQC) techniques, and employed a posteriori i.e. after the part machining, as depicted in Figure 5. It consists in product conformity control after manufacturing steps with a statistical sampling strategy. So, these types of quality control strategies observe quality deviation once it already started. Deviation is mostly observed by means of control charts. Control charts show if a process is in control or not. They show the variance of the output of a process over time, such as measurement of width or length. Control charts compare this variance against upper and lower limits to see if it fits within the expected, specific, predictable and normal variation levels. If so, the process is considered *in control* and the variance between measurements is considered normal random variation that is inherent in the process. If, however, the variance falls outside the limits, or has a run of “non-natural” points, the process is considered as *out of control* (Cospers, 1999). **In the Renault context, the process is most of the time measured in control.** Then, the process or machine is reconfigured when out of control. In this case, production time is lost in order to reconfigure machine tool parameters. Nevertheless, deviation occurs more and more frequently in relation with a machine degradation and can lead to another situation. This later corresponds to a process out of control due to unexpected and important machine degradation. In this case, a consequent number of machined workpieces can potentially be wasted, time production lost in machine repair and reconfiguration, tool change, etc. It is resulting a direct (non-conformed workpiece) and indirect (production breakdown) costs loss. These quality control policies consist in observing the quality deviation and react, but not really to control it by anticipation.

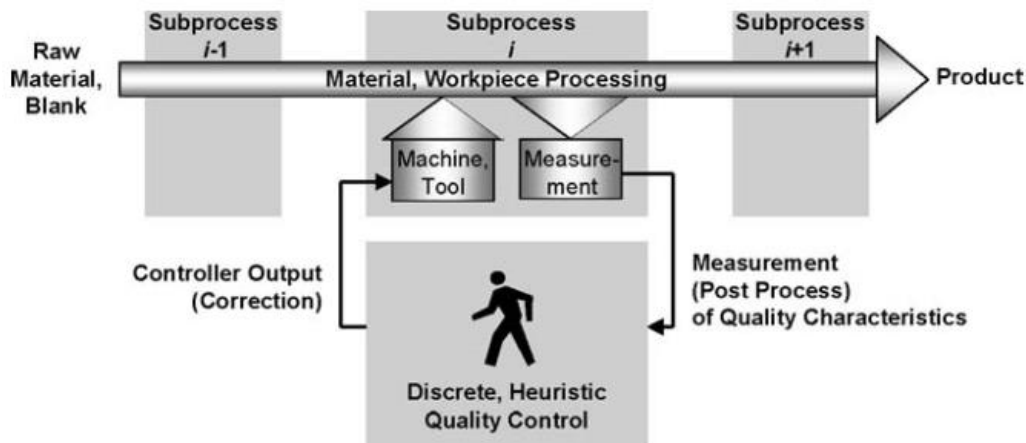

Figure 5: Sub-processes and heuristic quality control (Ament & Goch, 2001)

So, quality of manufactured product results from a conjunction of machine performance, process parameters and workpiece material. Process parameters are usually estimated by simulation and validated by field experimentation, while workpiece material conformity is the responsibility of supplier's quality assurance. Only the machine performance is not fully under control, mainly due to the evolution of its operational context, and the degradation/failure of its components (Brecher, Esser, & Witt, 2009). To sustain the machine tool performances in an operating domain as close as possible to the nominal one, maintenance plans are deployed. Despite the maintenance policy efforts, it is observed that unexpected machine degradations and breakdowns are faced, as well as unexpected and uncontrolled deviation of workpiece quality. Currently, these plans correspond mainly to conventional strategies (i.e. periodic and curative maintenance policy). Even if periodic plans solved the degradation or failure that may lead to component degradation, a lot of maintenance interventions are not optimal (e.g. change of component whereas it is not necessary) with regard to the impact they have on machine availability but also they have directly on the product quality (Laloix, Iung, Voisin, & Romagne, 2016). A relationship between both phenomenon (i.e. machine degradation and product quality deviation) has been established without convincing solution supported by conventional approaches (mainly periodic maintenance actions). At this time, the control of both types of performances is not performed in synergy. It is mainly supported by sectorial approaches treating one type of performance (with an isolated view, silo view) but rarely both together (with an integrated view).

This finding is not isolated on this particular case but is shared by almost all the machine tool application class and can be widely generalized to manufacturing systems where the tryptic product-process-machine is true. There is, for instance, a wide diversity of machines on the cylinder-block production line, such as various types of GROB machine tools and COMAU ones, cleaning machines and robots.

Generally, production and maintenance management are realized by the use of Equipment Follow-up System (EFS) information, corresponding roughly to machine functioning/not functioning

information. This leads to limited control of manufacturing systems process and passive maintenance management in the face of the real state of degradation of the machine and the impact of this degradation on the product quality. In manufacturing organisation, machine and product consideration does not impact the same entities. Maintenance will more conveniently consider machine condition (performance and degradation) as belonging to its main prerogatives, whereas the manufacturer will consider the product quality, in relation with the machine performance. As anticipative strategy is founded on manufacturing system stakeholders' decisions and actions, there is an interest to provide current and future machine condition taking into consideration the impact that this later has on the realized product. Monitoring of machine degradation should enable anticipation of machine failure but also product deviation.

In that way, a challenge is to consider product quality aspect into the development of predictive maintenance strategy based on controlling, by advance, the evolution of manufacturing system performances and degradations.

This problem statement represents not only a need for Renault to evolve towards a proactive management of manufacturing systems production and maintenance, but globally for all manufacturing companies. **The need to face this challenge stands at the genesis of the PhD thesis.** It also represents an important part of the global vision of the future of manufacturing systems of Renault. Indeed, these issues are the ones faced by Renault in Industry 3.0 paradigm. However, since few years, to be more competitive, Renault launched some initiatives in the orientation of Industry 4.0. Such initiatives, in manufacturing context, are motivated by the increase of manufacturing systems performances, by means of scrap diminution and increase of machine availability. A lever of such goal is to provide, to decision makers, the ability to anticipate non-productive situations and maintenance technician and production operators, a better understanding of the machine degradation, performance deviation and product quality deviation. Defined by (NF EN 13306, 2001) as “*condition-based maintenance carried out following a forecast derived from repeated analysis or known characteristics and evaluation of the significant parameters of the degradation of the item*”, predictive maintenance is a convincing area of development to perform such finality. However, despite availability of advanced technologies, there is an issue for industrial companies to possess methodology to develop generic approach of predictive maintenance from data capture to relevant information restitution to dedicated end user. This industrial problem statement rises an industrial question standing as the cornerstone of the thesis.

<p>Industrial problem statement: How to anticipate manufacturing product deviation, machine degradation and performance deviation through machine monitoring, in the framework of predictive maintenance?</p>
--

With regards to a generalization of the Renault case, the industrial problem statement can be declined in some axes related to sub-problems in link with methodological issues. These axes are materialized by five independent industrial issues. The industrial issues extracted from Renault needs, correspond to a chain of objectives with a sequential/temporal aspect, from the monitoring step until the anticipative decision making.

Industrial issue n°1: How to construct efficient monitoring system for health indicators development with both consideration of machine health state and its consequences on the related product quality?

Industrial issue n°2: On the basis of data coming from the monitoring system, how to elaborate health indicators to constitute relevant machine health check with joint machine-product consideration?

Industrial issue n°3: How to assess the future evolution of machine health check through the prognostics of its health indicators?

Industrial issue n°4: How to create a pertinent dashboard on the basis of the current state and future health check for facilitating decision making according to several businesses?

Industrial issue n°5: How to capitalize and update the machine health check and its prognostics considering the dynamic of system in the shop floor (e.g. maintenance intervention, changing environmental context, production rate evolution)?

These issues are all referring to the engineering of product quality control from machine monitoring. It raises questions related to how to perform the transition between the manufacturing system process and product characteristics. It also entails the consideration of such engineering formalization.

1.2.3. Automated relationship between product and machine requirement: a gap to fill

To understand the relationship between the manufacturing system and product it produces, it is necessary to describe the whole process of product life cycle, from the design step to the production one. Such review leads to identify the limits of the current engineering process which contribute to guarantee product quality towards machine performance. This process is broadly inherited of the third industrial revolution technological developments.

In manufacturing field, product quality highly relies on transformation process, from the need leading to its design until its realisation. The following process description is machine tool-oriented but is representative of general product process elaboration in manufacturing context. The whole process is depicted Figure 6. The shape is first elaborated in the design phase supported by CAD (Computer-Aided Design) tool. It aims to respond to a functional need. The resulting model, called CAD model, describes, in 2-D or 3-D, the geometry of the workpiece and its features (e.g. dimensions, tolerances). Then this model is referred to manufacturing considerations through the CAM (Computer-Aided Manufacturing) tool leading to the definition of manufacturing entities and to introduce tool constraints. The CAM generates tool path and “interpolates the tool path into set points according to the geometry of the workpiece, the machining parameters and the kinematics of the machine tool”(Sang & Xu, 2017). Process parameters and tools might be optimized by experience and human skills. After this step, machine instructions (e.g. displacement position, feed rate) are generated in a dedicated program – corresponding to part programming - by CNC (Computer Numerical Control) programming (G code and M code) and loaded to the CNC unit of the machine tool (Altintas, Verl, Brecher, Uriarte, & Pritschow, 2011). CNC sends set points to the machine sub-systems which ensure the kinematic behavior of the machine effectors. The way the CNC unit calculates the trajectories from the workpiece program describes the tool path (Desforgues & Archimède, 2006). Finally, machine effectors ensure the movements of machining operations.

From this transformation chain, a requirement chain is derived (Figure 6) in order to ensure the product quality. Indeed, product finality is to carry out a specific customer need in consistence with its expected functional requirements. These requirements are the basis to design the workpiece shape leading to define shape requirements related to workpiece geometry and features. Then, CAM tool introduces the tool path and set-points in conformity with the shape requirements. It allows providing a cutting model which accuracy is in accordance with geometry and dimension requirements. Moreover, optimization of CAD/CAM systems is a mature field in which quality requirements are well mastered (El-Mounayri & Deng, 2010). The CAM tool is also used to generate the CNC code, piloting the realisation of the cutting model by the machine. This coding procedure is well-controlled as G-code/M-code are generated by simulation (through CAD-CAM systems) and process parameters are optimized from technicians/experts knowledge (Chryssolouris, 2013). It leads to define machining process requirements. Machine movements are then realized in conformity with machine instructions (CNC code), to ensure process requirements. This well-known process come from the third industrial revolution.

The fulfilment of machine process requirements and their impacts on quality requirements are usually addressed through process condition monitoring (Chryssolouris, 2013) to predict machined part quality. It represents machine movement requirements. Finally, machine movement requirements are fulfilled by machine effectors actuation. These latter are controlled with a feedback loop to realize the

required actions. These requirements are achieved until effectors degradation entails a decrease of machine performance. Indeed, product quality is highly correlated with the machine ability to perform machining operations. This correlation is most of the time materialized thanks to data driven approach (Chryssolouris, 2013), where CNC machining parameters (e.g. feed system parameters) are considered as main inputs of the defined model. Such requirements are well controlled through low level control loop when the machine is in a good state. Nevertheless, when degradations increase and interact, control loop is less able to ensure the movement requirements. The product deviation is then perceived due to machine effectors performance decreasing, leading to consider quality deviation as a consequence of machine effectors failure/degradation.

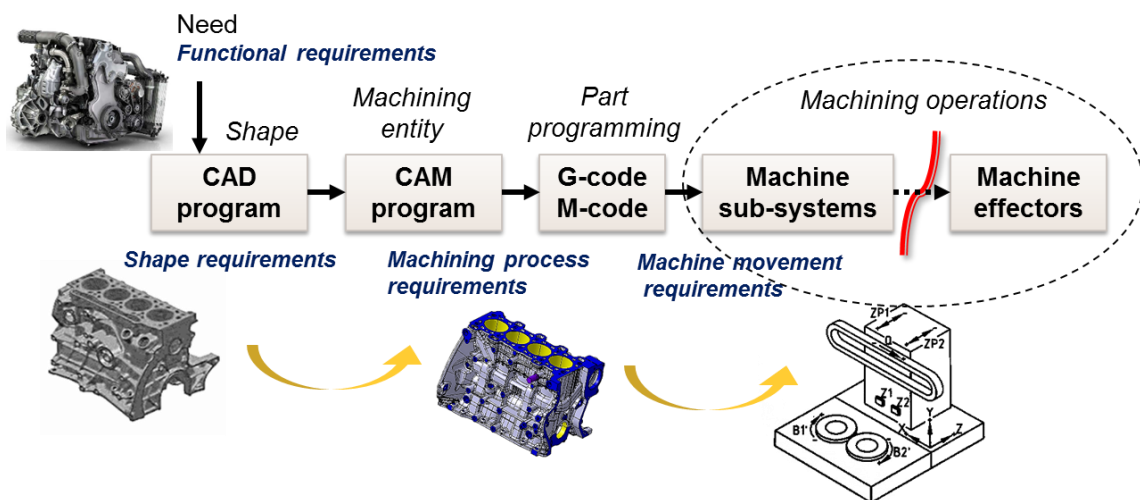

Figure 6: Gap between machine effectors and machine movement requirements

Consequently, **influences of machine effectors performances and the effect of effectors degradation on machine sub-systems movement accuracy are not really formalized in terms of their impacts on product quality.**

On this basis and industrial problem statement, anticipation of product quality deviation based on machine effectors performance and degradation monitoring is a real challenge. Such approach should close the requirements chain by filling the gap between machine movement requirement and effectors movement operation (i.e. illustrated by the relationship between Machine sub-systems and Machine effectors on Figure 6). So, in addition to the joint machine and product consideration in the development of a predictive maintenance framework, filling this gap represents a second contribution to face.

Thus, the thesis is founded on a double observation: in one hand, towards the industrial problem statement and the related industrial issues, and on the other hand, towards the gap in the requirement chain from product design until its production.

The interest of such challenge is also noticed as an important axis of future manufacturing systems in the “Factory of the Future” roadmap.

1.3. From industrial problem statement to scientific positioning

From these industrial-oriented observations, it is necessary to address this challenge towards a scientific positioning. This later refers to the “Factory of the Future” (FoF) initiative, and to the PHM problematic, due to the maintenance orientation of the thesis.

Indeed, researches led in the FoF initiatives, especially regarding the control and monitoring systems, optimization of manufacturing system performance, real time production quality control, are in line with the industrial problem statement. It is particularly true regarding the intelligent maintenance systems topic towards the usage of predictive techniques on the basis of monitoring data. Also, the industrial problem statement is credible in the Prognostics and Health Management community towards the PHM ability to perform health condition monitoring and prediction in the aim to provide to decision makers relevant information to efficiently pilot manufacturing systems.

1.3.1. “Factory of the Future” initiative

The “Factories of the Future” (FoF) term represents the European initiative to recover industry competitiveness since the 2008 worldwide crisis by development plan of high-value-adding manufacturing processes. This research programme was launched by the European Factories of the Future Research Association (EFFRA) in 2009 as one of the three public-private partnership included in the EU commission’s recovery plan (EFFRA, 2013). It addressed the challenges and opportunities for manufacturing future products and economic, social and environmental sustainability towards the development and deployment of technologies and enablers such as (i) advanced manufacturing processes and technologies, (ii) mechatronics for advanced manufacturing systems, (iii) information and communication technologies, (iv) manufacturing strategies, (v) knowledge workers, (vi) modelling, simulation and forecasting methods and tools (Larue, Cadavid, Tucci, Naudet, & Anastassova, 2017). The researches and innovations priorities facing the FoF challenges are divided in 6 major domains (as depicted in Figure 7):

- Advanced Manufacturing Process
- Adaptive and Smart Manufacturing Systems
- Digital Virtual & Resource Efficient Factories
- Collaborative & Mobile Enterprises
- Human-Centred Manufacturing
- Customer-Focused Manufacturing

The thesis problem statement is in line with such roadmap. Thus, among the domain Adaptive and Smart Manufacturing Systems, a sub-domain regards the Dynamic production systems and shop floors, and the monitoring, perception and awareness on manufacturing. This sub-domain highlights the

importance to monitor the actual state of components and machine in a continuous manner, as a mean of ensuring diagnosis and context-awareness capabilities in the associated systems. It also notes the necessity of sensing strategy to support approach in the aim of detecting, measuring and monitoring variables, events and situations which affect the performance, energy-use and reliability of these manufacturing systems and the production at factory level. This point is shared with the industrial problem statement regarding the necessity of manufacturing systems data access to ensure its condition assessment.

In another domain: Digital, Virtual and Resource-Efficient Factories, a sub-domain regards the intelligent maintenance systems aiming at increasing reliability of production systems. This latter is fully in connection with the thesis industrial problem statement regarding the maintenance role to guarantee the required quality product. In this way, EFFRA report claims that complex and expensive production assets in conjunction with market requests for high quality products require novel maintenance approaches able to ensure required capacity and production quality. It is thus noted that maintenance should increasingly take place before the failure occurs and when its impact is at a minimum, and the development of condition prediction reference models would assist in the scheduling of maintenance operations together with user interfaces that will give a holistic overview to decision-makers about automated maintenance operations.

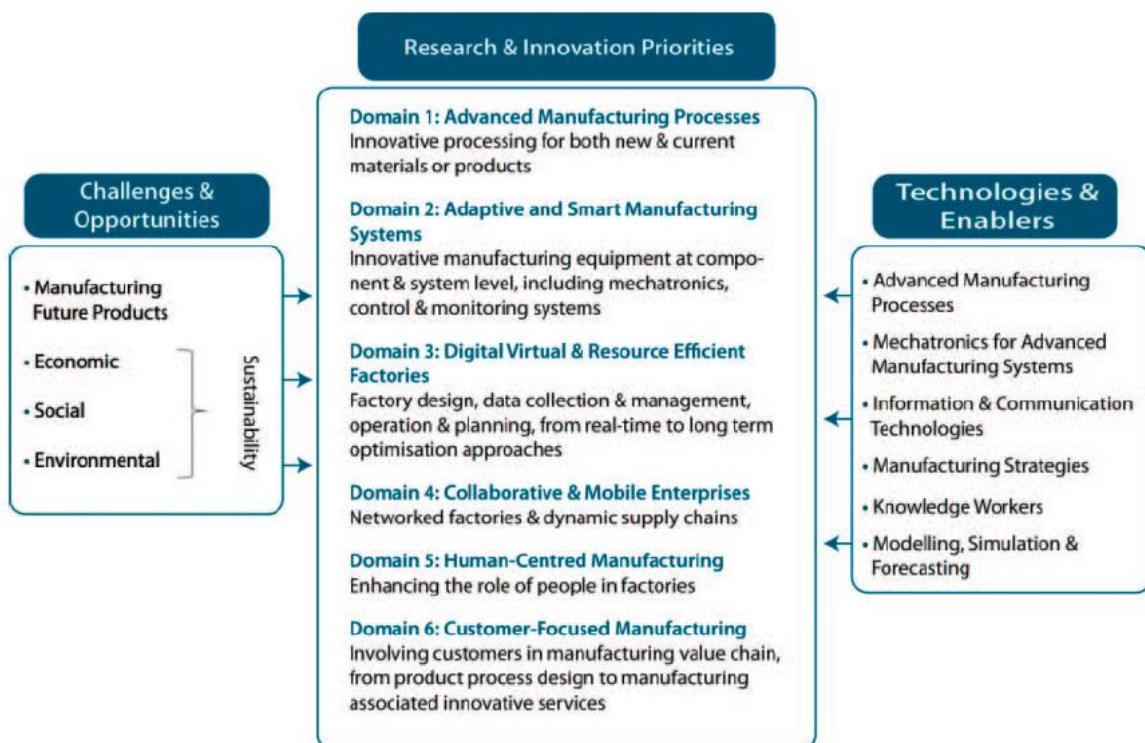

Figure 7: The FoF roadmap framework

In addition to domain consideration, FoF is placing technical aspects impacting the industrial problem statement. It is particularly true on the Mechatronics for advanced manufacturing systems

topic, where continuous monitoring of the condition and performance of the manufacturing system at process, component and machine level is considered as a major technological area. It enables diagnosis capabilities and context-awareness. Moreover, detecting, measuring and monitoring variables, events and situations involves anomaly detection, diagnostics, prognostics and predictive maintenance. This is reinforced by another technical enabler represented by methods and tools providing the capability of simulating manufacturing process and forecasting the behavior of manufacturing systems and processes during their operational phase (EFFRA, 2013). Nevertheless, the monitoring aspect is mainly considered by EFFRA through the spectrum of data science.

Indeed, the continuous monitoring aspect refers to data management: from the data capture (with embedded sensors and related reliability, energy consumption, communication protocols, etc.) to data quality, data security and data analysis (Thoben, Wiesner, & Wuest, 2017). The related main drivers are considered by (Vaidya et al., 2018) to be IOT, IIOT, cloud based manufacturing and smart manufacturing. These data can be found at several levels with different semantics. Thus, (Wang, Wan, Li, & Zhang, 2016) identify four tangible layers constituting “Factory of the Future” technical features and operational mechanism. They represent (i) physical resource layer, (ii) industrial network layer, (iii) cloud layer and (iv) supervision and control terminal layer. The providing of data from physical resource layer to cloud layer enables digital representation of physical asset and constitutes a Cyber Physical System (CPS). Indeed, CPS is defined as the intersection of the physical and the cyber worlds (J. Lee, Bagheri, & Kao, 2015). A noticeable element of the FoF is the ability to benefit from access to data, particularly through CPS development. In line with these principles, the concept of Cyber-Physical Production Systems (CPPS) has been developed. CPPS consists of “autonomous and cooperative elements and sub-systems that are connected based on the context within and across all levels of production, from processes through machines up to production and logistics network” (Monostori et al., 2016). It promotes, among other, flexible production structures, co-evolution of products, processes and production systems, industrial Product-Service Systems, Open-architecture products and cloud-enable prognosis for manufacturing. This increasing availability of data from data monitoring as part of machine condition monitoring constitutes a perspective for the integrated consideration of product-process-machine condition to enhance the control of product quality towards the control of machine and process conditions.

It emerges from these considerations that industrial problem statement is consistent with “Factory of the Future” positioning, particularly considering the role played by maintenance to ensure the product quality and the importance of data access for condition assessment supported by the development of methods and tools.

Finally, the FoF highlights the need of anticipating ability enabling by the digital technologies. It constitutes an important lever of Adaptive and Smart Manufacturing Systems domain and enable the

enhancement of the role of people in factory. Anticipating ability constitutes also the main principle of Prognostics and Health Management (PHM) and can contribute to FoF perspectives. Based on information coming from manufacturing systems and its environment, PHM aims to provide to decision makers relevant future trend of indicators to pilot and maintain manufacturing production and equipment in advance (e.g. failure anticipation).

1.3.2. PHM concepts as key-enabler to face machine-product relationship consideration

1.3.2.1. PHM concepts, methodologies and standards: a maintenance perspective

a) Concepts

Prognostics and Health Management (PHM) is based on the development of ICT infrastructure in manufacturing domain and the consideration of monitoring, diagnostic process, prognostics process and decision-making process (Riera et al., 2017). The PHM concept is a closed-loop process, from data acquisition and data analysis to decision making and advisory generation, as depicted in Figure 8. Its finality aims to assess the current and future health state of a system on the basis of past, present and future information in relation with its environmental, operational and usage condition (Cocheteux, 2010; J. Lee et al., 2014; Zio, 2012). This information is then provided to decision makers to efficiently pilot and maintain manufacturing production and equipment. A PHM system can be viewed as a collection of information extraction phases, layered from low-level data acquisition to predictions about future health and decision support to assess the consequence of actions (e.g. maintenance) (Callan, Larder, & Sandiford, 2006).

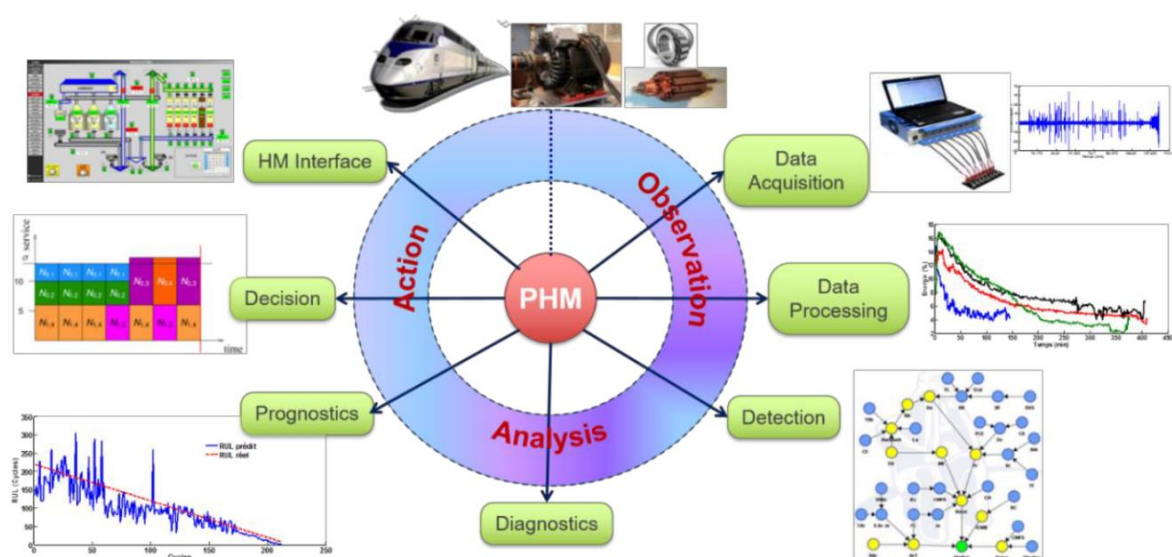

Figure 8: PHM steps illustrated by (Atamuradov, Medjaher, Dersin, Lamoureux, & Zerhouni, 2017)

PHM has become as one of the key enablers for achieving efficient system-level maintenance and lowering Life-Cycle Cost (LCC) (Ly, Tom, Byington, Patrick, & Vachtsevanos, 2009). Indeed, the concept and framework of PHM have been developed on the basis of well-known maintenance strategies such as Preventive Maintenance (PM), Reliability Centred Maintenance (RCM) and Condition-Based Maintenance (CMB) (J. Lee et al., 2014). Integrating the principles of Condition-based Maintenance (CBM) and Reliability-Centred Maintenance, the PHM paradigm extends these capacities and provide a robust environment to optimize maintenance and logistic for increase operational availability and reduce Life-Cycle Cost (LCC) while potentially increase the reliability and life expectancy (Kalgren, Byington, Roemer, Ph, & Watson, 2006). It aims to promote the shift of a preventive/reactive paradigm to a reasoned, scheduled, optimised approach to asset management. Overall, the objective of PHM is to provide timely actionable information to enable intelligent decision – making for improved performance, safety, reliability, and maintainability.

PHM concept is also a strong contribution for the Maintaining in Operational Condition (MOC) objective of manufacturing systems. The MOC concept (i.e. to sustain the system in operational conditions (Medina-Oliva, Weber, & Iung, 2013) is complex to master. It contributes to face the FoF related manufacturing challenges in social, environmental and economic dimension. Regarding the economical aspect, PHM intends to ensure optimal manufacturing system performance, leading to required production quality combining flexibility, adaptability. Concerning sustainable aspect, it can contribute to master manufacturing system energy consumption, energy efficiency and service achievement (Diez, Marangé, Mayer, & Levrat, 2016; Godichaud, Tchangani, Pérès, & Iung, 2012; Hoang, Do, & Iung, 2017). Finally, the social aspect corresponds to the consideration of people, as human resource as a central “component” of the manufacturing system. This aspect is faced by the decision making process of PHM with the consideration of people with various levels of intellectual capacity and skills (from manual workers to skilled machine operators to innovative designers and managers) (Iung & Levrat, 2014).

Two axes can be pointed out to support PHM implementation, (i) standards to structure PHM concepts and (ii) methods and approaches - based on standards - to illustrate PHM approach application.

b) PHM standards

Standards have been established to serve as guideline to develop and implement PHM solution. They are needed for harmonizing terminology, visibility, uniformity and consistency of PHM methods and tools, and compatibility and interoperability of technology (Guillén, González-Prida, Gómez, & Crespo, 2015; Vogl, Weiss, & Donmez, 2014). Current standards respond partially to industrial needs by proposing the formalization of PHM process and activities to support industrial issues for PHM approach implementation. These PHM key activities are in line with the industrial issues presented in

previous sections. Indeed, standards PHM activities globally begin with data acquisition until generation of relevant information for decision makers.

Some international organization attempted to define the PHM process and PHM related architecture definition. The most spread are The Institute of Electronic and Electrical Engineers (IEEE), Machinery Information Management of Open Standards (MIMOSA), International Organization for Standardization (ISO), International Electrotechnical Commission (IEC) and others such as Society of Automotive Engineers (SAE), United State Army (US army), and Air Transportation Association (ATA) (Guillén et al., 2015). Most of PHM-related standards report unified main operational processes: sense, acquire, analyse, advise and act. Complete review of current available standards can be found in (Vogl et al., 2014).

A most notable standard is the ISO 13374 series (Condition monitoring and diagnostics of machines - Part 1: General guidelines, part 2: Data processing, part 3: Communication). It aims to provide logical and physical support dealing with the problem of integration and compatibility. ISO13374-1 established the general guidelines of an open machine condition monitoring information schema architecture. ISO13374-2 provides requirements for a reference information model and a reference processing model for an open condition monitoring and diagnostics (CM&D) architecture (Figure 9). Hence, it specifies data repository, in relation with external information systems, leading to store, structure and deliver real time information. In another way, ISO13374-3 details the communication requirements for any open CM&D systems to aid the interoperability of such systems.

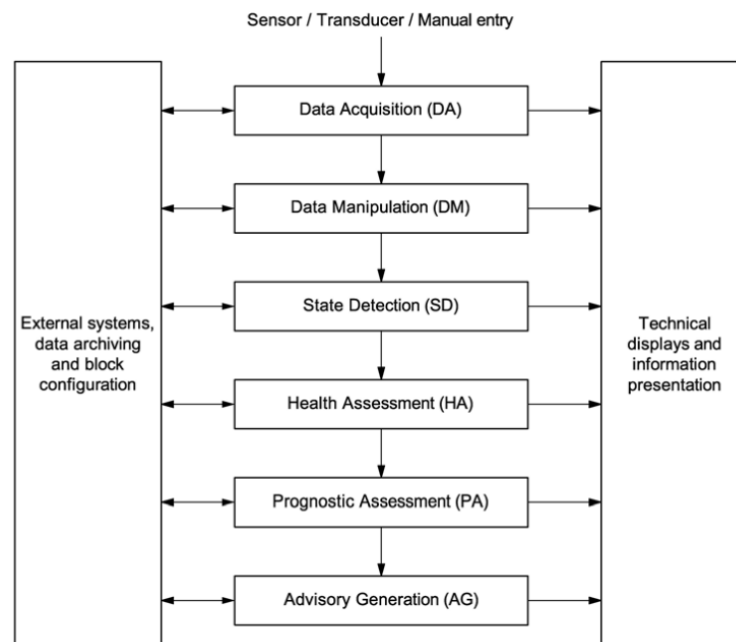

Figure 9: Data processing block diagram for open CM&D information architecture from ISO13374-2

Implementation of such standards has been facilitated by MIMOSA⁹ initiatives with the publication of corresponding open CM&D related to each part of the ISO13374. Thus, in compliance with the first two parts of the ISO 13374, MIMOSA published an open CM&D information specification, known as the MIMOSA Open Systems Architecture for Enterprise Application Integration (OSA-EAI). Then, based on OSA EAI, MIMOSA publishes an open CM&D specification known as the MIMOSA Open Systems Architecture for Condition Based Maintenance (OSA-CBM).

Today, the OSA-CBM standard is the most commonly used by the PHM community in academic research and industrial domain. Seven different layers, all representative of the functional capabilities are specified: (1) Sensor Module, (2) Signal Processing, (3) Condition Monitor, (4) Health Assessment (diagnosis), (5) Prognostics, (6) Decision Support, and (7) Presentation (Figure 10). For more information on each layer, refer to (Thurston & Lebold, 2001).

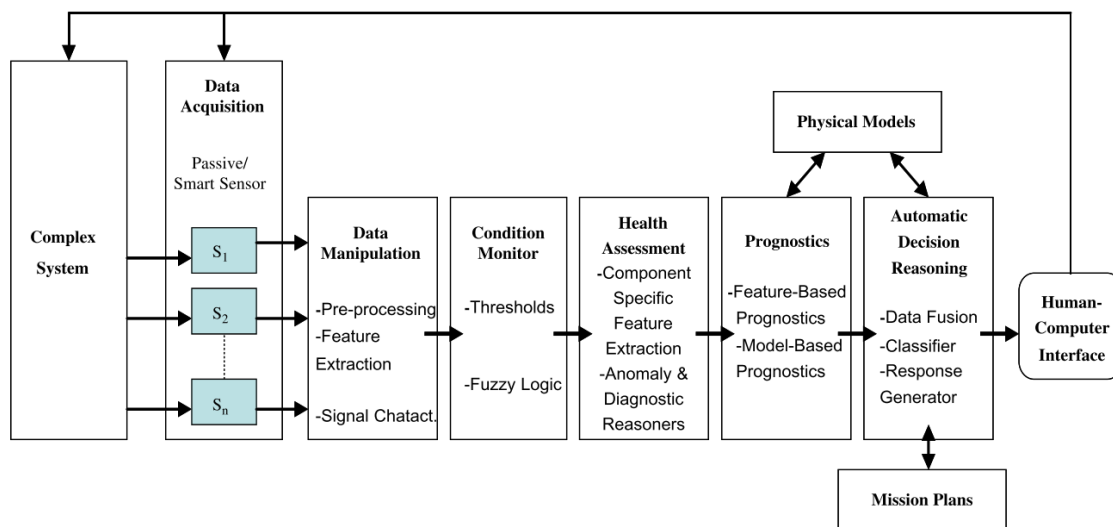

Figure 10: OSA-CBM architecture (Lebold and Thurson, 2001)

In 2004, (Bengtsson, 2004) synthesized the current OSA-CBM and IEEE standards on the succession of steps established by OSA-CBM (Figure 11). They concluded that the sensor module, the signal processing module, the condition monitoring module and the diagnostic module can all be partially developed using standards means. Thus, they advised researchers and developers of CBM system technology to start focus research on the next steps and modules, namely prognosis and decision support.

⁹ Machinery Open Systems Alliance, a United States non-profit association of industry and government (mimosa.org)

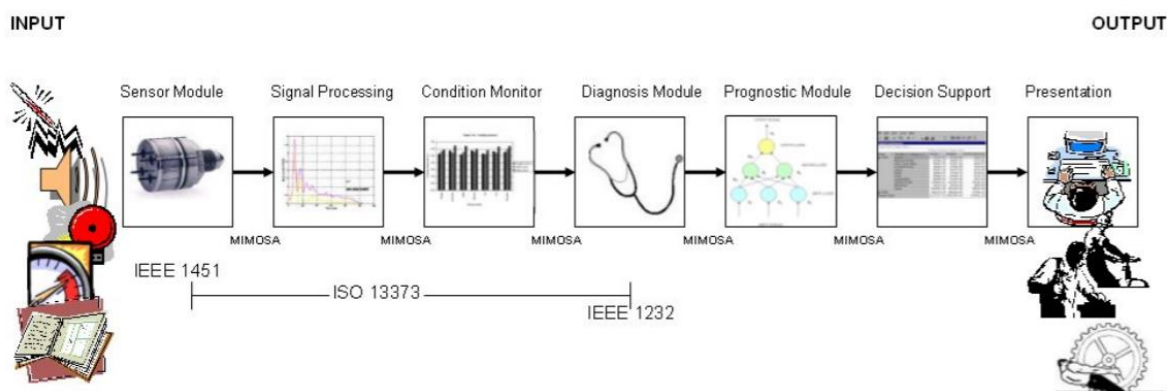

Figure 11: Sequential modules of CBM systems (Bengtsson, 2004)

In that way, and to overcome other standard limits regarding the lack of standardization of semantics of information being communicated between system components, (Sheppard et al., 2009) proposed to enhance IEEE standards. Indeed, on the basis of OSA-CBM framework, they explore the application of IEEE Standards established by the Coordination Committee 20 (SCC20) on Test and Diagnosis of Electronic Systems including AI-ESTATE and SIMICA standards. The first one has the ability to enhance diagnostic reasoner, when the second contributes to the prognostics step in that it captures the history of the monitored data.

Understanding that a unify lexicon of a technology is a key to promote and shape its implementation, (Kalgren et al., 2006) presented terminology and associated definitions for PHM. PHM is defined along a grey-scale health index, considered as a continuous variable in the range from 1 to 0, with 1 considered as system health/performance state undamaged, new or fully operate and 0 complete functional failure. The index is elaborated by algorithms that assess the equipment performance or health through measured symptoms, modelled data and/or usage-based predictions.

Terminology is also proposed in the IEEE Standard Framework for Prognostics and Health Management of Electronic Systems (IEEE, 2017). Based on the PHM functional model, (IEEE, 2017) bring some precision on each PHM activity, as depicted in Figure 12. Despite the standard is dedicated to electronic systems, it is widely interesting for complex systems. The *Sense process* is enabled by the data from the physical sensors and any system performances variables available within the considered system. The *Acquire process* is enabled by the data acquisition and data manipulation functions inherent in the system design. It includes data capture, processing, storage, management and communication. The *Analyse process* is enabled by the detection, health assessment and prognostic assessment functions inherent in the system design or external to the system and includes fault detection, isolation and identification, assessment of the system's health state and estimation of the future health state. The *Advise process* is enabled by the advisory generation function towards the presentation of health state data, prescriptive information or display advisory. Finally, based on the previously generated

information, it is proposed *Fault mitigation* and *Recovery processes* leading to fault avoidance, tolerance or repair.

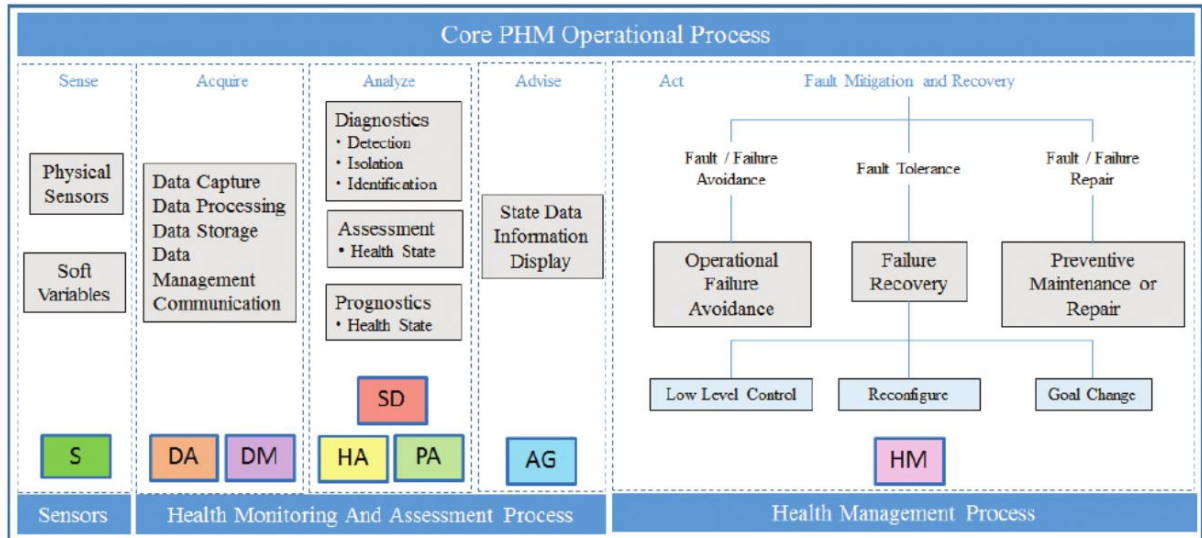

Figure 12: PHM system operational view (IEEE, 2017)

Standards provide solution of formalizing relationship between layers, structuring the vision of PHM, but nothing regarding the methods and best practices for PHM development process within manufacturing systems. Thus, on the basis of these standards, some original approaches have been developed for PHM application in manufacturing context, from data acquisition to decision making. A review of such approaches and methods is performed to establish the current limits in PHM system application considering not only the manufacturing system but also the product it realizes.

c) PHM approaches and methodologies, and product quality consideration

Depending on the case of study, methods and approaches for PHM implementation differ. Based on principles of diagnostics and prognostics, PHM methods and approaches depend on the corresponding knowledge and data availability related to the considered manufacturing system. These approaches can be characterized as physical model-based (i.e. physics-based), knowledge-based, data-driven, or hybrid (resulting from the combination of the three approaches) (Peng, Dong, & Zuo, 2010). Also, it corresponds to an essential matter to make PHM more methodical and understandable to be used in industrial field (J. Lee et al., 2014). Indeed, even if the framework of industrial PHM system has been discussed by some studies, the specific establishment procedure is rarely described (Pei, Fu, Li, & Zou, 2012). Besides the technical aspects related to data analysis and usage of computing tools, a general challenge in the development process of a PHM system is the design of methodology to support its implementation. This section does not seek to review diagnostics or prognostics technical details, but rather attempts to provide a large vision of current initiatives of methodology elaboration to facilitate the implementation of PHM system in industrial field. The reader interested in diagnostics and prognostics techniques will find extensive reviews in (Atamuradov et al., 2017; Javed, Gouriveau, &

Zerhouni, 2017; Khan & Yairi, 2018; Kothamasu, Huang, & Verduin, 2006; J. Lee et al., 2014; Peng et al., 2010; Tsui, Chen, Zhou, Hai, & Wang, 2015; Vogl, Weiss, & Helu, 2016; Zio, 2012)

Among existing initiatives, essential steps for PHM approach has been introduced by (Das et al., 2011). It consists in collection of raw data from sensors, data characterization, digital signal processing, extraction of condition indicators and finally intelligent processing engine for diagnosis and prognosis. These steps are presented in Figure 13. (Das et al., 2011) proposed an illustration of PHM for milling machine by the estimation of the remaining useful life of a cutting tool for milling operations. Vibrations, acoustic emissions and forces information has been used as monitored parameters, and resilient back propagation learning algorithm for predicting the wear patterns from the derived features. This application is close to the **industrial issue n°3** related to the prognostics of health indicators but located on a specific application: tool wear.

In the same way, (Vogl, Weiss, et al., 2016) proposed a guide of best practices for PHM system development on the basis of discussion about diagnostics and prognostics activities. They suggest a general PHM system development process and essential PHM system process, as depicted Figure 14. The identification of the system component to monitor, representing the **industrial issue n°1**, is determined by cost-benefit analysis and dependability analysis. It is noted that PHM benefits vastly outweigh the startup costs with ROI on the order of 10:1 (Barajas & Srinivasa, 2008). Also, it is recommended for data management, to be integrated into the company business process to easily have data access, and the use of open-system architectures for maximum interoperability, portability and scalability. Considering the measurement techniques, direct condition measurement is usually not possible, so sensors and parameters that are placed for other functional purposes can be used to infer others component condition. Also, diagnostics and prognostics methods - that can be attached to **industrial issue 2** and **3** - should be widely reusable for PHM systems application and designed with flexibility for data from multiple sources. Finally, PHM systems should incorporate the “human factor”, expert knowledge and accepted and utilized by trained personnel. This recommendation can be connected with the **industrial issue n°4**, related to the decision-making aspect.

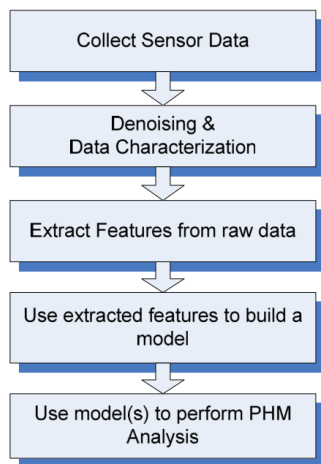

Figure 13: Essential steps for a PHM system (Das et al., 2011)

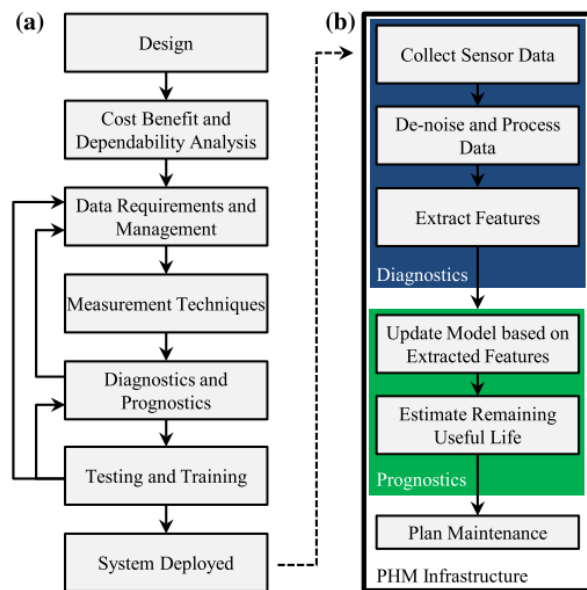

Figure 14: General PHM development process (a) and essential PHM processes (b) (Vogl, Weiss, et al., 2016)

(Guillén et al., 2015) propose a general methodology supported by the use of different available standards and structured in five steps. The first step consists in the definition of the level of consideration of the maintainable items, from plant or installation, and description of operational contexts. The second represents a criticality analysis to choose the most important systems and precise the aim of decision. These two steps lead to the realization of reliability-centered maintenance (RCM) analysis as third step. It is divided in two distinctive stages, respectively the realization of Failure Mode, Effects and Criticality Analysis (FMECA) and the identification of the most relevant maintenance policy to perform regarding every failure mode. The fourth step corresponds to measurement identification phase leading to describe the symptom of failures and related mean of measure. All these steps can be considered as addressing the **industrial issue n°2**, related to the development of monitoring system. Finally, PHM algorithms are used and the result is reintroduced in the third step to redefine the maintenance plan.

On the basis of a wide review of PHM methodologies, mostly oriented on specific component or application cases, (Pecht, 2009) proposed a general PHM methodology. This methodology corresponds to the CALCE¹⁰ work in this field. It includes two main parts: virtual life assessment and real prognostics assessment. The virtual life assessment corresponds to knowledge aspect: design data, expected life cycle, FMMEA (Failure Mode, Mechanism and Effect Analysis) and physics of failure (PoF) models. Next step is to get the monitoring data for prognostics assessment in real system life cycles. This basically address respectively the **industrial issues n°1** and **3**. The proposed application is

¹⁰CALCE: Center for Advanced Life Cycle Engineering, University of Maryland

focused on electronics. The portability of the methodology is quite limited by the diversity of the system considered.

Towards the Watchdog Agent® Toolbox, developed by the IMS¹¹ Center, (J. Lee, Yang, Lapira, Kao, & Yen, 2013) merge the IOT and cloud computing paradigm with PHM systems to provide a framework for cloud based PHM system. The aim is to ease the development and implementation of PHM solutions in industrial applications. The system utilizes modularized PHM algorithms from Watchdog Agent® Toolbox as basic components to form different PHM workflows. Workflows for typical components and mechanical problems are summarized and saved in knowledge base that can later be used as templates for similar problems. Based on specific need (e.g. type of component for monitoring, type of data available, etc.) dedicated workflow will be selected and provisioned into a virtual machine as an individual PHM server dedicated to an industrial user. The PHM server also consists of preconfigured database engine and a web server so that user can upload new condition monitoring data and retrieve PHM results using Web browser and smart mobile devices. The Watchdog Agent® Toolbox provide PHM solution *as a Service*, and addresses the **industrial issues 2, 3, 4 and 5** towards its ability to dispose of PHM algorithms for data analysis, Web interface for results visualization and usage capitalization.

Also, in the aim to facilitate PHM implementation in industry, (Atamuradov et al., 2017) proposed a PHM methodology for maintenance practitioners on the basis of a broad review of PHM techniques and approaches. The proposed methodology is divided in four steps. The first consists in critical component analysis bringing the second, the selection of appropriate sensor for condition monitoring. The third represents the prognostics of feature evaluation under data analysis and finally, the fourth, the prognostics methodology and tool evaluation matrices derived from predictive maintenance literature. As such, they address the **industrial issues 1, 2 and 3**. It presents an application on a railway vehicle bogie in order to illustrate the usage of PHM overcoming each step-related challenge to promote it for industrial use.

(J. Lee et al., 2014) introduced a 5S systematic methodology for PHM design which was evaluated in different industrial application cases. This 5 steps methodology is depicted in Figure 15. It consists in identification of critical components and prioritization of data to ensure the accuracy of the smart processing, which corresponds to the second step. Identifying the critical components for which the prognostics should be performed is the first key step of smart processing by determining which components' degradation or failure has the most significant impact on a system in terms of performance and/or cost of downtime. It partially addresses the **industrial issue n°1** by the investigation of the impact of a component degradation on the system performances. The second step consists in the transformation of data to information, to perform health degradation evaluation, performance trend

¹¹ Intelligent Maintenance System, University of Cincinnati

prediction and potential failure diagnosis. It is proposed at this step to systematically include a means of selecting and combining a set of data-to-information conversion tools to convert machine data into performance-related information to provide real-time health indicators/indices for decision makers to effectively understand the current performance and make maintenance decisions before potential failures occur. This clearly faces the **industrial issue n°2** about health indicator elaboration. Moreover, when combined, performance assessment and degradation models can describe a machine's relative health status and indicate what kind of degradation patterns may exist. The third step aims at integrating the results of the first two steps to enable the selection of the most relevant hardware solutions and software platforms to facilitate data-to-data information conversion and information transmission. The fourth step corresponds to the standardization to deploy large scale information technology application. It can benefit from a standardized open architecture. Finally, the last step is related to the sustainable aspect by the consideration of the closed loop product life cycle.

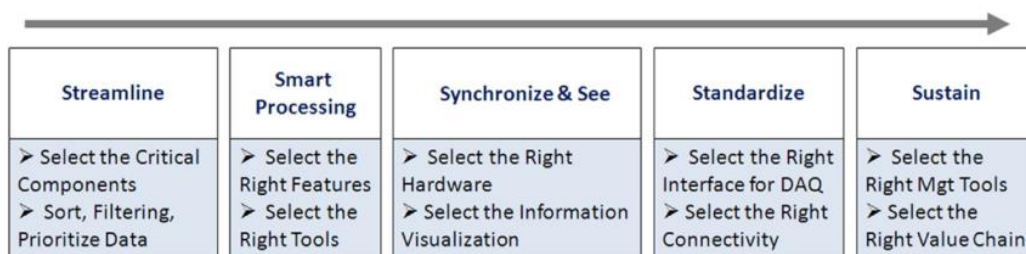

Figure 15: 5S approach for systematic PHM design and implementation (J. Lee et al., 2014)

(Adams, Malinowski, Heddy, Choo, & Beling, 2017) proposed the so-called WEAR methodology for selection of PHM methods to implement in manufacturing system. The methodology is presented in Figure 16. They highlighted the necessity to adapt the PHM techniques with the considering manufacturing system. The four steps methodology start with the definition of the scope of the PHM system with objective to identify areas that will have the greatest impact on the increasing productivity and decreasing cost. The outputs of the first step are a hierarchical model of the manufacturing system with the boundaries for the PHM system clearly defined, an ordered list of targets for PHM and a list of evaluation metrics. The second step consists in listing candidate to be implemented as PHM system. The third step represents the evaluation of the PHM candidates in relation with the objective target, and the final step represents the return of evaluation metrics, recommendation of a PHM system and the trade-offs associated with each PHM system. The identification of relevant candidate is also performed in (Pei et al., 2012), towards an combination and extension of dysfunctional analysis: PFMECA¹² and aFMEA¹³. Both approaches can be closed to the **industrial issues 1 and 2**.

¹²PFMECA: Process Failure Mode Effect Criticality Analysis

¹³ aFMEA : Augmented Failure Mode Analysis

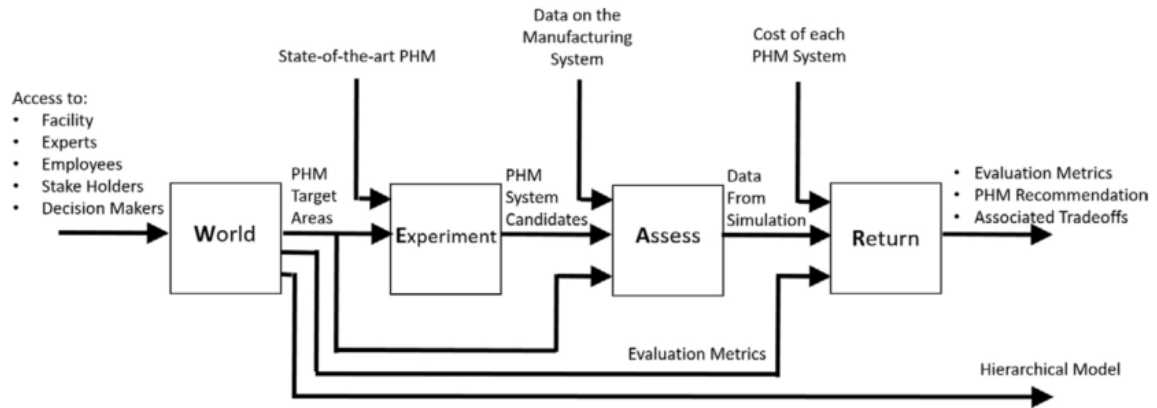

Figure 16; Information flow between each step of the WEAR methodology (Adams et al., 2017)

Towards this review of PHM methodologies, it can be stated that efforts have been performed to enable PHM systems to fit diverse application cases, being reusable, portable and scalable to satisfy industrial environment. **Nevertheless, even if some of them face several parts of the identified industrial issues, the presented methodologies are machine or component oriented and do not address the quality issue.**

1.3.2.2. Initiatives for integrated machine and product consideration

Even if PHM approaches do not consider the joint machine-product relationship (product quality resulting from the degradation of machine's effectors), other communities attempt to couple these two orientations. It is particularly true in machining domain.

In this way, to face the integration of product quality and machine condition, considered usually as isolated, some approaches are proposed. For example, (Colledani & Tolio, 2009) search to estimate machine performance through SPC techniques, but do not tackle the limit caused by sampling inspections. (Bhuiyan, Choudhury, & Dahari, 2014), towards a machine tool application case, demonstrate a relationship between acoustic emission (i.e. machine degradation) and surface roughness (i.e. product quality deviation), and vibration emission and tool wear, during machining. This domain of application benefits from extensive work aiming at the control of machined product quality (Lu, 2008). Thus, this finality is attempted to be reached towards the use of process parameters (Rajasekaran, Palanikumar, Vinayagam, & Prakash, 2010), machine tool symptoms through monitoring (Elangovan, Sakthivel, Saravanamurugan, Nair, & Sugumaran, 2015; Liang et al., 2016; Risbood, Dixit, & Sahasrabudhe, 2003), or combination of both (Jain & Lad, 2015; Tseng, Konada, & Kwon, 2016). Nevertheless, these approaches are limited to the machine tool application case and are not portable on other type of manufacturing equipment. Most of the resulting models proposed are component-oriented with difficulties to obtain performance at the machine level, i.e. considering the interaction of several components. Moreover, they are usually specific to an application case (Lu, 2008).

Existing approaches are not fully satisfactory to face the global industrial problem statement. However, towards its ability to elaborate and provide actionable information to support decision making based on current and future health condition of complex systems, PHM framework seems useful to face the industrial problem statement. Nevertheless, the product orientation is not yet covered by the PHM community and some issues have to be addressed to consider not only the manufacturing system condition but also the impact it has on the product it is delivering.

Finally, FoF appears mostly product oriented whereas PHM seems mainly component or system oriented. So, in straight connection with the industrial issues, raised the following research question:

Research question: Is it possible to develop and formalize an efficient PHM-based approach to control the performances (and their deviations) of the machined part directly from the control of machine tool performances (and its degradations)?

The research question is addressed in the thesis towards a new PHM-based approach. The latter is structured in five steps and presented in the next section.

1.4. Global roadmap for Manufacturing System Prognostics and Health Management

This section is dedicated to the proposition of a PHM-based approach. It constitutes a global roadmap based on **five steps**. For each step, we identified related scientific issues, in line with the research question, to face the industrial problem statement. The scientific issues are justified in regard with the reviews presented section 1.3.1 and 1.3.2. The first two steps are addressed in next chapters of the thesis. The whole PHM-based approach is presented in Figure 17.

1.4.1. Manufacturing system Prognostics and Health Management framework for machine-product joint consideration

Step 1: As stated in 1.3.2.1, PHM system elaboration starts with data acquisition from sensors. Nevertheless, the review of PHM methods highlights the lack in product consideration and the necessary for the knowledge to be reused for industrial application. Thus, a way consists in the formalization of the required knowledge of manufacturing system to facilitate the identification of relevant parameters to monitor considering causality relationship between manufacturing system degradation and product quality deviation. This contribution faces the **industrial issue n°1** and is presented in Chapter 2. It addresses the following scientific issue:

Scientific issue n°1: Formalization of the machine-product relationship to support the identification of relevant parameters to serve as a basis of health check elaboration.

Step 2: On the basis of incoming knowledge from the previous step, and in accordance with the PHM standards (section 1.3.2.1), it is necessary to assess the system health state. However, current approaches are generally component-oriented which is not sufficient for an effective industrial usage. Thus, there is an issue in data aggregation to provide health indicators not only dedicated to component but to the whole system with consideration of the product quality (**scientific issue n°2**). It corresponds to the second step of the proposed methodology. This step contributes to decision making process by providing decision makers with the current state of machine-product relationship towards multi-levels health indicators elaboration. In relation with **industrial issue n°2**, this step is tackled in Chapter 3. It consists in monitored parameters combination for health indicators elaboration, attempting to face to the following scientific issue:

Scientific issue n°2: Elaboration of a manufacturing system health check considering machine -product relationship, on the basis of machine data aggregation to provide health indicators.

Step 3: Resulting health indicators can be proposed to prognostics process to estimate their future trend and finally the machine remaining useful life, which constitutes the step 3, according to prognostics step as stated in 1.3.2.1. It consists in the prediction of the health indicators and generate the different remaining useful life (RUL) of the system, part of the system or component, for each detected (current) or potential degradation/failure mode, by taking into account the knowledge of the system, past information, current information and future information (scenario with manufacturing and maintenance data) (Voisin, Levrat, Cochetoux, & Iung, 2010). Thus, a challenge corresponds to apply the prognostics process on the health indicators previously defined considering their interactions and corresponding degradation dynamic and estimated impacts on the product quality (**scientific issue n°3**). This step is necessarily supported by knowledge coming from step 1 (manufacturing system knowledge) and information from step 2 (health indicators) and leads to identify the following scientific issue:

Scientific issue n°3: Elaboration of efficient prognostic model to provide relevant health indicators prognostic.

Step 4: The current and future state of health indicators are then usable to make relevant decision with regards to manufacturing process/product future evolutions. It appears, in accordance with the previous steps, a lack in joint machine-product consideration on the decision-making step. Aiming at simplifying the daily life of operators and managers, the decision-making step have to satisfying production and maintenance team (in accordance with industrial need, section 1.2.1). Thus, a real challenge for decision-making to be relevant in industrial context is to provide business-oriented

information dedicated to different decision makers, i.e. from the production operators to production manager and maintenance technician to maintenance manager, to ensure optimal machine performance and product quality. This challenge raises the **scientific issue n°4**.

Scientific issue n°4: Generation of efficient decision-making model to support multiple businesses decision makers field and skills considering the joint machine-product relationship.

Step 5: According to the standards, final step consists in closing the PHM processes by means of capitalisation loop (Thurston & Lebold, 2001). Nevertheless, capitalization loop is often reduced to a single process (i.e. prognostics) or missing. Thus, a challenge is to integrate it at each step of the PHM process, with the real usage of machine and process condition feedback for continuous improvement of PHM models, adaptation according to the context and optimization of user experience (Potes Ruiz, Kamsu-Foguem, & Noyes, 2013) (**scientific issue n°5**). This closed-loop will enable system knowledge models, eventually monitoring parameters, proposed in step 1, update and enhance robustness of health indicators elaborated - and particularly degradation and failure thresholds, in step 2. It also leads to validate prognostics assumptions (regarding system mission, context, etc.) in step 3 and finally adjusts, confirms the proposed action dedicated to manufacturing practitioners, and the way to present it, in step 4. This knowledge formalization is referred to our last scientific issue:

Scientific issue n°5: Capitalization of real manufacturing shop floor event, machine condition and maintenance intervention to increase robustness and relevance of PHM methodology steps.

The steps 1 and 2 are discussed in the following of this manuscript.

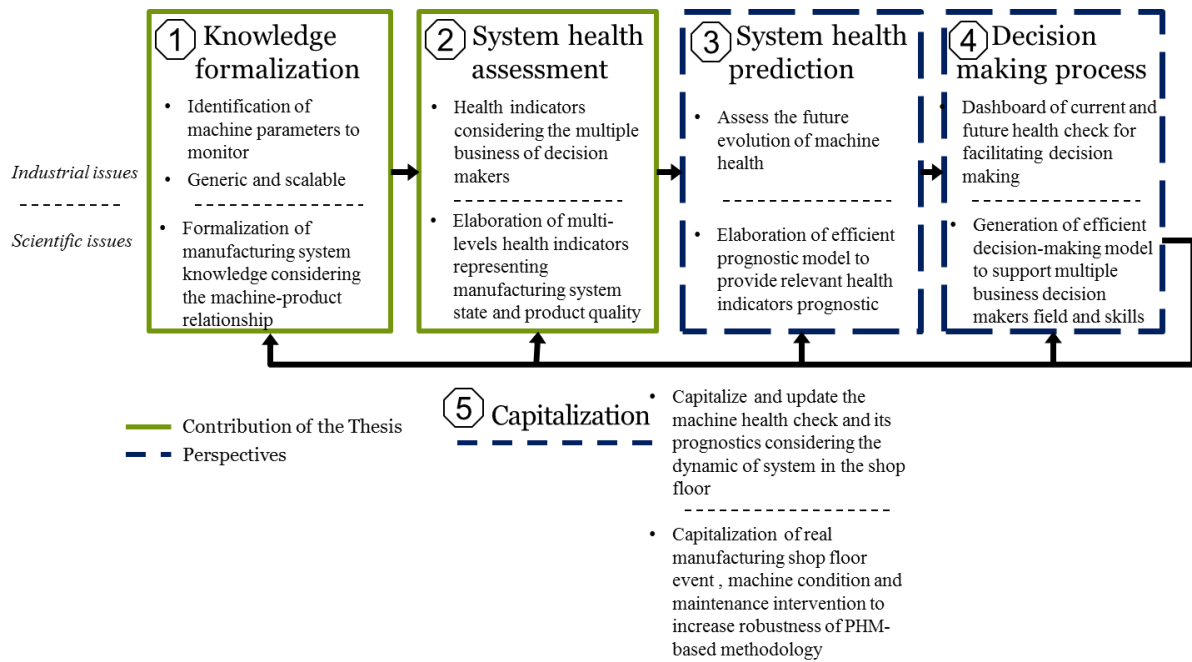

Figure 17: Proposed PHM methodology with contributions

1.5. Conclusion

The motivation of the industrial initiator of the thesis, the car manufacturer Renault, to move through the “Factory of the Future” paradigm leads to express an industrial problem statement raised by day-to-day shop floor concerns. This industrial problem statement addresses the challenge of the control of product quality deviation towards the control of manufacturing system performance and degradation. This dual consideration of manufacturing system performance and the quality of product it is delivering is declined in five independent sequential industrial issues, from the machine monitoring until an anticipative decision making. In addition, it appears some lack in the engineering chain of product elaboration (from the product design to product manufacturing) materializing the transition between the product characteristics and the manufacturing system process, particularly regarding the formalization of machine effectors performance and degradation impacts on product quality. Thus, this double observation, i.e. in one hand, towards the industrial problem statement and the related industrial issues, and on the other hand, towards the gap in the requirement chain from product design until its production, stand as the main drivers of the thesis.

Scientific positioning of the industrial problem statement and related issues is consistent with “Factory of the Future” paradigm, particularly considering the role plays by the maintenance to ensure the product quality and the importance of data access for manufacturing system condition assessment. Then, demonstrating abilities to face the industrial problem statement by providing organization and technological capabilities to face the machine-product dual consideration, the positioning in PHM framework is studied through the review of PHM standards and methods. It highlights some limits in

current approaches to face the industrial problem statement, especially regarding the product consideration. Consequently, from this review emerges the following research question:

“Is it possible to develop and formalize an efficient PHM-based approach to control the performances (and their deviations) of the machined workpiece from the control of machine tool performances (and its degradations)?”

To address such research question, a PHM-based methodology is, finally, proposed. The PHM-based methodology is structured in five key sequential steps, facing respectively dedicated scientific issues resulting from the literature review, namely (1) Knowledge formalization, (2) System health assessment, (3) System health prediction, (4) Decision making and (5) Capitalization.

The following chapters are organized to face the two first steps of the proposed methodology and address scientific issues respectively:

Chapter 2

Scientific issue n°1: Formalization of the machine-product relationship to support the identification of relevant parameters to serve as a basis of health check elaboration.

Chapter 3

Scientific issue n°2: Elaboration of a manufacturing system health check considering machine -product relationship, on the basis of machine data aggregation to provide health indicators.

Chapter 2 From system knowledge structuration to relevant parameters identification for health monitoring

2.1. Introduction

The second chapter tackles the first step of the proposed methodology - Knowledge formalization - by addressing the **Scientific issue n°1**: Formalization of the machine-product relationship to support the identification of relevant parameters to serve as a basis of health check elaboration. The first step of the PHM-based methodology consists in identification of relevant parameters to be monitored considering the causality relationship between manufacturing system degradation and product quality deviation. To this end, the chapter proposed two contributions consisting in (i) the evolution of current methods for system knowledge elicitation and (ii) the formalization of the resulting concepts of knowledge to face the concern of empiricism and interpretation that may be caused by the usage of the methods in (i).

In that way, the next section introduces common approaches of monitoring parameter selection for manufacturing system. Investigations are first oriented on machine tool case, industrial application of the thesis and then extended to dedicated methods, such as FMEA and its improvement, and combination of methods, particularly FMECA and HAZOP. Finally, the first contribution of the chapter is founded, on the basis of precursor approaches introduced by the CRAN through functional and dysfunctional analysis, which extension leads to address the **industrial issue n°1**¹⁴.

In the section 3, the necessity to formalize the resulting concepts of knowledge of the proposed approach is discussed, principally to avoid semantic and syntactic ambiguity and to enable knowledge structuration and reuse. The concepts of knowledge are then formalized in a meta-model in accordance with Object Management Group¹⁵ meta-modelling definition. In section 4, the meta-model is, finally, instantiated on a dedicated application class, e.g. machine tool, leading to demonstrate its interest for creating reference model and validate its structure and quality.

¹⁴ “How to construct efficient monitoring system for health indicators development with both consideration of machine health state and its consequences on the product quality it is producing?”

¹⁵ <https://www.omg.org/>

2.2. Current approaches for relevant parameter monitoring

This section reviews the current approaches for monitoring parameter identification to satisfy the first step of PHM standards, such as Data Acquisition regarding to OSA-CBM.

Existing approaches for selecting relevant manufacturing systems parameters to be monitored mainly come from conditional and predictive maintenance initiatives. When considering indicator design, monitored parameters are usually given in ad hoc solution. This aspect is firstly reviewed in this section. Then, current methods based on degradation mode identification are introduced to structure the approach of monitoring parameters identification. Finally, a combination of well-known dysfunctional analysis is proposed to respond to the industrial issue.

2.2.1. Identification of monitoring parameters: current approaches

2.2.1.1. Rule of thumb

In relation with the thesis framework, an attention is primarily focused on the monitoring of machine tool key components and their related monitoring solution. Due to their importance on the machine tool process, linear axis, spindles and tools are the main sub-systems concerned by monitoring solutions.

Thus, (Altintas et al., 2011) review the most widely used techniques to monitor the feed drive performances on machine tool application case. It corresponds to (i) position measurement, (ii) speed measurement, (iii) acceleration measurement and (iv) current measurement. Each measurement corresponds to a linear axis characteristic. The position measurement is used to measure the precision positioning of the tool on the workpiece. This corresponds in most of the case by information directly measured by the machine tool towards direct measurement, e.g. optical encoders, or indirect measurement, e.g. rotary encoders or synchro-servo-resolvers. Feed drive velocity is employed by the servo controller for tracking and damping of the table motion. While acceleration is used in control law for damping the structural dynamics and inspecting the actual trajectory of the feed drive. The current is used to compensate friction and cutting force disturbance. It is also used to predict cutting forces.

Regarding the same application case, intrusive ball screw drives monitoring solution is developed in (Möhring & Bertram, 2012) to monitor linear axis degradation. Strain gauges are used to directly measure the preload forces in a double nut system. Indeed, it is stated that run-outs of the screw shaft cause periodic force variations and have an impact on the load, operational behavior and life expectancy. This monitoring system is integrated in the screw nut unit (Figure 18). The ability of wear identification towards the measurement of internal mechanical state of the ball screw drive is verified. However, this intrusive monitoring system is quite difficult to implement on a large number of existing machine tools and does not directly consider the product quality of ball screw drive degradation.

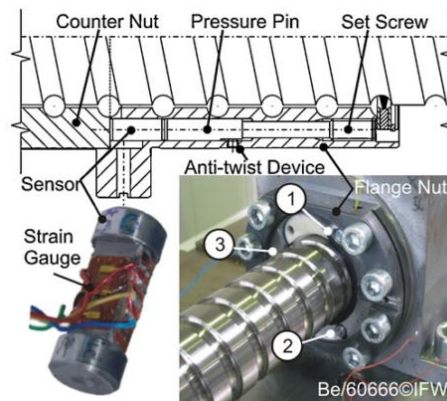

Figure 18: Realized ball screw drive with integrated sensory pins (Möhring & Bertram, 2012)

Another linear axis monitoring solution is developed by (Vogl, Donmez, & Archenti, 2016; Vogl, Weiss, & Alkan Donmez, 2015). Based on the principles that accuracy of machine tool axis impacts the quality of manufactured workpiece, it is developed an online condition monitoring system. This solution corresponds to Inertial measurement unit (UMI). The IMU-based method uses data from both accelerometers and rate gyroscopes to identify changes in the translational and angular errors, due to axis degradation. Verified and validated via a linear axis testbed, the method proves its robustness for the detection of defects. Although located on linear axis application cases, most of these monitoring solutions are dedicated to a specific technology and component oriented - without consideration of the impact on the machine, and on the product.

Also, in the field of machine tool monitoring (especially machining operation), (Teti, Jemielniak, O'Donnell, & Dornfeld, 2010) review the contribution of the CIRP community. Focus is done on the monitoring of the cutting region where can be monitored several process variables such as cutting forces, vibrations, acoustic emission, noise, temperature, surface finishing, etc. influenced by the cutting tool state and the material removal process conditions. It is reminded that measuring techniques have traditionally been categorized into direct and indirect approaches. Direct approach measures the actual quantity of a variable while indirect approach principle corresponds to the deduction of actual quantity by empirically determined correlation. Signals coming from the sensors are processed to extract features changing with the tool conditions, process conditions, machined workpiece quality and machine tool state, to provide information for decision making support. Machine tool and cutting tool condition monitoring is known as Tool Condition Monitoring, where a review can be found in (Nithin, Dinesh, Satish, & Vishal, 2015), (Byrne et al., 1995) and (Zhang, To, Wang, & Zhu, 2015). Despite a precise monitoring of the cutting region, limits of the considered perimeter of such approaches lead to a lack in the consideration of the machine kinematic degradation.

By extending the context, (Cheng, Azarian, & Pecht, 2010) stated that the parameter to monitor for PHM include performance parameters (e.g. the speed of a fan); physical characteristics (e.g. pressure or strain); electrical characteristics (e.g. the resistance, current, voltage); environmental conditions (e.g.

temperature, vibration, pressure, acoustic level and humidity level); and operational conditions (e.g. usage frequency, usage severity, usage time, power and heat dissipation). They classified these parameters in the following table:

Domain	Examples
Mechanical	Length, area, volume, velocity or acceleration, mass flow, force, torque, stress, shock, vibration, strain, density, stiffness, strength, angular, direction, pressure, acoustic intensity or power, acoustic spectral distribution
Electrical	Voltage, current, resistance, inductance, capacitance, dielectric constant, charge, polarization, electric field, frequency, power, noise level, impedance
Thermal	Temperature (ranges, cycles, gradients, ramp rates), heat flux, heat dissipation
Chemical	Chemical, species concentration, gradient, reactivity, mass, molecular weight
Humidity	Relative humidity, absolute humidity
Biological	pH, concentration of biological molecules, microorganisms
Electromagnetic radiation and ionizing radiation	Intensity, phase, wavelength (frequency), polarization, reflectance, transmittance, refractive index, distance, exposure dose, dose rate
Magnetic	Magnetic field, flux density, permeability, direction, distance, position, flow

Table 1: Examples of parameters for PHM applications (Cheng et al., 2010)

Extensive research focus on the development of measurement science for PHM roadmap can be found in (Weiss et al., 2015).

The monitoring of these particular industrial cases is performed by experience and years of experiments, particularly in laboratory context (Verl, Heisel, Walther, & Maier, 2009). It can be stated that monitoring parameters are mostly component oriented and related to a particular technology. Individual component degradation is monitored without consideration of degradation interaction and causality relationship. The above-mentioned research works do not regard the monitored parameter evolution in the framework of the whole system. Also, despite product quality consideration with the monitoring of the parameters in the cutting region (vibrations, acoustic emission, force...), the Tool Condition Monitoring does not consider the global impact of machine kinematic degradation on the product quality deviation. Nevertheless, it is necessary to consider the impact of such degradation on the system itself but also on the product quality. A solution can be found in the usage of dysfunctional analysis. In this way, a degradation can be related to both technological and functional aspects (Mathew, Das, Rossenberger, & Pecht, 2008).

2.2.1.2. Dysfunctional analysis for monitoring parameters identification

In the identification of relevant parameters to be monitored, several methods based on dysfunctional analysis (e.g. identification of degradation modes) are already operational in industrial context. In this way, one of the most common methods is Failure Modes and Effects Analysis (FMEA). FMEA is a documented step-wise process performed in product development and operations management for analysis of potential failure modes within a system for classification by the severity and likelihood of the failure (Ambekar, Edlabadkar, & Shrouty, 2013). As an extension, Failure Mode Effect and Criticality Analysis (FMECA) is considered as composed of two separate analysis, the Failure Mode and Effects Analysis (FMEA) and the Criticality Analysis (CA) (Catelani et al., 2015). FMEA is a bottom-up analysis method which development has spawned several related methods (e.g. Design Review Based on Failure Modes: DRBFM, Process and Design Failure Modes and Effects Analysis: PFMEA and DFMEA, Failure Modes Mechanisms and Effects Analysis: FMMEA, ...) and standards (Bowles, 1998; International Electrotechnical Commission, 2006; MIL-STD-1629A, 1980).

In relation to degradation knowledge, (Catelani et al., 2015) identified monitoring parameters for each dysfunctional mechanism in case of failure mode. It is proposed a FMECA augmented with FMMEA concepts. Towards these integration, the monitoring system is considered since the design phase, leading to the establishment of a proper monitoring strategy, i.e. selection of sensors, sensors deployment, identification of parameters that allow to identify the evolution of the fault and data acquisition strategy. The monitoring system includes the collection of sensing units deployed in the system for acquiring data and transmitting them, and data acquisition for pre-processing, storing, post processing and visualizing the data.

As presented in (Cheng et al., 2010), FMMEA methods is widely used to determine parameters that need to be monitored for PHM application. FMMEA is depicted as a methodology used to identify the critical failure mechanisms and models for all potential failure modes of a product under expected operational and environmental conditions. The output of the FMMEA process is a list of critical failure modes and mechanisms that enable to identify the parameters to monitor and the relevant physics-of-failure models to predict the remaining life of the component.

FMMEA is also used in (Mathew et al., 2008) to identify the critical precursor parameters to monitor. In this case, data coming from sensing strategy serve for component remaining useful life estimation.

(Pei et al., 2012) suggest an integrated method to determine monitoring objects and parameters. It is proposed the use of PFMECA, where criticality is estimated with Risk Priority Number (RPN) by multiplying the levels of severity, occurrence and detection. Based on this knowledge, monitoring aspect is added by principles of Augmented Failure Modes and Effects Analysis (aFMEA) put forward by J. Tian and T. D. Zhao (Tian & Zhao, 2006). By the use of aFMEA, the relation between failure

causes and failure symptoms can be clarified and the parameters which can be used to evaluate the procedure of failure developing, can also be acquired.

As an essential part of a PHM process structured in 8 steps, (Weiss, Sharp, & Klinger, 2018) introduced a step of risk identification. Based on a hierarchical system decomposition, risk identification is supported with a FMEA family method and include quantitative and qualitative likelihood of failure, importance of the impact and what level is concerned (physical vs. functional level vs. both levels). Following steps correspond to data collection and physical metric identification representing the elaboration of monitoring strategy implementation.

(Efthymiou, Papakostas, Mourtzis, & Chryssolouris, 2012) formalized the monitoring process in an integrated predictive maintenance platform. Thus, an advanced Intelligent Engine analyse the data in order to detect any possible deviation from a nominal condition. The Advanced Intelligent Engine includes a list of failure criteria closely related to the equipment's parameters that are monitored with the help of the sensors.

Another approach is introduced in (Tiddens, Braaksma, & Tinga, 2018) by proposing to examine economic and technical factors to select the suitable component to monitor, after the reduction of candidate by criticality classification.

As stated in (Renu et al., 2016), these methods are time consuming, difficult to reuse and to interpret, non-exhaustive because subject to the knowledge of their creators, etc. To face the genericity and scalability issues many researches have been performed in the development of knowledge-based FMEA approaches. Therefore, (Renu et al., 2016) identify the impact of process degradation on product quality through a knowledge based system. In the same way, (Rehman & Kifor, 2016) propose a reusable and scalable tool based on ontology to support FMEA knowledge in the field of risk management. Also, (Rehman & Kifor, 2016) face this issue by the proposition of a case-based reasoning approach. The proposed knowledge system is supported by FMEA-driven software and is deployed on a manufacturing context.

Nevertheless, each of these approaches are mostly component oriented without consideration of interactions between components degradations, their impacts on the system performances and finally on product quality. Also, when quality aspect is considered (Renu et al., 2016), it does not lead to the elaboration a of monitoring strategy in the aim to constitute indicators as input of decision making process. In order to identify the impact of a component degradation on the whole system in which it is considered, some approaches could be investigated based on the combination of well-known approaches.

2.2.1.3. Combined approaches for monitoring parameters identification

Research carried out by the CRAN within predictive maintenance framework demonstrated some interests. Initiated by (J. B. Leger & Morel, 2001), the usage of a combination of FMECA and Hazards and Operability study (HAZOP) methods formalize the causality relationship concepts inherent to a proposed framework of predictive maintenance system or an integrated vision within enterprise information systems. Indeed, whether FMECA is process-oriented and leads to the identification of degradation and failure modes, HAZOP is focused on flow deviations, their causes and consequences (an example of HAZOP guideline is given in the following).

Component	Flow	Deviation mode	Causes	Consequences	Safeguards	Action required
-----------	------	----------------	--------	--------------	------------	-----------------

In line with this contribution, (Muller, Suhner, & Iung, 2008) and (Cocheteux, Voisin, Levrat, & Iung, 2009), focused particularly on the formalization of the prognostics process towards an approach called Integrated System of Proactive Maintenance. FMECA and HAZOP combination, coupled with notions of system theory, model the components dysfunctional causality relationships and the related impacts on manufacturing system performances for RUL¹⁶ evaluation. In continuity, when considering root cause analysis, (Medina-Oliva, Iung, Viveros, & Ruin, 2012) highlighted that no unique tool is able to characterize the knowledge about causal relationship between degradations. Also, combination of FMECA and HAZOP is performed to formalize the interactions between an industrial system and its support system (maintenance system). In one hand, FMECA is used to model failure modes of the functions and the components, failure consequences and the criticality of the failure. In another hand, HAZOP is used to model flow deviations, causes of deviation and failure consequences (impact on the flow). Functional and dysfunctional concepts of knowledge support Probabilistic Relational Model (PRM).

Among other initiatives, based on functional system knowledge and structural knowledge, provided by FMEA and HAZOP methods, (Desforges, Diévert, Charbonnaud, & Archimède, 2012) proposed the concept of sub-system prognostic agents to perform the prognosis of complex system from the RULs of its devices. Motorola developed a hybrid HAZOP and FMEA technique for risk assessment approach. This technique separates the risk factors related to human safety, the environment, facility and product damage and business interruption. It provides a systematic method to thoroughly review failure modes and the effects of failures and deviations on the overall system. As these deviations are identified, the HAZOP nodes and the deviation are logged on the FMEA's worksheet. HAZOP deviations are noted on the FMEA worksheet as potential failure modes. Each of these deviations are reviewed to determine

¹⁶ Remaining Useful Life

the consequences and logged onto the worksheet as potential Effects failure. The HAZOP causes are logged also as potential cause mechanisms (Trammell & Davis, 2001).

Although the ability of such approaches to make the link between the degradation of the technical level and the functional degradation or even system towards, among other, the concepts of dysfunctional causality relationship, these approaches only allow an empirical and intuitive identification of monitoring parameters based on textual information provided by worksheet analysis. Moreover, this does not lead to link identified monitoring parameters to sensor solution. To face the need in formalization for the identification of the monitoring parameters, it is proposed in the section 2.2.2. an integrated method based on the core principles introduced by works initiated in CRAN and adapted to consider the joint consideration of the machine degradation and product quality deviation.

2.2.2. Integrated method for monitoring parameter identification in joint machine-product consideration

The combination of both FMECA and HAZOP methods enable the identification of causal relationship between root cause, degradation, failure and flow deviation. On the basis of this postulate, the proposed approach is in the continuity of the precursor works led by the CRAN. It results a succession of a key steps constituting a coherent methodology (Figure 19).

First, functional knowledge of the system (Figure 19-A) is identified. It provides knowledge about hierarchical topo-functional structure of the system from the main functions down to the components supporting their own function. Then, dysfunctional analysis is performed (Figure 19-B) for identifying the degradation and failure modes (FMECA) and the corresponding flow deviations (HAZOP). Inter related causal relationships are identified in order to consider degradation to failure propagation. A quantification phase of the causality relationship between root causes and failure modes is performed in order to weight a cause on the failure mode against each other. Finally, monitoring parameters are identified to provide information for health indicators elaboration.

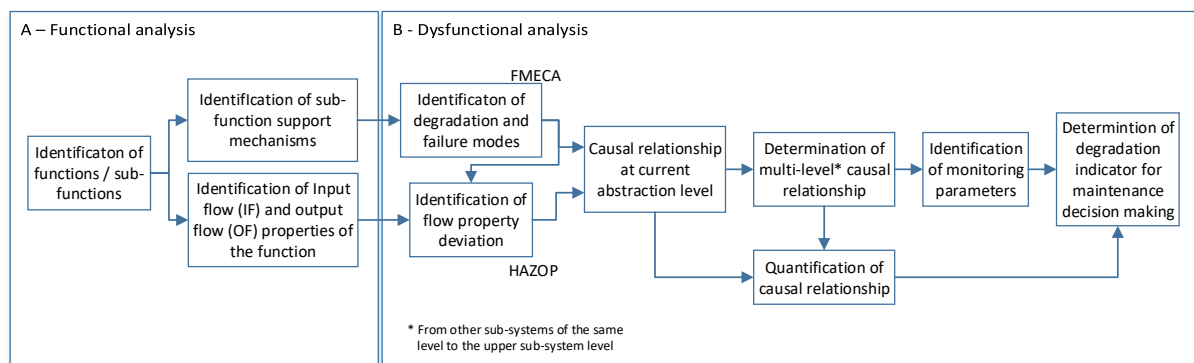

Figure 19: Methodology for monitoring parameter identification

In relation with the methodology and to face with the industrial issue, the succession of steps illustrated in Figure 19 depicted a deterministic workflow. Each step is clearly identified (in opposition to empiric or intuitive approaches) and benefits from one to another. In the sense that these key steps require knowledge or information coming from others. It results a set of information that support the identification of parameters for health indicators elaboration. The steps are divided in two processes. The first is founded on systemic aspects while the second regards integrated degradation analysis.

As structured on the foundations of previous works, the presented methodology originality (MO) focused on steps of phase B, Figure 19, and is structuring on three main considerations:

MO 1. Adaption of the notion of causality relationship up to the product manufactured by the system, to fit with manufacturing context,

MO 2. Adaption of the FMECA criticality quantification on causality relationship aspect,

MO 3. Introduction of the concept of external factor and process context, for health indicators elaboration requirement,

Following sections detail the methodological concepts and the originality defended.

2.2.2.1. Functional analysis

The functional analysis (Part A, Figure 19) allows identifying the functional structure of the system. It formalizes the interaction between the system functions down to each of the sub-systems until the component level (elementary functions) and lead to identify performances attached to each of them. It is necessary to understand the manufacturing system functioning, to define the functional interactions between components and sub-systems to then establish the dysfunctional aspect.

The system functional modelling is based on the principle of decomposition of activity into sub-activities until elementary activities supported by technological mechanism (component). This latter represents the resource used to perform the activity. Activity consumes and produces flows, as depicted Figure 20. Flows represent (Medina-Oliva, Weber, Levrat, & Iung, 2010; Santarek & Buseif, 1998):

- (i) items which are transformed by the activity - “Having to do” (HD),
- (ii) energy, resources and activity support - “being Able to Do” (AD),
- (iii) knowledge allowing how to do activity - “Knowing How to Do” (KHD),
- (iv) triggers related to the activity - “Wanting to Do” (WD).

Regarding manufacturing context, activities represent a class of process, for instance workpiece transformation (machining process, stamping process) or parts assembly (welding process, bonding process). Also, in accordance with manufacturing systems, items represent the objects resulting from the process (system theory).

These flows are characterized by a quantity of objects per unit of time which are defined by spatial, temporal and morphologic attributes. These latter can be more generally considered as functional properties, e.g. torque, speed, flow rate, etc. In the context of manufacturing system, the object resulting from the process is, most of the time, characterized by dimensional and/or geometrical attributes, i.e. quality characteristics.

Another concept of functional analysis is the system performance. It represents the ability of the system to perform its finality (goal) (Cocheteux *et al.*, 2009). The finality is represented by the system output flows. Thereby system/sub-system/component performance relates to properties of these flows (e.g. average strip flow rate, pressure of an oil flow or rotation speed of a rotation movement). The performance has only a sense by considering (i) the use conditions which provide the expected finality level, (ii) input flows such as control flows, the energies flows or main flows (flows processed by the function). Such aspects have necessarily to be considered by the monitoring steps to avoid misinterpretation.

Functions are linked through the chain of input/output flows: the input flow of a considered function corresponds necessarily of the output flow of another. The input/output flow chain will be used in the dysfunctional analysis to propagate the effect of degradation. Such formalization can be supported by a method such SADT¹⁷ coupled with notions of system theory rules (e.g. flow concept) (Cocheteux, Voisin, Levrat, & Jung, 2010). The relationships between input and output flows of each function may be constrained by some physical rules of conservation (energy or flow balance, specific features of the transformations, ...).

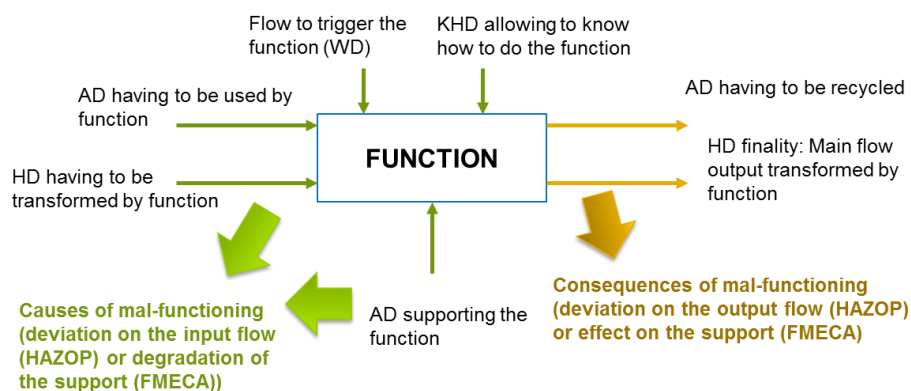

Figure 20: Knowledge formalization, illustrated by (Medina-Oliva *et al.*, 2012)

Identification of system function and related support, from system level to component level, and definition of corresponding input and output flows, objects and properties correspond to the main objective of the process illustrated Figure 18-A.

¹⁷ Structured Analysis and Design Technique

2.2.2.2. Dysfunctional analysis

Identification of degradation and failure modes and flow property deviations correspond to the next step of the methodology. It is the first step of dysfunctional analysis (Figure 18-B) which finality corresponds to find the related causes and consequences such phenomenon have on the behavior of sub-systems and system performances. Transition between normal to abnormal state of a system can be analysed in terms of the degradation mechanism of the support the function (Figure 20). This degradation is then both spread to the rest of the system through the flow exchanging between function and the propagation of the degradation mechanism (Medina-Oliva et al., 2010). The impact of component degradation on flow deviation and on downstream functions is achieved by identification of degradation modes and related consequences by the use of FMECA, while flow deviations, their causes and consequences are identified with HAZOP concepts.

2.2.2.3. Dysfunctional causal relationship

Dysfunctional causal relationship is a basic notion of the proposed approach. This approach is based on concept initiated by (J.-B. Leger, 1999) formalized by the following equation:

$$InputFlow\ state \wedge Component\ state \rightarrow OutputFlow\ state \quad (1)$$

Dysfunctional causal relationship is the chain of cause-effect relation occurring. Causal relationship between sub-systems of the same abstraction level corresponds to link of degradation modes and the relation to the support degradation to the flow deviation. Regarding particularly the causal relationship with upper abstraction level, the degradation modes leading to the upper effect will be considered as the root causes of failure mode at this abstraction level. This chain starts from the root cause, goes through the lowest component level, up to the system level. Such causality relationships have been formalized by (Muller et al., 2008) to support the formalization of a generic prognosis process. The resulting causality relationship typology is presented *Table 2*, where relation R1 corresponds to nominal functioning, relations R3, R4 and R7 correspond to the impact of degradation mode (and failure mode) on output flows, and finally, relations R2, R4 and R6 represent the impact of deviation flow on other flow deviation. It models also the degradation impact of upstream degradation mode and of flow deviation (Cocheteux et al., 2009). Further development of causality relationship formalization have been performed by (Cocheteux, 2010) to support ANFIS modelling for system performance prognostic.

		F	Flow	X_n	Nominal state
SP	Support	iF	Input Flow	X_d	Degraded state
R	Relation	oF	Output Flow	X_f	Failed state

Input Flow	Support	Output Flow	Causal relationship	Type
IF _n	SP _n	OF _n	$iF_n \wedge SP_n \rightarrow oF_n$	R1
IF _d	SP _n	OF _d	$iF_d \wedge SP_n \rightarrow oF_d$	R2
IF _n	SP _d	OF _d	$iF_n \wedge SP_d \rightarrow oF_d$	R3
IF _d	SP _d	OF _d	$iF_d \wedge SP_d \rightarrow oF_d$	R4
IF _d	SP _d	OF _f	$iF_d \wedge SP_d \rightarrow oF_f$	R5
IF _f	SP _n / SP _d or SP _f	OF _f	$iF_f \wedge (SP_n \vee SP_d \vee SP_f) \rightarrow oF_f$	R6
IF _n or IF _d	SP _f	OF _f	$(Fe_n \vee Fe_d) \wedge SP_f \rightarrow oF_f$	R7

Table 2: Causality relation typology

The above relationship typology can be synthetized with FMECA-based and HAZOP-based concepts, considering vertical and horizontal causal relationship, as following relation types:

- (i) root cause and degradation mode,
- (ii) degradation mode and degradation mode,
- (iii) degradation mode and flow deviation,
- (iv) flow deviation and degradation mode.

These 4 types of relations to be studied as a whole, materialise **the first originality MO 1**, consisting in adaptation of causality relationship leading to express the necessary concept of knowledge to consider the impact of performance deviation and degradation on the product manufactured by the system. The (i) relationship is well known and constitute the starting point of failure or degradation mode (Medina-Oliva et al., 2012). The (ii) relationship corresponds either to chain degradation mode at the same level of abstraction or different abstraction levels. A degradation mode can cause another one within the same function/component (e.g. bearing wear leading to bearing vibrations) or between other functions/components (e.g. bearing vibrations leading to shaft vibrations). The (iii) corresponds also to the propagation of failure mode between the abstraction levels. Indeed, the degradation of a bearing causes the degradation of the motor then the degradation of the performance characterized by an increase of power consumption until the breakdown of the production system. Finally, the (iv) corresponds to the impact of a flow deviation on a degradation mode. For instance, voltage surges cause motor aging.

Identification of causal relationship at current and on different abstraction levels of the system is an essential step of the methodology for monitoring parameter definition in the aim of the elaboration of health indicators (Figure 18-B). Following step consist in causal relationship quantification.

2.2.2.4. Dysfunctional causal relationship quantification

Each degradation and deviation leading to a failure mode does not have the same weight. The quantification of such a weight of causal relationship has to be evaluated to estimate causes criticality. It is, thus, proposed to adapt the standard criticality calculus of FMECA methodology, by considering occurrence (F), dynamic and probability that failure mode occurs once appearance of the cause (G), and level of detectability (D) (Table 3). **This evolution constitutes the second originality of the proposed approaches, MO 2.** Such quantification produces a general criticality indicator (risk priority number – RPN) for low level interactions: $RPN = F \cdot D \cdot G$ (Ambekar et al., 2013). The RPN is quite different from the known ones because of the consideration of the dynamic of degradation propagation into the estimation of criticality.

Frequency criteria		Non-detection criteria	
Value	Probability that the cause occurs	Value	Probability that the cause will not be detected (2)
1	Cause of failure is practically non-existent (1 fault during an average lifespan)	1	Total detection of the initial cause or the failure
2	Cause of failure appears rarely (less than 1 fault / year)	2	The failure mode or cause are partially detected
3	Cause of failure appears occasionally (1 fault / year)	3	Low detection of the failure mode or cause
4	Cause of failure appears frequently (1 fault / 3 month)	4	No detection of the failure mode or cause
		(2) Early warning sign	

Gravity criteria	
Value	Gravity of the causes leading to failures (1)
1	Minor impact: no notable impact of the cause on the failure
2	Medium impact: low probability of failure with rapid dynamic OR high probability with low dynamic of the failure
3	Major impact: high probability and rapid dynamic of failure
4	Catastrophic impact : immediate failure
5	Safety/quality : failure leading to non conformity or dysfunction for the final customer
(1) Impact on the dynamic and probability that the failure mode occurs from apparition of the cause	

Table 3: Criticality quantification proposal

2.2.2.5. Identification of monitoring parameters

Causality relationship knowledge is crucial for guiding the monitoring strategy. Also, since in predictive maintenance the anticipation ability is based on the progressive propagation of degradation, failure modes are not considered for monitoring purposes. Failure mode is assumed to result from the degradation modes. It therefore corresponds to their final state.

Monitoring of a particular failure mode can be mainly related to:

- a. the degradation mechanism itself,
- b. the causes of the degradation,
- c. the effects of the degradation mode.

Hence, sensing strategy should be focused on: usage degradation for (b), physical mechanism for (a) and flow property measurement for (b) and (c). Moreover, degradation related parameters can be merged to focus on a specific failure mode identification.

Monitoring parameters can be classified in physic characteristics of the mechanism supporting the function (e.g. temperature, vibrations, acoustic emission), system performance (via output flow properties) and resulting effects on upstream or downstream degradation mechanism or function properties (e.g. torque rise, output reduction, vibrations). System performance is particularly characterized by effectiveness (ratio of results to objectives) and efficiency (ratio of results to engaged resources).

Moreover, in accordance with the section 2.2.2.1, the process context has to be considered to avoid interpreting a degradation or deviation instead of a change in the operational context. In the same way, production rate or effectiveness of maintenance interventions can have an impact on the machine degradation or performances, as well as the surrounded environment. The contextual aspect is, thus, to consider in monitoring parameters identification to cover the *operational conditions* (contextualization of internal operation of the system, e.g. type of manufacturing product), the *functioning conditions* (contextualization regarding the system control, e.g. production rate) and the *environmental conditions* (contextualization in relation to exogenous elements, e.g. external temperature). The introduction of these concepts corresponds to the **originality MO 3** of the methodology.

Identification of monitoring parameters and related sensor solutions is the final process of the knowledge extraction methodology and constitutes a prerequisite for health indicators elaboration (**industrial issue n°2**), as depicted Figure 19. Indeed, health indicator is mainly defined as an aggregated index assessing a current global state in comparison to a nominal one, considering various aspect such as performance, on-going degradation, environment, etc. (Rizzolo, Abichou, Voisin, & Kosayyer, 2011) - an extensive definition of health indicator is given in Chapter 3, section 3.2.

The joint consideration of machine kinematic and product quality is supported by the relationship of component/sub-system/system, their related functions and the concept of input and output flows which enable the analysis of causality relationship (functional and dysfunctional). Nevertheless, the textual form of all these concepts can be confused and lead to interpretation, while the methodology is intended to be deterministic to avoid syntactic and semantic ambiguity. So, to overcome any ambiguity and provide a certain determinism in the approach (**scientific issue n°1**), the next section proposes a formalization of the concepts and their functional/dysfunctional relationship towards a meta-model.

2.3. Proposal of a meta-model to support monitoring parameter selection for health indicator definition

To face with the lack of knowledge storage and reuse, and difficulties in interpretation, it is proposed to support the previous methodology by a meta-model formalizing all the generic knowledge concepts, their attributes and their rules required to identify relevant parameters to be monitored for the elaboration of health indicators, in compliance with MIMOSA-OSA/CBM standards. This formalization, based on UML with MEGA¹⁸ tool, is integrating:

- Knowledge concepts of system functional analysis to identify the basic items on which the meta-model is constructed,
- Knowledge concepts of system dysfunctional analysis to identify, from relevant FMECA and HAZOP methods and some extensions, the items to support causality from degradation to deviation necessary for health indicators elaboration (Laloix, Vu, Voisin, Romagne, & Iung, 2018).

UML formalism was adopted as modelling methodology by the reason of its object-oriented ability to handle concepts like inheritance, polymorphism, abstraction, encapsulation... (Desforges, Habbadi, & Archimède, 2011). Those features enable, for instance, to consider various types of components (e.g. rotating electric motor or linear electric motor), constituting various types of sub-systems (e.g. ball-screw feed-drive type or linear motor feed-drive type) for the realisation of a same function (e.g. displacement of cutting tool). The object-oriented approach enables to define common interfaces for knowledge of concepts that are implemented according to each system's technological feature.

The meta-modelling **only concerns the data or object view** for ensuring the semantics and syntax consistency of the knowledge concepts manipulated (closed to ontology concepts (Matsokis, Karray, Chebel-morello, & Kiritsis, 2010). The treatment (processing) aspect is not covered since it is expected to establish a data-centered repository, the objects representing the manipulated data. Treatments (processing) are approached, in the thesis context, by using the specialist tools (such as FMEA monitoring) having access to data by exploiting the common repository.

To meet the above-mentioned goal, a meta-model is used to define and structure the rules and concepts for manufacturing system health indicators elaboration considering system-product relationship, towards information coming from relevant monitored parameters.

¹⁸ <https://www.mega.com/en/product/hopex>

2.3.1. Meta-modelling formalization

Modelling is the process to provide formal description of real-world element through abstractions. Meta-modelling is about the model of the models and is most commonly referred to the modelling language (Krause & Kaufmann, 2007). This describes the common syntax, semantic or structural features of a class of models which provides elements for constructing models in this domain and helps to establish an unified and standard modelling system for certain domain (Yang, Qiao, Zhu, & Wulan, 2016).

A popular approach to the design of system modelling framework is Model Driven Architecture (MDA), proposed by the Object Management Group (OMG) (Soley & OMG Staff Strategy Gropu, 2000). MDA was initially designed to give a sound and theoretic and methodological framework of code generation from ULM models, but is today used to describe abstraction in other modelling domains like system modelling (Krause & Kaufmann, 2007). MDA belongs to Model-driven engineering (Bocciarelli, Ambrogio, Caponi, Giglio, & Paglia, 2014), engineering field supported by Model-based systems engineering (MBSE). MBSE is defined by INCOSE¹⁹ as the *“formalized application of modelling to support systems requirements, design, analysis, verification and validation activities beginning in the conceptual design phase and continuing throughout development and later life cycle phases”* (INCOSE, 2007). Its main purpose is to provide a methodology, which can be defined as a collection of related processes, methods and tools (Bocciarelli et al., 2014). Thus, MDA can be considered as a specific MBSE method (Vicente, Neto, Fernando, & Loja, 2017). The MDA framework specifies four conceptual levels, as depicted in Figure 21.

The lowest level (M0) presents different subjects for modelling: each of them representing the lower abstraction level, called as the universe of discourse. It represents the particularization stage, where manufacturing system is distinct, considering its particular organic composition, technical specificity, singular history, location etc.

Next level (M1) contains different models of each of the universe of discourse. These models belong to diverse independent domains of interest with regards to the universe of discourse that they represent. The same kind of interest is applicable to different universes of discourse, therefore models of different universes of discourse may belong to the same domain of interest. It is named in the rest of the thesis **“reference model”**. Reference model is a partial-generic model related to a manufacturing system typology (e.g. robot, press, machine tool). M0 models are particularized from the associated reference model. For a given manufacturing system, its corresponding reference model defines relations between different categories that exist for this manufacturing system, as well as their related meaning.

¹⁹ INCOSE: International council on Systems Engineering, <https://www.incose.org/>

The level (M2) presents meta-models. It corresponds to the higher abstraction level of the thesis system modelling. Globally, a meta-model is dedicated for each of the domain of interest relevant for the M1 models. For a given meta-model, its corresponding meta-model defines relations between different conceptual categories that exist in the domain models, as well as the meaning of each modelling concept. It structures the conceptual categories to be instantiated to create reference model. It defines relations between the conceptual categories, as well as the meaning of each modelling concept. Manufacturing systems reference models are obtained by means of meta-model instantiation (Laloix et al., 2018).

The final (M3) level presents the meta-meta level and is not discussed in the system modelling presented in the thesis. Meta-meta-model contains the meta-characteristics for all the domain specific meta-models and should be designed to allow for definition of all the existing in the scope of interest meta-models and for their unification under a common framework (Naumenko & Wegmann, 2003).

In synthesis, “a metamodel is a special kind of model that specifies the *abstract syntax* of a modeling language. It can be understood as the representation of the *class of all models* expressed in that language. Metamodels in the context of MDA are expressed using Meta-Object Facility (MOF)” (Atkinson & Kühne, 2003). OGM specification to facilitate a standardized way of metadata management, MOF is used to define the meta-model of UML (Krause & Kaufmann, 2007). For more information, refer to (OMG, 2006).

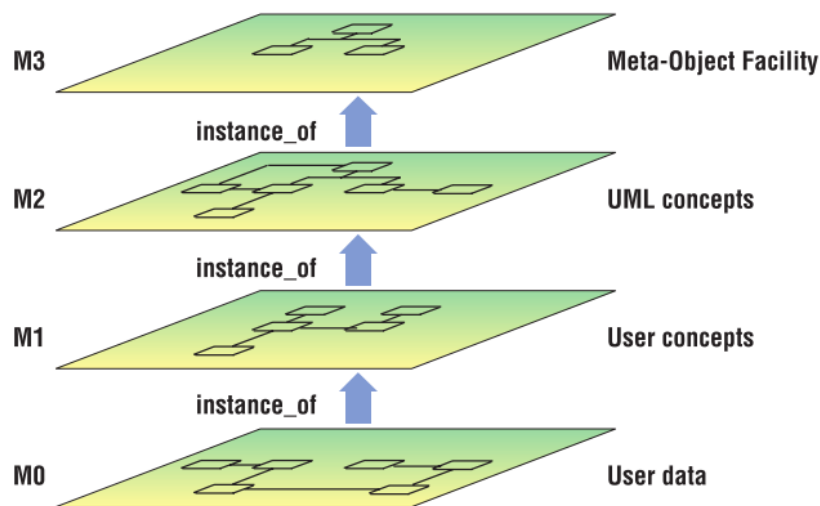

Figure 21: Fourth-levels of the MDA approach (Atkinson & Kühne, 2003)

According to the construction method, meta-model is constituted by **classes**, representing in the present case the concept of knowledge, **attributes**, representing classes characterization, **class relationships**, associated with cardinalities (or multiplicities) expressing the type of relation and rules of class association. Cardinalities are expressed in Table 4. An illustration of x and y class association with cardinality [1..*] is given Figure 22.

Multiplicity	Signification	Syntax
0..1	No instance or one instance	A class x can be linked with a class y
1..1	Exactly one instance	A class x is linked with a class y
0..*	Zero or more instances	A class x can be linked with, at least, a class y
1..*	At least one instance	A class x shall be, at least, linked with a class y
Subtype	Considered as a specialized form of the supertype	Class x is subtype of class y

Table 4: Cardinality and associated syntax

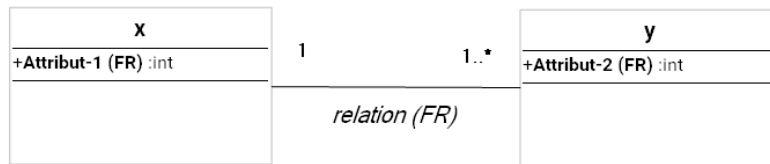

Figure 22: x and y classes association

Meta-model has been defined with compliance to MIMOSA modeling by constituting a data repository in relation with OSA-CBM functional steps. Thus, it is interesting to note the importance of sensing and monitoring aspect, particularly towards the Data Acquisition, Data Manipulation, State Detection and Health Assessment OSA-CBM models. Nevertheless, causality relationship is not clearly expressed, and models are component/machine oriented with no consideration with quality impact. This meta-model is also compliant with IEC/ISO 62264 standards.

Also, interested knowledge formalization concern the meta-modeling work performed by (Deeb, 2008) related to the formalization of quality concepts and maintenance standards represented by Ishikawa diagram, and FMEA and SPC method. It introduced the product concept as resulting from a process and process guided by requirements in relation with the quality requirements. Causality aspect is also partially addressed (component oriented). **The proposed formalization enhances this modeling with the consideration of monitoring aspect and health indicator elaboration.**

Thus, the proposed meta-model is the basis to a systematic formalization of necessary knowledge of concepts for monitoring parameters identification and for manufacturing system health indicators definition. Meta-model (M2) validation and credibility are demonstrated towards the elaboration of various reference model (M1) by meta-model instantiation. Then, reference models (M1) are particularized to provide singular manufacturing system model (M0) in consistence with class of manufacturing application.

2.3.2. Knowledge concepts of functional analysis

In relation with the section 2.2.2.1, the functional analysis corresponds to a process decomposition in functions and sub-functions until elementary functions supported by technological mechanism. Thus, the global function is associated to the global system (higher level of abstraction), and each function is associated to a sub-system until the component level. A system owns specific attributes such as its name, its class, its type ... Each (sub)function achieves finality. It consumes Input flows and produces Output flows materializing, in sense of system theory, knowledge related to the finality, the know-how, the energies, the resources, the information ... (Medina-Oliva et al., 2012).

The physical manufacturing system is represented by the *System* class. It represents the higher abstraction level of manufacturing system decomposition. A System S is composed of sub-systems S_n , which are in turn composed of components S_{nm} (2)

$$S = \{\{S_{11} \dots S_{1a}\}, \{S_{21} \dots S_{2b}\} \dots \{S_{n1} \dots S_{nm}\}\} \quad (2)$$

where n represents the total number of sub-systems constituting the manufacturing system, a the number of components under the first sub-systems, b the number of components under the second sub-system and m the number of components under the n^{th} sub-system.

As a manufacturing system, sub-system and component realise a function, functional decomposition can be noted as:

$$F = \{\{F_{11} \dots F_{1c}\}, \{F_{21} \dots F_{2d}\} \dots \{F_{i1} \dots F_{ik}\}\} \quad (3)$$

where i represents the total number of sub-functions decomposing the manufacturing system function, c the number of elementary functions under the first sub-function, d the number of elementary functions under the second sub-function and k the number of elementary function attached to the i^{th} sub-function. In compliance with MIMOSA OSA-CBM standard, a function is always associated with an item, thus, manufacturing system, sub-system and component are necessarily associated with a function. However, a same function can be performed by various type of system/sub-system/component (technological aspect). It is stated in the rule n°1. Cardinalities (multiplicities) are specified in brackets.

Rule n°1: A class Function shall be, at least, linked to a class System. The cardinalities have to be understood as [1 - *].

This represents vertical decomposition of the manufacturing system. Horizontal relationship (i.e. connection between sub-systems and components at the same level) is materialized by the flows exchanged between functions. It is materialized by *Main flow* (Fl_{MF}) concept, corresponding to “Having to Do” (HD) materializing the Input/Output (I/O) finality, “Knowing How to Do” (KHD) materializing the I/O knowledge, “being Able to Do” (AD) representing I/O energies, resources, activity support and finally “Wanting to Do” (WD) materializing the I/O triggers (Medina-Oliva et al., 2012).

$$Fl_{MF} \subseteq \{HD\} \cup \{KHD\} \cup \{AD\} \cup \{WD\} \quad (4)$$

Each flow is characterized by a quantity of objects per unit of time, and each flow and object are characterized by properties (e.g. weight, length for the final workpiece being one object among the flow of produced parts). Related to system theory, these properties referred to shape, time and space.

Rule n°2: A class Function shall be, at least, linked with a class Main flow [1 - *].

Rule n°3: Each class Main flow is characterized by its attribute in term of HD, KHD, AD or WD.

In link with the Chapter 1 postulate, manufacturing system is designed in the aim to produce or transform a product in compliance with its related quality requirements. From these initial requirements are derived machine process requirements - *Functional requirement* class, whose fulfilment ensure to produce with the required performance - *Performance requirement* class. Functional requirements correspond to the action expected to be performed by the system, while performance requirements regard flow or object of flow properties.

Rule n°4: Classes System and Function shall be, at least, linked with a class Function requirement [1 - *].

Rule n°5: Classes Functional requirement and Main Flow shall be, at least, linked with a class Performance requirement [1 - *].

The performance has only a sense by considering (a) the use conditions which provide the expected finality level - *Process context* class - and (b) input flows such as control flows, the energies flows or main flows (flows processed by the function) - *Main flow* class (Figure 23). All these concepts are derived from the higher abstraction level of the manufacturing system (machine) to the lower level (component).

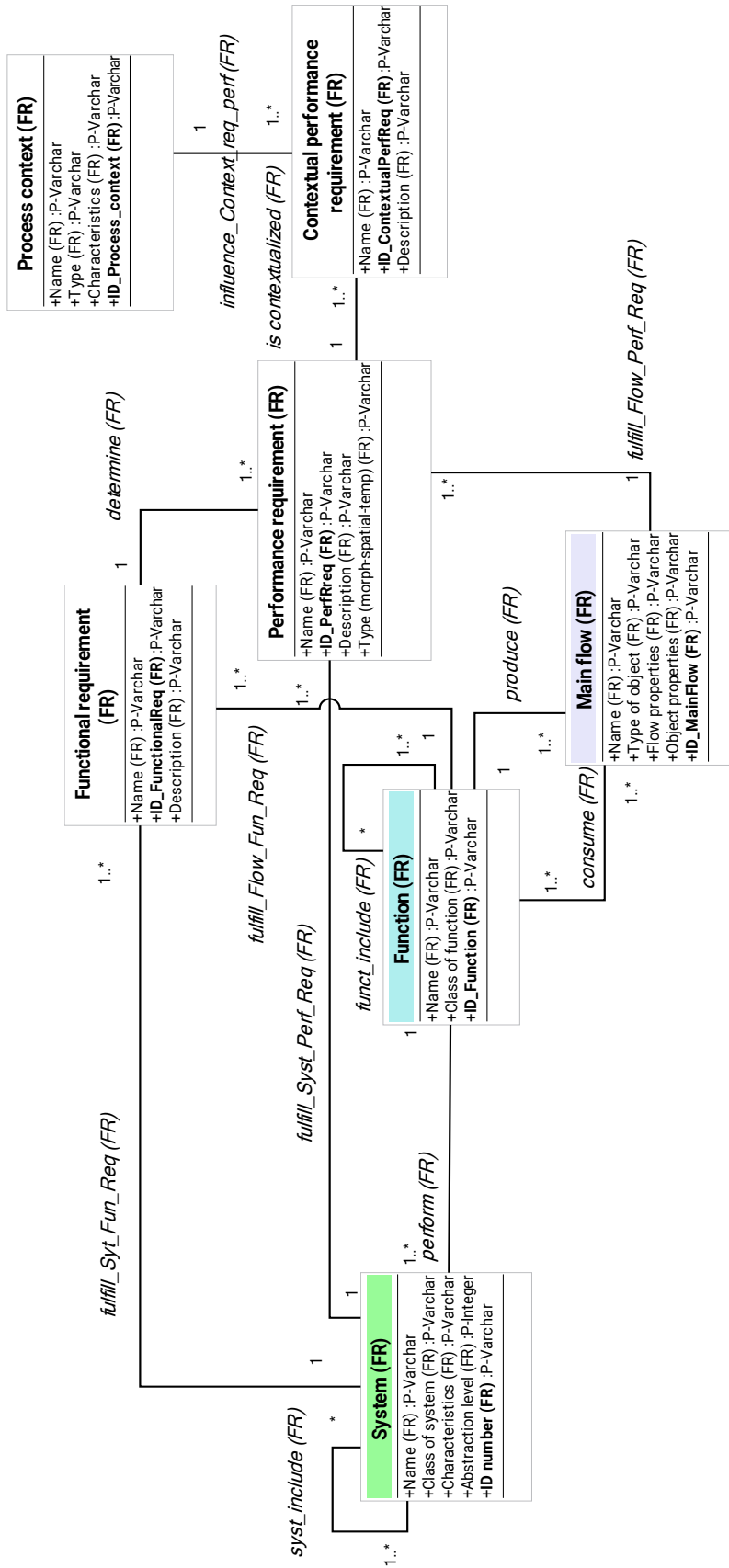

Figure 23: Extract of the meta-model related functional concepts of knowledge

2.3.3. Knowledge concepts of dysfunctional analysis

According to the section 2.2.2 and related proposed originalities, from the concepts of system, function, and flow, related to functional aspect, it is now necessary to focus on dysfunctional one. Dysfunctional analysis is done by considering concepts of approved FMECA and HAZOP methods knowing that FMECA is oriented toward technical aspects (machine, component) and leads to the identification of degradation and failure mode, while HAZOP is focused on flow deviation (see section 2.2.2).

Thus, knowledge concepts introduced by FMECA is *Degradation mode* while knowledge concepts introduced by HAZOP is *Flow Deviation*. Both are attached with a *Criticality Quantification* class. Association between these concepts of degradation mode and flow/property deviation is a first step on linking the product/process joint consideration. It is formalized by causality relationship Figure 24.

Rule n°6: A System class shall be, at least, linked with a class Degradation mode [1 - *].

Rule n°7: A class Main flow shall be, at least, linked with a class Flow Deviation mode [1 - *].

Moreover, the notion of criticality is added to the meta-model through Criticality Quantification class. It represents the importance of degradation mode or deviation mode on the process and is evaluated by ranking criteria. The ranking criteria appear on Criticality Quantification attributes.

Rule n°8: Classes Degradation Mode and Flow Deviation are both linked with a class Criticality quantification [1 - 1].

Also, it is necessary to identify manufacturing systems internal and external interactions. Internal interactions mean the components interactions and their impacts on the sub-systems, and sub-systems interactions and their impact on the output product (focus on the topology also). External interaction represents exogenous constraints influencing the functioning of the manufacturing system (Bernard, Labrousse, & Perry, 2006), or manufacturing system itself influencing the functioning of others systems. The concept of flow devoted to *Function* concept leads to the introduction of *Disturbance flow*, considered as *External factor* influencing the criticality quantification (Gravity or Occurrence) and triggering degradation mode.

Rule n°9: A class Function can be linked with a class Disturbance Flow [0 - *]. This will impact Criticality Quantification and Degradation Mode classes by the way of External factor class.

Rule n°10: A class External factor shall be, at least, linked with a class Degradation Mode [1 - *].

Rule n°11: A class External factor is linked with a class Criticality quantification [1 - 1].

In compliance with causality relationship, a flow deviation can trigger another flow deviation (causality_FD_FD), but also another degradation mode (causality_FD_MD). As well as a degradation

Rule n°12: A class Degradation Mode can be linked with, at least a class Degradation Mode and a class Flow deviation. As well as a class Flow Deviation can be linked with, at least, a class Flow Deviation and Degradation Mode [0 - *].

Other rules can be added to the formalization regarding monitoring parameters, contextual consideration and health indicators aspects.

Monitoring parameters

The strategy to identify the monitoring parameters is directly issued from functional and dysfunctional causality relationship. Thus, monitoring parameters can be both focused on the performance associated to the function and its deviation or on the degradation/failure mode related to the component. Furthermore, this causality formalizes a real link between degradation mode and flow deviation. Consequently, monitoring parameters represent either the symptoms of the degradation (e.g. temperature, vibrations), the system performance (via output flow properties) and resulting effects on upstream or downstream degradation mechanism or function properties (e.g. torque rise, output reduction). Formalized relationship between classes related to these concepts of knowledge is illustrated Figure 25. It can be associated with Data Acquisition (DA) layer of OSA-CBM standard.

Rule n°13: Classes Degradation Mode and System can be linked with the class System physical parameter [0 - *].

Rule n°14: Classes Main flow and Flow deviation can be linked with the class Flow physical parameter [0 - *].

Rule n°15: Classes System physical parameter and Flow physical are subtypes of the class Physical parameter [1 - *].

Then, physical parameters can be monitored by sensors. Some of them are directly embedded in manufacturing system due to the physical information necessity for machine good operation. These are managed by manufacturing system itself and a challenge is to catch such information. Others are not monitored by the machine but sensing solution is available as off-the-shelf solution. Economic evaluation can be performed to estimate if the physical parameter monitoring is really necessary, considering the upstream causes related monitoring and downstream effects related monitoring (Tiddens et al., 2018). Finally, some physical parameters cannot be monitored due to the lack of sensing solution. In this case, the corresponding phenomenon cannot be precisely identified: only by the monitoring of the related cause(s) or effect(s), potentially generating a group of ambiguity for root causes or degradation mode detection.

Rule n°16: A class Physical parameter can be linked with a class Sensor whose attributes will precise if this latter is in situ or commercial (added to the machine) [0 - 1].

Contextual consideration

Information has only a sense when interpreted in the appropriate context. Associated context of monitored data is considered by (Voisin et al., 2010), towards extension of MIMOSA standards for prognosis processes formalization, as `OperationalData`, `EnvironmentalData`, `MaintenanceData`, `ConditionMonitoringData`. It defines the context such as asset/segment information, models, data... maintenance actions, production and environmental conditions.

In the present case, context represents **functioning conditions** (e.g. production rate, maintenance intervention efficiency, maintenance policy, workpiece diversity), **environmental conditions** (temperature, hygrometry) and **operational conditions** (e.g., machining operation, cutting tool type, cutting tool life time) (Figure 26).

Rule n°17: A class Performance requirement shall be, at least, linked with a class Contextual performance requirement [1 - *].

Rule n°18: A class Process context shall be, at least, linked with a class Contextual performance requirement [1 - *].

Rule n°19: A class Process context shall be, at least, linked with a Degradation Mode class [1 - *].

Rules n°20: Classes Functioning conditions, Environmental conditions and Operational conditions are subtypes of the class Process context.

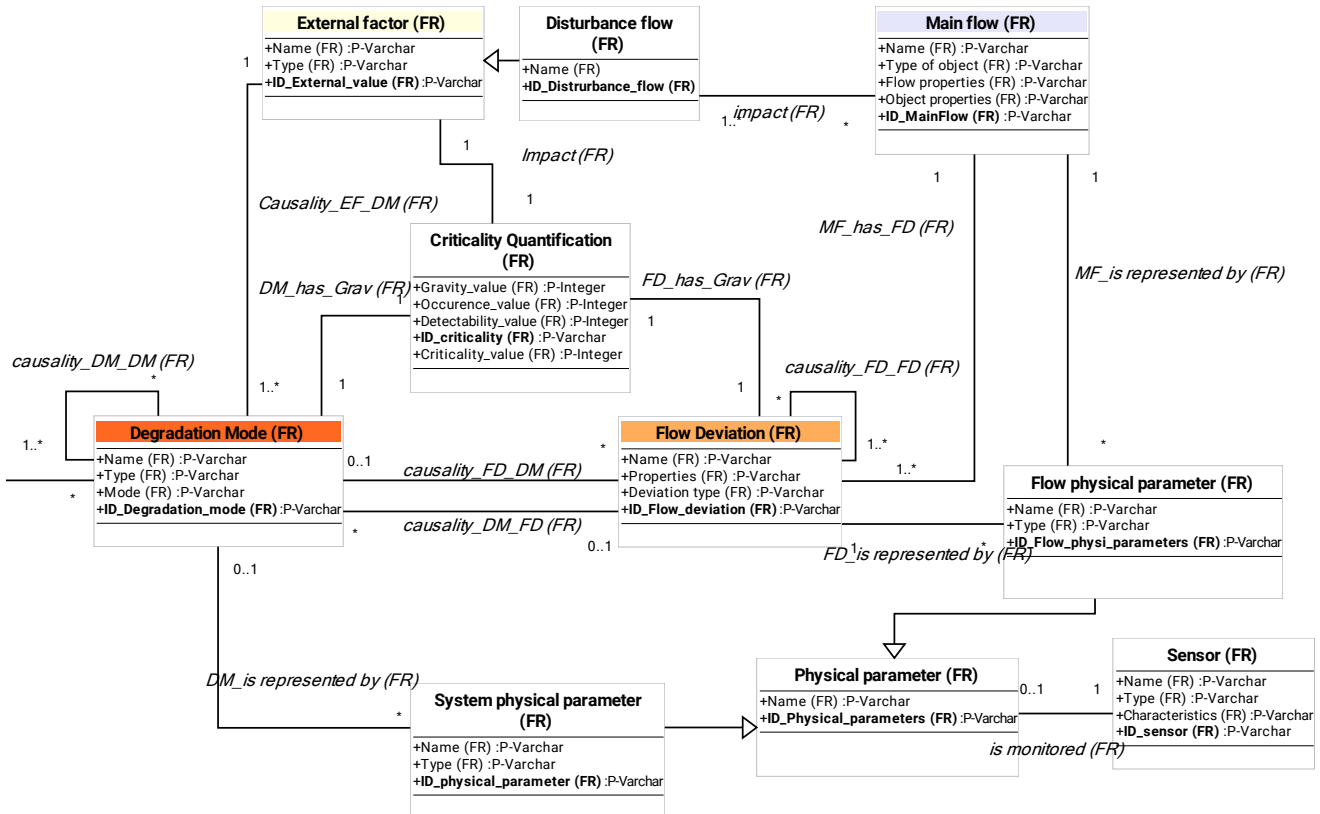

Figure 25: Extract of meta-model related on monitoring concepts of knowledge

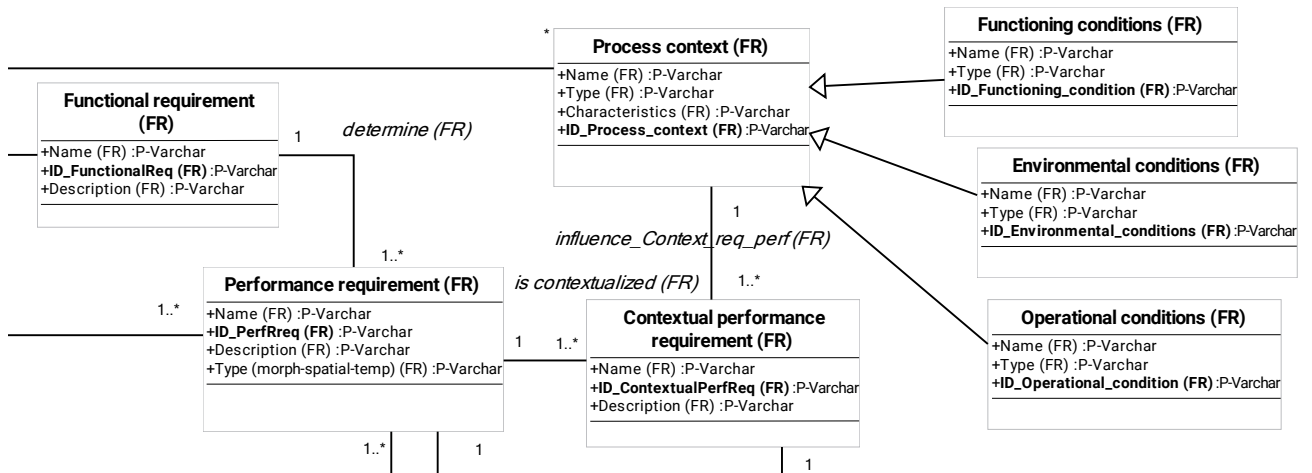

Figure 26: Extract of meta-model related on contextual concepts of knowledge

Health indicators elaboration

The process of health indicator elaboration is formalized by the relationship between Physical parameter monitoring, Algorithm and Health indicator (Figure 27).

Rules n°21: Classes Degradation mode and Flow deviation are respectively linked with a class Degradation indicator [1 - 1].

Rules n°22: A class Performance requirement is linked with a class Performance indicator [1 - 1].

Rules n°23: Classes Degradation indicator and Performance indicator are subtypes of the class Health indicator.

In regards with the incoming monitored parameters, the influence of the process context is considered in health indicator process elaboration by the relationship between Contextual performance requirement class and Algorithm class.

The class Algorithm represents the mean of indicators calculation. It can either represents the mean to transform monitored parameters in the aim to be commensurable to each other to provide indicators (performance and degradation), or the mean to combine them into a single synthetic index (health indicator) in the aim of decision making.

Rules n°24: A class Contextual performance requirement is, at least, linked with a class Algorithm [1 - *].

Rules n°25: A class Processed signal can be linked with, at least, a class Algorithm [0 - *].

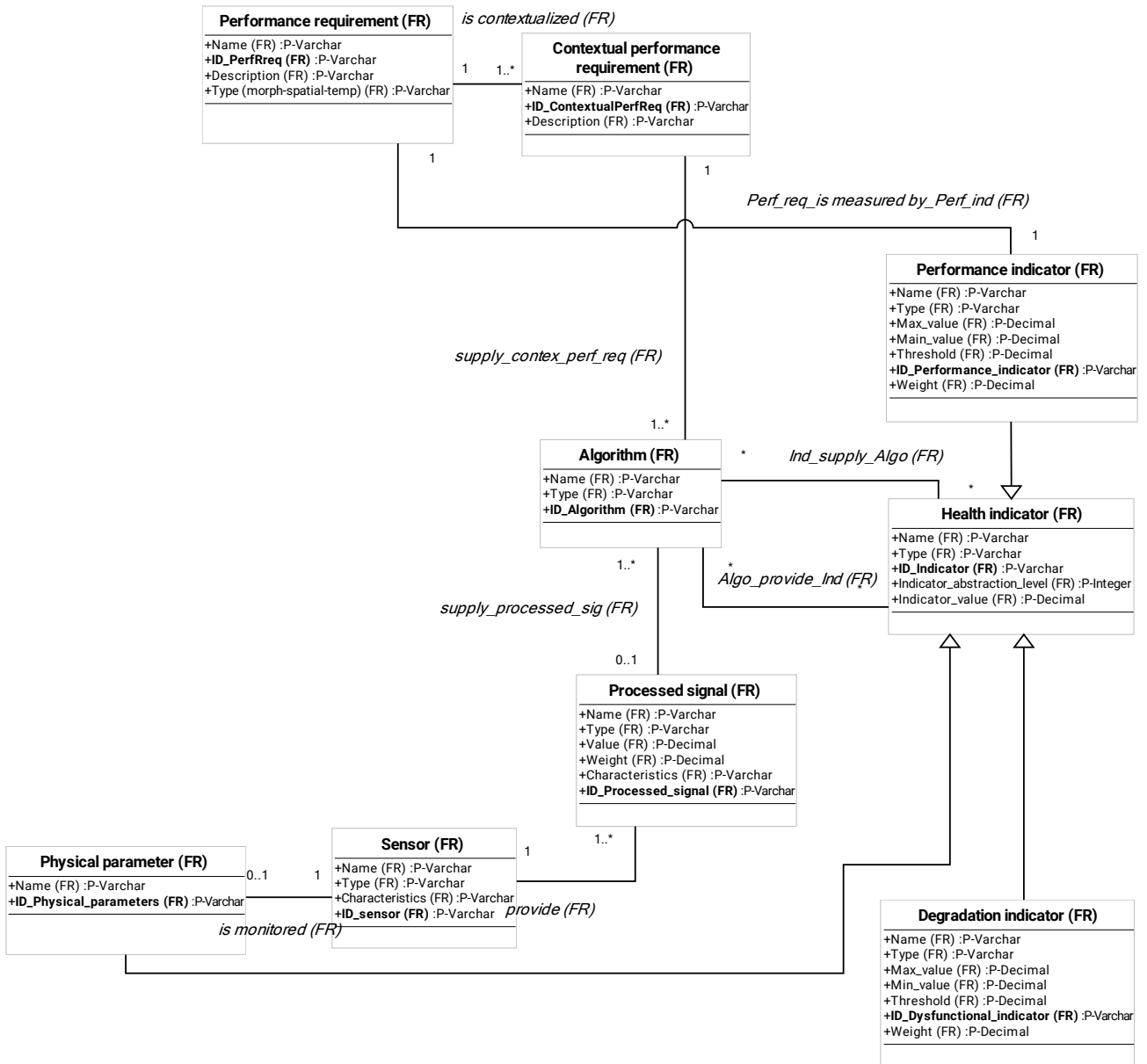

Figure 27: Extract of meta-model related on health indicator elaboration concepts of knowledge

Thus, the current global meta-model is composed of all the concepts, attributes and relationships to generate health indicators of combined process/product consideration. The process of health indicator elaboration (Algorithm and Health indicator relationship) is deeply defined in Chapter 3. This knowledge is the key inputs of the decision-making process.

The next step is to consider meta-model validation to guide credibility of such formalization.

2.4. Instantiation of meta-model to different manufacturing system application classes

Validation of the meta-model is then necessary. It is performed by meta-model instantiation on a class of manufacturing system represented by machine tool. Principles of meta-model instantiation are defined in this section, leading to an iterative meta-model validation procedure.

2.4.1. Reference model definition

According to the hierarchisation defined by the OMG, relation between the different modelling level is illustrated in relation with the thesis context (Figure 28). The meta-model (M2 level) instantiation leads to the elaboration of a partial generic models, i.e. reference model, dedicated to an application class of manufacturing system, e.g. machine tool, robot, (M1 level) whose particularization leads to design specific manufacturing system model referred to application class (M0 level). This procedure, at this time, is only a first step of validation which gives a first confidence degree to the meta-model. Nevertheless, the procedure need to be continued on several other application cases to achieve a required validation of the meta-model. In addition, verification test could be, in short term, initiated to provide formal proof on the meta-model (structure and content).

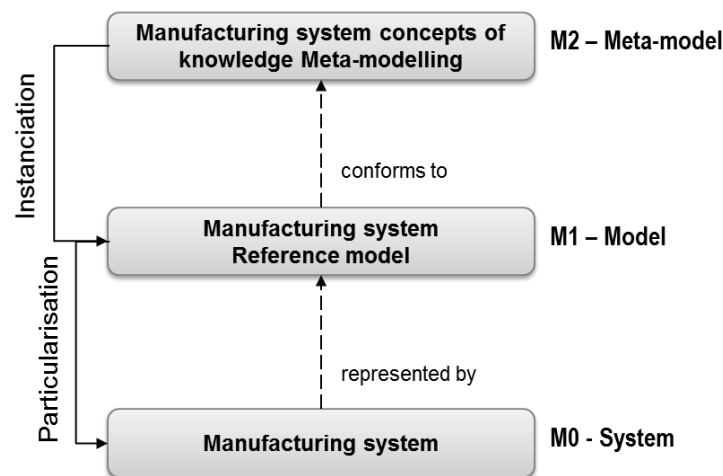

Figure 28: Meta-model instantiation framework

The interest of reference model is the ability to contain a wide diversity of technical architecture of manufacturing system typology and to be enriched whether a new manufacturing system does not fit current models. Indeed, a reference model is dedicated to a class of application, in the way that it supports functional and technological knowledge of this class of application. For instance, regarding the machine tool application case, the functional aspect is supported by the classes Function, Main flow and Flow deviation and respectively can correspond to *transform workpiece*, *machined workpiece* and *chips*, and *workpiece dimensional characteristic deviation*. The technological aspect is more supported

by the classes System with sub-system relationship, and Degradation mode, which can respectively correspond to *machine tool*, *spindle* and *defective tool clamping*. Reference model objective is to contain all knowledge in order to be able to address each of the specific occurrence of the application class, the potential evolution of functionality and technology. Thus, the knowledge contained in the reference model is resulting from the diversity of systems in a considered application class. In this way, there is a partial genericity between different models of a same application class with shared functional and technological characteristics by means of structured classes and relationships. For instance, let's consider the machine tool application case. It exists different types of machine depending on the degree of freedom: 3-axis, 4-axis and 5-axis machine tools. Each type of machine share functionalities but is structurally different. Another illustration is provided by axis case. The same function is shared by both sub-systems, i.e. displace linearly the cutting tool, but their technological aspect is different (Figure 29). This knowledge is important since it determines the inherent degradation modes and associated monitoring parameters.

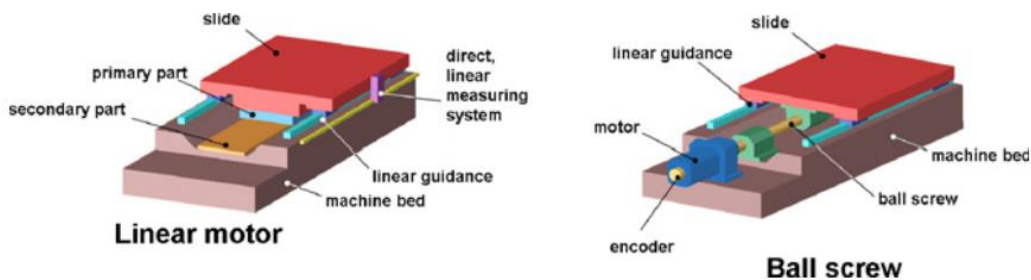

Figure 29: Linear and ball-screw drive mechanisms (Altintas et al., 2011)

In this way, two types of monitored parameters can be highlighted: the generic ones, which are related to the functional aspect and regards the flows, and the component-oriented ones, which are related to the technological aspect and regards the degradation mode.

Then, reference model particularization will represent a sort of selection phase depending on the technical specificity (architecture and technology) of the considered manufacturing system. In the sense that, once the reference model is established, particularization phase consists in selecting the proper type of machine considered, and right type of sub-systems and components technology (see Chapter 4). In that way, the same reference model (“Machine tool” class of application) can be used for obtaining, by particularization procedure, several specific models such as GROB G520, GROB BZ560 or COMAU SmartDrive in the frame of Renault.

2.4.2. Instantiation phases

Meta-model instantiation procedure phases develop progressively the reference model dedicated to manufacturing system health indicator elaboration. The main steps of the meta-model instantiation procedure are the following:

Step 0. Selection of class application to be modelled [instantiation of *system* class].

Step 1. Identification of the topo-functional structure decomposition [instantiation of *system* class (i.e. representing lower abstraction levels)]. It consists in breaking down the physical manufacturing system (class of application) into sub-systems, components, based upon user-defined boundaries. The manufacturer defines the levels of its system based upon the maintenance practices (Weiss & Qiao, 2017). It is translated into the levels that the manufacturer cares to monitor for performance or health degradation, the levels at which maintenance is performed, and controlled during the manufacturing process (Weiss et al., 2018). Diversity of the considered manufacturing system typology have to be determined. Indeed, the Reference model have to be encompassed in relation to the manufacturing system typology.

Step 2. Identification of system/sub-system/component related function and flows [Instantiation of *function* and *main flow* classes]. The completing of this step may requires substantial time commitment, especially during the first iteration of manufacturing system decomposition. Nevertheless, the step is essential for functional relationship knowledge modelling and for expliciting the machine-product relationship.

Step 3. Identification of system/sub-system/component related functional and performance requirements [Instantiation of *functional requirement* and *performance requirement* classes]. Functional requirements are related to the system (what is expected from the system/function?), while performance requirements possess a notion of quantification (to what level of precision must satisfy the system?). Both lead to quantify the deviation of system performance.

Step 4. Identification of manufacturing system process context [Instantiation of *process context* class and related *functioning context*, *environmental context*, *operational context* sub-classes]. The process context, at this stage, consists essentially in identifying the potential different functioning conditions (e.g. production rate, maintenance policy), operational conditions (e.g. cutting tool diversity), and environmental conditions (temperature, proximity with other machines) that could have an impact on the performance requirements. Indeed, machine functioning (and then requirements) is potentially not the same regarding the diversity of workpiece to process.

Step 5. Identification of manufacturing system degradation mode and flow deviation on the basis of organic system decomposition and related function [Instantiation of *degradation mode* and *flow deviation* classes]. This step is important in the identification of horizontal and vertical causality

relationships, inside and between components and sub-systems, and their impact at the machine level (degradation mode) and on the product properties (flow deviation).

Step 6. Identification of physical parameters, associated monitoring solutions corresponding to each degradation mode, flow deviation and indicators definition [Instantiation of *physical parameter* and *sensor* classes, then of *performance indicator*, *degradation indicator* and *health indicator* classes]. The identified physical parameters and related sensing solution (when this later exist) stand at the basis of manufacturing system indicators definition. Indeed, functional and dysfunctional indicators result in monitored parameters commensurability and decontextualization. Then, their combination/aggregation will provide degradation indicators at higher abstraction level (i.e. from component to sub-system) or health indicators of each element (i.e. components, sub-systems) of the manufacturing system. This process of elaboration is the core contribution of the Chapter 3.

Thus, from the association of the identified monitoring solutions and the defined indicators, the sensing strategy can be assessed by facing the criticality of degradation identified in the previous step and the ability of sensors to be implemented. These steps lead to the constitution of the necessary inputs knowledge dedicated to the process of health indicator elaboration (Figure 30).

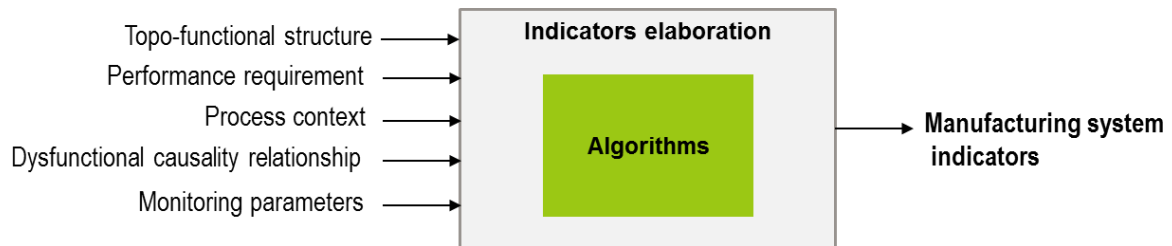

Figure 30: Necessary manufacturing system knowledge to support health indicator elaboration

The instantiation principles have been mainly used for the realization of a reference model referring to machine tool application class because this class is our research object as already explained in section 1.2.1 of Chapter 1.

2.4.3. Machine tool reference model

The machine tool reference model has to contain all the knowledge expected to be exploited for identifying relevant parameters to monitor in the way to implement predictive maintenance for this category of machine. The reference model is created from instantiation of the meta-model items. This results in a high capacity of model portability from a machine tool case to another. Indeed, machine tool share the same upper abstract level subsystems such as electro spindle, linear axis, cutting tool storage unit, etc. Only when the level comes to technical ones, the models can significantly differ.

Our machine tool reference model is based on functional analysis of the machine (SADT analysis) knowledge from machine tool manufacturer documentation, literature review (P.

Vichare, Nassehi, & Newman, 2009) and field expertise extracted from Renault Cléon factory practices, Return Of Experience (REX) and experts.

As an illustration, machine tool instantiation is represented by about **40** occurrences of the class system with as much corresponding class of function, and about **50** classes of main flow. Hence, from the component level up to the system level, has been identified about **200** degradation modes and **150** flow deviations, which finally contribute to the product quality deviation (considered as properties deviation of the machine tool function output flow). Therefore, the development of meta-model instantiation on a machine tool sub-system - linear axis - is given in the following, by focusing on the main items (not all the occurrences) in order to make the reference model creation clearer.

Instantiation procedure (made by means of MEGA tool) starts by creating, from system class of meta-model, a class *machine tool* (**Step 0**) and by identifying its topo-functional decomposition (**Step 1**). Then, related to system, sub-system and components are associated a function (**Step 2**). Machine tool function corresponds to *transform workpiece* and represents an instance of function class. It is constituted of *spindle unit*, which function corresponds to *rotate cutting tool*, *linear axis*, which function corresponds to *displace linearly cutting tool*, *rotative axis*, which function corresponds to *rotate workpiece*, and *tool change unit*, which function corresponds to *provide and store cutting tool* (Figure 31). It is specified, in machine tool attributes, the abstraction level (system level) and characteristics (5 axis machine tool). **Step 1** and **Step 2** can be performed until component level. In that way, linear axis function is decomposed into elementary functions such as (i) *transform electrical energy into rotational mechanical energy*, (ii) *transmit motor shaft rotation to ball-screw*, (iii) *guide ball-screw rotational movement*, (iv) *transform ball-screw rotational movement into table linear displacement*, (v) *monitor table position* and (iv) *guide table linear displacement*. Each of elementary functions is respectively supported by (i) *electrical motor*, (ii) *coupling*, (iii) *bearings*, (iv) *nut*, (v) *sensors* and (vi) *guides*.

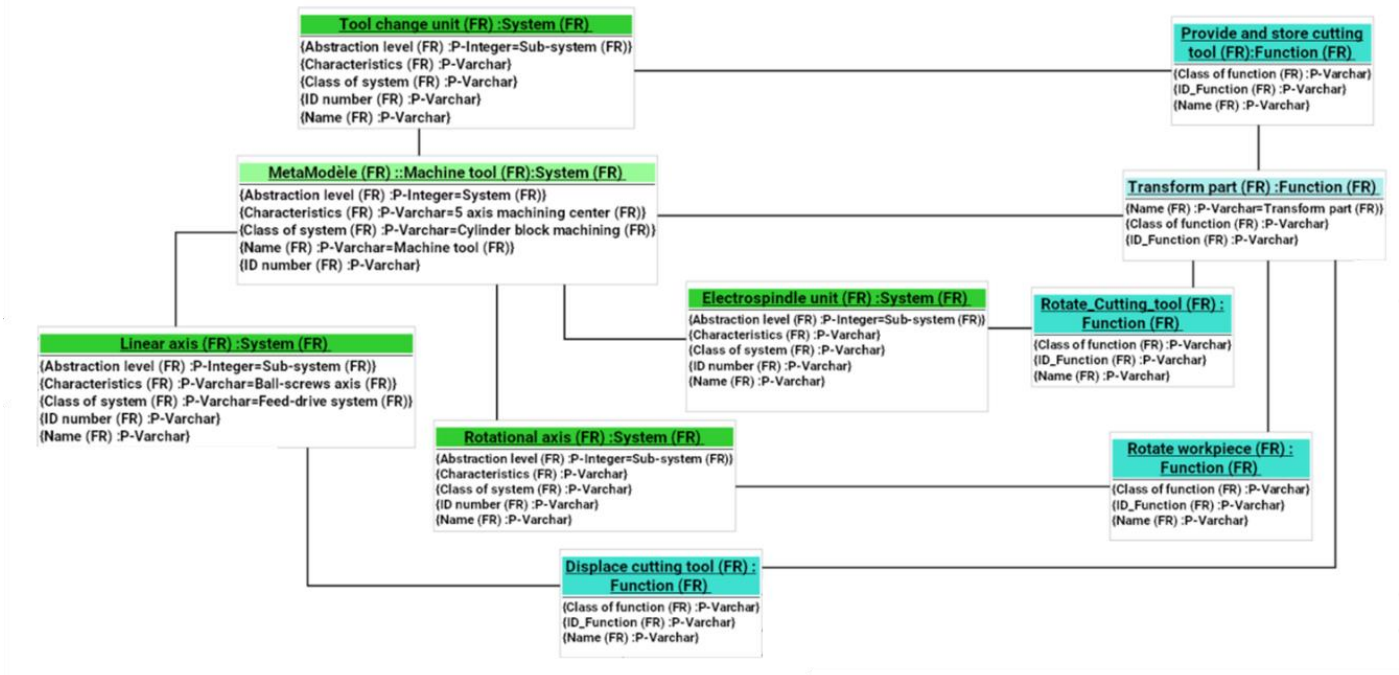

Figure 31: Extract of Machine tool reference model related on functional aspects

Machine tool function consumes and produces flows. Related instantiated input flows are *raw workpiece*, *cutting tools*, *energies*, and output flows are *transformed workpiece* and *metal removal*. Instantiation of main flow class is also performed at sub system level. Linear axis, for instance, consumes *electrical energy*, is controlled by *process order* and produces *displacement information* and a *guided linear displacement*. Then, focusing on the function *guide table linear displacement*, input flow corresponds to *table linear displacement* (output flow of the function *transform ball-screw rotational movement into table linear displacement*), characterized by *position* and *time* properties. The output flow is represented by *guided displacement*, characterized by *spatial positioning precision* and *guiding resistance* properties.

The **step 3** consists in functional requirement and performance requirement identification. It respectively corresponds, for machine tool, to the *realisation of machining operations* and to the *workpiece dimensional and geometric characteristics*. Regarding sub-system level, functional requirement corresponds for instance for the linear axis to *positioning* requirements (in space and relative to workpiece) while corresponding performance requirements, linked with *guided linear displacement* flow, are in terms of *stability* and *precision error*. Performance requirements are impacted by the process context (**Step 4**). It corresponds for the machine tool to *machine commitment* and *workpiece diversity* regarding functioning conditions, *temperature* regarding environmental condition and *machining operation*, *cutting tool type* and *cutting tool lifetime* for operational context.

Then, the instantiation procedure is performed with the identification of degradation mode and flow deviation (**Step 5**) related to technological aspect and associated flows (and their attributes). An extract

of the reference model on this point is illustrated in Figure 32 on linear axis perimeter. Thus, for each component (e.g. *guides*), related failure modes are identified (e.g. *guides vibrations*) as well as output flow properties deviation (e.g. *less spatial positioning precision, more displacement resistance*). Then, the causes are developed in link with the component state and the deviation of the input flow properties. For instance, *guides vibration* main causes can correspond to *lack of lubricant, clearance between guides and table, pollution, or guides wear*. Related effect of such degradation is materialized in terms of output flow properties deviations of the guides function (e.g. *less spatial positioning precision*), but also on the output flow properties of upstream function (e.g. *more engine torque* related to the function *transform electrical energy into rotational mechanical energy*). Consequences at upper abstraction level (i.e. linear axis level) is illustrated by deviation of *displacement precision* output flow property. The resulting effect on linear axis performance is an increase of linear axis *position error*.

Finally, sensing solution is identified on the basis of the physical parameters associated with the degradation mode and flow deviation (**Step 6**). For instance, regarding linear axis, deviation mode *displacement precision* leads to the increase of *position error*. The associated physical parameter is basically the *axis position*. Related sensing solution and signal processing are internally managed by machine tool, because they are compulsory for working. Hence, physical parameter associated with this degradation cause (i.e. guides clearance) is *vibration*, which sensing solution can be *accelerometers*. Each degradation mode or flow deviation is monitored, either by their causes, or by the degradation modes or flow deviations themselves or by the resulting effects. According to the monitored parameters, the definition of indicator can be addressed. In this way, performance indicator of linear axis is *position error*. Hence, *bearing wear* and *guides clearance* are degradation indicators at component level, and *resistance in kinematic chain* is degradation indicator at linear axis level.

Indeed, the machine tool reference model is elaborated to be the common generic model able to serve for the whole diversity of machine tools inside an industrial context and to provide useful information for health indicator elaboration.

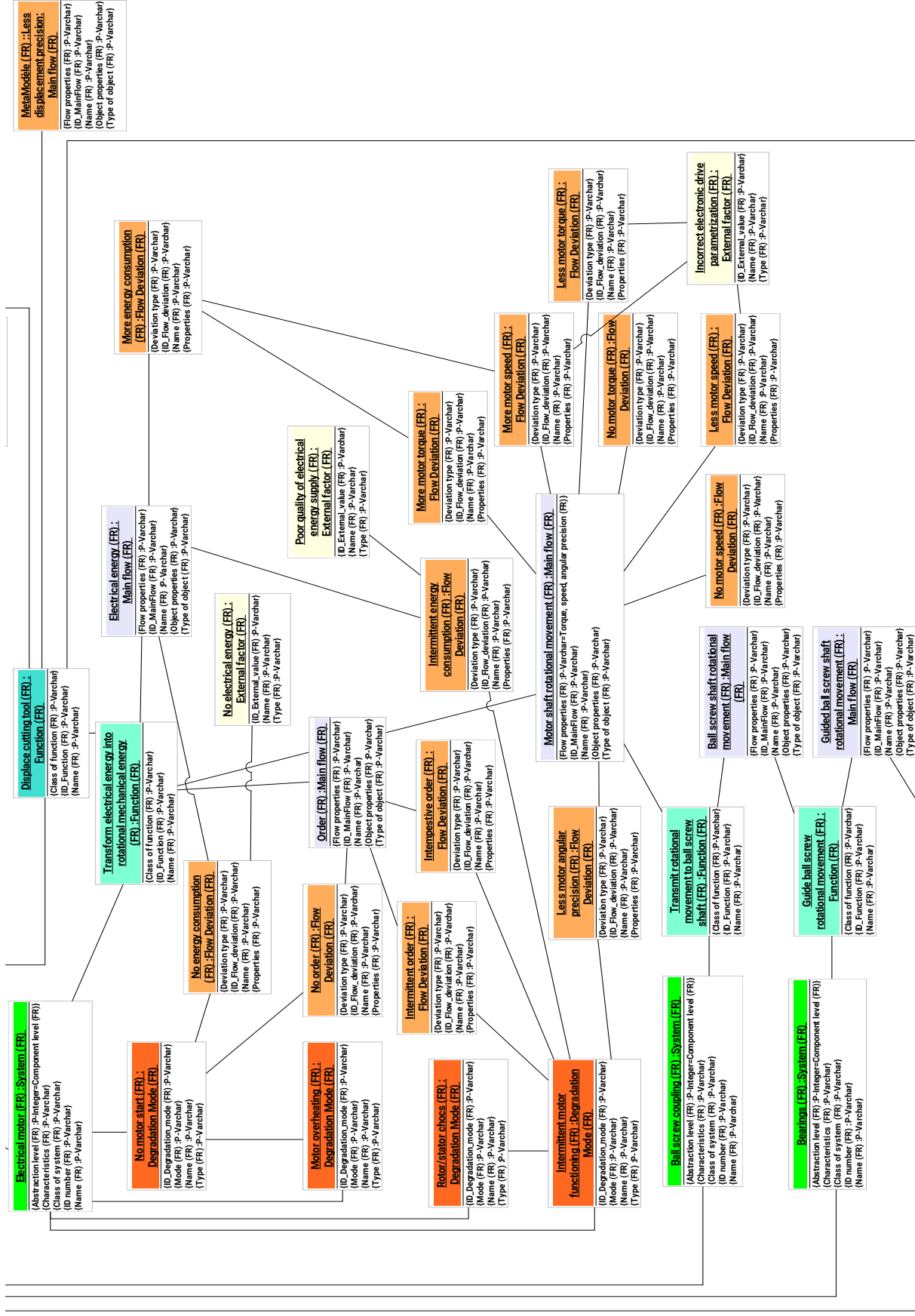

Figure 32: Extract of machine tool reference model related on dysfunctional aspects

2.5. Conclusion

This chapter aims to face the first step of the proposed PHM-based methodology regarding the knowledge formalization of a considered system. To this end, an extension of approaches developed by the CRAN is presented. These extensions address mainly the combination of FMECA and HAZOP methods in the consideration of identification of relevant parameters to monitor for health indicators elaboration. The interest of such approach results in the identification of causality relationships highlighting how a degradation is spread into the system and finally, its consequences on the product quality. This first contribution faces the **industrial issue n°1**. Nevertheless, the proposed approach is intended to be deterministic to avoid semantic and syntactic ambiguity. So, to prevent multiple interpretation in the usage of the approach, the resulting concepts of knowledge and their relationships are formalized by means of meta-modelling.

In accordance with the OMG meta-modelling definition, the proposed meta-model formalizes the knowledge of concepts for health indicators elaboration. It is supported by a set of rules defining and structuring the concepts and their relationships. The resulting meta-model represents the second contribution of this chapter and addresses the **scientific issue n°1**. A first validation phase has been performed by meta-model instantiation on machine tool class of application. Iterative validation procedure is defined by instantiation principles. This process concludes the first step of the PHM-based methodology proposal. A second validation is in progress on stamping press application case to improve the quality of the meta-model.

The next chapter is dedicated to the development of the second step of the PHM-based methodology representing the system health check elaboration.

Chapter 3 From machine monitored parameters to health check elaboration

3.1. Introduction

This chapter aims to face the second step of the methodology, representing the health check elaboration. In this way, the chapter addresses the **scientific issue n°2** by proposing an original method of health check elaboration on the basis of concepts of performance, degradation and health indicators. Supported by the knowledge formalization of the system proposed in Chapter 2, the health check elaboration relies on the assumption that the process and the incoming product (material) are under control and that monitored parameters variability rely on machine and tool degradations.

Towards this goal, it is proposed in section 2, to clarify the concept of system health thanks to the concept of system's performance and degradation with regard to sensors and monitored parameters, health indicators, health check related KPI (Key Performance Indicator), in consistence with the necessity to jointly consider the machine-product relationship. Based on these clarification, some requirements are stated in accordance with the industrial problem statement. It highlights three main steps for health check elaboration: (i) monitored parameters commensurability and decontextualization to provide performance and/or degradation indicators, (ii) indicators aggregation to elaborate both degradation indicators at upper abstraction level and health indicators at a given level, and finally, (iii) construction of health check and associated KPIs.

Based on a literature review, the section 3 presents potential candidate methods to ensure the realisation of the steps for health check elaboration. Selection of methods is oriented on approach proposed by (Abichou, 2013) for indicator elaboration. In this way, commensurability method is performed by histogram-based relative entropy and Choquet integral is selected for indicator aggregation. Nevertheless, some limits still have to be addressed to face the requirements proposed in section 2. Thus, from (Abichou, 2013) the decontextualization for the commensurability step is not appropriate in our case, since the procedure is not fitted for industrial case, and the use of Choquet Integral in the elaboration of health indicators raised the question of the multi-levels capacities identification.

In this way, the section 4 presents proposals addressing both items. First, facing the necessity for the monitored parameters to be commensurable and decontextualized, i.e. considered on a same scale for the aggregation step and independent of exogenous variables, it is proposed an extension of existing relative entropy-based method of *normalization* (Abichou, 2013) adding contextual consideration. From this point, capacity identification is oriented considering the multi-levels of the health check and

the question of the propagation of the modelling error is addressed. Indeed, capacity identification for a *single level* is known and already addressed in the literature. Nonetheless, when considering the propagation error for capacity identification of *chained multi-levels* (i.e. aggregation of [N-1]-level indicators in order to get the degradation indicators at level N, and so on until the system level) is still a scientific question and requires a study to address the best way to process: local optimization (i.e. identification between 2-successive-levels independently) or global optimization (i.e. identification considering all levels of the system at the same time). In this way, it is proposed a global optimization model for capacity identification according to multi-levels system. Since the global optimization problem faces a complex optimization criterion, a Genetic Algorithm identification method has been chosen.

Finally, a comparison between local and global optimization for capacity identification is presented on a case study.

3.2. Health check in the decision-making process

The aim of the second step of the PHM-based methodology is to provide to decision-makers a manufacturing system health check, constituted by performance and degradation indicators, and health indicators, in relation with business consideration rather than raw data closed to physical phenomenon. The second step benefits from the first step through the study and selection of monitoring solution to instantiate the formalized system model. Such step, contributes to the transformation of monitored parameters, provided by the physical implementation of sensors, into information materialized by indicators. Benefits are not only to reduce the quantity of data investigated but also to maximize the useful information content issued from relationships between health indicators at a given hierarchical level (Abichou, Voisin, & Iung, 2012). Thus, this section proposes the formalization of key concepts and principles for health check elaboration, in accordance with industrial problem statement.

Assessing the state of a system in PHM standards is located between the OSA-CBM layer State Detection and Health Assessment (Figure 9). State Detection represents the evaluation of features against their specified values and limits for computing conditions indicators. Health Assessment step regards the determination of the current health of the monitored system, sub-system or component, by considering the history of health assessment, maintenance and operational conditions (Thurston & Lebold, 2001). In this line, the concept of health check considered in this work, results in a succession steps of information transformation (from data to knowledge) leading to provide useful information for decision-makers representing the condition of multi-levels system elements (from component level to system level). An illustration of health check is given Figure 33.

In relation with the system abstraction levels, health indicator can be associated with each function at each abstraction level. The resulting elaboration of health indicator will then differ. In this way, in

order to consider the multi-levels dimension of the system in the elaboration of the system health check, (Abichou, Voisin, & Iung, 2015) identified two kinds of aggregation: **horizontal and vertical aggregation**. The horizontal aggregation represents the aggregation of indicators at a same abstraction level (Figure 33). **Horizontal aggregation**, can be seen as local aggregation and is dedicated to the aggregation of performance indicators and/or degradation indicators to provide health indicators at component or sub-system level. **Vertical aggregation** regards the aggregation between levels. It is often performed by physical law for performance indicator (Panetto & Pétin, 2005), e.g. energy consumption of a system is the sum of the consumption of all its sub-systems and components. For degradation indicators, other form of aggregation operators is required to model the impact that a degradation at level has on the upper one since indicators at lower levels are considered in the aggregation process. This aggregation can be seen as a global aggregation. Both concepts are highlighted in Figure 33. Both aggregations are thus necessary for health check elaboration.

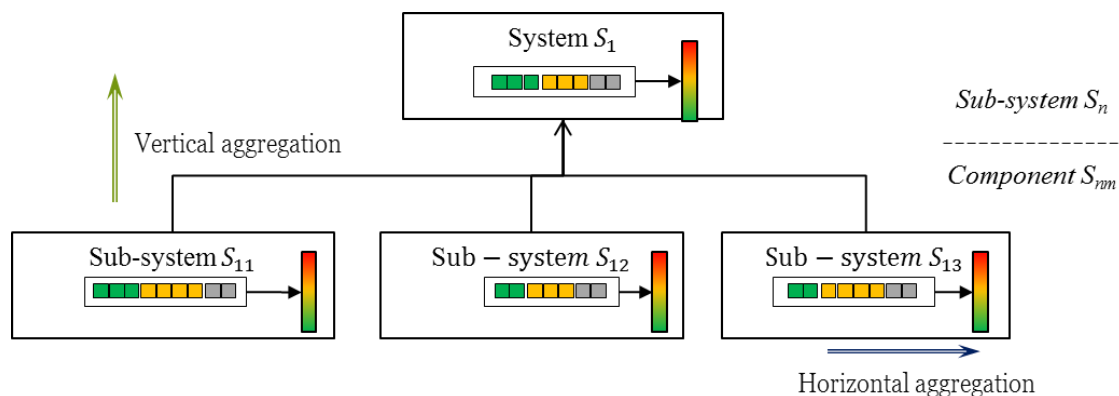

Figure 33: Synthetic overview of system health check

Despite the development of approaches to assess health condition of multi-levels system in the aim of decision making, e.g. by proposing PHM solution dedicated to robot work cells through hierarchical physical and functional decomposition (Weiss & Qiao, 2017; Weiss et al., 2018) and supported by technologies (e.g. cyber-physical system) (J. Lee et al., 2015; Nuñez & Borsato, 2017), the formalization of multi-levels health check has not been totally addressed. Nevertheless, such formalization can be found in (Abichou, 2013). This way, the defended approach in this PhD work is in line with the concepts they introduced, and the notation is reused as much as possible. However, some issues remain to be tackled for industrial usage, regarding particularly (i) the clarification of the concepts of monitored parameter, performance/degradation indicators and health indicators, (ii) the contextual consideration in performance/degradation indicators elaboration and (iii) the process to identify vertical aggregation parameters.

The following sections introduce the sequential steps of data transformation and concepts involved in the elaboration of a machine health check and KPI for decision makers and highlights dedicated

requirements to be satisfied. These requirements are then covered in parts 3.3, 3.4 and 3.5 of this chapter.

3.2.1. Sensors and monitored parameters

Sensors acquire system physical parameters and provide monitored parameters. These concepts are formalized in the meta-model proposed in Chapter 2, by *sensor* and *physical parameter* and *processed signal* classes. These monitored parameters are associated with a semantic and scale defined by the international metric system, and their values depend on the context of the system usage.

Monitored parameters include operational and environmental loads as well as the performance conditions, for example, temperature, vibration, shock, pressure, acoustic levels, strain, speed, stress, voltage, current, usage frequency, usage severity, usage time, power, heat dissipation, etc. (Cheng et al., 2010). The monitored parameters have to reflect the change in the system/flow in one of their characteristics such as magnitude, variation, peak level, frequency (Cheng et al., 2010).

In accordance with Chapter 2 and meta-model concepts, monitored parameters are considered at every level of the system (i.e. component, sub-system, system) and might represent:

- flow properties of the function or the symptom of degradation mechanism,
- contextual information required for interpretation.

A definition of monitored parameter can be given by:

“monitored parameters is raw or “slightly” processed data coming from the sensors resulting from the system/sub-system/component monitoring and representing system/sub-system/component degradation, related function performance or contextual aspect. Monitored parameters are associated with physical quantity expressed on physical measurement scale.”

To facilitate the notation, system/sub-system/component are considered in the following in the same way as the notation found in (Abichou et al., 2015). This way, let's define an element E in the sense that each function is associated to an element E with regards to its supporting components. For instance, considering the machine tool application case, an element E shall be bearings at lower hierarchical level, spindle at sub-system level and machine tool at system level. The monitored parameters vector attached to the element E can be defined by:

$$\zeta(E) \triangleq \{mp_1^P, mp_2^P, \dots, mp_{np_E}^P\} \cup \{mp_1^D, mp_2^D, \dots, mp_{nd_E}^D\} \cup \{mp_1^C, mp_2^C, \dots, mp_{nc_E}^C\},$$

with:

- $\zeta(E)$ corresponds to the set of monitored parameters related to an element E .

- mp_j^P corresponds to the j^{th} monitored parameter ($j=1, \dots, np_E$) related to the functional aspect of the element E , np_E is the number of monitored parameters related to the functional aspect of the element E .
- mp_j^D corresponds to the j^{th} monitored parameter ($j=1, \dots, nd_E$) related to the degradation aspect of the element E , nd_E is the number of monitored parameter related to the degradation aspect of the element E .
- mp_j^C corresponds to the j^{th} monitored parameter ($j=1, \dots, nc_E$) related to the contextual aspect of the element E , nc_E is the number of monitored parameter related to the contextual aspect of the element E .

Nevertheless, the semantics and numerical scales of monitored parameters raise difficulties in comparing them with each other. It is thus required to consider monitored parameters on the same numerical and semantics scale. Such transformation of data into information is addressed in the following section.

3.2.2. Performance and degradation indicators

The necessity to propose to decision makers indicators representing system health condition is highlighted by (Mehta, Werner, & Mears, 2015). It aims at guiding decision makers to take complex integrated decisions on their own (Rabenoro, Lacaille, Cottrell, & Rossi, 2014). Some approaches are proposed in literature, where indicators elaboration is based on the fusion or aggregation of monitored parameters. For instance, indicator for decision making is provided by the fusion of component features to prevent false alarms (Ly et al., 2009). Three selected features of bearing are fused with PCA (Principal Component Analysis), after normalization on a 0-1 scale. The resulting fused feature is dedicated to the degradation at component level. Another way consists to provide to decision makers a binary indicator, as proposed by (Rabenoro et al., 2014). The dissimilarity between the expected behavior and the observed one can be quantified leading to one (or several) anomaly scores. Such scores are transformed into binary indicators where 1 means an anomaly is detected and 0 means no anomaly detected. Information fusion is also widely used in Tool Condition Monitoring area, providing better and more robust assessment of tool state. These approaches usually consist in multi-sensors fusion for fault detection of component (e.g. spindle bearings) or cutting tool state assessment (wear and breakage) (Cao, Zhang, & Chen, 2017).

Such approaches seem not satisfactory in regard of the industrial problem we are faced with, since it requires a vision of all the hierarchical system level states. Nevertheless, an interesting way is founded in the continuity of the work of (J.-B. Leger, 1999), (Muller, 2005), (Cocheteux, 2010), (Abichou, 2013), and based on the principles introduced in Chapter 2, through the concepts of performance and degradation indicators.

Indeed, construction of performance indicators should be based on the input and output flow properties of a function supported by a component/sub-system/system. In this way, function performance is described by output flow properties for every function “transform input flow in output flow” and supported by an element (this one should be a component/sub-system/system). Degradation indicators are related to the element/mechanism supporting the function, i.e. a component or a group of components (sub-systems). Both types of indicators are linked through the causality concept (Chapter 2, section 2.2.2). Then, according to the principles introduced in Chapter 2, both types of indicators are contextualized in relation with a particular “process context” (concepts of knowledge, see Figure 26).

So, an element is characterized, according to decision making, by functional and dysfunctional aspects. But, to be commensurable with each other and overcome interpretation difficulties due to the diversity in natures (e.g. vibration level, displacement, torque), such information has to be mapped to the same semantics (deviation from nominal reference state) and numerical scale (e.g. [0,1]). Thus, the transformation ensuring the information to be commensurable leads to map monitored parameters representing functional (performance) or dysfunctional (degradation) aspect of a component or sub-system into performance and degradation indicator. Nevertheless, in accordance with causal relationship, a degradation at a given level N can be the consequence of a single, or a combination, of degradation(s) occurring at lower level ($N-1$). Thus, another way of degradation indicator elaboration results in the combination of lower-level degradation indicators. The same applies for performance indicators.

To structure these concepts, the following definitions are proposed.

Indicator definition:

“Indicator expresses component/sub-system/system performance and degradation condition with values between 0 and 1, commensurable to indicators of the same type. Indicator is not impacted by context changes.”

Performance indicator definition:

“Performance indicator is the measure of the degree of fulfillment of performance requirements. It is quantified by an index between 0 and 1, where the more the performances requirements are reached (resp. not reached), the more performance indicator value is near to 1 (resp. near to 0). Performance indicator results from normalization function on monitored parameters.”

Degradation indicator definition:

“Degradation indicator is the measure of deviation degree of a characteristics from a nominal state. It is quantified by an index between 0 and 1, where the more the situation is

normal (resp. abnormal or degraded), the more indicator value is near to 1 (resp. near to 0). It results either from commensurable process on monitored parameters or from an aggregation process of degradation indicator belonging to lower abstraction level when exist.”

Based on the previous definitions, it is proposed a generic normalization function f_{com} leading to quantify a deviation from a nominality, thus ensuring the commensurability of performance monitored parameter $mp_j^P \in \{mp_1^P, mp_2^P, \dots, mp_{np_E}^P\}$ considering a given context $\{mp_1^C, mp_2^C, \dots, mp_{nc_E}^C\}$:

$$I_j^{Pc} = f_{com}(mp_j^P, \{mp_1^C, mp_2^C, \dots, mp_{nc_E}^C\}), \quad (1)$$

where I_j^{Pc} is the j^{th} performance indicator mp_j^P . And for ensuring the commensurability of degradation monitored parameter $mp_j^D \in \{mp_1^D, mp_2^D, \dots, mp_{np_E}^D\}$ under the context $\{mp_1^C, mp_2^C, \dots, mp_{nc_E}^C\}$:

$$I_j^{Dc} = f_{com}(mp_j^D, \{mp_1^C, mp_2^C, \dots, mp_{nc_E}^C\}), \quad (2)$$

where I_j^{Dc} is the j^{th} performance indicator of the corresponding

Regarding the “vertical” path of degradation indicators elaboration (Figure 33), related to each element E composed of sub-element E_k , it can be formalized as follow:

$$I_j^{Dc} = Aggr^v \left(\bigcup_{k=1, \dots, n_E} g_k(I_j^{Dc}) \right). \quad (3)$$

where $Aggr^v: [0,1]^{\#(E)} \rightarrow [0,1]$ is an aggregation operator used and $g_k(I_j^{Dc})$ represents the set of indicators of the sub-element E_k which contribute to the indicator I_j^{Dc} , with $\#(E) = \sum_{k=1, \dots, n_E} |g_k(I_j^{Dc})|$ and represents the sum of the number of indicators of the sub-element E which contribute to the indicator of the element E .

The definitions structuring the concept of indicators raised requirements regarding the method of elaboration.

Requirement 1: Commensurability method has to consider the context for indicator elaboration.

Performance and degradation indicators are useful for decision making due to the information they convey. However, the number of performance and degradation indicators increases in regards of the size and complexity of the considered system. Such information benefits from being synthetized in a single indicator (i.e. health indicator), presented in the following section.

3.2.3. Health indicator definition

Health status of a manufacturing system is considered by (González, Desforges, & Archimède, 2018) as the ability of multicomponent systems to carry out a future sequence of productive tasks. An instance of health representation, dedicated to machine tool application, is presented by (Parag Vichare et al., 2015) as machine tool capability with related information regarding geometric errors, positional accuracy, repeatability, etc. Note that these capability characteristics highly influence the ability to produce in conformity with the quality requirements. Also, the final form of the output from a PHM system is defined by (Kalgren et al., 2006) as to be an actionable information formalized by a health index along a grey-scale. Health index is considered as a continuous variable in the range from 1 to 0, with 1 considered as system health/performance state undamaged, new or fully operate and 0 complete functional failure. The index is elaborated by algorithms that assess the equipment performance or health through measured symptoms, modelled data and/or usage-based predictions (Kalgren et al., 2006).

Then, in line with (Abichou, 2013), and with the formalization presented in the meta-model in Chapter 2, health indicator is composed of performance indicators and degradation indicators (see Figure 27). A definition is given by:

“Health indicator is a value in $[0,1]$ resulting from the fusion/aggregation of performance and degradation indicators, according to their relationship as specified in the step 1 of the PHM-based methodology and represents the health state of the considered component, sub-system or system. A value near 0 means an impossibility of component/sub-system/system ability to fulfill its finality, while a value near 1 means a nominal situation.”

Upon these concepts, health indicator, elaborated by aggregation of normalized indicators (performance and degradation), is formalized by (Abichou et al., 2015) as follow:

$$HI_E = Aggr^h(I_1, \dots, I_{ni_E}), \quad (4)$$

with $Aggr^h: [0,1]^{ni_E} \rightarrow [0,1]$ is the aggregation operator and ni_E the number of performances and degradation indicators for the element E.

Requirement 2: Indicators have to be aggregated at several abstraction levels of the system, considering their weights and interactions, to provide relevant indicators.

Relations between indicators and health indicators, considering horizontal and vertical aggregation is presented Figure 34.

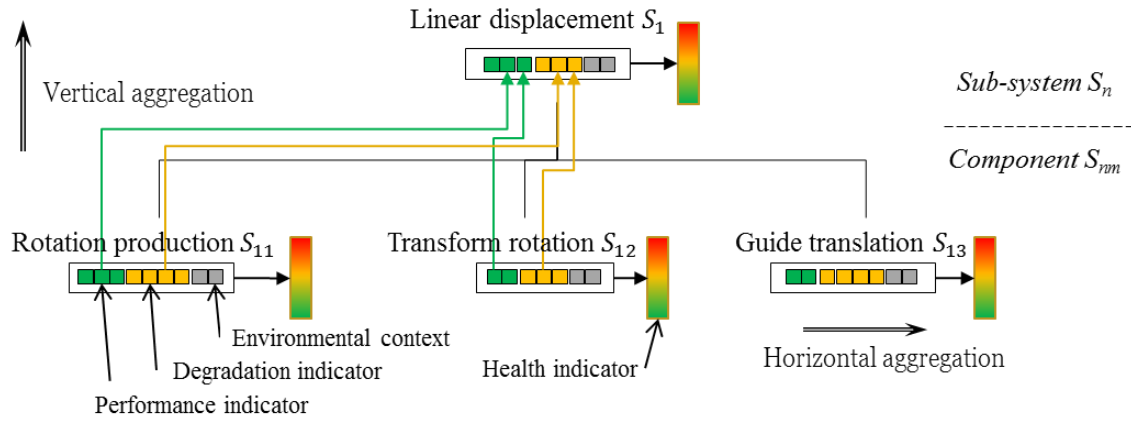

Figure 34: Health check illustration

Hence, the all multi-levels system performances, degradations and health indicators constitute a global overview of the system condition. Besides providing such detailed information, indicators can also contribute in the elaboration of synthetic business-oriented Key Performance Indicators (KPI).

3.2.4. Health check and related Key Performance Indicators (KPI) in PHM framework

The justification of system health check stands in the decision making. This decision has to be considered in a changing and uncertain environment with a complex system under constraints (delay, rentability, etc.). Decision requires a proper business-oriented vision of the considered complex system, at the right scale.

System health check is considered by (Abichou et al., 2015) as a structure supported by health indicators conveying information related to any industrial system health on a generic manner. The structure is based on functional decomposition of systems in order to describe the health related to each single function, highlighting each function performance and related support (component/sub-system/system) degradation state (Abichou et al., 2012). Multi-indicators aspect leads to an easy-understanding representation of complex system state.

Health check is considered by (Abichou, 2013) and (González et al., 2018) as characterized by:

- system functional performance in relation with system finality,
- degradation characteristics,
- environmental condition in which the system operates.

A health check is thus composed of health indicators attached to sub-systems and components allowing continuous monitoring of state of deterioration and performance in relation to a mission in a considered context (Abichou, 2013). In the thesis context, oriented in the field of manufacturing system, the mission represents the production mean in accordance with quality requirements. **Thus, in line with**

the industrial problem statement, health check has to provide to decision makers information related to system degradation and system ability to produce in relation with quality requirements. Such consideration of health check addresses the dual vision of machine performance/degradation and the product quality.

A definition of manufacturing system health check can be given by:

“Health check is a set of all indicators (performance, degradation, health) conveying information related to its hierarchical decomposition levels. Health check at the system abstraction level provides a set of KPI related to decision maker business, resulting from the vertical aggregation of performance and degradation indicators of lower levels. Such indicators correspond to system condition or system finality (in our case, product quality).”

A formalization of system health check is:

$$\mathcal{H}(S) \triangleq \{I_1^{Pc}, \dots, I_{np_S}^{Pc}\} \cup \{I_1^{Dc}, \dots, I_{nd_S}^{Dc}\} \cup \{HI_1, \dots, HI_{ni_S}\} \cup \{HC_1, \dots, HC_{nc_S}\}, \quad (5)$$

where $\mathcal{H}(E)$ corresponds to a set of performance indicators $I_{np_S}^P$, of degradation indicators $I_{nd_S}^D$, of health indicators HI_{ni_S} and of health check KPI HC_{nc_S} indicators related to system S , such as:

$$HC_{nc_S} = Aggr^h(I_1, \dots, I_{n_S}) \quad (6)$$

The concept of health check presented in this section highlights the necessity to consider for its elaboration:

- function, f_{com} to make commensurable monitored parameters for degradation and performance indicators elaboration in the aim of indicators to be on a same scale [0,1], with an equivalent semantics (deviation from a nominal condition) and decontextualized,
- function, $Aggr^h$ to combine degradation and performance indicators to provide health indicators at every level of the system, and KPI at system level,
- function, $Aggr^v$ to combine indicators (performance and dysfunctional) of each sub-system for a given level to provide performance and degradation indicators of the upper levels.

Such methods shall cover the following requirements:

Requirement 1: Commensurability method have to consider the context for indicator elaboration.

Requirement 2: Indicators have to be aggregated at several abstraction levels of the system, consider weights and interactions, to provide relevant indicators.

The essential steps of health check elaboration, developed in this section, are illustrated in Figure 35, with related attached requirements.

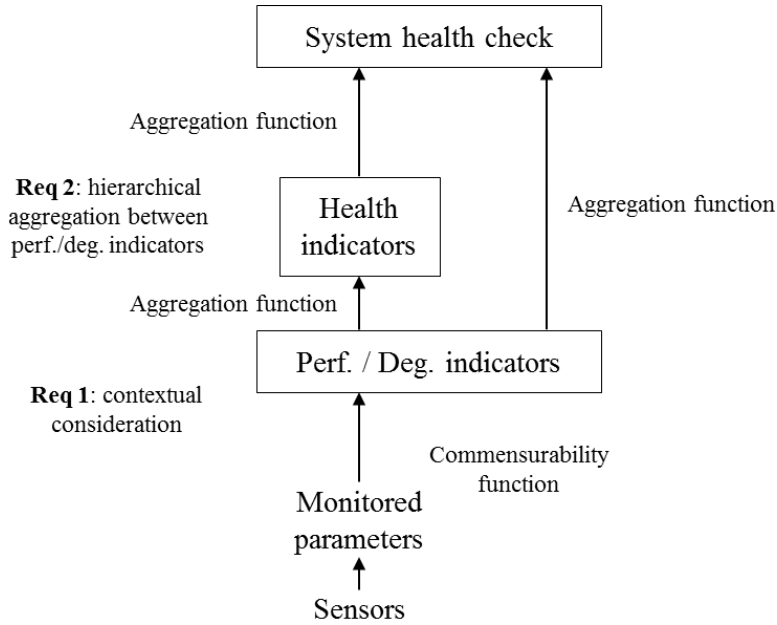

Figure 35: Functional process of information transformation for health check elaboration

On this basis, we must provide the proper function for f_{com} , $Aggr^h$, and $Aggr^v$.

3.3. Methods for health check elaboration

This section attempts to review the suitable methods identified as necessary for health check elaboration. To this end, it is first proposed investigations on methods to make commensurable the monitored parameters for indicators elaboration, i.e. f_{com} function definition. Then, methods of fusion/aggregation are reviewed considering the necessity to handle the relative importance of indicators to be aggregated and their interactions, i.e. $Aggr^h$, and $Aggr^v$ functions. Finally, considering the choice of Choquet integral as aggregation operator, the question of capacity identification is addressed.

3.3.1. Methods for commensurable monitored parameters

The aim of this step consists in the transformation of the monitored parameters, involved in the indicator elaboration process, so that the whole set of incoming data are on the same scale of values and expressing an equivalent semantic.

To perform the transformation of data into information, the domain of anomaly detection can be addressed. (Chandola, Banerjee, & Kumar, 2009) distinguished four aspects in the determination of anomaly detection technique: *nature of input data*, *type of anomaly*, *data labels* and *output of anomaly detection*. The *nature of input data* refers to data instance (object, vector, point, vector, pattern...), the

types such as binary, categorical or continuous, etc. The *type of anomaly* refers to nature of the anomaly, classified in three categories: point anomaly, contextual anomaly and collective anomalies. For details refers to (Chandola et al., 2009). The *data labels* correspond to the labeling of data instance if that instance is normal or anomalous. It results three modes of anomaly detection techniques related to data labels: supervised anomaly detection (i.e. availability of training dataset which has labeled instances for normal and anomaly class), semi-supervised anomaly detection (i.e. the training data has labeled instances for only the normal class) and unsupervised anomaly detection (i.e. the training data is not labeled and it is assumed that normal instances are far more frequent than anomalies in the test data). Finally, the *output of anomaly detection* regards the way the anomalies are reported. Two categories of outputs are identified in the name of scores and labels.

Anomaly detection techniques is structured by (Chandola et al., 2009) as follow:

- classification-based anomaly detection techniques,
- nearest neighbor-based anomaly detection techniques,
- clustering-based anomaly detection techniques,
- statistical anomaly detection techniques,
- information theoretic anomaly detection techniques,
- spectral anomaly detection techniques.

A complementary classification is proposed by (Katipamula & Brambley, 2005) in Figure 36, mainly divided in two approaches differing in the necessary knowledge used for the anomaly detection. They represent *model-based methods* and *models derived from process history*. *Model-based* major principle consists in the usage of a priori knowledge for specifying a model that serves as the basis to identify and evaluate the differences (residuals) between the actual operating states determined from measurements and the expected operating state and values of characteristics obtained from the model. Despite their strengths in terms of accuracy, transparency, understandability, simple to develop and apply, such types of model are based on a detailed behavioral knowledge implying a specific mathematical description of the system physics and behavior. Thus, in term of genericity, model-based anomaly detection is not suitable as commensurability method in regards of indicator elaboration. The space of candidate solution research can, then, be refined in the *models derived from process history* class.

Among this category, two types of detection techniques emerge: the statistical approaches (Markou & Singh, 2003a) and the pattern recognition approaches (Markou & Singh, 2003b). Both can be divided in parametric and non-parametric methods, but considering the genericity aspect, the choice is oriented towards non-parametric methods. Hence, as stated in the previous section, a score between 0 and 1 is required for performance and degradation indicators. Thus, the satisfying methods which deliver a score

as output are the non-parametric statistical methods (histogram-based, clustering based, and nearest neighbor based) and the information theoretical methods.

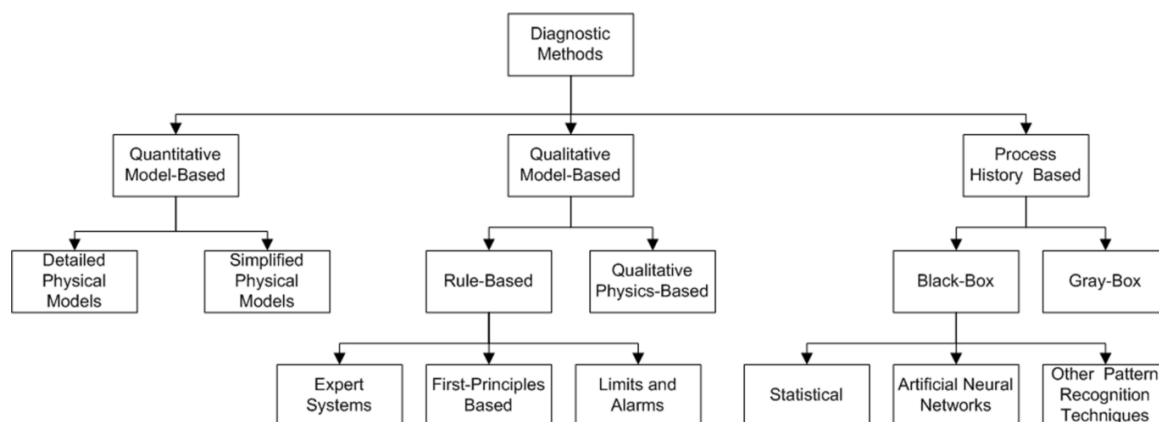

Figure 36: Classification scheme for fault detection and diagnostics methods (Katipamula & Brambley, 2005)

Among these techniques, the clustering-based, nearest neighbor and information theoretical methods are approaches based on optimization algorithms requiring important calculation duration which is not convenient for an online monitoring. This way, (Abichou, 2013) proposed the use of the histogram-based methods to face the commensurability issue. Then, to quantify the deviation of the score delivered by the histogram, she used the concepts of entropy and relative entropy. Introduced by Shannon, the entropy concept specifies that the more redundant a signal is, the lower its entropy. From this, emerges the relative entropy measuring the similarity between two distributions. The closer they are, the lower the relative entropy. Also, in the aim to cover two types of histogram deviation, i.e. (i) histogram disjunction and (ii) histogram dispersion deviation, as shown Figure 37 and Figure 38, (Abichou, 2013) proposed two ways of score elaboration (i.e. *type 1* and *type 2* in the following).

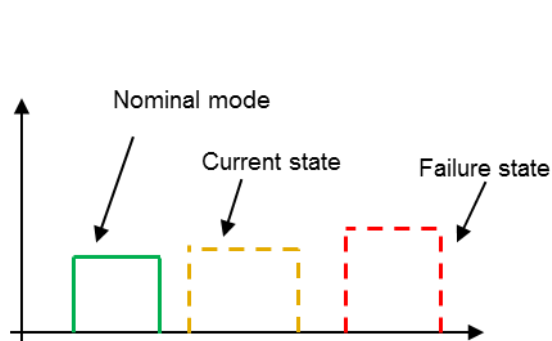

Figure 37: Histogram deviation type I

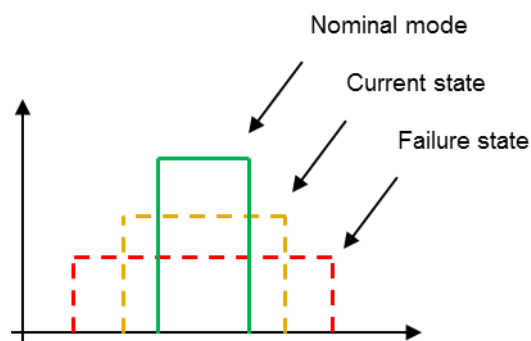

Figure 38: Histogram deviation type II

(Abichou, 2013) proposes, for f_{com} , to quantify according to the type of deviation, as follow.

Type 1 - mean deviation

$$i_1 = 1 - \frac{H_R(\text{Hist}(mp), \text{Hist}_{nom}(mp))}{-\log \alpha} \cdot \frac{l - l_{nom}}{l_f - l_{nom}} \quad (7)$$

Type 2 - variance deviation

$$i_2 = 1 - \frac{H_R(\text{Hist}(mp), \text{Hist}_{nom}(mp))}{H_R(\text{Hist}(mp), \text{Hist}_{nom}(mp)) + H_R(\text{Hist}(mp), \text{Hist}_f(mp))} \quad (8)$$

where $i \in [0,1]$ is the score of deviation, and $H_R(p_1, p_2)$ corresponds to the skew divergence²⁰ between the distributions p_1 and p_2 such as:

$$H_R(p_1, p_2) = \sum_{x \in C_x} p_1(x) \cdot \log \left(\frac{p_1(x)}{\alpha \cdot p_1(x) + (1 - \alpha) \cdot p_2(x)} \right), \quad (9)$$

and, for a monitored parameter (mp), the following histogram notation:

- $\text{Hist}(mp) = (p_1, p_2, \dots, p_k)$, the histogram (density distribution) of current observation.
- $\text{Hist}_{nom}(mp) = (p_1^{nom}, p_2^{nom}, \dots, p_{kn}^{nom})$, the histogram of the monitored parameter (mp) nominal reference state.
- $\text{Hist}_f(mp) = (p_1^f, p_2^f, \dots, p_{kn}^f)$, the histogram of the monitored parameter (mp) fault reference state.

More information related to the construction of the method can be found in (Abichou, 2013).

Nevertheless, the main drawback of the approach refers to the contextual consideration. Indeed, (Abichou, 2013) proposed to handle the influence of the context on indicator deviation by partitioning the contextual space. Contextual influence is assessed empirically. A test is performed to assess, for the *first deviation type*, if indicator deviation from nominal state is due to influence of the context. This test consists in the ratio between the size of the nominal histogram and the distance between the nominal and the fault histogram. If the ratio is higher than a parameter γ , the indicator is judged as depending on context. Regarding the *second deviation type*, the test consists in checking the disjunction of the histograms for the considered contexts. Then, nominal histogram space is segmented according to the contextual space. **Such process can be time expensive according to the necessity to a priori categorization of all the situations with contextual change. Also, the fault histogram, subject to deviation, is not considered by the contextual change.**

²⁰ the skew divergence is a particular case of the relative entropy (L. Lee, 2001)

Thus, in order to face these issues to provide f_{com} function in compliance with the **requirement 1**, it is proposed, in the section 3.4.1, an extension of the relative entropy histogram-based method.

The next section addresses the identification of methods for the following step of health check elaboration, meaning a method to combine performance and degradation indicators to provide health indicators and health check KPI.

3.3.2. Method to combine indicators to provide performance, dysfunctional and health indicators at every level of the system

Once the monitored parameters are commensurable and decontextualized, the following step consists in their combination to provide health indicators at several abstraction levels considering their weights and interaction (**requirements 2**). This section aims at finding the most appropriate method to achieve such function, in order to define with $Aggr^h$, and $Aggr^v$.

In PHM context, fusion technique is often used for data, features and knowledge fusion in order to gather information for elaborating key health indices (J. Lee et al., 2014). Such step in the PHM process is formalized in OSA-CBM as Health assessment. Nevertheless, they are generally component oriented and/or specific to a dedicated application case (refer to PHM limits Chapter 1 of this thesis).

The issue of fusion information is also addressed by the Multiple-Criteria Decision-Making (MCDM) community, in the frame of decision theory. Within this field of research, information aggregation is distinguished from information fusion since considered as referring to concrete mathematical functions (Torra, 2013). By this way, it is considered as particular fusion methods. Such methods have demonstrated their interest in the case of indicators combination for health check elaboration (Abichou et al., 2015).

3.3.2.1. Aggregation functions

Aggregation functions (or operators) aim to summarize the information contained in an n-tuple of input values by means of a single representative value (Michel Grabisch, Marichal, Mesiar, & Pap, 2010). Aggregation functions take arguments from the closed interval $[0,1]$ and produce a real value in $[0,1]$. This is usually denoted as $f: [0,1]^n$ for function that takes argument with n components (Beliakov, Pradera, Calvo, & Mehler, 2007).

Such functions are used in *multiple attribute decision making* (or multicriteria decision making), *group decision making* and *fuzzy logic and rule-based system*. *Multiple attribute decision making* problems consists in the choice of an alternative based on several, usually conflicting criteria (M Grabisch, 1996). The *group decision making* represents a problem in the synthesis of the evaluation of experts on one (or more) alternatives. Finally, aggregation functions are used to support operations in the frame of *fuzzy set theory* (Beliakov et al., 2007). The usage of aggregation function in the thesis

framework is attached to the decision-making context. Nevertheless, the concept of criteria refers to system-related indicators.

The basic feature of all aggregation functions is their nondecreasing monotonicity, expressing the idea that “an increase of any of the input values cannot decrease the output value” (Michel Grabisch et al., 2010). (Beliakov et al., 2007) specified that aggregation operators are expected to satisfy several mathematical properties including three fundamental properties namely identity, boundary condition and monotonicity as well as several behavior properties such as having the ability to express the interactions shared by criteria. Aggregation function is defined in (Beliakov et al., 2007) as:

$$f: [0,1]^n \rightarrow [0,1]$$

$$(x_1, x_2, \dots, x_n) \rightarrow f(x_1, x_2, \dots, x_n) = y$$

and satisfies the following conditions (Beliakov et al., 2007; Michel Grabisch et al., 2010).

- is non-decreasing (for each variables),
- boundary conditions:

$$f(0,0, \dots, 0) = 0,$$

$$f(1,1, \dots, 1) = 1,$$

- idempotency condition

$$f(x_i, x_i, \dots, x_i) = x_i,$$

- monotonicity condition

$$\forall (x_1, x_2, \dots, x_n), (z_1, z_2, \dots, z_n) \in [0,1]^n$$

$$\text{If } (x_1, x_2, \dots, x_n) \leq (z_1, z_2, \dots, z_n)$$

$$\text{Then } f(x_1, x_2, \dots, x_n) \leq f(z_1, z_2, \dots, z_n)$$

The four main classes of aggregation functions are given by (Beliakov et al., 2007) as:

- (i) averaging aggregation, if for every x an aggregation function is bounded by:

$$\min(x) \leq f(x) \leq \max(x).$$

The quasi-arithmetic mean, weighted arithmetic mean, ordered weighted average, Choquet integral and Sugeno integrals are the most popular averaging operators (Michel Grabisch et al., 2010).

- (ii) conjunctive aggregation, if for every x an aggregation function is bounded by:

$$f(x) \leq \min(x) = \min(x_1, x_2, \dots, x_n).$$

A conjunctive function is the minimum function.

- (iii) disjunctive aggregation, if for every x an aggregation function is bounded by:

$$f(x) \geq \max(x) = \max(x_1, x_2, \dots, x_n).$$

A disjunctive function is the maximum function.

(iv) mixed.

An aggregation function is mixed if it does not belong to any of the above classes.

Thus, the selection of the proper aggregation function has to consider the desired aggregation operator behavior in line with the decision issue. In our case, to face the necessity to consider the weights and interaction of indicators, “averaging” functions are the most suitable.

Among the averaging function class, all the aggregation operators consider the weight of indicators. Nevertheless, the interaction between indicators is only considered by Choquet and Sugeno integral. Moreover, Choquet integral is better suited for numerical or quantitative based problems whereas Sugeno integral is more suited for qualitative problems (Krishnan, Kasim, & Bakar, 2015). Thus, Choquet integral appears to be the most suitable aggregation operator to achieve $Aggr^h$, and $Aggr^v$ functions.

The next section provides some basis regarding the Choquet integral and associated capacities.

3.3.2.2. Choquet integral and associated capacities

The Choquet integral is based on the concept of capacities, also called fuzzy measures or non-additive measures (Combarro & Miranda, 2006). A capacity value is defined on a finite set of criteria (indicators) and models the relative importance of these criteria and their mutual interactions.

Let $\{X\}: \{x_1, \dots, x_n\}$ be a finite set of criteria (indicators). A capacity $\mu : \wp(X) \rightarrow [0,1]$ defined on the set of the subsets of $\{X\}$ must satisfies the following conditions:

$$\begin{cases} \mu(\emptyset) = 0 \\ \mu(X) = 1 \\ \mu(A) \leq \mu(B), \forall A \subseteq B \text{ et } \forall B \subseteq X \end{cases} \quad (10)$$

The capacity coefficient can be interpreted as the weights of a weighted mean over the power set of X . Indeed, $\mu(A)$ represents the degree of importance of $A \subseteq X$ in regards of the value of X . Then, boundary condition means that an empty set, with the absence of any indicators, has no importance where $\mu(\emptyset) = 0$ and the whole set, i.e. the presence of all indicators, has maximal importance where $\mu(X) = 1$ (Krishnan et al., 2015). Meanwhile, monotonicity condition implies that adding a new indicator to a combination or subset cannot decrease its importance. A capacity can express three types of interactions between indicators. Suppose A and B two subsets of indicators where $A \cap B = \emptyset$, then the interaction shared by these two indicators subsets are described as follow:

- additive interaction between the two indicators A and B : $\mu\{A \cup B\} = \mu\{A\} + \mu\{B\}$,
- sub-additivity interaction (or redundant effect) between the two indicators A and B : $\mu\{A \cup B\} < \mu\{A\} + \mu\{B\}$,

- super-additivity interaction (or synergistic effect) between the two indicators A and B :
 $\mu\{A \cup B\} > \mu\{A\} + \mu\{B\}$.

Thus, the importance of indicators combination can be estimated by understanding the interaction shared by the indicator. For instance, in the context of machine tool application, the lack of lubricant and an unbalance spindle interact in synergy in spindle degradation, whereas bearing wear and nut wear of a linear axis interact in redundancy since their combination does not lead to a more important impact on the axis. An illustration of interaction interpretation by means of capacity is given at the end of this section with the usage of Choquet integral.

The Choquet integral calculus is defined as:

$$C_{\mu}(x_1, \dots, x_n) = \sum_{i=1}^n (x_{(i)} - x_{(i-1)})\mu(A_{(i)}) \tag{11}$$

where $(.)$ used in the sub-script, is a permutation operator such that:

$$x_{(1)} \leq \dots \leq x_{(n)} \text{ and } A_{(i)}: \{x_{(i)}, \dots, x_{(n)}\} \text{ with } x_{(0)} = 0$$

In the aim to illustrate the usage and interest of Choquet integral, a basic example is given below.

Example: indicator aggregation with known capacities

Let consider a set of indicators i_n on a finite space S of cardinality $n=3$, such as $S=\{1,2,3\}$, with corresponding capacities μ , such as shown in Table 5 and corresponding digraph in Figure 39.

$A \subseteq S$	\emptyset	{1}	{2}	{3}	{1,2}	{1,3}	{2,3}	S
$\mu(A)$	0	0.4	0.4	0.3	0.5	0.8	0.8	1

Table 5: Capacities example

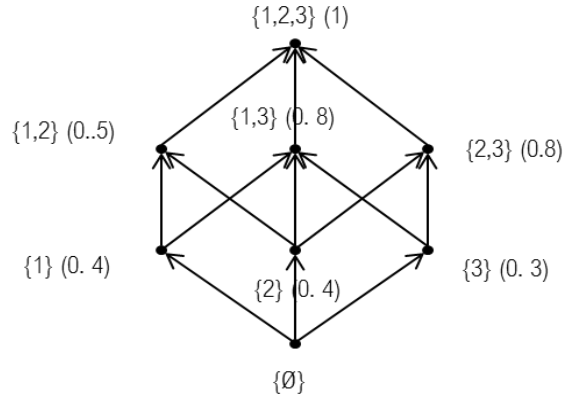

Figure 39: Digraph example

With the complete set of capacity values and available indicator score, the Choquet integral operator can be applied to compute the aggregated or global score. Let $\mu(A)$ be a capacity on S , with $A = (a_1, a_2, a_3)$ and $I = (i_1, i_2, i_3)$ be a set of indicators, represented by respective score, with respect to the attributes in A and respective scores equal to 0.65, 0.89 and 0.55. Scores are ranked on ascending order $i_3 \leq i_1 \leq i_2$, so $A = \{a_3, a_1, a_2\}$, then the aggregated score using Choquet integral is provided by

$$\begin{aligned} \text{Choquet } \mu(i_1, i_2, i_3) &= i_3 \cdot \mu(\{a_3, a_1, a_2\}) + [i_1 - i_3] \cdot \mu(\{a_1, a_2\}) + [i_2 - i_1] \cdot \mu(\{a_2\}) \\ &= (0.55) * (1) + (0.65 - 0.55) * (0.5) + (0.89 - 0.65) * (0.4) \\ &= 0.70 \end{aligned}$$

It is to be noted that:

- $\mu\{1,3\} = 0.8 > \mu\{1\} + \mu\{3\} = 0.7$
- $\mu\{2,3\} = 0.8 > \mu\{2\} + \mu\{3\} = 0.7$
 - the combination of capacity coefficients of indicators 1 and 3, and 2 and 3 reflect super-additive (synergy) interaction
- $\mu\{1,2\} = 0.5 < \mu\{1\} + \mu\{2\} = 0.8$
 - the combination of capacity coefficients of indicators 1 and 2 reflect sub-additive (redundant) interaction

A comparison between the results of the usage of Choquet integral and the weighted mean, with weights $w_{i_1} = w_{i_2} = 0.4$ and $w_{i_3} = 0.3$ is presented Table 6.

Scenario	Indicator 1	Indicator 2	Indicator 3	Choquet integral	Weighted mean
1	0.65	0.89	0.55	0.70	0.78
2	0.65	0.89	0.33	0.59	0.72
3	0.55	0.89	0.65	0.73	0.77

4	0.89	0.33	0.65	0.68	0.68
5	0.89	0.33	0.89	0.78	0.76

Table 6: Experiment results

Thus, the major steps for the use of Choquet integral are:

1. rank scores in ascending order where $x_{(1)} \leq x_{(2)} \leq x_{(3)}$ and so $A: \{\mu x_{(1)}, \mu x_{(2)}, \mu x_{(3)}\}$,
2. replace the estimated capacity values and score accordingly into Choquet integral equation.

This example highlights on one hand, the redundancy interaction between indicators i_1 and i_2 decreases their importance in regard to i_3 , compared to the weighted mean, in scenario 1, 2, 3. On the other hand, scenario 4 and 5 show the synergy between i_3 and the other indicators, the aggregated indicators are more sensitive in regard to the value of indicator i_3 .

Nevertheless, the main drawback of Choquet integral is that its usage requires a prior identification of capacities value (Combarro & Miranda, 2006). The next section addresses this issue.

3.3.2.3. Capacities identification

The distinctiveness of capacities relies on its ability to represent interaction between criteria in addition to their relative importance. Thus, capacities represent useful information for decision makers. Nevertheless, capacity identification constitutes an important drawback in the practical use of Choquet integral, particularly in the case of large system with an important number of inputs. Indeed, the number of parameters to be identified for each capacity, with n entries/criteria/attributes, is $2^n - 2$ (Combarro & Miranda, 2006; Michel Grabisch, Kojadinovic, & Meyer, 2008).

The issue of capacity identification stands in MCDM²¹ (Multicriteria decision making) community and has been widely addressed in literature. Thus, to cope with capacities identification complexity, additional constraints on the capacity have been used leading to different subfamilies in order to reduce the dimension of the problem. Among the most popular, (Michel Grabisch, 1997) introduced the concept of k-additive capacities, (Miranda, Grabisch, & Gil, 2002) proposed a generalization of symmetric capacities, the p-symmetric capacities, and (Marichal, 2004) presented the k-tolerant and k-intolerant capacities. In these cases, an important reduction in the number of capacities coefficient is obtained, nevertheless, it is too restrictive for MCDA (Michel Grabisch & Labreuche, 2010).

Most of the methods for capacity identification founded in the literature can be stated as optimization problems. A review of methods for capacity identification is proposed by (Michel Grabisch et al., 2008) in the frame of multi-attributes utility theory. They identified four main approaches in the name of (i) the least-squares based approaches, (ii) the maximum split approach, (iii) the minimum variance and

²¹ or MCDA for Multi-Criteria Decision Aiding

minimum distance approaches and (iv) the less constrained approach. (i) and (ii) approaches does not necessarily lead to a unique solution. Solution provided (ii) approach can sometimes be considered as too extreme. (Michel Grabisch et al., 2008) finally proposed a hybrid method using a generalized least squares approach and additional constraints. Nevertheless, the usage of such methods is limited, in the fact that it requires initial inputs or information on the desired overall score of each alternative, which cannot be easily or accurately provided by the decision makers (Krishnan et al., 2015).

(Krishnan et al., 2015) review methods for capacity identification with related advantages and disadvantages. It is noticed that the usability of each identification method can be measured on three aspects: (i) the types of inputs required by the methods, (ii) the number of inputs required by the methods and (iii) the number of capacities that needs to be identified. Following these points, and according to our industrial context, the Genetic Algorithm (GA)-based method seems interesting as optimization method thanks to its simplicity to be implemented and the flexibility to express the optimization function. Such approach is successfully applied by (Combarro & Miranda, 2006) as optimization method looking for the capacity that best fits a set of data, with squared error as a criterion of fitness. The proposed approach consists in the use of convex combination as cross-over operator coupled with the setting of initial population to the set of extreme points of the capacities. The aim is to overcome the reduction of search space in each generation by guaranteeing that all possible capacities are inside the search region. More details on the GA principles are given in section 3.3.2.4.

Nevertheless, (Combarro & Miranda, 2006) approach address capacities identification at a single level, i.e. $Aggr^h$, and does not address multi-levels capacities identification, i.e. $Aggr^v$, where the output error has to be chained. Indeed, in such case, **the question of the propagation of the modelling error needs to be considered.**

To face the identification of Choquet integral capacities for multi-levels system, (Abichou et al., 2015) proposed an another approach based on principles of bottom-up capacities inference. In accordance with the context of their application case - data were only available at component level - the capacities of upper elements are inferred given the capacities of the related sub-elements at the lower level. The boundaries of the application case differ from the ones of this PhD work, in the sense that in our case the monitored parameters (and so degradation and performance indicators), are not only available at component level but also at all levels of the system. Such quantity of information can be useful for capacities identification, thus, an interesting way for capacity identification consists in a global **optimization model.**

3.3.2.4. Genetic Algorithms

Genetic algorithms are general optimization methods inspired by the mechanism of natural selection, “a biological process in which stronger individuals are likely be the winners in a competing

environment” (Man, Tang, & Kwong, 1996). This way, GA uses a direct analogy of such natural evolution.

Based on the concept of *individual* and *population* corresponding respectively to a candidate solution and the set of individuals, GA is structured in sequential steps. The elementary principles are given in (Combarro & Miranda, 2006):

“Starting from an initial population, at each iteration (or *generation*), some individuals are selected with probability proportional to their *fitness* (which is measured according to the function that we want to optimize) and new individuals are generated from them using a *cross-over operator*. These new individuals replace the old ones (their *parents*) and the process continues till an optimum is found or till the maximum number of generations is reached (or other suitable termination condition holds). Then, the best individual in the last population is returned as a possible solution to the problem.”

To prevent the finding of local optimum due to the reduction of the diversity of the population by the cross-over function, a *mutation operator* changing randomly individuals is defined.

This process is summarized in a basic algorithm given by (Combarro & Miranda, 2006) as:

```
Generate initial population
repeat
    Evaluate fitness of every individual in the population
    Select individuals to reproduce
    Mate pairs of individuals and apply cross-over operator
    Select individuals to mutate and apply mutation operator
until termination condition is reached
```

An illustration of the use of Genetic algorithm for capacity identification is given in the following with the integration of cross-over function inspired by (Combarro & Miranda, 2006).

Example: Identification of capacities of horizontal aggregation

It is assumed that the value of indicators to be aggregated and resulting output aggregated indicator are known. The GA algorithm for capacity identification of (Combarro & Miranda, 2006) has been applied on the dataset introduced in 3.4.1 experiment as input of the genetic algorithm. The data represents 100 samples of quadruplet (i_1, i_2, i_3, i_4) values, corresponding for i_1, i_2, i_3 , to Choquet integral input and i_4 , to aggregated output value, with $i_j \in [0,1]$ for $j=1, \dots, 4$.

The value of parameters selected for the experiment are presented in Table 7.

Stopping criteria used for the simulation are the max number of generation and max stall generation.

Parameter	Value
Number of generation (max)	800
Population size	500
Max stall generation	200
Crossover fraction	0.6

Table 7: Values of parameters

The results of learned capacities from the Genetic algorithms are given Table 8.

$A \subseteq S$	\emptyset	{1}	{2}	{3}	{1,2}	{1,3}	{2,3}	S
$\mu(A)$	0	0.04762	0.17153	0.12679	0.24728	0.45297	0.59711	1

Table 8: Value of capacities learned by Genetic algorithm

The relative error is defined by:

$$\sum_1^m \frac{|C\mu'(f_i) - C\mu(f_i)|}{C\mu(f_i)}$$

Maximum relative error is equal to 2.08%.

Quadratic error is given by:

$$\frac{1}{m} \sum_1^m (C\mu'(f_i) - C\mu(f_i))^2,$$

where $\{f_i\}_{i=1,\dots,m}$ are the m objects considered as example - in our case 100. Quadratic error is equal to 4.8012e-06.

Local optimization is quite mastered regarding the error. Nevertheless, some learned capacities are not close to the given ones. It might be due to the fact that optimization process has found a local optimum.

In the case of system health elaboration, a multi-levels aggregation is necessary. In this way, we propose a multi-levels capacities identification.

3.4. Proposal of Choquet Integral-based health indicator elaboration for manufacturing system health check

This section intends to face the current limits highlighted in the previous one, in the light of health check elaboration in the Renault context. The main proposals regard (1) the context consideration in the process of performance and degradation indicators elaboration and (2) the multi-levels capacities identification methods for Choquet integral for health indicators elaboration.

3.4.1. Extension of relative entropy histogram for monitored parameters commensurability

The use of relative entropy histogram-based is motivated by the necessity to realize f_{com} , which allows to (1) quantify the deviation of monitored parameters and (2) make this deviation commensurable in order to compare indicators each other. The methodology is based on the approach proposed in (Abichou, 2013). Relative entropy concept leads to quantify the deviation while the use of reference histograms ensures the results to be commensurable. Nevertheless, the contextual consideration is not satisfying since not fully applied for fault histogram, and also, time expensive. **Thus, to achieve the function f_{com} , it is proposed to integrate contextual change (e.g. manufactured product diversity) into histogram-based relative entropy.**

On the basis of histogram concepts enounced in 3.3.1, a challenge is to ensure a continuity of the provided performance indicators I_j^{Pc} and degradation indicators I_j^{Dc} , despite changes in the context. This later has essentially an effect on the dynamic of the degradation (i.e. indicator deviation speed), thus it will affect the limit of failure at the earliest or the latest depending on whether context impacts. It results a specific l_{nom} and l_f value related to the context.

Thus, let's consider a contextualization function f_{hist} , such as:

$$Hist_{nom}^c(mp) = f_{hist}(mp^c),$$

where mp^c can be a vector and f_{hist} depends on the context variable and can represent: (i) a function such proposed in (Abichou, 2013) if the variable is discrete (i.e. function partitioning the histogram according to the contextual space), or (ii) a deformation function if the variable is continuous, shifting either the mean or the standard deviation according to the value of the contextual variable.

It is to be noted that the process is of elaboration of $Hist_f^c(I)$ is the same as $Hist_{nom}^c(I)$.

Then, according to respective deviation quantification, equations (7) and (8), f_{com} is given by:

Type 1 - mean deviation

$$I = f_{com}(mp, \{mp^c\}) = 1 - \frac{H_R(Hist(mp), Hist_{nom}^c(mp))}{-\log \alpha} \cdot \frac{l - l_{nom}^c}{l_f^c - l_{nom}^c}. \quad (12)$$

Type 2 - variance deviation

$$I = f_{com}(mp, \{mp^c\}) = 1 - \frac{H_R(Hist(mp), Hist_{nom}^c(mp))}{H_R(Hist(mp), Hist_{nom}^c(mp)) + H_R(Hist(mp), Hist_f^c(mp))}. \quad (13)$$

Regarding a practical consideration, $Hist_{nom}^c(mp)$, $Hist_f^c(mp)$ and respective limits (i.e. l^c and l_{nom}^c) can easily be defined.

Thus, performance and degradation indicators are able to be elaborated following the f_{com} function in regard to a dedicated context leading to a commensurability, whatever the context. Then, in the aim to elaborate health indicators and health check KPI, the issue of multi-levels capacities identification needs to be addressed.

3.4.2. Proposal of global identification of Choquet Integral capacities

This section proposes to face the issue of capacity identification in the case of a multi-levels system. The question of modeling error propagation is addressed in the following section 3.5, by comparing both local and global identification approaches.

3.4.2.1. Local vs. “chained” computation

Let's us consider the example that will be used for the comparison of both local and global identification approaches.

We consider a system S composed of 3 sub-systems, $\{S_1, S_2, S_3\}$, each of them respectively composed of 3 components $\{S_{11}, S_{12}, S_{13}\}$, $\{S_{21}, S_{22}, S_{23}\}$ and $\{S_{31}, S_{32}, S_{33}\}$. System structure is illustrated Figure 40.

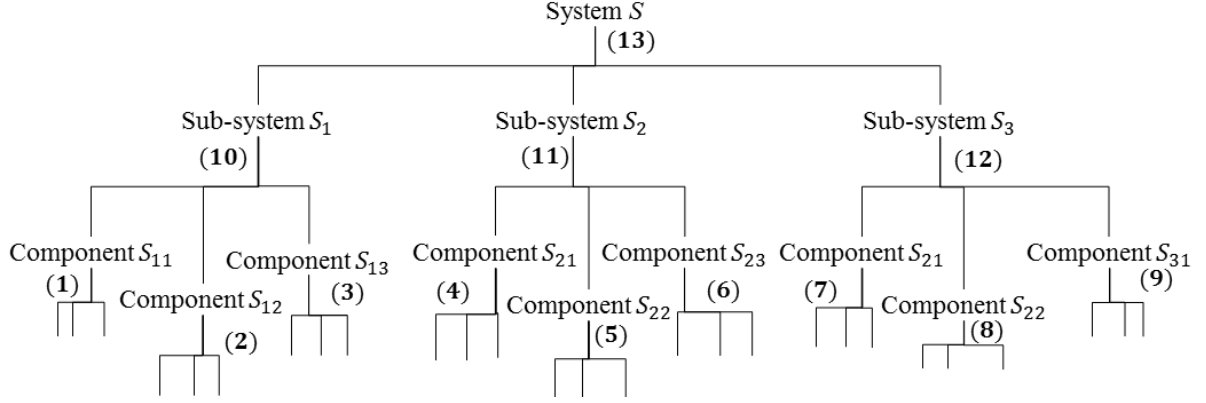

Figure 40: Ad hoc system structure

For every component, 3 indicators are considered, e.g. for S_{11} the set of indicators is $\{I_{111}, I_{112}, I_{113}\}$. For the case of this example, all capacities have been set randomly.

Hence, when considering indicators at all levels, it requires 13 capacities which are used in the vertical aggregation and set a system of equation:

$$\begin{cases} I_S = Aggr_S^{\forall} (I_{S_1}, I_{S_2}, I_{S_3}), \\ I_{S_k} = Aggr_{S_k}^{\forall} (I_{S_{k1}}, I_{S_{k2}}, I_{S_{k3}}), \quad \forall k \in \{1,2,3\} \\ I_{S_{kl}} = Aggr_{S_{kl}}^{\forall} (I_{S_{kl1}}, I_{S_{kl2}}, I_{S_{kl3}}), \quad \forall k \in \{1,2,3\}, l \in \{1,2,3\}. \end{cases}$$

The above equations system clearly shows the nested relation existing between the levels of the system.

We generate some learning dataset with uniformly distributed random values for every lower level indicators, i.e. $I_{S_{jkl}}$ and compute the results using the Choquet integrals. We also add some noise²² to input and output at every level to simulate the situation in a realistic way. Hence learning data, noted with the LD subscript, are represented by:

- at the lower level, $\forall jkl$

$$\begin{aligned} IN_{LD_{S_{jkl}}} &= random(NBpoint, 1), \\ OUT_{LD_{S_{jk}}} &= Aggr_S^{\forall} (IN_{LD_{S_{jk1}}}, IN_{LD_{S_{jk2}}}, IN_{LD_{S_{jk3}}}), \\ IN_{LD_{S_{jkl}}} &= IN_{LD_{S_{jkl}}} + noise, \\ OUT_{LD_{S_{jk}}} &= OUT_{LD_{S_{jk}}} + noise. \end{aligned}$$

- at sub-system and system level, the computation is the same, except for the input

$$IN_{LD_{S_{jk}}} = OUT_{LD_{S_{jk}}} \quad (14)$$

²² The noise added is the white gaussian noise as usually considered to mimic the effect of many random processes that occur in the system and mainly for the measurement process

For a given element E , identification error is:

$$E_E = OUT_E - \widehat{OUT}_E.$$

The difference between local and global error lies in \widehat{OUT}_E . Indeed, “local” optimization is based on error for every indicator considered separately:

$$\widehat{OUT}_E = \widehat{Aggr}_S^v(IN_{LD_E}, \dots).$$

While, for global optimization, the error is propagated through:

$$\widehat{OUT}_E = \widehat{Aggr}_S^v(\widehat{OUT}_{LD_{E1}}, \widehat{OUT}_{LD_{E2}}, \widehat{OUT}_{LD_{E3}}),$$

where $E1, E2, E3$ are the sub-elements of E . For the lowest elements, indeed, inputs of \widehat{Aggr}_S^v are $IN_{LD_S jkl}$.

The local optimization represents the capacity identification between 2-levels being considered independently for every level of the system, while the global optimization represents the capacity identification at all levels of the system being considered as a whole in the same identification process.

The concept of “chained” computation materialized the multi-levels indicators aggregation (\widehat{Aggr}_S^v) and is illustrated by the equation (14): the aggregation of indicators (IN) at level $n-1$ will provide an aggregated indicator (OUT) which will be considered at the upper level n , as an input (IN) for another aggregation process at this level n . Thus, the question regards the propagation of the capacity identification error all along this computational chain, and the best way to proceed to minimize this error considering the use of local or global approach.

The method chosen to perform the optimization is the Genetic Algorithm from, adapted from (Combarro & Miranda, 2006).

3.4.2.2. Genetic Algorithm construction for global capacities identification

To fit with the global optimization model of capacity identification, the Genetic Algorithm requires adaptations.

Indeed, in compliance with the methodology presented in (Combarro & Miranda, 2006), the optimization problem in the frame of local capacity identification can be stated as the identification of capacities that minimize the squared error with regards of given capacities. Consider m entries/criteria/attributes represented by the dataset input f_1, \dots, f_m . An overall score is given by Choquet integral, which value of function f_i is y_i , with $i = 1, \dots, m$. For $\mu \in \mathcal{F}$, with \mathcal{F} a subfamily of capacities, the squared error (QE) to minimize is:

$$QE = \sum_{i=1}^m (C_{\mu}(f'_i) - y_i)^2. \quad (15)$$

The QE is the criterion of fitness. Adapted to the global identification problem, the score to be optimized regard all the capacities for every element of the system jointly considered. Thus, to consider all the capacities in the same identification process, the fitness function represents the finding of a set of capacities minimizing the sum of the all element local quadratic errors, equation (15). To this end, consider a set of n capacities related to its elements. The set of capacities must minimize:

$$\sum_{j=1}^n \sum_{i=1}^m (C_{\mu_j}(f'_i) - y_i)^2, \quad (16)$$

where f'_i depends on the level according to the nested relation presented in the previous sub-section. For the lowest level, we used the input of the learning dataset, $f'_i = f_i$. For levels above the lowest, $f'_i = \hat{f}_i = C_{\mu_j}(f'_j)$, with f'_j , the output of the lower level.

From this basic of quadratic error extend to system, one may notice that the numbers of element will increase as the level lowers. Indeed, it leads to give more weight to lower levels. To overcome such effect, we propose to adapt equation (16) to compute nested quadratic error NQE , as:

$$NQE = \sum_{j=1}^n \omega_j \sum_{i=1}^m (C_{\mu_j}(f'_i) - y_i)^2, \quad (17)$$

On the basis of this proposal, we need to address the question of the propagation of the modelling error and validate the best way to proceed for capacity identification in the process of system health check elaboration.

3.5. Case study: local optimization vs. global optimization

This section proposes to compare the both local and global capacities identification approaches on an ad-hoc application case. The considered system, presented in Figure 40, is composed of three sub-systems (10, 11, 12), individually constituted by three components (1, 2, 3; 4, 5, 6; 7, 8, 9), and the corresponding capacities are presented in Appendix A.

The experimentation is performed with several values of noises, number of input points and population size of GA, in the way to make a sensitivity analyses. The values of the parameters selected for the experiment are synthetized in Table 9.

Parameter	Different values		
Noise	0.10	0.15	0.20

Sample	20	50	100
Population size Global	10000	50000	100000
Population size Local	3800	10000	

Table 9: Set of variation for experiment parameters

To evaluate the relevance of both approaches, we consider NQE (equation (17)), where the weighting vector is 1 for all elements. It will be referred as nested quadratic error (NQE). For the global fitness function of GA, we chose as weighting vector with a factor 1 for all components, a factor 2 for sub-systems and a factor 3 for system.

Results of experiments are presented Table 10 for 100 points, Table 11 for 50 points and Table 12 for 20 points. It clearly shows that the NQE of the global capacity identification is always upper than the local one, whatever the experiment parameters. In our cases, the simulation duration of the global optimization is between 3 and 7 hours whereas the simulation duration of the local optimization is about a couple of tens of minutes. It can be explained by the number of parameters to identify at each optimization iteration. Indeed, it represents for the local identification approach 2^n , with $n=3$, whereas it is $13 \cdot 2^n$ for the global identification.

Experiments	1	2	3	4	5
Noise	0.20	0.15	0.15	0.10	0.05
Points	100	100	100	100	100
Population size Local	3800	10000	10000	10000	10000
Population size Global	50000	50000	100000	100000	100000
NQE for local GA	0.6719	0.4018	0.4018	0.1734	0.0477
NQE for global GA	0.6946	0.4592	0.4573	0.2062	0.0834
Time local	590	874	873	1.12e+03	1.12e+03
Time global	1.14e+04	1.08e+04	2.11e+04	2.73e+04	1.17e+04

Table 10: Approximation error for 100 points

Experiments	1	2	3
Noise	0.20	0.15	0.15
Points	50	50	50
Population size Local	3800	3800	10000
Population size Global	50000	50000	50000
NQE for local GA	0.7672	0.3399	0.3916
NQE for global GA	0.7923	0.4080	0.4369

Time local	599	630	1.03e+03
Time global	1.39e+04	7.89e+03	9.3e+03

Table 11: Approximation error for 50 points

Experiments	1	2	3	4
Noise	0.20	0.15	0.15	0.10
Points	20	20	20	20
Population size Local	5000	3800	10000	5000
Population size Global	50000	50000	50000	50000
NQE for local GA	0.6113	0.3177	0.2646	0.1588
NQE for global GA	0.5620	0.3756	0.3118	0.2186
Time local	588	654	961	648
Time global	7.29e+03	1.88e+04	1.17e+04	1.09e+04

Table 12: Approximation error for 20 points

Nevertheless, when considering the experiment at the different abstraction levels, as illustrated Figure 41 for experiment 2, in Table 12, with 20 points and 15% of noise standard deviation, it appears that the global identification is better for sub-system and system level whereas the local identification is better at component level. When we focus on the scale of the error, the difference of errors between local and global at component level is too high, i.e. about 1.5, to be compensated at sub-system and system level, i.e. resp. about 0.4 and 0.25. It is explained by the higher number of component (i.e. 9 in the considered system) compared to upper levels (i.e. 4, 3 sub-systems and 1 system).

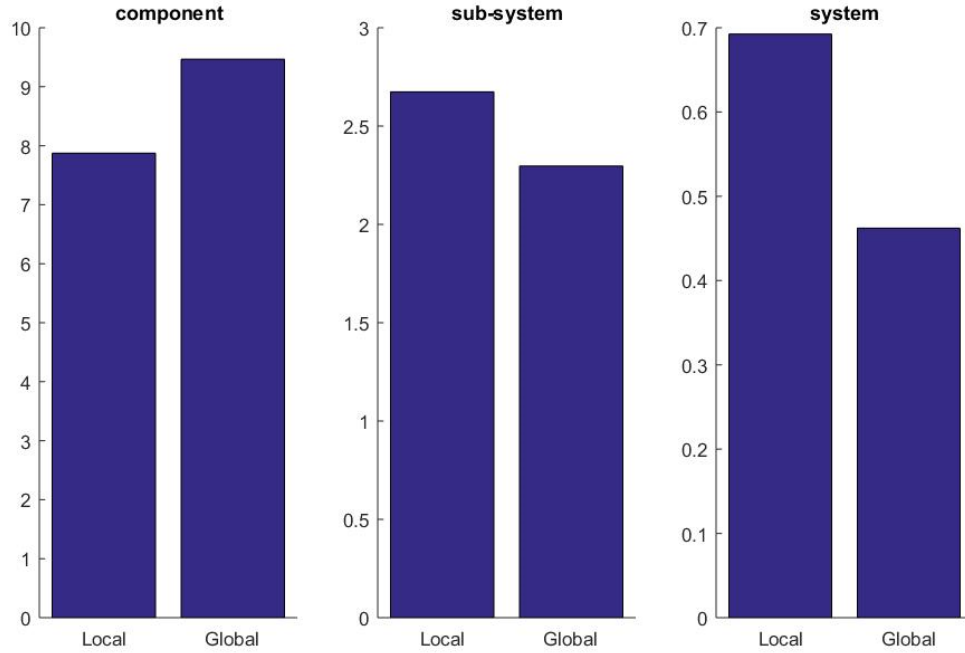

Figure 41: NQE contribution by abstraction level for experiment 2, Table 12

This experiment is particularly interesting in the sense that it represents a configuration, in a real application, where an expert (or a group of experts) defines a set of values of indicators depending on their relationship, i.e. with few data and “important” noise.

When considering the error at every element, as illustrated Figure 42, it is to be noted that the global error is systematically higher than the local one at component level (from 1 to 9), then, at sub-system and system level, the global is systematically lower than the local one.

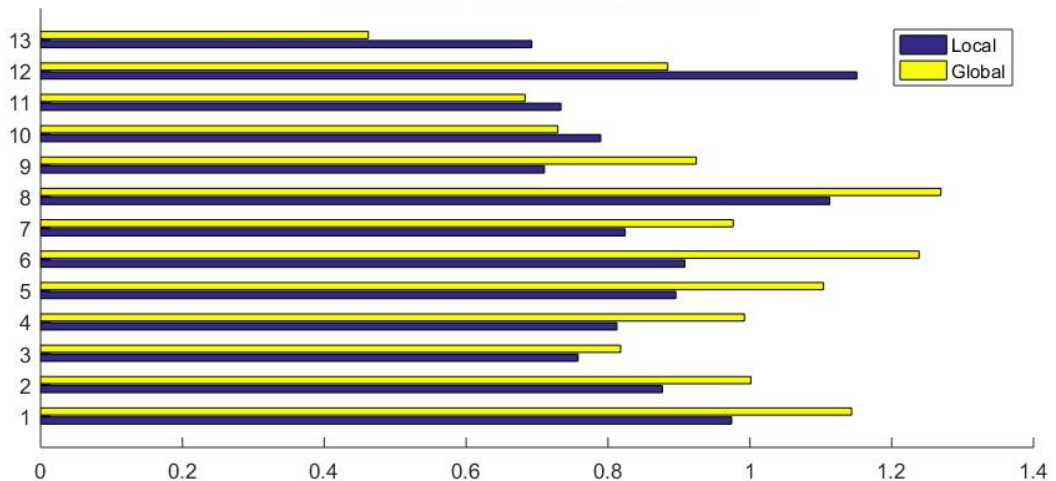

Figure 42: NQE contribution of every element of the system for experiment 2, Table 12

In order to illustrate the contribution of the NQE, the Figure 43 presents a comparison between the QE, equation (15), of the sub-systems and of the system, and the NQE contribution at the same levels.

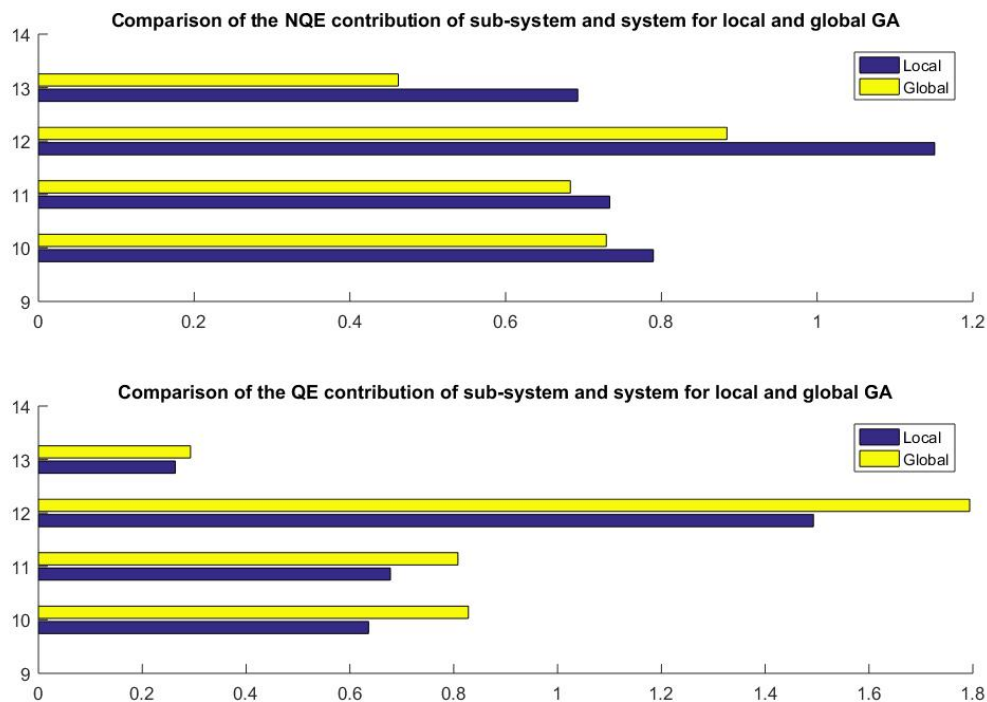

Figure 43: Comparison of QE and NQE contributions for experiment 2, Table 12

Nevertheless, in real application case, indicators are in relation from one to another between system abstraction levels. Thus, global approach has some interests in capacity identification due to its ability to handle the capacity identification of the whole system at the same time. However, to overcome its limits in performance at component level, a perspective can result in the combination of both approaches, i.e. the local identification dedicated to the component level while the global identification dedicated to the upper level - sub-systems and system.

We have to mention that these conclusions are based on about 50 experiments and the results for the global GA shows significant variations. As such, we think that further attention should be made in order to explore the tuning of the GA algorithm. More specifically, we encounter time computation and memory size limitation. The fitness function may require some adjustments as well. In order to handle this issue and get more confidence in our results, we ask for an access to the Lorraine computer mesocenter EXPLOR²³ in the way to develop additional simulation in a short term.

²³ <http://explor.univ-lorraine.fr/>

3.6. Conclusion

The contributions developed in this chapter faces the second step of the PHM-based methodology regarding the elaboration of system health check. In this sense, it is first proposed a clarification of the steps of the sequential process contributing to system health check elaboration. On this basis, the **industrial issue n°2** is addressing and some requirements are established related to the methods inherent to (i) the process of performance and degradation indicators elaboration and to (ii) the process of health indicators elaboration. A review of the methods facing these requirements highlights limits that the chapter contributions address. Such contributions cover the **scientific issue n°2**.

The first contribution of the chapter results in an extension of the commensurability method proposed by (Abichou, 2013) by considering discrete contextual aspect of monitored parameters in the aim to be aggregated and provide decontextualized performance and degradation indicators.

The second contribution concerns the Choquet integral capacity identification for health check elaboration. The capacity identification is performed by means of Genetic Algorithm, in line with the approach developed by (Combarro & Miranda, 2006). Nevertheless, to fit with multi-levels system consideration, the proposal consists in global optimization approach for multi-levels capacity identification. An experiment highlights that the global approach is not fully relevant since the approximation error is systematically upper than the local optimization. Yet, when considering the different abstraction levels, the global optimization provides better approximation error at sub-system and system level than the local one. Thus, an interesting perspective in the construction of an efficient approach for capacity identification in the elaboration of multi-levels system health check is to combine both approaches: local optimization for the component level and global optimization for the sub-system and system level. Nevertheless, further experimentation needs to be conducted in order to improve our confidence in these results.

The contributions of this chapter will be illustrated Chapter 4.

Chapter 4 Health check elaboration for machine tool

4.1. Introduction

The present chapter presents the application of the two first contributions representative of the PHM-based methodology developed in the Chapter 2 and 3 facing the industrial and scientific issues introduced in Chapter 1. This chapter is structured as a methodological guide, in the sense that manufacturer can use it to drive implementation of PHM methodology on his own manufacturing plant. Results, relevance and feasibility of the propositions are illustrated, in the case of GROB BZ560 machine tool (see Chapter 1).

As such, the industrial case and its operational context are presented in the next section. This knowledge is essential to start the first step of the PHM-based methodology by defining the cylinder-block requirements and the context of its manufacturing process. This part is done in consistence with the models already defended in Chapter 2.

The section 3 discusses the procedure for the particularization of the reference model up to the definition of an operational monitoring platform architecture, as monitoring solution for health check elaboration, in the case of GROB BZ560 machine tool. Sensors and monitoring solutions are implemented in Renault environment.

On the basis of the knowledge expressed in section 3, the section 4 presents the process of health indicator elaboration. In this way, it is first proposed to define the performance indicators, degradation indicators and health indicators associated to the levels of the GROB BZ560. This definition highlights the concepts of horizontal and vertical aggregations introduced in 3.2. Then, the application of the global optimization approach for indicators capacities identification, defined in 3.3, is applied on a set of GROB BZ560 sub-systems.

4.2. Machine tool application case within Renault industrial context

Implementation of PHM-based approach requires a good understanding of the (a) machine functioning, (b) machining process, (c) product requirements and (d) machine dysfunctioning. This work has been guided considering machine tool as research object. In the present case, the machine tool

is a GROB BZ560, as already presented in Chapter 1, section 1.2.1. It corresponds to a five axes and dual spindle machine tool.

4.2.1. From cylinder-blocks design requirements...

The product considered in this work belongs to the Renault cylinder-block family. It is a diesel cylinder-block with two definitions 4626 and 4369, i.e. two families. In the aim to ensure design requirements, i.e. tightness, assembly, and in accordance with the concepts introduced in 1.2.3, the cylinder-block is characterized by dimension and geometry requirements. Such requirements correspond for instance to surface roughness, distance, diameter, parallelism, surface location, hole location. Regarding especially the cylinder-block considered in this work, it is characterized with about 350 quality characteristics associated with machining operations, i.e. milling, drilling, boring, performed by dedicated cutting tools. An example is given in Table 13. Only few characteristics varies from one type to another and thus the associated cutting tools.

During the manufacturing phase, the cylinder-block follows a process of quality control to ensure the conformity of dimensional and geometrical requirements. The quality control process is realized thanks to Statistical Process Control (SPC) with a sampling strategy of one cylinder-block every 300 machining cycles.

Tool	Machining operation	Characteristics ID	Signification
5004	milling	200x2	location
		208x2	
		250x3	
		404x2	
		405x2	parallelism
		454pa	
		274x2	
		t5004z	
5006	boring	407x2	location
		408x2	
5014	milling	460ep1	parallelism
		460y1	location
		t5014z	dimension
5015	milling	235x3	location
		237x3	
		238x3	
		t5015z	dimension
5025	drilling	210lc1ng	location
		210d1ng	diameter

Table 13: Quality characteristics related to machining operations

4.2.2. ... to GROB BZ560 machining process

From its raw state, the cylinder-block follows a succession of machining step to operate its transformation for the dimensional and geometrical requirements to be fulfilled. The cylinder-block machining operations, considered in this work, are realized by five machines associated in parallel and performing the same operations. Thanks to a conveyor (gantry), each cylinder-block is dispatched on one of the machine tool. The conveyor informs the machine tool on the cylinder-block diversity (4626 or 4369) from which the type of program is derived. Two cylinder-blocks are machined simultaneously each cycle on a machine. As such, both cylinder-blocks belong to the same type.

In order to ensure the product requirements, machine tool performs machining operations such as drilling/tapping, boring and milling requiring about twenty cutting tools (Table 14). The cutting operation is induced by rotational motion of the cutting tools. Tapping and boring are considered as cutting operations inherent to drilling process (Chryssolouris, 2013). Especially for drilling, boring and tapping operations, the feed motion in the direction of the rotating axis is performed by the tool (i.e. the tool is displacing thanks to the axes). Milling is similar to drilling in the sense that the main rotary cutting movement is produced by the tool and not by the cylinder-block. However, in milling, the feed motion is not in the axial direction of the cutting tool but is rather orthogonal to the main axis of the tool. Tap is used to create screw threads.

	Workpiece type		Machining operation	Cutting tool type
	4626	4369		
Cutting tool name	5015	5015	milling	milling cutter
	5004	5004	milling	milling cutter
	-	5023	drilling	drill
	-	5024	boring	boring reamer
	5005	5005	drilling	drill
	5006	5006	boring	boring reamer
	5009	5009	drilling	drill
	5010	5010	drilling	drill
	5011	5011	drilling	drill
	5021	5021	drilling	drill
	5022	5022	tapping	tap
	5025	5025	drilling	drill
	5012	5012	drilling	drill
	5013	5013	tapping	tap
	5014	5014	milling	milling cutter
	5002	5002	boring	boring reamer
	5003	5003	boring	boring reamer

Table 14: Process information of the diesel engine cylinder block

4.2.3. GROB BZ560 machine tool working principles

The realization of machining operations requires machine tools with several axes. The number of axes of a machine tool normally refers to the number of degrees of freedom or the number of independent controllable motions on the machine slides (Bohez, 2002). Generally speaking, the five axes refer to the classical three axes (X, Y, Z), allowing the linear displacement of the tool or the workpiece, and two rotative axes among two of the axes A, B and C. The tool axis corresponds generally to the Z axis. Axis A corresponds to the rotational axis around X, B is around Y while C is around Z. Considering the GROB BZ560 machine tool, the five degrees of freedom are the three translation movements X, Y, Z and the two rotational movements B and C. Axis B bears the workpiece while the four others axes carry the cutting tool (Figure 44). Rotational movement of the cutting tool (C axis) is ensured by spindles supported by axes Z1 and Z2.

Thus the main GROB BZ560 machine tool sub-systems are the linear axes (X, Y, Z1 and Z2), the tool change/storage unit, the two electro-spindle units respectively supported by Z1 and Z2 axes, and the axes B1' and B2', as depicted on Figure 44. An additional accent is noted for axes B1' and B2' axes since they bear the workpiece (Bohez, 2002). ZP1 and ZP2, refer to the tool check unit attached to the tool changer/storage unit, and are considered as minor elements (without high impact on product quality deviation).

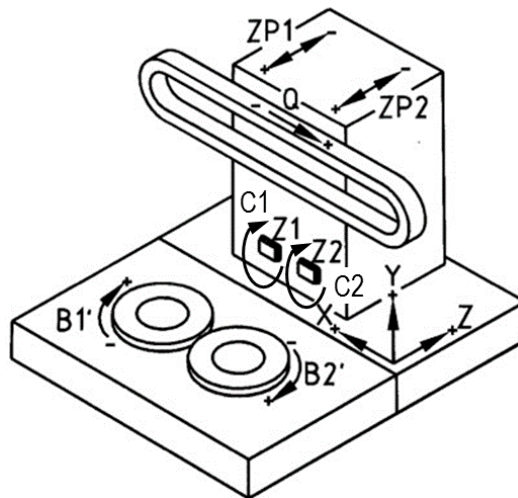

Figure 44: Machine tool BZ560 kinematic

Cutting tools are attached to the spindle, which rotates them at high speeds. The spindle is dedicated to transmit the required energy to the cutting zone for metal removal (Abele, Altintas, & Brecher, 2010). Thus, milling operations are realised by the displacement of X and Y axes and the maintaining in position of Z1 and Z2 axes while drilling operations result in the displacement of Z1 and Z2 axes, and the maintaining in position of X and Y axes. Also, the movement of the workpiece, to access its sides, is carried out by axes B1' and B2'.

Based on such information on the considered manufacturing system, the PHM-based methodology can be implemented.

4.3. From the functional and dysfunctional knowledge to monitoring parameter selection

4.3.1. From system knowledge and monitoring parameters selection...

The first step of the PHM-based methodology consists to determine the functional and dysfunctional relationships from component level to the system by means of the elaboration of an instance of reference model. This instantiation procedure has been developed in section 2.4.2 of Chapter 2, the reference model of machine tool being proposed in section 2.4.3 of the same chapter. Following the same instantiation principles, this section presents the particularization of the machine tool reference model to the GROB BZ560 machine tool. It leads to obtain a specific GROB BZ560 reference model (see Figure 28 showing the link between meta model, reference model and specific model).

Step 0. Selection of the application class reference model to be particularized.

As GROB BZ560 belongs to machine tool application class, machine tool reference model has to be particularized and well take the name of “GROB BZ560 model, OP50.2, line CC03”.

Step 1. Identification of the topo-functional structure decomposition.

GROB BZ560 is composed of *tool change unit*, *linear axis*, *spindle unit*, *rotative axes*, *hydraulic system unit*, as main sub-systems. Each of them is respectively constituted by components: let's consider sub-systems of GROB BZ560 involved in machining operations with their main components.

- Spindle unit sub-system is constituted by electrical motor (drive rotor, drive stator), bearings, drawbar, clamping spring, rotary encoder.

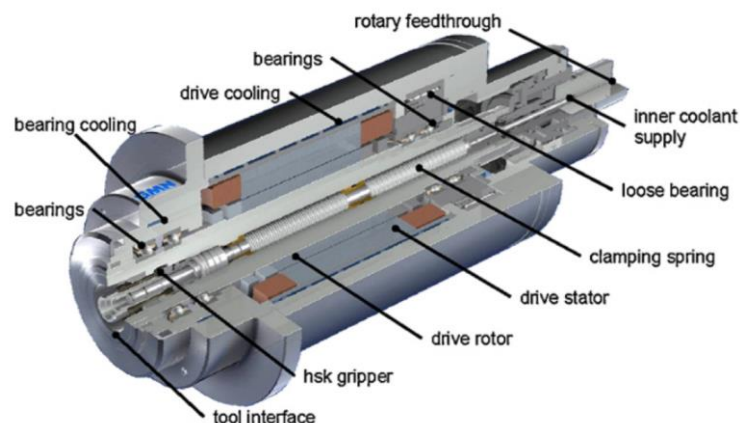

Figure 45: Sectional view of a motor spindle (Abele et al., 2010)

- linear axis sub-system is constituted by an electrical motor, coupling, bearings, ball-screw, nut, guideway and linear encoder.

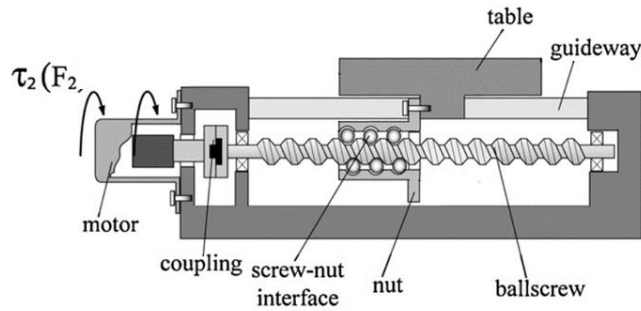

Figure 46: Ball-screw drive mechanism, adapted from (Altintas et al., 2011)

- Rotative axis sub-system is constituted by electrical motor, bearings, angular encoder and clamping unit dedicated to workpiece.

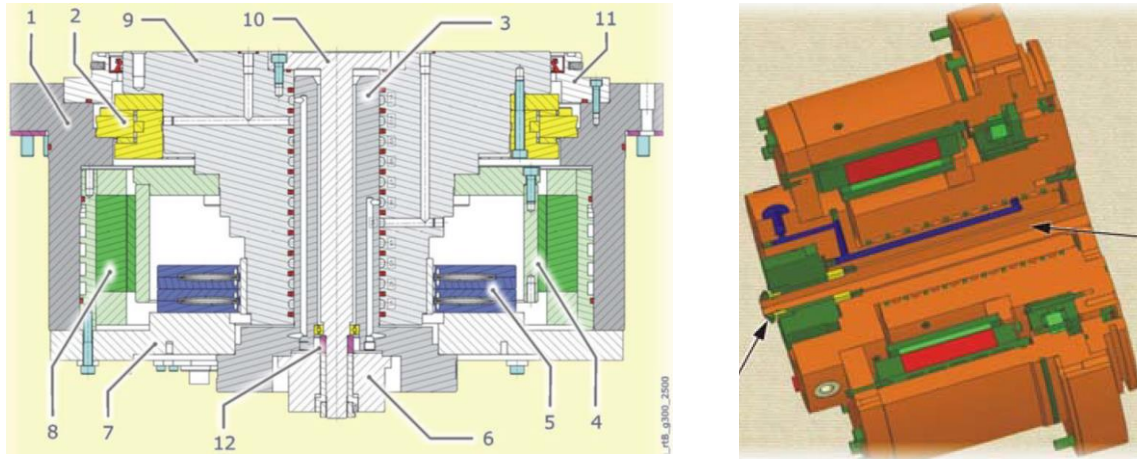

Figure 47: Rotative axis (axes B'), from GROB documentation

Step 2. Identification of system/sub-system/component related function and flows.

Machine tool function and flows, at each abstraction level is summarized in the following table²⁴ by considering the results of the previous step:

Abstraction level	Element	Function	Funct. Label	Input flow	Output flow
System	GROB BZ560	Transform workpiece	A0	Raw workpiece	Machined workpiece
Sub-system	Spindle	Rotate cutting tool	A1	Available cutting tool	Cutting tool rotation

²⁴ the table is not exhaustive, and assumptions have been considered in the aim to facilitate the illustration

				Electrical energy	
Component	Electrical motor	Transform electrical energy in mechanical rotational energy	A11	Electrical energy	Spindle rotation
Component	Bearings	Guide the rotational movement	A12	Spindle rotation	Guided spindle rotation
Component	Clamping unit	Transmit the rotational movement to cutting tool	A13	Cutting tool Guided spindle rotation	Cutting tool rotation
Component	Rotary encoder	Capture and transmit rotational movement information	A14	Cutting tool rotation	Information
Sub-system	Linear axis X	Displace linearly cutting tool	A2	Cutting tool	Cutting tool displacement
Component	Electrical motor	Transform electrical energy in mechanical rotational energy	A21	Electrical energy	Rotational movement
Component	Coupling	Transmit motor shaft rotation to ball-screw	A22	Motor shaft rotation	Ball-screw rotation
Component	Bearings	Guide the rotational movement	A23	Ball-screw rotation	Guided ball-screw rotation
Component	Ball-screw	Transmit rotational movement to screw-nut	A24	Guided ball-screw rotation	Rotation to screw-nut
Component	Nut	Transform rotational movement in linear displacement	A25	Rotation to screw-nut	Table (cutting tool) linear displacement
Component	Guideway	Guide the linear displacement	A26	Cutting tool linear displacement	Guided cutting tool linear displacement
Component	Linear encoder	Capture and transmit linear displacement information	A27	Cutting tool linear displacement	Information
Sub-system	Linear axis Y	Displace linearly cutting tool	A3	Cutting tool	Cutting tool displacement
Component	Electrical motor	Transform electrical energy in mechanical rotational energy	A31	Electrical energy	Rotational movement

Component	Coupling	Transmit motor shaft rotation to ball-screw	A32	Motor shaft rotation	Ball-screw rotation
Component	Bearings	Guide the rotational movement	A33	Ball-screw rotation	Guided ball-screw rotation
Component	Ball-screw	Transmit rotational movement to screw-nut	A34	Guided ball-screw rotation	Rotation to screw-nut
Component	Nut	Transform rotational movement in linear displacement	A35	Rotation to screw-nut	Table (cutting tool) linear displacement
Component	Guideway	Guide the linear displacement	A36	Cutting tool linear displacement	Guided cutting tool linear displacement
Component	Linear encoder	Capture and transmit linear displacement information	A37	Cutting tool linear displacement	Information
Sub-system	Linear axis Z	Displace linearly cutting tool	A4	Cutting tool	Cutting tool displacement
Component	Electrical motor	Transform electrical energy in mechanical rotational energy	A41	Electrical energy	Rotational movement
Component	Coupling	Transmit motor shaft rotation to ball-screw	A42	Motor shaft rotation	Ball-screw rotation
Component	Bearings	Guide the rotational movement	A43	Ball-screw rotation	Guided ball-screw rotation
Component	Ball-screw	Transmit rotational movement to screw-nut	A44	Guided ball-screw rotation	Rotation to screw-nut
Component	Nut	Transform rotational movement in linear displacement	A45	Rotation to screw-nut	Table (cutting tool) linear displacement
Component	Guideway	Guide the linear displacement	A46	Cutting tool linear displacement	Guided cutting tool linear displacement
Component	Linear encoder	Capture and transmit linear displacement information	A47	Cutting tool linear displacement	Information
Sub-system	Rotative axis B'	Rotate workpiece	A5	Available workpiece Electrical energy	Workpiece rotation

Component	Electrical motor	Transform electrical energy in mechanical rotational energy	A51	Electrical energy	Rotational movement
Component	Bearings	Guide the rotational movement	A52	Rotational movement	Guided rotational movement
Component	Clamping unit	Transmit the rotational movement to workpiece	A53	Workpiece Guided rotational movement	Workpiece rotational movement
Component	Angular encoder	Capture and transmit rotational movement information	A54	Workpiece rotation	Information

Table 15: Extract of GROB BZ560 constituting functions, input and output flows

The description of machine tool hierarchical decomposition and functional relationship is a prerequisite for the identification of the corresponding functional and performances requirements.

Step 3. Identification of system/sub-system/component related functional and performance requirements.

Functional and performance requirements should correspond, for system and sub-system levels of the GROB BZ560 machine tool, to requirements presented Table 16.

Element	Functional requirement	Performance requirement
GROB BZ560	Machining operations	Workpiece dimensional and geometric characteristics
Spindle	Speed ($f_{A1.1}$), torque ($f_{A1.2}$)	Rotation accuracy, stiffness, power (p_{A1})
Clamping unit	Clamping (f_{A13})	Stability, clamping effort
Linear axis X	Position (f_{A2})	Stability, position error (p_{A2})
Linear axis Y	Position (f_{A3})	Stability, position error (p_{A3})
Linear axis Z	Position (f_{A4})	Stability, position error (p_{A4})
Rotative axis B'	Position (f_{A5})	Stability, position error (p_{A5})
Clamping unit	Clamping (f_{A53})	Stability, clamping effort (p_{A53})

Legend:

$f_{Aij,n}$ refers to the n functional requirement related to the component j of the sub-system i

$p_{Aij,n}$ refers to the n performance requirement related to the component j of the sub-system i

Table 16: Extract of GROB BZ560 constituting sub-systems functional and performance requirements

Such knowledge is the key for machine tool GROB BZ560 functional aspects monitoring, defined in step 6. Another important aspect refers to the contextual consideration.

Step 4. Identification of manufacturing system process context.

Thus, this step regards the definition of the context in which the GROB BZ560 operates. It implies the identification of the functioning context, the operational context and environmental context which are able to impact the GROB BZ560 performances and degradation dynamics.

Regarding the functioning/working context of the application case, the GROB BZ560 is engaged during the whole week, and 24h a day. A slot of 4 hours is weekly dedicated to preventive maintenance operations but is not always employed. The GROB BZ560 is not a critical machine since 4 other machines on the line performed the same process in parallel (see section 4.2.2). Hence, upstream and downstream process event may imply a GROB BZ560 production stop (i.e. lack of cylinder-block to machine or process saturation).

About the operational context of GROB BZ560, information related to the (i) type of the workpiece is essential since determining the chain of machining operation and the duration of the process. It is a first element of the context. The GROB machine tool is able to machine two types of cylinder-blocks (i.e. 4626 and 4369) and uses respectively, for each type, 15 and 17 different cutting tools realizing milling, boring, drilling and tapping operations. Then, it is necessary to know (ii) the tool performing the cutting operation to contextualize more precisely, with the data coming from the machine kinematic, the type of operation it performs. With the cutting tool is associated a type of operation (i.e. milling, drilling) and a set of quality characteristics (i.e. surface location, diameter) with corresponding tolerances. Information coming from (iii) the cutting tool life cycle counter are also interesting to prevent misunderstanding related to unexpected GROB BZ560 behavior (e.g. increase of spindle torque). Also, (iv) program name can be useful to validate the type of cylinder-block to be machined. Finally, to confirm the impact of GROB BZ560 degradation on the product quality, it is necessary to collect (v) the data of machined workpiece measurement (cylinder-block).

To summarize the parameter to be monitored regarding the context aspect are:

- i- type of workpiece to be machined (4626 or 4369),
- ii- cutting tool name,
- iii- cutting tool life counter,
- iv- program name,
- v- cylinder-block measurements.

Finally, information related to environmental context is represented by external temperature.

Step 5. Identification of manufacturing system degradation mode and flow deviation on the basis of organic system decomposition and related function.

For the GROB BZ560, an example of degradation mode and flow deviation identification is illustrated on the linear axis in section 2.4.3, Chapter 2.

It is proposed in the current section to highlight more directly the causes leading to quality deviation. Thus, from the whole GROB BZ560 system, let's consider a top-down vision following a deductive logic leading to address all the causes contributing to a quality deviation. It is resulting the Table 17 and Table 18 constructed from the knowledge already defined in Table 15 and Table 16. The notation ($d_{Aij.n}$) refers to the degradation n of the j component of sub-system i .

Function / sub-system	Flow property	Failure mode / deviation	Causes	Product quality impact / machining context	
Rotate cutting tool supported by Spindles	/	Incorrect tool clamping ($d_{A1.3}$)	Insufficient clamping effort ($d_{A13.1}$)	<u>Milling:</u> Surface location	
				Surface roughness	
		Unbalance ($d_{A1.2}$)	Chips on tool holder	<u>Drilling/boring:</u> Diameter	
	Rotating precision	LESS	Bearing wear ($d_{A12.1}$)	Erroneous control information	<u>Milling:</u> Surface location
				Bearing wear ($d_{A12.1}$)	Surface roughness
				Non-conform cylinder-block material	<u>Milling:</u> Surface roughness
Rotation resistance ($d_{A1.1}$)	MORE	Bearing wear ($d_{A12.1}$)	Cutting tool wear	Surface roughness	
			Bearing wear ($d_{A12.1}$)	Surface roughness	
			Bearing clearance ($d_{A23.2}$)	Surface roughness	
			Guides clearance ($d_{A26.2}$)	Surface roughness	
Displace linearly cutting tool supported by X axis	/	Instability at stop ($d_{A2.1}$)	Unintended axis control	<u>Drilling/boring:</u> Diameter	
			LESS rotational guiding precision	Hole location	
			LESS linear guiding precision	Hole location	
			Non-conform cylinder-block material	<u>Milling:</u> Surface roughness	
		MORE	Non-conform cylinder-block material	<u>Milling:</u> Surface roughness	

	Displacement		Bearings wear ($d_{A23.1}$)	
	Resistance		Guides wear ($d_{A26.1}$)	
	($d_{A2.2}$)			
	Displacement		LESS spatial positioning precision	<u>Milling:</u>
	precision	LESS	Erroneous position information	Surface roughness
	($d_{A2.3}$)		Unexpected motor stops	<u>Drilling/boring:</u>
			Guides wear ($d_{A23.1}$)	Hole location
		Instability at	Bearing clearance	
		stop	Guides clearance	<u>Drilling/boring:</u>
			Unintended control	Diameter
			LESS rotational guiding precision	Hole location
			LESS linear guiding precision	
Displace linearly cutting tool supported by Y axis	Displacement		Non-conform cylinder-block material	
	Resistance	MORE	Bearings wear($d_{A33.1}$)	<u>Milling:</u>
			Bearings nut wear ($d_{A35.1}$)	Surface roughness
			Guides wear($d_{A36.1}$)	
	Displacement		LESS spatial positioning precision	<u>Milling:</u>
	precision	LESS	Erroneous position information	Surface roughness
			Unexpected motor stops	<u>Drilling/boring:</u>
			Guides wear ($d_{A36.1}$)	Hole location
		Instability at	Bearing clearance	
		stop	Guides clearance	<u>Milling:</u>
			Unintended control	Surface location
			LESS rotational guiding precision	Parallelism
			LESS linear guiding precision	Surface roughness
Displace linearly cutting tool supported by Z axis	Displacement		Non-conform cylinder-block material	
	Resistance	MORE	Bearings wear	<u>Milling:</u>
			Bearings nut wear	Surface roughness
			Guides wear	
	Displacement		LESS linear guiding precision	
	precision	LESS	Erroneous position information	<u>Drilling/boring:</u>
			Unexpected motor stops	Diameter
			Guides wear	
Rotate workpiece supported by			Insufficient hydraulic pressure ($d_{A53.1}$)	<u>Milling:</u>
				Surface location

B' axes		Incorrect workpiece clamping	Clamp device or locator default	Surface roughness <u>Drilling/boring:</u> Diameter
	Displacement precision	LESS	LESS spatial positioning precision	<u>Milling:</u> Parallelism Surface location
	Rotation resistance ($d_{A5.1}$)	MORE	Erroneous position information Bearings wear ($d_{A52.1}$) Pollution	<u>Drilling/boring:</u> Perpendicularity

Table 17: Quality deviation causes at GROB BZ560 sub-system level - extract

The following Table 18 presents an extract of the dysfunctional analysis at component level.

Function / component	Flow property	Failure mode / deviation	Causes	Effects
Transform electrical energy in mechanical rotational energy supported by Motor	/	Overheat	Resistance in the kinematic chain ($d_{A21.1}$)	MORE motor Torque
		Unexpected stops	Erroneous control	LESS axis displacement precision
	Torque	MORE	Resistance in the kinematic chain ($d_{A21.1}$)	MORE motor energy consumption
	Angular precision	LESS	Erroneous control Bearing wear	LESS axis displacement precision
Guide the rotational movement supported by Bearings		Bearing clearance	Pollution or wear	LESS guiding precision MORE Displacement resistance
		Bearing wear ($d_{A23.1}$)	Abnormal solicitation	LESS displacement precision
	Rotational guiding precision	LESS	Bearing wear ($d_{A23.1}$)	Instability at stop
Guide the linear displacement supported by Guides		Guides wear ($d_{A26.1}$)	Abnormal solicitation	LESS displacement precision MORE Displacement resistance
		Guides clearance	Pollution	Instability at stop

Linear guiding precision	LESS	Guides wear	Instability at stop
-----------------------------	------	-------------	---------------------

Table 18: Dysfunctional causality relationship from GROB BZ560 component level for axis X

One has to note that a given component (e.g. bearings wear) of different sub-systems (e.g. linear axis) share the same degradation modes, in the analysis, independently of the considered linear axis X, Y, Z1 or Z2, and the impact on sub-system level is the same (e.g. more displacement resistance). Obviously, when instantiated in the databased, they are stored as separate instances.

Step 6. Identification of physical parameters, associated monitoring solutions corresponding to each degradation mode, flow deviation and indicators definition.

Based on information expresses in the previous steps, a monitoring solution can be elaborated.

The monitoring parameters, regarding the machine itself, refer to functional and degraded aspects. In consistence with the steps 3 and 5, they are listed for sub-systems and components in Table 19. **Every monitoring parameter is associated to degradation mode or deviation mode, or to functional requirements (in square). Each of them is, then, linked with monitoring parameters corresponding to contextual aspect.** Please refer in Table 16 for functional aspect, Table 17 and Table 18 for dysfunctional aspect, and step 4 for contextual aspect.

This step is essential for the elaboration of performance indicators, degradation indicators and health indicator for every level of the GROB BZ560, towards identifying the monitored parameters to be aggregated.

Element	Monitored parameters		
	Funct. aspect - perf. requirement	Dysfunctional aspect	Contextual aspect
Spindle	Power (mp_{A1}^P)	Torque ($mp_{A1.1}^D$)	($mp_{A1.1}^{ct}$)
	▪ Speed ($f_{A1.1}$), torque ($f_{A1.2}$)	▪ Rotation resistance ($d_{A1.1}$) Vibrations ($mp_{A1.2}^D$) ▪ Unbalance ($d_{A1.2}$)	($mp_{A1.2}^{ct}$)
Bearings		Vibrations ($mp_{A12.1}^D$) ▪ Bearing wear ($d_{A12.1}$)	($mp_{A12.1}^{ct}$)
Clamping unit		Drawbar position (mp_{A13}^P) ▪ Insufficient clamping effort (d_{A13})	(mp_{A13}^{ct})

Linear axis	Position error (mp_{A2}^P) <div style="border: 1px solid black; padding: 2px;"> <ul style="list-style-type: none"> ▪ Position (f_{A2}) </div>		$(mp_{A2}^{c_{wp}})$
Motor		Torque ($mp_{A21.1}^D$) <div style="border: 1px solid black; padding: 2px;"> <ul style="list-style-type: none"> ▪ Resistance in kinematic chain ($d_{A21.1}$) </div>	$(mp_{A21.1}^{c_{wp}})$
Bearings		Vibrations ($mp_{A23.1}^D$) <div style="border: 1px solid black; padding: 2px;"> <ul style="list-style-type: none"> ▪ Bearing wear ($d_{A23.1}$) </div>	$(mp_{A23.1}^{c_{wp}})$
Guides		Vibrations ($mp_{A26.1}^D$) <div style="border: 1px solid black; padding: 2px;"> <ul style="list-style-type: none"> ▪ Guides wear ($d_{A26.1}$) </div>	$(mp_{A26.1}^{c_{wp}})$
Rotative axis	Position error (mp_{A5}^P) <div style="border: 1px solid black; padding: 2px;"> <ul style="list-style-type: none"> ▪ Position (f_{A5}) </div>	Torque ($mp_{A5.1}^D$) <div style="border: 1px solid black; padding: 2px;"> <ul style="list-style-type: none"> ▪ Resistance in kinematic chain ($d_{A5.1}$) </div>	$(mp_{A5}^{c_{wp}})$ $(mp_{A5.1}^{c_{wp}})$
Bearings		Vibrations ($mp_{A52.1}^D$) <div style="border: 1px solid black; padding: 2px;"> <ul style="list-style-type: none"> ▪ Bearing wear ($d_{A52.1}$) </div>	$(mp_{A52.1}^{c_{wp}})$
Clamping unit	Hydraulic pressure (mp_{A53}^P) <div style="border: 1px solid black; padding: 2px;"> <ul style="list-style-type: none"> ▪ Clamping workpiece (f_{A53}) </div>	Pressure build-up time ($mp_{A53.1}^D$) <div style="border: 1px solid black; padding: 2px;"> <ul style="list-style-type: none"> ▪ Incorrect workpiece clamping - insufficient hydraulic pressure ($d_{A53.1}$) </div>	$(mp_{A53}^{c_{wp}})$ $(mp_{A53.1}^{c_{wp}})$

Legend:

mp_{Aij}^P refers to the monitored parameter related to the functional aspect of the element Aij

mp_{Aij}^D refers to the monitored parameter related to the dysfunctional aspect of the element Aij

mp_{Aij}^C refers to the monitored parameter related to the contextual aspect of the element Aij

c_t represents the cutting tool name,

c_{wp} represents the workpiece type.

Table 19: Identification of monitoring parameters of GROB BZ560 machine tool

A synthesis of the monitored parameters related to machine-tool are synthetized in Figure 48.

A preliminary step of identification of performance and degradation indicators for GROB BZ560 sub-systems and related components is required. Thus, on the basis of information from Table 16 (functional and performance requirements), Table 17 and Table 18 (dysfunctional causality relationship), and Table 19 (ability to be monitored), a definition of performance and degradation indicators is presented in Table 20.

Element	level	Performance indicator	Degradation indicator
Spindle	A1	Power (p_{A1}): I_{A1}^{PC}	Rotation resistance ($d_{A1.1}$): $I_{A1.1}^{DC}$ Unbalance ($d_{A1.2}$): $I_{A1.2}^{DC}$
Bearings	A12		Bearing wear ($d_{A12.1}$): $I_{A12.1}^{DC}$
Clamping unit	A13		Insufficient clamping effort (d_{A13}): I_{A13}^{DC}
Axis X	A2	Position error (p_{A2}): I_{A2}^{PC}	
Motor	A21		Resistance in kinematic chain ($d_{A21.1}$): I_{A21}^{DC}
Bearings	A23		Bearing wear ($d_{A23.1}$): I_{A23}^{DC}
Guides	A26		Guides wear ($d_{A26.1}$): I_{A26}^{DC}
Axis Y	A3	Position error (p_{A3}): I_{A3}^{PC}	
Motor	A31		Resistance in kinematic chain ($d_{A31.1}$): I_{A31}^{DC}
Bearings	A33		Bearing wear ($d_{A33.1}$): I_{A33}^{DC}
Nut	A35		Nut wear ($d_{A35.1}$): I_{A35}^{DC}
Guides	A36		Guides wear ($d_{A36.1}$): I_{A36}^{DC}
Axis Z	A4	Position error (p_{A4}): I_{A4}^{PC}	
Motor	A41		Resistance in kinematic chain ($d_{A41.1}$): I_{A41}^{DC}
Bearings	A43		Bearing wear ($d_{A43.1}$): I_{A43}^{DC}
Nut	A45		Nut wear ($d_{A45.1}$): I_{A45}^{DC}
Guides	A46		Guides wear ($d_{A46.1}$): I_{A46}^{DC}
Axis B'	A5	Position error (p_{A5}): I_{A5}^{PC}	Resistance in kinematic chain ($d_{A5.1}$):
Bearing	A52		Bearing wear ($d_{A52.1}$): $I_{A52.1}^{DC}$
Clamping unit	A53	Clamping effort (p_{A53}): I_{A53}^{PC}	Insufficient hydraulic pressure ($d_{A53.1}$): I_{A53}^{DC}

Table 20: Identification of performance and degradation indicators of GROB BZ560 machine tool

Based on these observations, the monitoring solution consists in the definition of a data acquisition platform to be able to acquire these parameters. The development of this platform (in the frame of the thesis), in the case of the GROB BZ560, is presented in the next section.

4.3.2. ...to the definition of a data acquisition platform structure

Previous steps of the methodology highlight the interest to collect data from heterogenous sources. This section describes the development of the monitoring system solution on the basis of the identified monitoring parameters. The monitoring system architecture is then described in the Renault environment.

The monitoring system to be defined is highly related with the availability of monitoring solutions. Three cases are distinguished:

- monitoring solution is available and operational on the system,
- monitoring solution exists but is not installed on the system,
- no relevant monitoring solution exists.

Figure 48 synthetizes the useful information to be collected regards the GROB BZ560 and the associated context. Among this information to be collected, some parameters to be monitored are already available in the Renault information systems.

First, regarding parameters related to the *functioning context*, in line with the **step 4**, a source of relevant parameters to be collected concern the Equipment Follow-up System (EFS) - SAM²⁵ Renault information system. Indeed, it informs about the machine engagement or not. It also provides machine alarms. Information of upstream and downstream machine information are able to be collected. It clarifies if machine stops due to the lack of incoming cylinder-blocks (upstream aspect) or due to the congestion of downstream process restricting the released of the machined cylinder-block. Furthermore, errors provide information dealing with the functioning context. It provides maintenance intervention information (e.g. intervention nature, time and resources). Renault uses Frontal Map²⁶ as Computerized Maintenance Management System (CMMS).

Regarding the *operational context*, a part of information is available in the quality measurement information system. Such information is provided by the Statistical Process Control system (SPC), i.e. Q-DAS²⁷ information system. The other part, regarding the parameters related to the machine (i.e. cutting tool name, program name, cylinder-block type), is available through the machine kinematic monitoring system, as illustrated Figure 48. The environmental context (e.g. external temperature) is not considered in this work.

²⁵ SAM: « Suivi de l'Amélioration des Moyens » is tool developed by Renault.

²⁶ Frontal Map is an application developed by Renault to access to SAP database.

²⁷ <https://www.hexagonmi.com/products/software/q-das-statistics>

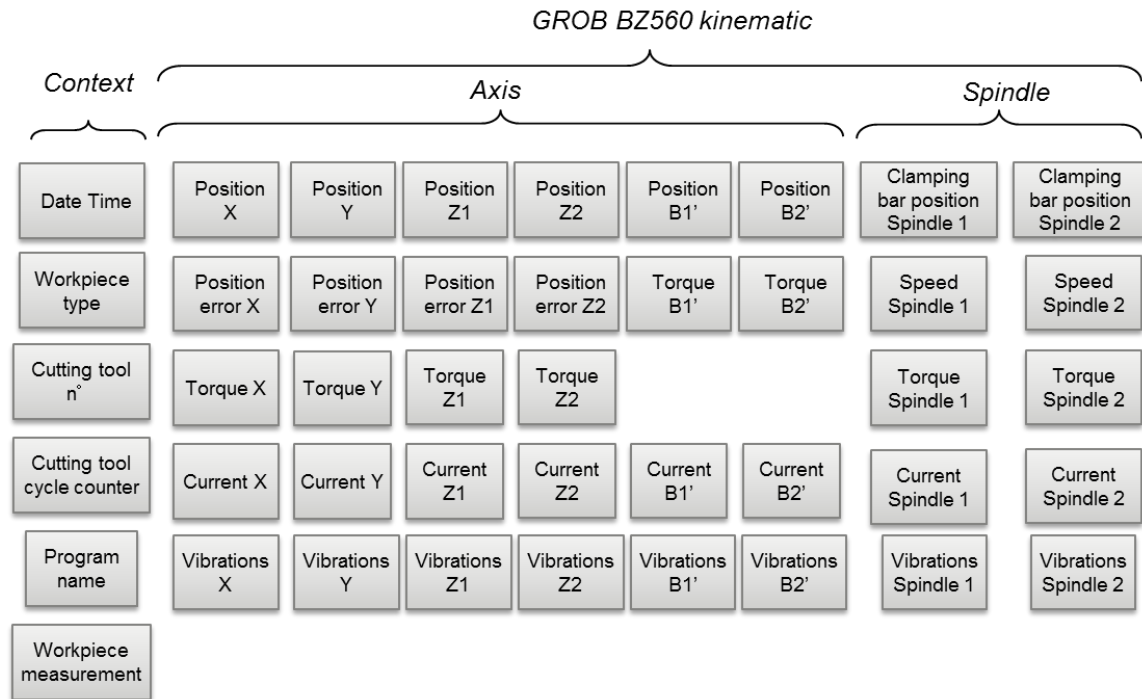

Figure 48: Synthesis of monitoring parameters for machine tool

The remaining information exists in the CNC and PLC (Programmable Logical Controller) of the machine tools and required a solution to be accessed. It concerns information in link with the machine tool behavior and kinematic in relationship with the processes executed, representing the type of workpiece to be machined, the program name, the cutting tools operating, the positions of axes, the torques of motors, etc. The chosen monitoring solution to access the CNC is a device proposed by Dizisoft²⁸ society, called Dizispy. The monitoring system is connected to the machine tool and communicates with the control unit of the machine (CNC and PLC). The Dizispy design only permits recording aspect of the control unit, in order to access to control memory in read-only mode, avoiding in this way any disturbance of the cutting program execution. The interest of such device is its ability to track of a large number of parameters. In the present case, about hundred parameters are monitored. All data recorded by Dizispy are sent and stored in a remotely accessible database located at Cl  on plant. On a periodic basis, data are uploaded on a dedicated cloud, located at the Renault Technocenter, to be processed and archived. Nevertheless, the available monitoring solution, Dizispy, covers mostly parameters related to functional aspect but is not sufficient.

To monitor some degradations related to machine kinematic, a vibration monitoring device has been selected, bought and installed on linear axes X, Y, Z1 and Z2, and B' axes to be able to track early degradation. The vibration monitoring solution is the accelerometers ACOEM²⁹. Vibration signals are synchronized with process sequences thanks to Dizispy solution (tool change, machining operation,

²⁸ <http://www.dizisoftweb.com/>

²⁹ <https://www.acoemgroup.com/>

axes displacement), contextualizing the vibration acquisition. For each vibration monitoring point, vibration signal is processed to extract features such as kurtosis, crest factor, velocity and acceleration. These four features are related to specific interpretation:

- kurtosis: is the normalized fourth statistical moment signal and is used to measure the impulsive nature of the signal and has a particular ability to amplify isolated peaks in the signal,
- crest factor: is defined as the ratio of the peak value to the RMS of the signal. It is often used as a measure of the impulsive nature of a signal and will increase in the presence of discrete impulses which are larger in amplitude than the background signal, but which do not occur frequently. It indicates damages in an early stage,
- velocity means the changing rate of the amplitude between the peaks of vibration to time (mm.s^{-1}),
- acceleration means the changing rate of velocity to time (g).

Both kurtosis and crest factor values increase according with the signal changes from a regular continuous pattern to one containing isolated peaks (e.g. chocks, clearance), while velocity and acceleration are more sensitive to kinematic wear.

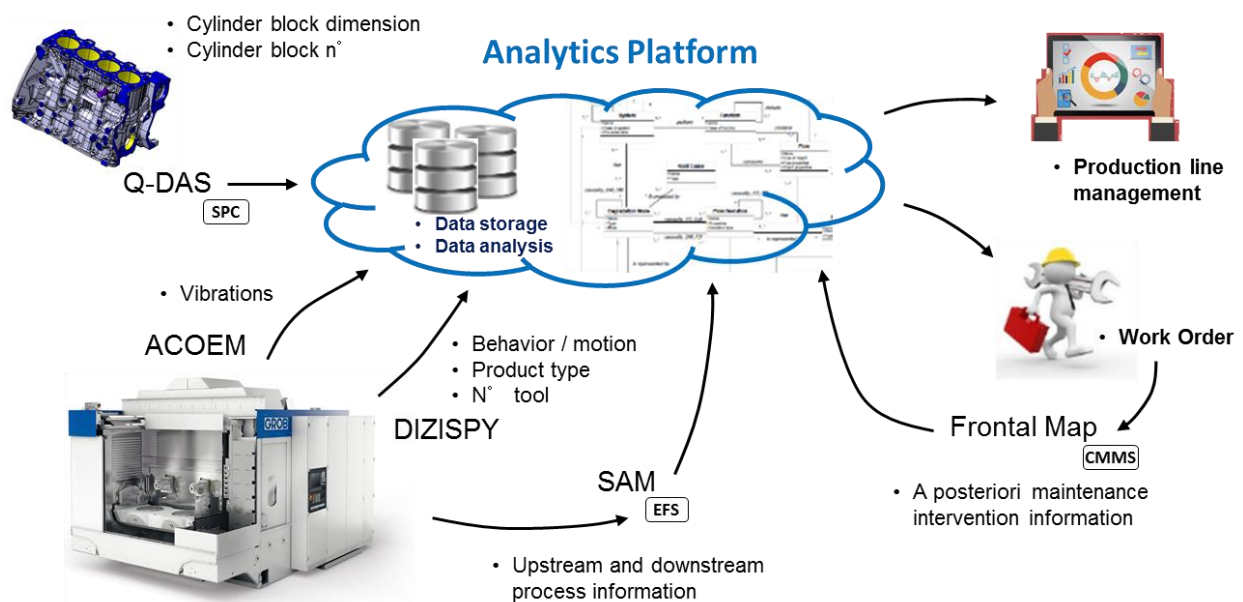

Figure 49: Data acquisition platform flows

An overview of functional architecture of the data acquisition is illustrated in Figure 49.

On this platform, the lack of information system interoperability is a real challenge to collect data from the information systems. It corresponds to a main challenge for manufacturing companies for an operational transition towards “Factory of the Future” and for PHM-based system implementation.

4.4. From monitoring parameters to machine health check elaboration

From the monitored parameters identified Table 19 and Table 20, the process of indicators elaboration can be initiated. This first sub-section presents the construction of the GROB BZ560 related indicators, which is the last particularization phase of the reference model. Then, the interest of the global optimization approach for indicators capacities identification is investigated on a sub-set of elements of GROB BZ560 machine tool.

4.4.1. Health check construction

The principles of indicators elaboration are performed, according to the principles presented in Chapter 3. Functional and degradation indicators are first elaborated, from functional and dysfunctional monitored parameters, by means of the definition of the f_{com} functions. Then, degradation indicators resulting from vertical aggregation, $Aggr^v$, are elaborated on the basis of lower-level degradation indicators. From these performance and degradation indicators health indicators can be generated, by means of horizontal aggregation $Aggr^h$.

Table 21 presents, for elements considered here, the performance, degradation and health indicators, and dedicated $Aggr^v$, $Aggr^h$ and f_{com} functions (table is shaded for confidentiality reasons).

Element	level	Performance indicator	Degradation indicator	Health indicator
Spindle	A1			
Bearings	A12			
Clamping unit	A13			
Axis X	A2			
Motor	A21			
Bearings	A23			
Guides	A26			
Axis Y	A3			
Motor	A31			
Bearings	A33			
Guides	A36			
Axis Z	A4			
Motor	A41			
Bearings	A43			

Guides	A46	
Axis B'	A5	
Bearing	A52	
Clamping system	A53	

Table 21: GROB BZ560-related performance, degradation and health indicators

The first part of the identification of GROB BZ560 health check is synthetized in Table 21, i.e. performance, degradation and health indicators related to machine hierarchical decomposition. The second part regards the elaboration of the KPI.

As stated in Chapter 3, the KPIs, in the Renault context, address both machine and product consideration. The machine aspect results in the horizontal aggregation of the GROB BZ560 sub-systems health indicators. Concerning the product aspect, it is proposed to orient quality consideration on the machining operation typology, since they are supposed to ensure the cylinder-block quality requirements. The machining operation typology can then be refined by typology of quality requirements in the sense that such KPI indicators represent the ability of the machine to perform a given quality requirement (e.g. surface location). Consequently, the related KPI of the GROB BZ560, in compliance with the thesis problem statement, are synthetized in Table 22 (table is shaded for confidentiality reasons).

KPI	
GROB BZ560	
Cylinder-block	

Table 22: GROB BZ560 health check KPI

Where, $HC_{GROB\ BZ560}$ refers to the machine degradation KPI, $HC_{Quality}$ represents the global quality KPI, HC_{sl} is the surface location quality characteristic, HC_{hl} is the hole location quality characteristic, HC_{dist} is the distance quality characteristic, HC_{par} is the parallelism quality characteristic and HC_{perp} is the perpendicular quality characteristic.

From the definition of the indicators constituting the GROB BZ560, established Table 21, the global optimization approach for capacities identification can be applied.

4.4.2. Health check elaboration

The experiment is oriented on a limited perimeter to facilitate some computational aspects. In this way, only the linear axes are considered in the global capacities' identification experiment on the GROB BZ560 machine tool. The structure of this partial health check is depicted Figure 50.

Due to the lack of events/degradations observed during the acquisition period, the experiment has been based on a learning dataset elucidated by experts. Such dataset is elaborated in association with machine tool experts and is constituted by 20 cases with several indicators' values. The expert datasets should embed the relations between components indicators and indicators from which there are elaborated, i.e. linear axes indicators and their related components indicators, and GROB BZ560 indicator with the axes one. All these datasets are given in Appendix B.

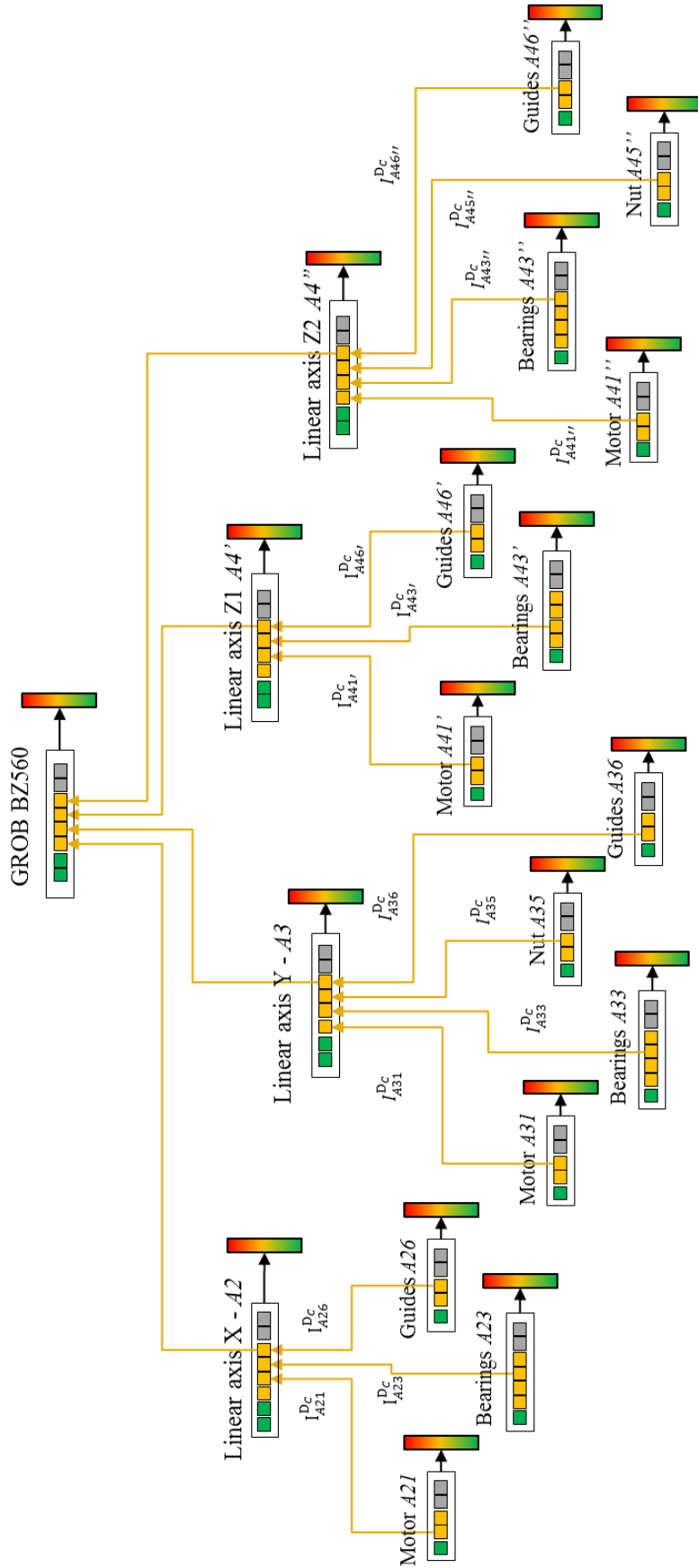

Figure 50: GROB BZ560 health check structure

The whole experiment is composed of 19 elements such as illustrated in the following table.

Element	Indicator	N°
Motor A21	I_{A21}^{Dc}	1
Bearings A23	I_{A23}^{Dc}	2
Guides A26	I_{A26}^{Dc}	3
Motor A31	I_{A31}^{Dc}	4
Bearings A33	I_{A33}^{Dc}	5
Nut A35	I_{A35}^{Dc}	6
Guides A36	I_{A36}^{Dc}	7
Motor A41'	$I_{A41'}^{Dc}$	8
Bearings A43'	$I_{A43'}^{Dc}$	9
Guides A46'	$I_{A46'}^{Dc}$	10
Motor A41''	$I_{A41''}^{Dc}$	11
Bearings A43''	$I_{A43''}^{Dc}$	12
Nut A45''	$I_{A45''}^{Dc}$	13
Guides A46''	$I_{A46''}^{Dc}$	14
Axis X A2	I_{A2}^{Dc}	15
Axis Y A3	I_{A3}^{Dc}	16
Axis Z A4'	$I_{A4'}^{Dc}$	17
Axis ZA4''	$I_{A4''}^{Dc}$	18
GROB BZ560	I_{A0}^{Dc}	19

Table 23: GROB BZ 560 indicators

Parameter	Values
Noise	0.10
Sample	20
Population size Global	50000
Population size Local	5000

Table 24: Set of parameters for GROB BZ 560 capacities identification

The values of parameters, for the GA optimization, selected for the experiment are synthetized in Table 24. Results of the experiments are given Table 25. The nested quadratic error (NQE), eq. (17), of the global capacity identification is always upper than the local one, for this set of optimization parameters. Hence, the simulation duration of the global optimization is systematically upper than the local optimization one.

Experiments	2	3	4	5	6
Points	20	20	20	20	20
Population size Local	5000	5000	5000	5000	5000
Population size Global	50000	50000	50000	50000	70000
NQE for local GA	0.0447	0.0446	0.0446	0.0447	0.0446
NQE for global GA	0.5652	0.4948	0.4492	0.4963	0.4370
Time local	472	398	423	512	345
Time global	2.04e+04	4.45e+04	3.24e+04	1.82e+04	5.07e+04

Table 25: NQE for linear axis-based health check

These experiments confirm some aspects highlighted Chapter 3, in the sense that the local approach provides better optimization results than the global one. Nevertheless, attention has to be paid on the learning dataset documented by experts. Indeed, specification of too similar indicators interactions might impact the results by “advantaging” the local approach in the finding of optimization. Hence, as expressed in the section 3.5 of Chapter 3, further investigations are currently led on the tuning of the GA and to overcome the limitation in memory size for computational aspect.

The computation time is not damaging in industrial context since it concerns the capacities identification. This step is performed to initiate the monitored parameters aggregation or when it is required to update the capacities, and this alter can be led in parallel of aggregation calculation.

4.5. Conclusion

This chapter illustrates the two first steps of the PHM-based methodology, proposed in Chapter 1, on a GROB BZ560 machine tool, in accordance with Renault context. The first step has faced the particularization of the machine tool reference model presented in Chapter 2, in order to provide the required knowledge to serve as input of the second step. The second step has tackled the elaboration of health check, in line with the approach developed in Chapter 3, on a limited perimeter of sub-systems of the GROB BZ560 machine tool.

The first step of the PHM-based methodology has resulted, on the basis of the GROB BZ560 functional and dysfunctional knowledge elicitation, on the development of a monitoring system solution. This solution corresponds to a data acquisition platform, currently operational in Renault environment. The data acquisition platform collects data and information from various information systems and store them in an enterprise cloud. Its development is complementary with other initiatives performed in Renault, in the framework of “Factory of the Future”.

From the knowledge expressed in the first step, the second step has, first, consisted in the definition of the multi-levels indicators related to GROB BZ560, from components indicators to GROB

BZ560 health check KPI. Then, based on a limited perimeter derived from this structure, the identification of indicators capacities has been faced. In this way, the global optimization approach has been performed. Due to the lack of GROB BZ560 degradations in the monitored parameters, the approach has been based on datasets elaborated in association with machine tool experts specifying the relations between indicators.

In term of results, it has to be underlined that the reference-model particularization on GROB BZ560 case study shown the interest of the approach. From the model reference particularization, performance, degradation and health indicators have been clearly identified at different levels of the GROB BZ560. Regarding the capacities identification, the experiment is in line with Chapter 3 in the sense that it is necessary to engage further experimentations to improve our confidence in these results, (i) by the improvement of GA parameters tuning, and (ii) by the increase of calculation capacities. In line with these postulates, further investigations are conducted.

General conclusion and perspectives

This proposal is in the frame of a CIFRE agreement between Renault and CRAN, for focusing on the challenge of dual consideration between manufacturing system performance and the quality of product, in the context of predictive maintenance. According to the global context of the performance and quality control in manufacturing framework, and more precisely Renault one, our proposal refers to the definition of a PHM-based methodology leading to the mastering of the product quality with respect to the control of the machine/system performances. In this way, the thesis leads to address industrial and scientific issues of PHM to face the following major industrial question in the context of machine tool: How to anticipate manufacturing product deviation, machine degradation and performance deviation through machine monitoring, in the framework of predictive maintenance? This later raises the following research question: Shall we develop and formalize an efficient PHM-based approach to control the performances (and their deviations) of the machined part directly from the control of machine tool performances (and its degradations)?

As a first answer to these industrial and scientific issues, the PHM-based methodology proposed is structured in five steps. The PhD work addresses the two first ones (see Figure 51). The step 1 leads to the development of an UML-based meta-model formalizing all the concepts and rules (e.g. functions, failure mode, indicators) related to the functioning and dis-functioning of machine/system in general. These functioning/dis-functioning visions are investigated through the extension of well-known methods such as FMECA and HAZOP. The meta-model allows to create reference models from instantiation procedure (e.g. machine tool reference model).

The second step is more focused on the Health check representative of the machine/system. In that way, a contribution is done to elaborate the machine/system health check based on the usage of Choquet integral as aggregation operator and Genetic algorithm for multi-levels system capacities identification.

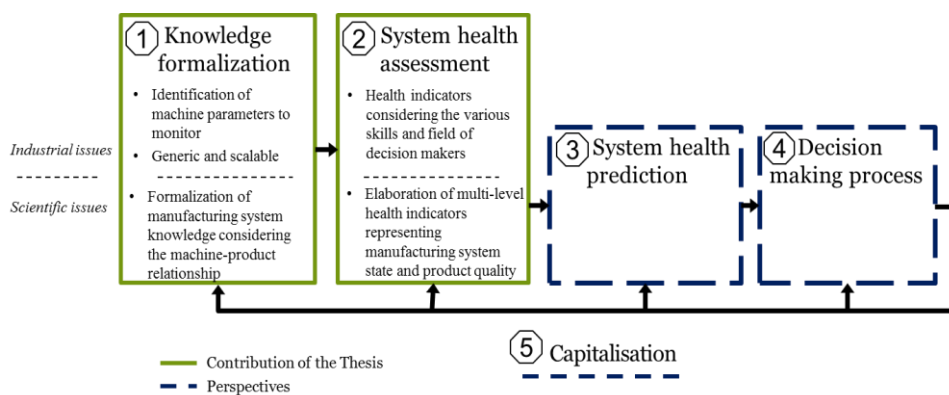

Figure 51: Proposed PHM methodology with contributions

These two global developments bring a first formalisation of the relationship between machine sub-systems and machine effectors to fulfil the current gap between the expected requirements (Figure 52, refer to requirement issue identified in Chapter 1).

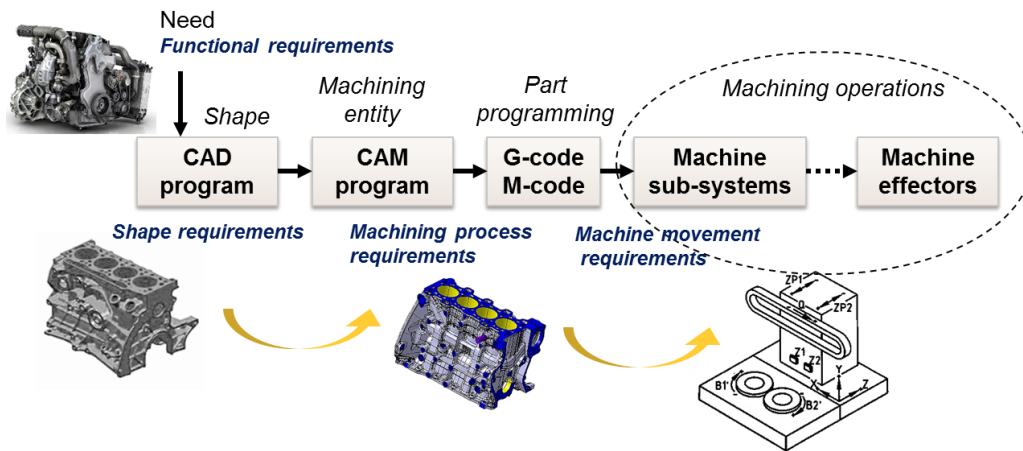

Figure 52: Relationship between workpiece, machine movements and machine effectors requirements

In relation to these developments, the main scientific contributions achieved in this thesis by means of the PHM-based methodology, are:

- The extension of combination of dysfunctional analysis methods such as FMECA and HAZOP,
- The formalization of the knowledge concepts related to this extension by means of meta-modelling to support the elaboration of machine health check,
- The proposal of a machine tool reference model from an instantiation phase of the meta-model,
- The integration of the context in the process of indicator elaboration for health check development,
- The global identification of Choquet integral capacities by the usage of Genetic Algorithms.

More precisely these contributions are faced the **industrial issues n°1 and n°2** and the **scientific issue n°1 and n° 2** (see chapter 1).

All these contributions started from and have been applied on the Renault application case study, i.e. the GROB BZ560 machine tool at Cléon factory, in order to demonstrate their applicability and interest. The first results are promising even if some aspects such as those related to global GA optimization are somewhat different from those expected. Moreover, this application in industrial environment highlighted technological and even organisational difficulties that raised question for the PHM deployment in factory and even more at worldwide company levels.

Despite these difficulties, the proposed results are a real improvement toward the structuring of the Renault approach to predictive maintenance framework. To reinforce these advances, additional works and perspectives have to be investigated both at short and long terms by extending step 1 and step 2 already engaged but also the other steps of Figure 51. It consists in:

Step 1: Knowledge formalization

- Implementation of the proposed meta-model on a dedicated operational modelling tool in connection with the industrial environment. In the context of “Factory of the Future”, OPCUA modelling could be an interesting perspective (Hastbacka et al., 2014; B. Lee, Kim, Yang, & Oh, 2017; Seilonen, Tuomi, Olli, & Koskinen, 2011).
- Enrichment of the machine tool reference model with other machine tool diversities (e.g. from other machine tool manufacturer).
- Development of reference models related to other classes of applications (additional phase of meta-model validation).
- Verification of the proposed meta-model to provide formal proof increasing the confidence degree to the model but also to its instantiations.

Step 2: System health state assessment

- Development of an automated connection to link the two first steps: from the knowledge extracted and the data repository to an automated elaboration of relations between indicators, with associated weights set on the relations and on the indicators themselves.
- Development of an integrated local and global approach to benefit from the advantage of both approaches for multi-levels system capacities identification.
- Development of an integrated “data-based” and “knowledge-based” approach, where the capacities identification process can be enhanced and validate by expert decisions. This raised the challenge of the quantification of the confidence degree related to identified capacity, thus uncertainty quantification.

... and finally, supporting the scientific issues related to the steps 3, 4 and 5 of the PHM-based methodology.

Scientific issue n°3: Elaboration of efficient predictive model to provide relevant health indicators prognostic.

Scientific issue n°4: Generation of efficient decision-making model to support various decision makers field and skills considering the joint machine-product relationship.

Scientific issue n°5: Capitalization of real manufacturing shop floor event, machine condition and maintenance intervention to increase robustness and relevance of PHM methodology steps.

Bibliography of the author

International conference with review committee and proceedings

Laloix, T., Iung, B., Voisin, A., and Romagne, E. *Towards the control of product quality from the process deviation monitoring: Overview and investigation in automotive sector*. 3rd IFAC Workshop on Advanced Maintenance Engineering, Service and Technology, IFAC A-Mest'16, 19-21 October 2016, Biarritz, France.

Laloix, T., Voisin, A., Deeb, S., Romagne, E., Iung, B., and Lorange, F. *Industrial system functioning/dysfunctioning-based approach for indicator identification to support proactive maintenance*. Proceedings in 20th IFAC World Congress, 7-14 July 2017, Toulouse, France.

Laloix, T., Vu, H. C., Voisin, A., Romagne, E., and Iung, B. (2018). *A priori indicator identification to support predictive maintenance: application to machine tool*. Proceeding of European Conference of the Prognostics and Health Management Society, Utrecht, Netherlands

Voisin, A., **Laloix, T.**, Iung, B., and Romagne, E. (2018). *Predictive Maintenance and part quality control from joint product-machine requirements: application to a machine tool*. 7th International Conference on Through-life Engineering Services (TESConf 2018), Cranfield University, UK

Main dissemination workshop

Laloix T., Romagne E.

PHM Workshop Renault/Nissan (slides)

Nissan, Yokohama, 5-7 February 2018 Japan

Laloix T.,

PHM presentation (slides)

All General Manager meeting Renault/Nissan, Cléon factory, 5 July 2018 France

Laloix T.,

PHM presentation (slides)

Tooling and Support Engineering Entity convention Renault/Nissan, 23 February 2017, Guyancourt, France

Bibliography

- Abele, E., Altintas, Y., & Brecher, C. (2010). Machine tool spindle units. *CIRP Annals - Manufacturing Technology*, 59(2), 781–802.
- Abichou, B. (2013). *Contribution à la formalisation de bilans/états de santé multi-niveaux pour aider à la prise de décision en maintenance*. Doctoral dissertation, Lorraine University, France.
- Abichou, B., Voisin, A., & Iung, B. (2012). Choquet integral parameters inference for health indicators fusion within multi-levels industrial systems: application to components in series. *IFAC Proceedings Volumes*, 45(31), 193–198.
- Abichou, B., Voisin, A., & Iung, B. (2015). Choquet integral capacity calculus for health index estimation of multi-level industrial systems. *IMA Journal of Management Mathematics*, 26(2), 205–224.
- Adams, S., Malinowski, M., Heddy, G., Choo, B., & Beling, P. A. (2017). The WEAR methodology for prognostics and health management implementation in manufacturing. *Journal of Manufacturing Systems*, 45, 82–96.
- Altintas, Y., Verl, A., Brecher, C., Uriarte, L., & Pritschow, G. (2011). Machine tool feed drives. *CIRP Annals - Manufacturing Technology*, 60(2), 779–796.
- Ambekar, S., Edlabadkar, A., & Shroufy, V. (2013). A Review: Implementation of Failure Mode and Effect Analysis. *International Journal of Engineering and Innovative Technology*, 2(8), 37–41.
- Ament, C., & Goch, G. (2001). A process oriented approach to automated quality control. *CIRP Annals - Manufacturing Technology*, 50(1), 251–254.
- Atamuradov, V., Medjaher, K., Dersin, P., Lamoureux, B., & Zerhouni, N. (2017). Prognostics and Health Management for Maintenance Practitioners -Review, Implementation and Tools Evaluation. *International Journal of Prognostics and Health Management*, (3), 2153–2648.
- Atkinson, C., & Kühne, T. (2003). Model-driven development: A metamodeling foundation. *IEEE Software*, 20(5), 36–41.
- Barajas, L. G., & Srinivasa, N. (2008). Real-time diagnostics, prognostics & health management for large-scale manufacturing maintenance systems. In *Asme 2008 international manufacturing science and engineering conference collocated with the 3rd jsme/asme international conference on materials and processing* (pp. 85–94).
- Beliakov, G., Pradera, A., Calvo, T., & Mehler, V. A. (2007). *Aggregation Functions: A Guide for*

Practitioners. Springer Heidelberg.

- Bengtsson, M. (2004). *Condition Based Maintenance Systems: An Investigation of Technical Constituents and Organizational Aspects*. Licentiate thesis. Mälardalen University Eskilstuna.
- Bernard, A., Labrousse, M., & Perry, N. (2006). LC universal model for the enterprise information system structure. In *Innovation in Life Cycle Engineering and Sustainable Developmen*, (Springer, Dordrecht), 429–446.
- Bhuiyan, M. S. H., Choudhury, I. A., & Dahari, M. (2014). Monitoring the tool wear, surface roughness and chip formation occurrences using multiple sensors in turning. *Journal of Manufacturing Systems*, 33(4), 476–487.
- Bocciarelli, P., Ambrogio, A. D., Caponi, E., Giglio, A., & Paglia, E. (2014). A Methodological Template for Model Driven Systems Engineering. *INCOSE Italian Chapter Conference on Systems Engineering*, (September 2016).
- Bohez, E. L. J. (2002). Five-axis milling machine tool kinematic chain design and analysis. *International Journal of Machine Tools and Manufacture*, 42, 505–520.
- Bowles, J. B. (1998). The new SAE FMECA standard. *Reliability and Maintainability Symposium. 1998 Proceedings. International Symposium on Product Quality and Integrity*, 48–53.
- Brecher, C., Esser, M., & Witt, S. (2009). Interaction of manufacturing process and machine tool. *CIRP Annals - Manufacturing Technology*, 58(2), 588–607.
- Brissaud, D., Frein, Y., & Rocchi, V. (2013). *FUTURPROD - Les systèmes de production du futur. Atelier de Réflexion Prospective*. France.
- Byrne, G., Dornfeld, D., Inasaki, I., Ketteler, G., König, W., & Teti, R. (1995). Tool Condition Monitoring (TCM) - The Status of Research and Industrial Application. *CIRP Annals - Manufacturing Technology*, 44(2), 541–567.
- Callan, R., Larder, B., & Sandiford, J. (2006). An Integrated Approach to the Development of an Intelligent Prognostic Health Management System. *Aerospace Conference, IEEE, Big Sky, MT, USA*.
- Cao, H., Zhang, X., & Chen, X. (2017). The concept and progress of intelligent spindles: A review. *International Journal of Machine Tools and Manufacture*, 112, 21–52.
- Catelani, M., Ciani, L., Cristaldi, L., Faifer, M., Lazzaroni, M., & Khalil, M. (2015). Toward a new definition of FMECA approach. *Conference Record - IEEE Instrumentation and Measurement Technology Conference, 2015–July*, 981–986.

-
- Chandola, V., Banerjee, A., & Kumar, V. (2009). Anomaly detection: a survey. *ACM Computing Surveys (CSUR)*, 41(3).
- Cheng, S., Azarian, M. H., & Pecht, M. G. (2010). Sensor systems for prognostics and health management. *Sensors*, 10(6), 5774–5797.
- Chryssolouris, G. (2013). *Manufacturing Systems: Theory and Practice*. *Journal of Chemical Information and Modeling*. Springer Science & Business Media.
- Cocheteux, P. (2010). *Contribution à la maintenance proactive par la formalisation de pronostic des performances de systèmes industriels*. Doctoral dissertation, Lorraine University, France.
- Cocheteux, P., Voisin, A., Levrat, E., & Iung, B. (2009). Methodology for assessing system performance loss within a proactive maintenance framework. *IFAC Proceedings Volumes (IFAC-PapersOnline)*, 13, 1889–1894.
- Cocheteux, P., Voisin, A., Levrat, E., & Iung, B. (2010). System performance prognostic: Context, issues and requirements. *IFAC Proceedings Volumes (IFAC-PapersOnline)*, 1, 134–139.
- Colledani, M., & Tolio, T. (2009). Performance evaluation of production systems monitored by statistical process control and off-line inspections. *International Journal of Production Economics*, 120(2), 348–367.
- Colledani, M., Yemane, A., & Tognetti, A. (2016). Analysis of In-line Quality-oriented Assembly Strategies in the Production of Electric Drives. *Procedia CIRP*, 50, 784–789.
- Combarro, E. F., & Miranda, P. (2006). Identification of fuzzy measures from sample data with genetic algorithms. *Computers and Operations Research*, 33(10), 3046–3066.
- Cosper, E. (1999). Statistical process control. *Printed Circuit Fabrication*, 1–41.
- Das, S., Hall, R., Herzog, S., Harrison, G., Bodkin, M., & Martin, L. (2011). Essential steps in prognostic health management. *2011 IEEE International Conference on Prognostics and Health Management, PHM 2011, Montreal, QC, Canada*.
- Deeb, S. (2008). *Contribution méthodologique à la maîtrise conjointe de la qualité d'un produit et de ses processus de production par une modélisation des concepts qualité*. Doctoral dissertation, Lorraine University, France.
- Desforges, X., & Archimède, B. (2006). Multi-agent framework based on smart sensors/actuators for machine tools control and monitoring. *Engineering Applications of Artificial Intelligence*, 19(6), 641–655.
- Desforges, X., Diévert, M., Charbonnaud, P., & Archimède, B. (2012). A distributed architecture to

-
- implement a prognostic function for complex systems. *Proceedings of the European Conference of the Prognostics and Health Management Society, Dresden, Germany*, 1–8.
- Desforges, X., Habbadi, A., & Archimède, B. (2011). Design methodology for smart actuator services for machine tool and machining control and monitoring. *Robotics and Computer-Integrated Manufacturing*, 27(6), 963–976.
- Diez, L., Marangé, P., Mayer, F., & Levrat, E. (2016). Maintenance as a cornerstone for the application of regeneration paradigm in systems lifecycle. *Conference on Complex Systems Design and Management, Springer*, 185–197.
- EFFRA. (2013). *Factories of the future: Multi-annual roadmap for the contractual PPP under Horizon 2020*. (E. F. of the F. R. Association, Ed.), *Publications Office of the European Union*. <https://doi.org/10.2777/29815>
- Efthymiou, K., Papakostas, N., Mourtzis, D., & Chryssolouris, G. (2012). On a predictive maintenance platform for production systems. In *Procedia CIRP* (Vol. 3, pp. 221–226).
- El-Mounayri, H., & Deng, H. (2010). A generic and innovative approach for integrated simulation and optimisation of end milling using solid modelling and neural network. *International Journal of Computer Integrated Manufacturing*, 23(1), 40–60.
- Elangovan, M., Sakthivel, N. R., Saravanamurugan, S., Nair, B. B., & Sugumaran, V. (2015). Machine Learning Approach to the Prediction of Surface Roughness Using Statistical Features of Vibration Signal Acquired in Turning. *Procedia Computer Science*, 50, 282–288.
- Godichaud, M., Tchangani, A., Pérès, F., & Iung, B. (2012). Sustainable management of end-of-life systems. *Production Planning & Control*, 23(2–3), 216–236.
- González, E. L. M., Desforges, X., & Archimède, B. (2018). Assessment method of the multicomponent systems future ability to achieve productive tasks from local prognoses. *Reliability Engineering & System Safety*, 180, 403–415.
- Grabisch, M. (1996). The application of fuzzy integrals in multicriteria decision making. *European Journal of Operational Research*, 89(3), 445–456.
- Grabisch, M. (1997). k-order additive discrete fuzzy measures and their representation. *Fuzzy Sets and Systems*, 92, 167–189.
- Grabisch, M., Kojadinovic, I., & Meyer, P. (2008). A review of methods for capacity identification in Choquet integral based multi-attribute utility theory. *European Journal of Operational Research*, 186(2), 766–785.
- Grabisch, M., & Labreuche, C. (2010). A decade of application of the Choquet and Sugeno integrals in
-

-
- multi-criteria decision aid. *Annals of Operations Research*, 175(1), 247–286.
- Grabisch, M., Marichal, J., Mesiar, R., & Pap, E. (2010). Aggregation Functions. Means. *Information Sciences*, 181(1), 1–22.
- Guillén, A. J., González-Prida, V., Gómez, J. F., & Crespo, A. (2015). Standards as reference to build a PHM-based solution. *Proceedings of the 10th World Congress on Engineering Asset Management (WCEAM 2015)*. Springer, Tampere, Finland, 207–214.
- Hastbacka, D., Barna, L., Karaila, M., Liang, Y., Tuominen, P., & Kuikka, S. (2014). Device status information service architecture for condition monitoring using OPC UA. *Proceedings of the 2014 IEEE Emerging Technology and Factory Automation (ETFA)*, Barcelona, Spain, 1–7.
- Hoang, A., Do, P., & Iung, B. (2017). Energy efficiency performance-based prognostics for aided maintenance decision-making: Application to a manufacturing platform. *Journal of Cleaner Production*, 142, 2838–2857.
- IEEE, S. 1856. (2017). *IEEE Standard Framework for Prognostics and Health Management of Electronic Systems* (IEEE stand). <https://doi.org/10.1109/IEEESTD.2017.8227036>
- INCOSE, I. C. on S. E. (2007). Systems Engineering Vision 2020. *Systems Engineering, INCOSE-TP*.
- International Electrotechnical Commission. (2006). IEC EN 60812:2016 - Analysis techniques for system reliability – Procedure for failure mode and effects analysis (FMEA).
- Iung, B., & Levrat, E. (2014). Advanced Maintenance Services for Promoting Sustainability. *Procedia CIRP*, 22, 15–22.
- Iung, B., Véron, M., Suhner, M. C., & Muller, A. (2005). Integration of Maintenance Strategies into Prognosis Process to Decision-Making Aid on System Operation. *CIRP Annals - Manufacturing Technology*, 54(1), 5–8.
- Jain, A. K., & Lad, B. K. (2015). Quality Control Based Tool Condition Monitoring. *Annual Conference of the Prognostics and Health Management Society, Coronado, California.*, 1–10.
- Javed, K., Gouriveau, R., & Zerhouni, N. (2017). State of the art and taxonomy of prognostics approaches, trends of prognostics applications and open issues towards maturity at different technology readiness levels. *Mechanical Systems and Signal Processing*, 94, 214–236.
- Kalgren, P. W., Byington, C. S., Roemer, M. J., Ph, D., & Watson, M. J. (2006). Defining PHM , a lexical evolution of maintenance and logistics. *IEEE AUTOTESTCON 2006 Conference Record, Anaheim, CA, USA*, 353–358.
- Katipamula, S., & Brambley, M. R. (2005). Methods for fault detection, diagnostics, and prognostics

-
- for building systems - A review, Part I. *HVAC and R Research*, 11(1), 3–25.
- Khan, S., & Yairi, T. (2018). A review on the application of deep learning in system health management. *Mechanical Systems and Signal Processing*, 107, 241–265.
- Kothamasu, R., Huang, S. H., & Verduin, W. H. (2006). System health monitoring and prognostics -a review of current paradigms and practices. *Int J Adv Manuf Technol*, 28, 1012–1024.
- Krause, F. L., & Kaufmann, U. (2007). Meta-modelling for interoperability in product design. *CIRP Annals - Manufacturing Technology*, 56(1), 159–162.
- Krishnan, A. R., Kasim, M. M., & Bakar, E. M. N. E. A. (2015). A Short Survey on the Usage of Choquet Integral and its Associated Fuzzy Measure in Multiple Attribute Analysis. *Procedia Computer Science*, 59, 427–434.
- Laloix, T., Iung, B., Voisin, A., & Romagne, E. (2016). Towards the control of product quality from the process deviation monitoring: Overview and investigation in automotive sector. *IFAC-PapersOnLine*, 49(28), 79–84.
- Laloix, T., Vu, H. C., Voisin, A., Romagne, E., & Iung, B. (2018). A priori indicator identification to support predictive maintenance : application to machine tool. *Proceedings of the European Conference of the PHM Society, Utrecht, Netherlands*, 1–8.
- Larue, A., Cadavid, J., Tucci, S., Naudet, S., & Anastassova, M. (2017). *The Factory of the Future. A study for the Government Office for Science. The National Metals Technology Centre, University of Sheffield AMRC* (Vol. 3). <https://doi.org/10.1109/MCS.1987.1105295>
- Lebold, M., Reichard, K., Hejda, P., Bezdicek, J., & Thurston, M. (2002). A framework for next generation machinery monitoring and diagnostics. *Proceedings of the Society for Machinery Failure Prevention Technology Meeting*, 115–126.
- Lee, B., Kim, D. K., Yang, H., & Oh, S. (2017). Model transformation between OPC UA and UML. *Computer Standards and Interfaces*, 50, 236–250.
- Lee, J., Bagheri, B., & Kao, H. A. (2015). A Cyber-Physical Systems architecture for Industry 4.0-based manufacturing systems. *Manufacturing Letters*, 3, 18–23.
- Lee, J., Ni, J., Djurdjanovic, D., Qiu, H., & Liao, H. (2006). Intelligent prognostics tools and e-maintenance. *Computers in Industry*, 57(6), 476–489.
- Lee, J., Wu, F., Zhao, W., Ghaffari, M., Liao, L., & Siegel, D. (2014). Prognostics and health management design for rotary machinery systems - Reviews, methodology and applications. *Mechanical Systems and Signal Processing*, 42(1–2), 314–334.
-

-
- Lee, J., Yang, S., Lapira, E., Kao, H., & Yen, N. (2013). Methodology and Framework of a Cloud-Based Prognostics and Health Management System for Manufacturing Industry. *Chemical Engineering Transactions*, 33, 205–210.
- Lee, L. (2001). On the Effectiveness of the Skew Divergence for Statistical Language. *AISTATS*.
- Leger, J.-B. (1999). *Contribution méthodologique à la maintenance prévisionnelle des systèmes industriels de production : proposition d'un cadre formel de modélisation*. Doctoral dissertation, Lorraine University, France.
- Leger, J. B., & Morel, G. (2001). Integration of maintenance in the enterprise: Towards an enterprise modelling-based framework compliant with proactive maintenance strategy. *Production Planning and Control*, 12, 176–187.
- Liang, T., Lu, D., Yang, X., Zhang, J., Ma, X., & Zhao, W. (2016). Feed fluctuation of ball screw feed systems and its effects on part surface quality. *International Journal of Machine Tools and Manufacture*, 101, 1–9.
- Lu, C. (2008). Study on prediction of surface quality in machining process. *Journal of Materials Processing Technology*, 205(1–3), 439–450.
- Ly, C., Tom, K., Byington, C. S., Patrick, R., & Vachtsevanos, G. J. (2009). Fault diagnosis and failure prognosis for engineering systems: A global perspective. *Automation Science and Engineering, 2009. CASE 2009. IEEE International Conference*, 108–115.
- Man, K. F., Tang, K. S., & Kwong, S. (1996). Genetic Algorithms : Concepts and Applications. *IEEE Transactions on Industrial Electronics*, 43(5).
- Marichal, J. (2004). Tolerant or intolerant character of interacting criteria in aggregation by the Choquet integral. *European Journal of Operational Research*, 155, 771–791.
- Markou, M., & Singh, S. (2003a). Novelty detection: A review - Part 1: Statistical approaches. *Signal Processing*, 83(12), 2481–2497.
- Markou, M., & Singh, S. (2003b). Novelty detection: A review - Part 2: Neural network based approaches. *Signal Processing*, 83(12), 2499–2521.
- Mathew, S., Das, D., Rossenberger, R., & Pecht, M. (2008). Failure mechanisms based prognostics. *Proceedings of the 1st International Conference on Prognostics and Health Management, Denver, CO*, 1–6.
- Matsokis, A., Karray, M. H., Chebel-morello, B., & Kiritsis, D. (2010). An Ontology-based model for providing Semantic Maintenance. In *1st IFAC Workshop on Advanced Maintenance Engineering, Services and Technology, Lisbon, Portugal*.

-
- Medina-Oliva, G., Iung, B., Viveros, P., & Ruin, T. (2012). Root Cause Analysis to Identify Physical Causes. *11th International Probabilistic Safety Assessment and Management Conference and The Annual European Safety and Reliability Conference, PSAM11 - ESREL 2012, Helsinki, Finland.*
- Medina-Oliva, G., Weber, P., & Iung, B. (2013). PRM-based patterns for knowledge formalisation of industrial systems to support maintenance strategies assessment. *Reliability Engineering and System Safety, 116*, 38–56.
- Medina-Oliva, G., Weber, P., Levrat, E., & Iung, B. (2010). Use of probabilistic relational model (PRM) for dependability analysis of complex systems. *IFAC Proceedings Volumes (IFAC-PapersOnline)*, 9, 501–506.
- Mehta, P., Werner, A., & Mears, L. (2015). Condition based maintenance-systems integration and intelligence using Bayesian classification and sensor fusion. *Journal of Intelligent Manufacturing, 26*(2), 331–346.
- MIL-STD-1629A. (1980). *Procedure for performing a Failure Mode, Effects and Criticality Analysis.*
- Miranda, P., Grabisch, M., & Gil, P. (2002). p-symmetric fuzzy measures. *International Journal of Uncertainty, Fuzziness and Knowledge-Based Systems*, 105–123.
- Möhring, H. C., & Bertram, O. (2012). Integrated autonomous monitoring of ball screw drives. *CIRP Annals - Manufacturing Technology, 61*(1), 355–358.
- Monostori, L., Kádár, B., Bauernhansl, T., Kondoh, S., Kumara, S., Reinhart, G., ... Ueda, K. (2016). Cyber-physical systems in manufacturing. *CIRP Annals - Manufacturing Technology, 65*(2), 621–641.
- Mori, M., Fujishima, M., Komatsu, M., Zhao, B., & Liu, Y. (2008). Development of remote monitoring and maintenance system for machine tools. *CIRP Annals - Manufacturing Technology, 57*(1), 433–436.
- Muller, A. (2005). *Contribution à la maintenance prévisionnelle des systèmes de production par la formalisation d ' un processus de pronostic.* Doctoral dissertation, Lorraine University, France.
- Muller, A., Suhner, M. C., & Iung, B. (2008). Formalisation of a new prognosis model for supporting proactive maintenance implementation on industrial system. *Reliability Engineering and System Safety, 93*(2), 234–253.
- Naumenko, A., & Wegmann, A. (2003). Two approaches in system modeling and their illustrations with MDA and RM-ODP. In *ICEIS 2003, the 5th International Conference on Enterprise Information Systems, Portugal* (pp. 398–402).
- NF EN 13306. (2001). *Maintenance terminology.* Paris. France.

-
- Nithin, A., Dinesh, K., Satish, C., & Vishal, W. (2015). Tool condition monitoring system. *Neural Networks*, 2(4–5), 2–5.
- Nuñez, D. L., & Borsato, M. (2017). An ontology-based model for prognostics and health management of machines. *Journal of Industrial Information Integration*, 6, 33–46.
- OMG. (2006). Meta Object Facility (MOF) Core Specification. *Management*, (January), 1–76.
- Panetto, H., & Pétin, J. (2005). Metamodelling of production systems process models using UML stereotypes. *International Journal of Internet and Enterprise Management*, 3(2), 155–169.
- Pecht, M. (2009). Prognostics and health management of electronics. *Encyclopedia of Structural Health Monitoring*, 1–13.
- Pei, C., Fu, G., Li, N., & Zou, H. (2012). A Research on the Application of Prognostics and Health Management to Process System. *Prognostics and System Health Management (PHM), 2012 IEEE Conference, Beijing, China*, 1–5.
- Peng, Y., Dong, M., & Zuo, M. J. (2010). Current status of machine prognostics in condition-based maintenance: A review. *International Journal of Advanced Manufacturing Technology*, 50(1–4), 297–313.
- Potes Ruiz, P. A., Kamsu-Foguem, B., & Noyes, D. (2013). Knowledge reuse integrating the collaboration from experts in industrial maintenance management. *Knowledge-Based Systems*, 50, 171–186.
- Rabenoro, T., Lacaille, J., Cottrell, M., & Rossi, F. (2014). A methodology for the diagnostic of aircraft engine based on indicators aggregation. In *Advances in Data Mining. Applications and Theoretical Aspects*. (Perner, pp. 144–158). Springer, Cham.
- Rajasekaran, T., Palanikumar, K., Vinayagam, B. K., & Prakash, S. (2010). Influence of machining parameters on surface roughness and material removal rate in machining carbon fiber reinforced polymer material. *Frontiers in Automobile and Mechanical Engineering (FAME)*, 75–80.
- Rehman, Z., & Kifor, C. V. (2016). An Ontology to Support Semantic Management of FMEA Knowledge. *International Journal of Computers, Communications & Control*, 11(4).
- Renu, R., Visotsky, D., Knackstedt, S., Mocko, G., Summers, J. D., & Schulte, J. (2016). A Knowledge Based FMEA to Support Identification and Management of Vehicle Flexible Component Issues. *Procedia CIRP*, 44, 157–162.
- Riera, B., Brissaud, D., Eynard, D., Iung, B., Voisin, A., Levrat, E., ... Lerondel, G. (2017). Industrie du futur - Témoignages et partages d' expériences : Vers les Services et Industrie du Futur, 1–44.

- Risbood, K. A., Dixit, U. S., & Sahasrabudhe, A. D. (2003). Prediction of surface roughness and dimensional deviation by measuring cutting forces and vibrations in turning process. *Journal of Materials Processing Technology*, 132, 203–214.
- Rizzolo, L., Abichou, B., Voisin, A., & Kosayyer, N. (2011). Aggregation of Health Assessment Indicators of Industrial Systems. *The 7th Conference of the European Society for Fuzzy Logic and Technology, EUSFLAT-2011, Aix-Les-Bains, France*.
- Sang, Z., & Xu, X. (2017). The Framework of a Cloud-based CNC System. *Procedia CIRP*, 63, 82–88.
- Santarek, K., & Buseif, I. M. (1998). Modelling and design of flexible manufacturing systems using SADT and Petri nets tools. *Journal of Materials Processing Technology*, 76(1–3), 212–218.
- Seilonen, I., Tuomi, A., Olli, J., & Koskinen, K. (2011). Service-Oriented Application Integration for condition-based maintenance with OPC Unified Architecture. *IEEE International Conference on Industrial Informatics (INDIN), Lisbon, Portugal*, 45–50.
- Sheppard, J. W., Kaufman, M. a., & Wilmering, T. J. (2009). IEEE Standards for Prognostics and Health Management. *Aerospace and Electronic Systems Magazine, IEEE*, 24(9), 34–41.
- Soley, R., & OMG Staff Strategy Gropu. (2000). Model driven architecture. *OMG White Paper*, (April), 1–12.
- Teti, R., Jemielniak, K., O'Donnell, G., & Dornfeld, D. (2010). Advanced monitoring of machining operations. *CIRP Annals - Manufacturing Technology*, 59(2), 717–739.
- Thoben, K.-D., Wiesner, S., & Wuest, T. (2017). “Industrie 4.0” and Smart Manufacturing – A Review of Research Issues and Application Examples. *International Journal of Automation Technology*, 11(1), 4–16.
- Thurston, M., & Lebold, M. (2001). Standards Developments for Condition-Based Maintenance Systems. *Pennsylvania State University Park Applies Research Lab*, 12.
- Tiddens, W., Braaksma, J., & Tinga, T. (2018). Selecting Suitable Candidates for Predictive Maintenance. *International Journal of Prognostics and Health Management*, Vol. 9, 1–14.
- Torra, V. (2013). Aggregation Operators. In *On Fuzziness* (Vol. 299, pp. 691–695). Springer Berlin Heidelberg.
- Trammell, S. R., & Davis, B. J. (2001). Using a modified Hazop/FMEA methodology for assessing system risk. *Proceedings 2nd International Workshop on Engineering Management for Applied Technology. EMAT 2001, Austin, Texas*, 47–53.
- Tseng, T.-L. (Bill), Konada, U., & Kwon, Y. (James). (2016). A novel approach to predict surface

-
- roughness in machining operations using fuzzy set theory. *Journal of Computational Design and Engineering*, 3(1), 1–13.
- Tsui, K. L., Chen, N., Zhou, Q., Hai, Y., & Wang, W. (2015). Prognostics and Health Management : A Review on Data Driven Approaches. *Mathematical Problems in Engineering*.
- Vaidya, S., Ambad, P., & Bhosle, S. (2018). Industry 4.0 - A Glimpse. *Procedia Manufacturing*, 20, 233–238.
- Verl, A., Heisel, U., Walther, M., & Maier, D. (2009). Sensorless automated condition monitoring for the control of the predictive maintenance of machine tools. *CIRP Annals - Manufacturing Technology*, 58(1), 375–378.
- Vicente, V., Neto, G., Fernando, L., & Loja, B. (2017). Towards Methods for Model-Based Software Development. *ArXiv Preprint ArXiv:1712.02448*, 1–8.
- Vichare, P., Nassehi, A., & Newman, S. (2009). A unified manufacturing resource model for representation of computerized numerically controlled machine tools. *Proceedings of the Institution of Mechanical Engineers, Part B: Journal of Engineering Manufacture*, 223(5), 463–483.
- Vichare, P., Nassehi, A., Thompson, J., Newman, S. T., Wood, F., & Kumar, S. (2015). Machine tool capability profiles for representing machine tool health. *Robotics and Computer-Integrated Manufacturing*, 34, 70–78.
- Villeta, M., Maria Rubio, E., Luis Valencia, J., & Angel Sebastian, M. (2012). Integrating the continuous improvement of measurement systems into the statistical quality control of manufacturing processes: A novel link. *CIRP Annals-Manufacturing Technology*, 61(1), 507–510.
- Vogl, G. W., Donmez, M. A., & Archenti, A. (2016). Manufacturing Technology Diagnostics for geometric performance of machine tool linear axes. *CIRP Annals - Manufacturing Technology*, 65(1), 377–380.
- Vogl, G. W., Weiss, B. A., & Alkan Donmez, M. (2015). A Sensor-Based Method for Diagnostics of Machine Tool Linear Axes. *Annual Conference of the Prognostics and Health Management Society*, 10.
- Vogl, G. W., Weiss, B. A., & Donmez, M. A. (2014). Standards Related to Prognostics and Health Management (PHM) for Manufacturing. *US Department of Commerce, National Institute of Standards and Technology*.
- Vogl, G. W., Weiss, B. A., & Helu, M. (2016). A review of diagnostic and prognostic capabilities and best practices for manufacturing. *Journal of Intelligent Manufacturing*, 1–17.
-

- Voisin, A., Levrat, E., Cocheteux, P., & Iung, B. (2010). Generic prognosis model for proactive maintenance decision support: Application to pre-industrial e-maintenance test bed. *Journal of Intelligent Manufacturing*, 21(2), 177–193.
- Wang, S., Wan, J., Li, D., & Zhang, C. (2016). Implementing Smart Factory of Industrie 4.0: An Outlook. *International Journal of Distributed Sensor Networks*, 2016.
- Weiss, B. A., & Qiao, G. (2017). Hierarchical Decomposition of a Manufacturing Work Cell To Promote Monitoring, Diagnostics, and Prognostics. *Proceedings of the ASME 2017 12th International Manufacturing Science and Engineering Conference, Los Angeles, California*, 1–11.
- Weiss, B. A., Sharp, M., & Klinger, A. (2018). Developing a hierarchical decomposition methodology to increase manufacturing process and equipment health awareness. *Journal of Manufacturing Systems*.
- Weiss, B. A., Vogl, G. W., Helu, M., Qiao, G., Pellegrino, J., & Justiniano, M. (2015). Measurement Science for Prognostics and Health Management for Smart Manufacturing Systems : Key Findings from a Roadmapping Workshop. *Proc Annu Conf Progn Health Manag Soc.*, 1–11.
- Welber, I. (1986). Factory of the Future. *International Symposium on Robot Manipulators: Modeling, Control, and Education*.
- Yang, B., Qiao, L., Zhu, Z., & Wulan, M. (2016). A Metamodel for the Manufacturing Process Information Modeling. *Procedia CIRP*, 332–337.
- Zhang, S. J., To, S., Wang, S. J., & Zhu, Z. W. (2015). A review of surface roughness generation in ultra-precision machining. *International Journal of Machine Tools and Manufacture*, 91, 76–95.
- Zhong, R. Y., Xu, X., Klotz, E., & Newman, S. T. (2017). Intelligent Manufacturing in the Context of Industry 4.0: A Review. *Engineering*, 3(5), 616–630.
- Zio, E. (2012). Prognostics and Health Management of Industrial Equipment. *Diagnostics and Prognostics of Engineering Systems: Methods and Techniques*, 4018, 333–356.

Résumé en français

La performance des systèmes industriels est un levier majeur de la compétitivité des entreprises manufacturières. C'est particulièrement le cas dans le contexte de « l'usine (ou industrie) du future » (ou encore « *Factory of the Future* ») avec l'émergence de nouvelles technologies clés (Vaidya et al., 2018; Zhong et al., 2017), aussi appelées « technologies génériques à forte valeur ajoutée » (Brissaud et al., 2013). Le concept de « *Factory of the Future* » est apparu à la fin des années 90 à la suite d'avancées conséquentes dans le domaine des technologies de l'informatique et des communications (TIC) (Welber, 1986). Ainsi, le développement de technologies venant de l'industrie, supportées par des concepts, méthodes et outils issues de la recherche (e.g. systèmes cyber-physiques, internet des objets, cloud manufacturing, cloud computing, etc.) soutiennent la transformation de modèles traditionnels des entreprises vers le paradigme de « *Factory of the Future* ». Cette (r)évolution doit conduire à l'élaboration d'un outil industriel plus flexible, intelligent et reconfigurable assurant une amélioration de la qualité du produit et du service, et une augmentation de la productivité (Zhong et al., 2017). Tandis que la 3^{ème} révolution industrielle représente l'essor de l'automatisation des systèmes industriels et du développement des technologies de l'information, la 4^{ème} révolution industrielle vise au développement de systèmes intelligents à travers la transformation digitale (Vaidya et al., 2018). Il en ressortirait une amélioration du contrôle des systèmes industriels et l'optimisation de leur processus menant à une augmentation des bénéfices des entreprises. Le concept de « *Factory of the Future* » n'aborde pas seulement l'augmentation des performances des systèmes industriels mais aussi la traçabilité des produits, la capacité de reconfiguration des processus, l'interopérabilité des systèmes d'information, etc. et propose un nouveau niveau d'organisation et de contrôle sur la chaîne de valeur globale du cycle de vie des produits. « *Factory of the Future* » offre également l'opportunité d'une gestion des ressources plus efficiente. Telles que soulignées dans le rapport prospectif sur les systèmes de production du futur (Brissaud et al., 2013) élaboré par un ensemble de chercheurs français et supporté par l'ANR³⁰, les orientations soulevées par « *Factory of the Future* » sont nombreuses et les domaines impactés sont aussi bien sociétaux que techniques. Parmi les aspects sociétaux peuvent être cités la formation et la gestion des compétences, l'organisation collaborative, l'innovation participative. Les aspects techniques correspondent, par exemple, à l'optimisation des performances des systèmes de production et leur contrôle, une attention particulière à une meilleure gestion de la consommation énergétique et une performance accrue de l'ensemble de la chaîne d'approvisionnement. Parmi ces orientations, la thèse adresse, plus particulièrement, les aspects en lien avec le contrôle et optimisation des performances des systèmes de production. En effet, au-delà de la disponibilité de certaines solutions

³⁰ French National Research Agency, <http://www.agence-nationale-recherche.fr/en/>

technologiques, de nombreux enjeux restent à adresser pour que les promesses de « *Factory of the Future* » trouvent une réalité opérationnelle dans l'industrie.

Afin d'atteindre ces objectifs dans le développement de systèmes de production avancés, des disciplines innovantes et champs de recherche associés ont émergé. Ainsi, considéré comme une évolution de la maintenance conditionnelle (ou CBM pour Condition-Based Maintenance), le Prognostics and Health Management (PHM) s'est largement développé depuis quelques années. Le PHM a pour principe de déterminer l'état de santé courant et à venir d'un équipement à partir de la transformation de données brutes issues de son instrumentation, de son environnement, de ses conditions d'usage, etc. (J. Lee et al., 2014; Zio, 2012). Le PHM est construit sur les mêmes principes que la maintenance prédictive, bien que d'une portée plus large car plus général. Ainsi, partant du captage d'informations issue d'un système, l'objectif est de fournir des indicateurs pertinents à des décideurs afin d'aider au pilotage du système et à sa maintenance. Le développement du PHM conduit donc à l'évolution de la stratégie de maintenance de type « *fail and fix* » vers une stratégie de type « *predict and prevent* » (Iung et al., 2005; J. Lee et al., 2006). Afin de promouvoir, structurer et faciliter le déploiement du PHM, un certain nombre de standards ont été développés. Parmi ces standard, il est à noter le standard MIMOSA OSA-CBM (Lebold et al., 2002) comme l'un des plus reconnu de la communauté et étant à l'origine de l'ISO-13374 (Condition Monitoring and Diagnostics of Machines). L'architecture OSA-CBM est constituée de sept niveaux fonctionnels. Les trois premiers niveaux permettent d'acquérir les mesures et de mettre en forme les données afin d'obtenir des indicateurs adaptés (Cocheteux, 2010). Les étapes suivantes consistent à évaluer le niveau de santé et de son pronostic permettant la constitution d'une aide à la décision fournie à travers une interface homme-machine. De ce standard peut être extraits des éléments clés pour le développement de cas applicatifs (Das et al., 2011; Sheppard et al., 2009).

Néanmoins, en dépit de nombreux travaux dans ce domaine, les enjeux en lien avec la qualité du produit ne sont pas clairement satisfaits par les approches courantes, plutôt orientées machine ou composant. Les aspects qualité sont principalement associés au contrôle de la déviation des propriétés du produit. D'un point de vue opérationnel, ce contrôle se manifeste généralement à travers des politiques de contrôle à posteriori par échantillonnage, de type Statistical Process Control (SPC). Dans ce domaine, des initiatives promouvant une vision proactive se développent, notamment à travers un control qualité continu (Colledani et al., 2016) ou une amélioration des systèmes de mesure (Villeta et al., 2012). Une piste intéressante serait donc d'anticiper la déviation de la qualité du produit avant de la subir. Ces déviations résultent de la combinaison de divers éléments tels que la performance de la machine, les paramètres du processus de fabrication ou encore la matière du produit. (Mori et al., 2008). Les paramètres du processus de fabrication sont généralement spécifiés par simulation puis validés par expérimentation tandis que la conformité matière est de la responsabilité du fournisseur, assurée à travers des démarches d'assurance qualité. Seule la performance machine n'est pas complètement

maitrisée, principalement en raison de l'évolution de son contexte environnementale ou opérationnel et de la dégradation de ses composants. Partant de ce constat, une piste d'investigation pourrait correspondre à la surveillance de la cinématique de la machine afin de prévenir sa dégradation et l'impact qu'elle pourrait avoir sur la qualité du produit réalisé.

Ainsi, un challenge scientifique majeur, autour duquel la thèse est construite, est de **définir une approche intégrée, basée sur les principes du PHM, dans le but de fournir des indicateurs pertinents permettant le contrôle de la déviation des performances du produit et de la machine sur la base de la surveillance des dégradations de sa cinématique.**

Une telle vision est en phase avec la vision que le Process Engineering de Renault vise à développer, en cohérence avec le concept de « *Factory of the Future* ». En effet, en dépit d'importants efforts en lien avec les politiques de maintenance, des arrêts de production consécutifs à des pannes et dégradations machines ainsi que des déviations de qualité produite sont observés. Une relation entre les deux phénomènes (i.e. dégradation machine et déviation de la qualité du produit) a été établie, sans qu'une solution convaincante ne soit apportée par les approches conventionnelles (principalement de maintenance périodique). **Cette thèse est construite sur ce challenge industriel.** Initiée par Renault, en collaboration avec le Centre de Recherche en Automatique de Nancy (CRAN) comme partenaire académique, l'objectif de la thèse est de poser les fondements d'une méthodologie générique permettant l'élaboration du bilan de santé de machine de production avec la considération conjointe machine-produit. Le caractère applicatif de la thèse est justifié par un cas d'application localisé à l'usine Renault de Cléon (Normandie, France), usine produisant des moteurs et boîtes de vitesses pour l'ensemble du groupe Renault, Nissan et Daimler. La classe d'application de la thèse correspond au centre d'usinage, machine présente en nombre important à l'usine de Cléon. Ainsi, l'objet de recherche de la thèse est un centre d'usinage GROB BZ560, bi-broche, produisant des carter-cylindres de moteur diesel. Ce type de cas d'application est très largement présent au sein des usines de mécanique du groupe dénotant un potentiel important de déploiement de la méthodologie à l'échelle mondiale.

A partir de cette méthodologie, la première originalité de la thèse représente la formalisation des connaissances de la relation machine-produit, basée sur l'extension de méthodes usuelles d'analyses fonctionnelle et dysfonctionnelles. La formalisation est matérialisée à travers une méta-modélisation réalisée sur UML (Unified Modeling Language). La capitalisation des connaissances est fondée sur la modélisation de concepts issus des principes de la théorie des systèmes, des méthodes AMDEC³¹ et HAZOP³². Cette contribution mène à l'identification de paramètres pertinents à surveiller, des composants jusqu'au niveau machine. Ces paramètres contribuent ensuite à l'élaboration d'un bilan de santé tenant compte de la relation conjointe machine-produit. La seconde originalité de la thèse consiste

³¹ Analyse des Modes de Défaillance de leurs Effets et de leur Criticité

³² HAZard and Operability study

à définir les principes d'élaboration des indicateurs de santé à partir des paramètres surveillés. L'élaboration de ces indicateurs de santé est réalisée à partir de méthode de fusion/agrégation des données telle que l'intégrale de Choquet. Ces deux contributions sont développées avec l'objectif d'être génériques (non seulement dédiées à une classe d'application) conformément au besoin industriel.

En lien avec ces originalités, la thèse est structurée en quatre chapitres.

Chapitre 1. Le premier chapitre introduit la problématique industrielle Renault dans le cadre de « *Factory of the Future* ». Cette problématique industrielle émerge à partir d'un cas d'étude concret matérialisé par le centre d'usinage BROG BZ560 localisé à l'usine Renault de Cléon. Elle concerne le challenge de la relation duale entre la performance de la machine et la qualité du produit qu'elle réalise dans le cadre de la maintenance prédictive. Il correspond particulièrement au contrôle des déviations de la qualité du produit à travers le contrôle de la performance et des dégradations du système. Le challenge industriel est décliné en différents axes relatifs à des sous-problèmes. Ces axes sont déclinés en 5 enjeux industriels, séquentiels et indépendants, allant de la phase de surveillance à celle de l'aide à la décision anticipative. Un second enjeu mis en évidence au sein de ce chapitre concerne une rupture de la chaîne d'ingénierie du cycle de vie d'un produit (de sa phase de conception à sa fabrication). En effet, considérant la chaîne d'élaboration d'un produit, le lien entre les exigences portées par ses caractéristiques et celles du processus manufacturier n'est pas assuré de façon automatique, au contraire du reste des relations du reste de la chaîne d'ingénierie, tel qu'illustré Figure R.1. Cette rupture concerne en particulier la formalisation de l'influence de la performance des effecteurs de la machine sur la qualité du produit réalisé.

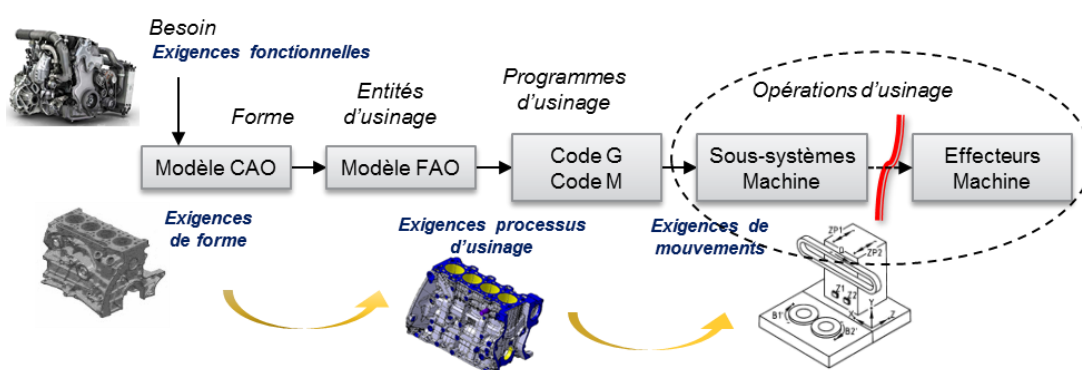

Figure R.1. Rupture de la chaîne d'exigences entre les effecteurs machine et les mouvements machine

Le positionnement scientifique de la problématique industrielle est démontré dans le cadre des concepts résultant de « *Factory of the Future* ». La considération duale entre la performance du système industriel et la qualité du produit est investiguée à travers des approches émergentes de type PHM par une revue de l'état de l'art des standards et des méthodologies PHM. Cet état de l'art met en évidence un certain nombre de limites à résoudre en relation avec les enjeux industriels contribuant à la définition de la question de recherche suivante : « **Est-il possible de développer et formaliser une approche**

basée sur les principes du PHM pour contrôler les performances (et leurs déviations) de la pièce usinée à partir du contrôle de la performance de la machine (et ses déviations) ? ». Les limites identifiées permettent de déterminer les enjeux scientifiques à appréhender pour traiter les challenges industriels d'un point de vue générique et ainsi répondre à la question de recherche. Les enjeux industriels et scientifiques sont appliqués au centre d'usinage, cas d'application de la thèse. La contribution globale réside en l'élaboration d'une approche basée sur le PHM, construite sur la considération conjointe de la performance de la machine et la qualité du produit qu'elle réalise. L'approche proposée est structurée en 5 étapes : (1) Formalisation des connaissances, (2) Bilan de santé courant, (3) Bilan de santé prévisionnel, (4) Aide à la décision et (5) Capitalisation, voir Figure R.2.

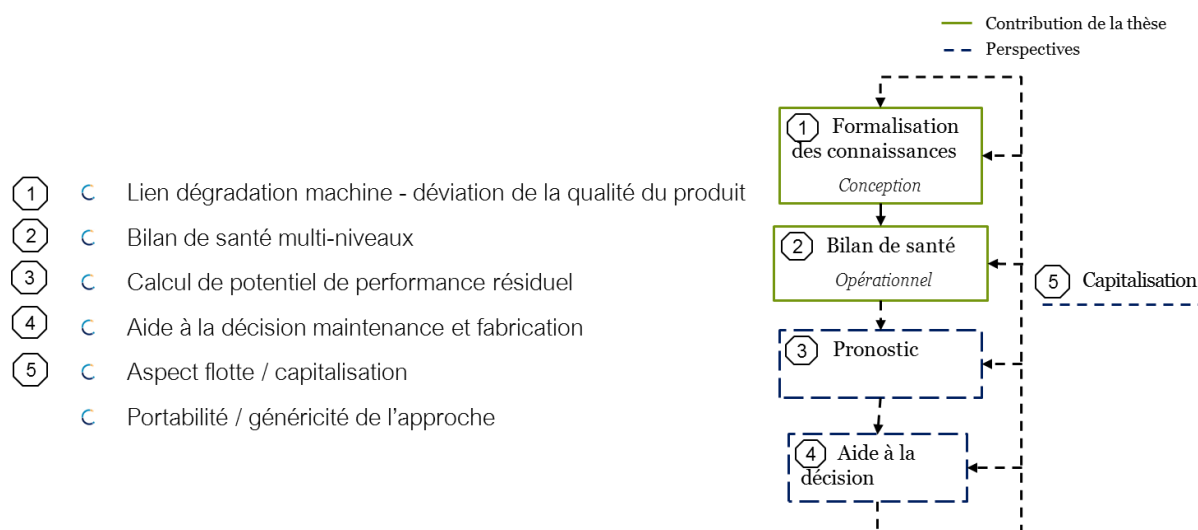

Figure R.2. Lien en les enjeux industriels et l'approche de type PHM

Parmi les 5 étapes de cette méthodologie, les deux premières étapes sont développées dans les chapitres 2 et 3 et constituent les contributions majeures de cette thèse. Ils répondent respectivement aux enjeux scientifiques suivants :

Chapitre 2

Enjeu scientifique n°1 : Formalisation de la relation machine-produit supportant l'identification des paramètres pertinent pour l'élaboration du bilan de santé machine

Chapitre 3

Enjeu scientifique n°2 : Elaboration du bilan de santé de la considération machine-produit, sur la base de l'agrégation des données machine pour fournir des indicateurs de santé

Chapitre 2. Le deuxième chapitre traite de la première étape de la méthodologie PHM : la formalisation des connaissances. Cette première étape vise à l'identification de paramètres pertinents, considérant la relation causale entre la dégradation du système manufacturier et la déviation de la qualité

du produit pour l'élaboration du bilan de santé machine. Pour ce faire, deux principales contributions sont présentées au sein de ce chapitre : (i) l'identification des concepts de connaissance nécessaires, sur la base de la théorie des systèmes et de la combinaison et l'extension de méthodes usuelles de sûreté de fonctionnement (e.g. AMDEC, HAZOP), (ii) la formalisation des concepts de connaissance et de leurs relations. Ainsi, la relation entre le système manufacturier et le produit est formalisée de façon générique à travers une méta-modélisation (conformément à la définition proposée par l'OMG³³). Sur la base de concepts de connaissance issus d'analyses fonctionnelle et dysfonctionnelles, le méta-modèle intègre les relations causales entre la dégradation de la machine et la déviation de la qualité du produit. Cette capitalisation des connaissances est fondée sur la modélisation de concepts extraits de méthodes usuelles telles que l'AMDEC et l'HAZOP, étendues dans le but de considérer le lien entre les propriétés du produit et le comportement du système manufacturier. La formalisation des concepts de connaissance est réalisée afin d'éviter les ambiguïtés syntaxique et sémantique et dans le but de faciliter la structuration des connaissances et leur réutilisation. Elle est supportée par une modélisation UML fournie par le logiciel MEGA³⁴. Le méta-modèle a été développé dans un souci de conformité avec le standard MIMOSA. Cela correspond à un modèle à généralité partielle de la classe d'application du système manufacturier (i.e. centre d'usinage). Le méta-modèle joue un rôle central dans la structuration de la connaissance pour l'identification des paramètres pertinents en lien avec les capteurs à surveiller afin de concourir à l'élaboration des indicateurs de santé entrant dans la composition du bilan de santé machine. La validation du méta-modèle est réalisée par son instanciation à la classe d'application « centre d'usinage », sur un périmètre limité. En lien avec ce cas d'application, un modèle de référence (issu du méta-modèle) est proposé pour cette même classe d'application. A partir de l'instanciation du méta-modèle, le modèle de référence permet de faciliter le déploiement et la réutilisation de la connaissance commune des systèmes inhérent à une même classe d'application (dans notre cas, la classe centre d'usinage). L'intérêt industriel a été démontré à travers la capacité du méta-modèle à être instancié.

Chapitre 3. Le troisième chapitre propose, dans la continuité du second chapitre, d'aborder la deuxième étape de la méthodologie PHM, i.e. l'élaboration du bilan de santé. Il répond ainsi au deuxième enjeu scientifique par la proposition d'une approche originale d'élaboration d'un bilan de santé sur la des concepts d'indicateurs de performance, de dégradation et de santé. Pour ce faire, il est proposé, dans un premier temps, une clarification du concept de bilan de santé à travers la définition de la chaîne de transformation de l'information (e.g. solution de captage de la donnée, paramètres surveillés, indicateurs de santé et indicateurs clés de performance (KPI)). Ainsi, sur la base d'une revue de la littérature scientifique et de la problématique industrielle, le bilan de santé est défini comme un ensemble d'indicateurs (de performance, de dégradation, de santé) en lien avec les différents de

³³ Object Management Group (www.omg.org)

³⁴ <http://www.mega.com/en/product/hopex>

décomposition hiérarchique d'un système. Les exigences issues de la clarification de ces concepts mettent en évidence 3 étapes majeures pour l'élaboration du bilan de santé. La première étape consiste à rendre commensurable les paramètres surveillés, les uns par rapport aux autres, et à les décontextualiser. Cette première étape permet l'élaboration des indicateurs de performance et de dégradation. La deuxième étape consiste à agréger les indicateurs d'un certain niveau pour obtenir l'indicateur de santé de ce niveau, et l'indicateur de dégradation du niveau supérieur. Cette seconde étape permet d'introduire respectivement les concepts d'agrégation horizontale et d'agrégation verticale. Enfin, la troisième étape consiste à construire les indicateurs de niveau système en lien avec la finalité et les KPI associés. Ces concepts sont illustrés Figure R.3.

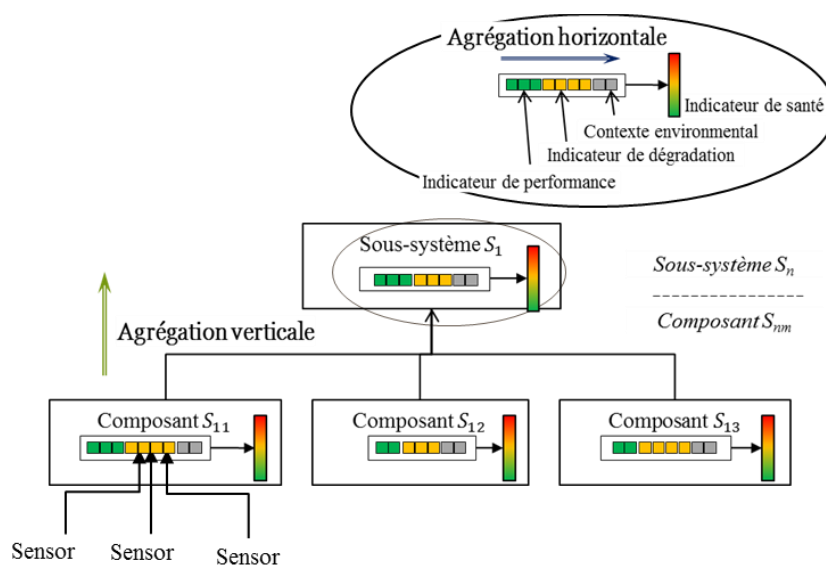

Figure R.3. Synthèse des concepts du bilan de santé

Afin d'assurer les différentes étapes inhérentes à l'élaboration du bilan de santé, un ensemble de méthodes a été identifié, sur la base d'un état de l'art. Ainsi, la commensurabilité des paramètres surveillés est assurée par la méthode des histogrammes basée sur l'entropie relative. Cette méthode permet de quantifier la dérive de moyenne ou d'écart type d'une distribution de données par rapport à des états de référence (e.g. état nominal, dégradé ou défaillant). La première originalité de ce chapitre réside dans l'intégration du contexte directement à la méthode des histogrammes à travers la définition des états de référence en fonction d'espaces contextuels. L'agrégation des indicateurs est, quant à elle, réalisée par l'intégrale de Choquet. L'intégrale de Choquet est sélectionnée comme opérateur d'agrégation de par sa capacité à prendre en compte les interactions entre indicateurs. Cependant, l'utilisation d'un tel opérateur d'agrégation nécessite l'identification de certains de ces paramètres, nommés capacités. Dès lors, une seconde contribution de ce chapitre réside dans l'approche permettant l'identification des capacités de l'intégrale de Choquet dans le contexte de l'élaboration d'un bilan de santé multi-niveaux. Le problème d'identification posé s'apparente à un problème d'optimisation. Il s'agit de trouver les capacités qui minimisent l'erreur quadratique par rapport à un jeu de données

d'apprentissage. Les méthodes issues de la littérature démontrent une bonne maîtrise de l'erreur dans le cas de l'identification pour un seul niveau mais ne traitent pas du cas multi-niveaux. La contribution de ce chapitre est donc de proposer un modèle d'optimisation global pour l'identification des capacités d'un système multi-niveaux à travers l'utilisation d'algorithmes génétiques. Le chapitre conclue par la comparaison des performances des approches d'optimisation locale et globale pour l'identification des capacités sur un cas d'étude Adhoc.

Chapitre 4. Le dernier chapitre (Chapitre 4) illustre l'application des contributions de la thèse sur le centre d'usinage GROB BZ560, dans l'environnement industriel imposé par le contexte Renault. Ce chapitre est structuré sous la forme d'un guide méthodologique pour l'application de la démarche PHM. L'application de la méthodologie débute par une présentation de la machine GROB BZ 560 et de son contexte opérationnel. Les analyses fonctionnelles et dysfonctionnelles permettent d'identifier les paramètres pertinents à suivre pour l'élaboration du bilan de santé machine. De cette identification peut être définie la stratégie d'instrumentation et de surveillance des paramètres de la machine. Ces éléments sont présentés au sein de l'environnement Renault. Les paramètres de surveillance sont ensuite mis en forme pour être commensurables et décontextualisés afin de pouvoir être agrégés. Les indicateurs de dégradation résultant de ce processus sont agrégés à travers l'utilisation de l'intégrale de Choquet, dont les capacités ont été identifiées à l'aide de l'approche d'optimisation globale. La comparaison des performances des approches d'optimisation globale et locale est réalisée. Ainsi, il est à noter que la performance de l'identification des capacités de niveau composant est meilleure à partir de l'optimisation locale, tandis que l'identification des capacités des niveaux d'abstraction supérieure (i.e. niveaux sous-système et système) est plus performance avec l'optimisation globale, voir Figure R4.. En conclusion, une piste pertinente d'investigation pour améliorer les performances globales de l'identification des capacités multi-niveaux résiderait donc la combinaison des deux approches d'optimisation.

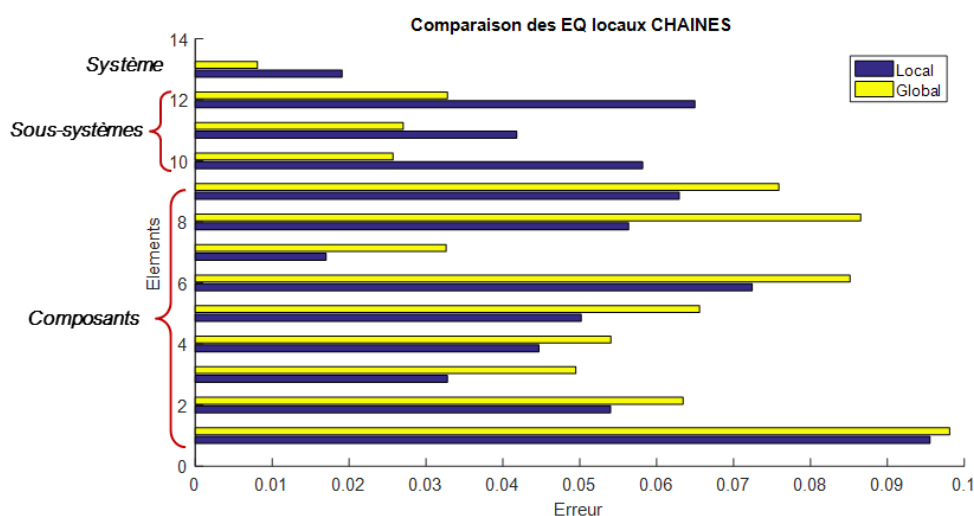

Figure R.4. Comparaison des erreurs quadratiques chaînées des optimisations globales et locales

Appendices

Appendix A: Given capacities for local vs. global optimization approach

The given capacities (Ch) related to the system illustrating the both local and global capacities identification approaches, in the section 3.5 of Chapter 3, are presented here after.

```
Ch{1}=[0 0.2416 0.2443 0.5487 0.0512 0.6222 0.4043 1];
Ch{2}=[0 0.2999 0.1762 0.5240 0.2594 0.4055 0.5542 1];
Ch{3}=[0 0.0349 0.0119 0.3926 0.2903 0.5725 0.5987 1];
Ch{4}=[0 0.0165 0.2305 0.4959 0.0707 0.5070 0.6500 1];
Ch{5}=[0 0.0865 0.3113 0.5527 0.0843 0.5468 0.4199 1];
Ch{6}=[0 0.1251 0.1490 0.4074 0.0373 0.1694 0.3789 1];
Ch{7}=[0 0.1934 0.1230 0.4466 0.0647 0.4145 0.3160 1];
Ch{8}=[0 0.1336 0.1801 0.5843 0.1243 0.5804 0.3674 1];
Ch{9}=[0 0.1659 0.1493 0.4396 0.0112 0.6277 0.4632 1];
Ch{10}=[0 0.0430 0.2239 0.2967 0.2561 0.5091 0.5214 1];
Ch{11}=[0 0.2197 0.2444 0.4219 0.2589 0.5337 0.5340 1];
Ch{12}=[0 0.3178 0.2661 0.3242 0.1354 0.3327 0.3281 1];
Ch{13}=[0 0.1719 0.0706 0.5354 0.2275 0.6244 0.5335 1];
```

Appendix B: Expert dataset for capacities identification

The dataset representing the relations between indicators, based on expert judgement, for capacities identification, is presented:

- Table 26, for axis X (A2), motor (A21), bearings (A23) and guides (A26),
- Table 27, for axis X (A3), motor (A31), bearings (A33), nut (A35) and guides (A36),
- Table 28, for axis Z (A4'), motor (A41'), bearings (A43') and guides (A46'),
- Table 29, for axis Z (A4''), motor (A41''), bearings (A43'') and guides (A46''),
- Table 30, for axis X (A2), axis X (A3), axis Z (A4'), axis Z (A4''), and GROB BZ560 (A0).

A211	A212	A213	A21	A231	A232	A233	A224	A22	A231	A232	A233	A23	A2
0,8	1	1	0,97	1	0,8	0,2	0,8	0,3	0,8	1	1	0,97	0,51
0,8	1	0,5	0,63	1	0,8	1	0,8	0,9	0,8	1	0,5	0,63	0,65
1	1	1	1	1	1	0,5	0,2	0,3	1	1	1	1	0,52
1	1	0,5	0,65	1	1	0,8	1	0,92	1	1	0,5	0,65	0,7
1	1	0,2	0,4	1	1	1	1	1	1	1	0,2	0,4	0,45
0,5	0,8	1	0,8	0,8	0,5	0,5	1	0,57	0,5	0,8	1	0,8	0,65
0,5	0,8	0,5	0,53	0,8	0,8	0,2	0,2	0,22	0,5	0,8	0,5	0,53	0,35
0,5	1	0,5	0,59	1	0,2	0,2	0,8	0,25	0,5	1	0,5	0,59	0,41
0,8	0,8	1	0,83	1	0,2	1	0,5	0,3	0,8	0,8	1	0,83	0,5
0,8	0,8	0,5	0,55	1	0,5	0,8	0,5	0,57	0,8	0,8	0,5	0,55	0,56
0,2	0,8	0,5	0,49	0,5	0,2	0,5	1	0,25	0,2	0,8	0,5	0,49	0,39
0,2	1	1	0,97	0,5	0,5	0,2	1	0,25	0,2	1	1	0,97	0,5
0,2	1	0,5	0,47	0,5	0,8	0,2	0,5	0,24	0,2	1	0,5	0,47	0,37
0,5	0,5	1	0,6	0,8	0,2	0,2	1	0,25	0,5	0,5	1	0,6	0,42
0,5	0,5	0,5	0,5	0,8	0,5	0,2	0,8	0,26	0,5	0,5	0,5	0,5	0,38
0,2	0,2	1	0,29	0,2	0,2	0,2	0,2	0,2	0,2	0,2	1	0,29	0,26
0,2	0,2	0,5	0,23	0,2	0,2	0,2	0,8	0,22	0,2	0,2	0,5	0,23	0,23
0,2	0,5	1	0,57	0,2	0,2	0,5	0,5	0,22	0,2	0,5	1	0,57	0,4
0,2	0,5	0,5	0,47	0,2	0,8	0,5	0,2	0,23	0,2	0,5	0,5	0,47	0,35
0,2	0,8	1	0,77	0,2	1	0,2	1	0,26	0,2	0,8	1	0,77	0,45

Table 26: Indicators relations related to motor (A21), bearings (A23), guides (A26) and axis X (A2)

A311	A312	A313	A314	A31	A321	A322	A323	A32	A331	A332	A333	A33	A341	A342	A343	A34	A3
0,8	0,5	0,5	1	0,57	0,5	0,8	1	0,8	0,5	0,8	1	0,8	0,5	0,8	1	0,8	0,65
0,8	0,8	0,2	0,2	0,22	0,5	0,8	0,5	0,53	0,5	0,8	0,5	0,53	0,5	0,8	0,5	0,53	0,48
1	0,2	0,2	0,8	0,25	0,5	1	0,5	0,59	0,5	1	0,5	0,59	0,5	1	0,5	0,59	0,52
1	0,2	1	0,5	0,3	0,8	0,8	1	0,83	0,8	0,8	1	0,83	0,8	0,8	1	0,83	0,65
1	0,5	0,8	0,5	0,57	0,8	0,8	0,5	0,55	0,8	0,8	0,5	0,55	0,8	0,8	0,5	0,55	0,55
1	0,8	0,2	0,8	0,3	0,8	1	1	0,97	0,8	1	1	0,97	0,8	1	1	0,97	0,7
1	0,8	1	0,8	0,9	0,8	1	0,5	0,63	0,8	1	0,5	0,63	0,8	1	0,5	0,63	0,65
1	1	0,5	0,2	0,3	1	1	1	1	1	1	1	1	1	1	1	1	0,71
1	1	0,8	1	0,92	1	1	0,5	0,65	1	1	0,5	0,65	1	1	0,5	0,65	0,7

1	1	1	1	1	1	1	0,2	0,4	1	1	0,2	0,4	1	1	0,2	0,4	0,45
0,2	0,2	0,2	0,2	0,2	0,2	0,2	1	0,29	0,2	0,2	1	0,29	0,2	0,2	1	0,29	0,25
0,2	0,2	0,2	0,8	0,22	0,2	0,2	0,5	0,23	0,2	0,2	0,5	0,23	0,2	0,2	0,5	0,23	0,22
0,2	0,2	0,5	0,5	0,22	0,2	0,5	1	0,57	0,2	0,5	1	0,57	0,2	0,5	1	0,57	0,5
0,2	0,8	0,5	0,2	0,23	0,2	0,5	0,5	0,47	0,2	0,5	0,5	0,47	0,2	0,5	0,5	0,47	0,45
0,2	1	0,2	1	0,26	0,2	0,8	1	0,77	0,2	0,8	1	0,77	0,2	0,8	1	0,77	0,55
0,5	0,2	0,5	1	0,25	0,2	0,8	0,5	0,49	0,2	0,8	0,5	0,49	0,2	0,8	0,5	0,49	0,35
0,5	0,5	0,2	1	0,25	0,2	1	1	0,97	0,2	1	1	0,97	0,2	1	1	0,97	0,65
0,5	0,8	0,2	0,5	0,24	0,2	1	0,5	0,47	0,2	1	0,5	0,47	0,2	1	0,5	0,47	0,44
0,8	0,2	0,2	1	0,25	0,5	0,5	1	0,6	0,5	0,5	1	0,6	0,5	0,5	1	0,6	0,53
0,8	0,5	0,2	0,8	0,26	0,5	0,5	0,5	0,5	0,5	0,5	0,5	0,5	0,5	0,5	0,5	0,5	0,51

Table 27: Indicators relations related to motor (A31), bearings (A33), nut (A35), guides (A36) and axis Y (A3)

A411'	A412'	A413'	A41'	A421'	A423'	A423'	A42'	A431'	A432'	A433'	A43'	A4'
0,8	1	1	0,97	0,8	1	1	0,97	0,8	1	0,2	0,35	0,97
0,8	1	0,5	0,63	0,8	1	0,5	0,63	1	1	1	1	0,66
1	1	1	1	1	1	1	1	1	1	0,8	0,85	0,95
1	1	0,5	0,65	1	1	0,5	0,65	1	1	0,5	0,65	0,65
1	1	0,2	0,4	1	1	0,2	0,4	1	1	0,2	0,4	0,4
0,5	0,8	1	0,8	0,5	0,8	1	0,8	0,8	0,8	1	0,83	0,81
0,5	0,8	0,5	0,53	0,5	0,8	0,5	0,53	0,8	0,8	0,5	0,55	0,54
0,5	1	0,5	0,59	0,5	1	0,5	0,59	0,8	0,8	0,2	0,3	0,35
0,8	0,8	1	0,83	0,8	0,8	1	0,83	0,8	1	1	0,97	0,85
0,8	0,8	0,5	0,55	0,8	0,8	0,5	0,55	0,8	1	0,8	0,83	0,6
0,2	0,8	0,5	0,49	0,2	0,8	0,5	0,49	0,5	0,5	0,5	0,5	0,5
0,2	1	1	0,97	0,2	1	1	0,97	0,5	0,5	0,2	0,25	0,35
0,2	1	0,5	0,47	0,2	1	0,5	0,47	0,5	0,8	0,2	0,27	0,3
0,5	0,5	1	0,6	0,5	0,5	1	0,6	0,5	1	0,5	0,59	0,6
0,5	0,5	0,5	0,5	0,5	0,5	0,5	0,5	0,5	1	0,2	0,31	0,33
0,2	0,2	1	0,29	0,2	0,2	1	0,29	0,2	0,2	0,8	0,25	0,26
0,2	0,2	0,5	0,23	0,2	0,2	0,5	0,23	0,2	0,5	0,8	0,55	0,25
0,2	0,5	1	0,57	0,2	0,5	1	0,57	0,2	0,8	0,8	0,75	0,6
0,2	0,5	0,5	0,47	0,2	0,5	0,5	0,47	0,2	0,8	0,2	0,25	0,28
0,2	0,8	1	0,77	0,2	0,8	1	0,77	0,5	0,5	1	0,6	0,65

Table 28: Indicators relations related to motor (A41'), bearings (A43'), guides (A46') and axis Z (A4')

A411	A412	A413	A41	A421	A422	A423	A42	A431	A432	A433	A43	A441	A442	A443	A44	A4
0,2	0,2	1	0,29	0,2	0,2	0,8	0,25	0,2	0,2	1	0,29	0,2	0,2	1	0,26	0,26
0,2	0,2	0,5	0,23	0,2	0,5	0,8	0,55	0,2	0,2	0,5	0,23	0,2	0,2	0,5	0,25	0,25
0,2	0,5	1	0,57	0,2	0,8	0,8	0,75	0,2	0,5	1	0,57	0,2	0,5	1	0,6	0,6
0,2	0,5	0,5	0,47	0,2	0,8	0,2	0,25	0,2	0,5	0,5	0,47	0,2	0,5	0,5	0,28	0,28
0,2	0,8	1	0,77	0,5	0,5	1	0,6	0,2	0,8	1	0,77	0,2	0,8	1	0,65	0,65
0,2	0,8	0,5	0,49	0,5	0,5	0,5	0,5	0,2	0,8	0,5	0,49	0,2	0,8	0,5	0,5	0,5
0,2	1	1	0,97	0,5	0,5	0,2	0,25	0,2	1	1	0,97	0,2	1	1	0,35	0,35
0,2	1	0,5	0,47	0,5	0,8	0,2	0,27	0,2	1	0,5	0,47	0,2	1	0,5	0,3	0,3
0,5	0,5	1	0,6	0,5	1	0,5	0,59	0,5	0,5	1	0,6	0,5	0,5	1	0,6	0,6

0,5	0,5	0,5	0,5	0,5	1	0,2	0,31	0,5	0,5	0,5	0,5	0,5	0,5	0,5	0,33	0,33
0,5	0,8	1	0,8	0,8	0,8	1	0,83	0,5	0,8	1	0,8	0,5	0,8	1	0,81	0,81
0,5	0,8	0,5	0,53	0,8	0,8	0,5	0,55	0,5	0,8	0,5	0,53	0,5	0,8	0,5	0,54	0,54
0,5	1	0,5	0,59	0,8	0,8	0,2	0,3	0,5	1	0,5	0,59	0,5	1	0,5	0,35	0,35
0,8	0,8	1	0,83	0,8	1	1	0,97	0,8	0,8	1	0,83	0,8	0,8	1	0,85	0,85
0,8	0,8	0,5	0,55	0,8	1	0,8	0,83	0,8	0,8	0,5	0,55	0,8	0,8	0,5	0,6	0,6
0,8	1	1	0,97	0,8	1	0,2	0,35	0,8	1	1	0,97	0,8	1	1	0,97	0,97
0,8	1	0,5	0,63	1	1	1	1	0,8	1	0,5	0,63	0,8	1	0,5	0,66	0,66
1	1	1	1	1	1	0,8	0,85	1	1	1	1	1	1	1	0,95	0,95
1	1	0,5	0,65	1	1	0,5	0,65	1	1	0,5	0,65	1	1	0,5	0,65	0,65
1	1	0,2	0,4	1	1	0,2	0,4	1	1	0,2	0,4	1	1	0,2	0,4	0,4

Table 29: Indicators relations related to motor (A41''), bearings (A43''), nut (A45''), guides (A46'') and axis Z (A4'')

A2	A3	A4'	A4''	A0
0,51	0,65	0,97	0,26	0,4
0,65	0,48	0,66	0,25	0,3
0,52	0,52	0,95	0,6	0,75
0,7	0,65	0,65	0,28	0,35
0,45	0,55	0,4	0,65	0,5
0,65	0,7	0,81	0,5	0,6
0,35	0,65	0,54	0,35	0,45
0,41	0,71	0,35	0,3	0,35
0,5	0,7	0,85	0,6	0,6
0,56	0,45	0,6	0,33	0,35
0,39	0,25	0,5	0,81	0,6
0,5	0,22	0,35	0,54	0,4
0,37	0,5	0,3	0,35	0,4
0,42	0,45	0,6	0,85	0,65
0,38	0,55	0,33	0,6	0,5
0,26	0,35	0,26	0,97	0,35
0,23	0,65	0,25	0,66	0,35
0,4	0,44	0,6	0,95	0,5
0,35	0,53	0,28	0,65	0,35
0,45	0,51	0,65	0,4	0,45

Table 30: Indicators relations related to axis X (A2), axis Y (A3), axis Z (A4'), axis Z (A4'') and GROB BZ560 (A0)