



HAL
open science

**The easiest way to a human mind is his stomach: a
cognitive study of food metaphors in Tunisian Arabic ,
Franch and English**

Faycel Dakhlaoui

► **To cite this version:**

Faycel Dakhlaoui. The easiest way to a human mind is his stomach: a cognitive study of food metaphors in Tunisian Arabic , Franch and English. Linguistics. Université de Lorraine, 2018. English. NNT: 2018LORR0286 . tel-02138963

HAL Id: tel-02138963

<https://hal.univ-lorraine.fr/tel-02138963v1>

Submitted on 4 Jan 2021

HAL is a multi-disciplinary open access archive for the deposit and dissemination of scientific research documents, whether they are published or not. The documents may come from teaching and research institutions in France or abroad, or from public or private research centers.

L'archive ouverte pluridisciplinaire **HAL**, est destinée au dépôt et à la diffusion de documents scientifiques de niveau recherche, publiés ou non, émanant des établissements d'enseignement et de recherche français ou étrangers, des laboratoires publics ou privés.



AVERTISSEMENT

Ce document est le fruit d'un long travail approuvé par le jury de soutenance et mis à disposition de l'ensemble de la communauté universitaire élargie.

Il est soumis à la propriété intellectuelle de l'auteur. Ceci implique une obligation de citation et de référencement lors de l'utilisation de ce document.

D'autre part, toute contrefaçon, plagiat, reproduction illicite encourt une poursuite pénale.

Contact : ddoc-theses-contact@univ-lorraine.fr

LIENS

Code de la Propriété Intellectuelle. articles L 122. 4

Code de la Propriété Intellectuelle. articles L 335.2- L 335.10

http://www.cfcopies.com/V2/leg/leg_droi.php

<http://www.culture.gouv.fr/culture/infos-pratiques/droits/protection.htm>

**THE EASIEST WAY TO A MAN'S MIND IS HIS STOMACH: A
COMPARATIVE STUDY OF FOOD METAPHORS IN ENGLISH,
FRENCH AND TUNISIAN ARABIC**

Dakhlaoui Faycel



**UNIVERSITÉ
DE LORRAINE**

crem centre
de recherche
EA 3476 sur les médiations
communication, langue, art, culture

École doctorale Fernand Braudel

Membres de Jury :

Mme. Akila Sellami Baklouti : Professeure.

M. Augusto Soares Da Silava: Professeur.

Mme. Malika Tamar : Maître de conférence.

M. Guy-Achard Bayle : Professeur (Directeur de thèse)

M. Habib Abdesslem : Professeur (co-directeur de thèse)

Date: 18 décembre 2018

UNIVERSITE DE LORRAINE



**THE EASIEST WAY TO A MAN'S MIND IS HIS STOMACH: A
COMPARATIVE STUDY OF FOOD METAPHORS IN ENGLISH,
FRENCH AND TUNISIAN ARABIC**

**A thesis submitted in partial fulfilment of the requirements for the PhD degree in
Linguistics Science**

By: Dakhlaoui Faycel

Supervised by:

Pr Guy Achard-Bayle

Pr Habib Abdesslem

Academic year 2018

*To the soul of my cherished mum.
To the heart of my dear sweetheart.*

Abstract

The easiest way to the man's mind is his stomach: A comparative study of food metaphors in English, French and Tunisian Arabic.

This study adopts a cognitive contrastive analysis of English, French and Tunisian Arabic (for short TA) food metaphors corpora. The three main objectives of the present study are:

1) reveal the cognitive tools governing the understanding of food metaphors across the three languages. 2) sort out and compare the different target domains of food in the three languages with a particular focus on universality and variation. 3) address through variation, the impact of the socio-cultural context on metaphors understanding, use, creation and recreation.

Investigating the conceptual role of food expressions, the impact of culture and the interaction between mind, body and culture is the common point among the main objectives of the present research. The study started with collecting a corpus of food-related terms used metaphorically in context. The data collection relied on written and spoken material. The corpus was then analysed qualitatively on the basis of the cross-domain mapping. The study investigated the pertinence of food and related practices in conceptualizing abstract experiences and then being a depository of familiar experiences ready for being created and recreated to frame newly abstract domains and situations. By doing so, the present work defined the role of the socio-cultural settings in metaphorical thought and reviewed the ways through which the context shapes metaphor use and understanding.

Keywords: Conceptual metaphor, embodiment, food domain, mapping, culture.

Résumé

Le plus court chemin au cerveau de l'homme est son estomac : une étude comparative des métaphores de l'alimentation en anglais, français et arabe tunisien.

Cette étude adopte une analyse cognitive et contrastive des métaphores de l'alimentation en arabe tunisien, en français et en anglais. Cette étude a pour objectif la comparaison des métaphores dans leurs cadres culturels tout en analysant l'effet du contexte socioculturel sur la compréhension et l'utilisation de ces métaphores. Cette étude part d'un corpus qui contient des expressions métaphoriques utilisant des termes en rapport avec l'alimentation. Ces termes incluent les différents types d'aliments et la description des expériences accompagnant l'alimentation. Le corpus a été collecté en consultant des dictionnaires pour le français et l'anglais dans les langues étudiées et en enregistrant des communications avec des sujets parlant la langue arabe tunisienne, où ils répondent à des questions portant sur l'utilisation des termes de l'alimentation.

L'analyse qualitative du corpus est basée essentiellement sur les correspondances entre les domaines (*cross-domain mapping*) (Lakoff & Johnson, 1980 ; Lakoff, 1993) l'un des principaux axes sur lesquels la théorie de la métaphore conceptuelle est construite. L'étude est divisée en trois grandes étapes :

1- Une description et l'analyse des différentes métaphores de l'alimentation dans les trois langues tout en essayant d'extraire les différentes métaphores conceptuelles et en expliquant leur rôle en interaction avec la théorie de l'incorporation (*embodiment*) : Johnson, 1987 ; Lakoff & Johnson, 1999 ; Maalej, 2004) dans la compréhension et l'utilisation de ces métaphores.

2- Une comparaison de ces métaphores en se basant sur le modèle postulé par Kövecses (2005) analysant la variation métaphorique et l'effet du contexte culturel. Ce modèle étudie les différents aspects de variation métaphorique entre langues/cultures. Ces aspects sont les domaines source et cible, les relations entre la source et la cible, les métaphores linguistiques, les correspondances et modèles culturels.

3- Une investigation de l'effet du contexte socioculturel sur la compréhension et l'utilisation des métaphores de l'alimentation a lieu à travers une étude basée sur la décomposition des différentes métaphores étudiées en métaphores simples et métaphores complexes. Ce modèle développé par Yu (2008) démontre à travers une étude comparative des métaphores

conceptuelles l'existence d'un filtre culturel qui permet l'apparition ou l'absence de certaines métaphores spécifiques à la langue/culture en question.

List of symbols

Θ: voiceless inter-dental fricative

H: voiceless pharyngeal fricative

x: voiceless uvular fricative

ð: voiced inter-dental fricative

š: voiceless palato-alveolar fricative

S: voiceless pharyngealized alveolar fricative

D: voiced pharyngealized inter-dental fricative

T: voiceless pharyngealized alveolar stop

ʒ: voiced pharyngeal fricative

R: voiced uvular fricative

q: voiceless uvular stop

y: palatal glide

Vowel length is signalled by doubling the vowel: **[aa]**, **[uu]**, **[ii]**

Table of content

INTRODUCTION.....	10
CHAPTER ONE:	20
LITERATURE REVIEW	20
2.1 Metaphor: Movement and improvement.....	21
2.1.1 The move from the rhetoric to the cognitive	22
2.1.2 Literal vs Figurative language	23
2.1.3 The Conceptual Metaphor Theory	26
2.1.4 Aspects of metaphor.....	29
2.1.5 Elements of the conceptual system	34
2.1.6 Cognitive styles.....	39
2.1.7 Metaphor and the body.....	42
2.1.8 Conceptual Blending	45
2.2 Metaphor and culture	46
2.2.1 On the definition of culture	47
2.2.2 Culture and thought.....	49
2.3 Cognitive-contrastive studies	54
2.4 Analytic tools and methodological concerns:	56
2.4.1 The introspection method	57
2.4.2 Metaphor identification: The MIPVU	58
2.4.3 Metaphorical conceptualizations and psychological experiments	59
2.4.4 Metaphor creation and unidirectionality of the mapping	60
2.5 Metaphor ubiquity and a possible classification.....	70
2.5.1 Basic vs. Generic-level Metaphors	71
2.5.2 Universal Vs culture-specific metaphors	74
2.5.3 The Great Chain Metaphor	76

2.6 Conclusion.....	86
CHAPTER THREE.....	87
THEORETICAL FRAMEWORK	87
3.1 The food domain under cognitive investigation.....	88
3.1.1 Abundance of the food domain.....	88
3.1.2. Research questions	90
3.1.3 Hypotheses.....	90
3.2 Methodology.....	91
3.3 Metaphor Identification and analysis.....	95
3.3.1 Description of the corpus.....	95
3.3.2 The interaction between body and culture in metaphor understanding	97
3.4 Analytical tools.....	99
3.4.1 The Cross-domain mapping.....	99
3.4.2 The Great Chain Metaphor Theory	100
3.4.3 The cross-cultural model of metaphor variation.....	100
3.4.4 The decompositional account	101
3.5 Limitations.....	103
3.6 Conclusion.....	104
CHAPTER FOUR:	105
ANALYSIS, FINDINGS AND DISCUSSIONS.....	105
4.1 Food metaphors analysis	106
4.1.1 The eating experience in TA.....	107
4.1.2 The eating experience in French.....	119
4.1.3 The eating experience in English.....	126
4.1.4 Conclusion	129
4.2 Food for human traits.....	131
4.2.1 Food for Human traits in TA	132

4.2.2 Food for human traits in French	143
4.2.3 Food for human traits in English	146
4.2.4 Conclusion	156
4.3 Bread metaphors	157
4.3.1 Bread in Tunisian Arabic.....	158
4.3.2 Bread in English.....	162
4.3.3 Bread in French.....	163
4.3.4 Conclusion	167
4.4 People’s experiences with food	167
CONCLUSION	185
REFERENCES.....	190
APPENDICES.....	197

Table of figures

Figure 1: The interaction between language, body and culture	18
Figure 2: A representative picture of the blend ‘smoke coming out of his ears’	38
Figure 3: Sample of conceptual mapping process (Turner & Fauconnier, 1995).....	46
Figure 4: A diagrammatic representation of cultural linguistics as suggested by Palmer (1996) quoted from (Sharifian, 2015).....	52
Figure 5: A distributed cultural model quoted from Sharifian (2011)	53
Figure 6: The hierarchal distribution of attributes according to the Great Chain of Being.	79
Figure 7: Operation Of the Great Chain Metaphor Theory in an irrelevant context situation.	82
Figure 8: Primary metaphors building-blocks in the eating concept.....	108
Figure 9: interaction between metaphor and metonymy	176
Figure 10: interaction between metaphor and metonymy	177
Figure 11: socio-cultural metaphor	181

INTRODUCTION

It seems that one of the many philosophical questions about the human nature is whether people eat to live or live to eat. Addressing such an issue, though seemingly reducing of the human role in the world, points to the fundamental presence of food in the human life as one of the driving forces leading people's quest for survival. The scholarly importance of the eating experience does not stop at analysing and depicting the biological needs of the bodies but more interestingly subsumes all the words used to talk about the food domain in almost all its constituents and the eating experience with all its patterns. When people taste a food, they immediately feel the need to send into existence the sensations spurred by this taste and naturally they will use words to do so. Similarly, the transmission of different recipes and the techniques of cooking takes place through books, magazines and also direct conversations. Furthermore, there are words surrounding the eating experience and referring to different types of food, serving for food, cooking etc. There are also local, universal and international appellations. The language concurrently joining the eating experience gives essence to this experience and bring into existence different sensations drawn into the memory of the speakers. The language used to describe food experience, to its variety, gives this experience a vivid salience. The present paper will not stop at the tip of the iceberg but will rather go deep into investigating food terms used to capture different experiences. These expressions, though related to the food domain, are not used in their original meanings. These expressions describe the food and the concurrent familiar experiences but are used and understood by speakers to talk about less delineated domain of experiences.

It seems that through its relatively abundant presence, the investigation and perspective particular to food-related terms have achieved such scholarly legitimacy that invites calls to orient more up-to-date linguistic research towards this miscellaneous domain. Studies cross at the food domain because it stands as 'a system of communication, a body of images, a protocol of usages, situations and behaviour' (Belasco, 2006). This claim places the food domain a candidate par excellence to represent a subject matter for diverse and sometimes

complementary investigations. ‘Food identifies who we are, where we came from, and what we want to be’ (Belasco, 2006). This can be made possible only through the language describing our experiences with food. The present study shares this scholarly attention to food with the aim to study the language employed to portray the food experiences from a cognitive perspective.

We have made our project to respond to some of the many questions about the remarkable presence of food metaphors in three different languages. The study adopts a cognitive (Lakoff & Johnson, 1980; Lakoff, 1993; Grady, 1997a; Yu, 2008, Kövecses, 2005; 2015) contrastive analysis of food metaphors in Tunisian Arabic (for short TA), French and English. Tackling a cross-linguistic and a cross-cultural investigation through food metaphors seems to corroborate with an up-to-date metaphor orientation in the sense that the latest tendencies in metaphor investigation seems to orient research more towards culture and communication (Gibbs, 2008; Sharifian, 2008; 2014; Maalej, 2004; 2008; Kövecses, 2015). Investigating the conceptual role of food expressions, the impact of culture and the interaction between mind, body and culture along with the effect of the various kinds of contexts on metaphorical conceptualization of food terms will represent the main objectives of the present study.

Some of the various questions about metaphor study which seem to remain unsettled issues and which require further investigations is the appropriate research technique adopted in metaphor analysis. These questions revolve around the appropriate methodology to be employed in order to exploit and account for the interplay between the universal and the cultural in metaphor analysis. It is believed that possible improvement of research techniques (Yu, 2008) and directing more attention to the socio-cultural context (Gibbs, 2008; Kövecses, 2005, 2015) by defining its exact role in metaphor understanding and creation, should add more rigor to the results found. The present research will investigate, from a cognitive perspective, the reasons underlying the abundant presence of food metaphors in the three languages, account for the interplay between the universal and the cultural in food metaphors and attempt to define in a precise way the role of the cultural element in metaphorical thought and explain how the context shapes metaphor use and understanding.

The present study acknowledges the contribution of the classical approach ‘I know it when I see it’ intensively employed to identify metaphorical linguistic expressions among everyday

language of speakers of different languages. Many conclusions about the conceptual metaphors constituting our conceptual knowledge (Lakoff & Johnson, 1980; Lakoff, 1993) and the relevance of the embodiment theory in accounting for people's understanding of abstract concepts (Johnson, 1987; Lakoff & Johnson, 1999) were drawn in light of the above mentioned approach and hence will make it one of its main techniques. This technique will be supported by other techniques lately devised first to respond to some critics addressed to the theory, which focuses mainly on the fact that the conceptual metaphor theory ignores the context in which the metaphorical linguistic expressions take place (Kövecses, 2015), and to explain the different contextual reasons behind metaphor variation (Kövecses, 2005, 2015; Yu, 2008).

The conclusions about the existence of conceptual metaphors subsuming the metaphorical linguistic expressions under investigation were made starting from these metaphorical expressions identified by the authors of these studies and they seem to have relied essentially and solely on their intuition. To exemplify for the salient presence of the food domain in language and also in our thought patterns and which serves to conceptualise many abstract ideas, Lakoff and Johnson (1980) presented the following examples:

- “I just can't *swallow* that claim.”
- “That argument *smells fishy*.”
- “Let me *stew* over that for a while.”
- “Now there's a theory you can really *sink your teeth into*.”
- “We need to let that idea *percolate* for a while.”
- “That's food for thought.”
- “He's a *voracious* reader.” (Lakoff & Johnson, 1980: 47)

These expressions exemplify for a set of metaphorical expressions that can be subsumed under one single conceptual metaphor IDEAS ARE FOOD, the readers took it for granted that these are linguistic metaphors and the authors did not tell the readers how did they judge on the metaphoricity of these expressions.

Such a theoretical claim does not contradict the essence of a linguistic study that is required to present a comprehensive methodology listing all the procedures followed to come to the conclusions. Throughout more than three decades, metaphor study has brought up numerous

conclusions relying essentially on the introspection as their major route to different conclusions (Lakoff & Johnson, 1980; Lakoff & Turner, 1989; Johnson, 1987; Lakoff & Johnson, 1999; Gibbs, 1994; Maalej, 2004, 2008; Kövecses, 2002). Many scholars focusing on metaphorical thought seemed to follow the same strategy in drawing their conclusions about conceptual metaphors governing the understanding of abstract concepts and their systematic spontaneous underpinnings (Lakoff & Johnson, 1980; Lakoff & Turner, 1989; Johnson, 1987; Lakoff & Johnson, 1999; Gibbs, 1994, Maalej, 2004, 2008, Kövecses, 2002). Interestingly enough, few were the researchers, as far my knowledge goes, who paid more attention to adjusting the research tools and explaining how the conclusions were obtained (Grady, 1997a; Gibbs, 2008; Steen et al, 2010).

Metaphor study appears to lack a more common and unified theoretical framework following the metaphor from its contextual source till its representative cognitive tool in the human mind. In its earlier versions, studies investigating metaphor placed a major focus on the results obtained which were viewed as a revolution in the field of linguistics as they finally provided part of the answer to the nature of the conceptual tools governing our understanding of metaphorical expressions (Lakoff & Johnson, 1980; Lakoff, 1993). Since then, a huge body of empirical work has demonstrated the ubiquity of metaphor in both everyday and specialized language (Kövecses, 2005, 2008b; Gibbs, 2008). “Most importantly, there is also significant research indicating the prominence of metaphor in many areas of abstract thought and in people’s emotional and aesthetic experiences” (Gibbs, 2008: 3). When viewed from a theoretical perspective, the study of metaphor appears to stereotypically agree on a sole axis around which revolves all metaphorical findings namely the cross-domain mapping and grounding metaphor in embodied experience (Johnson, 1987; Lakoff & Johnson, 1999). It is true that the mapping stands at the heart of metaphorical thought but the steps preceding it seem to be overlooked or at least ashamedly dealt with. Despite its difficulty of analysis, the move from the linguistic to the conceptual must be analysed in a more detailed way. Questions about the rapid spontaneous understanding of already-existing metaphors as well as novel ones are still asked.

Similarly, metaphor analysis keeps developing with an attempt to maximize its explanatory power pertaining to metaphor use and understanding, the relationship between the concrete and the abstract, the role of the embodiment of people’s experiences and the effect of the

socio-cultural context (Gibbs, 2008; Kövecses, 2015). The earliest studies relied essentially on the researcher's interpretations of different linguistic metaphors to come to conclusions about thought and cognition. The interpretation of different linguistic expressions has brought consistent results about the metaphorical thought. However, the pervasiveness and wide variety of metaphorical expressions was not to be only accounted for by a systematic mapping between a set of ontological correspondences (Lakoff & Johnson, 1980). It appears that the cross-domain mapping stops short of accounting for a big number of metaphorical expressions. This potential theoretical limitation made many scholars (Turner, 1991; Maalej, 2004; Grady et al, 1996) introduce successively panoply of metaphorical classifications in an attempt to encompass the ubiquity of metaphor which goes beyond people's expressions to cover even some of their actions.

To respond to this, many classifications were made to make metaphor theory responsive to the biggest number of linguistic metaphors to their variety. Scholars started to add ramifications to the theory classifying metaphor into different types. First, they attempted to exploit the systematic salience of metaphorical linguistic expressions arising from bodily action which yielded the embodiment hypothesis (Johnson, 1987). The latter was in turn developed into versions each time it was given a new definition (Maalej, 2004; Rohrer, 2006-7). Second, they classified conceptual metaphors into generic-level and basic-level metaphors (Turner, 1991). Third, they distinguished simple and complex metaphors (Grady et al, 1996, Lakoff & Johnson, 1999). Finally, the conceptual apparatus governing the understanding of expressions involving an interaction between metaphor and metonymy was labeled metaphonymy (Goossens, 1990). In light of the ubiquity of metaphorical expressions and also the increasing number of the different labeling of these expressions, the image of metaphor as being only a cross-domain mapping seems to lose its striking explanatory power. Although the mapping remains the essential tool for any metaphorical conceptualization, the frequency and the directionality of the mapping are not well defined.

The mapping as a salient feature of the metaphor theory presents also two main questions about the frequency and the directionality of the mapping. The study of proverbial expressions from a metaphorical perspective has shown that proverbs can be classified under three main classes: proverbs with no mapping (Eat well, drink well and do your duty well), proverbs with a single mapping (Patience is bitter, its fruit is sweet) and proverbs with

multiple mapping (Don't put all your eggs in one basket) (Dakhlaoui, 2012; 2015). The directionality of the mapping has for long been considered unidirectional and the mapping from the concrete to the abstract could never be reversed. The abstract experience can only be understood in terms of a concrete experience. This claim started to lose essence with counter examples across many languages showing that the concrete can also be understood in terms of the abstract (Jakel, 2007). In TA a human being is compared to a soul *Flan nafs mumna* (X is a virtuous soul), an angel *Flaan mlayka* (X is an angel), a devil *malla chiTann* (What a devil). The human traits of kindness and wickedness are framed in terms of intangible creatures. These examples and many others stand as a proof that the metaphorical mapping can be reversible and that the mapping can be seen as bidirectional.

Through investigating food metaphors the present work will attempt to bring support to already made attempts to account for the above mentioned unsettled issues. The study allows for general conclusions with respect to the abundant presence of food metaphors in the three studied languages. Studying three different languages will allow for safer generalizations to be made since the three languages belong to three disparate cultures with different cuisines and diverse culinary habits. Moreover, the present work will compare food metaphors across three cultures, define the exact role of the cultural factor in embodiment and metaphorical thought and explain through analysis that the conceptual metaphors AHUMAN BEING IS FOOD, LIFE IS FOOD and AN EMOTION IS FOOD represent essential elements in the thought patterns of the speakers of the three languages though the understanding and/ or the creation of their linguistic instantiations is / are directly or indirectly affected by the context. This study aims to compare and contrast the usage and understanding of English, French and TA food metaphors. Furthermore, addressing the direct impact of the different types of contexts in metaphorical thinking is one of the objectives of the present study.

The contemporary theory of metaphor has resulted in many cognitive linguistics studies which highlight the cognitive foundations of metaphorical expressions used in everyday language (Lakoff & Johnson, 1980; Lakoff, 1993, Kövecses, 2002; 2005, Yu, 2004; 2008). Most of the findings confirmed the mapping of one familiar concrete domain onto an abstract less delineated domain. Most of the results presented a set of conceptual metaphors which were viewed essential elements in our conceptual knowledge.

Many expressions used by TA speakers to communicate in everyday situations exploit the characteristics of several natural or cooked food types. In order to frame moral attributes, TA speakers use food types through focusing on their taste. “The delicious taste of sweet food provides an experiential model for the conceptualization of human traits. Conversely, the disgusting taste of certain food types represents an active feature in people’s understanding of moral attributes” (Dakhlaoui, 2012: 7). In the text of some TA expressions, human beings are featured in terms of food. These expressions are best seen motivated by the conceptual metaphor A HUMAN BEING IS FOOD. The conceptual metaphor A HUMAN BEING IS FOOD accounts for the understanding of these expressions. The metaphorical scenario of framing human beings in terms of food focuses either on the taste whether it is delicious and appreciable or it is bitter and repulsive. The meaning focus of this metaphor is built on the state of the food (soft, hard, cooked, raw, half-cooked...) to frame different human traits. Let us take as an example onion; a food type productively exploited in TA expressions to frame wickedness and social rejection. Despite its nutritional benefits, Onion is generally rejected because of its sharp pungent smell. In TA onion serves to conceptualize persons with bad reputation *iða ummi-k l-bSal w bu-k ith-thuum mniin tji-k ir-riiHa eT-Tayb-a ya mšuum* (If your mother is onion and your father is garlic, how will you then smell good). Onion serves also to capture human beings and their actions. Expressions like *3malt 3amla ki l-bsal* (I made something bad) and *kla l-bsal* (He ate onion out of regret) are used to capture respectively bad behavior and regret. The contradiction in tastes is projected onto the contradiction of bad and good behavior. Sweetness of a food is conceptualized as generosity and kindness. Bitterness is, however, conceptualized as wickedness. These expressions are motivated by the conceptual metaphors A HUMAN BEING IS FOOD with its two versions SWEET IS GOOD and BITTER IS BAD. A study of food metaphors seems far-reaching and relevant to the scientific development of the theory because it addresses a domain deeply pervasively present in people’s experiences and deeply entrenched in their cultures.

The study of metaphor is, however marked by some unsettled debates. These debates revolve mainly around drawing a dividing line that separates literal from metaphorical language (Honeck & Temple, 1994 ; Gozzi, 1999; Gibbs, 2002) settling the distinction between universally valid and culture-specific metaphors and also questions about metaphors, metonymy (Kovecess and Radden, 1998) and embodiment (Lakoff& Johnson, 1999; Rohrer, 2006-7). These divides invite more research on metaphor as a distinct feature of our everyday

actions hence the choice of the food domain seemingly exhibiting itself abundantly in more than one language.

The ubiquity of metaphor in everyday expressions places it as a potential candidate to mirror the culture (Kövecses, 2005). According to Kövecses (2005), metaphor is credited with passing cultural traditions from one generation to another and is known as an agent serving to condition culture. In this respect a comparative cross-cultural study provides a promising area of research. While most metaphors are systematically subsumed under a set of universal conceptual metaphors grounded in bodily experience, many other metaphors seem to be grounded in culture. This contrast has stimulated this piece of research which will try to account for the difference that may exist between different metaphors and whether this difference can be traced back only to cultural differences.

Food metaphors are built on the physiological experiences associated with the eating experience. In fact, the experiences pertaining to the food domain involves many embodied experiences. These experiences include desiring food, feeling hungry, putting food in the mouth, tasting, chewing, swallowing, choking, digesting and being satiated (Dakhlaoui, 2012). “These lived experiences in our bodies, which are not inclusive of all food related experiences, inspire and contain the way we conserve and articulate many of our other experiences” (Emanation, 1995: 164). The experiences associated with the food domain seem to conduct the mapping of many conceptual metaphors however the existence of non-embodied conceptual metaphors is not excluded. In the light of this difference an investigation of the difference between embodied and non-embodied metaphors through different languages will be conducted. Moreover an investigation of the different body parts exploited in the food metaphors sounds promising along with the significance of this exploitation.

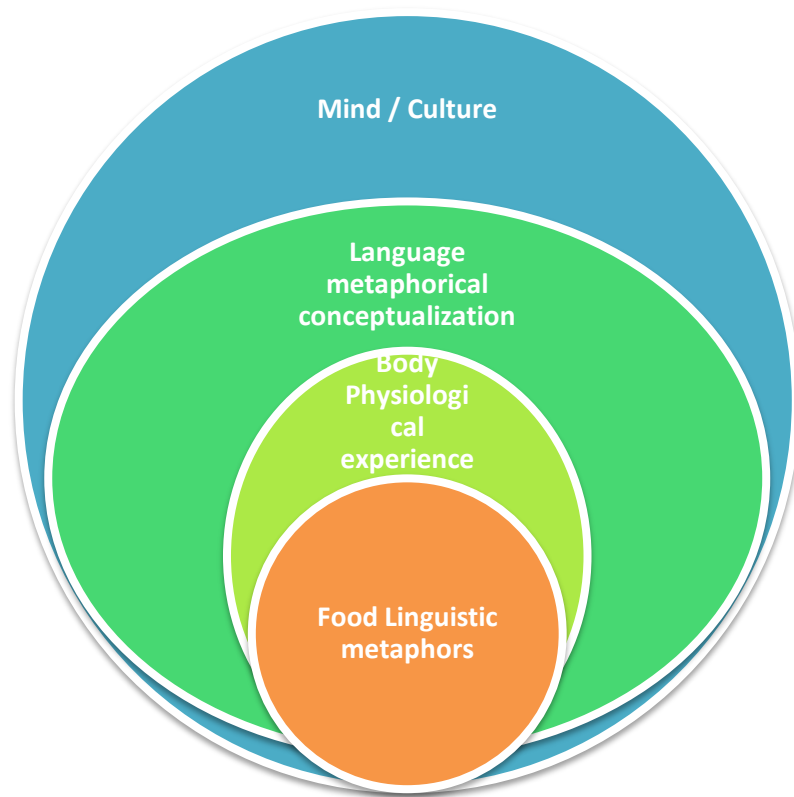

Figure 1: The interaction between language, body and culture

The present study attempts to contribute knowledge in the field of cross-cultural studies of language, with a particular focus on metaphor. Most of the research done on metaphor, I believe, has been done for and in the English Language. Despite the increasing concern of many researchers with the field of cognitive studies, literature on the comparative analyses of TA, French and English, with emphasis on food metaphorical language, are still scanty. Moreover, literature comparing food metaphors, and as far as my knowledge goes, is not so voluminous. One of the main possible contributions of the present study will be to attempt to fill this gap by undertaking a comparative study of three languages, namely English, French and TA and this in order to achieve two objectives. On the one hand, this study will contribute to the literature comparing TA to English and French. On the other hand, comparing three languages relating three food experiences and using food terms metaphorically in three different socio-cultural settings seems to be far-reaching with respect to the increasing importance of the context in metaphor studies. Varying the socio-cultural contexts in which the language is spoken can also be resourceful and disclosing more on where do we recruit various metaphorical images particularly the interactive social, cultural, political, physical and, most evidently, culinary settings in which metaphors are produced, understood and created denovo.

CHAPTER ONE:

LITERATURE REVIEW

Cognitive linguistics revolutionized the study of metaphor and the revolution does not seem to have come to an end. Cognitive linguists released the study of metaphor from being reserved to literary research investigating the ornamental characteristics of poetry and literature to spread it first over all the linguistic realisations (Lakoff & Johnson, 1980) then moving it up to the mind (Lakoff & Johnson, 1999), then down to the body (Johnson, 1987) and next to the culture (Kövecses, 2005; 2015; Palmer, 1996, Sharifian, 2008; 2015).

The scope of metaphor reached the non linguistic and proved itself valid with non-linguistic means of expressions like sign languages, music and even paintings (Gibbs, 2008). The review of some of the literature on metaphor will focus more on the move from the purely mental cognitive explanation of metaphorical expressions to the seemingly more realistic analysis bodily grounded and then focusing on the effects of the socio-cultural context. Moreover, a targeted survey of some of the analytic tools adopted in metaphor research oriented towards investigating cultural variation will be carried out while trying to adjust this domain of study to its cultural grounding.

A state of the art of metaphor study displays a mosaic of varied orientations in studying metaphor. The conceptual metaphor theory has allowed investigating languages and cultures from different perspectives while keeping on varying the techniques.

“There is now a huge body of empirical work from many academic disciplines that clearly demonstrates the ubiquity of metaphor in both everyday and specialized language. Most importantly there is also significant research indicating the prominence of metaphor in many areas of abstract thought and in people’s emotional and aesthetic experiences” (Gibbs, 2008: 3).

It is important to situate the present study in its appropriate orientation so that we can have a clear strategy for reviewing the literature. Since the main objective of this study is investigating food metaphors variations and answering questions about the duality of bodily universality and cultural specificity along with detailed explanations of their contextual origins, the literature review will have a specific focus on this duality and the interrelated techniques used to account for and analyze it. The study can be situated within studies that pay “greater attention to the ways that context shapes metaphor use and understanding” (Gibbs, 2008: *ibid*) and takes the interaction between brain, body and culture its point of departure raising questions about the origins of metaphors and trying to detail how the interaction mind-body-culture contributes to figuring out the whole image of metaphor use, understanding and creation. The review of the literature will focus on the gradual development of the metaphor study from being purely a mental tool enabling to account for people’s spontaneous understanding of metaphorical expressions they use daily (Lakoff, 1993), then being grounded in bodily experience (Lakoff & Johnson, 1999, Gibbs, 2004, Maalej, 2004) and finally being also a product of interactive participants in a context (Kövecses, 2005; 2015).

The review of the literature will be divided into two main parts. In the first part, we will introduce the conceptual metaphor theory and explain its ‘movement and improvement’ with a particular focus on its expanding explanatory power and sometimes puzzling ubiquity since it “does not always appear in nice, neat packages that can easily plucked out from some context of analysis. Speakers use metaphorical language and engage in metaphorical thought, in complex, often contradictory patterns that make simple conclusions about the ubiquity and structure of metaphor difficult to make”(Gibbs, 2008: 4). In the second part, a review of the concurrently developing techniques of analysis will be conducted with a particular focus on the techniques oriented towards studying metaphor variation and the impact of context.

2.1 Metaphor: Movement and improvement

In this part of the literature review, we will outline the main developments in the theory by focusing on three main axes; metaphor as a cognitive tool, the embodiment hypothesis grounding metaphor in bodily experience and the cultural significance of metaphorical understanding. In this part we will attempt to demonstrate the expanding prevalence of

metaphor and the corresponding effects of this ubiquity. Metaphor has moved from being an ornamental device exclusively used only in poetry and literature to be an ‘instrument of the mind’ used and understood by every language speaker. Rhetoricians may consider it a degradation of metaphor since it is put in the hands of the laymen. Paradoxically enough, this ‘downward movement’ in rhetoric is an ‘upward movement’ in linguistics since it expanded areas of research and paved the way to conducting multiple researches on the manifestations of metaphor, its internal organization and the reasons behind its variation across language despite its universal bodily basis. This section will be divided into four main subsections. First, we will make a brief introduction of the theory. Next, we will present the embodiment hypothesis and focus on the bodily grounding of metaphor and illusive claims about universality. In fact a hasty conclusion about embodiment advocates universality of metaphors basically because all human beings share the same body thus having in common all the metaphors grounded in bodily experiment. The examples provided by Kövecses (2005) demonstrate that the correlation between anger and bodily experience manifested in the conceptual metaphor AN ANGRY PERSON IS A HOT FLUID IN A CONTAINER has a different configuration in Japanese culture since the container is filled with gas and not a fluid. In the third subsection we will tackle metaphor variation and relate it to the impact of the socio-cultural context. Finally, we will present some attempts made to classify metaphors and the pertinence of these classifications.

2.1.1 The move from the rhetorical to the cognitive

The word metaphor originates from the Greek *metaphora* which means ‘transfer’. The composite meta, which means ‘transfer, carry over,’ and pherein which is translated into English as ‘to bear, to carry’ (Webster’s online dictionary). This definition conveys some kind of change or shift. By shifting certain distinct attributes of one object to another, metaphor was originally qualified as an ornamental device typical of poetic language.

Classical theories consider metaphor an exception to the rules of the language. Words are not used in their literal meaning and through metaphorical comparison their meanings change. Metaphor has been recognized as a rhetorical device that compares two seemingly different objects. It is mainly restricted to poetic language and is thought to perform no more than an ornamental function. The basic claim of classical theory was that “everyday language had no metaphor, and metaphor used mechanisms outside the realm of everyday conventional

language” (Lakoff, 1993: 202). Yet, this device proved to play different roles and cannot be merely reserved to extraordinary language.

The scope of metaphor seems to surprise the scholars each time by the ability of this cognitive tool to account for both linguistic and non-linguistic realisations of the human mind. Since more than three decades, cognitive linguistics has drawn a clear cutting line in the history of metaphor (Lakoff & Johnson, 1980). The study of metaphor has witnessed structural developments which placed it higher in the agenda of scholars. When Lakoff & Johnson (1980) introduced a different view of metaphor by spreading it over everyday expressions and not leaving it in the hands of literary analysts to view which author exploits it better for the ornamental ends to his texts, it was almost very difficult to predict the reach that the metaphor study can attain. These two scholars offered a cognitive view of metaphor and they placed it closer to the linguists’ center of interest. The essence of their contribution lies essentially in proving that metaphor must no longer be viewed as an ornamental device but as an instrument of the mind.

Metaphor was proven to account for the understanding of many everyday expressions (Lakoff, 1993). This big number of linguistic metaphors can be subsumed under a limited number of conceptual metaphors governing people’s understanding of abstract concepts. Such a finding paved the way for many scholars to view the link between the abstract and the concrete through the lens of metaphorical correspondences (Lakoff & Johnson, 1980; Kövecse, 2015). By exploiting the different domains involving the understanding of abstract experiences, people’s physiological nature and their socio-cultural context provided much of the answer on how the understanding takes place.

2.1.2 Literal vs Figurative language

To have a better insight into the increasingly explanatory importance of metaphor in interpreting people’s ability to use, understand and create unusual connections between different and sometimes opposing domains, a review of the difference between literal and figurative language is deemed fundamental. Originally, the distinction between figurative and literal language is clear-cut. While the latter is stable and precise the former is more ambiguous and imprecise (Evans and Green, 2006). The distinction is invalidated with further investigations which showed that the borderline between the two is quite blurred. By

conducting a number of experiments, Gibbs (2002b) deduced that there is no evidence for a principled distinction between literal and figurative language. Gibbs (2002b) identifies a number of different definitions of literal meaning assumed within the cognitive science literature, four of which are presented in the following excerpt (Gibbs 1994: 75):

“Conventional literality, in which literal usage is contrasted with poetic usage, exaggeration, embellishment, indirectness, and so on.

Nonmetaphorical literality, or directly meaningful language, in which one word (concept) is never understood in terms of a second word (or concept).

Truth conditional literality or language that is capable of ‘fitting the world’ (that is, referring to objectively existing objects or of being objectively true or false).

Context-free literality, in which the literal meaning of an expression is its meaning [independent of any communicative situation].”

Gibbs (2002b) claims that there seems to be no convention on one unique definition of non-literal language. We can mention for example ironic expressions which are viewed non-literal expressions. Metonymic expressions are classified under the same cluster.

(1) Mother: Time for bed . . . You have a BIG exam in the morning!

Teenage son: I can’t wait (uttered without enthusiasm).

(2) My wheels are parked in the back.

In (1) the expression is ironic because what is meant is the opposite of what is said while in (2) there is an association between two entities so that one entity can stand for the other. The salient component of the car, namely the wheels, can be used to stand for the car as a whole (Evans & Green, 2006). The distinction between literal and figurative language does not appear to be basic as it is thought to be. The question should be therefore whether these two kinds of language are easily recognised and to what extent they bear ambiguous judgements. The distinction between literal and figurative language was wrongly built on the distinction between ordinary or everyday language and literary or poetic expressions used by creative authors. On closer inspection, much of our everyday expressions turn out to be non-literal or figurative in nature.

(3) All *went smoothly* until we reached the British customs.

(4) The economy *is going from good to better*.

Though seemingly literal through reporting operations and changes in economy, these two sentences use language of motion and change in location to talk about non-physical entities. Consider sentence (3): While boats can ‘go smoothly’ across a river or an ocean, abstract objects do not necessarily obey this physical rule and can undergo motion. Similarly in example (4), a change of a state is framed in terms of a change of location. The words referring to motion and change in location have non-literal meaning in these expressions since they are used to talk about operations and changes of state. To overcome this ambiguity, Gibbs (1994) suggested the metaphor device as a criterion of non-literality. According to this view, literality is language that directly expresses meaning rather than relying on metaphor. People should be able to express their ‘true’ meaning without recourse to metaphorical mapping that is without expressing one idea in terms of another.

(4) Achilles is brave.

(5) Achilles is a lion.

While sentence (4) has a literal meaning since we directly qualify Achilles with braveness, sentence (5) has a non-literal meaning. Comparing Achilles to a lion conveys directly the common feature between the two. According to folk knowledge the salient feature of the lion is courage. This feature is recruited to qualify the braveness of Achilles.

Some concepts are, however, very difficult to be talked about non-metaphorically. It is difficult to express concepts like TIME without recourse to SPACE or MOTION. The following examples in (6) show clearly that a particular point in time is viewed as a moving entity in space.

(6) a. *Christmasis approaching.*

b. *We’re moving towards Christmas.*

c. *Christmas is not very far away.*

Though being everyday usual expressions, the words used to describe these temporal concepts do not seem to have a clear literal meaning. It appears that these concepts are clearly described in non-literal terms. Placing them under the literal group seems to be

inappropriately and superficially taken. ‘If certain concepts are wholly or mainly understood in metaphorical terms, then the non-metaphorical definition of literality entails that concepts like CHRISTMAS and TIME somehow lack meaning in their own right’ (Evans & Green, 2006). Many other everyday concepts seem to be understood in metaphorical terms. The way we conceptualize a primitive basic emotion of the human nature experience like anger is highly metaphorical in nature as the following examples illustrates.

- (7) a. You make my *blood boil*.
b. He was *red with anger*.
c. She’s just *letting off steam*.
d. Don’t *fly off the handle*.
e. Try to get a grip on yourself.
f. He almost *burst a blood vessel*.

These examples illustrate clearly that we cannot easily express ourselves in literal terms and that the metaphorical conceptualizations of basic lived experiences is so entrenched in our thought patterns and exhibits itself abundantly and sometimes overwhelmingly in the language we speak and more surprisingly dominates even newly created expressions about life events.

To sum up, we introduced many definitions of literality but we do not agree on one unique definition. According to Gibbs (1994) it is very difficult to define a clear borderline between the figurative and the literal meaning of numerous concepts, no matter how concrete, basic and primitive they appear. The dichotomy between the literal and the figurative needs to be challenged by providing a more convincing answers to account for the speakers’ ability to understand one concept in terms of another and also using figurative, perhaps metaphorical, expressions to talk about concrete, basic and everyday events.

2.1.3 The Conceptual Metaphor Theory

Metaphor gained larger scopes with the contributions of the Conceptual Metaphor Theory for short ‘CMT’. Lakoff & Johnson (1980) found that metaphor is a central property of everyday language. Many everyday expressions cluster under “general principles which take the form

of conceptual mappings” (Lakoff, 1993: 208). Metaphor has become “a matter of thought and reason (where) the language is secondary and the mapping is primary” (Lakoff, 1993: 208). Metaphor proved to be more than an ornamental device but rather a “connection through which one conceptual domain is understood in terms of the other” (Turner, 1991: 158).

In conceptual metaphor theory, metaphor is thought of very broadly as conceptualizing one domain of experience in terms of another (Lakoff & Johnson, 1980; Kövecses, 2010a; 2015). The domain of experience that is used to understand another domain is more familiar, more physical, and more directly experienced than the domain we wish to understand, which is typically more abstract, less directly experienced, and less familiar. In the cognitive linguistic view of metaphor, originated by George Lakoff and Mark Johnson’s (1980) *Metaphors We Live By*, the more concrete, or physical, domain is called the source domain and the more abstract one is called the target domain. Domains of experience are drawn in the mind of language speakers as concepts given as mental frames, or cognitive models. Hence we talk about conceptualization instead of understanding and conceptual metaphors instead of linguistic poetic devices called linguistic metaphors. The source frame and the target frame are connected by a set of conceptual correspondences, or mappings. Thus, on this view, metaphor is a set of correspondences, or mappings, between the elements of two mental frames i.e. domains. For example, a set of correspondences between a traveler and a person leading a life—the way the traveler is traveling and the manner in which the person lives, the destination the traveler wants to reach and the life goals of the person, and the physical obstacles along the way and the difficulties the person has in life—all comprise a set of mappings that make up the conceptual metaphor life is a journey. A conceptual metaphor typically has a number of linguistic manifestations (metaphorically used words and more complex expressions) to talk about the target domain. In the example, the sentences ‘I *hit a roadblock*,’ ‘She *wanders aimlessly* in life,’ ‘This is not the *right way* to live,’ and so on make manifest, or simply express, correspondences between the elements of obstacle and difficulty, destination and purpose, and path and manner, respectively (Lakoff & Johnson, 1980). Taken together, they indicate that the highly abstract concept of life is partially understood in terms of the more concrete concept of journey. The meanings of the particular metaphorical expressions are based on the conceptual correspondences, or mappings.

These findings have paved the way for different studies on cognitive linguistics which confirm the claim that metaphor has conceptual and cognitive foundations (Gibbs, 1994; Kövecses, 2002). Metaphor is now widely recognized as representing and relating to conceptual domains and life experiences. To gain a further understanding of these theoretical claims and to corroborate with the thematic orientation of the present study, it will be tempting to present in what follows concrete examples belonging to the food domain.

One of the most recurrent life experiences happens with food. Whether it is eating, drinking, digesting, tasting, liking..., people seem to experience daily at least one of the aspects of food. People's familiarity with the food domain places it to be a productive source resulting in many metaphorical mappings. Eating and related experiences constitute panoply of concrete bodily experiences serving to conceptualize abstract domains. Food cannot be disentangled from people's physiological and psychological experiences. It is associated with feelings of desire, hunger, satiation and sometimes rejection. This depository of mental experiences is combined with another set of kinaesthetic physiological experiences with food. Food goes from the outside of the body inside it and then goes out again. This overwhelming contact with food seems to affect people's use and understanding of metaphorical expressions; hence the importance of conducting this piece of research.

One of the main merits of cognitive linguistics in its first stages is that it destroyed the long-lasting assumption that metaphor can only be an ornamental device and linguistic realizations of metaphor and thought must be kept apart. In 1980, and through analyzing a set of everyday expressions Lakoff & Johnson (1980) were able to conclude that these expressions were reflective of systematic organization of our thought patterns under a limited number of conceptual metaphors governing the understanding of abstract domains. By presenting expressions such as the following:

“What he said left a bad *taste in my mouth*.”

“All this paper has in it are raw facts, half-baked ideas, and warmed-over theories.”

“There are too many facts here for me to *digest* them all.”

“I just can't *swallow* that claim.”

“That argument *smells fishy*.”

“Let me *stew* over that for a while.”

“Now there's a theory you can really *sink your teeth into*.”

“We need to let that idea *percolate* for a while.”

“That’s food for thought.”

“He’s a *voracious* reader.”

“We don’t need to *spoon-feed* our students.”

“He *devoured* the book.”

“Let’s let that idea *simmer on the back burner* for a while.”

“This is the *meaty* part of the paper.”

“Let that idea *jell* for a while.”

“That idea has been *fermenting* for years”(Lakoff & Johnson, 1980: 47).

Through presenting the above examples, Lakoff & Johnson (1980: 47) were able to conclude that all these expressions can be viewed as instantiations of the conceptual metaphor IDEAS ARE FOOD. They explained that the concrete domain of food is recruited to conceptualize the abstract domain of thinking. Ideas are conceptualized in terms of food involving different situations associated with the food domain. This systematic mapping from the food domain onto the thinking domain provides part of the answer to the question about the structure of the human conceptual system. Metaphor is no longer viewed as an ornamental device but rather a central tool of human thought. The work of Lakoff & Johnson (1980) pointed to the prominence of metaphor in language as an instrument of thought and paved the way for better exploitations of the cognitive potential of metaphor. With reference to its large explanatory power and ability to bring together distinct domains, the conceptual metaphor theory displays different elements interacting together and justifying the move from the linguistic metaphors to the conceptual metaphors.

2.1.4 Aspects of metaphor

The complexity of the conceptual metaphor theory lies in the number of its varied co-interactive aspects and elements (Kövecses, 2005). The theory is made of the following:

- Source domain
- Target domain
- Experiential basis
- Neural structures corresponding to (1) and (2) in the brain
- Relationship between the source and the target
- Metaphorical linguistic expressions
- Mappings

- Entailments
- Blends
- Nonlinguistic realizations
- Cultural models

These different elements interact with each other to account for the understanding of verbal and non-verbal metaphorical forms of expressions. In order to have a better understanding of the theory we will try to define and exemplify for these different parts. The different examples presented here are discussed by Kövecses (2002; 2005):

1-2. Metaphor consists of a source and a target domain such that the source is concrete and the target is an abstract kind of domain.

Examples: Source domains: WARMTH, JOURNEY, FOOD. Target domains: AFFECTION, LIFE, LOVE, IDEAS. Thus: AFFECTION IS WARMTH; LIFE IS A JOURNEY; LOVE IS A JOURNEY, IDEAS ARE FOOD.

3. The choice of a particular source serving to capture a particular target is mostly motivated by an experiential basis, that is, some embodied experience.

Examples: Affection correlates with bodily warmth; forces often act as causes; motion is a type of event.

4. Neural connections between areas of the brain are the immediate results of some embodied experiences (these areas correspond to source and target).

Potential example: When the area of the brain corresponding to affection is activated, the area corresponding to warmth is also activated.

5. The relationship of the source and the target is potentially very productive in the sense that a source domain may apply to several targets and a target may attach to several sources.

Example: The journey domain applies to both life and love, given the linguistic evidence in English.

6. The special connections of source and target domains give rise to metaphorical linguistic expressions; linguistic expressions thus are products of the pairing of two conceptual domains.

Examples: ‘warm relationship’ (from affection is warmth), ‘get around a problem’ (from difficulties are obstacles).

7. There are primary, and essential, conceptual correspondences, or mappings, between the source and target domains.

Example:

Conceptual metaphor: LOVE IS A JOURNEY

Mappings:

Travelers → lovers

Vehicle → love relationship

Destination → purpose of the relationship

Distance covered → progress made in the relationship

Obstacles along the way → difficulties encountered in the relationship

8. Source domains often map additional ideas onto the target beyond the basic correspondences. These extra mappings are called *entailments*, or *inferences*.

Example: If love is framed as a journey and the vehicle corresponds to the relationship, then our knowledge about the vehicle can be used to understand love relationships. If the vehicle breaks down, we have three options: (1) we get out and try to continue our trip by some other means; (2) we try to repair the vehicle; or (3) we remain hopeless in the vehicle and do nothing. Correspondingly, if a love relationship is not going very well, we can (1) stop and leave the relationship; (2) try to make it go again ;or (3) keep the situation as it is (and suffer).

9. Matching a source domain with a target domain often results in blends, that is, newly created conceptual materials that are different with respect to both the source and the target.

Example: Take the example ‘He was so mad, smoke was coming out of his ears.’ In this example we have an angry person corresponding to the target domain and smoke (fume) in a container as the source domain. The target (the angry person) has no smoke coming out of it

and the source (the container with hot fluid) has no ears. But the example conceptually integrates the two: We have a created blend in which a container has ears. The latter in turn have smoke blowing out of them (Fauconnier & Turner, 2002).

10. Conceptual metaphors often appear, or are realized, in nonlinguistic ways, that is, not only in language and thought but also in social–physical practice and reality.

Example: Given THE IMPORTANT IS CENTRAL conceptual metaphor and its linguistic manifestations (such as ‘the *central* issue, The *central* point’), at meetings and various other public events important persons (e.g., higher-ups and CEOs and managers) tend to stay in more ‘central’ physical locations in the setting than other people with lower hierarchies.

11. Conceptual metaphors congregate on, and often result in, cultural models that are functional in thought. These are structures simultaneously cultural and cognitive (hence, the term *cultural model*, or *cognitive model*) in that they are culturally-specific mental representations of aspects of the world.

What is peculiar to the model presented by Kövecses (2005) is the attempt to structure the different elements involved in metaphor understanding into an interactive paradigm. The main merit of this partition is that it will allow a better targeted understanding of variation. A more organized analysis of metaphor understanding with a particular focus on the different aspects of metaphor involved in variation should bring more accurate accountancy to the irregularities in metaphor structures within the same language and also across languages. Along with the advantages brought about in this partition, it stops short of accounting for the bi-directionality of the mapping, an aspect that will be developed in later parts of the literature review.

The study of metaphor and for the sake of delineating the origins of variation should take into consideration the bases on which metaphorical connections are built. It is very probable to say that metaphor is built on similarity. Two domains are linked to each other because there is a resemblance of some aspect between the two. This kind of motivation is accepted in cognitive linguistics but there is another essential type of motivation on which metaphorical connections are built; the embodied motivation which defines the choice of a particular source to go with a particular target (Kövecses, 2015). To exemplify for the embodied motivation of metaphor let us take the example of the correlation between intensity and body heat. Vigorous

bodily activity results in an increase in body heat. Similarly, when you undergo a strong emotional event like being very angry or when you have strong sexual feeling, your body will experience a heat increase that manifests itself physiologically in a variety of ways. In TA someone expresses his anger in a variety of ways. Some of them are faithful to the embodied correlation between the emotion and its effect. In The expressions *'s5ont*, (I heated up, I got enraged), *ch3ilt* (I turned up into fire, I got enraged). The correlation between heat and anger are present conspicuously in the anger expressions in TA. There seem to be a gradual development in the intensity of anger and the bodily heat increases from normal heat till setting into fire.¹ 'In all of these cases, the increase in the intensity of an activity or state goes together with an increase in body heat, and your body responds this way automatically' (Kovecses, 2015: 21). The correlation between the intensity of a human activity and body heat is typical to all human being. This correlation results in the conceptual metaphor INTENSITY IS HEAT. This correlation will be the basis on which a number of metaphors will be built each time varying the concept that undergoes the intensity. These concepts can be ANGER, LOVE, LUST, WORK, ARGUMENT, and so forth.

Many conceptual metaphors are grounded in bodily experience because of these types of correlations. Metaphors are thus produced out of two possible scenarios; bodily-motivated metaphors and metaphors built on the similarity of two domains. This echoes plainly in many food metaphors since a big number of expressions are either bringing up a similarity between human beings and one food type or describing an embodied experience involving food. These two types of motivation are not mutually exclusive. Sometimes one food metaphor seems to be motivated by embodied experience and used to make a comparison of similarity. In this respect, "we can think of embodiment and similarity as different kinds of constraint on the creation of metaphor" (Kövecses, 2015: 21). This claim will be justified with concrete examples in later parts of the present study.

¹ Strangely enough Anger is differently conceptualized in terms of a food metaphor. A food container is exploited in the anger TA expression *'ya3fis fi tajiin ya9a3rou* (He walks on a dish to the point of gouging it; He is infuriated). This expression does not mention the correlation between the emotion and its bodily effect. This expression (and some others see Maalej, 2004) is a culture specific since it selects a food container that is subject to the violence carried out by the angry person.

In this section we introduced the different aspects of metaphor. These different aspects are directly shaped by variation. Since these elements account for the conceptual operations governing metaphor understanding and use, they will represent key elements in defining variation and specifying the metaphorical constraints of any language/culture. The above introduced aspects will, then, make the difference between metaphors across the three studied languages and will have an important role in the analysis of the different linguistic metaphors under investigation.

2.1.5 Elements of the conceptual system

In this part we will introduce different elements constituting construal operations as they were presented by Kövecses (Kövecses, 2015) that are part and parcel of our conceptual system. They are responsible for the metaphor understanding, use and creation. I will discuss in this part the elements that are more frequently present in metaphors. These operations include abstraction, schematization, attention, perspective (subjectivity-objectivity), metonymy, metaphor, and conceptual integration (Kövecses, 2015). Although some of these elements were developed in earlier parts of this work, their active participation in creating new metaphors and their interactions with other elements will be highlighted in this part.

2.1.5.1 Abstraction

The abstraction is a process by which the human mind is capable of subsuming specific concrete examples under one generic example. The ability to capture many abstract concepts in a number of concrete familiar experiences and then producing novel metaphors following the mapping in question accounts for this type of construal operation. Take for example the human ability to frame human traits in terms of food types. Thanks to the process of abstraction a number of human traits are understood through different food types by which a sweet person is a kind one and a bitter person is a wicked one².

² Concrete examples of this type of framing will be discussed in later parts of the present study. It was found that a food serves to conceptualize human traits. The expressions discussed were found to be governed by the metaphor A HUMAN BEING IS FOOD and its two versions SWEET IS GOOD and BITTER IS BAD.

2.1.5.2 Schematization

Metaphorical conceptualization can work jointly with the construal operation of schematization. Kövecses (2007) presented the conceptualization of the biblical notion of HEAVEN as an example. It is metaphorically conceptualized as a number of different places that share the property of 'being ideal.' That is, the source domains of the concept of heaven are all places where (eternal) life is good and pleasant that is to say void of suffering, injustice, sorrow, pain, and so forth. The target concept of heaven sounds to be a schematically ideal place; hence the metaphor heaven is an ideal physical place. The particularities and qualities of the places in the source domains are somehow removed thoroughly with only the schematic idealization remaining. We can think of this schematic idealization as heaven.

In such cases, we can suggest that the target is a schematization of the different source domains relating to the target domain. The nature of this process of schematization is essentially metonymic. The sources are specific instances of the target; this is the metonymy a particular instance of a category stands for the whole category. We can put this in the present example as particular pleasant place to stand for heaven. Since such places and heaven share only the property of 'being ideal,' we can construe the basically metonymic relationship as a metaphor. Another example is the god is a father metaphor (see Kövecses, 2007). Given this conceptual metaphor, the nurturant aspect of god the father can be conceptualized through the generic-level metaphor PROVIDENCE IS NURTURANCE . We can consider this latter to be a case of schematization of the kind we just saw for heaven. The domain of father in THE GOD IS A FATHER metaphor consists of several distinct meaning foci. (On the notion of 'meaningfocus,' see Kövecses, 2005, 2010a.) One of these is that we consider the father to provide food for his children. This feeding can be of various kinds, such as providing food, money, compassion, etc. Moreover, nurturance engges caring for people in all types of ways and protecting them from any possible peril. In this light, we can view God's providential care as a schematization of various types of nurturance; hence providence is nurturance. The concept of providence schematizes the specific manifesttions of nurturance and it thus turns out a concept that shares only one property with the various types of nurturance, namely, that God cares for people.

2.1.5.3 Metonymy

Metonymy is another process through which we conceptualize the whole through the part. This part-whole relationship plays an important role in defining the metonymic mapping. Similar to the concept of heaven, providence is nurturance. The metaphor is based on a metonymic relationship in which specific instances of a category stand for the whole category; in other words providing food, and the like, metonymically stands for providential care. The only link between the two ideas is that in both, people are cared for. This enables us to think of the metonymy as metaphor (Kövecses, 2015).

2.1.5.4 Metaphor

This mental construal is characterized by framing one domain of experience, generally an abstract one, in terms of a concrete one. The mapping can be unidirectional enabling the understanding of the less experienced domain in terms of the concrete more familiarly experienced domain. If we continue with the same connection between the god and the father, we can concretely exemplify for this construal. If we consider that God as the creator can be conceptualized via the causation is progeneration generic-level metaphor, what we have in this case is the following: There is the GOD IS A FATHER metaphor, in which father has as its meaning focus ‘progeneration’. In this metaphor, we have the following mapping:

‘progeneration → creation.’

The relation between progeneration and creation is also built on metonymy; namely, a particular instance of a category for the whole category (i.e., progeneration is one kind of creation). Furthermore, creation is a particular instance of causation. This is again a metonymic relationship. The relationship explains in part the existence of the generic-level metaphor

causation is progeneration.

Finally, another metonymy-based relationship, that obtaining between progeneration and causation (progeneration is a kind of causation) provides further motivation for the same metaphor.

What happens in all of these cases is that particular instances that share a feature are converted into a schematic category. This schematization becomes the target domain of a

number of various but related source domains. We think that this is a metonymy-based process, but its final result acts as a metaphor, such as the various specific-level versions of HEAVEN IS AN IDEAL PHYSICAL PLACE or GOD IS A FATHER with its generic-level versions: CAUSATION IS PROGENERATION and PROVIDENCE PROVIDENTIAL CARE IS NURTURANCE. In the cognitive linguistic literature on metaphor, it is common to differentiate between two basic types of metaphor: those based on similarity (perceived or real) and those on correlations in experience (such as primary metaphors). The metaphors such as HEAVEN IS AN IDEAL PHYSICAL PLACE, CAUSATION IS PROGENERATION and PROVIDENCE IS NURTURANCE are based on the source domain schematized into the target; the target is a schematic version of the source, where the specific rich imagery of the source is removed completely. In summary, some metaphors may arise out of schematization via a metonymic process (Kövecses, 2015).

2.1.5.5 Conceptual Integration

To see what conceptual integration, or blending involves, we can take an example from a well-known metaphor: ANGER IS A HOT FLUID IN A CONTAINER (Kövecses, 1986, 1990; Lakoff, 1987; Lakoff and Kövecses, 1987). This metaphor is constituted by the mappings ‘container → body,’

‘hot fluid → anger,’

‘degrees of heat → degrees of intensity,’ and so forth.

However, there is more going on than just having straightforward mappings from source to target in one of the linguistic manifestations of this metaphor. The following expression ‘*God, he was so mad I could see the smoke coming out of his ears*’ stands as an example of how blends are created. This example was discussed by Fauconnier and Turner (2002) who specify that in the case in question an element of the source is blended with an element of the target. When they analyzed the example, they mentioned that there is no smoke in the source and no ears in the target. The understanding of this expression happens through the creation of a frame and smoke and ears are elements of it. Fauconnier and Turner (2002) specify that the blend can undergo some continuous developments. In this respect, the person would catch fire with the increasing emotion of anger like the following example, ‘*God, was he ever mad. I could see the smoke coming out of his ears—I thought his hat would catch fire!*’ The

understanding of this sentence in addition requires the understanding of how the notion of intensity is conceptualized in the network: A submapping of the ANGER IS HEAT metaphor is INTENSITY OF EMOTION IS DEGREE OF HEAT. Given this submapping, we have a piece of knowledge that a high degree of heat may cause fire and that, correspondingly, extreme anger may result in a perilous social situation. The emergence of the hat is traced back to the smoke coming out of the ear. In fact, the hat is metonymically associated with the head and the ear. The blend is extended thanks to the metonymic relationship of the hat and the head. The image of the hat catching fire is produced as a result of the entailment of the the INTENSITY IS HEAT metaphor in this sense that highest degrees of heat can cause fire. This would suggest an increase in the intensity of the person's anger along with its repercussions. The overall network relating to the understanding of the sentence is given in Figure 2.

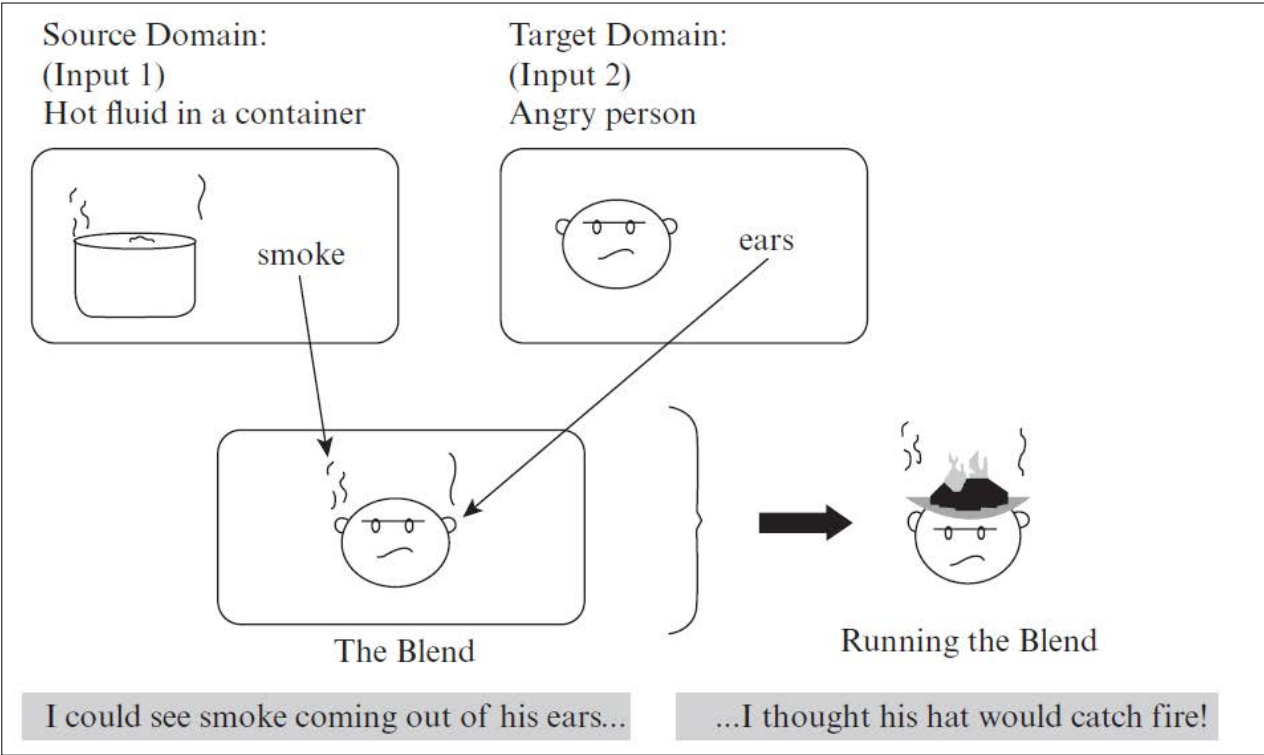

Figure 2: A representative picture of the blend ‘smoke coming out of his ears’

This is a highly creative blend, but, as Fauconnier and Turner (2002) emphasize, blending just as commonly involves entirely everyday and conventionalized cases.

2.1.6 Cognitive styles

The application of different construal, or cognitive operations, either by individuals or groups, can result in ‘differential cognitive styles’ (Kövecses, 2005). Differential cognitive styles can be defined as the particular ways in which members of a group use the presumably universal, and shared by all speakers universally, cognitive processes at hand. Such cognitive processes, discussed in part earlier, as elaboration, specificity, conventionalization, transparency, (experiential) focus, viewpoint preference, prototype categorization, framing, metaphor vs. metonymy preference, and others, (Kövecses, 2005) though universally available to all humans, are not employed in the same way by all groups or individuals. As a result, these cognitive processes may lead to cross-cultural and sometimes intracultural metaphorical variation.

We will briefly describe these construal operations in relation to their constraining effects on metaphor use across individuals and groups. These operations provide part of the answer to the wide range of metaphorical variations across cultures and within the same culture.

2.1.6.1 Experiential focus

Given multiple aspects of embodiment for a particular target domain, groups of speakers and even individuals may differ in which aspect of its embodiment they will use for metaphorical conceptualization (Kövecses, 2005). The term ‘experiential focus’ is used to refer to this operation. Consider as an example the case of English and Chinese metaphors for anger. Yu (1995, 1998) points out that in Chinese body heat plays a much weaker role in the emergence of anger metaphors than in English and other languages. Whereas in English heat-related metaphorical expression for anger abound (such as *boil*, *seethe*, *simmer*, *hotheaded*), in Chinese their occurrence is much less frequent. Chinese seems to emphasize internal pressure, rather than body heat, in the emergence and use of anger metaphors. This results from differences in the way English and Chinese speakers focus on particular aspects of their physiology in anger.

2.1.6.2 Salience

In a sense, salience is the converse of focusing on something. In focusing, a person highlights or profiles an aspect of something, whereas in the case of salience an aspect of something becomes salient for the person. In different cultures different concepts are salient, that is,

psychologically more well-known. Salient concepts are more likely to become both source and target domains than non salient ones and their salience may depend on the culture. For example, Boers and Demecheleer (1997, 2001) suggested that the concepts of HAT and SHIP are more productive of metaphorical idioms in English (e.g., *hats off*, *a hat trick*) than in French, and, conversely, the concepts of SLEEVE and FOOD are more productive of metaphorical idioms in French than in English. The authors argue that this happens because the former two concepts are relatively more salient for speakers of (British) English.

2.1.6.3 Prototype categorization

Often, there are differences in the prototypes across groups and individuals. When such prototypical categories become source domains for metaphors, the result is variation in metaphor. When a source domain concept in one culture is represented by a particular prototype and the corresponding concept in another culture by another prototype, the conceptual metaphors involving these prototypical concepts will differ. The prototypical concepts that we use in conceptual metaphors are based on our experiences in the cultures in which we live. An interesting example of this is provided by Chilton and Lakoff (1995), who analyze the notion of HOUSE in the conceptual metaphor popular in the 1990s: A COMMON EUROPEAN HOUSE. The notion of HOUSE is represented by different prototypes in Western Europe and Russia, more precisely, the former Soviet Union, where the metaphor came from. The differences in the prototype (free-standing house with one family vs. a large apartment building) lead to different metaphorical inferences concerning certain political issues, given this conceptual metaphor (Chilton and Lakoff, 1995).

2.1.6.4 Framing

A frame is a schematization of experience which is represented at the conceptual level and held in long-term memory. A frame links elements and entities associated with a culturally-filled scene or event from human experience. Groups and individuals may use the same source concept in metaphorical conceptualization, but they may frame the 'same' concept differentially. The resulting metaphors will show variation (in proportion to differences in framing).

2.1.6.5 Metaphor vs Metonymy preferences

Several cognitive processes may be used to conceptualize a particular target domain. Groups and individuals may differ in which cognitive process they prefer. A common difference across groups and individual people involves whether they prefer metaphoric or metonymic conceptualization for a particular domain. As we saw in Chapter 1, Charteris-Black (2003) examined the figurative uses of three concepts—mouth, tongue, and lip—in English and Malay (*tight-lipped*, *tongue-tied*). In addition to the similarities in metaphorical conceptualization, he also found that the figurative expressions involving the three concepts tended to be metonymic in English and metaphoric in Malay. It seems that in the domain of speech organs the figurative employment of these concepts is culture specific. The cultural preference accounts for the variability. The cultural preference for the metaphor or the metonymy acts as a constraint for the creation of similar metaphors. A concept is framed through a metonymy in one culture however it is captured through a metaphorical mapping across domains. The study has demonstrated that accessing the type of cognitive process at work—metaphor or metonymy—has also been viewed as a key into the effect of culture on language. Preference for hyperbole or euphemism as a stylistic product of culture is viewed as an important assertion for the effect of socio-cultural context on the one hand and the constraining impact of the different metaphorical artifacts on the other hand. Figurative phrases such as “*tight-lipped*” and “*one’s lips are sealed*” express particular cultural perspectives and evaluations of social situations.

2.1.6.6 Elaboration

As noted by Barcelona (2000), a particular conceptual metaphor may give rise to a larger or smaller number of linguistic expressions in different languages. If it gives rise to a larger number of types (not tokens) of expressions, it is more elaborated. (Lakoff and Kövecses, 1987) Given the conceptual metaphor ANGER IS A HOT FLUID IN A CONTAINER, American English is characterized by metaphorical expressions such as *blow a fuse*, *blow a gasket* and *flip your lid*, *blow your top*, *blow your stack*, *fly off the handle*. According to Barcelona, one does not find such a wealth of expressions in Spanish to describe anger.

2.1.6.7 Specificity

Barcelona (2001) notes that linguistic metaphors may vary according to the level of a specificity hierarchy at which they are expressed in different groups of speakers. A group of

speakers may express a particular meaning at one level of specificity, whereas the same meaning may be expressed at a different level of specificity by another group. The combined metaphor (CAUSED) CHANGE OF STATE IS (CAUSED) MOTION IN A CONTAINER can be expressed in English at both a generic and a specific level. Whereas one can say in English ‘His behavior *sent me into* a fury’ (with *send* as generic) or ‘The news *threw him into* a state’ (with *throw* as specific), in Spanish, according to Barcelona, the more specific ‘*throws someone into* a state’ is not quite acceptable. In other words, as evidenced by several examples, Spanish speakers tend to express this conceptual metaphor at a higher level of generality than speakers of English.

2.1.6.8 Conventionalization

Barcelona (2001) observes that linguistic instantiations of the same conceptual metaphor in two languages may differ in their degree of conventionalization. A linguistic metaphor in one language may be more or less conventional than the corresponding linguistic metaphor in another language. According to Barcelona (2001), the Spanish metaphor in ‘Romeo se ha *enamorado* (‘Romeo is in love’)’ is less conventional and more creative than the metaphor in ‘Romeo *fell in* love with Juliet’ in English although both metaphorical expressions are based on the same conceptual metaphor, LOVE IS A CONTAINER. These construal operations constrain the use of metaphors; in particular, they produce variation in metaphors by means of how speakers *present* a metaphor.

In this section we introduced aspects of metaphor, that is, the elements that motivate and constitute the metaphorical meaning making. These elements interact with each other in the form of linguistic metaphorical expressions and appear to the surface when providing the link between the two frames domains intervening in the conceptual system. These elements will play a remarkable role in making a detailed description of cross-cultural variation. These aspects are not the only factors affecting variation. Cognitive preferences among language users play also a seemingly important role in defining the metaphorical linguistic expression to be used in a particular situation.

2.1.7 Metaphor and the body

This cognitive potential has grown in importance when many analysed metaphorical expressions were found to be anchoring in bodily actions thus introducing the embodiment

hypothesis. This theory is built on the correlation between an action and its effect on the body (Johnson, 1978; Lakoff & Johnson, 1999). In its early stages the theory acknowledged the universal dimension of cognitive processing by stipulating that all human beings share the same physiology and that the experiences associated with their bodies will serve to conceptualize the same abstract experiences. The nature of our embodiment defines and delimits the range of and nature of concepts that can be represented; we can then examine how these concepts are encoded and externalised via language by finding out how the language system provide meaning based on concepts derived from embodiment (Evans & Green, 2006).

The physiological experience of eating which involves chewing, swallowing, digesting, desiring, tasting...afford a strong link between the bodily action and other psychological experiences. Many expressions under investigation are particular descriptions of the embodied experiences of dealing with food. These concrete physiological experiences ground food expressions' understanding in metaphor. Accordingly, metaphorical thinking based on bodily experiences seems to provide an answer the conceptualization of food metaphors. The latters are employed to understand abstract and concrete domains. Since we are most familiar with our bodies and the experiences of our bodies, food metaphors being essentially descriptions of familiar highly experienced situations and particularly physiological experiences, are more likely to be used in the mapping of abstract psychological experiences (Dakhlaoui, 2012). Henceforth, food metaphors are more likely to describe bodily experiences in line with familiarity and concreteness, which are the main characteristics of the source domain of food the main theme of the present study. Metaphors including food related terms seem to fit this condition with respect to the concreteness of the human experience with food. The present work will investigate how our bodies constrain and give insight to less concrete experiences (Johnson, 1987; Lakoff & Johnson, 1999) and how the culture allows or disallows certain bodily experiences with food to frame similar or different target domains (Maalej, 2008; Yu, 2008; Kövecses, 2015).

An image schema is a concept that has always been associated with the embodiment hypothesis in the cognitive linguistics literature. The definition of image schemas revolves around the generic knowledge shared by human beings and governing many of their everyday actions and movements. Image schemas are relatively abstract conceptual representations that arise directly from our everyday interaction with and observation of the world around us

(Johnson, 1987). They are concepts arising from embodied experience. The body interaction with its environment results in a number of repeated experiences. Let us take the example of UP-DOWN schemas. Our physiological nature guarantees that our vertical axis, which interacts with gravity, gives rise to meaning as a result of how we interact with our socio-cultural world. In this respect, image schemas are not considered innate knowledge structure, neither rich and detailed concepts, but rather abstract concepts made of a pattern emerging from repeated instances of embodied experiences. Some views consider image schemas to be pre-conceptual in origin. Image schemas like the CONTAINER are directly grounded in embodied experience. They relate and derive from sensory experience. “Image schemas are concepts, but of a special kind: they are the foundations of the conceptual system, because they are the first concepts to emerge in the human mind, and precisely because they relate to sensory-perceptual experience, they are particularly schematic”(Evans & Green, 2006: 179). The following table presents a partial list of image schemas:

SPACE	UP-DOWN, FRONT-BACK, LEFT-RIGHT, NEAR-FAR, CENTRE-PERIPHERY, CONTACT, STRAIGHT, VERTICALITY
CONTAINMENT	CONTAINER, IN-OUT, SURFACE, FULL-EMPTY, CONTENT
LOCOMOTION	MOMENTUM, SOURCE-PATH-GOAL
BALANCE	AXIS BALANCE, TWIN-PAN BALANCE, POINT BALANCE,
UNITY/MULTIPLICITY	MERGING, COLLECTION, SPLITTING, ITERATION, PARTWHOLE,COUNT-MASS, LINK(AGE)
EXISTENCE	REMOVAL, BOUNDED SPACE, CYCLE, OBJECT, PROCESS

Table 1: A partial list of image schemas quoted from Evans & Green (2006: 190).

The theory's refrain to address the impact of culture on the embodiment theory has triggered different dimensions of the embodiment hypothesis for metaphorical thought. Later developments of the theory (Rohrer, 2006-7; Maalej, 2004, 2008, 2011) pointed to the impact of the socio-cultural context in influencing the mapping of our bodily experiences on other abstract domains. The outcome of these contributions seems to fill "what is missing from the psycholinguistic work, and from aspects of the work on metaphor in cognitive linguistics, [by presenting]...an explicit acknowledgement of culture and its important, perhaps defining, role in shaping embodiment and, consequently, metaphorical thought" (Gibbs, 1999: 153).

Many linguistic metaphors were found to be descriptions of different bodily experiences. People are most familiar with their bodies and this familiarity places the bodily actions as potential active actors in the cognitive processing of abstract experiences. The bodily basis for metaphor creation and understanding will be analysed and reviewed in this study particularly in its interaction with the cultural factor to produce food metaphors. These notions of embodied culture and cultural embodiment seem to be more accounted for through conducting metaphorical comparative studies. The present work seems to fit this challenge particularly when focusing on the food domain; a domain that joins the body and the culture since food is naturally a natural need for all humans hence producing different embodied experiences. People seem to qualify these experiences and then use them to understand and create metaphors corresponding to their respective cultures.

2.1.8 Conceptual Blending

By a process known as conceptual blending, Turner and Fauconnier (1995) claimed that we can see how metaphors create a new domain out of two previously distinct ones. This new domain has features of both domains, but has evolved its own unique characteristics. In their collaborative article, Turner and Fauconnier (1995) cited the case of the phrase 'Land yacht' to refer to an expensive luxury automobile. The two words come from disparate domains, *yachts* being vehicles confined to water and *land* being distinct from bodies of water, a surface upon which only vehicles with wheels can travel. As the two scholars pointed out, "Land yacht" gives us land from one space and yacht from another, and asks us to perform a mapping between these spaces. In this mapping, yacht corresponds to luxury car, land corresponds to water, driver corresponds to skipper, the road for the car corresponds to the course for the boat, and so on" (Turner & Fauconnier, 1995). The diagram below represents

the process by which conceptual blending takes place, with ‘land yacht’ being the illustrative case (Turner & Fauconnier, 1995).

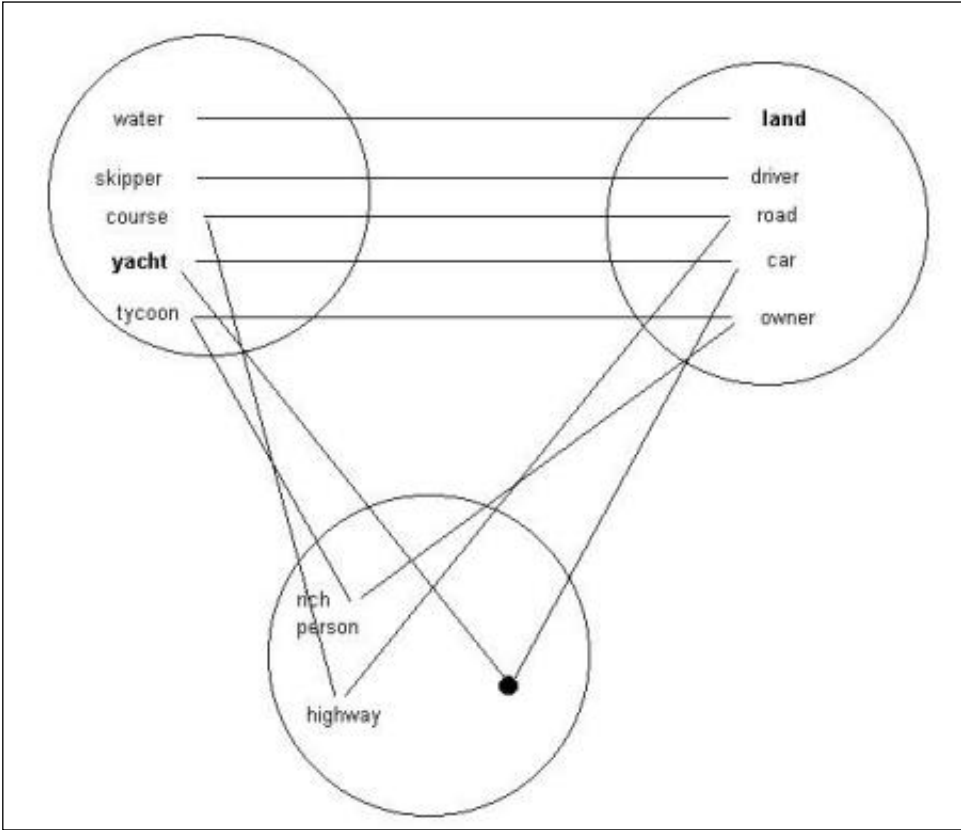

Figure 3: Sample of conceptual mapping process (Turner & Fauconnier, 1995).

2.2 Metaphor and culture

In this second part of the literature review we will place focus on, through exhibiting examples of variation cross-culturally, the impact of the socio-cultural context on metaphor understanding, use and creation. As explained above, metaphors are primarily based on embodied human experience (Lakoff & Johnson, 1999; Grady, 1997a, 1997b) and consequently since all human beings share the same physiology, metaphors are more likely to be universal. This view was later subject to amendment through the development of the theories which adhered in the latest years to a more seemingly balanced approach through giving the socio-cultural context, in which the body acts and reacts, the importance it deserves (Kövecses, 2005, 2015). The analysis and discussion of the development of the cultural involvement in metaphor analysis, use and understanding will be presented in four main parts.

First, we will approach the definition of culture with a particular focus on its direct/indirect relationship to the definition of metaphor in cognitive linguistics. Second, we will present some examples of contrastive studies of metaphors which depicted embodied experiences in their context of use and highlighted the relevance and impact of the socio-cultural context. Third we will present kövecses model (2005) of addressing metaphor studies across cultures with the aim of having a more comprehensive metaphor analysis and comprehension. Finally, we will end with a summary and discussion of the seemingly potential contributions of culturally-focused analyses to metaphor study along with its relevance to the present study.

2.2.1 On the definition of culture

Defining exactly what culture is remains out of the scope of the present study; that is why we will try to make on a grass root approach to the definition of the word culture. We consulted some languages dictionaries and encyclopaedias and find out the following definitions:

“the customs, ideas, values, etc of a particular civilization, society or social group, especially at a particular time” *The Chambers online dictionary*.

“the way of life, especially the general customs and beliefs, of a particular group of people at a particular time” *Cambridge online English dictionary*.

“the beliefs, customs, arts etc., of a particular society, group, place, or time.” “The way of thinking, behaving, or working that exists in a place or organisation (such as a business).” *Websters online dictionary*.

“1- the arts and other manifestations of human intellectual achievement regarded collectively”

“2- the ideas, customs and social behaviour of a particular people or society” *Oxford online dictionary*.

“1- Culture consists of activities such as the arts and philosophy, which are considered to be important for the development of civilization and people” “2- A culture is a particular society or civilization especially considered in relation to its beliefs, way of life, or art.” “3- The culture of a particular organisation or group consists of the habits of the people in it and the way they generally behave” *Collins Cobuild advanced learner’s English dictionary*.

“1- (a)art, literature, music and other intellectual expressions of a particular society or time”

“(b) an understanding or appreciation of this” “2- the customs, arts, social institutions, etc of a

particular group or nation.” “3- development through regular training, exercise, treatment.”
Oxford Advanced Learner’s Dictionary.

The analysis of this brief survey of the definition of culture will be based mainly on two main metaphor interrelated axes, that are viewed central to the present study, namely food and thought. The first will be the place the impact that food and its related practices have in figuring out the different elements constituting a culture. On the other hand, we will view through the lens of culture definitions the direct and/or indirect link with the mind and particularly one of the “instrument[s] of the mind” in Lakoffian terms i.e. the metaphor.

The terms customs (6) habits, (3), way of life (2) and behaviour and way of behaving (3) are recurrent in these definitions. They encompass, among other practices, food and its surrounding activities. Whether it is, essentially but not limited to, cooking or eating, these activities are habitual actions and represent everyday recurrent experiences shared by people across different cultures/societies. Society is made up of individuals interacting with each other to try to satisfy their various needs. ‘Culture’ is, however, a word used by anthropologists to refer to the rules, customs, and other shared plans and behaviours that result from this interaction. If we consider that food and food practices are part of people’s everyday habits then we will logically find out that food is at the heart of cultures. Irrespective of its being an essential element for the survival of all creatures, as far as my knowledge goes, People’s experiences with food has gone far from being merely this primary need. Food has developed from being a basic need to be a source of enjoyment and pleasure for many and also to furnish specific events in people’s life. In this way it has become more a ‘way of life’ and ‘social behaviour’ than a ‘habit’ in the definitions terms. “Food is culture *when it is produced...*Food becomes culture *when it is prepared...*Food is culture *when it is eaten*” (Montanari, 2006: xi). Food in its different abundant manifestations seems to be a candidate par excellence to disclose about the culture in a variety of ways. The link between food and culture is conspicuous through the above stated basic definitions. The present cross-cultural study of food metaphors will probably point to the relevance of this claim and give more insight into the nature of the link between food and culture on the one hand and between culture and metaphor on the other hand.

Other expressions that are recurrent in the above presented definitions are mainly related to thought in general. We can see that expressions like ‘beliefs’ (4), thought and way of thinking (2), ‘intellectual (2) achievement and expression’ and ‘understanding’ (1) are pointing directly to the mind. The mind is directly involved in the definition of culture since culture is stored and transferred through the mind. According to the above definitions, culture revolves around beliefs and intellectual expression. If we consider that culture is partially thought and beliefs shared by people belonging to different groups, then we are moving a step further towards metaphor since the latter is about understanding the abstract in terms of the concrete.

‘The shared understanding suggested by anthropologists as a large part of the definition of culture can often be metaphorical understanding. They can be metaphorical when the focus of understanding is on some intangible entity such as time, our inner life, mental processes, emotions, abstract qualities, moral values, and social and political institutions’ (Kövecses, 2005: 2).

This direct link between thought and metaphorical understanding on the one hand and the link between culture and thought on the other hand is very relevant to the present cross-cultural study. The latter will focus through food; a domain deeply entrenched in culture, on the impact of the socio-cultural context on metaphor creation, use and understanding. It is through investigating these two types of relations that the interaction mind-culture-language; a new challenge to metaphor studies, will be revealed and accounted for.

This brief survey of metaphor definitions has allowed creating a perspective from which both food and metaphor can be viewed at the heart of culture. By being basically an understanding of one abstract domain in terms of another familiar and highly experienced domain, metaphor places itself into the cultural arena since the latter is about both concrete practices along with abstract understanding of these practices. The correlation between metaphor and culture seems far reaching and the present study is supposed to provide answers to the questions about the nature of this correlation and its direct impact on understanding.

2.2.2 Culture and thought

Since the link between metaphor and culture is very pertinent to the present study, a brief review of the interrelation between culture, language and understanding will be conducted in this part. We will first discuss Worf’s view of the relationship between culture and language, then we will review culture as viewed in relation to metaphor study and then we will end by

making a brief introduction of cultural linguistics as it espouses culture and language through metaphor.

2.2.2.1 The Sapir-Whorf Hypothesis

The hypothesis tackled the relationship between language and culture differently. In fact, their view revolves around the fact that language, particularly lexical units or words and even grammar, is not independent of the socio-cultural context in which it is used. Rather it is in major part its construct. Culture affects language so much and people perceive the world differently and are not free to use language objectively but rather they use it according to what culture affords to them. In other words the lexical units are somehow culture made and they do not refer to the world objectively but depending on the cultural perception of these words.

“Human beings do not do not live in the objective world alone...but are very much at the mercy of the particular language which has become the medium of expression for their society. The world in which different societies live are distinct worlds, not merely the same world with different labels attached” (Sapir in Mandelbaum, 1985: 162).

This emphasizes the word-based or lexical nature of a language—While the world in which people live is one unique nature, human beings cut it into discrete categories according to the culture in which they live. People use words to talk about the world they live in and this world is their own cultural one. These words will be different from other words in other different context.

This theory brings to light the impact of culture on language and thought. Language cannot be analysed and interpreted regardless of its own cultural setting. Similarly, metaphor which is a linguistic manifestation of speakers’ thought patterns is more logically viewed to be influenced by culture. This relationship between language and culture is an important parameter in the analysis of metaphorical expressions.

2.2.2.2 Metaphor and culture

Although metaphorical thought is based on bodily experience, metaphors vary cross-culturally and within the same culture. According to Kövecses (2005) metaphor can display a variation of the specific-level but also studies of metaphor across cultures have proved that a

culture exploits a group of different source domains to conceptualize a particular target domain and conversely a culture uses a specific source to capture a number of different target domains. Studying metaphorical conceptualizations of many abstract concepts has unveiled the difference at the level of the configuration of metaphors across cultures.

Metaphor constitutes the core tool in all cultures however each culture presents it in its own way. ‘The metaphor constitutes a generic-schema that is filled out by each culture that has the metaphor’ (Kövecses, 2005). Metaphor analysis has gone through two main steps one was mainly characterised by a major focus on the conceptual knowledge underlying people’s understanding of metaphorical expressions (Lakoff& Johnson, 1980, Lakoff, 1993) with little or almost no mention of the cultural element and a second step in which the cultural element emerged as being very influential in our conceptual knowledge (Kövecses, 2005, 2010, Maalej, 2008, Gibbs, 2008, Yu, 2008). The present work will try to fill part of the cultural gap which has characterised metaphorical studies for a long time through focusing on the role of the context in metaphor understanding and creation. Defining and describing the exact role of culture in shaping embodiment and metaphorical thought will be a support to previous works done in this respect (Sharifian, 2008, Yu, 2011, Maalej, 2011, Kövecses, 2015).

2.2.2.3 Cultural conceptualization

The investigation on the relationship between culture and language seems is more likely to focus research on the entrenchment of many feature so human languages in cultural conceptualizations. Cross-linguistic studies of metaphors have concluded that apart from universality of bodily conceptualizations of experiences, many culturally-grounded conceptualizations account considerably for the variation across languages (Sharifian, 2011, Yu, 2011, Maalej, 2011, Kövecses, 2015). These are conceptualizations deeply rooted in culture and are communicated through interactions between members of the cultural group in questions. Conceptualization is not only related to language but also to culture mainly because culture affects thought and language. The meaning is identified as conceptualization, but cognition at all levels is embodied and culturally embedded (Langaker, 1994). Investigating the interface between language, culture and conceptualizations is the subject matter of a whole field of linguistics which is cultural linguistics (Palmer, 1996, Sharifian, 2011; 2015). It is viewed as a discipline that owes its existence to three anthropological traditions; the Boasian linguistics, ethnosemantics and the ethnography of speaking. The Boasian

Linguistics, which is after the German-American anthropologist Frans Boas, asserts that language reflect people’s mental life and culture and that language users categorize experiences differently in a way that influence their thought patterns (Sharifian, 2015). Ethnosmenatics is, however the study in which different cultures organize and categorize domains of knowledge such as those of plants, animals and kins (Palmer, 1996). The ethnography of speaking or the ethnography of communication explores culturally distinctive means and modes and speaking and communication. These three linguistic-anthropological traditions share the scholarly attention to the socio-cultural anchoring of language hence their positive contribution to the development of cultural linguistics.

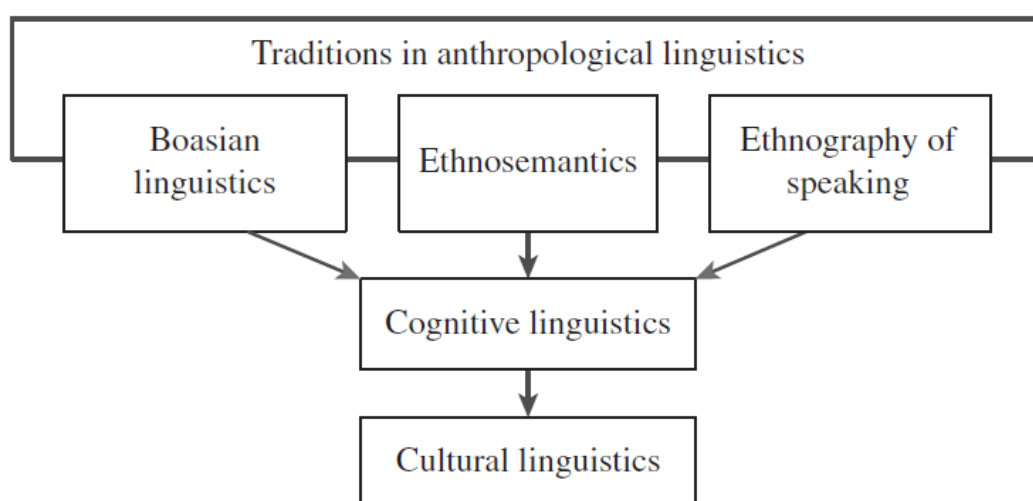

Figure 4: A diagrammatic representation of cultural linguistics as suggested by Palmer (1996) quoted from (Sharifian, 2015).

The concept of cultural conceptualization refers to the mechanism underlying the variety of framing shared by groups belonging to the same culture. These groups are permanently sharing codes for perceiving the world and changing them denovo:

Distributed, Emergent Cultural Cognition



Figure 5: A distributed cultural model quoted from Sharifian (2011)

The cultural model presented above seems to account for the intracultural variety.

“In this model, cultural conceptualisations are viewed to be representations that are distributed across the minds of members of a cultural group. These conceptualisations largely emerge from the interactions between the members of the cultural group and are constantly negotiated and renegotiated across generations” (Sharifian: 2011, 17).

This brings back the culture to the surface through assigning cognition to the cultural group and not the individual. The individual conceptualizes domain of experience through the language that he uses to communicate with members of his cultural group. The bodily-based cognition should be joined with cultural cognition to account for the understanding of many domains of experience.

2.2.2.4 Conclusion

The role of the socio-cultural context in metaphor understanding, creation and recreation may stand at the heart of food metaphor understanding. Food metaphors exhibit the shared knowledge between speakers of a given cultural group. This knowledge is not necessarily centered around the human body. Metaphor understanding is no longer only a matter of systematic conceptual mapping part of the speaker’s conceptual system. It is neither the effect

of bodily experiences nor their understanding. This gives partial accountance to the understanding of metaphors. Speakers understand metaphorical expressions to their variety because he is a member of a cultural group that share common knowledge and spreading it across different individuals belonging or not to his cultural group. The ubiquity of food metaphors demonstrates that the socio-cultural context influences the production of these metaphors by providing familiar concrete experiences ready to be mapped on a number of abstract domains. Moreover, the dynamic aspect of metaphor makes it productive by itself. One mapping may lead to another and the metaphor may turn itself into a source for other types of metaphors to be created *denovo*.

2.3 Cognitive-contrastive studies

In this section we will present some of the studies that adopted a contrastive-cognitive approach with a particular focus on the food theme (Maalej, 1999; Emanation, 1995; Charteris-Black, 2003; Gibbs et al, 2004). Though seemingly similar, the upcoming samples of these comparative studies share the attention to the food domain. However the different studies adopted different methods to study food metaphorically. Moreover, these studies do not seem to target food in all its manifestations. They rather focused on a limited number of food terms. In what follows a brief presentation of these different studies that will be followed with a summary and discussion.

It seems that the familiarity with and the concreteness of the food domain and the experiences associated with it make it act as a productive domain to figure out many different abstract concepts. Maalej (1999, 2004) demonstrated through examples from TA that metaphorical thinking based on cross-domain mapping accounts for the understanding of abstract domains. Through presenting and discussing some TA linguistic metaphors (Maalej, 1999) demonstrated that conceptual metaphors influence the thought patterns of TA speakers.

“To name a few, the metaphor A HUMAN BEING IS FOOD structures the understanding of expressions like *klaaha b-3aynih* (*He devoured her with his eyes .i.e. He drank her with his eyes*) , *matišba3š mil-Razran liha* (*You are never full up with looking at her .i.e. You cannot get enough of her*) (Maalej, 1999 :197). The domain of food is used here to structure knowledge about human traits. There is a mapping from the domain of food onto the domain of human beings” (Dakhlaoui, 2012: 5).

Emanation (1995) investigated the eating and heat metaphors in Chagga and how they serve to describe feelings of lust and feeling about sex, and compared them with their English

counterparts. Such an investigation spotlighted the importance of our embodied experience and the human ability to extract and extend common schemas in the conceptualization of emotion. The different Chagga expressions investigated by Emanation (1995) reveal a strong systematicity between the expressions of food with their different patterns particularly hunger, desire and satisfaction and the expression of sexual practices and feelings.

To justify the prominent role played by embodied experiences in people's use and understanding of metaphor, Gibbs et al. (2004) worked on the DESIRE IS HUNGER metaphor showing that bodily experience with food serves as a source domain for many metaphorical mappings. It was claimed that people's conceptualization of desire originates from their embodied experience of feeling hungry. By comparing expressions from American English and Brazilian Portuguese, Gibbs et al. (2004) found that both languages structure their understanding of desire in terms of experiences of hunger.

The productivity of the food domain is highlighted by the different food domain patterns involved in studying food-related expressions. The physiological experiences related to food such as tasting, desiring, hunger, digestion, satiation...structure much of our conceptualization of less delineated experiences. This echoes plainly in some of the studied food metaphorical expressions and will be developed in many parts of this study.

Cross-cultural studies conducted on metaphor so far are dominated by two conflicting intellectual camps-the one claiming that there are metaphors that transcend cultural and language barriers and the other which claims that metaphors are unique to cultures as they are products of their distinct experiences .Many comparative studies were conducted to confirm the universal dimension of conceptual metaphor theory. Several languages were investigated in comparison to give more solid evidences for the universality of our conceptual knowledge allowing us to understand metaphors across languages.

Charteris-Black (2003) compares three figurative uses of three oral body parts in English and Malay phraseology to establish whether either language shows an orientation toward metaphor or metonymy. The findings confirmed the impact of culture tendency in Malay to use metaphor. Talibenjad and Dastejerdi (2005) investigated the nature of metaphor in English and Persian through comparing animal metaphors .They come up to find that , despite

the similarities between the two languages, many aspects of the animal metaphors are culture-specific. Yu (1995) attempted to demonstrate that English and Chinese share the same conceptual metaphors for anger and happiness. The study revealed that differences exist at the level of the elaborations of the metaphors in the two languages. The conclusion that anger and happiness metaphors are mainly embodied was another important finding of this study.

Lakoff and Johnson's (1980) seminal work, with its emphasis on embodiment, might lead one to surmise that many, if not most, metaphors are grounded in basic human experience, and thus are universal. However, Kövecses (2000) claimed that there are wide cultural discrepancies between any two cultures, which make the argument for universally valid conceptual metaphors quite debatable.

Despite the seeming validity of the notion of culture-specific metaphors there were scholars who countered them. Many points were raised disputing the arguments laid down by scholars who adhere to the school of universally shared non-literal language. It was advanced that in terms of the underlying structures and constraints, the differences between languages are trivial, and that in a sense there is only one major language-human (Johnson, 1987). Although metaphor belongs to the domain of usage and not of abstract core linguistic structures, Lakoff and Johnson's original claims (1980) seem to also hold a universalistic position, one that has also been found in work on other areas, such as that of Eckman on emotional expression across cultures. Basically, the relationship between universal and culture-specific is not well understood, and much more study is needed to shed light on this issue. This last claim has triggered the present study aiming at disclosing more clarifying conclusions about the interchange between universality and culture-specificity in metaphor use and understanding.

2.4 Analytic tools and methodological concerns:

In this part we will proceed with a presentation and then a discussion of some of the analytical tools adopted by most metaphor scholars. The study of metaphor developed qualitatively and also technically. The techniques involved in analyzing metaphorical expressions have gained gradual rigor throughout three decades of metaphor investigation. Scholars faced the challenge of providing each time a convincing analysis of metaphors in varied situations. In fact "each methodology can be seen as having certain capacities and limitations that accord it a particular perspective on the nature of conceptual organization in language" (Talmy: XII,

2000). The study has moved from accounting for the understanding of everyday metaphorical expressions by the set of correspondences governing the mapping across domains (Lakoff & Johnson, 1980) to studies attempting to explain the embodied, cultural and contextual interferences, exact roles and positions in the sets of common patterns of metaphors (Kövecses, 2005; Kövecses, 2015; Maalej, 2004; Gibbs, 2004; Gibbs, 2008; Yu, 2008; Steen et al, 2010).

In this section we will present and then discuss classical³ and emerging methods of metaphor analysis. The study of metaphor is expanding enormously and the debate over the methods of its analysis does not seem to be a settled issue. We will start first with introducing the introspection technique as a tool governing the selection of linguistic metaphors under investigation. Then, we will move to presenting the MIPVU (Steen et al, 2010) as a method of metaphor recognition. Then we will introduce some of the experimental psychology tools employed in investigating metaphors. After that, we will end this section by discussing and justifying our choice for the method mostly accommodated to the objectives of the present study. Finally, we will discuss, through analyzed examples from the three studied languages, the unidirectionality of the mapping and how first the context and second the metaphor itself shape the creation of new metaphors and even violates the directionality or at least makes it bi-directional.

2.4.1 The introspection method

Broadly speaking, this method can be defined as consciously directing attention by a language user to aspects of language as manifest in his/her cognition. In the case of metaphor attention is directed to the connections between domains and how speakers can access meaning of one domain in terms of another. Aspects of language differ in their readiness to appear in first level of consciousness. If they appear, they differ in their amenability to second-level attention. It is judged more amenable if an aspect of language has greater strength and clarity and can remain more stably present in first-level consciousness while attention is directed at it. It is viewed less amenable if it is vaguer and more subtle under such scrutiny. As a cover

³The method of introspection as first used by Lakoff & Johnson (1980) that is selecting specific expressions, acknowledging their metaphoricity, looking for the source and the target, accounting for the mapping and then sorting out the conceptual metaphor corresponding to them is considered the classical one.

term spanning such first-level readiness and second-level amenability, aspects of language will here be said to differ in their accessibility to consciousness, attention or introspection (Talmy, 2007). The method of introspection directs attention at the aspect of language of meaning making which is at the heart of metaphorical connections. It has the advantage of being the only method able to access meaning directly. This method is still valid and represents the one of the widely used tool used in comparative studies (Charteris-Black, 2004; Kovecses, 2005; 2010).

2.4.2 Metaphor identification: The MIPVU

Metaphor recognition has for long been confined to the poets and rhetoricians and then the linguist in the conceptual metaphor theory (Lakoff & Johnson, 1980). His own tool is his own intuition about the different expressions under investigation. Most metaphor studies place a major focus on the analysis and interpretation of metaphorical expressions. The salient systematicity of metaphorical expressions seems to influence the linguists' rapid leap to conclusions. The scholars' agenda was filled more with answers to questions on the conceptual elements justifying the systematic and spontaneous understanding of metaphorical expressions and actions than with questions about the detailed empirical foundations of the conclusions reached⁴. The concern with cognition and the expanding explanatory power of metaphor to everyday expressions spontaneously used and understood can account for the 'neglect' that linguistic metaphor identification is facing by the scholars who pioneered studies on metaphor (Lakoff & Johnson, 1980; Johnson, 1987; Lakoff & Turner, 1989). Bringing to light the potential methodological weaknesses in the conceptual metaphor theory and devising methods and tools to avoid the linguist's intervention in metaphor identification is contributively developing the theory and giving a solid support to the conclusions made on the conceptual knowledge underlying the understanding of metaphorical expressions. One of the pioneering attempts in this perspective is Steen's project known as MIPVU (Steen et al, 2010).By adopting such a theory, the researcher will theoretically keep his distance. Like the scientist who rarely interferes with the experiments he makes but rather observes what is

⁴The study of metaphor revolved around two main axes during that time; the systematicity of the mapping across conceptual domains and the embodied theory. It was very important at that time to relate metaphor analysis and understanding to the physiological experiences of our bodies through showing the correlation between the embodied experiences exploited in a big number of metaphorical expressions and the conceptualization of abstract domains.

happening, the linguist will not intervene with the selection of the metaphorical expressions. The theory will give him codes for identifying these expressions. This algorithmic attitude can possibly optimize the objectivity of the research and reduce the risk of making errors.

Despite its scientific significance, this project does not seem to fit the objectives of the present study. This seemingly unprecedented project exhibits scientifically plausible methods and establishes a more organized way of metaphor detection. However, this method stops short of delineating the limits between embodied and cultural motivation of metaphors. Though being very sound in targeting corpus studies, this method can yield efficient results when looking at different source domains in predefined number of texts. Cross-linguistic studies however, I believe, still need to follow also manual techniques in data collection so that to cover enough language representations.

2.4.3 Metaphorical conceptualizations and psychological experiments

To justify the prominent role played by embodied experiences in people's use and understanding of metaphor, Gibbs et al. (2004) worked on the DESIRE IS HUNGER metaphor showing that bodily experience with food serves as a source domain for many metaphorical mappings. It was claimed that people's conceptualization of desire originates from their embodied experience of feeling hungry. By comparing expressions from American English and Brazilian Portuguese, Gibbs et al. (2004) found that both languages structure their understanding of desire in terms of experiences of hunger. The contribution of this study is the investigation of bodily symptoms associated with the experience of hunger. The informants are presented first, with local symptoms, general symptoms and behavioural symptoms to say which ones are either closely related or possibly related to hunger. They were also asked to decide which ones are not at all related to hunger. Then, the participants receive a booklet containing a long random list of symptoms and had to rate each one on a 7-point scale to judge whether they had experienced the effect associated with hunger (with 1 meaning 'never' and 7 meaning 'quite frequently'). The results indicated significant regularities in people embodied experience of hunger by speakers belonging to two different cultures.

Furthermore, the study investigated the correlation between people's folk knowledge about hunger and their understanding of different experiences of hunger. The participants, who belong to the same population sampled in the first investigation, are asked to give their

intuitions about their feelings when experiencing three types of desire namely: love, lust and desire for other things. Participants are asked to rate various bodily experiences on a 7-point scale. The findings were consistent across English and Portuguese, which demonstrates how ‘knowing something about people’s embodied experiences of hunger allows us to predict which aspects of desire will, and will not, be thought of and talked about in terms of our complex embodied understanding of hunger’(Gibbs et al, 2004: 1206). These findings highlighted the role played by embodied experience and how the embodied understanding of this experience is mapped onto the abstract experience of desire.

“Studying metaphors involving the food domain with its different patterns highlighted the productivity of this source domain. Moreover, the embodied experiences associated with food, be it hunger, eating, tasting, or feeling satiated, structure much of our knowledge about less concrete experiences” (Dakhlaoui, 2012: 5). This echoes plainly in some of the studied food metaphors and will be developed in a later stage of this study.

2.4.4 Metaphor creation and unidirectionality of the mapping

The cross-domain mapping is a common psychological procedure underlying the understanding of unfamiliar less delineated domains. Despite its considerable explanatory power for the logic of connections between different domains, the characteristics of unidirectionality seems to go too far into making the understanding operation so structural and reduce it to a repetitive operation that lacks the flexibility needed to account for the complex operation of understanding. Moreover, this one-way route from the concrete to the abstract stops short of explaining a big number of comparisons that exploits the abstract to understand the concrete and which we term ‘ambiguous similarities’. The following analysis will present some of the ambiguous similarities and then discuss their understanding. The ambiguous similarities taken from TA are either metaphors and/ or sometimes also analogies.

The examples under investigation challenge the unidirectionality of the mapping and rests on exploiting abstract and unfamiliar domains to understand seemingly concrete domains.

(1)

(a) flaan malayka⁵

X angel

X is an angel

'He's an angel'

(b) flaan šiTaan

X devil

X is a devil.

'He's a devil.'

(c) sRari janna

Children my be-PRESENT paradise

My children are paradise.

'My children are well-behaved.'

These expressions share the peculiar characteristics of connecting one concrete element to another abstract. How much do we know about angels, devils and heaven so that we can use them as facilitators to understand human beings? These expressions seem to violate or at least challenge the basics on which metaphor and analogy are built; using concrete highly informative domains to capture abstract ones. This mapping unidirectionality violation is what makes me term these expressions ambiguous. The degree of the ambiguity correlates with the degree of the familiarity with the elements used in the comparison. The fictive unseen creatures or location used in these expressions are abstract, unfamiliar and hard to perceive. Yet, the TA language includes different examples that are commonly used by TA speakers and their understanding does not require much effort.

The mapping in (1a) is from the domain of supernatural beings to the domain of human beings. We map knowledge about angels in order to understand human traits. According to the TA culture which relies on the Islamic religion in the interpretation of angels' behaviours. These creatures are placed higher than human beings in the hierarchy of creatures. They do not live on earth and they dwell higher in the sky closer to god than any other creatures. This physical proximity to god being his direct servants give them the moral and physical stature

⁵The presentation of examples is organized as follows: the first line gives a transliteration of the TA conceptualization, the second the Arabic morpheme gloss, the third the English close translation and the last line the English closest idiomatic equivalent.

they enjoy. The distinct feature of Angels is obedience. Unlike the devil, angels obey god blindly and they manifested this first when god created humans, angels and the devil and asked the latter to pray for the formers. Angels followed god's instruction while the devil refused to do that⁶. This was the first test of god's creatures and this gave them the reputation they enjoy. Paradoxically, the devil has become well-known for disobedience. He is known to be the chief spirit of evil and adversary of god through tempting mankind. The paradox between angels and devils is projected on human beings and their features of obedience and disobedience are recruited to frame respectively the features of kindness and wickedness. This paradox is exploited to frame virtuous and wicked persons respectively. The devil in (1b) is compared to a human being to capture the trait of wickedness.

Human beings are also compared to an imaginative never seen supernatural place in (1c). This expression maps knowledge about the paradise which is known as a place of bliss, delight and peace onto human beings. The relation between the two situations being in heaven and dealing with children appears arbitrary. The system of relations governing the two situations is important for the understanding of this expression. The imaginative feeling of delight and peace of mind in heaven is projected on a real-life situation when a father or mother deals with well-behaved children.

(2)

(a) xabbaha win y-xabbi iššiTaan wladu
 Hide-PERF her where hide-IMPERF the devil children him
 He hid her where the devil hides his children.
 'He cunningly concealed her.'

(b) HaT-lu l-kuura win y-skon iššiTaan
 He put-PERF to him the ball where live-IMPERF the devil
 He put the ball where the devil lives.
 'He shot a very difficult ball for the goalkeeper to reach.'

⁶According to the text of the holy Koran, after the creation of Adam, the first human being, Allah asked all the angels to bow as a mark of respect to Adam who was created so miraculously. When the angels heard the commandment of Almighty Allah, they all complied without hesitation. They bowed with respect and admiration to the new creation and that was Adam. However Iblis (Satan) did not surrender on various pretexts and stood still.

The supernatural creatures are used to map knowledge about human beings and also their actions. The devil and his descendants are exploited in TA to frame particular human actions. The overall meaning revolves around cunning and finding ways to compete with a person and beat him. The location where the devil hides his children in (2a) is imaginatively conceived in the minds of TA speakers to capture any place where it is possible to hide something that cannot be easily found. TA speakers seem to rely on the folk culture and try to imagine the unseen. What links the lost place and where the devil hides his children is the absence of perception. These two places are unseen. This movement from the perceptual physical world to the imaginative world is made active by the presence of the unseen supernatural creature; the devil and his children. Whether we consider this expression a metaphor or an analogy, we still need to account for the mapping from the domain of devils onto the domain of human beings. The failure to find something hidden involves a failure to reach it, to see it and to touch it. The absence of physical perception pushes forward a mental imaginative substitution. The lost object seems to get out of the perceptible world and transgresses the borders into the imaginative world; the fairy-like world of devils. This can be governed by the conceptual metaphor THE UNSEEN IS IMAGINARY. This metaphor rhymes with the metaphor KNOWING IS SEEING presented by Lakoff (1993) which is presented in accordance with LIFE IS A JOURNEY metaphor. Not knowing the path of a trip is expressed in terms of being in a dark place. The examples in (2a) and (2b) present the situation in a reversed way. Not finding something or not reaching it evokes the absence of any physical contact with it. In the absence of a physical concrete experience, the imagined scenario of putting something where the devil hides his children (2a) or where the devil resides (2b) plays the role of the domain that will allow us to understand unreachable places. The examples discussed above confirm that the abstract can play the role of the facilitator in understanding different domains and that the source or base domain is an abstract imaginative domain.

Not only do the ambiguous similarities used in TA recruit supernatural creatures from the religious diction but also use imaginative fictive creatures and compare them to human beings relying on folk tales and popular stories:

(3)

(a) Jinn mta3 qraya
 (He be-IMPERF) fairy of education

He is a djinny student.
'He is a genius student.'

(b) Mla3bi Ghuul
Player ghouL.
A monsteroL player.
'An outstanding player.'

(c) Malla 3obbitha !
What a female ghost !
What a female ghost !
'What a female ghost!'

These expressions challenge the directionality of the mapping by comparing human beings to abstract fictive creatures. The expression in (3a) maps knowledge about djinnis onto human beings to capture mastermind. What we know about djinnis is their extraordinary abilities to perform different actions in superior way to humans. This superiority is selected as distinct feature and then projected onto the domain of education. An outstanding student superior to his comrades with extraordinary abilities will no longer belong to humans but rather to fairies. The feature of being a genius is framed in terms of an ambiguous similarity connecting humans to fairies. The domain of fairies is exploited in TA to frame genius people in different domains. Genius in sports is also perceived in an abstract-to-concrete cross-domain mapping. TA speakers frame an outstanding player in terms of the fictive creature of the ghouL. An outstanding player is supposed to frighten any opponent and beat him easily. The psychological dominance of the ghouL onto human precedes the physical dominance. The psychological dominance of ghouLs on human beings and their folk image as a terrific creatures serve to conceptualize the features of superiority. This expression can reverse the mapping from the psychological onto the physical. According to the embodiment theory (Lakoff & Johnson, 1999) the physical concrete experiences serve to conceptualize psychological experiences. People in many languages use the physiological experience⁷ of hunger to frame the psychological experience of desire. 'Knowing something about people's

⁷ The embodiment theory is a sub-theory of the conceptual metaphor theory (Lakoff & Johnson, 1999). The main assertion of this theory is that a major part of our metaphorical thought is grounded in bodily experiences and that our bodies constrain and define the way we use and understand metaphors.

embodied experience of hunger allows us to predict which aspects of desire will, or will not, be thought of and talked about in terms of our complex embodied understanding of hunger' (Gibbs et al, 2004: 1206). The above discussed expression can be subsumed under the conceptual metaphor A HUMAN BEING IS A CREATURE and its two subparts AN OUTSTANDING PERSON IS A SUPERNATURAL CREATURE and PHYSICAL SUPERIORITY IS PSYCHOLOGICAL SUPERIORITY. These expressions from TA challenge the fact that 'we tend to structure the less concrete and inherently vaguer concepts (like those for the emotion) in terms of more concrete concepts, which are more delineated in our experience' (Lakoff & Johnson, 1980: 112). These examples show that the socio-cultural context plays an important role in metaphorical thought which can equate the role played by the body 'postulating a dual way between the body of cognitive cognition and the non-bodily (cultural)...[thus] challeng[ing] not only the formulation of the embodiment hypothesis, but also Lakoff & Johnson's companion formulation that the physiological body grounds cultural thought and never the reverse' (Maalej, 2008: 91). The analogical mapping seems to fail to account for these reverse correspondences from the abstract to the concrete mainly because 'in processing analogy and metaphor, the initial symmetric alignment process is followed by directional inferences. Furthermore and because inferences are understood to follow from base to target, people prefer companion statements that have the more informative term in the base position' (Gentner & Bowdle, 2008: 115). In line with this preference for the more informative term, it will be very rewarding to define what makes it a rich informative term. Is it the concrete physiological bodily experience or the socio-cultural knowledge with its many folk tales and religious beliefs?

(4)

(a) daxl-it fi-na Ghuula

Enter-PERF in us a ghoull

A ghoull has came in.

'We were in a chaotic situation.'

(b) l-flous mchat fi fum 3ifriit

The money go-PERF in mouth goblin

The money was eaten by a goblin.

'The money faded into thin air.'

The supernatural creature of the ghouls is recruited in (4a) to frame the psychological situation of nervous tension. In TA people express their feeling of anxiety and continuous worry in a chaotic situation by recruiting the scenario of being in front of ghouls. The psychological experience of anxiety is not conceptualized in terms of a concrete bodily-based experience but rather in another psychological experience. The salience of the experience of terror and anxiety facing a ghouls makes it serve as source for understanding parallel experiences of terror. Notwithstanding, it is almost impossible for human beings to see these fictive creatures. TA speakers do not rely on their lived experiences to understand abstract concepts but rather recruit a scenario part of their common knowledge of these fictive creatures. The metaphorical understanding of this expression is deeply rooted in the cultures which define the characteristics of the fictive creatures and the way to use them metaphorically. The goblin is another creature selected in the expression (4b) to understand the experience of disappearance. The metaphorical scenario in this expression joins the concrete and the abstract to understand the concept of disappearance. The physiological experience of eating serves to conceptualize the idea of disappearance. This experience involves an eater and a food. While the money is metaphorically eaten, the eater is a fictive creature; the goblin. This renders the whole scenario imaginative. The understanding of this expression is governed by a combination of two conceptual metaphors: DISAPPEARANCE IS BEING EATEN and THE UNSEEN IS IMAGINATIVE. While the first metaphor seems to be common to many languages; English and French as an example (*my car eats a lot of petrol, cette activité mange beaucoup de temps; This activity took all my time*) and seems to have a universal dimension, the second metaphor seems to be more culture-specific. The goblin as eater of disappeared elements is grounded in culture and arises from cultural knowledge about fictive creatures and characters of fairy tales and folk stories.

Three main findings were achieved after studying this type of similarities from a cognitive perspective and relying on the metaphorical mapping and the structure mapping. First, there seems to be room in the language to view concrete domains understood in terms of abstract ones in a mismatch with the unidirectionality of the mapping. Second, the relationship between the concrete and the abstract needs to be reviewed and their corresponding roles in the understanding operations can be more developed interactively. Finally, the socio-cultural impact on metaphor understanding exhibits itself abundantly in these expressions since it acts as a source for producing these particular metaphorical expressions which are challenging the

one-way direction of the mapping from the concrete to the abstract.

Despite being a distinct feature of metaphorical mapping, understanding the abstract in terms of the concrete can be adjusted and made rather more flexible in a way that respond to many expressions in the language. In light of the examples discussed above and which do not seem to be only particular to TA since we can find similar expressions in English (*what a devil!*; *He's a little devil*; *He 's ghoulish*) and also in French (*petit démon, faire le démon, On le prendrait pour un fantôme*). These expressions from languages other than TA confirm that in order to understand human traits and sometimes even their physical appearances, we recruit our knowledge about supernatural fictive creatures and map it onto human beings. The systematic correspondences relevant to the connection of one domain to another explain to a large extent people's understanding of different comparisons whether they are analogies or metaphors. This mapping is coherently presented as proceeding from the concrete to the abstract and this claim was built on a solid basis with respect to the voluminous number of examples justifying this assertion (Lakoff & Johnson, 1980; Lakoff, 1993; Gibbs, 1994; Kovecses, 2002). What needs further considerations, I believe, is rather the directionality of the mapping. This raises questions about the relationships between domains and also the possibility of reducing the mapping in a one-way route that can never be reversed. What needs to be reviewed, I believe, is the configuration of the concrete-abstract relationship. I suggest sticking to a broader view of the mapping without specifying its directionality or at least leaving space for a more flexible movement of the mapping across domains. The analysis of the expression discussed above demonstrated that the mapping can be bi-directional. What matters most in the understanding operation is which part in the comparison gives more information that allows us to understand the metaphorical expression at hand. The understanding of metaphorical expressions is built on interactive mapping between domains whether they are concrete or abstract.

The relationship between the concrete and the abstract in metaphor understanding seems to be more than a vertical relationship between a source or a base holding all possible information needed to understand the comparison in question and a passive target domain generally unfamiliar and its mere role is to become less delineated and better understood after the comparison. The examples discussed in this part show clearly that the abstract can also play the same role of the concrete domain and allow people to capture human traits and their

physical appearances in terms of less familiar creatures. These examples prove that the abstract is not always that black box that needs to be understood. The abstract may act as a facilitator in the understanding operation and that the configuration of the relationship between the two domains involved in the metaphor needs to be reviewed focusing on the interaction between the two. When we use the supernatural creature the angel to qualify virtuous human beings, the relationship becomes rather horizontal through which every domain plays a fundamental role in the understanding operation. We rely on the cultural knowledge of angels to capture virtuous human beings and this thanks to the mapping from the abstract to the concrete. Simultaneously, we gain a better understanding of the abstract through the concrete and the example of the virtuous person at hand provides a concrete example that allows us to better understand angels. This duality of the mapping is a feature that seems to characterise human cognition. The position and the nature of the elements in the comparison seem to be secondary compared to their role in the understanding operation and the information they provide to the comparison.

The understanding of the expressions discussed above has challenged one of the foundations of the conceptual metaphor theory and the structure mapping theory of analogy by presenting examples so entrenched in the language and that are viewed going in a reverse way to the one-way route from the concrete to the abstract. The examples discussed above are instantiations of an abstract-to-concrete mapping. These are not exceptions and do not seem to be particular to TA since we find examples in French and English. These examples show that the understanding of metaphorical and analogical expressions can be more flexible and turn the other way round by not abiding to the one-way mapping particular of the metaphor and analogy theories. This ‘conception of metaphor as a kind of one-way street suggests a rigidity of fixed, rule-governed direction of transfer which simply does not exist in linguistic reality’(Jakel, 1999: 374-75). While the metaphor theory is built on the embodiment theory suggesting that the human body constrains and defines the understanding of much of our abstract experiences (Johnson, 1987), the structure-mapping theory is built on systematic alignment and projections of relational structures among domains (Gentner & Markman, 1997), The two theories seem to turn a blind eye on the importance of the socio-cultural context. Maalej (2008) expresses that the commitments to the concrete-abstract directionality on which the conceptual metaphor theory is built do not seem to allow for enough maneuver for the socio-cultural to impregnate the bodily and the linguistic.

The analysis of the expressions taken from TA above brings to the surface the important role of the socio-cultural in understanding metaphorical expressions. The different supernatural creatures manifest themselves markedly in everyday expressions and are used to frame human traits and also physical appearances. People rely on their cultural knowledge (religion and folk tales) to understand these expressions. The impact of culture in metaphor and analogy understanding seems to be absent in the two theories. Gibbs (1999) was among the first scholar who paid due attention to the importance of culture. ‘What is missing from the psycholinguistic work, and from aspects of the work on metaphor in cognitive linguistics, is an explicit acknowledgement of culture and its important, perhaps defining, role in shaping embodiment and, consequently, metaphorical thought’ (Gibbs, 1999: 153). The socio-cultural context affects people’s use and understanding of metaphors. The relevance of the context arises when ‘we comprehend something metaphorically, we are under two kinds of pressure: the pressure of our embodiment and the pressure of context’ (Kövecses, 2010: 667). The context defines people’s knowledge about supernatural creatures and allows using them to conceptualize human traits. I suggest that the understanding of metaphorical and analogical expressions is made possible owing to the interaction between the mind, body and culture. Further investigations are however needed to support this claim and a more concern should be addressed towards the cultural relevance of metaphorical thinking so that to make the theories of figurative language understanding more responsive to a greater number of expressions particularly those challenging the one-way street from concrete to abstract and by doing so allowing for a more flexible transfer across domains.

The examples discussed above investigated similarities in TA on the basis of metaphorical and analogical mappings. What was particular to the expressions under investigation is the use of abstract elements in the different comparisons. The analysis reveals that speakers of TA understand physical supremacy in terms of psychological supremacy. The supernatural creatures used in the comparison are either used to capture outstanding human traits or impossible scenarios in real life situations. Two main conceptual metaphors were found to govern the understanding of the discussed ambiguous similarities; AN OUTSTANDING PERSON IS A SUPERNATURAL CREATURE and THE UNSEEN IS IMAGINATIVE. Other metaphors correlate with these two metaphors to account for the peculiarities of metaphorical mappings of the expressions in question. The abstract domains used in these

expressions seem to play the same role as concrete domains. This changes the configuration of the mapping making it less rigid and more interactive allowing the two domains to play a considerable role in the understanding process.

Giving more flexibility to the mapping allows a better exploratory work on an alternative type of metaphorical expressions that are governed by an abstract-to-concrete mapping in TA. Metaphorical expressions built on the abstract to the concrete mapping need further investigation and a possible review of the relationship between the concrete and the abstract in figurative language understanding. The relationship between domains can be misguidedly built on the mapping from the concrete to the abstract. It appears that the abstract plays an important role in the understanding operations and can be more informative in particular situations because it originates in the culture. The latter is an element that has long been excluded or at least ashamedly referred to in earlier version of the conceptual metaphor (Lakoff & Johnson, 1980; Lakoff, 1993). It is high time perhaps the interaction between mind, body and language was given due importance. By focusing on the importance of the socio-cultural context the CMT will possibly review the relationship between the domains involved in metaphorical mapping and define in a precise way their interactive role in the understanding operation. In this respect, the present study will attempt to highlight the importance of the socio-cultural context in the use, understanding and creation of metaphors no matter what the direction of the mapping is.

2.5 Metaphor ubiquity and a possible classification

Since the main concern of the present work is a comparative one and does not concentrate on metaphoricity accuracy, we will rely basically on the introspection method for selecting the metaphorical expressions under investigation. Accordingly, the potential contribution of this work will be its combinatory approach used to conduct the comparative aspect of the study on the one hand and to account for the impact of the socio-cultural context on the other. In the present part we will first introduce the difference between basic and generic-level metaphors. Second we will discuss universal and culture-specific metaphors. In the third part the Great Chain Metaphor Theory (for short GCMT) will be presented.

2.5.1 Basic vs. Generic-level Metaphors

One way to account for the variance across conceptual metaphors and in order to account better for embodied grounded vs culturally based metaphors, metaphors were given different labellings. The literature of metaphor presents different classifications ranging from the orientational to the ontological (Lakoff, 1980), Basic and Generic level metaphors (Grady et al, 1996), Universal and culture –specific etc. These classifications were attempts to account for the panoply of conceptual metaphors governing the understanding of everyday linguistic expressions especially when compared to their counterparts in different languages. In this section we will focus on two types of classifications which are relevant to the present study; the basic vs generic level metaphors and the universal vs the culture-specific metaphors.

Unlike basic metaphors, which join two conceptual domains attempting to understand one in terms of the other and limited by a set of ontological correspondences across domains (Turner, 1991: 158), generic-level metaphors seem to operate within a larger mental space. Their peculiarity lies in the fact that ‘they need have neither a fixed specific level source domain nor a fixed specific level target domain’ (Turner, 1991: 162). According to Turner (1991) our conceptual system is essentially characterised by our ability to bring about ‘metaphoric connection’ joining two distinct concepts and allowing the understanding of one in terms of the other. Two important elements building such understanding are basic metaphors and generic-level metaphors. Second we will delineate the particularities of universal bodily-based metaphors and culture-specific metaphors. Third we will present a different type of metaphor presented in the great chain metaphor theory which is of immediate relevance to the present theory since it puts a specific order into the relationship between human beings, animals, plants and objects and substances; these four elements are active participants in the food domain.

2.5.1.1 Basic metaphors

What characterises basic metaphors is this systematicity of mapping across fixed domains. It ‘is a connection through which one conceptual domain is understood in terms of the other’ (Turner, 1991: 158). This connection happens when one conceptual domain representing the target is understood in terms of a source conceptual domain. Turner presents LIFE IS A PLAY as one type of basic metaphor. Expressions like ‘*It’s curtains for him*’, ‘*She’s my leading lady*’, ‘*The kid stole the show*’, ‘*He always plays the fool*’, ‘*That attitude is just a mask*’ are automatically understood thanks to the activation of this metaphor. The fixed target

domain of life is understood in terms of the fixed source domain of a play, thanks to mapping knowledge about plays onto life topics. The expressions governed by this metaphor seem to be so entrenched in our thought patterns that they do not carry metaphorical aspects.

Similarly, many Tunisian Arabic expressions are motivated by the basic conceptual metaphor ARGUMENT IS SPORTS metaphor (Maalej, 1999):

'šadd-lu gol' (He played the goalkeeper to him).

'xallah fi tasallul', (He trapped him in the offside).

'HaSr-u' (He marked him man to man).

'takka-h 3la t-tuus' (He kicked him out the touchline).

These expressions represent illustrations for one single conceptual metaphor ARGUMENT IS SPORTS. This type of conceptual metaphor is simple in its mapping across fixed domains. It accounts for the metaphorical work involving the understanding of a huge number of everyday expressions. But how is it possible for this metaphor and the like to be subsumed under generic-level metaphors?

2.5.1.2 Generic-level metaphors

Generic-level metaphor is another important element constituting our conceptual system. It is built on the distinction between specific-level schemas and generic level schemas. Generic level metaphors are different from basic metaphors terms of flexibility and generality. While 'a basic metaphor connects a specific-level schema [generic-level metaphors] operate at the level of generic-level schemas' (Turner, 1991: 162).

To exemplify for this, compare the DEATH schemas with the EVENT schemas. DEATH as an example of the specific-level schema is an instance of the generic-level schema EVENT and DEPARTURE is a specific-level schema coming under the generic-level schema ACTION. Interactively, DEATH AS DEPARTURE is a basic metaphor that comes under the generic-level metaphor EVENTS ARE ACTIONS.

This distinction between basic and generic-level metaphors hints at the internal structure of our conceptual system. It uncovers the systematicity of basic metaphors and how they are organised in clusters under generic-level metaphors. Turner argues that 'the theory of generic-

level metaphors subsumes the theory of basic metaphors: (at least many) basic metaphors are entrenched special instantiations of conventional generic-level metaphor' (Turner, 1991: 169).

However, Grady et al (1996) departed from some problems associated with the conceptual metaphor theory; specifically poverty of the mapping, lack of experiential basis and independence of submapping, to introduce primitives and compounds referring respectively to simple metaphors and complex ones. These two concepts are defined as follows:

'A primitive is a metaphorical mapping for which there is an independent and direct experiential basis and independent linguistic evidence.

A compound is a self consistent metaphorical complex composed of more than one primitive'(Grady et al, 1996: 181).

These definitions structure metaphorical expressions under broader classes of metaphorical correspondences. Though primitives may come under a compound metaphor, they 'exist independently of any particular complex metaphorical structures into which they may be recruited' (Grady et al, 1996: 181).

To show the logic of decomposing complex metaphors into primitive ones, the metaphor THEORIES ARE BUILDINGS was presented to subsume LOGICAL STRUCTURE IS PHYSICAL STRUCTURE and PERSISTING IS REMAINING ERECT. In fact these two metaphors may account for a set of data that can be included under THEORIES ARE BUILDINGS. Grady et al (1996) assert that the combination of these two metaphors results in (VIABLE) LOGICAL STRUCTURES ARE PHYSICAL STRUCTURES. The contribution of this analysis is that it allows for more flexibility of mapping which results in a broader set of data to be included under one compound metaphor. The role of primitives, then, is to respond to the metaphorical requirements of the different linguistic expressions that are difficult to be instantiations of the compound metaphor.

Let us illustrate these theoretical claims with the examples provided by Grady et al (1996) to solve the problem of the poverty of mapping. The following sentences were presented as instantiations of THEORIES ARE BUILDINGS:

- a. you have failed to *buttress* your arguments with sufficient facts.
- b. Recent discoveries *have shaken* the theory to its *foundations*.
- c. Their theory *collapsed/caved in* under the weight of scrutiny.
- d. ?This theory has no *windows*.
- e. ?The *tenants* of her theory are behind in their *rent*.

These five sentences were introduced to discuss the problem of poverty of mapping. While certain experiential elements of the source domain are systematically mapped onto the target domain (sentences a, b and c), others elements of buildings fail to map onto the target. Sentences d and e are semantically invalid because ‘the metaphor is clearly concerned with certain basic structures and structural properties of building’ (Grady et al, 1996: 178). Decomposing THEORIES ARE BUILDINGS into LOGICAL STRUCTURE IS PHYSICAL STRUCTURE and PERSISTING IS REMAINING ERECT which in turn produce (VIABLE) LOGICAL STRUCTURES ARE PHYSICAL STRUCTURES provides a solution to the problem of the poverty of mapping. This analysis accounts for all the data under this compound metaphor. Moreover the resulting compound (VIABLE) LOGICAL STRUCTURES ARE PHYSICAL STRUCTURES ‘solves the ‘poverty of mapping’ problem, since reference to floors, decor, occupant and other non aspects of buildings are not expected’ (Grady et al, 1996: 182).

2.5.2 Universal Vs culture-specific metaphors

In order to demonstrate the interaction between body and culture in the conceptualisation of abstract domains, Yu (2008) has conducted a comparative study of a body part ‘face’ in Chinese and English. He relied on the new version of the conceptual metaphor theory (Grady, 1997) built on the decompositional analysis which distinguishes between primary and complex metaphors. This analysis will be presented in a detailed way since it represents, to my view, one of the most convincingly organised method that was able to clarify the difference between universal, wide-spread and culture-specific conceptual metaphors arising from the interplay between body and culture.

The analysis relies on the decomposition account (Grady, 1997; 2007). The decompositional analysis maintains that metaphors deriving directly from our experience and very often from our bodily experience are more likely to be universal and are primary. Complex metaphors, however, are combinations of primary metaphors and cultural beliefs and tend to be more

culture-specific. ‘The decompositional approach to the analysis of conceptual metaphors has an important implication, namely the judgement of conceptual metaphors in terms of their universality and cross-cultural variation’ (Yu, 2008: 248). This new distinction between primary and complex has shed more lights on the dark parts of the theory specifically the difference at the level of motivation for and internal structure of conceptual metaphors. Thanks to the works done by (Grady, 1997), Lakoff & Johnson (1999) reviewed their theory providing a better insight into the difference between wide-spread and rare metaphors and explaining the reasons for this clear cut distinction. According to Lakoff & Johnson (1999) complex metaphors are ‘molecular’ made up of ‘atomic’ metaphorical parts called primary metaphors. Their approach seems very promising in terms of providing a solid link between parts and subparts of the conceptual system. Primary metaphors are derived from experiential correlations.

‘We acquire them automatically and unconsciously via the normal process of neural learning and may be unaware that we have them. We have no choice in this process. When the embodied experiences in the world are universal, then the corresponding primary metaphors are universally acquired’ (Lakoff & Johnson, 1999: 56).

Conversely, complex metaphors are ‘built out of primary metaphors plus forms of commonplace knowledge: cultural models, folk theories, or simply knowledge or beliefs that are widely accepted in a culture’ (Lakoff & Johnson, 1999: 50). The cultural elements brought to light in the cognitive linguistics literature starting from this review. The effect of the socio-cultural context will give more relevance and accountability to many questions about a considerable part of the data under investigation. The decompositional approach seems to be responsive to the internal organisation of different metaphors whether they are universal or culture-specific. One example was given to justify this theoretical claim. (Lakoff & Johnson, 1999) proposed the complex metaphor A PURPOSEFUL LIFE IS A JOURNEY. This metaphor is produced as a result of the combination of the two primary metaphors based on common bodily experience PURPOSES ARE DESTINATIONS and ACTIONS ARE MOTIONS and two cultural beliefs framed in two propositions PEOPLE SHOULD HAVE PURPOSES IN LIFE and PEOPLE SHOULD ACT SO AS TO ACHIEVE THEIR PURPOSES. A PURPOSEFUL LIFE IS A JOURNEY has a less tendency to be universal ‘because its validity in a particular culture depends on this culture’s holding the combination of the two propositions and the two primary metaphors (Yu, 2008: 249).

The interaction between the body and the culture in terms of motivating the existence or non-existence of metaphorical mapping does not seem to be dealt with in the depth it deserves. Yu (2008) suggests what he called the ‘culture as a filter’ and ‘the body as a source’ approach. This view seems to give a less arbitrary determination of the interaction between the body and the culture by attempting to define their precise roles in motivating metaphorical mappings.

‘While body is a potentially universal source domain from which bodily-based metaphors emerge, culture serves as a filter that only allows certain bodily experiences to pass through so that they can be mapped onto certain target-domain concepts (Yu, 2008: 249).

By analysing and comparing the different senses associated with body part of face, Yu (2008) was able to confirm the bodily basis of human conceptualization because ‘our body, with its experiences and functions, is a potentially universal source domain for metaphorical mappings from bodily experiences onto more abstract and subjective domains’(Yu, 2008: 250). His main contribution remains however his convincing explanation the interaction between body and culture. He believes that a potential metaphor cannot become an actual metaphor unless it passes through the filter of culture. His argument gives the cultural context the importance it deserves after being disregarded in earlier versions of the conceptual metaphor theory (Lakoff, 1993). The relevance of this assertion arises from the fact that ‘Embodied metaphor arises not from within the body alone, and is then represented in the minds of individuals, but emerges from bodily interactions that are to a large extent defined by the cultural world’ (Gibbs, 1999: 155). This reveals that the bodily basis for metaphors is only part of the experiential basis. It does not provide the answer t whether the metaphor in question will be selected and validated by the culture. A concrete exemplification given by Yu (2008) to support his theoretical claim with concrete examples will be presented in later parts of this study.

2.5.3 The Great Chain Metaphor

Relying basically on metaphorical thinking, Lakoff & Turner (1989) devised a theory to account for proverb understanding according toThe Great Chain of Being. The four components are the GENERIC IS SPECIFIC metaphor, The Great Chain of Being, The Nature of Things and The Maxim of Quantity. These elements act together to account for the specific mental processes underlying the comprehension and use of proverbs.

2.5.3.1 GENERIC IS SPECIFIC

What is important here is the particularity of generic-level metaphors, which makes them free from being tied to cross-domain mapping and restricted by a list of ontological correspondences. This particularity conveys the characteristics of proverbial utterances in the sense that many of them are descriptions of a particular situation with no explicit mention of a target domain (Gibbs, 1994).

Proverbs enable us to understand a number of situations by evoking one particular situation. Most of the work in our conceptual system is done through the activation of the generic-level metaphor *GENERIC IS SPECIFIC*. This metaphor selects the generic-level information pertaining to the specific situation described in the text of the proverb then maps it onto a large number of specific situations sharing the generic-level information. The role of this metaphor consists in ‘preserv[ing] the generic-level structure of the target domain, except for what the metaphor exists explicitly to change -in this case nothing- and imports as much as possible of the generic-level structure of the source domain -in this case everything’ (Lakoff & Turner, 1989: 164).

Lakoff & Turner (1989) proposed the proverb ‘*Blind blames the ditch*’ as an example. This proverb includes a specific-level schema associated with a blind person blaming his tools rather than his own physical handicap. The role of *GENERIC IS SPECIFIC* consists in extracting the generic-level information associated with this specific-level schema. The generic-level information will then be about someone with an apparent incapacity. This incapacity is the cause of his failure to achieve certain objectives. This person, however, blames the situation and not his incapacity. This generic-level information is productive for a huge number of parallel equivalent specific-level scenes which renders the mapping extremely specific. It maps one generic-level schema onto a large number of specific-level schemas provided that the generic-level information is preserved. It is important to note that ‘the constraint on generic-level metaphors, becomes, in the case of *GENERIC IS SPECIFIC*, equivalent to requiring that the source and target have the same generic-level structure. In other words, *GENERIC IS SPECIFIC* maps specific-level schemas on to the generic-level schemas they contain’ (Lakoff & Turner, 1989:163).

2.5.3.2. The Great Chain of Being

As a cultural model that classifies kinds of beings and their properties in a hierarchical order, the Great Chain of Being works in harmony with GENERIC IS SPECIFIC to account for proverb understanding. Proverbs are generally precise descriptions of a particular situation. The elements involved in the events of this situation are not necessarily human beings and in most cases they are other things. To name a few, many proverbs include other things such as eggs *'Don't put all your eggs in one basket'*, water *'Still waters run deep'*, sugar *'Too much sugar spoils the best coffee'*, and bread and butter *'Don't butter your bread on both sides'*. The Great Chain of Being seems to facilitate understanding human capacities in terms of these other things categorized down the scale of being.

This model denotes three general features of the universe; plenitude, continuity, and gradation (Lakoff & Turner, 1989). The principle of plenitude states that the universe is 'full', exhibiting maximal diversity of existence. The principle of continuity stipulates that the infinite series of forms filling the universe have at least one common attribute linking one to the other. The principle of gradation labels these series in a hierarchical order. Interactively, the great chain classifies forms of beings and their properties. The scale of forms of beings include humans as the highest form of beings and the lowest forms of beings are objects with animals and plants occupying, respectively, a position between the two. Consequently, reason is the highest property and physical attributes the lowest one. The following graph draws the hierarchal classification of the different forms of being.

The Great Chain of Being

			specifically human features
		instincts	instincts
biological features		biological features	biological features
physical features	physical features	physical features	physical features
THINGS, SUBSTANCES	PLANTS	ANIMALS	HUMAN BEINGS

	= non-human
	= shared (non-human + human)
	= only human

Figure 6: The hierarchal distribution of attributes according to the Great Chain of Being.
 Source <http://haldjas.folklore.ee/folklore/nr1/pics/gcb.gif> (n. d)

Forms of being are defined according to the attributes that distinguish them from the other forms of being a level lower in the scale of the Great Chain of Being (Lakoff & Turner, 1989). What defines human beings is not instinct, because this property is shared with the animals; the form of being positioned a step lower in the scale. What characterize humans are capacities for abstract reasoning, morality and developed consciousness. Lakoff & Turner, (1989: 168) assert that ‘where a being falls in the scale depends strictly on its highest property’. Distinguishing beings on account of their highest attributes provides a set of parameters for each form of being. These parameters will interact with the nature of thing to provide a better understanding of the relationship between whatever forms of beings mentioned in the text of the proverb and the supposed target story or situation concerning human affairs.

2.5.3.3 The Nature of Things

This sub theory asserts that the forms of beings have essences, which result in the behaviour of the forms of beings. For instance, plants have essential biological natures which lead to

essential behavior, as when a deciduous tree drops its leaves or a flower photo tropically follows the sun (Lakoff & Turner, 1989). Not all attributes are essential, some of them are temporary or caused by certain events. A human being is essentially reasonable but he can be angry, excited, agitated, sad, reckless, etc. In simpler terms, the theory states that the attributes of a given form of being produces the behavior of these forms of being. Consequentially, essential attributes lead to essential behaviors and provisional attributes lead to provisional behaviours.

Combining the Nature of Things with the Great Chain Theory constitutes a complex common sense theory that represents an essential element in the theory of proverb understanding. These elements interact with GENERIC IS SPECIFIC and the maxim of quality, which stipulates that someone or an utterance should be as informative as required without extra unnecessary information. The whole will constitute the great chain metaphor as a cognitive apparatus that accounts for metaphorical thinking associated with proverb understanding. By acting together, these four components give the theory three different dimensions. The great chain metaphor has a metaphoric character imposed by GENERIC IS SPECIFIC. It is a common sense theory as well, since it derives essentially from two common sense theories, namely the great chain and the nature of things. The pragmatic dimension of the theory is explicitly mentioned by the maxim of quality.

Consider the TA proverb *kan sahib-k 3sal ma ta-lsHuš l-kol* (If your friend is honey, don't lick it all). This proverb describes a particular situation associated with eating food in which food is not consumed moderatel. The element mentioned in the text of the proverb to be placed in the Great Chain of Being is honey. This substance occupies the lower position in the hierarchal structure of the Great Chain. The distinct feature of this substance will be a physical feature. Since it is the highest feature of this substance, the only property of vinegar in this proverb is its physical feature. Being a drinkable liquid, vinegar is essentially characterized by its sweet taste and its moderate consumption with regard to its high value. According to the nature of things, natural physical things will have a natural physical behaviour. Having a natural delicious sweet taste, honey must be consumed in moderate quantities, unlike water, oil, milk which have different features, and generally can be used with other types of food. The combination of Great Chain and the Nature of Things will produce the following information about honey. The behaviour of honey as a liquid is

different from that of water. Though belonging to the same class in the great chain, each substance has its own special characteristic that will define its behaviour. Being a tasteless vital liquid, water is consumed without any constraint. The nutritional benefit and high value of honey invite moderate consumption. This knowledge will interact with the GENERIC IS SPECIFIC metaphor to extract generic information associated with this proverb and then project it onto a number of parallel situations that share this generic information.

Lakoff & Turner (1989) exemplified for the theory with the proverb *'Big thunder, little rain'*. Like most proverbs, this one mentions a very specific situation dealing with two contradictory natural phenomena. The analysis should account for how a proverb about thunder and rain can be applied to human beings. The Great Chain links storms with human beings, the Nature of Things selects attributes and their corresponding behaviours at the levels of humans and storms, the maxim of quantity selects the highest attributes and behaviour relevant to each level, and then GENERIC IS SPECIFIC picks out the generic-level information associated with the schema of storms and then applies it to human beings. The interaction between the four components of the GCMT produces a particular mapping 'through a combination of GENERIC IS SPECIFIC + the great chain. What the mapping does is to associate the relevant source-domain information about people' (Lakoff & Turner, 1989: 177).

Though the different constituents of the great chain metaphor work in harmony to account for proverb understanding, it is still possible to find different interpretations of the same proverb (Achard-Bayle, 2013; 2015). This depends crucially on the mechanism used for interpreting the proverb. Lakoff and Turner (1989: 180) proposed two proverbs *'blind blames the ditch'* and *'burned lips on broth now blows on cold water'* to show that an interpretation based on evoking, specific-level schemas (respectively, incapacity and traumatic experience) and then extracting the generic-level information associated with them, to apply them to habitual behaviour. This interpretation will use the other constituents of the great chain metaphor to make sense of high-level attributes (mental incapacity) in terms of lower-level attributes (physical incapacity). This graph presents the operation of the GCMT in an irrelevant context situation:

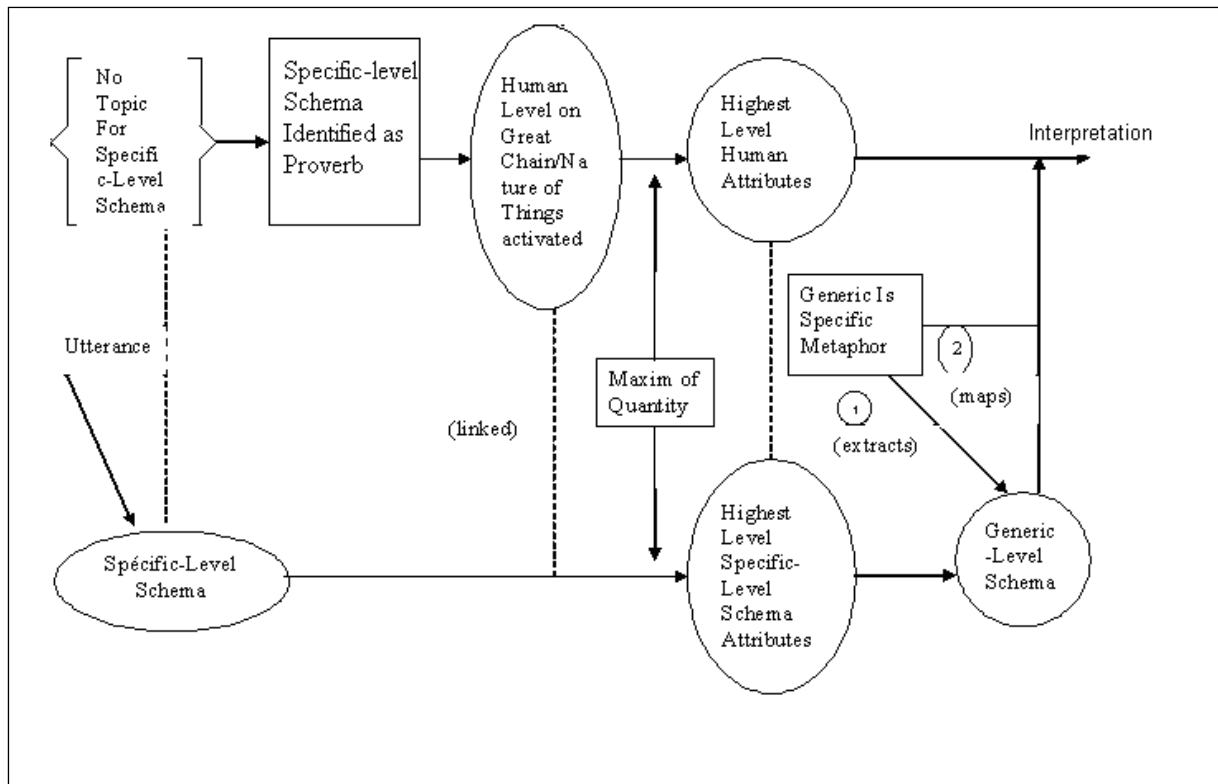

Figure 7: Operation Of the Great Chain Metaphor Theory in an irrelevant context situation.
 Source: Honeck and Temple (1994: 90)

2.5.3.4 Critique of the Great Chain theory

Though being theoretically valid, the Great Chain metaphor was subject to criticism, especially from scholars working on proverbial utterances (Honeck and Temple, 1994). Honeck claims that the GCMT asserts that all proverbs must be familiar, and we can only find familiar proverbs since all of them are culturally shared. Accordingly, the theory is cultural because of the interaction between two cultural theories namely the Great Chain of being and the Nature of Things and ‘because all this knowledge underlying proverbs is shared, their understanding assumes an automatic quality, with little or no room for misunderstandings’ (Colston, 2000: 633 quoted from Honeck, 1997: 153).

When comparing the two theories of proverb understanding, the Great Chain Metaphor Theory (GCMT) and The Extended Conceptual Base Theory (ECBT), Honeck & Temple (1991) discussed some weaknesses of the GCMT. Their comparative study focused mainly on the absence of problem-solving situation, the limitedness of human matters as a target domain

with regard to the all-embracing quality of proverbs and the absence of experimental evidence in support of the theory.

Honeck & Temple (1994) consider the theory to be a structuralist one based on the interaction of different mechanisms. The theory is built on the evocation of a specific-level schema and the extraction of its generic-level information. They asserted that 'their presentation of the theory has problem-solving play little or no role' (Honeck & Temple, 1994: 98). In fact the theory does not account for people different and, in certain cases, poor understanding of the same proverb. If proverb understanding is so automatic and if the different mechanisms work in harmony to account for proverb understanding, why is it possible to find poor interpretation and even misunderstanding of the general meaning of proverbs? They suggest that the theory should have addressed the utterance of a proverb as problem solving where the literal meaning is not enough to reach meaning.

Another shortcoming attributed to the theory arises from the creative aspect of proverbs (Honeck & Temple, 1994). It is claimed that proverbs are living forms of speech and that they are subject to change. This is considered 'important theoretically because it makes it clear that individual proverbs do not have to be part of the linguistic heritage of a culture' (Honeck & Temple, 1994: 99). This claim contradicts the automatic operation of the GCMT particularly the Great Chain and The Nature of Things, which are activated on the basis of recognizing a sentence as a proverb. Familiarity with proverbs is a prerequisite for the activation of the GCMT. This familiarity is considered relative and totally absent in the case of novel proverbs. This entails a difficult, if not impossible, extraction of the generic level schema as an essential step in the mapping of a specific-level schema onto parallel specific-level schemata. 'In fact, there is now ample evidence that as literal familiarity decreases, the time to get figurative meaning increases' (Honeck & Temple, 1994: 99).

Honeck & Temple (1994) assert that proverbs should be given a larger scope than the one assigned by the GCMT. Proverbs are considered all-embracing and touching life in all its aspects. Consequently, proverbs cannot be restricted to human concerns. Accordingly, the GCMT builds on the assumption that human concerns are more likely to represent the main topic of proverbs. However, 'this probability should not be turned into a principle' (Honeck & Temple, 1994: 100).

Another weakness of the GCMT, according to Honeck & Temple (1994), consists in the difficulty and the relatively long time associated with interpreting proverbs. Their experiments showed that the average reading time of a contextualized proverb is 4 seconds. These results do not support at all the claim of the automatic nature of metaphorical thinking about proverbs as based on the systematic mapping across multiple situations. It is claimed rather that the extraction of a generic-level schema lacks evidence. 'Generic-level schemas look very much like the end result of a fairly sophisticated set of integrated inferences. We would consider these integrated inferences to be an interpretation (a verbal performance) that was only guided and partially due to the literal proverb meaning' (Honeck & Temple, 1994: 101). This claim clearly questions the automatic operation of the different mechanisms of the GCMT in understanding proverbs. Additionally, Lakoff and Turner's claim that a proverb can have different interpretations with respect to 'a background of assumptions and values'(Honeck & Temple, 1994: 101) seems inappropriate. Lakoff & Turner suggest the proverb '*Jelly in a vase*' to show that it can have many readings. This proverb 'might refer to someone who is good at getting out of tight spots, to someone trying to control a rather uncontrollable situation or to a brutish person trying to control a delicate matter, and so on' (Honeck & Temple, 1994: 101). What is questioned here is not the variety of readings of proverbs but rather the mechanisms leading to these readings. In Honeck & Temple's claim (1994), an extraction of a generic-level schema out of a specific-level schema is so automatic that that it can only yield one unique reading of such a proverb.

Another inadequacy attributed to the GCMT, and it is the same for the ECBT, is the absence of a detailed description of the nature of the specific-level schema and the generic level schema. The theory should have detailed precisely the construction and the content of these schemata. Additionally, the way instantiation takes place remains unclear and too general (Honeck & Temple, 1994: 104).

Through the mention of some experiments on proverb understanding and interpretation, Honeck & Temple (1994) state that the theory lacks empirical evidence on account of the results found. In fact, throughout decades of proverb understanding and interpretation study, it was confirmed that the results are more consistent with the ECBT than the GCMT. The GCMT asserts that automatic proverbs' understanding is governed by conceptual metaphors

‘conventionalized, a ready and powerful conceptual tool - automatic, effortless and largely unconscious’ (Lakoff & Turner, 1989: 62). This claim of automatic rapid understanding of proverbs does not prove valid to all proverbs with regard to the experiments conducted in this respect. By investigating the reaction time (for short RT) of different subjects’ understanding of proverbs both in relevant context situations, Honeck & Temple (1994: 101) found overall mean RT to range from 3.45 sec to 4.39 sec (Honeck & Temple, 1994: 101 quoted from Case, 1991; Honeck et al, 1990; Honeck & Temple, 1991) however the RT to the proverb ‘*The early bird catches the worm*’ was only 1.94 sec (Honeck & Temple, 1994: 101 quoted from Case, 1991). Such results suggest that the reaction time is too long to justify such an automatic rapid understanding of proverbs.

The shortcomings of the GCMT discussed by Honeck & Temple were, however, built on wrong assumptions about the GCMT. Their critique of the theory is built on a misunderstanding or rather faulty reasoning about the conceptual metaphor theory in general. Honeck builds his critique on the assumption of the familiarity with proverbs as a prerequisite for the operation of the GCMT. This turns to be ‘an erroneous consequence of the GCMT derived by Honeck, not one claimed by proponents of the GCMT’ (Colston, 2000: 633). His claim that the GCMT derives essentially from the cultural view; this is another misconception about the theory. In fact, the computational nature of the GCMT is essentially based on the mapping, generally multiple, and the interaction between the GCMT and other conceptual metaphors. This represents a premeditated argument in support of the cognitive dimension as a key element in the theory. Understanding the proverb ‘*Look before you leap*’, could ‘involve computation of the specific components mappings between source and target domains ATTEMPTING TO KNOW IS ATTEMPTING TO SEE [look] and ACTING IRREVERSIBLY IS MOVING IRREVERSIBLY [leap] from the selected source domains (e.g.; SEENG and MOVING)’ (Colston, 2000: 633). Additionally, the present study will show that the understanding of many TA proverbs can be accounted for on the basis of the function of some basic conceptual metaphors coming under the generic-level metaphor, GENERIC IS SPECIFIC, which should plainly support and justify the cognitive dimension of proverb understanding.

2.6 Conclusion

The review of the literature has allowed a state-of-the art reading of the advancements made in the field of cognitive linguistics asking questions about some of the challenges facing metaphor studies. These Metaphor studies expanded considerably to go beyond justifying the prominence of metaphor in everyday language and through exhibiting itself as an instrument of the mind, to investigate the embodied origins of metaphor. Later on, the study moved to exploit the wide variation between metaphors across cultures. This variation is traced back to the cultural specificity of metaphors and the impact of the socio-cultural context in which they are produced understood and reproduced.

Scholars on cognitive linguistics seem to orient more research towards cognition in relation with communication and culture (Sharifian, 2008; Kövecses, 2015). The theory has advanced from targeting isolate metaphorical expressions with the aim to justify their conceptual foundations to more multidisciplinary orientations through focusing on the interaction of metaphor with the socio-cultural context. ‘Theories of metaphor are now, more than ever, linked to detailed theoretical frameworks that aim to describe the underlying nature of language, thought and communication (Gibbs, 2008: 4). The present study can be situated in this orientation focusing on the mind-body-culture interaction. It is important to mention here that this study has three main objectives; studying food metaphors cross-culturally, accounting for variation with respect to the theme selected and explaining the role of the socio-cultural context in food metaphor understanding, use and creation. These three objectives can be at the heart of the above mentioned orientation. Previous studies that addressed this issue, focused essentially either on emotions metaphors (Kövecses, 2005, 2010a; Maalej, 2004) or studying body parts used in metaphors (Sharifian, 2008). As far as my knowledge goes, and with respect to the importance of the food domain for bodies and for cultures, metaphorical studies on this overwhelming domain seem to be scanty. The present work attempts to fill a gap in studying food metaphorically, at least cross-culturally with a particular focus on the effect of the context, while attempting to account for the mind-body-culture interaction in metaphor studies.

Throughout more than three decades of metaphor studies, the ubiquity and internal complexities of metaphorical expressions yielded different classifications. Each time metaphors were classified into different categories. Classifying metaphors into universal, bodily-motivated primary metaphors and cross-cultural, complex metaphors (Lakoff &

Johnson, 1999, Grady, 1997) seems to be fitting partially the objectives of the following study. This classification is later exploited to detail the articulations between these two types of metaphors and demonstrate the embodied/cultural duality at work while studying metaphors contrastively. The duality between embodied and cultural metaphor was at the heart of the decompositional account developed by Yu (2008) to show the interaction between complex culturally-motivated metaphors and primary bodily-motivated metaphors.

CHAPTER THREE

THEORETICAL FRAMEWORK

The present chapter will present the theoretical framework adopted in this cognitive contrastive study. The state-of-art review of the techniques involved in identifying and analyzing metaphorical expressions allows a possible amendment of the techniques adopted. A combinatory approach that joins more than one method of research and analysis seems to fit the multiple requirements of the present study. Since the study aims at analyzing metaphors cross-culturally, showing the interplay between the universal and the cultural in metaphor understanding and use and accounting for the influence of the socio-cultural context, three main techniques will be exploited namely the cross-domain mapping (Lakoff & Johnson, 1980, Lakoff, 1993), the decompositional account (Grady, 1997, Yu, 2008) and metaphor classification (Kövecses, 2005; Kövecses, 2015) .

3.1 The food domain under cognitive investigation

The present chapter discusses the theories adopted to conduct this research. In fact, in a big number of cognitive studies, the most salient feature of cross-domain mapping will be a crucial element in defining the metaphoricity of the expressions under investigation. However, the study will not limit itself to this main metaphorical feature. In fact, our approach will be also multifold by adopting a theoretical engagement towards attempting to account for the messy nature of metaphors and not stopping at the simplistic difference between primary bodily-based metaphors and complex culturally-constructed metaphors. With respect to the ubiquity of metaphor in people's everyday speech, tackling research on metaphorical thought with one unique tool does not seem to help cover the issue in the depth it deserves. Metaphor is not static but will be considered as a moving entity in a number of contexts. This contextual dimension seems to be a major factor leading to the high variance among metaphorical expressions whether it is in the same culture or across different cultures. A multifold combinatory approach espousing introspection, metaphor classification and the decompositional analysis seems to be more capable of achieving the three-fold objective of the present study namely demonstrating the high productivity of the food domain by sorting out the different target domains conceptualized in terms of food experiences, comparing them and accounting for the difference and showing the impact of the socio-cultural context on metaphor understanding, use and creation *denovo*.

In this section we will first discuss on a grass root level the reasons behind the seemingly pervasive presence of the food domain in the three languages. Next we will postulate the research questions to be answered in this study. Then we will posit the hypotheses of to the results to be reached by the end of this study.

3.1.1 Abundance of the food domain

The seemingly remarkable presence of food expressions used to talk about many issues has stimulated this study. It was not difficult to hypothesize that these expressions are used in their metaphorical meaning. Accordingly, a cognitive analysis seems more than needed to decipher the abundant presence of figurative expressions. A comprehensive analysis should start with identifying the conceptual metaphors that encompass all these linguistic expressions, define their exact role in the understanding, use and creation of food metaphors

and account for, on the basis of the importance of the context, the intercultural and intra-cultural variation.

It is fairly well-known that metaphor relies mainly on mapping. Relating conceptual domains and life experiences under the cognitive scope has shed more light on many of our habitual, familiar and repetitive everyday experiences. These experiences present themselves as a depository of instruments so entrenched in people's minds and ready for conceptualizing abstract domains. One of the objectives of this study is to show to what extent our everyday experiences with food are exploited and whether the food domain is a productive one.

Eating and related experiences present concrete bodily experiences that may possibly be active agents in motivating the mapping from the food domain to less delineated domains. Food metaphors seem to be drawn in the light of our biological formations as creatures needing to eat and drink in order to survive. A second objective of the present study is not only to show to what extent our embodied experiences associated with food is so crucial in the understanding of these metaphors but also to define their particularities and the possible changes they may undergo across cultures or the way speakers of different languages perceive these experiences, talk about them and use them to frame less delineated domains and also when interacting with the particularities of the context in which the metaphors are produced. Moreover, it seems tempting to investigate and then account for the difference that may exist between bodily metaphors and metaphors grounded in culturally acquired knowledge. Food metaphors involve the exploitation of the body parts involved in the eating process. This study will also investigate the significance of exploiting body parts in food metaphors particularly those that are not related directly with the eating process like heart, eye and face.

Confirming the conceptual foundations of everyday metaphorical expressions through different studies has contributed to uncover the conceptual knowledge responsible for understanding everyday metaphorical expressions. Undertaking a cross-cultural study of food metaphors through different languages may contribute to checking and exploring the potential universality of the conceptual knowledge accounting for the systematic classification of different metaphorical expressions under conceptual metaphors hence the third objective of the present study. The present study will attempt to account for the similarities and differences that characterize people's understanding of food metaphors thus uncovering the

impact of culture in metaphorical thinking about food. Investigating the role of the physical environment in defining the aspects of our conceptual knowledge may have a considerable impact on accounting for people's understanding of metaphors.

3.1.2. Research questions

In order to spell out the nature and purpose of the study, the following research questions have been formulated:

- 1- What kinds and what frequency of food metaphorical usage appear in TA, English and French?
- 2- To what extent is the food domain explored in those three languages?
 - a. To what extent are food metaphors grounded in bodily experiences?
 - b. What is/are the difference (s) between embodied vs non-embodied conceptual metaphors?
- 3- To what extent can the differences found in answering 2b above be related to the socio-cultural context? How can the latter influence the understanding, use and creation of metaphors?
- 4- How to account for the differences that may exist between different metaphors in terms of the internal complexities and also the frequency and the directionality of the mapping within the same language and across the three languages.

3.1.3 Hypotheses

Along with these questions, these hypotheses were postulated:

Hypothesis 1:

- Metaphor lies mainly on mapping concrete experiences in order to understand less delineated domains.

- The food experiences present a potential depository of concrete experiences.

We hypothesize that food metaphors exhibit themselves abundantly in the studied languages hence the high productivity of the food domain.

Hypothesis 2:

- People's experiences with food exhibit a wide variety to people speaking or not the same language.

- Metaphor was proved to be an instrument of the mind (Lakoff& Johnson, 1980)

We hypothesize that the conceptual metaphors governing the understanding of food metaphorical expressions alternate similarity and disparity in the three studied language hence the non-universality and non-uniformity of our conceptual knowledge about food.

Hypothesis 3:

- Most food experiences are embodied.
- Many body parts are involved in the eating and related experiences.

We hypothesize that the mapping in the embodied food metaphors is unidirectional and food metaphors are mainly primary metaphors.

3.2 Methodology

The present study will conduct a cross-cultural contrastive analysis of food metaphors in TA, French and English relying, essentially but not solely, on Kövecses works on cultural variation which he kept developing (Kövecses, 2002; 2005; 2015). The initial model seemed to focus more on the internal structures of metaphors. Although the model focused on the interaction between metaphor and metonymy, it can be viewed as a reliable method for delineating the differences between metaphors, particularly the way different target domains are figured out and the complex articulations of the metaphoric meaning production:

1. Variation in the *range* of conceptual metaphors and metonymies for a given target;
2. Variation in the particular *elaborations* of conceptual metaphors and metonymies for a given target;
3. Variation on the *emphasis* on metaphor versus metonymy associated with a given target, or the other way around (Kövecses, 2002).

In addition to these principles Maalej (2004) included a fourth one:

4. Variation in the *culture specificity of the basic-level category* realizing conceptual metaphors and metonymy for a given target across cultures.

This classification allows a structured comparison of the different food metaphors met in the three languages. Furthermore, the significance of such classification will account for the degree of dependence of some conceptual metaphorical expressions to the cultural context.

In addition to the above mentioned model, food metaphors analysis will tackle variation with a particular focus on the aspects of metaphors affected by variation as they are presented by Kövecses (2005). These aspects include the following:

- Source domain
- Target domain
- Experiential basis
- Neural structures corresponding to (1) and (2) in the brain
- Relationship between the source and the target
- Metaphorical linguistic expressions
- Mappings
- Entailments
- Blends
- Nonlinguistic realizations
- Cultural models

In order to gain a further understanding and analysis of the cross-cultural disparity of food metaphors, aspects of metaphor involved in variation will be highlighted following Kövecses (2005) analysis. In his investigation of the relevance of cultural knowledge in metaphor use and understanding, Kövecses focused on what is, in metaphor, exactly affected by variation.

In a very scrupulous attempt to account for whether metaphors are mostly universal or are more likely to be cultural, he was able to figure out the different features of variations. His analysis moved from the general to the specific through mentioning the common and the different in metaphors then moved to delineating the specific areas in metaphors affected by variation. Since metaphor is built on cross-domain mapping, it was important to mention that the elements directly involved in the mapping, namely the source domain, the target domain and the mapping and its entailments, are involved in variation along with the experiential basis, neural structures corresponding to the source and the target in the brain, metaphorical linguistic expressions blends, nonlinguistic realizations and cultural models.

The different embodied experiences associated with the food domain cannot be cut short in the eating experience. The latter is a complex one involving a number of successive and sometimes concurrent experiences. They start with putting food in the mouth and they end with digestion. These different experiences act as a set of familiar bodily experiences mappable onto a set of abstract psychological experiences.

“The embodied experience of dealing with food characterizes many of the texts of metaphorical expressions included in the corpus. Such a concrete experience grounds these expressions in metaphor, and metaphorical thinking based on embodied experiences seem to govern the understanding of many expressions. Since we are most familiar with our bodies and the experiences of our bodies, food metaphors are drawn in light of our biological formation as living beings needing to eat and drink in order to survive” (Dakhlaoui, 2012: 5).

Henceforth, the selected metaphors including food related terms seem to fit this condition with respect to the concreteness of the human experience with food. Yet, these experiences seem to be affected by their socio-cultural setting.

Despite few similarities, the three studied cultures do not seem to share the same eating habits. They do not belong to the same cuisines and do not offer the same meals. They do not share the eating time either. These differences seem to have an impact on food metaphor production. The eating experiences are affected by their context and the expressions describing them will vary accordingly. These expressions will be potential source domains to figure out less concrete experiences. The present work will investigate how our bodies, and

particularly the experiences of our bodies with food⁸, constrain and give insight to less concrete experiences (Johnson, 1987; Lakoff & Johnson, 1999) through experiences with food. The physiological experiential will be also viewed in its corresponding socio-cultural context. As pointed out by Lakoff & Johnson, the physical experience

“is never a matter of having a body of certain sort; rather , every experience takes place within a vast background of cultural presuppositions...cultural assumptions, values and attitudes are not a conceptual overlay which we may or may not place upon experience as we choose. It would be more correct to say that all experience is cultural through and through, that we experience our ‘world’ in such a way that our culture is already present in the very experience itself.”(Lakoff & Johnson, 1980; 57).

Going through the engagement of different body parts in different food experiences, whether directly or indirectly related or unrelated to the food domain, the embodiment theory will be highlighted as being a cornerstone in the conceptual metaphor theory and then the interaction of our bodies with their socio-cultural context and how these experiences are related to frame abstract experiences will be also discussed in the depth it deserves to give a further evidence for the so called ‘cultural embodiment’ (Maalej, 2004; 2007). The interplay between embodied cognition i.e. conceptualizations of abstract experiences grounded in physiological embodied experiences and cultural cognition which presents metaphors arising from cultural knowledge related to a particular group of language users will be also highlighted in this study.

The last part of the analysis will rely mainly on the decompositional analysis technique (Yu, 2008). This method takes its point of departure the distinction made between primary and complex metaphors (Lakoff & Johnson, 1999; Grady, 1997). This technique exploits this difference, basically between the embodied and the cultural, to compare and contrast metaphors by decomposing complex metaphors into different constituents; primary metaphors, metonymies and propositional accounts to account for the understanding of some expressions. This analysis will precisely explain the role of the cultural filter in allowing

⁸ The centrality of people’s experiences with food is very influential in the understanding of many food metaphors particularly the experience of eating which establishes a duality between the food and the eater. This duality will define the way a food is prepared, tasted, chewed, swallowed, eaten, digested, etc. This embodied experiential will be a depository of context-dependent concrete experiences to be mapped onto a number of parallel experiences.

certain metaphors to appear or not in the language. The cultural filter limits, constrains and defines the mapping. Such analysis will probably answer pertinent questions about the exact role of the socio-cultural context in metaphor understanding.

The present study faces two challenges; a theoretical one and a cognitive one. By investigating the metaphorical thinking about different concepts through the food domain, this study follows a thematic handling of metaphor. The food theme and thanks to its familiarity to all human being, provide a set of experiences ready to be mapped on a number of abstract domains. The comparative aspect of the study and through focusing on three languages at the same time seems to go far in exploiting the potential ubiquity of the food domain through different languages. Such a study should go through multiple variations of food metaphors whether it is within one language or at the level of the three investigated languages. The theoretical challenge consists in trying to account for these different variations and also try to answer questions about the internal complexities of metaphors. The cognitive challenge revolves around the importance of conducting such a comparison which seems to fit the latest developments in the cognitive linguistics field. The latter seems to dip into the interior of our conceptual system in an attempt to disclose its constituents (kövecses, 2015) and account, through universality and cultural-specificity, the articulations between embodied cognition and cultural cognition by placing more focus on the role played by the context in shaping metaphor understanding, use and creation and eventually re-creation.

3.3 Metaphor Identification and analysis

The present research revolves around the food domain. The study adopts a thematic handling of metaphor. The study investigates the different metaphorical conceptualizations of many abstract experiences through the food domain across Tunisian Arabic, English and French. The present chapter presents first how the metaphor will be analysed throughout all the stages of the study. It starts with presenting the corpus. Next, it introduces the techniques used in metaphor analysis. Finally, it describes the tools exploited to analyse the relationship between body and culture in food metaphors.

3.3.1 Description of the corpus

The corpus is made of food expressions used in Tunisian Arabic, English and French spoken and written languages. The corpus encompasses terms describing food experiences in almost all its patterns. Food is so entrenched in people's lives that it exhibits a pervasive presence in human's cultural and social interests. The vocabulary related to the food domain seems to be

very sophisticated with regard to the experiences involved therein. The corpus is made of all possible expressions that are related whether directly or indirectly to the food domain.

The investigation of food terms follows almost all its possible manifestations. The terms were looked at the food from being a grain grown in land till becoming a waste. The corpus describes the growing of foods and some farming experiences were included like growing, ploughing, milking are recruited in the corpus. The different stages that the plant goes through till becoming a fruit ripe for eating are also included in the corpus. The corpus follows food in the market and in the kitchen. The experience of cooking involve ‘several main manipulative techniques,’ including particulation (cutting, slicing, mincing into smaller sizes), incorporation (mixing two substances to yield a third, such as the combination of water and milled grain to produce dough), marination, application of dry or wet heat, dry curing, frying, and fermentation’ (Belasco, 2008). All these lexical units are also included in the research for food-related terms. The research moves then to the eating experience which is followed in all its patterns from being hungry, desiring food, salivating, putting food in the mouth, tasting, chewing, swallowing, being choked sometimes, being satiated, digesting, etc.

The corpus is made of food related terms as they are used by Tunisian Arabic, English and French Speakers. These terms are looked for from different sources. The TA corpus is collected out of two main sources; the limited number of books written in TA and a questionnaire. While TA is used mainly for oral communication, documents written in TA are still scanty. In order to maximize the number of studied expressions a questionnaire was conducted. The choice of the questionnaire was made due to the scarcity of written texts whether they were stories, dictionaries, etc. The questionnaire is meant to elicit food expressions in their context of use. The aim of the questionnaire was to test Tunisian Arabic knowledge of TA food expressions used in short sentences. The questionnaire tests the familiarity of a certain number of agreed upon expressions. Subjects were asked to add similar expressions they know in order to maximize the number of expressions and build data representative of an optimized number of TA speakers. Along with the questionnaire, books written in Tunisian Arabic were consulted to sort out food metaphors in their context of use.

The English corpus is taken essentially from general English dictionaries, one Food expressions dictionary and the British National Corpus. The corpus includes food-related

terms on the basis of what is indicated above. After sorting all the terms, these expressions will be looked at in the National British Corpus accessed online at <http://www.natcorp.ox.ac.uk/>. The corpus presents expressions in their context of use and gives different examples of the selected word used in sentences that are chosen randomly. Sometimes some historical dictionaries are consulted to look back at the original meanings of some lexical units. The study purposefully collects food expressions at a first stage in their context of use. This choice is adopted for methodological reasons related to metaphor identification. In search for linguistic metaphorical expressions, the study adopts a different technique other than the writer's intuition about the existence or not of the metaphor.

Similarly to the English Corpus, The French corpus is drawn from general French language dictionaries and also some specialized books on food-related terms. Online dictionaries are equally consulted to collect the data. All the collected words are made in their context of use so as to study the existence of linguistic metaphors on a solid basis.

The three collected corpora include a multitude of food expression as used in their context. These expressions exhibit a wide variety in terms of the type of the lexical units themselves and also their syntactic structure. Some adjectives were the product of food types (meaty, saucy...) some verbs in TA are produced out of cooked food types (*3asbenni*; He turned me stuffed tripe, He infuriated me). The selected food metaphors revolve around food in general and the eating experience in particular. The extent to which the metaphorical connections built around food-related terms is astonishing with respect to the pervasive presence of these expressions in the language and also the high variety of meanings they are used for to express mainly human psychological and physical traits, different types of actions, emotions, socio-cultural values, etc.

3.3.2 The interaction between body and culture in metaphor understanding

The interaction between metaphor and culture was implicitly acknowledged by anthropologists but this interaction needs to be better clarified under the cognitive linguistics perspective. Metaphor in literature is considered to be related to culture and it is rather an exemplary manifestation of culture (Kövecses, 2005). In its broad definition culture is considered to be the set of shared of understanding characterising smaller or larger groups. The importance of this shared understanding was ashamedly dealt with in the earliest version

of the conceptual metaphor theory (Lakoff & Johnson, 1980) but then was brought to light thanks to the works of some metaphor researchers (Barcelona, 2001; Boers, 2003; Charteris-Black, 2003; Kövecses, 2001, 2004, 2005; Maalej, 2004; Talibenzad & Dastjerdi, 2005; Yu, 2008, Sharifian, 2008; 2011) who demonstrated that that social and cultural constructions of experience shape embodied metaphor. The present study will first confirm the cognitive reality of conceptual metaphors by studying its manifestations in three different languages and confirming the existence of the wide-spread or rather universal conceptual metaphors. The study will then, relying on the distinction between primary and complex metaphors, try to define the real impact of the cultural context on the metaphors grounded in bodily experience. ‘Primary metaphors are patterns that have a high likelihood of being found in any language, regardless of location, cultural affiliation, or historical period. On the other hand, there are long lists of metaphors which appear in some languages and societies but not others’ (Grady, 2007: 204). The cross-linguistic study of food metaphor will finally attempt to define the exact contribution, whether it is universal or cultural, to defining the internal structure of the conceptual mappings governing the understanding of food metaphors.

Kövecses (2005) has paid much attention to the cultural impact on metaphor understanding trying to give a more detailed explanation to the difference between universality and culture-specificity. To explain his motivation behind studying metaphor and culture, he postulated the following problem setting:

- ‘1. Which metaphors are universal, and why?’
- ‘2. Where is metaphor variation most likely to occur?’
- ‘3. What are the aspects of metaphor that are most commonly affected by variation?’
- ‘4. What are the causes of metaphor variation?’
- ‘5. Do conceptual metaphors form a seamless fit with embodiment, cultural experience, and cognitive processes? Do these systems function together in a completely coherent fashion? If not, how can we account for the conflicts among these various systems that interact with metaphor?’ (Kövecses, 2005).

This problem setting can be viewed as a generic template to be filled each time either by a theme of research among several themes of investigation across different languages.

Answering these questions remains one of the objectives of the present study since it shares the same concern with cross-linguistic and cross-cultural variation of metaphors. A particular focus will be made on the last question with the respect to its multi-sided explanatory aspirations. Metaphor scholars need to define exactly what roles does the socio-cultural context have in motivating embodied metaphors. If ‘metaphor seems to belong to language, thought, social-cultural practice, brain and body with metaphor in thought being essential’ (Kövecses, 2005), then more research on metaphor variation will be essential to confirm or reject this hypothetical postulation.

3.4 Analytical tools

The present study will adopt three main interrelated analytic tools to answer the above-mentioned research questions. First, the study will rely essentially on the cross-domain mapping (Lakoff & Johnson, 1980, Lakoff, 1993) as distinctive feature of the conceptual metaphor theory. Second, the cross-cultural model developed and amended by Kövecses (2002, 2005, 2015) will be used to analyse the different layers of variations. Finally, the decompositional approach (Grady, 1997a; Yu, 2008) will also be adopted especially when trying to delineate the clear difference between universal and culture-specific metaphors and also to clarify the role played by context in metaphor use, understanding and/or creation.

3.4.1 The Cross-domain mapping

The first analysis of the data will be done essentially by defining the cross-domain mapping. The present study will adopt the metaphor theory in general. The choice of adopting a metaphorical investigation of food metaphors goes back to different reasons. First of all, the conceptual metaphor theory (Lakoff & Johnson, 1980), with its sub theory the embodiment theory (Lakoff & Johnson, 1999), provided an answer for the human spontaneous conceptualisation metaphorical expressions used in everyday communication. This high explanatory significance makes the theory a suitable technique to account for the pervasive presence of food-related terms used metaphorically across the three-studied languages. In fact, metaphor as a cross-domain mapping can provide part of the answer to the figurative meaning of many food-related expressions. Besides, the cross-domain mapping is central to the conceptualization of abstract experiences. This type of connection is very common in the text of many expressions under investigation, especially when we know that most food-related linguistic metaphors are descriptions of people’s experiences with food and its

interrelated elements. This places the cross-domain mapping to be as a basic tool underlying the analysis and the understanding of food metaphors' conceptualizations. In this respect, the present study will adopt the cross-domain mapping to determine the metaphorical dimension of the food domain. The present study will try to demonstrate the different metaphors underlying the food schema with its different constituents. The physiological experiences associated with food and their socio-cultural setting will be focal points of analysis since they constrain and define our conceptualization of less concrete experiences. This is essentially dictated by the metaphor theory which will account for the cross-cultural similarity and/or disparity of the different metaphorical conceptualisations arising from the food domain in the two languages.

In many of the expressions under investigation food-related terms are used to describe human being. The great chain metaphor theory (Lakoff & Johnson, 1989) originally devised to account for the understanding of proverbial expressions will be used as an analytical tool; first because many of the expressions under investigation are either fixed expressions or proverbs and second because the theory relies on the Great Chain of Beings which structures and organises the metaphorical connection between human beings and food as either plants, animals and objects or substances.

3.4.2 The Great Chain Metaphor Theory

This theory is mainly a combination between the generic-level metaphor THE GENERIC IS SPECIFIC and the great chain of being (Lakoff & Turner, 1989). The Great Chain of Being made a specific classification which organises in a hierarchical order the relationships between human beings, animals, plants, and objects and substances based on their traits. These four elements interact with each other through food. The food of human being is made essentially from animals, plants and substances. Classifying these four elements according to their features fits well the metaphorical connections made between human beings and many food types, which are commonly encountered in many of the expressions included in the corpora.

3.4.3 The cross-cultural model of metaphor variation

Along with the model mentioned above, a particular focus on aspects of metaphor affected by variation will be very useful for the analysis of the different metaphors cross-culturally

(Kövecses, 2005). Since metaphor is built on cross-domain mapping, it was important to mention that the elements directly involved in the mapping, namely the source domain, the target domain and the mapping and its entailments, are involved in variation. Similarly, the experiential basis, neural structures corresponding to the source and the target in the brain, metaphorical linguistic expressions blends, nonlinguistic realizations and cultural models play a relevant role in accounting for the disparity across cultures. These different elements account for the wide range of differences that may exist in the internal structures of metaphors and explains the origins of metaphor production.

3.4.4 The decompositional account

In order to give an explicit analysis of the interaction between body and culture in metaphor understanding along with their role in defining universality and cultural specificity, the decompositional approach (Grady, 1997a; Yu, 2008) will be adopted. This approach will give more explanatory power to metaphor analysis particularly through the interaction between metaphorical, metonymic and propositional motivations of the different possible combinations.

Yu (2008) took the decompositional approach as his main technique for analysing and demonstrating what he called the cultural filter at work in the two metaphors DIGNITY IS FACE and PRESTIGE IS FACE. He first analyses the complex metaphor DIGNITY IS FACE pointing out that DIGNITY is not understood merely as FACE. It is rather FACE AS A PHYSICAL OBJECT. In this respect, the source concept is formed by conceptual blending based on a complex metaphor:

- a- DIGNITY IS FACE AS A VALUABLE POSSESSION (a complex metaphor)
- b- DIGNITY IS FACE AS A PHYSICAL OBJECT (a complex metaphor)
- c- DIGNITY IS A FEELING (a proposition)
- d- FACE IS A PHYSICAL OBJECT (a complex metaphor)
- e- A FEELING IS A PHYSICAL OBJECT (a primary metaphor)
- f- FACE STANDS FOR A FEELING (a metonymy)
- g- DIGNITY IS A DESIRABLE FEELING (a proposition)

As a complex metaphor (a) is decomposed into the combination of another complex metaphor (b) and a proposition (g) representing the cultural belief. Then, (b), a complex metaphor itself is decomposed into two components: (c) is a proposition presenting the pre-mapping target concepts whereas (d) is another complex metaphor representing the source concept. The source domain concept in itself is a complex metaphor composed of a primary metaphor (e) and a metonymy (f). Any change in the content or in the number of those elements, and in the way they are combined, will result in a different compound. Such compounds are assembled by cultures. 'Therefore the sets of components (metaphorical, metonymic or propositional) and the ways they are combined function as conditions that 'shape' the final products of complex metaphors. They constitute what I mean by 'cultural filters' (Yu, 2008: 256).

The merits of the decompositional analysis consist in the ability to provide a more organised analysis of the interaction between body and culture. The detailed analysis of complex metaphors is another important contribution of this approach since it delimits the difference between basic and complex metaphors and presents the basic metaphors and the cultural beliefs propositionally forming them. The analysis seems to give more order to metaphor analysis and describes in a detailed way the interaction between metaphorical, metonymic and propositional mapping pointing exactly to the borderline between body and culture when motivating, creating and understanding metaphors. 'The cultural basis of metaphor consists in its interpretive function, thus viewing certain parts of the body or certain aspects of bodily experience as especially salient and meaningful in the understanding of certain abstract concepts'(Yu, 2008: 257).

The interplay between body and culture exhibits itself abundantly when dealing with domains like the food domain. Food related-terms under analysis are either food types or human organs directly and indirectly related to the eating experience. The interaction between body and culture is fundamental to the analysis of food metaphors since it will provide a clear answer to the exact role of both of them in defining the metaphorical configurations of the conceptual mappings governing the understanding of the different linguistic food metaphors under investigation.

3.5 Limitations

The complexities of and the difficulties of conducting experiments on metaphor study is the main limitation on selecting appropriate methods for analysis. Despite the relevance of experimental psychology which contributed to uncovering the elements of our conceptual System (Gibbs, 2004), the debate over the usefulness of this approach remains an unsettled issue.

Evidence from experimental psychology allowed confirming the cognitive reality of conceptual metaphors. Gentner (2001) has reported on a series of experiments designed to test whether people actually invoke metaphorical conceptualizations when they think and speak about time. Her results indicate that when people switch from one metaphorical system for understanding time to another, there is a cost in reaction time. Subjects were first asked a question framed in terms of either the so-called “ego-moving” model of time or the “time-moving” model. In the ego moving model, time is conceptualized as the path or landscape through which we move, with the future lying in front of us (e.g., is Boston ahead or behind us time-wise?). The time-moving model frames time independently of the observer (e.g. Is it later or earlier in Boston than it is here?), as a series of objects following each other through space; in this model, a later time follows and is therefore “behind” an earlier time. When the first and second questions were framed in terms of conflicting models, response times were slower than when they were framed in terms of the same model. Furthermore, in the “conflicting” condition, subjects often reformulated the second question for themselves, apparently in order to make it easier to understand and reply to; this reformulation did have the effect of significantly improving response times. Gentner (2001) draws the conclusion that the metaphorical systems are playing a real role in subjects’ conceptualization of time and their understanding of temporal language.

Another kind of evidence comes from Gibbs (1994: 163–64), who has reported that there are consistencies in the mental images described by experimental subjects interpreting metaphorical idioms which go beyond the information supplied in the idioms themselves. Conversely, metaphorical idioms suggest the same set of inferences to people, even when those inferences go far beyond what is expressed in the words themselves; subjects agree that when you blow your stack, ‘the expression of anger is unintentional and is done in an abrupt, violent manner’.

Despite the range of evidence in favour of the view of metaphors as entrenched conceptual patterns, there are challenges to this position from a number of directions. One common view which runs contrary to the conceptual metaphor theory perspectives is that metaphorical thought and language are essentially unconstrained. Philosopher Donald Davidson (2001), for instance, has suggested that any two things can be understood, when juxtaposed, as bearing a metaphorical connection. If one person states that ‘Life is a kiwi fruit,’ another will be clever enough to point out the shared features which make these two entities comparable and which provide the ground for the metaphorical mapping of one onto the other. In some sense, the range of possible metaphorical correspondences would appear to be limitless, or to be limited only by our imagination and our ability to interpret expressions based on pragmatic context. In fact, Davidson (2001) goes so far as to claim that metaphors have no meaning and that they merely invite us to infer whatever appropriate message we can. Obviously, such a view has no room for conventional metaphors—lasting structures which may narrow in advance the possible interpretations of a given expression and which in practice also limit the metaphors we produce. Psychologists, too, have typically assumed that there are no metaphorical relationships with a special status, instead looking for parameters which make individual metaphorical sentences more “apt” or more comprehensible (Grady, 2007).

3.6 Conclusion

The present study will adopt three seemingly complementary tools of analysis with the aim to give solid evidence to the findings and also explain in a more rigorous way the relationship between metaphor, body and culture, the essence of variation cross-culturally and also account for the relevance of the socio-cultural context in the creation and understanding of metaphors. The cross-domain based analysis will allow a better understanding of the particularities of the food domain which make it serve as a productive domain in the conceptualization of different abstract experiences. By making a particular focus on the aspects of metaphor influenced by variation, the wide variety of metaphorical expressions will be more precisely accounted for. By focusing on these aspects and finding out the particular disparities across the three studied languages, a partial answer will be given to the reasons behind the wide variety and the cultural vs. universal dimension of metaphors arising from on unique universal experience i.e. the experience with food. The decompositional account will demonstrate the “cultural filter” (Yu, 2008) at work by selecting the bodily-grounded metaphors to get through in one culture and not in another. By focusing on the impact of the

cultural filter in the creation and understanding of metaphor, the role of the socio-cultural will be more detailed.

CHAPTER FOUR:

ANALYSIS, FINDINGS AND DISCUSSIONS

Before moving to discussing the findings of the present study, we will go back to remind our readers of the main objectives of the following study.

- 1) Analyse and discuss the understanding of different domains and experiences through the food domain in the three languages by sorting out the different target domains of food metaphors.

- 2) Discuss the aspects of metaphor involved in variation showing the interplay between universality and variation in metaphor understanding.
- 3) Analyse and discuss the role of the socio-cultural context in metaphor understanding, use and creation through exhibiting different experiences with food being the origin of specific metaphorical connections particular to the languages in questions.

To achieve the following objectives, this chapter will be divided into three main parts. The first part will analyze different food metaphors and discuss the way different target domains are framed in the three languages. In the second part we will discuss what is in metaphor influenced by variation focusing on the particularities of the three languages/cultures. In the third part, we will focus our analysis on context by studying its important influence on metaphor understanding and creation and then we will discuss the interaction between mind, body and culture and how they contribute to furnishing our conceptual system in different manners.

In the present chapter we will analyze a considerable prototypical number of food metaphors. The analysis will rely heavily on the cross-domain mapping as a distinct feature of the conceptual metaphor theory. Relying on Lakoff & Johnson (1980, 1989) metaphorical mapping as the main pillar of the metaphor theory, the different conceptual metaphors governing the food experience understanding will be sorted out. Next, aspects of metaphor involved in variation will be analysed throughout the three languages. Finally, the interaction between body and culture will be focused on in later parts of the analysis following the decompositional approach (Grady 1997a, Yu, 2008). This analysis will enable us to check the important influence of the socio-cultural context and how it can be considered as a part of the conceptual system (Kövecses, 2015).

4.1 Food metaphors analysis

The analysis of metaphorical expression will follow a bi-directional method. The food-related terms and after being recognized to be instances of a cross-domain mapping, will be analyzed from bottom to top and from up to down. A bottom-up analysis will start with the interpretations of the different linguistic metaphors to find out the limited number of

conceptual metaphors encompassing all these expressions. A top-down analysis will do the opposite. It starts with the conceptual metaphors and then moves to exemplify for them a number of linguistic metaphors.

This section will be devoted to the analysis of the different food metaphors identified in their context of use. We made our choice relying on the results found in the studied examples. We reserved one session for the analysis of the feeding experience in itself i.e. the act of entering substances in the body through the oral route. The lexical unit ‘eat’ is not only used in its primary meaning. Along with eating, the drinking experience will be also included in the analysis. The analysis of the related lexical units will be made respectively in TA, French and English. The second section will focus on food types as they are used to frame human trait. The last section will be however exhibiting varied examples reflecting the affluence of the food related terms used metaphorically to frame socio-cultural values.

4.1.1 The eating experience in TA

The analysis of The different metaphorical expressions of the verb ‘eat’ produces two main clusters of meanings⁹; one in which the meaning is built on the FULL-EMPTY schemas and the eating experience serves to conceptualize the consumption of the eaten element and in the other cluster the human body, whether partially or totally, is either the eater or the food to frame the disappearance of the emotion and / or the function produced by the organ directly or indirectly involved in the eating operation. In TA, eater and food play a crucial role in creation and understanding of metaphors, metonymies and related tropes.

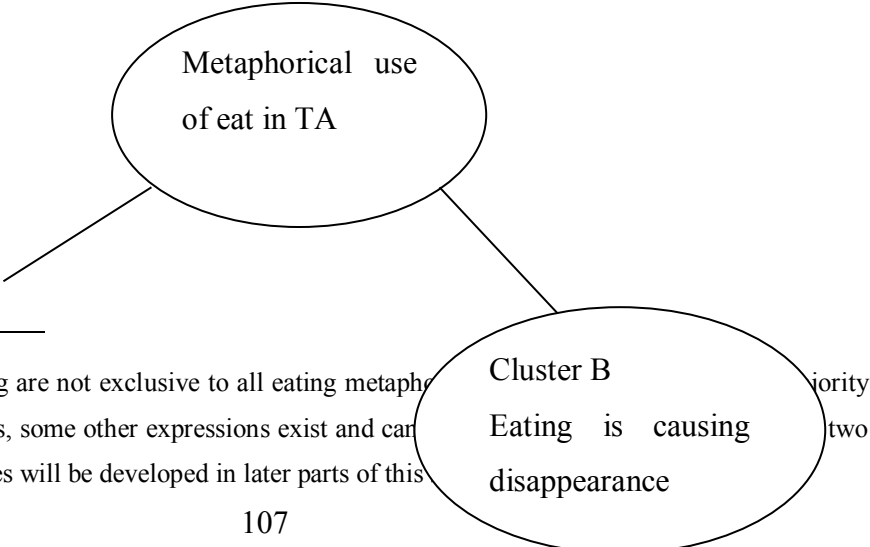

⁹ These two clusters of meaning are not exclusive to all eating metaphors of the expressions. Nevertheless, some other expressions exist and can form clusters. Some of these examples will be developed in later parts of this

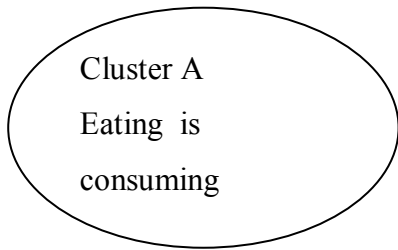

Figure 8: Primary metaphors building-blocks in the eating concept

In the first cluster of meaning the eating experience describes entities eating one another. This move from the state of being full to being empty is framed in terms of eating experiences. The examples *tractors eat petrol*, *Cette activité mange beaucoup de temps* (This activity eats a lot of time) and *l-karahba t-akil essence* (The car eats petrol) are governed by the conceptual metaphor CONSUMING IS EATING. The feature of eating characterising living beings is transferred to objects. Accordingly, food in itself turns into a range of consumed entities. (Petrol for engines, electricity for machines, memory for software, time for activities etc.)

The second cluster of meanings builds on the embodied experience of eating as it plays a crucial role in the creation and understanding of metaphors. The different expressions involved in this cluster capture many abstract experiences by conceptualizing the human being as the eater of other human beings and the food of other human beings at the same time. The human body is exploited partially by eating human organs or wholly through eating the self. The following table illustrates some of the metaphorical meanings of the eating experiences as it is used in TA.

The eating scenario	The corresponding meaning
---------------------	---------------------------

- eating one another	quarrelling
- eating another person	dominance
- eating one's own heart	carelessness / passivity
- eating other persons' heart	beating / dominance
- The heart eating the self	consciousness
- eating other persons' face	blame causing embarrassment
- eating the head	death
- eating the self	extreme anger
- An organ eating the self	itching
- eating with the eyes	desire / lust
- eating upon one's heart	dominance

Table 2: Some of the meanings of the eating scenarios in TA

These meanings are exclusive to the eating scenarios involving the body organs directly or indirectly associated with the eating experience. These different scenarios will be exemplified through TA expressions in order to gain a further understanding of the exploitation of the eating schemas to capture less concrete experiences most of which are emotional experiences.

Some of the human organs intervene in the eating operation though being naturally unrelated to the eating operation:

(1)

(a) kla-ha b-3inih

[he]PERF-eat her with eyes his.

He ate her with the eyes.

'He lusted for her.'

(b) ma t-akil kaan l-3iin

no [she]eatPERF only the eye

'only the eye does eat.'

'The eyes eat more than the belly.'

The eye is an organ described metaphorically acting in the eating operation. The eye is not directly related to the eating experience but in the TA language it substitutes the mouth in the eating process. Desire for food happens mostly through the eye. This organ is mainly associated with psychological greed in 1(a) and 1(b). These two expressions, which are motivated by the conceptual metaphor DESIRE IS HUNGER, mean that psychological greed transcends physical greed. Since the eye establishes the first contact, though at a distance, with the subject of desire it includes all the desire and seems in a hurry to move to the act of eating. The senses involved are generally more rapid to achieve the action. The eye does not seem to stop at the level of desiring and goes on to acquire a faculty appropriate to the whole body which is eating. The highest the degree of emotion is, the more likely it is to go beyond the function of the organ in question. We see with our eyes. We desire through the eyes and we eat with too especially when the desire is strong and overwhelming.

These claims echo plainly in the text of some TA proverbs *3iin iš-šiix jaa-t fi š-šaHma* (The eye of the old man comes into the flesh), *l-3in l-waas3-a w iS-Sorra iD-Dayq-a* (The eye is wide open and the fist is too small) as well as in some other TA expressions *3in-u waas3-a*, *3in-u kbiira*, *3inu maHhuul-a* (his eye is spacious/ big/ wide open, he is over-ambitious) (Maalej, 2011). “The eye offers different conceptualizations for greed and desire captured essentially as being big, wide and very often involved in the eating activity. Additionally, the eye serves to conceptualize shyness in the proverb *aT3im l-fom t-stHaa l-3iin*, (Feed the mouth and the eye will be shy)” (Dakhlaoui, 2012: 23). The eye acts in TA as a “bearer of mental faculty” (Maalej, 2011), which gives it a further faculty apart from perception. The conceptualizations of these emotions do not “proceed from the physiological body directly to the mind, but it is mediated by the body as a cultural entity” (Maalej, 2011: 214). As shown by Maalej (2008; 2011) “cultural embodiment” occurs when the neural, physiological function of an organ underlies a change when it goes through the road of the culture.

Food metaphors in TA manifest themselves abundantly with the verb to eat. Being a transitive verb, this verb requires a complement. The analysis reveals that the complement is an inedible substance, a human organ, a person, and an abstract concept. Such combinations are responsible for the cross-domain mapping production. The eating schema serves to conceptualize the process of sending out of existence something. It is all the time associated with consumption, disappearance and dominance:

(2)

(a) Kla kabbut

[He] eat-PERF a capot

'He ate a capot.'

'He endured a humiliating loss.'

(b) Kla kaff

[He] eat-PERF a slap

'He ate a slap'

'He endured a humiliating loss.'

(c) kla l-3Sa

[He] eat-PERF the stick

'He ate the stick'

He went through difficult experiences.

In addition to different food types a human being can metaphorically in TA eat inedible objects and sometimes even eating human acts (the slap, beats). The expression (2) serves to conceptualize loss. Enduring the psychological experience of loss is conceptualized in terms of losing in a card game. This expression can be subsumed under the conceptual metaphor LIFE IS A GAME. The playing rules are recruited to describedifferent challenges encountered in human life. Loss is one of the possible scenarios of people's life experiences. Losing one of the challenges is described in terms of eating a 'hood'; the situation in a card game where a player loses all his tricks. Eating in TA is exploited in different games. In card games a player can play by 'eating' cards that is winning one of the tricks and adding numbers to his scores. In football, when a team scores a goal the opposing team systematically 'eats' a goal. The eating scenarios which is orienting food from outside to the inside functions as a medium to facilitate the understanding of more difficult experiences. The recurrent schema OUT/IN contributes as a cognitive element enabling the understanding of a number of parallel experiences. The eating scenario undergoes a shift of the food addressed to the body, which allows for the mapping to occur. Actions substitute edible elements in the eating scenario to frame loss and humiliation. The body receives food through eating and the human being receives loss through eating beats. While the similarity exists at the level of directing something towards the human body, the difference arises when food enters the body

while beats do not. These expressions can be subsumed under the conceptual metaphor LOSS IS FOOD.

The example in (2c) is governed also by the metaphor LOSS IS FOOD. This metaphor interacts with the metonymy INSTRUMENT FOR RESULT to account for the understanding of eating the inedible. Being humiliated or enduring a considerable loss is framed in terms of eating an inedible object which is the stick. The stick is culturally known to be the main punishment tool. Speakers of TA start to discover being punished with stick since their tender ages. They go through this difficult experience whether in their families or at school. Being the main instrument used for beating, the stick has become likened to food since it is directed to the body. This echoes plainly in the TA expression *kla ma y-akil i-TTbal nhar l3iid* (*He ate as much as the drum in the feast*) where it associates the experience of person receiving beats with a musical instrument which is the drum. This analogy between the drum and the human being is built on the similarity of being the center of gravity of beats. A human being is neither like a drum in the shape nor in the sound does it produce. The metaphorical connection is built on being both subject to beats and also hyperbolically on the abundance of beats. The feast is a day of festivity during which people are supposed to visit each other, feel happy and eat and drink special food. It is not really well known in the TA culture that people play the drums the day of the feast that is why we may deduce that the feast here is meant to be the different celebrations of marriages. Traditionally and almost in all regions of the country the drum is pervasively present in the variety of popular music bands that animate marriages. The image of beating the drum is very conspicuous in the TA culture and this makes it a concrete source of conceptualizing human enduring beats which is in turn serving to frame psychological sufferance and going through very difficult experiences. This expression is governed by the conceptual metaphor LOSS IS FOOD with its two versions A HUMAN BEING IS DRUM and ENDURING BEATS IS EATING.

Loss is framed in terms of eating inedible things in (2b). Once more the eating schema is employed to serve the loss endured by a person. The direction of food from outside into the body is mapped to explain the psychological state of loss. The CONTAINMENT image schematic structure of the eating experience from outside the body inside it recurs in many metaphorical expressions especially those framing orienting beats whether they are physical or mental psychological. ‘The image schemas like the CONTAINER are directly grounded in

the embodied experience: they relate to and derive from sensory experience. This means that they are ‘pre-conceptual in nature’ (Evans & Green, 2006: 180). The IN/OUT schemas arising from directing food from outside the body inside it, is recurrent with many repetitive examples. Beating is also directing beats, slaps in the above mentioned example, from the outside into the body:

(3)

(a) *kla-li wjĥ-i*

[He] eat-PERF to me face me

‘He ate my face.’

I lost face.

(b) *kla-lu qalb-u*

[He] eat-PERF to him heart him

‘He ate him his heart’

He beated him severely.

(c) *kla ras-u*

[He] eat-PERF head him

‘He ate his head’

He passed away.

Food metaphors describe also eating human organ. In TA a person can eat his own organ or other people’s organ / organs. In the expression (3a) eating someone else’s face is used to frame putting someone in a very embarrassing situation. The physiological effect of this emotion can be the face blushing, sweating and feeling some heat. This feeling is culturally tainted in TA and the face turns into food to the blaming person. The face is hyperbolically sent out of existence. The scheme of disappearance is recurrent with the emotion of embarrassment. The degrees of embarrassment develop from the state of the human organ undergoing a change (sweating, blushing, and heating up) till disappearance. The latter can be partial in case of eating the face or total including the whole body. The TA expression *tmannit larth tšaqĥit w bal3atni* (*I wished the land would split into two parts and swallow me*) illustrates this situation of total disappearance. The suffering endured by the embarrassed is culturally viewed in TA worse than death. A person wishes to be buried alive instead of living a very embarrassing situation. The schema of disappearance is always associated with eating and what govern this disappearance are the different elements involved in the eating /

swallowing experience. In this particular expression a human being is the food and the eater is the land.

The heart is another organ that turns into food to human beings. In TA a person can eat his own heart, someone else's heart and he can himself turn into food for the heart. The multifunctionality of the heart in TA reveals embodied and cultural interactions. In the expression (2b), the suffering of the person enduring beats causes the disappearance of the heart. The heart is sent out of existence when it is eaten by the eater. The heart is commonly perceived to be the seat of the emotions. The disappearance of the heart involves extreme pain causing intensity in the emotion ultimately resulting in the absence of the emotion. The heart is also involved in the eating experience but in a different way. In the TA expression *qalb-u maki-u*, (He ate his own heart, He is careless), the heart turns into food for the self. This description serves to frame passivity and lack of enthusiasm. The heart takes different forms in the TA culture. It can also turn into an eater of the self *qalb-i kila-ni* (My heart ate me, I am deeply concerned) this expression serves to conceptualize consciousness. If the heart is sent out of existence this involves absence of consciousness. Conversely, Consciousness manifests itself through the presence of the heart as an agent acting positively through eating the self. The cultural configuration of consciousness in TA designs the heart and the self in a mutually exclusive situation. It bears only the presence of the one or the other.

The eating experience in TA is variously exploited to frame many abstract domains. The role-play system accounts for this variety in the sense that the eater and the food vary considerably. The eating experience involves an eater, food, containers and a place where the eating takes place. The TA language selects for example the place of eating to frame the feeling of undergoing domination by someone. The TA expression '*kila 3la qalb-i w šrab*, (He ate and drank over my heart, He ate me alive)' selects the place of the eating. What is particular in this metaphorical expression is the location of the eating experience. Not only are eating and drinking vital to the human existence, they are also two important manifestations of life pleasure. Eating is commonly associated with celebrating happy events. The TA selects the heart as a place upon which some of life pleasures take place to frame the feeling of bitter loss and hopeless inability to react. It is commonly known in TA that the expression '*fuuq min qalb-i* (from upon my heart, Half-heartedly)' expresses unwillingness and reluctance on behalf of the agent. The culture seems to separate between what is inside the heart and what is

outside it or emerging on the surface of the heart. The heart acts like a filter that absorbs all the positive events and people and rejects the negative ones. A liked person in TA is said to enter into the heart like a drop of honey does *'dخال في قلب-I ki noktī l-3sal*, (He entered into my heart like a drop of honey does)' while an undesirable event or action is said to be done upon the heart, that is outside it *'min fuq min qalbi* (I did it half-heartedly). In English for example all noble feelings are said to come 'from the bottom of the heart'. The bottom involves a surface and the actions seem to take an UP-DOWN movement depending on the degree of the emotions associated with them. The heart is commonly associated with the eating experience despite being not involved in feeding the human body. The TA metaphorical configuration of the eating experience assign to the heart different and sometimes opposing roles; the heart can be the food, the eater, the place of eating, and the place for keeping food.

The head is another organ involved in the eating experience. In the TA expression (2c) death is associated with eating one's head. A person dies when he eats his own head. The disappearance schema is also relevant in this example. Eating is sending out of existence. The head is the location of the brain and is indispensable for survival unlike other organs like the hand, the leg etc. Disappearance of the head is associated with death. The image of separating the head from the body seems to have a cultural referent in TA. In TA culture, people are first exposed to death as separating the head from the body when they slaughter animals for food. This image is stored even in the memory of children because they see it when they celebrate the Idha Eid.¹⁰The partial separation of the head from the body is very important for this religiously permitted way of killing. The metaphor DEATH IS DISAPPEARANCE governs the understanding of the two preceding experiences. Eating is one of the means for this disappearance. This can be a simple metaphor DISAPPEARANCE IS BEING EATEN:

(4)

šrab-lu moxx-u

[He] drink-PERF to him brain his

He drank his brain,

He persuaded him

¹⁰Also called the "Sacrifice Feast", is the second of two Muslim holidays celebrated worldwide each year, and considered the holier of the two. During this feast, every married muslim is supposed to slaughter a sheep at home, preferably by himself, for his family to eat meat and also donate for the poor and the needy.

The brain is another organ used in the food metaphor A HUMAN BEING IS FOOD to perceive persuasion. In expression (4), the brain turns into a drinkable liquid drunk by the person whose responsibility is to convince his interlocutor. The brain being the center of ideas is recruited to frame persuasion. The brain disappears and moves from one person to another. The different levels of analysis develop from perceiving a human being in terms of a food or an liquid then using one particular organ that stands metonymically both for the person and for the action ORGAN FOR PERSON and ORGAN FOR FUNCTION. When someone is convinced by another person's ideas, he will no longer be in possession of his brain and his ideas. Only one brain, one idea will dominate that of the person who succeeds to convince his interlocutor. The schema of DISEAPPEARANCE accounts for the understanding of this expression by making someone unable to think and assigning this faculty to someone else. Persuasion is the ability to dominate someone's thoughts by directing them to one particular perspective. This intellectual abstract process is framed in terms of the concrete familiar experience of drinking. The metaphorical scenario is built not of the act of drinking itself but rather on the liquid to be drunk. The liquid corresponds to a limp human organ which is the brain. The percentage of water in this organ is higher¹¹ than many other organs which are eaten in the metaphorical scenarios causing accordingly the disappearance of their functions. Like eating, drinking is causing disappearance. The disappearance of the organ takes place through its passage from the outside to the inside of the body. This takes the two main forms of eating and drinking. The eating and drinking scenarios in TA are recruited to frame psychological emotional experiences.

Food metaphors in TA involve interplay between the different elements constituting the eating schemas to link between domains and to activate the mapping. The eater can be a human organ and the speaker is the food. In the TA expressions *qalb-I klan-I* (My heart eats me)and *yidd-I kla-t-ni* (*My hand eats me*). The eaters are organs not related (heart) or indirectly related (the hand) with the eating experience. While the first expression frames the psychological experience of regret and worry in terms of the physical experience of eating the self by the heart, the second expression is used to express the physical sensation of itching:

¹¹According to H.H. Mitchell, Journal of Biological Chemistry 158, the brain and heart are composed of 73% water, and the lungs are about 83% water. The skin contains 64% water, muscles and kidneys are 79%, and even the bones are watery: 31%.

(5)

(a) *'kla-lu 3arq-u'*

[He] eat-PERF him sweat his

He ate him his sweat

He did not pay him his salary.

(b) *'kla-lu flussu'*

[He] eat-PERF him money his

He ate him his money

He did not pay him his due money

(c) *'kla-lu Haqqu'*

[He] eat-PERF him right his

He ate him his right

He did not pay him his due right.

Besides framing consumption and some emotions, the entailments of the eating metaphors in TA make it possible to figure out human relationships in terms of people's relations with food. Many TA expressions use the eating experience and map it on knowledge about human relationships. Along with the main meaning focus of the food domain, which is dominance, where the eater is the dominant and the food corresponds to the part undergoing dominance, the eating scenario is recruited to frame the deceitful behavior of not paying people their due rights. The expression (5 a) is used to capture the fraudulent practices of some employers who refuse to pay the earnings of their employees. This expression is governed by the conceptual metaphor CAUSING DISAPPEARANCE IS EATING and the conceptual metonymy RESULT FOR ACTION and its two subparts SWEAT FOR EFFORT and MONEY FOR EFFORT. The combination of these two metonymies results in understanding eating the sweat as refusing to pay a worker his due earnings. This expression seems to logically violate the natural logic of eating and drinking. Being a liquid the sweat is more logically viewed to be drunk, however because the metaphor CAUSING DISAPPEARANCE IS EATING is so entrenched in the TA culture, the eating experience is more likely to present itself in the disappearance and dominance meaning foci. In (5b) the eaten element is money. This expression exploits the eating scenario to frame the disappearance of money through eating. Eating the inedible is a very common scenario which serves to capture any loss or disappearance. These abstract experiences are conceptualized in terms of eating the inedible.

The eaten element can be either concrete (money) or abstract (a right). The expression (5c) frames losing one's right in terms of eating. The schema of DISAPPEARANCE is recurrent in the three above mentioned examples though with different degrees of complexities. Eating the inedible can refer to a specific loss (money) or to a more generic loss (a right). Eating one's right subsumes eating money or eating a salary hence the complexity of the (5c).

In the TA culture the eating experience has stereotypically been transformed and acquired a generic knowledge that has become associated with it. The term '*y-akil, He eats*' in TA has become metaphoric in essence. Even in the absence of a direct explicit target, this expression seem to have a metaphoric meaning and speakers of TA will look for the target domain in the situation at hand for the mapping to take place. Eating metaphorically in TA is pervasively used to frame different experiences. The type of the eaten food will define the targeted meaning. Gaining money in TA corresponds to eating bread or a mouthful *ya-kil xobza, ya-kil fomm*. Losing money is paradoxically framed in terms of eating. *kla-lu flus-u* (He ate him his money) and *kla-lu 3arq-u*, (He stole him his sweat) frame respectively losing money and losing one's earnings. The eating domain seems to be so productive to the point of framing opposing experiences. This polyvalence points to the highly productive nature of the eating experience along with its importance in the culture of the language in question. The extent to which this experience is framed defines different metaphorical scenarios that serve to conceptualize different psychological experiences and constitute a depository for the creation of new metaphors. This point will be discussed in further details in later parts of the present work.

The eating experience serves to conceptualize psychological experiences of consciousness, unconsciousness, passivity, embarrassment and persuasion. Eating in TA exhibits metaphorically different situational scenarios through which the eater and the food exchange roles revealing each time a new dimension of embodiment culturally tainted where organs indirectly associated with the eating experience are recruited to stand for actions other than theirs and to frame psychological experiences to which they are indirectly related. The context seems to play a significant role in defining the directionality of the eating act along with the elements constituting the setting of this highly familiar experience.

The analytical part of the act of eating in TA has allowed a demonstration of panoply of conceptualizations exploiting differently the multiple elements involved in the eating setting. This brief analysis points to the high productivity of the food domain. Whether it is the experience of eating or the food to be eaten itself, a multitude of target domains were sorted out of the different linguistic metaphors under analysis. These target domains revolve around two meaning foci; consumption and disappearance. In the next part, we will tackle the different meanings of the eating experience as they are used in the French language.

4.1.2 The eating experience in French

The conceptualization of many abstract concepts happens through describing particularities of the eating experience in French. The French culture seems to share with its Tunisian Arabic counterpart the wide-ranging exploitation of the eating experiential to capture different psychological experiences. The differences lie at the configurations and the parts involved in the eating scenario. It seems that the geographical proximity of the two people and countries may have an impact of the particularities of the two cultures in terms of giving more concerns to practices and actions around the eating experience. Metaphor usage and understanding relate to all ‘real objects, artifacts, institutions practices, actions, and so on , that people use and participate in any culture , but it includes a large portion of it, namely the shared understanding that people have in connection with all of these things’ (Kövecses, 2005: 1).

The eating experience in French is used metaphorically to map knowledge about the eating process onto more abstract domains of emotions. The metaphorical eating scenario in French places some human organs to be eaten. These human organs are not directly related to the eating process. These different eating experiences and their corresponding meaning are presented in the following table.

The selected eating experience	The corresponding meaning
- manger des yeux (eat with the eyes)	- avidity
- manger le blanc des yeux (eat the eyes)	- quarrelling
- manger le nez de quelqu'un (to eat someone's nose)	- to quarrel
- manger dans la main de quelqu'un	- familiarity

(To eat in someone's hand)	
- manger la soupe sur la tête de quelqu'un	- Dominance
(to eat soup over someone's head)	
- manger la laine sur le dos to quelqu'un	- exploitation
(to eat the wool over someone's back)	
- manger de quelqu'un (to eat of someone)	- hostility
- manger de l'herbe (to eat grass)	- stupidity
- manger quelqu'un avec un grain de sel	- dominance
(to eat someone with a grain of salt)	
- être mangé par quelqu'un (to be eaten by someone)	- attraction
- se manger les poings (to eat one's fists)	- impatience

Table 3: The eating experiences in French and their corresponding meanings

The eating scenario in French produces expressions where the eater in most examples selects particular human parts as foods. The eating experience with its main meaning focus disappearance is used to frame emotions. The parts of the body selected in these metaphors are neither directly related to the eating process nor in accordance with the emotion in question. These are called

“‘culturally-schematised expressions’ which are different than ‘physiologically realistic expressions’, in that the part of the body selected may or may not be known to be associated with [the emotion in question] and its image schematic profile emerge according to imagined scenarios in the culture” (Maalej, 2008: 93).

(6)

(a) manger des yeux

eat[INF] with eyes

eat with the eyes

(b) manger le blanc des yeux

eat[INF] the white of the eyes

eat the white of the eyes

(c) manger le nez de quelqu'un

Eat[INF] the nose of someone

to eat someone's nose

(d) manger dans la main de quelqu'un
Eat[INF] in the hand of someone
To eat in someone's hand

(e) manger la soupe sur la tête de quelqu'un
Eat[INF] soup on the head of someone
To eat the soup over someone's head

(f) manger la laine sur le dos to quelqu'un
Eat[INF] the wool on the back of someone
to eat the wool over someone's back

(g) manger de quelqu'un
Eat[INF] of someone
to eat of someone

(h) manger de l'herbe
Eat [INF] of the grass
To eat grass

(g) manger quelqu'un avec un grain de sel
Eat[INF] someone with a grain of salt
to eat someone with a grain of salt

(j) être mangé par quelqu'un
Be[INF] eat[PARTICIPLE] by someone
to be eaten by someone

(k) se manger les poings
Eat[INF][REFLEXIVE] the fists
to eat one's fists

The eye in French in example (6a) intervenes in the eating operation to replace organs involved in the eating experience and turns into eater of human beings to frame feelings of avidity. The psychological hunger for sex is conceptualized in terms of a physical hunger manifesting itself through a specific eating experience. What makes the eating specific is the involvement of an organ unrelated directly to the eating. In the French culture the eye encompasses and transmits the hunger and sight is never enough to get satisfied. The cultural scenario in French relegates the function of eating to the eye in order to establish an imagined

contact with the desired person and allows ‘the eating’ to take place. These expressions present the eating schema with its different parts and how it is exploited to describe sexual practices. This expression is governed by the conceptual metaphors A HUMAN BEING IS FOOD, HAVING SEX IS EATING and LUST IS HUNGER. The physiological experience of hunger serves to conceptualize the psychological experience of lust. Desire for food and also desire for sex can be triggered through sight which explains the involvement of the eye into the eating metaphorical scenario. The eye establishes the first contact with the desired food/person. According to the scenario of framing desire in terms of eating, the basic shape of the experience of hunger and eating is transferred to the sexual domain. “A schematic gestalt based on a repeated pattern in experience of feeling hungry, looking for food, obtaining some, eating it; and being nourished and feeling satisfied lends its internal structure to the experiences of lust and sex” (Emanation, 1995: 169). The French expression ‘manger avec les yeux’ (to eat with the eyes) is governed by the conceptual metaphor a HUMAN BEING IS FOOD and its subpart DESIRING IS EATING. The eating experience is activated by hunger and the two experiences are fused in people’s cognition about food. The psychological hunger for sex is conceptualized in terms of eating with the eyes. The human organ is not metonymically used to refer for function when the function of eye is sight. Sight in the French culture acquires a new function which is eating and this new function is used to frame psychological desire and imaginative satisfaction of this desire. Similarly in the TA culture, The eye is productive of many conceptualizations of lust which are framed as the eye undergoing a change in the size i.e. becoming wider and participating actively in the eating operation *3in-u waas3-a*, *3in-u kbiira*, *3inu maHhuula*(his eye is spacious/ big/ wide open, he is over-ambitious).

The different eating scenarios vary in the way of furnishing the eating operation with specific foods or particular places for the eating. These scenarios vary in terms of the organs selected for eating. The French language allows for eating the eyes in example (6a) and also eating the nose (6c) to capture disagreement and quarrel. This seems to follow the same line of the domination meaning focus in terms of framing the eater to be dominant and the food, partially and metonymically standing for the whole, to be the dominated part. The cultural configuration of the French language is built on the conceptualization of quarrelling and disagreement in terms of eating respectively the eyes and the nose. These organs are not selected for example in TA to frame the same meanings of quarrelling and disagreement.

Conversely, The TA culture selects the heart and the face to capture situations of quarrelling and disagreement. The TA expression *kla-lu qalb-u* (he ate him the heart) and *kla-lu wjhu* (he ate him the face) are used to figure out situations of quarrel and disagreement. The heart and the face seem to be abundantly exploited in TA to frame different feelings and sensations and they are given each time a different role depending on the cultural configuration of the metaphorical expression they are formulating.

The variation of the eating scenarios does not only include the selection of the human organ subject for eating but also it encompasses places for the eating in direct relation with human organs. In French the metaphoricity of the eating experience lies in the selection of the place for eating. When the place of eating is over someone's back *manger la laine sur le dos de quelqu'un* (to eat wool over someone's back) or over his head *manger la soupe sur la tête de quelqu'un* (to eat soup over someone's head) as stated in examples (6e) and examples (6f). As mentioned in example (6d) it can be in the hands of someone *manger dans la main de quelqu'un* (to eat in the hands of someone) another metaphorical meaning of the eating experience arises. These three described scenarios frame respectively exploitation, dominance and familiarity. These two mental situations are conceptualized in terms of different situational eating experiences. These two expressions are governed respectively by the conceptual metaphors DOMINATING IS EATING and FAMILIARITY IS CLOSENESS. Domination allows for exploitation and these two concurrent situations go hand in hand. The second conceptual primary metaphor does not seem to account for the understanding of the expression in question. Its subpart CLOSENESS IS SHARING FOOD however may give an explanation to the eating scenario in question. This echoes plainly in the TA expression which refers to familiarity and closeness in terms of water and salt *3išra w ma milH* (a long company, water and salt¹²; a long company sharing food and drinks). These two elements are metonymically employed to refer to food in general.

In French and also in TA, some human organs are selected and made active in the eating experience mostly through being the food. Other inedible objects are present to represent an

¹² Salt stands metonymically for food in general. The conceptual metonymy PART FOR WHOLE accounts for the activation of the food image in terms of one ingredient which is salt. The latter enjoys omnipresence in many food types. The prevalence of salt in TA food is exploited to frame human omnipresence in the TA expression *Ki lmiH ma yRiib 3la T3am* (Flen is like salt always present in food).

active element in the metaphorical eating scenario. In French people may eat wool to frame exploitation (6f) or they may eat grass to frame stupidity (6h). Eating wool is used to frame experience of luxurious enjoyment over the back of someone. The whole eating experience is mainly associated with pleasurable experiential. The pleasure is accentuated depending on the type of food or the place of eating. The imaginative scenario of eating wool over someone's back uploads cultural significance. The wool seems to have a highly-standardized cultural significance in the French context which renders the experience of eating this object gaining due value hence adding more salience to the situation of exploitation. Eating grass however equates human beings to animals taking off their capacity for thinking and accordingly resulting in stupidity. Naivety and stupidity is similarly figured out in terms of an eating experience. The implicit connection to animals in French is concretely mentioned in TA. Through the analogical mapping between the cow and the human being, framing naivety was made possible. The TA expression *ki l-bagra t-akil fi l-Hšiiš* (Like a cow eating grass, She is so naive). The analogical mapping selects the instinct of eating grass for cows and maps it onto human beings uniquely reserving his capacities in this basic instinct. Framing stupidity in French is built on metaphorical mapping and implicitly using the animal metaphor A HUMAN BEING IS A HERBIVOROUS the TA language however, exploits the analogical mapping by selecting the eating faculty of cows and mapping it onto human beings. The relationship between human beings and animals is the same and unique concern with eating food which is grass in the situation in question.

Along with the meaning focus of dominance the eating scenario in French moves partially from eating human organs to wholly eating human beings. The conceptual metaphor DOMINATING IS EATING seems to govern many of the understanding of food metaphors in French and so far in TA (6i). Physical dominance presupposes mental and psychological dominance. Dominance is figured out in terms of eating human beings. The French expression *manger quelqu'un avec un grain de sel* (to eat someone with a grain of salt) is used to frame attraction. Attraction rhymes with domination in the sense that it incarnates dominance and can be more effective than dominance. Adding a grain of salt to food is a technique used to make it tastier and add more flavour to it. The dominance meaning focus is present in this metaphor. The psychological experiences of dominating someone or feeling dominated by someone are conceptualized in terms of an eating experience. The physical experience of directing food towards the body and making the former disappear inside the

latter exploits the scenario of joining two things in one to capture the particular situation of dominance and attraction when psychologically speaking one personality is fused into another. The disappearance schema involves the elimination of one element in favour of another. The physical disappearance of food into the body of someone corresponds to the mental absence of a person in favour of the dominating person. Manipulation of food and choosing time and place and also the degree of its saltiness lies in the hand of the eater and corresponds for the time when, the place where and the way how the dominating person wants to deal with the dependent/ dominated person.

The EATING schema is very productive for a number of conceptualizations mostly cultural framing mainly emotions. It appears that the metaphorical configuration of emotions is partially constructed around the eating scenarios. The eating scenario varies each time its constituents to frame a different emotion. Hostility is framed in terms of eating of someone (6g). Hostility involves attacking someone violently whether verbally or physically. The force involved in the eating scenario is mapped onto human relationships. Hostility is metaphorically connected with eating through sharing the act of imposing force on food through cutting, chewing and swallowing while eating and imposing force on the person subject to the hostility through verbal or physical violence.

The eating experience is exploited in French to frame feelings of regret (6k). The French expression '*se manger les poings*' (to eat one's fists) frames the sensation of regret. The seemingly logical relationships between the fists and the hands may provide part of the answer to the logic behind the use of this human organ. Eating the fists metonymically standing for the hands may reflect a desire to eat the hands. The hands in their turn stand metonymically for the functions done by them. These functions are the origin of this regret and eating them may cause the disappearance of the actions leading to regret. This expression is similarly used to capture feeling of eagerness. The scenario of eating the fists is used to frame mental situation of unrest. Eating the fists metonymically standing for the hands is a way to get control over the hands and disallow any possible action that violates the patience needed in the situation at hand. The French culture selects another human organ that is indirectly related to the eating process, and integrates it into a metaphorical connection making the people play the role of eaters of their human organs. Similarly, in TA eating the parts of the hands i.e. the fingers are used to frame the feeling of regret. The TA expression

ndim kla swab3-u (He ate his fingers out of regret) captures the psychological experience of regret in terms of an imaginative physical experience of eating one's fingers. The TA expressions *Kla-lu wjrh-u* (He ate him his face) and *kla-lu qalbu* (he ate him his heart) offer a different configuration. This configuration is drawn in light of the cultural sensitivity of these two organs along with their multiple usages in the creation and understanding of emotions.

It appears from the analysis performed so far that the eating experience is very important since it represents a concrete physical situation used in TA and French to frame several psychological experiences. The different imaginative situations of eating put on various cultural furnishings and each culture seems to select its own experience through varying the food, the place of eating and the human organ, directly or indirectly related to the eating experience, to be active element in the mapping. The food domain, particularly the eating experience, appears to be highly productive. The embodied experience of eating food along with its all patterns starting from entering food into the mouth, chewing it, swallowing it and digesting are so influential in the understanding of abstract experiences namely emotions. The context plays a crucial role in activating some scenarios and not others. The metaphorical scenarios are built by conceptualizing emotions and psychological experiences through eating scenarios. This eating scenario can be either faithful to the reality (regret in TA is framed in terms of eating a vegetable; onion) or unreal imaginative (eating a human organ e.g. the nose in French to frame disagreement). The relevance of particular eating experience, eating spicy food in TA for example, points to the possibly significant role of the context in the creation and understanding of metaphors. Metaphor is no where but in the areas joining the mental, the embodied and the cultural. Metaphor seems to have a subtle presence as it dwells between different locations and it is best recognized in the interaction between the mind, the body and the socio-cultural context.

4.1.3 The eating experience in English

The eating experience seems to have a less significant presence in English. It appears that this concrete familiar experience serves to figure out a limited number of abstract domains. In addition to framing consumption in terms of eating, the English language does not allow for varied imaginative scenarios of the eating experience. This can be traced back to the peculiarities of the English cuisine which does not allow the mappings to appear or the preferences of the English speakers to use these experiences or not.

The selected eating experience	The corresponding meaning
- eating crow	- humiliating defeat
- eat out of someone's hand	- being manipulated
- eat someone alive	- domination
- eating one's hat	- surprise
- eat dirt	- suffering humiliation
- eat someone's dust	- considerable loss
- eat humble pie	- accepting humiliation
- eating one's heart	- grief and sufferance

Table 4: The eating experiences and their corresponding meanings in English

It appears that most expressions describing the eating experience to frame abstract concepts revolve around the meaning of dominance. The DOMINANCE schema is conspicuously shared across the three languages. The metaphorical understanding of dominance in terms of an eating experience is common to the three languages since they all frame eating in terms of dominance, the eater is the dominant and the food is the dominated part. Dominance involves a relationship between at least two parts governed by opposing roles; one part holding the power and another part being subject to the authority of the former. The unconscious knowledge about the supremacy of human beings on their food serves to be mapped onto more abstract situation governed by this type of relationships. Originally, people's quest for food has always been equated to the degree of their dominance and supremacy over their food. In the primitive life, human beings would need to have a full control of what they will take as food and their quest for food consisted essentially in hunting. Today, they still do that but more for pleasure rather than for a vital need for food. People's relationship with food has always been one of manipulation. When people eat food they are not aware that this food has undergone different stages through which it has been the subject of human manipulation. Before being served to people in their everyday meals, food has gone through different stages

and has interacted with different ingredients to turn into a particular meal specific to one culture and eaten at particular moments. People are not aware when they eat a given food that they have a full control of what they are eating. They can choose the quantity, the time when and the place where to eat. This subconscious knowledge is also used spontaneously to frame other types of dominance relationships. The details about the dominance characterising people's relationship with food arises in the analysis of metaphorical conceptualizations of dominance in terms of eating:

(7)

(a) eat someone alive

(b) eating crow

(c) eat out of someone's hand

(e) eating one's hat

(f) eat dirt

(g) eat someone's dust

(h) eat humble pie

(I) eating one's heart

The English metaphorical eating scenario selects particular inedible objects and one unique human organ. The English culture does not go too far in choosing disparate food types. The English language is similar to its French and TA counterparts in framing dominance in terms of eating particular objects. The expression '*to eat someone alive*' (7a) is used to frame full dominance of someone over the other. This expression is governed by the conceptual metaphor DOMINANCE IS EATING. The culture selects each time the dominated element to differently furnish the eating scenario. The eating experience serves also to frame the emotions of bitter loss and humiliation (7 a, 7c, 7e). The eating experience is imaginatively altered to allow for eating inedible and sometimes horrible objects (7b, 7f, 7g). Expressions like '*eat crow, eat someone's dust and eat dirt*' are used to serve the senses associated with

undergoing a humiliating situation. The culture selects the eaten element to frame negative emotions of humiliation. The metaphorical connection is built on the act of eating. Although eating is originally a pleasurable experience that results first in enjoyment and then in satisfaction, the conceptualization of a negative emotion renders it a negative experience through intervening with the food itself. Instead of eating the tasty delicious food, people transfer their experience of eating the inedible horrible food to frame feeling of humiliation. Human are generally resistant to failure and defeat. Similarly people are generally resistant to horrible tastes. Though the degree of deliciousness remains a subject to cultural variation, human beings have some common tastes that are pleasurable all over the world and vice versa. The physical experience of suffering the eating an unpleasant inedible thing is projected to the psychological experiences of unwillingly accepting dominance and humiliation. These expressions are seen to be governed by the conceptual metaphor EMOTION IS FOOD with its subpart SUFFERING IS EATING THE INEDIBLE.

4.1.4 Conclusion

The foregoing analysis has demonstrated three main peculiarities about the eating experience as it is used metaphorically across three different languages/cultures. First, the high productivity of the EATING schemas was highlighted. Second, the eating scenarios used to frame emotions vary according to the language. Third, the elements involved in the eating situation play interchangeable roles which make these situations vary gradually from the purely realistic to the hyperbolically imaginative and then will be created for the sake of the metaphorical conceptualization.

The EATING schema involves the presence of an eater and a food for the eating operation to take place. This recurrent scenario describing the trip of food from the OUTSIDE to the INSIDE of the human body was exploited productively to frame several emotions and psychological experiences. The eating scenario was altered each time through varying the food, its nature and also the eating setting. Emotions are framed in terms of eating the edible and the inedible, the human organ, the whole body etc. This variation has allowed for the productivity to be remarkably present across the three languages/cultures though with different degrees.

The various scenarios used metaphorically to frame different psychological experiences vary also at the level of the languages themselves. Each language selects its own scenario through varying the inedible object to be eaten, the human organ to be eaten and/or the eating setting. These variations are defined by the socio-cultural context in which these expressions are understood. The speakers of the language in question seem to have developed a shared knowledge around these expressions which make them particular to the culture in question.

The eating scenarios described in the expressions discussed so far exhibit a high productivity thanks to the interchangeable roles played by the elements involved in the eating experiences as they are described in the metaphorical expression. What makes these expressions metaphoric serving to conceptualize abstract domain is the imaginative situations of the eating experience. The different eating experiences described in the metaphorical expressions analysed in the three languages assign different roles to the different elements involved in the eating experiences. This variation can be summed up in table 5.

The eater	The food	The setting
A human being	An edible food	Not mentioned
A human being	Not mentioned	On a human organ
A human being	An inedible food	Not mentioned
A human being	An inedible food	On a human organ
A human being	A human organ	Not mentioned
A human being	A human being	Not mentioned
A human organ	A human being	Not mentioned
A human being	The self	Not mentioned
An activity	A human being	Not mentioned
An activity	Time	Not mentioned
A machine /an Appliance	Fuel / power	Not mentioned
A fictive creature	An object	Not mentioned

Table 5: Different eating scenarios across the three languages

These examples show that the embodied experience of eating serves to conceptualize different concepts. The understanding of these different terms is mediated by the culture. Throughout these examples we notice that the three cultures/languages agree in framing emotions metaphorically through the eating experience but each culture selects its own ‘meal’. While eating the heart expresses a feeling of sufferance in TA and English, the French culture does not select this organ for eating. The interaction between the embodied action of eating and the cultural context accounts for this difference. Eating the heart was filtered by the French culture and did not appear to the surface in the form of a linguistic metaphor to frame sufferance. Alternatively, the French cultural filter has allowed other scenarios to get through and appear to the surface in the form of a metaphorical scenario where another organ is eaten but not the heart.

These different scenarios are exploited across the three languages to frame abstract experiences. The cultural variation is traced back to the cultural particularities which allow for metaphorical scenarios to appear and at the same time constrain others. On the other hand, these scenarios will act as a template that can be filled each time by a given culture or allow for new metaphorical conceptualizations to be created. (Table 6)

Relevant senses associated with eating	TA	English	French
- eat one another (dominance)	+	-	+
- eating with the eye (avidity)	+	-	+
- eating the heart (grief / sufferance)	+	+	-
- eating the face (embarrassment)	+	-	-
- eating the head (death)	+	-	-
- eating the self (anger)	+	-	+

Table 6: examples of some relevant senses associated with eating in TA, English and French.

4.2 Food for human traits

This section will focus on the conceptualizations of human traits in terms of food types. The food types are variously exploited to capture human characteristics. Across the three languages human beings are likened to food types, which are used in panoply of situations.

The food types are used in their natural state, while being prepared for cooking, while being cooked, throughout the different stages of cooking and even after being cooked and served for eaters. Food types' tastes are pervasively exploited throughout the three languages to frame human traits. We will first analyse food for human traits in TA. Second, we will present the different food types serving to conceptualize human characteristics in French. Third we will discover the different conceptualizations of human beings in terms of food in English. Finally we will end with a summary and some concluding remarks.

4.2.1 Food for Human traits in TA

It seems that TA speakers' experience with food is so entrenched in their cognition, which provides a tacit knowledge serving to capture abstract and concrete human traits. The variety of food types whether in their raw nature, after being cooked, being sieved and being ground, etc. are used to frame psychological and also physical human traits. The mapping selects the distinct feature of the food in question and maps it on the human being. These expressions can be subsumed under A HUMAN BEING IS FOOD metaphor. The linguistic manifestations of this metaphor exhibit a wide variety and are hardly seen to be subsumed under one single conceptual metaphor. The different metaphors exhibit a considerable variety of food types. The metaphorical scenarios are so developed and sometimes complex through focusing each time on different aspects, sometimes unique and sometimes multiple, of the food type used in the mapping. The complexities of the different metaphorical expressions invite different level of analysis based on the sources from which we recruit our metaphors whether they were conceptual, bodily or socio-cultural. The way to redeem to this theoretical concern will be dealt with in later parts of the study. The seemingly messy nature of metaphor is not a problem in itself. The logic of metaphor creation may account for this methodological concern. In this level of analysis we will focus on the different target domains sorted out of the food types used to capture human traits along with the metaphorical procedures underlying their understanding by TA speakers.

The conceptualisation of human traits in terms of food types characterises much of the understanding of food metaphors in TA. It appears that people's experiences and familiarity with food provides them with a potential background knowledge that will be mapped to frame less delineated domains. People qualify the food they eat essentially on the basis of

deliciousness before they move to details such shape, colour, smell etc. This experiential is abundantly exploited in TA to frame human traits.

The selected food type	The corresponding meaning
- Honey	Kindness and social acceptability
- onion	rudeness and social rejection
- porridge	naivety
- raw food	lack of experience
- half-cooked food	lack of experience
- Flesh / meat	sexy woman
- Fish	beautiful attractive woman
- bitter almond	wickedness
- spicy food	hard work
- vegetables / tomatoes / butter	exhaustion
- stuffed tripe	nervousness
- fenugreek	weakness and vulnerability
- milk	purity and tolerance

Table 7: some food types and their corresponding meanings in TA

It appears that the TA language variously exhibits the food types in almost all their states. People’s contact with food types provides a background knowledge that will serve to map less delineated domains. Human traits illustrate some of these mapped domains that are heterogeneously joined and captured through the food-related perception. The TA culture selects panoply of food types and maps them on human beings to frame different psychological and sometimes physical characteristics. This type of connection is accounted for a sort of metaphors ‘which appear to be based on shared qualities which are not perceptual: when we refer to a person as some type of animal based on a personality trait, for example (e.g., as a “pig,” “snake,” or the more classical, not to mention complimentary, “lion”), we are apparently invoking a commonality which we believe unites the person and the animal (or some stereotype of the animal).’ (Grady, 2007: 193) Mapping a human being in terms of a food type belongs to a set of mappings that ‘are based on conceptual relationships

which can be reversed and still be meaningful' (Grady, 2007: 193). In TA, we frame physical obesity in terms of a vegetable; an obese person is called *škara baTaTa* a sack of potatoes and we frame abundance of a given fruit or vegetables in terms of craziness *TmaTim mahbul-a* (crazy tomatoes; the land produced abundant tomatoes).

Food types are recruited to frame human traits in TA. These food types are either natural or cooked. The cultural model of framing human beings in terms of food is built on the dichotomy between the delicious and the tasteless. This dichotomy is projected on human moral attributes to frame respectively kind, sociable and appreciated human beings on the one hand and dishonest and repulsive persons on the other. In the text of some TA, French and English expressions, human beings are featured in terms of food and the understanding of these expressions is constructed around the dichotomy mentioned above. These expressions can be subsumed under the generic metaphor A HUMAN BEING IS FOOD. Dakhlaoui (2012) suggested the following examples to demonstrate the dichotomy between the delicious and the tasteless. The two conceptual metaphors DELICIOUS IS GOOD and TASTELESS IS BAD can be viewed two versions of the generic metaphor a HUMAN BEING IS FOOD.

(8)

(a) *kaan SaHib-k 3sal ma ti-lsH-u-š l-koll*

If friend-your [be] honey not you lick-IMPERATIVE the all.

If your friend is honey, do not lick all of it.

(b) *flaan 3sal id-dinya*

X [be] honey of life.

X is honey.

(c) *ya 3asla*

Hey a honey

Hey honey

(d) *klaam ma3suul*

Speech honeyed

Honeyed speech

Honey appears to be a productive food type used in TA to frame kindness and social acceptance. Sweetness and health benefits are the two distinct features characterizing this food type. This food domain is used as an expression of endearment. It is similarly used to frame kind and very sociable persons. The cultural model of honey in TA makes it a valuable possession to be consumed with moderation. “Human beings are conceptualized in terms of a sweet food that should be either consumed with moderation or that is best tasted in the mouth (8a, 8b). Besides its framing of moral attitudes, honey is also used to characterize types of speech (8c), particularly speech that aims at persuading others” (Dakhlaoui, 2012: 8). Honey appears to be one of the most productive food types in TA, French and to a less extent in English hence its frequent use:

(9)

(a) *iða ummi-k l-bSal w bu-k ith-thuum mniin tjii-k ir-riiHa eT-Tayb-a ya mšuum*

If mother your be [IMPERF] the onion and father your be [IMPERF] garlic where come [IMPERF] you the smell good.

If your mother is onion and your father is garlic, how will you then smell good?

(b) *kol šayy yi-t3addaa illa iD-Diif ir-rkiik*

Everything pass [PERF] except the guest dull

Everything can be digested except the dull guest.

(c) *illi aSl-u toffaaH la yu-jaaH w illi aSl-u difla la ya-Hla*

Who origin-his Apple never bitter [IMPERF] and who origin-his never sweeten [IMPERF]

Whose origin is apple never turns bitter and whose origin is colocynth never turns sweet

(d) *Darb l-Habib zbiib w Hjartu TuffeH*

Beat the lover raisin and stones his apples

Beats from the lovers are like raisins and his stones are like apple.

Sweet fruits are recruited to conceptualize kindness and social acceptability of in TA (9a, 9b), apple (9c), and raisins (9 d)). Similarly an attractive woman is captured in terms of a cupcake in English. Wickedness, however, and social rejection are captured respectively in terms of a pungent and sharp-tasted food (garlic, onion) (9a) or heavy and difficult to be digested food (9b). Generosity and kindness are framed in terms of a sweet fruit. Bitterness is, however, conceptualized as wickedness (9c).

These expressions are motivated by the conceptual metaphors SWEET IS GOOD and BITTER IS BAD (Dakhlaoui, 2012):

(10)

(a) *lqaa-h 3siida l-lbal3aan*

Find [PERF] him porridge for swallowing.

He finds him porridge to swallow, (He is easily deceived)

(b) *fiaan 3Dam SHiiH*

X bone hard

X is a hard bone

(c) *qalb-i Taab w rasi šaab*

Heart me cook[PASSIVE] and head me turn[PERF] grey

my heart turns ripe and my head turns grey, (I got very experienced)

(d) *fiaan nayy*

X be [IMPERF] unripe

He is inexperienced

(e) *fiaan naaqis Ralwa*

X be [IMPERF] half-cooked

He is a greenhorn

The TA culture selects a change in the taste of food to frame opposing human traits. Not only does the TA culture select a change in the taste of food to frame opposing human traits, but also a change in its state to distinguish between easily eaten foods and hard ones; those who involve a lot of chewing. In TA a naïve person is captured in terms of an easily eaten food. In French we frame the naïve person in terms of an apple. *C'est une vraie pomme* (he is really an apple). Porridge is known as a soft type of food that is devoured directly and its eating does not involve chewing inside the mouth. Apple and porridge represent sweet easily eaten food. This experiential is selected differently across the two languages while the TA culture selects porridge, the French culture chooses apple to frame persons that are easily deceived. The conceptual metaphor A HUMAN BEING IS FOOD governs the understanding of these two expressions.

“They can be considered as versions of the two metaphors A NAIVE PERSON IS AN EASILY EATEN/SWALLOWED FOOD In TA and A NAÏVE PERSON IS A SWEET FRUIT in French. Soft and sweet foods serve to conceptualize inexperienced and easily trapped people” (Dakhlaoui, 2012: 8).

Conversely, foods that are hard to eat are recruited to characterize experienced persons that are difficult to be deceived. There is a schematic isomorphism between the ease involved in eating a sweet and soft food that does not involve almost any effort. The eating of soft food involves little or even no chewing. The ease with which people enjoy eating a sweet soft food is projected on the experience of dealing with naïve ill-experienced persons. The difference between easily eaten food and hard to eat food is more apparent in everyday TA expressions. A human being is conceptualized in terms of a hard bone. The experiential that TA speakers live in the Tunisian cuisine involves that bones are cooked with meat but never eaten by human beings. The lived experience of selecting meat and rejecting bones are influential for the conceptualization of human beings in terms of bones. The difficulty involved in eating bones is recruited to frame difficulty of facing strong competitors. Hard bones serve to conceptualize persons that are experienced and socially vigilant enough that they can never be ‘eaten’ i.e. trapped or deceived.

“This metaphor is motivated by the metaphor A VIGILANT PERSON IS TOUGH/BITTER FOOD. In accordance with this, a person is perceived to have sweet meat *laHmt-i Hlu-wa* (I have sweet meat) when he is subject to people’s gossip and attacks. A person with bitter meat *laHm-i morr* (I have bitter meat) is, however, someone capable of facing people’s attack and denouncing them. He is hardly subject to people’s attacks” (Dakhlaoui, 2012: 8).

The metaphorical scenario of framing human beings in terms of food exploits the difference between raw and cooked food to frame degrees of experience. The path that a person goes in to accumulate experience is metaphorically projected on the different steps that a food undergoes to move from the state of being raw till the state of being cooked. The expression (10c) is motivated by the conceptual metonymy PART OF THE BODY FOR PERSON with its two versions HEART FOR PERSON and HEAD FOR PERSON and the conceptual metaphor A HUMAN BEING IS FOOD. An experienced person who accumulated experiences is conceptualized in terms of a fully cooked food or a ripe fruit. The movement from the state of raw to the state of being cooked requires different cooking techniques depending on the meal being cooked. Time is crucial for cooking food. Similarly time is

determinant for someone to accumulate experiences and acquire knowledge. The Schema of cooking serves to conceptualize people's life scenarios.

Meal ingredients are collected	————→	People come to life and live together
The ingredients are mixed	————→	People interact with each other
The ingredients are put on the stove	————→	People are put in difficult situations
The ingredients are half-cooked	————→	People learn and still make mistakes
Food acquires with time a specific taste	————→	People acquire knowledge
The ingredients are fully cooked	————→	People become experienced and wise

The time spent in cooking a food is projected on the time people spend to become wise and experienced. Throughout the process of cooking the food undergoes different changes and forms. These changes are mapped on the changes that people know throughout their lives particularly in terms of accumulating mistakes and consequently acquiring experiences. This schema is filled in TA in the following way: an inexperienced person is conceptualized in terms of raw food (10d), a person who lacks experience is conceptualized in terms of half-cooked food (10e), and mature experienced persons correspond to well-done food (10c). In expression (10c), the heart stands metonymically for the person. The metonymies PART FOR WHOLE and ORGAN FOR PERSON account for the understanding of this expression. Being the site of the emotions the heart encompasses the wisdom acquired and the development of the emotional intelligence. The latter is acquired with age after undergoing various and particularly different experiences. These everyday TA expressions serve as further illustrations of the relevance of the food domain in serving as an experiential to express views about experience in TA. In French, however, an inexperienced person is framed in terms of a green fruit that is not ripe yet *Jeunesse verte* (at the green age). Similarly in English we talk of *youthful person at their green ages*.

The two cultures select the feature of tenderness to frame lack of experience and inability to face hardships:

(11)

Raas il-lHam

Head [of] the meat

He is stupid (cabbage head)

Each culture uses its own meal or food type to qualify human beings. Stupidity is framed in terms of food types. In TA, a stupid person is captured in terms of meaty head. *Raas il-lHam*(head of meat, Stupid). It seems that the abundance of meat contradicts the existence of other organs. Physiologically speaking, a meaty head leaves no room for the brain. The brain being essentially the tool of thinking and the site of human intelligence should be logically placed in the head. A meaty head is equated with stupidity since it leaves little or almost no place for the brain to exist or at least to function. Thinking has always been associated with making up one's mind. Making up one mind involves making this organ active physically. The physical activity of the mind means its ability to face problems and beats them i.e. solve them. The TA expressions *Xaddem moxx-k* (switch on your mind) and *Hil moxx-k* (open your mind; switch on your mind) are used to invite people to find solutions to problems through activating their minds. In TA the mind serves as a productive source domain to conceptualize different human traits. The description of the human mind is built on contradictory states. The mind in TA can be open *moxx-u maHlul* (His mind is opened), closed *moxx-u msakkar* (His mind is closed), clean *moxx-u nDhiif* (his mind is clean), dirty *moxx-u immasax* (his mind is dirty), big *moxx-u kbiir* (His mind is big) and *moxx-u sRiirr* (His mind is small). These different descriptions frame respectively intelligence, stupidity, honesty, wickedness, wisdom and irresponsibility. The metaphorical scenario of the mind in TA frames it as an entity that undergoes different contradictory states and shapes to frame opposing human characteristics. These expressions can be viewed as linguistic realizations of the basic metaphors OPEN IS GOOD, CLOSE IS BAD, BIG IS GOOD, SMALL IS BAD, CLEAN IS GOOD and DIRTY IS BAD.

In English *a cabbage head* is used to frame a stupid person. The English culture selects this vegetable to qualify stupid persons. This vegetable is relatively a big one compared to other vegetables such as tomatoes and potatoes. Another important characteristic of this vegetable is its stuck leaves with almost no space between its different layers. The main feature of this vegetable is compactness. This compactness is exploited to conceptualize stupidity. While intelligence is the ability to make up the mind, be imaginative and devise solutions to the encountered problems, stupidity is associated with lack of movement and stagnation. This expression and its Tunisian counterpart *Rass il-lHam* (Head of meat) are governed by the conceptual metaphor a HUMAN BEING IS FOOD and OPEN IS GOOD and two primary

metaphors OPEN IS GOOD and CLOSE IS BAD along with the conceptual metonymy ORGAN FOR PERSON. On the other hand, the French language selects milk;*soupe au lait* (a milk soup, an easily enraged person) to frame a rapidly enraged person. This mapping selects the main feature of the milk soup which it is rapid change into a boiling soup. This abrupt shift from calmness to boiling is used to capture the movement from the state of placidness to extreme anger. Apart from A HUMAN BEING IS FOOD, the conceptual metaphor AN ANGRY PERSON IS A HEATED FLUID IN A CONTAINER governs the understanding of this expression. The TA cultural scenario of anger exploits the same liquid that undergoes a change in its state to frame anger. The TA expression *rawab-li dam-I* (He made my blood a sour milk) is used to frame extreme anger. The TA cultural scenario for the metaphor is not a heated a fluid but rather a fluid changing its state. The expression is governed by the conceptual metaphor AN ANGRY PERSON IS A CHANGING FLUID and not AN ANGRY PERSON IS A HEATED FLUID IN A CONTAINER. The cultural configuration of this metaphor accounts for the variation in this metaphor. This metaphor is governed by a combination of the complex metaphors A HUMAN BEING IS FOOD, the primary metaphor SOUR IS BAD, and the bodily based metaphor AN ANGRY PERSON IS A CHANGING FLUID along with the conceptual metonymy ORGAN FOR PERSON. The combination of the metaphors and the interaction with the metonymy do seem to be a cultural product. This combination seems to account for the variation and clarifies the influence of the socio-cultural environment in allowing, constraining and also modifying the mapping. In the TA expression we map knowledge about the state of human blood to frame angry persons. The fluid exploited is blood. It is not heated but rather turning into a different state. Unlike normal milk, the sour milk is known to be unctuous. This change in the state of this fluid is mapped to frame state of the blood of an angry person.

The TA culture selects specific food types whether they were in their natural state or after undergoing some modifications after being subject to a panoply of cooking and preparation techniques. This versatile experiential is exploited differently across cultures. Each culture selects its own food type and its cooking techniques to frame human beings' traits and emotions in different ways:

(12)

- (a) Flan 3osbena
- X is stuffed tripe

He is a nervous person

(b) 3asbenn-i

He made me stuffed tripe

He made me nervous

The Tunisian Arabic cuisine exploits a very specific cooking experience to frame a nervous person (12a). The experience of cooking stuffed tripe involves a lot of complexity. The stuffed tripe is distinct food of the Tunisian cuisine. This food type is cooked particularly in the holy feast. The cooking of the stuffed tripe involves a lot of preparation. The stuffed tripe is made of lot of ingredients including among other things vegetables, meat, rice, spices. The preparation involves also cutting the tripe into small pieces of different sizes and then sewing these pieces and leaving only one entry to put inside the mixture prepared in advance and then sew it again to close the entrance and obtain ball-like pieces of stuffed tripe. All this experiential is recruited to frame a nervous person. The difficulty involved in preparing this food is projected on the difficulty involved in dealing with a nervous easily enraged person. Choosing a stuffed type of food and not a food in its natural state seems coherent with the primary metaphor CLOSE IS BAD. While compactness is associated with lack of movement and stagnation, openness is positively perceived in the culture. As explained above, a close mind in the two expressions *moxxu msakker* (He is close-minded) and *Rasu mlaHem* (He has a meaty head) serves to conceptualize respectively obstinacy and stupidity. These two negative traits are captured in terms of compactness. Along with this configuration, framing a human being in terms of a compact food type to conceptualize anger seems coherent. Anger has always been associated with recklessness and inability to take good decisions. The expression (12b) refers to the action of making stuffed tripe to frame making someone enraged. The state of collecting a mixture of food types onto one closed ball-like entity is projected on the situation of moving a person to the state of anger that is causing him or his mind to be close. The movement from openness to closeness serves as a schema that serves to conceptualize different states of minds and emotions. Anger being as an intensive emotion is captured in terms of closeness. The cultural scenario of this metaphor A ANGRY PERSON IS A STUFFED FOOD is different from the universal bodily-based metaphor AN ANGRY PERSON IS A FLUID IN A CONTAINER. The effect of the culture on the way how TA speakers conceptualize anger does not only intervene with the elaboration of the bodily-based metaphor through defining the type of the fluid or by changing its nature. Instead the effect of

the socio-cultural context leads to the emergence of a new mapping exploiting the experiential of preparing and cooking a food type particular to the culture in question. This accounts for the cultural specificity of food metaphors. The abundance of the food-related expressions in TA highlights the productivity of this domain which makes it serve to conceptualize human traits and emotions:

(13)

(a) Flan Hilba

X is a fungreek

He is a feeble person

(b) Flan Tmatim / zebda

X is tomatoe / butter

He is exhausted.

The food domain is also recruited in TA to frame weakness and exhaustion. The fenugreek (13a) seed is known for having high nutritional benefits. Its distinct feature is however its pungent smell. The seed is mainly consumed after being grinded and mixed with water. This food type is mainly consumed in summer to quench the feeling of thirst. Many people avoid consuming it despite its nutritional benefits because of its pungent smell which appears on the consumer through his sweat. This distinct feature is used to frame weakness. Unlike many other food types, particularly fruits and vegetables which join the delicious taste and the attractive smell, the seed of fenugreek is known for its pungent unpleasant smell. This food type serves to conceptualize human being with very limited capacities.

Other food types are similarly recruited to frame physical exhaustion (13b). In TA we frame a very tired person in terms of tomatoes, vegetables and butter. It seems that there is an intra-cultural variation in the conceptualization of exhaustion¹³. Tomatoes and butter are known to be soft food types easily eaten and cut. This softness serves to frame the situation of physical vulnerability caused by exhaustion. This expression is governed by the conceptual metaphor

¹³ I presented one of these examples (Flan XoDra, X is vegetables) in a conference in 2012 in Tunisia. During the discussion, TA speakers among the audience told me that in their regions they conceptualize exhaustion differently still using food i.e. tomatoes.

A HUMAN BEING IS FOOD and its versions VULNERABILITY IS SOFTNESS and A FRAGILE PERSON IS A SOFT FOOD.

The above discussed examples demonstrate that the TA cuisine with its various elements is almost fully at the disposal of TA speakers to exploit food types in capturing human traits. The food types analysed above prove that the high familiarity with food is part of TA speakers' conceptual system, which allows them to conceptualize abstract experiences, understand them and communicate with them through the food domain. The high productivity of the food domain is also highlighted through the big number of human traits captured in terms of food types. The analysed examples have shown also that the socio-cultural context influences so much the creation and the understanding of metaphors. When put into comparison with some of their English counterparts, the effect of the culture was brought to light. The cultural preference through hiding or highlighting certain mappings (Kövecses, 2005) was very much apparent in the discussion of the examples above. The human trait of stupidity was understood through mapping knowledge about meaty heads in TA and cabbage in English.

4.2.2 Food for human traits in French

Many food types are recruited to frame human traits. People's repetitive experience with food provides many concrete elements ready to be mapped onto human traits. The closeness to different food types and the kinaesthetic experiences with food types whether before eating through touching, seeing, smelling and cutting...or while eating and the different tastes the food types may have, provide a set of common knowledge ready to be mapped onto more abstract domain and figure out psychological and physical experiences.

(14)

(a) sauce au lait

X a sauce with milk

He is a very nervous person

(b) c'est une vraie pomme

It be [IMPERF] a real apple

He is a naive person

(c) être tout sucre tout miel
Be [INF] all sugar all honey
He is an attractive person

(d) Avoir la tête comme une citrouille
Have [INF] the head like a squash.
He is very busy

(e) Bête comme un chou
Stupid like cabbage.
He is stupid

(f) Avoir un pois dans la tête
Have[INF] a pea in the head
He is stupid

The different food types selected to frame different human traits vary considerably. They include fruits, vegetables, cooked food etc. The dichotomy between delicious foods and tasteless ones is employed to frame opposing characteristics. A socially accepted person is framed in terms of sweet delicious food. SWEET IS GOOD is common in the three languages and it seems to have a cross-cultural similarity. Socially appreciated persons are conceptualized in terms of sweet food (14c). The French expression ‘*être tout sucre tout miel*’ (to be too sweet like sugar and honey) exploits sweetness to frame socially appreciated persons. Being a sweet delicious food is sometimes negatively perceived in the culture when it comes to framing naivety. The French language selects the apple to frame naivety and hence possibly being dominated by other persons (14b). The French expression *être une vraie pomme* (to be really an apple) maps knowledge about the easy manipulation of an apple and its being a food ready for eating by human beings in order to capture the possibility of their dominance. In TA a naïve easily manipulated person is conceptualized in terms of a sweet food; the porridge. The TA expression *lqa-h 3sida l-lbal3an* (He is an easily swallowed porridge) recruits the features of sweetness and easy swallowing to frame naïve and easily deceived persons. The porridge is a sweet food, cooked with flour and its eating does not involve its chewing into the mouth. It is rather swallowed effortlessly. The effortless way of manipulating easily eaten food serves a source experience to understand easily manipulated persons.

The selected food type	The corresponding meaning
- sauce au lait (a milk sauce)	- A nervous person
- c'est une vraie pomme (an apple)	- A naive person
- être tout sucre tout miel (a sugar / honey person)	- An attractive kind person
- Avoir la tête comme une citrouille (a squash head)	- mental preoccupation
- Bête comme un chou (Stupid like cabbage).	- stupidity
- Avoir un pois dans la tête (To have a pea in the head)	- stupidity

Table 8: some food types and their corresponding meanings.

Some vegetables in French are recruited to frame stupidity. The Human being is compared to a cabbage (14d) or is said to have a pea in the head (14e). Both scenarios are used to capture stupidity. The first possible interpretation lies in the particularities of the cabbage plant. This round vegetable is characterised by having a big number of leaves that are so stuck together making them sound more like layers. Another feature of this vegetable is the absence of a kernel inside. Knowing that the kernel represents the central part in a fruit and in some vegetables, this particular feature of not including a kernel will serve to frame a head without a brain or a body without mind. In TA a stupid or a foolish person is similarly framed in terms of a mindless person. The mappability of this fruit onto human beings selects the characteristic of not having a kernel but also it may select the particular characteristics of the cabbage which is having stuck leaves. This type of vegetable shares this particularity only with the lettuce which produces the salience of the feature in question. Having stuck leaves contradicts movement and limits the spaces of manoeuvre. This inflexibility contradicts the essence of the human mind which should essentially be a dynamic active and a moving one. The second selected vegetable is the pea. This very small vegetable is mapped to the human mind. The head and the mind are metonymically joined and the PART FOR WHOLE metonymy accounts for using the mind and the head interchangeably. Having a pea in the head is used to frame stupidity. The conceptual metaphors STUPIDITY IS SMALLNESS OF THE MIND and SMALL IS BAD govern the understanding of this expression. The small fruit is used not for eating but to be placed imaginatively in the head. The original place of peas in the human body should be the stomach. This vegetable moves up and settles in the

head to frame stupidity. The head is commonly viewed as exclusively containing the brain. The existence of another object in the head reduces and even annuls the importance of the mind. In TA wisdom is associated with bigness of the mind. The TA expression *flan 3aql-u kbiir* (He is a wise person) is governed by the conceptual metaphor BIGNESS IS IMPORTANCE and the expression *flan 3aqlu sRiir* (He is a dull person) is an instantiation of the conceptual metaphor SMALNESS IS TRIVIALITY.

The French language selects its own particular food types to frame human characteristics. The different linguistic expressions analysed so far can be subsumed under the conceptual metaphor A HUMAN BEING IS FOOD. People's subconscious knowledge about food types facilitates figuring out the complex human behaviour in terms of food types. This metaphor seems to embrace many linguistic expressions to their variety. The wide variety of food terms used metaphorically points to the high productivity of this domain. It also places a pressure on the metaphor in question in the sense that it may stop short of accounting for the detailed mappings used in food metaphors. Since people's experiences with different food types vary considerably across-cultures, the analysis should provide more support for the generic metaphor A HUMAN BEING IS FOOD and target the possible variations arising from the socio-cultural context along with people's shared understanding of the particularities of the food type active in the mapping. Thus responding to one important objective of the present study which is 'to pay sufficient attention to the importance of culture and society in human cognition, in the motivation of linguistic structure, and in the acquisition of language' (Sinha and Jensen de López, 2000: 22).

4.2.3 Food for human traits in English

Different food types are recruited to frame personal traits in English. The selection of these food types does not seem to obey a particular organisation since these food types vary widely. These food types include raw food, cooked foods, containers for food, vegetables, etc. People's experiences with these food types does not seem to have a particular significance, however, the language selects these food types and not others to frame human characteristics. This seemingly arbitrary selection can be investigated in the depth it deserves when analysing the roots of the mapping of the food domain onto human beings in later parts of the present study.

The conceptualization of human traits in terms of food types/tastes represents a common feature shared by the three languages. People qualify food essentially on the basis of deliciousness before they move to depicting details such as the shape, the colour, the smell, etc. This experiential is abundantly exploited in the three languages to frame human traits. People's experience with food is subjective and very much influenced by the cultural environment. This can account for the variation between the three languages since each language selects its own food type to qualify human beings, conveys the knowledge of its users and uses the cultural filters to constrain or allow the mapping:

(15)

- (a) The apple of the eye
- (b) muffin
- (c) pumkin
- (d) sugar
- (e) a cupcake

In these expressions, the domain of food is exploited to frame cherished human beings. These appellations bear emotional communicative meanings added to their metaphorical meaning. These expressions of endearment frame human being in terms of a sweet food. These expressions are governed by the conceptual metaphor A HUMAN BEING IS FOOD and its version SWEET IS GOOD. The combination of these two metaphors results in A GOOD HUMAN BEING IS SWEET FOOD. These expressions are used to express endearment. The food types chosen are mainly delicious soft sweet food that can be productive for human beings with positive physical or moral characteristics. These characteristics are very much influenced by the speakers using them since they view their interlocutors, cherished persons to their hearts, persons with highly positive characteristics hence their framing in terms of sweet delicious food types. In the expression (15a) a human being is framed in terms of a sweet delicious fruit very much appreciated in the culture¹⁴. However the value of this fruit is more highlighted when it is put in human organ which the eye. This metaphorical image

¹⁴ The apple has a distinct value in the English culture not because of its delicious taste but rather due to its therapeutic effect. The culture acknowledges the high nutritional benefit of this fruit to the point of enabling its daily consumers to efficiently avoid sicknesses. A claim hyperbolically stated in the proverb 'an apple a day keeps the doctor away'.

connects a human being to an extraordinary apple, very much distinct from everyday apples, since it is placed in the eye. The eye bears a mental faculty in this expression in the sense the heart is known to be the site of emotions. Endearment in this expression happens via the eye; an organ that establishes the first contact with the person in question. In the expressions (15b, 15c, 15d, 15e) the language selects food types soft, sweet and delicious to frame beloved human beings. The distinct feature of sweetness serves to conceptualize appreciation and acceptability. Though these expressions are used for endearment, they are in harmony with the metaphorical configurations of food metaphors used to frame human traits. The basic metaphor SWEET IS GOOD accounts for the understanding of these expressions. It appears that the conceptual metaphor SWEET IS GOOD constitutes part and parcel of the English speakers' conceptual system. The socio-cultural context intervenes through defining which type of sweet food will be used in the mapping. The importance of this conceptual metaphor will be highlighted in the upcoming expressions used to frame attractive persons, particularly women:

(16)

- (a) a cupcake
- (b) a peach
- (c) a tomatoe

The food related terms selected to capture beautiful attractive women belong also to the sweet food types (the cupcake, the peach). Another food type that is similarly used to frame beauty of women is the tomato. These food types share the beautiful shape and appearance and also the delicious taste. Food types serve also to capture women traits mainly beauty and youth (16a, 16b, 16c). These features are commonly figured out in terms of food. There is symmetry between physical hunger for food and physical hunger for sex. There seems to be a strong systematicity between the expressions of food with their different patterns particularly hunger, desire and satisfaction and the expression of sexual practices and feelings. Emanation (1995) describes the eating schema with its different parts and how it is exploited to describe sexual practices. He claims that “the basic shape of the experience of hunger and eating is transferred to the sexual domain. A schematic gestalt based on a repeated pattern in experience of feeling hungry, looking for food, obtaining some, eating it; and being nourished and feeling satisfied lends its internal structure to the experiences of lust and sex” (Emanation, 1995: 169). Conceptualizing sexual feelings and practices in terms of hunger and eating are motivated by

'The schematic isomorphism' between the act of eating and the sex act and the psychological connection between eating and having sex in the sense that both of them are caused by a desire and result in satisfaction. One way to account for this connection is that our embodied interactions in the world provide the fundamental 'shape' of experiences, and that our cognitive abilities perceive and further abstract and schematise those basic shapes. Both of course, get filtered through the culture to which we belong (Emanation, 1995). The eating experience is present implicitly in the mapping. People's unconscious knowledge about a given food subsumes the set of features characterising that food including the way of preparation, shape, colour, smell, taste and the resulting feelings of pleasure. The metaphorical connection gives rise to all this knowledge allows for mapping desire for food with desire for sex and also the satisfaction for pleasure. However this physiological experience of desire and hunger for food which is equated to desire for sex seems to bear cultural imprints and this may account for the interaction between body and culture in metaphorical creation and usage. While the desire for food is common for all human bodies, the type of the desired food is particular to cultures. The English language selects sweet foods (cupcake) and (spicy food) to frame the sexual attractiveness of a woman. Conversely, TA speakers frame a sexually attractive woman in terms of meat *malla Habra, malla laHma* (what a meat, She is sexy). This example explains the interaction between body as a source motivating many of our metaphorical connection and that our bodily hunger for food serves to conceptualize people's desire for sex while the culture selects the desired food to frame the same desire for sex:

(17)

- (a) He's a string bean
- (b) He is a bean pole
- (c) dumpling
- (d) a tub of lard
- (e) carrot top
- (f) cauliflower ear
- (g) egg head
- (h) a breadbasket

The following expressions serve to frame human physical appearances. The physical resemblance between the food types mentioned above and the human physical appearances.

The image metaphor of the string bean is used to capture height and thinness (17a, 17b). This vegetable is characterized by being long and thin. This image serves to recruit being physically tall and thin. The feature of being green is not selected because it is shared with many other vegetables. The TA language selects a different food type to frame the same feature. In TA a thin tall person is called metaphorically *banana* (a banana). TA language uses some foreign terms resulting from social and historical factors. This term is recruited from the French language and undergoing a syntactic rule of a female noun. The same features of being long and thin applies here to another food type which is banana. Each language selects, seemingly arbitrarily, its own food type to frame the same physical traits. A tall thin person is a banana in TA and a string bean in French. The two cultures select different food types to conceptualize the same physical characteristics.

Along with resemblance metaphors knowledge about the dumplings is recruited to describe slightly fat women. The ball-like shape of dumplings serves to conceptualize fatness. The food type selected is very much different. The language selects a natural food to conceptualize thinness and a cooked food type is used to frame obesity. It seems that the choice is not arbitrary. In fact, thinness is closer to the original form of a human body. Obesity is however involves that the human body has undergone some kind of alteration. Obesity is also framed in terms of tub of lard (17d). Framing a fat person in terms of a container full of food highlights the idea of fullness. Similarly in TA, food types are recruited to frame obesity and thinness. While obesity is framed in terms of a potato sack *škara baTaTa* (She's a potato sack, She's obese), thinness is framed in terms of the pasta type spaghetti; *malla spaghetti* (What a spaghetti, He's very thin). The physical resemblance between these food types and the physical appearances of obesity and thinness motivates the metaphorical connection between these food types and human beings. Not only are food types recruited in the two languages to frame the overall shape of the human body but also to capture peculiarities of some body parts.

In the expressions (17e, 17f, 17g, 17h), food types are exploited to frame particular human organs. The peculiarity of these human organs seems to put some pressure on the speakers of the language which may lead to the production of resemblance metaphors (Kövecses, 2005,

2015). The concreteness and uniqueness of some food types features serves to conceptualize specific physical human traits. In expression (17 e) the carrot's distinct feature of red orange colour is selected to frame persons with a red head. The French expression *poils de carottes* (carrot head) is similarly used to frame red-haired persons. The English language selects features of the egg to frame human beings. In the expressions *bad egg, good egg and rotten egg*, the food type is used to frame psychological traits of honesty and wickedness. Conversely in the expression (17f) the physical feature of baldness is conceptualized in terms of an egg. The image metaphor is built on the resemblance between the oval shape and the softness between the egg and the bald head. The cauliflower is exploited in expression (17g) to frame boxers' ears. The bumpy surface of the cauliflower is the distinct feature highlighted in this expression to capture the image of boxers' ears which are generally uneven ears and they have undergone distortions because of beats throughout different competitions. Food containers are also used to capture human beings body parts. In the expression (17h) the human abdomen is likened to a bread basket. The bread is used metonymically to stand for food in general BREAD FOR FOOD. This expression is governed by the conceptual metonymies BREAD FOR FOOD and PART FOR WHOLE and the conceptual metaphor A HUMAN BEING IS CONTAINER FOR FOOD.

Meanings of triviality, stupidity and craziness are framed in terms of food types. Similarly, honesty, smartness and social acceptability are conceptualized through food types. The dichotomy between delicious appreciated food and horrible, disgusting and unwanted food is projected on the meaning of linguistic metaphors using food-related terms. Following the great chain metaphor theory, the highest feature of a food type is selected to be mapped onto human beings. In the English expression *cool as a cucumber* the feature of being cool is selected to be mapped onto human beings. The cucumber is known to be a soft digestive vegetable used mainly in salads and sandwiches. Unlike the chilly pepper which is known for being hot or the apple which is known to be sweet and attractive, the main feature of cucumber is its fresh taste and light effect. The cucumber is good for health and 'cool' to the body. The light healthy effect of cucumber is its main feature summed up in being cool. This coolness is projected on human beings to frame cool persons whose effect on others is light and appreciable:

(18)

- (a) small fry
- (b) little shrimp
- (c) half pint
- (d) huckleberry
- (e) chopped liver
- (f) make mince meat of someone

In English some food metaphors serve to conceptualize human characteristics. These food metaphors are built on resemblance. The metaphor SMALL IS TRIVIAL builds a connection between physical shape and importance. The smaller the food is, the more likely it is used to frame people who are either small physically or morally. In the expressions (18a, 18b, 18c) littleness is explicitly mentioned in the metaphorical expressions and attributed to food types through the words half, little and small. These expressions are governed by the metaphor SMALL IS UNIMPORTANT. The physical smallness of food serves to frame people with little importance. In expression (18a) a human being with little importance is framed in terms of a very simple basic type of food; small fry. This type of food is generally less appreciated from other type of meals hence framing people with no importance. Likewise, a small person is framed in terms of a little shrimp (18b). This expression is governed by the conceptual metaphor SMALL IS TRIVIAL. Similarly, a short, insignificant person is conceptualized in terms of half pint (18c). While the feature of the first source is being small, the feature of the second source is being being half-full or half-empty. While fullness serves to conceptualize abundance and importance, emptiness is used to frame triviality. This echoes plainly in the French expression *mi-figue mi raisin* (half-fig, half-raisin) used to qualify unimportant or at least average situations, actions and/or human beings. In expression (18d) smallness is conceptualized through the mapping from a fruit the feature of which is being too small. The relationship between the huckleberry occupying the second position in the great chain of being as a plant and human being placed in the highest position accounts for the understanding of this expression. The highest feature of this fruit is smallness. This feature is selected to frame small persons.

Food metaphors in expressions (18d) and (18e) exploits food undergoing some cooking techniques namely chopping and slicing. The high productivity of the food domain does not only arise from the various type of food but also from the cooking methods and techniques used to prepare different meals. Chopping liver and slicing meat are exploited to capture

human beings with little importance. A human being is metaphorically connected to a chopped liver when he/she is never praised for his actions no matter how important they are. The English culture selects the liver as a food in a particular situation which is being chopped to frame persons who are never thanked. On the other hand, the TA language selects meat to frame human beings who are not praised for their actions. The TA expression *ki-lkrouma mitakla maDhmouma* (He's like the throat meat always eaten and always criticized). Each language selects its own food type to frame the same target. This is an aspect of metaphorical variation in the present study. Food metaphors conceptualize the same target through distinct food types. This highlights the effect of the socio-cultural context in the understanding of metaphors and their production. Food metaphors are influenced by their socio-cultural context because it allows specific food types to be active in the mapping particularly when these food types have salience presence in the minds of the speakers of the language in question. In the expression (18e) the cooking technique of slicing meat is used to frame domination and humiliation. To humiliate someone in English is to prepare him/her for being eaten. Humiliation in TA is framed in terms of eating experience. The TA expression *Klah makla* (he did eat him thoroughly, He thoroughly dominated him). Domination is a concept commonly conceptualized in terms of food type and/or experience across the three languages. The culture intervenes with selecting the way domination takes place. The metaphorical scenario of humiliation can be preparing food for cooking (slicing meat in English), cooking (to cook someone in TA means to dominate him mentally through influencing him to do or not to do some actions), eating (a scenario common to the three studied languages). Metaphor creation and understanding seem to depend heavily on the socio-cultural context. The productivity of the food domain is traced back to the variety of food types and experiences. These experiences are mostly culture specific. They constitute a depository of familiar experiences ready to map abstract domains. The mapping varies across culture mainly because of the effect of the socio-cultural context despite the common bodily experiences with food:

(19)

- (a) He is an apple knocker
- (b) Chowder head (clumsy stupid person)
- (c) Pudding headed (stupid)
- (d) Crumb (a repellent, worthless person)
- (e) Crackers (crazy person)
- (f) A fruit cake (fool)

- (g) A potato head (fool)
- (h) Bad egg (naughty boy)
- (i) rotten egg (a despicable person)
- (j) saucy (rude)

Food types are equally exploited to frame mental weaknesses. A human being is compared to a small food to frame physical smallness like in examples (18). The expressions in (19) revolve around the meanings of craziness and stupidity. These two human traits are framed in terms of food types with particular characteristics. The metaphorical scenario is built on altering the original state of a food type. In examples (19h, 19i) the egg as a food type is selected then it is given a negative description. (bad, rotten). These framings are mapped onto dishonest human beings. Another possible scenario is framing human beings in terms of food is through a resemblance between a human organ and a food type (19g). Craziness and stupidity are generally associated with the brain. The latter is located in the head. The human organ associated with thought, intelligence, stupidity, etc. Stupidity is captured in terms of having a food in the head across the three languages (chowder head, pudding head, cabbage head, and potato head, having a pea in the head, having a meaty head). These expressions are governed by the metonymies ORGAN FOR FUNCTION and ORGAN FOR PERSON and the metaphor A HUMAN BEING IS FOOD.

Food terms are also exploited to capture repellent persons. The terms crumbs is used (19d) to frame repellent worthless persons. The highest feature of this food is being left out and never eaten. The eating scenario is recruited here to frame rejection. People generally appreciate some food types and reject others. Human beings are framed in terms of rejected food types when they are worthless and repellent. This expression is governed by the conceptual metaphor A HUMAN BEING IS FOOD and its two versions APPRECIATION IS ACCEPTANCE and DISLIKE IS REJECTION:

(20)

- (a) good egg
- (b) you are the cream in my coffee
- (c) smart cookie

(21)

- (a) cool as a cucumber
- (b) flavour of the month
- (c) egg on the face
- (d) Mealy-mouthed

Selected food types	Their corresponding meaning
- A bad / good egg	- dishonesty /honesty
- A string bean	- Thin tall person
- cheesecake	- a beautiful woman
- cabbage head	- stupidity
- cucumber	- being cool
- cupcake	- attractive young woman
- crumb	- disgusting person
- cornball	- countrified person
- hard-boiled	- a hard-hearted or heartless person
- long drink of water	- a tall and thin person
-milk toast	- shyness
- saucy	- spirited person
- mealy mouthed	- deceitful / dishonest person
- Chopped liver	- a person who is never respected or credited.

Table 9: Some food types and their corresponding meanings in English

The above cited examples are viewed to be governed by the conceptual metaphor A HUMAN BEING IS FOOD. The culture selects each time particular food types with salient characteristics and maps them onto human beings. Whether being raw, cooked, green or ripe, food types are abundantly present in English to frame human traits. A human being is compared to an egg, a cupcake, a dish, beans etc. This mixture of food types is so present in the mind of English speakers since it reveals the underlying knowledge to be mapped onto

less delineated domains. People's experiences with these different types of food has equipped them with the required knowledge on how to deal with these food types along with their tastes and the degree of their appreciation to them. All the food related knowledge is activated when mapped onto other domains. The expression '*he is a bad egg*' brings about and then activates people's knowledge about bad eggs and how this kind of eggs must be left out because of the harm it may cause. This knowledge when mapped onto human beings serves to figure out the human trait of wickedness. Wicked persons are best seen left out because of the harm they may provoke.

4.2.4 Conclusion

The discussion of the examples in this section shows that the embodied experience of eating serves to conceptualize different concepts. The understanding of these different terms is mediated by the culture. Throughout these examples we notice that the three cultures/languages agree in framing emotions metaphorically through the eating experience but each culture selects its own 'meal'. While eating the heart expresses a feeling of sufferance in TA and English, the French culture does not select this organ for eating. The interaction between the embodied action of eating and the cultural context accounts for this difference. Eating the heart was filtered by the French culture and did not appear to the surface in the form of a linguistic metaphor to frame sufferance. Alternatively, the French cultural filter has allowed other scenario to get through and appear to the surface in the form of a metaphorical scenario where another organ is eaten but not the heart.

Relevant senses associated with eating	TA	English	French
- eat one another (dominance)	+	-	+
- eating with the eye (avidity)	+	-	+
- eating the heart (grief / suffering)	+	+	-
- eating the face (embarrassment)	+	-	-
- eating the head (death)	+	-	-
- eating the self (anger)	+	-	+

Table 10: examples of some relevant senses associated with eating in TA, English and French.

All the above cited examples reveal three important conclusions about food metaphors. First, the food domain seems to exhibit itself abundantly in the three languages as a productive domain serving to conceptualize many abstract experiences. The food domain appears to be exploited in almost all its patterns to capture many abstract experiences. Second, the three cultures map knowledge about food types to understand human traits. Each culture uses its own food type sometimes to frame the same characteristic. A HUMAN BEING IS FOOD, AN EMOTION IS FOOD and AN ACTION IS FOOD are common to the three languages with its different manifestations varying widely across the three cultures. These metaphors may interact with other conceptual metaphors and metonymies to account for the understanding of some abstract domains in terms of food experiences.

4.3 Bread metaphors

This food type has a salient presence in the corpora and this can be accounted for by its wide use in the three cuisines due to its prevalent accompanying of different meals. People eat with bread many dishes and their need for pasta as a mandatory constituent besides fruits and vegetables explains their abundant consumption of bread. With regard to its nutritional benefit, along with different type of pasta, bread is known to be one type of complex carbohydrates that helps the body to consume sugar gradually throughout a relatively long

period and subsequently gives the body energy. The experiential with bread seems to define the way speakers use this term metaphorically to conceptualize abstract domains of experience. Across the three languages, Bread serves to frame integratively and through interaction between metaphor and metonymy effort, work, money and interest. The difference between the three languages defines the cultural model of bread in each language/culture. In the first part we will analyse bread metaphorical expressions in TA. Next, we will present the conceptualizations of bread in English. After that, we will view bread used metaphorically in French. Finally, we will discuss commonalities and differences across the three languages.

4.3.1 Bread in Tunisian Arabic

Bread occupies a remarkable presence in the Tunisian cuisine. The latter makes of stew, which is cooking different types of vegetables, individually, or with other vegetables and with or without meat, in a sauce, one of its main ways to vary its dishes and alternate them with regard to the availability of the vegetables throughout the different cultivation seasons. This stew must be eaten with bread. The centrality of bread in the Tunisian cuisine is projected also in many aspects of its daily life and accordingly has had important politico-economic repercussions¹⁵. Similarly, bread has a significant effect on the way TA speakers create, use and understand some food metaphors.

The food term 'bread' serves to conceptualize work or effort or one's occupation in general. Bread is employed metonymically as A PART FOR WHOLE to frame food in general. The food is then in an integrative way employed to frame money then at higher level the occupation producing that money and then at an even higher level the effort spent in that occupation. The metaphorical foci of bread in the TA culture varies from taste, method of baking and state on the one hand and as being drawn, having an end and being played with on the other hand.

Bread is used in TA metaphorically through featuring it in different tastes and states. In the following TA expression:

¹⁵ Bread is a product subsidized by the government in Tunisia and the government invest huge sums of money because of this subsidy. Whenever the government tried to remove, even gradually, this subsidy, this was met by massive social protestations that approximated a revolution in 1984.

(22)

(a) il-xobza morra

bread bitter

The bread is bitter

A bitter life.

(b) t-muut 3la l-xobz lmbassess.

You die [IMPERF] on bread roll

He adores bread roll

He knows which side his bread is buttered

(c) Y-sawar fi xobza.

He make [IMPERF] in a bread.

He is making money for bread.

He is earning a living.

Bread is framed in (22a) in terms of being a bitter food. Bitterness as being a food trait is negatively perceived and it is recruited to frame the suffering associated with working, having money and finally buying bread. The suffering in one's life in order to make a living is negatively perceived and affects the taste of the bread. Although the bread can be delicious but the physical effort to reach that bread is not such a pleasant experience. This expression is governed by the generic metaphor BITTER IS BAD. The physical experience associated with eating or even tasting a bitter food serves to conceptualize less concrete experiences involving undergoing a suffering in order to reach an objective.

Besides the taste, the way of baking the bread is recruited to frame different experiences. Some types of bread are baked in a specific way through adding much oil to it so it turns out softer to chew and more delicious. This type of bread serves to conceptualize easy experiences that do not involve much effort.

In this TA the particular type of bread is exploited to frame advantageous situation. Consuming bread roll is preferred to consuming occasional bread. Bread roll are even easier to chew and sometimes sweeter. The change in the taste and the state of the edible element serves to frame different degrees of effort involved in experiences. The less difficult the experience is, the more delicious the food will be. The conceptual metaphor DELICIOUS IS

EASY which in turn can be subsumed under the conceptual metaphor SWEET IS GOOD accounts for the understanding of this expression. In TA easy tasks are generally conceptualized in terms of very simple eating experiences and they vary from drinking water *sehla šarbit ma* (it is as easy as drinking water) to eating sweets *Halwa* (It's a sweet) and biscuit *baškutu* (a piece of cake). The pleasure associated with eating a sweet food defines the mapping. The pleasurable experience of eating an easily swallowed food is employed to conceptualize different experience involving the least effort to achieve one's objective. The objective in the text of the metaphor i.e. nurturing the body is mapped onto the overall objective of whatever experience and chewing the crunchy soft food corresponds to the degrees of the difficulties involved in the experience. It appears that eating soft food is an easy experience that can be projected on a number of other experiences which involve dealing with a difficulty and 'eating it' that is manipulating it to reach an objective.¹⁶

The state of the bread is similarly recruited to frame opportunism and reaching one's objective without making almost any effort (22b). A situation where a person is enjoying gaining an interest as a result of other people's effort is compared to cold bread *xobza berda*(cold bread). The specific feature of coldness of one's food whether it is specifically a bread or in generally a meal as in the TA expression *loqma berda* (a cold meal) is recruited to frame passivity and lack of activity. The physical correlation between coldness and lack of activity and conversely heat and activity and movement seems to account for the use of the feature of coldness. The body's heat correlates with the degree of activity. This metaphor can be subsumed under the more generic metaphors INACTIVE IS COLD and ACTIVE IS HOT.

The bread in TA frames one's living by capturing earning money out of work and the metaphorical scenario is of someone drawing bread. The act of drawing is essentially an act of creation and recreation. Whether it is imitating a really existing situation, or creating a new one, drawing moves something from imagination into reality. This isomorphism between drawing an image and making one's bread makes the metaphorical scenario of this expression. In both scenario, out of an effort, whether it is mental or physical, something is being created; the bread and the picture. The two mental spaces are created and then blended and the picture is bread and the result is earning one's living and having one's bread.

¹⁶ This echoes plainly in the above discussed example where the easy experience of dealing with a naive person is framed in terms of eating a soft sweet food; the porridge.

Not only is the bread drawn but also played with or gambled with, in the TA metaphorical scenario. The TA expressions frames bread in terms of a valuable possession played with or also gambled with:

- (23) Y-l3ib bxobzet wled-u
Play [IMPERF] with bread children his
He plays with his children's bread.
He is risking his own job

The metonymic conceptualization of one's job in terms of bread is later on employed metaphorically to conceptualize taking risk. The experience of taking financial risk is conceptualized in terms of an experience with food. Food in this situation is not prepared or cooked in a wrong way but rather played with. When we know the centrality of bread in the Tunisian cuisine, we accordingly give it a due importance. This highly valued food type should be preserved with care and must not be played with. The importance of bread approximates sacredness since bread is inclusively referred to as being God's purse and it is strongly forbidden to get rid of it inappropriately. The cultural model of bread in TA makes of it a valuable possession that must be preserved with care. Having bread, eating it and preserving it are associated with safety while danger is figured out in terms of playing with one's (children's) bread. Safety is associated with eating one's bread discretely *n-akil fi xobzt-I mserqa* (I eat my bread discretely) or having one's bread baked and oil preserved *xobz-ou maxbuz w zit-u fi l-kouz* (He has his bread baked and his oil preserved). These expressions can be subsumed under the generic metaphor AN ACTION IS FOOD with its two metaphors SECURITY IS HAVING BREAD and DANGER IS LOSING BREAD.

Bread occupies a remarkable position in the Tunisian cuisine and this centrality serves, through describing concurrent experiences, to conceptualize different abstract experiences. Bread is metonymically used as PART FOR WHOLE to frame food in general. The relevance of this food type in the eating experience in TA makes it serving to conceptualize one's living in general. Through compression bread subsumes the effort spent in an occupation, the job itself, the money gained out of this job and the food obtained out of the money. The cultural model of bread in TA places it in the center of the eating experience and this centrality makes

it serving in the conceptualizations of socio-cultural values of hard work, security, opportunism and recklessness.

4.3.2 Bread in English

Bread seems to occupy a central position in the English culinary settings. Yet, bread does not occupy this position by itself as it is the case in the Tunisian cuisine. It is rather accompanied with butter. The food type is not a single unique piece of or a loaf of bread but it is a duality of bread and butter.

(24)

- (a) bread and butter
- (b) bread winner
- (c) daily bread

This does not change much in the metaphorical meaning they convey. As in example (24a) bread and butter, these two basic food types, stand for one's source of income that is his/her main activity and the money gained out of this activity. The word 'bread' bears a metonymic dimension for food. Bread is metonymically used to serve the understanding of food in general. Based on the metonymy PART FOR WHOLE, speakers of English, conceptualize food in terms of bread. Unlike in TA, bread does not seem to bear an utterer representation for food since it is associated with two other food types; butter or water. Yet, bread serves to conceptualize integratively an activity, money and/or a possession. The generic image of bread makes of it a valuable possession. It is viewed as the objective and the means to reach that objective. Bread frames metonymically the effort, the money gained out of this effort and the overall food bought out of this money. The compression of meaning (Kövecses, 2010) can account for the understanding of the link between the list of interrelated elements and one type of food namely bread. The cultural image of bread revolves around food money and work. Expression like bread and butter is polysemous in English. It is very productive for conceptualizing action and their results. They are governed by the conceptual metaphor AN ACTION IS FOOD with its two submetaphors A BASIC ACTION IS A BASIC FOOD and JOB IS BREAD. Along with framing one's occupation, bread serves to conceptualize money (24b). The direct relationship between having money and buying food seems to be well elaborated through this metaphor which uses a basic type of food i.e. bread to capture a financial situation. Mapping knowledge about bread onto knowledge about money brings to

light the direct relationship between giving money and having food. It seems that this metaphor has historical backgrounds. In fact, before issuing the first currency people used to exchange goods in the form of bargaining in order to afford their needs. This exchange for food basically bread seems to be maintained and which makes it still present in the mind of English, TA and French¹⁷ speakers and that is why they conceptualize money in terms of bread.

The meaning focus of bread in English expressions revolves around mainly conceptualizing a human effort, his earnings and also money in terms of either bread or bread and butter. These two food types stand metonymically to frame through A RESULT FOR ACTION metonym, money in general. Bread acts as a generic schema in English and also in TA to conceptualize the actions done to earn money and have this bread. By conceptualizing either a job or a salary, the meaning focus of the metaphor AN ACTION IS FOOD with its two versions; A JOB IS BREAD and EARNING MONEY IS HAVING BREAD is centered around the schemas of work with its different parts having money, buying food and living a decent life.

4.3.3 Bread in French

The centrality of bread in the French cuisine exhibits itself abundantly in many metaphorical expressions used mainly to conceptualize LIFE in general through many of its actions. The conceptual metaphor LIFE IS FOOD and an ACTION IS FOOD governs the understanding of a considerable number of bread expressions in French. Bread is at the heart of the French table and its high experiential makes it serve to conceptualize different types of actions.

(25)

- (a) ‘il gagne son pain à la sueur de son front
He’s making his bread out of his forehead sweat
He is a bread winner

- (b) ‘prendre un pain dans la fournée’
to take bread in the oven
to do something prematurely

¹⁷This will be developed in the upcoming subsection which will conduct a metaphorical analysis of some bread expressions in French.

- (c) 'je ne mange pas de ce pain là
I don't eat that bread'
I never do such actions.

Likewise in TA and English, bread in French serves to conceptualize someone's job and/or his earning and thus referring to his possessions and his financial situation. Similarly, Bread is metonymically serving to conceptualize food in general. The conceptual metaphor BREAD IS JOB and the conceptual metonymy BREAD FOR FOOD are common across the three languages. In the French expression (25a) bread serves here to conceptualize one's earning. The metaphorical image is built on conceptualizing bread as a valuable possession to be fought for and achieved after a considerable effort. The competition schemas is present in this expression where someone is supposed to compete with and strive to win and not eat his bread. Winning involves a competition and bread is more a trophy or a reward. This expression is governed by the metaphor LIFE IS A COMPETITION or LIFE IS A WAR and A REWARD IS FOOD. The centrality of bread makes it a valuable possession to be fought for and to be won after a coarse struggle.

Like many food types, bread exhibits different states and can be cooked in different ways. Bread can be just cooked, well-cooked, half cooked, burned, hot, cold, fresh or even rotten. The French experiential with bread selects its state of being in the oven to frame premature actions. The French expression focuses on the place of the bread while taken i.e. eaten. Although the expression does not talk about the state of the bread in the oven (25 b) whether it is half-cooked or very hot, in both cases a premature action takes place. This experiential serves to conceptualize sexual relationship before marriage. Eating bread before being served captures the premature act of having sex before marriage. The concrete experience of eating a hot bread is exploited to frame a physically hot experience too. The second experience is generally less talked about and speakers recruit a more familiar act which is the act of eating to conceptualize the former experience. The understanding of this metaphor is built on the schematic isomorphism between the act of eating and the sex act. It is framed as follows

Eating = Having sex

Food = partner

Entering food into the body = Getting into a sexual intercourse

The meaning focus of this expression is the alteration of the eating scenario. The usual eating process normally takes place on a table after the food is being served. The metaphor scenario intervenes with the timing of the eating. Bread is not eaten when the table is set for the eating. Prematurely, bread is eaten in the oven. It seems that the experience of having a premature sexual relationship can be a challenging one pertaining to its forbidden nature among many conservative families. Following Yu model of decompositional account we can analyse the following expression as follows:

- 1- AN ACTION IS FOOD
- 2- A PREMATURE ACTION IS A FOOD IN AN OVEN
- 3- HAVING SEX IS EATING
- 4- PART FOR WHOLE
- 5- BREAD FOR FOOD
- 6- A HUMAN BEING IS FOOD
- 7- A WOMAN IS BREAD

The generic metaphors AN ACTION IS FOOD and A HUMAN BEING IS FOOD and the generic metonymy PART FOR WHOLE account for this type of conceptualizations. The mapping exploits eating a particular type of food which is bread when it is hot to frame sexual intercourse. The two corresponding versions of the above cited metaphors; HAVING SEX IS EATING and A WOMAN IS BREAD and the metonymy BREAD FOR FOOD governs the particular understanding of this metaphor. The French culture selects the particular type of experience of eating hot bread food to frame sexual act. In TA the framing selects different food types and different experiences of eating. The schemas of EATING, which defines the relationship between the eater and the food as a relationship of domination and full control, accounts for the understanding of the sex act in terms of an eating experience. The agent, who is the eater interacts with the dominated person; the food in different ways. The metaphorical scenario furnishes the schemas in a variety of ways. The metaphor can focus on a number of parameters such as the place, the manner, the timing and the circumstances etc. It seems that what defines the variation are these parameters that make the cultural specificity of the expression in question. Roughly speaking having sex is framed in terms of eating. The metaphorical scenario varies from one culture to another. In the French culture, having sex is framed in terms of hot bread that has just been cooked. The mapping is built on the list of

analogical correspondences between eating the bread in the oven and having sex before marriage. The metaphorical scenario of having sex in TA is similarly built on eating. The TA culture selects different food types dates and meat respectively in these two expressions '*l-mra kif it-tamra imsaH-ha w kul-h* (*The woman is like date wipe her and then eat her*)' and '*malla Habra* (*what a meat*)'. Moreover, in some expressions when the male eats the female in the expression '*kla-ha; (he ate her)*', TA speakers frame sex in terms of eating a whole human being. The scenario in this expression is built hyperbolically on eating the inedible.

Bread in French serves as well to conceptualize other types of action. The French expression in (25c) can be viewed as linguistic metaphor of the conceptual metaphor AN ACTION IS FOOD and its version ABAD ACTION IS A BAD FOOD. This expression selects a particular type of bread that is negatively perceived and its eating corresponds to a dishonest action. The French culture exhibits different types of bread to frame different actions. These different types bear different judgments and can also be neutral. A bread can be daily '*pain quotidien; (daily bread)*'. This expression serves repetitive usual actions. The salience of eating bread makes it serve as an experience to be mapped on a number of repetitive actions regardless of persons and their socio-cultural context. A daily bread corresponds to the different experiences that people live daily. A daily bread for a computer science engineer can be designing algorithms and programming, which is very much different from the daily bread of a doctor. The latter repetitively deals with patients and assign different treatments to them. This expression does not bear any judgment unlike the expression '*c'est du pain bénit; (It's a blessed bread)*'. Bread is qualified in this expression as being blessed. This expression serves to conceptualize very well done or well deserved actions. A well executed project can be described as blessed bread. This expression bears a positive judgment. Contrary to the above cited example, the food is positively perceived and it is recruited to frame positive actions. This example is governed by the conceptual metaphor AN ACTION IS FOOD and its second version A GOOD ACTION IS A GOOD FOOD. '*Manger son pain blanc le premier, (To eat his white bread first)*' is another expression that qualifies bread and is used metaphorically to frame preferable actions. A favourite action or activity is framed in terms of a white bread. This expression employs the colour to qualify bread. The conceptual metaphors AN ACTION IS FOOD and A GOOD ACTION IS A GOOD FOOD and WHITE IS GOOD govern the understanding of this expression. The parameter selected to qualify this type of food is the

colour. The timing is another influential element in the metaphorical scenario. When we do something first implies that we are eager to get into the experience. Temporal proximity serves here to frame likes and desires. Placing actions into order of preference is gauged by the time of performance. What we like most we do first and vice versa. The experience of eating serves a desired type of food serves to conceptualize preferred actions and thus classifying them into order of preference. The metaphor AN ACTION IS FOOD interacts with the metaphor TIME IS SPACE and its versions TEMPORAL PROXIMITY IS PHYSICAL PROXIMITY and PHYSICAL PROXIMITY IS PSYCHOLOGICAL PROXIMITY.

4.3.4 Conclusion

The metaphorical analysis of some bread metaphors across the three languages has allowed two main conclusions. First bread is commonly central to the culinary experiences and this centrality affects the way speakers of the three languages use bread metaphorically to frame more abstract actions and experiences. Second, Bread is qualified metaphorically differently across the three languages because each language/culture selects a particular aspect or state of this salient food type to conceptualize particular experiences.

The commonalities across the three languages/cultures use bread metaphorically to frame one's job and or effort to make money. The centrality and abundant presence of bread in the three cuisines makes it stand metonymically for food in general. The conceptual metonymy PART FOR WHOLE governs the representation of food in terms of bread in the three cultures.

4.4 People's experiences with food

People's experiences with food involve many body parts. The salience of the eating experiences makes it serve as a depository of concrete experiences ready to be mapped onto a number of abstract experiences. They will also serve to be reproduced and thus leading to novel metaphors. The scope of the eating experience covers the path that food covers to go from the outside inside the body. The expressions under investigation describe mostly concrete lived experiences. People's experiences with food involve hunger, desire, tasting, satiation, digestion, swallowing, chewing...along with the associated emotions. "These lived experiences in our bodies inspire and contain the way we conserve and articulate many of our

other experiences” (Emanation, 1995: 164). The analysis will attempt to cover all the steps involved in the eating process and their concurrent emotions.

Throughout this trip the human body establishes different contacts with the food that involves almost all the senses. We can distinguish at least four experiences that the human body establishes with food; visual, olfactory, gustative and kinesthetic. The concurrent experiences are very much influenced by the socio-cultural context in which they are produced. The latter has its own culinary habits and practices. Let us take the visual experience with food. When a person sees a food, he may desire it. The concurrent emotion and/or attitude will serve as a concrete experience to frame more complicated and abstract experiences. Similarly, the olfactory experiences with different food types have a physiological effect. This physiological effect will be used metaphorically or used to conceptualize different experiences. The analysis will focus essentially on the experiences preceding the eating, while eating and following the eating process. These experiences includes feelings of hunger, desire for food spurred or intensified by the sight and/or the smell of the food type, tasting, feeling of satiation and even sometimes rejecting of or vomiting food. These different experiences are very much influenced by the context in which they occur. The latter exhibits a wide variety with respect to the different culinary habits and traditions that make their identity. People’s experiences with food exhibit a wide variety. This variety is dependent to the context but also it is more intensified when used metaphorically. The production of new metaphorical expressions is not only dependent to the already existing conceptual metaphors grounded in bodily experiences, but also it is very much related to the socio-cultural context. These expressions will exploit the different words related to the food settings and to people’s experiences with food to conceptualize different abstract experiences and also develop new metaphors out of them.

The analysis will follow the path that food crosses from outside inside the body. It will start with hunger and desire for food, then we will analyse experiences of taste and chewing and swallowing food. Finally we will end with feeling of satisfaction. A major focus will be made on the two experiences preceding and following the eating; hunger and satiation. These two experiences, though they do not involve a physical contact with food, they are deeply entrenched in the food schema. The emotional effect of these two experiences is influential in the different metaphorical scenarios portraying the eating experience.

Hunger and feeling a desire for food is a universal experience common to all human beings. The high familiarity of this psychological experience will act as a template to be filled each time with different categories of drives and desires defining people's intensity of actions and yearn for achievements. The desire of the human body for food correlates with a number of psychological effects. The concurrent experiences of biological need for food and the psychological quest for satiation seem to be highly productive metaphorically. The analysis of the three studied languages will confirm this claim. The three languages share this high productivity though with a lot of variation.

Hunger launches desire for food. Some TA proverbs correlate the bodily physiological experience of hunger with the mental psychological experience of desire. Likewise hunger which precedes eating and seeks satiation, desire is an emotion that awaits patiently satisfaction. The following proverbial expression (26) demonstrates the conceptual food metaphor DESIRE IS HUNGER at work.

- (26) ij-jii3aan jii3aan wa law y-RaTs-u-h fi ziir dhaan
The hungry hungry and if they-dump-him in jar butter
The hungry hungry and if they dump him in jar cooking butter
'The hungry person will be hungry even if they dump him in a cooking butter jar.'

The experience of physiological hunger is variably productive in TA. The expressions under analysis are mainly governed by the conceptual metaphor PHYSIOLOGICAL HUNGER IS PSYCHOLOGICAL HUNGER. The desire for food serves to conceptualize desire for money, sex, etc. In fact hunger and desire for food represents a drive that can be served to frame different types of desire. There is also a gradual development in the hunger that will define the intensity of the mapped activity. This echoes plainly in many TA proverbs and expressions.

This expression generates knowledge about hunger and is used to serve in framing desire in more than similar situations. The generic knowledge associated with the specific situation described in the text of the proverb focuses on a situation of greed that can never be satiated to frame different situations of physical and also psychological greed. This proverb applies to desire for money, shopping, watching TV, connecting to facebook, playing video games, fishing, sex etc. The desire for performing these actions is framed mainly in terms of eating

food. Physiological hunger is serving to map psychological hunger. This proverb can be viewed to be governed by two metaphors. A GENERIC IS SPECIFIC and PHYSIOLOGICAL HUNGER IS PSYCHOLOGICAL HUNGER. Hunger in the TA context has become metaphoric in essence. The Tunisian Arabic expression '*Ji3aan*' (Hungry) is used to frame greedy persons in general.

By projecting this hunger experience onto a number of parallel experiences of desire, physical hunger is exploited to conceptualize psychological hunger. This situation described in the proverbial expression refers to hunger that can never be satiated no matter what the quantity of food available is. This serves to conceptualize incessant greed for possession. This scenario can be projected onto a person who is obsessed with gathering money. Hunger and food will correspond respectively to desire and money. Hunger is one experience used to frame mental experiences. Similarly, eating which starts by entering food into the mouth is used to conceptualize many abstract experiences like the ones discussed above. Eating can also be exploited to conceptualize sexual intercourse.

- (27) l-mra kif t-tamra imsaH-ha w kul-ha
the woman like the date wipe-IMPERATIVE to her and eat-IMPERATIVE to her
'The woman is like a date, wipe her before eating her.'

The understanding of the expression (27) is governed by the metaphor A HUMAN BEING IS FOOD. In this proverbial expression the woman is framed in terms of a sweet fruit. The metaphorical scenario is built on gradual development of actions to frame care and preparation for the sexual act. The intimacy involved in the sexual relationship is captured in terms of wiping. Likewise wiping, which precedes eating, intimate actions and preparatory settings precede the sexual act. This is essentially motivated by "the 'schematic isomorphism' between the act of eating and the sex act [and] the set of psychological correspondences between eating and sex" (Emanation, 1995: 177).

Taste is made active as soon as food is entered into the mouth. The taste may vary in deliciousness ranging from the very delicious to the horrible. The experiential of tasting different foods serves to conceptualize people with different moral attributes. We taste people, that is we get to know their character and traits. The pleasurable experience of tasting a delicious food serves to conceptualize the joy associated while dealing with kind persons.

(28) a. uxt-ii min umm-ii kil-3sal fi fumm-ii
 sister my be-IMPERFECT like honey in mouth my
 ‘My sister is like the honey in my mouth.’

b. iD-Durra murr-a
 the fellow wife bitter
 ‘The fellow wife is bitter.’

“While sweetness serves to conceptualize cherished persons, bitterness frames repulsive persons (28a, 28b). This is captured in the two conceptual metaphors LOVE IS SWEET FOOD and HATE IS BITTER FOOD. A sweet food is often very much liked. This appreciation is mapped onto feelings of fraternal love. Conversely, eating a bitter food represents an unpleasant experience. This experience is mapped onto the feeling of hate towards the fellow wife. The physical experience of tasting serves to conceptualize mental experience of appreciation. The next step involved in the eating process, which is chewing food, serves to conceptualize other mental experiences” (Dakhlaoui, 2012: 16-17).

Food types range from softness to hardness according to their nature. People’s way of eating them varies accordingly. The physical experience of putting food in the mouth and chewing it as a preparation for swallowing serves as an experiential to understand abstract experiences. “Some food types are soft and easily eaten. They do not involve chewing. Conversely, other food types are hard and involve chewing for a long time before swallowing” (Dakhlaoui, 2012, 17).

(29) a. lqaa-h 3Siida l-lbal3aan
 [he] find-PERFECT porridge for swallowing
 ‘He found him porridge to swallow.’

He is a naive person

b. ir-raajil l-Horr fi l-3arka morr
 the man brave in the quarrel bitter
 ‘The brave man is hardly beaten.’

Expression (29a) conceptualizes naivety in terms of soft sweet food. The experiential associated with eating a soft sweet food does not involve a lot of effort. It is a productive scenario serving to conceptualize moral attributes of naivety. A naive person is like a soft food rapidly and easily devoured i.e. dominated. Conversely, the TA expression *flaan 3Dam*

SHiiH (X is a hard bone) conceptualizes a human being who is very difficult to deal with. In fact, The bone is often cooked with meat but never eaten. It can be chewed inside the mouth but never swallowed for the harm it can result in. These physiological experiences of trying to chew or eat a bone serve to conceptualize the difficult experience of competing with vigilant people. Along with difficulty of eating inedible food, a brave man is captured in terms of a bitter food (29b). The bitter food cannot be easily chewed or swallowed because of pungent taste. This experiential of the difficulty of eating a bitter food serves to frame courageous persons that cannot be competed with easily. “A food that is not well chewed cannot be easily swallowed thus resulting in choking” (Dakhlaoui, 2012: Ibid).

Being choked is a different physical experience that serves to conceptualize mental experiences.

- (30) *l-RaaSiS y-3ad-di b-l-xall*
 the choking person drink-IMPERF vinegar
 ‘The choking person drinks vinegar.’

This expression captures a critical situation in terms of choking and a difficult situation in terms of drinking vinegar. The physiological difficulty of being choked serves to conceptualize psychological mental difficulties.

“Choking is a severe physical problem that calls for an urgent solution. Being limited by the time constraint, the choice of the solution will be limited too. Drinking water is the remedy for a choking person but if water is not provided any other liquid must do the job, regardless of its taste. The embodied experience of suffering a lack of oxygen is mapped onto any psychological problem involving lack of time. Drinking vinegar is mapped onto the first urgent solution to that problem. The solution involves a less harmful difficulty” (Dakhlaoui, 2012: Ibid).

Digestion is another bodily experience serving to conceptualize the mental experiences of appreciation or rejection.

- (31)
kol šay y-t3addaa illa iD-Diif ir-rkiik
 everything digest-IMPERF-PASSIVE except the guest dull
 ‘Everything can be digested except the heavy guest.’

The diversity of food type, its way of cooking, its ingredients and the time of its consumption define the way of digestion. Some food types are light and easily digested and others are heavy and hard to be digested. The way food enters the body and affects it is mapped on the way people enter the heart and affect it.

“Some food types can cause ill-digestion. This physiological experience is generally associated with a feeling of irritation. This feeling is mapped onto the feeling associated with the situation of having to deal with a dull person. The food corresponds to the guest, eating corresponds to hospitality and ill-digestion corresponds to lack of appreciation. This is captured in the two conceptual metaphors APPRECIATION IS DIGESTION and REJECTION IS ILL-DIGESTION” (Dakhlaoui, 2012: 18).

Ill-digestion is very likely to result in vomiting. This physiological experience is recruited to conceptualize abstract experiences:

(32)

3laa qad Hlawt-u 3la qad illi t-tqayyaa mraart-u

with respect to sweetness its with respect [you] vomit-IMPERF bitterness

‘The sweeter you eat the bitterer you vomit.’

This proverbial expression is built on the contraction between entering food into the body and getting food out of the body. The juxtaposition between the sweet and the bitter is projected onto the acts of eating and vomiting. While eating the sweet is a pleasurable experience, vomiting bitterly involves sufferance. These two physiological experiences are mapped on mental experiences involving losing cherished possessions that used to be sources of happiness that made the life ‘sweet’. Let us imagine that this proverbial expression is used to describe a love relationship that started sweetly and ended bitterly.

“Eating a sweet food corresponds to the love experience, enjoying the sweet food corresponds to the joy involved in the love experience, vomiting corresponds to the end of this experience and bitterness corresponds to the suffering caused by the separation. This proverb calls for moderation by joining two contrastive but correlating situations. Moderating one’s emotion is essential because happy moments can turn easily into their opposites. This controversy is conceptualized in terms of two embodied experiences common to all cultures” (Dakhlaoui, 2012: Ibid).

The physiological experiences associated with the eating process bear some culture specificity.

(34)

a. *l-ma3da šab3aan-a w l-3in jii3aan-a*

The stomach be-IMPERF filled up and the eye be-IMPERF hungry

‘filled up stomach, hungry eye.’

The eye is bigger than the belly.

b. *qalb-u klaa-h w xraa-h*

heart his eat-PERFECT it and excrete-PERFECT it

‘he ate his heart and excreted it.’

c. *l-fumm ybuus w l-qalb b-issuus*

The mouth-IMPERFECT kiss and the heart be-IMPERFECT with weevil

‘The mouth kisses and the heart is with weevil.’

Many kiss the hand and wish it cut off.

d. *l-fumm tamra w l-qalb jamra*

the mouth a date and the heart blaze.

‘The mouth is a date and the heart is fire’.

A honey tongue, a heart of gall.

Many food expressions exploit body organs that are directly related to the eating process. Greed in TA food expressions is directly associated with the stomach. The conceptualization of greed is framed metaphorically through the eating-related organ which is the stomach. The latter is made active while eating and never being satisfied *l-karšš maða klaa-t w ma qarri-tšii* (The stomach usually eats and has never been satisfied). Expression (34a) however, uses an organ unrelated to the eating process. This expression is governed by the metonymy ORGAN FOR PERSON. The contradiction is constructed around two organs; ‘the stomach being filled up’ (satiation) and eye being hungry (greed). The eye offers different conceptualizations for greed and desire captured essentially as being big, wide and very often involved in the eating activity. The eye serve to conceptualize shyness in the proverb *aT3im l-fom t-stHaa l-3iin*, (Feed the mouth and the eye will be shy). The eye acts in TA proverbs as a ‘bearer of mental faculty’ (Maalej, 2008), which gives it a further faculty apart from perception. The conceptualizations of these emotions do not “proceed from the physiological body directly to

the mind, but it is mediated by the body as a cultural entity” (Maalej, 2008: 396). As shown by Maalej (2004; 2008) ‘cultural embodiment’ occurs when the neural, physiological function of an organ underlies an alteration when it goes through the road of the culture.

While expression (34b) frames unconsciousness in terms of food experience, proverbs (34b and 34c)

“describe a contrast between a physical state and its concurrent psychological state. The route to express the psychological states of unconsciousness and spite is to describe the physiological change that happens to body parts. The metaphor A HUMAN BEING IS FOOD may interact with the conventional conceptual metonymy ORGAN FOR PERSON to account for proverbs that frame some human organs in terms of food experiences. One of the organs involved in metaphorical conceptualizations of food is the heart activating the conceptual metonymy HEART FOR PERSON” (Dakhlaoui, 2012: 19).

In accordance with Maalej (2008) analysis of the metaphorical conceptualizations of the heart where the latter turns into an eater of the self to express conscientiousness *qalb-i kalaan-i* (My heart ate me) or the heart in a state of rest to express unconsciousness *qalb-i ma kalaan-i-š* (My heart did not eat me) (Maalej, 2008: 408), degrees of unconsciousness go from the heart being cold as in *qalb-u baarid* (His heart is cold), to the heart being dead as in *qalb-u mayiit* (His heart is dead) (Maalej, 2008) to reach the highest degree of unconsciousness with heart being food to the self. Expression (34a) frames this high degree of unconsciousness in terms of the heart being eaten by the self and then excreted resulting in a final separation between the heart and the body. While consciousness is framed in terms of the heart eater to the self and unconsciousness is captured in terms of the heart being in a state of rest, a higher degree of unconsciousness is framed in this TA proverb in terms of the heart being a victim to the eater self. The mental experience of the conscience is framed in terms of an eating experience. The heart may be the eater or the food. Conscience is when the self eats the heart and unconsciousness holds on when the self eats the heart. This proverb describes unconsciousness in terms of a heart, perceived as the centre of consciousness, that no longer makes part of the body. This may be captured in the conceptual metaphor UNCONSCIOUSNESS WHEN THE SELF EATS THE SELF or UNCONSCIOUSNESS IS WHEN THE HEART BECOMES FOOD TO THE SELF (Dakhlaoui, 2012).

The conceptualization of spite is framed in terms of the heart the site of emotions as being attacked by weevil in (34c) or a blaze in (34d). These expressions are governed by the metonymy HEART FOR PERSON. The figure below demonstrates the interaction between metonymy, metaphor and image schema. Their interaction is mostly reflective of the metaphorical thinking governing the understanding of food expressions. The nature of the interaction and the selection of the different elements involved therein is however determined by the socio-cultural setting in which the analyzed expressions are produced, used and understood.

This expression exhibits an interaction between metaphor, metonymy, and image schema. These expressions are governed by the conceptual metaphor AN ACTION IS FOOD, the conceptual metonymy ORGAN FOR FUNCTION and the CONTAINER image schema.

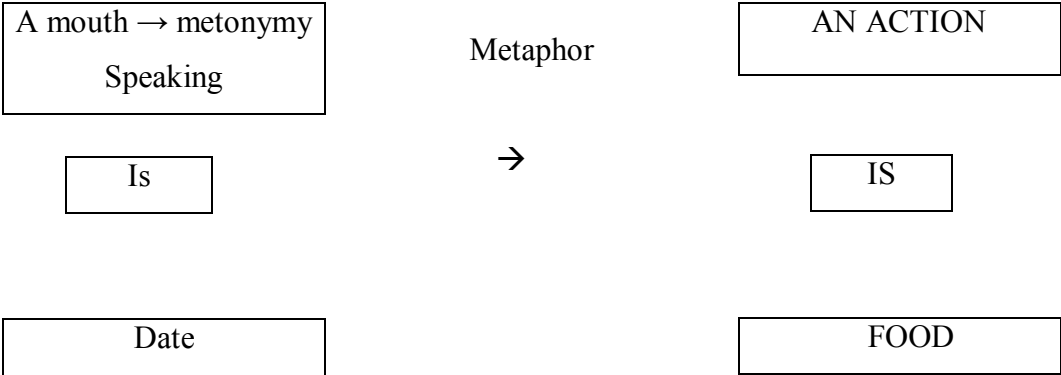

Figure 9: interaction between metaphor and metonymy

Within the source domain of the metaphor AN ACTION IS FOOD, the conceptual metonymy ORGAN FOR FUNCTION acts to map mouth into words. The human organ is used here to stand for the function performed by the organ. The source of the metonymy here is the mouth mapped onto the target which is normally its function speaking .i.e. words. This mapping interacts with the CONTAINER schema. This schema consists of an interior, an exterior and boundary (Johnson, 1987). The mouth is an entity that can hold things inside. Words are generally located into the mouth. This schema interacts with the metonymy and the metaphor to facilitate the understanding of this proverb specifically its first part.

Similarly, the second part of the proverb can be analysed following the same pattern the heart stands the emotions following the conceptual metonymy ORGAN FOR FUNCTION

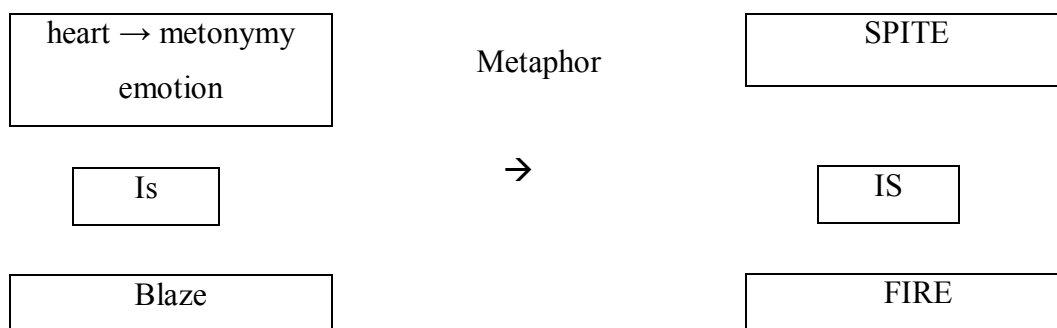

Figure 10: interaction between metaphor and metonymy

Expression (34d) describes two contradictory situations with each of them involving an independent metaphorical understanding built on the interaction between metaphor and metonymy. In fact the metaphoric understanding of this expression is motivated by the metonymic mapping ORGAN FOR FUNCTION of the mouth onto its corresponding function which is speech, resulting in a metaphorical expression motivated by a metonymy. This may furnish evidence in support of Barcelona’s claim about the metonymic motivation for metaphor perceiving them to be two parts in the same continuum (Barcelona, 2000).

The heart in TA food metaphors is not only conceptualized as the centre of emotions but as bearer of cultural conceptualizations of spite. This new meaning of embodiment embraces “not just the physiological body- or worse yet, just the physiological brain- but the body-in-space, the body as it interacts with the physical and social environment” (Rohrer, 2006-7: 5).

The expressions discussed above yield three main conclusions. First, the high productivity of the food domain seems to be traced back to its nature as an embodied domain involving different bodily experiences. One of the main characteristics of food metaphors is their description of familiar highly experienced situations. Since people are mostly familiar with their bodies, embodied experiences are more likely to exhibit themselves abundantly in metaphorical connections exploiting the food domain. Second, the food domain is almost fully exploited with all its patterns. Being an embodied domain, this domain involves many physiological experiences. These bodily-based experiences are recruited to conceptualize human beings, actions and emotion. Finally, the cultural specificity of some food embodied experiences emphasizes the importance of the socio-cultural context which allows for the

mapping to take place. The conceptualization of abstract domains through food embodied experiences is mediated by the culture (Dakhlaoui, 2012).

4.5 Particularities of food metaphors

This partial analysis of food metaphors, has allowed two main conclusions. First the role of the eating operation schematically structuring the metaphorical mapping points to the importance of the physiological input as governing the creation and understanding of many abstract experiences. Second, a possible classification of metaphors based on physical resemblance and socio-cultural resemblance can be made.

4.2.1 Image-schematic feature

The above analysis has permitted an explicit confirmation of the high productivity of the food domain in motivating and figuring out the understanding of conceptual domains of emotions, human traits and socio-cultural values. The analysis demonstrates the metaphorical mapping at work in the three languages. The analysis has also confirmed the role of image schemas in metaphors. The range of recursive and repetitive experiences with food, inspire the image schematic organization of food metaphors and confirms that many metaphors are grounded in bodily experience and our physiology defines and constrains the nature of our metaphorical mappings (Johnson, 1987). The REMOVAL schema structures much of the understanding of the eating experience across the three languages. Whether it is used to frame consumption or disappearance, the eaten food is always removed by means of the eater. The metaphorical distribution of roles varies accordingly. A removal of something will take a place. We need an agent to do the operation of removal and the removed element will vanish. The agent corresponds each time to the eater, the removed element is the food and disappearance is the movement of food from the outside to the inside that is from the food container into the body.

Similarly, in the domination meaning focus metaphors, The REMOVAL schema is filled up in this way. The dominating person will correspond to the eater and the dominated person will be the food. Dominance involves the removal or disappearance of someone in favour of the other. With dominance, whether it is physical or moral intellectual, only one person or one idea will dominate. In the TA examples *qalbu maklu* (He has eaten his heart, He is careless)

and *qalb-i Klani* (My heart ate me, I am conscious) where a person is both eater of and food to the heart the eating scenario is used to frame respectively emotions of carelessness and consciousness. Carelessness is an emotion framed in terms of a culture-specific eating experience. A person turns into eater of a human organ that is known to be the site of emotions. Eating the heart corresponds to the disappearance of the organ responsible for the emotion hence the disappearance of the emotion itself. Conversely, Consciousness is also framed in terms of an eating experience through which the heart dominates i.e. eats the person. The REMOVAL image schema is filled interchangeably through the eating experience. A human being is either the food or the eater of his own organ. The psychological experiences of consciousness and carelessness involve a disappearance/ domination of one or the other. Consciousness corresponds to the domination of the heart and the disappearance of the self and Carelessness is the domination of the self and the disappearance of the heart. The image schema of removal is framed in terms of an eating experience and is filled in TA by the heart and the self playing interchangeably the role of the eater/dominant and the food/dominee.

4.2.2 Physically-motivated metaphors and Socio-culturally motivated metaphors

In their attempt to tide up the messy nature of metaphorical mappings, scholars attempted different classifications of metaphors. Grady et al (1996) introduced basic-level and generic-level metaphors. Then, Grady (1997a) made a distinction between basic metaphors and complex metaphors. He claimed that basic metaphors are motivated by bodily experience which explains their universality and complex metaphors are a combination of basic metaphors and shared knowledge metaphors and hence their cultural-specificity. He also added another classification of conceptual metaphors making a distinction between ‘correlation metaphor’ and ‘resemblance metaphor’. In correlation metaphor, two distinct concepts are cognitively linked because of the correlation in experience. Two concepts share features of co-occurrence where one concept is the logical result of another or when temporal proximity of two kinds of concepts or events is noticed. Examples of this kind include MORE IS UP, ACTIONS ARE EVENTS and KNOWING IS SEEING. Let us consider the example MORE IS UP. This metaphor is experientially motivated because we experience the correlation between ‘more’ and ‘up’. Having more things and a vertical pile of things co-occur and are always joined together. This co-occurrence is recurrent in people’s experience that is why it governs and structures their understanding of many abstract concepts. In

resemblance metaphor however, the mapping is motivated by resemblance between two things. For example in the TA expression *kiršu ki-ddilla3a* (His belly is like a water melon, he has a big belly) we do not ordinarily perceive recurring correlation such as perceiving a man's belly and a water melon at the same time. The association by the resemblance of the visual image motivates this metaphor. These two kinds of metaphors differ in terms of motivation one is motivated by correlation and the other is motivated by resemblance.

The analysis of food metaphors revealed a remarkable presence of resemblance metaphors. We will distinguish between physically-motivated resemblance metaphor and socio-cultural resemblance metaphor. This distinction may provide part of the answer to the exact role of the cultural context in interaction with body to motivate food metaphors. The socio-cultural metaphors may have an important explanatory power with respect to the importance of the cultural specificities of the food domain with all its related culinary practices and eating habits.

Physically-motivated metaphor is a metaphor motivated by the physical similarity between the two compared elements. Since this metaphor is based on sensory input it is expected to be cross-culturally common while socio-cultural metaphor is expected to vary cross-culturally because it is built on the interpretation of the source and the target.

For example, in the expression *un lycéen de poil de carotte* (carrottop, a red head). The sensory input and knowledge we have about the source concept (carrot) and the target concept (a human being) are viewed similar and this resemblance motivates the mapping. First, we get the sensory input of the human being described as having a red head or red hair and then we have access onto the main physical characteristic of the carrot which is the red orange colour. Even in cultures where this kind of comparison does not exist, the interpretation of the metaphor will be the same.

Type	Correlation	Resemblance	
		Physically-motivated	Socio-cultural
Motivation	Correlation in experience	Motivated by physical similarities based on sensory input; the association is cross-culturally common	Motivated by a socio-cultural interpretations of source and target and the association is arbitrary and symbolic.
Examples	MORE IS UP	Her waist is an hourglass	Achilles is a lion

Table 11: Typology of Metaphor.

Socio-cultural metaphors are not however built on such a resemblance. The understanding of the metaphor depends so much on the interpretation of the relationship between the source and the target. Let us consider the following example from English. He is cool as a cucumber.

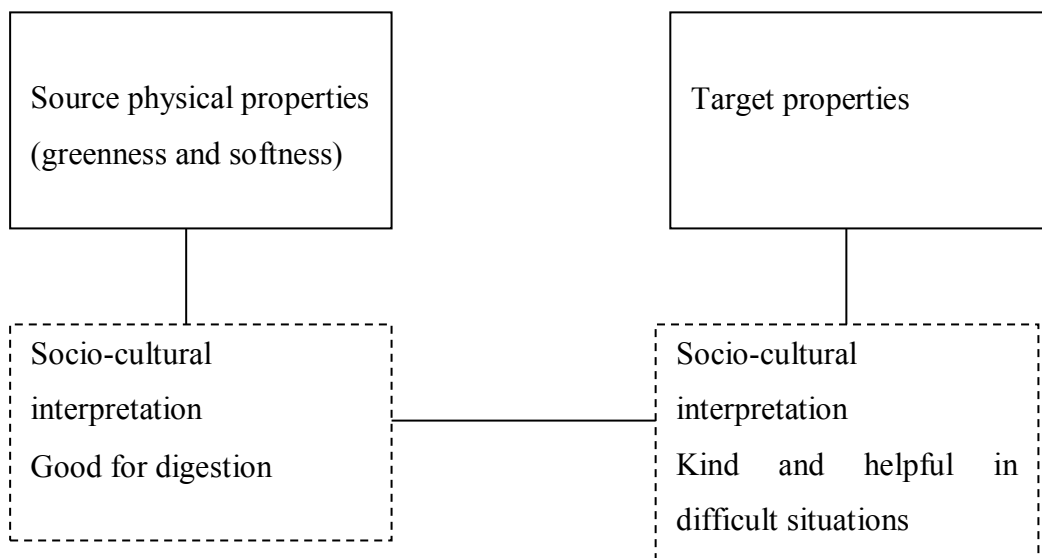

Figure 11: socio-cultural metaphor

The understanding of this metaphor depends so much on the socio-cultural interpretation of the source and also of the target. The lack of similarity in the sensory input between the source and the target allows for the socio-cultural interpretation to take place in order to account for the mapping. This socio-cultural interpretation accounts for many cross-cultural metaphors. Each food type seems to carry cultural imprints and these cultural particularities play an important role in governing and motivating possible metaphorical mappings. In TA for example cucumber is negatively perceived in the culture. The expression '*Faqqusa*' (a cucumber) in TA culture is viewed as an offensive term and is not pronounced by many TA speakers and they use euphemism instead to refer to it by another term '*wild l-gamra*' (son of the moon, a cucumber):

The resemblance in socio-cultural metaphors is found only when we interpret the target and the source in terms of socio-cultural codes, i.e. shared knowledge or value system within a community. Once the socio-cultural interpretations have been established, and the resemblance identified, the metaphorical mapping can take place.

A heterogeneous mixture in TA is conceptualized in terms of a Tunisian meal named šakšuka (hodgepodge). This meal is prepared in a very rapid way through a mixture of different types of vegetables. The connection between this food type and the heterogeneous mixture is built on resemblance. We interpret the relationship between the source and the target by comparing the hodgepodge to the situation at hand. The different vegetables of the hodgepodge correspond to the different elements involved in the chaotic situation described. Similarly, in French, this kind of situations is framed in terms of a similar food type cooked through mixing different vegetables. The conceptual metaphor LIFE IS A KITCHEN seems to be so entrenched in the three cultures. The different events correspond to different food types based on the conceptual metaphor AN ACTION IS FOOD.

4.3 Cultural variation

Relying basically on Kövecses model of cultural variation (2005), this section will present through examples some metaphor aspects influenced by variation. Food metaphors transfer culinary practices and cooking experiences of three cultures. The food concurrent experiences are exploited in food metaphors mainly due to its high familiarity and explanatory concreteness, which make them serve as a depository of concrete experiences ready to map

less delineated domains. Some of these experiences were used to map abstract domains, while the others represent potential source experience ready for the mapping. Some experiences are activated in the mapping and others are not. The activation of these source experiences is a matter of cultural group choices and preferences (Kövecses, 2015). Some experiences are more salient than others hence their repetitive use. Some source experiences are exploited in more concrete details than others.

One type of striking variation is at the level of the different source domains. The concrete experience serves to conceptualize different emotions across the three languages. Emotions are mainly framed through a metaphorical configuration in which a human being eats his or someone else organ and/or body. The emotion is eating the body more concretely than the two other languages. In TA the emotion of embarrassment is framed in terms of eating the face. The TA expression *kla-lu wj-h-u* (he ate him the heart) does not exist in the two other languages. The TA expression *qalb-i kla-ni* (my heart ate me) which is used to frame the emotion of consciousness and worry about a given situation does not exist in the two other languages. The metaphorical scenario of the person eating his organs seems to be more pronounced in the TA culture.

Tunisian Arabic	French	Metaphorical scenario	Cultural conceptualization
Kla b3inih (eat with eyes)	Manger des yeux (Eat with the eyes)	Eating someone/something with a human organ unrelated to the eating.	Desire
Kla sweb3ou (eat one's fingers)	Se mordre les doigts (bite one's fingers)	Eating a human organ	Regret
-	Se ronger les poings (Eat one's fists with impatience)	Eating a human organ	Eagerness

Kla-luwijh-u (Eat someone's face)	-	Eating a human organ	Embarrassment
Qalb-u kla-h (his heart ate him)	-	The heart eating the body/self	Consciousness
Qla ba3ðu/ruH-u	-	Eating the self/the soul	Anger

Table 12: The eating scenario framing emotions in TA and French

If the eating experiences bear physical, mental and emotional images within them, so do the words about these experiences. The present study investigates the eating expressions used metaphorically to frame more abstract domains across the three languages namely Tunisian Arabic, English and French. A brief survey of the expressions surrounding the eating experiences in the two languages has yielded three main conclusions. 1) Many of the eating expressions are used to frame emotions by exploiting the organ directly associated with the emotion in question. 2) The organs involved in the description of the eating experiences are either directly associated with the eating and also the emotion or totally unrelated to the eating and the emotion. 3) The descriptions develop gradually by exploiting different human organs and going beyond the body to frame emotions through eating inedible things. The body serves as source for conceptualizing emotions but this conceptualization is constrained by culture which determines and sometimes plays a crucial role in the mapping. The eating experiences in the two cultures serve to conceptualize emotions by framing human organs eating or being eaten one another. Table 12 illustrates some examples.

The conceptual metaphor A HUMAN BEING IS FOOD interacts with the metonymy ORGAN FOR ACTION differently in the two languages. These can be viewed as complex metaphors and metonymy producing simple ones pertaining to them and are mostly defined by the socio-cultural context.

CONCLUSION

In this last section we will first go back to remind our readers of the objectives, the hypotheses and the research questions of the present study. Next, we will discuss the results achieved in relation to what has been set as points of departures to check to what extent the objectives of this research have been reached.

In order to spell out the nature and purpose of the study, the following research questions have been formulated:

- 1- What kinds and what frequency of food metaphorical usage appears in TA, English and French?
- 2- To what extent the food domain is explored in those three languages?
 - a. To what extent are food metaphors grounded in bodily experiences?

b. What is/are the difference (s) between embodied VS non-embodied conceptual metaphors?

3- To what extent can the differences found in answering 2b above be related to the socio-cultural context? How can the latter influence the understanding, the use and the creation of metaphors?

4- How to account for the differences that may exist between different metaphors in terms of the internal complexities and also the frequency and the directionality of the mapping within the same language and across the three languages.

Along with these questions, these hypotheses were postulated:

Hypothesis 1:

- Metaphor lies mainly on mapping concrete experiences in order to understand less delineated domains.
- The food experiences present a potential depository of concrete experiences.

We hypothesize that food metaphors exhibit themselves abundantly in the studied languages hence the high productivity of the food domain.

Hypothesis 2:

- People's experiences with food exhibit a wide variety to people speaking or not the same language.
- Metaphor was proved to be an instrument of the mind (Lakoff & Johnson, 1980)

We hypothesize that the conceptual metaphors governing the understanding of food metaphorical expressions alternate similarity and disparity in the three studied language hence the non-universality and non-uniformity of our conceptual knowledge about food.

Hypothesis 3:

Most food experiences are embodied.

Many body parts are involved in the eating and related experiences.

We hypothesize that the mapping in the embodied food metaphors is unidirectional and food metaphors are mainly primary metaphors.

After collecting food metaphors, sorting out the different conceptual metaphors underlying their understandings along with the different elements affecting their configurations and presenting the findings of the present study, we can answer the research questions and confirm or invalidate the hypotheses postulated. As for the research questions, we can give these answers. First we can now safely assert that the food domain is exploited in the three languages in almost all its patterns. Food types, eating drinking and digestion, related acts, experiences with food, colour, shape, form, state, cooking techniques, dishes, meals, traditions, containers for food, etc...are almost thoroughly exploited throughout the three languages though with different degrees of explicitness. The food domain is thoroughly exploited in the three languages with all its patterns. Second, many food metaphors are grounded in bodily experiences to exploit the experiences related to food mainly feeling of hunger, desire, tasting, satiation and digestion. These experiences are exploited by the different metaphorical scenarios to frame mainly emotions and psychological experiences. While embodied conceptual metaphors are grounded in bodily experiences, non-embodied conceptual metaphors are grounded in their socio-cultural contexts. Some embodied conceptual metaphors are also mediated by the culture. Many food metaphors are built on the shared knowledge between speakers of a cultural group on food types, cooking techniques and eating experience. The distinct experience of eating a hot spicy food serves to frame diligence and hard work in TA, however it is used to frame sexuality in English.

The internal complexities of metaphors, the frequency of the mapping and the directionality of the mapping are features of metaphor that are responsible for variation. The socio-cultural context acts effectively on the way metaphors are understood and produced. Once the metaphor has been produced and used by a cultural group in communication, it can be subject to change and can lead to the emergence of new metaphors. The frequency of the mapping is very common in food metaphors because food experiences are so entrenched in people's mind they experience them daily and are overwhelmingly present in their surrounding context.

Some food experiences serve to frame a number of parallel experiences related to a generic abstract domain. The verb (*yakil* he eats) has become a source to conceptualize corruptive acts of bribery and can be mapped on a number of scenarios framing the act of illegal taking money in return of an undue service.

The conceptualisation of human traits in terms of food types represents a common feature shared by the three languages. It appears that people's experiences with food serve to frame less delineated domains. People qualify the food essentially on the basis of deliciousness before they move to depicting details such as the shape, the colour, the smell etc. This experiential is abundantly exploited in the three languages to frame human traits. The conceptual metaphor A HUMAN BEING IS FOOD is common to them but each language uses its own food type to qualify human beings. The food domain is used in its raw nature, half-cooked, fully cooked and sometimes mixed with other food types to qualify human traits and sometimes physical appearances. It is very common to meet a large variety of food linguistic metaphors serving to conceptualize human beings. The meaning focus of these metaphors is built basically, but not solely, on conceptualizing the dichotomy between virtuality and wickedness through figuring out opposing tastes. The two conceptual metaphors SWEET IS GOOD and BITTER IS BAD are common throughout the three languages/cultures. Each context is acting by selecting its particular food type to frame knowledge about human beings. Each language conveys the knowledge of its users and uses the cultural filters to constrain or to allow the mapping.

The eating schemas with all its elements; the eater, the food and the setting presents a very constructive paradigm for the understanding of abstract, mostly emotional, experiences. The interplay between the food, the eater and the setting for the eating has played an interesting role in meaning construction throughout the three languages. While consumption and dominance are pervasively framed in terms of eating in the three languages, the eating experience serves additionally to conceptualize emotions through eating the inedible. The gradual intensiveness of the emotions develops from eating human external organ, then an internal organ, next the whole body and finally the soul. These eating scenarios make emotions eating the body and more. The embodied experience of eating is projected onto a number of parallel experiences of hyperbolic fictive eating through which the organ involved directly or indirectly in the emotion is eaten and sent out of existence. Throughout the three

languages the eating scenarios vary widely and they are influenced by their socio-cultural context. In this respect the socio-cultural context contributes to understanding and creating metaphors.

The present study has demonstrated that the food domain is a very productive domain and that metaphor comprehension is not a matter of the conceptual system of the individual neither his body only but additionally it is a matter of a socio-cultural context influencing radically the nature, the frequency and the directionality of the mapping. The productivity of the food domain is mostly apparent in the way this domain is exploited with all its patterns to frame less concrete experiences. The food domain is very present in people's daily life and this high familiarity places it to be a candidate par excellence to serve the understanding of other domains mostly abstract ones. The concreteness of the food domain and the high familiarity of its different experiences vary across cultures and this variation is responsible for the metaphorical disparity across the three studied languages. The studied examples demonstrate that the understanding of food metaphors is dependent to their context of use. The latter defines the degree of the familiarity, the level of salience and culinary practices in which they are involved.

Food metaphors stand as an evidence of the dynamic aspect of the metaphor as a system of connection constructed and reconstructed each time. The metaphor is dynamic because it acts sometimes as a source of creating new metaphors. The understanding of certain mappings will enable other types of connection hence the productivity of the metaphor itself. Metaphor is not only an 'instrument of the mind' it is rather an interactive instrument moving heuristically between the mind, the body and their direct and indirect context. Further cross-cultural investigations exploiting the interaction between metaphor, mind and culture could shed more light on this dynamic aspect of the metaphor which is reinforced by the context. Orienting more research to the dynamic nature of metaphor seems far-reaching because not only will it uncover the where we recruit our conceptual knowledge, but also can possibly define the exact role of the context in metaphor understanding and creation and how can the metaphor itself be a source for the creation of new metaphors.

REFERENCES

- Achard-Bayle, G. (2013). Construction de variantes systématiques de proverbes pour la modélisation de calculs sémantiques et cognitifs. In J.-M. Benayoun, N. Kübler & J.-Ph. Zouogbo (éds), *Parémiologie, proverbes & formes voisines*, 3 volumes, Saint-Gemme, PUSG, tome 1, 65-79.
- Achard-Bayle, G. (2015). Les niveaux de l'analyse parémique. *Aliento* 6, 263-290.
- Barcelona, A. (2000). On the plausibility of claiming a metonymic motivation for conceptual metaphor. In A. Barcelona (Ed.), *Metaphor and Metonymy at the Crossroads: A Cognitive Perspective* (pp. 31-58). Berlin/New York: Mouton de Gruyter.

- Boers, F. (1997). No pain, no gain in a free-market ideology: A test for cognitive semantics? *Metaphor and Symbol*, 12, 231-241.
- Boers, F. (2003). Applied linguistics perspectives on cross-cultural variation in conceptual metaphor. *Metaphor and Symbol*, 18(4), 231–238.
- Boers, F., and Demecheleer, M. (1997). A few metaphorical models in (Western) economic discourse. In W. A. Liebert, G. Redeker, and L. Waugh (Eds.), *Discourse and perspective in cognitive linguistics* (pp. 115–129). Amsterdam: John Benjamins.
- Boers, F., and Demecheleer, M. (2001). Measuring the impact of cross-cultural differences on learners' comprehension of imageable idioms. *ELT Journal*, 55, 255–262.
- Cambridge Online English Dictionary. Available at <https://dictionary.cambridge.org/> (accessed on 12-01-17).
- Charteris-Black, J. (2004). *Corpus approaches to critical metaphor analysis*. Houndmills, Basingstoke; Hampshire, New York: Palgrave Macmillan.
- Charteris-Black, J. (2003). Speaking with forked tongue: A comparative study of metaphor and metonymy in English and Malay phraseology. *Metaphor and Symbol*, 18(4), 289-310.
- Colston, H. L. (2000). Book review. Richard Honeck, *A proverb in mind: The cognitive science of proverbial wit and wisdom*. *Journal of Pragmatics*, 32 (5), 627-638.
- Dakhlaoui, F. (2012). Food Metaphors in Tunisian Arabic Proverbs. *Rice Working Papers in Linguistics* volume 3 accessible at https://scholarship.rice.edu/bitstream/handle/1911/64168/RWPL3_Faycel.pdf?sequence=1
- Dakhlaoui, F. (2015). Proverbs Understanding and the Interplay between the Generic and the Specific: Tunisian Arabic as an example. *Aliento* 6, 311-336.
- Davidson, F. (2001). *Inquiries into Truth and Interpretations: Philosophical Essays*. Clarendon Press. Oxford.

- Dubois, M., M. (1981). *Dictionnaire Larousse Français / Anglais Anglais/Français*. Paris: Larousse.
- Emanation, M. (1995). Metaphor and the Expression of Emotion: The Value of Cross-Cultural Perspectives. *Metaphor and Symbolic Activity*, 10(3), 163-182.
- Evans, V and Green, M (2006) *Cognitive Linguistics: An Introduction*. Edinburgh University Press: Edinburgh.
- Fauconnier, G and Turner, M. (2002). *The Way We Think*. New York: Basic Books.
- Gentner, D., & Bowdle, B. 2008. Metaphor as structure-mapping. In Ray Gibbs (ed) *The Cambridge Handbook of Metaphor and Thought*. 109-128
- Gibbs, R.W. (1999). Taking metaphor out of our heads and putting it into the cultural world. In R. Gibbs and G. Steen (Eds.), *Metaphor in cognitive linguistics* (pp. 146–166). Amsterdam: John Benjamins.
- Gibbs, R. W. (1994). *The poetics of mind*. Cambridge: Cambridge University Press.
- Gibbs, R. W. (2002a). Psycholinguistic comments on metaphor identification. *Language and Literature*, 11(1), 78-83.
- Gibbs, R. W. (2002b). A new look at literal meaning in understanding what is said and implicated. *Journal of Pragmatics*, 34(4), 457-486.
- Gibbs, R. W. Jr. 2008. Metaphor and thought: The State of the Art. *The Cambridge Handbook of Cognitive Linguistics*: 3-16. Cambridge. Cambridge University Press.
- Gibbs, R. W, Costa, L. P. L. & Francozo, E. 2004. Metaphor is grounded in embodied experience. *Journal of Pragmatics*, 36(7), 1189-1210.
- Goossens, L. (1990). Metaphonymy: The interaction of metaphor and metonymy in expressions for linguistic action. *Cognitive Linguistics*, 1 (3), 323-342.
- Gozzi, R. Jr. (1999). The Power of Metaphor in the Age of Electronic Media. ETC.: A Review of General Semantics. 56 (4), 380.
- Grady, J. (1997a). Theories are building revisited. *Cognitive Linguistics*, 8, 267–290.
- Grady, J. (1997b). *Foundations of meaning: Primary metaphors and primary scenes*. Doctoral dissertation, Department of Linguistics, University of California at Berkeley.

- Grady, J. (2007). 'Metaphor'. *The Oxford Handbook of Cognitive Linguistics*. 187-213. Oxford. Oxford University Press.
- Grady, J., Tand, S., & Morgan, P. (1996). Primitive and Compound Metaphors. In E. Goldbeing(Ed), *Conceptual structure, discourse and language*, 177-187.
- Honeck, R. P., & Temple, J. G. (1994). Proverbs: The Extended Conceptual Base and Great Chain Metaphor Theories. *Metaphor and Symbolic Activity*, 9(2), 85-112.
- John, S. (1987). *Williams Cobuild Collins Dictionary*. London: William Collins sons & Co Ltd.
- John, S. (1988). *Williams Cobuild Collins Dictionary*. London: William Collins sons & Co Ltd.
- John, S. (1990). *Williams Cobuild Collins Dictionary*. London: William Collins sons & Co Ltd.
- John, S. (1993). *BBC English Dictionary*. London: BBC English and Harper Collins Publishers Ltd.
- Jäkel, O. (1999). "Is metaphor really a one-way street? One of the basic tenets of the cognitive theory of metaphor put to the test". In *Issues in Cognitive Linguistics: 1993. Proceedings of the International Cognitive Linguistics Conference*, L. de Stadler and C. Eyrich (eds), 367-388. Berlin. Mouton de Gruyter.
- Johnson, M. (1987). *The Body in the Mind: the Bodily Basis of Meaning, Imagination and Reason*. Chicago: University of Chicago Press.
- Kövecses, Z. 1986. *Metaphors of Anger, Pride, and Love*. Amsterdam: John Benjamins.
- Kövecses, Z. 1990. *Emotion Concepts*. Berlin and New York: Springer-Verlag.
- Kövecses, Z. (2000). The scope of metaphor. In A. Barcelona (Ed.). *Metaphor and Metonymy at the Crossroads: A Cognitive Perspective*, 79-92.
- Kövecses, Z. (2002). *Metaphor: A Practical Introduction*. Oxford: Oxford University Press.
- Kövecses, Z. (2005). *Metaphor in culture. Universality and variation*. Cambridge: Cambridge University Press.
- Kövecses, Z. 2007. The biblical story retold: Symbols in action. In Mario Brdar, Stefan Gries, and Milena Žic Fuchs and (eds.), *Converging and Diverging Tendencies in Cognitive*

- Linguistics*, 325–354. Amsterdam: John Benjamins.
- Kövecses, Z. 2008b. Metaphor and emotion. In R. Gibbs (ed.), *The Cambridge Handbook of Metaphor and Thought*, 380–396. New York: Cambridge University Press.
- Kövecses, Z. 2010a. *Metaphor: A Practical Introduction*. Second edition. Oxford and New York: Oxford University Press.
- Kövecses, Z. 2010b. A new look at metaphorical creativity in cognitive linguistics. *Cognitive Linguistics*, 21(4): 663–697.
- Kövecses, Z. (2015). *Where metaphors come from. Reconsidering context in metaphor*. Oxford: Oxford University Press.
- Kövecses, Z., & Radden, G. (1998). Metonymy: Developing a cognitive linguistic view. *Cognitive Linguistics*, 9(1), 37-77.
- Lakoff, G. 1987. *Women, Fire, and Dangerous Things: What Categories Reveal About the Mind*. Chicago: The University of Chicago Press.
- Lakoff, G. (1993). The contemporary theory of metaphor. In A. Ortony (Ed.), *Metaphor and thought* (Second ed., pp. 202-251). Cambridge: Cambridge University Press.
- Lakoff, G., & Johnson, M. (1980). *Metaphors we live by*. Chicago; London: University of Chicago Press.
- Lakoff, G and Zoltán K. 1987. The cognitive model of anger inherent in American English. In D. Holland and N. Quinn (eds.), *Cultural Models in Language and Thought*, 195–221. Cambridge and New York: Cambridge University Press.
- Lakoff, G., & Turner, M. (1989). *More than cool reason: A field guide to poetic metaphor*. Chicago: University of Chicago Press.
- Lakoff, G., & Johnson, M. (1999). *Philosophy in the Flesh : The Embodied Mind and its Challenge to Western Thought*. New York: Basic Books.
- Langacker, R. W. (1994). *Concept, Image and Symbol: The cognitive Basis of Grammar*. Berlin and New York. Mouton de Gruyter.
- Maalej, Z. (1999). Metaphoric Discourse in the Age of Cognitive Linguistics, with Special Reference to Tunisian Arabic (TA). *Journal of literary semantics*, XXVIII, 189-206.

- Maalej, Z. (2004). Figurative language in anger in Tunisian Arabic: An extended view of embodiment. *Metaphor and Symbole*, 19(1), 51-75.
- Maalej, Z. (2008). The heart and cultural embodiment in Tunisian Arabic. In René Dirven, Farzad Sharifian, & Ning Yu (eds.). In *Looking for the Mind inside the Body: Conceptualization of Heart and other Internal Body Organs across Languages and Cultures*. Amsterdam and Philadelphia: John Benjamins Publishing Company.
- Maalej, Z. (2011). Figurative dimensions of 3ayn ‘eye’ in Tunisian Arabic. In Z. Maalej & N. Yu (Eds.), *Embodiment via body parts: Studies from various languages and cultures* (pp. 213–240). Amsterdam/Philadelphia: John Benjamins Publishing Company.
- Mandelbaum, D. (1985). *Selected Writings of Edward Sapir in Language, Culture and Personality*. University of California Press: London.
- Oxford Online Dictionary. Available at <https://en.oxforddictionaries.com/>. (accessed on 12-01-2017).
- Palmer, G. B. (1996). *Towards a Theory of Cultural Linguistic*. University of Texas Press. Austin.
- Sharifian, F. (2008). Conceptualizations of *del* ‘heart-stomach’ in Persian. In F. Sharifian, R. Dirven, N. Yu & S. Niemeier (Eds.), *Culture, body, and language: Conceptualizations of internal body organs across cultures and languages* (pp. 247–266). Berlin: Mouton de Gruyter.
- Sharifian, F. (2011). Conceptualizations of *cheshm* ‘eye’ in Persian. In Z. Maalej & N. Yu (Eds.), *Embodiment via body parts: Studies from various languages and cultures* (pp. 197–211). Amsterdam/Philadelphia: John Benjamins Publishing Company.
- Sharifian, F. (2015). *The Routledge Handbook of Language and Culture*. London, New York: Routledge.
- Steen, G. J., Dorst, A. G., Kaal, A. A., Herrmann, J. B., & Krennmayr, T. (2010). *A method for linguistic metaphor identification: From MIP to MIPVU*. Amsterdam: Benjamins.
- Rohrer, T. (2006-7). The body in space: Dimensions of embodiment. In Tom Ziemke, Jordan Zlatev & Roslyn M. Frank (Eds.). In *Body, Language and Mind: Embodiment* (Vol. 1). Berlin: Mouton de Gruyter.

- Talebinejad, M. & Dasterjendi, H (2005) A Cross-Cultural Study Of Animal Metaphors: When Owls Are not Wise! *Metaphor and Symbol*. 20 (2), 133- 150.
- Turner, M. (1991). *Reading Minds. The Study of English in the age of Cognitive Science*: Princeton University Press.
- Turner, M and Fauconnier, G. (2000). Metaphor, metonymy, and binding. In A.Barcelona,ed. *Metaphor and Metonymy at the Crossroads*. 133–145. Berlin: Mouton de Gruyter.
- Turner, M., and Fauconnier, G. (1995). Conceptual Integration and Formal Expression. *Metaphor and Symbolic Activity* 10:3, 1 83-203.
- Webster Online Dictionary. Available at www.websters-online-dictionary.org (accessed 19-01-06).
- Yu, N.(1995). Metaphorical Expressions of Anger and Happiness in English and Chinese. *Metaphor and Symbolic Activity*. 10 (2), 59-92.
- Yu, N. (2004). The eyes for sight and mind. *Journal of Pragmatics*, 36, 663–686.
- Yu, N. (2008). Metaphor from body and culture. In Raymond Gibbs (ed.), *The Cambridge Handbook of Metaphor and Thought*, 247–261. New York: Cambridge University Press.
- Yu, N. (2011). Speech organs and linguistic activity/function in Chinese. In Z. Maalej &N. Yu (Eds.), *Embodiment via body parts: Studies from various languages and culture* (pp. 117–148). Amsterdam/Philadelphia: John Benjamins Publishing Company.
- Webster Online Dictionary. available at www.websters-online-dictionary.org (accessed 19-01-16).

APPENDICES

1. The English Corpus

Everyone to his own taste.

A corn doesn't fall far from the tree.

Acorn squash A squash that resembles a corn.

Acquied taste an acquired taste. An appreciation for something that must be developed over time.

Adam's apple an adam's apple. A bony projection midway up the front of the neck.

All hands and the cook! All able-bodied men are needed to respond to an emergency.

Alligator pear an alligator pear. An avocado.

Alphabet soup the initial and acronyms that are used as shorthand names for government organizations.

Ambrosia a food that is fit for the gods.

American as apple pie as American as apple pie. As American as baseball and hotdogs.

Angel food cake a cake that even an angel couldn't resist.

Angel on horseback oysters wrapped in bacon strips, cooked, and served as hors d'oeuvres.

Animal crackers small cookies in the shapes of circus and zoo animals.

Antipasto Italian hors d'oeuvres.

Appetite an appetite for culture, knowledge, work, etc. An intense interest in or desire for culture, knowledge, work, etc.

Appetizer an appetizer. A tempting preliminary to an even more satisfying main event.

Apple a day keeps the doctor away Apples are good for your health.

Applebutter as pread consisting of apples cooked in cider, along with sugar and spices.

Apple-knocker A rustic; a stupid person.

Apple of discord an apple of discord. A cause of disagreement, dispute, rancor, or revenge.

Apple of your eye the apple of your eye. What you hold most dear.

Apple-pie bed an apple-pie bed. A bed that has been 'short-sheeted.'

Apple-polisher an apple-polisher. A sycophant.

Applesauce! Nonsense!

Army marches on its stomach Soldiers can't fight unless they are fed.

Bad egg a dishonest, disreputable, no-good, rotten person.

Bake(v) to bake in the sun; to bake something into the budget. To bask in the sunshine; to include something in the budget.

Baked Alaska A baked sponge cake containing ice cream and meringue.

Baker's dozen Thirteen.

Baloney! Nonsense! Rubbish! Hdas: 1922.

Bean: to bean someone on the bean. For a baseball pitcher to hit a batter on the head with a ball.

Bean eater a bean eater. A resident of Boston, Mass.

Beanpole: A tall, thin person.

Beef(n) a complaint.

Beef(v) to beef ('build') something up; to beef ('complain') about something.

Beef eater a warden of the tower of London.

Be fruitful, and multiply be productive, and bring forth many progeny.

Berries (you're the berries!) The greatest.

Big apple: the big apple. New York city.

Biscuit shooter A waitress in a lunch counter, a cook on a ranch.

Bite(n) A small amount of food.

Bite(v) To go along with a joke or riddle.

Bite off more than you can chew To attempt more than you can accomplish.

Bite someone's head off To respond angrily, curtly, or sharply to a simple question, answer, or request.

Bite the hand that feeds you To turn on your benefactor.

Bitter harsh; intense; severe.

Bitter end to the bitter end. To the very end of a long and difficult struggle.

Bitter pill to swallow A negative occurrence that is hard to accept.

Blackberries are red when they're green blackberries—and blueberries—are red-colored when they're immature.

Blow the lid off to blow the lid off something. To expose something criminal or scandalous.

Blue cheese cheese that has been treated with mold.

Boarding house reach An ability to grasp objects that are beyond most people's reach.

Boil down to for something to boil down to something else.

Bon fire A large outdoor fire.

Born with a silver spoon in your mouth To be born into a wealthy family.

Bottle neck a bottle neck. An impasse or obstruction; a constriction or congestion.

Bottom feeder: a human scavenger.

Brain food: fish

Bread: money.

Bread always/never lands butter side up: things always/never seem to turn outright for him/her.

Bread and butter(1) : your bread and butter. Your living or livelihood; the source of your income or sustenance.

Bread and butter(2) : bread and butter! Good luck!

Bread-and-butter(1): bread-and-butter issues or activities. Basic or fundamental issues or activities

Bread-and-butter(2): a bread-and-butter producer skill. Something that you can depend on for your livelihood.

Bread-and-butterletter: a bread-and-butter letter (or note). A thank-you letter or note.

Bread and circuses: free food and entertainment to pacify the masses.

Bread and water: the reputed diet of criminal and political prisoners throughout history; the 'staff of life'.

Bread basket: The abdomen (stomach, belly) of a human being.

Bread winner: The wage earner of the family, the one who provides its major financial support.

Break bread: To dine with someone, not necessarily on bread.

Breakfast(n) the first—and most important—meal of the day.

Bring home the bacon: To win a prize; to support a family.

Brown-bag lunch: A lunch prepared at home, packed in a brown paper bag, carried to work, and eaten at a desk or in a lunchroom.

Brown Betty: A baked pudding of spiced apples and buttered crumbs.

Browse(v) to browse. To casually, leisurely, or randomly examine, inspect, or sample an assortment of things.

Butcher(n) An incompetent tradesperson, surgeon, writer.

Butter-and-egg money pin money.

Butter ball: A chubby child or young adult.

Butter cup: A yellow-flowered herb commonly found in pastures.

Butter fingers A butter fingers.

Butter nuts quash: A variety of squash bearing some resemblance to a nut of the butter nut tree.

Butter wouldn't melt in your mouth

Butter your bread on both sides To engage in wasteful extravagance.

Cabbage money; folding money.

Cake sandale: fun; good times.

Cake walk: An easy task.

Canadian bacon: back bacon.

Candy: illegal drugs.

Can't even boil water he/she can't even boil water. He/she doesn't know the first thing about cooking.

Carrottop A red head; a term of address for a red-head.

Cast your bread upon the waters don't be afraid to take a chance: you'll probably get your entire investment back—and more.

Caught with your hand in the cookie jar to be caught with your hand in the cookie jar. To be caught stealing money from your employer.

Cauliflower ear A human ear whose cartilage has been thickened and disfigured in the boxing or wrestling ring.

Caviar to the general too sophisticated for the general public to appreciate.

Cheese head A resident of Wisconsin.

Cheese stands alone: You're the only one left.

Cheesy cheap, crummy, flimsy, shabby, or tacky.

Cherry picker a cherry picker. A large plastic bucket hanging from the end of a telescoping crane.

Cherry tomato A tomato, about the size of a sweet cherry, that is often used in salads.

Chew out To reprimand someone severely.

Chew the fat To chat with friends; to make small talk.

Chew your cud To turn something over and over in your mind.

Chicken feed a paltry sum of money.

Chicken in every pot Prosperity for all.

Chief cook and bottle washer: the only employee of a small business; a jack-of-all-trades at a large business.

Chopped liver what am I, chopped liver? What about me? Don't I deserve some credit (praise, recognition, respect)?

Chopping block to have your head—or neck—on the chopping block. To be about to be fired.

Chowder head a chowder head. A clumsy or stupid person: a 'blockhead.'

Churn(v) To agitate; to be agitated.

Clam bake An outdoor social gathering, often for political purposes.

Coconut milk the natural juice of a coconut; the liquid prepared by mixing shredded coconut with water.

Cold shoulder A cool reception; a snub.

Comfort food food that reminds you of your childhood.

pareapples and oranges To compare unlike, and therefore incompatible, entities.

Cookie-cutter(adj.) Cookie-cutter houses. Houses that all look alike.

Cookie pusher: a cookie pusher. A waitress.

Cook someone's goose: To spoil someone's plans.

Cook the book: To falsify the accounts.

Cool as a cucumber: to be as cool as a cucumber. For someone in a situation of confusion, danger, or fear to be calm, collected, and composed; un-disturbed, unemotional, and unruffled; neither anxious, nervous, nor upset.

Cornball(adj.) Countrified, old-fashioned, unsophisticated; banal, hackneyed, trite.

Cornball(n) a cornball. A countrified, old-fashioned, or unsophisticated person.

Cottage-cheese thighs lumpy, bumpy, fatty thighs.

Couch potato a couch potato. A tv junkie.

Cowpie a cowpie. A single, fresh deposit of cow manure.

Cracker-barrel philosopher: A small-town expounder of truth and wisdom.

Cream(n) something having the color, consistency, or quality of real cream.

Cream in my coffee: you're the cream in my coffee. You make my life worth living.

Cream of the crop: the cream of the crop. The 'pick of the litter'; the 'top of the line.'

Cream puff: a used car condition.

Crock a crock. A lie.

Crumb a crumb. A despicable, disgusting, filthy, lousy, mean, miserable, repellent, or worthless person.

Crust a crust. A hard surface.

Cry over spilled milk: To get up set over something that you caused but can't correct.

Cry with a loaf of bread under your arm: To feel sorry for yourself when you really have a lot to be thankful for.

Cuisine a manner of cooking or preparing food; the food so cooked or prepared.

Cup A golf hole; an athletic protector; a breast supporter; a cooking measure.

Cupcake: An attractive young woman; a term of address or endearment for a wife or daughter.

Curate's egg: the curate's egg. A mixed blessing.

Curdle your blood: For something to frighten or terrify you.

Cut the feed: To cut off the electronic transmission of a radio or television signal to a particular audience.

Cut the mustard: To perform satisfactorily; to live up to expectations.

Cutting edge: The avant-garde of art, design, style, etc.

Digest(v) to digest spoken or written material. To assimilate spoken or written material mentally; to condense spoken or written material verbally.

Dig your grave with a knife and a fork

Dinner(1) the main meal of the day. Source: dinner.

Dip into to dip into a book; to dip into your savings. To sample—or'skim'— a book; to remove a portion of your savings.

Dish(n) A pretty woman; a favorite activity; a satellite or microwave antenna; dirt or gossip.

Dish it out to dish it out. To dispense something freely, plentifully, or forcefully.

Dog-eat-dog It's every person for him/herself in the highly competitive world of business.

Don't count your chickens before they hatch: don't count on something happening until it happens.

Double-dipper a double-dipper. A person who receives a government salary while at the same time receiving a government pension.

Dough money.

Dough boy A foot soldier in the U.S. Army before World War Two.

Drive someone crackers: To drive someone crazy.

Drum stick a drum stick. The portion of a fowl's leg between the 'knee' and the 'thigh.'

Dumpling a little dumpling. A pudgy little girl or young woman.

Dutch treat each person pays for his/her own meal.

Easy as duck soup Child's play: a 'cinch.'

Easy as pie: A cinch.

Eat away at to eat away at something. For wind or water (liquid or frozen) to destroy earth or stone; for chemicals to deface or destroy metal; for disease to destroy flesh and bone.

Eat crow to eat crow. To admit your error; to accept defeat.

Eat dirt To put up with insults and other verbal abuse; to humiliate yourself as punishment for making an error.

Eat high on/off the hog to eat high on—off—the hog. To live well and prosperously.

Eat humble pie to eat humble pie. To humble yourself; to apologize under pressure.

Eat it up to eat something up. To enjoy or appreciate something immensely.

Eat like a bird to eat like a bird. To eat very little; to 'pick' at your food.

Eat like a horse to eat like a horse. To eat a lot; to eat heartily.

Eat like a pig to eat like a pig. To eat rapidly, greedily, noisily, and indiscriminately.

Eat nails to be mad enough to eat—or chew—nails. To clench your teeth so hard that you feel as though you could chew on nails.

Eat someone alive. To completely dominate or defeat someone.

Eat someone out of house and home to eat someone out of house and home. To bankrupt someone by eating everything he/she has in stock and store.

Eat your first peach: To take your first risk.

Eat your hat: I'll eat my hat if I'm wrong. I'll humble myself in some appropriate way if my prediction doesn't come true.

Eat your heart out to eat your heart out. To suffer excessive worry or grief, to be consumed by envy or jealousy.

Eat your words: To be forced to take back what you have said.

Egg beater: A helicopter.

Egg head: an egghead. A bald man; a male intellectual

Egg on to egg someone on. To urge someone to do something that he/she will prob.

Egg on your face. To be embarrassed, humiliated, or chagrined as a result of your own foolish actions.

Egg plant an egg plant. A large berry of the night shade family, related to the potato and the tomato

Elephant ear: A large, thin, honey glazed cookie.

Everyone to his own taste everyone is entitled to his/her own likes and dislikes; to each his own.

Everything but the kitchen sink almost everything you own; almost everything you can think of.

Everything from soup to nuts everything that you could possibly imagine.

Eyes are bigger than your stomach your eyes are bigger than your stomach. Your wishes are bigger than your wallet.

Fat is in the fire the fat is in the fire. The initial damage has been done, and serious consequences will follow.

Fed up to be fed up. To have had all you can take of someone or something.

Feedback intentional or unintentional return of part of the output of an electronic system as part of the input.

Feeding frenzy a feeding frenzy. A frantic scramble toward an attractive object or goal.

Feed the fish(es) to feed the fish (or fishes). To drown at sea; to become fish food.

Feed your face to feed your face. To eat like death warmed over.

Feelyou roats to feel you roats. For an animal or a human to feel eager, energetic, excited, exuberant, feisty, frisky, lively, peppy, playful, or spirited.

Filled to the brim to be filled to the brim. To be chock-full of food and drink; to be showered with good fortune; to be overcome with emotion.

First come, first served the early bird gets the worm.

Fishy to seem fishy. To appear to be doubtful, dubious, questionable, or suspicious.

Flash in the pan. A person or thing that starts out with great success but ends up with disappointing failure a short time later.

Flat as a cheese soufflé: To be as flat as a pancake; to fall from grace into disgrace.

Flat as a pancake: Extremely flat or thin.

Flavor of the month: The person or thing that is recognized as being the most popular during the past month or judged to be the most promising during the coming month.

Food for worms To be dead and buried—or dead and not buried.

Food of love music.

Forbidden fruit illicit pleasure.

Fork in the road a fork in the road. The division of a road (or river) into two branches.

Fried to be fried. To be burned by the sun; to be executed in the electric chair; to be high on drugs or alcohol.

Fried egg: A 'buried' lie (of a golf ball) in a sand trap, with only the top of the ball showing.

Fruit A male homosexual.

Fruitcake: A 'nut'; a fool.

Fruits of your labors: The results of your hard work.

Fudge! Oh, fudge! Nonsense!

Full of prunes: To be full of hot air; to be talking nonsense.

Full plate To have a busy schedule, a full

Garnish(v) to garnish someone's wages. For an employer to withhold, by order of the court, a certain amount of money from an employee's wages in order to repay a creditor.

Get your just desserts: To get what you deserve.

Ginger pep; spirit; vigor.

Ginger bread lavish, ornate, and superfluous ornaments, carvings, and other decorations on houses and furniture.

Glass is half empty We're in trouble; we're in good shape.

Glutton or punishment: One who finds pleasure in service to others.

Goodegg: An agreeable, considerate, friendly, good-natured, kind, trustworthy, and wholesome person (usu. Male).

Good taste: To have excellent judgment of beauty and quality in the arts and entertainment.

Goose hangs high: All is well, and the future looks bright.

Go to pot: To be ruined.

Go to seed: To become decayed or decrepit, deteriorated or disreputable, shabby or squalid, uncared for or useless, weak or worn out.

Grape shot small iron balls fired in a cluster from a cannon.

Grapes of wrath: The seeds—or fruits—of discord and disaster.

Grate on your nerves: For a sound to irritate you to the point of illness.

Greatest thing since sliced bread The best thing to come along in a lifetime.

Grenade a grenade. A handheld explosive.

Grill a suspect: For police to interrogate a suspected criminal intensely and at length in order to obtain a confession.

Grin like a cheshire: To grin inscrutably.

Grist for the mill: raw material for the manufacturers; fuel for the fires; data for the scholars.

Grueling: exhausting; punishing.

Gusto: enjoyment; enthusiasm.

Half a loaf is better than none: something is better than nothing.

Half-baked: A poorly thought-out scheme, plan, or idea.

Half-pint: A small, short, or insignificant person.

Ham: a licensed amateur radiostation operator.

Hard-boiled strict, tough, demanding, rigid, hardheaded; unfeeling, unemotional, unsentimental, hard-hearted, heartless.

Hard to swallow: To find something difficult to believe or accept.

Hash(n) A hodgepodge or jumble; a mess or muddle.

Hash(v) to hash something up, over, or out. To make a mess of things; to talk things over; to work out a solution to a problem.

Have a belly full: To have all you can take of something.

Have a bone to pick: To have an argument to settle with someone.

Have a finger in the pie: To be interested or involved in a project or activity.

Have a lot of hungry mouths to feed: To have a large family that includes a lot of young children.

Have no stomach for: To have no appetite or tolerance for something.

Have other fish to fry: To have other matters to attend to.

Have someone eating out of your hand(s): To have domination or control over someone.

Hidebound: To be narrow-minded, inflexible, or ultra conservative.

Hit as our note: To change, for the worse, the entire complexion of an event or relationship.

Hit the spot: To be exactly what your mouth, throat, or stomach wants or needs.

Hodgepodge: A mixture, mess, or jumble.

Hog(n) A greedy glutton.

Hold out an olive branch: To make an offer of peace.

Hold the mayo! Don't add mayonnaise to my sandwich.

Holey as swiss cheese: Full of holes.

Honeymoon: A harmonious vacation for a newly married couple.

Horse raddish: a large, white, pungent root of the mustard family.

Hotdog(n) A show-off or exhibitionist.

Hot off the griddle produced only minutes ago, with no delay in delivery: 'hot off the press!'

Hot potato A controversial or embarrassing subject; a difficult or dangerous problem; a disagreeable or unpleasant person.

How do you like them apples? What do you think about that?

Huckleberry A person of little consequence (e.g., huckleberryfinn).

Hungry as abear: To be so hungry that you could eat just about anything, including garbage.

Hungry for affection: For a child to be starving for love.

Ice-cream pants white flannel trousers.

Icing on the cake An unexpected bonus.

If life hands you a lemon, make lemonade: if you're faced with a stroke of bad luck, turn it into a stroke of good fortune.

If you can't stand the heat, get out of the kitchen: if you can't put up with the pressures, get out of the business.

In a jam: To be in a bind, a fix, a tight spot; to be 'between a rock and a hard place.'

In a nutshell: briefly; in summary; in a few words.

In a peck of trouble: To be in a predicament from which you may not be able to escape.

In a pickle: To be in a difficult or troubling situation..

In apple-pie order: in perfect order.

In a stew: To be in a state of heated anger, high anxiety, deep confusion, serious difficulty, profound worry, etc.

In good taste: To be fitting and proper.

In the can: in the golf cup or hole; in the bathroom or washroom; in the basket ball basket or hoop; in jail or prison

Is it bigger than a breadbox? Are its dimensions greater than One foot high, one foot deep, and one and one-half feet wide?

It must be jelly ('cause jam don't shake like that): it must be fat because muscle isn't that soft.

Jam sandwich: A bruise resulting from an accident in a baseball game.

Java: a cup of java (or a java). A cup of coffee.

Jell(v) for things to come to get her as expected, hoped, or planned.

Jelly fish: A weak-willed person who lacks the courage of his/her convictions and can't make or maintain strong decisions.

Jellyroll: sex; the female genitalia.

Johnny cake: corn bread.

Juice(n): the essence of something.

Junket: A vacation trip taken by a public official and financed either by the tax payers or an interested corporation.

Keep the pot boiling: to keep the ball rolling, sustain an activity, or maintain a momentum

Kettle drum: A musical percussion instrument.

Kettle of fish: A sorry state of affairs: a 'mess.' Lcrh: early-18th cent.

Kill the fatted calf: To prepare an elaborate celebration for an honored guest.

Kill the goose that laid the golden eggs: To destroy a source of future revenue out of impatience for immediate wealth

Kitchen cabinet: A group of friends whom aheadof state relies on for advice more than he/she does the officially appointed secretaries or ministers.

Kitchen police u.s.Army mess hall duty.

Kitchen spanish 'pidgin' Spanish used by an english-speaking house- holder to communicate with his/her predominantly sp.-speaking kitchen staff.

Kiwi fruit thechinesegooseberry.

Knock the stuffing out of: To trounce someone decisively.

Know which side your bread is buttered on: To know what's good for you; to know what's to your physical, social, or economic advantage.

Land of milk and honey Paradise; heaven on earth.

Lay an egg To fail miserably.

Layer-cake effect: The resemblance of a building or a hierarchy to a layercake.

Leak like a sieve:To hold water(etc.)As well as a sieve does.

Leave a bad taste in your mouth: For the memory of something unpleasant to linger with you for a long time afterwards.

Leaven(v): To alleviate, modify, temper, or lighten the tone of something.

Lemon: A new car that turns out to be a dud.

Let them eat cake!: That's their problem!

Lettuce money: folding money.

Life is just a bowl of cherries: life is good, great, wonderful!

Like a hot knife through butter: easily; without difficulty or impediment.

Like the pot calling the kettle black: like a hypocrite.

Like two peas in a pod: To be virtually indistinguishable.

Limey: An englishman.

Little shrimp: A small or puny person; a small or unimportant enterprise.

Live from hand to mouth: To have only enough food or money for the present.

Longdrinkofwater: A person who is both tall and slim.

Look like a boiled lobster: To have a severe case of sunburn.

Look like death warmed over:To look—or feel—like a zombie.

Look like the cat that ate the canary:To look smug or self-satisfied; to look sheepish or guilty.

Lotus-eater: An indolent, self-indulgent person.

Love apple: A tomato.

Macaronic verse: verse containing a mixture of words from two languages.

Make a pig of yourself:eat like a pig.

Make hamburger of:To beat someone to a pulp; to defeat an opponent soundly.

Make it hot for: slave over a hot stove all day.

Make mince meat of :To defeat, demolish, destroy, or devastate someone or something.

Make no bones about it: To have no hesitation or doubt about doing or saying something; to speak frankly or bluntly about something.

Make someone's blood boil: To make someone very angry.

Make your gorge rise: To make you angry, disgusted,or nervous.

Make your mouth water: For something to be so attractive that you want to have it—now.

Man cannot live by bread alone:there is more to life than food.

Mange-tout:like two peas in a pod.

Manna from heaven unexpected help from a benevolent source.

Mashed potato: A variation of the dance called the 'twist.'

Mash your thumb: To hit the nail of your thumb— instead of the nail in the board—with the head of a hammer.

Mealy mouthed devious; deceitful; dishonest.

Meaty meaty hands; a meaty role; a meaty topic. Large, heavy hands; a substantial role in a play; a profound topic.

Melt in your mouth see butter wouldn't melt in your mouth.

Memory like a sieve see leak like a sieve.

Milk(v) to milk something.To drain the resources of something.

Milk of human kindness Compassion; mercy.

Milkrun a milkrun. A routine flight of a military or commercial airplane.

Milksop A sissy.

Milktooth a milktooth.One of the twenty-four 'babyteeth' of a human child.

Mills of the gods grind slowly Sooner or later you will be punished for your sins.

Milque toast: A timid man.

Mince words: To use evasive language.

Mock chicken: imitation chicken legs.

Mock duck an imitation duck roll.

Mock turtle soup imitation green turtle soup.

Moon is made of green cheese: ('you just won the lottery!' 'sure, and the moon is made of green cheese.'That is, only a fool would believe that.)

Moth-eaten: To be dilapidated, decayed, or decrepit; to be antiquated, out-of-date, or outmoded.

Mousse a foam used for styling hair: 'styling mousse.'

Moxie nerve, courage; gall, guts; spunk, spirit; energy, pep; expertise, shrewdness.

Muffin a term of endearment and address for a girl or young woman: 'hi, muffin!' snack bar.

Mustard 'heat.'

Mutton headed: To be dim-, dull-, or slow-witted.

Neither fish nor fowl: To be neither one thing nor another: 'unclassifiable.'

Nest egg: Money saved for retirement or 'a rainy day.'

Nopicnic difficult; unpleasant.

Not for all the tea in china: not for any amount of money.

Not kosher: not acceptable.

Not worth a fig: worth nothing at all.

Not worth a hill of beans: Practically worthless.

Nut: A difficult problem

Nuts about: To be delighted, elated, or excited about something; to be crazy, mad, or wild about someone.

Old chestnut: A hackneyed, overused, stale, or worn out adage, anecdote, joke, or story.

Old salt: An old sailor.

Olive drab: the color of U.S. Army non dress uniforms during WWII

One rotten apple spoils the barrel: one corrupt person in a group tends to corrupt the other persons in the group.

Onion skin paper: strong, thin, light, glossy, translucent paper.

On the half shell open-faced.

Out of the frying pan into the fire: To go from bad to worse.

Packed like sardines: To be crowded in a small enclosure.

Pancake(v): For a series of horizontal structures to fall down on top of each other during an earthquake or explosion.

Pancake make up: the atrical make up in cake form.

Pancake Tuesday: The day before each Wednesday in the Christian calendar.

Pan handle(n): A narrow extension of land from a larger territory.

Pan out: To turn out as planned, hoped, or expected.

Pap: over simplified writing; simplistic ideas.

Pare down: To reduce the size of the budget or the length of a speech(etc.).

Patty-cake: a clapping game usually played by a mother and child.

Peach: A friendly and generous member of either sex; a beautiful young woman.

Pear-shaped bell-shaped.

De résistance : The chief attraction; the main event.

Pie chart : A circle graph.

Pie in the sky: unrealistic hopes and dreams.

Pigeon milk: predigested food that is regurgitated from the throat of an adult pigeon into the throat of one of the nestlings.

Pits: The worst.

Plain-vanilla basic, bland, boring, dull, ordinary, uninteresting.

Plum: An unexpected prize; a generous reward.

Pop your cork: To go wild or crazy.

Pork: political patronage.

Pork pie hat: A men's cloth hat with a flat to panda narrow brim.

Potatohead: A fool.

Potbelly: A protruding abdomen.

Pressure cooker: A tense situation; an emotion-packed environment; a stressful job.

Proof of the pudding is in the eating: The success of a person or product can only be measured by his/ her/ its performance.

Pudding headed (adj.) Soft-headed; stupid.

Pull someone's chestnuts out of the fire: To bail someone out of trouble At considerable hardship to yourself.

Pumpkin: A term of endearment and address for a child (usu. A girl).

Put all your eggs in one basket: To foolishly put all your trust in one plan, one individual, one company, one bank, etc.

Put on ice: To set something aside; to hold something in reserve; to postpone or delay something.

Put on the feedbag: To eat.

Quit cold turkey: To terminate a harmful addiction suddenly, without gradual withdrawal.

Reach the boiling point to reach the boiling point. For matters to reach the point of crisis; for anger to become uncontrollable.

Recipe: A set of instructions for making something from a set of ingredients.

Red as a beet: To be redfaced with anger, embarrassment, fever, or sunburn.

Red herring: A deliberate diversion, distraction, or false clue.

Rhubarb: A heated argument; a noisy controversy.

Ripe advanced, appropriate, mature, mellow, odoriferous, offensive, prepared.

Rotten egg: A despicable person (usu. Male).

Rubber-chicken circuit: The series of speech and lectures required of political candidates, authors of bestsellers, and other celebrities.

Rump: Your bottom.

Salad: A heterogeneous mixture: a hodgepodge; a pot pourri.

Saladdays: a time of youth; a time of happiness and prosperity.

Salt-and-pepper: having a mixture of white and black—or light and dark—colors.

Saltaway: To put money aside for future use.

Salt of the earth: The light of the world.

Sandwich(v): To place one object between two objects; to place two objects around one object.

Sauce impudence or impertinence; alcohol.

Saucy rude; pert; smart.

Save your bacon: To save your career, life, marriage, reputation, skin, etc.

Saycheese: Smile for the camera!

Schmaltz: sticky sentimentality.

Scrambled eggs: the gold oak leaves (brit.) Or gold braid (amer.) On the bill of the cap of a high-ranking military officer.

Scrape the bottom of the barrel: To be forced to use whatever is left, even if it is of unsatisfactory quality.

Seersucker: light, striped, puckered fabric.

See what I can dig up: I'll see what I can throw to get her for dinner.

Sell like hot cakes: To sell fast and in great quantities.

Set the table: To lay the ground-work or prepare the way for someone or something.

Shell out: To pay out cash for something.

Short cake: A dessert consisting of a biscuit, fruit, and whipped cream.

Silverware: eating utensils.

Simmer down: To calm or quiet down.

Sink your teeth into: To tackle a job or a problem that is both difficult and rewarding.

Sizzle(v) To suddenly reach a higher level of performance

Slave over a hot stove all day: To work as hard as a housewife-cook did during the 19th and early-20th century.

Slice of life: An accurate representation of actual life.

Slice of the melon: A piece of the action; a percentage of the profits; a share of the spoils.

Slow as molasses in January: To be dilatory, lethargic, or sluggish.

Slowburn: For anger to build up slowly within you.

Slush fund: A contingency fund within a congressional budget; a political fund for financing illegal activities.

Smack of: To have the distinctive features of something.

Small fry unimportant people; young children; minor organizations.

Small potatoes insignificant; trivial; unimportant; worthless.

Smart cookie: A very smart or clever person.

Smorg as bord: A heterogeneous mixture or mélange.

Soup dense fog; a liquid mixture; power; sentimentality; trouble.

Soup-strainer: A large mustache.

Sour dough: A prospect or for gold in California

Sour grapes: disparagement of something that is desirable but unattainable.

Spaghetti squash: A large, oval squash whose flesh forms little strings when baked.

Spaghetti western: A 'western' movie made in Europe, in Italian, with an Italian producer, director, and supporting cast.

Spill the beans to spill the beans. To divulge information that was supposed to be kept secret.

Spinach: money; folding money.

Spit: An arrow point of sand or gravel projecting into a large river, lake, or sea.

Spoiled rotten coddled, pampered, over indulged.

Spoon-fed: over indulged, spoiled, pampered.

Spring up like mushrooms: To multiply rapidly.

Stew in your own juice: To suffer from the consequences of your own actions.

Stick in your craw: For something to anger, annoy, bother, 'bug,' disgust, or repel you.

Stir up trouble: To cause trouble to occur.

Stone soup: Bernard's soup: a free meal.

Strawberry mark: A red birth mark.

Submarine sandwich: A sandwich made with an entire (small) loaf of French or Italian bread, split lengthwise, and filled with meat and vegetables.

Suck(v) to form a vacuum; to extract by means of a vacuum; to become vacuous.

Sucker: A leech, a fish; a lolly pop; a dupe, a pushover; a 'shoot.'

Sugar: a term of address and endearment :e.g., 'hi, sugar!'

Sundae: A bowl of ice cream topped with syrup and (optionally) crushed fruit, nuts, and whipped cream

Swallow your pride: To admit your mistake and accept your punishment.

Sweetbread the thymus or pancreas of a calf when prepared as food.

Sweeten the kitty: To increase the stakes or incentives.

Sweet the art contract: A privately arranged 'contract' between an employer and a union official.

Sweetie pie : A sweetheart. (usu. Female.)

Sweetpotato: Anocarina.

Sweets to the sweet: sweet treats for a sweet person.

Sweet tooth: A fondness for sweet food.

Taffy: cajolery; flattery.

Take pot luck: To take what is offered to you.

Take the bitter with the sweet: To accept the bad with the good.

Take the bread out of someone's mouth: To rob someone of his/her livelihood.

Take the cake: To be the best ; to be the worst.

Take the starch out of: To loosen someone up; to make someone act less stiff and formal.

Take with a grain of salt: To react to a spoken or written statement with considerable skepticism.

Tart(n): A prostitute.

Taste a taste of success (etc); to taste success (etc). A sample of what success (etc.) is really like; to experience success (etc.) For the first time.

Taste like dish water: To taste weak and watery; to have no flavor at all.

Tastes just like chicken: You're going to love it!

Tea a tea. A late afternoon family or social gathering at which refreshments, including tea, are served.

Teach your grand mother to suck eggs: to presume to give advice to an expert.

Tempest in a teapot: Much a do about nothing.

That's the way the cookie crumbles: that's the way it is; that's life.

Thirst(n) a thirst. A craving or longing.

Through the mill: To have experienced difficulty and hardships that have contributed positively to your development.

Toad eater: A parasite; a sycophant.

Tomato: An attractive young woman.

Too many cooks spoil the broth a successful outcome can be achieved only if there is a single person in charge.

Top banana: The chief member of a comedy team; the top official of a business or organization.

Tree is known by its fruit: A person is judged by his/her words and deeds.

Truffle a truffle. A ball of soft, rich chocolate candy.

Tub of lard: A fat person.

Twinkie defense: A 'temporary insanity' defense.

Two bites of the cherry: To get (or have) a second chance to succeed where you have previously failed; to make a job last twice as long as necessary (or to take twice as long as necessary to do a job).

Upper crust: The highest class of society: the elite; the aristocracy.

Upset the apple cart: To ruin someone's carefully laid plans.

Variety is the spice of life: diversity is what makes life interesting.

Vegetable: A person who has permanently lost the ability to move, feel, or respond and is being kept alive by machines.

Vine apple: A squash.

Vinegar sourness or disagreeableness

Walk on eggs: To watch your step.

Warm as toast: To be warm and comfortable.

Watched pot never boils: Impatience never hastens progress.

Water, water, everywhere, but not a drop to drink: we are surrounded by an abundance of riches that are just beyond our reach.

Welsh rabbit melted cheese on toast.

Wet noodle The mildest possible punishment.

What's cooking? What's happening? What's up?

What's sauce for the goose is sauce for the gander what's good (fair, fitting, right) for one person is good (fair, fitting, right) for the other.

Which came first, the chicken or the egg? Which of two things was the cause, and which was the effect?

Wish bone: An offensive formation in football.

Wither on the vine: To fail, in the planning stage, from lack of interest or involvement.

Work for peanuts: To work for practically nothing.

Yeasty: frivolous, superficial; restless, unsettled.

You are what you eat: if you eat healthful food, you'll lead a healthy life.

You can lead a horse to water, but you can't make it drink: you can't make someone do what he/she doesn't want to do.

You can't eat your cake and have it too: you can't have it both ways.

You can't get blood from a turnip: you can't do the impossible.

You can't make an omelette without breaking eggs: you can't achieve a difficult goal without hurting somebody's feelings.

You can't unscramble an egg: You can't undo what you have done.

You said a mouthful your comments hit the nail right on the head.

Yummy: delicious; delightful.

2. The French Corpus

- Manger son blé en herbe/ en vert.
- Manger des briques.
- Etre bête à manger du charbon / du foin / de l'herbe.
- Manger des coups, une dégelée, une raclée, la volée = être battu.
- Manger le bon dieu
- Manger la laine sur le dos de quelqu'un
- Avoir mangé du lion.
- Manger le morceau = avouer

- Manger son pain blanc le premier.
- Ne pas manger de ce pain là.
- Manger les /des pissenlits par la racine.
- Manger de la vache enragée.
- Savoir bien son pain manger.
- Manger la soupe sur la tête de quelqu'un. (être nettement plus grand que quelqu'un).
- Manger ses mots (mal articuler, prononcer précipitamment).
- Manger dans la main de quelqu'un (être familier).
- Etre joli à manger, être à manger. Une jolie personne à croquer.
- Il me mangeait le blanc des yeux. Il me querellerait.
- Manger les crucifix = se dit en parlant des hypocrites.
- Je le mangerai avec un grain de sel, à la croque du sel = se dit d'un homme qui l'ont se croit très supérieur en force.
- Les gros poissons mangent les petits.
- Les loups ne se mangent pas entre eux.
- Se manger le nez = se quereller.
- Manger de quelqu'un = être hostile à quelqu'un.
- Manger des yeux = regarder avec avidité.
- Manger de baisers, de caresse.
- Etre mangé, être attiré par quelqu'un ou quelque chose.
- Manger = ronger altérer, user lentement bois mangé par des termites.
- Mordiller = se manger les poings d'impatience.
- Altérer = plaque de fer mangé par la rouille.
- Face mangée d'anémie. Un ulcère qui lui mange la jambe.
- Altérer modifier le comportement : être mangé par la jalousie.
- Anéantir faire disparaître = l'ombre avait mangé tous le bas de l'atelier.
- Recouvrir, cacher partiellement = visage mangé de barbe.
- Ces visages mangés par des yeux immenses.
- Dépenser, dilapider, manger de l'argent.
- Faire de grosse dépenses a quelqu'un le ruiner = Ses chevaux, ses chiens le mangent.
- Consommer = les arbres mangent le sucre de la terre.
- Cela ne mange pas de pain = cela ne coûte rien.
- Faire perdre = occuper= activité qui mange du temps.

- Manger la consigne = oublier.
- Boire la tasse, boire un bouillon = avaler de l'eau en quantité plus au moins grande.
- Boire à la grande tasse = se noyer dans la mer
- Boire une somme d'argent = la dépenser en boissons
- Il est bu = il est ivre
- Pour boire = une gratification à un travailleur, salarié.
- Le vin est tiré, il faut le boire.= il faut poursuivre une affaire dans laquelle on s'est trop engagé pour pouvoir reculer.
- On ne saurait boire un âne s'il n'a pas soif
- C'est la mer à boire = c'est une entreprise qui présente des difficultés insurmontables.
- Qui a bu boira = on ne se corrige jamais de certains défauts
- Il y a à boire et à manger = c'est une chose qui présente divers aspects contradictoires, de bons et de mauvais coté.
- Cheval qui boit dans son blanc = cheval qui a le nez blanc, le reste du corps étant d'une autre couleur.
- Boire = désigne un corps perméable ou poreux.
- Boire la lumière.
- Faire boire une étoffe = la coudre d'une manière lâche.
- Boire = recevoir un bien d'ordre physique, moral ou intellectuel et en jouir ou tirer parti intéressément.
- Boire quelqu'un du regard, des yeux = le regarder intensément.
- Boire les paroles de quelqu'un = les écouter avec passion ou avec une admiration sans réserve les savourer.
- Boire du lait = voir ou entendre quelque chose avec un plaisir intense.
- Boire la sueur de quelqu'un = tirer injustement profit de son travail, l'exploiter.
- Boire = surmonter une difficulté. Cheval qui boit l'obstacle/.
- Boire = supporter quelque chose de pénible d'humiliant = boire l'amertume, la honte.
- Boire la ciguë = subir une peine, un malheur généralement causé par autrui
- Boire la calice jusqu'à la lie = endurer une souffrance jusqu'au bout.
- Boire un bouillon = échouer dans une entreprise, subir une perte.
- Oublier, en perdre le boire et le mangé = être accaparé tout entier par une préoccupation, un souci, une passion.
- Le coeur nourriture de l'esprit.
- Nourriture de l'âme.
- Nourriture passe nature

- Le miel des principes
- Le sucre des promesses
- La langue de vipère n'est jamais plus venimeuse que lorsqu'elle est enduite de miel
- Terre de lait et de miel
- De miel : qui montre de la douceur dans son aspect.
- Le miel de l'éloquence
- Le miel de la parole
- Bouche de miel coeur de fiel
- Avoir le miel sur ses lèvres
- Etre tout sucre tout miel
- Faites vous miel, les mouches vous mangeront.
- Lune de miel
- On prend plus de mouche avec du miel qu'avec du vinaigre
- Donner ordre aux sauces
- Bouffer des briques a la sauce des cailloux
- Il n'est sauce que l'appétit
- A bon appétit il ne faut point de sauce
- Changer, varier la sauce
- A quelle sauce va t-il manger
- A toutes les sauces
- La sauce fait manger le poisson= l'accessoire fait passer le travail.
- Sauce = accompagnement inutile
- Allonger la sauce
- Sauce= correction, réprimande : donner une sauce à quelqu'un
- Gober, payer la sauce. Etre gourmandé ou puni pour le mefait d'un autre.
- Sauce= pluie averse
- Mettre toute la sauce, y mettre de la sauce : forcer la dose.
- Balancer, allonger, envoyer la sauce = rafale d'armes.
- Un lycéen de poil de carotte.
- Couleur carotte
- Personne rousse= carotte
- Carotte = échantillon de terrain.
- Les carottes sont cuites = tout est décidé.

- Vivre des carottes.
- Jouer la carotte = jouer d'une manière mesquine.
- Marcher à la carotte
- Tirer la carotte a quelqu'un
- Tirer une carotte
- Carotte= petite escroquerie.
- Carotte de longueur.
- Promettre plus du beurre qu du pain.
- Mettre des beurres dans les épinards.
- Faire son beurre
- Faire une salade
- L'assiette au beurre.
- Fondre comme du beurre
- Etre tout en beurre ou avoir des mains de beurre.
- Compter pour du beurre
- Pas plus que du beurre en branche = rien
- Avoir un oeil de beurre noir
- Beurre de zinc = composant chimique.
- Sel de baptême, se la sagesse, sel purificateur = symbole de vie de lumière.
- L'enfance est le sel de la terre.
- Renverser du sel à table
- Alliance de sel
- Offrir le pain et le sel
- Semer du sel
- Spectacle qui ne manque pas de sel
- Ces rencontres sont les sels de voyage.
- Sel d'une plaisanterie.
- Voila de ces terribles histoires, dont le sel est bien anglais.
- Sel gaulois = caractère leste.
- Gros sel = manque de finesse.
- Grain de sel= pointe d'esprit que l'on met dans le langage.
- Mettre un grain de sel sur la queue d'un oiseau.
- Mettre son grain de sel = donner son avis.

- Poivre et sel.
- Tablette de chocolat.
- Il ne mangeront point un minot de sel ensemble = nous ne serons pas longtemps unis.
- Casser du sucre sur la tête ou le dos de quelqu'un
- Sucre = douceur, charme ; Reçu ce matin un lettre de Bardoux, toute en sucre.
- Etre tout sucre tout miel.
- Etre en sucre = manquer d'énergie.
- C'est pas du sucre
- C'est pas du gâteau
- Sucrer= il sucre sa voix pour amadouer l'huissier.
- Sucrer quelqu'un = arrêter quelqu'un
- Sucrer = maltraiter, blesser
- Sucrer= condamner a une forte peine.
- Sucrer = se faire dérober, voler quelque chose.
- Sucrer = s'octroyer un part excessive.
- Prendre un pain dans la fournée = avoir des relations intimes avec une fille avant le mariage.
- Etre au pain sec = être réduit au pain pour tout nourriture.
- Rompre le pain ensemble = partager le pain.
- Lorsque le pain se ramollit la pluie va venir.
- C'est pain bénit.
- S'ils n'ont plus de pain qu'ils mangent de la brioche.
- Du pain et des yeux.
- Pain = toute espèce de nourriture indispensable à la vie.
- Faire la guerre au pain = rentrer affamé chez soi.
- Gagner son pain à la sueur de son front = Gagner sa vie en travaillant.
- Il fait son pain manger.
- Il ne vaut pas le pain qu'il mange
- Mendier son pain.
- Pour une bouchée de pain.
- Pour un morceau de pain
- Retirer, ôter à quelqu'un le pain de la bouche.
- Faire passer le goût du pain
- Manger du pain rouge.

- Manger son pain blanc le premier.
- Pain = source de vie
- Avoir du pain cuit.
- Ne pas manger de ce pain là.
- Etre le pain quotidien
- Pain= symbole du nécessaire. Son corps long comme un jour sans pain.
- Pain= symbole de la bonté = il était franc comme le pain.
- La diète affame la maladie mais elle affame plus encore la vitalité.
- Affamer une écriture= la rendre plus maigre.
- Affamer un habit
- Affamer un ameublement.
- Affamer (architecture)= terminer brusquement une moulure par une section oblique, plane ou courbe.
- Affamer (construction)= affaiblir une pièce de bois.
- Affamer = donner des désirs à quelqu'un en le privant des biens corporels, spirituels et intellectuels.
- Il la priva même pour le mieux affamer.
- Affamer le coeur
- Affamer l'esprit.
- Affamer l'intelligence.
- Le malheureux prisonnier se vit enlever plumes, encre, livre ... on voulait absolument l'affamer.
- Affamer une table
- Affamer les convives
- Et après avoir sué l'eau et le sang, il s'affamera
- Saccard s'affamait, sentait ses désirs s'accroître à voir ce ruissellement d'or qui lui glissait entre les mains.
- Ventre affamé n'a pas d'oreilles
- Sol affamé qui ne retient pas l'eau.
- Affamé d'amour
- Affamé de justice
- Affamé de vérité
- Je revenais à elle épuisé le coeur affamé de la voir et le coeur intact.
- La passion affamée engloutissait mes lèvres.
- Il faut de la pâture aux affamés de temps.
- La femme hystérique affamée de baisers.

- Je rigolerais au plus soif.
- Il fait soif = il fait chaud.
- Je reste toujours sur ma soif devant les merveilles de la nature.
- J'emportais comme réserve, comme poire pour la soif, une paire de boucle d'oreilles.
- On ne saurait faire boire un âne s'il n'a pas soif.
- Soif de sang.
- Notre époque est dévorée d'une soif de recherches et de découvertes.
- J'ai faim de vous lire et de vous embrasser.
- J'ai soif de toi.
- Mon satin est un satin fort et celui ci une pelure d'oignon.
- Se mettre en rang d'oignons.
- S'occuper de ses oignons
- Se mêler de ses oignons.
- Ce n'est pas mes / tes / ses oignons
- C'est mes oignons
- Il y a de l'oignon.
- Aux petits oignons
- Pleurer sans oignon
- Pleurer sans avoir éplucher d'oignons.
- Regretter ses oignons d'Egypte.
- Avoir la tête comme une citrouille.
- Bête comme un chou
- Avoir un pois dans la tête
- Soupe au lait.
- La mayonnaise prend.
- Jeunesse verte.
- Faire un fromage peut remplacer faire tout un plat
- Faire son beurre : faire des profits
- Faire l'andouille : faire l'imbécile
- Mettre à toutes les sauces : utiliser à tout propos une expression, une excuse... en abuser.
- Mettre les petits plats dans les grands : faire de son mieux pour accueillir quelqu'un
- Se faire cuire un oeuf, ce dont il faut se contenter si on a refusé une offre généreuse d'autrui
- Avoir un pépin : avoir des ennuis

- Etre pris pour une poire : pour un imbécile
- Avoir la banane : être heureux, du moins très souriant
- Avoir la pêche : être en pleine forme
- Etre mi figue mi-raisin : d'humeur indécise
- En deux coups de cuiller à pot : très vite
- Tourner la cuiller autour du pot : hésiter longuement
- Ne pas y aller avec le dos de la cuiller : sans aucun égard
- Faire choux blanc : échouer
- Prendre une prune : être verbalisé
- La moutarde monte au nez : se mettre en colère
- La mayonnaise prend : les personnalités sont compatibles
- C'est du gâteau ! : trop facile
- Mouler un cake : aller à la selle
- Châtaigne ou marron et pain ou encore patate ou beignet pour un coup de poing.
- Ratatouille pour plusieurs gros coups
- Pomme ou poire sont le visage
- Brochette désigne un ensemble de choses ou de gens
- Boeuf-carotte désigne l'inspection de la police
- Le bouillon de onze-heure est un poison
- Pomme et cornichon désignent une personne pas finaude
- La salade est un mensonge
- Je bois du petit lait = je constate avec grand plaisir que j'avais raison, je savoure ma vengeance.
- Je bois la tasse = j'avale de l'eau par accident en me baignant.
- Mettre de l'huile : apaiser une tension
- Boudiner : serrer de très près, surtout pour les vêtements (être boudiné dans un pantalon)
- Larder : couvrir de multiples plaies (lardé de coups de couteau)
- Mijoter : penser longuement à un plan
- Saler : trop excessif (une facture salée, une punition salée)
- Se poivrer : s'enivrer
- Emmieller : embêter
- Sucer jusqu'à la moëlle : abuser de quelqu'un, en profiter totalement
- Rome est un **millefeuille** urbain où cohabitent 2 500 ans de civilisations, de croyances, de styles de vie.

- La crème de la crème : le dessus du panier
- Faire monter la mayonnaise. Aggraver un problème, un conflit en en exagérant les termes. Dresser les uns contre les autres les parties d'une dispute. Créer le *buzz*.
- Rouler dans la farine : tromper par de belles paroles
- Un brasse bouillon : une personne pas délicate pour un sou
- Avoir un bon coup de fourchette = être bon mangeur.
- Etre à la petite cuiller ou en bouillie = être réduit en pièce détachée, suite à un accident par exemple, ou tout amolli, suite à une grosse émotion.
- Tasse de thé.
- Pain sur la planche.
- Pas grand-chose à voir avec la choucroute renvoyé la patate chaude.
- Aux petits oignons.
- Pour leur pomme.
- Ce fut une autre limonade (= *ce fut une autre paire de manches*)
- Etre, tomber dans la limonade : être dans les ennuis, la misère
- Tomber dans la limonade : être en déconfiture.
- Tirer qqn de la limonade : l'aider à s'en sortir.
- Tremper sonbiscuit: en parlant d'un homme, pénétrer avec son membre viril (issu du sens propre "manger un biscuit en le trempant dans du thé, du café ou du chocolat".)
- Avoir dubiscuit : avoir de la ressource, des réserves, un savoir qui permettra de faire face (issu du sens propre comme terme maritime : "avoir du biscuit sur un bateau", c'est avoir de quoi manger. Il est recommandé de *ne pas s'embarquer sans biscuit*.)
- Mieux vaut du foie haché que des soucis terribles
- Faire des boniments à la graisse d'oie. : essayer d'embobiner les gens, tenir des propos faux et ridicules.
- Il a toujours l'oeuf = il se plaint toujours , il est toujours à geindre.
- Cracher dans la soupe. = mépriser ce qui vous fait vivre, ce qui fait votre profit.
- Etre trempé comme une soupe = être complètement mouillé.
- Faire la soupe à la grimace : se montrer désagréable, peu gentil.
- Les plats que nous mangeons ne sont jamais aussi chauds qu'au moment de la cuisson = de la fiction à la réalité, il y a loin.
- L'omelette est faite : quelque chose de déplaisant s'est passé.

- Aplatir comme une crêpe

3. The Tunisian Arabic corpus

الن عظم صيح
الننيء
الننقص
مرا م ح حرة
الن طلط
النبلل
ن هارك قلة ولحب
الن قلة
الن عولة
الن عمل لبي
الن مر
الن عمري دة ليلع ان
طلي بوبدة
خضرة
طم اطم
علمة كليلصل
سرع قعرع
عظمة حارمة
ويح قبينة
بافان بيونة

لبيش تسلاطة
باصص انبار
ببوشبوصة
مجان
مجان كورة
ميتشر
حطه ولو نوى طبق
عطاها روح للبدة
مش اتفوفم فقريت
رولي دمي
طيب زبدة
طيب لقمه
طيب خضرة
سقي اطم
علم فوق سة
شبان
شبعي هاهي ه
نحو
ن هارك قلة ولبب
الن صلفي كلال لبيب
صو
فركو لرملة
شك اربطاطا
يصوصرفي خضرة
ي موت نوى لخنز لبحس س
ببببب بلبو
ي موت نوى لقمه للاردة
ي عرف يبي
س لبيته و مخرية
كل واحد مخرتو اش مزت
قد لول حمو
شول وللببتو
هناك ال قبرص هناك الامعجون

كشر ولجيرة
بهي م ق دمقرعة
بهي جي كلبهي م
بشرك و طو
لجوى
لجوال دغوار
لجوة فك
مر خنظل
بل علسلو
عجين مس من
عجيه حارة
الم حلل ط
ري قبارد
بل لى لى هال لى لى
غريل
فورلي دمي
ن لى
ش ل ط ه
فاحت ل لى لى
ضرفرشك
منقاع ل لى لى
عمرلو القار صرفي لى لى ه
كول حاج قش لى ه اوليهك
شوش
زيت لى لى لى
كول لى هاش لى لى
ضزقارده
رض عوفى ل لى لى
وليهو لى لى
ذوقو لمر
يكل ل لى لى
يكل ل لى لى
يكل لى لى لى

يبدرفي خزة
يلعب خزة الالدو
طبق كروي
يفتتح شاية الامداف
العيي عجان كورة
ماضيقوش
دافيك رشو
كش و لخيرة
عجن و لخيرة
وليه و لخير
خلاه شوي
خزق اطو
يخمي يامك
فاحت ل لخيرة
فوح هال لخيرة
للعب شرا
حمص و زيب
عصني كلق ارضة
صوني كلقبوشة
شني لحم و سيني عظم
شبع قلوبوس
عدى عمرو الطة
عطا هلو و عوى طبق
ندم ال لصل
ندم ال خراه
الريلو
ال عريلو
الكف
اللبوط
ال عويلي و شرب
ال مبعي ه
ال و لخيرة
ال و لخير

البحضو
الروحو
ال ملجعيه
ي لظبيعيه
ولهبوكلاه
ولهبو ملظو
ي لظيخزة
اللاوعرقو
اللاولوسو
اللاووج هو
ي لظضو
ي لظماء
ي لظبيعجو
ي لظبيروحو
ي لظبيوحيح
اللبصل
اللاووج هو
تسربوحوك
تسربعقوك
شربو مخر
لمربو شرب
تسربو لظمن دمك
شربها
فضض مشرب عماء
سالي مشرب عماء
لظخزة مزة
ي لظيخزة
ظنظقارده
لويله
فركو لرحله
دظي ل عجه
شيشوكه
عج قهالبيه

بجرة
 عجلية
 لحمه
 لحمي مر
 لحمي حلو
 جملو فلي ييندي
 ريلو يينلق لك لحمه
 لحمه ملتق ولتق الا مطي هاشق
 يمرق لالجيز
 ريلو لحام
 النكتف سمين
 ي موت غوي ل قندي ل قشر
 قلب الصحن
 الهم لقة
 عشرة و ماء و لحاح
 سالي فصيلي شرب
 فضض مشرب ماء
 موشفوي صحن
 الفيف ورمه
 اللي يحب عن ابيات الشري.
 اللي يكل زرع للناسي عمل زرع وفي للثنية.
 اللي يكل عظم القمضي يبيض هم اللست ذن.
 اللي ال وذاق مبيتس ماش متناق.
 اللي التوالع يز جداري يطع غوي ظمر هاباغ.
 اللي ال عن امل غداه ماش يتقي ه اعداه.
 اللي اطيب لعش في لظوا اولاده.
 اللي يبي ه في قبي فص اعش عير.
 اللي عن اولهوية بدا هبل غز.
 اللي مولى قش لري هوقول هتن ه مي.
 اللي كان لني كسي سر كره ان لني كسي سباط.
 اللي سبق غز للبق.
 اللي باع كبل ولهي عوب القشور.
 اللي موشعش من القصعة موشعش من حبيس ه.

اللي مبن سري كل فاكلي في راكي جوع.
 اللي ال ق قبي ها مات.
 اللي عمل طاحون في عظمه اادن دان.
 اللي يثيت هيش هو في حططي عشا.
 اللي تلتف رصنا عوي موتب لشر.
 اللي يتس كر بي هفط ربي ه.
 اللي تحببت مع ملفطور وتحزر للضري وف لجزم هتخدم لجيل ووصوف.
 اللي عن ذوال قروض في ل كمزود لاي جي ه للنوم ولاي قد.
 اللي تخق لاش ماش ما هو عشا.
 اللي شبع م ليق ولبع.
 اللي ماتب شبع لاقام.
 اللي بنت امت هتدف مو.
 اللي م ليت حيلشي م لي لاش ل خنز.
 اللي ماعن دوش ل ع لفي اركل ووي حطو عوى طرطوش فليس وا.
 اللي م لي دري يق ول سبول.
 اللي ن اولك عوى قوتك اولك عوى موتك.
 اللي يكل قد زبية م لي رى صرهبه.
 اللي مت عوشت غزل لدوارة وتغزل للشركار قل واشت اخوفي لى دلن اس نجرارة.
 ل فحبيب وس ولقل بيب لس وس.
 قلبلة لامن وس قيراها غراب اعور.
 ل ففبي لام ال ول عي رفي لن ادر.
 لعظم قل وفيها وفيزي مزو ه انثيين.
 ل يد لك يمة مت موتب جوع.
 ال لي في له اية ولاخ ام في القرطة.
 الاوى عمل ولثري تس من ولثلاثة فت ق طران.
 لبعال ولجة ولقل زينة.
 ل نخري طري ولا مهي هري.
 ليلدي بيلدي لي فيكون زيت دردي.
 ل لجدل رويق م اذلي فوع من فيق.
 ل ملكه فهو ولانق اد عيه.
 لقم جي دوروي دور هيرجع الى قلب للرحى.
 للاحم رطل وللقطوس رطل.
 لسان ل لخي ققص ل لدي.

الاماء لاهلئى للسدره لانيون الولى عبي ه .
 لعين عجله والامعدتشبعلة .
 لعين لولسعة والسرة لضيقه .
 لبقه ما اطي شربالمرس .
 لقلب لالحبيب عمرو مويثريب .
 للفلسفسى ضرب نهي ه الطال .
 لكروش م اذا الت ومقوتشبي .
 للععببغزل ا .
 المشلهة وللقاروس .
 لاني حيشبع في ه حد .
 لراجل لنيف لالو مرفارغ ومرة لبيان .
 كقول ولخي بلاني ونهي .
 لدارفي لزرقة ولانيونفي لالحقة .
 لطم اعبي انتباري .
 لطم عباب منيبيان لاطحين .
 لاطوع طوع لالحقة وللبوط ببوطالولخه .
 لانيات اذلتبزعنلبي للملوا .
 لشيء لاني جيب لغازة خزوق لاني ذوقه .
 لادجرك ال عي ولوع دظهن عروس .
 لريع بع ولهنقراس ولاني عن دوصي نهي عطي ه التراس .
 لاني لاني قبلاناس ولاني بي شمشفي لراس .
 لشبع عبي ع ولجوع عي عمل طرومه .
 لشجرة لاني تظل نهيك ملتد عيش نهي ه لاني .
 لانيك مبيت لاصه ..
 اش عديفي لقومح اذا ال راجل اميوليلو، ولانقع عدع لاني خردن ليلوا .
 اخزرللو جوه فرق للحم .
 اذاضرت اوجع واذا اطمعتشبع .
 اذبرد لمانهي للهيق لفل مهي اغلل .
 انطسك لاطع امقول شبعت وانطسك لال الحقول سمعت .
 اذليش وفقومح لاني عيش عيرو .
 اذكانق دالشرق اقدالقوم لبارك النبي هم النبيين .
 اذاشبعت لكروش تقول للراس نهي .
 اذكان لاجبولي كل ويه للاح اذق م لي عطي هالوش .

شررب ولا طيرقرنك .
 لصبري دجاجة ضيبي جيك لقمح منباجة .
 اطعموا منفمو هو منأهيو .
 اطعموا منمتوتحي ليعين .
 اطوق بصنتك وشدد ضنتك .
 اعطيني قرطتي ما حاجتي برب .
 اعطاه جناح فيخوبالصرياح .
 اعمل لاي جوع لانيب ولا يثنتكي للراعي .
 ؤصدد لدراللييرة اذا ملتغش وينباتفي لفي .
 قل الاحي ربك رشو .
 بناقص لفي ببواي دلحمة .
 بركة لاصران فينار حطقام تلتقى شهر .
 بات ال شلتصيح ال فين .
 للسيهية ولفنا ولا لديدة ولا ال .
 نصارة للنساء غلنساء اعطيني خي تنكن عليها حواء .
 بع دلقمة وابي نيق البسمة الله للرحمان الرحيم ."
 بلكركول للفينج وصللي ال شفاء وجاء .
 بروجيبل لدلاع لفلهم من انرد الام اتلقم .
 تغدى وتمدى متغشى وتغشى .
 تحزم الهبت وللهو خيس ، قل وللهم لاني ان علموس بلاطة .
 نتلقم للشربلي من فدام ال ال .
 شو مو رمل في فعل شري طلي .
 حجة ال غريية وشنة امليات والاي غشى .
 حوته مطي قبل الصربون .
 حدك حدل مرقي اما لمفوفي خمس .
 لحف غلدار دخل للرزقة لحف غل ح مشرب للمرة .
 حال للكرموس في لعلية .
 خوذها مني دشبعان اذا جاع وملتخذهاش مني د جي عان اذا شبع .
 خمس فسربات نتغشى .
 لحفي قرعة في شركة وراس لثيب .
 نصف غلتي غلاظ .
 العة ليهيمة ضزة وليمة .
 ضنتي وضنتك وبقوال ام عينين .

ضفتي ورفيتي جملوا الهمليتي.
 خبز ولبارفي كل دار.
 دامقري لا تخيفي برم ولاتحرفني طاجر.
 دورفي لثريه نجر من صاعش عجر.
 دواك عديي ا فدي اطيب ونعلمك مثة.
 ذراعكيا الف.
 رخص لحرير خيت تختسي ه لطناجر.
 ركوبك فوي ال الحفاح، قلوالحب هين طاح.
 راجل امي مزور ولنا ازور فهو موي عد اللحم وللقص فهو.
 نير نمكي لا يضحك لا يلكي.
 سريقة وجريه وماتلش لشن عجر.
 شاف للكرمسة وماتلش للصوان.
 شمس لولتدي للهور.
 ش موة لصل لفق وسفي لليلي.
 صهب عينت عمران فطر تسيه رمضان.
 صام عام فطر فوي جرادة.
 ضرب ال الحفاح.
 طاعني ا لني لاجامع.
 عي شبل فوي الكمون اذا راد الله عنك عمريه.
 فوي خاطر عبيي لظني عدوا.
 فوي قل، فيكسر هي اقلة.
 عمريه لظبل غان.
 عوي متخطف لام حصة م لطنجرة.
 فوي قد الوتو فوي قد اللبي تقي مراتو.
 فوي عيون لني تتنكل لبيورة.
 عيشة ل مغبون قين لرحى ولطبنه.
 غلق وتباعدوا ليلوت وملقوتل موال ليلوت.
 فولة تقسمت فوي ثوين.
 فني هو احصد زرعك لي فويك ونفليو.
 فني مارسنق زرعك وهارس.
 فني فا وسرور ل ارقبل وللنسك اس فيور.
 فس ادوني لامعدة ولاق ع ادوا ال عدا.
 قلبه وكلاه وخراه.

قلهو طاب ورنل وشاب.
 ق م ح ل ن اس ت ر ح ه وش ع ج ر ل ن اس ت ك ر ي ن ه .
 ق ل ت ل ه ا ب اش م ت ل ن ه ي ا ق ي دة ؟ ق ل ت ل ه ل ل م اء و ل ل ه ح .
 ق ل و ع ي شة ر ج بة ، ق ل ل ن م ز ي د ن ي غ فة .
 ل ه ي ف ل م ح م ص ر ف ي ق ا ع ل ط ن ج رة .
 ا ب ه ي ف ل ح و ت ا ذ ا خ ر ج م ن ل م ا ع ي م و ت .
 ل ه ي ف ل ح و ت ن ت ك ل م ذ م و م .
 ل ه ي ف ل ح و ت س ل ا ي ت ك ل ل ا ي ت ل ع ب ي ه .
 ل ه ي ف ن ك ر ل ح و ت ن ت ك ل م ذ م و م .
 ل ه ي ف ك ا ن ح ي ن ت ط ب س رة و ل ه ي ف م ا ت ل ح ق و ل و ع ر ج و ن .
 ل ه ي ف ق ط ا ط س ب ا ر د و ل ش ر و ل ا خ ل ا عة .
 ل ه ي ف ا م ل ل ه ب ع ف ط ط ا ر .
 ل ه ي ف ل ش ر ا ب س ب ب ك ل ف ن ت قة .
 ل ه ي ف ل ق ه ب و د ي ك ل و ه ي س .
 ل ه ي ف ش ر ك ا رة ل ل ن خ ل اة : ل ت ت ر ص و ه ي ف س و ج .
 ك ل ز ع ي ب ق س ي ك ر ه ا ع و د .
 ك ا ف و ل ل ا ه ي ف ي ن و ا ر و .
 ك ل ط ع ا م و ي ت و .
 ك ل ش ي ع ي ت ع د ي ال ا ل ض ر ي ف ل ر ل ه ي ك .
 ا ل م ل ه ي ل م د ه و ن ب ل ن دة .
 ك ث ر م ل ع ل ي م ا ط .
 ل ع ن الف ل و س ك ل ق س ن ط قة ل م و ت .
 ك ل و ا و ق ق و ا س ع ي ل ه ي ت ح ل خ و ا .
 ا ل ل ه ي ا و ن ل س ح ر ب ال ا خ رة .
 ك ذ ب ق ل ه ق ط ا ح ال ك و ز ق ع د ل ن ي ت م ن ق .
 ك ل ن ي ل ه ي ف خ و ك و ح ل ي ن ي ك ي ع د و ك .
 ا ل م ل ك ل ل ط ل ن ه ا ر ل ع ي د .
 ا ل ق ت و و س ر ك ت .
 ا ل ه ا و س ر ك ت .
 ك ي ل ا خ ر و ع ي ش ر ب ل م اء و ه ي ن ي ق ع ل ل ج ر .
 ك ي م و ل اة ل ق ر ص ت ك ل و ت غ ص .
 ك و ل ب ع ر ق م ي ن ك ن ج ر م ن ل ل ه ي ت ي ع ي ن ك .
 ك س ل س ل و ه ي ر ج ع ل ا ل و .

لاهي للشبغ خرة و لاهي لاجوع عار.
 لا مو من ضننا و لانا من عداه.
 لوكان امهني صني من عظمة رنني.
 لسروي حرق فموي لحق.
 ما خص لثنونق الا ملتت لالجوى.
 ملتباع لزيدة ك ان لطة لضهبان.
 مات دخل لدرارك الا لقمح وللشجر اما لولوليقوع.
 م القاش ضنن لهما ه لولقى عروس لوليام ها.
 متكل الا لتبل ك.
 ملي يجب لريت الا لامحسنار.
 م لولرفي دارك ان لقرع.
 متكل ان ليعن.
 ما ذا شر و ن هارت لذي خطوه سبلوا لعن لفي الاولي.
 ما ذا الت و ما قتش ي.
 من فقت و بيلن شاه جاب لس منفي ورقة.
 من عه هير كر.
 من لاه هيني قة.
 ضغان لولك و لاب طلة.
 موش كل مدورك عك.
 لاس من طين كوصب لوك اذا ما جبرم تي جي لكس كاس.
 مطرفي بليل اطع لبللة منقاع ليعر.
 شات لزيدة جراك هيس ها.
 نوريه لزمنا لعناش يتباع، لخر رقبنا صري.
 نحي ضنتك و اطق بعنتك.
 مرب من لقطرة جاعتحت ليهزاب.
 همو لا الفيبرم ولا حركتو طناجر.
 يا مودع لري في رقة لقطوس.
 وصيتو عللوان جاب لجاوي.
 هينو لرجبفي الليالي.
 وقت الاكولتذ هب لولول.
 يا و ح منت حطي لمام.
 يا خن ارتقم حي وشجر في يباردات لركليب.
 يا م ي ضرت لشي؟ قلوا لذي عمل ل شجر م ليش اورشي.

يامبي الا الد لئاسي اصيبب لام اغسي اللئسك اس .
 يكلفي ه لدمر فيضل .
 يكمل لئبر .
 يكمل لئبها ويتصرب الاخرة .
 يكمل في غمض عجب .
 يكمل لئقوة ويسبب لئلهة .
 تعديفي للهيع اتبلاقم .
 يشفي لئراطل لئى راحة لئعرب .
 يلهزك لئى لئليل لئدون ي جوعيلئى صغارك .
 يلهزك علمر ما امر فو .
 تثتاق لئار صفي مارس .
 يئشد لئى لئسلسلة ومن زرعها .
 يطلع لاماء للصعدة .
 يكمل ويشرب قوت لئاج في مرب .
 يلقن يئيد وملت لئفي شن عجة .
 يكمل بضرة من ارقه .
 يئسلو بضرة من عام لئدر .
 قال لئبيع لئبزموري، قال لئصريف لئببقولي، قال لئخريف لئببقولي، قال لئثتال مورا وملتولي .
 اخي من اميكي لئعريف فيمي .
 قال لئ يئلبلا لئببقولون بال ببقول الله: لت يا ام اللئين .
 كان يئلبلا، كئنت امي، لئنت كئلفي لئلحم، ماتبباب، كئنت امي، قعدت ن شمشفي لئعظم .
 اش عندي في لئمحا اذا ال، راجل امي وئليهي وئلبلقم من لئيه .
 لئ اموفي لئبب بئكل لئبب .
 لئولد ائلبكى، مترضعه كان امه .
 كئبلق درة لئوفم هتطلع لئبب لامها .
 قال لئه ياعم لئسطاس، اختار لئي حيرة لئجاص: قال: لئى جوبلك لئبببت تار هلى لئفي لئي .
 بارة لئبب اع لئبب اع طين ي خي بئكن ع لئها ساء .
 لئراجل لئيه عشان لئص لئيه وسويت من لئصة طية .
 لئراجل لئيه كئعود لئسيسة لئي فيضل في موصة .
 لئمرأة لئيف لئمرة امحها وكئبها .
 لئمرأة مرمي لئها لئمحا من لئببدره ولئببب من لئمحمرة ولئحم من لئمجزرة .
 اذا كان امك لئصل ووك لئوم بئببب لئي لئح لئطبي فيا شوم .
 ائبخ لئول وئببببب .

قد هاقد قلبه و صوته هاصوت الغلّة .
 للي لثروا الدهاء، كقول من زاده .
 لليل دلست ه خنارة و لثفت حارة .
 انلقول لليل و ط الحى من لثم / للناست حيب ال خنر .
 قلا و لليلي للناست جواع فق اليل و اللب الوة .
 للي يكر هك م لي صاكل و تطي مبال الحوى .
 ضرب ال حيب زيب و حجاته رمان .
 لابلت مر ه م ه و موبل عدل عيني .
 عين لثريخ ج انقسي للشممة .
 للي يلى موا الل م لفي ع امي لثو ال ج م لفي م .
 ل طمت مرة و للقلب ج مرة .
 قبل لثرو و في حرق لسر و صر يد ل مرق .
 الم لليل مد موزيل زبدة كي ي طع عني ه اليل ذوب .
 حجرة من يد ال صي بفتح .
 ليد ال طويل قتل حق ال عرجون .
 ليد ال مرقرة مرزقة .
 بغي ولي دامة عني صبحي .
 للي ي سب سويل حس صبحه .
 ك ان صا حك عمل م لث حوش للكل .
 للي يكل ل خروب م لث حن عني ه لللوب .
 للي شب عجد جوع هي ي في للبل وعة .
 اعطيني عمل ل ن لخص معاه ولا مبول نكل رزق ه .
 حواء دارنا خنر من لث لسي دار ال عرس .
 للي ي عمل عني مرقرة جات و بات ال عشا .
 اعمل روحك مبولت كل ل طير .
 لي م لي ك لبيده م لثي ع .
 بيضة لليوم احمن من دجاجة غدوة .
 لعدو م لي رج ع صيق و للخللة م لث رج ع فيق .
 كقول ل خنر لليلس ، و لث عدى عني عدوك لابس .
 جوع و لثص حو .
 اذا شب عين ادم لفسر .
 لث لثير ل لثني لايض حك لاي لثي .
 شب ع انبل لراحة هي تبال عيني .

الشجر متقوول للشرج ربعه ذلك لحي ظيبن يجب حلهك وحلهي.
 ضرب بال الحفاح.
 عيشبال في الكمون.
 لبقوة متطي شربال مرس.
 في الثناء جمره مخير منتمرة.
 قمح في الهنبرة وزيت في الامعصرة.
 الكرم كرمه والخبب شربشونة وللهك لجة والخبى زيتونة.
 لشك اتيت تخيني لحي سميد جاتي.
 لخب لاطاحون في عس لحي فيق للناس.
 لحي فلاح مص الثني خير من الكرم.
 حي ثوب هيسرة مات لبقول و عرجون.
 لحي الفرج ل كل كدم قبخسة.
 كشي شارة للنخلة كل كدم قبخسة.
 كشي لبقولة هيت شي مكولة.
 كلق محي دوروي دور هيج في قلب للرحى.
 كشي الاموث في للنخلة.
 لاتعمل روح كنخلة لانتبشك لادجاج.
 لاصح لا من الكوفة ولا من الصقلي.
 لاي عرف لستق من الليندق ولا لمام من الليندق.
 لعب لباويم مع لبقوس.
 لعب لاجمل لحي لخرش ف.
 ملتفت خياق م ح را مو خوكش عجر.
 فار كليل لعب لحي لزيب.
 لامع اودفي للفيق الاحرش.
 نخلتي بلن من سميد جاتي.
 للنخلة ملتصير فيق ولعدو ملو صير صيق.
 لك الازمن عس لور شقلع وللصل لتخرس.
 واحدك لا لتمره و واحد مص اللوى، صبحت لوجوس واسوا.
 واحدي كل لبول وواح ملتفت لخرش ه.
 يكل اللستق ابر لبحن لقطوس.
 حطال فيدي لحي لالخير ويات.
 ضزي مضموز وزيت في الكوز.
 نكل ضزي ورق عفي عزي.

اعجن ليين خبز ليهك .
 خبزة للشركا رتيردال خدن وارة .
 خبزة للسوق ولا مهجولوق .
 لخبز ولا لهجيج ورفي اليعيون .
 لظم عيين خمر خبزة .
 الليث اردال خبز . عار فسا شي لظاه .
 كل شي يبال حيلة صب لذي تتشعل لقميلة .
 اللى عوده لانيت عيش على نيل .
 اللى يلبز على لذي تنسى لذي يقى بي عمل لهك عك .
 من حوض لانيت ، نيري يعيت .
 بارك اللهيك ، كم لبار لفي لانيت ، لظينا و دقا ، والضرفى لبيت .
 لبريا راس خي بي عيك لانيت من قصة .
 جاعني طع في هالعمل عطل مصوعو .
 لىود من لبحم ، يهيج لخبز وللحم .
 رطل صربون زي حطك حذا الاكلبي ، ورطل لحمي حطك حذا لهراتي .
 سلبى و ملج ، هيتش لفي اللحم لفظلج .
 هين اللحم لثم .
 بردى عمي من اللحلة ، و بردى خللة من لذي يقى ، بي عطي هالذي يقى .
 لحو و مر خي بيت عدى لالعمر .
 لو كان لقا طاطس بتص طادل بي ، رام ليران الون .
 يظن بص يد و ملي لظيش لظب .
 ياشح ايل حام ييا هجاب لخبز و لدهان .
 لانس لك لتجرى وراء لخبز .
 مان لظش خبز لمان ، لو كاني ببال خبز لمان .
 ملي ان بقرى ك ان بالكوشة .
 مقوي من لاطعام ك ان ليدل حرام .
 لاتعطينى عملك وبتدغرى .
 ماذا من ناس هوما هوما و ماذا من ناس عمل فى قرجوم .
 الخى من خبزة ، طاح تنفى لعمل .
 يجمع ال عمل وقدرك عمل .
 شمر عمل و لظى يبصل .
 يلى بفسى ال بظوب .
 تم حفى لزيدة ، وتخفى ليين .

خطة الدمج ال لخبب.
لللب ال لخبب عمره م لخبب

Questionnaire1

ضع الة امام ال عبارات اللتبعها او تستع لى طى ال م ك الومى من بن للقامة للتللة:

ال كف

شبع ةض ح ك

وب ق ب ف نة

شرب عرق ك

ن هارك قلة و لخبب

لبل لل بعبان بعبان

بب ب ب ب ب

الل و لل و

علمة كالمثل

ما مضيقوش

حاول انتجد عبارات اخرى تستعمل فمردات عن الاكل والشرب ولكن هل تؤدي معلي اخرى.

.....
.....
.....
.....
.....
.....
.....
.....
.....
.....

Questionnaire 2

ضع الة امام العبارات التي تحبها او تستعملها في طهي الة لك اليوم من بين القائمة التالية:

ل حكي لجة

فرك ولرمة

شرب و م خ و

ال لجة شرب

فرك ولرمة

فوح هال لجة

شبع فلووس

ح م ص و زيب

ما مضيقوش

علمة الصحن

حاول انتجد عبارات اخرى تستعمل فمردات عن الاكل والشرب ولكن هل تؤدي معلي اخرى.

.....
.....
.....
.....
.....

.....
.....
.....
.....
.....

Questionnaire 3

ضع الـمة امام الـعارات الـتي يتـخـفها او تتـسـتـعـلـي طـي الـمـك الـيـومـي منـيـن الـقـائمة الـتـالـيـة:

فضض مشرب ةماء
ي لظ عريه
اللبوط
يلع ببضزة الـدو
عدى عمرو الـطة
يقيارد
ضرفرشك
هـذـك الـقـرـص هـذـك الـمـعـجـون
بلـعـسـلـو
كل واحد مـغـنـتـو اش هـزـت

حاول انتـجـد عـارـات اـخـرى تـسـتـعـمـل فـهـرـدات عـن الـاـكـل و الـشـرب و لـمـن هـتـؤـدي مـعـلـي اـخـرى.

.....
.....