



**HAL**  
open science

# Design of adaptive observers for LPV systems: Application to fault tolerant control

Abraham Jashiel Pérez-Estrada

► **To cite this version:**

Abraham Jashiel Pérez-Estrada. Design of adaptive observers for LPV systems: Application to fault tolerant control. Automatic. Université de Lorraine; Centro Nacional de Investigación y Desarrollo Tecnológico (Cuernavaca, Mor., México), 2020. English. NNT : 2020LORR0069 . tel-02960200

**HAL Id: tel-02960200**

**<https://hal.univ-lorraine.fr/tel-02960200>**

Submitted on 7 Oct 2020

**HAL** is a multi-disciplinary open access archive for the deposit and dissemination of scientific research documents, whether they are published or not. The documents may come from teaching and research institutions in France or abroad, or from public or private research centers.

L'archive ouverte pluridisciplinaire **HAL**, est destinée au dépôt et à la diffusion de documents scientifiques de niveau recherche, publiés ou non, émanant des établissements d'enseignement et de recherche français ou étrangers, des laboratoires publics ou privés.



## AVERTISSEMENT

Ce document est le fruit d'un long travail approuvé par le jury de soutenance et mis à disposition de l'ensemble de la communauté universitaire élargie.

Il est soumis à la propriété intellectuelle de l'auteur. Ceci implique une obligation de citation et de référencement lors de l'utilisation de ce document.

D'autre part, toute contrefaçon, plagiat, reproduction illicite encourt une poursuite pénale.

Contact : [ddoc-theses-contact@univ-lorraine.fr](mailto:ddoc-theses-contact@univ-lorraine.fr)

## LIENS

Code de la Propriété Intellectuelle. articles L 122. 4

Code de la Propriété Intellectuelle. articles L 335.2- L 335.10

[http://www.cfcopies.com/V2/leg/leg\\_droi.php](http://www.cfcopies.com/V2/leg/leg_droi.php)

<http://www.culture.gouv.fr/culture/infos-pratiques/droits/protection.htm>

---

Département de formation doctorale en automatique  
UFR Sciences et Technologies

École doctorale IAEM Lorraine

# Observateurs adaptatifs des systèmes LPV. Application à la commande et au diagnostic

## THÈSE

présentée et soutenue publiquement le 6 mai 2020

pour l'obtention du

**Doctorat de l'Université de Lorraine**

(Spécialité Automatique, Traitement du Signal et Génie Informatique)

par

Abraham Jashiel PÉREZ ESTRADA

### Composition du jury

<i>Rapporteurs :</i>	Mondher FARZA	Professeur, Université de Caen
	Olivier SENAME	Professeur, Grenoble-INP
<i>Examineurs :</i>	Gloria Lilia OSORIO GORDILLO	Professeur, Centre National de Recherche et Développement Technologique, CENIDET
	Victor Hugo OLIVARES PEREGRINO	Professeur, Centre National de Recherche et Développement Technologique, CENIDET
	Marouane ALMA	Maître de conférences, Université de Lorraine, CRAN, Co-directeur de thèse
	Mohamed DAROUACH	Professeur, Université de Lorraine, CRAN, Directeur de thèse
	Holger VOOS	Professeur, Université de Luxembourg



# Design of adaptive observers for LPV systems. Application to fault tolerant control

## THESIS

presented and publicly defended on May 6, 2020  
for obtaining the

**Doctorate from the University of Lorraine**

(Speciality : Automatic, Signal Processing, and Computer Science)

by

Abraham Jashiel PEREZ ESTRADA

### Composition of the jury

<i>Rapporteurs :</i>	Mondher FARZA	Professor, Université de Caen
	Olivier SENAME	Professor, Grenoble-INP
<i>Reviewers :</i>	Gloria Lilia OSORIO-GORDILLO	Professor, Centro Nacional de Investigación y Desarrollo Tecnológico, CENIDET
	Victor-Hugo OLIVARES-PEREGRINO	Professor, Centro Nacional de Investigación y Desarrollo Tecnológico, CENIDET
	Marouane ALMA	Associate Professor, Université de Lorraine, CRAN, Co-director of thesis
	Mohamed DAROUACH	Professor, Université de Lorraine, CRAN, Thesis director
	Holger VOOS	Professor, Université de Luxembourg



*To my family...*





## Acknowledgments

First of all, I would like to express my sincere thanks to Dr. Gloria Lilia Osorio Gordillo for her support, dedication and patience during these four years. Likewise, I would like to thank my CRAN advisors Prof. Mohamed Darouach and Dr. Marouane Alma for the trust they placed in me to develop this research topic. The advice, discussions, teamwork and motivation provided by my advisors encouraged me to exceed my expectations resulting in a good academic performance.

I would like to express my gratitude to Henry Poncairé IUT of Longwy. I considered this institute as my house, the people from IUT always gave me support to achieve my yearning dreams which it was to obtain the PhD degree. On the other hand, it was not difficult to live in a foreign country because the people around me gave me the trustful and so, I could overcome my fears. Likewise, I would like to thank Yassine Boukal, Noussaiba Gasmi, Ahlem Sassi, Michel Zasadzinski, Ali Zemouche for the support in the academic and the bureaucracy of the University.

On the other hand, I would like to thank my MEXPROTEC friends which gave me good moments in France. I always had Mexico with me.

Likewise I would like to thank my parents Abraham Pérez Torres and Sonia Estrada Bazán; my siblings Miguel, Isamary and Gustavo. Even though we've been away physically, I've never felt alone in knowing that I've always had them.

I thank my wife Miriam Monserrat Lopez Osorio because she was always comforting me in bad times, she always supported me and she has always believed in me. Thank you for being by my side.

The stay at CENIDET not only educated me in the academic part, it made me get some great friendships. I am grateful to my friend and colleague Ricardo Schacht Rodríguez because we shared many experiences, had fruitful discussions regarding our thesis topics, but above all, we were always very motivated to finish this journey. I am grateful to my friend and colleague Dr. Gerardo Ortiz, who had valuable talks regarding my thesis topic.

Finally I thank CONACYT for the doctoral scholarship granted for the development of this work.



## Abstract

**Keywords :** Adaptive Observers, Dynamic Observers, Unknown inputs, Disturbances, LPV systems, Fault-tolerant control.

In this thesis, the observer design for linear parameter-varying systems and their applications to fault diagnosis and fault-tolerant control is studied. A linear parameter-varying (LPV) system can approximate the nonlinear dynamic behavior through a set of linear state space models that are interpolated by a mechanism depending on the scheduling variables.

The observer used in this research is called generalized dynamic observer (GDO), where the principal idea is to add dynamics structure to increase its degrees of freedom, with the purpose of achieving steady-state accuracy and improve robustness in estimation error against disturbances and parametric uncertainties. Therefore, this structure can be considered as more general than a proportional observer and proportional-integral observer.

It addresses the GDO synthesis for LPV systems with measured and unmeasured scheduling variables such as the quasi-LPV system, in which the scheduling variables are functions of endogenous signals such as states, inputs, or outputs instead of exogenous signals.

Conditions of existence and stability for each GDO structure are given through the Lyapunov approach using parameter-independent Lyapunov function or parameter-dependent Lyapunov function. The design is obtained in terms of a set of linear matrix inequalities. Engineering applications are used to illustrate the performance and effectiveness of the proposed approaches.

It considers a fault-tolerant control (FTC) strategy for polytopic LPV systems to maintain the current system close to the desired performance and preserve stability conditions in the presence of actuator faults. A fault diagnosis unit is built to estimate the states, the actuator faults, and the parameter variation. That information is essential to the FTC law.



## Résumé

**Mots-clés :** Observateurs adaptatifs, observateurs dynamiques, entrées inconnues, perturbations, systèmes LPV, commande à tolérance de pannes.

Dans cette thèse, la conception d'observateurs pour les systèmes linéaires à paramètres variables (LPV) et leurs applications au diagnostic et à la commande tolérante aux fautes est étudiée. Un système LPV peut approcher le comportement dynamique non linéaire via un ensemble de modèles linéaire interpolés par un mécanisme dépendant de variables de planification.

L'observateur utilisé dans cette recherche s'appelle l'Observateur Dynamique Généralisé (GDO), où l'idée principale est d'ajouter une structure dynamique pour augmenter ses degrés de liberté, dans le but d'obtenir une précision en régime permanent et d'améliorer la robustesse de l'erreur d'estimation contre les perturbations et les incertitudes paramétriques. Par conséquent, cette structure peut être considérée comme plus générale qu'un observateur proportionnel ou qu'un observateur proportionnel intégral.

Le sujet traite de la synthèse de GDO pour les systèmes LPV avec des variables d'ordonnement mesurées et non mesurées, telles que les systèmes quasi-LPV, dans lesquels les variables d'ordonnement sont des fonctions de signaux endogènes (les états, les entrées ou les sorties), au lieu de signaux exogènes.

Les conditions d'existence et de stabilité de chaque structure de GDO sont définies par l'approche de Lyapunov en utilisant une fonction de Lyapunov qui peut être indépendante ou dépendante des paramètres. La conception est obtenue en termes d'un ensemble d'inégalités matricielles linéaires (LMIs). Les applications d'ingénierie illustrent la performance et l'efficacité des approches proposées.

Dans la dernière partie, une stratégie de commande tolérante aux fautes (FTC) pour les systèmes LPV polytopiques, afin de maintenir le système proche des performances souhaitées et de préserver les conditions de stabilité en présence de défauts d'actionneurs. Une unité de diagnostic des défauts est construite pour estimer les états, les défauts d'actionneurs et la variation des paramètres, ces informations sont essentielles à la loi FTC.



# Table of contents

List of figures	xiii
List of tables	xv
Notation and acronyms	xvii

<b>Introduction générale</b>	<b>1</b>
1 Contexte de la thèse . . . . .	1
2 Formulation du problème . . . . .	1
3 Objectifs . . . . .	3
4 Justification . . . . .	3
5 Plan de la thèse et contribution . . . . .	4

<b>Chapter 1</b>	
<b>Introduction</b>	<b>7</b>
1.1 LPV system . . . . .	7
1.1.1 Stability for LPV systems . . . . .	8
1.1.2 Observation . . . . .	10
1.1.2.1 Observers for LPV systems . . . . .	10
1.1.2.2 Dynamic observers . . . . .	10
1.1.2.3 Unknown input observers . . . . .	11
1.1.2.4 Adaptive observers . . . . .	11
1.1.3 Control . . . . .	12
1.1.3.1 Gain-scheduled static controllers for LPV systems . . . . .	12
1.1.3.2 Gain-scheduled dynamic controllers for LPV systems . . . . .	12
1.1.4 Polytopic Bounded Real Lemma . . . . .	13
1.1.5 Unmeasured scheduling variables . . . . .	13
1.2 Fault-tolerant control . . . . .	14
1.2.1 Type of fault-tolerant control systems . . . . .	14
1.2.2 Fault diagnosis scheme . . . . .	15
1.3 Tools for the stability analysis of dynamic systems . . . . .	15
1.4 Conclusion . . . . .	16

**Chapter 2**

**$H_\infty$  generalized dynamic observers for LPV systems 17**

2.1	Introduction . . . . .	17
2.2	Generalized dynamic observer design for LPV systems . . . . .	18
2.2.1	Problem formulation . . . . .	18
2.2.2	Parameterization of the observer . . . . .	19
2.2.3	Stability analysis . . . . .	21
2.2.4	Particular cases . . . . .	22
2.2.4.1	Proportional observer . . . . .	22
2.2.4.2	Proportional-Integral observer . . . . .	22
2.2.5	Application to double pipe heat exchanger . . . . .	23
2.3	Generalized dynamic observer design for quasi-LPV systems . . . . .	25
2.3.1	Problem formulation . . . . .	25
2.3.2	Parameterization of the observer . . . . .	28
2.3.3	Observer stability . . . . .	29
2.3.4	Particular cases . . . . .	29
2.3.4.1	Proportional observer . . . . .	30
2.3.4.2	Proportional-Integral observer . . . . .	30
2.3.5	Numerical example . . . . .	30
2.4	Generalized dynamic observers for quasi-LPV systems with unmeasurable scheduling functions . . . . .	34
2.4.1	Problem formulation . . . . .	34
2.4.2	GDO design . . . . .	36
2.4.3	Particular cases . . . . .	38
2.4.4	LPV quarter-car suspension model . . . . .	38
2.4.5	Simulation . . . . .	40
2.5	Conclusions . . . . .	40

**Chapter 3**

**$H_\infty$  generalized dynamic unknown inputs observer design for discrete LPV systems. 49**

3.1	Introduction . . . . .	49
3.2	Problem formulation . . . . .	49
3.3	Observer parameterization . . . . .	52
3.4	$H_\infty$ generalized dynamic observer design . . . . .	53
3.4.1	Particular cases . . . . .	56
3.5	Wind turbine system . . . . .	57
3.5.1	LPV modeling of benchmark wind turbine . . . . .	57
3.5.2	Simulation . . . . .	59
3.6	Conclusions . . . . .	66

**Chapter 4**

**Adaptive observer design for LPV systems 67**

4.1	Introduction . . . . .	67
-----	------------------------	----



4.2	Adaptive observer design for LPV systems . . . . .	67
4.2.1	Problem statement . . . . .	67
4.2.2	Observer stability analysis . . . . .	70
4.2.3	Illustrative example : DC motor . . . . .	73
4.3	Adaptive generalized dynamic unknown input observer . . . . .	77
4.3.1	Problem statement . . . . .	77
4.3.2	Stability conditions . . . . .	78
4.3.3	Numerical example . . . . .	80
4.4	Conclusions . . . . .	80

<b>Chapter 5</b>	<b>83</b>
<b>Fault tolerant control using reference model for LPV systems</b>	<b>83</b>

5.1	Introduction . . . . .	83
5.2	Actuator fault tolerant control for LPV systems . . . . .	83
5.2.1	Problem statement . . . . .	83
5.2.2	Observer parameterization . . . . .	86
5.2.3	Fault tolerant control design . . . . .	88
5.2.4	Application to vehicle lateral dynamics . . . . .	89
5.3	Parameter estimation and actuator fault tolerant control . . . . .	93
5.3.1	Problem formulation . . . . .	93
5.3.2	Numerical example . . . . .	95
5.4	Conclusions . . . . .	100

<b>Chapter 6</b>	<b>101</b>
<b>Conclusions and perspectives</b>	<b>101</b>

<b>Bibliography</b>	<b>103</b>
---------------------	------------



# List of figures

1	Esquisse de la thèse. . . . .	5
1.1	Active FTC scheme. . . . .	14
2.1	Uncertainty $\alpha(t)$ and variant parameter $\rho(t)$ . . . . .	24
2.2	Estimation of states $x_1(t)$ and $x_2(t)$ . . . . .	25
2.3	Estimation error $e(t) = \hat{T}_{co}(t) - T_{co}(t)$ . . . . .	25
2.4	Estimation error $e(t) = \hat{T}_{ho}(t) - T_{ho}(t)$ . . . . .	26
2.5	Input $u(t)$ and unknown input $d(t)$ . . . . .	32
2.6	Uncertainty factor $\delta(t)$ and weighting functions $\mu_1(\varrho)$ and $\mu_2(\varrho)$ . . . . .	33
2.7	Estimation of $x_1(t)$ and estimation error of $x_1(t)$ . . . . .	33
2.8	Estimation of $x_2(t)$ and estimation error of $x_2(t)$ . . . . .	33
2.9	Estimation of $x_3(t)$ and estimation error of $x_3(t)$ . . . . .	34
2.10	Model of quarter car with a semi-active damper. . . . .	39
2.11	Estimation of $x_2(t)$ and estimation error of $x_2(t)$ . . . . .	41
2.12	Uncertainty factor $\delta(t)$ and scheduling functions. . . . .	41
2.13	Suspension deflection $z_{def}(t) = z_s(t) - z_{us}(t)$ . . . . .	42
2.14	Suspension velocity deflection $\dot{z}_{def}$ . . . . .	42
2.15	Estimation error $e(t) = \hat{\dot{z}}_{def} - \dot{z}_{def}$ . . . . .	43
2.16	Estimation of $x_1(t)$ and estimation error of $x_1(t)$ . . . . .	44
2.17	Estimation of $x_2(t)$ and estimation error of $x_2(t)$ . . . . .	45
2.18	Estimation of $x_3(t)$ and estimation error of $x_3(t)$ . . . . .	46
2.19	Estimation of $x_4(t)$ and estimation error of $x_4(t)$ . . . . .	47
3.1	Uncertainty factor $\alpha$ and scheduling functions . . . . .	60
3.2	Disturbance from plant and sensors and actuator fault . . . . .	60
3.3	Rotor angular speed estimation and its estimation error. . . . .	61
3.4	Generator rotating speed estimation and its estimation error. . . . .	62
3.5	Torsion angle estimation and its estimation error. . . . .	63
3.6	Pitch angle estimation and its estimation error. . . . .	64
3.7	Pitch rate estimation and its estimation error. . . . .	65
3.8	Generator torque estimation and its estimation error. . . . .	66
4.1	Uncertainty. . . . .	74
4.2	Scheduling functions for adaptive PO. . . . .	75
4.3	Scheduling functions for adaptive observer . . . . .	75
4.4	State $x_1$ and its estimate. . . . .	75
4.5	State $x_2$ and its estimate. . . . .	76
4.6	Unknown parameter and their estimations. . . . .	76
4.7	Input. . . . .	80
4.8	Actuator fault. . . . .	80
4.9	Real and estimated state variables . . . . .	81
4.10	Real and estimated parameter . . . . .	81

4.11 Scheduling functions . . . . .	82
5.1 Fault tolerant control scheme. . . . .	84
5.2 Steering angle and rear cornering stiffness variation. . . . .	91
5.3 Reference lateral velocity and its faulty estimated state with FTC. . . . .	91
5.4 Reference yaw rate and its faulty estimated state with FTC. . . . .	92
5.5 Fault tolerant control law. . . . .	92
5.6 Actuator fault and its estimate. . . . .	93
5.7 Fault tolerant control scheme. . . . .	94
5.8 Fault tolerant control scheme. . . . .	96
5.9 Reference $x_1$ and their estimates. . . . .	97
5.10 Reference $x_2$ and their estimates. . . . .	97
5.11 Reference $x_3$ and their estimates. . . . .	98
5.12 Parameter $\theta(t)$ and its estimated. . . . .	98
5.13 Actuator fault and its estimated. . . . .	99
5.14 Reference input $u_d(t)$ . . . . .	99
5.15 FTC input. . . . .	100

# List of tables

2.1	Heat exchanger parameters . . . . .	23
2.2	Parameter index of each observer . . . . .	24
2.3	Performance indexes of each observer. . . . .	32
2.4	Performance indexes of each observer . . . . .	41
3.1	Parameter symbols of benchmark model . . . . .	58
3.2	Parameter index of each observer . . . . .	59
4.1	Parameter index of each observer . . . . .	74
4.2	Design parameters . . . . .	77
5.1	Model parameters . . . . .	90



# Notation and acronyms

## Notation related to vectors and matrices

$I_n$	Identity matrix of dimension $n \times n$
$\mathbf{1}_{n \times m}$	$n \times m$ ones matrix
$A > 0, A \succeq 0$	Real (semi) positive-definite matrix $A$ .
$A < 0, A \preceq 0$	Real (semi) negative-definite matrix $A$ .
$I, 0$	Identity matrix (resp. zero matrix) of appropriate dimension.
$A^{-1}$	Inverse of matrix $A \in \mathbb{R}^{n \times n}$ , $\det(A) \neq 0$ .
$A^+$	Any generalized inverse matrix $A$ , verifying $AA^+A = A$ .
$A^\perp$	Any maximal row rank matrix such that $A^\perp A = 0$ , by convention $A^\perp = 0$ when $A$ is of full row rank.
$A^T$	Transpose of matrix $A$ .
$\text{rank}(A)$	Rank of matrix $A \in \mathbb{R}^{n \times m}$ .
(*)	The transpose elements in the symmetric positions.
$\text{diag}(A_1, \dots, A_p)$	Diagonal matrix with elements $A_i \in \mathbb{R}^{n \times n}$ , $i = 1, \dots, p$ on its diagonal.
$\mathcal{R}(A)$	Denotes the row space of matrix $A$ .

## Sets and norms

$\mathbb{R}, \mathbb{C}$	Set of all real numbers (resp. complex).
$\mathbb{R}^n$	Set of $n$ -dimensional real matrices.
$\mathbb{R}^{n \times m}$	Set of $n \times m$ dimensional real matrices.
$\mathcal{L}_2[0, \infty)$	Signals having finite energy over the infinite time interval $[0, \infty)$ .
$ a $	The absolute value of scalar $a$ .
$\ x\ _2$	The norm-2 of signal $x$ .

## Acronyms

LPV	Linear Parameter Varying.
CT LPV	Continuous Time Linear Parameter Varying.
DT LPV	Discrete Time Linear Parameter Varying.
LTI	Linear Time-Invariant.
UI	Unknown Input.
LMI	Linear Matrix Inequality.
PDL	Parameter Dependent Lyapunov.
GDO	Generalized Dynamic Observer.
PO	Proportional Observer.
PIO	Proportional-Integral Observer.
FTC	Fault Tolerant Control.





# Introduction générale

## 1 Contexte de la thèse

Ce rapport présente les résultats de la thèse de recherche intitulée "Observateurs adaptatifs des systèmes LPV. Application à la commande et au diagnostic". Ces résultats consistent à proposer une nouvelle structure d'observateur adaptatif pour les systèmes à variation linéaire des paramètres (LPV), et par conséquent, une unité de diagnostic de défaut (FD) est conçue de telle sorte que la variation des paramètres et le défaut de l'actionneur du système sont estimés.

D'autre part, cette recherche est développée dans le cadre d'une collaboration de recherche entre le Centre National de Recherche et de Développement Technologique (CENIDET) et le Centre de Recherche en Automatique de Nancy (CRAN) de l'Université de Lorraine.

## 2 Formulation du problème

Dans la revue bibliographique, il a été possible de détecter différents problèmes ouverts et certaines tendances dans le domaine du contrôle de la tolérance aux fautes, basé sur l'approche polytopique du LPV. Néanmoins, il existe une vaste littérature sur l'estimation de la LPV basée sur les paramètres de planification mesurés (exactement connus), et il existe un autre type de structures d'observation avec cette condition. Cependant, ce cas pourrait présenter certaines restrictions :

- Dans un cas concret, les paramètres de programmation choisis pourraient ne pas être mesurés, ou les paramètres de programmation pourraient être incertains. Dans la littérature, ce problème est résolu soit en estimant le paramètre de planification, soit en concevant un filtre pour annuler l'effet de l'incertitude.
- L'utilisation de variables endogènes dans les paramètres de planification (approche quasi-LPV). Cette approche est très pratique lorsqu'il est nécessaire de représenter de la manière la plus simple la dynamique non linéaire du système. Par conséquent, les variables d'état pourraient être non mesurées. Ce point est très courant dans la littérature pour les systèmes quasi-LPV.

Dans la conception de l'observateur, ces paramètres de planification doivent être estimés et l'interpolation des modèles linéaires invariants dans le temps (LTI) est basée sur leur estimation. De même, dans le domaine du contrôle tolérant aux défauts (FTC), il existe des travaux portant sur les défauts de capteurs, les défauts d'actionneurs et les défauts de paramètres basés sur les contraintes précédentes. Ces questions sont encore des problèmes ouverts et nous avons trouvé une contribution possible basée sur la structure polytopique LPV suivante

$$\dot{x}(t) = \sum_{i=1}^{2^k} \mu_i(\tilde{\theta}(t))(A_i x(t) + B_i u(t) + G f(t)) \quad (1a)$$

$$y(t) = C x(t) \quad (1b)$$

où  $x(t) \in \mathbb{R}^n$  est le vecteur d'état,  $u(t) \in \mathbb{R}^m$  est le vecteur d'entrée,  $y(t) \in \mathbb{R}^p$  est le vecteur de sortie et  $f(t) \in \mathbb{R}^{n_f}$  est le vecteur de défaut additif de l'actionneur.  $A_i \in \mathbb{R}^{n \times n}$ ,  $B_i \in \mathbb{R}^{n \times m}$ ,  $C \in \mathbb{R}^{p \times n}$  et  $G \in \mathbb{R}^{n \times n_f}$  sont des matrices constantes.  $k$  est le nombre de paramètres de planification.

La variable  $\tilde{\theta}(t)$  est un vecteur qui dépend de paramètres non mesurés qui varient sur un polytope convexe. Ces paramètres de planification ne prennent pas en compte les variables d'état, mais seulement les paramètres qui varient dans le temps.

## Conception d'observateurs dynamiques généralisées pour les systèmes LPV

Pour respecter les restrictions ci-dessus, il est important d'estimer les paramètres de planification afin de connaître le point de fonctionnement du système. Pour résoudre ce problème, nous avons choisi l'observateur dynamique généralisé (ODG), qui présente des caractéristiques telles que la précision en régime permanent, et la robustesse de l'erreur d'estimation face aux perturbations et aux incertitudes paramétriques. Par conséquent, la structure des observateurs adaptative suivante, basée sur les ODG, est proposée pour le système (1)

$$\dot{\zeta}(t) = \sum_{i=1}^{2^k} \mu_i(\hat{\theta}(t))(N_i\zeta(t) + H_i v(t) + F_i y(t) + J_i u(t)) \quad (2a)$$

$$\dot{v}(t) = \sum_{i=1}^{2^k} \mu_i(\hat{\theta}(t))(S_i\zeta(t) + L_i v(t) + M_i y(t)) \quad (2b)$$

$$\hat{x}(t) = P\zeta(t) + Qy(t) \quad (2c)$$

$$\dot{\hat{\theta}}(t) = \Phi_1(\hat{\theta}(t), \hat{x}(t), y(t)) \quad (2d)$$

où  $\zeta(t) \in \mathbb{R}^{q_0}$  est le vecteur d'état de l'observateur,  $v(t) \in \mathbb{R}^{q_1}$  est un vecteur auxiliaire et  $\hat{x}(t) \in \mathbb{R}^n$  est l'estimation de  $x(t)$ .  $\hat{\theta}(t)$  est l'estimation de  $\tilde{\theta}(t)$ . Matrices  $N_i, H_i, F_i, J_i, S_i, L_i, M_i, P$  et  $Q$  sont des matrices inconnues de dimensions appropriées. La fonction  $\Phi_1$  doit être déterminée de telle sorte que  $\hat{\theta}(t)$  converge asymptotiquement avec  $\tilde{\theta}(t)$ . De même, l'observateur doit satisfaire à la condition  $\lim_{t \rightarrow \infty} e(t) = 0$ , où  $e(t) = \hat{x}(t) - x(t)$ .

Dans le Chapitre 4 est présenté le théorème pour l'estimation de  $\tilde{\theta}$  en considérant le système (1) sans défaut de l'actionneur où  $f(t) = 0$  et le cas où  $f(t) \neq 0$ .

## Conception d'un contrôle tolérant aux défauts pour les systèmes LPV

Pour maintenir le système en boucle fermée à une performance souhaitable en préservant les conditions de stabilité en présence d'une défaillance de l'actionneur. La structure suivante est proposée sur la base d'un système LPV polytopique (1) avec des paramètres de planification non mesurables.

$$\dot{\zeta}(t) = \sum_{i=1}^{2^k} \mu_i(\hat{\theta}(t))(N_i(\zeta(t) + TG\hat{f}(t)) + H_i v(t) + F_i y(t) + J_i u(t) + TG\hat{f}(t)) \quad (3a)$$

$$\dot{v}(t) = \sum_{i=1}^{2^k} \mu_i(\hat{\theta}(t))(S_i(\zeta(t) + TG\hat{f}(t)) + L_i v(t) + M_i y(t)) \quad (3b)$$

$$\hat{x}(t) = \zeta(t) + TG\hat{f}(t) + Qy(t) \quad (3c)$$

$$\dot{\hat{f}}(t) = \Phi_2(\hat{\theta}(t), \hat{x}(t), y(t)) \quad (3d)$$

où  $\zeta(t) \in \mathbb{R}^{q_0}$  est le vecteur d'état de l'observateur,  $v(t) \in \mathbb{R}^{q_1}$  est un vecteur auxiliaire et  $\hat{x}(t) \in \mathbb{R}^n$  est l'estimation de  $x(t)$ .  $\hat{\theta}$  est l'estimation de  $\tilde{\theta}(t)$  accordée par l'observateur adaptatif (2). Matrices  $N_i, H_i, F_i, J_i, S_i, L_i, M_i, T, P$  et  $Q$  sont des matrices inconnues de dimensions appropriées. La fonction  $\Phi_2(t)$  doit être déterminée de telle sorte que  $\hat{f}(t)$  converge asymptotiquement avec  $f(t)$ .

Avec les informations fournies par les observateurs adaptatifs (2) et (3), une technique de contrôle tolérante aux fautes sera utilisée. Le contrôleur proposé pourra compenser les défauts des actionneurs même en présence de la variation paramétrique  $\tilde{\theta}(t)$ .

Pour stabiliser le système sur la trajectoire souhaitée  $x_d(t)$ , il faut déterminer la loi de contrôle tolérante aux défauts suivante

$$u(t) = \vartheta(\hat{\theta}(t), \hat{x}(t), \hat{f}(t), x_d(t)) \quad (4)$$

où la fonction  $\vartheta(t)$  doit être déterminée sur la base de la trajectoire souhaitée et des informations fournies par les observateurs adaptatifs.

Le chapitre 5 présente la stratégie de contrôle à tolérance de défauts utilisée pour le système LPV (1). Il utilise les informations fournies par les observateurs adaptatifs (2) et (3) en estimant simultanément les variables d'état et de défaut dans l'actionneur.

### 3 Objectifs

L'objectif général de cette thèse est de proposer une nouvelle structure d'observateurs adaptatifs pour les systèmes de LPV, qui doivent être capables d'estimer les paramètres et les variables d'état du système. Ces informations devraient être utiles pour concevoir un système de contrôle tolérant aux défauts.

#### Objectifs particuliers

- Proposer une nouvelle structure d'observateurs adaptatifs pour les systèmes LPV, capables d'estimer les variations des paramètres du processus.
- Proposer une stratégie de diagnostic des défauts pour les systèmes LPV afin d'estimer les états, les défauts des actionneurs et la variation des paramètres en fonction de l'observateur proposé.
- Mettre en œuvre une loi de contrôle qui tient compte de l'estimation des paramètres et des informations fournies par le schéma de diagnostic, afin de maintenir les conditions de fonctionnement souhaitées, même en présence de défauts.

### 4 Justification

La qualité du produit, le système d'exploitation économique et la sécurité sont des facteurs importants pour les processus industriels [Jiang and Yu, 2012]. Un moyen de maintenir ces facteurs est la mise en œuvre des méthodes FTC et FD. Ces stratégies assurent une opération de sécurité, en évitant les situations dangereuses ; un fonctionnement continu, en maintenant le système même en présence de perturbations et de défauts ; et un fonctionnement efficace, en préservant des performances acceptables.

L'installation pourrait produire des erreurs de mesure ou des changements importants dans le fonctionnement nominal en raison de défauts qui sont souvent classés comme des défauts d'actionneurs, des défauts de capteurs et des défauts de paramètres. Afin d'améliorer la fiabilité de la centrale, la FD est souvent utilisée pour surveiller, localiser et identifier les défauts en utilisant le concept de redondance, soit de redondance matérielle, soit de redondance analytique. Ces informations sur la défaillance sont utilisées dans une stratégie de FTC afin de satisfaire les objectifs de contrôle avec une dégradation minimale des performances après l'apparition de la défaillance.

Dans certains ouvrages, la conception du contrôle suppose que le vecteur d'état est accessible pour la mesure. Dans un cas pratique, la disponibilité de l'instrumentation est limitée en raison du coût des composants ou simplement parce qu'il n'existe pas de technologie permettant de mesurer une variable d'état. Dans le modèle FD, le principal outil pour estimer ces variables d'état non mesurées est l'observateur. Pour concevoir ces observateurs, un modèle dynamique est nécessaire pour connaître le comportement du système. Dans la littérature, il est très courant de représenter le comportement dynamique d'un système à l'aide de modèles non linéaires. Généralement, les modèles non linéaires ont été dérivés grâce à la connaissance du système ou par des équations représentant le comportement physique. En raison de la complexité de la conception des contrôleurs non linéaires, ce modèle est parfois linéarisé à un point de

fonctionnement pour obtenir un modèle LTI.

L'approche LPV présente un grand avantage dans la comparaison des modèles linéaires et non linéaires. Cette théorie peut représenter un système à travers plusieurs points d'opération (modèles LTI) décrivant mieux le comportement dynamique de l'installation et réduire la complexité des contrôleurs de conception ou des observateurs de conception qui sont des outils clés dans le domaine du FTC.

Cette recherche tente d'apporter une contribution dans le domaine du FTC pour les systèmes LPV. Il existe une vaste littérature sur ce sujet, mais il reste des questions qui n'ont pas été abordées.

## 5 Plan de la thèse et contribution

Sur la base des objectifs de cette thèse, ce travail est organisé en six chapitres. Le chapitre 1 décrit le contexte de ce travail de recherche, et de même, l'état de l'art est présenté pour démontrer la motivation de cette thèse. La théorie des systèmes linéaires à paramètres variables est introduite, donnant les concepts nécessaires à l'analyse de stabilité basée sur la méthode de Lyapunov. Ensuite, il est présente les différents types de structures d'observation et de conception de contrôle pour les systèmes à basse tension en se basant sur la revue bibliographique. Comme cette recherche est orientée vers le domaine de FTC, les définitions de FTC active et de FTC passive sont décrites.

Le chapitre 2 présente la synthèse de l'observateur dynamique généralisé (ODG) pour les systèmes LPV à temps continue. Cette structure d'observation généralise les résultats sur les structures d'observation comme que l'observateur proportionnel (PO) et l'observateur proportionnel-intégral (PIO). De même, pour satisfaire aux conditions d'existence de l'ODG, une paramétrisation des contraintes algébriques obtenues à partir de l'analyse des erreurs d'estimation est détaillée. En outre, il est présenté le problème de conception de l'observateur pour les systèmes LPV avec une entrée inconnue. D'autre part, il illustre les cas où les variables de planification sont des signaux exogènes ou endogènes, comme le cas où la variable de planification n'est pas mesurée. Des exemples académiques sont utilisés pour comparer les performances des GDO par rapport à leurs cas particuliers.

Le chapitre 3 décrit la conception GDO pour les systèmes LPV à temps discret avec des entrées et des perturbations inconnues. Pour la synthèse de cet observateur, une fonction de Lyapunov dépendante des paramètres est utilisée, ce qui est suffisant pour assurer une stabilité asymptotique globale. De même, un système d'ingénierie comme système de référence pour les turbines éoliennes de 4,8 MW est utilisée pour comparer les performances des GDO avec leurs cas particuliers.

Au chapitre 4, en utilisant la structure GDO, un concept d'observateur adaptatif pour les systèmes LPV est développé, qui peut estimer simultanément les états et les paramètres du système. En outre, les conditions de conception de l'observateur pour les systèmes à LPV avec des entrées inconnues sont définies. Les termes variables dans le temps sont délimités, en tirant parti des propriétés polytopiques. La méthode de Lyapunov et les notions de gain de  $\mathcal{L}_2$  sont utilisées pour obtenir les conditions de stabilité en termes de LMI. Des exemples numériques sont utilisés pour démontrer la performance de cette structure d'observation.

Le chapitre 5 concerne une stratégie active de FTC pour les systèmes LPV qui combine les résultats des chapitres précédents. Dans le premier chapitre, la loi FTC utilise l'estimation de l'état et des défauts fournie par un observateur adaptatif. La loi de contrôle est ensuite conçue pour entreprendre le suivi de l'état de référence, en minimisant la déviation de la trajectoire de l'état du système causée par les défauts. Enfin, elle suppose que la variable de planification n'est pas mesurée ; par conséquent, un autre observateur adaptatif capable d'estimer la variation des paramètres du système est ajouté au schéma de FTC précédemment établi. Par conséquent, une nouvelle unité FD est construite, qui peut estimer les états, les défauts et la variation des paramètres.

Enfin, le chapitre 6 présente les conclusions de ces travaux de recherche et quelques perspectives pour les travaux futurs sont discutés. L'organisation des chapitres est également illustrée dans la figure 1.

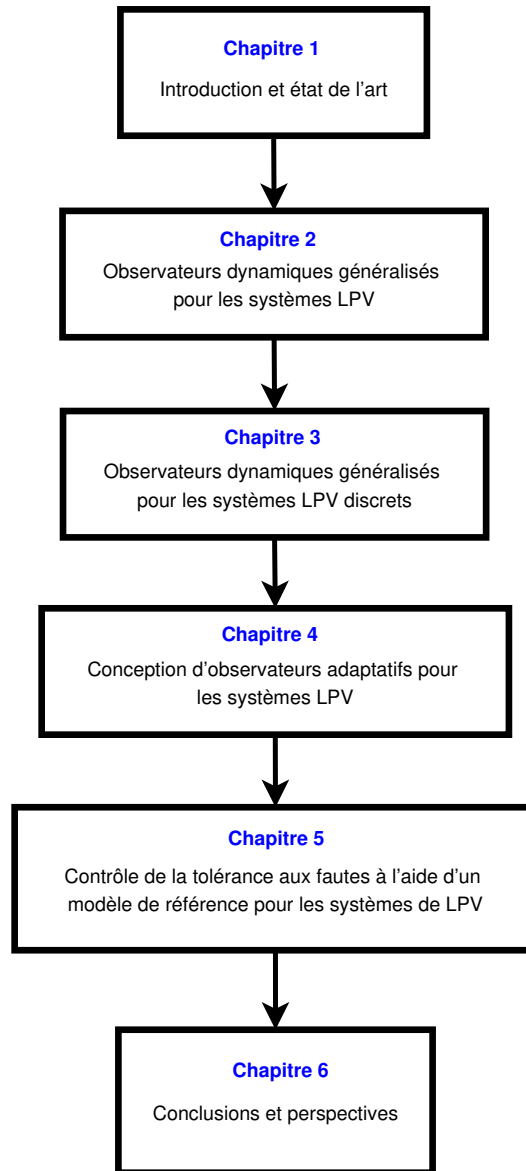

FIGURE 1 – Esquisse de la thèse.

## Liste des publications

Les produits scientifiques obtenus au cours de cette recherche seront présentés ci-dessous.

### Reuves internationales avec comité de lecture

- A.-J Pérez-Estrada, G.-L. Osorio-Gordillo, M. Darouach, V.-H Olivares-Peregrino. "Generalized dynamic observer design for quasi-LPV systems". *at-Automatisierungstechnik*. 66 (3) (2018) 225-233, DOI : 10.1515/auto-2017-0060
- A.-J. Pérez-Estrada, G.-L Osorio-Gordillo, M. Darouach, M. Alma, V.-H. Olivares-Peregrino. "Generalized dynamic observers for quasi-LPV systems with unmeasurable scheduling function". *International Journal of Robust and Nonlinear Control*. 28 (17) (2018) 5262-5278, DOI : 10.1002/rnc.4309.
- A.-J. Pérez-Estrada, G.-L Osorio-Gordillo, M. Alma, M. Darouach, V.-H. Olivares-Peregrino.

" $H_\infty$  generalized dynamic unknown inputs observer design for discrete LPV systems. Application to wind turbine". *European Journal of Control*. (2018), DOI : 10.1016/j.ejcon.2018.09.013.

- G.-L Osorio-Gordillo, C.-M Astorga-Zaragoza, A.-J. Pérez-Estrada, R. Vargas-Méndez, M. Darouach, L. Boutat-Baddas. "Fault estimation for descriptor linear systems based on the generalised dynamic observer". *International Journal of Systems Science*. 49 (11) (2018) 2398- 2409, DOI : 10.1080/00207721.2018.1503357.
- R. Schacht-Rodriguez, G. Ortiz-Torres, C.-D Garcia-Beltran, C.-M Astorga-Zaragoza, J.-C Ponsart, A.-J Perez-Estrada. "Design and development of a UAV Experimental Platform". *IEEE Latin America Transactions*. 16 (5) (2018) 1320-1327, DOI : 10.1109/TLA.2018.8408423.

## Conférences internationales avec comité de lecture

- A.-J. Pérez-Estrada, G.-L Osorio-Gordillo, M. Darouach, M. Alma. "Adaptive observer design for LPV systems". 3rd IFAC Workshop on Linear Parameter-Varying Systems 2019. Eindhoven, The Netherlands.
- A.-J. Pérez-Estrada, G.-L Osorio-Gordillo, M. Darouach, M. Alma, V.-H. Olivares-Peregrino. "Observer design for quasi-LPV systems with unmeasurable scheduling functions using the norm-L2 approach". National Congress of Automatic Control 2018. San Luis Potosí, Mexico.
- A.-J. Pérez-Estrada, G.-L Osorio-Gordillo, M. Darouach, M. Alma, V.-H. Olivares-Peregrino. "Generalized dynamic observer design for discrete LPV systems with parameter dependent Lyapunov functions". The 14th European Workshop on Advanced Control and Diagnosis 2017. Bucharest, Romania.
- A.-J. Pérez-Estrada, G.-L Osorio-Gordillo, M. Darouach, V.-H. Olivares-Peregrino. "Generalized dynamic observers for LPV systems". National Congress of Automatic Control 2017. Nuevo León, Mexico.
- D.-A. Arámbula-Jiménez, A.-J. Pérez-Estrada, G.-L Osorio-Gordillo, C.-M. Astorga-Zaragoza, G. Madrigal-Espinosa. "Detección y localización de fallas en sensores de la caja de transmisión de una turbina eólica". National Congress of Automatic Control 2019. Puebla, Mexico.
- M.-A. Flores-Martínez, G.-L. Osorio-Gordillo, A.-J. Pérez-Estrada, J. Reyes-Reyes, M. Adam-Medina. "Diseño de un observador dinámico generalizado para el proceso glucosa-insulina utilizando el enfoque Takagi-Sugeno". National Congress of Automatic Control 2018. San Luis Potosí, Mexico

# Chapter 1

## Introduction

### Contents

---

<b>1.1</b>	<b>LPV system</b> . . . . .	<b>7</b>
1.1.1	Stability for LPV systems . . . . .	8
1.1.2	Observation . . . . .	10
1.1.2.1	Observers for LPV systems . . . . .	10
1.1.2.2	Dynamic observers . . . . .	10
1.1.2.3	Unknown input observers . . . . .	11
1.1.2.4	Adaptive observers . . . . .	11
1.1.3	Control . . . . .	12
1.1.3.1	Gain-scheduled static controllers for LPV systems . . . . .	12
1.1.3.2	Gain-scheduled dynamic controllers for LPV systems . . . . .	12
1.1.4	Polytopic Bounded Real Lemma . . . . .	13
1.1.5	Unmeasured scheduling variables . . . . .	13
<b>1.2</b>	<b>Fault-tolerant control</b> . . . . .	<b>14</b>
1.2.1	Type of fault-tolerant control systems . . . . .	14
1.2.2	Fault diagnosis scheme . . . . .	15
<b>1.3</b>	<b>Tools for the stability analysis of dynamic systems</b> . . . . .	<b>15</b>
<b>1.4</b>	<b>Conclusion</b> . . . . .	<b>16</b>

---

## 1.1 LPV system

LPV systems are linear state-space models with matrices depending on time-varying parameters that can evolve over wide operating ranges. These parameters, called scheduling variables, depend on exogenous signals that are unknown a priori, but measured or estimated in real-time. The LPV systems can be described by the following equations :

$$\dot{x}(t) = A(\rho(t))x(t) + B(\rho(t))u(t) \tag{1.1a}$$

$$y(t) = C(\rho(t))x(t) + D(\rho(t))u(t) \tag{1.1b}$$

where  $x(t) \in \mathbb{R}^n$  is the state vector,  $u(t) \in \mathbb{R}^m$  represents the control input vector,  $y(t) \in \mathbb{R}^p$  represents the measured output vector, and  $\rho(t) \in \mathbb{R}^{n_\rho}$  is the time-varying parameter vector.  $A(\rho(t))$ ,  $B(\rho(t))$ ,  $C(\rho(t))$  and  $D(\rho(t))$  are varying matrices of appropriate dimensions. The class of LPV systems encompasses a wide variety of systems according to the type of trajectories of the parameters [Briat, 2015]. The most common technique to obtain an LPV system is the polytopic LPV approach, where the plant depends affinely on time-varying parameter vector which evolves into a polytopic set [Hoffmann and Werner, 2015].

It is assumed that each component  $\rho_j(t)$ ,  $j \in \{1, 2, \dots, n_\rho\}$  of the time-varying parameter vector  $\rho(t)$  is bounded, in which their values remain into a hyper-rectangle such that

$$\rho(t) \in \mathcal{P} = \left\{ \rho_j(t) \mid \underline{\rho}_j \leq \rho_j(t) \leq \bar{\rho}_j \right\}, \quad \forall j \in \{1, 2, \dots, n_\rho\}, \forall t \geq 0 \tag{1.2}$$

Based on the affine parameter dependence (1.2), the varying matrices of the LPV system (1.1) can be represented in the following form :

$$\begin{aligned} A(\rho(t)) &= A_0 + \sum_{j=1}^{n_\rho} \rho_j(t) \mathcal{A}_j, & B(\rho(t)) &= B_0 + \sum_{j=1}^{n_\rho} \rho_j(t) \mathcal{B}_j, \\ C(\rho(t)) &= C_0 + \sum_{j=1}^{n_\rho} \rho_j(t) \mathcal{C}_j, & D(\rho(t)) &= D_0 + \sum_{j=1}^{n_\rho} \rho_j(t) \mathcal{D}_j \end{aligned}$$

where  $A_0, B_0, C_0, D_0, \mathcal{A}_j, \mathcal{B}_j, \mathcal{C}_j$ , and  $\mathcal{D}_j$  are known matrices with appropriate dimensions. From this characterization, system (1.1) can be transformed in a convex combination where the vertices  $\mathcal{S}_i$  of the polytope are the images of the vertices of  $\mathcal{P}$  such that  $\mathcal{S}_i = [A_i, B_i, C_i, D_i]$ ,  $\forall i \in \{1, 2, \dots, \tau\}$  where  $\tau = 2^j$ . The polytopic coordinates are denoted by  $\mu(\rho(t))$  and vary into the convex set  $\Lambda$  where

$$\Lambda = \left\{ \mu(\rho(t)) \in \mathbb{R}^\tau, \mu(\rho(t)) = [\mu_1(\rho(t)), \mu_2(\rho(t)), \dots, \mu_\tau(\rho(t))]^T, \mu_i(\rho(t)) \geq 0, \sum_{i=1}^{\tau} \mu_i(\rho(t)) = 1 \right\} \quad (1.3)$$

The polytopic coordinates can be computed as in [Pellanda et al., 2002]. The polytopic LPV system with the time-varying parameter vector  $\mu_i(\rho(t)) \in \Lambda$  is represented by

$$\dot{x}(t) = \sum_{i=1}^{\tau} \mu_i(\rho(t)) (A_i x(t) + B_i u(t)) \quad (1.4a)$$

$$y(t) = \sum_{i=1}^{\tau} \mu_i(\rho(t)) (C_i x(t) + D_i u(t)) \quad (1.4b)$$

with  $\mu_i(\rho(t)) = \prod_{j=1}^{n_\rho} \mu_j^k(\rho_j(t))$ ,  $A_i = A_0 + \sum_{j=1}^{n_\rho} \rho_j^k \mathcal{A}_j$ ,  $B_i = B_0 + \sum_{j=1}^{n_\rho} \rho_j^k \mathcal{B}_j$ ,  $C_i = C_0 + \sum_{j=1}^{n_\rho} \rho_j^k \mathcal{C}_j$ ,  $D_i = D_0 + \sum_{j=1}^{n_\rho} \rho_j^k \mathcal{D}_j$ , where  $k$  is equal to 1 or 2 depending of the partition of the  $j^{\text{th}}$  parameter ( $\mu_j^1$  or  $\mu_j^2$ ). It can be reformulated in a convex linear combination of linear time-invariant (LTI) models, such that the LTI system theory can be used.

**Remark 1.1.** [Kwiatkowski et al., 2006] *If the scheduling variables are functions of endogenous signals such as states, inputs, or outputs instead of exogenous signals, the system is referred to as quasi-LPV and describes a large class of nonlinear systems.*

Likewise, there are many LPV control/observer applications reported in the literature such as aircraft dynamics [Varga and Ossmann, 2014, Pellanda et al., 2002], wind turbines [Shao et al., 2018, Liu et al., 2017a, Bakka et al., 2014], automotive [Zhang and Wang, 2017a, Zhang and Wang, 2017b, Zhang et al., 2016, Zhang and Wang, 2016], vehicle motion [Hu et al., 2016, Yacine et al., 2013], mechatronic [Nguyen et al., 2016, Nagy Kiss et al., 2015], anaerobic digesters [López-Estrada et al., 2015, Nagy Kiss et al., 2011], biomechanical systems [Blandeau et al., 2018] and unmanned aerial vehicles (UAV) [López-Estrada et al., 2016, Rotondo et al., 2013]. Based on these applications, it can be noted that the LPV approach is useful when the component parameters, like stiffness, inertias, resistances, microbial growth rates, are depending on the state variables. For more information about LPV applications, see [Hoffmann and Werner, 2015, Shamma, 2012] and references therein.

The following sections address some properties of LPV systems like stability, and it will be presented different controller and observer structures into the LPV systems area.

### 1.1.1 Stability for LPV systems

Let us consider the following LPV system represented as

$$\begin{aligned} \dot{x}(t) &= A(\rho(t))x(t) \\ x(0) &= x_0 \end{aligned} \quad (1.5)$$

where  $x(t) \in \mathbb{R}^n$  is the state vector and the parametric uncertainty vector  $\rho \in \mathbb{R}^j \subset \mathcal{P}$  where  $j$  is the number of parameters. A usual type of stability for LPV system (1.5) is the quadratic stability which is described in Definition 1.1.



**Definition 1.1.** (Quadratic stability) System (1.5) is said to be quadratically stable if the positive definite quadratic form

$$V_q(x(t)) = x^T(t)Px(t), \quad P = P^T > 0 \quad (1.6)$$

is a Lyapunov function for (1.5). Such a Lyapunov function is often referred to as a common Lyapunov function or parameter-independent Lyapunov Function.

Quadratic stability is only sufficient for asymptotic stability for a LPV system [Briat, 2015]. This approach suffers from conservatism since it does not take into account the parameter variations of the LPV system. The terms stable and asymptotically stable, are established in Definition 1.2.

**Definition 1.2.** Consider the system (1.5) which its solution is denoting by  $x(x_0, \rho, t)$  where  $\rho \in \mathcal{P}$  and  $x_0 \in \mathbb{R}^n$ . The system (the zero equilibrium point) is said to be

- **stable** if, for each  $\epsilon > 0$ , there is  $\delta = \delta(\epsilon) > 0$  such that

$$\|x_0\|_2 \leq \delta \Rightarrow \|x(x_0, \rho, t)\|_2 \leq \epsilon \quad (1.7)$$

$\forall t \geq 0$  and all  $\rho \in \mathcal{P}$ .

- **attractive** if there exists  $\delta$  with the property that

$$\|x_0\|_2 \leq \delta \Rightarrow \lim_{t \rightarrow \infty} \|x(x_0, \rho, t)\|_2 = 0 \quad (1.8)$$

$\forall \rho \in \mathcal{P}$ .

- **asymptotically stable** (in the sense of Lyapunov) if it is both stable and attractive.
- **exponentially stable** if there exist  $\delta, \alpha > 0$  and  $\beta \geq 1$  such that

$$\|x_0\|_2 \leq \delta \Rightarrow \|x(x_0, \rho, t)\|_2 \leq \beta e^{-\alpha t} \|x_0\|_2 \quad (1.9)$$

$\forall t \geq 0$  and all  $\rho \in \mathcal{P}$ .

- **unstable** if it is not stable in the sense of Lyapunov.

The following Theorems characterize the quadratic stability for LPV systems for the continuous and discrete cases.

**Theorem 1.1.** (Quadratic stability for CT LPV systems) The autonomous LPV system (1.5) is quadratically stable if there exists  $P > 0$  such that :

$$A^T(\rho(t))P + PA(\rho(t)) < 0 \quad \forall \rho \in \mathcal{P} \quad (1.10)$$

*Proof.* Considering the Lyapunov candidate function (1.6) which its dynamics is described by

$$\dot{V}_q(t) = \dot{x}(t)^T Px(t) + x(t)^T P \dot{x} = x(t)^T [A^T(\rho(t))P + PA(\rho(t))] x(t). \quad (1.11)$$

$\dot{V}_q(t) < 0$  if  $A^T(\rho(t))P + PA(\rho(t)) < 0$ . □

**Theorem 1.2.** (Quadratic stability for DT LPV systems) The autonomous LPV system (1.5) is quadratically stable :

1. if there exists  $P > 0$  such that :

$$A(\rho_k)^T PA(\rho_k) - P < 0 \quad \forall \rho \in \mathcal{P} \quad (1.12)$$

2. if there exists  $P > 0$  such that :

$$\begin{bmatrix} -P & PA(\rho_k) \\ A(\rho_k)^T P & -P \end{bmatrix} < 0 \quad \forall \rho \in \mathcal{P} \quad (1.13)$$

*Proof.* The system (1.5) is represented in discrete form as

$$x_{k+1} = A(\rho_k)x_k \quad (1.14)$$

Let  $V_{q_k} = x_k^T P x_k$  with  $P = P^T > 0$ , be a Lyapunov candidate function, then  $\Delta V_{q_k}$  along the solution of (1.14) is given by

$$\Delta V_{q_k} = V_{q_{k+1}} - V_{q_k} = x_k^T (A(\rho_k)^T PA(\rho_k) - P) x_k \quad (1.15)$$

if  $A(\rho_k)^T PA(\rho_k) - P < 0$  then  $\Delta V_{q_k} < 0$ . Then, (1.13) can be obtained from (1.12) by using Schur complement. □

**Remark 1.2.** The polytopic approach has a unique feature in the LPV systems stability, which turns the solution of an infinite set of LMI into a finite set of LMI by only considering the vertices of the polytope [Apkarian et al., 2000].

## 1.1.2 Observation

For this section, we consider the following LPV system :

$$\dot{x}(t) = A(\rho(t))x(t) + B(\rho(t))u(t) + E(\rho(t))w(t) \quad (1.16a)$$

$$y(t) = C(\rho(t))x(t) + F(\rho(t))w(t) \quad (1.16b)$$

where  $x(t) \in \mathbb{R}^n$  is the state vector,  $u(t) \in \mathbb{R}^m$  represents the control input,  $y(t) \in \mathbb{R}^p$  represents the measured output vector,  $w(t)$  represents the disturbance vector.  $\rho(t) \in \mathbb{R}^j$  is the time-varying parameter vector, in which their values remain into some compact set  $\mathcal{P}$  giving reasonable trajectories ensuring that solutions to (1.16) exist.

The study of LPV observers design is addressed for proportional observer (PO) [Ichalal et al., 2016], proportional integral observers (PIO) [Ichalal et al., 2009] and adaptive observers (AO) [Nagy-Kiss et al., 2015, Bezzaoucha et al., 2013] framework respectively.

### 1.1.2.1 Observers for LPV systems

The observation objective aims to reconstruct the state or a linear combination of the system states from the input and output measurements. Commonly, the observer design ensures asymptotic stability using the observation error. Now, let us consider the following LPV observer for system (1.16) assuming that  $y(t) = Cx(t)$

$$\dot{\zeta}(t) = M(\rho(t))\zeta(t) + N(\rho(t))y(t) + S(\rho(t))u(t) \quad (1.17)$$

$$\hat{x}(t) = \zeta(t) + Hy(t) \quad (1.18)$$

where  $\zeta(t)$ ,  $\hat{x}(t) \in \mathbb{R}^q$  are the state observer and the estimate of  $x(t)$ , respectively. The observer matrices are determined through the asymptotic convergence analysis of the estimation error  $e(t) = \zeta(t) - Tx(t)$ , where  $T$  is any full row rank matrix. Likewise, the  $\mathcal{L}_2$  gain is used to minimize the effect of  $w(t)$  to  $e(t)$ .

More restrictive observer structures have the form

$$\dot{\hat{x}}(t) = A(\rho(t))\hat{x}(t) + B(\rho(t))u(t) + L(\rho(t))(y(t) - C\hat{x}(t)) \quad (1.19)$$

with  $\hat{x} \in \mathbb{R}^n$  is the estimated state and the observer gain  $L(\rho(t))$  is used to ensure a good estimation of the full state  $x(t)$  of the system (1.16). For this case, the estimation error is defined as  $e(t) = \hat{x}(t) - x(t)$ . The observability problem for CT LPV observers and DT LPV observers is addressed in [Tóth, 2010].

### 1.1.2.2 Dynamic observers

More recently, the study of a new observer structure, called generalized dynamic observer (GDO) has been introduced for descriptor systems [Osorio-Gordillo et al., 2015], linear time invariant systems [Gao et al., 2016], discrete-time systems [Gao et al., 2017, Pérez-Estrada et al., 2018a] and continuous-time LPV systems [Pérez-Estrada et al., 2018b]. These observer structures are based on [Park et al., 2002, Marquez, 2003], where the principal idea is to add dynamics structure to increase its degrees of freedom, with the purpose of achieving steady state accuracy and improve robustness in estimation error against disturbances and parametric uncertainties. Therefore, this structure can be considered as more general than PO and PIO.

The GDO structure for system (1.16) is described by

$$\dot{\zeta}(t) = N(\rho(t))\zeta(t) + H(\rho(t))v(t) + F(\rho(t))y(t) + J(\rho(t))u(t) \quad (1.20a)$$

$$\dot{v}(t) = S(\rho(t))\zeta(t) + L(\rho(t))v(t) + M(\rho(t))y(t) \quad (1.20b)$$

$$\hat{x}(t) = P\zeta(t) + Qy(t) \quad (1.20c)$$

where  $\zeta(t) \in \mathbb{R}^{q_0}$  represents the state vector of the observer,  $v(t) \in \mathbb{R}^{q_1}$  is an auxiliary vector and  $\hat{x}(t) \in \mathbb{R}^n$  is the estimate of  $x(t)$ . Matrices  $N(\rho(t))$ ,  $H(\rho(t))$ ,  $F(\rho(t))$ ,  $J(\rho(t))$ ,  $S(\rho(t))$ ,  $L(\rho(t))$ ,  $M(\rho(t))$ ,  $P$  and  $Q$  are unknown matrices of appropriate dimensions which must be determined such that  $\hat{x}(t)$  converges asymptotically to  $x(t)$ .

This observer structure generalizes the PO and PIO considering the following algebraic constraints :

— If  $H(\rho(t)) = 0$ ,  $S(\rho(t)) = 0$ ,  $M(\rho(t)) = 0$ , and  $L(\rho(t)) = 0$ , then the observer reduces to the PO for LPV systems.

$$\dot{\zeta}(t) = N(\rho(t))\zeta(t) + F(\rho(t))y(t) + J(\rho(t))u(t) \quad (1.21a)$$

$$\hat{x}(t) = P\zeta(t) + Qy(t) \quad (1.21b)$$

— For  $L(\rho(t)) = 0$ ,  $S(\rho(t)) = -CP$ , and  $M(\rho(t)) = -CQ + I$ , then the following PIO for LPV systems is obtained :

$$\dot{\zeta}(t) = N(\rho(t))\zeta(t) + H(\rho(t))v(t) + F(\rho(t)) + J(\rho(t))u(t) \quad (1.22a)$$

$$\dot{v}(t) = y(t) - C\hat{x}(t) \quad (1.22b)$$

$$\hat{x}(t) = P\zeta(t) + Qy(t). \quad (1.22c)$$

The integral term of a PIO aims to cancel the effect of the disturbance in the estimation error in steady-state [Ellis, 2012]. The difference between PIO and GDO is that the GDO has more degrees of freedom than the PIO, improving the estimation performances against uncertainties and disturbances.

**Remark 1.3.** *The order of the observer is  $q_0 \leq n$ , when  $q_0 = n - p$ , a reduced order observer is obtained. For  $q_0 = n$ , we obtain the full order one.*

### 1.1.2.3 Unknown input observers

Similarly, the study of model-observer design for LPV systems in the presence of unknown inputs or disturbances is challenging research in the field of robust control, fault-tolerant control, and system supervision [Chadli et al., 2017, Chadli and Karimi, 2013]. This problem came across in practice since the disturbances or partial inputs are inaccessible, or can result from either model uncertainties or faults. In [Marx et al., 2019] the authors addressed the unknown input decoupling approaches which consist in obtaining the state estimation error free from an unknown input, the conditions for the existence of the considered observer are also given.

This type of observers is useful for systems with the following LPV representation

$$\dot{x}(t) = A(\rho(t))x(t) + B(\rho(t))u(t) + D(\rho(t))d(t) + E(\rho(t))w(t) \quad (1.23a)$$

$$y(t) = C(\rho(t))x(t) \quad (1.23b)$$

where  $x(t) \in \mathbb{R}^n$  is the state vector,  $u(t) \in \mathbb{R}^m$  represents the control input,  $y(t) \in \mathbb{R}^p$  represents the measured output vector,  $w(t)$  represents the disturbance vector, and  $d(t) \in \mathbb{R}^{n_d}$  is the unknown input vector.  $\rho(t) \in \mathbb{R}^j$  is the time-varying parameter vector, in which their values remain into some compact set  $\mathcal{P}$ . An UI observer for the LPV system (1.23) can be proposed as equation (1.21).

The majority of physical processes are subject to disturbances as measurement noises, modeling uncertainties, sensors, and actuators faults, which can be considered as unknown inputs. In (1.23), the distinction of the variable  $d(t)$  and  $w(t)$  is that  $w(t)$  represents disturbances and model uncertainties which are always present, while  $d(t)$  represents unknown inputs which may be present or not [Blanke et al., 2003]. The disturbance  $w(t)$  satisfies certain conditions such as be stochastic with some statistical proprieties or to be of finite energy.  $d(t)$  may be any exogenous signal affecting the systems and taking any values (for example, the resistant torque in DC motor).

These disturbances, considered as unknown inputs, have adverse effects on the normal behavior of the real system, and their estimates can be used to conceive systems of diagnostic and control [Youssef et al., 2014].

### 1.1.2.4 Adaptive observers

Commonly, the observer design assumes that the parameters of the system are known. This fact is not always true in a practical mean, because unknown parameters are encountered frequently in physical systems and these ones can introduce uncertainty in the observer design obtaining an inaccuracy reconstruction of the state variables. In this case, the adaptive observers are an efficient solution to solve this problem due to its characteristic of jointly estimates parameters and states. In the literature, two major approaches have been developed to face the design of adaptive

observer. These approaches are essentially based on the following points : the unknown parameter vector is deduced from the stability analysis of a state observer and the convergence property of the parameter error is obtained by the persistence of excitation type constraint, consequently, a parameter adaptation law is proposed. Many contributions deal with this approach as in [Zhang, 2002, Cho and Rajamani, 1997, Alma et al., 2018]; and an augmented system for which the adaptive observer design is elaborated. In this case, the system dynamics are augmented with the dynamics of its unknown parameters as in [Nagy-Kiss et al., 2015, Bezzaoucha et al., 2013, Srinivasarengan et al., 2018].

Along with the chapters of this thesis, we address these observer structures, undertaking the observer stability analysis of each one. In the case of the GDO, its performance is compared with particular cases as PO and PIO using academic examples. Besides, the UI scenery is addressed in continuous and discrete-time.

### 1.1.3 Control

For the control of LPV systems, let us consider the following LPV system :

$$\dot{x}(t) = A(\rho(t))x(t) + B(\rho(t))u(t) + E(\rho(t))w(t) \quad (1.24a)$$

$$y(t) = C(\rho(t))x(t) + F(\rho(t))w(t) \quad (1.24b)$$

where  $x(t) \in \mathbb{R}^n$  is the state vector,  $u(t) \in \mathbb{R}^m$  represents the control input,  $y(t) \in \mathbb{R}^p$  represents the measured output vector,  $w(t)$  represents the disturbance vector.  $\rho(t) \in \mathbb{R}^j$  is the time-varying parameter vector, in which their values remain into some compact set  $\mathcal{P}$  giving reasonable trajectories ensuring that solutions to (1.24a) exist. In the literature, we can find the following gain-scheduled controllers.

#### 1.1.3.1 Gain-scheduled static controllers for LPV systems

The control action is an algebraic function of the system state. In this category, there exist state-feedback and static output feedback controller, such as :

- Gain-scheduled static output-feedback controllers are given by

$$u(t) = K(\rho(t))y(t). \quad (1.25)$$

- Gain-scheduled state-feedback controllers are given by

$$u(t) = K(\rho(t))x(t). \quad (1.26)$$

#### 1.1.3.2 Gain-scheduled dynamic controllers for LPV systems

For this type of controllers, the control action is computed on the state of an auxiliary system with proper dynamics. These controllers can be classified by :

##### Observer-based controllers

If the system state is not directly accessible, this type of controller is designed by two parts. The first one is estimating the state of the system, and a control part is computed through the estimated state. Observer-based controller can take the following forms

$$\dot{\zeta}(t) = M(\rho(t))\zeta(t) + N(\rho(t))y(t) + S(\rho(t))u(t) \quad (1.27a)$$

$$\hat{x}(t) = \zeta(t) + Hy(t) \quad (1.27b)$$

$$u(t) = K(\rho(t))\hat{x}(t) \quad (1.27c)$$

or

$$\dot{\hat{x}}(t) = A(\rho(t))\hat{x}(t) + B(\rho(t))u(t) + L(\rho(t))(y(t) - C\hat{x}(t)) \quad (1.28a)$$

$$u(t) = K(\rho(t))\hat{x}(t) \quad (1.28b)$$

where  $\hat{x}(t), \zeta(t) \in \mathbb{R}^n$  are the states of the observes and  $M(\rho(t)), N(\rho(t)), S(\rho(t)), H, K(\rho(t))$  are matrices to be determined with appropriate dimensions.

### Dyamic output-feedback controllers

This controller structure do not take into account the estimated state. It computes a control input from the measured output as the following equations :

$$\dot{x}_c(t) = A_c(\rho(t))x_c(t) + B_c(\rho(t))y(t) \quad (1.29a)$$

$$u(t) = C(\rho(t))x_c(t) + D_c(\rho(t))y(t) \quad (1.29b)$$

where  $x_c(t) \in \mathbb{R}^n$  is the state of the controller. Depending on the dimension of the controller, this one can call it either full-order or reduced order.

### 1.1.4 Polytopic Bounded Real Lemma

Based on quadratic stability for LPV system and the  $\mathcal{L}_2$  performance formulation, we can obtain an adaptation of the bounded real lemma [Xie, 2008] if there is a matrix  $P = P^T > 0$  such that

$$\begin{bmatrix} A(\rho(t))^T P + P A(\rho(t)) & P B(\rho(t)) & C(\rho(t))^T \\ B(\rho(t))^T P & -\gamma I & D(\rho(t))^T \\ C(\rho(t)) & D(\rho(t)) & -\gamma I \end{bmatrix} < 0, \quad \rho(t) \in \mathcal{P} \quad (1.30)$$

is satisfied, then the  $\mathcal{L}_2$  gain of the system described by

$$\dot{x}(t) = A(\rho(t))x(t) + B(\rho(t))w(t) \quad (1.31)$$

$$z(t) = C(\rho(t))x(t) + D(\rho(t))w(t) \quad (1.32)$$

is less than  $\gamma$ , i.e., for zero initial conditions  $x(0) = 0$  it guaranteed that

$$\sup_{\|w\|_2 \neq 0, w \in \mathcal{L}_2} \frac{\|z\|_2}{\|w\|_2} < \gamma < \infty \quad (1.33)$$

Using the convex properties described in (1.3), the inequality (1.30) becomes

$$\sum_{i=1}^{\tau} \mu_i(\rho(t)) \begin{bmatrix} A_i^T P + P A_i & P B_i & C_i^T \\ B_i^T P & -\gamma I & D_i^T \\ C_i & D_i & -\gamma I \end{bmatrix} < 0, \quad \rho(t) \in \mathcal{P} \quad (1.34)$$

if  $\begin{bmatrix} A_i^T P + P A_i & P B_i & C_i^T \\ B_i^T P & -\gamma I & D_i^T \\ C_i & D_i & -\gamma I \end{bmatrix} < 0, \forall i \in \{1, 2, \dots, \tau\}$  then inequality (1.34) is negative definite.

### 1.1.5 Unmeasured scheduling variables

In practical situations, the scheduling variables could be inaccessible by the fact that the scheduling variables are functions of the system states [Theilliol and Aberkane, 2011]. On the other hand, if the scheduling variables depend on sensor/actuator signals, these measurements can be corrupted by measurement noises or sensor/actuator faults deviating them from the true parameter values [Hassanabadi et al., 2018].

In the polytopic LPV observer design, a trustful knowledge on the scheduling variables is of paramount importance, because this information is needed to design the observer. In the literature, many researchers have proposed solutions to both problems in the polytopic systems framework. The first solution is to consider the estimation error dynamics and the original system in an uncertain system structure. The uncertainty describes the mismatch between either scheduling variables measurement or estimated scheduling variables with the real values as in [Hassanabadi et al., 2017, Zhang et al., 2016, Srinivasarengan et al., 2017, López-Estrada et al., 2017, Theilliol and Aberkane, 2011, Yoneyama, 2009]. Then, the observer design needs to guarantee a robust convergence against those uncertainties. Other solutions are established

by [Heemels et al., 2010, Millerioux et al., 2004, Maalej et al., 2017] based on input to state stability (ISS) property, designing LPV observers through bounded estimation error convergence, instead of asymptotic convergence. In the same context of a convex linear combination of LTI models, in [Bergsten et al., 2001, Ichalal et al., 2010, Lendek et al., 2009] a perturbation term is added to the original system on the assumption that this term is Lipschitz function. The obtained LMI, in the design, depends on the admissible Lipschitz constant. In Section 2.4 the unmeasured scheduling variables case is addressed.

## 1.2 Fault-tolerant control

Nowadays, the need for acceptable performances of practical engineering systems is required for avoiding economic losses and dangerous situations. With the augmentation of system complexity and integration, the system failures as sensor, actuator, and process faults raise increasingly, which can cause system performance deterioration and instability. In the FTC area, a fault is defined as the deviation of a parameter from the acceptable value, and failure is defined as the inability of a system to carry out its intended operation under specific conditions [Frank, 2004].

In order to avoid the propagation of the fault effects, the fault-tolerant control strategies are viewed as the most effective control area to face these issues since they improve the system safety and reliability [Patton et al., 1989]. An FTC possesses the ability to accommodate component failures automatically. The basic idea of an FTC is tolerating component malfunctions while maintaining desirable performance and stability properties [Blanke et al., 2003].

### 1.2.1 Type of fault-tolerant control systems

There exist two fault-tolerant control categories, which are : passive and active FTC. The passive FTC techniques take into consideration a set of supposed faults modes designing control laws to make the system robust against the presumed faults. On the other hand, the active FTC techniques can reconfigure control actions depending on the faulty situation so that the stability and acceptable performance of the entire system can be maintained. Commonly, the active strategy uses the information provided by a fault diagnosis unit [Jiang and Yu, 2012]. The main goal of these approaches is to design a controller with a suitable structure to ensure stability and satisfactory performance, not only when the system is in the free-fault case, but also in cases when there are malfunctions in actuators, sensors, or other system components.

#### Objectives of active FTC

An active FTC can be divided into four subsystems, a reconfigurable controller, a fault diagnosis (FD) unit which include the *fault isolation* and *fault identification* tasks, a controller reconfiguration mechanism, and a command/reference governor [Zhang and Jiang, 2008].

The main difference between active and passive FTC is the incorporation of both FD unit and reconfigurable controllers within the overall system structure. An active FTC is illustrated in Figure 1.1.

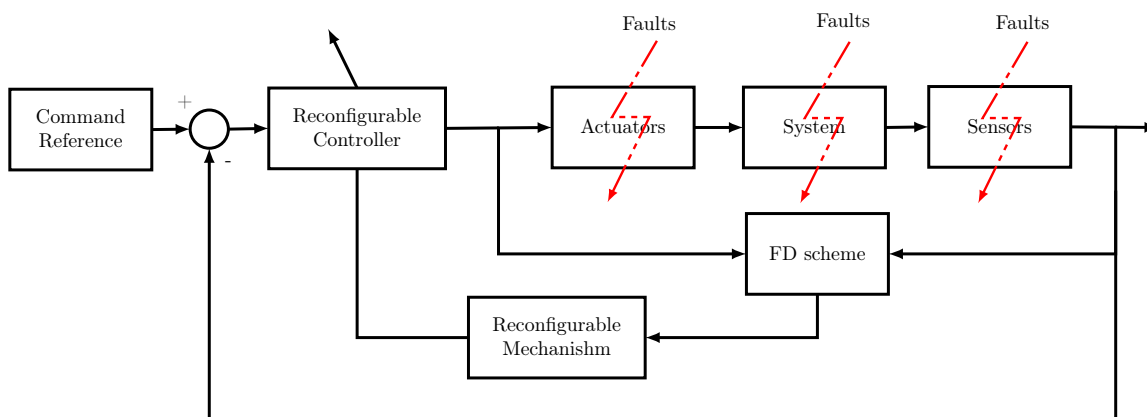

FIGURE 1.1 – Active FTC scheme.

In [Zhang and Jiang, 2008], the design objectives of active FTC are established as :

- A FD unit to provide as precisely as possible, the information about the fault in real-time.
- A control scheme (reconfigurable/restructurable) to compensate the fault-induced changes in the system so that the stability and acceptable close-loop system performance can be maintained.

In the literature, there exist many active FTC methods which can be classified based on mathematical design tools as linear-quadratic, intelligent control, gain scheduling/LPV, model following, adaptive control, eigenstructure assignment,  $H_\infty$  and other robust techniques ; by the design approaches as pre-computed control laws, and online automatic redesign ; by type of systems as linear and nonlinear systems ; or based on field of applications [Amin and Hasan, 2019, Jiang and Yu, 2012, Zhang and Jiang, 2008]. It can be concluded that the controller in an active FTC is less conservative than the controller used in a passive FTC. A comparative study between these two approaches is carried out in [Jiang and Yu, 2012].

### 1.2.2 Fault diagnosis scheme

It can be found a variety of diagnostic methods from different perspectives. In [Venkatasubramanian et al., 2003b, Venkatasubramanian et al., 2003a, Venkatasubramanian, 2003], the diagnostic methods are classified by quantitative model-based methods, qualitative model-based methods, and process history based methods, the study of each classification is illustrated in the three works. The main characteristic of an FD unit is to provide information in a short time to minimize the interval between the fault occurrence and the initiation of the reconfigured controller, maintaining the safe operation of the system. An FD unit has three tasks ; the first one is *fault detection*, which indicates that something is wrong in the system ; the second is *fault isolation*, which determines the location and the type of the fault, and *fault identification* which determines the magnitude of the fault.

This research focused on a quantitative model-based approach which, it has demonstrated that the state estimation based schemes are most suitable for fault detection due to the short time delay in the real-time decision-making process in comparison with parameter estimation approach. Nonetheless, the state estimation information may not be detailed since fault induced changes in parameters or even system model need to be determined. For this issue, a parameter estimation based schemes are more applicable or a combination of the state and the parameter estimation based scheme will be suitable.

Most of the engineering applications are nonlinear ; therefore, an active FTC must consider fault scenarios and operation condition changes. Gain scheduling type approaches can deal with these issues since they take into account changes caused by both failures and operating conditions variations [Orjuela et al., 2019, Kharrat et al., 2018, Rotondo, 2018, Montes de Oca et al., 2014]. In the recent literature, it is still an open problem on how to design an active FTC, which can work efficiently in the entire range of general nonlinear systems and how to distinguish the changes induces by faults from that by operating conditions.

## 1.3 Tools for the stability analysis of dynamic systems

**Lemma 1.1.** Consider two matrices  $X$  and  $Y$  with appropriate dimensions, a time varying matrix  $\Delta(t)$  and a positive scalar  $\epsilon$ . The following inequality is verified

$$X^T \Delta^T(t) Y + Y^T \Delta(t) X \leq \epsilon X^T X + \epsilon^{-1} Y^T Y \quad (1.35)$$

for  $\Delta^T(t) \Delta(t) \leq I$ .

**Lemma 1.2.** (Schur complement) Let  $A$ ,  $B$  and  $D$  be matrices of appropriate dimension. Then the following statements are equivalent :

- (i)  $\begin{bmatrix} A & B \\ B^T & D \end{bmatrix} < 0$ .
- (ii)  $D < 0$  and  $A - BD^{-1}B^T < 0$ .
- (iii)  $A < 0$  and  $D - B^T A^{-1} B < 0$ .

**Remark 1.4.** If  $D$  is nonsingular, then  $\begin{bmatrix} A & B \\ B^T & D \end{bmatrix} \leq 0$  is equivalent to  $D < 0$  and  $A - BD^{-1}B^T \leq 0$ .

**Lemma 1.3.** [Skelton et al., 1997] Let matrices  $\mathcal{B} \in \mathbb{C}^{n \times m}$ ,  $\mathcal{C} \in \mathbb{C}^{k \times n}$  and  $\mathcal{D} = \mathcal{D}^T \in \mathbb{C}^{n \times n}$  be given. The following statements are equivalent.

(i) There exists a matrix  $\mathcal{X}$  satisfying

$$\mathcal{B}\mathcal{X}\mathcal{C} + (\mathcal{B}\mathcal{X}\mathcal{C})^T + \mathcal{D} < 0. \quad (1.36)$$

(ii) The following two conditions hold

$$\begin{aligned} \mathcal{B}^\perp \mathcal{D} \mathcal{B}^{\perp T} < 0 \text{ or } \mathcal{B} \mathcal{B}^T > 0, \\ \mathcal{C}^{T\perp} \mathcal{D} \mathcal{C}^{T\perp T} \text{ or } \mathcal{C}^T \mathcal{C} > 0 \end{aligned}$$

Suppose the above statements hold. Let  $r_b$  and  $r_c$  be the ranks of  $\mathcal{B}$  and  $\mathcal{C}$ , respectively, and  $(\mathcal{B}_l, \mathcal{B}_r)$  and  $(\mathcal{C}_l, \mathcal{C}_r)$  be any full rank factors of  $\mathcal{B}$  and  $\mathcal{C}$ , i.e.,  $\mathcal{B} = \mathcal{B}_l \mathcal{B}_r$ ,  $\mathcal{C} = (\mathcal{C}_l, \mathcal{C}_r)$ . Then all matrices  $\mathcal{X}$  in statement (i) are given by

$$\mathcal{X} = \mathcal{B}_r^+ \mathcal{K} \mathcal{C}_l^+ + Z - \mathcal{B}_r^+ \mathcal{B}_r Z \mathcal{C}_l \mathcal{C}_l^+$$

where  $Z$  is an arbitrary matrix and

$$\mathcal{K} = -\mathcal{R}^{-1} \mathcal{B}_l^T \vartheta \mathcal{C}_r^T (\mathcal{C}_r \vartheta \mathcal{C}_r^T)^{-1} + \mathcal{S}^{1/2} \phi (\mathcal{C}_r \vartheta \mathcal{C}_r^T)^{-1/2} \quad (1.37)$$

$$\mathcal{S} = \mathcal{R}^{-1} - \mathcal{R}^{-1} \mathcal{B}_l^T [\vartheta - \vartheta \mathcal{C}_r^T (\mathcal{C}_r^T \vartheta \mathcal{C}_r^T)^{-1} \mathcal{C}_r \vartheta] \mathcal{B}_l \mathcal{R}^{-1} \quad (1.38)$$

where  $\phi$  is an arbitrary matrix such that  $\|\phi\| < 1$  and  $\mathcal{R}$  is an arbitrary positive definite matrix such that

$$\vartheta_i = (\mathcal{B}_r \mathcal{R}^{-1} \mathcal{B}_l^T - \mathcal{D})^{-1} > 0 \quad (1.39)$$

## 1.4 Conclusion

In this introductory chapter, it has presented the necessary tools to encompass the later chapters. Based on the bibliography review, we can find many applications using the LPV systems framework due to the characteristic to embed the component parameters behavior in an interpolation mechanism. It has described the basic properties of LPV systems like stability, observation, and control. Likewise, the state of art of observers for LPV systems is presented addressing the cases of unknown input, adaptive observers, and the problematic of unmeasured scheduling variables, which is common in quasi-LPV systems. On the other hand, it addressed the FTC theory focusing on the model-based approach.



## Chapter 2

# $H_\infty$ generalized dynamic observers for LPV systems

### Contents

---

<b>2.1</b>	<b>Introduction</b>	<b>17</b>
<b>2.2</b>	<b>Generalized dynamic observer design for LPV systems</b>	<b>18</b>
2.2.1	Problem formulation	18
2.2.2	Parameterization of the observer	19
2.2.3	Stability analysis	21
2.2.4	Particular cases	22
2.2.4.1	Proportional observer	22
2.2.4.2	Proportional-Integral observer	22
2.2.5	Application to double pipe heat exchanger	23
<b>2.3</b>	<b>Generalized dynamic observer design for quasi-LPV systems</b>	<b>25</b>
2.3.1	Problem formulation	25
2.3.2	Parameterization of the observer	28
2.3.3	Observer stability	29
2.3.4	Particular cases	29
2.3.4.1	Proportional observer	30
2.3.4.2	Proportional-Integral observer	30
2.3.5	Numerical example	30
<b>2.4</b>	<b>Generalized dynamic observers for quasi-LPV systems with unmeasurable scheduling functions</b>	<b>34</b>
2.4.1	Problem formulation	34
2.4.2	GDO design	36
2.4.3	Particular cases	38
2.4.4	LPV quarter-car suspension model	38
2.4.5	Simulation	40
<b>2.5</b>	<b>Conclusions</b>	<b>40</b>

---

## 2.1 Introduction

This chapter addresses the GDO design for LPV systems for the continuous-time approach. Likewise, it considers LPV systems with scheduling variables depending on exogenous and endogenous signals, knowing the bounds of these, boarding the cases of measurable and unmeasurable scheduling variables. In the same way, it presents particular structures of the GDO, such as PIO and PO, in order to compare their performances in simulation. In Section 2.2, it presents a GDO for LPV systems with measurable scheduling variables where a general parameterization is shown,

which it will be used in later designs. In section 2.3, it introduces the unknown input problematic in LPV systems, the manner of approaching this issue is using rank conditions to decouple the unknown input. At last, in Section 2.4, it considers the problematic of unmeasured scheduling variables, which describes a large class of nonlinear systems; the  $L_2$  gain is used to face this issue. To demonstrate the performance of the GDO in comparison to PIO and PO, it computes a performance index for each design.

## 2.2 Generalized dynamic observer design for LPV systems

### 2.2.1 Problem formulation

Let us consider the following LPV system

$$\dot{x}(t) = A(\rho(t))x(t) + B(\rho(t))u(t) \quad (2.1a)$$

$$y(t) = Cx(t) \quad (2.1b)$$

where  $x(t) \in \mathbb{R}^n$  is the state vector,  $u(t) \in \mathbb{R}^m$  the input vector,  $y(t) \in \mathbb{R}^p$  represents the measured output vector.  $A(\rho(t)) \in \mathbb{R}^{n \times n}$ ,  $B(\rho(t)) \in \mathbb{R}^{n \times m}$  and  $C \in \mathbb{R}^{p \times n}$  are known matrices.  $\rho(t) \in \mathbb{R}^j$  is a varying parameter vector, it is assumed that all parameters  $\rho(t) = \{\rho_1(t), \rho_2(t) \dots, \rho_j(t)\}$  are bounded, measurable and their values remain in a convex polytope of  $\tau$  vertices as in [Rodrigues et al., 2007]. The LPV system (2.1) can be rewritten as the following polytopic representation :

$$\dot{x}(t) = \sum_{i=1}^{\tau} \mu_i(\rho(t))(A_i x(t) + B_i u(t)) \quad (2.2a)$$

$$y(t) = Cx(t) \quad (2.2b)$$

where

$$\sum_{i=1}^{\tau} \mu_i(\rho(t)) = 1, \quad 0 \leq \mu_i(\rho(t)) \leq 1 \quad (2.3)$$

$\forall i \in [1, 2, \dots, \tau]$  where  $\tau = 2^j$ .  $\mu_i(\rho(t)) = \mu(\bar{\rho}_i, \underline{\rho}_i, \rho_i(t), t)$  ( $\bar{\rho}_i$  and  $\underline{\rho}_i$  represent the maximum and minimum value of  $\rho_i(t)$  respectively).

Now, let us consider the following GDO for state estimation for system (2.2).

$$\dot{\zeta}(t) = \sum_{i=1}^{\tau} \mu_i(\rho(t))(N_i \zeta(t) + H_i v(t) + F_i y(t) + J_i u(t)) \quad (2.4a)$$

$$\dot{v}(t) = \sum_{i=1}^{\tau} \mu_i(\rho(t))(S_i \zeta(t) + L_i v(t) + M_i y(t)) \quad (2.4b)$$

$$\hat{x}(t) = P\zeta(t) + Qy(t) \quad (2.4c)$$

where  $\zeta(t) \in \mathbb{R}^{q_0}$  represents the state vector of the observer,  $v(t) \in \mathbb{R}^{q_1}$  is an auxiliary vector and  $\hat{x}(t) \in \mathbb{R}^n$  is the estimate of  $x(t)$ . Matrices  $N_i$ ,  $H_i$ ,  $F_i$ ,  $J_i$ ,  $S_i$ ,  $L_i$ ,  $M_i$ ,  $P$  and  $Q$  are unknown matrices of appropriate dimensions which must be determined such that  $\hat{x}(t)$  converges asymptotically to  $x(t)$ .

The following lemma gives the existence conditions of the observer (2.4).

**Lemma 2.1.** *There exists an observer of the form (2.4) for the system (2.2) if the following two statements hold*

1. *There exists a matrix  $T$  of appropriate dimension such that the following conditions are satisfied*

(a)  $N_i T + F_i C - T A_i = 0$

(b)  $J_i = T B_i$

(c)  $S_i T + M_i C = 0$

(d)  $P T + Q C = I_n$

2. *The system  $\dot{\varphi}(t) = \sum_{i=1}^{\tau} \mu_i(\rho(t)) \begin{bmatrix} N_i & H_i \\ S_i & L_i \end{bmatrix} \varphi(t)$  is asymptotically stable.*

*Proof.* Let  $T \in \mathbb{R}^{q_0 \times n}$  be a parameter matrix and consider the transformed error  $\varepsilon(t) = \zeta(t) - Tx(t)$ , then its derivative is given by :

$$\dot{\varepsilon}(t) = \sum_{i=1}^{\tau} \mu_i(\rho(t)) (N_i \varepsilon(t) + (N_i T + F_i C - T A_i) x(t) + H_i v(t) + (J_i - T B_i) u(t)) \quad (2.5)$$

by using the definition of  $\varepsilon(t)$ , equations (2.4b) and (2.4c) can be written as :

$$\dot{v}(t) = \sum_{i=1}^{\tau} \mu_i(\rho(t)) (S_i \varepsilon(t) + (S_i T + M_i C) x(t) + L_i v(t)) \quad (2.6)$$

$$\hat{x}(t) = P \varepsilon(t) + (P T + Q C) x(t) \quad (2.7)$$

If conditions (a)-(d) of Lemma 2.1 are satisfied, the following observer error dynamics is obtained from (2.5) and (2.6)

$$\underbrace{\begin{bmatrix} \dot{\varepsilon}(t) \\ \dot{v}(t) \end{bmatrix}}_{\varphi(t)} = \sum_{i=1}^{\tau} \mu_i(\rho(t)) \underbrace{\begin{bmatrix} N_i & H_i \\ S_i & L_i \end{bmatrix}}_{\tilde{A}_i} \underbrace{\begin{bmatrix} \varepsilon(t) \\ v(t) \end{bmatrix}}_{\varphi(t)} \quad (2.8)$$

From (2.7), we have

$$\hat{x}(t) - x(t) = e(t) = P \varepsilon(t). \quad (2.9)$$

The system (2.8) can be written as

$$\dot{\varphi}(t) = \tilde{A}(t) \varphi(t) \quad (2.10)$$

where  $\tilde{A}(t) = \sum_{i=1}^{\tau} \mu_i(\rho(t)) \tilde{A}_i$ .

Let  $V(t) = \varphi(t)^T X \varphi(t)$  with  $X = X^T > 0$ , be a Lyapunov candidate function, then we have

$$\dot{V}(t) = \dot{\varphi}(t)^T X \varphi(t) + \varphi(t)^T X \dot{\varphi}(t) = \varphi(t)^T [\tilde{A}(t)^T X + X \tilde{A}(t)] \varphi(t)$$

and  $\dot{V}(t) < 0$  if  $\tilde{A}(t)^T X + X \tilde{A}(t) < 0$  or equivalently

$$\sum_{i=1}^{\tau} \mu_i(\rho(t)) [\tilde{A}_i^T X + X \tilde{A}_i] < 0 \quad (2.11)$$

Eq. (2.11) is satisfied if  $\tilde{A}_i^T X + X \tilde{A}_i < 0$ . In this case if the system (2.8) is asymptotically stable then  $\lim_{t \rightarrow \infty} e(t) = 0$ .  $\square$

## 2.2.2 Parameterization of the observer

In this section, we shall give the parameterization of the algebraic constraint equations (a)-(d) of Lemma 2.1. Let  $E \in \mathbb{R}^{q_0 \times n}$  be any full row rank matrix such that the matrix  $\Sigma = \begin{bmatrix} E \\ C \end{bmatrix}$  is of full column rank and let  $\Omega = \begin{bmatrix} I_n \\ C \end{bmatrix}$ . Conditions (c) and (d) of lemma 2.1 can be written as :

$$\begin{bmatrix} S_i & M_i \\ P & Q \end{bmatrix} \begin{bmatrix} T \\ C \end{bmatrix} = \begin{bmatrix} 0 \\ I_n \end{bmatrix} \quad (2.12)$$

The necessary and sufficient condition for (2.12) to be consistent is that  $\mathcal{R} \left( \begin{bmatrix} 0 \\ I_n \end{bmatrix} \right) \subset \mathcal{R} \left( \begin{bmatrix} T \\ C \end{bmatrix} \right)$  or equivalently

$$\text{rank} \begin{bmatrix} T \\ C \end{bmatrix} = \text{rank} \begin{bmatrix} T \\ C \\ 0 \\ I_n \end{bmatrix} = n \quad (2.13)$$

On the other hand, since  $\text{rank} \begin{bmatrix} T \\ C \end{bmatrix} = n$ , there always exist matrices  $T \in \mathbb{R}^{q_0 \times n}$  and  $K \in \mathbb{R}^{q_0 \times p}$  such that :

$$T + KC = E \quad (2.14)$$

which can be written as :

$$\begin{bmatrix} T & K \end{bmatrix} \Omega = E \quad (2.15)$$

and since  $\text{rank}(\Omega) = \text{rank} \begin{bmatrix} \Omega \\ E \end{bmatrix}$ . The general solution to equation (2.15) is given by :

$$\begin{bmatrix} T & K \end{bmatrix} = E\Omega^+ - Y_1(I_{n+p} - \Omega\Omega^+) \quad (2.16)$$

From equation (2.16) we deduce that

$$T = T_1 - Y_1 T_2 \quad (2.17)$$

$$K = K_1 - Y_1 K_2 \quad (2.18)$$

where  $T_1 = E\Omega^+ \begin{bmatrix} I_n \\ 0 \end{bmatrix}$ ,  $T_2 = (I_{n+p} - \Omega\Omega^+) \begin{bmatrix} I_n \\ 0 \end{bmatrix}$ ,  $K_1 = E\Omega^+ \begin{bmatrix} 0 \\ I_p \end{bmatrix}$  and  $K_2 = (I_{n+p} - \Omega\Omega^+) \begin{bmatrix} 0 \\ I_p \end{bmatrix}$ .

By inserting the value of matrix  $T$  given by equation (2.14) into condition (a) we obtain

$$N_i E + \tilde{K}_i C = T A_i \quad (2.19)$$

where  $\tilde{K}_i = F_i - N_i K$  and equation (2.19) can be written as :

$$\begin{bmatrix} N_i & \tilde{K}_i \end{bmatrix} \Sigma = T A_i \quad (2.20)$$

Since matrix  $\Sigma$  is of full column rank, the general solution to (2.20) is given by :

$$\begin{bmatrix} N_i & \tilde{K}_i \end{bmatrix} = T A_i \Sigma^+ - Z_i (I_{n+p} - \Sigma \Sigma^+) \quad (2.21)$$

where  $Z_i$  is an arbitrary matrix. By inserting the value of matrix  $T$  given in (2.17) into equation (2.21) we obtain

$$N_i = N_{1,i} - Y_1 N_{2,i} - Z_i N_3 \quad (2.22)$$

$$\tilde{K}_i = \tilde{K}_{1,i} - Y_1 \tilde{K}_{2,i} - Z_i \tilde{K}_3 \quad (2.23)$$

where  $N_{1,i} = T_1 A_i \Sigma^+ \begin{bmatrix} I_{q_0} \\ 0 \end{bmatrix}$ ,  $N_{2,i} = T_2 A_i \Sigma^+ \begin{bmatrix} I_{q_0} \\ 0 \end{bmatrix}$ ,  $N_3 = (I_{q_0+p} - \Sigma \Sigma^+) \begin{bmatrix} I_{q_0} \\ 0 \end{bmatrix}$ ,  $\tilde{K}_{1,i} = T_1 A_i \Sigma^+ \begin{bmatrix} 0 \\ I_p \end{bmatrix}$ ,

$\tilde{K}_{2,i} = T_2 A_i \Sigma^+ \begin{bmatrix} 0 \\ I_p \end{bmatrix}$ ,  $\tilde{K}_3 = (I_{q_0+p} - \Sigma \Sigma^+) \begin{bmatrix} 0 \\ I_p \end{bmatrix}$ . As matrices  $N_i$ ,  $T$ ,  $K$ ,  $\tilde{K}_i$  have a known structure, we can deduce the matrix  $F_i$  as :

$$\begin{aligned} F_i &= \tilde{K}_i + N_i K \\ &= \tilde{K}_{1,i} + N_{1,i} K - Y_1 (\tilde{K}_{2,i} + N_{2,i} K) - Z_i (\tilde{K}_3 + N_3 K) \\ &= F_{1,i} - Y_1 F_{2,i} - Z_i F_3 \end{aligned} \quad (2.24)$$

where  $F_{1,i} = T_1 A_i \Sigma^+ \begin{bmatrix} K \\ I_p \end{bmatrix}$ ,  $F_{2,i} = T_2 A_i \Sigma^+ \begin{bmatrix} K \\ I_p \end{bmatrix}$ ,  $F_3 = (I_{n+p} - \Sigma \Sigma^+) \begin{bmatrix} K \\ I_p \end{bmatrix}$ .

On the other hand from equation (2.14) we obtain :

$$\begin{bmatrix} T \\ C \end{bmatrix} = \begin{bmatrix} I_{q_0} & -K \\ 0 & I_p \end{bmatrix} \Sigma \quad (2.25)$$

inserting equation (2.25) into the equation (2.12) we get :

$$\begin{bmatrix} S_i & M_i \\ P & Q \end{bmatrix} \begin{bmatrix} I_{q_0} & -K \\ 0 & I_p \end{bmatrix} \Sigma = \begin{bmatrix} 0 \\ I_n \end{bmatrix}. \quad (2.26)$$

Since matrix  $\Sigma$  is of full column rank and

$$\begin{bmatrix} I_{q_0} & -K \\ 0 & I_p \end{bmatrix}^{-1} = \begin{bmatrix} I_{q_0} & K \\ 0 & I_p \end{bmatrix}$$

the general solution to equation (2.26) is given by :

$$\begin{bmatrix} S_i & M_i \\ P & Q \end{bmatrix} = \left( \begin{bmatrix} 0 \\ I_n \end{bmatrix} \Sigma^+ - \begin{bmatrix} U_{1,i} \\ U_2 \end{bmatrix} (I_{q_0+p} - \Sigma \Sigma^+) \right) \begin{bmatrix} I_{q_0} & K \\ 0 & I_p \end{bmatrix} \quad (2.27)$$

where  $U_{1,i}$  and  $U_2$  are matrices of appropriate dimensions with arbitrary elements.

Then, matrices  $S_i$ ,  $M_i$ ,  $P$  and  $Q$  can be determined as :

$$S_i = -U_{1,i} N_3 \quad (2.28)$$

$$M_i = -U_{1,i} F_3 \quad (2.29)$$

$$P = \Sigma^+ \begin{bmatrix} I_{q_0} \\ 0 \end{bmatrix} - U_2 N_3 \quad (2.30)$$

$$Q = \Sigma^+ \begin{bmatrix} K \\ I_p \end{bmatrix} - U_2 F_3 \quad (2.31)$$

The estimation error (2.9) shows that  $e(t) \rightarrow 0$  when  $\varepsilon(t) \rightarrow 0$ , i.e., the error  $e(t)$  is independent of the matrix  $P$ . Then, without loss of generality, we can take  $U_2 = 0$  to obtain  $P = \Sigma^+ \begin{bmatrix} I_{q_0} \\ 0 \end{bmatrix}$  and  $Q = \Sigma^+ \begin{bmatrix} K \\ I_p \end{bmatrix}$ . Now, by using (2.22) and (2.28) the observer error dynamics (2.8)-(2.9) can be rewritten as :

$$\dot{\varphi}(t) = \sum_{i=1}^{\tau} \mu_i(\rho(t)) ((\mathbb{A}_i - \mathbb{Y}_i \mathbb{A}_2) \varphi(t)) \quad (2.32a)$$

$$e(t) = \mathbb{P} \varphi(t) \quad (2.32b)$$

where  $\mathbb{A}_i = \begin{bmatrix} N_{1,i} - Y_1 N_{2,i} & 0 \\ 0 & 0 \end{bmatrix}$ ,  $\mathbb{A}_2 = \begin{bmatrix} N_3 & 0 \\ 0 & -I_{q_1} \end{bmatrix}$ ,  $\mathbb{Y}_i = \begin{bmatrix} Z_i & H_i \\ U_{1,i} & L_i \end{bmatrix}$  and  $\mathbb{P} = [ P \ 0 ]$ .

### 2.2.3 Stability analysis

In this section, a method to design a GDO from (2.4) is presented. This method is obtained from the determination of matrices  $\mathbb{Y}_i$  and  $Y_1$ , such that system (2.32) is stable. The GDO matrices can be obtained by using the following theorem.

**Theorem 2.1.** *There exist parameter matrices  $\mathbb{Y}_i$  and  $Y_1$  such that the system (2.32) is asymptotically stable if there exists a matrix  $X = \begin{bmatrix} X_1 & X_2 \\ X_2^T & X_3 \end{bmatrix} > 0$  with  $X_1 = X_1^T$  such that the following LMI's are satisfied.*

$$N_3^{T\perp} [X_1 N_{1,i} - W_1 N_{2,i} + N_{1,i}^T X_1 - N_{2,i}^T W_1^T] N_3^{T\perp T} < 0 \quad (2.33)$$

where  $Y_1 = X_1^{-1} W_1$ . The matrices  $\mathbb{Y}_i$  are parameterized as

$$\mathbb{Y}_i = X^{-1} (\mathcal{B}_r^+ \mathcal{K}_i \mathcal{C}_l^+ + \mathcal{Z} - \mathcal{B}_r^+ \mathcal{B}_r \mathcal{Z} \mathcal{C}_l \mathcal{C}_l^+) \quad (2.34)$$

where

$$\mathcal{K}_i = -\mathcal{R}^{-1} \mathcal{B}_l^T \vartheta_i \mathcal{C}_r^T (\mathcal{C}_r \vartheta_i \mathcal{C}_r^T)^{-1} + \mathcal{S}_i^{1/2} \phi (\mathcal{C}_r \vartheta_i \mathcal{C}_r^T)^{-1/2} \quad (2.35)$$

$$\mathcal{S}_i = \mathcal{R}^{-1} - \mathcal{R}^{-1} \mathcal{B}_l^T [\vartheta_i - \vartheta_i \mathcal{C}_r^T (\mathcal{C}_r^T \vartheta_i \mathcal{C}_r^T)^{-1} \mathcal{C}_r \vartheta_i] \mathcal{B}_l \mathcal{R}^{-1} \quad (2.36)$$

$$\vartheta_i = (\mathcal{B}_r \mathcal{R}^{-1} \mathcal{B}_l^T - \mathcal{D}_i)^{-1} > 0 \quad (2.37)$$

with  $\mathcal{D}_i = \begin{bmatrix} X_1(N_{1,i} - Y_1 N_{2,i}) + (N_{1,i} - Y_1 N_{2,i})^T X_1 & (*) \\ X_2^T (N_{1,i} - Y_1 N_{2,i}) & 0 \end{bmatrix}$ ,  $\mathcal{B} = -I$ ,  $\mathcal{C} = \begin{bmatrix} N_3 & 0 \\ 0 & -I_{q_1} \end{bmatrix}$ ,  $\phi$  is an arbitrary matrix such that  $\|\phi\|_2 < 1$  and  $\mathcal{R} > 0$ . Matrices  $\mathcal{C}_l$ ,  $\mathcal{C}_r$ ,  $\mathcal{B}_l$  and  $\mathcal{B}_r$  are any full rank matrices such that  $\mathcal{C} = \mathcal{C}_l \mathcal{C}_r$  and  $\mathcal{B} = \mathcal{B}_l \mathcal{B}_r$ .

*Proof.* Consider the following Lyapunov candidate function

$$V(\varphi(t)) = \varphi(t)^T X \varphi(t) > 0 \quad (2.38)$$

with  $X = \begin{bmatrix} X_1 & X_2 \\ X_2^T & X_3 \end{bmatrix} > 0$ . Its derivative along the trajectory of (2.32) is given by

$$\dot{V}(\varphi(t)) = \sum_{i=1}^{\tau} \mu_i(\rho(t)) (\varphi(t)^T ((\mathbb{A}_i - \mathbb{Y}_i \mathbb{A}_2)^T X + X(\mathbb{A}_i - \mathbb{Y}_i \mathbb{A}_2)) \varphi(t)) < 0 \quad (2.39)$$

the inequality  $\dot{V}(\varphi(t)) < 0$  is valid for all  $\varphi(t) \neq 0$  if

$$(\mathbb{A}_i - \mathbb{Y}_i \mathbb{A}_2)^T X + X(\mathbb{A}_i - \mathbb{Y}_i \mathbb{A}_2) < 0 \quad (2.40)$$

which can be written as

$$\mathcal{B} \mathcal{X}_i \mathcal{C} + (\mathcal{B} \mathcal{X}_i \mathcal{C})^T + \mathcal{D}_i < 0 \quad (2.41)$$

where  $\mathcal{B} = -I$  and  $\mathcal{D}_i = \mathbb{A}_i^T X + X \mathbb{A}_i$  and  $\mathcal{X}_i = X \mathbb{Y}_i$ . According to the elimination lemma [Skelton et al., 1997], the inequality (2.41) is equivalent to :

$$\mathcal{C}^{T\perp} \mathcal{D}_i \mathcal{C}^{T\perp T} < 0 \quad (2.42)$$

with  $\mathcal{C}^{T\perp} = \begin{bmatrix} N_3^{T\perp} & 0 \end{bmatrix}$ . By using the definition of matrix  $\mathcal{D}_i$ , inequality (2.42) becomes (2.33). If (2.42) is satisfied, the parameter  $\mathbb{Y}_i$  is obtained as in (2.34).  $\square$

## 2.2.4 Particular cases

In this section, two particular cases of the obtained results are presented.

### 2.2.4.1 Proportional observer

The PO corresponds to the following values of the parameter matrices of the GDO (2.4) :  $H_i = 0$ ,  $S_i = 0$ ,  $M_i = 0$  and  $L_i = 0$ , to obtain the following observer :

$$\dot{\zeta}(t) = \sum_{i=1}^{\tau} \mu_i(\rho(t)) (N_i \zeta(t) + F_i y(t) + J_i u(t)) \quad (2.43)$$

$$\hat{x}(t) = P \zeta(t) + Q y(t) \quad (2.44)$$

and the observer error dynamics (2.32) becomes

$$\dot{\varepsilon}(t) = \sum_{i=1}^{\tau} \mu_i(\rho(t)) (\mathbb{A}_i - \mathbb{Y}_i \mathbb{A}_2) \varepsilon(t) \quad (2.45)$$

where  $\mathbb{A}_i = N_{1,i} - Y_1 N_{2,i}$ ,  $\mathbb{A}_2 = N_3$ , and  $\mathbb{Y}_i = Z_i$ .

Consequently matrices  $\mathcal{D}_i$  and  $\mathcal{C}$  of Theorem 2.1 become  $\mathcal{D}_i = (N_{1,i} - Y_1 N_{2,i})^T X_1 + X_1 (N_{1,i} - Y_1 N_{2,i})$  and  $\mathcal{C} = N_3$ .

### 2.2.4.2 Proportional-Integral observer

The PIO corresponds to the following values of the parameter matrices of the GDO (2.55)-(2.57) :  $L_i = 0$ ,  $S_i = -CP$  and  $M_i = -CQ + I_p$ , to obtain the following observer :

$$\dot{\zeta}(t) = \sum_{i=1}^{\tau} \mu_i(\rho(t)) (N_i \zeta(t) + H_i v(t) + F_i y(t) + J_i u(t)) \quad (2.46)$$

$$\dot{v}(t) = y(t) - C \hat{x}(t) \quad (2.47)$$

$$\hat{x}(t) = P \zeta(t) + Q y(t) \quad (2.48)$$

and the observer error dynamics (2.32) becomes

$$\dot{\varphi}(t) = \sum_{i=1}^{\tau} \mu_i(\rho(t)) (\mathbb{A}_i - \mathbb{A}_{2,1} \mathbb{Y}_i \mathbb{A}_{2,2}) \varphi(t) \quad (2.49)$$

where  $\varphi(t) = \begin{bmatrix} \varepsilon(t) \\ v(t) \end{bmatrix}$ ,  $\mathbb{A}_i = \begin{bmatrix} N_{1,i} - Y_1 N_{2,i} & 0 \\ -CP & 0 \end{bmatrix}$ ,  $\mathbb{A}_{2,1} = \begin{bmatrix} I \\ 0 \end{bmatrix}$ ,  $\mathbb{A}_{2,2} = \begin{bmatrix} N_3 & 0 \\ 0 & -I_{q_1} \end{bmatrix}$ , and  $\mathbb{Y}_i = \begin{bmatrix} Z_i & H_i \end{bmatrix}$ .

Consequently matrices  $\mathcal{Q}_i$ ,  $\mathcal{B}$  and  $\mathcal{C}$  of Theorem 2.1 become  $\mathcal{D}_i = \begin{bmatrix} \Pi_i & \\ X_2^T (N_{1,i} - Y_1 N_{2,1}) - X_3 CP & 0 \end{bmatrix}^{\ast}$  with  $\Pi_i = X_1 (N_{1,i} - Y_1 N_{2,i}) + (N_{1,i} - Y_1 N_{2,i})^T X_1 - X_2 CP - (X_2 CP)^T$ ,  $\mathcal{B} = -X \begin{bmatrix} I \\ 0 \end{bmatrix}$  and  $\mathcal{C} = \begin{bmatrix} N_3 & 0 \\ 0 & -I_{q_1} \end{bmatrix}$ .

### 2.2.5 Application to double pipe heat exchanger

In order to illustrate our results, it considers a double pipe heat exchanger. It is used for energy exchange between at least two fluid streams, a hot and a cold stream. In this case, the hot water flows through the inner pipe, and the cooling water flows through the annular section (outside of the inner pipe) [López-Zapata et al., 2016].

To obtain a simple model of the heat transfer, the following modeling assumptions are used :

- A1. Constant volume and mass in the heat exchanger pipes.
- A2. Physico-chemical properties of the fluid are constant.
- A3. Global heat transfer coefficient ( $U$ ) and area ( $A_r$ ) are constant.
- A4. There is not heat transfer with the environment.
- A5. Inlet temperatures are measured.

The continuous time state equations that represent the energy balance are given in (2.50)

$$\dot{T}_{co}(t) = \frac{v_c}{V_c} (T_{ci}(t) - T_{co}(t)) + \frac{U A_r}{c_{pc} \rho_c V_c} (T_{ho}(t) - T_{co}(t)) \quad (2.50a)$$

$$\dot{T}_{ho}(t) = \frac{v_h}{V_h} (T_{hi}(t) - T_{ho}(t)) + \frac{U A_r}{c_{ph} \rho_h V_h} (T_{co}(t) - T_{ho}(t)) \quad (2.50b)$$

where the lumped parameters are represented in Table 2.1.  $T_{ci}(t)$  and  $T_{hi}(t)$  are the inlet temperatures in the cold and hot streams respectively.  $T_{co}(t)$  and  $T_{ho}(t)$  are the outlet temperatures in the cold and hot streams respectively.

TABLE 2.1 – Heat exchanger parameters

Symbol	Meaning	Value
$V_c$	Volume in external side	$9.679 \times 10^{-5} \text{m}^3$
$V_h$	Volume in the inner side	$2.233 \times 10^{-5} \text{m}^3$
$v_c$	Flow in the cold stream	$6.67 \times 10^{-6} \text{cm}^3/\text{min}$
$c_{pc}$	Specific heat of cold water	$4179.2 \text{J}/\text{kg}^\circ\text{C}$
$c_{ph}$	Specific heat of hot water	$4190.3 \text{J}/\text{kg}^\circ\text{C}$
$\rho_c$	Density of cold water	$988.876 \text{kg}/\text{m}^3$
$\rho_h$	Density of hot water	$975.876 \text{kg}/\text{m}^3$
$A_r$	Heat transfer surface area	$0.0199 \text{m}^2$
$U$	Global heat transfer coefficient	$1055.9 \text{W}/\text{m}^2\text{C}$

Consider the following LPV system described by (2.1) where there exists one scheduling parameter  $\rho(t) \in [0.5 \times 10^{-5}, 3 \times 10^{-5}] \text{cm}^3/\text{min}$  which represents the variation of the flow in the hot stream  $v_h$ . Therefore, the matrices of the LPV system (2.1) are

$$A(\rho(t)) = \begin{bmatrix} -\frac{U A_r}{c_{pc} \rho_c V_c} - \frac{v_c}{V_c} & \frac{U A_r}{c_{pc} \rho_c V_c} \\ \frac{U A_r}{c_{ph} \rho_h V_h} & -\frac{U A_r}{c_{ph} \rho_h V_h} - \frac{\rho(t)}{V_h} \end{bmatrix},$$

$$B(\rho(t)) = \begin{bmatrix} \frac{v_c}{V_c} & 0 \\ 0 & \frac{\rho(t)}{V_h} \end{bmatrix}, \quad \text{and} \quad C = \begin{bmatrix} 1 & 0 \end{bmatrix}.$$

with  $x(t) = [T_{co} \ T_{ho}]^T$ . Such that the scheduling functions  $\mu_i(\rho(t))$  are

$$\mu_1(\rho(t)) = \frac{\bar{\rho} - \rho(t)}{\bar{\rho} - \underline{\rho}} \quad (2.51)$$

$$\mu_2(\rho(t)) = \frac{\rho(t) - \underline{\rho}}{\bar{\rho} - \underline{\rho}} \quad (2.52)$$

The problem is to estimate the states  $[T_{co} \ T_{ho}]^T$  by using the GDO. By solving the LMI's of Theorem 2.1 and choosing the matrix  $E = \begin{bmatrix} 3 & 0 \\ 0 & 3 \end{bmatrix}$ ,  $\mathcal{L} = 1_{4 \times 3} \times 0.18$  and  $\mathcal{R} = I_4 \times 0.01$  we obtain the following results :

$$N_1 = \begin{bmatrix} -87.945 & 0.0263 \\ -4.550 & -1.193 \end{bmatrix}, N_2 = \begin{bmatrix} -87.9458 & 0.0263 \\ -6.264 & -2.3123 \end{bmatrix}, S_1 = \begin{bmatrix} -18.012 & 0 \\ -18.012 & 0 \end{bmatrix}, S_2 = \begin{bmatrix} -18.012 & 0 \\ -18.012 & 0 \end{bmatrix},$$

$$H_1 = \begin{bmatrix} -13.405 & -13.405 \\ -4.472 & -4.472 \end{bmatrix}, H_2 = \begin{bmatrix} -13.405 & -13.405 \\ -6.199 & -6.199 \end{bmatrix}, L_1 = L_2 = \begin{bmatrix} -118 & -18 \\ -18 & -118 \end{bmatrix},$$

$$F_1 = \begin{bmatrix} 132.845 \\ -37.720 \end{bmatrix}, F_2 = \begin{bmatrix} 132.845 \\ -82.3968 \end{bmatrix}, M_1 = M_2 = \begin{bmatrix} 27.019 \\ 27.019 \end{bmatrix}.$$

$$P = \begin{bmatrix} 0.3 & 0 \\ 0 & 0.33 \end{bmatrix} \text{ and } Q = \begin{bmatrix} 0.55 \\ 14.071 \end{bmatrix}.$$

The initial conditions for the system are  $x(0) = [45, 80]^T$  for the GDO are  $\hat{x}(0) = [47, 70]^T$ ,  $v(0) = [0, 0]^T$  and  $u(t) = [29, 81]^T$ . To evaluate the performance of the observers an uncertainty  $\Delta A_1(t)$  is added to the system dynamics matrix  $A(\rho(t))$ , where  $\Delta A_1(t) = \alpha(t)\bar{A}_1$  with  $\bar{A}_1 = \begin{bmatrix} 0.1 & 0 \\ 0.6 & 0.5 \end{bmatrix}$ . The results of the simulation are depicted in Figures 2.1-2.4.

In order to compare the observer performances, the integral of absolute error (IAE) is calculated in the Table 2.2. We

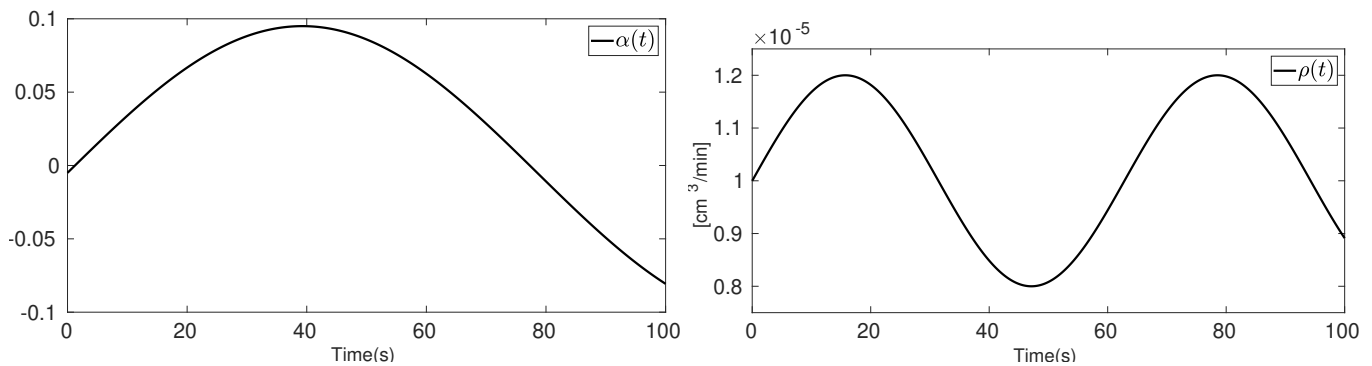

FIGURE 2.1 – Uncertainty  $\alpha(t)$  and variant parameter  $\rho(t)$ .

can conclude that the GDO performance is better than the PO and PIO in the presence of parameter uncertainties, obtaining the minimum values of IAE on the estimation errors.

TABLE 2.2 – Parameter index of each observer

		$\hat{x}_1 - x_1$	$\hat{x}_2 - x_2$
GDO	IAE	0.176	20.81
PIO	IAE	1.14	22.40
PO	IAE	9.53	26.26

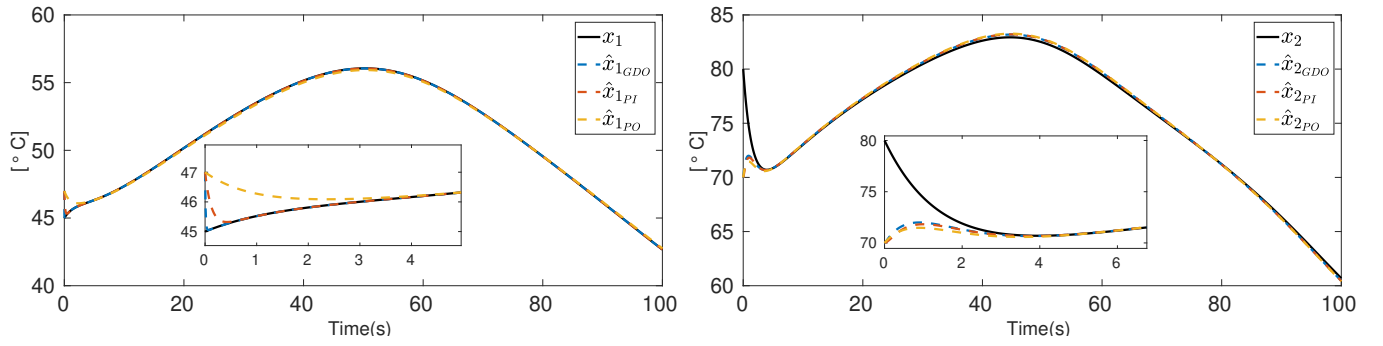
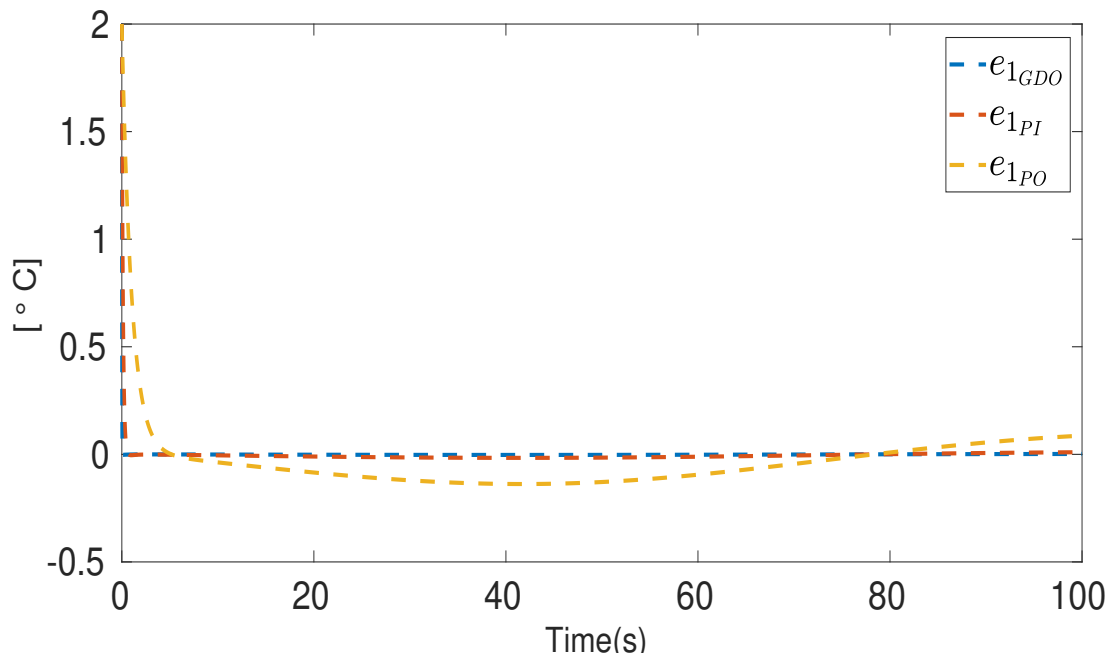

 FIGURE 2.2 – Estimation of states  $x_1(t)$  and  $x_2(t)$ .

 FIGURE 2.3 – Estimation error  $e(t) = \hat{T}_{co}(t) - T_{co}(t)$ .

## 2.3 Generalized dynamic observer design for quasi-LPV systems

### 2.3.1 Problem formulation

Let us consider the following parameter variant system with unknown input

$$\begin{aligned} \dot{x}(t) &= A(\varrho(x(t)))x(t) + B(\varrho(x(t)))u(t) + Gd(t) \\ y(t) &= Cx(t) \end{aligned} \quad (2.53)$$

where  $x(t) \in \mathbb{R}^n$ ,  $u(t) \in \mathbb{R}^m$ ,  $d(t) \in \mathbb{R}^s$  and  $y(t) \in \mathbb{R}^p$  are the state, the input, the unknown input and the measured output vectors, respectively.  $A(\varrho(x(t))) \in \mathbb{R}^{n \times n}$ ,  $B(\varrho(x(t))) \in \mathbb{R}^{n \times m}$ ,  $G \in \mathbb{R}^{n \times s}$ , and  $C \in \mathbb{R}^{p \times n}$  are known matrices.  $\varrho(x(t)) = \{\varrho_1(x(t)), \varrho_2(x(t)), \dots, \varrho_j(x(t))\}$  is the vector that collect the nonlinearities of the systems. Furthermore, it assumes that  $\varrho(x(t))$  is available (i.e. perfectly measurable) for the observer which will be proposed.

The quasi-LPV system case is treated, in which the nonlinearities  $\varrho(x(t))$  varies in a convex polytope of  $\tau$  vertices, where each vertex corresponds to the extreme value of  $\varrho_j(x(t))$  [Rodrigues et al., 2007]. Under this consideration, the

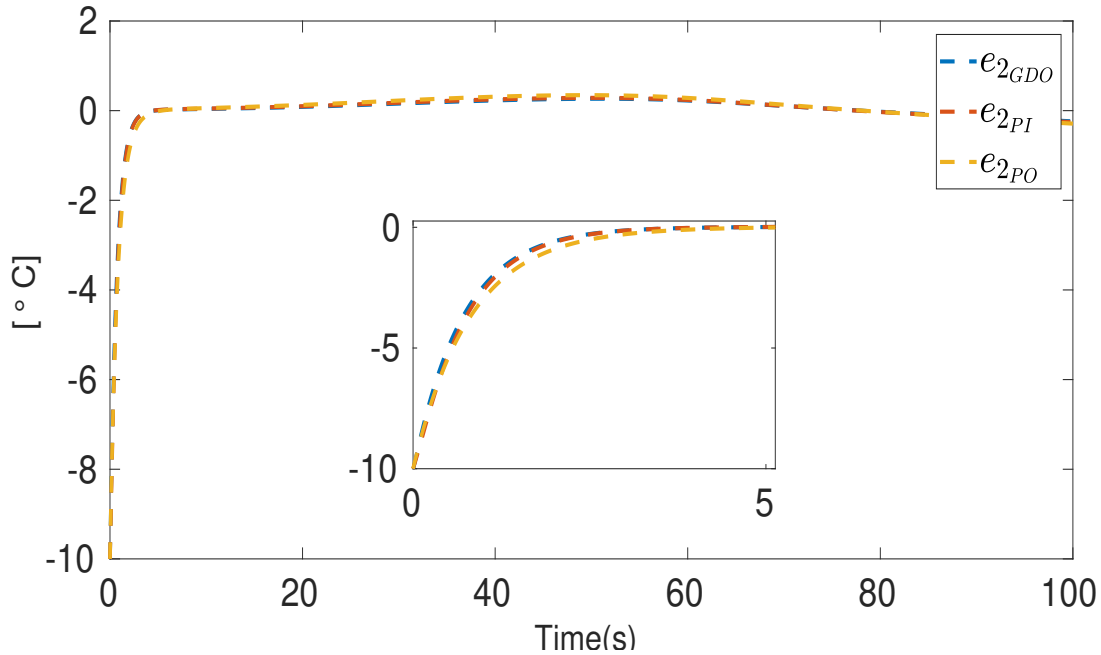
 FIGURE 2.4 – Estimation error  $e(t) = \hat{T}_{ho}(t) - T_{ho}(t)$ .

structure of the quasi-LPV system (2.53) is

$$\begin{aligned} \dot{x}(t) &= \sum_{i=1}^{\tau} \mu_i(\varrho(x(t))) (A_i x(t) + B_i u(t)) + Gd(t) \\ y(t) &= Cx(t) \end{aligned} \quad (2.54)$$

where  $\sum_{i=1}^{\tau} \mu_i(\varrho(x(t))) = 1$ ,  $0 \leq \mu_i(\varrho(x(t))) \leq 1$ ,  $\forall i \in \{1, 2, \dots, \tau\}$  where  $\tau = 2^j$ , and  $\mu_i(\varrho(x(t)))$  are the scheduled functions of each  $i^{\text{th}}$  local model.

**Remark 2.1.** Since  $\varrho(t)$  depends on measurable variables state  $\varrho(x(t))$ , system (2.54) is called quasi-LPV and the scheduled functions  $\mu_i(\varrho(x(t)))$  are assumed to be known.

Now, let us consider the following full-order GDO for system (2.54)

$$\dot{\zeta}(t) = \sum_{i=1}^{\tau} \mu_i(\varrho(x(t))) (N_i \zeta(t) + H_i v(t) + F_i y(t) + J_i u(t)) \quad (2.55)$$

$$\dot{v}(t) = \sum_{i=1}^{\tau} \mu_i(\varrho(x(t))) (S_i \zeta(t) + L_i v(t) + M_i y(t)) \quad (2.56)$$

$$\hat{x}(t) = \zeta(t) + Qy(t) \quad (2.57)$$

where  $\zeta(t) \in \mathbb{R}^n$  represents the state vector of the observer,  $v(t) \in \mathbb{R}^{q_1}$  is an auxiliary vector and  $\hat{x}(t) \in \mathbb{R}^n$  is the estimate of  $x(t)$ .  $N_i$ ,  $H_i$ ,  $F_i$ ,  $J_i$ ,  $S_i$ ,  $L_i$ ,  $M_i$  and  $Q$  are unknown matrices of appropriate dimensions.

The problem of the observer design is to guarantee the asymptotic convergence of the estimation error

$$e(t) = \hat{x}(t) - x(t)$$

to zero in the presence of the unknown input  $d(t)$ . The unknown input is decoupled on the estimation error through decoupling conditions described in the observer design section. The following lemma gives the sufficient conditions for the existence of the observer (2.55)-(2.57).

**Lemma 2.2.** *There exists an observer of the form (2.55-2.57) for the system (2.54) if the system*

$$\dot{\varphi}(t) = \sum_{i=1}^{\tau} \mu_i(\varrho(x(t))) \begin{bmatrix} N_i & H_i \\ S_i & L_i \end{bmatrix} \varphi(t)$$

is asymptotically stable  $\forall i \in \{1, 2, \dots, \tau\}$ , and if there exists a matrix  $T$  of appropriate dimension such that the following conditions are satisfied

- (a)  $N_i T + F_i C - T A_i = 0$
- (b)  $J_i = T B_i$
- (c)  $T G = 0$
- (d)  $S_i T + M_i C = 0$
- (e)  $T + Q C = I_n$ .

*Proof.* Define the estimation error as

$$e(t) = \hat{x}(t) - x(t) = \zeta(t) - (I_n - Q C)x(t) \quad (2.58)$$

Let  $T \in \mathbb{R}^{n \times n}$  be a parameter matrix, such that

$$T = I_n - Q C \quad (2.59)$$

so that, (2.58) can be written as

$$e(t) = \zeta(t) - T x(t) \quad (2.60)$$

then, its derivative is given by

$$\dot{e}(t) = \sum_{i=1}^{\tau} \mu_i(\varrho(x(t))) (N_i e(t) + H_i v(t) + (N_i T + F_i C - T A_i)x(t) + (J_i - T B_i)u(t)) - T G d(t) \quad (2.61)$$

On the other hand from (2.56) and the definition of  $e(t)$  we have

$$\dot{v}(t) = \sum_{i=1}^{\tau} \mu_i(\varrho(x(t))) (S_i e(t) + L_i v(t) + (S_i T + M_i C)x(t)) \quad (2.62)$$

Now, if the conditions (a) – (e) of Lemma 2.2 are satisfied the following observer error dynamics is obtained from (2.61) and (2.62)

$$\underbrace{\begin{bmatrix} \dot{e}(t) \\ \dot{v}(t) \end{bmatrix}}_{\dot{\varphi}(t)} = \sum_{i=1}^{\tau} \mu_i(\varrho(x(t))) \underbrace{\begin{bmatrix} N_i & H_i \\ S_i & L_i \end{bmatrix}}_{\mathbb{A}_i} \underbrace{\begin{bmatrix} e(t) \\ v(t) \end{bmatrix}}_{\varphi(t)} \quad (2.63)$$

which can be written as

$$\dot{\varphi}(t) = \tilde{A}(t) \varphi(t) \quad (2.64)$$

where  $\tilde{A}(t) = \sum_{i=1}^{\tau} \mu_i(\varrho(x(t))) \mathbb{A}_i$ .

Let  $V(t) = \varphi(t)^T X \varphi(t)$  with  $X = X^T > 0$ , be a Lyapunov candidate function, then we have

$$\dot{V}(t) = \dot{\varphi}(t)^T X \varphi(t) + \varphi(t)^T X \dot{\varphi}(t) = \varphi(t)^T [\tilde{A}(t)^T X + X \tilde{A}(t)] \varphi(t)$$

and  $\dot{V}(t) < 0$  if  $\tilde{A}(t)^T X + X \tilde{A}(t) < 0$  or equivalently

$$\sum_{i=1}^{\tau} \mu_i(\varrho(x(t))) [\mathbb{A}_i^T X + X \mathbb{A}_i] < 0 \quad (2.65)$$

Eq. (2.65) is satisfied if  $\mathbb{A}_i^T X + X \mathbb{A}_i < 0$ . In this case if the system (2.63) is asymptotically stable then  $\lim_{t \rightarrow \infty} e(t) = 0$ .

□

### 2.3.2 Parameterization of the observer

In this section, the parameterization of all the observers (4)-(6) will be given. First, define the matrices  $\Sigma = \begin{bmatrix} I_n & G \\ C & 0 \end{bmatrix}$  and  $\Omega = [I_n \ 0]$ , to write conditions (c) and (e) of Lemma 1 as

$$[T \ Q] \Sigma = \Omega \quad (2.66)$$

The following condition must be verified to have a solution of (2.66)

$$\text{rank} \begin{bmatrix} I_n & G \\ C & 0 \end{bmatrix} = \text{rank} \begin{bmatrix} I_n & G \\ C & 0 \\ I_n & 0 \end{bmatrix} = n + \text{rank}(G) \quad (2.67)$$

In order to simplify the computation, condition (2.67) can be also written as

$$\text{rank} \begin{bmatrix} I_n & 0 \\ C & -I_p \end{bmatrix} \begin{bmatrix} I_n & G \\ C & 0 \end{bmatrix} = n + \text{rank}(CG) = n + \text{rank}(G)$$

or

$$\text{rank}(CG) = \text{rank}(G) \quad (2.68)$$

**Assumption 2.1.** *We assume that condition (2.67) (or its equivalent (2.68)) is always satisfied.*

Under Assumption 2.1 the general solution to (2.66) is given by

$$[T \ Q] = \Omega \Sigma^+ - Y(I_{n+p} - \Sigma \Sigma^+) \quad (2.69)$$

which leads to

$$T = T_1 - Y T_2 \quad (2.70)$$

$$Q = Q_1 - Y Q_2 \quad (2.71)$$

where  $Y$  is an arbitrary matrix of appropriate dimension.  $\Sigma^+$  is any generalized inverse of  $\Sigma$ , such that it verifies  $\Sigma \Sigma^+ \Sigma = \Sigma$ . Matrices  $T_1 = \Omega \Sigma^+ \begin{bmatrix} I_n \\ 0 \end{bmatrix}$ ,  $T_2 = (I_{n+p} - \Sigma \Sigma^+) \begin{bmatrix} I_n \\ 0 \end{bmatrix}$ ,  $Q_1 = \Omega \Sigma^+ \begin{bmatrix} 0 \\ I_p \end{bmatrix}$  and  $Q_2 = (I_{n+p} - \Sigma \Sigma^+) \begin{bmatrix} 0 \\ I_p \end{bmatrix}$ .

Now, from conditions (a) and (e) of Lemma 1, and considering the definition of matrix  $T$  from (2.70) we obtain

$$N_i = T_1 A_i - Y T_2 A_i - K_i C \quad (2.72)$$

where  $K_i = F_i - N_i Q$ .

On the other hand from condition (d) of Lemma (2.2) we get

$$S_i = -Z_i C \quad (2.73)$$

where  $Z_i = M_i - S_i Q$ .

By using (2.72) and (2.73) the observer error dynamics (2.63) can be written as

$$\dot{\varphi}(t) = \sum_{i=1}^{\tau} \mu_i(\rho(x(t))) (\mathbb{A}_{1i} - \mathbb{Y}_i \mathbb{A}_2) \varphi(t) \quad (2.74)$$

where  $\mathbb{A}_{1i} = \begin{bmatrix} T_1 A_i - Y T_2 A_i & 0 \\ 0 & 0 \end{bmatrix}$ ,  $\mathbb{A}_2 = \begin{bmatrix} C & 0 \\ 0 & -I_{q_1} \end{bmatrix}$ , and

$\mathbb{Y}_i = \begin{bmatrix} K_i & H_i \\ Z_i & L_i \end{bmatrix}$ . The design of the observer is reduced to the determination of parameter matrices  $Y$  and  $\mathbb{Y}_i$ .

### 2.3.3 Observer stability

In this section a method for design a GDO given by (2.55-2.57) is presented. This method is obtained from the determination of matrix  $\mathbb{Y}_i$ , such that the matrix  $(\mathbb{A}_{1i} - \mathbb{Y}_i \mathbb{A}_2)$  is a stability matrix.

The following theorem gives the LMIs conditions which allow the determination of all GDO matrices.

**Theorem 2.2.** *Under Assumption 2.1, there exists a parameter matrices  $Y$  and  $\mathbb{Y}_i$  such that system (2.74) is asymptotically stable if there exist a symmetric positive matrix  $X_1$  and a matrix  $X_Y$  such that the following LMIs are satisfied*

$$C^{T\perp}[(T_1 A_i)^T X_1 + X_1 (T_1 A_i) - (T_2 A_i)^T X_Y^T - X_Y (T_2 A_i)] C^{T\perp T} < 0 \quad (2.75)$$

$\forall i \in \{1, 2, \dots, \tau\}$ , and  $X_Y = X_1 Y$ .

Let  $X = \begin{bmatrix} X_1 & X_2 \\ X_2^T & X_3 \end{bmatrix} > 0$ , then all the matrix  $\mathbb{Y}_i$  are parameterized as

$$\mathbb{Y}_i = X^{-1}(-\sigma \mathcal{B}^T + \sqrt{\sigma} \mathcal{L} \Gamma_i^{1/2})^T \quad (2.76)$$

where

$$\Gamma_i = \sigma \mathcal{B} \mathcal{B}^T - \mathcal{D}_i \quad (2.77)$$

with  $\mathcal{D}_i = \begin{bmatrix} (T_1 A_i)^T X_1 + X_1 (T_1 A_i) - (T_2 A_i)^T X_Y^T - X_Y (T_2 A_i) & (*) \\ X_2^T (T_1 A_i) - X_2^T Y (T_2 A_i) & 0 \end{bmatrix}$ ,  $\mathcal{B} = \begin{bmatrix} C^T & 0 \\ 0 & I \end{bmatrix}$ .  $\mathcal{L}$  is any matrix such that  $\|\mathcal{L}\|_2 < 1$  and  $\sigma > 0$  is any scalar to obtain  $\Gamma_i > 0$ . In this case the parameter matrix  $Y = X_1^{-1} X_Y$ .

*Proof.* Consider the following Lyapunov function

$$V(\varphi(t)) = \varphi(t)^T X \varphi(t) > 0 \quad (2.78)$$

with  $X = \begin{bmatrix} X_1 & X_2 \\ X_2^T & X_3 \end{bmatrix} > 0$  and  $X_1 = X_1^T$ . Its derivative along the trajectory of (2.74) is given by

$$\dot{V}(\varphi(t)) = \varphi(t)^T [(\mathbb{A}_{1i} - \mathbb{Y}_i \mathbb{A}_2)^T X + X (\mathbb{A}_{1i} - \mathbb{Y}_i \mathbb{A}_2)] \varphi(t) < 0 \quad (2.79)$$

the inequality  $\dot{V}(\varphi(t)) < 0$  is valid for all  $\varphi(t) \neq 0$  if

$$(\mathbb{A}_{1i} - \mathbb{Y}_i \mathbb{A}_2)^T X + X (\mathbb{A}_{1i} - \mathbb{Y}_i \mathbb{A}_2) < 0 \quad (2.80)$$

which can be written as

$$\mathcal{B} \mathcal{X}_i + (\mathcal{B} \mathcal{X}_i)^T + \mathcal{D}_i < 0 \quad (2.81)$$

where  $\mathcal{X}_i = -\mathbb{Y}_i^T X$ ,  $\mathcal{B} = \mathbb{A}_2^T$ , and  $\mathcal{D}_i = \mathbb{A}_{1i}^T X + X \mathbb{A}_{1i}$ .

According to [Skelton et al., 1997], the inequality (2.81) is equivalent to

$$\mathcal{B}^\perp \mathcal{D}_i \mathcal{B}^{\perp T} < 0 \quad (2.82)$$

with  $\mathcal{B}^\perp = [C^{T\perp} \ 0]$ . By using the definition of matrix  $\mathcal{D}_i$  we obtain (2.75).

From [Skelton et al., 1997], if condition (2.82) is satisfied, the parameter matrix  $\mathbb{Y}_i$  is obtained as in (2.76) and (2.77).  $\square$

### 2.3.4 Particular cases

This section shows how the PO and PIO can be directly designed from the results presented in this paper.

### 2.3.4.1 Proportional observer

The PO corresponds to the following values of the parameter matrices of the GDO (2.55)-(2.57) :  $H_i = 0$ ,  $S_i = 0$ ,  $M_i = 0$  and  $L_i = 0$ , to obtain the following observer :

$$\dot{\zeta}(t) = \sum_{i=1}^{\tau} \mu_i(\varrho(t))(N_i \zeta(t) + F_i y(t) + J_i u(t)) \quad (2.83)$$

$$\hat{x}(t) = \zeta(t) + Qy(t) \quad (2.84)$$

and the observer error dynamics (2.74) becomes

$$\dot{e}(t) = \sum_{i=1}^{\tau} \mu_i(\varrho(x(t)))(\mathbb{A}_{1i} - \mathbb{Y}_i \mathbb{A}_2) e(t) \quad (2.85)$$

where  $\mathbb{A}_{1i} = T_1 A_i - Y T_2 A_i$ ,  $\mathbb{A}_2 = C$ , and  $\mathbb{Y}_i = K_i$ .

Consequently matrices  $\mathcal{D}_i$  and  $\mathcal{B}$  of Theorem 2.2 become  $\mathcal{D}_i = (T_1 A_i)^T X + X(T_1 A_i) - (T_2 A_i)^T X_Y^T - X_Y(T_2 A_i)$  and  $\mathcal{B} = C^T$ , where  $X_Y = XY$ .

### 2.3.4.2 Proportional-Integral observer

The PIO corresponds to the following values of the parameter matrices of the GDO (2.55)-(2.57) :  $L_i = 0$ ,  $S_i = -C$  and  $M_i = -CQ + I_p$ , to obtain the following observer :

$$\dot{\zeta}(t) = \sum_{i=1}^{\tau} \mu_i(\varrho(t))(N_i \zeta(t) + H_i v(t) + F_i y(t) + J_i u(t)) \quad (2.86)$$

$$\dot{v}(t) = y(t) - C\hat{x}(t) \quad (2.87)$$

$$\hat{x}(t) = \zeta(t) + Qy(t) \quad (2.88)$$

and the observer error dynamics (2.74) becomes

$$\begin{bmatrix} \dot{e}(t) \\ \dot{v}(t) \end{bmatrix} = \sum_{i=1}^{\tau} \mu_i(\varrho(x(t)))(\mathbb{A}_{1i} - \mathbb{Y}_i \mathbb{A}_2) \begin{bmatrix} e(t) \\ v(t) \end{bmatrix} \quad (2.89)$$

where  $\mathbb{A}_{1i} = \begin{bmatrix} T_1 A_i - Y T_2 A_i & 0 \\ -C & 0 \end{bmatrix}$ ,  $\mathbb{A}_2 = \begin{bmatrix} C & 0 \\ 0 & -I_{q_1} \end{bmatrix}$ , and

$$\mathbb{Y}_i = \begin{bmatrix} I_{q_1} \\ 0 \end{bmatrix} \begin{bmatrix} K_i & H_i \end{bmatrix}.$$

Consequently matrices  $\mathcal{D}_i$  and  $\mathcal{B}$  of Theorem 2.2 become  $\mathcal{D}_i = \begin{bmatrix} X_2^T(T_1 A_i) - X_2^T Y(T_2 A_i) - X_3 C & \Pi_i \\ 0 & 0 \end{bmatrix}^*$  with  $\Pi_i = (T_1 A_i)^T X_1 + X_1(T_1 A_i) - (T_2 A_i)^T X_Y^T - X_Y(T_2 A_i) - C^T X_2^T - X_2 C$ , and  $\mathcal{B} = \begin{bmatrix} C^T & 0 \\ 0 & I_{q_1} \end{bmatrix}$ , where  $X_Y = X_1 Y$ .

### 2.3.5 Numerical example

Consider the quasi-LPV system in the form (2.54), where

$$A(\varrho(x_3(t))) = \begin{bmatrix} -2.7\varrho(x_3(t)) & 2 & 0.3 \\ -0.2 & -\varrho(x_3(t)) & 0 \\ -1 + \varrho(x_3(t)) & 0 & -1 \end{bmatrix},$$

$$B(\varrho(x_3(t))) = \begin{bmatrix} 0 \\ 2\varrho(x_3(t)) \\ 1 \end{bmatrix}, \quad G = \begin{bmatrix} 0 \\ 0.7 \\ 1 \end{bmatrix} \quad \text{and} \quad C = [0 \quad 0 \quad 1]$$

and where the parameter  $\varrho(x_3(t))$  depends explicitly of  $x_3(t)$  and varies from 5 to 17. The scheduling functions  $\mu_i(\varrho(x_3(t)))$  are

$$\mu_1(\varrho(x_3)) = \frac{\bar{\varrho} - \varrho(t)}{\bar{\varrho} - \underline{\varrho}} = \frac{17 - \varrho(t)}{12}$$

$$\mu_2(\varrho(x_3)) = \frac{\varrho(t) - \underline{\varrho}}{\bar{\varrho} - \underline{\varrho}} = \frac{\varrho(t) - 5}{12}$$

By selecting matrix  $\mathcal{L} = \begin{bmatrix} 1 & 1 & 1 & 1 \\ 1 & 1 & 1 & 1 \end{bmatrix} \times 0.1$  and a scalar  $\sigma = 15$ , the LMIs of Theorem 2.2 are solved to obtain the matrices of the GDO

$$\begin{aligned} N_1 &= \begin{bmatrix} -13.5 & 2 & 4.65 \\ -3 & -5 & 2.76 \\ 0 & 0 & -1.33 \end{bmatrix}, \quad F_1 = \begin{bmatrix} 1.7 \\ -2.8 \\ 0 \end{bmatrix}, \\ N_2 &= \begin{bmatrix} -45.9 & 2 & 8.65 \\ -11.4 & -17 & 4.67 \\ 0 & 0 & -1.33 \end{bmatrix}, \quad F_2 = \begin{bmatrix} 1.7 \\ -11.2 \\ 0 \end{bmatrix}, \\ H_1 &= \begin{bmatrix} 4.34 \\ 2.07 \\ 0.14 \end{bmatrix}, \quad J_1 = \begin{bmatrix} 0 \\ 9.3 \\ 0 \end{bmatrix}, \quad M_1 = 0, \\ H_2 &= \begin{bmatrix} 8.34 \\ 3.97 \\ 0.14 \end{bmatrix}, \quad J_2 = \begin{bmatrix} 0 \\ 33.3 \\ 0 \end{bmatrix}, \quad M_2 = 0, \\ S_1 &= [0 \ 0 \ 0.15], \quad S_2 = [0 \ 0 \ 0.15], \\ L_1 &= -1.34, \quad L_2 = -1.34 \quad \text{and} \quad Q = \begin{bmatrix} 0 \\ 0.7 \\ 1 \end{bmatrix}. \end{aligned}$$

From Section 2.3.4.1 we can obtain the PO by considering matrix  $\mathcal{L} = [1 \ 1 \ 1] \times 0.6$  and a scalar  $\sigma = 15$ , so that the PO matrices are :

$$\begin{aligned} N_1 &= \begin{bmatrix} -13.5 & 2 & 8.33 \\ -3 & -5 & 3.93 \\ 0 & 0 & -0.15 \end{bmatrix}, \quad F_1 = \begin{bmatrix} 1.7 \\ -2.8 \\ 0 \end{bmatrix}, \\ N_2 &= \begin{bmatrix} -43.2 & 2 & 15.47 \\ -10.7 & -16 & 6.88 \\ 0 & 0 & -0.23 \end{bmatrix}, \quad F_2 = \begin{bmatrix} 1.7 \\ -10.5 \\ 0 \end{bmatrix}, \\ J_1 &= \begin{bmatrix} 0 \\ 9.3 \\ 0 \end{bmatrix}, \quad J_2 = \begin{bmatrix} 0 \\ 33.3 \\ 0 \end{bmatrix} \quad \text{and} \quad Q = \begin{bmatrix} 0 \\ 0.7 \\ 1 \end{bmatrix}. \end{aligned}$$

From Section 2.3.4.2 we can obtain the PIO by considering matrix  $\mathcal{L} = \begin{bmatrix} 1 & 1 & 1 & 1 \\ 1 & 1 & 1 & 1 \end{bmatrix} \times 0.3$  and a scalar  $\sigma = 15$ , so that the PIO matrices are :

$$\begin{aligned} N_1 &= \begin{bmatrix} -13.5 & 2 & 4.65 \\ -3 & -5 & 2.77 \\ 0 & 0 & -1.29 \end{bmatrix}, \quad H_1 = \begin{bmatrix} 4.34 \\ 2.07 \\ 0.19 \end{bmatrix}, \\ N_2 &= \begin{bmatrix} -45.9 & 2 & 8.66 \\ -11.4 & -17 & 4.67 \\ 0 & 0 & -1.29 \end{bmatrix}, \quad H_2 = \begin{bmatrix} 8.35 \\ 3.98 \\ 0.19 \end{bmatrix}, \\ F_1 &= \begin{bmatrix} 1.7 \\ -2.8 \\ 0 \end{bmatrix}, \quad F_2 = \begin{bmatrix} 1.7 \\ -11.2 \\ 0 \end{bmatrix}, \end{aligned}$$

$$J_1 = \begin{bmatrix} 0 \\ 9.3 \\ 0 \end{bmatrix}, J_2 = \begin{bmatrix} 0 \\ 33.3 \\ 0 \end{bmatrix} \quad \text{and} \quad Q = \begin{bmatrix} 0 \\ 0.7 \\ 1 \end{bmatrix}.$$

To evaluate the performances of these observers, an uncertainty  $\Delta A(t)$  is added in the system matrix  $A_i$ , then we obtain the matrix  $(A_i + \Delta A(t))$ , where

$$\Delta A(t) = \delta(t) \times \begin{bmatrix} 0 & 0 & 0.5 \\ 0 & 2 & 0 \\ 0 & 1 & 0 \end{bmatrix}$$

The initial conditions for the system are  $x(0) = [0.5, 3, 6]^T$ , for the GDO are  $\zeta(0)_{GDO} = [1, -2.2, -0.5]^T$ ,  $v(0)_{GDO} = 1$ , for the  $\zeta(0)_{PIO} = [1, -2.2, -0.5]^T$ ,  $v(0)_{PIO} = 1$  and for the PO are  $\zeta(0)_{PO} = [1, -2.2, -0.5]^T$ . Despite  $x_3$  is measured, the initial conditions between the system and the observer are different to show the performance of each observer. The results of the simulation are depicted in Fig. 2.5-2.9. Fig. 2.5 shows the input  $u(t)$  and the unknown input  $d(t)$ . Fig. 2.6 shows the uncertainty factor and the weighting functions of each model. Figs. 2.7-2.9 show the estimated states and the estimation error obtained by the designed GDO, PO and PIO.

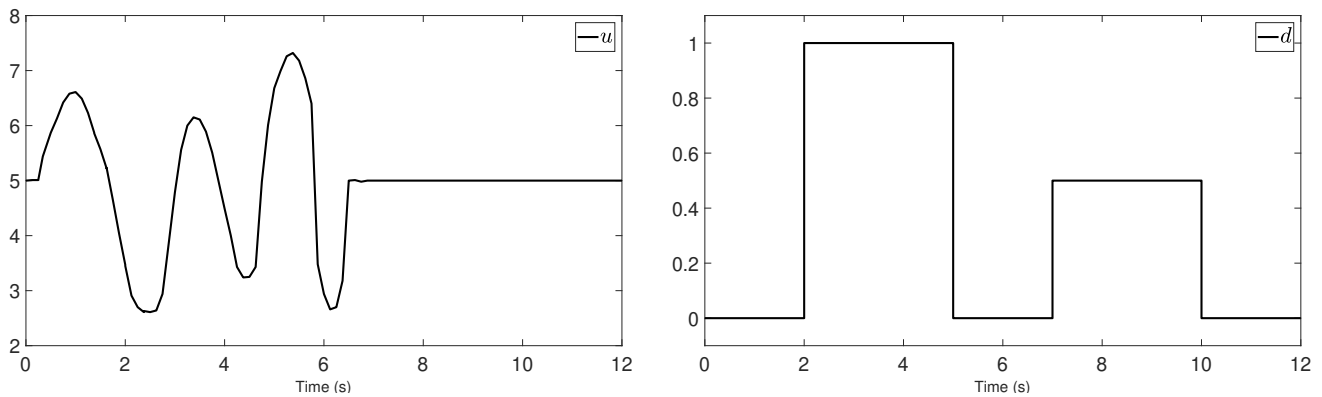

FIGURE 2.5 – Input  $u(t)$  and unknown input  $d(t)$ .

TABLE 2.3 – Performance indexes of each observer.

		Error		
		$\hat{x}_1 - x_1$	$\hat{x}_2 - x_2$	$\hat{x}_3 - x_3$
GDO	IAE	0.244	0.595	0.296
	ITAE	1.247	3.806	0.169
PIO	IAE	1.745	1.13	1.196
	ITAE	7.103	4.545	5.562
PO	IAE	0.717	1.088	2.266
	ITAE	2.297	5.333	8.398

In order to compare the observer performances, the integral of absolute error (IAE) and the integral of time absolute error (ITAE) are calculated in the Table 2.3. We can conclude that the GDO performance is better than the PO and PIO in the presence of parameter uncertainties and unknown inputs, obtaining the minimum values of IAE and ITAE on the estimation errors.



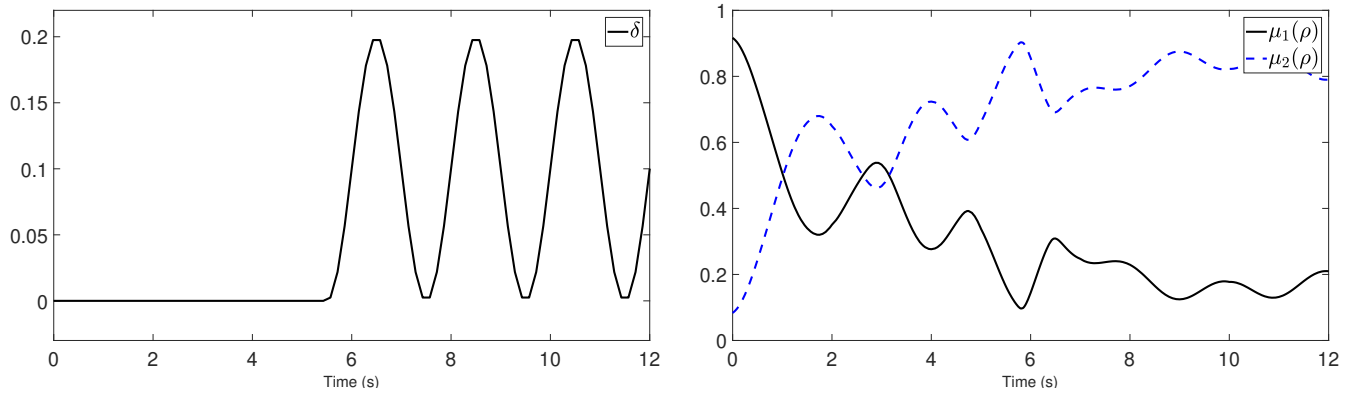

FIGURE 2.6 – Uncertainty factor  $\delta(t)$  and weighting functions  $\mu_1(\varrho)$  and  $\mu_2(\varrho)$ .

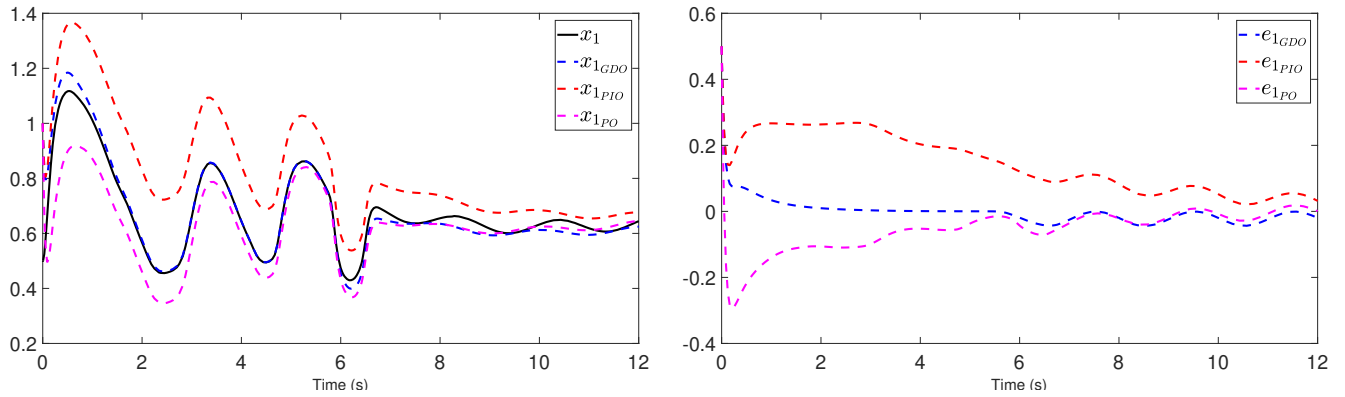

FIGURE 2.7 – Estimation of  $x_1(t)$  and estimation error of  $x_1(t)$ .

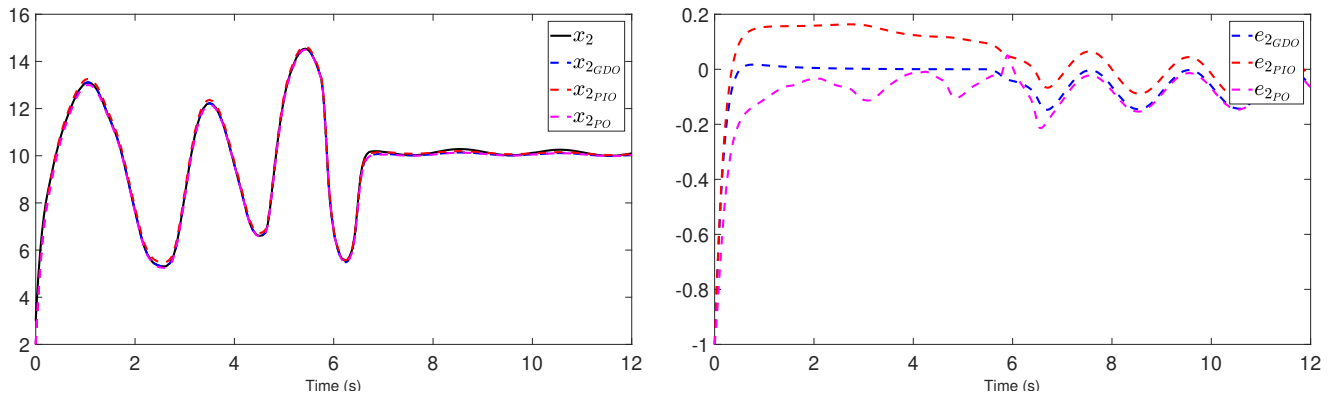
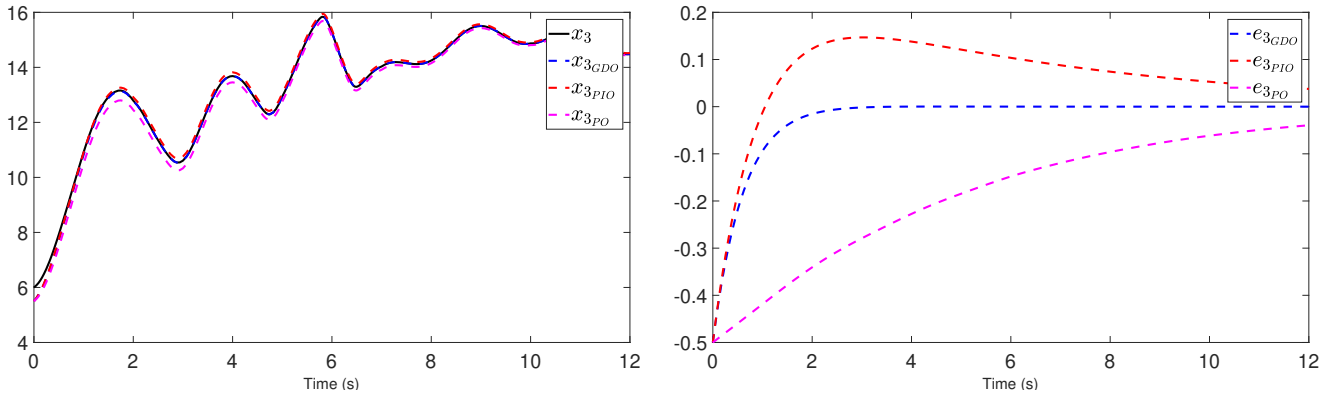

FIGURE 2.8 – Estimation of  $x_2(t)$  and estimation error of  $x_2(t)$ .

 FIGURE 2.9 – Estimation of  $x_3(t)$  and estimation error of  $x_3(t)$ .

## 2.4 Generalized dynamic observers for quasi-LPV systems with unmeasurable scheduling functions

### 2.4.1 Problem formulation

Let us consider the following quasi-LPV system

$$\dot{x}(t) = \sum_{i=1}^{\tau} \mu_i(\varrho(t))(A_i x(t) + B_i u(t)) \quad (2.90a)$$

$$y(t) = Cx(t) \quad (2.90b)$$

where  $x(t) \in \mathbb{R}^n$  is the state vector,  $u(t) \in \mathbb{R}^m$  the input vector and  $y(t) \in \mathbb{R}^p$  is the output vector. Matrices  $A_i \in \mathbb{R}^{n \times n}$ ,  $B_i \in \mathbb{R}^{n \times m}$ ,  $C \in \mathbb{R}^{p \times n}$  are constant matrices and  $\tau$  is the number of local models. The scheduling functions  $\mu_i(\varrho(t))$  depend on the unmeasured state  $x(t)$  and they have the following convex properties :

$$\sum_{i=1}^{\tau} \mu_i(\varrho(t)) = 1 \quad \text{and} \quad \mu_i(\varrho(t)) \geq 0. \quad (2.91)$$

Now, let us consider the following GDO for system (2.90).

$$\dot{\zeta}(t) = \sum_{i=1}^{\tau} \mu_i(\hat{\varrho}(t))(N_i \zeta(t) + H_i v(t) + F_i y(t) + J_i u(t)) \quad (2.92a)$$

$$\dot{v}(t) = \sum_{i=1}^{\tau} \mu_i(\hat{\varrho}(t))(S_i \zeta(t) + L_i v(t) + M_i y(t)) \quad (2.92b)$$

$$\hat{x}(t) = P\zeta(t) + Qy(t) \quad (2.92c)$$

where  $\zeta(t) \in \mathbb{R}^{q_0}$  represents the state vector of the observer,  $v(t) \in \mathbb{R}^{q_1}$  is an auxiliary vector and  $\mu_i(\hat{\varrho}(t))$  depends on  $\hat{x}(t)$  which is the estimate of  $x(t)$ . Matrices  $N_i$ ,  $F_i$ ,  $J_i$ ,  $H_i$ ,  $L_i$ ,  $M_i$ ,  $P$  and  $Q$  are unknown matrices of appropriate dimensions which must be determined such that  $\hat{x}(t)$  asymptotically converges to  $x(t)$ . In order to facilitate the comparison between the system (2.90) and the GDO (2.92), the system can be written with scheduling functions depending on the estimated state vector by adding and subtracting  $\sum_{i=1}^{\tau} \mu_i(\hat{\varrho}(t))(A_i x(t) + B_i u(t))$  such that

$$\dot{x}(t) = \sum_{i=1}^{\tau} \mu_i(\hat{\varrho}(t))(A_i x(t) + B_i u(t)) + \omega(t) \quad (2.93a)$$

$$y(t) = Cx(t) \quad (2.93b)$$

where

$$\omega(t) = \sum_{i=1}^{\tau} (\mu_i(\varrho(t)) - \mu_i(\hat{\varrho}(t)))(A_i x(t) + B_i u(t)) \quad (2.94)$$

Due to the convex properties described in (2.91) and the assumptions that  $x(t)$  and  $u(t)$  are norm bounded, the term  $\omega(t)$  can be considered as a perturbation of finite energy. Its effect on the estimation error must be minimized.

The problem of the observer design is to guarantee the convergence of the state estimation error toward zero when  $\omega(t) = 0$  and minimizing the  $\mathcal{L}_2$  gain for  $\omega(t) \neq 0$ , which can be formulated as  $\|e(t)\|_2 < \gamma \|\omega(t)\|_2$ , where  $e(t)$  is the estimation error  $e(t) = \hat{x}(t) - x(t)$ . The following lemma gives the existence conditions of observer (2.92) under the assumption  $\omega(t) = 0$ .

**Lemma 2.3.** *For  $\omega(t) = 0$ , there exists an observer of the form (2.92) for the system (2.93) if the following two statements hold.*

1. *There exists a matrix  $T$  of appropriate dimension such that the following conditions are satisfied*

- (a)  $N_i T + F_i C - T A_i = 0$
- (b)  $J_i = T B_i$
- (c)  $S_i T + M_i C = 0$
- (d)  $P T + Q C = I_n$

2. *The system  $\dot{\varphi}(t) = \sum_{i=1}^{\tau} \mu_i(\hat{\varrho}(t)) \begin{bmatrix} N_i & H_i \\ S_i & L_i \end{bmatrix} \varphi(t)$  is asymptotically stable.*

*Proof.* Let  $T \in \mathbb{R}^{q_0 \times n}$  be a parameter matrix and consider the transformed error  $\varepsilon(t) = \zeta(t) - T x(t)$ , then its derivative is given by :

$$\dot{\varepsilon}(t) = \sum_{i=1}^{\tau} \mu_i(\hat{\varrho}(t)) (N_i \varepsilon(t) + (N_i T + F_i C - T A_i) x(t) + H_i v(t) + (J_i - T B_i) u(t)) \quad (2.95)$$

by using the definition of  $\varepsilon(t)$ , equations (5.6b) and (5.6c) can be written as :

$$\dot{v}(t) = \sum_{i=1}^{\tau} \mu_i(\hat{\varrho}(t)) (S_i \varepsilon(t) + (S_i T + M_i C) x(t) + L_i v(t)) \quad (2.96)$$

$$\hat{x}(t) = P \varepsilon(t) + (P T + Q C) x(t) \quad (2.97)$$

If the conditions (a)-(d) of Lemma 2.3 are satisfied, then the following observer error dynamics is obtained from (2.95) and (2.96)

$$\dot{\varphi}(t) = \sum_{i=1}^{\tau} \mu_i(\hat{\varrho}(t)) \begin{bmatrix} N_i & H_i \\ S_i & L_i \end{bmatrix} \varphi(t) \quad (2.98)$$

where  $\varphi(t) = [\varepsilon(t) \quad v(t)]^T$ . Also from (2.97) we have

$$\hat{x}(t) - x(t) = e(t) = P \varepsilon(t) \quad (2.99)$$

in this case if system (2.98) is asymptotically stable then

$$\lim_{t \rightarrow \infty} e(t) = 0.$$

□

It can note that the algebraic constraints established in Lemma 2.3 are equal that Lemma 2.1. Therefore, based on the parameterization described in Section 2.2.2, the observer error dynamics (2.98) can be rewritten as :

$$\dot{\varphi}(t) = \sum_{i=1}^{\tau} \mu_i(\hat{\varrho}(t)) (\mathbb{A}_i - \mathbb{Y}_i \mathbb{A}_2) \varphi(t) \quad (2.100a)$$

$$e(t) = \mathbb{P} \varphi(t) \quad (2.100b)$$

where  $\mathbb{A}_i = \begin{bmatrix} N_{1,i} - Y_1 N_{2,i} & 0 \\ 0 & 0 \end{bmatrix}$ ,  $\mathbb{A}_2 = \begin{bmatrix} N_3 & 0 \\ 0 & -I_{q_1} \end{bmatrix}$ ,  $\mathbb{Y}_i = \begin{bmatrix} Z_i & H_i \\ U_{1,i} & L_i \end{bmatrix}$  and  $\mathbb{P} = [ P \quad 0 ]$ .

### 2.4.2 GDO design

This section presents the GDO design by considering the LPV systems (2.93) and (2.92) with  $\omega(t) \neq 0$ . From Lemma 2.3, the dynamic of error  $\varepsilon(t)$  becomes

$$\dot{\varepsilon}(t) = \sum_{i=1}^{\tau} \mu_i(\hat{\varrho}(t))(N_i \varepsilon(t) + H_i v(t) - T \omega(t)) \quad (2.101)$$

the dynamic of variable  $v(t)$  is given by

$$\dot{v}(t) = \sum_{i=1}^{\tau} \mu_i(\hat{\varrho}(t))(S_i \varepsilon(t) + L_i v(t)) \quad (2.102)$$

and the estimation error  $e(t)$  can be written as

$$e(t) = P \varepsilon(t). \quad (2.103)$$

From the previous results we obtain the following system :

$$\dot{\varphi}(t) = \sum_{i=1}^{\tau} \mu_i(\hat{\varrho}(t))((\mathbb{A}_i - \mathbb{Y}_i \mathbb{A}_2) \varphi(t) + \Gamma \omega(t)) \quad (2.104a)$$

$$e(t) = \mathbb{P} \varphi(t) \quad (2.104b)$$

where  $\Gamma = \begin{bmatrix} -T^T & 0 \end{bmatrix}^T$ .

Consequently, the observer design can be obtained from the analysis of system (2.104). It reduces to determine the matrices  $\mathbb{Y}_i$ . The following theorem gives the existence conditions of the GDO by using the results of Lemma 2.3.

**Theorem 2.3.** *Given a positive scalar  $\gamma$ , system (2.104) is asymptotically stable and  $\|e(t)\|_2 < \gamma \|\omega(t)\|_2$  if there exist parameter matrices  $\mathbb{Y}_i$  and symmetric positive definite matrices  $X_1$  and  $X_3$  such that the following LMIs are satisfied.*

$$\begin{bmatrix} \Pi_i & N_3^{T\perp}(-X_1 T_1 + W T_2) & N_3^{T\perp} P^T \\ (*) & -\gamma^2 I_n & 0 \\ (*) & 0 & -I_n \end{bmatrix} < 0 \quad (2.105)$$

where

$$\Pi_i = N_3^{T\perp}(N_{1,i}^T X_1 - N_{2,i}^T W^T + X_1 N_{1,i} - W N_{2,1}) N_3^{T\perp T}, \quad (2.106)$$

$\forall i \in \{1, 2, \dots, \tau\}$ , and matrix  $Y_1 = X_1^{-1} W$ .

Let  $X = \begin{bmatrix} X_1 & X_2 \\ X_2^T & X_3 \end{bmatrix}$ , then the matrices  $\mathbb{Y}_i$  are parameterized as

$$\mathbb{Y}_i = X^{-1}(\mathcal{B}_r^+ \mathcal{K}_i \mathcal{C}_l^+ + \mathcal{Z} - \mathcal{B}_r^+ \mathcal{B}_r \mathcal{Z} \mathcal{C}_l \mathcal{C}_l^+) \quad (2.107)$$

with

$$\mathcal{K}_i = \mathcal{R}^{-1} \mathcal{B}_l^T \vartheta_i \mathcal{C}_r^T (\mathcal{C}_r \vartheta_i \mathcal{C}_r^T)^{-1} + \mathcal{S}_i^{1/2} \phi (\mathcal{C}_r \vartheta_i \mathcal{C}_r^T)^{-1/2} \quad (2.108)$$

$$\mathcal{S}_i = \mathcal{R}^{-1} - \mathcal{R}^{-1} \mathcal{B}_l^T [\vartheta_i - \vartheta_i \mathcal{C}_r^T (\mathcal{C}_r^T \vartheta_i \mathcal{C}_r^T)^{-1} \mathcal{C}_r \vartheta_i] \mathcal{B}_l \mathcal{R}^{-1} \quad (2.109)$$

$$\vartheta_i = (\mathcal{B}_r \mathcal{R}^{-1} \mathcal{B}_l^T - \mathcal{D}_i)^{-1} > 0 \quad (2.110)$$

where

$$\mathcal{D}_i = \begin{bmatrix} \mathbb{A}_i^T X + X \mathbb{A}_i & X \Gamma & \mathbb{P}^T \\ (*) & -\gamma^2 I_n & 0 \\ (*) & 0 & -I_n \end{bmatrix}$$

$\mathcal{B} = \begin{bmatrix} -I \\ 0 \\ 0 \end{bmatrix}$ ,  $\mathcal{C} = \begin{bmatrix} \mathbb{A}_2 & 0 & 0 \end{bmatrix}$ ,  $\phi$  is an arbitrary matrix such that  $\|\phi\|_2 < 1$  and  $\mathcal{R} > 0$ . Matrices  $\mathcal{C}_l$ ,  $\mathcal{C}_r$ ,  $\mathcal{B}_l$  and  $\mathcal{B}_r$  are any full rank matrices such that  $\mathcal{C} = \mathcal{C}_l \mathcal{C}_r$  and  $\mathcal{B} = \mathcal{B}_l \mathcal{B}_r$ .

*Proof.* Consider the following Lyapunov function candidate

$$V(\varphi(t)) = \varphi(t)^T X \varphi(t) > 0 \quad (2.111)$$

with  $X = \begin{bmatrix} X_1 & X_2 \\ X_2^T & X_3 \end{bmatrix} > 0$ . Its derivative along the trajectory of (2.104) is given by

$$\dot{V}(\varphi(t)) = \sum_{i=1}^{\tau} \mu_i(\hat{\rho}(t)) (\varphi^T(t) ((\mathbb{A}_i - \mathbb{Y}_i \mathbb{A}_2)^T X + X(\mathbb{A}_i - \mathbb{Y}_i \mathbb{A}_2)) \varphi(t) + \omega^T(t) \Gamma^T X \varphi(t) + \varphi^T(t) X \Gamma \omega(t)) \quad (2.112)$$

Now let  $\mathcal{S} = \dot{V}(\varphi(t)) + e^T(t)e(t) - \gamma^2 \omega^T(t)\omega(t)$ , then we have

$$\mathcal{S} = \sum_{i=1}^{\tau} \mu_i(\hat{\rho}(t)) \begin{bmatrix} \varphi(t) \\ \omega(t) \end{bmatrix}^T \Theta_i \begin{bmatrix} \varphi(t) \\ \omega(t) \end{bmatrix} \quad (2.113)$$

with

$$\Theta_i = \begin{bmatrix} (\mathbb{A}_i - \mathbb{Y}_i \mathbb{A}_2)^T X + X(\mathbb{A}_i - \mathbb{Y}_i \mathbb{A}_2) + \mathbb{P}^T \mathbb{P} & X \Gamma \\ (*) & -\gamma^2 I_n \end{bmatrix} \quad (2.114)$$

We can deduce that if  $\Theta_i < 0$  then  $\mathcal{S} < 0$ . It implies that

$$\dot{V}(\varphi(t)) < \gamma^2 \omega^T(t)\omega(t) - e^T(t)e(t) \quad (2.115)$$

By integrating the two sides of this inequality we obtain

$$\int_0^{\infty} \dot{V}(\varphi(t)) dt < \int_0^{\infty} \gamma^2 \omega^T(t)\omega(t) dt - \int_0^{\infty} e^T(t)e(t) dt \quad (2.116)$$

or equivalently

$$V(\infty) - V(0) < \gamma^2 \|\omega(t)\|_2^2 - \|e(t)\|_2^2 \quad (2.117)$$

For the zero initial condition, it leads to

$$\frac{\|e(t)\|_2}{\|\omega(t)\|_2} < \gamma \quad (2.118)$$

By applying the Schur complement to  $\Theta_i < 0$ , we obtain the following inequality

$$\begin{bmatrix} (\mathbb{A}_i - \mathbb{Y}_i \mathbb{A}_2)^T X + X(\mathbb{A}_i - \mathbb{Y}_i \mathbb{A}_2) & X \Gamma & \mathbb{P}^T \\ (*) & -\gamma^2 I_n & 0 \\ (*) & 0 & -I_n \end{bmatrix} < 0 \quad (2.119)$$

which can also be written as

$$\mathcal{B} \mathcal{X}_i \mathcal{C} + (\mathcal{B} \mathcal{X}_i \mathcal{C})^T + \mathcal{D}_i < 0 \quad (2.120)$$

where  $\mathcal{B} = \begin{bmatrix} -I \\ 0 \\ 0 \end{bmatrix}$ ,  $\mathcal{C} = [ \mathbb{A}_2 \ 0 \ 0 ]$ ,  $\mathcal{X}_i = X \mathbb{Y}_i$  and  $\mathcal{D}_i$  is defined in Theorem 2.3. According to the solvability conditions of elimination lemma [Skelton et al., 1997], the equation (2.120) is reduced to :

$$\mathcal{C}^{T\perp} \mathcal{D}_i \mathcal{C}^{T\perp T} < 0 \quad (2.121)$$

with  $\mathcal{C}^{T\perp} = \begin{bmatrix} [ N_3^{T\perp} & 0 ] & 0 & 0 \\ 0 & I_n & 0 \\ 0 & 0 & I_n \end{bmatrix}$ . By using the definition of  $\mathcal{D}_i$  and  $W$ , the inequality (2.121) becomes (2.105).

If condition (2.105) is satisfied, then the matrix  $\mathbb{Y}_i$  is obtained as in (2.107)-(2.110).  $\square$

### 2.4.3 Particular cases

The GDO (2.92) is in general form and generalizes the existing results on the observer design for LPV systems. In fact :

- If  $H_i = 0$ ,  $S_i = 0$ ,  $M_i = 0$  and  $L_i = 0$ , then the observer reduces to the PO for LPV systems.

$$\begin{aligned}\dot{\zeta}(t) &= \sum_{i=1}^{\tau} \mu_i(\hat{\rho}(t))(N_i \zeta(t) + F_i y(t) + J_i u(t)) \\ \hat{x}(t) &= P \zeta(t) + Q y(t)\end{aligned}$$

the observer dynamic error (2.104) becomes

$$\dot{\varepsilon}(t) = \sum_{i=1}^{\tau} \mu_i(\hat{\rho}(t))((\mathbb{A}_i - \mathbb{Y}_i \mathbb{A}_2) \varepsilon(t) + \Gamma \omega(t)) \quad (2.122a)$$

$$e(t) = P \varepsilon(t) \quad (2.122b)$$

where  $\mathbb{A}_i = N_{1,i} - Y_1 N_{2,i}$ ,  $\mathbb{A}_2 = N_3$ ,  $\mathbb{Y}_i = Z_i$  and  $\Gamma = -T$ . Consequently, Theorem 2.3 can be applied to (2.122).

- For  $L_i = 0$ ,  $S_i = -CP$  and  $M_i = -CQ + I$ , then the following PIO for LPV systems is obtained

$$\begin{aligned}\dot{\zeta}(t) &= \sum_{i=1}^{\tau} \mu_i(\hat{\rho}(t))(N_i \zeta(t) + H_i v(t) + F_i y(t) + J_i u(t)) \\ \dot{v}(t) &= y(t) - C \hat{x}(t) \\ \hat{x}(t) &= P \zeta(t) + Q y(t)\end{aligned}$$

the observer dynamic error (2.104) becomes

$$\dot{\varphi}(t) = \sum_{i=1}^{\tau} \mu_i(\hat{\rho}(t))((\mathbb{A}_i - \mathbb{Y}_i \mathbb{A}_2) \varphi(t) + \Gamma \omega(t)) \quad (2.123a)$$

$$e(t) = \mathbb{P} \varphi(t) \quad (2.123b)$$

where  $\mathbb{A}_i = \begin{bmatrix} N_{1,i} - Y_1 N_{2,i} & 0 \\ -CP & 0 \end{bmatrix}$  and  $\mathbb{Y}_i = \begin{bmatrix} I \\ 0 \end{bmatrix} [Z_i \quad H_i]$ . Consequently, Theorem 2.3 can be applied to (2.123).

**Remark 2.2.** From the structure of the GDO we can see that the order of the observer is equal to  $q_0 \leq n$ , when  $q_0 = n - p$  we obtain the reduced-order observer one and if  $q_0 = n$  we obtain the full order one.

### 2.4.4 LPV quarter-car suspension model

In order to illustrate the previous results, let us consider a quarter-car model with a semi-active suspension, as seen in the Figure 2.10 the quarter-car model is represented by a sprung mass  $m_s$  and an unsprung mass  $m_{us}$ , which are connected by a spring with stiffness coefficient  $k_s$  and a semi-active damper. A spring models the tire with stiffness coefficient  $k_t$ . The vertical displacements of the masses  $m_s$  and  $m_{us}$  are described by  $z_s$  and  $z_{us}$ , respectively, and  $z_r$  is the road profile. It is assumed that the tire contact is ensured.

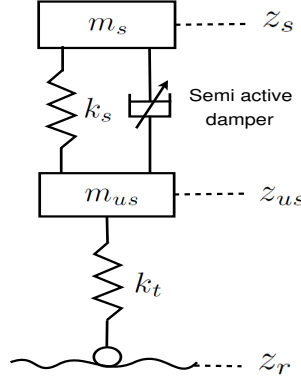

FIGURE 2.10 – Model of quarter car with a semi-active damper.

The dynamical equations of a quarter-car model are given by

$$m_s \ddot{z}_s = -F_{k_s} - F_{mr} \quad (2.124a)$$

$$m_{us} \ddot{z}_{us} = F_{k_s} + F_{mr} - k_t(z_{us} - z_r) \quad (2.124b)$$

where  $F_{k_s} = k_s(z_s - z_{us})$ . In this paper, we consider the realistic behavior of an Magneto-Rheological (MR) damper by using the following nonlinear equation as in [Lozoya-santos and Ramirez-mendoza, 2009]

$$F_{mr} = c_0(\dot{z}_s - \dot{z}_{us}) + k_0(z_s - z_{us}) + f_I \tanh(c_1(\dot{z}_s - \dot{z}_{us}) + k_1(z_s - z_{us})) \quad (2.125)$$

where  $c_0, k_0, k_1$  are constant parameters and the controllable force coefficient is described by  $f_I = y_{mr}I$  which varies according to the electrical current  $I$  in the coil ( $0 \leq f_{Imin} \leq f_I \leq f_{Imax}$ ). The parameter values used in this paper belong to the quarter-car Renault Mégane Coupé equipped with an MR damper presented in [Do et al., 2010a].

Therefore, the dynamical equations (2.124) are rewritten as

$$m_s \ddot{z}_s = -k_p(z_s - z_{us}) - c_0(\dot{z}_s - \dot{z}_{us}) - f_I \tanh(c_1(\dot{z}_s - \dot{z}_{us}) + k_1(z_s - z_{us})) \quad (2.126a)$$

$$m_{us} \ddot{z}_{us} = k_p(z_s - z_{us}) + c_0(\dot{z}_s - \dot{z}_{us}) + f_I \tanh(c_1(\dot{z}_s - \dot{z}_{us}) + k_1(z_s - z_{us})) - k_t(z_{us} - z_r) \quad (2.126b)$$

with  $k_p = k_s + k_0$ .

From (2.126), the quarter-car model can be represented by the following quasi-LPV system.

$$\dot{x}(t) = A_o x(t) + B_{o_1}(\varrho_1(x(t)))f_I(t) + B_{o_2}z_r(t) \quad (2.127a)$$

$$y(t) = Cx(t) \quad (2.127b)$$

where  $x(t) = [z_s \quad \dot{z}_s \quad z_{us} \quad \dot{z}_{us}]^T$ ,

$$A_o = \begin{bmatrix} 0 & 1 & 0 & 0 \\ -\frac{k_p}{m_s} & -\frac{c_0}{m_s} & \frac{k_p}{m_s} & \frac{c_0}{m_s} \\ 0 & 0 & 0 & 1 \\ \frac{k_p}{m_{us}} & \frac{c_0}{m_{us}} & -\frac{k_p - k_t}{m_{us}} & -\frac{c_0}{m_{us}} \end{bmatrix}, \quad B_{o_1}(x(t)) = \begin{bmatrix} 0 \\ -\frac{\varrho_1(x(t))}{m_s} \\ 0 \\ \frac{\varrho_1(x(t))}{m_{us}} \end{bmatrix}, \quad B_{o_2} = \begin{bmatrix} 0 \\ 0 \\ 0 \\ \frac{k_t}{m_{us}} \end{bmatrix}$$

$C = [1 \quad 0 \quad -1 \quad 0]$  and the scheduling variable  $\varrho_1(x(t)) = \tanh(c_1(\dot{z}_s - \dot{z}_{us}) + k_1(z_s - z_{us})) \in [\underline{\varrho}_1, \overline{\varrho}_1] = [-1, 1]$ . The variable  $f_I$  is positive and fulfill with the dissipativity constraint. According to works [Do et al., 2010a, Do et al., 2010b], the positivity problem is solved by defining  $u_1 = f_I - F_0$ , where  $F_0$  is the mean value of  $f_I$  such that  $F_0 = (f_{Imin} + f_{Imax})/2$  where  $f_{Imin} = 0$  [N] and  $f_{Imax} = 800$  [N]. Therefore, based on the previous results, system (2.127) is rewritten as

$$\dot{x}(t) = A(\varrho_2(x(t)))x(t) + B(\varrho_1(x(t)))u(t) \quad (2.128a)$$

$$y(t) = Cx(t) \quad (2.128b)$$

where  $u(t) = [u_1(t) \quad z_r(t)]$  and

$$A(\varrho_2(x(t))) = A_0 + \varrho_2(x(t))F_0 \begin{bmatrix} 0 & 0 & 0 & 0 \\ -\frac{k_0}{m_s} & -\frac{c_0}{m_s} & \frac{k_0}{m_s} & \frac{c_0}{m_s} \\ 0 & 0 & 0 & 0 \\ \frac{k_0}{m_{us}} & \frac{c_0}{m_{us}} & -\frac{k_0}{m_{us}} & -\frac{c_0}{m_{us}} \end{bmatrix}, \quad B(\varrho_1(x(t))) = \begin{bmatrix} 0 & 0 \\ -\frac{\varrho_1(x(t))}{m_s} & 0 \\ 0 & 0 \\ \frac{\varrho_1(x(t))}{m_{us}} & \frac{k_t}{m_{us}} \end{bmatrix}$$

the scheduling variable  $\varrho_2(x(t)) = \tanh(c_1(\dot{z}_s - \dot{z}_{us}) + k_1(z_s - z_{us})) / (c_0(\dot{z}_s - \dot{z}_{us}) + k_0(z_s - z_{us})) \in [\underline{\varrho}_2, \overline{\varrho}_2] = [0, 1]$ . The scheduling functions are defined as follows :

$$\begin{aligned} \mu_1 &= \left( \frac{\overline{\varrho}_1 - \varrho_1(x(t))}{\overline{\varrho}_1 - \underline{\varrho}_1} \right) \left( \frac{\overline{\varrho}_2 - \varrho_2(x(t))}{\overline{\varrho}_2 - \underline{\varrho}_2} \right), & \mu_2 &= \left( \frac{\overline{\varrho}_1 - \varrho_1(x(t))}{\overline{\varrho}_1 - \underline{\varrho}_1} \right) \left( \frac{\varrho_2(x(t)) - \underline{\varrho}_2}{\overline{\varrho}_2 - \underline{\varrho}_2} \right), \\ \mu_3 &= \left( \frac{\varrho_1(x(t)) - \underline{\varrho}_1}{\overline{\varrho}_1 - \underline{\varrho}_1} \right) \left( \frac{\overline{\varrho}_2 - \varrho_2(x(t))}{\overline{\varrho}_2 - \underline{\varrho}_2} \right), & \mu_4 &= \left( \frac{\varrho_1(x(t)) - \underline{\varrho}_1}{\overline{\varrho}_1 - \underline{\varrho}_1} \right) \left( \frac{\varrho_2(x(t)) - \underline{\varrho}_2}{\overline{\varrho}_2 - \underline{\varrho}_2} \right). \end{aligned}$$

These scheduling functions must satisfy the convex properties described in (2.91).

### 2.4.5 Simulation

The presented approach for the GDO design is applied to the quarter-car suspension system. In this case, the measurement output is the suspension deflection ( $z_s - z_{us}$ ), however the suspension deflection velocity ( $\dot{z}_s - \dot{z}_{us}$ ) can be estimated. The scheduling functions are related to the states and outputs, therefore, the scheduling variables are considered unmeasurable and need to be estimated.

The observer gains are obtained by solving the LMIs of Theorem 2.3 using Yalmip Toolbox [Lofberg, 2004] by selecting

matrix  $\phi = 1_{8 \times 5} \times 0.15$ ,  $\mathcal{R} = 0.02 \times I_8$ ,  $\mathcal{Z} = 0$ ,  $E = 80 \times \begin{bmatrix} 1 & 1 & 0 & 0 \\ 1 & 1 & 0 & 0 \\ 0 & 0 & 1 & 0 \\ 0 & 1 & 0 & 1 \end{bmatrix}$ . The attenuation level for each observer

is  $\gamma = 0.059$ . To evaluate the performance of the presented observers, an uncertainty  $\Delta \overline{A}(t)$  is added in the system dynamics  $A_o$ , then the following matrix ( $A_o + \Delta \overline{A}(t)$ ) is obtained, where  $\Delta \overline{A} = \delta(t)\overline{A}$ , with

$$\overline{A} = \begin{bmatrix} 0 & 0 & 0.009 & 0 \\ \frac{5}{m_s} & \frac{-2}{m_s} & \frac{-5}{m_s} & \frac{2}{m_s} \\ 0.002 & 0 & 0 & 0 \\ \frac{7}{m_{us}} & \frac{2}{m_{us}} & \frac{-7}{m_{us}} & \frac{-2}{m_{us}} \end{bmatrix}.$$

The initial condition for the system is  $x(0) = [0, 0, 0, 0]^T$ , for the GDO we take  $\zeta(0)_{GDO} = [0, 0, 0, 2.4]^T$ ,  $v(0)_{GDO} = [0, 0, 0, 0]^T$ , for PIO we take  $\zeta(0)_{PIO} = [0, 0, 0, 2.4]^T$ ,  $v(0)_{PIO} = 0$  and PO we take  $\zeta(0)_{PO} = [-0.002, 0.002, 0, 0.24]^T$ , these values correspond to the same initial condition of the state which is  $\hat{x}(0) = [0, 0, 0, 0.03]^T$ . The results are depicted in Figures 2.11-2.19. Figure 2.11 shows the input  $u_1(t)$  and the road profile  $z_r(t)$ . Figure 2.12 depicts the uncertainty factor  $\delta(t)$  and the scheduling functions. The estimated states obtained by GDO, PIO and PO are shown in figures 2.13-2.14. The estimation error of the suspension velocity deflection is shown in Figure 2.15. In Figure 2.13, we can note that the estimated suspension deflection is almost equal to the measured for each observer. Figures 2.16-2.19 show the estimated states and the estimation errors obtained by the designed GDO, PIO and PO.

In order to compare the observer performances, the integral of absolute error (IAE) and the integral of time absolute error (ITAE) obtained for the estimation error. Table 2.4 shows that the minimum values of IAE and ITAE are obtained for the GDO in the presence of parameter uncertainties. These results show that the GDO presents a good performances in presence of uncertainties compared to the existing PO and PIO.

## 2.5 Conclusions

In this chapter, the GDO designs for continuous-time LPV systems was presented. It addressed the cases when the scheduling parameters are measured and unmeasured. In each case, it presents the problem formulations, such as



TABLE 2.4 – Performance indexes of each observer

		GDO	PIO	PO
$\dot{z}_s - \dot{z}_{u,s}$	IAE	0.192	0.214	0.227
	ITAE	2.328	2.593	2.714
$z_s - z_{u,s}$	IAE	$1.99 \times 10^{-13}$	$2.76 \times 10^{-13}$	$3.55 \times 10^{-13}$
	ITAE	$1.74 \times 10^{-13}$	$1.50 \times 10^{-13}$	$2.03 \times 10^{-12}$
$\hat{x}_1 - x_1$	IAE	0.022	0.031	0.033
	ITAE	0.351	0.547	0.586
$\hat{x}_2 - x_2$	IAE	0.3549	0.441	0.458
	ITAE	4.889	6.623	6.983
$\hat{x}_3 - x_3$	IAE	0.022	0.031	0.033
	ITAE	0.351	0.547	0.586
$\hat{x}_4 - x_4$	IAE	0.2184	0.3	0.313
	ITAE	3.37	5.063	5.389

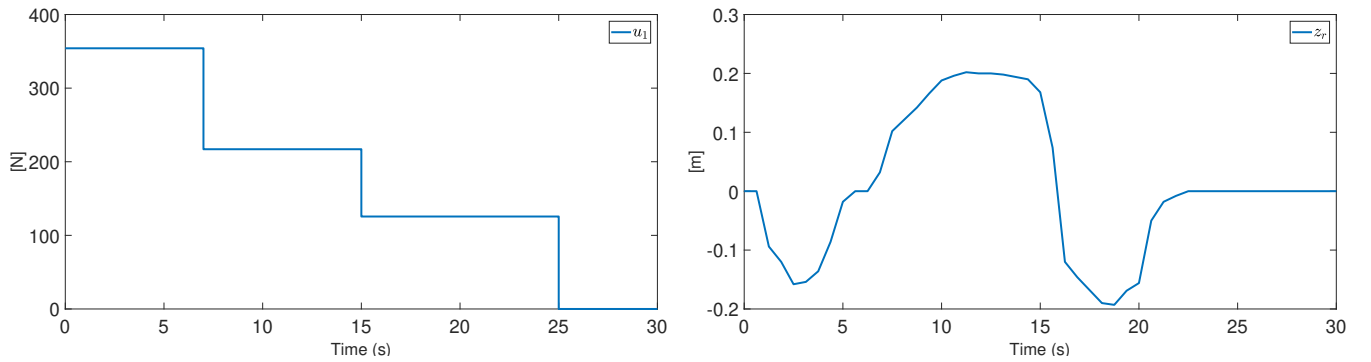
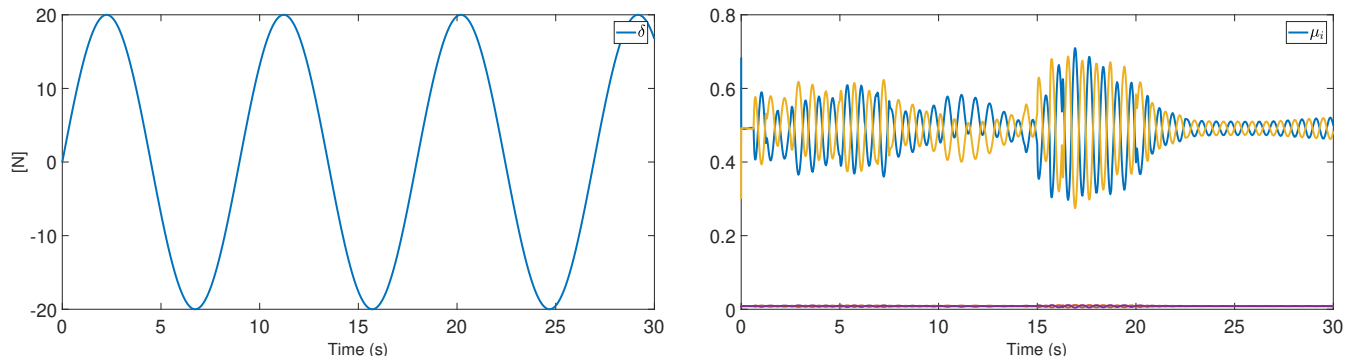
FIGURE 2.11 – Estimation of  $x_2(t)$  and estimation error of  $x_2(t)$ .FIGURE 2.12 – Uncertainty factor  $\delta(t)$  and scheduling functions.

the parameterization method, to satisfy the observer existence. The stability conditions for each design are presented through the solution of LMIs. Academic examples are used to demonstrate the performances of each design. Similarly, it has made a comparison among the particular cases of the GDO to highlight the GDO characteristics.

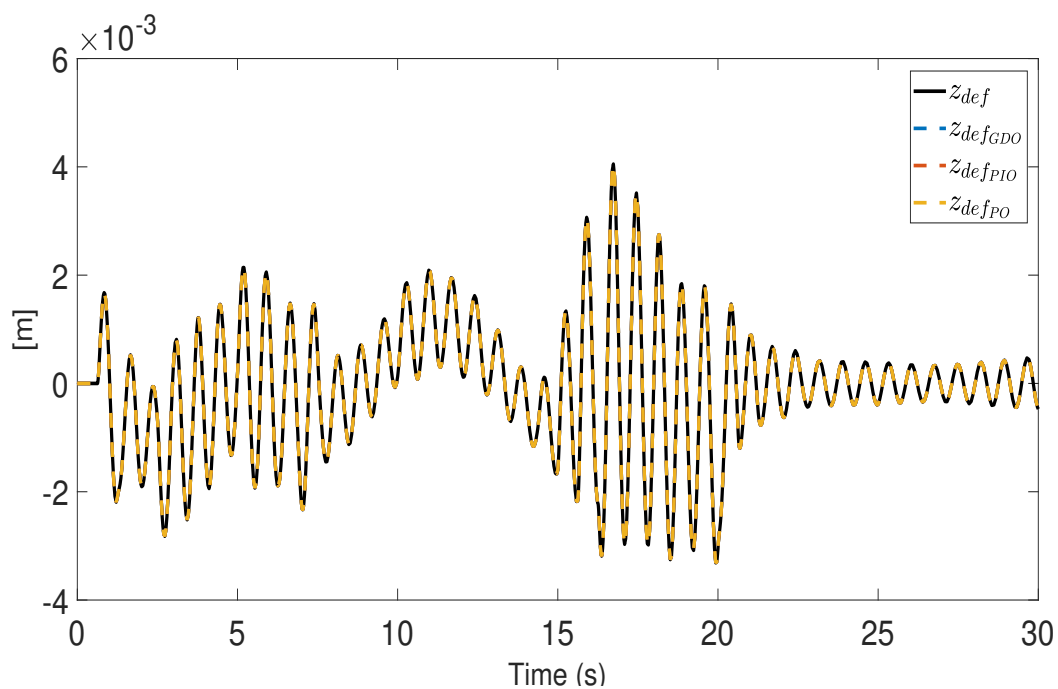

FIGURE 2.13 – Suspension deflection  $z_{def}(t) = z_s(t) - z_{us}(t)$ .

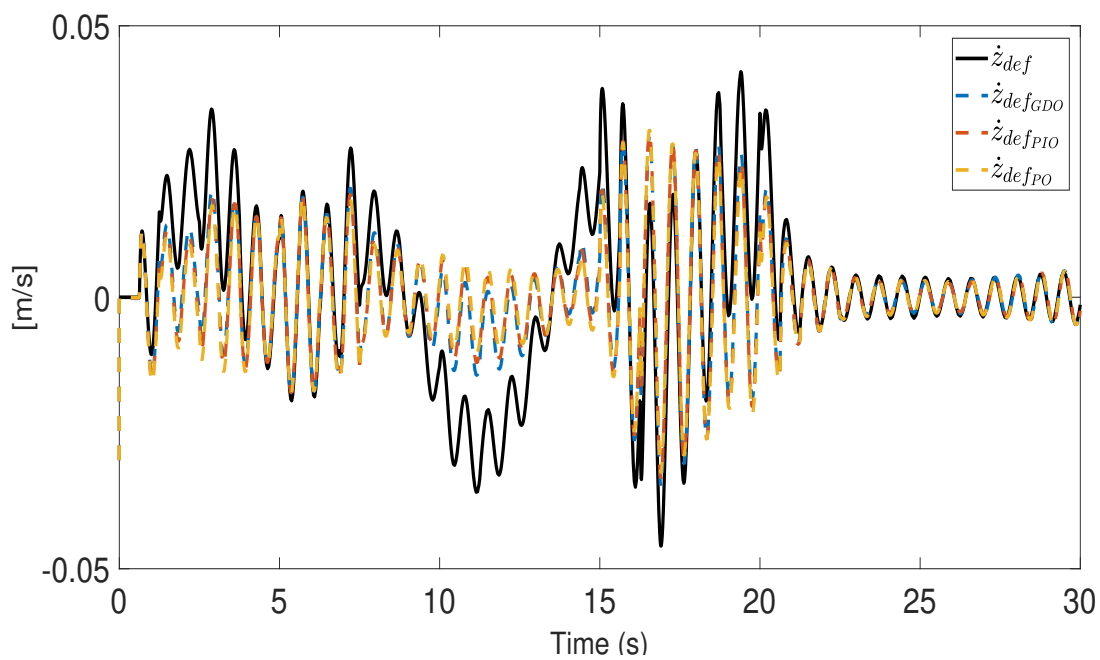
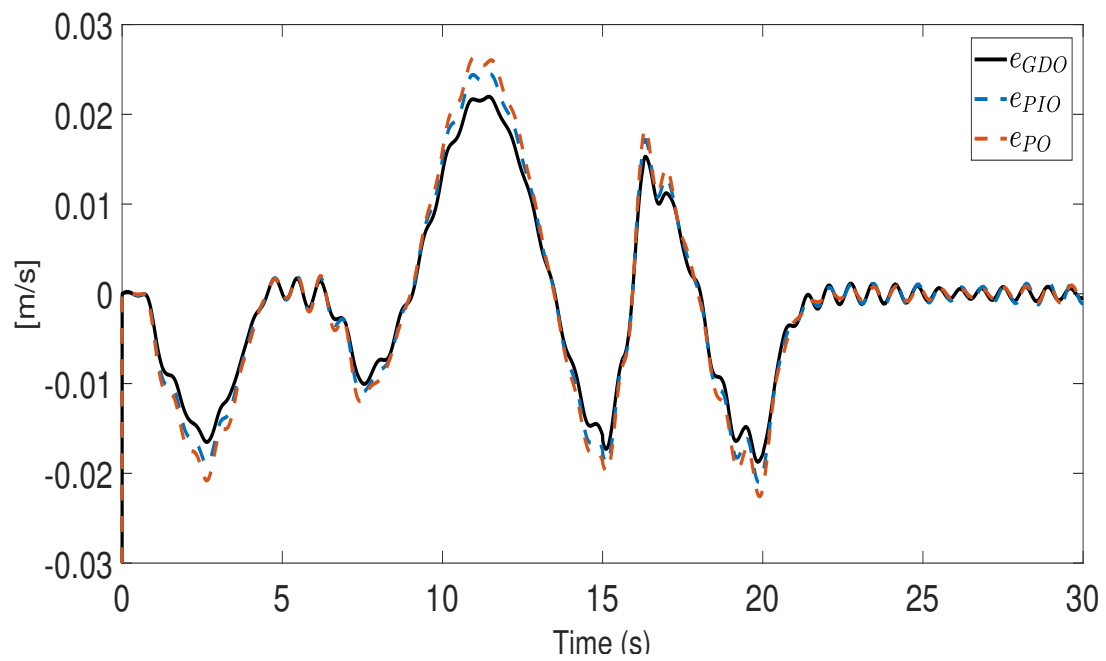

FIGURE 2.14 – Suspension velocity deflection  $\dot{z}_{def}$ .

FIGURE 2.15 – Estimation error  $e(t) = \hat{z}_{def} - \dot{z}_{def}$ .

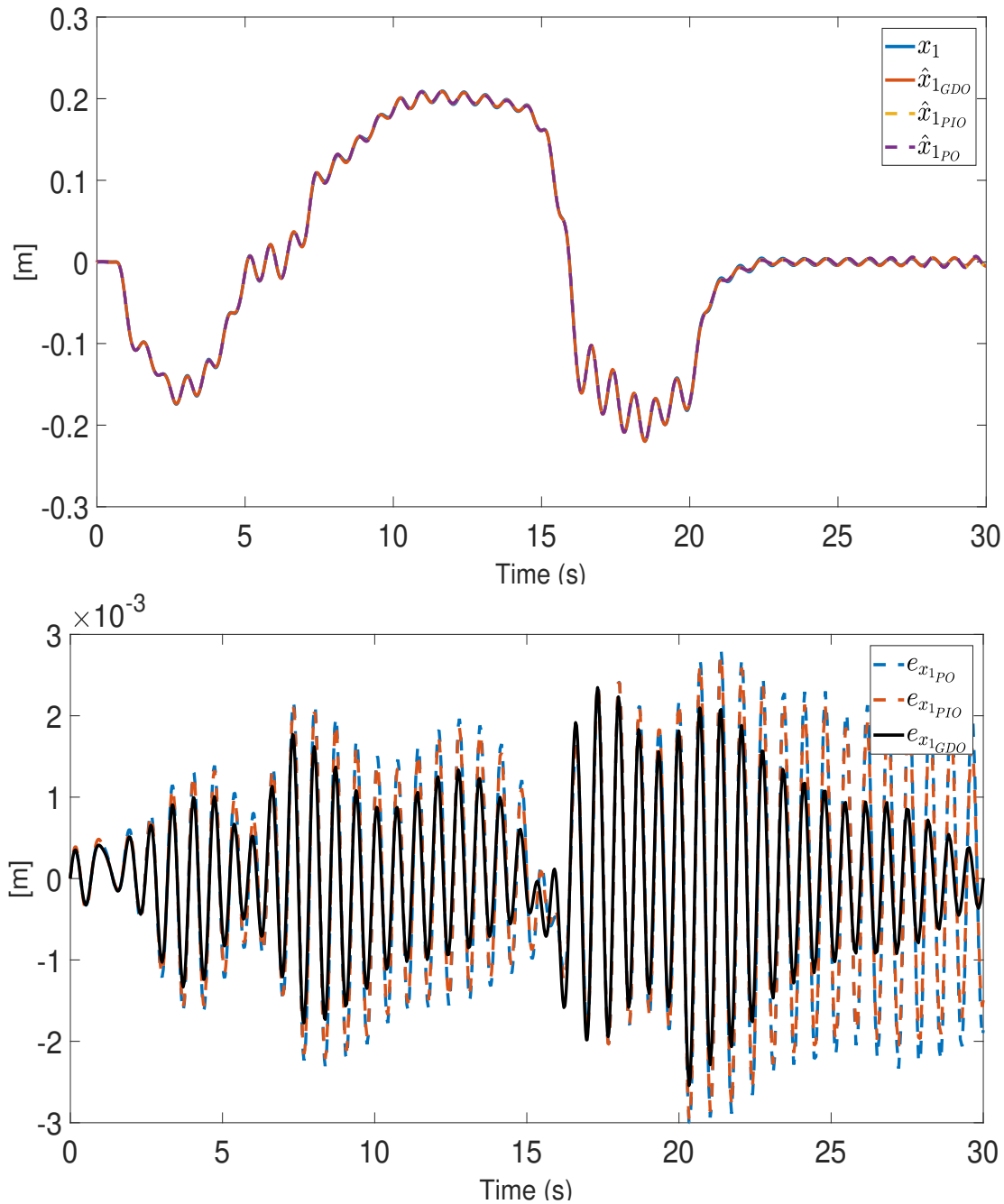
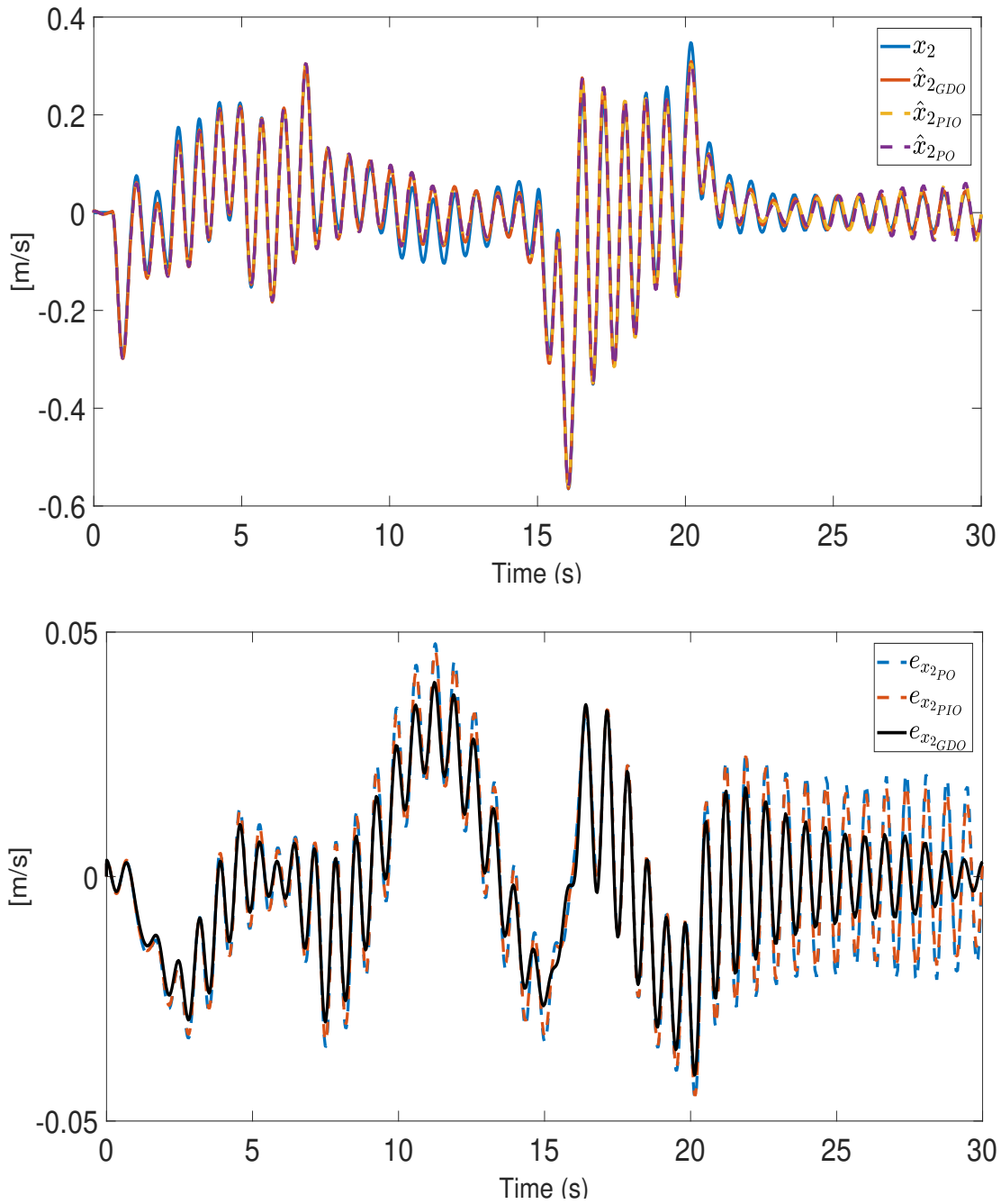

FIGURE 2.16 – Estimation of  $x_1(t)$  and estimation error of  $x_1(t)$ .

FIGURE 2.17 – Estimation of  $x_2(t)$  and estimation error of  $x_2(t)$ .

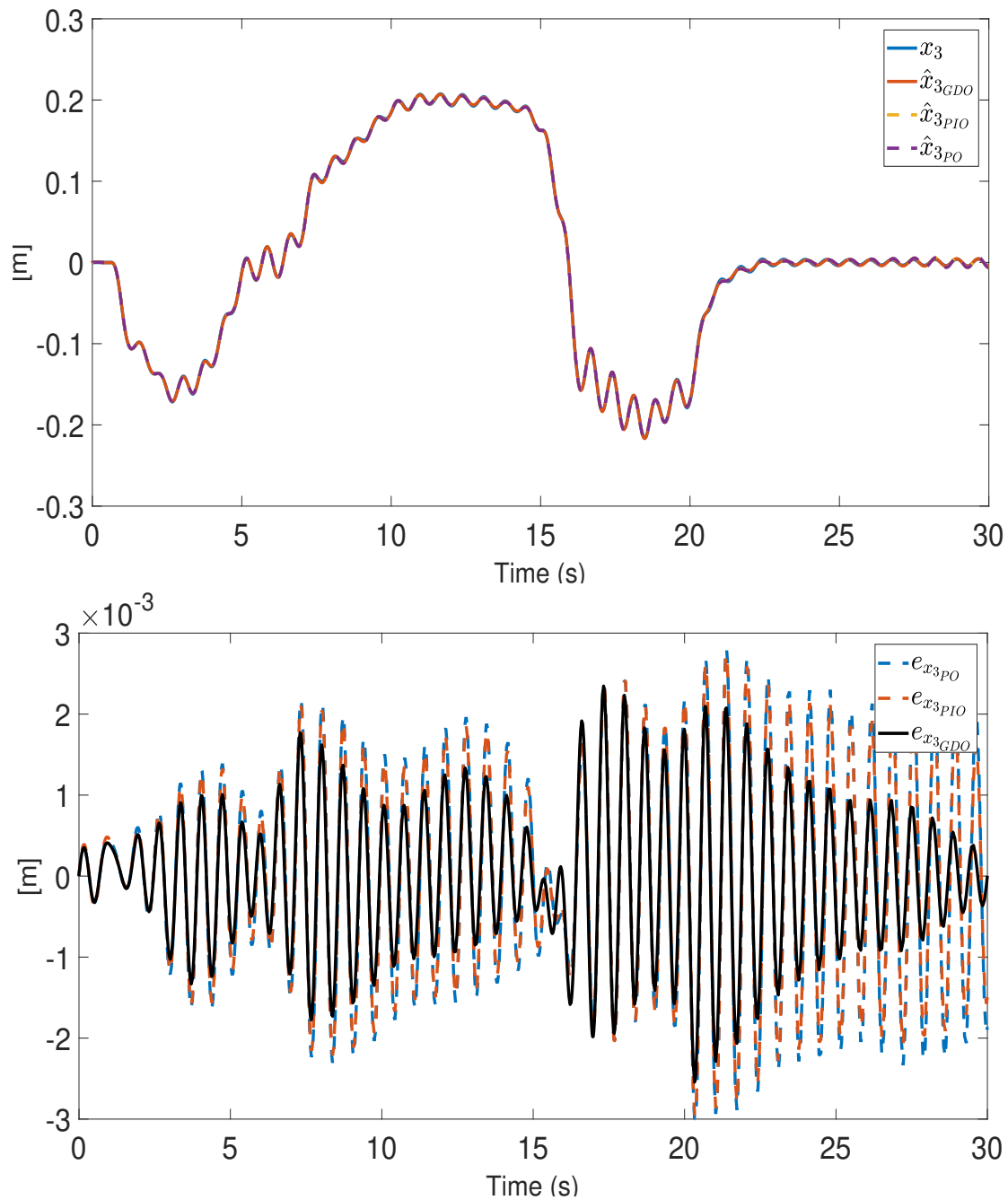
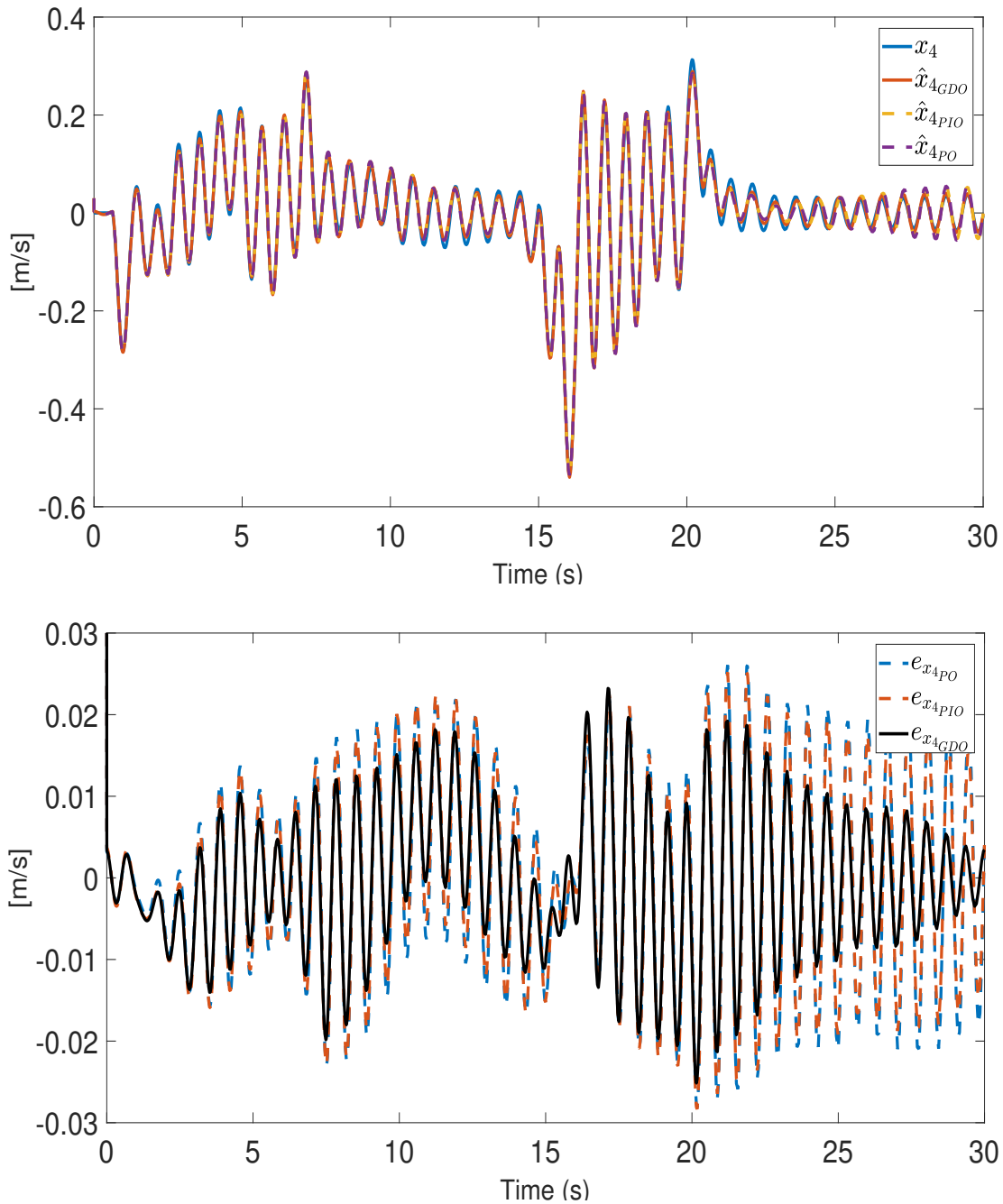

FIGURE 2.18 – Estimation of  $x_3(t)$  and estimation error of  $x_3(t)$ .

FIGURE 2.19 – Estimation of  $x_4(t)$  and estimation error of  $x_4(t)$ .





# Chapter 3

## $H_\infty$ generalized dynamic unknown inputs observer design for discrete LPV systems.

### Contents

---

<b>3.1</b>	<b>Introduction</b>	<b>49</b>
<b>3.2</b>	<b>Problem formulation</b>	<b>49</b>
<b>3.3</b>	<b>Observer parameterization</b>	<b>52</b>
<b>3.4</b>	<b><math>H_\infty</math> generalized dynamic observer design</b>	<b>53</b>
3.4.1	Particular cases	56
<b>3.5</b>	<b>Wind turbine system</b>	<b>57</b>
3.5.1	LPV modeling of benchmark wind turbine	57
3.5.2	Simulation	59
<b>3.6</b>	<b>Conclusions</b>	<b>66</b>

---

### 3.1 Introduction

This chapter presents the GDO design for discrete LPV systems with measurable scheduling variables. It considers unknown inputs and disturbances affecting states and outputs of the system. This structure is general, and the PO and PIO designs can be considered as particular cases. Parameter Dependent Lyapunov (PDL) functions are used to obtain sufficient conditions for the existence and design of the GDO in terms of LMI, as an attempt to reduce the conservatism. In Section 3.2 the GDO design problem is presented. In Section 3.3 and 3.4 present, a parameterization method which is provided for the proposed GDO, then the observer design for the LPV system is developed. Section 3.5 presents the efficiency of the proposed design by using an engineering system as the 4.8 MW wind turbine benchmark system.

### 3.2 Problem formulation

Consider the LPV discrete time system described by

$$x_{k+1} = A(\rho_k)x_k + B(\rho_k)u_k + Dd_k + R w_k \quad (3.1a)$$

$$y_k = Cx_k + R_1 w_k \quad (3.1b)$$

where  $x_k \in \mathbb{R}^n$  is the state vector,  $u_k \in \mathbb{R}^m$  the known input vector,  $d_k \in \mathbb{R}^s$  the unknown input vector,  $w_k \in \mathbb{R}^l$  the disturbance vector of finite energy,  $y_k \in \mathbb{R}^p$  represents the measured output vector and  $\rho_k \in \mathbb{R}^j$  is a varying parameter vector.

**Remark 3.1.** The system (5.1) describes a general form in the presence of unknown inputs. In fact when the unknown inputs affect the output  $y_k$ , system (5.1) can be written as

$$x_{k+1} = A(\rho_k)x_k + B(\rho_k)u_k + Dd_k + Rw_k \quad (3.2a)$$

$$y_k = Cx_k + D_1d_k + R_1w_k \quad (3.2b)$$

Let  $D_1 \in \mathbb{R}^{p \times s}$ , assume that  $\text{rank} D_1 = s_1 \leq s$  and let  $p > s_1$ . Then, there exist two nonsingular matrices  $U$  and  $V$  such that  $UD_1 = \begin{bmatrix} I_{s_1} & 0 \\ 0 & 0 \end{bmatrix} V$ , let also  $Vd_k = \begin{bmatrix} d_k^z \\ d_k^\theta \end{bmatrix}$  and  $DV^{-1} = [\bar{D}_1 \quad \bar{D}_2]$ , then system (3.2) is described as

$$x_{k+1} = \bar{A}_1(\rho_k)x_k + \bar{B}_1(\rho_k)\bar{u}_k + \bar{D}_2d_k^\theta + \bar{R}w_k \quad (3.3a)$$

$$y_k^\theta = C_2x_k + R_{12}w_k \quad (3.3b)$$

where  $\bar{A}_1(\rho_k) = A(\rho_k) - \bar{D}_1C_1$ ,  $\bar{R} = R - \bar{D}_1R_{11}$ ,  $\bar{B}_1(\rho_k) = [B(\rho_k) \quad \bar{D}_1]$ ,  $\bar{u}_k = \begin{bmatrix} u_k \\ y_k^z \end{bmatrix}$ ,  $Uy_k = \begin{bmatrix} y_k^z \\ y_k^\theta \end{bmatrix}$ ,  $UR_1 = \begin{bmatrix} R_{11} \\ R_{12} \end{bmatrix}$  and  $UC = \begin{bmatrix} C_1 \\ C_2 \end{bmatrix}$ . With the previous considerations, the system (3.3) is in form (3.1).

It is assumed that each component  $\rho_k^i$ ,  $i \in \{1, 2, \dots, j\}$  of the time-varying parameter vector  $\rho_k$  is bounded, measurable and their values remain into a hyper-rectangle such that

$$\rho_k \in \mathcal{P} = \{\rho_k^i \mid \underline{\rho}^i \leq \rho_k^i \leq \bar{\rho}^i\}, \quad \forall i \in \{1, 2, \dots, j\}, \forall k \geq 0 \quad (3.4)$$

Based on the affine parameter dependence (3.4), the matrices  $A(\rho_k)$  and  $B(\rho_k)$  of the LPV system (3.1) can be represented in the following form :

$$A(\rho_k) = A_0 + \sum_{i=1}^j \rho_k^i A_i, \quad B(\rho_k) = B_0 + \sum_{i=1}^j \rho_k^i B_i \quad (3.5)$$

From this characterization, system (3.1) can be transformed in a convex combination where the vertices  $\mathcal{S}_i$  of the polytope are the images of the vertices of  $\mathcal{P}$  such that  $\mathcal{S}_i = [A_i, B_i, D, R, C, R_1]$ ,  $\forall i \in \{1, 2, \dots, \tau\}$  where  $\tau = 2^j$ . The polytopic coordinates are denoted by  $\mu(\rho_k)$  and vary into the convex set  $\Lambda$  where

$$\Lambda = \left\{ \mu(\rho_k) \in \mathbb{R}^\tau, \mu(\rho_k) = [\mu_1(\rho_k), \mu_2(\rho_k), \dots, \mu_\tau(\rho_k)]^T, \mu_i(\rho_k) \geq 0, \sum_{i=1}^\tau \mu_i(\rho_k) = 1 \right\} \quad (3.6)$$

The polytopic coordinates can be computed as in [Pellanda et al., 2002]. The polytopic LPV system with the time-varying parameter vector  $\mu_i(\rho_k) \in \Lambda$  is represented by

$$x_{k+1} = \sum_{i=1}^\tau \mu_i(\rho_k)(A_i x_k + B_i u_k + Dd_k + R w_k) \quad (3.7a)$$

$$y_k = Cx_k + R_1 w_k \quad (3.7b)$$

where the matrices  $A_i \in \mathbb{R}^{n \times n}$ ,  $B_i \in \mathbb{R}^{n \times m}$ ,  $D \in \mathbb{R}^{n \times s}$ ,  $R \in \mathbb{R}^{n \times l}$ ,  $C \in \mathbb{R}^{p \times n}$  and  $R_1 \in \mathbb{R}^{p \times l}$  are constant known matrices.

Now, let us consider the GDO for system (3.7) in the following form

$$\zeta_{k+1} = \sum_{i=1}^\tau \mu_i(\rho_k)(N_i \zeta_k + H_i v_k + F_i y_k + J_i u_k) \quad (3.8a)$$

$$v_{k+1} = \sum_{i=1}^\tau \mu_i(\rho_k)(S_i \zeta_k + L_i v_k + M_i y_k) \quad (3.8b)$$

$$\hat{x}_k = P\zeta_k + Qy_k \quad (3.8c)$$

where  $\zeta_k \in \mathbb{R}^{q_0}$  represents the state vector of the observer,  $v_k \in \mathbb{R}^{q_1}$  is an auxiliary vector and  $\hat{x}_k \in \mathbb{R}^n$  is the estimate of  $x_k$ .  $N_i, H_i, F_i, S_i, L_i, M_i, P$  and  $Q$  are unknown matrices of appropriate dimensions which must be determined

such that  $e_k = \hat{x}_k - x_k$  converges asymptotically to zero for  $w_k = 0$ . For  $w_k \neq 0$ , we must minimize the effect of  $w_k$  on  $e_k$  such that  $\sup_{w \in \mathcal{L}_2 - \{0\}} \frac{\|e_k\|_2^2}{\|w_k\|_2^2} < \gamma^2$  where  $\gamma$  is a given positive scalar.

For the sake of simplicity, the following notation is used

$$\Psi(\rho_k) = \sum_{i=1}^{\tau} \mu_i(\rho_k) \Psi_i, \quad \forall i \in \{1, \dots, \tau\}$$

Thus, system (3.8) can be rewritten as follows :

$$\zeta_{k+1} = N(\rho_k)\zeta_k + H(\rho_k)v_k + F(\rho_k)y_k + J(\rho_k)u_k \quad (3.9a)$$

$$v_{k+1} = S(\rho_k)\zeta_k + L(\rho_k)v_k + M(\rho_k)y_k \quad (3.9b)$$

$$\hat{x}_k = P\zeta_k + Qy_k \quad (3.9c)$$

The following lemma gives the existence conditions of the observer (3.9).

**Lemma 3.1.** *For  $w_k = 0$ , there exists an observer of the form (3.9) for the system (3.7) if the following two statements hold*

1. *There exists a matrix  $T$  of appropriate dimension such that the following conditions are satisfied*

(a)  $N(\rho_k)T + F(\rho_k)C - TA(\rho_k) = 0$

(b)  $J(\rho_k) = TB(\rho_k)$

(c)  $TD = 0$

(d)  $S(\rho_k)T + M(\rho_k)C = 0$

(e)  $PT + QC = I_n$

2. *The system  $\varphi_{k+1} = \begin{bmatrix} N(\rho_k) & H(\rho_k) \\ S(\rho_k) & L(\rho_k) \end{bmatrix} \varphi_k$  is asymptotically stable.*

*Proof.* Let  $T \in \mathbb{R}^{q_0 \times n}$  be a parameter matrix and consider the transformed error  $\varepsilon_k = \zeta_k - Tx_k$ , then its dynamics is given by :

$$\begin{aligned} \varepsilon_{k+1} = & N(\rho_k)\varepsilon_k + (N(\rho_k)T + F(\rho_k)C - TA(\rho_k))x_k + H(\rho_k)v_k + \\ & (J(\rho_k) - TB(\rho_k))u(k) - TDd_k + (F(\rho_k)R_1 - TR)w_k \end{aligned} \quad (3.10)$$

by using the definition of  $\varepsilon_k$ , equations (3.9b) and (3.9c) can be written as :

$$v_{k+1} = S(\rho_k)\varepsilon_k + (S(\rho_k)T + M(\rho_k)C)x_k + L(\rho_k)v_k + M(\rho_k)R_1w_k \quad (3.11)$$

$$\hat{x}_k = P\varepsilon_k + (PT + QC)x_k + QR_1w_k \quad (3.12)$$

If conditions a)-e) of Lemma 3.1 are satisfied, the following observer error dynamics is obtained from (3.10) and (3.11)

$$\underbrace{\begin{bmatrix} \varepsilon_{k+1} \\ v_{k+1} \end{bmatrix}}_{\varphi_{k+1}} = \underbrace{\begin{bmatrix} N(\rho_k) & H(\rho_k) \\ S(\rho_k) & L(\rho_k) \end{bmatrix}}_{\mathbb{A}(\rho_k)} \underbrace{\begin{bmatrix} \varepsilon_k \\ v_k \end{bmatrix}}_{\varphi_k} + \underbrace{\begin{bmatrix} F(\rho_k)R_1 - TR \\ M(\rho_k)R_1 \end{bmatrix}}_{\mathbb{B}(\rho_k)} w_k \quad (3.13)$$

From (3.12), we have

$$\hat{x}_k - x_k = e_k = P\varepsilon_k + QR_1w_k \quad (3.14)$$

in this case if  $w_k = 0$  and  $\varphi_{k+1} = \mathbb{A}(\rho_k)\varphi_k$  is asymptotically stable then  $\lim_{k \rightarrow \infty} e_k = 0$ . □

The problem of the GDO design is reduced to find all the parameter matrices of the observer such that conditions a) – e) of Lemma 3.1 are satisfied and system (3.13) is stable for  $w_k = 0$  and for  $w_k \neq 0$ ,  $\sup_{w \in \mathcal{L}_2 - \{0\}} \frac{\|e_k\|_2^2}{\|w_k\|_2^2} < \gamma^2$  where  $\gamma$  is a given positive scalar.

### 3.3 Observer parameterization

This section, we shall give the parameterization of the algebraic constraint equations (a)-(e) of Lemma 3.1. Let  $E \in \mathbb{R}^{q_0 \times n}$  be any full row rank matrix such that the matrix  $\Omega = \begin{bmatrix} E \\ C \end{bmatrix}$  is of full column rank. Conditions d)-e) can be written as :

$$\begin{bmatrix} S(\rho_k) & M(\rho_k) \\ P & Q \end{bmatrix} \begin{bmatrix} T \\ C \end{bmatrix} = \begin{bmatrix} 0 \\ I_n \end{bmatrix} \quad (3.15)$$

the necessary and sufficient condition for equation (3.15) to have a solution is :

$$\text{rank} \begin{bmatrix} T \\ C \end{bmatrix} = \text{rank} \begin{bmatrix} T \\ C \\ 0 \\ I_n \end{bmatrix} = n \quad (3.16)$$

Now, since  $\text{rank} \begin{bmatrix} T \\ C \end{bmatrix} = n$ , there always exist matrices  $T \in \mathbb{R}^{q_0 \times n}$  and  $K \in \mathbb{R}^{q_0 \times p}$  such that :

$$T + KC = E \quad (3.17)$$

On the other hand from equation (3.17) we obtain :

$$\begin{bmatrix} T \\ C \end{bmatrix} = \begin{bmatrix} I_{q_0} & -K \\ 0 & I_p \end{bmatrix} \Omega \quad (3.18)$$

inserting equation (3.18) into equation (3.15) we get :

$$\begin{bmatrix} S(\rho_k) & M(\rho_k) \\ P & Q \end{bmatrix} \begin{bmatrix} I_{q_0} & -K \\ 0 & I_p \end{bmatrix} \Omega = \begin{bmatrix} 0 \\ I_n \end{bmatrix} \quad (3.19)$$

Since matrix  $\Omega$  is of full column rank and  $\begin{bmatrix} I_{q_0} & -K \\ 0 & I_p \end{bmatrix}^{-1} = \begin{bmatrix} I_{q_0} & K \\ 0 & I_p \end{bmatrix}$  the general solution to equation (3.19) is given by :

$$\begin{bmatrix} S(\rho_k) & M(\rho_k) \\ P & Q \end{bmatrix} = \left( \begin{bmatrix} 0 \\ I_n \end{bmatrix} \Omega^+ - U(\rho_k)(I_{q_0+p} - \Omega\Omega^+) \right) \begin{bmatrix} I_{q_0} & K \\ 0 & I_p \end{bmatrix} \quad (3.20)$$

where  $U(\rho_k)$  is a matrix with arbitrary elements of appropriate dimensions. Then matrices  $S(\rho_k)$ ,  $M(\rho_k)$ ,  $P$  and  $Q$  can be determined as :

$$S(\rho_k) = -U_1(\rho_k)S_1, \quad (3.21)$$

$$M(\rho_k) = -U_1(\rho_k)M_1, \quad (3.22)$$

$$P(\rho_k) = P_1 - U_2(\rho_k)S_1 \quad (3.23)$$

$$Q(\rho_k) = Q_1 - U_2(\rho_k)M_1 \quad (3.24)$$

where  $U_1(\rho_k) = [I \ 0]U(\rho_k)$ ,  $U_2(\rho_k) = [0 \ I]U(\rho_k)$ ,  $P_1 = \Omega^+ \begin{bmatrix} I_{q_0} \\ 0 \end{bmatrix}$ ,  $Q_1 = \Omega^+ \begin{bmatrix} K \\ I_p \end{bmatrix}$ ,  $S_1 = (I_{q_0+p} - \Omega\Omega^+) \begin{bmatrix} I \\ 0 \end{bmatrix}$  and  $M_1 = (I_{q_0+p} - \Omega\Omega^+) \begin{bmatrix} K \\ I_p \end{bmatrix}$ .

The estimation error (3.14) shows that  $e_k \rightarrow 0$  when  $\varepsilon_k \rightarrow 0$ , i.e., the error  $e_k$  is independent of the matrix  $P$ . Then we can suppose that  $U_2(\rho_k) = 0$  and obtain  $P = P_1$  and  $Q = Q_1$ .

Consequently, from the equation (3.17) and c) of Lemma 3.1, we have the equation :

$$KCD = ED \quad (3.25)$$

which has solution if and only if

$$\text{rank} \begin{bmatrix} E \\ C \end{bmatrix} D = \text{rank} CD \quad (3.26)$$

or, since  $\begin{bmatrix} E \\ C \end{bmatrix}$  is of full column rank

$$\text{rank } D = \text{rank } CD \quad (3.27)$$

**Assumption 3.1.** We assume that condition (3.26) (or its equivalent (3.27)) is satisfied.

The previous rank conditions are established in [Darouach, 2009]. Under Assumption 3.1, the one solution of equation (3.25) is

$$K = ED(CD)^+ \quad (3.28)$$

and it is possible to deduce matrices  $K$  and  $T$  when the matrix  $E$  is chosen.

By replacing  $T$  from equation (3.17) into equation a) of Lemma 3.1 we obtain :

$$N(\rho_k)(E - KC) + F(\rho_k)C = (E - KC)A(\rho_k) \quad (3.29)$$

or

$$\begin{bmatrix} N(\rho_k) & \tilde{K}(\rho_k) \end{bmatrix} = \Theta(\rho_k) \quad (3.30)$$

where  $\tilde{K}(\rho_k) = F(\rho_k) - N(\rho_k)K$ ,  $\Theta(\rho_k) = (E - KC)A(\rho_k)$  and the general solution of (3.30) is given by

$$\begin{bmatrix} N(\rho_k) & \tilde{K}(\rho_k) \end{bmatrix} = \Theta(\rho_k)\Omega^+ - Z(\rho_k)(I - \Omega\Omega^+) \quad (3.31)$$

which can be rewritten as :

$$N(\rho_k) = N_1(\rho_k) - Z(\rho_k)N_2 \quad (3.32)$$

$$\tilde{K}(\rho_k) = \tilde{K}_1(\rho_k) - Z(\rho_k)\tilde{K}_2 \quad (3.33)$$

where  $N_1(\rho_k) = \Theta(\rho_k)\Omega^+ \begin{bmatrix} I_{q_0} \\ 0 \end{bmatrix}$ ,  $N_2 = (I - \Omega\Omega^+) \begin{bmatrix} I_{q_0} \\ 0 \end{bmatrix}$ ,  $\tilde{K}_1(\rho_k) = \Theta(\rho_k)\Omega^+ \begin{bmatrix} 0 \\ I_p \end{bmatrix}$ ,  $\tilde{K}_2 = (I - \Omega\Omega^+) \begin{bmatrix} 0 \\ I_p \end{bmatrix}$  and  $Z(\rho_k)$  are matrices with arbitrary elements of appropriate dimensions.

From the previous results, the observer error dynamics (3.13) can be rewritten as :

$$\varphi_{k+1} = (\mathbb{A}_1(\rho_k) - \mathbb{Y}(\rho_k)\mathbb{A}_2)\varphi_k + (\mathbb{B}_1(\rho_k) - \mathbb{Y}(\rho_k)\mathbb{B}_2)w_k \quad (3.34a)$$

$$e_k = \mathbb{P}\varphi_k + \mathbb{Q}w_k \quad (3.34b)$$

where  $\mathbb{A}_1(\rho_k) = \begin{bmatrix} N_1(\rho_k) & 0 \\ 0 & 0 \end{bmatrix}$ ,  $\mathbb{A}_2 = \begin{bmatrix} N_2 & 0 \\ 0 & -I_{q_1} \end{bmatrix}$ ,  $\mathbb{Y}(\rho_k) = \begin{bmatrix} Z(\rho_k) & H(\rho_k) \\ U_1(\rho_k) & L(\rho_k) \end{bmatrix}$ ,  $\mathbb{B}_1(\rho_k) = \begin{bmatrix} \Theta(\rho_k)\Omega^+ \begin{bmatrix} K \\ I_p \\ 0 \end{bmatrix} R_1 - TR \\ 0 \end{bmatrix}$ ,  
 $\mathbb{B}_2 = \begin{bmatrix} M_1 R_1 \\ 0 \end{bmatrix}$ ,  $\mathbb{P} = \begin{bmatrix} P & 0 \end{bmatrix}$  and  $\mathbb{Q} = QR_1$ .

### 3.4 $H_\infty$ generalized dynamic observer design

In this section, a method to design the  $H_\infty$  GDO from (3.8) is presented. This method is obtained from the determination of matrix  $\mathbb{Y}(\rho_k)$ , such that system (3.34) is poly-quadratically stable and an upper bound  $\gamma$  to the  $H_\infty$  performance is minimized. This problem is described as

$$\sup_{w \in \mathcal{L}_2 - \{0\}} \frac{\|e_k\|_2^2}{\|w_k\|_2^2} < \gamma^2 \quad (3.35)$$

which can be solved by the discrete-time version of the bounded real lemma in terms of LMI's based condition of poly-quadratic stability presented in [Heemels et al., 2010, Daafouz et al., 2002]. Those results are extended to the  $H_\infty$  generalized dynamic observer in the context of linear parameter varying systems by using the following theorem.

**Theorem 3.1.** Under Assumption 3.1, if there exists a parameter matrices  $\mathbb{Y}_i$ , matrices  $G_i$ , a scalar  $\gamma > 0$  and matrices  $X_i = X_i^T > 0$  of appropriate dimensions such that the LMIs (3.36)-(3.37) are feasible

$$\mathcal{C}^{T\perp} \begin{bmatrix} X_j - G_i - G_i^T & 0 & (*) & (*) \\ 0 & -I & (*) & (*) \\ \mathbb{A}_{1,i}^T G_i & \mathbb{P}^T & -X_i & 0 \\ \mathbb{B}_{1,i}^T G_i & \mathbb{Q}^T & 0 & -\gamma I \end{bmatrix} \mathcal{C}^{T\perp T} < 0 \quad (3.36)$$

$$\begin{bmatrix} -I & (*) & (*) \\ \mathbb{P}^T & -X_i & 0 \\ \mathbb{Q}^T & 0 & -\bar{\gamma}I \end{bmatrix} < 0 \quad (3.37)$$

$\forall i, j \in \{1, \dots, \tau\}$  with  $\gamma = \sqrt{\bar{\gamma}}$ , then the system (3.34) is asymptotically stable with an  $H_\infty$  disturbance attenuation level  $\gamma$ .

The matrix  $\mathbb{Y}_i$  is parametrized as

$$\mathbb{Y}_i = G_i^{-T} (\mathcal{B}_r^+ \mathcal{K} \mathcal{C}_l^+ + \mathcal{Z}_i - \mathcal{B}_r^+ \mathcal{B}_r \mathcal{Z}_i \mathcal{C}_l \mathcal{C}_l^+) \quad (3.38)$$

where

$$\mathcal{K} = -\mathcal{R}^{-1} \mathcal{B}_l^T \vartheta \mathcal{C}_r^T (\mathcal{C}_r \vartheta \mathcal{C}_r^T)^{-1} + \mathcal{S}^{1/2} \phi (\mathcal{C}_r \vartheta \mathcal{C}_r^T)^{-1/2} \quad (3.39)$$

$$\mathcal{S} = \mathcal{R}^{-1} - \mathcal{R}^{-1} \mathcal{B}_l^T [\vartheta - \vartheta \mathcal{C}_r^T (\mathcal{C}_r \vartheta \mathcal{C}_r^T)^{-1} \mathcal{C}_r \vartheta] \mathcal{B}_l \mathcal{R}^{-1} \quad (3.40)$$

$$\vartheta = (\mathcal{B}_r \mathcal{R}^{-1} \mathcal{B}_l^T - \mathcal{D}_u)^{-1} > 0 \quad (3.41)$$

with  $\mathcal{D}_u$  as the matrix  $D_{ij}$  with  $\lambda_{\max}(D_{ij})$  where

$$D_{ij} = \begin{bmatrix} X_j - G_i - G_i^T & 0 & (*) & (*) \\ 0 & -I & (*) & (*) \\ \mathbb{A}_{1,i}^T G_i & \mathbb{P}^T & -X_i & 0 \\ \mathbb{B}_{1,i}^T G_i & \mathbb{Q}^T & 0 & -\gamma^2 I \end{bmatrix}$$

$\mathcal{B} = \begin{bmatrix} -I \\ 0 \\ 0 \\ 0 \end{bmatrix}$ ,  $\mathcal{C} = [0 \ 0 \ \mathbb{A}_2 \ \mathbb{B}_2]$ .  $\phi$  is an arbitrary matrix such that  $\|\phi\|_2 < 1$  and  $\mathcal{R} > 0$ . Matrices  $\mathcal{C}_l$ ,  $\mathcal{C}_r$ ,  $\mathcal{B}_l$  and  $\mathcal{B}_r$  are any full rank matrices such that  $\mathcal{C} = \mathcal{C}_l \mathcal{C}_r$  and  $\mathcal{B} = \mathcal{B}_l \mathcal{B}_r$ .

*Proof.* Consider the PDL function

$$V(\varphi_k, \rho_k) = \varphi_k^T X(\rho_k) \varphi_k \quad (3.42)$$

where  $X(\rho_k) = X(\rho_k)^T > 0$ , then the difference  $\Delta V(\varphi_k)$  along the solution of (3.13) is given by

$$\begin{aligned} \Delta V(\varphi_k, \rho_k) &= \varphi_k^T (\mathbb{A}(\rho_k)^T X(\rho_{k+1}) \mathbb{A}(\rho_k) - X(\rho_k)) \varphi_k - \\ &\quad w_k^T \mathbb{B}(\rho_k)^T X(\rho_{k+1}) \mathbb{A}(\rho_k) \varphi_k + \varphi_k^T \mathbb{A}(\rho_k)^T X(\rho_{k+1}) \mathbb{B}(\rho_k) w_k + \\ &\quad w_k^T \mathbb{B}(\rho_k)^T X(\rho_{k+1}) \mathbb{B}(\rho_k) w_k \end{aligned} \quad (3.43)$$

Now let  $\mathcal{S} = \Delta V(\varphi_k, \rho_k) + e_k^T e_k - \gamma^2 w_k^T w_k$ , then we obtain

$$\mathcal{S} = \begin{bmatrix} \varphi_k \\ w_k \end{bmatrix}^T \begin{bmatrix} \mathbb{A}^T(\rho_k) X(\rho_{k+1}) \mathbb{A}(\rho_k) - X(\rho_k) + \mathbb{P}^T \mathbb{P} & \mathbb{A}^T(\rho_k) X(\rho_{k+1}) \mathbb{B}(\rho_k) + \mathbb{P}^T \mathbb{Q} \\ (*) & \mathbb{B}^T(\rho_k) X(\rho_{k+1}) \mathbb{B}(\rho_k) + \mathbb{Q}^T \mathbb{Q} - \gamma^2 I \end{bmatrix} \begin{bmatrix} \varphi_k \\ w_k \end{bmatrix} \quad (3.44)$$

We have used the fact that  $e_k = \mathbb{P} \varphi_k + \mathbb{Q} w_k$ .

Now  $\mathcal{S} < 0$ , implies that

$$\Delta V(\varphi_k, \rho_k) < -e_k^T e_k + \gamma^2 w_k^T w_k \quad (3.45)$$

or equivalently

$$\sum_{k=0}^{\infty} \Delta V(\varphi_k, \rho_k) < -\|e_k\|_2^2 + \gamma^2 \|w_k\|_2^2 \quad (3.46)$$

which gives

$$V(\infty) - V(0) < -\|e_k\|_2^2 + \gamma^2 \|w_k\|_2^2 \quad (3.47)$$

which leads to (3.35) since  $V(0) = 0$  and  $V(\infty) > 0$ .

On the other hand,  $\mathcal{S} < 0$  if

$$\begin{bmatrix} \mathbb{A}^T(\rho_k)X(\rho_{k+1})\mathbb{A}(\rho_k) - X(\rho_k) + \mathbb{P}^T\mathbb{P} & \mathbb{A}^T(\rho_k)X(\rho_{k+1})\mathbb{B}(\rho_k) + \mathbb{P}^T\mathbb{Q} \\ (*) & \mathbb{B}^T(\rho_k)X(\rho_{k+1})\mathbb{B}(\rho_k) + \mathbb{Q}^T\mathbb{Q} - \gamma^2I \end{bmatrix} < 0 \quad (3.48)$$

We can decompose the inequality (3.48) as follows

$$\begin{bmatrix} -X(\rho_k) & 0 \\ 0 & -\gamma^2I \end{bmatrix} - \begin{bmatrix} \mathbb{A}^T(\rho_k)X(\rho_{k+1}) & \mathbb{P}^T \\ \mathbb{B}^T(\rho_k)X(\rho_{k+1}) & \mathbb{Q}^T \end{bmatrix} \begin{bmatrix} -X(\rho_{k+1})^{-1} & 0 \\ 0 & -I \end{bmatrix} \begin{bmatrix} X(\rho_{k+1})\mathbb{A}(\rho_k) & X(\rho_{k+1})\mathbb{B}(\rho_k) \\ \mathbb{P} & \mathbb{Q} \end{bmatrix} < 0 \quad (3.49)$$

and by applying Schur complement to the inequality (3.49) we get

$$\begin{bmatrix} -X(\rho_{k+1}) & 0 & (*) & (*) \\ 0 & -I & (*) & (*) \\ \mathbb{A}^T(\rho_k)X(\rho_{k+1}) & \mathbb{P}^T & -X(\rho_k) & 0 \\ \mathbb{B}^T(\rho_k)X(\rho_{k+1}) & \mathbb{Q}^T & 0 & -\gamma^2I \end{bmatrix} < 0 \quad (3.50)$$

Consider  $X(\rho_k) = \sum_{i=1}^{\tau} \mu_i(\rho_k)X_i$  and  $X(\rho_{k+1}) = \sum_{j=1}^{\tau} \mu_j(\rho_{k+1})X_j$  and using the convex properties (3.6), the inequality (3.50) is valid if

$$\begin{bmatrix} -X_j & 0 & (*) & (*) \\ 0 & -I & (*) & (*) \\ \mathbb{A}_i^T X_j & \mathbb{P}^T & -X_i & 0 \\ \mathbb{B}_i^T X_j & \mathbb{Q}^T & 0 & -\gamma^2I \end{bmatrix} < 0 \quad (3.51)$$

Premultiplying (3.51) by  $\begin{bmatrix} G_i^T X_j^{-1} & 0 & 0 & 0 \\ 0 & I & 0 & 0 \\ 0 & 0 & I & 0 \\ 0 & 0 & 0 & I \end{bmatrix}$  and postmultiplying it by its transpose we obtain

$$\begin{bmatrix} -G_i^T X_j^{-1} G_i & 0 & (*) & (*) \\ 0 & -I & (*) & (*) \\ \mathbb{A}_i^T G_i & \mathbb{P}^T & -X_i & 0 \\ \mathbb{B}_i^T G_i & \mathbb{Q}^T & 0 & -\gamma^2I \end{bmatrix} < 0, \quad \forall i, j \in \{1, 2, \dots, h\} \quad (3.52)$$

Now, by applying the Young's Inequality to the (1,1) entry of the inequality (3.52) we obtain

$$-G_i^T X_j^{-1} G_i \leq X_j - G_i - G_i^T$$

which implies, from equation (3.52), that if

$$\begin{bmatrix} X_j - G_i - G_i^T & 0 & (*) & (*) \\ 0 & -I & (*) & (*) \\ \mathbb{A}_i^T G_i & \mathbb{P}^T & -X_i & 0 \\ \mathbb{B}_i^T G_i & \mathbb{Q}^T & 0 & -\gamma^2I \end{bmatrix} < 0, \quad (3.53)$$

is satisfied then (3.52) is also satisfied.

By replacing  $\mathbb{A}_i$  and  $\mathbb{B}_i$  from (3.34) into (3.53)

$$\begin{bmatrix} X_j - G_i - G_i^T & 0 & (*) & (*) \\ 0 & -I & (*) & (*) \\ (\mathbb{A}_{1,i} - \mathbb{Y}_i \mathbb{A}_2)^T G_i & \mathbb{P}^T & -X_i & 0 \\ (\mathbb{B}_{1,i} - \mathbb{Y}_i \mathbb{B}_2)^T G_i & \mathbb{Q}^T & 0 & -\gamma^2I \end{bmatrix} < 0. \quad (3.54)$$

The inequality (3.54) can be decomposed as

$$\begin{aligned} & \begin{bmatrix} -I \\ 0 \\ 0 \\ 0 \end{bmatrix} G_i^T \Upsilon_i \begin{bmatrix} 0 & 0 & \mathbb{A}_2 & \mathbb{B}_2 \end{bmatrix} + \left( \begin{bmatrix} -I \\ 0 \\ 0 \\ 0 \end{bmatrix} G_i^T \Upsilon_i \begin{bmatrix} 0 & 0 & \mathbb{A}_2 & \mathbb{B}_2 \end{bmatrix} \right)^T + \\ & \begin{bmatrix} X_j - G_i - G_i^T & 0 & (*) & (*) \\ 0 & -I & (*) & (*) \\ \mathbb{A}_{1,i}^T G_i & \mathbb{P}^T & -X_i & 0 \\ \mathbb{B}_{1,i}^T G_i & \mathbb{Q}^T & 0 & -\gamma^2 I \end{bmatrix} < 0 \end{aligned} \quad (3.55)$$

which can be also written as

$$\mathcal{B} \mathcal{X}_i \mathcal{C} + (\mathcal{B} \mathcal{X}_i \mathcal{C})^T + D_{ij} < 0 \quad (3.56)$$

where  $\mathcal{B} = \begin{bmatrix} -I \\ 0 \\ 0 \\ 0 \end{bmatrix}$ ,  $\mathcal{C} = \begin{bmatrix} 0 & 0 & \mathbb{A}_2 & \mathbb{B}_2 \end{bmatrix}$  and  $\mathcal{X}_i = G_i^T \Upsilon_i$ . According to elimination lemma [Skelton et al., 1997] the solvability conditions of equation (3.56) are reduced to :

$$\mathcal{C}^{T\perp} D_{ij} \mathcal{C}^{T\perp T} < 0 \quad (3.57)$$

$$\mathcal{B}^\perp D_{ij} \mathcal{B}^{\perp T} < 0 \quad (3.58)$$

Now, from the solution of (3.57) and (3.58) we can determine matrices  $D_{ij}$  and therefore matrix  $D_u$ . Then we have that (3.57) and (3.58) are equivalent to

$$\mathcal{B} \mathcal{X}_i \mathcal{C} + (\mathcal{B} \mathcal{X}_i \mathcal{C})^T + D_u < 0 \quad (3.59)$$

If condition (3.59) is satisfied, then the parameter matrix  $\Upsilon_i$  is obtained from (5.50).  $\square$

**Remark 3.2.** The choice of matrix  $D_u$  as the matrix  $D_{ij}$  with  $\lambda_{\max}(D_{ij})$  allow us to obtain matrix  $\Upsilon_i$ , so that matrix  $D_u$  represents the worst case of matrices  $D_{ij}$ . Therefore, if we solve (3.56) for the worst case, it implies that the other cases for matrices  $D_{ij}$  are also satisfied.

### 3.4.1 Particular cases

The GDO (5.6) is in a generalized form. In fact :

— For  $L_i = 0$ ,  $S_i = -CP$  and  $M_i = -CQ + I$  then the following PIO for LPV systems is obtained

$$\zeta_{k+1} = \sum_{i=1}^{\tau} \mu_i(\rho_k) (N_i \zeta_k + H_i v_k + F_i y_k + J_i u_k) \quad (3.60a)$$

$$v_{k+1} = y_k - C \hat{x}_k \quad (3.60b)$$

$$\hat{x}_k = P \zeta_k + Q y_k \quad (3.60c)$$

the observer dynamic error (3.34) becomes

$$\varphi_{k+1} = \sum_{i=1}^{\tau} \mu_i(\rho_k) ((\mathbb{A}_i - \Upsilon_i \mathbb{A}_2) \varphi_k + (\mathbb{B}_i - \Upsilon_i \mathbb{B}_2) w_k) \quad (3.61a)$$

$$e_k = \mathbb{P} \varphi_k + \mathbb{Q} w_k \quad (3.61b)$$

where  $\mathbb{A}_i = \begin{bmatrix} N_{1,i} & 0 \\ -CP & 0 \end{bmatrix}$ ,  $\mathbb{A}_2 = \begin{bmatrix} N_2 & 0 \\ 0 & -I \end{bmatrix}$ ,  $\mathbb{B}_i = \begin{bmatrix} \Theta_i \Omega^+ \begin{bmatrix} K \\ I_p \end{bmatrix} R_1 - TR \\ R_1 - CQR_1 \end{bmatrix}$ ,  $\mathbb{B}_2 = \begin{bmatrix} M_1 R_1 \\ 0 \end{bmatrix}$  and  $\Upsilon_i = \begin{bmatrix} I \\ 0 \end{bmatrix} \begin{bmatrix} Z_i & H_i \end{bmatrix}$ . Consequently, Theorem 1 is applied to (3.61).



— For  $H_i = 0$ ,  $S_i = 0$ ,  $M_i = 0$  and  $L_i = 0$  the observer reduces to the PO for LPV systems.

$$\zeta_{k+1} = \sum_{i=1}^{\tau} \mu_i(\rho_k)(N_i \zeta_k + F_i y_k + J_i u_k) \quad (3.62a)$$

$$\hat{x}_k = P \zeta_k + Q y_k \quad (3.62b)$$

the observer dynamic error (3.34) becomes

$$\varepsilon_{k+1} = \sum_{i=1}^{\tau} \mu_i(\rho_k)((\mathbb{A}_i - \mathbb{Y}_i \mathbb{A}_2) \varepsilon_k + (\mathbb{B}_i - \mathbb{Y}_i \mathbb{B}_2) w_k) \quad (3.63a)$$

$$e_k = P \varepsilon_k + Q R_1 w_k \quad (3.63b)$$

where  $\mathbb{A}_i = N_{1,i}$ ,  $\mathbb{A}_2 = N_2$ ,  $\mathbb{B}_i = \Theta_i \Omega^+ \begin{bmatrix} K \\ I_p \end{bmatrix} R_1 - T R$ ,  $\mathbb{B}_2 = M_1 R_1$  and  $\mathbb{Y}_i = Z_i$ . Consequently, Theorem 1 is applied to (3.63).

## 3.5 Wind turbine system

### 3.5.1 LPV modeling of benchmark wind turbine

In this section a benchmark wind turbine system is used to illustrate the observer design approach proposed previously. This benchmark was designed by [Odgaard et al., 2013] based on a 4.8 MW wind turbine, which is composed by the blade and pitch systems, drive train, generator and converter, and controller. In [Shao et al., 2018, Liu et al., 2017b] a global wind turbine model is obtained by interconnecting the models of each subsystem, then the global wind turbine model is represented by the following state-space form

$$\dot{x}(t) = A(\lambda, \beta, \omega_r) x(t) + B u(t) \quad (3.64a)$$

$$y(t) = C x(t) \quad (3.64b)$$

where  $x(t) = [ \omega_r(t) \quad \omega_g(t) \quad \theta_{\Delta}(t) \quad \beta(t) \quad \dot{\beta}_o(t) \quad \tau_g(t) ]^T$  is the state vector,  $u(t) = [ \beta_r(t) \quad T_{gr}(t) ]^T$  is the control input vector obtained by the benchmark model and  $y(t) = [ \omega_r(t) \quad \omega_g(t) \quad \beta(t) \quad \tau_g(t) ]^T$  is the output vector.  $\lambda$ ,  $\beta$  and  $\omega_r$  are the measurable scheduling variables,  $\lambda$  is calculated through the measuring variables  $v_r$  and  $\omega_r$ , hence is known. The system matrices (3.64) are described as :

$$A(\lambda, \beta, \omega_r) = \begin{bmatrix} a_{11}(\lambda, \beta, \omega_r) & \frac{B_{dt}}{N_g J_r} & \frac{-K_{dt}}{J_r} & 0 & 0 & 0 \\ \frac{\eta_{dt} B_{dt}}{N_g J_g} & -\frac{\eta_{dt} B_{dt}}{N_g^2 J_g} - \frac{B_g}{J_g} & \frac{\eta_{dt} K_{dt}}{N_g J_g} & 0 & 0 & -\frac{1}{J_g} \\ 1 & -\frac{1}{N_g} & 0 & 0 & 0 & 0 \\ 0 & 0 & 0 & 0 & \omega_n^2 & 0 \\ 0 & 0 & 0 & -1 & -2\zeta \omega_n^2 & 0 \\ 0 & 0 & 0 & 0 & 0 & -\alpha_{gc} \end{bmatrix},$$

$$B = \begin{bmatrix} 0 & 0 \\ 0 & 0 \\ 0 & 0 \\ 0 & 0 \\ 1 & 0 \\ 0 & \alpha_{gc} \end{bmatrix}, \quad C = \begin{bmatrix} 1 & 0 & 0 & 0 & 0 & 0 \\ 0 & 1 & 0 & 0 & 0 & 0 \\ 0 & 0 & 0 & 1 & 0 & 0 \\ 0 & 0 & 0 & 0 & 0 & 1 \end{bmatrix}$$

with  $a_{11}(\lambda, \beta, \omega_r) = \frac{1}{2\lambda^2 J_r} \rho_w \pi R_w^5 C_q(\lambda, \beta) \omega_r - \frac{B_{dt} + B_r}{J_r}$ . The symbols used are shown in Table 3.1, the parameter values are extracted from [Odgaard et al., 2013].

$C_q(\lambda, \beta)$  is a strong non-linear term which represents the torque coefficients depending on tip-speed-ratio  $\lambda$  and the pitch angle  $\beta$ . In [Shao et al., 2018], the term  $C_q(\lambda, \beta)$  is identified by the curve fitting method using the real data,

TABLE 3.1 – Parameter symbols of benchmark model

Symbol	Meaning	Symbol	Meaning
$\omega_r$	Rotor angular speed	$\tau_{gr}$	Generator torque reference
$\omega_g$	Generator rotating speed	$\beta_r$	Pitch reference
$\theta_\Delta$	Torsion angle	$N_g$	Gear ratio
$\beta$	Pitch angle	$J_r$	Rotor moment of inertia
$\tau_g$	Generator torque	$K_{dt}$	Torsion stiffness
$\lambda$	Tip-speed-ratio	$\rho_w$	Air density
$\varsigma$	Damping ration	$\eta_{dt}$	Efficiency of drive train
$\alpha_{gc}$	Generator and converter parameter	$R_w$	Rotor radius
$B_g$	Generator external damping	$C_q$	Torque coefficient
$\omega_n$	Natural frequency	$B_{dt}$	Torsion damping coefficient
$B_r$	Rotor external damping	$J_g$	Generator moment of inertia

from the Lookup Table scheme illustrated in the benchmark model, and Linear Least Square method. The polynomial obtained of two input parameters is described as follows :

$$C_q(\lambda, \beta) = p_{00} + p_{10}\beta + p_{01}\lambda + p_{11}\beta\lambda + p_{02}\lambda^2 \quad (3.65)$$

where  $p_{00} = -0.101$ ,  $p_{10} = 0.003$ ,  $p_{01} = 0.054$ ,  $p_{11} = -0.002$  and  $p_{02} = -0.004$ . The states comparison between the parameter varying model and benchmark model is depicted in [Shao et al., 2018].

To design the discrete-time observer presented in Section 3.4, an Euler discretization is used for the model (3.64) taking into account the same sampling time used in the pre-designed controller. The nonlinear discrete-time model is

$$x_{k+1} = A_d(\lambda_k, \beta_k, \omega_{r_k})x_k + B_d u_k \quad (3.66a)$$

$$y_k = C x_k \quad (3.66b)$$

where

$$A_d(\lambda_k, \beta_k, \omega_{r_k}) = \begin{bmatrix} 1 + T_s a_{11}(\lambda, \beta, \omega_r) & \frac{T_s B_{dt}}{N_g J_r} & -\frac{T_s K_{dt}}{J_r} & 0 & 0 & 0 \\ \frac{T_s \eta_{dt} B_{dt}}{N_g J_g} & 1 - \frac{T_s \eta_{dt} B_{dt}}{N_g^2 J_g} - \frac{T_s B_g}{J_g} & \frac{T_s \eta_{dt} K_{dt}}{N_g J_g} & 0 & 0 & -\frac{T_s}{J_g} \\ T_s & -T_s \frac{1}{N_g} & 0 & 0 & 0 & 0 \\ 0 & 0 & 0 & 0 & T_s \omega_n^2 & 0 \\ 0 & 0 & 0 & -T_s & 1 - 2T_s \varsigma \omega_n^2 & 0 \\ 0 & 0 & 0 & 0 & 0 & 1 - T_s \alpha_{gc} \end{bmatrix},$$

$$B_d = T_s B$$

with sampling time  $T_s = 0.01$ . In order to obtain the LPV model of the parameter varying model (3.66), the scheduling variables and the scheduling functions are defined as follows

$$\rho_1 = \frac{1}{2\lambda^2 J_r} \rho_w \pi R_w^5 C_q(\lambda, \beta) \in [\underline{\rho}_1, \overline{\rho}_1] = [-250, 150], \quad \rho_2 = \omega_r \in [\underline{\rho}_2, \overline{\rho}_2] = [0, 3],$$

$$\mu_1 = \left( \frac{\overline{\rho}_1 - \rho_1}{\overline{\rho}_1 - \underline{\rho}_1} \right) \left( \frac{\overline{\rho}_2 - \rho_2}{\overline{\rho}_2 - \underline{\rho}_2} \right), \quad \mu_2 = \left( \frac{\overline{\rho}_1 - \rho_1}{\overline{\rho}_1 - \underline{\rho}_1} \right) \left( \frac{\rho_2 - \underline{\rho}_2}{\overline{\rho}_2 - \underline{\rho}_2} \right),$$

$$\mu_3 = \left( \frac{\rho_1 - \underline{\rho}_1}{\overline{\rho}_1 - \underline{\rho}_1} \right) \left( \frac{\overline{\rho}_2 - \rho_2}{\overline{\rho}_2 - \underline{\rho}_2} \right), \quad \mu_4 = \left( \frac{\rho_1 - \underline{\rho}_1}{\overline{\rho}_1 - \underline{\rho}_1} \right) \left( \frac{\rho_2 - \underline{\rho}_2}{\overline{\rho}_2 - \underline{\rho}_2} \right),$$

the minimum and maximum bounds are selected according to the Lookup Table in [Odgaard et al., 2013]. These scheduling functions must satisfy the convex properties described in (5.4).

To demonstrate the effectiveness and performance of the proposed robust estimation approach, we consider actuator fault  $f_k$  and disturbance  $w_k$  of finite energy. In [Shao et al., 2018, Liu et al., 2017b], the generator torque is assumed to be faulty due to faults in either generator or converter torque producing a bias on the generator torque reference.

Considering the actuator fault and disturbance affecting both states and outputs of the system, the system (3.66) is rewritten as

$$x_{k+1} = A_d(\lambda_k, \beta_k, \omega_{r_k})x_k + B_d u_k + B_{df} f_k + B_{dw} w_k \quad (3.67a)$$

$$y_k = C x_k + R_1 w_k \quad (3.67b)$$

$B_{df}$ ,  $B_{dw}$  and  $R_1$  are the distribution matrices of the actuator fault and disturbance which are represented by  $B_{df} = [0 \ 0 \ 0 \ 0 \ 0 \ \alpha_{gc}]^T$ ,  $B_{dw} = [0.04 \ 1 \ 0 \ 0 \ 0 \ 1]^T$  and  $R_1 = [0.04 \ 0.25 \ 0.02 \ 0.4]^T$ .

### 3.5.2 Simulation

The problem is to estimate the state variables of the benchmark wind turbine model by using the GDO proposed. The observer initial conditions are  $\zeta_k(0) = [0.01 \ 20 \ 0 \ 40 \ 0 \ 1]^T$  and  $v_k(0) = [0 \ 0 \ 0 \ 0 \ 0 \ 0]^T$ .

The observer parameters are computed by solving the LMIs of Theorem 3.1 through Yalmip Toolbox [Lofberg, 2004]

and the SeDuMi solver [Sturm, 1999] by choosing the matrices  $E = 0.01 \times \begin{bmatrix} 1 & 0 & 2 & 0 & 0 & 0 \\ 0 & 20 & 0 & 0 & 0 & 0 \\ 0 & 0 & 1 & 0 & 0 & 0 \\ 0 & 40 & 0 & 1 & 0 & 0 \\ 0 & 0 & 1 & 0 & 1 & 0 \\ 0 & 0 & 0 & 0 & 0 & 8 \end{bmatrix}$ ,  $\phi = \mathbf{1}_{12 \times 8} \times 0.08$ ,

$\mathcal{Z} = 0$  and  $\mathcal{R} = 100 \times I_{12}$ .

The obtained attenuation level is  $\gamma = 2.1$  which guarantee a good disturbance attenuation. Figure 3.2 represents the disturbance process  $w_k$  and the actuator fault  $f_k$ . To evaluate the performance of the presented observers, we add an uncertainty  $\Delta A_1(t)$  to the system dynamics  $A(\lambda, \beta, \omega_r)$ , where  $\Delta A_1(t) = \alpha(t)\bar{A}$  and  $\bar{A} = \begin{bmatrix} 0.01 & 0 & 0 & 0 & 0 & 0 \\ 0 & -0.002 & 0 & 0 & 0 & 0 \\ 0 & 0 & 0.2 & 0 & 0 & 0 \\ 0 & 0 & 0 & 0 & 0.3 & 0 \\ 0 & 0 & 0 & 0.1 & 0 & 0 \\ 0 & 0 & 0 & 0 & 0 & 0 \end{bmatrix}$ .

Figure 3.1 shows the variable  $\alpha(t)$  and the evolution of the scheduling functions.

Similarly, we designed a PIO and PO based on the method proposed with the same parameter design with  $\gamma = 2.1$  to compare the performances of each observer. Figures 3.3-3.8 represent the state variables of the benchmark wind turbine system and their estimates.

In Table 3.2, the integral of absolute error (IAE) is calculated for the obtained observers. We can see that the GDO performances are better than those of PO and PIO in the presence of parameter uncertainties and unknown inputs, obtaining the minimum values of IAE on the estimation errors.

TABLE 3.2 – Parameter index of each observer

		$\hat{x}_1 - x_1$	$\hat{x}_2 - x_2$	$\hat{x}_3 - x_3$	$\hat{x}_4 - x_4$	$\hat{x}_5 - x_5$	$\hat{x}_6 - x_6$
GDO	IAE	1.72	56.39	0.594	18.04	2.98	6584
PIO	IAE	1.72	240.4	1.67	20.65	3.07	6584
PO	IAE	1.72	253.9	1.65	18.5	3.4	6584

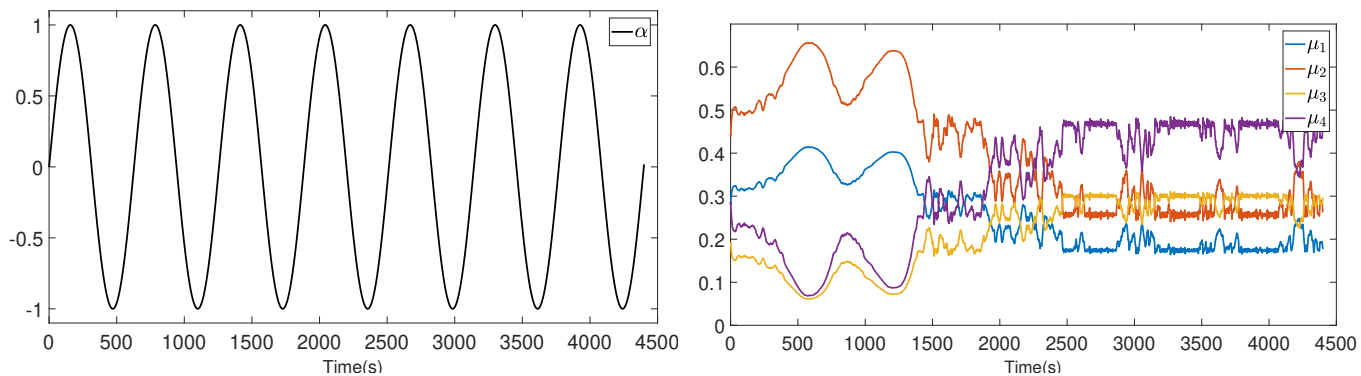

FIGURE 3.1 – Uncertainty factor  $\alpha$  and scheduling functions

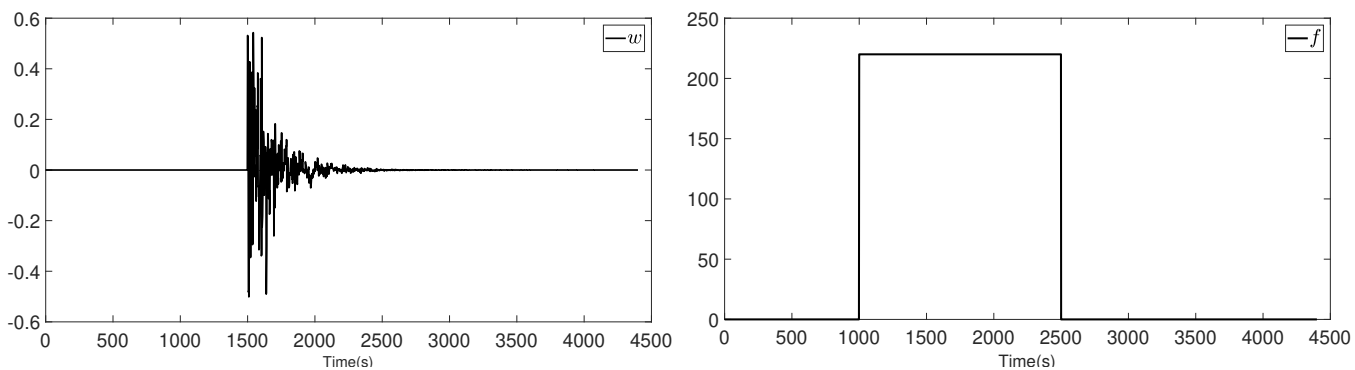

FIGURE 3.2 – Disturbance from plant and sensors and actuator fault

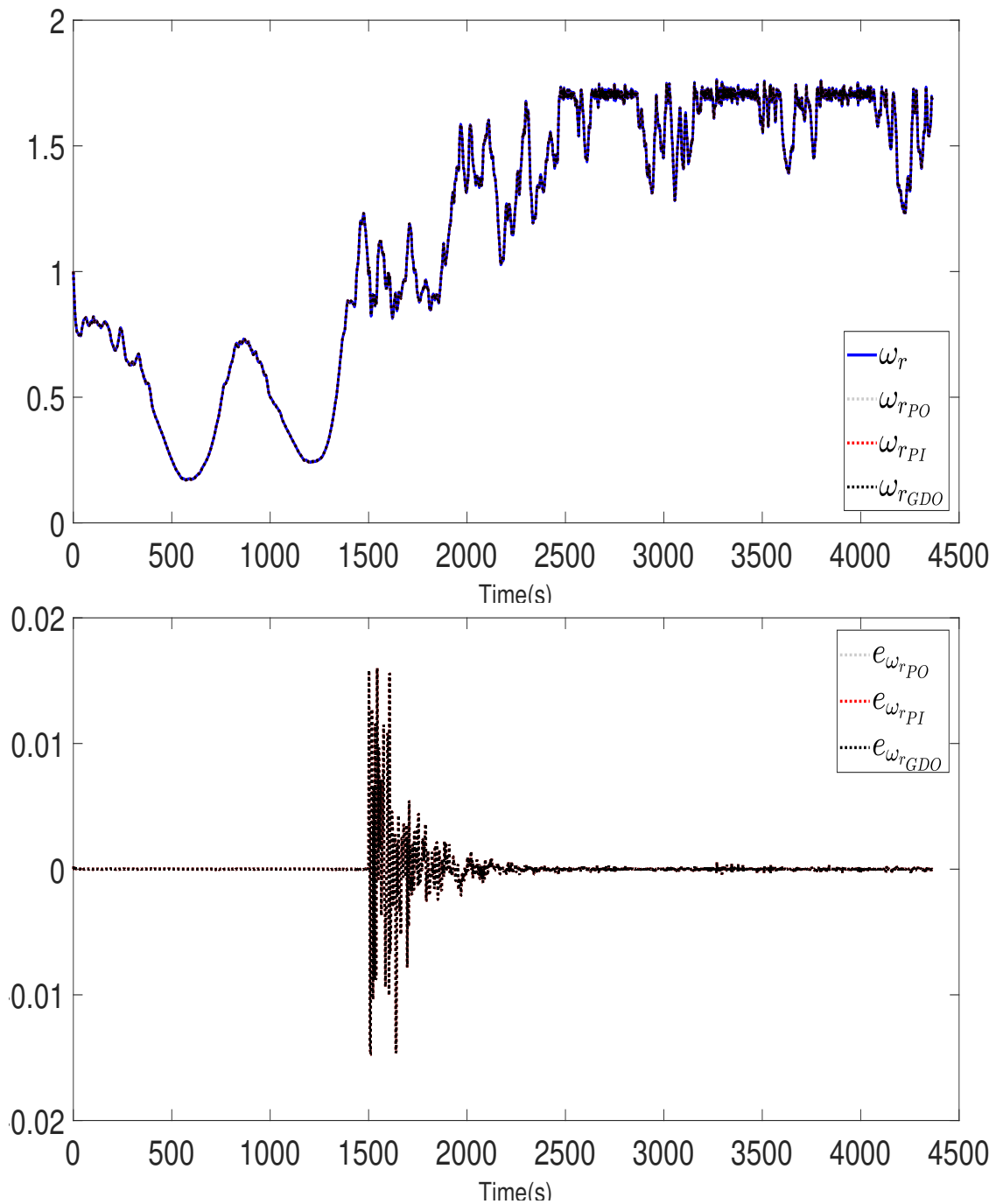

FIGURE 3.3 – Rotor angular speed estimation and its estimation error.

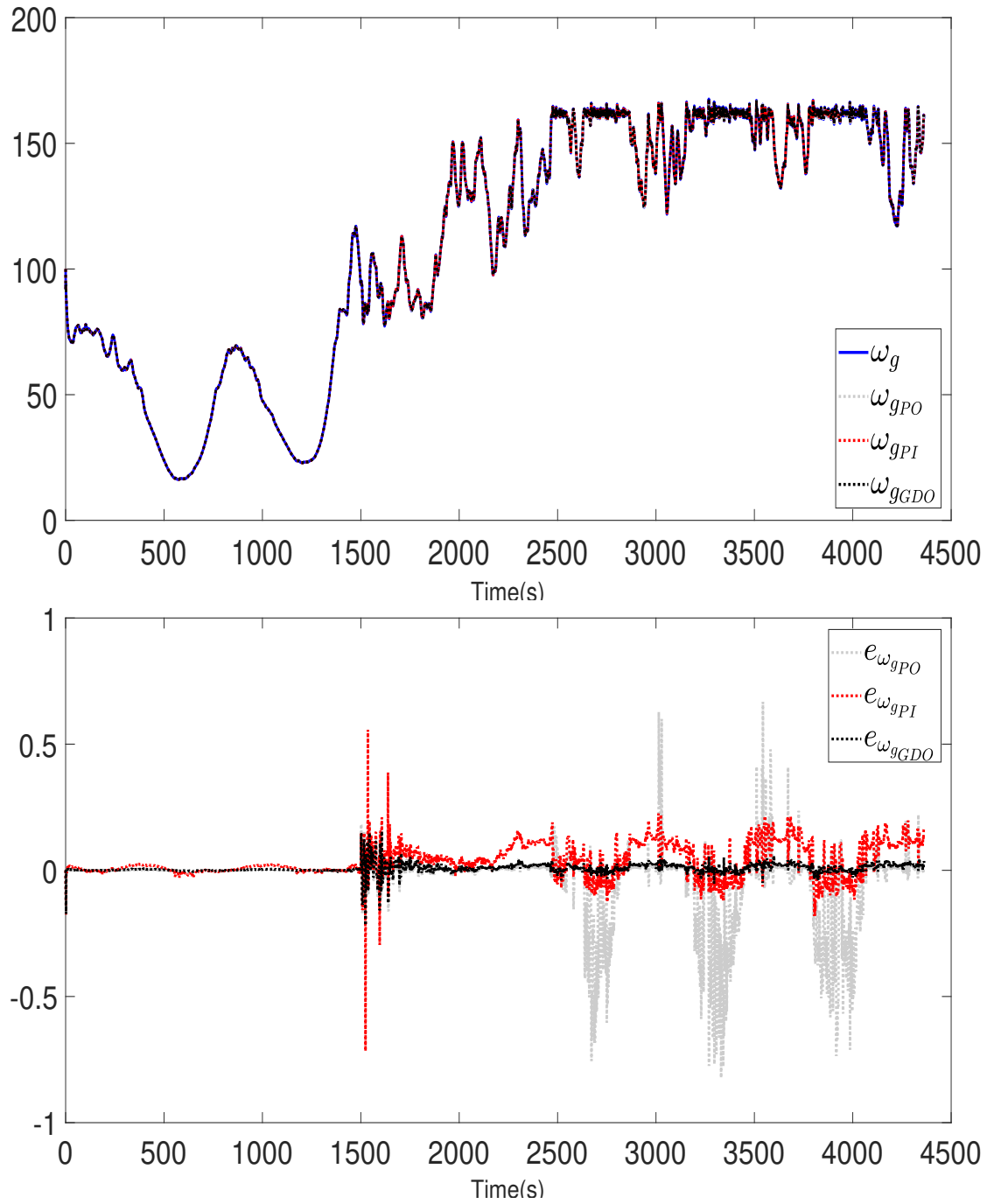

FIGURE 3.4 – Generator rotating speed estimation and its estimation error.

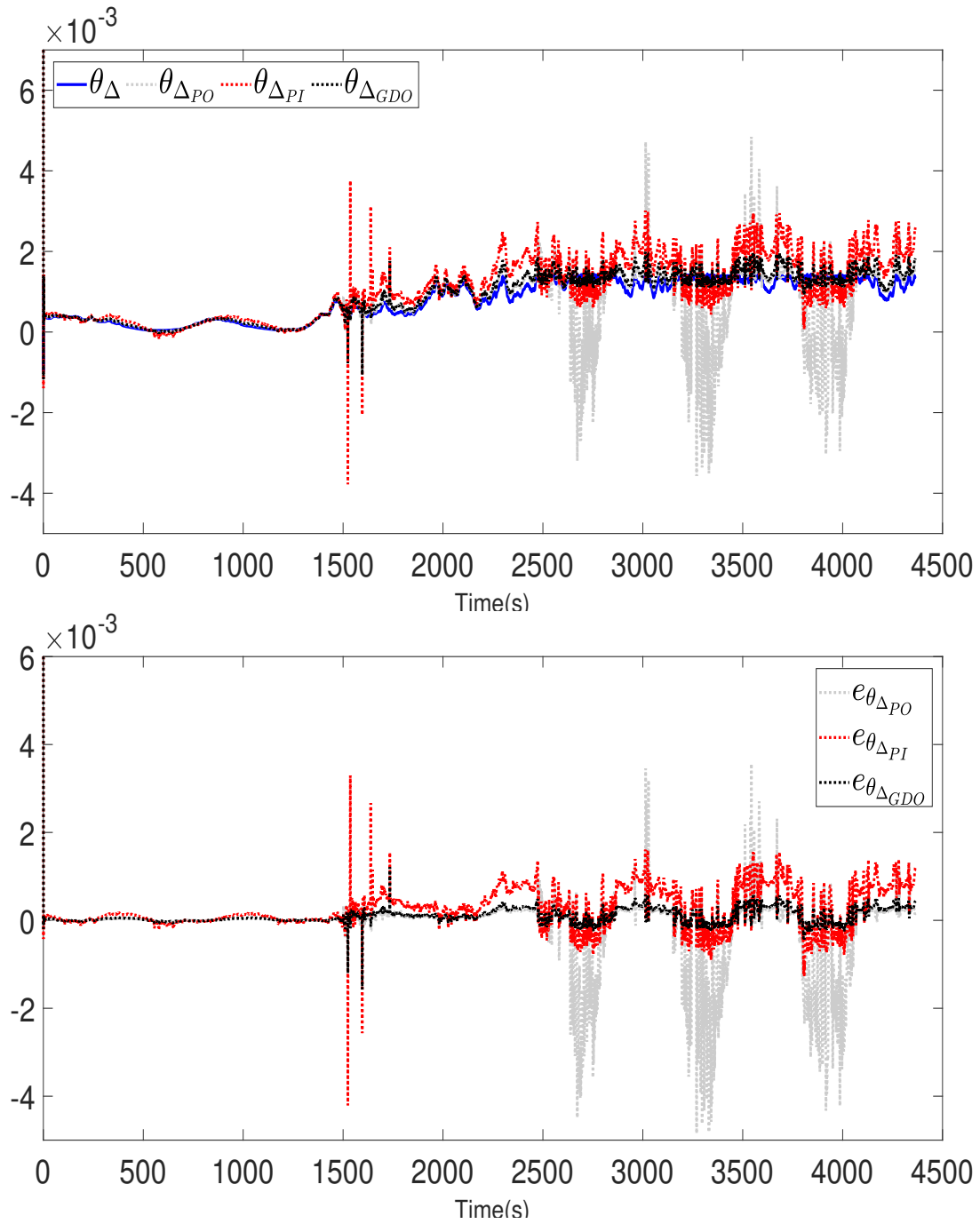

FIGURE 3.5 – Torsion angle estimation and its estimation error.

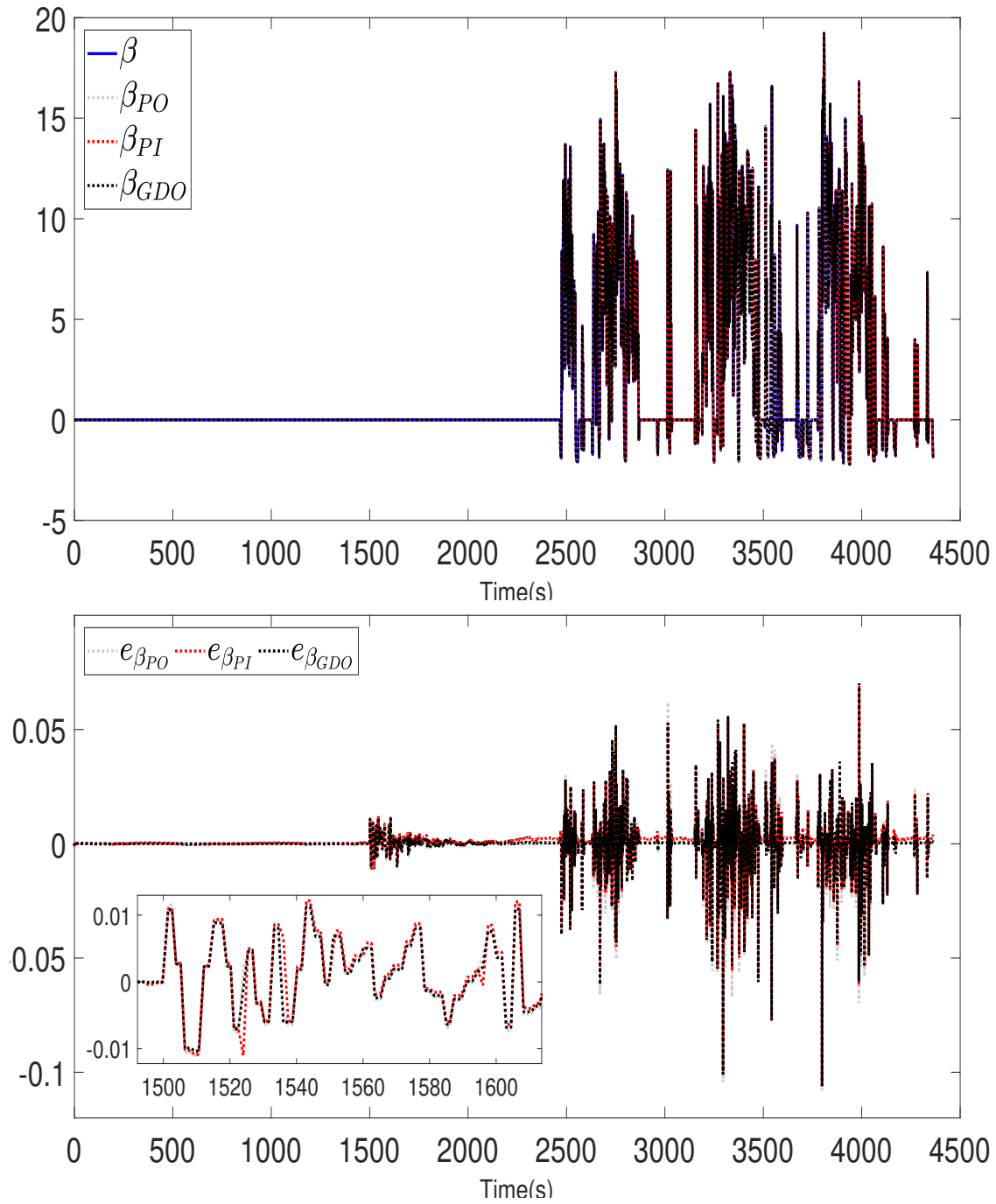

FIGURE 3.6 – Pitch angle estimation and its estimation error.



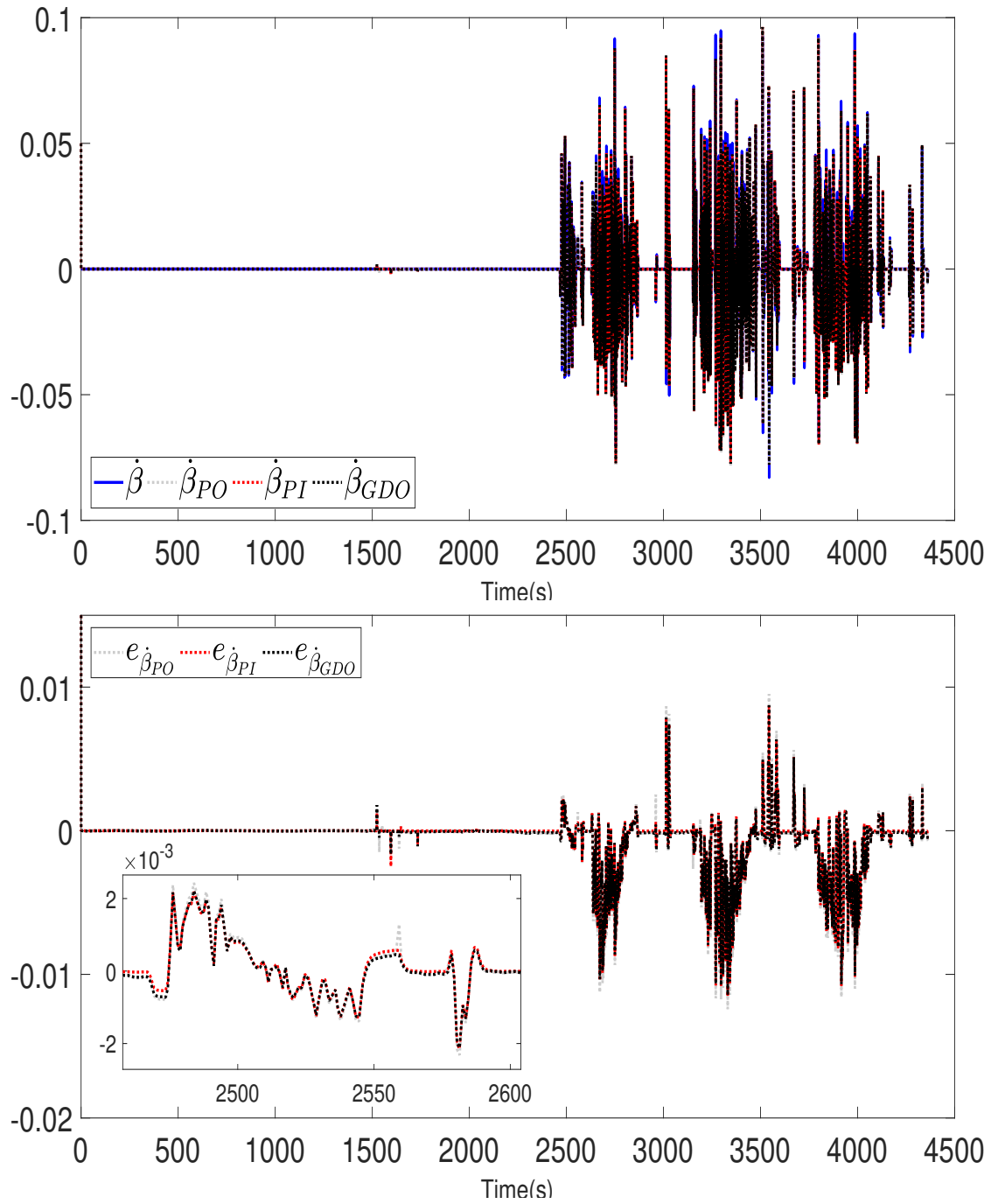

FIGURE 3.7 – Pitch rate estimation and its estimation error.

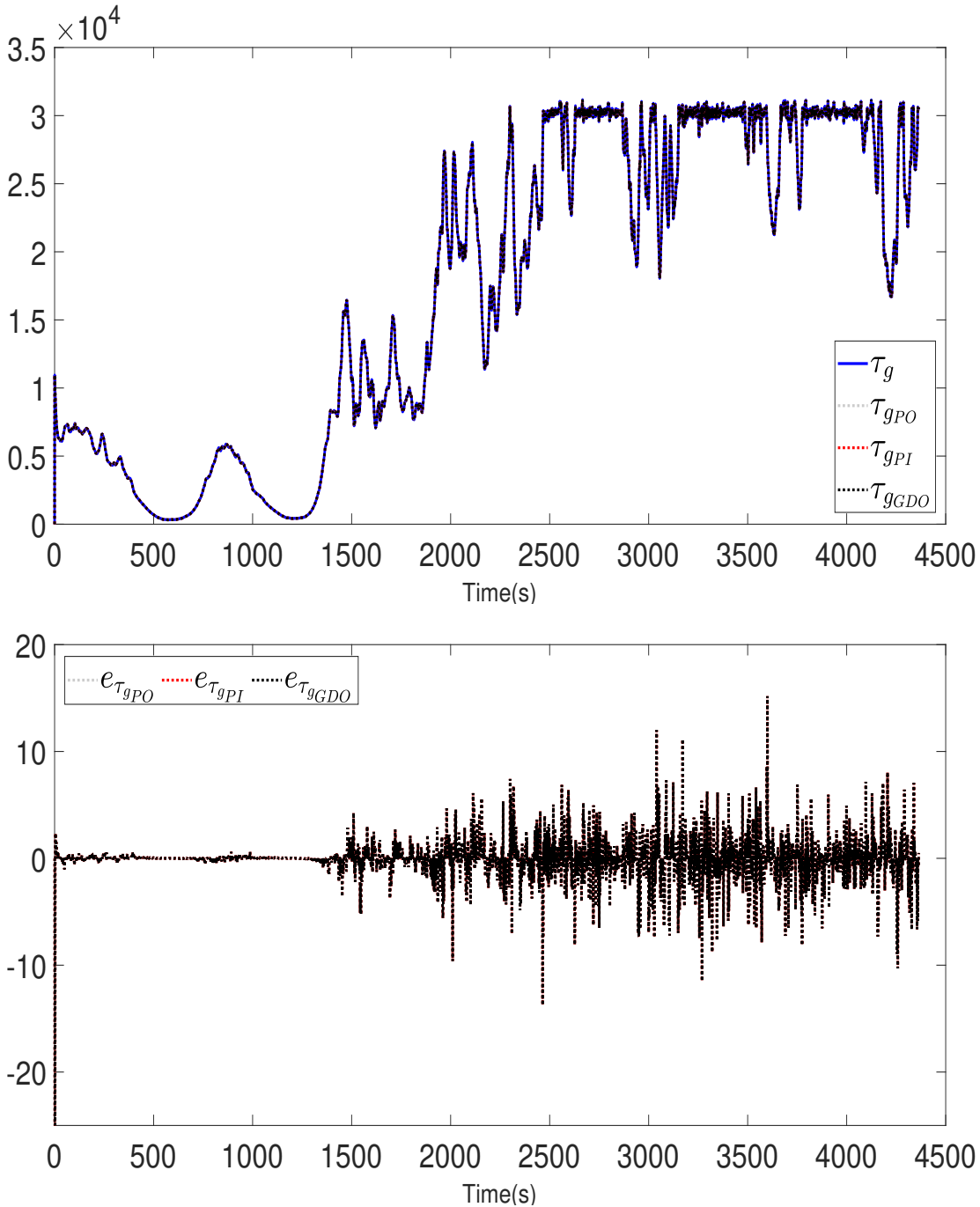

FIGURE 3.8 – Generator torque estimation and its estimation error.

### 3.6 Conclusions

In this chapter, a GDO design for discrete-time unknown inputs LPV systems is presented. The conditions for the existence of this observer design is given in the form of a set of LMIs. The design uses the PDL function to obtain results less conservative than the ones obtained from the quadratic stability. In order to illustrate the observer performances, a benchmark wind turbine model was used. From the simulation results, the GDO has the best performances and robustness compared to PO and PIO in the presence of parametric uncertainties.

# Chapter 4

## Adaptive observer design for LPV systems

### Contents

---

<b>4.1</b>	<b>Introduction</b>	<b>67</b>
<b>4.2</b>	<b>Adaptive observer design for LPV systems</b>	<b>67</b>
4.2.1	Problem statement	67
4.2.2	Observer stability analysis	70
4.2.3	Illustrative example : DC motor	73
<b>4.3</b>	<b>Adaptive generalized dynamic unknown input observer</b>	<b>77</b>
4.3.1	Problem statement	77
4.3.2	Stability conditions	78
4.3.3	Numerical example	80
<b>4.4</b>	<b>Conclusions</b>	<b>80</b>

---

### 4.1 Introduction

This chapter presents the design of an adaptive observer for LPV systems. This observer structure must be able to estimate states and parameters simultaneously. The estimated parameter vector is used to compute the scheduling functions and thus interpolate the local linear models. A case in which an unknown input affects the system is presented. The observer design is obtained in terms of a set of linear matrix inequalities (LMI), and the conditions of existence and stability are given. Academic examples illustrate the efficiency of the proposed approach.

### 4.2 Adaptive observer design for LPV systems

#### 4.2.1 Problem statement

Consider the following linear system subject to time varying parametric uncertainty  $\theta(t)$

$$\dot{x}(t) = A(\theta(t))x(t) + B(\theta(t))u(t) \quad (4.1a)$$

$$y(t) = Cx(t) \quad (4.1b)$$

with  $A(\theta(t)) = A_0 + \sum_{j=1}^{n_\theta} \theta_j(t)\bar{A}_j$ ,  $B(\theta(t)) = B_0 + \sum_{j=1}^{n_\theta} \theta_j(t)\bar{B}$ ,  $\theta_j(t) \in [\theta_j^1, \theta_j^2]$  where the superscripts 1 and 2 represent the lower and upper bound of  $\theta_j(t)$ , respectively.  $n_\theta$  is the number of unknown parameters.  $x(t) \in \mathbb{R}^n$  is the state vector,  $u(t) \in \mathbb{R}^m$  the input vector,  $y(t) \in \mathbb{R}^p$  represents the output vector.  $\theta(t) \in \mathbb{R}^{n_\theta}$  is a time varying parameter vector, non measurable but bounded, hence, each parameter can be written as

$$\theta_j(t) = \mu_j^1(\theta_j(t))\theta_j^1 + \mu_j^2(\theta_j(t))\theta_j^2 \quad (4.2)$$

where  $\mu_j^1(\theta_j) = \frac{\theta_j^2 - \theta_j(t)}{\theta_j^2 - \theta_j^1}$  and  $\mu_j^2(\theta_j) = \frac{\theta_j(t) - \theta_j^1}{\theta_j^2 - \theta_j^1}$ . The system (4.1) can be represented in a polytopic form where the parameter  $\theta(t)$  evolves inside a polytope represented by  $\tau = 2^{n_\theta}$  vertices.

$$\dot{x}(t) = \sum_{i=1}^{\tau} \mu_i(\theta(t)) (\mathcal{A}_i x(t) + \mathcal{B}_i u(t)) \quad (4.3a)$$

$$y(t) = Cx(t) \quad (4.3b)$$

with  $\mu_i(\theta(t)) = \prod_{j=1}^{n_\theta} \mu_j^k(\theta_j(t))$  and  $\mathcal{A}_i = A_0 + \sum_{j=1}^{n_\theta} \theta_j^k \bar{A}_j$ ,  $\mathcal{B}_i = B_0 + \sum_{j=1}^{n_\theta} \theta_j^k \bar{B}_j$  where  $k$  is equal to 1 or 2 depending of the partition of the  $j^{\text{th}}$  parameter ( $\mu_j^1$  or  $\mu_j^2$ ).  $A_0$ ,  $B_0$ ,  $\bar{A}_j$  and  $\bar{B}_j$  are known matrices with suitable dimensions. Now, let us consider the following adaptive dynamic observer for system (4.3)

$$\dot{\zeta}(t) = \sum_{i=1}^{\tau} \mu_i(\hat{\theta}(t)) (N_i \zeta(t) + H_i v(t) + F_i y(t) + J_i u(t)) \quad (4.4a)$$

$$\dot{v}(t) = \sum_{i=1}^{\tau} \mu_i(\hat{\theta}(t)) (S_i \zeta(t) + L_i v(t) + M_i y(t)) \quad (4.4b)$$

$$\dot{\hat{\theta}}(t) = \sum_{i=1}^{\tau} \mu_i(\hat{\theta}(t)) (K_{o,i} (C\hat{x}(t) - y(t)) + \alpha_i \hat{\theta}(t)) \quad (4.4c)$$

$$\hat{x}(t) = P\zeta(t) + Qy(t) \quad (4.4d)$$

where  $\zeta(t) \in \mathbb{R}^{q_0}$  represents the state vector of the observer,  $v(t) \in \mathbb{R}^{q_1}$  is an auxiliary vector,  $\hat{x}(t) \in \mathbb{R}^n$  is the estimate of  $x(t)$ ,  $\hat{\theta}(t) \in \mathbb{R}^{n_\theta}$  is the estimate of  $\theta(t)$ . The matrices  $N_i$ ,  $H_i$ ,  $F_i$ ,  $J_i$ ,  $S_i$ ,  $L_i$ ,  $M_i$ ,  $Q$ ,  $K_{o,i}$  and  $\alpha_i$  are unknown matrices of appropriate dimensions.

In order to facilitate the comparison between system (4.3) and adaptive observer (4.4), the system can be written with scheduling functions depending on the estimated state vector adding and subtracting  $\sum_{i=1}^{\tau} \mu_i(\hat{\theta}(t)) (\mathcal{A}_i x(t) + \mathcal{B}_i u(t))$  such that

$$\dot{x}(t) = \sum_{i=1}^{\tau} \mu_i(\hat{\theta}(t)) (\mathcal{A}_i x(t) + \mathcal{B}_i u(t)) + \sum_{i=1}^{\tau} (\mu_i(\theta(t)) - \mu_i(\hat{\theta}(t))) (\mathcal{A}_i x(t) + \mathcal{B}_i u(t)) \quad (4.5)$$

Now, let us define :

$$\Delta A(t) = \sum_{i=1}^{\tau} (\mu_i(\theta(t)) - \mu_i(\hat{\theta}(t))) \mathcal{A}_i = Z_A \Psi_A(t) E_A \quad (4.6)$$

$$\Delta B(t) = \sum_{i=1}^{\tau} (\mu_i(\theta(t)) - \mu_i(\hat{\theta}(t))) \mathcal{B}_i = Z_B \Psi_B(t) E_B \quad (4.7)$$

$$\text{where } Z_A = [\mathcal{A}_1, \mathcal{A}_2, \dots, \mathcal{A}_\tau], \Psi_A(t) = \begin{bmatrix} \delta_1(t) I_n & \dots & 0 \\ \vdots & \ddots & \vdots \\ 0 & \dots & \delta_\tau(t) I_n \end{bmatrix}, Z_B = [\mathcal{B}_1, \mathcal{B}_2, \dots, \mathcal{B}_\tau], \Psi_B(t) = \begin{bmatrix} \delta_1(t) I_m & \dots & 0 \\ \vdots & \ddots & \vdots \\ 0 & \dots & \delta_\tau I_m \end{bmatrix},$$

$$E_A = [I_{n_1}, I_{n_2}, \dots, I_{n_\tau}]^T \text{ and } E_B = [I_{m_1}, I_{m_2}, \dots, I_{m_\tau}]^T.$$

$\delta_i(t) = \mu_i(\theta(t)) - \mu_i(\hat{\theta}(t))$  for  $i = 1, 2, \dots, \tau$  and due to the convex property implies that  $-1 \leq \delta_i(t) \leq 1$ . Therefore the matrices  $\Psi_A(t)$  and  $\Psi_B(t)$  have the following property

$$\Psi_A(t)^T \Psi_A(t) \leq I, \quad \Psi_B(t)^T \Psi_B(t) \leq I, \quad (4.8)$$

which it is used to bound the time varying difference between the known and estimated scheduling functions. With the previous conditions, the system (4.3) is represented as an uncertain system with scheduling functions depending on time-varying parameter estimation :

$$\dot{x}(t) = \sum_{i=1}^{\tau} \mu_i(\hat{\theta}(t)) ((\mathcal{A}_i + \Delta A(t))x(t) + (\mathcal{B}_i + \Delta B(t))u(t)) \quad (4.9a)$$

$$y(t) = Cx(t) \quad (4.9b)$$

For the sake of simplicity, the following notation is used  $\sum_{i=1}^{\tau} \hat{\mu}_i = \sum_{i=1}^{\tau} \mu_i(\hat{\theta}(t))$ .

Let  $T \in \mathbb{R}^{q_0 \times n}$  be a parameter matrix and considering the transformed error  $\varepsilon(t) = \zeta(t) - Tx(t)$ , we have its derivative given by

$$\dot{\varepsilon}(t) = \sum_{i=1}^{\tau} \hat{\mu}_i (N_i \dot{\varepsilon}(t) + (N_i T + F_i C - T A_i) x(t) + H_i v(t) + (J_i - T B_i) u(t) - T \Delta A(t) x(t) - T \Delta B(t) u(t)) \quad (4.10)$$

By using the definition of  $\varepsilon(t)$ , equations (4.4b) and (4.4d) can be written as

$$\dot{v}(t) = \sum_{i=1}^{\tau} \hat{\mu}_i (S_i \dot{\varepsilon}(t) + (S_i T + M_i C) x(t) + L_i v(t)) \quad (4.11)$$

$$\hat{x}(t) = P \varepsilon(t) + (PT + QC) x(t) \quad (4.12)$$

If the following conditions are satisfied

$$N_i T + F_i C - T A_i = 0 \quad (4.13)$$

$$J_i - T B_i = 0 \quad (4.14)$$

$$S_i T + M_i C = 0 \quad (4.15)$$

$$PT + QC = I \quad (4.16)$$

the equations (4.10) and (4.11) are reduced to the following system

$$\underbrace{\begin{bmatrix} \dot{\varepsilon}(t) \\ \dot{v}(t) \end{bmatrix}}_{\dot{\varphi}(t)} = \sum_{i=1}^{\tau} \hat{\mu}_i \left( \underbrace{\begin{bmatrix} N_i & H_i \\ S_i & L_i \end{bmatrix}}_{A_i} \underbrace{\begin{bmatrix} \varepsilon(t) \\ v(t) \end{bmatrix}}_{\varphi(t)} + \underbrace{\begin{bmatrix} -T \\ 0 \end{bmatrix}}_{F_f} \Delta A(t) x(t) + \begin{bmatrix} -T \\ 0 \end{bmatrix} \Delta B(t) u(t) \right) \quad (4.17)$$

and according to (4.12) the estimation error is written as

$$e(t) = \hat{x}(t) - x(t) = P \varepsilon(t). \quad (4.18)$$

Let us establish the parameter estimation error as  $\tilde{\theta}(t) = \hat{\theta}(t) - \theta(t)$ . Using the  $\tilde{\theta}(t)$  definition, the dynamics of this error is given by

$$\begin{aligned} \dot{\tilde{\theta}}(t) &= \dot{\hat{\theta}}(t) - \dot{\theta}(t) \\ &= \sum_{i=1}^{\tau} \mu_i(\hat{\theta}(t)) (K_{o,i} (C \hat{x}(t) - y(t)) + \alpha_i \hat{\theta}(t)) - \dot{\theta}(t) \\ &= \sum_{i=1}^{\tau} \hat{\mu}_i (K_{o,i} C P \varepsilon(t) + \alpha_i \tilde{\theta}(t) + \alpha_i \theta(t) - \dot{\theta}(t)) \end{aligned} \quad (4.19)$$

The algebraic constraints described by (4.13)-(4.16) are satisfied through the parameterization detailed in Section 2.2.2.

There exist two approaches to joint state-parameter estimation. The first one is based on adaptive laws derived from the observer stability analysis under some persistent excitation condition [Zhang, 2002, Cho and Rajamani, 1997]. The second one, it considers an augmented system taking into account the dynamics of the parameter estimation error where the persistent excitation condition could be related to the feasibility of the LMIs [Farza et al., 2018, Farza et al., 2017]. Therefore, in order to estimate simultaneously the states and unknown parameters, the following augmented system is proposed by considering system (4.9), observer error dynamics (4.17) and parameter estimation error dynamics (4.19) :

$$\dot{\beta}(t) = \sum_{i=1}^{\tau} \hat{\mu}_i (\Phi_i(t) \beta(t) + \xi_i(t) \omega(t)) \quad (4.20a)$$

$$e_o(t) = \mathbb{P}_1 \beta(t) \quad (4.20b)$$

$$\text{where } \beta(t) = \begin{bmatrix} x(t) \\ \varphi(t) \\ \tilde{\theta}(t) \end{bmatrix}, \omega(t) = \begin{bmatrix} u(t) \\ \theta(t) \\ \dot{\theta}(t) \end{bmatrix}, e_0(t) = \begin{bmatrix} e(t) \\ \tilde{\theta}(t) \end{bmatrix}, \Phi_i(t) = \begin{bmatrix} \mathcal{A}_i + \Delta A(t) & 0 & 0 \\ F_f \Delta A(t) & \mathbb{A}_{1,i} - \mathbb{Y}_i \mathbb{A}_2 & 0 \\ 0 & [K_{o,i} C P \ 0] & \alpha_i \end{bmatrix},$$

$$\mathbb{P}_1 = \begin{bmatrix} 0 & \mathbb{P} & 0 \\ 0 & 0 & I \end{bmatrix}, \xi_i(t) = \begin{bmatrix} \mathcal{B}_i + \Delta B(t) & 0 & 0 \\ F_f \Delta B(t) & 0 & 0 \\ 0 & \alpha_i & -I \end{bmatrix}, \mathbb{A}_{1,i} = \begin{bmatrix} N_{1,i} - Y_1 N_{2,i} & 0 \\ 0 & 0 \end{bmatrix}, \mathbb{P} = [P \ 0], \mathbb{Y}_i = \begin{bmatrix} Z_i & H_i \\ U_{1,i} & L_i \end{bmatrix}$$

$$\text{and } \mathbb{A}_2 = \begin{bmatrix} N_3 & 0 \\ 0 & -I \end{bmatrix}.$$

## 4.2.2 Observer stability analysis

For  $\omega \neq 0$ , we must satisfy  $\sup_{w \in \mathcal{L}_2 - \{0\}} \frac{\|e_o(t)\|_2^2}{\|\omega(t)\|_2^2} < \Gamma^2$ . Based on the parameterization and the stability analysis, the following Theorem gives the stability conditions which allow the determination of all observer matrices.

**Theorem 4.1.** *System (4.20) is asymptotically stable with an attenuation level  $\Gamma$ , such that  $\sup_{w \in \mathcal{L}_2 - \{0\}} \frac{\|e_o(t)\|_2^2}{\|\omega(t)\|_2^2} < \Gamma^2$  if there exist parameter matrices  $\mathbb{Y}_i$ ,  $X_0 = X_0^T > 0$ ,  $X_1 = \begin{bmatrix} X_{11} & X_{12} \\ X_{12}^T & X_{13} \end{bmatrix} > 0$ ,  $X_2 = X_2^T > 0$  and diagonal matrices  $\Gamma_1^2, \Gamma_2^2, \Gamma_3^2$  with appropriate dimensions.  $\vartheta$ ,  $\lambda_1$ ,  $\lambda_2$ ,  $\bar{\alpha}_i$  and  $\bar{K}_i$  which satisfy the optimization problem (4.21) under LMIs (4.23)*

$$\min_{X_0, X_1, X_2, \lambda_1, \lambda_2, \Gamma_1^2, \Gamma_2^2, \Gamma_3^2} \vartheta \quad (4.21)$$

$$\Gamma_s^2 < \vartheta I, \quad \text{for } s = 1, 2, 3 \quad (4.22)$$

$$\begin{bmatrix} He\{X_0 \mathcal{A}_i\} & 0 & 0 & X_0 \mathcal{B}_i & 0 & 0 & 0 & \lambda_1 E_A^T & X_0 Z_A & 0 & X_0 Z_B \\ 0 & \Pi_{1,i} & N_3^{T\perp} P^T C^T \bar{K}_i^T & 0 & 0 & 0 & N_3^{T\perp} P^T & 0 & 0 & \Pi_2 & 0 & \Pi_3 \\ 0 & \bar{K}_i C P N_3^{T\perp T} & \bar{\alpha}_i + \bar{\alpha}_i^T & 0 & \bar{\alpha}_i & -X_2 & 0 & I & 0 & 0 & 0 & 0 \\ \mathcal{B}_i^T X_0 & 0 & 0 & -\Gamma_1^2 & 0 & 0 & 0 & 0 & 0 & 0 & \lambda_2 E_B^T & 0 \\ 0 & 0 & \bar{\alpha}_i^T & 0 & -\Gamma_2^2 & 0 & 0 & 0 & 0 & 0 & 0 & 0 \\ 0 & 0 & -X_2^T & 0 & 0 & -\Gamma_3^2 & 0 & 0 & 0 & 0 & 0 & 0 \\ 0 & P N_3^{T\perp T} & 0 & 0 & 0 & 0 & -I & 0 & 0 & 0 & 0 & 0 \\ 0 & 0 & I & 0 & 0 & 0 & 0 & -I & 0 & 0 & 0 & 0 \\ \lambda_1 E_A & 0 & 0 & 0 & 0 & 0 & 0 & -\lambda_1 I & 0 & 0 & 0 & 0 \\ Z_A^T X_0 & \Pi_2^T & 0 & 0 & 0 & 0 & 0 & 0 & -\lambda_1 I & 0 & 0 & 0 \\ 0 & 0 & 0 & \lambda_2 E_B & 0 & 0 & 0 & 0 & 0 & 0 & -\lambda_2 I & 0 \\ Z_B^T X_0 & \Pi_3^T & 0 & 0 & 0 & 0 & 0 & 0 & 0 & 0 & 0 & -\lambda_2 I \end{bmatrix} < 0 \quad (4.23)$$

where  $\Pi_{1,i} = N_3^{T\perp} (X_{11} N_{1,i} - W_1 N_{2,i} + N_{1,i}^T X_{11} - N_{2,i}^T W_1^T) N_3^{T\perp T}$ ,  $\Pi_2 = N_3^{T\perp} W_1 T_2 Z_A - N_3^{T\perp} X_{11} T_1 Z_A$ ,  $\Pi_3 = N_3^{T\perp} W_1 T_2 Z_B - N_3^{T\perp} X_{11} T_1 Z_B$  with  $Y_1 = X_{11}^{-1} W_1$ ,  $\alpha_i = X_2^{-1} \bar{\alpha}_i$  and  $K_{o,i} = X_2^{-1} \bar{K}_i$ .

According to the elimination lemma [Skelton et al., 1997], the matrix  $\mathbb{Y}_i$  is parameterized as

$$\mathbb{Y}_i = X_1^{-1} (\mathcal{B}_r^+ \mathcal{K}_i \mathcal{C}_l^+ + \mathcal{Z} - \mathcal{B}_r^+ \mathcal{B}_r \mathcal{Z} \mathcal{C}_l^+) \quad (4.24)$$

with

$$\mathcal{K}_i = -\mathcal{R}^{-1} \mathcal{B}_l^T \Lambda_i \mathcal{C}_r^T (\mathcal{C}_r \Lambda_i \mathcal{C}_r^T)^{-1} + \mathcal{S}_i^{1/2} \phi (\mathcal{C}_r \Lambda_i \mathcal{C}_r^T)^{-1/2} \quad (4.25)$$

$$\mathcal{S}_i = \mathcal{R}^{-1} - \mathcal{R}^{-1} \mathcal{B}_l^T [\Lambda_i - \Lambda_i \mathcal{C}_r^T (\mathcal{C}_r^T \Lambda_i \mathcal{C}_r^T)^{-1} \mathcal{C}_r \Lambda_i] \mathcal{B}_l \mathcal{R}^{-1} \quad (4.26)$$

$$\Lambda_i = (\mathcal{B}_r \mathcal{R}^{-1} \mathcal{B}_l^T - \mathbb{D}_i)^{-1} > 0 \quad (4.27)$$

where  $\phi$  is an arbitrary matrix such that  $\|\phi\|_2 < 1$  and  $\mathcal{R} > 0$ ,

$$\mathbb{D}_i = \begin{bmatrix} He\{X_0\mathcal{A}_i\} & 0 & 0 & X_0\mathcal{B}_i & 0 & 0 & 0 & 0 & \lambda_1 E_A^T & X_0 Z_A & 0 & X_0 Z_B \\ 0 & He\{X_1\mathbb{A}_{1,i}\} & \mathbb{Y}_{2,i}^T X_2 & 0 & 0 & 0 & \mathbb{P}^T & 0 & 0 & X_1 F_f Z_A & 0 & X_1 F_f Z_B \\ 0 & X_2 \mathbb{Y}_{2,i} & X_2 \alpha_i + \alpha_i^T X_2 & 0 & X_2 \alpha_i & -X_2 & 0 & I & 0 & 0 & 0 & 0 \\ \mathcal{B}_i^T X_0 & 0 & 0 & -\Gamma_1^2 & 0 & 0 & 0 & 0 & 0 & 0 & \lambda_2 E_B^T & 0 \\ 0 & 0 & \alpha_i^T X_2 & 0 & -\Gamma_2^2 & 0 & 0 & 0 & 0 & 0 & 0 & 0 \\ 0 & 0 & -X_2^T & 0 & 0 & -\Gamma_3^2 & 0 & 0 & 0 & 0 & 0 & 0 \\ 0 & \mathbb{P} & 0 & 0 & 0 & 0 & -I & 0 & 0 & 0 & 0 & 0 \\ 0 & 0 & I & 0 & 0 & 0 & 0 & -I & 0 & 0 & 0 & 0 \\ \lambda_1 E_A & 0 & 0 & 0 & 0 & 0 & 0 & 0 & -\lambda_1 I & 0 & 0 & 0 \\ Z_A^T X_0 & Z_A^T F_f^T X_1 & 0 & 0 & 0 & 0 & 0 & 0 & 0 & -\lambda_1 I & 0 & 0 \\ 0 & 0 & 0 & \lambda_2 E_B & 0 & 0 & 0 & 0 & 0 & 0 & -\lambda_2 I & 0 \\ Z_B^T X_0 & Z_B^T F_f^T X_1 & 0 & 0 & 0 & 0 & 0 & 0 & 0 & 0 & 0 & -\lambda_2 I \end{bmatrix}, \quad (4.28)$$

$$\mathbb{Y}_{2,i} = [K_{o,i} C P \ 0], \quad \mathbb{B} = [0 \ -I \ 0 \ 0 \ 0 \ 0 \ 0 \ 0 \ 0 \ 0 \ 0 \ 0]^T,$$

$\mathbb{C} = [0 \ \mathbb{A}_2 \ 0 \ 0 \ 0 \ 0 \ 0 \ 0 \ 0 \ 0 \ 0 \ 0]$ . Matrices  $\mathcal{C}_l$ ,  $\mathcal{C}_r$ ,  $\mathcal{B}_l$  and  $\mathcal{B}_r$  are any full rank matrices such that  $\mathbb{C} = \mathcal{C}_l \mathcal{C}_r$  and  $\mathbb{B} = \mathcal{B}_l \mathcal{B}_r$ .

*Proof.* Consider the following Lyapunov function

$$V(\beta(t)) = \beta(t)^T X \beta(t) > 0 \quad (4.29)$$

with  $X = \begin{bmatrix} X_0 & 0 & 0 \\ 0 & X_1 & 0 \\ 0 & 0 & X_2 \end{bmatrix} > 0$ ,  $X_1 = \begin{bmatrix} X_{11} & X_{12} \\ X_{12}^T & X_{13} \end{bmatrix}$ . Its derivative along the trajectory of (4.20) is given by

$$\dot{V}(\beta(t)) = \sum_{i=1}^{\tau} \hat{\mu}_i(\beta^T(t)(\Phi_i^T X + X \Phi_i)\beta(t) + \omega^T(t)\xi_i^T(t)X\beta(t) + \beta^T(t)X\xi_i(t)\omega(t)) \quad (4.30)$$

Now let  $\mathcal{S} = \dot{V}(\beta(t)) + e_o^T(t)e_o(t) - \Gamma^2 \omega^T(t)\omega(t)$ , then we have

$$\mathcal{S} = \sum_{i=1}^{\tau} \hat{\mu}_i \begin{bmatrix} \beta(t) \\ \omega(t) \end{bmatrix}^T \underbrace{\begin{bmatrix} \Phi_i^T X + X \Phi_i + \mathbb{P}_1^T \mathbb{P}_1 & X \xi_i \\ (*) & -\Gamma^2 \end{bmatrix}}_{\Theta_i} \begin{bmatrix} \beta(t) \\ \omega(t) \end{bmatrix} \quad (4.31)$$

with  $\Gamma^2 = \text{diag}(\Gamma_1^2, \Gamma_2^2, \Gamma_3^2)$ .

We can deduce that if  $\Theta_i < 0$  then  $\mathcal{S} < 0$ . It implies that

$$\dot{V}(\beta(t)) < \Gamma^2 \omega^T(t)\omega(t) - e_o^T(t)e_o(t) \quad (4.32)$$

By integrating the two sides of this inequality we obtain

$$\int_0^\infty \dot{V}(\beta(t)) dt < \int_0^\infty \Gamma^2 \omega^T(t)\omega(t) dt - \int_0^\infty e_o^T(t)e_o(t) dt \quad (4.33)$$

or equivalently

$$V(\infty) - V(0) < \Gamma^2 \|\omega(t)\|_2^2 - \|e_o(t)\|_2^2 \quad (4.34)$$

For the zero initial condition, it leads to  $\frac{\|e_o(t)\|_2^2}{\|\omega(t)\|_2^2} < \Gamma^2$ .

By applying the Schur complement to  $\Theta_i < 0$ , we obtain the following inequality

$$\begin{bmatrix} \Phi_i^T X + X \Phi_i & X \xi_i & \mathbb{P}_1^T \\ (*) & -\Gamma^2 & 0 \\ \mathbb{P}_1 & 0 & -I \end{bmatrix} < 0 \quad (4.35)$$

which can also be written as

$$\begin{bmatrix} \text{He}\{X_0(\mathcal{A}_i + \Delta A(t))\} & \Delta A^T(t)F_f^T X_1 & 0 & X_0(\mathcal{B}_i + \Delta B(t)) & 0 & 0 & 0 & 0 \\ (*) & \text{He}\{X_1(\mathbb{A}_{1,i} - \mathbb{Y}_i \mathbb{A}_2)\} & \mathbb{Y}_{2,i}^T X_2 & X_1 F_f \Delta B(t) & 0 & 0 & \mathbb{P}^T & 0 \\ (*) & (*) & \text{He}\{X_2 \alpha_i\} & 0 & X_2 \alpha_i & -X_2 & 0 & I \\ (*) & (*) & (*) & -\Gamma_1^2 & 0 & 0 & 0 & 0 \\ (*) & (*) & (*) & 0 & -\Gamma_2^2 & 0 & 0 & 0 \\ (*) & (*) & (*) & 0 & 0 & -\Gamma_3^2 & 0 & 0 \\ (*) & (*) & (*) & 0 & 0 & 0 & -I & 0 \\ (*) & (*) & (*) & 0 & 0 & 0 & 0 & -I \end{bmatrix} < 0 \quad (4.36)$$

where  $\mathbb{Y}_{2,i} = [K_{o,i} C P \ 0]$ .

It is noted that there exist time varying terms in the previous inequality whereby based on Lemma 1.1, it will obtain the upper bound of each one.

By using the definitions (4.6) and (4.7) the inequality (4.36) can be decomposed into the following terms

$$Q_i + \mathcal{T}(t) + \mathcal{T}^T(t) < 0 \quad (4.37)$$

where

$$Q_i = \begin{bmatrix} \text{He}\{X_0 \mathcal{A}_i\} & 0 & 0 & X_0 \mathcal{B}_i & 0 & 0 & 0 & 0 \\ (*) & \text{He}\{X_1(\mathbb{A}_{1,i} - \mathbb{Y}_i \mathbb{A}_2)\} & \mathbb{Y}_{2,i}^T X_2 & 0 & 0 & 0 & \mathbb{P}^T & 0 \\ (*) & (*) & \text{He}\{X_2 \alpha_i\} & 0 & X_2 \alpha_i & -X_2 & 0 & I \\ (*) & (*) & (*) & -\Gamma_1^2 & 0 & 0 & 0 & 0 \\ (*) & (*) & (*) & 0 & -\Gamma_2^2 & 0 & 0 & 0 \\ (*) & (*) & (*) & 0 & 0 & -\Gamma_3^2 & 0 & 0 \\ (*) & (*) & (*) & 0 & 0 & 0 & -I & 0 \\ (*) & (*) & (*) & 0 & 0 & 0 & 0 & -I \end{bmatrix}$$

and

$$\mathcal{T}(t) = \begin{bmatrix} X_0 Z_A \\ X_1 F_f Z_A \\ 0 \\ 0 \\ 0 \\ 0 \\ 0 \\ 0 \end{bmatrix} \Psi_A(t) \begin{bmatrix} E_A^T \\ 0 \\ 0 \\ 0 \\ 0 \\ 0 \\ 0 \\ 0 \end{bmatrix}^T + \begin{bmatrix} X_0 Z_B \\ X_1 F_f Z_B \\ 0 \\ 0 \\ 0 \\ 0 \\ 0 \\ 0 \end{bmatrix} \Psi_B(t) \begin{bmatrix} 0 \\ 0 \\ 0 \\ E_B^T \\ 0 \\ 0 \\ 0 \\ 0 \end{bmatrix}.$$

Using Lemma 1.1 on  $\mathcal{T}(t) + \mathcal{T}^T(t)$ , there exists positive scalars  $\lambda_1$  and  $\lambda_2$  such that

$$\begin{aligned} \mathcal{T}(t) + \mathcal{T}^T(t) &\leq \lambda_1^{-1} \begin{bmatrix} X_0 Z_A \\ X_1 F_f Z_A \\ 0 \\ 0 \\ 0 \\ 0 \\ 0 \\ 0 \end{bmatrix} \begin{bmatrix} X_0 Z_A \\ X_1 F_f Z_A \\ 0 \\ 0 \\ 0 \\ 0 \\ 0 \\ 0 \end{bmatrix}^T + \lambda_1 \begin{bmatrix} E_A^T \\ 0 \\ 0 \\ 0 \\ 0 \\ 0 \\ 0 \\ 0 \end{bmatrix} \begin{bmatrix} E_A^T \\ 0 \\ 0 \\ 0 \\ 0 \\ 0 \\ 0 \\ 0 \end{bmatrix}^T + \lambda_2^{-1} \begin{bmatrix} X_0 Z_B \\ X_1 F_f Z_B \\ 0 \\ 0 \\ 0 \\ 0 \\ 0 \\ 0 \end{bmatrix} \begin{bmatrix} X_0 Z_B \\ X_1 F_f Z_B \\ 0 \\ 0 \\ 0 \\ 0 \\ 0 \\ 0 \end{bmatrix}^T + \\ &\lambda_2 \begin{bmatrix} 0 \\ 0 \\ 0 \\ E_B^T \\ 0 \\ 0 \\ 0 \\ 0 \end{bmatrix} \begin{bmatrix} 0 \\ 0 \\ 0 \\ E_B^T \\ 0 \\ 0 \\ 0 \\ 0 \end{bmatrix}^T. \end{aligned} \quad (4.38)$$

The quadratic entries of the previous inequality can be handled by Schur's complement. Consequently, the inequality



(4.37) becomes

$$\begin{bmatrix}
 \text{He}\{X_0 A_i\} & 0 & 0 & X_0 B_i \\
 0 & \text{He}\{X_1(\mathbb{A}_{1,i} - \mathbb{Y}_i \mathbb{A}_2)\} & \mathbb{Y}_{2,i}^T X_2 & 0 \\
 0 & X_2 \mathbb{Y}_{2,i} & X_2 \alpha_i + \alpha_i^T X_2 & 0 \\
 B_i^T X_0 & 0 & 0 & -\Gamma_1^2 \\
 0 & 0 & \alpha_i^T X_2 & 0 \\
 0 & 0 & -X_2^T & 0 \\
 0 & \mathbb{P} & 0 & 0 \\
 0 & 0 & I & 0 \\
 \lambda_1 E_A & 0 & 0 & 0 \\
 Z_A^T X_0 & Z_A^T F_f^T X_1 & 0 & 0 \\
 0 & 0 & 0 & \lambda_2 E_B \\
 Z_B^T X_0 & Z_B^T F_f^T X_1 & 0 & 0
 \end{bmatrix}
 \begin{bmatrix}
 0 & 0 & 0 & 0 & \lambda_1 E_A^T & X_0 Z_A & 0 & X_0 Z_B \\
 0 & 0 & \mathbb{P}^T & 0 & 0 & X_1 F_f Z_A & 0 & X_1 F_f Z_B \\
 \bar{\alpha}_i & -X_2 & 0 & I & 0 & 0 & 0 & 0 \\
 0 & 0 & 0 & 0 & 0 & 0 & \lambda_2 E_B^T & 0 \\
 -\Gamma_2^2 & 0 & 0 & 0 & 0 & 0 & 0 & 0 \\
 0 & -\Gamma_3^2 & 0 & 0 & 0 & 0 & 0 & 0 \\
 0 & 0 & -I & 0 & 0 & 0 & 0 & 0 \\
 0 & 0 & 0 & -I & 0 & 0 & 0 & 0 \\
 0 & 0 & 0 & 0 & -\lambda_1 I & 0 & 0 & 0 \\
 0 & 0 & 0 & 0 & 0 & -\lambda_1 I & 0 & 0 \\
 0 & 0 & 0 & 0 & 0 & 0 & -\lambda_2 I & 0 \\
 0 & 0 & 0 & 0 & 0 & 0 & 0 & -\lambda_2 I
 \end{bmatrix} < 0 \quad (4.39)$$

which can also be written as

$$\mathbb{B} \mathbb{X}_i \mathbb{C} + (\mathbb{B} \mathbb{X}_i \mathbb{C})^T + \mathbb{D}_i < 0 \quad (4.40)$$

where  $\mathbb{B} = [0 \ -I \ 0 \ 0 \ 0 \ 0 \ 0 \ 0 \ 0 \ 0 \ 0 \ 0]^T$ ,  
 $\mathbb{C} = [0 \ \mathbb{A}_2 \ 0 \ 0 \ 0 \ 0 \ 0 \ 0 \ 0 \ 0 \ 0 \ 0]$ ,  $\mathbb{X}_i = X_1 \mathbb{Y}_i$  and  $\mathbb{D}_i$  is represented by (4.28).  
 According to the elimination lemma, the solvability conditions of equation (4.40) is reduced to :

$$\mathbb{C}^{T\perp} \mathbb{D}_i \mathbb{C}^{T\perp T} < 0 \quad (4.41)$$

□

### 4.2.3 Illustrative example : DC motor

In order to illustrate the previous results, let us consider the physics-based model of a DC motor which considers an electric equivalent circuit of the armature and the rotor free of charge. Its dynamics is described by the following state-space representation

$$\dot{x}(t) = \begin{bmatrix} -\frac{R(t)}{L} & -\frac{K_a}{J} \\ \frac{k_\tau}{J} & -\frac{K_w}{J} \end{bmatrix} x(t) + \begin{bmatrix} \frac{1}{L} \\ 0 \end{bmatrix} v_e(t) \quad (4.42a)$$

$$y(t) = Cx(t) \quad (4.42b)$$

where  $x(t) = \begin{bmatrix} i(t) \\ w(t) \end{bmatrix}$ . The parameter values are  $K_a = 0.01 \text{ V/rad/s}$ ,  $L = 0.5 \text{ H}$ ,  $k_\tau = 0.01 \text{ N} \cdot \text{m/A}$ ,  $K_w = 0.1 \text{ N} \cdot \text{m} \cdot \text{s}$  and  $J = 0.01 \text{ Kg} \cdot \text{m}^2$ . It is assuming that the electric resistance is an unmeasured time-varying parameter therefore, the DC motor model can be considered as an LPV system where the scheduling function  $\theta(t) = R(t) \in [0, 1.3]\Omega$ . The system (4.42a) is rewritten as

$$\dot{x}(t) = (A_0 + \theta(t)\bar{A})x(t) + Bv_e(t) \quad (4.43a)$$

$$y(t) = Cx(t) \quad (4.43b)$$

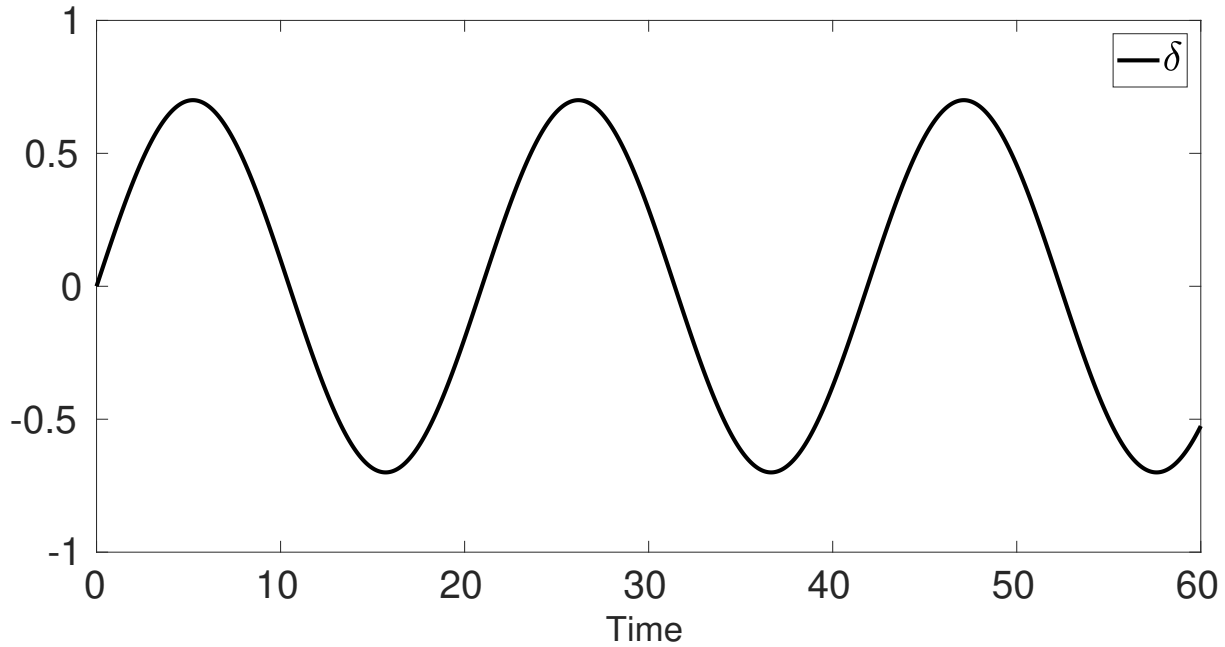

FIGURE 4.1 – Uncertainty.

with

$$A_0 = \begin{bmatrix} 0 & -\frac{K_a}{J} \\ \frac{k_r}{J} & -\frac{K_w}{J} \end{bmatrix}, \bar{A} = \begin{bmatrix} -\frac{1}{L} & 0 \\ 0 & 0 \end{bmatrix}, B = \begin{bmatrix} \frac{1}{L} \\ 0 \end{bmatrix}, C = [1 \quad 0]$$

The input variable  $v_e = 6V$ . The initial condition for the system is  $x(0) = [0, 0]^T$ , the initial condition for all the observers is  $\hat{x}(0) = [0, 0.7]^T$  and the initial condition of the estimated parameter is  $\hat{\theta}(0) = 0.1$ . The observer gains are obtained by solving the LMIs of the Theorem 4.1 using YALMIP toolbox using 'lmilab' as solver. In order to evaluate the performances of these observers an uncertainty  $\Delta A(t)$  is added to the system matrices  $A_0 + \theta(t)\bar{A}$ , where

$$\Delta A(t) = \delta(t) \begin{bmatrix} 0.01 & 0 \\ 0 & 2 \end{bmatrix}. \quad (4.44)$$

The obtained results for the adaptive observer with GDO and PO structures are depicted in the Figures 4.1-4.4. In this academic example, the measured state is  $x_1(t)$ , for the case of observation, it is important to estimate the dynamics behavior of the unmeasured state described in Figure 4.5 which it is illustrated that the GDO has a less steady-state error in comparison with the PO. Likewise, in Figure 4.6 is estimated the electric resistance of the DC motor. We can observe that the estimation of this unknown parameter is acceptable in both observers.

In order to compare the observer performances, the integral of absolute error (IAE) is calculated in the Table 4.1. The parameters  $\Gamma_1, \Gamma_2, \Gamma_3$  and  $\lambda_1$  described in Table 4.2 were chosen for the LMI feasibility problem.

TABLE 4.1 – Parameter index of each observer

		GDO	PO
$\hat{x}_1 - x_1$	IAE	0.279	0.530
$\hat{x}_2 - x_2$	IAE	0.196	3.01
$\hat{\theta} - \theta$	IAE	0.622	0.775

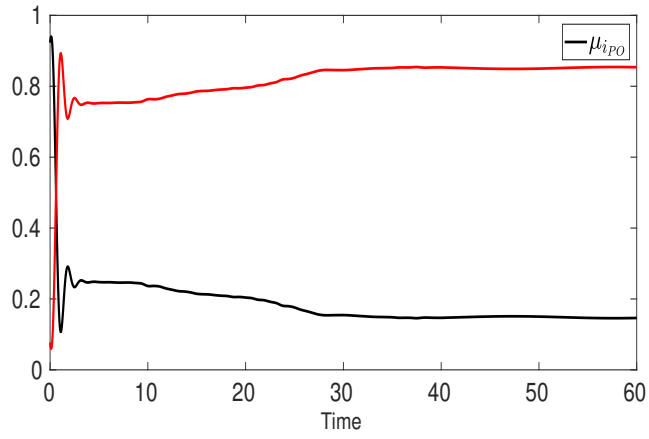

FIGURE 4.2 – Scheduling functions for adaptive PO.

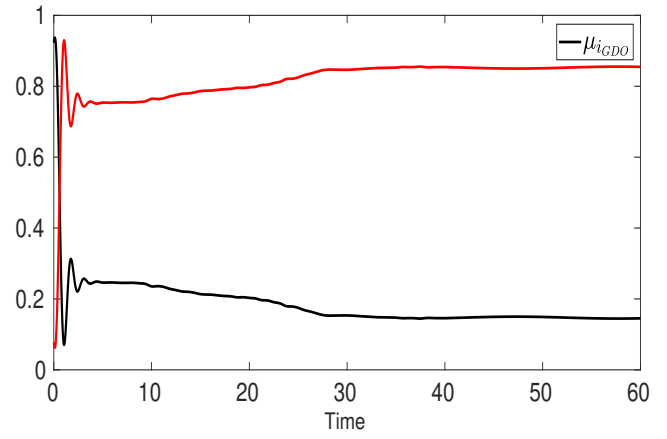

FIGURE 4.3 – Scheduling functions for adaptive observer

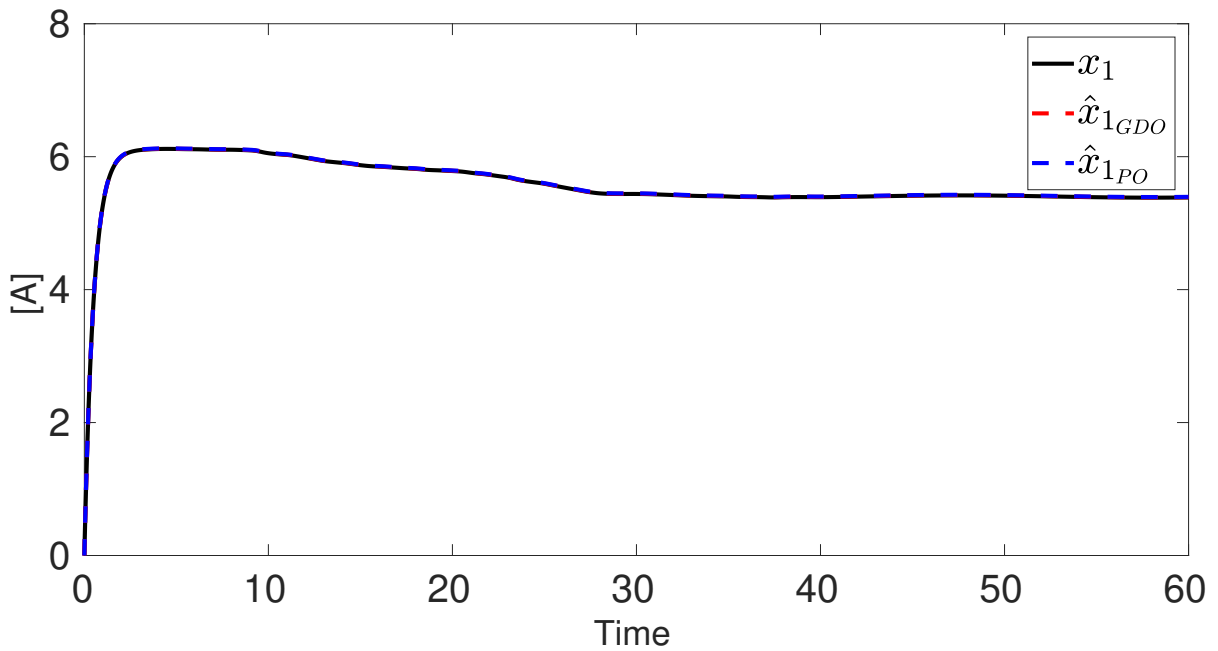

FIGURE 4.4 – State  $x_1$  and its estimate.

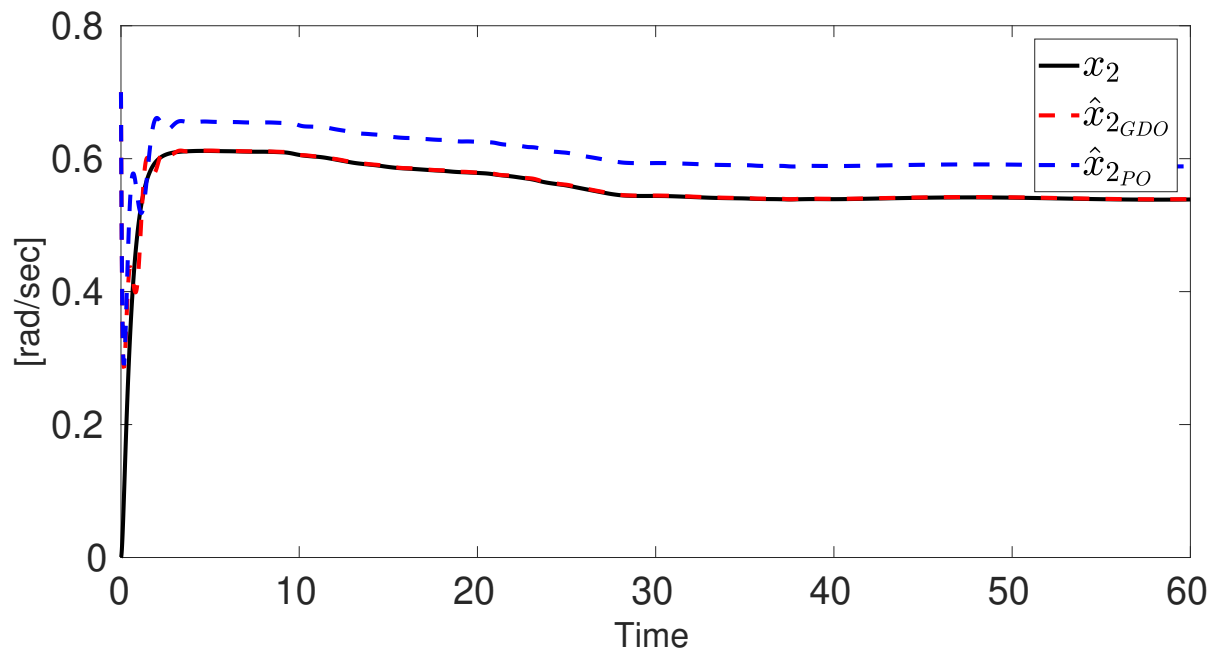

FIGURE 4.5 – State  $x_2$  and its estimate.

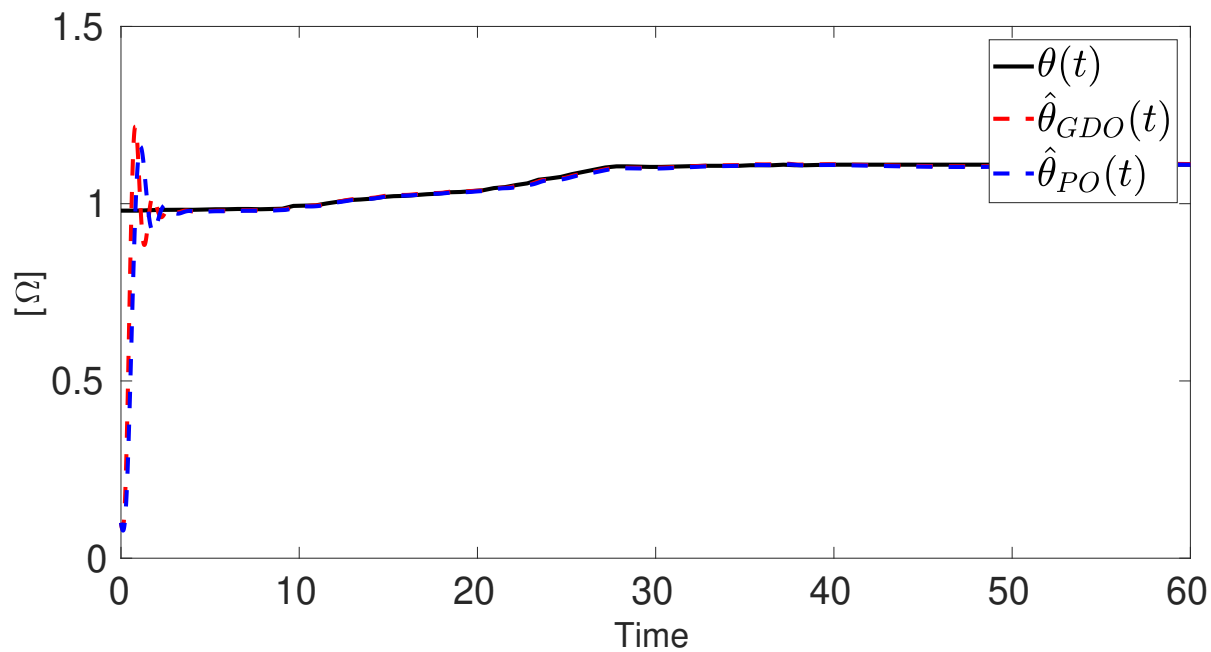

FIGURE 4.6 – Unknown parameter and their estimations.

TABLE 4.2 – Design parameters

	$\Gamma_1$	$\Gamma_2$	$\Gamma_3$	$\lambda_1$
GDO	0.5	0.5	0.5	0.591
PO	0.5	0.5	0.5	0.561

## 4.3 Adaptive generalized dynamic unknown input observer

### 4.3.1 Problem statement

For this design, an unknown input is considered in the system (4.1), which becomes as follows :

$$\dot{x}(t) = A(\theta(t))x(t) + B(\theta(t))u(t) + Dd(t) \quad (4.45a)$$

$$y(t) = Cx(t) \quad (4.45b)$$

with  $A(\theta(t)) = A_0 + \sum_{j=1}^{n_\theta} \theta_j(t)\bar{A}_j$ ,  $B(\theta(t)) = B_0 + \sum_{j=1}^{n_\theta} \theta_j(t)\bar{B}_j$ ,  $\theta_j(t) \in [\underline{\theta}_j, \bar{\theta}_j]$  and  $n_\theta$  is the number of unknown parameters.  $x(t) \in \mathbb{R}^n$  is the state vector,  $u(t) \in \mathbb{R}^m$  the input vector,  $y(t) \in \mathbb{R}^p$  represents the measured output vector,  $d(t) \in \mathbb{R}^{n_d}$  represents the unknown input. The description and properties of the unknown parameter vector  $\theta(t)$  are detailed in Section 4.2.1. Based on the conditions described in Section 4.2.1, the system (4.45) becomes

$$\dot{x}(t) = \sum_{i=1}^{\tau} \mu_i(\hat{\theta}(t))((\mathcal{A}_i + \Delta A(t))x(t) + (\mathcal{B}_i + \Delta B(t))u(t)) + Dd(t) \quad (4.46a)$$

$$y(t) = Cx(t) \quad (4.46b)$$

Now let us consider the following adaptive dynamic observer for system (4.46)

$$\dot{\zeta}(t) = \sum_{i=1}^{\tau} \mu_i(\hat{\theta}(t))(N_i\zeta(t) + H_i v(t) + F_i y(t) + J_i u(t)) \quad (4.47a)$$

$$\dot{v}(t) = \sum_{i=1}^{\tau} \mu_i(\hat{\theta}(t))(S_i\zeta(t) + L_i v(t) + M_i y(t)) \quad (4.47b)$$

$$\dot{\hat{\theta}}(t) = \sum_{i=1}^{\tau} \mu_i(\hat{\theta}(t))(K_{o,i}(C\hat{x}(t) - y(t)) + \alpha_i \hat{\theta}(t)) \quad (4.47c)$$

$$\hat{x}(t) = P\zeta(t) + Qy(t) \quad (4.47d)$$

where  $\zeta(t) \in \mathbb{R}^{q_0}$  represents the state vector of the observer,  $v(t) \in \mathbb{R}^{q_1}$  is an auxiliary vector,  $\hat{x}(t) \in \mathbb{R}^n$  is the estimate of  $x(t)$ ,  $\hat{\theta}(t) \in \mathbb{R}^{n_\theta}$  is the estimate of  $\theta(t)$ . The matrices  $N_i$ ,  $H_i$ ,  $F_i$ ,  $J_i$ ,  $S_i$ ,  $L_i$ ,  $M_i$ ,  $Q$ ,  $K_{o,i}$  and  $\alpha_i$  are unknown matrices of appropriate dimensions.

Let  $T \in \mathbb{R}^{q_0 \times n}$  be a parameter matrix and considering the transformed error  $\varepsilon(t) = \zeta(t) - Tx(t)$ , we have its derivative given by

$$\dot{\varepsilon}(t) = \sum_{i=1}^{\tau} \mu_i(\hat{\theta}(t))(N_i\varepsilon(t) + (N_iT + F_iC - T\mathcal{A}_i)x(t) + H_i v(t) + (J_i - TB_i)u(t) - T\Delta\mathcal{A}(t)x(t) - T\Delta\mathcal{B}(t)u(t) - TDd(t)) \quad (4.48)$$

By using the definition of  $\varepsilon(t)$ , equations (4.47b) and (4.47d) can be written as

$$\dot{v}(t) = \sum_{i=1}^{\tau} \mu_i(\hat{\theta}(t))(S_i\varepsilon(t) + (S_iT + M_iC)x(t) + L_i v(t)) \quad (4.49)$$

$$\hat{x}(t) = P\varepsilon(t) + (PT + QC)x(t) \quad (4.50)$$

If the following conditions are satisfied

$$N_i T + F_i C - T A_i = 0 \quad (4.51)$$

$$J_i - T B_i = 0 \quad (4.52)$$

$$T D = 0 \quad (4.53)$$

$$S_i T + M_i C = 0 \quad (4.54)$$

$$P T + Q C = I \quad (4.55)$$

the equations (4.48) and (4.49) reduce to the following system

$$\underbrace{\begin{bmatrix} \dot{\varepsilon}(t) \\ \dot{v}(t) \end{bmatrix}}_{\dot{\varphi}(t)} = \sum_{i=1}^{\tau} \mu_i(\hat{\theta}(t)) \left( \underbrace{\begin{bmatrix} N_i & H_i \\ S_i & L_i \end{bmatrix}}_{\mathbb{A}_i} \underbrace{\begin{bmatrix} \varepsilon(t) \\ v(t) \end{bmatrix}}_{\varphi(t)} + \underbrace{\begin{bmatrix} -T \\ 0 \end{bmatrix}}_{F_f} \Delta A(t) x(t) + \begin{bmatrix} -T \\ 0 \end{bmatrix} \Delta B(t) u(t) \right) \quad (4.56)$$

and the estimation error is written as

$$e(t) = \hat{x}(t) - x(t) = P \varepsilon(t). \quad (4.57)$$

Let us define the parameter estimation error as  $\tilde{\theta}(t) = \hat{\theta}(t) - \theta(t)$ , its dynamics is given by

$$\dot{\tilde{\theta}}(t) = \sum_{i=1}^{\tau} \mu_i(\hat{\theta}(t)) (K_i C P \varepsilon(t) + \alpha_i \tilde{\theta}(t) + \alpha_i \theta(t) - \dot{\theta}(t)) \quad (4.58)$$

The algebraic conditions (4.51)-(4.55) are satisfied using the parameterization described in Section 3.3 since both observer designs share the same algebraic constraints.

**Assumption 4.1.** *It assumes that  $\text{rank} \begin{bmatrix} E \\ C \end{bmatrix} D = \text{rank} C D$  or, since  $\begin{bmatrix} E \\ C \end{bmatrix}$  is of full column rank,  $\text{rank} D = \text{rank} C D$ .*

In order to deal with the uncertain term, by considering system (4.46), observer error dynamics (4.56) and parameter estimation error dynamics (4.58), we obtain the following augmented system

$$\underbrace{\begin{bmatrix} \dot{x}(t) \\ \dot{\varphi}(t) \\ \dot{\theta}(t) \end{bmatrix}}_{\dot{\beta}(t)} = \sum_{i=1}^{\tau} \mu_i(\hat{\theta}(t)) \left( \underbrace{\begin{bmatrix} \mathbb{A}_i + \Delta A(t) & 0 & 0 \\ F_f \Delta A(t) & \mathbb{A}_{1,i} - \mathbb{Y}_i \mathbb{A}_2 & 0 \\ 0 & [K_{o,i} C P \ 0] & \alpha_i \end{bmatrix}}_{\Phi_i} \underbrace{\begin{bmatrix} x(t) \\ \varphi(t) \\ \tilde{\theta} \end{bmatrix}}_{\beta(t)} + \underbrace{\begin{bmatrix} \mathbb{B}_i + \Delta B(t) & 0 & 0 & D \\ F_f \Delta B(t) & 0 & 0 & 0 \\ 0 & \alpha_i & -I & 0 \end{bmatrix}}_{\xi_i(t)} \omega(t) \right) \quad (4.59a)$$

$$e_o(t) = \underbrace{\begin{bmatrix} 0 & \mathbb{P} & 0 \\ 0 & 0 & I \end{bmatrix}}_{\mathbb{P}_1} \beta(t) \quad (4.59b)$$

where  $\mathbb{P} = [I_{q_0} \ 0]$ ,  $F_f = \begin{bmatrix} -T \\ 0 \end{bmatrix}$ ,  $\omega(t) = \begin{bmatrix} u(t) \\ \theta(t) \\ \dot{\theta}(t) \\ d(t) \end{bmatrix}$ ,  $\mathbb{A}_{1,i} = \begin{bmatrix} N_{1,i} & 0 \\ 0 & 0 \end{bmatrix}$ ,  $\mathbb{Y}_i = \begin{bmatrix} Z_i & H_i \\ U_{1,i} & L_i \end{bmatrix}$  and  $\mathbb{A}_2 = \begin{bmatrix} N_3 & 0 \\ 0 & -I \end{bmatrix}$ .

### 4.3.2 Stability conditions

The following Theorem shows sufficient stability conditions of the problem of the observer design guarantying the convergence of the system  $\dot{\beta}(t)$  towards zero when  $\omega(t)$  is null. For  $\omega \neq 0$  we must minimize the effect of  $\omega(t)$  on  $e_o(t)$  such that  $\sup_{w \in \mathcal{L}_2 - \{0\}} \frac{\|e_o(t)\|_2^2}{\|\omega(t)\|_2^2} < \Gamma^2$ .

**Theorem 4.2.** *If there exists the parameter matrix  $\mathbb{Y}_i$ ,  $X_0 = X_0^T > 0$ ,  $X_1 = \begin{bmatrix} X_{11} & X_{12} \\ X_{12}^T & X_{13} \end{bmatrix} > 0$ ,  $X_2 = X_2^T > 0$  and diagonal matrices  $\Gamma_1^2, \Gamma_2^2, \Gamma_3^2, \Gamma_4^2$  with appropriate dimensions.  $\vartheta$ ,  $\lambda_1$ ,  $\lambda_2$ ,  $\bar{\alpha}_i$  and  $\bar{K}_i$  which satisfy the optimization problem (4.60) under LMIs (4.62)*

$$\min_{X_0, X_1, X_2, \lambda_1, \lambda_2, \Gamma_1^2, \Gamma_2^2, \Gamma_3^2, \Gamma_4^2} \vartheta \quad (4.60)$$

$$\Gamma_{k_1}^2 < \vartheta I, \quad \text{for } k_1 = 1, 2, 3, 4 \quad (4.61)$$

$$\left[ \begin{array}{cccccccccccc} He\{X_0 A_i\} & 0 & 0 & X_0 B_i & 0 & 0 & X_0 D & 0 & 0 & \lambda_1 E_A^T & X_0 Z_A & 0 & X_0 Z_B \\ 0 & \Pi_{1,i} & N_3^{T\perp} P^T C^T \bar{K}_i^T & 0 & 0 & 0 & 0 & N_3^{T\perp} P^T & 0 & 0 & \Pi_2 & 0 & \Pi_3 \\ 0 & \bar{K}_i C P N_3^{T\perp T} & \bar{\alpha}_i + \bar{\alpha}_i^T & 0 & \bar{\alpha}_i & -X_2 & 0 & 0 & I & 0 & 0 & 0 & 0 \\ \mathcal{B}_i^T X_0 & 0 & 0 & -\Gamma_1^2 & 0 & 0 & 0 & 0 & 0 & 0 & 0 & \lambda_2 E_B^T & 0 \\ 0 & 0 & \bar{\alpha}_i^T & 0 & -\Gamma_2^2 & 0 & 0 & 0 & 0 & 0 & 0 & 0 & 0 \\ 0 & 0 & -X_2^T & 0 & 0 & -\Gamma_3^2 & 0 & 0 & 0 & 0 & 0 & 0 & 0 \\ D^T X_0 & 0 & 0 & 0 & 0 & 0 & -\Gamma_4^2 & 0 & 0 & 0 & 0 & 0 & 0 \\ 0 & P N_3^{T\perp T} & 0 & 0 & 0 & 0 & 0 & -I & 0 & 0 & 0 & 0 & 0 \\ 0 & 0 & I & 0 & 0 & 0 & 0 & 0 & -I & 0 & 0 & 0 & 0 \\ \lambda_1 E_A & 0 & 0 & 0 & 0 & 0 & 0 & 0 & 0 & -\lambda_1 I & 0 & 0 & 0 \\ Z_A^T X_0 & \Pi_2^T & 0 & 0 & 0 & 0 & 0 & 0 & 0 & 0 & -\lambda_1 I & 0 & 0 \\ 0 & 0 & 0 & \lambda_2 E_B & 0 & 0 & 0 & 0 & 0 & 0 & 0 & -\lambda_2 I & 0 \\ Z_B^T X_0 & \Pi_3^T & 0 & 0 & 0 & 0 & 0 & 0 & 0 & 0 & 0 & 0 & -\lambda_2 I \end{array} \right] < 0 \quad (4.62)$$

with  $\Pi_{1,i} = N_3^{T\perp} (X_{11} N_{1,i} + N_{1,i}^T X_{11}) N_3^{T\perp T}$ , with  $\alpha_i = X_2^{-1} \bar{\alpha}_i$ ,  $\Pi_2 = -N_3^{T\perp} X_{11} T A$ ,  $\Pi_3 = -N_3^{T\perp} X_{11} T B$  and  $K_i = X_2^{-1} \bar{K}_i$ , then (4.59) is asymptotically stable with an  $H_\infty$  disturbance attenuation level  $\Gamma$ . According to the elimination lemma, the matrix  $\mathbb{Y}_i$  is parameterized as

$$\mathbb{Y}_i = X_1^{-1} (\mathcal{B}_r^+ \mathcal{K}_i \mathcal{C}_l^+ + \mathcal{Z} - \mathcal{B}_r^+ \mathcal{B}_r \mathcal{Z} \mathcal{C}_l \mathcal{C}_l^+) \quad (4.63)$$

with

$$\mathcal{K}_i = \mathcal{R}^{-1} \mathcal{B}_l^T \Lambda_i \mathcal{C}_r^T (\mathcal{C}_r \Lambda_i \mathcal{C}_r^T)^{-1} + \mathcal{S}_i^{1/2} \phi (\mathcal{C}_r \Lambda_i \mathcal{C}_r^T)^{-1/2} \quad (4.64)$$

$$\mathcal{S}_i = \mathcal{R}^{-1} - \mathcal{R}^{-1} \mathcal{B}_l^T [\Lambda_i - \Lambda_i \mathcal{C}_r^T (\mathcal{C}_r^T \Lambda_i \mathcal{C}_r^T)^{-1} \mathcal{C}_r \Lambda_i] \mathcal{B}_l \mathcal{R}^{-1} \quad (4.65)$$

$$\Lambda_i = (\mathcal{B}_r \mathcal{R}^{-1} \mathcal{B}_l^T - \mathcal{D}_i)^{-1} > 0 \quad (4.66)$$

where

$\mathbb{D}_i =$

$$\left[ \begin{array}{cccccccccccc} He\{X_0 A_i\} & 0 & 0 & X_0 B_i & 0 & 0 & X_0 D & 0 & 0 & \lambda_1 E_A^T & X_0 Z_A & 0 & X_0 Z_B \\ 0 & He\{X_1 \mathbb{A}_{1,i}\} & \mathbb{Y}_{2,i}^T X_2 & 0 & 0 & 0 & 0 & \mathbb{P}^T & 0 & 0 & X_1 F_f Z_A & 0 & X_1 F_f Z_B \\ 0 & X_2 \mathbb{Y}_{2,i} & X_2 \alpha_i + \alpha_i^T X_2 & 0 & X_2 \alpha_i & -X_2 & 0 & 0 & I & 0 & 0 & 0 & 0 \\ \mathcal{B}_i^T X_0 & 0 & 0 & -\Gamma_1^2 & 0 & 0 & 0 & 0 & 0 & 0 & 0 & \lambda_2 E_B^T & 0 \\ 0 & 0 & \alpha_i^T X_2 & 0 & -\Gamma_2^2 & 0 & 0 & 0 & 0 & 0 & 0 & 0 & 0 \\ 0 & 0 & -X_2^T & 0 & 0 & -\Gamma_3^2 & 0 & 0 & 0 & 0 & 0 & 0 & 0 \\ D^T X_0 & 0 & 0 & 0 & 0 & 0 & -\Gamma_4^2 & 0 & 0 & 0 & 0 & 0 & 0 \\ 0 & \mathbb{P} & 0 & 0 & 0 & 0 & 0 & -I & 0 & 0 & 0 & 0 & 0 \\ 0 & 0 & I & 0 & 0 & 0 & 0 & 0 & -I & 0 & 0 & 0 & 0 \\ \lambda_1 E_A & 0 & 0 & 0 & 0 & 0 & 0 & 0 & 0 & -\lambda_1 I & 0 & 0 & 0 \\ Z_A^T X_0 & Z_A^T F_f^T X_1 & 0 & 0 & 0 & 0 & 0 & 0 & 0 & 0 & -\lambda_1 I & 0 & 0 \\ 0 & 0 & 0 & \lambda_2 E_B & 0 & 0 & 0 & 0 & 0 & 0 & 0 & -\lambda_2 I & 0 \\ Z_B^T X_0 & Z_B^T F_f^T X_1 & 0 & 0 & 0 & 0 & 0 & 0 & 0 & 0 & 0 & 0 & -\lambda_2 I \end{array} \right] \quad (4.67)$$

$$\mathbb{Y}_{2,i} = [K_{0,i} C P \quad 0], \quad \mathbb{B} = [0 \quad -I \quad 0 \quad 0 \quad 0 \quad 0 \quad 0 \quad 0 \quad 0 \quad 0 \quad 0 \quad 0 \quad 0]^T,$$

$\mathbb{C} = [0 \quad \mathbb{A}_2 \quad 0 \quad 0 \quad 0 \quad 0 \quad 0 \quad 0 \quad 0 \quad 0 \quad 0 \quad 0 \quad 0]$ ,  $\phi$  is an arbitrary matrix such that  $\|\phi\|_2 < 1$  and  $\mathcal{R} > 0$ . Matrices  $\mathcal{C}_l$ ,  $\mathcal{C}_r$ ,  $\mathcal{B}_l$  and  $\mathcal{B}_r$  are any full rank matrices such that  $\mathbb{C} = \mathcal{C}_l \mathcal{C}_r$  and  $\mathbb{B} = \mathcal{B}_l \mathcal{B}_r$ .

The proof of this theorem is similar to Theorem 4.1.

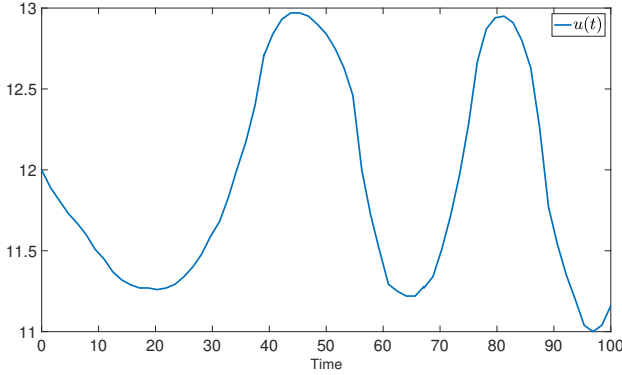

FIGURE 4.7 – Input.

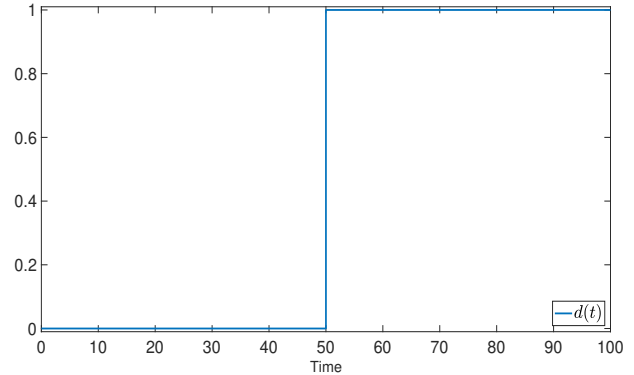

FIGURE 4.8 – Actuator fault.

### 4.3.3 Numerical example

Let us consider the linear time varying system defined by :

$$\dot{x}(t) = (A_0 + \theta(t)\bar{A})x(t) + B(u(t) + d(t)) \quad (4.68a)$$

$$y(t) = Cx(t) \quad (4.68b)$$

$$A_0 = \begin{bmatrix} -2 & 1.4 & 0.3 \\ 0.2 & -3 & 0 \\ 0.1 & 0 & -1 \end{bmatrix}, \bar{A} = \begin{bmatrix} 0 & 0 & 0 \\ 0 & 0 & 0 \\ 0 & 0 & -1.1 \end{bmatrix}, B = \begin{bmatrix} 1 \\ 0.5 \\ 0 \end{bmatrix}, C = \begin{bmatrix} 1 & 0 & 0 \\ 0 & 0 & 1 \end{bmatrix}$$

In this example, an actuator fault  $d(t)$  is added to the system. The time varying parameter is  $\theta(t) \in [-1, 1]$ . The initial condition for the system is  $x(0) = [2, 1, 2.5]^T$ , the initial condition for the observer is  $\hat{x}(0) = [2, 1.4, 2.5]^T$  and the initial condition of the estimated parameter is  $\hat{\theta}(0) = 0.2$ .

The observer gains are obtained by solving the LMIs of the Theorem 4.2 using the YALMIP toolbox. The obtained results are depicted in Figures 4.7-4.11. Figure 4.9 illustrates the state estimation against unknown input; it can be observed that the unmeasured state has an acceptable estimation despite the actuator fault which is illustrated in Figure 4.8. Figure 4.10 shows the estimation of the real dynamics behavior of  $\theta(t)$  and its estimation  $\hat{\theta}(t)$ . It can be noted that there exists an acceptable estimation of this unknown parameter despite the actuator fault which occurs in the steady-state of the simulation as long as Assumption 4.1 holds.

## 4.4 Conclusions

In this chapter, we consider the joint estimation of states and parameters for linear parameter varying (LPV) systems. Its conditions of existence and stability are given in terms of a set of LMIs. On the other hand, it has addressed rank conditions to decouple the estimation and the unknown input. This fact is satisfied using the parameterization used in the previous GDO designs. In order to illustrate the efficiency of the proposed approach, academic examples were presented.



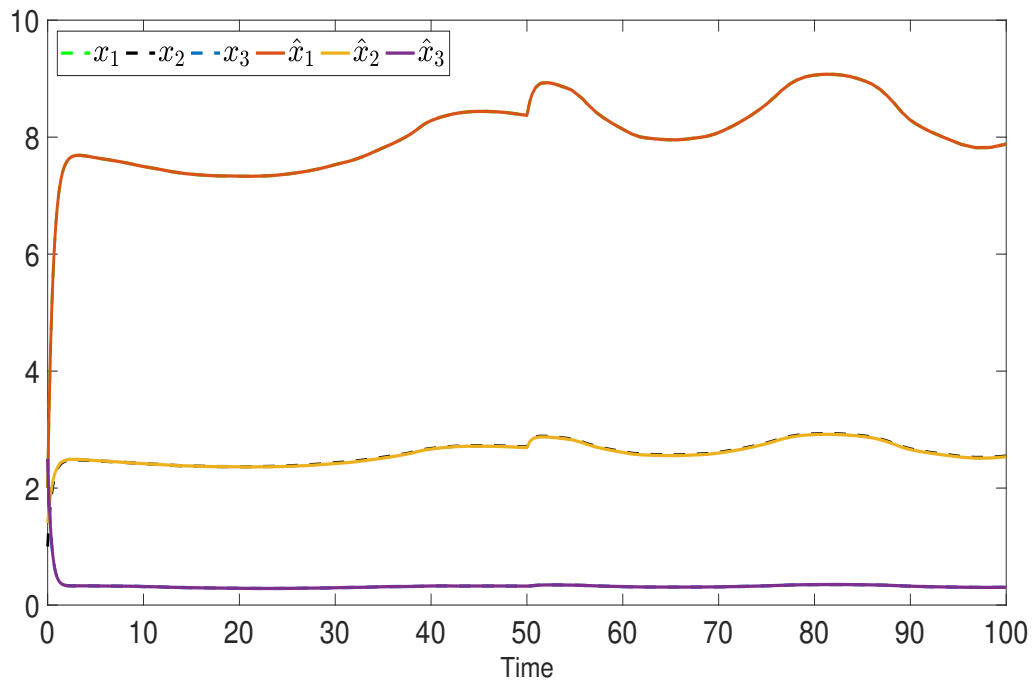

FIGURE 4.9 – Real and estimated state variables

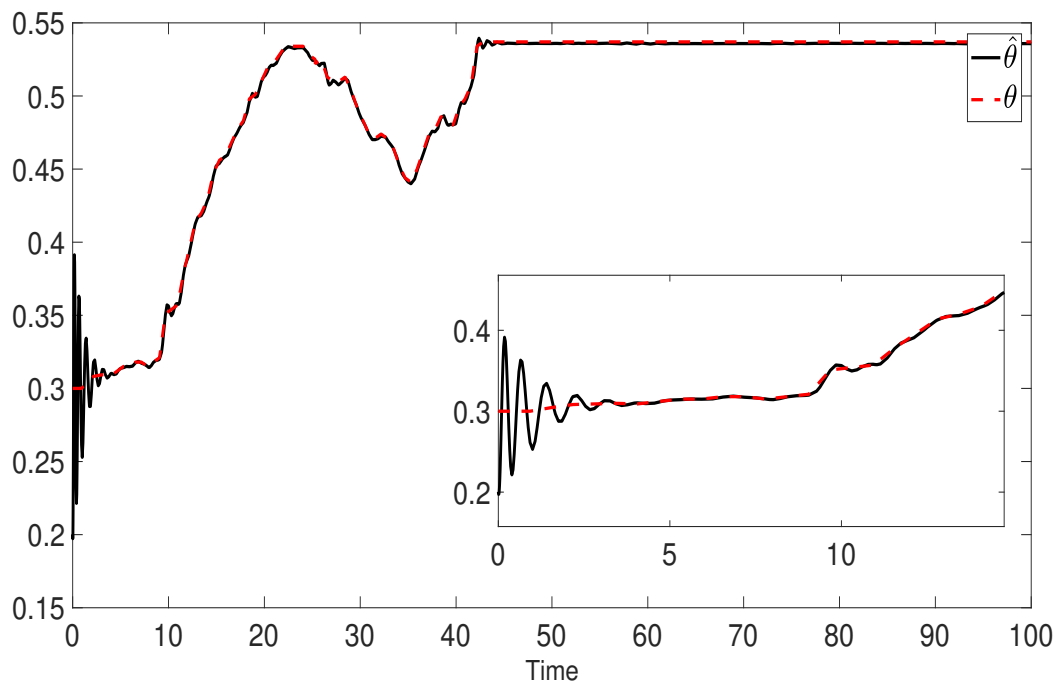

FIGURE 4.10 – Real and estimated parameter

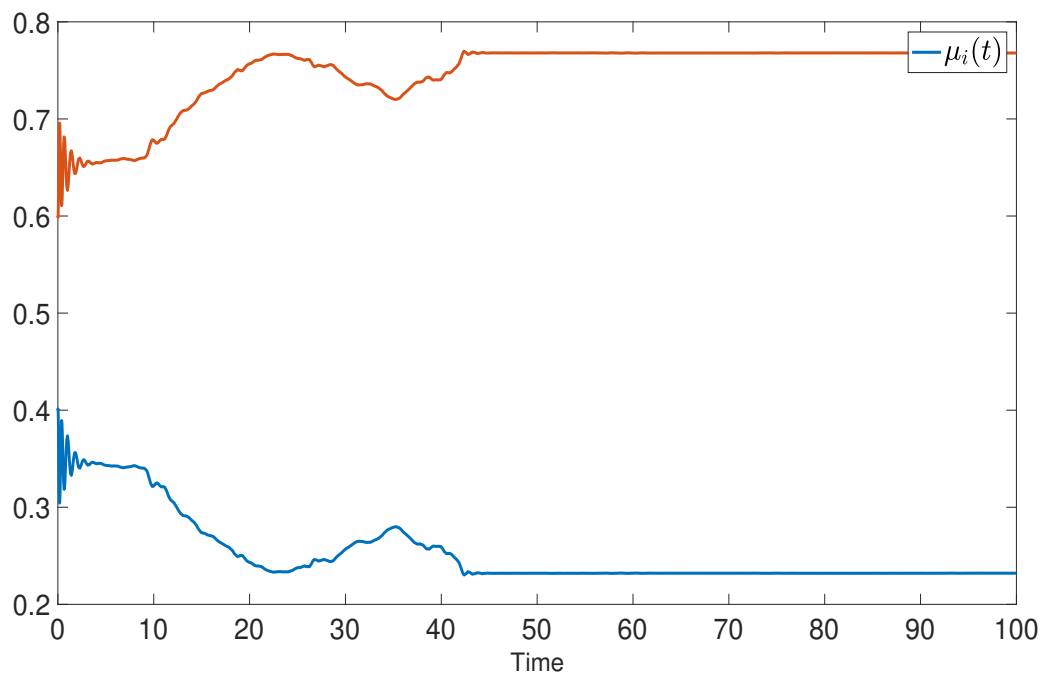

FIGURE 4.11 – Scheduling functions

## Chapter 5

# Fault tolerant control using reference model for LPV systems

### Contents

---

<b>5.1</b>	<b>Introduction</b>	<b>83</b>
<b>5.2</b>	<b>Actuator fault tolerant control for LPV systems</b>	<b>83</b>
5.2.1	Problem statement	83
5.2.2	Observer parameterization	86
5.2.3	Fault tolerant control design	88
5.2.4	Application to vehicle lateral dynamics	89
<b>5.3</b>	<b>Parameter estimation and actuator fault tolerant control</b>	<b>93</b>
5.3.1	Problem formulation	93
5.3.2	Numerical example	95
<b>5.4</b>	<b>Conclusions</b>	<b>100</b>

---

## 5.1 Introduction

In the previous chapters, results related to generalized dynamic unknown input observers, adaptive observers for LPV with measured and unmeasured scheduling variables were presented. In this chapter, some techniques for fault estimation and model reference control for LPV systems are studied. Afterward, based on the obtained results, an active FTC will be proposed with the purpose to detect actuator faults which produce measurement errors or changes in the nominal operation. A model-based fault diagnosis unit is proposed to monitor, locate, and identify the actuator faults. The FTC strategy will use the fault and parameter variation information to satisfy the control objectives with the minimum performance degradation after the fault occurrence.

The following sections describe in detail the FTC system used in this research work.

## 5.2 Actuator fault tolerant control for LPV systems

The active FTC scheme used in this section is illustrated in Figure 5.1.

### 5.2.1 Problem statement

Consider the following linear parameter varying (LPV) system subject to actuator faults

$$\dot{x}(t) = A(\rho(t))x(t) + Bu_c(t) + Gf(t) \quad (5.1a)$$

$$y(t) = Cx(t) \quad (5.1b)$$

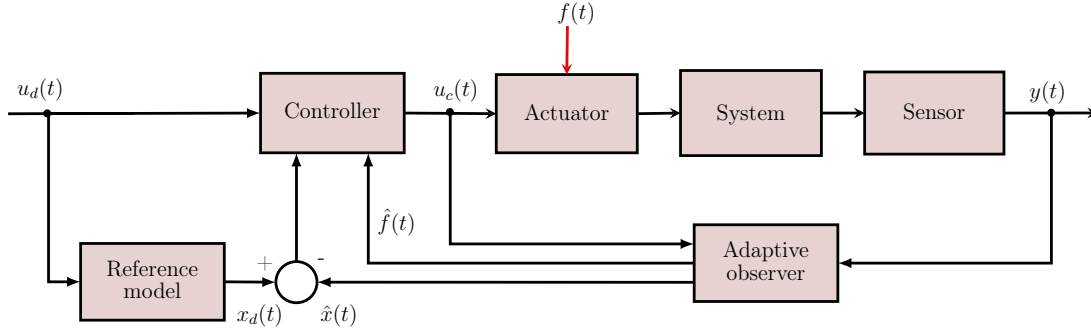

FIGURE 5.1 – Fault tolerant control scheme.

where  $x(t) \in \mathbb{R}^n$  is the state vector,  $u_c(t) \in \mathbb{R}^m$  the control input vector,  $f(t) \in \mathbb{R}^{n_f}$  is the fault vector,  $y(t) \in \mathbb{R}^p$  is the output vector and  $\rho(t) \in \mathbb{R}^j$  is a varying parameter vector.

It is assumed that each component  $\rho^i(t)$ ,  $i \in \{1, 2, \dots, j\}$  of the time-varying parameter vector  $\rho(t)$  is bounded, measurable and their values remain into a hyper-rectangle such that

$$\rho(t) \in \mathcal{P} = \left\{ \rho^i(t) \mid \underline{\rho}^i \leq \rho^i(t) \leq \bar{\rho}^i \right\}, \forall i \in \{1, 2, \dots, j\}, \forall t \geq 0 \quad (5.2)$$

Based on the affine parameter dependence (5.2), the matrices  $A(\rho(t))$  of the LPV system (5.1) can be represented by the following form :

$$A(\rho(t)) = A_0 + \sum_{i=1}^j \rho^i(t) A_i \quad (5.3)$$

From this characterization, system (5.1) can be transformed into a convex combination where the vertices  $\mathcal{S}_i$  of the polytope are the images of the vertices of  $\mathcal{P}$  such that  $\mathcal{S}_i = [A_i, B, G, C]$ ,  $\forall i \in \{1, 2, \dots, \tau\}$  where  $\tau = 2^j$ . The polytopic coordinates are denoted by  $\mu(\rho(t))$  and they vary into the convex set  $\Lambda$  where

$$\Lambda = \left\{ \mu(\rho(t)) \in \mathbb{R}^\tau, \mu(\rho(t)) = [\mu_1(\rho(t)), \mu_2(\rho(t)), \dots, \mu_\tau(\rho(t))]^T, \mu_i(\rho(t)) \geq 0, \sum_{i=1}^{\tau} \mu_i(\rho(t)) = 1 \right\} \quad (5.4)$$

The polytopic LPV system with the time-varying parameter vector  $\mu_i(\rho(t)) \in \Lambda$  is described by

$$\dot{x}(t) = \sum_{i=1}^{\tau} \mu_i(\rho(t)) A_i x(t) + B u_c(t) + G f(t) \quad (5.5a)$$

$$y(t) = C x(t) \quad (5.5b)$$

where matrices  $A_i \in \mathbb{R}^{n \times n}$ ,  $B \in \mathbb{R}^{n \times m}$ ,  $G \in \mathbb{R}^{n \times n_f}$  and  $C \in \mathbb{R}^{p \times n}$  are constant known matrices.

Now, let us consider the GDO for system (5.5) in the following form

$$\dot{\zeta}(t) = \sum_{i=1}^{\tau} \mu_i(\rho(t)) (N_i(\zeta(t) + T G \hat{f}(t)) + H_i v(t) + F_i y(t) + T G \hat{f}(t) + J u_c(t)) \quad (5.6a)$$

$$\dot{v}(t) = \sum_{i=1}^{\tau} \mu_i(\rho(t)) (S_i(\zeta(t) + T G \hat{f}(t)) + L_i v(t) + M_i y(t)) \quad (5.6b)$$

$$\hat{x}(t) = P(\zeta(t) + T G \hat{f}(t)) + Q y(t) \quad (5.6c)$$

$$\dot{\hat{f}}(t) = \sum_{i=1}^{\tau} \mu_i(\rho(t)) K_{o,i} (C \hat{x} - y(t)) \quad (5.6d)$$

where  $\zeta(t) \in \mathbb{R}^{q_0}$  represents the state vector of the observer,  $v(t) \in \mathbb{R}^{q_1}$  is an auxiliary vector,  $\hat{x}(t)$  is the estimate of  $x(t)$  and  $\hat{f}(t) \in \mathbb{R}^{n_f}$  is the estimate of  $f(t)$ . Matrices  $N_i$ ,  $F_i$ ,  $J$ ,  $H_i$ ,  $L_i$ ,  $S_i$ ,  $M_i$ ,  $P$ ,  $Q$ ,  $T$  and  $K_{o,i}$  are unknown and of appropriate dimensions.

For the sake of simplicity, the following notation is used

$$\Psi(\rho) = \sum_{i=1}^{\tau} \mu_i(\rho(t)) \Psi_i, \quad \forall i \in \{1, \dots, \tau\}$$

Thus, system (5.6) can be rewritten as follows :

$$\dot{\zeta}(t) = N(\rho)(\zeta(t) + TG\hat{f}(t)) + H(\rho)v(t) + F(\rho)y(t) + TG\hat{f}(t) + Ju_c(t) \quad (5.7a)$$

$$\dot{v}(t) = S(\rho)(\zeta(t) + TG\hat{f}(t)) + L(\rho)v(t) + M(\rho)y(t) \quad (5.7b)$$

$$\hat{x}(t) = P(\zeta(t) + TG\hat{f}(t)) + Qy(t) \quad (5.7c)$$

$$\dot{\hat{f}}(t) = K_o(\rho)(C\hat{x} - y(t)) \quad (5.7d)$$

Let  $T \in \mathbb{R}^{q_0 \times n}$  be a parameter matrix and considering the transformed error  $\varepsilon(t) = \zeta(t) - Tx(t) + TGf(t)$ ,  $\tilde{f}(t) = \hat{f}(t) - f(t)$  and that  $\dot{f}(t) = 0$ , we have the derivative of  $\varepsilon(t)$  given by

$$\dot{\varepsilon}(t) = N(\rho)\varepsilon(t) + (N(\rho)T + F(\rho)C - TA(\rho))x(t) + H(\rho)v(t) + (J - TB)u_c(t) + (N(\rho)TG + TG)\tilde{f}(t) \quad (5.8)$$

By using the definition of  $\varepsilon(t)$ , equations (5.6b) and (5.6c) can be written as

$$\dot{v}(t) = S(\rho)\varepsilon(t) + (S(\rho)T + M(\rho)C)x(t) + L(\rho)v(t) + S(\rho)TG\tilde{f}(t) \quad (5.9)$$

$$\hat{x}(t) = P\varepsilon(t) + (PT + QC)x(t) + PTG\tilde{f}(t) \quad (5.10)$$

If the following conditions are satisfied

- (a)  $N(\rho)T + F(\rho)C - TA(\rho) = 0$
- (b)  $J - TB = 0$
- (c)  $S(\rho)T + M(\rho)C = 0$
- (d)  $PT + QC = I$

the equations (5.8)-(5.10) are reduced to the following system

$$\begin{bmatrix} \dot{\varepsilon}(t) \\ \dot{v}(t) \end{bmatrix} = \begin{bmatrix} N(\rho) & H(\rho) \\ S(\rho) & L(\rho) \end{bmatrix} \begin{bmatrix} \varepsilon(t) \\ v(t) \end{bmatrix} + \begin{bmatrix} N(\rho)TG + TG \\ S(\rho)TG \end{bmatrix} \tilde{f}(t) \quad (5.11)$$

and the state estimation error is written as

$$e(t) = \hat{x}(t) - x(t) = P\varepsilon(t) + PTG\tilde{f}(t). \quad (5.12)$$

In this case, if  $\tilde{f}(t) = 0$  and the system (5.11) is asymptotically stable then  $\lim_{t \rightarrow \infty} e(t) = 0$ .

On the other hand, since  $\dot{f}(t) = 0$  and the condition (d) is satisfied so, the derivative of  $\tilde{f}(t)$  is given by

$$\dot{\tilde{f}}(t) = K_o(\rho)CP\varepsilon(t) + K_o(\rho)CPTG\tilde{f}(t) \quad (5.13)$$

### Fault tolerant tracking controller

The FT tracking controller design is based on the information provided by the adaptive observer (5.6). It consists in tracking a given trajectory  $x_d(t)$  corresponding to a desired input  $u_d(t)$ . The following equation describes the dynamics of  $x_d(t)$

$$\dot{x}_d(t) = A(\rho)x_d(t) + Bu_d(t). \quad (5.14)$$

Consequently, the FTC law is given by

$$u_c(t) = -K_c(\rho)(\hat{x}(t) - x_d(t)) - B^+G\hat{f}(t) + u_d(t) \quad (5.15)$$

such that the system  $x(t)$  affected by actuator fault converges towards the healthy state  $x_d(t)$  even when the faults appear on the system.

**Assumption 5.1.** We assume that  $\text{rank } B = \text{rank } [B \ G]$

The tracking error is described by  $\tilde{x}(t) = x(t) - x_d(t)$  which its dynamics is

$$\dot{\tilde{x}}(t) = (A(\rho) - BK_c(\rho))\tilde{x}(t) - BK_c(\rho)P\varepsilon(t) - (BK_c(\rho)PTG + G)\tilde{f}(t) \quad (5.16)$$

**Remark 5.1.** Under Assumption 5.1, the equation (5.16) is satisfied if there exists a matrix  $B^+$  such that

$$(I_n - BB^+)G = 0. \quad (5.17)$$

## 5.2.2 Observer parameterization

In this section, we will give the parameterization of the algebraic constraints (a)-(d). Let  $E \in \mathbb{R}^{q_0 \times n}$  be any full row rank matrix such that the matrix  $\Sigma = \begin{bmatrix} E \\ C \end{bmatrix}$  is of full column rank and let  $\Omega = \begin{bmatrix} I_n \\ C \end{bmatrix}$ . Conditions (c) and (d) can be written as :

$$\begin{bmatrix} S(\rho) & M(\rho) \\ P & Q \end{bmatrix} \begin{bmatrix} T \\ C \end{bmatrix} = \begin{bmatrix} 0 \\ I_n \end{bmatrix} \quad (5.18)$$

The necessary and sufficient condition for (5.18) to be consistent is that  $\mathcal{R} \left( \begin{bmatrix} 0 \\ I_n \end{bmatrix} \right) \subset \mathcal{R} \left( \begin{bmatrix} T \\ C \end{bmatrix} \right)$  or equivalently

$$\text{rank} \begin{bmatrix} T \\ C \end{bmatrix} = \text{rank} \begin{bmatrix} T \\ C \\ 0 \\ I_n \end{bmatrix} = n \quad (5.19)$$

On the other hand, since  $\text{rank} \begin{bmatrix} T \\ C \end{bmatrix} = n$ , there always exist matrices  $T \in \mathbb{R}^{q_0 \times n}$  and  $K \in \mathbb{R}^{q_0 \times p}$  such that :

$$T + KC = E \quad (5.20)$$

which can be written as :

$$\begin{bmatrix} T & K \end{bmatrix} \Omega = E \quad (5.21)$$

and since  $\text{rank}(\Omega) = \text{rank} \begin{bmatrix} \Omega \\ E \end{bmatrix}$ . The general solution to equation (5.21) is given by :

$$\begin{bmatrix} T & K \end{bmatrix} = E\Omega^+ - Y_1(I_{n+p} - \Omega\Omega^+) \quad (5.22)$$

From equation (5.22) we deduce that

$$T = T_1 - Y_1 T_2 \quad (5.23)$$

$$K = K_1 - Y_1 K_2 \quad (5.24)$$

where  $T_1 = E\Omega^+ \begin{bmatrix} I_n \\ 0 \end{bmatrix}$ ,  $T_2 = (I_{n+p} - \Omega\Omega^+) \begin{bmatrix} I_n \\ 0 \end{bmatrix}$ ,  $K_1 = E\Omega^+ \begin{bmatrix} 0 \\ I_p \end{bmatrix}$  and  $K_2 = (I_{n+p} - \Omega\Omega^+) \begin{bmatrix} 0 \\ I_p \end{bmatrix}$ .

By inserting the value of matrix  $T$  given by equation (5.20) into condition (a) we obtain

$$N(\rho)E + \tilde{K}(\rho)C = TA(\rho) \quad (5.25)$$

where  $\tilde{K}(\rho) = F(\rho) - N(\rho)K$  and equation (5.25) can be written as :

$$\begin{bmatrix} N(\rho) & \tilde{K}(\rho) \end{bmatrix} \Sigma = TA(\rho) \quad (5.26)$$

Since matrix  $\Sigma$  is of full column rank, the general solution to (5.26) is given by :

$$\begin{bmatrix} N(\rho) & \tilde{K}(\rho) \end{bmatrix} = TA(\rho)\Sigma^+ - Z(\rho)(I_{n+p} - \Sigma\Sigma^+) \quad (5.27)$$

and by inserting the value of matrix  $T$  given in (5.23) into equation (5.27) we obtain

$$N(\rho) = N_1(\rho) - Y_1 N_2(\rho) - Z(\rho)N_3 \quad (5.28)$$

$$\tilde{K}(\rho) = \tilde{K}_1(\rho) - Y_1 \tilde{K}_2(\rho) - Z(\rho)\tilde{K}_3 \quad (5.29)$$

where  $N_1(\rho) = T_1 A(\rho)\Sigma^+ \begin{bmatrix} I_{q_0} \\ 0 \end{bmatrix}$ ,  $N_2(\rho) = T_2 A(\rho)\Sigma^+ \begin{bmatrix} I_{q_0} \\ 0 \end{bmatrix}$ ,  $N_3 = (I_{q_0+p} - \Sigma\Sigma^+) \begin{bmatrix} I_{q_0} \\ 0 \end{bmatrix}$ ,  $\tilde{K}_1(\rho) = T_1 A(\rho)\Sigma^+ \begin{bmatrix} 0 \\ I_p \end{bmatrix}$ ,  $\tilde{K}_2(\rho) = T_2 A(\rho)\Sigma^+ \begin{bmatrix} 0 \\ I_p \end{bmatrix}$ ,  $\tilde{K}_3 = (I_{q_0+p} - \Sigma\Sigma^+) \begin{bmatrix} 0 \\ I_p \end{bmatrix}$  and  $Z(\rho)$  is an arbitrary matrix of appropriate dimension. As matrices  $N(\rho)$ ,  $T$ ,  $K$ ,  $\tilde{K}(\rho)$  have structure known, we can deduce the matrix  $F(\rho)$  as :

$$F(\rho) = F_1(\rho) - Y_1 F_2(\rho) - Z(\rho)F_3 \quad (5.30)$$

where  $F_1(\rho) = T_1 A(\rho) \Sigma^+ \begin{bmatrix} K \\ I_p \end{bmatrix}$ ,  $F_2(\rho) = T_2 A(\rho) \Sigma^+ \begin{bmatrix} K \\ I_p \end{bmatrix}$ ,  $F_3 = (I_{n+p} - \Sigma \Sigma^+) \begin{bmatrix} K \\ I_p \end{bmatrix}$ .

On the other hand from equation (5.20) we obtain :

$$\begin{bmatrix} T \\ C \end{bmatrix} = \begin{bmatrix} I_{q_0} & -K \\ 0 & I_p \end{bmatrix} \Sigma \quad (5.31)$$

inserting equation (5.31) into the equation (5.18) we get :

$$\begin{bmatrix} S(\rho) & M(\rho) \\ P & Q \end{bmatrix} \begin{bmatrix} I_{q_0} & -K \\ 0 & I_p \end{bmatrix} \Sigma = \begin{bmatrix} 0 \\ I_n \end{bmatrix} \quad (5.32)$$

Since matrix  $\Sigma$  is of full column rank and

$$\begin{bmatrix} I_{q_0} & -K \\ 0 & I_p \end{bmatrix}^{-1} = \begin{bmatrix} I_{q_0} & K \\ 0 & I_p \end{bmatrix}$$

the general solution to equation (5.32) is given by :

$$\begin{bmatrix} S(\rho) & M(\rho) \\ P & Q \end{bmatrix} = \left( \begin{bmatrix} 0 \\ I_n \end{bmatrix} \Sigma^+ - U(\rho)(I_{q_0+p} - \Sigma \Sigma^+) \right) \begin{bmatrix} I_{q_0} & K \\ 0 & I_p \end{bmatrix} \quad (5.33)$$

where  $U(\rho)$  is an arbitrary matrix of appropriate dimension.

Then matrices  $S(\rho)$ ,  $M(\rho)$ ,  $P$  and  $Q$  can be determined as :

$$S(\rho) = -U_1(\rho)N_3 \quad (5.34)$$

$$M(\rho) = -U_1(\rho)F_3 \quad (5.35)$$

$$P = \Sigma^+ \begin{bmatrix} I_{q_0} \\ 0 \end{bmatrix} - U_2(\rho)N_3 \quad (5.36)$$

$$Q = \Sigma^+ \begin{bmatrix} K \\ I_p \end{bmatrix} - U_2(\rho)F_3 \quad (5.37)$$

where  $U_1(\rho) = [I \ 0] U(\rho)$ ,  $U_2(\rho) = [0 \ I] U(\rho)$ . The estimation error (5.12) shows that  $e(t) \rightarrow 0$  when  $\varepsilon(t) \rightarrow 0$ . i.e., the error  $e(t)$  is independent of the matrix  $P$ . Then we can suppose that  $U_2(\rho) = 0$  and obtain  $P = \Sigma^+ \begin{bmatrix} I_{q_0} \\ 0 \end{bmatrix}$  and  $Q = \Sigma^+ \begin{bmatrix} K \\ I_p \end{bmatrix}$ .

By inserting the previous parameterization into the observer error dynamics (5.11), there exists a bilinearity in the product of matrices  $N(\rho)TG$ . In order to avoid this bilinearity, an adaptation in the parameterization is carried out. Let  $\bar{T}_2 = T_2 G$  and  $Y_1 = Y(I_{n+p} - \bar{T}_2 \bar{T}_2^+)$ , where  $Y$  is an arbitrary matrix of appropriate dimension, so that, the product of matrices  $N(\rho)TG$  becomes

$$N(\rho)TG = N_1(\rho)T_1G - YN_2(\rho)T_1G - Z(\rho)N_3T_1G, \quad (5.38)$$

where the fact of  $\bar{T}_2 \bar{T}_2^+ \bar{T}_2 = \bar{T}_2$  is considered. In the same way, the following expressions are obtained for matrices  $T$ ,  $K$ ,  $N(\rho)$  and  $F(\rho)$

$$T = T_1 - Y\mathcal{T}_2, \quad (5.39)$$

$$K = K_1 - Y\mathcal{K}_2, \quad (5.40)$$

$$N(\rho) = N_1(\rho) - Y\mathcal{N}_2(\rho) - Z(\rho)N_3, \quad (5.41)$$

$$F(\rho) = F_1(\rho) - Y\mathcal{F}_2(\rho) - Z(\rho)F_3, \quad (5.42)$$

where  $\mathcal{T}_2 = (I_{n+p} - \bar{T}_2 \bar{T}_2^+)T_2$ ,  $\mathcal{K}_2 = (I_{n+p} - \bar{T}_2 \bar{T}_2^+)K_2$ ,  $\mathcal{N}_2(\rho) = (I_{n+p} - \bar{T}_2 \bar{T}_2^+)N_2(\rho)$ ,  $\mathcal{F}_2(\rho) = (I_{n+p} - \bar{T}_2 \bar{T}_2^+)F_2(\rho)$ . Using the previous considerations, the observer error dynamics (5.11) can be written as

$$\dot{\varphi}(t) = (\mathbb{A}(\rho) - \mathbb{Y}(\rho)\mathbb{A}_2)\varphi(t) + (\mathbb{F}(\rho) - \mathbb{Y}(\rho)\mathbb{F}_2)\tilde{f}(t) \quad (5.43)$$

where  $\mathbb{A}(\rho) = \begin{bmatrix} N_1(\rho) - Y\mathcal{N}_2(\rho) & 0 \\ 0 & 0 \end{bmatrix}$ ,  $\mathbb{A}_2 = \begin{bmatrix} N_3 & 0 \\ 0 & 0 \end{bmatrix}$ ,  $\mathbb{Y}(\rho) = \begin{bmatrix} Z(\rho) & H(\rho) \\ U_1(\rho) & L(\rho) \end{bmatrix}$ ,  $\mathbb{F}(\rho) = \begin{bmatrix} N_1(\rho)T_1G + T_1G - Y\mathcal{N}_2(\rho)T_1G \\ 0 \end{bmatrix}$ ,  $\mathbb{F}_2 = \begin{bmatrix} N_3T_1G \\ 0 \end{bmatrix}$  and  $\varphi(t) = \begin{bmatrix} \varepsilon(t) \\ v(t) \end{bmatrix}$ .

By putting together the observer error dynamics (5.43), the fault estimation error dynamics (5.13) and state tracking error dynamics (5.16) we get

$$\dot{\beta}(t) = \Phi(\rho)\beta(t) \quad (5.44)$$

where

$$\Phi(\rho) = \begin{bmatrix} A(\rho) - BK_c(\rho) & [-BK_c(\rho)P & 0] & -BK_c(\rho)PTG - G \\ 0 & \mathbb{A}(\rho) - \mathbb{Y}(\rho)\mathbb{A}_2 & \mathbb{F}(\rho) - \mathbb{Y}(\rho)\mathbb{F}_2 \\ 0 & [K_o(\rho)CP & 0] & K_o(\rho)CPTG \end{bmatrix}, \text{ and } \beta(t) = \begin{bmatrix} \tilde{x}(t) \\ \varphi(t) \\ \tilde{f}(t) \end{bmatrix}.$$

A solution to the fault tolerant control problem is given by finding matrices  $\mathbb{Y}(\rho)$ ,  $Y$ ,  $K_o(\rho)$  and  $K_c(\rho)$  such that the system (5.44) is asymptotically stable.

### 5.2.3 Fault tolerant control design

In this section, an observer-based fault tolerant control is presented. This method is obtained from the determination of the matrices  $\mathbb{Y}(\rho)$ ,  $K_c(\rho)$  and  $K_o(\rho)$  through the stability analysis of the system (5.44). The stability conditions are established in the following theorem.

**Theorem 5.1.** *Under Assumption 5.1, there exist parameter matrices  $K_{c,i}$ ,  $\mathbb{Y}_i$ ,  $K_{o,i}$ , and  $Y$  such that the system (5.44) is asymptotically stable if there exist matrices  $X_1 = X_1^T > 0$ ,  $X_2 = \begin{bmatrix} X_{21} & X_{21} \\ X_{21} & X_{22} \end{bmatrix} > 0$ , with  $X_{21} = X_{21}^T$ , and a matrix  $X_3 > 0$  such that the following LMIs are satisfied*

$$\mathcal{C}^{T\perp} \begin{bmatrix} He\{A_iX_x - BM_i\} & -BK_{c,i}P & 0 & -BK_{c,i}PT_1G - G \\ (*) & He\{X_{21}N_{1,i} - W_1\mathcal{N}_{2,i}\} & \Pi_1 & \Pi_2 \\ (*) & (*) & 0 & X_{21}(N_{1,i}T_1G + T_1G) - W_1\mathcal{N}_{2,i}T_1G \\ (*) & (*) & (*) & \Pi_3 \end{bmatrix} \mathcal{C}^{T\perp T} < 0 \quad (5.45)$$

where  $\Pi_1 = N_{1,i}^T X_{21} - \mathcal{N}_{2,i}^T W_1^T$ ,  $\Pi_2 = X_{21}(N_{1,i}T_1G + T_1G) - W_1\mathcal{N}_{2,i}T_1G + P^T C^T K_{o,i}^T X_3$ ,  $\Pi_3 = X_3 K_{o,i} CPTG + (K_{o,i} CPTG)^T X_3$  and

$$\begin{bmatrix} He\{A_iX_x - BM_i\} & -BK_{c,i}PT_1G - G \\ (*) & \Pi_3 \end{bmatrix} < 0. \quad (5.46)$$

In this case  $Y = X_{21}^{-1}W_1$ ,  $X_1 = X_x^{-1}$  and  $K_{c,i} = M_iX_1$ . Matrices  $\mathbb{Y}_i$  are parameterized as

$$\mathbb{Y}_i = X_2^{-1}(\mathcal{B}_r^+ \mathcal{K}_i \mathcal{C}_l^+ + \mathcal{Z} - \mathcal{B}_r^+ \mathcal{B}_r \mathcal{Z} \mathcal{C}_l \mathcal{C}_l^+) \quad (5.47)$$

with

$$\mathcal{K}_i = \mathcal{R}^{-1} \mathcal{B}_l^T \vartheta_i \mathcal{C}_r^T (\mathcal{C}_r \vartheta_i \mathcal{C}_r^T)^{-1} + \mathcal{S}_i^{1/2} \phi (\mathcal{C}_r \vartheta_i \mathcal{C}_r^T)^{-1/2} \quad (5.48)$$

$$\mathcal{S}_i = \mathcal{R}^{-1} - \mathcal{R}^{-1} \mathcal{B}_l^T [\vartheta_i - \vartheta_i \mathcal{C}_r^T (\mathcal{C}_r^T \vartheta_i \mathcal{C}_r^T)^{-1} \mathcal{C}_r \vartheta_i] \mathcal{B}_l \mathcal{R}^{-1} \quad (5.49)$$

$$\vartheta_i = (\mathcal{B}_r \mathcal{R}^{-1} \mathcal{B}_l^T - \mathcal{D}_i)^{-1} > 0 \quad (5.50)$$

where

$$\mathcal{D}_i = \begin{bmatrix} He\{A_iX_x - BM_i\} & -BK_{c,i}P & 0 & -BK_{c,i}PT_1G - G \\ (*) & He\{X_{21}N_{1,i} - W_1\mathcal{N}_{2,i}\} & \Pi_1 & \Pi_2 \\ (*) & (*) & 0 & X_{21}(N_{1,i}T_1G + T_1G) - W_1\mathcal{N}_{2,i}T_1G \\ (*) & (*) & (*) & \Pi_3 \end{bmatrix} \quad (5.51)$$

$\mathcal{B} = \begin{bmatrix} 0 \\ -I \\ 0 \end{bmatrix}$ ,  $\mathcal{C} = [0 \quad \mathbb{A}_2 \quad \mathbb{F}_2]$ ,  $\mathcal{C}^{T\perp} = \begin{bmatrix} I_n & 0 \\ 0 & \begin{bmatrix} \mathbb{A}_2^T \\ \mathbb{F}_2^T \end{bmatrix}^\perp \end{bmatrix}$  and  $\mathcal{B}^\perp = \begin{bmatrix} I & 0 & 0 \\ 0 & 0 & I \end{bmatrix}$ ,  $\phi$  is an arbitrary matrix such that  $\|\phi\|_2 < 1$  and  $\mathcal{R} > 0$ . Matrices  $\mathcal{C}_l$ ,  $\mathcal{C}_r$ ,  $\mathcal{B}_l$  and  $\mathcal{B}_r$  are any full rank matrices such that  $\mathcal{C} = \mathcal{C}_l \mathcal{C}_r$  and  $\mathcal{B} = \mathcal{B}_l \mathcal{B}_r$ .



*Proof.* Consider the Lyapunov function  $V(\beta(t)) = \beta(t)^T X \beta(t)$  with a positive definite symmetric matrix  $X = \begin{bmatrix} X_1 & 0 & 0 \\ 0 & X_2 & 0 \\ 0 & 0 & X_3 \end{bmatrix}$ . Then its derivative is given by

$$\dot{V}(\beta(t)) = \beta^T(t)(\Phi^T(\rho)X + X\Phi(\rho))\beta(t) \quad (5.52)$$

The asymptotic stability of system (5.44) is guaranteed if  $\dot{V}(\beta(t)) < 0$ . By inserting the form of matrices  $\Phi(\rho)$  and  $X$ , the following inequality is obtained

$$\begin{bmatrix} \text{He}\{X_1(A(\rho) - BK_c(\rho))\} & X_1[-BK_c(\rho)P \ 0] & -X_1(BK_c(\rho)PTG + G) \\ (*) & \text{He}\{X_2(\mathbb{A}(\rho) - \mathbb{Y}(\rho)\mathbb{A}_2)\} & X_2(\mathbb{F}(\rho) - \mathbb{Y}(\rho)\mathbb{F}_2) + [K_o(\rho)CP \ 0]^T X_3 \\ (*) & (*) & X_3K_o(\rho)CPTG + (K_o(\rho)CPTG)^T X_3 \end{bmatrix} < 0 \quad (5.53)$$

which is true as soon as

$$\begin{bmatrix} \text{He}\{X_1(A_i - BK_{c,i})\} & X_1[-BK_{c,i}P \ 0] & -X_1(BK_{c,i}PTG + G) \\ (*) & \text{He}\{X_2(\mathbb{A}_i - \mathbb{Y}_i\mathbb{A}_2)\} & X_2(\mathbb{F}_i - \mathbb{Y}_i\mathbb{F}_2) + [K_{o,i}CP \ 0]^T X_3 \\ (*) & (*) & X_3K_{o,i}CPTG + (K_{o,i}CPTG)^T X_3 \end{bmatrix} < 0 \quad (5.54)$$

Pre- and post-multiplying (5.54) by  $\begin{bmatrix} X_1^{-1} & 0 \\ 0 & I \end{bmatrix}$  and  $\begin{bmatrix} X_1^{-T} & 0 \\ 0 & I \end{bmatrix}$  we obtain the following inequality

$$\begin{bmatrix} \text{He}\{(A_i - BK_{c,i})X_1^{-1}\} & [-BK_{c,i}P \ 0] & -BK_{c,i}PTG - G \\ (*) & \text{He}\{X_2(\mathbb{A}_i - \mathbb{Y}_i\mathbb{A}_2)\} & X_2(\mathbb{F}_i - \mathbb{Y}_i\mathbb{F}_2) + [K_{o,i}CP \ 0]^T X_3 \\ (*) & (*) & X_3K_{o,i}CPTG + (K_{o,i}CPTG)^T X_3 \end{bmatrix} < 0 \quad (5.55)$$

which can be written as :

$$\mathcal{B}\mathcal{X}_i\mathcal{C} + (\mathcal{B}\mathcal{X}_i\mathcal{C})^T + \mathcal{D}_i < 0 \quad (5.56)$$

where  $\mathcal{B} = \begin{bmatrix} 0 \\ -I \\ 0 \end{bmatrix}$ ,  $\mathcal{C} = [0 \ \mathbb{A}_2 \ \mathbb{F}_2]$ ,  $\mathcal{X}_i = X_2\mathbb{Y}_i$  and

$$\mathcal{D}_i = \begin{bmatrix} \text{He}\{A_i X_x - BM_i\} & -BK_{c,i}P & 0 & -BK_{c,i}PT_1G - G \\ (*) & \text{He}\{X_{21}N_{1,i} - W_1\mathcal{N}_{2,i}\} & \Pi_1 & \Pi_2 \\ (*) & (*) & 0 & X_{21}(N_{1,i}T_1G + T_1G) - W_1\mathcal{N}_{2,i}T_1G \\ (*) & (*) & (*) & \Pi_3 \end{bmatrix},$$

where  $Y = X_{21}^{-1}W_1$ ,  $X_1 = X_x^{-1}$  and  $K_{c,i} = M_i X_1$ . The solvability conditions of inequality (5.56) are

$$\mathcal{C}^{T\perp}\mathcal{D}_i\mathcal{C}^{T\perp T} < 0 \quad (5.57)$$

$$\mathcal{B}^\perp\mathcal{D}_i\mathcal{B}^{\perp T} < 0 \quad (5.58)$$

with  $\mathcal{C}^{T\perp} = \begin{bmatrix} I_n & 0 \\ 0 & \begin{bmatrix} \mathbb{A}_2^T \\ \mathbb{B}_2^T \end{bmatrix}^\perp \end{bmatrix}$  and  $\mathcal{B}^\perp = \begin{bmatrix} I & 0 & 0 \\ 0 & 0 & I \end{bmatrix}$ . Inequalities (5.57) and (5.58) correspond to (5.45) and (5.46), respectively. If condition (5.56) is satisfied, then the parameter matrix  $\mathbb{Y}_i$  is obtained from (5.47).  $\square$

## 5.2.4 Application to vehicle lateral dynamics

In order to illustrate the previous results, let us consider the single-track vehicle model that is a simplified model for the vehicle lateral motion [Rajamani, 2012] represented in the state space form

$$\begin{bmatrix} \dot{v}_y \\ \dot{\psi}(t) \end{bmatrix} = \begin{bmatrix} -\frac{C_f+C_r}{mv_x} & -\frac{a_f C_f - a_r C_r}{mv_x} - v_x \\ -\frac{a_f C_f - a_r C_r}{I_z v_x} & -\frac{a_f^2 C_f + a_r^2 C_r}{I_z v_x} \end{bmatrix} \begin{bmatrix} v_y(t) \\ \psi(t) \end{bmatrix} + \begin{bmatrix} \frac{C_f}{I_z} \\ \frac{a_f C_f}{I_z} \end{bmatrix} \delta_f(t) + \begin{bmatrix} 0 \\ \frac{1}{I_z} \end{bmatrix} M_z(t) \quad (5.59a)$$

$$y(t) = \begin{bmatrix} 0 & 1 \end{bmatrix} \begin{bmatrix} v_y(t) \\ \psi(t) \end{bmatrix} \quad (5.59b)$$

where  $v_y(t)$  and  $\dot{\psi}(t)$  denote the lateral velocity and the yaw rate, respectively.  $\delta_f(t)$  represents the steering angle which is considered as a measured input. The controlled input is the yaw moment  $M_z(t)$  generated by a differential braking on the rear wheels. The parameters are summarized in Table 5.1.

TABLE 5.1 – Model parameters

Variable	Description	Value
$C_f$	front cornering stiffness	61000 N/rad
$m$	total mass	1700 kg
$v_x$	longitudinal velocity	15 m/s
$a_f$	distance from gravity center to front axle	1.1 m
$a_r$	distance from gravity center to rear axle	1.44 m
$I_z$	vehicle yaw moment inertia	2454 Kg.m <sup>2</sup>

For this example, it supposes that rear cornering stiffness  $C_r$  is varying over time in the interval  $C_r \leq C_r(t) \leq \overline{C_r}$  N/rad, this variation is known. Consequently, the system (5.59) can be represented by the following LPV system considering additive actuator fault  $f_a(t)$  :

$$\dot{x}(t) = \begin{bmatrix} \frac{-C_f+C_r(t)}{mv_x} & \frac{-a_f C_f - a_r C_r(t)}{I_z v_x} - v_x \\ -\frac{a_f C_f - a_r C_r(t)}{I_z v_x} & \frac{-a_f^2 C_f + a_r^2 C_r(t)}{I_z v_x} \end{bmatrix} x(t) + \begin{bmatrix} C_f \\ \frac{m}{a_f C_f} \\ I_z \end{bmatrix} \delta_f(t) + \begin{bmatrix} 0 \\ \frac{1}{I_z} \end{bmatrix} (u_c(t) + f_a(t)) \quad (5.60a)$$

$$y(t) = Cx(t) \quad (5.60b)$$

where  $x(t) = \begin{bmatrix} v_y(t) \\ \psi(t) \end{bmatrix}$  and  $C = \begin{bmatrix} 0 & 1 \end{bmatrix}$ . The scheduling variable is  $C_r(t)$  and the scheduling functions are defined as follow :

$$\mu_1(t) = \frac{\overline{C_r} - C_r(t)}{\overline{C_r} - \underline{C_r}}, \quad \mu_2(t) = \frac{C_r(t) - \underline{C_r}}{\overline{C_r} - \underline{C_r}}$$

The fault-free reference model is

$$\dot{x}_d(t) = \begin{bmatrix} \frac{-C_f+C_r(t)}{mv_x} & \frac{-a_f C_f - a_r C_r(t)}{I_z v_x} - v_x \\ -\frac{a_f C_f - a_r C_r(t)}{I_z v_x} & \frac{-a_f^2 C_f + a_r^2 C_r(t)}{I_z v_x} \end{bmatrix} x_d(t) + \begin{bmatrix} C_f \\ \frac{m}{a_f C_f} \\ I_z \end{bmatrix} \delta_f(t) \quad (5.61)$$

The solution of LMIs constraints (5.45)-(5.46) of the Theorem 5.1 and choosing the matrix  $E = \begin{bmatrix} 1 & 0 \\ 0 & 1 \end{bmatrix} \times 10^4$ ,  $\mathcal{L} = I_{4 \times 3} \times 0.1$  and  $\mathcal{R} = I_4 \times 0.01$  leads to the following FTC gains.

$$N_1 = \begin{bmatrix} -4.156 & -13.9436 \\ -0.031 & -2.2231 \end{bmatrix}, N_2 = \begin{bmatrix} -4.352 & -13.735 \\ 0.066 & -2.288 \end{bmatrix}, H_1 = \begin{bmatrix} 0.301 & -0.054 \\ -0.106 & 0.305 \end{bmatrix}, H_2 = \begin{bmatrix} 0.299 & -0.065 \\ -0.097 & 0.306 \end{bmatrix},$$

$$F_1 = \begin{bmatrix} -8.118 \\ -1.158 \end{bmatrix} \times 10^4, F_2 = \begin{bmatrix} -7.940 \\ -1.266 \end{bmatrix} \times 10^4, J = \begin{bmatrix} 3.58 & 0 \\ 1.367 & 0 \end{bmatrix} \times 10^5, S_1 = \begin{bmatrix} 0 & -0.151 \\ 0 & -0.012 \end{bmatrix},$$

$$S_2 = \begin{bmatrix} 0 & -0.1421 \\ 0 & -0.022 \end{bmatrix}, L_1 = \begin{bmatrix} -0.132 & -0.006 \\ -0.001 & -0.125 \end{bmatrix}, L_2 = \begin{bmatrix} -0.132 & -0.001 \\ -0.003 & -0.125 \end{bmatrix}, M_1 = \begin{bmatrix} 758.739 \\ 59.889 \end{bmatrix}, M_2 = \begin{bmatrix} 714.347 \\ 112.156 \end{bmatrix}$$

$$K_{o,1} = K_{o,2} = -4000, K_{c,1} = [-4.705 \quad -1.873] \times 10^4, K_{c,2} = [-4.551 \quad -1.9227] \times 10^4$$

$$P = \begin{bmatrix} 1 & 0 \\ 0 & 1 \end{bmatrix} \times 10^{-4}, \text{ and } Q = \begin{bmatrix} 0 \\ 0.5 \end{bmatrix}.$$

The obtained results are depicted in Figures 5.2-5.6. Figure 5.2 represents the steering angle variation and rear cornering stiffness variation. We suppose that this parameter is varying due to environmental conditions. For example, the change in the tire-floor friction coefficient caused by ice or snow on a winter road [Bennani et al., 2019].

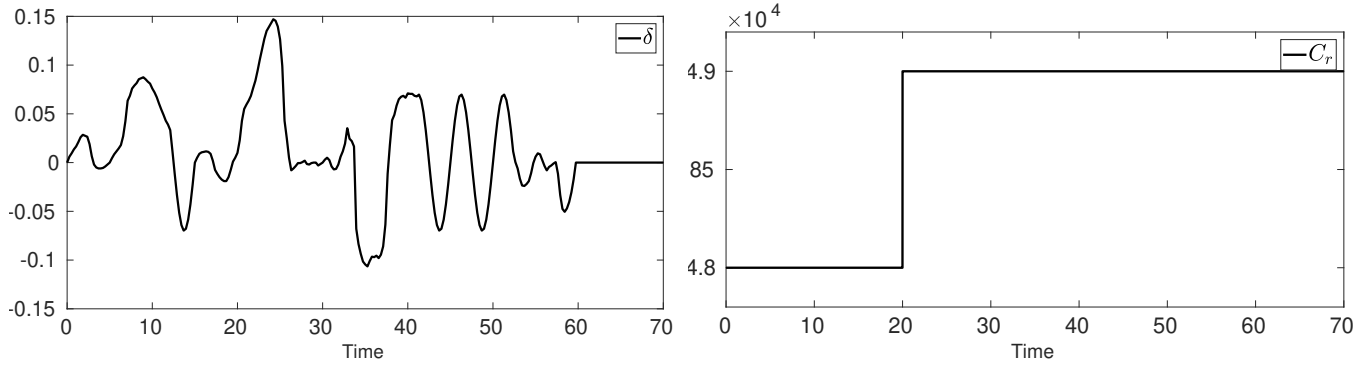

FIGURE 5.2 – Steering angle and rear cornering stiffness variation.

Figures 5.3-5.4 depicts the estimation of the state variables. Likewise, it can be noted that the trajectory tracking is acceptable despite the actuator fault. The control action is illustrated in Figure 5.5 which represents the yaw moment generated by a differential braking on the rear wheels. At last, the fault magnitude estimation is represented in Figure 5.6.

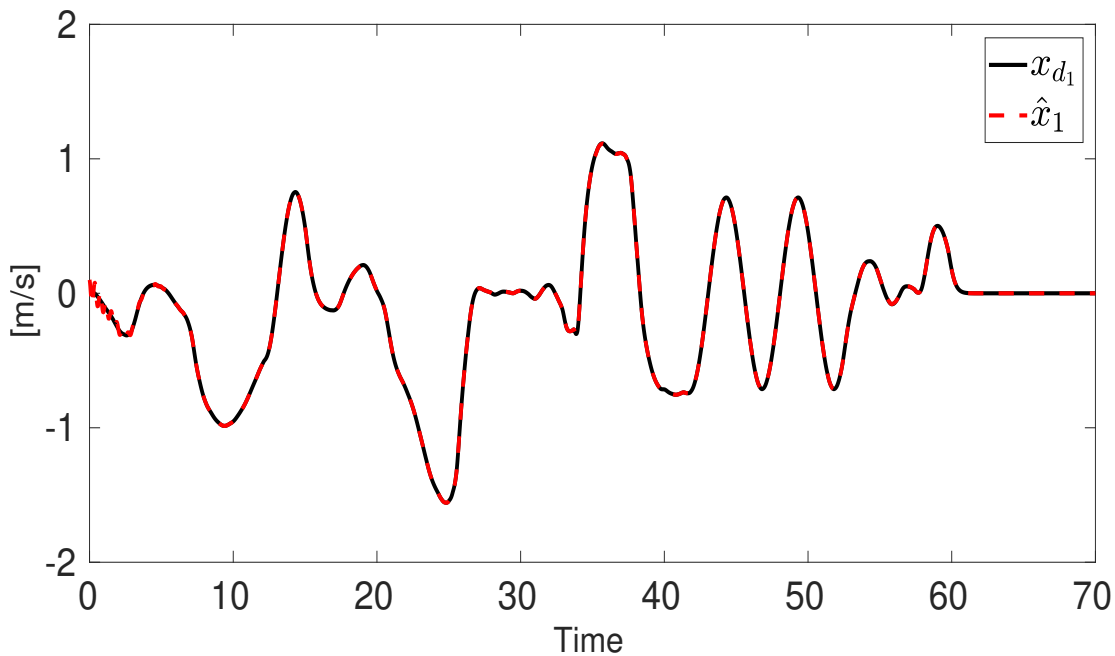

FIGURE 5.3 – Reference lateral velocity and its faulty estimated state with FTC.

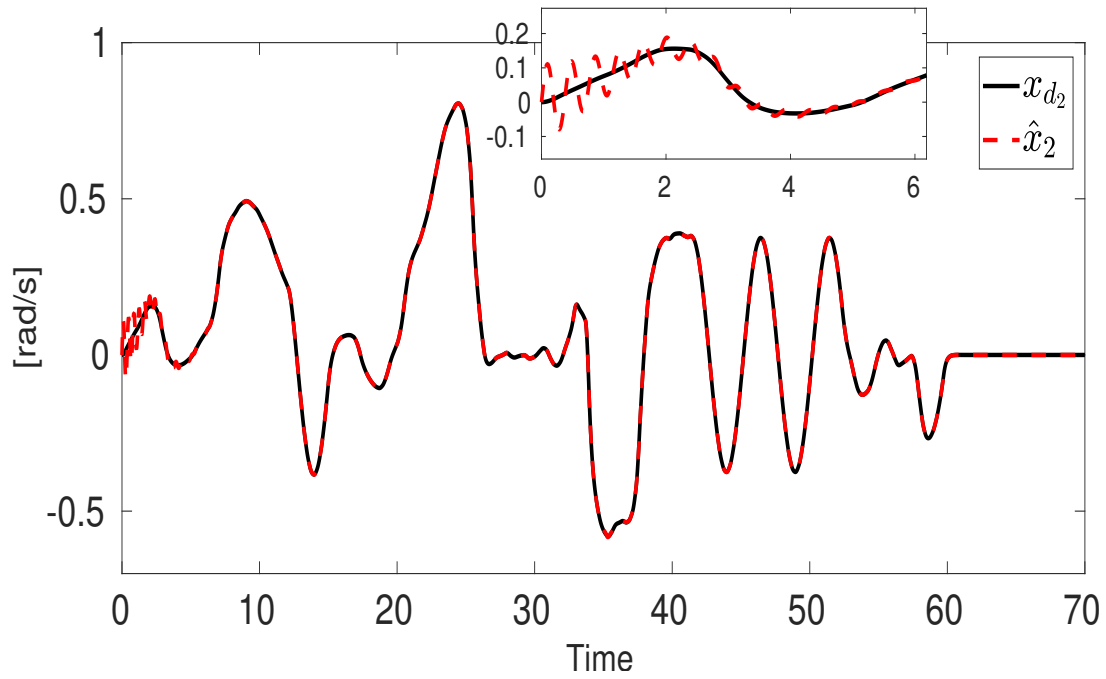

FIGURE 5.4 – Reference yaw rate and its faulty estimated state with FTC.

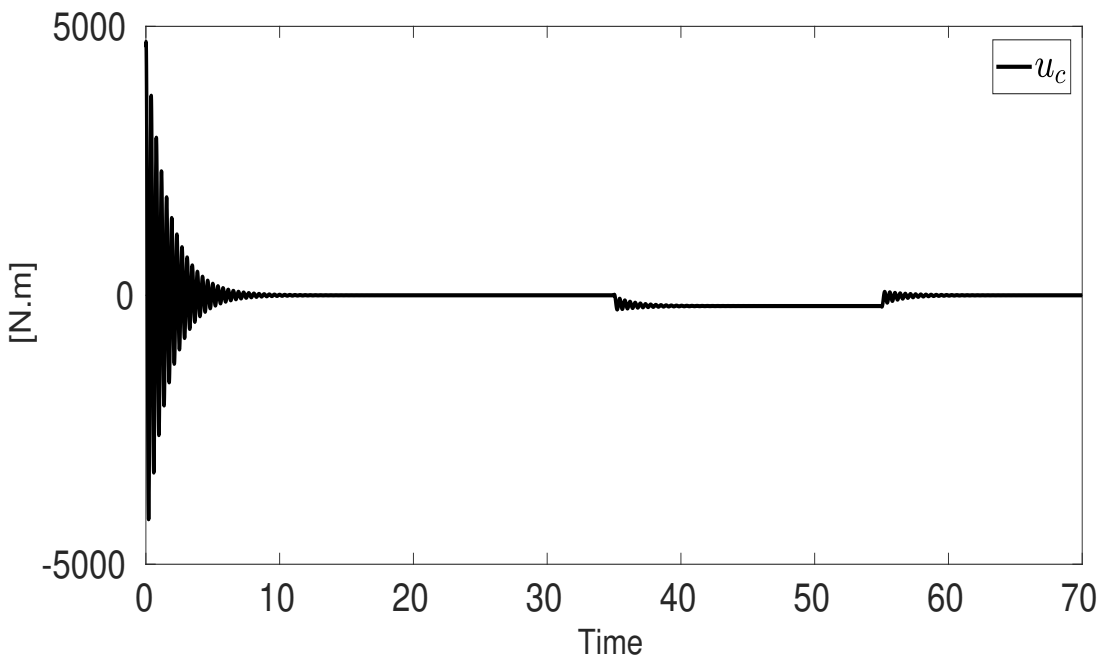

FIGURE 5.5 – Fault tolerant control law.

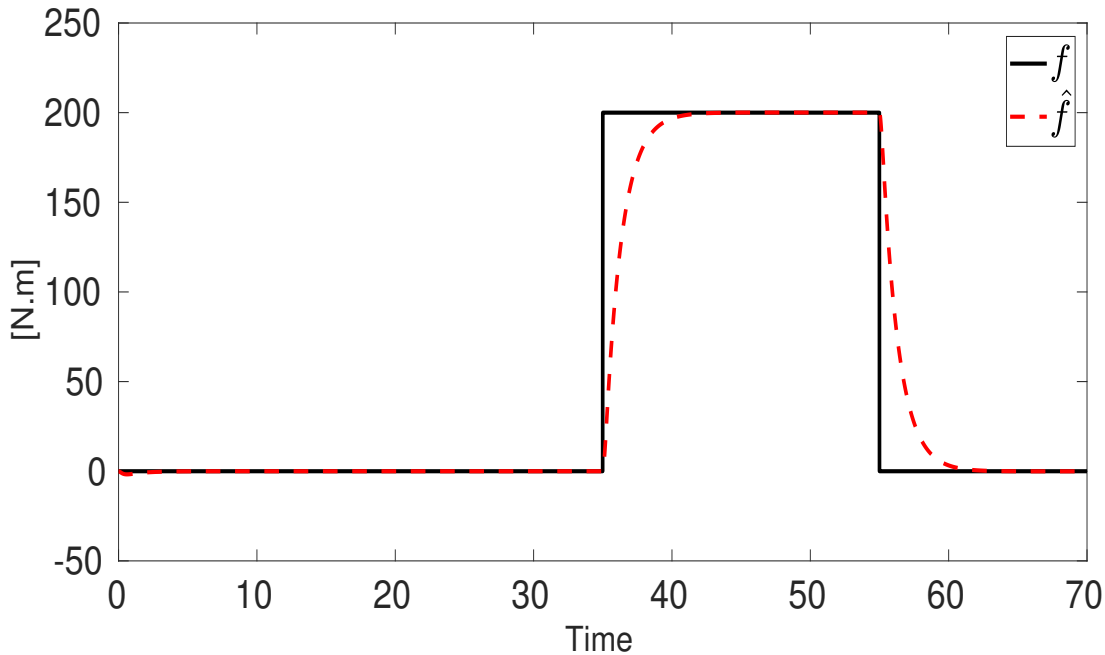

FIGURE 5.6 – Actuator fault and its estimate.

## 5.3 Parameter estimation and actuator fault tolerant control

### 5.3.1 Problem formulation

The FTC design is based on the following LPV system

$$\dot{x}(t) = A(\theta(t))x(t) + Bu(t) + Gf(t) \quad (5.62a)$$

$$y(t) = Cx(t) \quad (5.62b)$$

with  $A(\theta(t)) = A_0 + \sum_{j=1}^{n_\theta} \theta_j(t) \bar{A}_j$ ,  $\theta_j(t) \in [\theta_j^1, \theta_j^2]$  and  $n_\theta$  is the number of unknown parameters.  $B_i \in \mathbb{R}^{n \times m}$ ,  $C \in \mathbb{R}^{p \times n}$  and  $G \in \mathbb{R}^{n \times n_f}$  are constant matrices.  $x(t) \in \mathbb{R}^n$  is the state vector,  $u(t) \in \mathbb{R}^m$  the input vector,  $y(t) \in \mathbb{R}^p$  represents the output vector and  $f(t) \in \mathbb{R}^{n_f}$  is the fault vector.

The variable  $\theta(t)$  is a vector integrated by unmeasured parameters that vary on a convex polytope. These scheduling parameters do not take into account the state variables (quasi-LPV case), only parameters that vary over time.

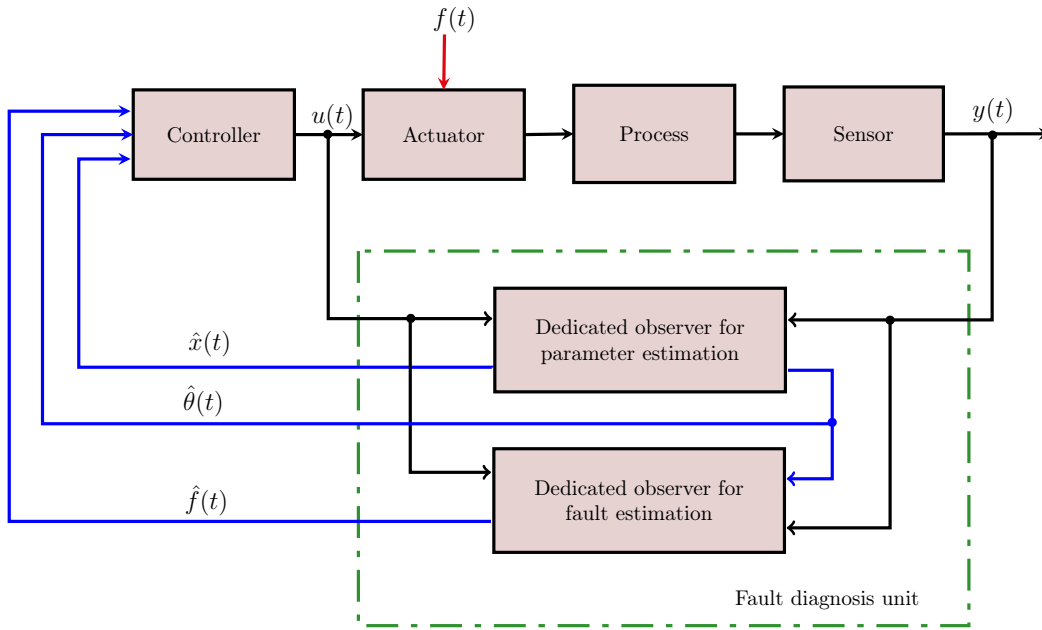

FIGURE 5.7 – Fault tolerant control scheme.

Similar to the design shown in Section 5.2, the FTC law  $u(t)$  undertake a reference state tracking using the information provided by the FD unit, in order, to minimize the state trajectory deviation caused by actuator faults. In a fault case, the current system will remain close to the desired performance and preserve stability conditions.

The following points describe the performance of the FD unit which is conformed by two dedicated observers as depicted in Figure 5.7.

- The dedicated observer for parameter estimation depends on a scheduling parameter  $\theta(t)$  which is not available. Similarly, this dedicated observer is robust against the actuator fault, if and only if, the Assumption 4.1 of section (4.3) holds. The information obtained through this observer is the estimated state variables of the system (5.62) and the estimated time-varying parameter  $\theta(t)$ , which its dynamic is unknown. The last information is essential for the following dedicated observer.
- The dedicated observer for fault estimation depends on the scheduling parameter estimation  $\hat{\theta}(t)$ , which is obtained from the previous observer. Therefore, the scheduling parameter is taken as available because it is estimated previously.
- At last, the fault diagnosis unit can give information about the unknown time-varying parameter  $\theta(t)$  and the actuator fault  $f(t)$ . This information must be useful to design the controller proposed in section (5.2).

The dedicated observer for parameter estimation for the system (5.62) is written as follows :

$$\dot{\zeta}_a(t) = N_a(\hat{\theta}(t))\zeta_a(t) + H_a(\hat{\theta}(t))v_a(t) + F_a(\hat{\theta}(t))y(t) + J_a u(t) \quad (5.63a)$$

$$\dot{v}_a(t) = S_a(\hat{\theta}(t))\zeta_a(t) + L_a(\hat{\theta}(t))v_a(t) + M_a(\hat{\theta}(t))y(t) \quad (5.63b)$$

$$\dot{\hat{\theta}}(t) = K_a(\hat{\theta}(t))(C\hat{x}_a(t) - y(t)) + \alpha(\hat{\theta}(t))\hat{\theta}(t) \quad (5.63c)$$

$$\hat{x}_a(t) = P_a\zeta_a(t) + Q_a y(t) \quad (5.63d)$$

where  $\zeta_a(t) \in \mathbb{R}^{q_0}$  represents the state vector of the observer,  $v_a(t) \in \mathbb{R}^{q_1}$  is an auxiliary vector,  $\hat{x}_a(t) \in \mathbb{R}^n$  is the estimate of  $x(t)$ ,  $\hat{\theta}(t) \in \mathbb{R}^{n_\theta}$  is the estimate of  $\theta(t)$ . The Theorem 4.2 is applied to obtain the observer gains for this one.

Consequently, to identify the actuator fault, a dedicated observer for fault estimation is proposed. The structure for this

one is described below

$$\dot{\zeta}(t) = N(\hat{\theta}(t))(\zeta(t) + TG\hat{f}(t)) + H(\hat{\theta}(t))v(t) + F(\hat{\theta}(t))y(t) + TG\hat{f}(t) + Ju_c(t) \quad (5.64a)$$

$$\dot{v}(t) = S(\hat{\theta}(t))(\zeta(t) + TG\hat{f}(t)) + L(\hat{\theta}(t))v(t) + M(\hat{\theta}(t))y(t) \quad (5.64b)$$

$$\hat{x}(t) = P(\zeta(t) + TG\hat{f}(t)) + Qy(t) \quad (5.64c)$$

$$\dot{\hat{f}}(t) = K_o(\hat{\theta}(t))(C\hat{x} - y(t)) \quad (5.64d)$$

where  $\zeta(t) \in \mathbb{R}^{q_0}$  represents the state vector of the observer,  $v(t) \in \mathbb{R}^{q_1}$  is an auxiliary vector,  $\hat{x}(t)$  is the estimate of  $x(t)$  and  $\hat{f}(t) \in \mathbb{R}^{n_f}$  is the estimate of  $f(t)$ . The Theorem 5.1 is used to obtain its observer gains.

**Remark 5.2.** *In the FD unit, the observer (5.64) depends on  $\hat{\theta}(t)$  which is known since the dynamic behavior of  $\theta(t)$  is estimated by the observer (5.63). Hence, the Theorem 5.1 can be applied.*

Likewise, the reference model is described in (5.14) and the FTC law in (5.15). The active FTC scheme is described in detail in Figure 5.8.

### 5.3.2 Numerical example

The results shown in this section refer to an FTC strategy previously established applied in the following numerical example.

$$\dot{x}(t) = (A_0 + \theta(t)\bar{A})x(t) + B(u(t) + f(t)) \quad (5.65)$$

$$y(t) = Cx(t) \quad (5.66)$$

where  $A_0 = \begin{bmatrix} -2 & 1.4 & 0.3 \\ 0.2 & -3 & 0 \\ 0.1 & 0 & -1 \end{bmatrix}$ ,  $\bar{A} = \begin{bmatrix} 0 & 1 & 0 \\ 0.1 & 0 & 0 \\ 0 & 0 & -1.1 \end{bmatrix}$ ,  $B = \begin{bmatrix} 1 \\ 0.5 \\ 0 \end{bmatrix}$  and  $C = \begin{bmatrix} 1 & 0 & 0 \\ 0 & 0 & 1 \end{bmatrix}$ . The scheduling variable is bounded  $\theta(t) \in [-1 \ 1]$  and it assumes that  $\theta(t)$  is unmeasured. The FTC scheme depicted in Figure 5.8 is applied. The initial condition for the reference model is  $x_r(0) = [3, 1, 2.5]^T$ ; for the system is  $x(0) = [1.5, 2.5, 2]^T$ ; for the adaptive observer (5.63) is  $\zeta_a(0) = [0.25, 0.04, 0.25]^T$ ,  $v_a(0) = [0, 0, 0]^T$  and  $\hat{\theta}(0) = 0.2$ ; for the fault estimation observer (5.64) is  $\zeta(0) = [-2.05, 0, -2.6]^T$ ,  $v(0) = [0, 0, 0]^T$  and  $\hat{f}(0) = 1$ . The gains of each observer are obtained by the Theorems 4.2 and 5.1.

**Remark 5.3.** *For this example, the reference model considers the real behavior of  $\theta(t)$ .*

The results of this FTC strategy are illustrated in Figures 5.9-5.15. Figures 5.9-5.11 illustrate the estimation of the states variables from the adaptive observers described in (5.63) and (5.64). The trajectory tracking is efficient despite the actuator fault. Figure 5.12 depicts the parameter estimation  $\hat{\theta}(t)$  which is obtained by the adaptive observer (5.63). The actuator fault estimation is represented in Figure 5.3.2 which is reconstructed by the observer (5.64). Figures 5.14-5.15 represent the desired input of the LPV reference model and the control input granted by the FTC law, respectively.

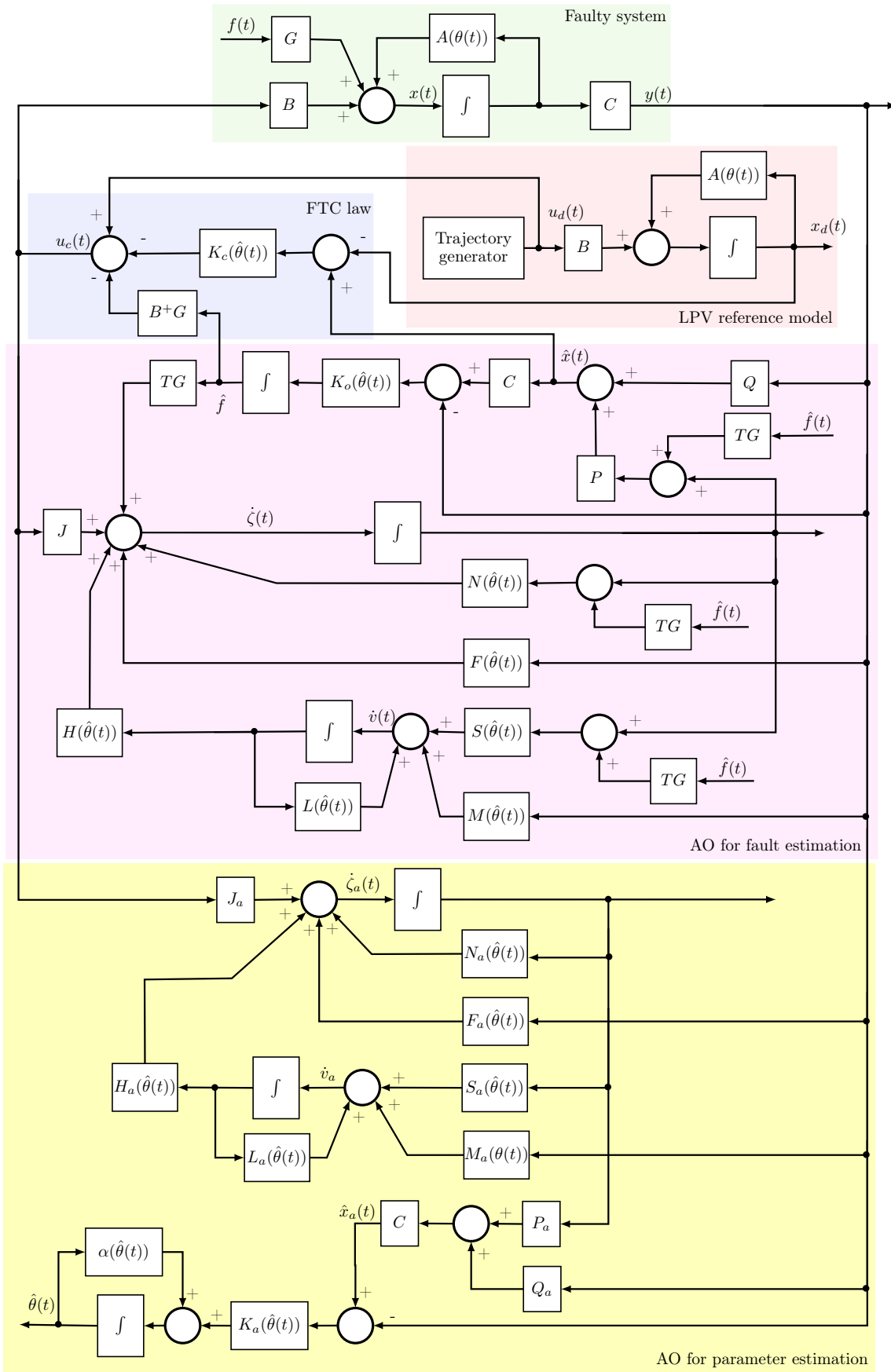
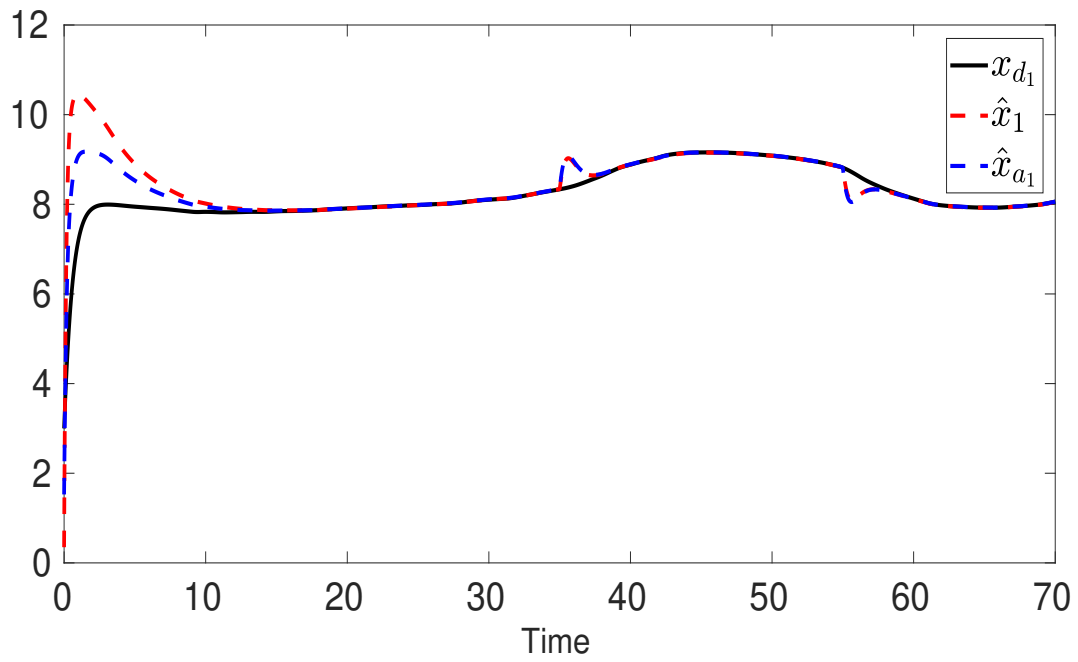
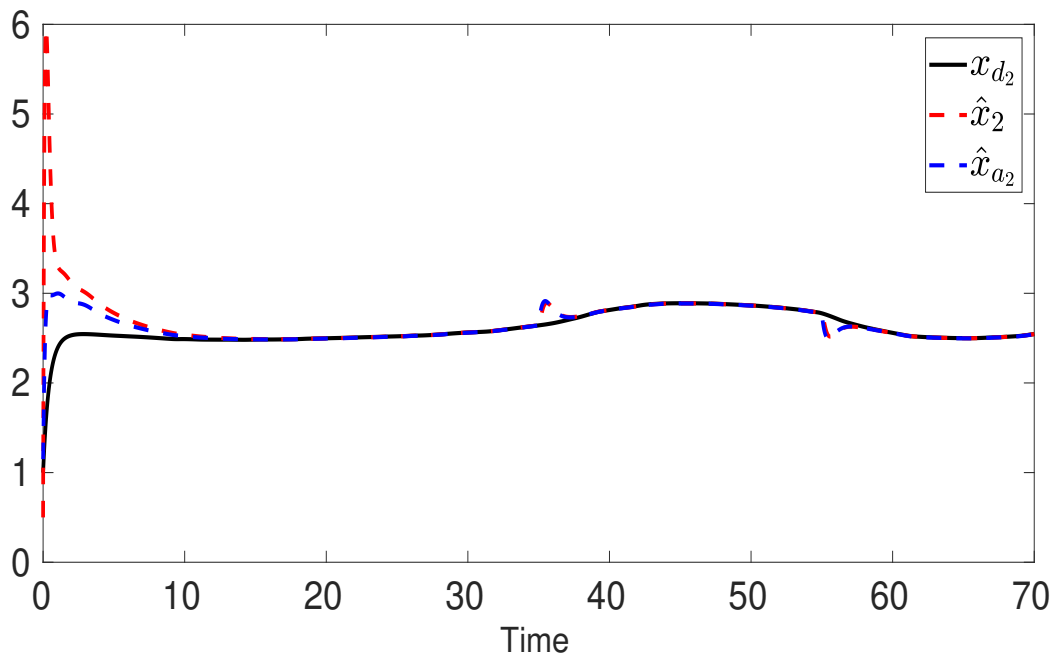

FIGURE 5.8 – Fault tolerant control scheme.



FIGURE 5.9 – Reference  $x_1$  and their estimates.FIGURE 5.10 – Reference  $x_2$  and their estimates.

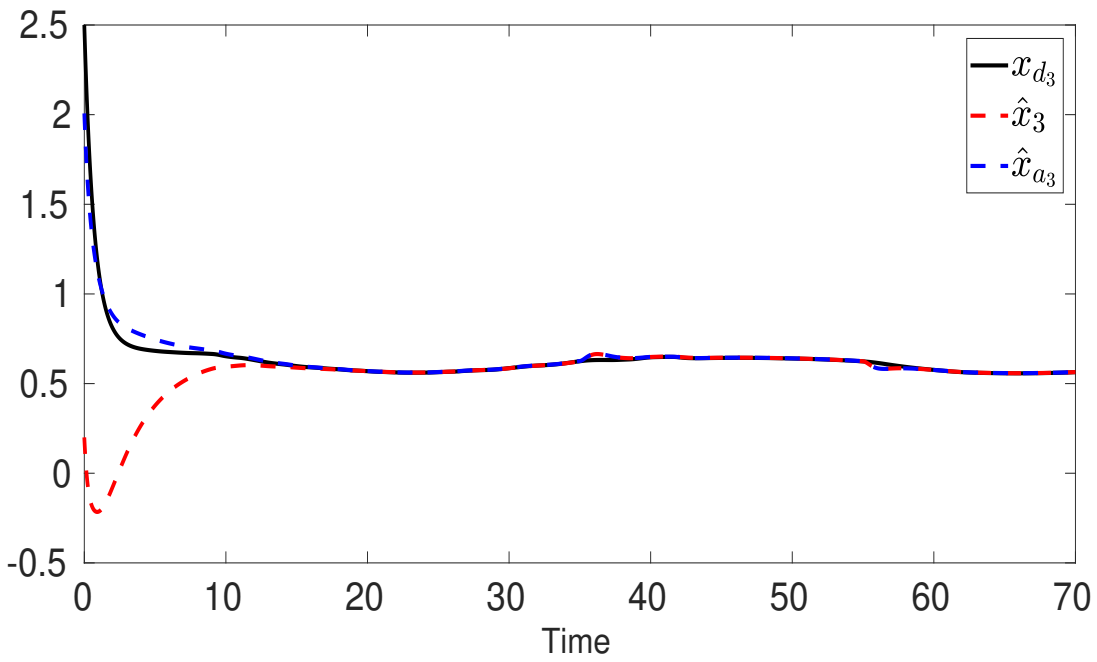

FIGURE 5.11 – Reference  $x_3$  and their estimates.

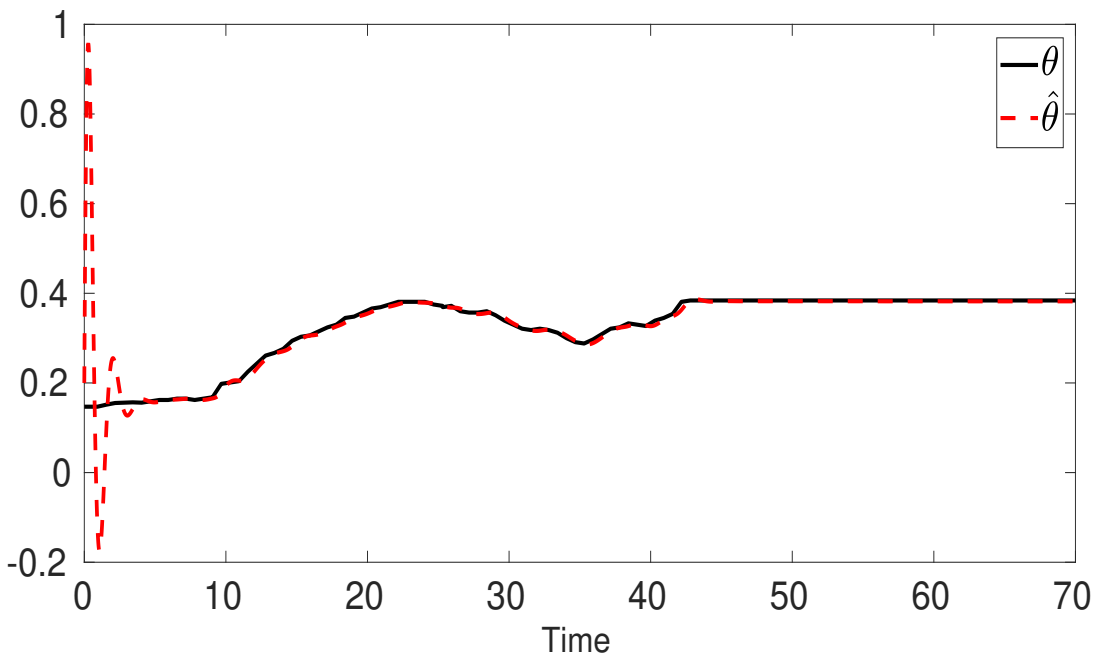

FIGURE 5.12 – Parameter  $\theta(t)$  and its estimated.

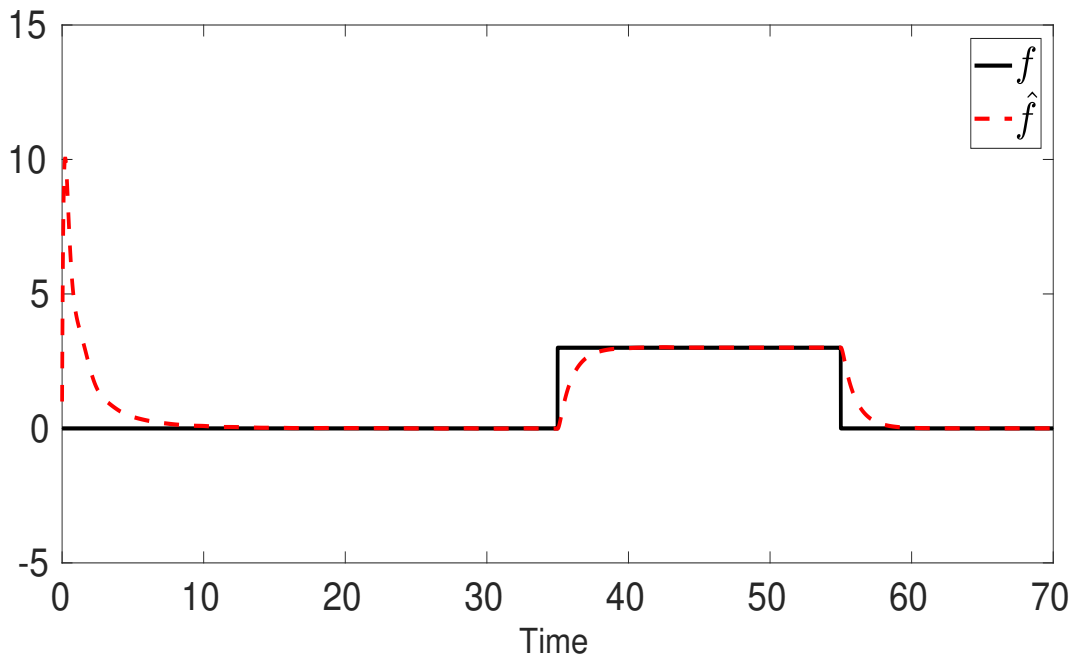
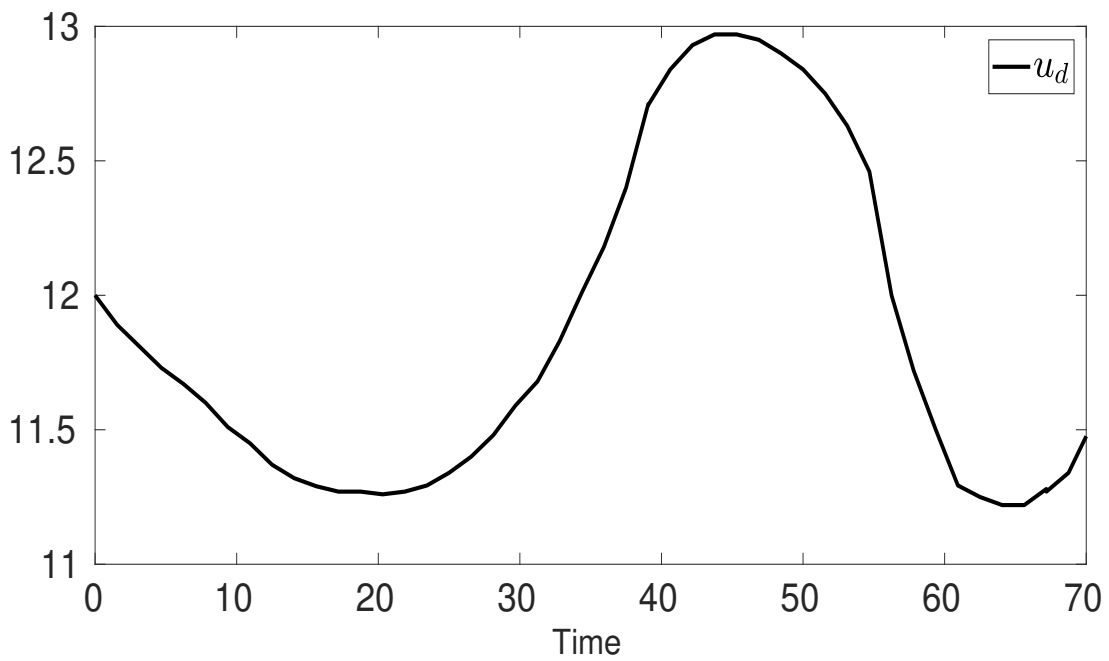

FIGURE 5.13 – Actuator fault and its estimated.

FIGURE 5.14 – Reference input  $u_d(t)$

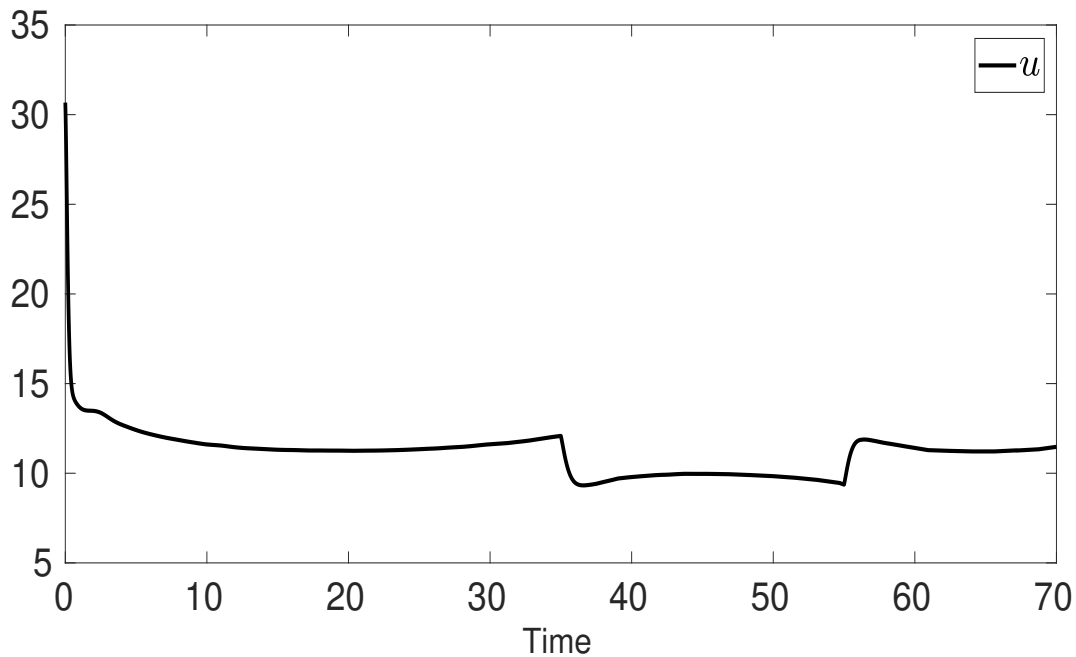

FIGURE 5.15 – FTC input.

## 5.4 Conclusions

In this chapter, an actuator fault-tolerant control strategy for LPV systems is presented. The FTC is based on an adaptive observer which estimates the states and actuator faults simultaneously. The conditions for the existence of the observer-based fault-tolerant control have been given in the form of LMIs. In order to illustrate the fault-tolerant control performances, an academic example with an actuator fault was presented. From the simulation results, it can be seen that the developed scheme is robust to a certain class of uncertainties in the steady-state regime.

It takes into account the observer design described in Chapter 4 to address the case when the scheduling variables are unmeasured or inexact; therefore, an FD unit is built, which can estimate states, faults, and parameter variation.

## Chapter 6

# Conclusions and perspectives

This thesis has contributed to polytopic LPV systems in different categories as state and parameter estimation, fault diagnosis, and fault-tolerant control. A bibliographical review based on these categories is presented to give the direction of this work.

Chapter 2 focuses on the GDO synthesis for LPV systems. It is introduced the GDO structure into the LPV framework considering the cases when the scheduling variables depend on either exogenous or endogenous signals considering unknown inputs. If the scheduling variables depend on endogenous signals (quasi-LPV), usually, the unmeasured scheduling variables case comes out. Conditions for the existence of the GDO are given, and its stability was proved to address this problematic. Based on the bounded real lemma and other mathematics complements, the stability conditions are given in terms of LMIs. Along with these designs, parameterizations of the algebraic constraints were detailed.

In the same way, Chapter 3 concerns on discrete-time LPV in the presence of unknown inputs and disturbances. It highlights the use of parameter-dependent Lyapunov function, which is less conservative than the observer designs obtained from the quadratic stability. It assumes that the disturbance is norm bounded to apply the  $\mathcal{L}_2$  gain approach.

The state and parameter estimation are addressed in Chapter 4, using the GDO structure. This design relaxes some conditions established in the literature, such as the persistent excitation condition, which must fulfill specific signals to estimate the unknown parameters. Moreover, the observer design conditions for LPV systems with unknown inputs are defined. Time-varying terms are bounded, taking advantage of the polytopic properties.

Combining the previous results, in Chapter 5 is proposed an active FTC. An FTC law uses the state and fault estimation provided by an adaptive observer, which is based on the GDO structure. The control law can be modified in order to undertake reference state tracking minimizing the system state trajectory deviation caused by faults. After that, it takes into account the observer design described in Chapter 4 to address the case when the scheduling variables are unmeasured or inexact; therefore, an FD unit is built, which can estimate states, faults, and parameter variation.

Academic examples were used in each observer design to prove the performance of each one. It can note that the performance of the GDO achieves a better performance index in comparison to their particular structures (PO, PIO).

Along with this research work, many open problems were detected, giving opportunities for more contributions to the topics encompassed in this thesis. Some of the open problems are presented below :

- The problematic of decoupling was studied in this research. The solutions given in the designs could be conservative since the distribution matrix of the unknown input does not depend on parameter variation. It can take into account that dependency and improving the observer designs previously showed.
- The adaptive observer design in Chapter 4 uses the parameter variation to interpolate the local linear models. It can generalize this design using endogenous signals to interpolate it in the same way.

- For the FTC design presented in Chapter 5, it considers the case when the scheduling variable is estimated. The observer design can become more robust against the inexact parameter estimation using the techniques for unmeasured scheduling variables.
- Along with the last FTC scheme of this thesis, it could study the identifiability concept to know if the system structure fulfills the necessary conditions to estimate the unknown parameter vector. Likewise, this concept could give more information on how to distinguish the changes induces by either faults or variations in parameter due to the nonlinear nature of the model.

# Bibliography

- [Alma et al., 2018] Alma, M., Ali, H. S., and Darouach, M. (2018). Adaptive observer design for linear descriptor systems \*. pages 5144–5149.
- [Amin and Hasan, 2019] Amin, A. A. and Hasan, K. M. (2019). A review of fault tolerant control systems : Advancements and applications. *Measurement*, 143 :58 – 68.
- [Apkarian et al., 2000] Apkarian, P., Pellanda, P. C., and Tuan, H. D. (2000). Mixed H2 H infinity multi-channel linear parameter-varying control in discrete time. *Systems & Control Letters*, 41(5) :333–346.
- [Bakka et al., 2014] Bakka, T., Karimi, H. R., and Christiansen, S. (2014). Linear parameter-varying modelling and control of an offshore wind turbine with constrained information. *IET Control Theory Applications*, 8(1) :22–29.
- [Bennani et al., 2019] Bennani, C., Bedouhene, F., Bibi, H., Zemouche, A., Rajamani, R., Chaib-Draa, K., and Aitouche, A. (2019). Robust  $H_\infty$  Observer-based Stabilization of Linear Discrete-time Systems with Parameter Uncertainties. *International Journal of Control, Automation and Systems*, 17(9) :2261–2273.
- [Bergsten et al., 2001] Bergsten, P., Palm, R., and Driankov, D. (2001). Fuzzy observers. *10th IEEE International Conference on Fuzzy Systems. (Cat. No.01CH37297)*, 2(June 2001) :700–703.
- [Bezzaoucha et al., 2013] Bezzaoucha, S., Marx, B., Maquin, D., and Ragot, J. (2013). Nonlinear joint state and parameter estimation : Application to a wastewater treatment plant. *Control Engineering Practice*, 21(10) :1377–1385.
- [Blandeau et al., 2018] Blandeau, M., Estrada-Manzo, V., Guerra, T. M., Pudlo, P., and Gabrielli, F. (2018). Fuzzy unknown input observer for understanding sitting control of persons living with spinal cord injury. *Engineering Applications of Artificial Intelligence*, 67(December 2016) :381–389.
- [Blanke et al., 2003] Blanke, M., Kinnaert, M., Lunze, J., and Staroswiecki, M. (2003). *Diagnosis and Fault-Tolerant Control*. Springer Berlin Heidelberg, Berlin, Heidelberg, 2nd editio edition.
- [Briat, 2015] Briat, C. (2015). *Linear Parameter-Varying and Time-Delay Systems*, volume 3 of *Advances in Delays and Dynamics*. Springer Berlin Heidelberg, Berlin, Heidelberg.
- [Chadli et al., 2017] Chadli, M., Davoodi, M., and Meskin, N. (2017). Distributed state estimation, fault detection and isolation filter design for heterogeneous multi-agent linear parameter-varying systems. *IET Control Theory & Applications*, 11(2) :254–262.
- [Chadli and Karimi, 2013] Chadli, M. and Karimi, H. R. (2013). Robust Observer Design for Unknown Inputs Takagi–Sugeno Models. *IEEE Transactions on Fuzzy Systems*, 21(1) :158–164.
- [Cho and Rajamani, 1997] Cho, Y. M. and Rajamani, R. (1997). A systematic approach to adaptive observer synthesis for nonlinear systems. *IEEE Transactions on Automatic Control*, 42(4) :534–537.
- [Daafouz et al., 2002] Daafouz, J., Riedinger, P., and Iung, C. (2002). Stability analysis and control synthesis for switched systems : a switched Lyapunov function approach. *IEEE Transactions on Automatic Control*, 47(11) :1883–1887.
- [Darouach, 2009] Darouach, M. (2009). Complements to full order observer design for linear systems with unknown inputs. *Applied Mathematics Letters*, 22(7) :1107–1111.
- [Do et al., 2010a] Do, A.-L., Senéme, O., and Dugard, L. (2010a). An LPV control approach for semi-active suspension control with actuator constraints. *American Control Conference*, pages 4653–4658.
- [Do et al., 2010b] Do, A. L., Spelta, C., Savaresi, S., Senéme, O., Dugard, L., and Delvecchio, D. (2010b). An LPV control approach for comfort and suspension travel improvements of semi-active suspension systems. *Proceedings of the IEEE Conference on Decision and Control*, pages 5560–5565.

- [Ellis, 2012] Ellis, G. (2012). Chapter 6 - Four Types of Controllers. In Ellis, G., editor, *Control System Design Guide (Fourth Edition)*, pages 97–119. Butterworth-Heinemann, Boston, fourth edition edition.
- [Farza et al., 2017] Farza, M., Ménard, T., Ltaief, A., Bouraoui, I., M'Saad, M., and Maatoug, T. (2017). Extended high gain observer design for a class of MIMO non-uniformly observable systems. *Automatica*, 86 :138–146.
- [Farza et al., 2018] Farza, M., M'Saad, M., Ménard, T., Ltaief, A., and Maatoug, T. (2018). Adaptive observer design for a class of nonlinear systems. Application to speed sensorless induction motor. *Automatica*, 90 :239–247.
- [Frank, 2004] Frank, P. M. (2004). Trends in fault-tolerant control of engineering systems. *IFAC Proceedings Volumes*, 37(15) :377 – 384. 11th IFAC Symposium on Automation in Mining, Mineral and Metal Processing (MMM'04), Nancy, France, September 8-10, 2004.
- [Gao et al., 2017] Gao, N., Darouach, M., and Alma, M. (2017).  $H_\infty$  dynamic observer design for discrete-time systems. In *20th IFAC World Congress, IFAC 2017*, pages 2811–2816, Toulouse, France.
- [Gao et al., 2016] Gao, N., Darouach, M., Voos, H., and Alma, M. (2016). New unified  $H_\infty$  dynamic observer design for linear systems with unknown inputs. *Automatica*, 65 :43–52.
- [Hassanabadi et al., 2017] Hassanabadi, A. H., Shafiee, M., and Puig, V. (2017). Actuator fault diagnosis of singular delayed LPV systems with inexact measured parameters via PI unknown input observer. *IET Control Theory & Applications*, 11(12) :1894–1903.
- [Hassanabadi et al., 2018] Hassanabadi, A. H., Shafiee, M., and Puig, V. (2018). Sensor fault diagnosis of singular delayed LPV systems with inexact parameters : an uncertain system approach. *International Journal of Systems Science*, 49(1) :179–195.
- [Heemels et al., 2010] Heemels, W., Daafouz, J., and Millerioux, G. (2010). Observer-Based Control of Discrete-Time LPV Systems With Uncertain Parameters. *IEEE Transactions on Automatic Control*, 55(9) :2130–2135.
- [Hoffmann and Werner, 2015] Hoffmann, C. and Werner, H. (2015). A survey of linear parameter-varying control applications validated by experiments or high-fidelity simulations. *IEEE Transactions on Control Systems Technology*, 23(2) :416–433.
- [Hu et al., 2016] Hu, C., Jing, H., Wang, R., Yan, F., and Chadli, M. (2016). Robust  $H_\infty$  output-feedback control for path following of autonomous ground vehicles. *Mechanical Systems and Signal Processing*, 70-71 :414–427.
- [Ichalal et al., 2016] Ichalal, D., Mammar, S., and Ragot, J. (2016). Auxiliary dynamics for observer design of nonlinear TS systems with unmeasurable premise variables. *IFAC-PapersOnLine*, 49(5) :1–6.
- [Ichalal et al., 2009] Ichalal, D., Marx, B., Ragot, J., and Maquin, D. (2009). Simultaneous state and unknown inputs estimation with PI and PMI observers for Takagi Sugeno model with unmeasurable premise variables. *2009 17th Mediterranean Conference on Control and Automation*, pages 353–358.
- [Ichalal et al., 2010] Ichalal, D., Marx, B., Ragot, J., and Maquin, D. (2010). State estimation of Takagi–Sugeno systems with unmeasurable premise variables. *IET Control Theory & Applications*, 4(5) :897.
- [Jiang and Yu, 2012] Jiang, J. and Yu, X. (2012). Fault-tolerant control systems : A comparative study between active and passive approaches. *Annual Reviews in Control*, 36(1) :60 – 72.
- [Kharrat et al., 2018] Kharrat, D., Gassara, H., El Hajjaji, A., and Chaabane, M. (2018). Adaptive Observer and Fault Tolerant Control for Takagi-Sugeno Descriptor Nonlinear Systems with Sensor and Actuator Faults. *International Journal of Control, Automation and Systems*, 16(X) :1–11.
- [Kwiatkowski et al., 2006] Kwiatkowski, A., Boll, M.-T., and Werner, H. (2006). Automated Generation and Assessment of Affine LPV Models. *Proceedings of the 45th IEEE Conference on Decision and Control*, (2) :6690–6695.
- [Lendek et al., 2009] Lendek, Z., Babu? ?ka, R., and Schutter, B. D. (2009). Stability of cascaded fuzzy systems and observers. *IEEE Transactions on Fuzzy Systems*, 17(3) :641–653.
- [Liu et al., 2017a] Liu, X., Gao, Z., and Chen, M. Z. Q. (2017a). Takagi Sugeno Fuzzy Model Based Fault Estimation and Signal Compensation With Application to Wind Turbines. *IEEE Transactions on Industrial Electronics*, 64(7) :5678–5689.
- [Liu et al., 2017b] Liu, X., Gao, Z., and Chen, M. Z. Q. (2017b). Takagi–Sugeno Fuzzy Model Based Fault Estimation and Signal Compensation With Application to Wind Turbines. *IEEE Transactions on Industrial Electronics*, 64(7) :5678–5689.
- [Lofberg, 2004] Lofberg, J. (2004). YALMIP : a toolbox for modeling and optimization in MATLAB. In *2004 IEEE International Conference on Robotics and Automation (IEEE Cat. No.04CH37508)*, pages 284–289. IEEE.



- 
- [López-Estrada et al., 2017] López-Estrada, F. R., Astorga-Zaragoza, C. M., Theilliol, D., Ponsart, J. C., Valencia-Palomo, G., and Torres, L. (2017). Observer synthesis for a class of Takagi–Sugeno descriptor system with unmeasurable premise variable. Application to fault diagnosis. *International Journal of Systems Science*, 48(16) :3419–3430.
- [López-Estrada et al., 2015] López-Estrada, F.-R., Ponsart, J.-C., Astorga-Zaragoza, C.-M., Camas-Anzueto, J.-L., and Theilliol, D. (2015). Robust sensor fault estimation for descriptor-LPV systems with unmeasurable gain scheduling functions : Application to an anaerobic bioreactor. *International Journal of Applied Mathematics and Computer Science*, 25(2) :233–244.
- [López-Estrada et al., 2016] López-Estrada, F. R., Ponsart, J.-C., Theilliol, D., Zhang, Y., and Astorga-Zaragoza, C.-M. (2016). LPV Model-Based Tracking Control and Robust Sensor Fault Diagnosis for a Quadrotor UAV. *Journal of Intelligent & Robotic Systems*, 84(1-4) :163–177.
- [López-Zapata et al., 2016] López-Zapata, B., Adam-Medina, M., Escobar, R. F., Álvarez-Gutiérrez, P. E., Gómez-Aguilar, J. F., and Vela-Valdés, L. G. (2016). Sensors and actuator fault tolerant control applied in a double pipe heat exchanger. *Measurement*, 93 :215–223.
- [Lozoya-santos and Ramirez-mendoza, 2009] Lozoya-santos, J. and Ramirez-mendoza, R. A. (2009). Frequency and current effects in a MR damper Ruben Morales-Menendez Elvira Niño-Juarez. 7 :121–140.
- [Maalej et al., 2017] Maalej, S., Kruszewski, A., and Belkoura, L. (2017). Stabilization of Takagi–Sugeno models with non-measured premises : Input-to-state stability approach. *Fuzzy Sets and Systems*, 329 :108–126.
- [Marquez, 2003] Marquez, H. J. (2003). A frequency domain approach to state estimation. *Journal of the Franklin Institute*, 340(2) :147–157.
- [Marx et al., 2019] Marx, B., Ichalal, D., Ragot, J., Maquin, D., and Mammar, S. (2019). Unknown input observer for LPV systems. *Automatica*, 100 :67–74.
- [Millerioux et al., 2004] Millerioux, G., Rosier, L., Bloch, G., and Daafouz, J. (2004). Bounded State Reconstruction Error for LPV Systems With Estimated Parameters. *IEEE Transactions on Automatic Control*, 49(8) :1385–1389.
- [Montes de Oca et al., 2014] Montes de Oca, S., Tornil-Sin, S., Puig, V., and Theilliol, D. (2014). Fault-tolerant control design using the linear parameter varying approach. *International Journal of Robust and Nonlinear Control*, 24(14) :1969–1988.
- [Nagy Kiss et al., 2015] Nagy Kiss, A. M., Ichalal, D., Schutz, G., and Ragot, J. (2015). Fault tolerant control for uncertain descriptor multi-models with application to wastewater treatment plant. *American Control Conference, ACC 2015*, 2015(July) :5718–5725.
- [Nagy Kiss et al., 2011] Nagy Kiss, A. M., Marx, B., Mourot, G., Schutz, G., and Ragot, J. (2011). Observers design for uncertain Takagi-Sugeno systems with unmeasurable premise variables and unknown inputs. Application to a wastewater treatment plant. *Journal of Process Control*, 21(7) :1105–1114.
- [Nagy-Kiss et al., 2015] Nagy-Kiss, A. M., Schutz, G., and Ragot, J. (2015). Parameter estimation for uncertain systems based on fault diagnosis using Takagi-Sugeno model. *ISA Transactions*, 56 :65–74.
- [Nguyen et al., 2016] Nguyen, M. Q., Sename, O., Dugard, L., Nguyen, M. Q., Sename, O., Dugard, L., Nguyen, M. Q., Sename, O., and Dugard, L. (2016). Comparison of observer approaches for actuator fault estimation in semi-active suspension systems To cite this version : Comparison of observer approaches for actuator fault estimation in semi-active suspension systems. pages 221–226.
- [Odgaard et al., 2013] Odgaard, P. F., Stoustrup, J., and Kinnaert, M. (2013). Fault-tolerant control of wind turbines : A benchmark model. *IEEE Transactions on Control Systems Technology*, 21(4) :1168–1182.
- [Orjuela et al., 2019] Orjuela, R., Ichalal, D., Marx, B., Maquin, D., and Ragot, J. (2019). Polytopic Models for Observer and Fault-Tolerant Control Designs. In *New Trends in Observer-Based Control*, pages 295–335. Elsevier.
- [Osorio-Gordillo et al., 2015] Osorio-Gordillo, G. L., Darouach, M., and Astorga-Zaragoza, C. M. (2015).  $H_\infty$  dynamical observers design for linear descriptor systems. Application to state and unknown input estimation. *European Journal of Control*, 26 :35–43.
- [Park et al., 2002] Park, J. K., Shin, D. R., and Chung, T. M. (2002). Dynamic observers for linear time-invariant systems. *Automatica*, 38(6) :1083–1087.
- [Patton et al., 1989] Patton, R. J., Frank, P. M., and Clarke, R. N., editors (1989). *Fault Diagnosis in Dynamic Systems : Theory and Application*. Prentice-Hall, Inc., Upper Saddle River, NJ, USA.

- [Pellanda et al., 2002] Pellanda, P. C., Apkarian, P., Tuan, H. D., and Alazard, D. (2002). Missile autopilot design via a multi-channel LFT/LPV control method. *IFAC Proceedings Volumes (IFAC-PapersOnline)*, 15(1) :107–112.
- [Pérez-Estrada et al., 2018a] Pérez-Estrada, A.-J., Osorio-Gordillo, G.-L., Alma, M., Darouach, M., and Olivares-Peregrino, V.-H. (2018a).  $H_\infty$  generalized dynamic unknown inputs observer design for discrete LPV systems. Application to wind turbine. *European Journal of Control*, (xxxx).
- [Pérez-Estrada et al., 2018b] Pérez-Estrada, A.-J., Osorio-Gordillo, G.-L., Darouach, M., Alma, M., and Olivares-Peregrino, V.-H. (2018b). Generalized dynamic observers for quasi-LPV systems with unmeasurable scheduling functions. *International Journal of Robust and Nonlinear Control*, 28(17) :5262–5278.
- [Rajamani, 2012] Rajamani, R. (2012). *Vehicle Dynamics and Control*. Mechanical Engineering Series. Springer US, Boston, MA.
- [Rodrigues et al., 2007] Rodrigues, M., Theilliol, D., Aberkane, S., and Sauter, D. (2007). Fault Tolerant Control Design For Polytopic LPV Systems. *International Journal of Applied Mathematics and Computer Science*, 17(1) :27–37.
- [Rotondo, 2018] Rotondo, D. (2018). *Advances in Gain-Scheduling and Fault Tolerant Control Techniques*. Springer Theses. Springer International Publishing, Cham.
- [Rotondo et al., 2013] Rotondo, D., Nejjari, F., and Puig, V. (2013). Quasi-LPV modeling, identification and control of a twin rotor MIMO system. *Control Engineering Practice*, 21(6) :829–846.
- [Shamma, 2012] Shamma, J. S. (2012). An overview of lpv systems. In *Control of linear parameter varying systems with applications*, pages 3–26. Springer.
- [Shao et al., 2018] Shao, H., Gao, Z., Liu, X., and Busawon, K. (2018). Parameter-varying modelling and fault reconstruction for wind turbine systems. *Renewable Energy*, 116 :145–152.
- [Skelton et al., 1997] Skelton, R., Iwasaki, T., and Grigoriadis, D. (1997). *A Unified Algebraic Approach To Control Design*. Series in Systems and Control. Taylor & Francis.
- [Srinivasarengan et al., 2017] Srinivasarengan, K., Ragot, J., Aubrun, C., and Maquin, D. (2017). An adaptive observer design approach for discrete-time nonlinear systems. (1).
- [Srinivasarengan et al., 2018] Srinivasarengan, K., Ragot, J., Aubrun, C., and Maquin, D. (2018). An adaptive observer design approach for a class of discrete-time nonlinear systems. *International Journal of Applied Mathematics and Computer Science*, 28(1) :55–67.
- [Sturm, 1999] Sturm, J. F. (1999). Using sedumi 1.02, a matlab toolbox for optimization over symmetric cones. *Optimization Methods and Software*, 11(1-4) :625–653.
- [Theilliol and Aberkane, 2011] Theilliol, D. and Aberkane, S. (2011). *Design of LPV observers with unmeasurable gain scheduling variable under sensor faults*, volume 18. IFAC.
- [Tóth, 2010] Tóth, R. (2010). *Modeling and Identification of Linear Parameter-Varying Systems*, volume 403 of *Lecture Notes in Control and Information Sciences*. Springer Berlin Heidelberg, Berlin, Heidelberg.
- [Varga and Ossmann, 2014] Varga, A. and Ossmann, D. (2014). Lpv model-based robust diagnosis of flight actuator faults. *Control Engineering Practice*, 31 :135 – 147.
- [Venkatasubramanian, 2003] Venkatasubramanian, V. (2003). A review of process fault detection and diagnosis : Part III : Process history based methods. *Computers & chemical . . .*, 27 :293–311.
- [Venkatasubramanian et al., 2003a] Venkatasubramanian, V., Rengaswamy, R., and Kavuri, S. N. (2003a). A review of process fault detection and diagnosis : Part II : Qualitative models and search strategies. *Computers & Chemical Engineering*, 27 :313–326.
- [Venkatasubramanian et al., 2003b] Venkatasubramanian, V., Rengaswamy, R., Yin, K., and Kavuri, S. N. (2003b). A review of process fault detection and diagnosis part I : Quantitative model-based methods.
- [Xie, 2008] Xie, W. (2008). An Equivalent LMI Representation of Bounded Real Lemma for Continuous-Time Systems. *Journal of Inequalities and Applications*, 2008(1) :672905.
- [Yacine et al., 2013] Yacine, Z., Ichalal, D., Oufroukh, N. A., and Mammam, S. (2013). Vehicle nonlinear observer for state and tire-road friction estimation. *IEEE Conference on Intelligent Transportation Systems, Proceedings, ITSC, (Itsc)* :2181–2186.
- [Yoneyama, 2009] Yoneyama, J. (2009).  $H_\infty$  filtering for fuzzy systems with immeasurable premise variables : An uncertain system approach. *Fuzzy Sets and Systems*, 160(12) :1738–1748.

- 
- [Youssef et al., 2014] Youssef, T., Chadli, M., Karimi, H., and Zelmat, M. (2014). Design of unknown inputs proportional integral observers for TS fuzzy models. *Neurocomputing*, 123 :156–165.
- [Zhang and Wang, 2016] Zhang, H. and Wang, J. (2016). Adaptive Sliding-Mode Observer Design for a Selective Catalytic Reduction System of Ground-Vehicle Diesel Engines. *IEEE/ASME Transactions on Mechatronics*, 21(4) :2027–2038.
- [Zhang and Wang, 2017a] Zhang, H. and Wang, J. (2017a). Active steering actuator fault detection for an automatically-steered electric ground vehicle. *IEEE Transactions on Vehicular Technology*, 66(5) :3685–3702.
- [Zhang and Wang, 2017b] Zhang, H. and Wang, J. (2017b). Improved NO and NO<sub>2</sub> Concentration Estimation for A Diesel-Engine-Aftertreatment System. *IEEE/ASME Transactions on Mechatronics*, 4435(2) :1–1.
- [Zhang et al., 2016] Zhang, H., Zhang, G., and Wang, J. (2016). H<sub>∞</sub> Observer Design for LPV Systems with Uncertain Measurements on Scheduling Variables : Application to an Electric Ground Vehicle. *IEEE/ASME Transactions on Mechatronics*, 21(3) :1659–1670.
- [Zhang, 2002] Zhang, Q. (2002). Adaptive observer for multiple-input-multiple-output (MIMO) linear time-varying systems. *IEEE Transactions on Automatic Control*, 47(3) :525–529.
- [Zhang and Jiang, 2008] Zhang, Y. and Jiang, J. (2008). Bibliographical review on reconfigurable fault-tolerant control systems. *Annual Reviews in Control*, 32(2) :229 – 252.