



HAL
open science

**Mesurer l'émergence et la structuration d'une industrie :
une approche par les réseaux de relations
interorganisationnelles autour d'Activités Technologiques
Clés**

Gulsemin Altundas

► **To cite this version:**

Gulsemin Altundas. Mesurer l'émergence et la structuration d'une industrie : une approche par les réseaux de relations interorganisationnelles autour d'Activités Technologiques Clés. Gestion et management. Université de Lorraine, 2021. Français. NNT : 2021LORR0002 . tel-03143049

HAL Id: tel-03143049

<https://hal.univ-lorraine.fr/tel-03143049v1>

Submitted on 16 Feb 2021

HAL is a multi-disciplinary open access archive for the deposit and dissemination of scientific research documents, whether they are published or not. The documents may come from teaching and research institutions in France or abroad, or from public or private research centers.

L'archive ouverte pluridisciplinaire **HAL**, est destinée au dépôt et à la diffusion de documents scientifiques de niveau recherche, publiés ou non, émanant des établissements d'enseignement et de recherche français ou étrangers, des laboratoires publics ou privés.



AVERTISSEMENT

Ce document est le fruit d'un long travail approuvé par le jury de soutenance et mis à disposition de l'ensemble de la communauté universitaire élargie.

Il est soumis à la propriété intellectuelle de l'auteur. Ceci implique une obligation de citation et de référencement lors de l'utilisation de ce document.

D'autre part, toute contrefaçon, plagiat, reproduction illicite encourt une poursuite pénale.

Contact : ddoc-theses-contact@univ-lorraine.fr

LIENS

Code de la Propriété Intellectuelle. articles L 122. 4

Code de la Propriété Intellectuelle. articles L 335.2- L 335.10

http://www.cfcopies.com/V2/leg/leg_droi.php

<http://www.culture.gouv.fr/culture/infos-pratiques/droits/protection.htm>

Thèse de Doctorat en Sciences de Gestion

Présentée et soutenue publiquement par

Gulsemin ALTUNDAS

Le 11 Janvier 2021

pour l'obtention du grade de Docteur en sciences de gestion

Assessing industry emergence and structuration: An approach through interorganizational relationship networks around Key Technological Activities

Dirigée par Hélène DELACOUR

Professeur des Universités,

IAE Nancy School of Management, Université de Lorraine

Rapporteurs	Mme Rachel BOCQUET	Professeur des Universités, IAE Savoie Mont Blanc, Université Savoie Mont Blanc
	Mme Caroline HUSSLER	Professeur des Universités, IAE Lyon School of Management, Université Jean Moulin
Examineurs	M. Paul CHIAMBARETTO	Professeur Associé, Montpellier Business School
	M. Jan LEPOUTRE	Professeur Associé, ESSEC Business School
	Mme Hélène DELACOUR	Directeur de thèse



L'université n'entend donner aucune approbation ou improbation aux opinions émises dans les thèses. Ces opinions doivent être considérées comme propres à leurs auteurs.

Yavuz-Selim, the gift to my heart;

To Yasemin, the friend of my spirit;

To my parents;

To Soner, of course.

SUMMARY

ACKNOWLEDGMENT	9
LIST OF ABBREVIATIONS	11
GENERAL INTRODUCTION	13
PART I: LITERATURE REVIEW	35
Chapter 1. Disruptive innovation: Theory, challenges, and evolution	38
Section I. The disruptive innovation theory	40
Section II. The proclivity of disruptive innovation to create turbulent environments	60
Conclusion of Chapter 1	79
Chapter 2. Interorganizational relationships networks as a response to disruptive innovation	81
Section I. Apprehending the emergence of an industry	83
Section II. Considering industry emergence from a network approach	97
Conclusion of Chapter 2	122
Chapter 3. Theoretical gaps and research questions	123
Section I. A critical review of macro level industry emergence dynamics	125
Section II. A multi-level analysis	136
Section III. A cross-level network analysis through organizational attributes	146
Conclusion of Chapter 3	153
PART II: METHODOLOGY	155
Chapter 4. Research context	157
Section I. The genesis of the traditional automotive industry	158
Section II. The autonomous vehicle industry	169
Section III. Justification of the research setting	183
Conclusion of Chapter 4	198
Chapter 5. Research design	200
Section I. Epistemological paradigm	202
Section II. Methodological anchorage	212

Conclusion of Chapter 5	223
Chapter 6. Construction of the databases	224
Section I. Sociometric data collection	226
Section II. Data codification process	248
Conclusion of Chapter 6	257
PART III: FINDINGS	261
Chapter 7. Interorganizational relationships as metrics to assess industry emergence and structuration	263
Section I. Interorganizational relationships as industry emergence metrics	265
Section II. Key Technological Activities as industry structuration metrics	284
Conclusion of Chapter 7	299
Chapter 8. Multi-network analysis based on organizational attributes	301
Section I. Identification of shared characteristics of interorganizational networks at the organizational level	303
Section II. Identification of specific characteristics of interorganizational networks at the network level	320
Conclusion of Chapter 8	374
Chapter 9. Discussion	379
Section I. Research synthesis	380
Section II. Theoretical contributions	383
Section III. Managerial and methodological contributions	401
Section IV. Limits and future research directions	408
REFERENCES	411
LIST OF TABLES	435
LIST OF FIGURES	437
TABLE OF CONTENT	441

ACKNOWLEDGMENT

Gratitude is the memory of the heart. *Hans Christian Andersen*

The work presented in this present thesis has been carried out at the Innovation and Entrepreneurial Dynamics Division at the CEREFIGE research laboratory (University of Lorraine) in collaboration with ARaymond Network as part of a CIFRE research project.

During these three years, I have received a generous amount of support from a large panel of people who have contributed either directly or indirectly to the completion of this fascinating work. These few lines will not be enough to express how grateful I am for these people.

Primarily, I owe the deepest gratitude to my supervisor, Pr. H  l  ne DELACOUR, for her support and constant inputs of energy and inspiration. I wish to acknowledge the continuous support, patience, motivation, and passion for research that she provided me during my Ph.D. Her guidance and support helped me in all the time of research and writing of this thesis and cleared the path for nothing more than excellence for me. I am grateful for the constructive discussions about the exciting topic that is research, the proofreading, and her availability at all times.

A thesis would not be one without the discussion with the members of my defense jury. I wish to express my thanks to the Professors who honor me with their presence and their knowledge: Mrs. Rachel Bocquet, Mrs. Caroline Hussler, Mr. Paul Chiambaretto, and Mr. Jan Lepoutre.

I want to express my gratitude to the ARaymond Network to provide the funding for this research project. A special thanks to Claire Lagorio, my manager as a Market analyst in the PMs Team, for sharing her life experiences and for the fascinating marketing and automotive-related discussions. Besides, I thank her for her kindness and empathy. This project also is supported by Christine Coup  , the Chief Marketing Officer of Raygroup; thank you for accepting a Ph.D. student in your team. Finally, a special thanks to Veronique Goerger, without whom I would have been weighed by the burden of the bureaucratic obligations of the thesis.

Besides, my most profound appreciation goes to Yassine, who helped me in the statistical treatment of the paramount data implied in this thesis.

Between discussions that initiate the thesis and the ones, which end it, hide all those discussions that make it happen.

I want to extend sincere thanks to my ARaymond colleagues for their unwavering support and valuable advice. A special thanks to Maxime for the constructive discussions.

I am deeply indebted to my parents, who, even if deeply confused by the challenges of this work, always have supported me, believed in me, and expressed a fascination for this project. To whom I owe valuable discussions in times of doubts and unforgettable times sharing my deepest joys and achievements; it would not have been possible without the support and nurturing of my mother, father, and siblings Soner, Oktay, Seda...

My friends: Léa, Calogero, Maria, Viktoria, Farhate, Amal, Joana...

Christapor, for the discussions about atypical life experiences, mountain hikes, and car rides.

Yasemin, my sister, of course. For her presence, warm-ups, and relentless commitment to my happiness. Side by side or miles apart.

Yavuz-Selim, my unfailing inspiration. To the unwavering support and faith in me. Your kindness, presence, and care for others is the golden thread to the meaning of life. My doctoral journey would not have been the same without your humor and peaceful mind.

LIST OF ABBREVIATIONS

ADAS	Advanced Driver-Assistance Systems
AI	Artificial Intelligence
AmoD	Autonomous mobility on-Demand
AV	Autonomous Vehicle
CD	Competence-Destroying
CE	Competence-Exploiting
C-V2X	Cellular Vehicle-to-X
ECU	Electronic Control Unit
GICS	Global Industry Classification Standard
GPS	Global Positioning Specification
HD	High-Definition
IEEE	Institute of Electrical and Electronics Engineers
INC	Incumbent
IoT	Internet-of-Things
IR	Interorganizational Relationship
ISO	International Organization for Standardization
KTA	Key Technological Activity
LIDAR	Light Detection and Ranging
MaaS	Mobility-as-a-Service
MDS	Multi-Dimension Scaling
NE	New Entrant
NLU	Natural Language Understanding
NPD	New Product Development
OEM	Original Equipment Manufacturer
OI	Open Innovation
OTA	Over-The-Air
PoC	Proof-of-Concept
RBV	Resource-Based View
RPP	Resource-Process-Priority

RPV	Resource-Process-Value
SAE	Society of Automotive Engineers
SCP	Structure-Conduct-Performance
SME	Small-Medium Enterprise
SNA	Social Network Analysis
SoC	System-on-Chip
TC	Transaction Cost
V2I	Vehicle-to-Infrastructure
V2P	Vehicle-to-Pedestrian
V2V	Vehicle-to-Vehicle
V2X	Vehicle-to-X

GENERAL INTRODUCTION

It has been said that the Industrial Revolution was the most profound revolution in human history because of its sweeping impact on people's daily lives due to the accelerated pace of change revealed to speed up. The non-questionable role of industry settings seems to be an empirical concept since the late 18th century. Yet the questions of industry change and emergence remain relevant nowadays. While traditional industries are in crisis, it is on the side of the emerging industries that organizations seize the greatest opportunities. How to find the right vein, what new constraints are needed, on which model organizations can count on to make the right decisions? These questions are crucial because "a key strategic issue is a balance a firm takes between industry advocacy and pursuing its narrow self-interest. This need for industry cooperation during the emerging period often seems to raise an internal dilemma for firms" (Porter, 1979: 230). Affirmatively, industry emergence is a dilemma condensing growth and opportunities with rising turbulences due to inadequate organizational resources to perform in the new industry.

There are alternative explanations for why industries emerge when considering Schumpeter (1934) and Marshall (1920) as the field's precursors.

Schumpeter (1934) argued that new technologies principally drive industries' emergence through creative destruction processes and later discussed by industrial economics. He introduced creative destruction to explain the unrelenting innovation mechanisms by which new products, services, or processes replace obsolete ones. Creative destruction is, by definition, the degradation of long-standing practices, procedures, products, or services. It is built on the concept that old assumptions need to be broken so that new technological requirements will drive new industries' development. As a trigger, an organization introduces a fundamentally different technology that disrupts the market equilibrium. Because it is the owner and the first to introduce such technology to the market, the organization obtain leadership; however, at some point in the industry's life cycle, this organization is imitated and even bypassed by new entrants that outperform it.

If we now consider Marshall's (1920) perception of industry emergence, knowledge and subjacent resources and competencies drive industries' emergence. From that perspective,

industry emergence will be driven by organizations' ability to find a balance between internal and external environments. Consequently, the new industry will result from organizations' opportunistic behaviors and the ability to accumulate a specific resource to back up newness by implementing routines (Nelson & Winter, 1982).

Despite being essential in management studies, the phenomenon of industry emergence that sets organizations' competitive environment is relatively neglected by the literature (Forbes & Kirsch, 2011). The reason is twofold: theoretical and empirical.

Theoretically, the lack of research in the field of industry emergence has fueled persisting research gaps in terms of how industries emerge. Emerging industries change the competitive landscape in a given industry (creative destruction); therefore, understanding how the emerging industry will impact organizational strategies could be a variable in strategic management studies.

Empirically, it has been discussed that industry emergence is difficult to analyze and assess, partly because it is challenging to consider when an industry is emerging due to a blurry definition of industries. Industry boundaries are either constructed by industry participants (Eisenhardt & Santos, 2009) or based on irrelevant industry codes (Porac et al., 2002). Studies on industry emergence also face the recurrent problem of identifying emerging ones after they are created (MacMillan & Katz, 1992). Therefore, they propose an industry structuration model rather than an analysis of how a given industry has emerged.

Considering that little is known about how new industries emerge and structure over time raises questions about predictability, network formation, and new competitive patterns. In those terms, the literature has unfolded many questions about how do industries emerge and do we assess them (Padgett & Powell, 2012). Still, only a limited amount of studies have addressed these questions, and when they examine these issues, they adopt a static approach through industry life-cycle models (Phaal, et al., 2011) that furthermore mostly study industry structuration rather than industry emergence.

The static approach in industry emergence studies represents a threat to examining such a phenomenon that is “the intersection of a unit of analysis and a temporal interval” (Forbes & Kirsch, 2011: 591). Low and Abramhamson (1997) explained that emerging industries are

experiencing the earliest development stage within an industry life cycle. Consequently, the industry emergence phenomena imply a time interval, which again induces a significant change in the duration of period across industries. Underlying this debate are some discussions about a precise temporal boundary in terms of ILC phases. When some studies consider the growth stage a natural way to finish the emerging stage (Low & Abrahamson, 1997), other studies extend the emerging phase beyond the growth stage (Aldrich & Ruef, 2006).

Some significant works also have been carried out in recent years by the industrial dynamics with the market structure and innovation approach (Kamien & Schwartz, 1975) and the evolutionary economics literature (Nelson & Winter, 1982; Padgett & Powell, 2012; Phaal, et al., 2011; Dosi & Nelson, 1994; Malerba, 2002, 2004) which considered learning and knowledge as core elements for industry emergence. These studies tend to focus on evolutionary mechanisms by which organizations acquire resources over time. The study of these mechanisms over time plays a central role because they predict the patterns of change in industries in terms of industry life cycles. Also, even though studies on industry emergence have started to explore the role of innovation and industry dynamics, little is known about how innovations and industry emergence coevolve as part of the same continuum. Are there any cause-effect relationships that may help to understand industry emergence processes better? Or maybe predict them?

From that initial postulate, we contended to focus our research on industry emergence, which has mostly been overlooked by the literature, although it is a critical phenomenon. Alongside our main observation stating the overlooked status of industry emergence in general, we have wondered that, given the role of innovation in the modern world, why does not industry emergence studies take innovation as a critical variable of industry emergence? Given many studies discussing the impacts of disruptive innovations on industries, why is the link between both concepts not clear?

Consequently, our initial questioning can be summarized in two assumptions.

Firstly, acknowledging a limited amount of research on industry emergence motivates research questions towards how can we assess industry emergence when emergence is occurring? For that, identifying an emerging industry seemed mandatory, and we argue that some industry indicators may help identify emergence. It induces identifying primarily what

can cause the emergence of a given industry. For that, the literature provides a wide array of responses in terms of technological discontinuities (Anderson & Tushman, 1990) that cause new-market disruption (Christensen & Raynor, 2003), or in other words, the emergence of a new industry.

Secondly, understanding how organizations react to a turbulent environment, inherent to disruptive innovation, can, by itself, give several clues on how to depict and assess industry emergence while emergence is happening.

As part of the same thinking process, we explain how we have proposed in this thesis a response to essential questions revolving around how to assess industry emergence through key theoretical variables. We present our intellectual journey to contribute to industry emergence studies by first discussing the main problems we faced when working on industry emergence, which mostly revolved around a blurry border between industry emergence and industry structuration. Secondly, the present thesis provides an interesting take on disruptive innovations by linking intrinsic innovation criteria to such a macro phenomenon that is industry emergence. The consideration of innovation content in industry emergence should be a more crucial variable (Grodal, et al., 2014).

1. The issue of emerging industries

As globalization and technology-driven disruptions will continue to encourage the increasing emergence and downfall of new industries, studies on industry emergence are deemed to gain traction in management studies (Agarwal & Sarkar, 2002). Tempted by the willingness to understand the phenomena of the emerging industries in technology-driven contexts and at different analysis levels, we have made several key observations that helped form our questionings regarding this essential yet overlooked subject. Despite the richness in industry emergence literature and the subjacent theoretical explanations to such phenomena, we still questioned if alone, these studies responded to the primary variable of industry emergence: unpredictability and lack of assessment. How can we build on the empirical model of industry structuration yet differentiating emergence from structuration?

1.1. The difference between industry emergence and structuration

Darwin's question on species' origins is as relevant in management studies as it is in biology (Padgett & Powell, 2012). Analogously, organizations, and industries like the human species experience change, perish, emerge, and evolve. In terms of industry emergence, authors (ibid) argued that what we know about the industry is "selection and equilibrium," yet "we do not understand the emergence of what we choose" (ibid: 2). Authors reminded that Darwin did not answer the question of origins of species; instead, he studied species selection when these species already existed. Through that analogy, authors raised a fundamental issue in industry emergence studies: do we assess industry emergence, or do we consider it a part of industry structuration by analyzing industrial selection processes?

We find that observation groundbreaking in terms of how we could contribute to industry emergence. Industry emergence studies are well-littered, but what if these studies mainly focus on industry structuration?

Industry emergence implies an alteration of an economic system (Malerba, 2007) and is nearly always driven by technology (Schumpeter, 1934; Marshall, 1920). We argue technologies that cause industry emergence are disruptive innovations due to their intrinsic characteristics (Christensen, 1997). As a result, industry emergence induces the study of something new that did not exist before and requires identifying key research variables. Our analysis presents two critical implications.

We observed that industry emergence studies tend to explain the development and structuration of relatively mature industries. From that perspective, we wondered what we could learn about industry emergence by focusing on mature industries? Both concepts, emerging and mature, seem to be antinomic because what is emerging is new. In contrast, what is mature has passed the emerging and growth phases crucial in industry emergence studies. Undoubtedly, we can learn so much in mature industries. Yet, they seem not to suit industry emergence studies' main variables: studying an emerging industry based on a temporal scale. The willingness to separate both theoretical concepts responded to our central problem about industry emergence assessment. While industry emergence focuses on emerging industries, namely new industries that respond to non-consumption (Christensen &

Raynor, 2003), industry structuration seizes a mature industry's evolution patterns, namely an industry that has already experienced emergence and growth priorly.

Indeed, industry structuration implies the study of patterns, meaning the depiction of regularity in a given environment, e.g., that is known. The study of patterns provides a standard or intelligible form to the studied elements. As such, it is a “leading depiction of the evolution of new industries” (Klepper, 1997: 145). In terms of industry structures and dynamics, a body of researchers has argued that industry structuration is fueled by technological cycles. The competitive patterns and attractiveness of the final product will determine an industry’s structure over a time period (Anderson & Tushman, 1990; Teece, 1986). These studies contend to analyze how industries pass from one phase of the industry life cycle to another. There are certainly debates amongst scholars on the temporal bracketing of ILCs, but they do not foster how to foresee and assess the first stage of ILC: the emergence phase.

Another stream of the literature argued that industry structure relies on past technological innovation to give incumbents and new entrants more or less power based on their existing resources and knowledge. Is the first phase of ILC based on a technological assessment then? Slowly the questions around how industries emerge and evolve, and the perspective of industry assessment showed that industry emergence and structuration are linked but necessitate different approaches to be assessed. Given the practical and theoretical importance of industry emergence in managerial studies in terms of contextual information regarding how organizations compete, we identified several critical observations.

The central variable differentiating industry emergence and structuration is the level of unknown between both settings. While industry structuration studies focus on the dynamics of an identified environment where the variables may already be known or predictable, and the questionings focus on how these variables react over time; research on industry emergence necessitate to take the unknown as a variable to allow predictability and turbulent management dynamics too, and incorporate structuration variables in different phases.

As mentioned, we identified a wide array of studies that examined industry structuration (e.g., innovation, internationalization, the introduction of new products, life cycles of manufacturing, and emerging technologies); yet the emphasis on industrial emergence based

on technology (Adner, 2017; Anderson & Tushman, 1990) seemed limited. In parallel, other studies found that while there is already an emerging industry, narrow is the evidence providing insights on the early stages of development (McGahan et al., 2004), i.e., emergence (Pagdett & Powell, 2012).

The questions around industry emergence become even more critical in the context of the Fourth industrial revolution (Industry 4.0), where industries incorporate cutting-edge innovations highly based on digitalization, data, and connectivity. The past two decades have seen the birth of an unprecedented number of new-to-the-world industries. These technologies are intrinsically disruptive because what results from their introduction is a paradigmatic shift between the traditional industry and the new one (Teece, 1986). As such, they modify the manufacturing processes and value chains, which step out of the traditional supply chains that we have known until now. Technologies such as cloud services, warehouse robotics, and smartphones have redefined entire industries, making old business categories obsolete. A steady stream of emerging innovations—from commercial drones and autonomous vehicles and trucks to virtual and augmented reality—suggests the era of industry emergence will continue for the near future.

These technologies provide solid ground for industry emergence studies because they profoundly modify industrial landscapes, processes, and organizational strategies that are forced to change and propose new variables to look at. Despite being disruptive, the fact that these technologies are currently emerging provides opportunities for real-time variables identification. Here we draw attention to disruptive innovation by discussing the growing role of such concept in industry emergence studies (Anderson & Tushman, 1990).

1.2. The role of disruptive innovation in industry emergence

Emerging industries, rather than real high growth, are characterized by high growth potential. While they are growing faster than the economy as a whole, much of their growth capacity has yet to materialize. Their growth rates are typically still lower than those of other mature industries. Even though emerging industries need to be examined because there are potential environments in which organizations compete and hold high potential growths, other elements need to be considered to understand how new industries emerge based on technological change.

Usually, emerging industries are generated based on a new product, service, or process that would create a change in customers' need and slowly cannibalize the consumption from the traditional industry that would then experience a paradigmatic shift (Teece, 1986) before dislocating into a new industry that responds to non-consumption (Christensen & Raynor, 2003). In these emerging industries, some studies have argued that these key enabling technologies will play the role of driver (Adner, 2017) for industry emergence and then structuration. Named differently by scholars, including discontinuous innovation (Anderson & Tushman, 1990), emerging innovations (Day & Schoemaker, 2000), architectural innovation (Abernathy & Clark, 1985), discrete innovation (Ghosh et al., 2017), and disruptive innovation (Christensen, 1997; Christensen et al., 2018), these technological innovations refer to "any new technology or startup" which "shake up an industry and alter its competitive patterns" (Christensen et al., 2015: 2).

By definition, disruptive innovation is the underlying explanation of industry emergence, i.e., the introduction of disruptive innovation is followed by the first phase of industry life cycle models like a creative destruction process. They are not only products and services, but also the mechanisms by which such goods or services initially take root at the bottom of the industry, usually by being more available and inexpensive than established products or services to step up-market aggressively and gradually displacing incumbents (Christensen, 1997; Christensen & Rosenbloom, 1995). This perspective will be criticized in later studies (Danneels, 2004).

Therefore, disruptive innovation induces dynamic patterns and timely evolution because is not merely a product or service delivered at a fixed point; much more, it is a mechanism for assessing the development of that product or service in a given industry and over time (Christensen et al., 2015). Gemici and Alpan (2015) define disruption as a metaphor for making a change of the game, instead of just holding to existing ones where the new value proposition leads to disuse of the standardized and defined value proposal.

Here, the interplay between disruption and industry emergence occurs because disruptive innovations are considered as technological discontinuities that cause new-market disruption, or in other words, the emergence of a new industry. Disruption innovations mention how innovations can create turbulence in a given industry, which then, by inference, links the concept of turbulence to the one of industry emergence.

All these changes caused by disruption consequently affect organizations, and managerial studies have focused on defining the challenges of disruptive innovations from incumbents (Ansari & Krop, 2012; Christensen, 1997; van Mossel et al., 2018) and new entrants' (Ansari et al., 2016; Chandy & Tellis, 2000; Markman & Waldron, 2013) perspective. The new entrant, also entitled as the challenger (Ansari & Krop, 2012), the disruptor (Ansari et al., 2016), or the innovator (Christensen 1997; O'Reilly & Tushman 2016), are the companies that enter the industry from the bottom intending to move upmarket. Incumbents are the companies that are already settled in a given industry; they populate an established industry.

Nokia's smartphone story exemplifies the common challenges often observed in disruptive innovation cases, where successful companies face disruption causing the emergence of a new industry. In that case, if Nokia, as an incumbent, would have chosen not to perform temporal myopia about the disruptive innovations that later became the smartphone industry, it could have seen the new emerging industry coming. Yet, in that case, success bred conservatism and hubris and, over time, resulted in a deterioration in strategy processes, which led to adverse strategic decisions. Nokia's downturn in mobile phones is not regarded as a single, straight answer: management decisions, inefficient organizational structures, increasing bureaucracy, and serious inner rivalries have altogether played a massive part in keeping Nokia from acknowledging the change from product-based competition to platform-based competition. When businesses have adopted new concepts and experiments to promote growth, they become risk-averse, less creative, and impervious to disruption. These concerns would be essential for organizations that want to thrive and prevent one of the most significant disruptive hurdles to their future – their success.

However, many questions may arise at that point. How do organizations like Nokia make sure of an emerging industry, and how disruption is assessed?

If managers had the certainty of the future, the results would have differed in Nokia's case. Nevertheless, Nokia is a long-gone example; yet organizations still experience similar problems because disruption is perceived as a threat. After all, disruptive innovation is not foreseeable, and the link between disruptive innovation and industry is not entirely clear. We understand that disruptive innovation creates a paradigmatic shift, and scholars often highlight that disruption is technological, yet to what extent technological variables are studied in the context of industry emergence. What are the implications of technological complexity in industry emergence?

As a consequence, we reckon disruptive innovation “as any new technology or startup that aims to shake up an industry and alter its competitive patterns” (Christensen et al., 2015: 2) through “substantially different core technologies” that cause turbulences (Christensen, 1997, 2003) by “reconfiguring positions of leadership” (Ansari & Krop, 2012: 1357) resulting from the emergence of a new industry (Christensen & Raynor, 2003).

In conclusion, disruptive innovations are drivers and imply a radical change in the competitive landscape, e.g., in given industries. When disrupting the existing industry, disruptive innovation causes the emergence of a new one to accommodate innovation, which does not suit the traditional industry’s customers' requirements and needs.

From this initial postulate, we have articulated our thinking process on how to consider disruptive innovation in a case where it causes the emergence of an entirely new industry and links both concepts as part of a cause-effect dynamic study.

Therefore, the present thesis proposes disruptive innovation and industry emergence as part of the same continuum. Industry emergence is caused by disruptive innovation through competence-destroying mechanisms making existing resources and competencies obsolete. Here, we found that the inadequacy of resources, structures, and incapacity to perform flexibly in rigid structures and dedicated teams trap organizations in a loop where disruptive represents a threat to the existing business.

The focus on disruptive innovation is purposed in different manners. First, we intend to consider disruptive innovation as a beginning point (causality) in studying emerging industries (effect) by considering such theory's critical variables. Second, we intend to study disruptive innovation's effects, e.g., the emergence of a new industry, by adopting several analysis levels, the predominant one being the macro level. Finally, we consider disruptive innovation as an aggregate of different technologies and depart from a linear perspective of complex technologies that our research field proposes: the autonomous vehicle industry.

This argument, coupled with the disruptive innovation theory's (Christensen, 1997) main postulates, represents critical aspects of our preliminary assumptions. The study of disruptive innovation can, therefore, give key insights concerning why and how industries change, evolve, and the effects of the disruption of industries that we approached through a three-level funnel analysis at the macro, network, and organizational levels. We are optimistic about the

relatedness of disruptive innovations, which often are studied at the organizational level and the industry emergence process.

However, industry emergence alone is a whole other literature where challenges are known and widely discussed. The discussions around the emergence of industries are, we believe, the guiding elements of this thesis. The research of how industries emerge is partially treated by considering disruptive innovation as the main reason. However, this answer is partial and led to identifying several critical problems discussed in the next paragraph.

1.3. Problematization: Interorganizational relationship networks as metrics

Our questioning around how industries emerge led us to identify the close link between such concept and disruptive innovation. However, understanding how to assess industry emergence caused by disruptive innovation remained the unsolved objective of this research work. As a result, all the intrinsic variables of disruptive innovation, creating turbulent environments for organizations, opened research directions for this work. The problem of industry emergence underpins several folders key for managing turbulences. First, industry emergence is covered by studies focusing on linear evolution based on industry life cycles. This perspective considers that technology-intensive industries and more traditional ones behave in the same manner. We argued that this vision is restrictive because if it was the case, why would the industry's emergence cause by disruptive cause turbulences?

We develop our arguments of problematization in the following paragraphs.

Over the years, management studies have assimilated industries to natural phenomenon such as autocatalysis (Padgett & Powell, 2012) and ecosystems (Guegen, 2009), which induced that industries alike species in a given ecosystem are composed of organizations which to survive in a given context, and particularly in turbulent environments, tend to communicate and interact with each other. In those terms, analogously, industries such as species have life cycles, in which phases are calibrated to contextual characteristics. Industries change with time, structurally, and overall growth; the industry life cycle is based on total sales and the increase in the industry's total sales. As a result, industry life cycles imply that organizations perform in evolving environments where the competitive forces also tend to change and create

turbulences because disruption makes competition patterns amongst existing competitors obsolete. It does so with the arrival of a large number of new entrants, the modification in buyer-supplier relationships as the final products are changing and making substitutability a source of growing efforts (Porter, 1989). Consequently, the alteration in competitive landscape inheres many concepts that need to be studied as part of a standard process, including the departing point of industries, their emergence, and structuration (Padgett & Powell, 2012).

However, the studies on industry emergence do not enable us to identify how industries emerge; instead, they focus on how they evolve and industry life cycles contribute to that stream (Phaal et al., 2011). The evolving disruptive innovation theory and the necessity to assess the emergence of industries rather than their evolution alone led recent studies to consider how organizations adapt to such innovations to stay in the race. It enabled us to identify the primary connection that was missing between industry emergence and disruptive innovation: interorganizational relationships (IRs). IRs are defined as the relationships between suppliers, clients, competitors, diverse partners; IRs are contracted to gain access to tangible and intangible resources that the partnering companies do not have access to in the first hand (Mandard, 2015).

As interorganizational relationships are seen as the primary strategic responses to disruptive innovation, we thought they could retransmit the change occurring at the organizational level in the form of macro level industry emergence patterns. We considered the first research question to study industry emergence at the macro level:

How could interorganizational relationship dynamics allow assessing ex-ante the patterns of industry emergence in a disruptive innovation context?

Baker and Faulkner (2017: 520) stated that networks are the “interorganizational form of the future and even the emerging form of society”, and are widely used in management studies aiming to capture organization dynamics (Bocquet et al., 2006). Similarly, in the literature review, we have depicted a rising interest in a network perspective to study industries' emergence in bounded structures (Gnyawali & Madhavan, 2001).

We argued that studying the evolution of interorganizational relationships (IR) formation patterns would give us critical information on the emerging industry through IR phases.

The identification of IRs as valuable industry emergence metrics represented a partial response to our problem, though. From there, where does the emerging industry go? What can we learn from IRs in terms of structuration? These network-level questions are in line with the willingness to incorporate the technological variables back into industry emergence models and led us to our second research question:

How do interorganizational relationship networks dynamics assess the structuration patterns of industry emergence caused by disruptive innovation?

To respond to our research question, we considered that studying IR's key variables would give essential information regarding why companies collaborate, for which technological reasons, and whom. We proposed to assess the structuration patterns of the IRs and identify if there are any significant characteristics in terms of technological content over time.

To complement the information we have retrieved from the macro and network levels, we proposed understanding if organizational attributes and the specific innovation content of each IR network could influence each specific network's collaboration patterns. We think each network is unique. One pattern analysis could not verify what influences or constrains a network. To bring light on organizational variables' role in networks, we wonder:

How could the innovation content explain industry emergence patterns in terms of interorganizational relationship types and partners' choice?

The response to our last research question implied a cross-level network analysis aiming to depict primary organizational attributes and IR formation patterns in each network based on each network's innovation content, and in fine, identify major patterns within each network to show whether or not organizational attributes and innovation may play an influential role in an emerging industry.

We scoped out our analysis of disruptive innovation. Amongst several intrinsic characteristics related to disruptive innovations, we have found it challenging to see precisely why disruptive innovations are assimilated to a source of threats more than opportunities to reach another milestone in the traditional industry. The lack of scenarios for organizations, regardless of

their typology, made us think that this might be one reason why organizations are threatened by disruption more than considering it as an opportunity.

As a research field selection, the autonomous vehicle (AV) industry represents an attractive case of industry emergence caused by disruptive innovation. AVs are emerging and are disruptive innovations currently reshaping the competitive landscape of the future automotive industry.

2. Focus on the autonomous vehicle industry

The historical automotive industry has begun a radical turn where the boundary between truth and science fiction disappears as the years go by—in the future, reading while driving will become commonplace, just like receiving emails on watches. This evolution may seem evident in an increasingly mobile society calling on millions of vehicle users daily, exposed to the road risks. Could the solution be found in the autonomous car? Furthermore, if so, what path should it take to find AVs on the roads given all the disruptiveness attached to them?

Autonomous vehicles are “unmanned (driverless) vehicles that move without human intervention and use for this purpose, several high-tech sub-systems, and devices” (Owczarzak & Źak, 2015: 473). Consequently, AVs propose a change in the transportation paradigm where the driver is deemed to be replaced by a technological system, which will replicate human behavior autonomously. Despite many questions surrounding autonomous vehicles, the idea to open the door, sit down, choose the destination and let the car autonomously drive to reach the destination seems to be the safe future that automotive stakeholders and institutions have chosen for final users. Advances in science, industry, and the discovery of new technologies lead us to believe that imagination only limits the future.

Eventually, autonomous vehicles will reach the roads, and understanding why automakers are investing massively in this technology, alone was enough to understand that tomorrow’s driving will be autonomous. This technology will not fade over the years if it does not become predominant. Amongst the primary motivations for AV development, we came across, among other things, to the reduction of road injuries caused by human errors—estimated at 81% by the World Health Organization, the reduction of commuting time for

users through anticipated routes resulting in a positive impact on traffic and pollution, and reduced government spending through declining accidents and medical relieves.

Besides that, making vehicles autonomous induces several technological challenges that translate into growth opportunities for automotive stakeholders, which face the disruption of their traditional industry. The global AV industry was estimated at 6.7 thousand units in 2020 and forecasts to increase at a CAGR of 63.1% between 2021 and 2030. Despite the global market overview, the AV industry is composed of many components that also hold great growth perspectives. For instance, AVs consists of various sensors, such as LiDAR and RADAR systems, which operate simultaneously without drivers' aid to carry out operations automatically. These sensors aid in navigation by performing situational analysis, motion planning, and trajectory control. The LIDAR business is expected to reach \$2.8billion by 2025.

In terms of the research field, the autonomous vehicle created an interesting link with the CIFRE setting. It enabled us to take advantage of discussions with managers and project leaders in AV team projects. Internal discussions enriched our work throughout its creation and helped structure our ideas, which we describe in the last paragraph.

3. Structure of the thesis

The present doctoral research is organized into three. **Part I** discusses the theoretical background of this research, **Part II** sheds light on the methodological choices, and **Part III** presents the findings and discusses them. We summarize the general structure of this thesis in Figure 1.

Figure 1. Thesis structure



The theoretical background is discussed in three chapters compounding in **Part I**.

Chapter 1 exposed the main theoretical foundations of this doctoral research by introducing the disruptive innovation theory and addressing the core concepts being the definition, the Innovator's Dilemma leading to the historical dispute between incumbents and new entrants, and the impact of low-end disruptive innovation and new market disruptive innovation on industries and organizational strategies.

Chapter 1 intends to clarify why disruptive innovation creates a paradigmatic shift in industries and explains through several theoretical approaches why organizations tend to fail more often than they succeed when disruption occurs. Studies showed that disruptive innovation is positively related to resources and competencies, which, when missing, put organizations in risky positions, causing failure. Yet, the disruptive innovation theory is straightforward in deciding how to be successful, who is and is not, and why. It showed that the evolving innovation strategies were overlooked because open innovation strategies are often argued to make the challenges of innovation volatile. Being stronger together becomes a response to technological complexity, such as organizational ambidexterity. The literature review on disruptive innovation remains at the organizational level and tends to omit the study of disruption and its effects at the new industry level. Slowly, studies started to find organizational responses on how to respond successfully to disruption and considered that autonomous structures and collaboration are the most relevant strategic actions to fade the risk and uncertainty related to disruption.

Chapter 2 analyzes interorganizational relationships as a response to disruptive innovation to understand how industries emerge and structure. The various theoretical approaches to industry emergence highlighted that industries are like species (Abrutyn, 2012), which undertake dynamic actions to adapt to turbulent environments (Hawley, 1944); it implies that industries are ever-changing structures where long-period of sustaining innovations are always upset by the introduction of disruptive innovations. In fine, scholars have agreed that industries alike products have a life cycle during which they emerge, change, adapt, evolve, and decline (Pagdett & Powell, 2012; Phaal et al., 2011) in given boundaries (Eisenhardt & Santos, 2009). The rise of the network approach to study industries has made an analogy of networked industry common in recent years.

Chapter 3 highlights the several theoretical approaches that we have identified at the macro, network, and organizational levels of industry emergence and structuration. We eventually

carried out a critical review of the industry emergence literature and the macro level gaps. Among other things, identifying a limited power of industry life cycle models to assess dynamically and empirically the emerging industries at the macro has been evoked. Regarding the network level, we agreed that disruptive innovation and industry emergence had to be theoretically linked (Adner, 2017) because technological complexities involve the interaction of various types of expertise-the Key Technological Activities (KTAs)- thus organizations. It led us to consider the emergence of industries by developing various interorganizational relationship networks building around these KTAs. Finally, in **Chapter 3**, we discuss the necessity to address organizational attribute analysis to determine the influence of such variables on industry emergence and structuration. We summarize the research questions in Table 1.

Table 1. Summary of research questions by analysis level

Level of analysis	Research questions
Macro level	How could interorganizational relationship dynamics allow assessing <i>ex-ante</i> the patterns of industry emergence in a disruptive innovation context?
Network level	How do interorganizational relationship networks dynamics assess the structuration patterns of industry emergence caused by disruptive innovation?
Organizational level	How could the innovation content explain industry emergence patterns in terms of interorganizational relationship types and choice of partners?

We intend to understand how linking IRs and industry emergence at the macro level could make industry emergence quantifiable and foreseeable. At the network level, by linking industry emergence and disruptive innovation, we aim to understand what the technological drivers of IR networks could teach us about industry structuration patterns. Finally, at the organizational level, we target to bring insights into the influence of organizational attributes on strategic decisions and how these strategic decisions affect the industry at the macro level.

The literature review and identification of literature gaps and research questions in **Part I** is followed by **Part II**, dedicated to the methodology and the presentation of the industry understudied, splits into three chapters.

In **Chapter 4**, we define the research context by giving a comprehensive presentation of the automotive industry all the ways towards the disruption it faces nowadays. From globalization to environmental constraints on automotive companies, the automobile industry has experienced significant changes since the first car saw the market. Yet, since the disruptive introduction of internal combustion engines in the 1885-1886s that made horse carriage obsolete, the automotive industry has not experienced disruption with autonomous vehicles (AVs), making this particular study industry interesting.

Chapter 5 develops the questions on the methodological and epistemological choices. From the epistemological standpoint, we justify the anchorage in the positivist paradigm and discuss our inductive research approach. In line with the epistemological anchorage and the research questions presented above, we ascribe to a quantitative methodology corroborating our inductive approach to study minor premises to draw conclusions. Given the lack of assessability of industry emergence, we consider IR as industry emergence metrics and propose analyzing the evolution patterns statistically. As IRs form networks, we have identified the most used methodology to analyze networks, their evolution, and composition: Social Network Analysis (SNA). This methodology comes with requirements and identifies two types of data to be indexed in matrices: structural and attribute data. The construction of databases is discussed in Chapter 6.

The detailed description of the SNA methodology in Chapter 5 prepared the ground for **Chapter 6**. We described the steps to collect and extract our empirical material and index it in two different yet interdependent databases. The first database has been constructed following a four-step process to gather the structural data, e.g., the interorganizational relationships. The second database indexes the organizational attribute data collected through a three-step process to identify industry type, role, and industry provenance. We explain the preparation of the data for the analysis carried out for the findings in **Part III**.

In **Part III**, we present our findings in two chapters.

Chapter 7 enables us to validate our initial postulate considering IRs as valuable industry emergence metrics in the context of disruptive innovation. In this chapter, we stand at a macro level and analyze an industry's emergence by quantifying IRs in a given period. The analysis splits into two main streams of findings. First, the longitudinal analysis of IR evolution enables us to depict that they serve as a signal of industry emergence. When the industrial change intensifies, so does the tendency of organizations to intensify their strategic actions. Secondly, we mirror the evolution of IRs with an adapted industry life cycle model to telegraph the first findings from a static standpoint. Third, we propose to review how IRs could assess industry structuration patterns by analyzing technological drivers of IR formation. The statistical treatment of the data shows that networks emerge gradually around Key Technological Activities (KTAs). Besides, our results highlight that IRs can be valuable industry emergence metrics. They also give signals about the various industries involved in the emerging industry and the geographical distribution of the innovation.

Chapter 8 presents the results about organizational attributes for each IR network around KTAs identified in Chapter 7 and proposes understanding how organizational attributes within networks could influence the given networks' structuration patterns based on the innovation content. We proposed 'strategic boxes' for each KTA network and invoked that networks have similar natures but differing composition. The network composition analysis for each KTA was determinant in several terms. Identifying each network's innovation content enabled the contextualization of the IRs then aggregated into the mesoscopic structure and IR type analysis. The patterns varied in each KTA in terms of 1) timing, 2) IR types. In some KTA partnerships were indisputably at the preferred rank (connectivity). In other, the patterns seem more blurry with partnerships, acquisitions, and equity investments in several mesoscopic structures. In general, these patterns showed each network's relatedness with the advances and development state of the innovation content.

We conclude the present thesis with our discussions by telegraphing the main theoretical, managerial, and methodological contributions of this research work in **Chapter 9**. We discuss the main contributions of the present research work with evolutionary economics and the theory of disruptive innovation. Adopting a non-linear perspective on disruptive innovation showed that disruptive innovation content is a variable of industry emergence. The dynamic assessment of IRs around these technological activities over time could respond to the origin of industries because it allows a quantifiable methodology on industry emergence assessment.

Moreover, our three-level funnel approach sheds light on the importance of giving space to a multi-level analysis of emerging industries rather than constraining the study to organizational level questionings. Amongst other things, this chapter discusses the anchorage of the present thesis in large works on industry emergence (Padgett & Powell, 2012) by proposing a dynamic model on industry emergence rather than a static study of industry structuration through applicable constructs seeing innovation as non-linear too (Adner, 2017).

PART I: LITERATURE REVIEW

Introduction Part I

In **Part I**, we intend to review the disruptive innovation and industry emergence literatures and create the theoretical link between both concepts by studying the rise of interorganizational relationships. Our literature review is structured in three different chapters.

Chapter 1 introduces innovation by presenting the core concepts of innovation according to their sustaining or disruptive characteristics. The synoptic view on the core concepts of innovation enables us to identify the intrinsic characteristics of both types of innovation. Therefore, it explains and justifies the choice to focus on disruptive innovations. In **Section I**, we focus on the concept of disruptive innovation and the disruptive innovation theory (Christensen, 1997). We present the core concepts of the model in the first hand and discuss the principles of disruptive innovations, which are the cause of uncertainty (Reinganum, 1983), resource scarcity (Kavadias & Chao, 2007; Pfeffer & Salancik, 1978), and industry emergence (Christensen & Raynor, 2003) on the second hand. We discuss that disruptive innovation can cause either low-end disruption or new-market disruption and discuss the paradigmatic changes (Teece, 1986) that such innovations have on industries.

Secondly, we discuss one of the disruptive innovation theory's significant contributions about the never-ending war between incumbents and new entrants. This theory argues that incumbents are condemned to failure when new-market disruption occurs because the disruptive innovation makes their internal resources and capabilities obsolete while also bumping into organizational robustness and lack of adaptability.

Because disruptive innovations are competence-destroying, they create technological discontinuities (Anderson & Tushman, 1990), which, *in fine*, are perceived as risks and turbulences by incumbents which tend to dismiss their turn to seize the right opportunities and be outperformed by new entrants (Christensen, 1997, 2003).

Many studies have focused on measuring organizational resources (Leonard-Barton, 1992; Nordin et al., 2018; Wernerfelt, 1984) and have preconized the crucial role of resource

assessment when organizations face disruption. In those terms, several frameworks are discussed in **Chapter 1** (Christensen & Kaufman, 2006). Finally, we discuss disruptive the propensity of innovations to create unstable environments by assessing different risk types that organizations encountered at the internal and external levels.

The identification of innovative strategies to tackle and manage the difficulties raised by disruptive innovation showed that the disruptive innovation theory seems to present obsolescence in a fast-changing organizational environment.

Said otherwise, **Chapter 1** enables us to depict significant trends in disruptive innovation literature. By highly being focused on the dualistic comparison between incumbents and new entrants, omits to study disruptive innovation as a trigger of industry emergence. While identifying the link between disruptive innovation and industry emergence is well-stated in the disruptive innovation theory (Christensen & Raynor, 2003), the study of the emergence itself, therefore, the evolution of the disruptive innovation seems to be overlooked.

Chapter 2 discusses the industry emergence literature and depicts the major theoretical approaches to such a complex phenomenon. We address the different theoretical approaches explaining industry emergence: the institutional approach, the evolutionary approach, the organizational ecology, and finally, we justify our anchorage in the evolutionary economics theory. The literature review shows that innovation is highly related and relatable to industry emergence patterns and has become a robust variable of industry emergence assessment. However, we have not encountered a verified conceptualization of innovation as industry emergence metrics despite the many industry life cycle models. In that sense, we have discussed the cognitive approach to industry emergence (Eisenhardt & Santos, 2009; Kaplan & Tripsas, 2008) and the evolutionary consideration of industry emergence based on industry life-cycles (Phaal et al., 2011).

However, the combination of disruptive innovation and industry emergence seems to lack bridging elements that the literature has mentioned in many studies (Christensen & Raynor, 2003): the interorganizational relationships as enablers of resources and capabilities acquisition. In that sense, incumbents are not automatically condemned to failure, and new entrants are not necessarily the only innovators; yet, they are complementary.

As a result, interorganizational relationships are innovative strategies for organizations and translate the paradigmatic change caused by disruption at the macro level. It enabled us to consider the dominance of new meta structures such as ecosystems (Adner, 2017; Anggraeni et al., 2007; Moore, 2006) and networks (Gulati, 1998; Jarillo, 1988; Padgett & Powell, 2012; Powell et al., 2005) that shape industry dynamics in recent years, and the need for an industry emergence assessment tool.

Industries are more and more considered as networks of organizations connected by Interorganizational Relationships (IRs hereafter), the study of the IR networks can give a broader perspective of industry emergence analysis as they give the possibility to carry out multi-level analysis (Borgatti et al., 2009), this element is discussed in Section II.

We will consider the theoretical gaps for each analysis levels, and the related research questions in **Chapter 3**.

Chapter 1. Disruptive innovation: Theory, challenges, and evolution

Chapter 1 telegraphs our willingness to set up our literature background and highlights the varying analysis levels we adopt throughout the present thesis. Following a funnel approach, in **Section I**, we position ourselves at the level of disruptive innovations, which hold the intrinsic triggers of making a new industry emerges. The review of the theory on disruptive innovation presents the critical elements and shows the two-tier analysis to which disruptive innovation can be subjected.

On the one hand, disruptive innovation disturbs the unison between organizations within an industry and leads to organizations' typology: incumbents vs. new entrants. On the other hand, disruptive innovation can happen in several industry tiers, either in a completely new industry or in lower tiers of the existing one (low-end industry). These elements are discussed in Section I and imply discussions around the critiques of this theory. Subsequently, we look further afield to reveal the intrinsic reasons why innovation is so disruptive to organizations while they hold many opportunities and development promises.

Therefore, **Section II** analyzes factors inherent to disruptive innovation, making organizations dependent on new resources and capabilities. The multiple models to assess resources and capabilities reported in **Section III** inform us about how critical it is for organizations to know what resources and capabilities they need to develop a disruptive innovation.

Particular attention is given to resources and capabilities as they are a critical factor of success for disruptive innovations and are considered the main enablers of disruption. Therefore, we present the necessity for organizations to acquire adequate resources to respond to a given disruption. Often, disruption elapses in phases of paradigm shifts. These resources are essential to sustain organization survival in those phases of innovation paradigm shifts that we discuss at the end of our chapter. In conclusion, the main critiques made to the theory of disruption (Danneels, 2004) and how to bypass them legitimize the consideration of resources and capabilities.

To end our chapter, we highlight that organizations demonstrated flexibility over the years when it comes to innovation strategies. The link between disruption, resources, and capabilities highlights that new forms of innovation paradigms and strategies are manipulated, such as ambidexterity at the organizational level and open innovation initiatives at the industry, network level. These emerging concepts allow us to create a bridge between the theory of disruptive innovation and the critiques made to it.

Section I. The disruptive innovation theory

In **Section I**, we aim to define a disruptive innovation by understanding the disruptive innovation theory (Christensen, 1997) and discuss how disruptive innovations trigger industry emergence. We intend to shed light on such a complex concept that has occupied researchers' agenda for years. Nevertheless, a victim of its growing success, the theory of disruptive innovation is also very criticized by a cohort of studies (Danneels, 2004).

We start by describing the theory of disruptive innovation developed by the Harvard Business School Professor Christensen (1997). The model will serve as a starting point for our argumentation through the analysis of the core concepts. We then shed light on several critiques made to the theory to depict our theoretical contributions (Danneels, 2004). We will take the opportunity to explain how disruptive innovations are synonymous with unstable environments for companies, either incumbents or new entrants, that suffer from them through competence-destroying (CD) and competence-exploiting (CE) processes, and the need for complementary assets in different paradigmatic phases (Teece, 1986).

Consequently, our research work takes root in the context of disruptive innovation. Therefore, and for lexical precision, we will take the following section to define such concepts and depict the discussions around it. By so doing, we intend to substantiate the challenging character of disruptive innovations.

The present section divides into three subsections. In the first one, we discuss the core concepts of the theory of disruptive innovation. Then, we present low-end and new-market disruptive innovation. We enclose our section by presenting the principles of the theory regarding new entrants and incumbents.

1. Core concepts

This section focuses on Christensen's (1997) disruptive innovation theory, which attempts to explain the success or failure of organizations in the face of disruptive innovation. We claim that many important observations make up the theory.

First, the theory adopts a double-take on explaining the success or failure towards disruption based on the company type. Second, disruption occurs at different levels: low-end disruptions and new market disruptions. Therefore, the analysis of disruptive innovation is made at two distinct levels: organizational level (meso) and industry level (macro).

The theory of disruptive innovation relies on the Innovator's Dilemma, which explains how incumbents, although resource-rich, ultimately fail to develop disruptive innovation. Disruptive technology refers to low performance, cheaper, and accessible products. Over time, as new entrants perform R&D activities, the performances improve, and the disruptive technology shifts from attracting the niche market to the mass market. By underperforming the existing product, disruptive innovations displace the latter. The intrinsic reasons are numerous, and Figure 2 presents the critical elements of the innovator's dilemma.

Figure 2. Conceptualization of the disruptive innovation theory (Christensen & Raynor, 2003: 310)

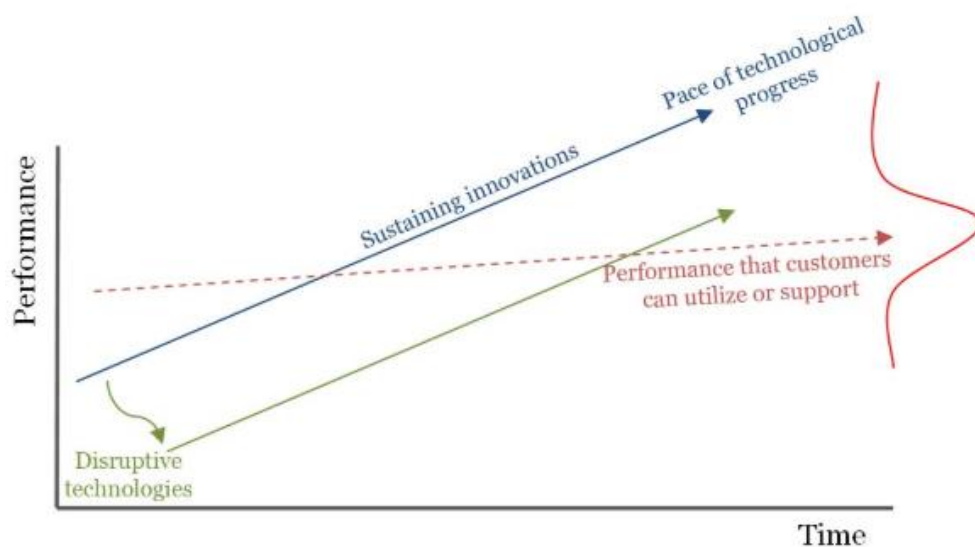

The first slopes ‘performance that customers can utilize or absorb’ represents the value of the technology that can be used or consumed by consumers, or in other words, the efficiency for which the consumer is expected to pay. Usually, this performance suits the needs of consumers and can also outpace it to some extent.

There are variations in consumers' inclination to pay based upon whether they are low-end or high-end consumers in the industry. For practical purposes, and because the consumer segment requirements are of less concern, it has been considered that the value that consumers can use or consume is the ‘good enough’ technology, which addresses the needs of most customers.

Second, ‘the pace of technological progress’ refers to the change that innovating companies create when introducing innovations. Often, the rate at which innovations develop is superior to the evolution of customers’ needs. The steeply upward going slope illustrates the different pace between customer utilization and the pace of technological progress.

Finally, yet importantly, the model depicts the differences between sustaining and disruptive innovations. As mentioned, companies' sustaining innovation is developed by making an existing product more simply and cost-effectively. In that sense, organizations tend to focus on the existing customer base and ignore niche markets. However, disruptive innovation happens to gain power from the innovator’s potency; the new market disruption arises, and so begins the improvement cycle of disruptive innovation.

The original performance-time model presented in Figure 2 defines the market where the existing offer meets the existing demand, i.e., where customers supply themselves with the products and the companies sell their products. Transactions happen within the boundaries of the existing industry, which the Innovator’s Dilemma calls the value network.

To summarize, King and Baatartogtokh (2015) reviewed four critical elements of this theory:

- Incumbents follow an improvement trajectory of innovation;
- Sustaining innovation outperformance in regards to mainstream customers is taking for granted;
- Incumbents are prosecuted for failing in the face of disruptive innovation even though they have the required capabilities;

- Incumbents stumble in the face of disruptive innovation.

However, in some cases, disruptive innovation can occur in the context of non-consumption, i.e., in a new value network. Therefore, scholars (Christensen & Raynor, 2003) develop a third dimension to study the impacts of disruptive innovation: the new customers and new contexts for consumption (Figure 3).

Figure 3. Low-end vs. new market disruptions (Christensen & Raynor, 2003: 44)

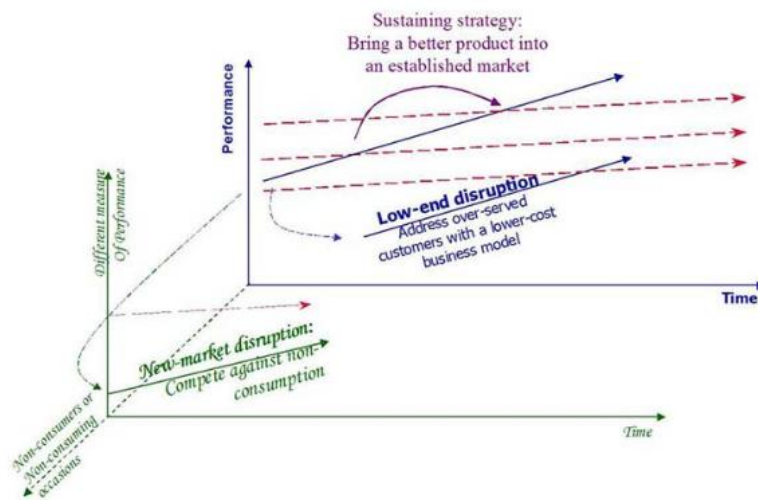

In Figure 2, Christensen and Raynor (2003) made a somewhat simplified description of The Innovator's Dilemma. However, there are two distinct forms of disruption in the disruptive innovation diagram that can be visualized by adding a third axis to the diagram, as seen in Figure 3.

Compared to the disruption theory's simplistic conceptualization, the vertical and horizontal axis remains unchanged; they reflect the product value and the time, respectively. The third dimension stands for "new consumers" and "new consumption contexts" (Christensen & Raynor, 2003: 43). These new customer contexts are known as new value networks because they indicate dedicated cost structures and organizational strategies. As a result, different value networks can emerge at dislocated places regarding the established industry along the third axis of the disruption diagram. In the following discussion, we will first address the disruptions that create a new industry in the third axis, as new-market disruptions. On the contrary, low-end disruptions target the least-profitable and most reached customers at the low layer of the established industry.

2. Low-end vs. new-market disruptive innovations

Disruptive innovations are new products or services that meet the requirements of new customers. The disruptive innovation theory argues that the targeted customer is of high importance when determining whether the disruption is at the low-or new-market level. In most cases, disruptive innovation attracts the customers of a niche market, and most of the time, the performances of the disruptive innovation do not meet the performances of the mainstream market product (Christensen, 1997), it creates a new need that customers are not aware of yet.

Scholars argue that the niche market builds on the price, simplicity, or convenience characteristics of disruptive innovation. Niche markets are different in characteristics; therefore, Christensen and Raynor (2003) depict differences between low-end market and new-market disruptive innovations summarized in Figure 4. A disruptive innovation systematically begins from one of these two footholds.

Figure 4. Segmentation of disruptive innovation (Lin et al., 2015: 830)

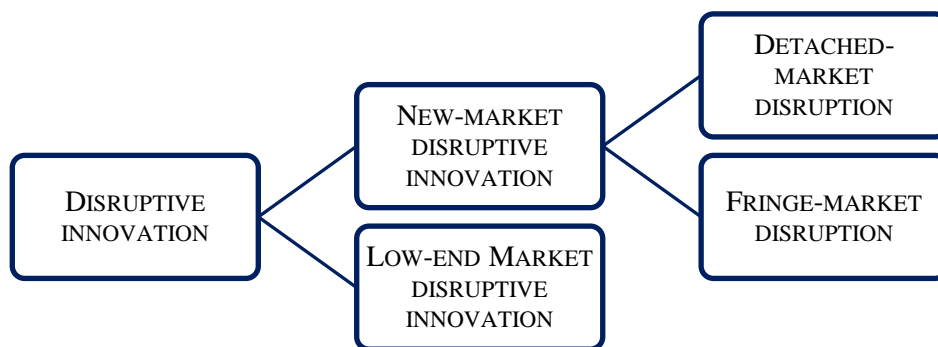

2.1. Low-end disruptive innovation

On the one hand, low-end disruptive innovations serve the low-margin segment of the existing industry. The theory of disruptive innovation argues that the product proposed in the lower tier of the industry is more affordable than in the higher tier of the market and highlights customers' sensitivity to the price criteria (Lin et al., 2015). Organizations tend to focus on low-end disruptions when motivated by cost-efficiency through low-cost business models (Droege & Johnson, 2010). Low-end disruptions do not create a new industry, yet,

they enable organizations to grow by acquiring mainstream customers through low-price strategies. If we observe Figure 4, low-end disruption happens when the pace of product innovation outpaces the rate of performance demanded by customers. In most cases, incumbents fuel low-end disruption markets to meet their existing customers' needs and tend to disregard disruption that happens at the new-market tier.

2.2. New market disruptive innovation

On the other hand, new market disruptive innovation addresses non-consumption (Christensen & Raynor, 2003) and creates a new industry where none existed. It transforms a niche market into a mass-market with a new value proposition (Gemici & Alpan, 2015). Indeed, the new-market disruptive innovation has small-scale markets that aim at attracting potential customers by converting non-consumption to consumption. When small-scale industries develop, they open opportunities for new industry emergence placing disruptive innovations at the rank of a trigger of such a phenomenon. New-market disruptive innovation is those innovations that make a new industry emerge.

In the Innovator's Dilemma, Christensen (1997) explained how Xerox, an incumbent photocopier manufacturer, failed at targeting large companies. Xerox proposed photocopiers to large organizations, librarians, and many other customers to meet their needs. However, the product prices had a high price tag. In the 1970s, new entrants invaded the mainstream industry that Xerox valued by proposing low priced personal photocopiers to the same customers previously targeted by Xerox. Thus, new entrants caused the emergence of a new industry by creating the personal photocopier industry through more affordable prices and simpler technologies.

Lower prices and more convenient product use steadily increase the willingness of the consumers to pay. Little by little, the new market disruptions become 'good enough' to attract customers of the mainstream industry. Although attracting mainstream customers, the new industry emerges independently and remotely. One can imagine a magnet effect of the new-market disruption that pulls the customers from the mainstream market to the new one, named encroachment (Schmidt & Druehl, 2008). Consequently, this creates disruption and new industry emergence; that incumbents of the existing industry did not foresee and nor felt threatened. From that breaking point, discussions around disruptive innovation focus on the impacts of such turbulences on organizations' performances and behaviors. In that sense, the

traditional disruptive theory unfolds new entrants' tendency to enter the existing industry from the bottom and move upmarket with 'low-end disruptions' (Christensen & Raynor, 2003).

To resume, 'new-market' disruptions by opposition to the low-end disruptions embody innovation in a completely new industry with a new value network. Thus, new customers will simply describe new market disruption as industry emergence. New entrants make efforts to conquer an entirely new set of customers, both unfamiliar with incumbents' products or services, while also being unknown by them. Consequently, incumbents, once unaware of the new market disruption, suffer from a crushed customer base cannibalized by the new entrants' offer in the new-market.

Scholars ascribed incumbents' failure in the face of disruptive innovation through asymmetric motivations. Indeed, empowered and focused on generating high margins and meeting current customers' needs, incumbents either tend to dismiss the niche market when they seized it or flee from the attacker when they confront it. In both cases, it results in passive behaviors towards disruptive innovation, causing them to fail. In the same vein, incumbents reach customers from established value networks where disruption is latent (Adner, 2017), while new entrants tend to do so in emerging value networks (Christensen, 1997). These emerging networks are considered 'new-market' disruptions and are opposed to low-end disruptions (Christensen & Raynor, 2003).

Companies act differently according to the advances of the disruption and the level of industry disruption. When the establishment and validation of disruptive innovation turn out to be sluggish, companies adapt accordingly, and *vice versa*. In that view, Teece (1986) investigates the evolution of innovation by turning the spot on two different stages: the preparadigmatic and paradigmatic phases. We define the two phases in the following subsection.

2.3. Preparadigmatic and paradigmatic phases

The effects of disruptive innovation make themselves feel gradual and spread in time. In that sense, Teece distinguished two phases of innovation: the preparadigmatic and paradigmatic phases (Figure 5). A paradigm refers to general patterns regarding a concept. When viewed from the disruptive innovation' perspective, a change in paradigm translates into a change in

how the company thinks about innovation, its actions to change the outcome of innovation, and how it does it.

Figure 5. Phases of innovation (Teece, 1986: 289)

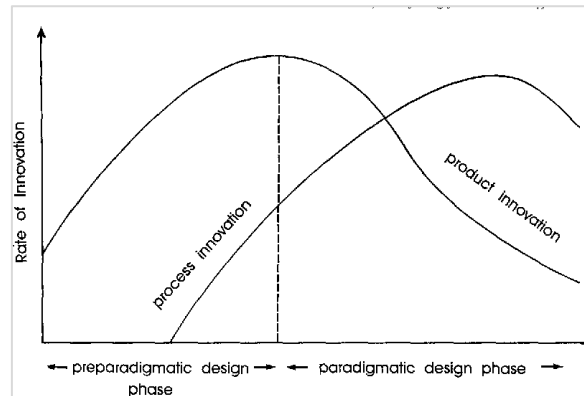

The phases developed by Teece (1986) are described in detail individually in the following subsections. For each phase, the author considers how competition manifests itself.

2.3.1. Preparadigmatic phase

The preparadigmatic phase happens in the early stage of an industry development when “there being no single generally accepted conceptual treatment of the phenomenon” (Teece, 1986: 287), called the dominant design by categorical studies (Anderson & Tushman, 1990; Grodal et al., 2014). New product development flood the market; companies are flexible when it comes to manufacturing the products.

In the preliminary phase, the preparadigmatic phase, competition between companies happens at the product design level. For instance, once the innovator, i.e., the owner of the innovation, releases the innovation, he enters the preparadigmatic phase, which will help determine whether his current product responds to the industry's standards and performances identify his improvement areas. Because of that, this phase is characterized by numerous designs that inundate the industry and tends to stage much back and forth flows with the marketplace to foreshadow the dominant design (Anderson & Tushman, 1990) through “trial and error” (Teece, 1986: 288).

Concretely, the innovator is said to let the innovation ‘float’ during this phase until industry players validate, refute, or modify the design. At one point, validations or modifications in the

product will be accepted, probing the legitimacy of the product in the industry. The number of possible designs is tapered, and one design overpowers other designs. The innovation is accepted, so it follows the paradigmatic phase.

2.3.2. Paradigmatic phase

Once companies shift into the paradigmatic phase, competition slides from product designs towards prices. Incumbents tend to deploy action to foster economies of scale in the view of decreasing the price of each product they manufacture. From the perspective of Anderson and Tushman (1990), the paradigmatic phase is characterized by low volumes as companies do not benefit from economies of scale, and the price is not placed at the rank of a competitive advantage either.

During this stage of an innovation lifecycle, companies are urging into identifying which standards will prevail and at which costs. Once the uncertainty related to dominant design identification is cut, companies will access mass-market production benefits such as scale economies due to increased production volumes. Dominant designs are “product-class standards,” their emergence terminates the period of “technological ferment” (Anderson & Tushman, 1990: 441). However, we stay critical regarding Anderson and Tushman’s framework as it seems to harmonize better with mass markets where customers are a homogeneous population.

However, gearing up for mass-production might not be easy tasks for companies. Indeed, disruptive innovations can disrupt existing paradigms by implementing new standards and performance requirements. The emergence of new standards and technical performance watershed is of considerable significance in innovation capabilities, especially as disruptive innovations necessitate a wide range of new resources, processes, and priorities (Christensen & Kaufman, 2006). Gearing up to mass production induce initial investments in production tools and specialized assets. During the paradigmatic phase, companies are less concerned about prices, and complementary assets become rare commodities. Acquiring complementary assets become a central managerial problem for companies.

To conclude, by laying the foundation of the disruptive innovation theory, Christensen defined disruptive innovation as “any new technology or startup that aims to shake up an industry and alter its competitive patterns” (Christensen et al., 2018: 1044). The primary focus

on research on disruptive innovation, despite being misused (Christensen et al., 2018), relies on understanding how companies manage it at the organizational level (Christensen, 1997).

In the following paragraphs, we will discuss the prevailing argument on the competitive dialogue between incumbents and new entrants regarding disruption. Arguments are various and diverging. We, therefore, organized our part as follows. Firstly, we introduce the practical problem that persists between incumbents and new entrants in the face of disruptive innovation. Secondly, we discussed the destiny of incumbents failing in the face of disruptive innovation. Lastly, we telegraph the part of the literature that discusses how incumbents can succeed in the face of disruptive innovation. It allows giving us a more nuanced picture of the theory of disruptive innovation.

3. Incumbent vs. new entrant' dispute

As aforementioned, the responses to disruptive innovation focus either on the incumbent or the new entrant's perspective. The organization type depends on the seniority of the company in regards to the disrupted industry. In that sense, the generic model of disruptive innovation illuminates that incumbents often fail when disruption triggers industry turbulences (Abernathy & Clark, 1985; Anderson & Tushman, 1990; Christensen, 1997; Henderson & Clark, 1990): they seem to be trapped in what Chandy and Tellis (2000) named the 'incumbent's curse.' On the opposite, another stream of studies has dissociated incumbents from failing in the face of disruptive innovation (Ahuja & Lampert, 2001; Christensen & Rosenbloom, 1995; Leifer et al., 2000; Rosenbloom, 2000; Rothaermel, 2001). We will present these two streams of works hereafter.

3.1. Explaining incumbents' failure in the face of disruptive innovation

In a wealth of studies on disruptive innovation, results have shown that incumbents owe their failures *vis-a-vis* disruptive innovation to several 'causal pathways' (Christensen et al., 2018). Incumbents are accepted to be rigid organizations embedded in long-standing organizational behaviors and processes. Hill and Rothaermel (2003) distinguished three main factors leading to incumbents' failure: economic explanations, organizational theory explanations, and strategy explanations. We unfold the details of each factor.

3.1.1. Economic explanations

Incumbents are, by definition, established organizations that already have embedded routines and processes. Resource structures also are part of established processes and create a rigid barrier towards flexibility and adaptability demanded by disruptive innovation. This rigid resource structure of incumbents is the insidious evil preventing them from spreading disruptive innovation in their established industry, which, in turn, phlegmatically responds to disruption.

An embedded resource allocation internally fosters sustaining innovations (Bower, 1972), which incumbents count on to ensure more substantial rents (Gilbert & Newbery, 1982) and market position sustainability (Henderson & Venkatraman, 1993; Hill & Rothaermel, 2003).

Moreover, when facing high levels of uncertainties triggered by disruption, incumbents will tend to adopt safe behaviors by limiting their investments in disruptive innovations (Reinganum, 1983) to maintain their market power through the enhancements of their current market position. Uncertainty is, therefore, the primary reason that inhibits incumbents from succeeding in the face of disruptive innovation (Hill & Rothaermel, 2003).

Indeed, Hill and Rothaermel (2003: 259) compare disruptive innovation to the opening of a “pandora’s box”: the introduction of the new technology, even if the incumbent itself introduce it, will create change and alter the competitive equilibrium of the industry when threatened in its existing industry: organizations will experiment decreasing performances and perish.

On the contrary, new entrants nearly always win to implement disruptive innovations as flexible resource allocation processes, less rigid and more risk-taking behaviors are typical behaviors of such companies. When considered from a resource perspective, the new entrant is generally a small structure that lacks resources. In contrast, their more flexible cost structure empowers them to undertake low-margin activities such as the one implied in disruptive innovations. Thus, new entrant companies outperform incumbents in implementing a leadership position in disruptive innovation due to their flexibility in resource allocation processes (O’Reilly & Tushman, 2016). Besides, they experience less pressure from the existing industry requirements. Generally, they benefit from incentives (Conner, 1991) that motivate them to invest in new technologies to suppress high entry barriers by doing things differently.

3.1.2. Organization theory explanations

The literature in organization theories argues that companies are valuable when they master predictability and reliability (Hannan & Freeman, 1984). Parallely, scholars argue that organizations' propensity to be reliable and predictable buries them into rigid and bureaucratic information systems and processes (Chandy & Tellis, 2000). Rigidity hinders change even though it ensures organization survival in steady contexts. In that sense, authors (*ibid*) highlight the paradoxical relationship between bureaucracy, rigid processes, and capabilities to adapt and foresee change. In steady contexts, organizations are disposed to routinize their processes to gain efficiency (Nelson & Winter, 1982). Although very cost-effective in controlled environments, these routines tend to narrow organizations' capabilities to look outside of what already exists and causes them to fail when new entrants perform disruptive innovations.

Scholars in organization theory also argue that incumbents' failure in the face of disruptive innovation is explained by inertia in leadership (Pfeffer, 1992) impeded by power and political battles. Disruptive innovation pragmatically necessitates organizational changes in power distribution across the company. As a result, political behaviors appear within companies as actors wish to maintain their position of power. As a consequence, conflict holds organizational transformation and creates inertia towards disruptive innovation (*ibid*).

O'Reilly and Tushman (2016) argue that structural and cultural inertia have beneficial impacts on organization performances in stable markets; however, it becomes a recipe for failure in shifting markets.

3.1.3. Strategy explanations

An enduring question in the strategy theory is how organization structures impact organizational performance while performing in disruptive, thus, dynamic industries (Davis et al., 2009). When industries are disrupted, and the five forces (Porter, 1979) are not identifiable as they were in the traditional industry, incumbents face real challenges to create value in the new competitive space. They require organizations to perform a 'parallel play' as called by McDonald and Eisenhardt (2020). Parallel play refers to the dynamic strategic thinking imposed on organizations that perform in dynamic, said otherwise, emerging industries. It is all the strategic gymnastic inherent to the passage from the settled strategy to adaptation.

In that vein, some arguments report that incumbents' failure to perform is inherent to their strategic choices. Incumbents are accepted to prioritize sustaining innovation as they benefit from having identifiable customers as opposed to disruptive innovations for which customers are not identified, as they are underserved. Indeed, in his seminal work, Christensen (1997) highlighted the systematic tendency of incumbents to focus on sustaining innovations that are valued by customers, when in parallel new entrants are creating a new customer base (non-consumption). Consequently, incumbents suffer from partially knowing or ignoring that new customer base and end up being disrupted (Christensen, 1997; Christensen & Tedlow, 2000), and consequently, are disrupted. Davis et al. (2009) discuss the unbalanced relationship between structural elements and contextual dynamism.

Henderson and Venkatraman (1993) agree that incumbents often limit disruptive innovation investments as the destruction of existing capabilities due to introducing new technology by a new entrant makes it challenging to coherently invest in disruptive innovation. Incumbents tend to see through their "organizational filters" (Chandy & Tellis, 2000: 3), which filter away the changes that do not meet the organization's current activities.

From a cognitive perspective, Eisenhardt and Martin (2000) discussed that company executives confronting decreasing product-market environments are often inertial in adjusting to such a downturn or participating in endgame strategies within those disrupted industries, even though such approaches are often inadequate for managers working in competitive industries.

To analyze the internal innovation process leading incumbents to focus on existing businesses, Chesbrough (2004, 2012) mentioned the closed innovation paradigm pushing organizations to develop a vertical development of products based on internal technology base (knowledge and competencies) to serve the existing, current market (Figure 6).

Figure 6. The closed innovation paradigm (Chesbrough, 2012: 22)

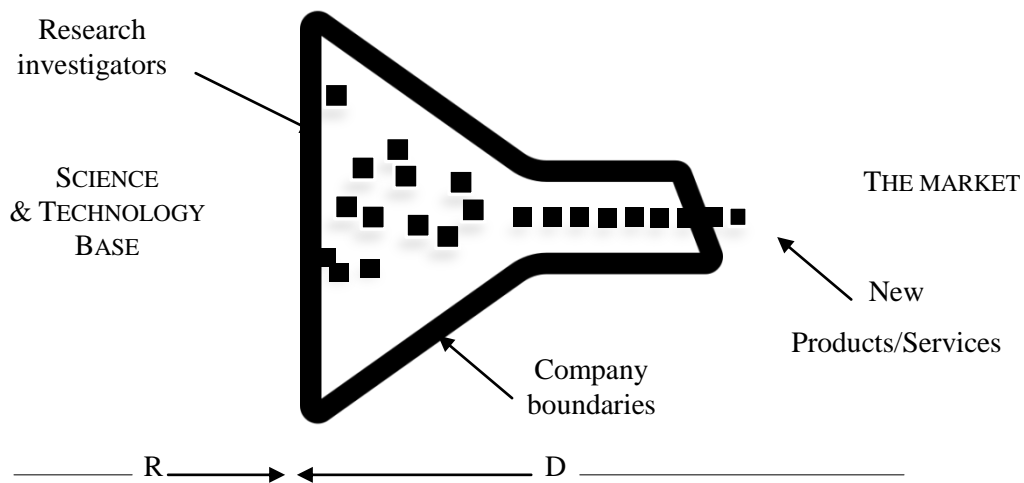

Figure 6 shows that the closed innovation paradigm is based on an internal R&D process reliant on the existing science and technology base. During the research phase (R), research investigators propose product ideas that could potentially reach the existing market as an innovation. During the development phase (D), information from existing customers helps determine which product will sustain the market. This closed innovation process elicits a vertical integration of the activities within the organization's boundaries. By disregarding other customers and technologies, incumbents are deprived of the disruptive innovation benefits. They ignored it because they were engaged in diligently meeting the actual performance and industry requirements.

In that view, a cohort of studies proposed to understand how incumbent can manage the challenges of disruptive innovation (Anderson & Tushman 1990; Hill & Rothaermel 2003). In fact, in most cases, incumbents tend to consider disruptive innovation as foes and dilemmas (Christensen, 1997), of which they need to fend rather than appreciating them as the main component of economic growth (Aghion & Howitt, 1992). We argue that incumbents lack insights regarding disruptive innovations' effects on the emergence of the new and attractive industry because they have the necessary resources to do so.

However, in contrast to the disruptive innovation theory, other studies have highlighted that disruptive innovation, the truth is that no single strategy always succeeds for every industry.

Even though the nature of the strategy is different, it depends on the circumstances to determine the variation — whether it is by various roles and different resources

To conclude, studies have highlighted the inherent reasons for incumbents and new entrants' behaviors when facing disruptive innovation. However, a contender stream of studies argues that incumbents can perform disruptive innovation, yet highlighted incumbents' slackened pace to adapt to change. The following section intends to understand how some incumbents fall through the net of failure in the face of disruptive innovation.

3.2. Explaining incumbents' success in the face of disruptive innovation

Following the incumbent's curse observations (Chandy & Tellis, 2000), recent studies argued that incumbents might not collapse amid disruptive innovations. The claim of incumbents' condemnation to fail is arguably based on some highly specialized case studies and call for a broader lens to legitimate such findings (Henderson & Clark, 1990). Besides, Ansari et al. (2016) argue that literature on disruptive innovation primarily focuses on the harm suffered by incumbents, whereas new entrants' challenges are surprisingly overlooked.

In the quest to understand how incumbents may successfully perform towards disruption, Hill and Rothaermel (2003: 262) adopted a binary positioning to identify factors that may “neutralize” or “reduce” the reasons explaining incumbents' failure. Drawing on the learning theories, the authors argued that incumbents suffer from organizational inertia, which prevents them from acting against the degrading effects caused by disruptive innovation actively. Incumbents need to invest more in basic and applied research to prevent inertia, survive, prosper, or pioneer disruptive innovation (Ahuja & Lampert, 2001). This theory assumes that innovation is highly knowledge-intensive (Cohen & Levinthal, 1990). Basic research implies the expansion of an existing knowledge base and increases the understanding of a specific area or subject, while applied research creates new knowledge and leads to the development of newness. In their reasoning, the authors describe various mechanisms to combine both types of researches. This combination and mixture of research enlarge organizations' way of allocating their resources and foster information.

However, Hill & Rothaermel (2003) discussed that some minor disruptive innovations could significantly affect incumbents' performances, while some major ones can have subtle effects. This paradoxical observation finds its intrinsic reasons in the "breadth of impact" as well as the "gestation" period of such innovations (*ibid*: 268). The breadth of impact explains that "not all radical technological innovations are equivalent in terms of their impact on the various value creation activities of a firm" (*ibid*: 267). Different factors, such as the impact on knowledge or processes, can affect how incumbents endure disruption.

The gestation time of the disruptive innovation also is of high importance as it explains the time that passes before the successful commercialization of the innovation, which settles the time that the company has at disposal to respond to disruption (Charitou & Markides, 2003). This period can last less or longer based on exogenous factors such as technology acceptance and industry standards adoption. More extended gestation periods will positively impact the successful response of incumbents to disruption, which might prepare to be responsive either by acquiring the required knowledge or by collaborating with new entrants.

Chandy and Tellis (2000) considered incumbents' intrinsic characteristics to explain their performances towards disruptive innovation. Results highlighted that competitive incumbents frequently tend to be large companies and demonstrated that there appears to be a positive connection between the size of the company and its type. Indeed, the larger the incumbent organizations are, the higher the chances of introducing and surviving in the face of disruptive innovation. From a financial standpoint, incumbents often benefit from more considerable financial resources and have enormous capabilities that they can use to harness disruptive innovation. In that sense, the authors empirically studied the emergence of disruptive innovation to undermine whether incumbents or new entrants are responsible for developing disruptive innovation over time.

Their results were two-phased. At the beginning (pre-World War II phase), small non-incumbents were more likely to commercialize disruptive innovation (73%) than incumbents (27%). However, later (post-World-War II), results were reversed. Incumbents accounted for 74% of the disruptive innovation against 26% for new entrants. The same samples were also observed at the level of the company size. Results corroborate the first findings. Indeed, during the pre-World War II period, the percentage of more substantial companies bottomed at 17% to rocket and reach 74% in the post-World War II period.

These results advocate the adaptation capabilities of larger companies. In fact, in the beginning, new entrants, which often are small organizations, benefit from the absence of organizational inertia and risk-taking behaviors. However, over time, incumbents seem to outpace new entrants because they have more significant financial resources and technical capabilities. Besides, new entrants' size exposes them to vulnerability and low rates of survival (O'Reilly & Tushman, 2016). Often they need support for incumbents in establishing the value network needed for the disruptive innovation to be commercialized.

Agreeing with Chandy and Tellis (2000), Charitou and Markides (2003) consider that incumbents can accommodate changes and develop disruptive innovations. They proposed five ways that could be adopted by organizations to respond to disruptive innovation based on their motivation and capabilities: focusing and investing in traditional business, dismissing innovation, attacking and undermining the new entrant, accepting innovation while simultaneously playing all games, fully embracing innovation and growing it.

3.2.1. To focus and invest in the traditional business

Even though the disruptive innovation theory considers that response as the main reason explaining the incumbent's failure in the face of disruptive innovation, Charitou and Markides (2003) highlight the taken for granted disruptive characteristics of the new technology. Authors explain that disruptive innovation cannot take the entirety of the traditional industry, and incumbents can control and increase their market share by increasing their attractiveness and competitiveness. In that sense, the authors proposed that responding to disruptive innovation can also resonate as choosing not to embracing it.

3.2.2. To ignore the innovation

In that particular case, authors differentiate industries from markets (Charitou & Markides, 2003; Chen & MacMillan, 1992). When the disruptive innovation is commercialized, incumbents may choose to ignore it because it is excessively far from their current offer, thus from their markets. Organizations need to compare what competencies and skills they have and the ones required for the new business to determine whether relatedness exists between the new product and the traditional business. When the required skills and resources do not match the existing ones, organizations can ignore disruptive innovation.

3.2.3. To attack back and disrupt the disruptor

Responding to disruption by attacking the attacker represent a substantial part of studies on disruptive innovation (Abernathy & Clark, 1985; Anderson & Tushman, 1990; Ansari et al., 2016; Ansari & Krop, 2012; Bergek et al., 2013; Christensen, 1997; Christensen & Raynor, 2003; Henderson & Clark, 1990; Hill & Rothaermel, 2003; Stubbart & Knight, 2006; van Mossel et al., 2018). In that sense, Charitou and Markides (2003) suggest that incumbents neither propose products to existing customers nor adopt the disruptor's innovation; instead, they focus on developing products with new yet competing attributes with the ones of the innovator.

3.2.4. To adopt the innovation

When an organization decides to embrace the innovation, it implies that the latter is here to last. However, in that case, organizations can face other difficulties, such as how to adopt and implement the right actions to compete with new competitors. Indeed, unlike new entrants, incumbents already have competencies, processes, and rules by which they perform their traditional business. Nevertheless, the new business may require a new set of rules.

Christensen and Raynor (2003) advocate creating a new organizational structure dedicated to disruptive innovation within organizational boundaries in the view of escaping from the inertia heritage of the traditional business. The new department benefits from its processes, making it possible to avoid inertia. Studies have shown that the higher the level of autonomy in decision making-processes of autonomous structures, the higher the impact on organizational ambidexterity (Charitou & Markides, 2003). As a derivative of the proposition of Christensen and Raynor (2003), Charitou and Markides (2003) highlight that organizations can carry ambidexterity in regards to their innovative strategies in the same industry without a clear cut between both, while Porter (1979) made a case for the complexity of exercising two different strategies in the same market, which is not viable in regards to positioning choices.

Organizational ambidexterity gave rise to exciting debates regarding managing the duality of both evolutionary and revolutionary strategies. Ambidexterity, by definition, implies complexity. It may be concerning for organizations to perform different innovation outputs dedicated to different customers and industries.

In the view of managing these concerns, Alpkın and Gemici (2015) propose that organizations should depict what differentiates the new business from the existing one, what strategies suit better each business, and then decide if the separation between both is mandatory or optional. Organizations need to find the right balance between their businesses (Aren & Alpkın, 2009).

3.2.5. To embrace the innovation completely and scale it up

Adopting the disruptive innovation mirrors an organization's surrender of traditional business. Therefore, the efforts of sustaining the traditional business are brushed under the carpet, and the organization secures a new agenda, which supports its new business perspectives (disruptive innovation). Once the technology is acquired (imitated), it has to serve a mass market (scale-up).

Conclusion of Section I

In **Section I**, we have depicted that a substantial amount of literature deals with disruptive innovation. The complexity of disruptive innovation with independently developing low-end market and new market disruptions confronts new entrants and incumbents to a relentless battle against perishment. Some arguments confront incumbents to fail regarding disruption, such as economic rigidity, organization theory explanations, and strategy elements. Some others support the financial performance and adaptation capabilities of incumbents, carrying them to a successful path.

All things being equal, disruptive innovation acts out as a trigger for unstable environments. In **Section II**, we discuss inherent characteristics that make disruption innovations factors of turbulent environments.

Section II. The proclivity of disruptive innovation to create turbulent environments

Disruptive innovations are challenging as they alter organizational routines and the competitive landscape. Nevertheless, we find it interesting to understand how disruptive innovations can damage organizations when they are a source of novelty and new opportunities. To respond to our question, we first intend to highlight the capabilities and resources dependency of disruptive innovations, which are competence-destroying technological discontinuities. Therefore, we discuss the turbulences caused by the cavity between organizations' existing capabilities and opportunities that arise from disruption and how to measure organizational capabilities.

Second, we present risk factors such as strategy and external risks inherent to disruptive innovations.

Third, we discuss new ways of responding to a disruption, such as the open innovation paradigm, which considers boundaries as a main variable of innovation processes (Burger-Helmchen et al., 2011) and organizational ambidexterity that aim at combining knowledge to develop disruptive innovations.

Lastly, we finish Section II by discussing the disruptive innovation theory and various critiques that have emerged over the years.

1. Reliance on capabilities and resources

Any organization that endeavors to develop a new product or a service faces the challenge of the right allocation of its resources (Kavadias & Chao, 2007). In some cases, not allocating the resources to the rightest product in the innovation portfolio causes the organization's dislocation from the disrupted industry. Therefore, understanding the change and managing the portfolio of New Product Development (NPD) is a central problem of resource allocation. All the more so important, the evolving nature of resources and capabilities of organizations shape their boundaries (Penrose, 1959).

Not to omit that organizations already have resources and capabilities in their possession in contexts of disruptive innovation. These capabilities are core competencies if they enable companies to differentiate strategically (Leonard-Barton, 1992). However, these resources are rendered obsolete when disruption occurs. Therefore, in this part, we endeavor to describe

how by destroying organizations' existing capabilities and making their knowledge obsolete, disruptive innovations can create turbulent competitive environments. We thus intend to portray the ubiquitous role of disruptive innovation's capabilities and resources.

Scholars consider that disruptive innovation requires organizations to develop a new idea and implement it; thus, the resources and capabilities needed for each stage are commonly different. As a result, incumbents usually lack the capabilities required to develop a new idea related to disruptive innovation. Yet, they have the required ones to scale up the new idea and hold a competitive advantage over the new entrants (Charitou & Markides, 2003). However, in periods where disruptive innovations emerge, companies find it challenging to understand what assets they may need to perform innovative strategies that will warrant success. Even more so, innovations are competence-destroying or enhancing (Anderson & Tushman, 1990). Anderson and Tushman (1990: 441) present disruption as a "cumulative process," where small innovations will lead to major technological innovations. These significant innovations raise several organizational challenges that organizations need to tackle.

1.1. Competence-destroying technological discontinuities

Based on competence-based explanations, disruptive innovation's competitive results are based on the set of existing resources, skills, and knowledge that the organizations have. Therefore, scholars argued that an organization's ability to respond to disruptive innovation is closely related to its portfolio of skills and resources (Charitou & Markides, 2003).

The existing industry's technological paradigms are bit-by-bit wiped up and replaced by new technological requirements (Teece, 1986). Incumbents find themselves hindered by their old technological paradigms (Anderson & Tushman, 1990) and face challenges to adapt to disruption due to clashing skills, knowledge, and capabilities. In most cases, new entrants introduce competence-destroying technological discontinuities (*ibid*). Incumbents then suffer from the obsolete knowledge base and hand over their leader seat to new entrants that master the new technology better as they acquire the necessary resources beforehand.

Indeed, in terms of technology, these breakthroughs are significant technological signs of progress with which existing products cannot compete. The competence-destroying discontinuities are challenging to imitate, and the existing knowledge of organizations in

development and production is often insufficient to compete with the disruptive innovation requirements. It resonates with the effects of disruptive innovation.

On the other hand, some types of innovations can enhance a company's capabilities and knowledge basis. When such innovations are introduced, the company already holds the needed expertise to successfully produce the given innovation. Knowledge exists for the company, but it is also advantageous and happens to impact the new technology or product to be manufactured. Typically, competence-enhancing innovations are commonly named as sustaining innovations, which incumbents prioritize due to the many reasons we listed in previous paragraphs.

To resume, research on disruptive innovation has confidence that the impact of knowledge and information on company innovativeness is definite and determines the innovation type resulting from it. In that sense, companies are considered as resource systems in which the right allocation of the latter will result in technological breakthroughs. When taken from the organization's perspective, innovations are disruptive when the new technology is competence destroying the company's existing capabilities vis-à-vis its existing capabilities (Anderson & Tushman, 1990). Organizations tend to lack the required resources to meet the challenges of disruptive innovation.

The concept of competencies acquired through knowledge and well-deployed capabilities is the building block of innovation. Thus, if one company wants to be the disruptor rather than disrupted, it must hold the right resources and capabilities. In that sense, we highlight the importance of asset capabilities and resources to innovate. The next subsection corroborates the need for companies to acquire new assets in the view of performing disruptive innovation when their resources are destroyed and reduce the cavity between their actual capabilities and their market opportunities.

1.2. Cavity between capabilities and opportunities

Disruptive innovation is not a one-time effort, as it requires organizations to continuously change their capabilities (Cohen & Levinthal, 1990). Capabilities are defined as “the key role of strategic management in appropriately adapting, integrating and reconfiguring organizational skills, resources and functional competencies to match the requirement of a changing environment” (Assink, 2006: 219). Leiponen (2005) perceives that there is

empirical evidence of complementarities between organizations' technical skills and their ability to innovate.

The literature on dynamic capabilities finds it confusing to distinguish between diverse capabilities, including ordinary capabilities, innovation capabilities, and dynamic capabilities. Nordin et al. (2018) depicted three core concepts and carried out some detailed definition amongst dynamic capabilities, innovation capabilities, and dynamic innovation capabilities.

Dynamic capabilities are “organizational and strategic routines by which firms achieve new resource configurations as market emerge, collide, split, evolve and die” (Eisenhardt & Martin, 2000: 1107). Teece et al. (1997: 516) added that dynamic capabilities mirror organizations' ability to generate “new and innovative forms of a competitive advantage given path dependencies and market positions”. Dynamic capabilities are the capabilities that “consist of organizational process or routines, which were imbibed by the firm over time and consequently used to reconfigure the firm's resource base by removing decaying resources or by recombining old resources with new ones using new methods or ways” (Čiutienė & Thattakath, 2014: 15). Studies recognize that dynamic capabilities are opposed to ordinary capabilities (zero-level capabilities) that can not change the product, manufacturing process, size, or consumer (Winter, 2003). Ordinary skills are the ones that allow an organization to perform operational activities.

The definition of innovation capabilities has been developed in parallel and is somewhat vague (Nordin et al., 2018). Lawson and Samson (2001: 377) defined innovation capabilities as “the ability to mold and manage multiple capabilities. Organizations possessing the innovation capability can integrate key capabilities and resources of their firm to stimulate innovation successfully”.

Scholars explore the connection between dynamic capabilities and innovation capabilities as dynamic capabilities cover, for example, new product innovations, strategic decisions, and networking (Eisenhardt & Martin, 2000), as do innovation capacities. From an organizational perspective, organizations need to have and perform dynamic capabilities to use the existing resources or adapt when the required resources are absent to access appropriate resources (Nordin et al., 2018).

However, Eisenhardt and Martin (2000) consent that the use of dynamic capabilities will determine the competitive advantage that organizations will get rather than the capabilities

themselves. The proper use of these dynamic capabilities will generate positive performance towards innovation. The question that arises is how the lack of dynamic capabilities can hinder disruptive innovation. Reciprocally, how dynamic capabilities foster disruptive innovation?

We aim at highlighting the theoretical links between dynamic capabilities and disruptive innovation in the following subsections. To do so, we shed light on the numerous frameworks that consider capabilities and resources as critical variables of organizational innovativeness. We thus present the Resource-Process-Priority (RPP) framework (Christensen & Kaufman, 2006) and the Resource-Process-Value (RPV) framework (Christensen & Overdorf, 2000) to deal with this issue.

2. Assessment of organizational resources and capabilities

In this paragraph, we discuss different resource assessment frameworks developed by the disruptive innovation theory.

2.1. The Resource-Process-Priority framework

For companies to understand why some innovations prosper while others perish, researchers enforce the need to assess the so-called tryptic, the RPP framework (Christensen & Kaufman, 2006) composed of three variables: resource, process, and priority. By completing a professional audit of their resources, processes, and priorities, organizations empower their capabilities to innovate. The RPP model framework helps managers decide whether their organization can perform innovation and what changes are needed to be innovative.

Resources include tangible assets, such as personnel, equipment, technology, product designs, labels, knowledge, cash, and less intangible assets, such as suppliers, distributors, and customer relations. Resource idiosyncrasy lies in the possibility of assessing them; as such, they are measurable, and managers know what resources are being employed or fired, traded, depreciated, or formed (Christensen & Kaufman, 2006).

Processes allow companies to transform their resources into valuable products or services through conventional processes that suit the company's operations the rightest. They include

the communication within a company, the validation processes, the manufacturing, and the procurement. Formal processes are distinguished from informal ones. Formal processes are documented in rules and best practices, whereas informal ones are the habitual routines of working that evolved over the years; they are neither written rules nor adopted laws. Often processes solve deficiencies; it is the case for repetitive tasks, for instance. In some cases, these processes cause natural inertia when incumbents make innovative efforts.

Authors assert that once companies realize what resources, processes, and priorities deficiency inhibits innovative growth, they call on other companies complementary assets if imitation is natural. Complementary assets refer to the mixture between the assets needed to have perfect technological expertise (knowledge) coupled with support capabilities such as marketing and manufacturing so that the commercialization of the technological innovation can occur. In most cases, the company, even the most established ones, do not have the assets altogether, and when innovation is part of a systemic process, the complementary assets might be located outside of the company.

2.2. The Resource-Process-Value framework

In the same vein, Christensen and Overdorf (2000) studied organizations' success or failure through the Resource-Process-Value (RPV) framework, which claims the importance of identifying what companies are capable of and not capable of doing, which will help them to identify critical success factors when innovating. Organizations need to identify their capabilities as well as how these capabilities could evolve if the company expands.

Capabilities, as aforementioned, are resources, processes, and values. Resources refer to tangible and intangible assets that the company owns. By tangible, one may think of the people, technologies, and cash, while product designs and information are sorted amongst the intangible resources. Processes are how employees work most effectively and efficiently and are relatively similar to the definition given in the previous framework. Once the organization defines its processes, the latter are supposed to stay unchanged. Lastly, values concern all the standards that enable employees to prioritize their tasks and make their decisions.

Christensen and Overdorf (2000) explain how incumbents fail to implement disruptive innovation due to blind strategies regarding the RPV framework and lack of adaptation of processes and values in regards to disruptive innovation. Incumbents show single-mindedness

when it comes to innovating. They instead focus on capitalizing and regularly launching sustaining innovations, which guarantee higher margins.

When considered from the perspective of the RPV framework, incumbents implement processes that evaluate sustaining innovation without considering disruptive innovation. In the same idea, although they indeed have the resources to invest in disruptive innovation before it affects the existing industry: they rather fail at managing both sustaining and disruptive innovations as a tandem. Therefore, incumbents fail at enforcing ambidexterity in regards to both types of innovation (March, 1991; O'Reilly & Tushman, 1986). The portfolio of resources and capabilities of organizations will hinder their innovativeness. However, when disruption happens, existing capabilities and resources are rendered obsolete by new technological requirements. As a result, existing capabilities are not sufficient for companies as the new entrants caused competence-destroying technological discontinuities for incumbents.

However, although highly dependent on resources and capabilities, disruptive innovation also hinders high levels of risks for companies—the next section endeavors to present the risks inherent to disruptive innovations.

3. Risks linked to disruptive innovations

Risk is the “effect of uncertainty on objectives” (ISO, 2018) in terms of risk sources, consequences, and the likelihood for it to happen. Knight (1921) differentiated risks and uncertainty, respectively, to their measurability and immeasurability.

In their risk management framework, Mikes and Kaplan (2012) categorized risks as follows: preventable risks, strategy risks, and external risks. Preventable risks or internal risks are the ones that companies suffer from and manage within their boundaries. These might be risks resulting from employees' or managers' lack of rigor in regards to processes. Usually, internal risks vanish through internal audits and process monitoring. They present less impact at the strategic level of the organization, in any case. We propose to present strategy risks and external risks in more detail.

3.1. Strategy risks

Strategy risks are critical and ought to be controlled by organizations. However, strategy risks are necessary to generate higher returns of investment. Mikes and Kaplan (2012) highlight that organizations generally accept to take strategic risks to foster their R&D activities. Indeed, in these cases, the returns on investment are scalable but not guaranteed. Organizations invest in a new product or service without being entirely assertive of the outcomes. In terms of disruptive innovation, incumbents tend to focus on sustaining innovations rather than disruptive innovation. In that particular case, March (1991) suggested that organizations can sustain a constant state of change by combining both exploration and exploitation activities (ambidexterity). They will sustain their financial performances by serving their existing market while developing disruptive innovation to serve a marginally developing industry.

March (1991) suggests that exploration activities fall under search, risk-taking, and experimenting towards disruptive innovation. Search enables R&D, which in turn is equal to costs: the amount that organizations need to invest to acquire something. R&D is already costly in typical contexts, so it happens to be a more expensive activity when shortened product life cycles push companies to invest more frequently and dedicate more people to developing new products (Holmstrom, 1989). Besides, organizations are willing to innovate more while their capabilities to do so are limited. The cost of innovation prevents them from innovating as they wish and exacerbated by low margins (Christensen, 1997).

Empirical studies emphasized the increasing amount of R&D investments required by companies to reach previous levels of outcomes that the organization used to obtain with fewer efforts. The number of people dedicated to R&D is also a variable that increased regarding an unchanged output than in previous years (Bloom et al., 2020). The increasing role of people and costs are variables that make innovation an expensive option for companies. However, it is paradoxical whether they choose to innovate or not; companies will face a challenge either way.

Besides, often-disruptive innovation is sophisticated technologies that need a combination of several sub-technologies. Therefore, the competitors, previously considered as such, become potential partners.

3.2. External risks

External risks come from outside of the companies and have to be managed by organizations. When new dominant designs emerge (Anderson & Tushman, 1990), they shatter the existing technological paradigms and render incumbents' activities obsolete. *In fine*, disruptive innovation changes the course of technological standards and force organizations to maintain constant technological and competitive monitoring. From a contextual perspective, disruptive innovation also puts organizational reputation at risk if it fails, so investigating external risks and uncertainties becomes a significant variable of innovation strategies. Even more, disruptive innovation is highly uncertain about the pace at which it develops and happens. According to the disruptive innovation theory, this type of innovation infringes on the existing industry by transforming the niche market into a mass market. However, if disruption occurs, the low level of margins generated destabilizes the new technology's performance and trust (Liang, 2013).

High external and strategy risks, accompanied by increasing R&D costs related to disruptive innovation, have made innovation an expensive option. Therefore, and for survival sake, organizations tend to enlarge their boundaries to multiply their resource and knowledge inflows while trying to reduce risks, costs, and uncertainties.

The last paragraph of this section will create the link between Chapters 1 and 2; indeed, we aim at discussing how exogenous sources of knowledge can prevent disruptive innovation from harming incumbents while creating synergies between competitors. We will discuss trending concepts around innovation, such as organizational ambidexterity and open innovation, to offer an overview of the evolution regarding the disruptive innovation theory.

4. Evolution of innovation strategies

In recent years, studies on innovation and, more precisely, disruptive innovations have proven to give growing interest in collaborative and open systems enabling companies to be innovative. Innovations shift from being the result of efforts made within one organization's boundaries to be a collaborative effort between organizations. This antinomic description of the innovation paradigm gives way to two paradoxical yet complementary terms: closed vs. open innovation (Chesbrough, 2012).

We propose studying the evolution of strategies at the organizational level through ambidextrous strategies adopted towards disruptive innovation. We assume that organizational ambidexterity relieves organizations from being torn between two complementary activities: sustaining and disruptive innovations. Therefore, the following section underlines the evolution of innovation paradigms to understand how companies adapt to turbulent environments. In the view of portraying the evolution of how companies deal with innovation, we intend to 1) explain the evolution path from closed to open innovation and 2) present dual strategies adopted by organizations in the view of managing disruptive innovation (ambidexterity) without having to make radical strategies of innovation which could prevent them from seizing the right technological opportunities.

4.1. Closed innovation vs. open innovation paradigm

We begin by defining both concepts and then discuss how the open innovation paradigm is related to the theory of disruptive innovation.

4.1.1. Definitions

Considered as an axiom in innovation studies, Open Innovation (OI) has experienced a full acceptance since the publication of Chesbrough's seminal work in 2003 (Chesbrough, 2012; Chesbrough & Bogers, 2014) who defined it as "the use of purposive inflows and outflows of knowledge to accelerate internal innovation and expand the markets for external use of innovation, respectively" (Chesbrough, 2003: 1).

Not a long time ago, innovation was considered the fruit of internal R&D efforts, where activities are vertically integrated and resources entirely owned by the organization. Consequently, it condemned organizations with limited resources to either fail in the face of disruptive innovation or suffer from the absence of revenues coming from innovations.

Over the years, scholars questioned whether the OI concept creates discussion around a wrong dichotomy by putting "old wine in new bottles" (Trott & Hartmann, 2009: 715). In their article, the authors believe that when studied as an isolated phenomenon, the closed innovation paradigm holds the truth; however, the concept does not match the field regarding what companies are doing. OI is considered the reverse strategy employed by companies to acquire knowledge from exogenous players in developing technological advances. This view clashes with the traditional paradigms of innovation. This closed innovation paradigm asserts

that vertical integration enables innovation and that internal R&D activities will support and lead to new product developments. The new product will then be made available by the organization.

Nevertheless, Trott and Hartmann (2009) believed that open innovation is not the only answer to the closed innovation paradigm. Later they will introduce counter-arguments to the six premises of the closed innovation paradigm.

Apart from conflictual discussions about the newness of such context, OI is accepted to shift from owning (traditional innovation paradigm) to openness, and scholars have suggested the emergence of new innovation models and practices that have emerged following the OI approach (Pénin et al., 2011). Companies do not own one technology in integrity; instead, they share it openly. Open innovation implies that value is created and captured differently (Chesbrough & Appleyard, 2007), as illustrated in Figure 7.

Figure 7. The Open Innovation model (Chesbrough, 2012: 23)

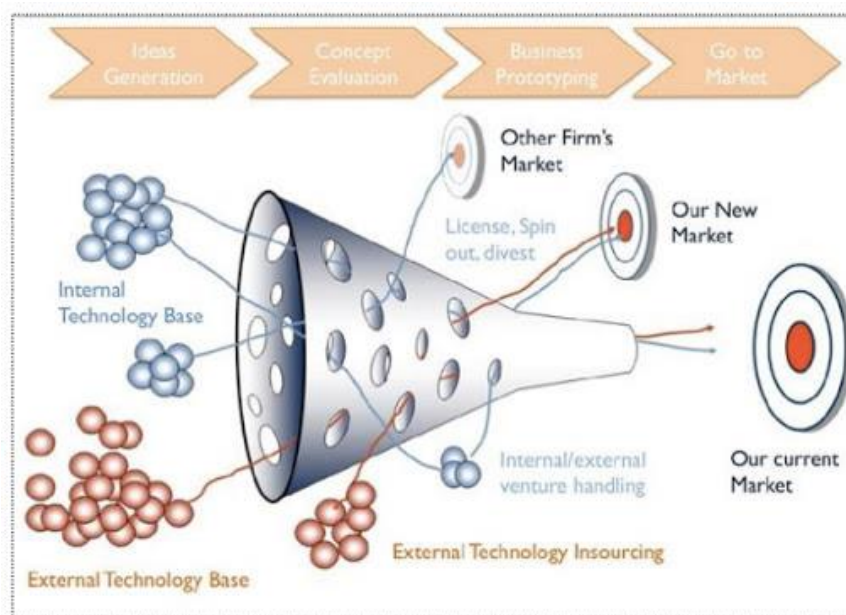

OI modelizes flows of information going from inside-out and outside-in (Chesbrough, 2006) in the organizational setting. According to Pénin et al. (2011: 13), the innovation funnel will “determine the firm’s boundaries”. Interactions with universities, startups, clients, or partners foster the outside-in flow of information. In contrast, inside out moves to translate organizations’ willingness to put their intellectual property into use through spin-offs and independent structures to foster the development of new products and services. Mutual

exchanges and mutual learning from one another are made possible by holes that illustrate the penetrability of the organization’s boundaries. To understand how companies consider innovation processes from both perspectives, Chesbrough (2003) depicted six principles (Table 2).

Table 2. Principles of closed and open innovation (adapted from Chesbrough, 2003)

Closed Innovation principles	Open Innovation principles
Talented people in the sector work for us	Not all the smart people in the fieldwork for us. We have to interact with knowledgeable people inside and outside the organization
We must discover it to expand it and deliver it to prosper from R&D	External research and development may yield substantial value: internal research and development are supposed to maintain some portion of that value
If we invent it first, we will get it first onto the market	To prosper from it, we may not have to originate from the research
If we generate the industry's most and strongest ideas, we will win	If we ensure the final use of inside and outside ideas, we will succeed
We should be monitoring our IP so our opponents do not reap our ideas	We should take benefit of the use of our IP by others, and we should buy the IP from others once our business strategy is mature

Organizations embedded into a closed innovation process will tend to perform misplaced pride by considering that the best of everything is already available within their organizational boundaries. As a result, the smartest people will enable to prosper in R&D activities and reap the benefits of being the first one: get to the market first, win the battle of ideas in regards to competitors while controlling and owning innovations with intellectual properties.

Somewhat open innovation suggests open-mindedness when it comes to the organization of activities. The search for innovation leads organizations to look for what they need outside of their boundaries. R&D is not vertically integrated; instead, it benefits from external inflows of valuable knowledge and has to be combined with internal R&D to generate innovation. Consequently, the mutually created research output generates enough profit that can be mutually used, thus enabling every organization to win from new ideas rather than battling it.

To finish, IP does not necessarily protect the new idea, and instead, it is protective of organizations' business models. The Open Innovation model seems to be related to significant challenges inherent to disruptive innovation. In the following subsection, we aim at finding what relates to both concepts.

4.1.2. Relatedness to disruptive innovation

What radically differs from the closed innovation paradigm is the final destination of the new product or service. Indeed, Figure 7 points out that the organization targets other organizations' markets and new markets and learns from them to nurture its innovation process. The model does not present the flow of information coming from the outside regarding the existing market. *In fine*, we reckon that this model fosters the development of disruptive innovation. We explain our argument based on several assumptions.

Firstly, the organization benefits from exogenous sources of information. Internally people benefit from fresh and new ideas thanks to combining both internal and external technology bases. The combination of new ideas, competencies, and knowledge brings a wind of change and opens a new product or service perspective. Secondly, we believe the acknowledgment of other markets not only serves as a warning for organizations that act accordingly in their R&D activities but also enable them to learn from the field rather than ignoring it. In previous sections, we focus on the potency of resources, capabilities, and knowledge in generating disruptive innovation that can be valuable for organizations. Therefore, access to external knowledge can offer the advantage to fill the gap between the missing capabilities and the willingness to seize market opportunities.

However, Cohen & Levinthal (1990) argued that having access to external resources and information is not sufficient if organizations do not have the capabilities to absorb it. Absorptive capacity refers to an organization's capacity to "recognize the value of the knowledge, assimilate, and exploit it" (Cohen & Levinthal, 1990: 140).

The notion of absorptive capacity considers that prior organizational experience should help identify the importance of the new information in converting it into products or services. It is tightly linked with the principle of alignment that defends the idea that organizations "must have the potential to learn, unlearn, or relearn based on its past behaviors" (Fiol & Lyles, 1985: 804). The better an organization's absorptive ability, the greater the opportunities to capture the new information's intrinsic value.

Lastly, the blurriness of the organizations' boundaries eliminates trust issues that may happen in a closed innovation paradigm where each organization checks to protect their intellectual property.

To conclude, OI contributes to understanding why disruptive innovation can be challenging for incumbents at the macro level. In a disrupted environment, organizations, which confine in their existing industry, tend to suffer due to a closed perspective towards innovating R&D activities. Nevertheless, even in open innovation systems, organizations are torn between focusing on sustaining or disruptive innovations at the organization level. Therefore, scholars have studied the effects of hybrid strategies of innovation, which internally combines the capabilities to develop both types of innovations.

4.2. Ambidextrous innovation strategies

In the previous paragraph, we revealed the increasing role of open innovation and its impacts on organizations. Open innovation provides organizations with access to more knowledge, creates synergies, and fosters innovation. However, an organization also needs to be ready to welcome the knowledge and use it purposefully to produce a product or a service. Therefore, in recent years, literature highlighted that organizations either focus on disruptive innovation or sustaining innovation. The wrong or right strategic decision drives the organization's survival or perishment (Christensen, 1997). Uncertainty is the result of the radical choice that organizations had to make between the two complementary types of innovation. Studies have reported the benefits of combining hybrid strategies that incorporate both efforts towards sustaining and disruptive innovation: ambidexterity (March, 1991).

Initially introduced by Duncan's work (1976), the concept of organizational ambidexterity was developed further by March (1991). Indeed, March (1991) indicates that innovation results from juggling between exploration and exploitation activities in the view of acquiring the required knowledge for innovation. Since then, organizational ambidexterity attracted growing interests (Li et al., 2018) and resulted in five research streams: organizational learning, technological innovation, organizational adaptation, strategic management, and organizational design (Birkinshaw, 2008). Many studies related to organizational ambidexterity to innovation (Simon & Tellier, 2008; van Bracht & Kortmann, 2014).

O'Reilly and Tushman (1996) narrowed ambidextrous organizations about their ability to perform sustaining and disruptive innovation simultaneously. They defined them as organizations that can "simultaneously pursue both incremental and discontinuous innovation,

and change results from hosting multiple contradictory structures, processes, and cultures within the same firm” (O’Reilly & Tushman, 1996: 24). In practice, organizations simultaneously exercise strategies to respond to evolutionary and revolutionary changes. Following the seminal work of O’Reilly and Tushman (1996) on ambidextrous organizations, scholars showed a continuous interest in the role played by ambidexterity in managing disruptive innovation (Charitou & Markides, 2003). For instance, He and Wong (2004) empirically proved that combining these two paradoxical activities positively impacts an organization’s capabilities to respond to disruptive innovation.

The importance of organization ambidexterity is twofold. First, ambidexterity is a medium to contour challenges brought by the disruptive innovation theory, which proceeded to a strict distribution of innovative tasks between incumbents and new entrants. So, incumbents owe their failure towards disruptive innovation due to their specialization in sustaining innovations. In contrast, new entrants with a high level of flexibility and less exposure to risks tend to navigate disruption successfully. Ambidexterity, therefore, shifts the focus from the innovation types to the capabilities necessary for the innovations. Secondly, ambidexterity shows the dynamics of innovation patterns and the complementarity between sustaining and disruptive innovations.

Many studies have tried to complement the theory of disruptive innovation with concepts such as open innovation and ambidexterity, which suggests immanent critiques of the theory. The following paragraph reviews the critiques made by several significant works (Danneels, 2004; King & Baartartogtokh, 2015; Sood & Tellis, 2010).

5. Critiques of the disruptive innovation theory and opening to interorganizational relationships

In recent years, the theory of disruptive innovation has encountered some limits that have unleashed incumbents from systematically failing in the face of disruptive innovation. Scholars advocated that disruptive innovation theory lacks constructive criticism and enlightenment regarding the inherent mechanisms and impacts on organizations and industries (Danneels, 2004).

First, scholars outline the blurry definition of disruptive innovation. Sood and Tellis (2010: 340) highlight that the “same term is used to describe the causative agent (disruptive) and its effect (disruption).” Similarly, Christensen (1997) uses disruptive innovation to qualify both the failure of incumbents in the face of disruption and industry alteration caused by disruption (Markides, 2006).

Danneels (2004) states that disruptive innovation is technological, given which companies will compete accordingly. Customers’ needs should determine this new competition metric, thus overshooting the needs is not an option. New entrants are considered as the catalyst for the disruption, which happens at the new-market level. In fact, prior the commercial success in the mass market, the technology has to prove itself in the niche market. Some studies have shown that in some industry emergence settings, some new entrants may succeed (Tesla) when others fail (Better Place) (Donada & Lepoutre, 2016). When performances are better and the disruptive technology introduced in mass-market: the disruption happens. Moreover, disruptive technology (Christensen, 1997) changed into disruptive innovation later (Christensen & Raynor, 2003) to enlarge its application in studies.

Besides, it is claimed that benefiting from its success; the theory is not questioned about its unpredictable characteristics. The disruptive innovation theory has proven itself in the *ex-post* analysis of disruption rather than *ex-ante* insights to help companies foresee disruption and execute flexibility in their innovative strategies (King & Baatartogtokh, 2015).

Moreover, studies were limited to particular industries (Danneels, 2004), such as the disk-drive industry (Christensen, 1997), which all happened to be successful cases of disruptive innovations introduced by new entrants. In that sense, Danneels (2004) states that the theory of disruptive innovation is limited in that it makes predictions impossible, thus does not meet the requirements of managerially useful theory and benefits from a limited amount of quantitative studies. The theory of disruptive innovation is blamed for selecting particular industries and shedding light on cases that stage the reliability and integrity of the theory.

In the same vein, in the fall issue of the *MIT Sloan Management Review*, King and Baatartogtokh (2015) concluded that Christensen and Raynor (2003) proposed many disruptive innovation cases happened not to fit the four critical elements of the theory.

Indeed, the authors surveyed and interviewed one or more experts on each of 77 cases discussed in *The Innovator’s Dilemma* and *The Innovator’s Solution*, where Christensen and

Raynor (2003) layout the elements of the theory. The sample of interviewed persons spans wide from academics, financial analysts, nonacademic authors, and participants to the industry. Bias prevention happened through the alienation of disruptive innovation to 'industry transitions,' and the sample was asked to test the theory's four critical elements.

As intended, results are contradictory with the theory of disruption and summarized as such (King & Baatartogtokh, 2015):

- Not all disruptive cases contained sustaining innovation;
- Not every incumbent misjudges the demand of consumers;
- Many incumbents could not respond to the potential disruption;
- The disruptive innovation did not absorb roughly one-third of incumbents.

It is also discussed that disruptive innovations are cheaper and more straightforward than mainstream products (Christensen, 1997). Yet, Schmidt and Druehl (2008) disengaged by bringing shreds of evidence of more expensive and more technologically sophisticated disruptive innovations. While the problem of technology complexity, high costs, and risks have emerged, Christensen and Overdorf (2000) proposed three solutions to address the managerial dilemma brought by disruptive innovation by proposing ways to address capability achievement:

- Establish new organizational structures inside company boundaries where innovative procedures can be implemented: committed teams (the physical component of the company devoted solely to disruptive innovation);
- Develop an individual spin-out from the current company and establish the new processes and principles needed to address the new challenge within it. In reality, disruptive innovation can require new cost structures to be profitable; the established cost structure can be too rigid for technological innovation (low-end structure does not match high-end structure). No focus on physical separation;
- Absorb another organization whose procedures and principles correspond closely to the criteria of the new task. Essentially, it means acquiring capabilities; however, organizations do not need to completely incorporate their acquisition into the parent organization, as it avoids vaporizing the capabilities for which the acquisition was initially carried out.

As with any theory, the theory of disruptive innovation has been subjected to critiques. They are founded on empirical arguments and are all the more remarkable because they open research perspectives to enrich a theory under which organizations consider the critical concept that disruptive innovation is. Although criticized, the theory of disruptive innovation developed by Christensen (1997) provides solid ground in management studies and serves as a robust conceptual framework.

Conclusion of Section II.

In **Section II**, we discussed the capabilities and resources dependency on disruptive innovation and the turbulences faced by an organization when they are missing. We also highlighted the risky side of disruptive innovation from the inherent lack of resources and capabilities and the external environments' pressure with the emergence of a new competitive landscape.

Therefore, disruptive innovation requires an analysis at several levels: organizational and industry levels, yet, the theory of disruptive innovation, as mentioned in the critiques, focuses more on the organizations themselves rather than the effects and the dynamics of such a phenomenon at the industry level. We corroborated this argument by examining several emerging concepts such as the Open Innovation paradigm that offends the traditional way of innovating (closed innovation), and hybrid and dynamic ambidexterity strategies that organizations can adopt to contour the rigid distribution of innovation tasks proposed in the theory of disruptive innovation.

The critiques brought to the theory highlighted the fuzzy definition of the term disruption itself, the very specialized case studies upon which the theory is based, and the modifications and enlargement of the theory over time witness some theoretical wobbliness.

Risk, uncertainty, and lack of resources are predominant characteristics of disruptive innovations. The difficulty in apprehending those threats transforms disruptive innovations into grey areas for organizations, all the more difficult to apprehend as the theory only provides with *ex-post* analysis.

To present the contributions of theoretical combinations, we propose to dig into the idea that disruptive innovations are not exclusively a challenge for organizations, but rather a perspective to benefit from environmental synergies.

If incumbents and new entrants have diverging advantages and disadvantages in the face of disruptive innovation, the natural survival instinct would call synergies between both types of organizations to bypass the limits of the theory.

Conclusion of Chapter 1

The overall objective of **Chapter 1** was to review the literature on disruptive innovation and set our theoretical context by distinguishing two levels of analysis of disruptive innovations: organizational level and industry level. We aimed to understand the core concepts of the theory of disruption and the inherent elements that make disruptive innovation a factor of turbulent environments for organizations.

Section I discusses the disruptive innovation theory introduced by Christensen (1997) and highlights the challenges that incumbents and new entrants face when a disruptive innovation occurs. The complexity of disruptive innovation with independently developing low-end market and new market disruptions confronts new entrants and incumbents to a relentless battle against perishment. Some arguments confront incumbents to fail regarding disruption such as economic rigidity, organization theory explanations, and strategy elements; others support incumbents' financial performance and adaptation capabilities carrying them to a successful path.

Then, in **Section II**, we have discussed how disruptive innovations rely on capabilities and the turbulences they face when these resources are missing. We have also highlighted the risky side of disruptive innovation from the internal lack of resources and the external environments' pressure with the emergence of a new competitive landscape.

Therefore, disruptive innovation requires an analysis at several levels: organizational and industry levels. We corroborate our argument by shedding light on several emerging concepts such as the Open Innovation paradigm that offends the traditional way of innovating (closed innovation) and hybrid and dynamic ambidexterity strategies that organizations can adopt to contour the stringent innovation tasks distribution of the disruptive innovation theory. We also discussed the critiques brought to the theory amongst years, such as the fuzzy definition of the term disruption itself or the very specialized case studies upon which the theory is based.

To conclude, over the years, scholars agreed that disruptive innovation, if handled in a collaborative way (Christensen & Overdorf, 2000), could lead to successful innovation strategies. We admit that if every organization facing disruption in a given industry responds collaboratively to it, this will give some interesting insights regarding the new industry's structuration. Therefore, the emerging and structuring patterns of disruptive innovation will be

captured by interorganizational relationships. Indeed, in the view of enriching their portfolios of resources and capabilities, companies are more and more observed to call on exogenous sources of knowledge (Hagedoorn & Duysters, 2002); we intend to discuss this point in **Chapter 2**.

Chapter 2. Interorganizational relationships networks as a response to disruptive innovation

Chapter 2 telegraphs our willingness to understand how industry emergence appears in the literature. Therefore, it is set at a higher level of analysis; indeed, in light of the above chapter, industry emergence is a macro-level phenomenon that happens through collective patterns that catch organizational behavior changes. Consequently, disruptive innovation triggers the new industry (new-market disruption) and makes its analysis of high importance. Therefore, we distinguish two levels of analysis. First, disruption arises in organizations that are then forced to change their way of doing things to adapt to the turbulent environment. Consequently, these behaviors mirror the industry's changing patterns and detachment from the established industry to emerge in a new one.

Based on this observation, **Section I** reports how industry emergence is considered in the literature by presenting the various theoretical approaches used to analyze such a phenomenon.

We finish our section by highlighting the theoretical gaps identified in the literature, which shelved the examination of industries' origin and instead focused on the structuration of industries (Padgett & Powell, 2012). Drawing on evolutionary economics, we proposed a way to seize the emergence of industries and propose a model to retrace the structuration process.

To do so, we shift from studying exclusively industry emergence to studying industry emergence through network structures in **Section II**, where we retrace the life cycle of a network from its origins to its structuration with an anchorage in the evolutionary economics. The analysis of networks requires a two-level analysis; the network aggregates being interorganizational relationships at an organization level and the network's structuration at a macro level. First, we focus on the genesis of networks by giving an extensive overview of interorganizational relationships, the motives of formation based on external and internal factors, the level of analysis of interorganizational relationships, and the typology of organizations involved in these relationships.

As mentioned, interorganizational relationships have been subjected to studies considering them as part of larger meta-organizational structures such as networks. In the literature, we found the rapprochement of two similar concepts that are networks and ecosystems. We find it interesting to telescope the similarities between networks and ecosystems to verify the applicability of Adner's ecosystem-construct (2017). We call on using the construct proposed by Adner (2017) for several reasons. First, the construct represents a groundbreaking conceptualization of industry structuration through key activities. Activities are defined as all “the activities required for [the disruptive innovation] instantiation” (Adner, 2017:43). The different key activities suggest that innovation complexity can be overcome through various networks of activities rather than typical networks that focal organizations may have in established industries.

Secondly, the industry's structuration around key activities presents double benefits: it contributes to identifying key technologies related to the final value proposition (the disruptive innovation) and the clique structures of organizations. Therefore, it responds to our positioning at a macro level examination of industry emergence.

To finish, we highlight the similarities between ecosystems and networks and justify using the ecosystem construct proposed by Adner (2017) to depict networked industry emergence through key activities.

Section I. Apprehending the emergence of an industry

Porter (1979: 215) defined industry emergence as “newly formed or re-formed industries that have been created by technological innovations, shifts in relative cost relationships, the emergence of new consumer needs, or other economic and sociological changes that elevate a new product or service to the level of a potentially viable business opportunity”. Porter (1979) highlights that emerging industries are blank canvasses when it comes to organizational strategies, as no rules are yet implemented in such industries, therefore, causing turbulence and uncertainty (Haunschild, 1994) as emerging industries are impermeable to the individual and organizational responses (Aldrich & Fiol, 1994).

Over the years, industry emergence has become of high interest regarding the number of researches dedicated to understanding the dynamics and patterns of such a phenomenon caused by disruptive innovation. Indeed, industrial dynamics have been a significant research area for scholars since the late 1970s (Malerba, 2007). Studies have highlighted the rapprochement of innovation and industrial dynamics, innovation being a trigger of various industry dynamics patterns, causing a paradigm shift.

Given the impact on an organization’s performance and economic development, ‘emerging’ (Auster, 1992) or ‘nascent’ (Eisenhardt & Santos, 2009) industries are complex systems with blurry boundaries (Gustafsson et al., 2016), making the understanding of emergence patterns even more difficult (Phaal et al., 2011), similarly to technological paradigm (Cantwell & Hayashi, 2019).

In the light of the above arguments, in **Section I**, we propose to present the theoretical approaches applied to industry emergence and presented three of the major ones: the institutional approach, the evolutionary economics, and the organizational economy. We finish by identifying theoretical gaps concerning the industry emergence analysis and connect the concept of industry emergence to network and ecosystem emergence constructs.

1. The theoretical approaches of industry emergence

The review of industry emergence approaches revealed the prevalence of three main theoretical approaches upon which studies on industry emergence draw: institutional theory (DiMaggio & Powell, 1983; Meyer & Rowan, 1977), evolution theory (Arthur, 1989; Nelson & Winter, 1982) and organizational ecology (Hannan & Freeman, 1977; Hannan & Freeman, 1984; Pfeffer, 1992; Singh & Lumsden, 1990). Additionally, in recent years cognitive studies have brought groundbreaking insights in regards to such a phenomenon. We describe each theory and its findings on industry emergence in the following subsections.

1.1. Institutional approach

The organizational ecology institutionalism considers that institutions are set in motions by ecological-like dynamics (Abrutyn, 2012). The institutional theory discusses organizations and industries are analogous to species in nature (Padgett & Powell, 2012). Mainly driven by survival, organizations like species undertake various dynamic actions to adapt to changing environments (Hawley, 1944). Institutions are a “constellations of established practices guided by enduring, formalized, rational beliefs that transcend particular organizations and situations” (Lammers & Barbour, 2006: 357). Therefore institutionalism is the process where “social processes, obligations, or actualities come to take on a rule-like status in social thought and action and focuses on how social structures emerge” (Antonova, 2018: 38).

From a broader spectrum and regarding the emergence of industries, institutionalist researchers have looked at how industry emergence can be affected by institutions (Antonova, 2018; Benner & Tripsas, 2012; Hargadon & Douglas, 2001). They also focused on the changes that may occur in institutional entrepreneurship (David et al., 2013; Eisenhardt & Santos, 2009) and discussed the importance of legitimacy and the foundation of industry entities in emerging industries (Aldrich & Fiol, 1994). Institutional theorists (DiMaggio & Powell, 1983; Meyer & Rowan, 1977) attest that the institutional environment shapes organizational behaviors. Organizations are looking for legitimacy (Aldrich & Fiol, 1994) in the institutional environment to guarantee their perennation. Industry emergence will result from institution pressures and obligations. This approach is widely accepted and used in industry emergence studies (Gustafsson et al., 2016).

Therefore, the institutional approach views industry emergence as a phenomenon influenced by social and cognitive processes, leading to socially constructed industries. Organizations are

considered as composed of the institutional environment in which they are embedded (DiMaggio & Powell, 1983).

1.2. Evolutionary economics approach

Like institutionalists, evolutionary economists claim that organizations influenced by their historical performances and internal routines tend to develop different path dependencies (Arthur, 1989; Nelson & Winter, 1982). The path dependency of an organization is reliant on industry information and competition. The evolutionary approach is the second most influential theory to approach industry emergence (Gustafsson et al., 2016). More than half a century ago, Schumpeter proposed the concept of ‘creative destruction’ (Schumpeter, 1942) that regards disruptive innovation as the critical mechanism of economic growth. Indeed, according to this concept, the Walrasian equilibrium is upset by companies’ implementation of new products, services, methods, and inputs, making irrelevant existing ones.

Before the disruptive innovation theory, the theory of biological evolutionary argued that organizations live up entirely in relatively long periods of sustaining innovation launches (O’Reilly & Tushman, 1996). However, these uneventful phases are disturbed by competitors or new technologies, which, when disruptive, can destroy and destruct existing paradigms (Abernathy & Clark, 1985). This perspective accepts that organizations evolve in gradually changing environments and ignores the periodicity at which innovations are introduced (O’Reilly & Tushman, 1996).

The evolutionary economists (Dosi et al., 1988; Nelson & Winter, 1982) consider that emergence is a macro level phenomenon based on dynamics created at the organizational level. For instance, Nelson and Winter (1982) focused on changes in organizational behavior and innovation dynamics.

In summary, the evolutionary theory has several principal characteristics described as follows (Dosi & Nelson, 1994).

Firstly, the theory explains how “the movement of something over time, or to explain why that something is what it is at the moment in time in terms of how it got there” (*ibid*: 154). Secondly, the theory created an analogous reference to evolutionary biology. It highlighted the necessity to identify the unit of selection (genes), the relationship linking the genotypic

level with the entities (the phenotypes), which are the ones that incur the environmental selection, the processes of interaction and mechanisms that generate variations of and amongst genotypes.

Besides, evolutionary economics shed light on industry life cycle models (Phaal et al., 2011), draw upon technological novelty (Padgett & Powell, 2012), technological changes (Rosenkopf & Tushman, 1998). Results discuss the emergence and evolution of IR networks and industries

(Rice & Galvin, 2006; Rosenkopf & Tushman, 1998) through advances in technological designs (Anderson & Tushman, 1990; Phaal et al., 2011).

Therefore, dynamics and change are the essence of evolutionary economics works of literature and focus on innovation, entrepreneurship, patterns of growth, and development approaches (Padgett & Powell, 2012).

Like institutionalists, evolutionary economists mention routines and path dependencies as critical insights for studying dynamic patterns (Boschma & Lambooy, 1999). Each organization is embedded in some 'routines' that will explain the given organization's technological path. These routines are singular to each organization and embed a high level of tacit knowledge, considered vital for innovation. When the industry is going through a phase of change, the theory testifies that some routines match the new industry while others fail.

However, over time the evolutionary theory led to contentions.

Firstly, the metaphorical analogy between biological species and industries presents some drawbacks. From a biological point of view, growth and development are not linked to a final objective, as industries and organizations which have intrinsic goals of economic development. Indeed, evolution in industries is broadly shaped by organizations' strategies. Therefore, some sort of constraining interventions affect their biological evolutions.

Secondly, some studies (Basalla, 1988) discuss the unmatched combination of knowledge source to produce innovations whereas, from a biological standpoint, species cannot interbreed. Through artifacts, skills, and new ideas, organizations generate problem-solving behaviors while biological species are limited in their boundaries. As a result, organizational behaviors and economic development to a broader sense result from human interventions to

solve an identified problem and lead to economic development. To do so, organizations are analyzed as part of a more extensive structure of relationships that constitute a network (Padgett & Powell, 2012). These interventions are considered as evolution patterns but are somewhat constrained than parallel to the rest of nature.

1.3. Organizational ecology approach

Lastly, organizational ecology represents, to a lesser extent, an approach to examine industry emergence (Gustafsson et al., 2016) and focuses on the study of “organizational diversity” (Singh & Lumsden, 1990: 162). The organizational ecology literature often falls back on the institutionalist and ecology theories (Gustafsson et al., 2016).

The organizational ecology theory has emerged in the 1970s; it stands at a macro-sociological level as it points out the influential role of exogenous events on organizations' changes (Hannan & Freeman, 1984). Studies raised a legitimate issue: “Why are there so many kinds of organizations?” (Hannan & Freeman, 1977: 936). Singh and Lumsden (1990) discuss several primary objectives of the organization's ecology. First, understanding the influential role of social events on the rate of creation of new organizations belongs to understanding dynamics resulting from social changes. Conversely, organizations' disappearance is equally essential to organizational creation related to significant events of social change. Lastly, organizational ecology studies the intra-organizational changes that may occur within organizations that try to adapt to turbulent environments. Therefore, organizational ecology focuses more on organizational diversity by shedding light on characteristic organizational patterns rather than adaptation strategies.

Therefore, it relies on empirical analysis, which involves studying organizational diversity over time (Glenn & Hannan, 2015) to understand how social, economic and political factors explain the density of organizations and their diversity while also encompassing their changing characteristics over time.

Organizational ecologists (Hannan & Freeman, 1977, 1989) consider that organizations are part of populations. Populations are groups of organizations that share the same characteristics, such as the size, for instance. When organizations from different populations engage in interorganizational relationships, they are said to create organization communities (Astley, 1985). The theory considers that organizations suffer from rigidity and unstable

structures that prevent them from navigating turbulent environments. Nevertheless, organizations are ‘the main vehicles for action’ in industries (Coleman, 1973); therefore, it is assumed that organizations drive economic development and change.

All actions happen in organizational contexts that imply collective actions. These collective actions carried by organizations are sources of changes, and the speed of changes is reliant on organizational dynamics. Studies on industry emergence (Van de Ven & Garud, 1993) focused on a social system framework that explains communities' facilitator role in preventing or fostering innovations. Innovation produces astonishment within organizations that need to retaliate and respond if they want to survive. Therefore, Van de Ven and Garud (1987) developed the social systems framework to shed light on industry emergence and innovation-driven organizational actions. It resulted that three main components of the social system are relevant to industry emergence: “institutional arrangements, resource endowments, and proprietary functions” (*ibid*: 26).

Institutional arrangements show how organizations show collaborative initiatives to modify or influence their institutional environments (Pfeffer & Salancik, 1978). Many studies highlight that institutional arrangements foster or prevent the development of innovations and the emergence of an industry (Teece, 1986) and highlight the importance of legitimacy (Akerlof, 1970) and technological standards (Anderson & Tushman, 1990; Rosenkopf & Tushman, 1998). As a result, organizations participate in innovation networks and carry out resource acquisition actions (Van de Ven, 1993). In terms of resources, organizational ecologists address three types of resources needed for innovation growth: “basic scientific or technological research, financial mechanisms, and the pool of competent human resources” (Van de Ven, 1993: 28).

Innovations trigger emerging industries; yet, innovations need basic scientific or technological research. By definition, basic research is very costly as it aims at producing at it lays the ground for significant innovations. Therefore, organization ecologists explore the tendency to underinvest in basic or technological research and recourse to external sources of knowledge (Utterback, 1994), shaping the industry emergence in the long term.

Closely linked with basic or technological research, and to a broader extent to the acquisition of knowledge and resources, organizational ecologists consider that every industry should

have intrinsic or inter-organizational financial mechanisms (venture capital) to endorse the development of innovations and their commercialization. Besides, industry emergence is reliant on human resources. Van de Ven (1993) ventilates organizations' tendency to access required human resources through hiring mechanisms in research institutes and proprietary organizations. Nelson (1992) discusses implementing educational training programs in colleges and universities to form the required human resources. Lastly, Allen & Stephenson (1983) argues that innovation related to human resources are trained in 'invisible colleges' networks of practitioners.

Finally, proprietary functions relate to organizations' binary possibilities to recourse to market or hierarchies (Williamson, 1973). Driven by the development of innovations, organizations may invest in technology-related assets to produce innovation internally (make). These innovations are often complex to imitate. Therefore, indirect investments seem to worth it. However, sometimes organizations may need complementary resources that they contract on the market (buy) as numerous sources already exist. The occurrence of make-or-buy decisions at the organizational level structures the industrial change over time (Van de Ven, 1993).

1.4. Cognitive considerations

From the beginning of the cognitive framework, organizations and their environments are set as crucial industry emergence variables. Named "nascent markets" from the framework, these emerging industries refer to "business environments in an early stage of formation" (Eisenhardt & Santos, 2009: 644). These emerging industries are characterized by undefined industry structure (Eisenhardt & Santos, 2009), the absence of dominant product designs (Hargadon & Douglas, 2001), and lack of strategic directions (Kaplan & Tripsas, 2008). These new industries also create blurriness for organizations confronted with non-adapted strategies and disrupt their balance on "how to play and how to win" (McDonald & Eisenhardt, 2020).

By definition, they present a high degree of ambiguity as organizations are not accustomed to the meaning of changes that occur. (Eisenhardt & Santos, 2009) characterized emerging industries as "unstructured settings with extreme ambiguity" (*ibid*: 644) and based on new business models (McDonald & Eisenhardt, 2020) requiring organization modularity, relatedness, and loose-coupling (Eisenhardt & Martin, 2000) so that resources are adequately combined according to organizations' changing environments.

A significant contribution of the cognitive approach to industry emergence recognizes that organizations are part of a broader system compared to the atomistic development of boundaries. They discuss the narrowness of empirical studies on organizational boundaries limited to the antecedents of single-boundary decisions.

The cognitive approach to industry emergence proceeds on the basis that the emerging industry implies challenges of structure apprehension. Consequently, organizations struggle to find strategically right positioning (Davis et al., 2009).

Significant works on cognitive and sociopolitical legitimacy center on how organizations and institutions collectively act to develop an emerging industry (Leblebici et al., 1991). Another stream of the literature on boundary creation discusses the role of interorganizational relationships in shaping organization boundaries.

Drawing on the resource dependence theory and social network literature (Eisenhardt & Schoonhoven, 1996), scholars consider organizations' willingness to attain a central network position and acquire adequate resources as boundary-setting mechanisms. Consequently, the strategic approach to shaping organizational boundaries will help organizations navigate turbulent environments, acquire defensible market position, and organize their interrelated boundary decision according to three processes: claiming, demarcating, and controlling (Eisenhardt & Santos, 2009). Claiming the market translates organizations' willingness to become a cognitive referent of the new market. As mentioned earlier, emerging industries are ambiguous with unclear customers, designs, and value chains. To acquire leadership positioning, organizations tend to devote paramount effort to define their identity and one of the emerging industry. If the industry is relevantly claimed, the organization benefits from the cognitive referent status through cognitive dominance.

In the light of cognitive dominance, organizations also need to acquire competitive dominance. Competitive dominance is challenging for organizations. While organizations consume efforts to establish their identities in ambiguous emerging industries, they may face powerful competitors that they may want to avoid. To avoid string competition and continue their paths towards identity settlement, organizations establish interorganizational mechanisms. By so doing, organizations determine their nearby industry structure, set their boundaries, and contribute to the industry's overall structuration.

Nevertheless, claiming and bracketing the market is not sufficient for organizations to anticipate whether competitors will overcomplete them or not. Organizations tend to multiply interorganizational mechanisms such as acquisitions to occupy as much space as possible and control the market.

The cognitive approach is fascinating; it gives careful consideration of industry emergence through organizational dynamics. These organizational dynamics are fostered by the necessity to claim, demarcate, and control the emerging industry and set organizational boundaries embedded into overall strategic action patterns. The cognitive framework to industry emergence has highlighted significant directions for future works on industry emergence in addition to the evolutionary models. The importance of embedded organizational behaviors into “overall patterns of strategic actions” (Eisenhardt & Santos, 2009: 644) is discussed and dislocate the problem of assessment to the organizational boundary level.

1.5. Drawing on the evolutionary economics approach

The review of the different industry emergence approaches reports a principal amount of work to study such a complex phenomenon. To legitimate our research and bring insightful contributions, we participate in discussions initiated by the evolutionary economic approach. We explain our positioning as follows.

First, our research concurs with the evolutionary approach to industry emergence. Industry emergence is a macro level phenomenon, yet, depicting the emergence and scrutinizing the structuration patterns resort to analyzing dynamics at a lower level of analysis. Therefore, organizational strategy dynamics become essential variables that can be used to study changes at a macro level. We believe that examining organization-level dynamics to understand industry emergence is a replicable model regardless of the disruptive innovation and the industry. Also, we propose to seize industry emergence through Interorganizational Relationship (IR) networks, which open the doors to a world of exciting discussions around the concept of IR networks as emergence metrics.

Secondly, the evolutionary economic literature highlights a significant gap in existing works on industry emergence (Padgett & Powell, 2012). A prominent critique made to existing studies on industry emergence deplores the assimilation of industry emergence and industry structuration. Existing theories and conceptualization models often consider structuration

phases. They overlook the importance of seizing the origin of industries, meaning their emergence.

Capturing the emergence point of an industry equals the necessity to understand its structuration process. Indeed, we support our argument for several reasons. Initially, it is beneficial for organizations to assess and portray the emergence of industry, which will appreciate the transition and take necessary or corrective steps upon becoming informed. Having a relatively clear view of the industry's future and technology will reduce organizations' tendency to be threatened by uncertainty, risks and serve as a guide for potential investments and positioning strategies.

Besides the main theoretical approaches to industry emergence, many studies have attempted to schematize the phases of industry life cycles introduced in the 1970s. To complement the theoretical view on industry emergence, we propose to present the dominant industry life-cycle models developed over the years.

2. The prevalence of industry life cycles

As mentioned, industry emergence represents an unpredictable subject in many theories. As a result of paramount studies dealing with the emergence of industries, many time-based life cycle models have emerged. They all share the standard metric of studying the emergence of industry paralleled with the advancements in innovations that have caused industry emergence.

We start our presentation by giving an overview of the cognitive framework that ultimately inspired interest in pursuing research on industry emergence by exploring organizational the evolution of organizational boundaries through a detailed examination of organizational dynamics (Eisenhardt & Santos, 2009). We then present the time based three-phase industry life cycle model: the initial, the co-evolutionary, and the growth stage.

2.1. Initial stage

The initial stage of industry emergence witnesses the dispute between the turbulences in the traditional industry and the embryonic phase of the new emerging industry (Phaal et al., 2011) created from a handful of small entrants. The initial stage is a rudimentary phase with room

for improvement. Neither rules nor directions in the new industry are cleared for organizations, nor are they ways to overcome the turbulences in the existing industry.

As the initial stage announces the new industry's commencement, studies have focused on understanding the triggers of the new industry emergence. 'Novelty' (Padgett & Powell, 2012) and 'technological developments' (Malerba, 2007; Phaal et al., 2011), 'disruptive innovations' (Christensen, 1997) are considered as the primary triggers of industry emergence. When they occur in an industry, they ultimately cause a paradigm shift by challenging the existing product and services. The initial stage is even more difficult for organizations as they perform with limited cognitive and sociopolitical legitimacy in the new industry (Aldrich & Fiol, 1994). Besides, the initial stage is characterized by the emergence of multiple "market categories" and "industry entities" (Gustafsson et al., 2016: 30) as ways of considering the new technology and the industry. The wide array of market categories and industry entities extend the initial stage until a dominant design emerges.

Because of its initial character, companies are confronted with limited resources and know-how related to the new technology during this phase. To adapt to disruption, companies must, therefore, be innovative in terms of strategy. It turns out that organizations use interorganizational relationships to rapidly make up for this lack of resources and know-how (Powell et al., 2005) or attract venture capitalists' investments to acquire the required capital (von Burg & Kenney, 2000). The initial phase leads to the co-evolutionary phase, also called the 'emergent' stage that we will develop next.

2.2. Co-evolutionary stage

The co-evolutionary stage also called the 'emergent stage' (Forbes & Kirsch, 2011) or 'the nurture phase' (Phaal et al., 2011), logically has varying characteristics than the initial stage. While many market categories and industry identities characterize the initial phase, we observe a consolidation of these multitude categories and identities during this phase. Groups of technologies are emerging and suggest a permissiveness to a dominant design (Grodal et al., 2014). Some researchers observe an increasing number of interorganizational relationships to develop or commercialize innovation, altering and modifying each organization's roles, which differ from the roles occupied in the traditional industry (Powell et al., 2005).

Several studies (Agarwal & Bayus, 2003; Klepper & Graddy, 1990) underline the growth potential of this phase and the dominance of collaborative strategies, which can partly explain the increase in the number of companies present in the new industries in general. Because technology follows its development course, the activities begin to organize themselves along a value chain, which results in a visible structuration of the emerging industry, organizations, and the technology itself through the implementation of common standards. The emerging industry presents some identifiable patterns, such as the technological requirements, the organizations present in the industry, and the multiplication of interorganizational relationships.

2.3. Growth stage

The growth phase highlights the operational nature of the emergence that is why the emergence is happening: the commercialization of an innovation that has created turbulence in the existing market. This phase corresponds to the convergence of companies and technological requirements that began in the initial and co-evolutionary phases. Studies look at this phase in different ways. Indeed, some studies characterize this phase as a catch-all category that considers the industry from its growth until its maturity (Forbes & Kirsch, 2011). Other studies focus on the emergence dynamics of the new phase: the transition from the co-evolutionary stage phase to the growth phase (Gustafsson et al., 2016). The transition from the co-evolutionary phase to the growth phase underlines the acceptance of an industry-wide dominant design (Abernathy & Utterback, 1978; Anderson & Tushman, 1990) and a unique identity.

The growth phase is monitored by the increasing level of sales following the commercialization of the innovation (Agarwal & Bayus, 2003), and the number of new organizations increases before it stabilizes. Qualitative criteria include observing an improvement in the quality of products or services that benefit from a value chain and a redistribution of roles between organizations. However, an intensification of the competitive landscape is observed. As a consequence of this competitive intensification, organizations face growing pressure and, therefore, call on exploratory and then exploitative interorganizational relationships in the early stage of the growth phase. These IRs help them to acquire production capabilities and robust intellectual properties in the view of becoming a potential industry leader (Rice & Galvin, 2006).

In conclusion, scholars agree with the prominence of these three stages. Through their systematic analysis of the empirical designs used in related articles, Gustafsson et al. (2016) established four sub-processes on which researchers focused their studies in their study of the emergence of the industry: the development of a technical foundation, the emergence of networks of production, the emergence of markets and the formation of industry identity. Subprocesses are variables known from the emergence of industry literature.

In the precedent parts, we reviewed the literature on industry emergence and how to monitor and capture industries' dynamic emergence and evolution. Nevertheless, we identified significant studies (Padgett & Powell, 2012) dealing with industry emergence and propose to discuss them in the following paragraphs. The cognitive framework to industry emergence has highlighted significant directions for future works on industry emergence in addition to the evolutionary models. The importance of embedded organizational behaviors into “overall patterns of strategic actions” (Eisenhardt & Santos, 2009: 644) is discussed and dislocate the problem of assessment to the organizational boundary level.

Conclusion of Section I.

In **Section I**, we had a general objective to understand the content of studies regarding industry emergence. In the first place, we described the different theoretical approaches and highlighted the predominant role of organizational actions in the emergence of new industries. Secondly, we allocated time to review how industry emergence is captured in current works, which led us to consider industry life cycle models. We have presented the most references model that conceptualizes industry emergence into three phases.

Our positioning relies on the major takeaways of the literature. First, we position our research work as a bridging response to the lack of metrics to seize industry emergence. Second, by proposing an applicable industry emergence assessment model, we aim to diminish the confusion around emergence and structuration. We will contribute to evolutionary approaches by focusing on the dynamics of emergence and structuration processes.

Therefore, in **Section II**, we discuss the new organizational form that networks as industries constitute and their strategic role in industry emergence dynamics. We discuss the similarities between ecosystems and networks in studying industry emergence as network constellations around given technologies.

Section II. Considering industry emergence from a network approach

Research on networks is considered a paradigm in management studies (Rumelt et al., 1995) and is considered an alternative to Williamson's (1973) dichotomy of markets vs. hierarchies. These forms of organizations have advantages that are primarily discussed by the literature on interorganizational relationships networks and have attracted many researchers' attention and led to the 'network era' (Möller & Halinen, 1999). Similarly, scholars (e.g., Ritter & Gemuenden, 2003) argue that management studies slowly shifted the focus from analyzing interorganizational relationships as isolated strategies to the study of more extensive relational structures: the networks as interorganizational relationships do not occur in a sans context, yet are embedded in broader structures (Gulati, 1995). Therefore, in the last decades, studies on interorganizational relations and networks seem not to go without the other.

There is a consensus that a clear definition of a network is ongoing. As underlined by Oliver and Ebers (1998: 548), there is a “cacophony of heterogeneous concepts, theories, and research results.”

We adopt here the definition developed by Håkansson and Snehota (1989: 15) in their well-cited article, ‘No business is an island: the network concept of business strategy’ which defines networks as “generalized connectedness of business relationships [that] implies the existence of an aggregated structure.” As a result, networks are a structural organization composed of actors, and their relationships describe the different links existing amongst the organizations. It offers a perspective for longitudinal studies of networks through the study of network aggregation.

The fragmented literature (Ritter & Gemuenden, 2003) causes difficulties in having a clear overview of networks. In their review of the literature, scholars highlight the existence of various studies, which can be contradicting with each other. The availability of ample definitions, theories, and core concepts have not made it effortless to use the findings on interorganizational relationships and network literature.

To link both equally essential concepts, Oliver and Ebers (1998: 551) endeavor to consolidate the findings on both streams of literature under the research of “interorganizational network

research,” which refers to the literature on interorganizational relations and networks among several organizations. When observed at the industry level, discussions regarding IRs (Najafian & Colabi, 2014), coupled with the concept of innovation, led to innovation networks. Following the Schumpeterian tradition, the concept of interorganizational innovation network describes the structural components of innovation: actors and their interorganizational network, and has attracted much researchers' attention (Ahrweiler & Keane, 2013).

As such, the consequences of such a concept on innovation and company performances have attracted attention, and scholars have, for example, outlined a positive correlation between IR network and innovation. However, empirical shreds of evidence seem to refute theoretical findings, and some consider networks as critical factor success for innovation (Kallio et al., 2010).

Networks can be a metaphor that conceptualizes organizations' relationships beyond their boundaries, where the relationships between organizations can be analyzed (Wasserman & Faust, 1994). From an analytical standpoint, networks are composed of nodes representing organizations and ties that symbolize the interorganizational relationships.

To summarize, networks are considered a new form of interorganizational relationships structure and emerge, evolve, and structure in the same way as industries do. Therefore, in the next section, we intend to report how networks emerge, structure, and link with a similar ecosystem concept.

In studying the dynamic patterns of network emergence, one needs to understand the aggregates of such structures. Therefore, in **Section II**, we focus on networks' genesis through the motives driving organizations to undertake interorganizational relationships. We then shed light on the levels of analysis of IRs and conclude by examining the types of organizations involved in IRs.

1. Emergence of networks

For years, scholars have considered companies autonomous and atomistic entities, which endeavor to achieve competitive advantages (Porter, 1979). The sharp dichotomy between

markets and hierarchies proposed by Coase (1937) and Williamson (1973) made room for a myriad of interorganizational relationships that exist as a parallel operation mode for organizations (Padgett & Powell, 2012). Observing the increase of IRs can also inform about changing environments. Inadequate in the current world, the isolated managerial behaviors seem not to provide companies with consistent strategic insights to battle against globalization's effects (Narula & Dunning, 1998), integrated economic areas (Mayrhofer, 2007), and the rise of new technologies. Therefore, the approach of the company that needs to battle alone seems to be outdated (Angué, 2006). Although considered as robust strategical tools, inter-organizational relationships (IRs hereafter) have known a drastic increase in the last decade (Kale & Singh, 2009).

Defined as the relationships between suppliers, clients, competitors, diverse partners, IRs are engaged in gaining access to tangible and intangible resources that the partnering companies do not have access to in the first hand (Mandard, 2015). They are dynamic relationships that change over time (Dwyer et al., 1987) as they fulfill an economic purpose (Turnbull et al., 1996). From a cognitive standpoint, IRs are considered as “boundary-mechanisms” (Eisenhardt & Santos, 2009: 644). In that view, Oliver (1990) developed six critical contingencies of IR formation: asymmetry, reciprocity, efficiency, stability, and legitimacy. It follows that if two or more companies create a joint venture (Oliver, 1990), they will increase their market power while also doing so on market entry barriers, benefit from synergies in technology and information sharing while sharing risks in entering new markets, for instance.

As a result, a considerable amount of literature has been published on inter-organizational relationships (e.g., Ariño & Ring, 2010). These studies show consensus among researchers and practitioners and have reported that such relationships enable companies to organize their activities differently. When compared with the premises of company management, we tend to observe that companies are giving out their independence by opting to cooperate with other companies. IRs have gone from arm's length relationships towards close partnerships, thus testifying companies' little interest in long-term strategic goals back then.

To date, there has been consensus on what IRs are; however, a large vocabulary is used to describe such relationships. One may not be unfamiliar with partnerships, interorganizational relationships, cooperation agreement, alliance, and joint ventures that all seem to characterize the relationships between companies in the view of generating benefits. There are commonly

named as alliances in the US literature (Ritter & Gemuenden, 2003). To bring clarification about IRs, in the following part, we draw attention to the different theoretical approaches on IR formation that we categorize according to whether they arise from internal or external motives.

1.1. Drivers of interorganizational relationships formation

Organizations' tendency to recourse to interorganizational relationships are many and various. Whether pressured by internal or external motives, organizations are driven by many reasons to use IRs (Mandard, 2015).

1.1.1. Intraorganizational motives

Besides underlying evolution trends that explain the new organizational behaviors, several other reasons influence organizations towards IRs. The theoretical approaches presented in the following paragraphs are positioned from an organizational management perspective. In this perspective, IRs are formed because their implementation will provide organizations with the most effective way of carrying out their activities. We present the three main approaches summarized by Mandard (2015): the transaction costs theory, the agency theory, and the resource-based approach.

1.1.1.a. The transaction costs theory

From the company management point of view, IRs are studied through the Theory of Transaction Costs (TTC) (Coase, 1937; Williamson, 1973) that explicitly argued that organizations arrange their activities so that their costs can be reduced. Organizations will eventually engage IRs to reduce costs. Consequently, in high competitive uncertainty contexts, an organization will tend to engage in joint ventures (Pfeffer & Nowak, 1976). In complement to Coase (1937), Williamson (1973) showed that the TTC dramatically influences organizational form choice. As the way of organizing their activities is changing, companies are continually looking for ways to organize their activities as efficiently as possible. Williamson (1973) defines efficiency by TC minimization. Consequently, organizations will engage in long-term IRs if the latter will be a source of TC minimization. According to Wulf et al. (2001), Williamson (1973), in the view of TC, IRs represent a consistent tool to reduce risks brought by market uncertainties and opportunism, enabling them to minimize their total transactional costs.

TC theory represents the essence of managers' decision-making processes by providing them with consistent insights regarding the desirability of their partners (Wulf et al., 2001). Therefore, organizations are in constant questioning about performing internally (hierarchy) or externally (market). The theory also argues that competition is also a variable that will affect organizational behaviors towards IRs. Indeed, if the competition is weak, companies tend to limit their participation in opportunistic behaviors and “small numbers bargaining” (Williamson, 1973).

1.1.1.b. The agency theory

The agency theory results from the works of Alchian and Demsetz (1972) and Jensen and Meckling (1976), which discussed organizations as a set of relationships between individuals and uses organizations' partnerships to analyze organizational behaviors.

Agency relationships are those arising between the principal who can be a shareholder, for instance, designated the agent as the executives to run the organizations in a way that secures the principal's interests. The theory discusses the relationship between agents, which act on behalf of principals, and are disengaged from any interests. Although prone to conflicts, agency relationships is a canonical model of social interaction (Ross, 1973) and suggest that opportunistic behaviors may result in collaborating organizations. Indeed, the partnering organizations will behave regarding their self-interests and ignore or not consider the other side's interests. In some cases, a corporate governance policy might encourage the agent (the partner) to act coherently to the principal's interests.

Therefore, the agent obfuscates the principal by poorly fulfilling his commitments. Consequently, the principal-agent problem reports the specific challenges facing principals and agents when deviating interests that cause poor communication and conflict. The problem resulting from the agency theory suggested the problem of moral hazards (Arrow, 1971) and led to the agency loss concept. The agency loss is prevented when the principal and the agent line up regarding their interests. Both sides focus on transparency issues to ensure the principal and the agent are aware of each other's activities.

The agency theory explains the discrepancy of fulfilling the same interests due to long-term and short-term perspectives adopted by the principal and agent. According to the theory, these divergent interests drive interorganizational relationships between the principal and the agent.

Indeed, at an interorganizational level, the agent's long-term positioning in projects fulfills the principal's interests in the short-term.

1.1.1.c. The resource-based view

The Resource-Based View (RBV) considers the organization as a broad set of resources (Wernerfelt, 1984: 172) that are defined as “tangible and intangible assets semi-permanently owned by the company.” Organizations' competitive advantage is not the result of market conditions, yet the right allocation and acquisition of resources. Consequently, the organization's activities are organized around trading these tangible and intangible assets to find the right balance between needs and assets that are internally available. Resources need to be valuable, rare, costly to imitate and integrated into the organization properly organized to capture the value from them (Barney, 1991). It demands organizations to sustain their resources in order to transform them into a competitive advantage (Barney, 1991); this will translate into organizing activities according to resources, i.e., organizations will engage in IRs if internal resources do not enable to achieve a competitive advantage, thus outstanding economic rents (*ibid*).

Competitive advantages are a source of economic rents, the fundamental purpose of organizations' operations. The RBV theory assumes that organizations will engage in IRs to obtain a competitive advantage. This competitive advantage will be obtained through a synergistic approach that combines different yet complementary resources and capabilities between organizations. In order, the IR to be considered as economically efficient, the economic returns generated from the IR has to hold a higher value than the ones realized if no IR was engaged (i.e., market transaction and internalization) (Loasby, 1994; Madhok & Tallman, 1998a). The TTC and the RBV, although addressing the economic efficiency through governance and competitive advantage, split into two focus points: costs and benefits. What differs from both theories is the problem they are addressing. While TTC considers the organization in the view of efficient governance from a cost perspective, RBV addresses its production attributes from a benefit point of view. However, both are contributing to increase economic rents through competitive advantage.

Consequently, in his article, Madhok (1998) highlights the convergence across both theories in terms of economic rent while developing the intrinsic linkage between them. A large panel of scholars argued that the RBV enables companies to engage in IRs to generate economic

rent through ‘synergistic’ and ‘interdependent complementarities’ (Dietrich, 1994; Jarillo, 1988; Zajac & Olsen, 1993). Consequently, the question of the underlying requirement to generate these complementarities arose. Dahlman (1979) brought one element of answer by arguing that TTC is associated with information costs stemming from the necessity to obtain knowledge in the view of sustained competitive advantage from the RB. However, the TTC tends to be questioned by social exchange theory and network approaches, as TTC provides little empirical evidence to measure transaction costs (Jarillo, 1988).

In conclusion, organizations tend to contract IRs when the synergies of IRs outweigh the externalities resulting from IRs such as technology dissemination and reputation erosion (Harrigan, 1985).

1.1.2. Exogenous motives

The theoretical approaches discussed here come from a perspective where organizations need to manage and take their environments into account. In light of changing environments, interorganizational relationships are considered a driver for action that enables organizations to influence their environment and participate in meeting their performances. Therefore, we present in the following subsections the main theoretical approaches mentioned in this respect: the theory of resource dependency, the industrial economics approach, the stakeholder theory, and the institutional theory.

1.1.2.a. Resource dependency theory

The Resource Dependency Theory (RDT) originated by Pfeffer and Salancik's (1978) seminal work has become a plausible theory in organizational theory and strategic management (Hillman et al., 2009) and one of the dominant theory to explain the rationale of IRs after the transaction cost theory. The RDT argues that an organization's survival depends on its capabilities to acquire critical resources beyond its boundaries, thus branching out from the RBV that considers all the resources necessary for organizational performances.

Central to the RDT are the concepts of power and uncertainty. Power is performed by organizations when they hold critical resources (Ulrich & Barney, 1984). The comparison of competitive power is relative to the organization's own power over others. The competitive game will result in trying to increase executive power by acquiring more critical resources and reducing uncertainty through interorganizational relationships. Through the RDT,

organizations are dependent on their environment to acquire critical resources and control power and uncertainties by modifying the relationships with competitors, regulatory and other agencies (Parmigiani & Rivera-Santos, 2011).

From a more general perspective, organizations have two main options to acquire critical resources. The acquisition of equity investments in organizations that hold critical resources enables smooth access to the acquiring organization's resources. Also, organizations can create a typical structure such as joint-ventures.

Pfeffer and Salancik (1978) identified IRs to reduce uncertainty and increase power inherent to critical resource acquisition. For instance, Pfeffer and Salancik (1978) explain organizations' propensity to acquire other ones to reduce the competitive landscape by absorbing a significant competitor and its dependency on the acquired organizations while diversifying its activities. Joint ventures (Pfeffer & Nowak, 1976) are commonly used by interdependent organizations and are considered interorganizational strategies to palliate uncertainties.

Lastly, Pfeffer and Salancik (1978) argue that organizations struggle to reduce uncertainty and interdependence in more extensive systems. Therefore, "organizations may use political means to alter the condition of the external economic environment" (*ibid*: 190) to alter governmental regulations and produce favorable environments. Nevertheless, this chapter of the book is highly overlooked in IRs studies.

1.1.2.b. The industrial economics

The perspective of industrial economics was initiated by Bain (1959) and completed by Porter's work (1979). The industrial economics perspective aims at analyzing how competitive forces within their environment influence organizations. The examination of the competitive forces enables an organization's propensity to generate profits because it can adopt and influence these forces. One of its foundations, called the Structure-Conduct-Performance paradigm - or SCP paradigm consists of considering that industry structure influences the organizations' behavior, which consequently influences their performances, performance being understood in the narrow sense of economic performance. The perspective of the industrial economy and the resource approach is generally seen as complementary, insofar as they focus respectively on the external constraints and internal constraints that organizations experience to explain their competitive performance.

Although the classical approach to industrial economics overlooks IRs as mechanisms to decrease the intensity of competitive forces, they were then considered as powerful strategies to counteract the competitive pressure, gain competitive advantage, increase the barriers to entry by implementing significant partnerships, which will reduce the bargaining power of suppliers and customers, for instance (Mandard, 2015).

The industrial economics perspective sheds light on the environmental rationale that motivates organizations to enter interorganizational relationships. The environmental rationale is driven by the profit that organizations can generate by reducing or increasing their effects.

1.1.2.c. Stakeholders theory

The stakeholder approach finds its origin in Freeman's work, 'Strategic management: A stakeholder' approach,' published in 1984. The theory was developed to fulfill the lack of strategic insights that managers and organizations could unfold to face turbulent environments.

The stakeholder theory considers the organization a more massive structure composed of stakeholders such as partners and clients. The management of the organization should take the stakeholders' satisfaction into account. The motives of taking stakeholders into account hold various theoretical explanations. From an RBV approach, the organization's resource has to be valuable, rare, inimitable, and non-substitutable. Stakeholders will provide different types of sources that will enable the unique combination of resources (Prahalad & Hamel, 1990), flexible renewal of resources and capabilities (Teece et al., 1997), and produce knowledge (Kogut & Zander, 1992). Therefore, organizations are interested in taking their stakeholders into account in their strategies (Freeman, 1984). From an interorganizational perspective, the stakeholder theory unfolds advantages at the strategic level: considering stakeholders' interests will help them serve them better and generate profits.

The theory encourages to look outside of the organizations to develop its strategies and foster long-term success and profits, yet cooperating stakeholders should share the same value (Freeman, 1984).

1.1.2.d. Institutional theory

As its name suggests, the institutional theory - also designated by the term ‘neo-institutional theory’ in its contemporary developments - aims to study social institutions, that is to say, the systems of rules which structure social behavior that we discussed in a previous part. This theoretical framework, which can be traced back to an article by DiMaggio & Powell (1983), underlines that social actors' behavior is constrained by various pressures exerted by their institutional environment to which they must conform to appear legitimate. It is undoubtedly one of the most popular theories of management research in recent decades. We presented the institutional theory in **Chapter 1** in more critical details.

Studies on the IRs formation rationale emphasized many reasons fueled by either internal or external factors to organizations. In conclusion, these IRs formation approaches outlined organizations' dependency on external resources to maintain their internal activities and manage their external environments. By inference, IRs are part of two-level strategic pictures that organizations need to manage. In light of the varying levels of analysis imposed by IRs, we propose to focus on these different levels in the following paragraph.

1.2. Levels of analysis for interorganizational relationships

Interorganizational relationships are complex systems, and the analysis can occur at several levels. The literature relates the tendency to focus on a single level of analysis (Schilke, 2014). However, seizing the organizational dynamics to mirror the emergence patterns of industry implies combining several levels of analysis of IRs. When considered pragmatically, IRs analysis levels are considered according to the traditional macro, meso, and micro level categorization (Mattsson, 1997). However, we propose to present Ritter and Gemuenden (2003) take on level categorization as it offers a higher degree of detail. There is an undoubted link between the two categorizations as the macro, meso, and micro levels are identifiable in Ritter and Gemuenden's (2003) definition.

- The episode/interaction: this level of analysis reflects a single interaction between various organizations. It is assumed to be a one-time event and regarded as an episode where the beginning and the end are known. This behavior is argued to imply the effect of past events and to insinuate possible future experiences.

- The dyad/individual relationship (Schilke, 2014): this stage is based on more medium to long-term relations between two organizations (dyad). It is suggested that dyad relationships draw on existing relationships that promote future longevity. Dyads refer to IRs between two organizations and generate discontinuity with Williamson's (1973) market and hierarchy dichotomy.
- The portfolio/similar relationship: this level focuses on the relationship of a focal organization. The degree of analysis reveals correlations that might emerge within the relationship portfolio of the focal organization. Relationships may be similar in various ways, such as the partnering organizations' size, their role in relation to the focal organization, their purpose, or type.
- The net/relationships of an organization: at this level, all the relationships that constitute the organization's portfolio are factored in. It allows, for example, to recognize the subnets of innovation.
- The network/industries and markets as networks: this level is the broadest lens of IR analysis and is an aggregate of multiple IRs. The attention transitions from the analysis of individual organizations to the analysis of the whole network structure.

Concerned with the changing environment and the increasing level of interdependent relationships between organizations, the contributions from recent research on IRs have slowly been considered from network or ecosystem levels of analysis. Nevertheless, an essential aspect still needs to be taken into account in the IR formation process, which are the types of organizations involved in IRs that will also play a crucial role during the network's structuration phase.

1.3. Typology of organizations engaging in interorganizational relationships

Interorganizational relationships, as mentioned above, are motivated by many internal and external reasons and call for a several-level analysis. It is all the more validated as organizations involved in IRs can also differ from each other. We propose to analyze which type of organizations tend to undertake IRs, thus depicting what kind of organizations are

causing the emergence of a network. We present two main approaches to partner selection: social structuralism and the theory of disruptive innovation.

1.3.1. Approach from social structuralism

Social theorist argues that IRs belong to a broader system that they call network (Ahuja, 2000; Gulati, 1995, 1998; Mohr & Spekman, 1994; Stuart et al., 1999). Gulati (1998) explains that social embeddedness within a network provides organizations with insights regarding organizational behavior and performance potential. Marsden (1981: 1210) defines embeddedness as “the fact that exchanges and discussions within a group typically have a history, and that this history results in the routinization and stabilization of linkages among members”. Embeddedness implies that decisions are taken by a set of actors rather than individualistically driven by an organization’s interests. Historical embeddedness will provide organizations with easier access to knowledge.

Social embeddedness aims at responding to five issues regarding IRs: the formation, the choices of governance structure, the dynamic evolution, the performance, and the performance consequence for firms entering IRs (Gulati, 1998). Therefore, social structuralists argue that any IR forms are embedded in a network of an organization and have an influence on IR formation at the dyadic level (*ibid*). An organization's position in the network explains the differences existing in the resources available to each organization. Therefore, the position occupied by an organization within a network plays an essential role in social embeddedness and on the decisions to form IRs.

In terms of resources, social structuralists identified social capital as a critical variable for assessing embeddedness. Social capital refers to an organization and its interorganizational networks (Gulati, 1995) and is regarded as a competitive advantage (Burt, 1997). In terms of IRs, organizations with more social capital are willing to find other potential partners and attract potential partners who want to collaborate with them.

Organizations benefit from informational benefits that enable them to create and maintain their network successfully. Historical embeddedness insinuates a certain level of incumbency of the organization’s embeddedness in a given network; social structuralism refers to that phenomenon as ‘incumbency prerogative’. Social embeddedness will influence an organization’s choice of partner. Organizations that already collaborated in the past are more

willing to reiterate their collaboration, as they know each other, their shared goals, and have already developed collaboration. When companies do not have a direct historical partnership, they tend to focus on partners' partners (Gulati, 1998; Pfeffer & Salancik, 1978). Similarly, Ahuja (2000) explains that the patterns of embeddedness in an organization's networks will influence its tendency to form IRs and explains IR formation with the inducement-opportunity framework.

Besides, reputation also plays a crucial role in the network. Reputation can be double-edged information for organizations' access to knowledge. Indeed, a poorly-reputed organization limits its chances of attracting potential partners, whereas a well-reputed organization is likely to attract potential partners and ease its access to knowledge.

The framework, however, responds to several limitations of the structuralist approach. Firstly, the social structuralist approach omits the importance of technological and commercial capital and exclusively focuses on social capital. Secondly, social structuralists exclude the possibility of new entrant organizations that tend to lack history within a given network. The inducement-opportunity framework argues that the balance between social, technological, and commercial capital will determine a company's willingness to form IRs.

In terms of capital deficiency, Ahuja (2000) argues that the higher an organization's deficiency in the social, technological, and commercial capital, the more induced it will be to form IRs. As developed by the learning theorists (Penrose, 1959), resources and knowledge are critical competitive advantages, and social structuralists argue that organizations form IRs to fill in the gaps of knowledge. Indeed, companies that are well endowed with technical and commercial resources will adopt a more muted behavior towards IR formation as learning dissimilarities between associated companies will emerge. The less endowed companies will learn more than the well-endowed one.

Therefore, the level of endowment of companies can outweigh the inducements of IR formation and impede it. Besides, building knowledge internally turns out to be a costly and time-consuming process for organizations (Ahuja, 2000). As a result, knowledge, and cost-mitigation (Pfeffer & Salancik, 1978) create IR formation inducements.

When it comes to considering new entrants' status in the social structuralist approach, Ahuja (2000) questions the incumbency prerogative. The social structuralists argue that the incumbency characteristics are essential for IR formation; in that sense, Ahuja (2000) argues that incumbency prerogative puts organizations with high asset stocks in the center of a network and demote new entrant out of the network. As a workaround, new entrants can reach inducement through their capabilities to develop disruptive innovations. Therefore, it shifts the balance from an incumbency prerogative to technological leverage.

1.3.2. Approach from the disruptive innovation theory

At a very general level, IRs are interactions that happen between two or more organizations. To reap the benefit of IR formation, the organization must carefully choose their partners (Forgues et al., 2006). In a context of innovation and disruption, companies are tempted to form IRs in the view of having access to the technology-specific knowledge. IRs occur between large business corporations, small start-up companies, public entities, universities, and other types of research organizations, government agencies, and non-governmental organizations (Sydow et al., 2008).

Disruptive innovation scholars tend to focus on the incumbent vs. new entrant dichotomy to explain IR partners' choice at the dyad level. IRs are not restricted in regards to involved organizations' combination. They occur between competitors and create a link with cooperative strategies, suppliers, customers, or service providers. Incumbents owe their failure to their incapacity to manage both sustaining and disruptive innovation on the same front. However, scholars have studied the positive impact of appealing to external resources (i.e., IRs) in the view of acquiring necessary resources, knowledge rapidly (Christensen & Overdorf, 2000).

To elevate their downstream capabilities, incumbents need to choose the right partners. Researchers have proposed many explanations to explain the partners' choice (Bengtsson & Kock, 2014; Christensen & Overdorf, 2000). Some of them meet the general motives of IRs formation, while others are relative to the partners themselves (Gulati, 1995).

Gulati (1998: 301) differentiates “low-status organization” from “high-status organization” and argues that the “homophile principle” occurs when each of both types of organization collaborates in the view of developing a new product. Constrained by available resources,

technological startups highly depend on alliances with incumbent companies, which will finance their activities.

2. Structuration of networks

In previous paragraphs, we discussed the genesis of a network by shedding light on organizations' motivations to undertake IRs and the types of organizations spearheading the emergence of the network premises. We highlighted intertwining levels of analysis between IRs and networks. Nevertheless, once the network emerged, a question of high importance remains unanswered, that of its structuration. Indeed, the network's structuration is necessary for the exchanges to occur in the network (Håkansson & Ford, 2002). The network structure is conceptualized by nodes and ties that represent organizations and the relationships among them.

In the following subsection, we look for answers regarding how networks structure during their development phase. To bring answers to our question, we propose to focus on network composition characterizing the organizations and then to network structure, which organizes the relationships between organizations.

Because networks focus on organizations and their relationships, it has been accepted that network analysis is the most suitable way of analyzing (Van de Ven et al., 1976). Nevertheless, the study of networks often is made upon a binary decision between the types of the network that one is willing to study. Padgett & Powell (2012) differentiated two types of networks: the static and the dynamic network.

The study of node characteristics, statistical measures, and link analysis can be subsumed under the static network analysis. Networks are composed of constant information change over time, such as the number of nodes and the nodes' characteristics that remain unchanged.

On the contrary, some networks may have evolving characteristics overtimes, and necessitate dynamics and evolving analysis. The number of nodes may increase, decrease or merge, and the network's edges widen or shrink. These networks are time-varying, and they suppose predictability and evolution. Dynamic networks also enable pattern identifications (Cordeiro et al., 2018). Therefore, we discuss dynamic network analysis through the social network

analysis theory (Borgatti et al., 2009). There is a lack of heterogeneous information regarding network structures and compositions (Lavie, 2006).

2.1. Typology of interorganizational relationships

In this paragraph, we present two sides of interorganizational relationships, which we considered into two different categories: the traditional IR typologies that categorize IR types according to the level of interdependence among organizations, and the more recent IR typology considering the type of organizations involved in the IRs: the cooperative strategies.

2.1.1. Typology based on interdependence among partners

As we mentioned in previous paragraphs, network analysis implied examining its aggregates, which are interorganizational relationships. Therefore, IRs are fundamental to networks. Burt (1995) correlated a network's density with the number of structural holes leading to a more or less modifiable network. The analysis of these IRs is referred to as the network structure analysis and requires analyzing patterns within networks themselves (Phelps, 2010).

Literature about IRs is extensive, and the terms to define such relationships are numerous and varied. The following paragraph summarizes the different types of IRs to stake out our scope of analysis and clarify the definitions for the rest of this thesis.

According to equity determinants, a cohort of scholars has considered IRs (Druckman et al., 1997). Hagedoorn (1993), according to their modes of governance, which can be steady (i.e., joint venture, research collaboration) or riskier such as minority investment (i.e., R&D agreement, customer-supplier relationship, technology exchange agreement). IRs with robust modes of governance are accepted to become of decreasing importance in IRs choices of an organization due to their high level of risks (high failure rate, organization costs, opportunism) (Hagedoorn & Schakenraad, 1992). Minority investments have known growing interest, and the evolution of their number regarding joint ventures corroborates the argument. The tendency is also to define relationships among organizations according to the relationship's nature that links them to their partners (Contractor & Lorange, 2002). We will adopt the same perspective as it is dominant in IR studies. In light of what precedes, Hagedoorn (1993) considers strategic alliances as a long-term strategic tool to leverage partnering companies' product positioning and defines strategic alliances as "interfirm

cooperative agreements” (Narula & Hagedoorn, 1999: 284). It is also essential to notice that the level of dependency varies from one relationship to another (Narula & Hagedoorn, 1999).

In terms of typology, drawing on Angué's (2006) and Mayrhofer's (2001) studies, Moalla and Triki (2011) set out an in-depth typology of inter-organizational relationships, which likewise previous scholars agree that IRs cover a wide range of terms. These two authors described two classification criteria that defined the relationship: the equity-based link among the companies and the legal structure of the relationship (Table 3).

Table 3. Typology of interorganizational relationships (Moalla & Triki, 2001: 284)

Partnership with equity investment		Partnership without equity investment	
Partnership with the creation of a legal entity	Creation of a joint venture	Agreement with no creation of a legal entity	Contractual agreements R&D Contract Consortiums Licensing contracts Outsourcing Other types of agreements
Partnership with no creation of a legal entity	Minority equity interest		

Because of the determination of such criteria, joint -ventures are then considered as partnerships with equity-based links among companies, while R&D contracts, consortiums, licensing contracts, franchising, and externalization contracts are classified as partnerships with no equity linkage amongst companies. Nevertheless, this typology does not characterize mergers and acquisitions' status, which we decided to counteract by looking at Contractor and Lorange (2002)’s typology (Figure 8).

To unravel the lack of a classification of M&As in the IR literature, we adopt the definition given by Contractor and Lorange (2002) that considers M&As as one side of the continuum of extremes of IRs with a relatively small interdependence between organizations, as they merge and become one.

Figure 8. Types of interorganizational relationships (Contractor & Lorange, 2002: 487)

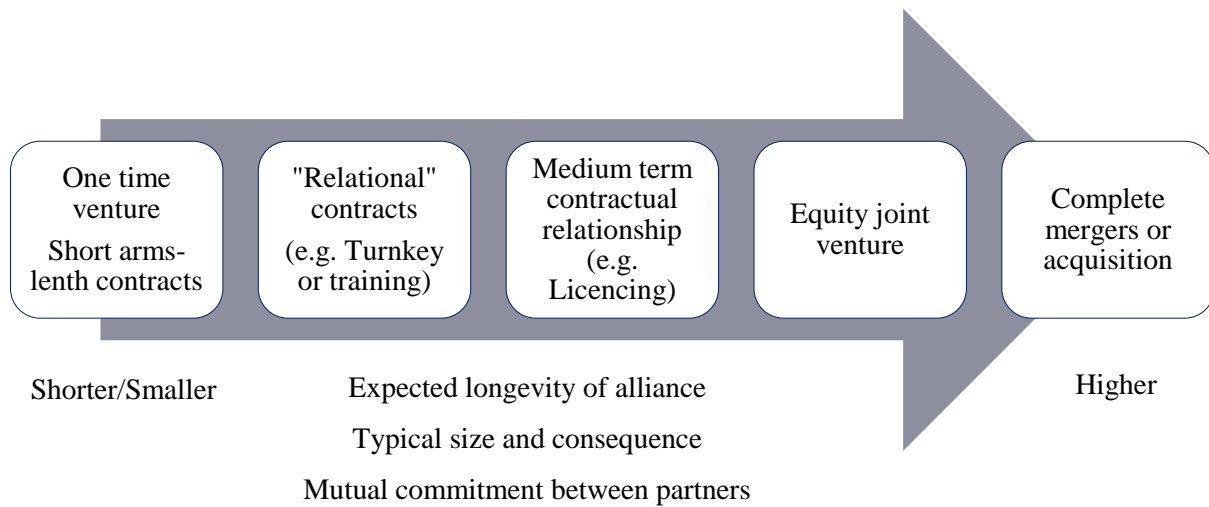

Consequently, mergers and acquisitions are considered IRs with high expected longevity, where the merged or the acquired organizations have mutual commitments with the acquirer organization. This typology is interesting as it considers the fusion of partners as a type of IR as much as partnerships and joint ventures and widens the possibilities of IR analysis by adding additional IR types.

Not only do those criteria bring light on the different types of IRs, but they also can be at the root of organizations' decision to engage in IRs. The legal structure could be considered a guarantee for a company to reduce risks by sharing them with partners.

In terms of IR differentiation, Teece (1986) proposes two different modes: the contractual modes and the integration modes where in between, many intermediate forms of IRs are found. Contractual modes insinuate that organizations are not required to make initial capital expenditures and ease incentive alignments and control. On the other hand, integration modes imply ownership. However, Teece (1986) argues that organizational behaviors may be complex to categorize into a binary classification. He argues that organizations' behaviors are characterized by mixed modes composed of both integration and contractual modes.

Unlike other studies, Rothaermel and Deeds (2004) classify the IRs according to the explorative-exploitative dichotomy based on product development (Figure 9). Here, organizations' need to explore or exploit resources or knowledge will determine the type of IRs they will contract.

Figure 9. The explorative-exploitative dichotomy of product development path
(Rothaermel & Deeds, 2004: 202)

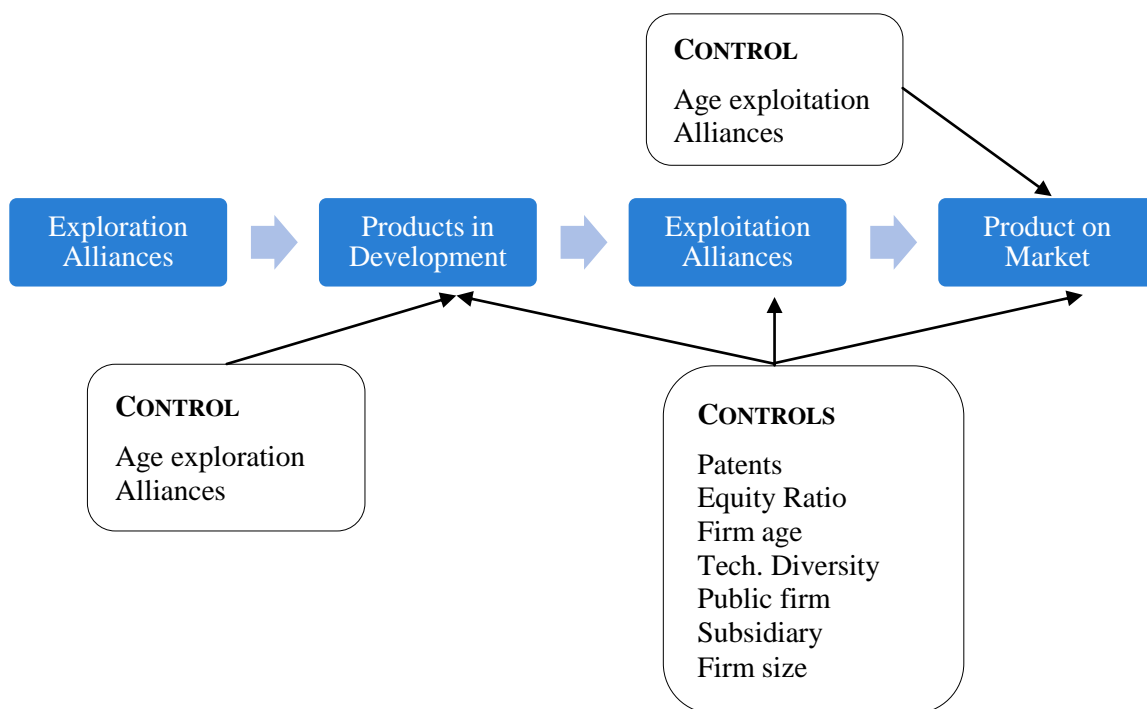

Firstly, companies implement an exploration alliance to predict product development, access to new knowledge, and figure out how to use it. Secondly, companies switch to an exploitation alliance where new knowledge and learning enable companies to bring the product on the market. Results empirically showed that the explorative alliance ultimately resulted in exploitative alliances highlighting the moderating role of companies involved in these alliances. The authors argued that exploration and exploitation are the motivational reasons driving companies' willingness to enter IRs.

This thesis does not engage with the will to create a new typology of IRs. Instead, it draws on an existing one: one of Contractor and Lorange (2002), based on interdependence and mutual commitment of the partners (cf. Figure 8). At the macro level, this typology is sufficient to characterize the link between organizations within a network and align with significant works that classify IRs according to the interdependence level (Hagedoorn, 1990). We consider that this typology is sufficient to characterize the nature of the relationships among two organizations and excluded that it is a case study our research work focuses on macro level dynamics based on IRs in general. We will use detailed typologies of IRs in a lower level of analysis, and this level of detail seems to provide sufficient information for data analysis.

2.1.2. Typology based on organizational relatedness

In the last two decades, management studies have increased their interest in coopetition (Bengtsson & Kock, 2014). Coopetition refers to a “paradoxical relationship between one or more actors simultaneously involved in cooperative and competitive interactions, regardless of whether their relationship is horizontal or vertical” (Bengtsson & Kock, 2014: 182). It highlights a paradoxical relationship (Bengtsson & Kock, 2000; Bonel & Rocco, 2007; Brandenburger & Nalebuff, 1996; Fernandez & Le Roy, 2013; Ritala, 2012; Ritala & Tidström, 2014; Rusko, 2011).

Some scholars consider that coopetition happens between competitors (Bengtsson & Kock, 2000; Bengtsson & Sölvell, 2004; Chen et al., 2007; Gnyawali & Madhavan, 2001) while others count customers, suppliers, and complementors in addition to competitors (Luo, 2005; Rusko, 2011). Bengtsson and Kock (2000) also argue that cooperative IRs happen between organizations that collaborate for some activities and compete against each other in some other industries while Brandenburger and Nalebuff (1996) insinuate the rapprochement between two complementors in the view of technological development sharing the same interests (Narula & Dunning, 1998). Scholars call for clarification on coopetition definitions and scope (Bengtsson & Kock, 2014).

Coopetitive strategies imply creating a total benefits compound (Volschenk et al., 2016) of shared and private benefits. Common benefits are the ones that “accrue to each partner in an alliance from the collective application of the learning that both firms go through as a consequence of being part of the alliance” (Khanna et al., 1998: 194). Private benefits “that a firm can capture unilaterally through acquiring knowledge or resources from its partner and applying them elsewhere” (Padula & Dagnino, 2007: 42).

Like any other type of IR, coopetitive relationships occur at several levels, such as at the intra organizational (Gnyawali & Park, 2009), the interorganizational (Luo, 2005), and the network level (Gnyawali et al., 2006). The increase of coopetitive strategies reflects the complexification of organizational relationships (Dorn et al., 2016) and highlight the risk inherent to such relationships (Mitchell et al., 1997). It is, therefore, essential to understanding the antecedents of engaging in such relationships.

Dorn et al. (2016) summarized the antecedents of entering cooperative relationships in three categories: the market conditions, the dyadic aspects, and the individual aspects. Industry dynamics and properties are subsumed under market conditions, which are relatively informative about the circumstances under which cooperative strategies are adopted. The market conditions typically endorse or hinder cooperation.

The dyadic aspects focus on the resource endowment amongst competitors. In a context of technological innovation where product life cycles are shortening, competitors tend to engage in cooperative strategies with their fiercest competitors, urging other competitors of the market to do the same to keep a competitive position (Gnyawali & Park, 2009). Finally, the individual aspects examine the related organization characteristics (Fernandez et al., 2010) involved in the relationship. For instance, Gnyawali and Park (2009) studied organizational characteristics in the SME context to identify the partnering organizations' vulnerability, their bargaining power, their resources and capabilities.

From a theoretical perspective, cooperative strategies open new research opportunities. Researchers highlight that both competitive and cooperative strategies dysfunction when considered separately (Le Roy, 2008). Over the years, studies started to analyze IRs between competitors. However, either result based on competitive or cooperative theories caused a partial study of the targeted phenomenon. Fernandez et al. (2010) argue that cooperation enables the study of cooperation IRs between competitors to integrate the paradox variable.

Similarly to other IRs, cooperative relationships are considered as essential strategies to manage innovation (Ritala, 2012). Many scholars examine the effects of cooperation on innovation (Bouncken & Kraus, 2013; Brandenburger & Nalebuff, 1996; Cygler et al., 2018; Yami & Nemeh, 2014) through the recombination of complementary knowledge between collaborating organizations.

However, studies on cooperation are concerned with the tension between the value creation and its appropriation (Chou & Zolkiewski, 2017; Padula & Dagnino, 2007; Ritala, 2012; Ritala & Tidström, 2014), as cooperation usually is formalized in cooperative agreements that omit the competitive side of the relationship. The more divergent are the interests of the collaboration organizations, the more tensions will create inertia in the appropriation of the

innovation value (Cassiman et al., 2009). Consequently, trust became a prerequisite for such IRs to defend against partners' opportunistic behaviors (Padula & Dagnino, 2007).

In terms of innovation performance, coopetition scholars have different positions. Given the high risk of opportunism and tensions to share the created value, some researchers question the effect of coopetition on innovation (Nieto & Santamaría, 2007); while other scholars have muted opinions arguing that coopetitive relationships serve incremental innovations as opposed to disruptive innovations (Ritala & Sainio, 2014). Bouncken and Kraus (2013) assert that coopetitive relationships lead to the development of disruptive innovations.

2.2. Network architecture

In addition to the functional perspective discussed in the previous paragraph, the network architecture plays a structural function in the network. The network architecture presents how activities are conducted within the network by identifying the configuration of ties. In the light of the discussions of production processes organized vertically or horizontally, the same applies to relationships amongst organizations within a network. In that regard, Douard and Heitz (2003) developed two fundamental network approaches: the integration and the additive approaches.

2.2.1. The integration approach

The integration approach refers to a vertical organization of nodes within a network. It implies that the network activities relate to the entire manufacturing process of a product. The different sections of the value chain altogether concur with the commercialization of the new product (Figure 10).

Organizations within the network are singular. They all perform a different activity localized in different phases of the value chain. The relationships amongst members are customer-supplier-like relationships that report a low concurrence level amongst members (Maignant, 2017). Interdependency is high as organizations focus on their core businesses, and the execution of the production process depends on the participation of each member of the network. This approach is closely linked with the resource dependency approach, which reports that organizations depend on other organizations' resources considered critical in the production process. It also refers to a specialization of each organization within the network,

enabling them to perform economies of scale and profit through increased competitive advantages (Porter, 1979).

Figure 10. The integration approach (Douard & Heitz, 2003: 26)

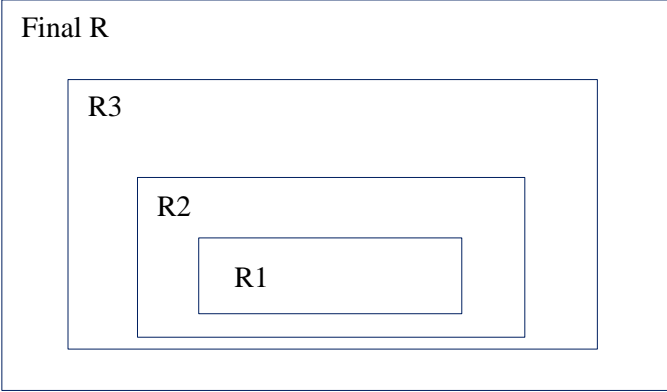

R= resources, competences, and processes

2.2.2. The additive approach

Unlike the integrative organization, this approach relies on a given activity's horizontal organization and does not span as more extensive as the value chain. This approach's starting point relies on the emergence of a new focal activity, which necessitates network members' convergence so that focal activity becomes a reality.

Activities are horizontally organized, and each organization of the network reaps the benefits of participating in the network (Figure 11). However, in these networks, competition amongst organizations tends to be high as, by definition, horizontally organized networks are composed of organizations that perform similar activities. As a result, organizations enter collaborative relationships with their competitors in the networks while competing against them once the product is commercialized. This paradoxical phenomenon redefines the concept of co-competition developed by Brandenburger and Nalebuff (1996). The additive approach highlights flexible networks, where the replacement of a node is less costly than in vertically organized networks. Indeed, knowing that each organization of the network performs similar activities, each node's substitutability is high due to the weak singularity of each node.

In terms of theoretical approaches, this approach of network organization finds its anchorage in several theories. In terms of transaction costs, it highlights the binary decision facing organizations willing to maximize their profits. In that perspective, organizations have to choose between internally executing an activity or externalizing it in the network.

The network is also an innovative way to organize organizational resources efficiently (Barney, 1991; Penrose, 1959; Wernerfelt, 1984) and reduce uncertainty and dependency in regards to other organizations by playing a central role in the network through the acquisition of critical resources (Pfeffer & Salancik, 1978) in terms of their rarity, inimitability and value (Barney, 1991).

Figure 11. The additive approach to network organization (Douard & Heitz, 2003: 25)

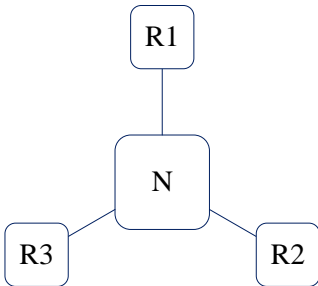

R= resources, competences, and processes; N= new competitive activity

Conclusion of Section II

As a conclusion in **Section II**, we have discussed a large panel of IR network-related elements. In considering networks as new forms of industries, we have first looked at the genesis of such concept and their composition. The review retrieved information regarding the aggregations of such meta structures and led us to study interorganizational relationships themselves. Understanding the genesis showed that IR networks had been subjected to paramount studies to understand the intrinsic reasons and inherent consequences of interorganizational relationships.

Our review sheds light on intraorganizational and exogenous motives for IR formation. The transaction costs theory, agency theory, and resource-based view explain how internal factors such as cost reduction, right resource allocation between disponible and required resources, and the need to analyze other organizations' behaviors.

Finally, it discussed IR networks' structuration by presenting the main network architectures split between the integration and additive approaches. The integrative approach reflates the vertical organization of tasks within an industry. It seems appropriate in an established setting because each organization specializes in a given task or more along the value chain. In contrast, the additive approach offers an innovative perspective on considering networks and joins Adner's (2017) argument following an activity-centric ecosystem emergence.

Conclusion of Chapter 2

Chapter 2 intended to identify the main characteristics of industry emergence and linked the network and industry concepts together. We shaped our reflection according to the following question; ‘what are the dynamics of industry emergence following disruptive innovation?’. To attempt to respond to our question, we discussed concepts of industry emergence. To make our reasoning as straightforward as possible, we presented the literature on industry emergence and made a parallel with the emergence of a network. We linked both concepts through an increasing amount of studies relating to industries as networks.

In **Section I**, the several theoretical approaches to industry emergence underlined several literature gaps (Phaal et al., 2011; Padgett & Powell, 2012) and identified new industry emergence models in contrast with the time-based life cycle models of industry emergence. The multi-level network analysis (Padgett & Powell, 2012) and the ecosystem-as-structure construct (Adner, 2017) provided solid theoretical grounds to consider industry emergence through new organizational forms such as networks.

Consequently, we switch our attention to network structures in **Section II**, where the network life cycle from its genesis to its structuration highlighted the dynamic evolution of networks. The implementation of IRs enables us to understand the rationale that motivates an organization to undertake IRs. To legitimate our back and forth flows between several analysis levels, we have discussed the meso and macro levels of analysis often used to study IR networks. Finally, we scoped out the network architecture more relatable to the present study: network analysis according to the additive approach.

In conclusion, we believe that we have achieved a general overview of the IR literature and the relatedness of networks with industry emergence studies. However, parallel to the literature review, we also noticed several critical theoretical gaps coming back in significant articles. Chapter 3 discusses the main theoretical gaps that we have identified to which we intend to contribute.

Chapter 3. Theoretical gaps and research questions

In line with the literature review in the previous chapters, we intend in **Chapter 3** to highlight the theoretical gaps leading to our research questions. As presented in the literature review, industry emergence occurs at several levels, representing our three-layer funnel approach. At each level of analysis, we have identified theoretical gaps in line with our research questions. The present chapter, therefore, splits into three distinct yet intertwined levels of analysis. Accordingly, the chapter follows a funnel logic compounded of a macro, an interorganizational, and an organizational level, which, when collided, provides rich content in regards to industry emergence caused by disruptive innovation.

In **Chapter 3**, we intend to telegraph our funnel approach in which each level of analysis brings additional insights on either the emergence or the structuration patterns of industries. At the macro level, the main discussions rotate around how to capture *ex-ante* industry emergence. Then, at the network level, discussions showed that we face a paucity of research about network structure and dynamics patterns. Finally, the literature has shown a limitation that we know about network composition at the organizational level, and little evidence has emerged about multi-network analysis.

In **Section I**, the discussions relate to issues about industry emergence mainly introduced by Padgett and Powell (2012) and induce a critical review of the industry emergence literature, including a summary of literature evidence, the limits of industry life-cycle models which are more static than dynamic, which led us to the need of proposing a dynamic network approach to assess industry emergence. Therefore, the first paragraph unfolds the theoretical gaps identified at the macro-level of analysis.

In **Section II**, we highlight the theoretical gaps at the network level, which among other things, invoke a non-linear consideration of disruptive innovation- a variable of industry emergence, which is a valuable conceptualization of innovation to identify industry structuration patterns.

Finally, in **Section III**, we unfold the last level of analysis of the thesis: the organizational level. At this level, we discuss the theoretical gaps identified in how organizations are studied in networks and the extent to which organizational attributes may influence network formation based on the innovation content.

Accordingly, we will start with the highest level of analysis that it is the macro level lens needed to assess industry emergence dynamics.

Section I. A critical review of macro level industry emergence dynamics

The following paragraph intends to discuss the theoretical gaps in the study of industry emergence at the macro level. It consists of a summary of literature evidence, which *inter alia*, links industry emergence to technological discontinuities (Abernathy & Utterback, 1978), turbulences (Aldrich & Fiol, 1994; Christensen, 1997), and changing organizational strategies (Eisenhardt & Martin, 2000). These considerations raise several critical questions at the macro level and identify a highly static perspective of industry emergence through industry life-cycles, bringing the discussions back to the Darwinian perspective on the origins of life. Thus, these models describe the evolution of the industry rather than the emergence. We found here our anchorage in evolutionary economics by discussing the need for a dynamic approach to assessing industry emergence in parallel to those insightful, yet limited, industry life-cycle model.

1. A summary of literature evidence

In recent research, the way to conceive organizations has drastically evolved. Indeed, considered from a very atomistic view in the early beginning (Porter, 1979), organizations have quickly become part of a whole composed of environmental variables (Angué, 2006; Davis et al., 2009). Several studies have discussed organizations' simultaneous embeddedness in networks and ecosystems (Mandard, 2015; Moore, 1993; Narula & Dunning, 1998; Shipilov & Gawer, 2019).

Consequently, researchers widened their lens by foreboding organizations and their environments together to understand the coevolution mechanisms that happen in parallel (Boschma & Lambooy, 1999; Hannan & Freeman, 1989; Leblebici et al., 1991). The apprehension of organizational mechanisms through interorganizational relationships calls into question the market and hierarchy dichotomy (Williamson, 1973), which appears to have limited explanatory power and is considered too stylistic to be sued for descriptive and expository matters (Bensaou & Venkatraman, 1995).

Environments, by definition, gather different types of organization and lead academic questionings to focus on the interorganizational level, which by loop mechanisms, socially, economically (Stuart, 2000), and cognitively (Eisenhardt & Santos, 2009), drives the industry emergence process. They are critical success factors for organizations, whether, for incumbents or new entrants, they constitute a significant spring of innovation in technologically intense industries (Ahrweiler & Keane, 2013; Phelps, 2010). The multiplication of smaller organizations in symbiosis with larger ones represents an essential joint development source and affects macro levels.

The concept of industry emergence and the dynamics by which emerging industries are formed and developed over time hold a significant dimension of evolutionary economic questionings (Krafft et al., 2011).

Despite many folders studied by the literature of industry emergence, in many cases, emerging industries ascribe to technological discontinuities caused by the recombination of existing technological designs (Abernathy & Utterback, 1978) requiring resource recombination (Eisenhardt & Martin, 2000). The propensity of new industries to be populated by many different technological designs cause the elevation of uncertainty. Complexity is driven by ever-changing customer needs, while companies struggle to make sense of new industries. Therefore, technological disruption with radically different technological designs has been studied as a winning combination to understand the reciprocal underpinnings of each concept on the other (Auster, 1992; Rice & Galvin, 2006).

Despite being turbulent because of high technological sophistication, technological discontinuities, and disruptive innovations, emerging industries provide unique characteristics (Abernathy & Utterback, 1978; Anderson & Tushman, 1990; Utterback, 1994).

Indeed, emerging industries are defined by how organizations understand the design of disruptive innovation. Linguistic studies have emphasized the importance of creating a shared product name to promote cooperation between organizations and to achieve a new technology benchmark following the existing one. Benchmarking disruptive innovation content helps companies to position themselves on the different segments that disruptive innovation could have. Because, indeed, disruptive innovation is equivalent to complex and sophisticated designs.

Consequently, industry emergence is a critical phenomenon that has attracted many researchers' attention. We have identified the irreversible link between industry dynamics and disruptive innovation in the literature review, placing disruptive innovations at the trigger rank. Both disruptive innovation and industry emergence alone represent a considerable amount of academic studies.

To identify a bridge to link both concepts, we zoomed on each concept's intrinsic characteristics.

As mentioned in **Part I**, disruptive innovation is a complex concept highly dependent on critical resources. They can affect how organizations and industries operate (Christensen, 1997). Resources, capabilities, and the risks of uncertainty place disruptive innovations at a strategical level for organizations wanting to take advantage of novelty. Indeed, organizational behaviors will play a key role and set organizations' positions within the different phases, whether during the pre-paradigmatic or paradigmatic phases (Teece, 1986). The race towards disruptive innovation will impose organizations to look for dominant designs (Anderson & Tushman, 1990) to gain legitimacy in a new industry (Aldrich & Fiol, 1994) through recombined strategies (Eisenhardt & Martin, 2000).

Also, disruptive innovation is resource and capability intensive (Eisenhardt & Martin, 2000) and deserve dedicated strategies. The literature has shown many approaches to the advantages of interorganizational relationships concerning resources and capabilities (Pfeffer & Salancik, 1978; Wernerfelt, 1984).

If we now consider the concept of industry emergence, we notice a growing interest around meta-organizational concepts such as networks. Studies have shown a shifting focus from a sharp market and hierarchy dichotomy (Coase, 1937; Williamson, 1973) towards parallel operation modes such as interorganizational relationships (Padgett & Powell, 2012) and alternative structuration modes around key activities (Adner, 2017).

Consequently, we find ourselves in a situation that might hold great value by the enlightenment of the following tryptic: disruptive innovation, interorganizational networks, and industry emergence.

In the following section, we intend to critically review the literature on industry emergence, identify the theoretical gaps, and present our research questions.

2. The limits of the industry life cycle

Over the years, the willingness to understand industry changes and the dynamics of emerging industries raised questions regarding changes in industry structures (Davis et al., 2009; Eisenhardt & Santos, 2009; Klepper & Graddy, 1990), the nature of innovation (Ahrweiler & Keane, 2013; Damanpour, 1991), and the determinants of organizational survival (Audretsch, 1995; Tohidi & Jabbari, 2012). Analogies comparing industries to human lives have been numerous (Moore, 1993; Padgett & Powell, 2012). The search for industry emergence and development patterns has inspired the development of industry life cycle models (Klepper, 1997; Rice & Galvin, 2006). The industry life cycle is a “leading depiction of the evolution of new industries” (Klepper, 1997: 145). It is argued that regularities are often observed when in the mature stage of industries and leads us to think that the determination of emerging patterns of industry emergence remains undone.

Padgett and Powell (2012) raised fundamental questions regarding the industry life cycle in their critical article, mainly arguing that they enable to capture industry structuration patterns rather than industry emergence dynamics. Therefore, it goes back to the question of the human life origins brought by Darwin. Authors (*ibid*) argue that the Darwinian perspective on the origins of lives brings answers to evolution rather than emergence. Ahuja et al. (2012) corroborated that lesser attention is given to the study of why and how networks emerge and evolve and defended the partiality of studying networks without appreciating the genesis of such structures. Other studies deplored that empirical studies on industry emergence tend to focus on mature industries rather than emerging industries (Klepper & Graddy, 1990) by highlighting the empirical regularities observed during the evolution of new industries.

We add to the authors' critiques of industry life cycle models by highlighting such models' static dimensions. Industries, if similar to human lives, are built upon internal and external interactions. The need to call on external relationships is influenced by the complexity of disruptive innovation discussed in **Chapter 1**.

The present research work's contribution is to answer a critical question: how can organizations adapt to change if the change is not foreseeable *ex-ante*? This question has been raised by many studies prior, and critical frameworks have been developed to capture the passage from industry life-cycle phases (Phaal et al., 2011). However, in recent studies, the tendency is to consider industries aggregates of IR networks, wherein organizational collaboration dynamically mirrors industrial change (Ter Wal & Boschma, 2011).

Nevertheless, we argue that capturing the toggle after each stage of the network's state change cannot be understood without integrating a temporal dimension. Although the literature largely accepts that statement, the works looked at their antecedent, the substance, and the structure of the relationships rather than their consequences at a macro level.

Research direction 1: The problem of the origin of an industry is not solved; there is a necessity to study emergence and structuration independently yet as part of a common process.

As a result, industry emergence studies have started to consider industries as networks of interorganizational relationships and have gone from static to dynamic (Gnyawali & Madhavan, 2001).

3. A dynamic network approach to industry emergence

Baker and Faulkner (2017: 520) stated that networks are the “interorganizational form of the future and even the emerging form of society”. Similarly, in the literature review, we have depicted a rising interest in a network perspective to study the emergence of industries in bounded structures (Gnyawali & Madhavan, 2001). Networks are aggregate wholes of interorganizational relationships between organizations. Van de Ven and Garud (1987) presented the undeniable correlation between industries and networks in their framework of industry emergence. They discussed the ‘social systems’ of the industry, of which they distinguished three: institutional, resource procurement, and instrumental.

In terms of emergent behaviors in complex evolutionary systems, Phaal et al. (2011) consider industries as compound and intricate structures and industry emergence as a dynamic process in contrast to static systems. Evolutionary systems benefit from dynamics inherent to

variations caused by interorganizational relationships; the study of these multifarious IRs gives insights into the coevolutionary dynamics of industry emergence patterns. Variation is an underlying principle of industry emergence as it creates dynamism in a given industry.

Organizations in a network work collaboratively towards the execution of a more or less common objective (Provan et al., 2007), final proposition (Adner, 2017) and therefore, the longitudinal scanning of the network covers the structural changes in patterns in interorganizational relationships (Ahuja et al., 2012; Krafft et al., 2014). IR networks are considered critical strategies for knowledge transfer, and resource and capabilities flow among network members (Tatarynowicz et al., 2016).

Research direction 2: Industries are complex social systems composed of interorganizational relationship networks.

Besides, it is stated that the network analysis is often discussed yet, seldom empirically studied. In parallel, Kilduff and Tsai (2003) discussed the importance of distinguishing both levels in that their analysis differs in inputs and outcomes.

Indeed, contemporary research on networks distinguishes between two levels of analysis of networks (Ahuja et al., 2012): individual/organization level and the network level. Wasserman and Faust (1994) discussed the macro and micro levels. At the organizational level, networks are called egocentric networks, and when studied at the network level, one analyzes ‘whole networks’ (Provan et al., 2007).

Consequently, network studies have addressed key dimensions of networks analyzed either at the organizational or whole-network levels (Ahuja et al., 2012). Bergenholtz and Waldstrøm (2011) argued that network studies also distinguish between metaphorical considerations of networks in contrast with the analytical perspective (Corallo & Protopapa, 2007).

The binary distinction of network-level analysis is detected as a source of an unbalanced amount of research. In that vein, Provan et al. (2007), in their literature review on empirical literature of IR networks, argued that IR networks studies adopting an organizational level are numerous while studies adopting a network level are overlooked.

Besides, to date, empirical studies are unable to clarify how different levels of action and structure might be linked (Pattison & Robins, 2002). For instance, Kurt and Kurt (2020) discuss the absence of correlation between structural patterns of social context on organizational level outcomes. It is all the more impressive as some studies have highlighted IRs as aggregated of networks, and some quantitative regularities have been accepted as signals of stabilization in emerging industries such as the number of organizations present (Klepper & Graddy, 1990).

Studies of networks at the organizational level, also known as or ecosystems-as-affiliation (Adner, 2017), are firmly embedded in social sciences and focus on structural issues. Works on egocentric networks propose to analyze and understand the impact of IRs on organizational performances, assess to what extent the type of IRs has an impact on network members, study the power of nodes within a network to depict the more and less influential nodes within a given network, but also study the position of a node over. However, understanding organizations' interdependence within networks in which IRs are contracted calls attention (*ibid*).

Besides, even though organizations' role in networks is overemphasized, these studies tend to overlook information about the network structure of individual network members (ego networks) (Bergenholtz & Waldstrøm, 2011). Ahuja et al. (2012) stated that the study of networks at the organizational level could give comprehensive information about dyadic IRs. However, they tend not to give information in regards to the whole network structure.

The study of networks as wholes is not sufficient if done statically; there is only so much we can know regarding networks when studying their static properties (Provan et al., 2007). Current studies on whole networks tend to focus on descriptive case studies performed in point in time and provide with research bias as their structural issues are aggregated across the entire network and then subjected to comparative analysis with those of other networks that are similar in their core businesses.

Research direction 3: Network analysis needs a multi-level analysis process assessing the macro and the meso levels equally.

It is possible because the dynamics of collaboration between organizations attest that change occurs and facilitates the surveying of industry emergence as “understanding network dynamics is also important because of the potential role of conscious agency by network participants in creating network structures that benefit them” (Ahuja et al., 2012: 435). In the same manner, interorganizational relationship dynamics form a substantial element of creating value through exchanges. It is relevant because some deliberate network modifying decisions made by network members can impact whole networks from a structural perspective compared to the traditional industry (Figure 12).

Figure 12. Network dynamics

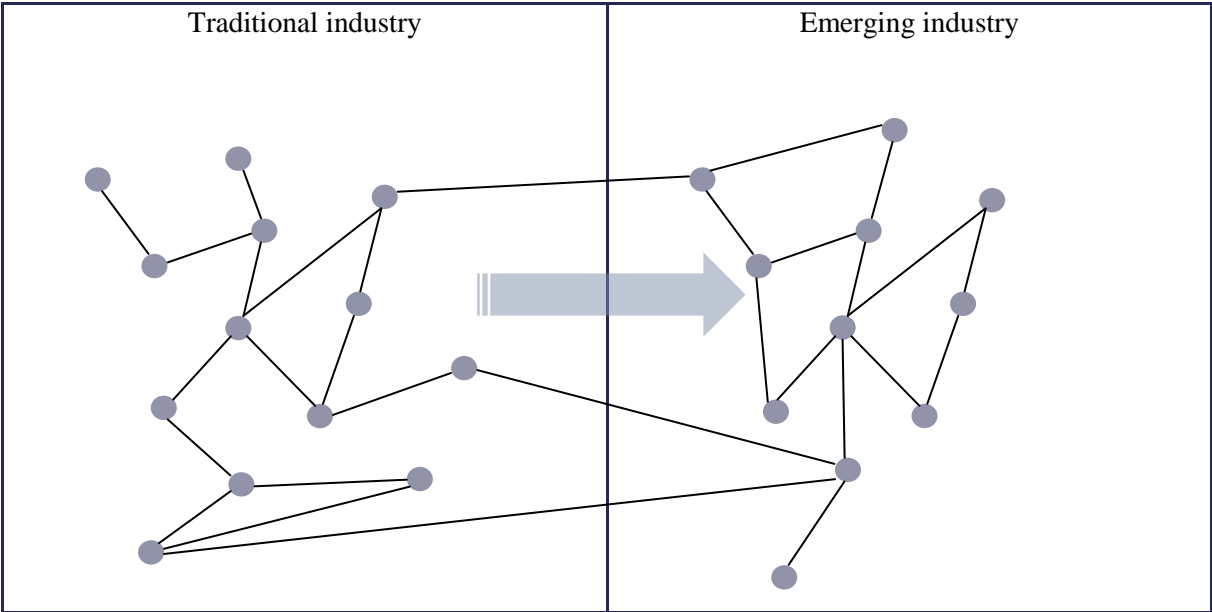

It is particularly noteworthy that no study has yet reported the emergence of the industry with interorganizational relationships to shadow the changes of configurations that occur in an established industry, which dislocates to emergence into a new one. The new industry is complex by nature.

McPherson et al. (2001) discussed the correlation between network change dynamics through which IR networks co-evolve and assume that understanding network evolution requires studying the network dynamics. In that sense, Coleman (1990) argued that the emergence of complex and large-scale networks could be studied through individual actors’ collaborative behaviors, i.e., IRs. In that way, it will dynamically capture the emergence of networks.

Building on Coleman's theory (1990), Powell et al. (2005) reckoned the dynamics of IR networks as critical network emergence dynamics due to continually changing network structure caused by organizations constantly reshaping their ties. The changing nature of ties is consequential of economic imperatives of value creation.

Finally, the authors argued that network dynamics are highly consequential for the emerging industry-wide network structure. Van de Ven and Garud (1987) also corroborated the need for multi-level analysis of networks. They examined the role of individual organizations in creating a new industry in their framework of industry emergence. In that perspective, the research intends to contribute to existing theories on network emergence by analyzing whether and to what extent the dynamics of IRs between organizations across helps to explain the IR network emergence patterns. Consequently, the vision of interorganizational relationships as metrics of industry emergence brims with the classical approach of pragmatic market and hierarchy transactions (Forgues et al., 2006).

Even if companies want to remain independent, they are motivated to integrate IRs as significant variables in their strategies, serving as the glue between the organization and its strategy. The sealing role of IRs in the constitution of competitive advantage puts the interorganizational level upfront for studying the emergence of an industry. They reflate the changes in organizational strategies inherent to turbulent environments and the need for organizational adaptation.

In developing our dynamic networked approach to industry emergence, we will build on the basic assumption that considers networks as complex social structures where the emergence of a whole network is tributary of individual actors 'collaborative patterns (Coleman, 1990).

Indeed, many theoretical approaches explain the tendency of organizations to fall back into IRs. In that sense, we described intra organizational motives of IR formation approached by the transaction costs theorists (Coase, 1937; Pfeffer & Nowak, 1976; Williamson, 1973), the theory of agency (Alchian & Demsetz, 1972; Jensen & Meckling, 1976), and the resource-based view (Barney, 1991; Dahlman, 1979; Dietrich, 1994; Jarillo, 1988; Loasby, 1994; Madhok & Tallman, 1998b; Wernerfelt, 1984; Zajac & Olsen, 1993).

In parallel, the analysis of exogenous motives of IR formation also witnesses the rising role of the organizational environment and the unequivocal place to look for a change in coevolution patterns (Padgett & Powell, 2012).

We argue that at a macro level, interorganizational relationships have several attributable consequences to industry emergence.

At the early stage of industry emergence, organizations and managers can depict turbulence by identifying how things are done and organized. When some industries are well established, and each organization is assigned to a given role, change is easily recognizable in such organizations will start to substitute products or suppliers or look for new technologies, which have no equivalent in the established industry.

In recent years, studies dealing with how to approach networks have multiplied methodically. Since “networks are reshaping the global business architecture” (Parkhe et al., 2006: 560), it is argued that they attract growing interest in diverse research fields (Bergenholtz & Waldstrøm, 2011). Besides, it has been discussed that studies on networks tend to use individually oriented methodologies that focus on the organizational level (Zaheer & Usai, 2004).

In fine, the critical work required to analyze large-scale networks over time limits the ability to produce theoretical evidence (Burt, 2002). It is all the more difficult in that authors argue that implementing a generic IR network framework is constrained by singular network characteristics (Ahuja, 2000). It is also discussed that changes in networks do not happen overnight, depicting significant change tributary patterns of years’ worth of data.

In terms of analytical consideration, network studies tend to utilize the Social Network Analysis methodology (SNA) (Kurt & Kurt, 2020), even though it is not systematical (Bergenholtz & Waldstrøm, 2011). It makes the question of the necessity of a principal amount of data even more relevant to the intrinsic methodological requirements. Ahuja et al. (2012) highlighted the need to balance structural data and ‘in-depth’ data about the network structure and members.

The dynamic approach opens opportunities to assess industry emergence *ex-ante* and offers complementary levels of analysis. However, recent studies have shown that industry emergence is correlated with disruptive innovations. Yet, the disruptive innovation theory largely overlooks the impact of disruption on industry emergence and stays focused on the organizational level.

As a result of the discussion here, we identified several research questions. In regards to identifying the genesis of industry and the why and how they emerge and evolve, in contrast with structuration patterns, we intend to propose a solution to solve emergence problems (Padgett & Powell, 2012). At the whole network level, the main research question touches upon the necessity to capture industry emergence and obviate any confusion between industry emergence and industry evolution. In the first place, we will answer the following research question:

How could interorganizational relationship dynamics allow to assess the patterns of industry emergence in a disruptive innovation context?

We intend to report how the longitudinal analysis of IR formation can assess the occurrence of the change at the macro level over a period. It displaces the problem of *ex-post* insights defended by the disruptive innovation researchers (Christensen 1997; Danneels, 2004) to an *ex-ante* stage (King & Baatartogtokh, 2015) through an empirical analysis starting from the very first IRs long before the emergence of repetitive designs at the network level that we discuss in the next section.

Section II. A multi-level analysis

In this section, we continue our reasoning in understanding industries, their emergence, and their structuration. We consider that emergence is depictable at the macro level and holds several critical advantages discussed in the previous paragraph. However, the depiction of emergence isolated from other concomitant variables seems to provide limited information. In these terms, we have identified that the structuration of industries happens at the network level and implies understanding IR network dynamics. Often discussed with innovation as a driver, studies on IR networks tend to overlook the intrinsic characteristics of innovations that make the rule of collaboration the preferred one. Building on that assumptions and agreeing with several significant works on structuration (Adner, 2017; Grodal et al., 2014), we scope out from a linear perspective on innovation to study the content – the various categories of which complex technologies are composed – to think toward a less vertical and whole-like consideration of innovation. *In fine*, the literature argued that understanding the innovation content gives meaningful orientation about how industries structure.

Considering the innovation content as a variable of industry structuration implies 1) that industries structure as the technology evolves; therefore, a dynamic perspective is needed, 2) if technologies are complex and motivate organizations to collaborate, there are interesting insights to capture at the network structuration level, and finally 3) the still-evolving technology coupled with IR patterns imply an evolutionary perspective based on a longitudinal analysis of the structuration process.

1. Allocating a non-linear innovation perspective to industry emergence

In this paragraph, we continue our reasoning in understanding industries, their emergence, and their structuration. We consider that emergence is depictable at the macro level and holds several critical advantages discussed in the previous paragraph. However, the depiction of emergence isolated from other concomitant variables seems to provide limited information. In these terms, we have identified that the structuration of industries happens at the network level and implies understanding IR network dynamics.

Building on that assumptions and agreeing with several significant works on structuration (Adner, 2017; Grodal et al., 2014), we scope out from a linear perspective on innovation to study the content – the various categories of which complex technologies are composed – to think toward a less vertical and whole-like consideration of innovation. *In fine*, the literature argued that understanding the innovation content gives meaningful orientation about how industries structure.

Considering the innovation content as a variable of industry structuration implies 1) that industries structure as the technology evolves; therefore, a dynamic perspective is needed, 2) if technologies are complex and motivate organizations to collaborate, there are interesting insights to capture at the network structuration level, and finally 3) the still-evolving technology coupled with IR patterns imply an evolutionary perspective based on a longitudinal analysis of the structuration process.

1.1. Building on the theory of disruptive innovation

In the introduction, we have explained the processual interlink between disruptive innovation, IR networks, and industry emergence.

The switch from organizational to interorganizational level to analyze the emergence and structuration of industry has additional insightful explanations because organizations are willing to manage disruption through interorganizational relationships (Christensen & Overdorf, 2000).

Networks are subjected to boundary questioning (Eisenhardt & Santos, 2009) because the determination of natural or nominal boundaries seems to be confusing (Ahuja et al., 2012). Bergenholtz and Waldstrøm (2011) questioned primarily when a network is considered ‘sufficiently bounded’ to be analyzed. Ahuja et al. (2012) proposed a structural take on network analysis by arguing that network studies need to categorize networks into subnetworks, which create an analogy with the concept of ecosystems-as-structure (Adner, 2017) and the call for categories of a network (Ahuja et al., 2012) where IR networks are created and categorized around critical activities.

On the first hand, as mentioned in the literature review, disruptive innovations are resource-intensive, and resources are a main IR formation driver (Oliver, 1990). Since resources are essential for disruptive innovation, and although willing to remain independent, organizations

are coerced to bond with other organizations to acquire critical knowledge and resources. Although established in the traditional industry, Incumbents often experiment with a resource and knowledge gap regarding the new technology, which is often possessed by new entrants. Even if organizations perform in an ambidextrous way (O'Reilly & Tushman, 1996; Simon & Tellier, 2008), they may find it challenging to succeed in the face of disruption.

On the other hand, new entrants suffer from minimal legitimacy on a given market and have limited financial resources (Lambkin, 1988). Although disconcerted, incumbents benefit from lively network capital and live on a recognized legitimacy. The theory of disruptive innovation is highly criticized in that sense, as it condemned the incumbents to fail in the shadow of rising new entrants companies at a new-market level (Danneels, 2004).

Particularly the binary vision of failing or succeeding in the face of disruptive innovation also backed up by an irreversible argument that highlights the ex-post power of the disruptive innovation theory, seems to be inconsistent with the modern organizational landscape where organizations are willing to bond together for a common goal to fulfill. It also seems that the theory of disruptive innovation overlooks the content of disruptive innovation, which gives critical insights on how industries can evolve.

Research direction 1: Disruptive innovation should not be considered as a fatality, preferably as a variable to depict industry emergence

By so doing, we confer the disruptive innovation theory, a larger lens of analysis, because instead of relaying organizational difficulties as an end of itself, we consider it as a driver for organizations' strategic changes.

1.2. Assessing industry emergence through Key Technological Activities

The present subparagraph presents a fascinating study dealing with the co-evolution of technologies and categories, which intrinsically shapes emerging industries (Grodal et al., 2014). The interplay between disruption and industry emergence occurs because disruptive innovations are considered as technological discontinuities that cause new-market disruption, or in other words, the emergence of a new industry.

However, suppose disruptive innovation is mainly considered from a technological standpoint. In that case, it seems appropriate to allocate more time and effort to studying the disruptive innovation content that we called key technological activities (Adner, 2017) and observe how organizations dynamically operate to fulfill their more or less common goal: making the disruptive innovation a commercial reality. In reality, Adner (2017) proposed a groundbreaking article where he exposes the necessity to branch out of a linear vision of IRs alienated around focal organizations to discuss the necessity to understand the driving role of 'activities' in the structuring of IR strategies. As Adner (2017) mentioned, activities are all the required technological expertise that altogether form the value proposition for which organizational initially contracted IRs.

Another stream of literature refers to 'activity' as 'categories,' enabling to understand the fundamental social processes that shape the dynamics of industries (Grodal et al., 2014). For the sake of clarity, we will stick to Adner's appellation (2017).

According to Anderson and Tushman (1990), periods following disruption are characterized by uncertainty caused by technological complexity, causing a concave and fine-grained environment (Lambkin, 1988). Considering that technological complexity is the main reason explaining the turbulences caused by disruption innovations, we have looked at the intrinsic reasons making such innovations appear like dangers more than market opportunities.

The technological complexity has been studied through several lenses such as industry life cycles, as discussed in the previous paragraph, and Abernathy and Utterback's (1978) categorical classification development. The study of activities, therefore, brings several critical contributions. The assessment of activities enables identifying the existing industry's critical variables through a comparative approach of the two technologies. It enables the determination of the state of industry emergence while also shedding light on dynamic organizational debates that try to make sense of the emerging industry, which, in fine, calls on IRs. The implementation and use of activities do not emerge in isolation but are continuously shaped, changed, and made evolve by the final architecture (Grodal et al., 2014).

In the context of industry emergence, the recombination of technological designs combined with uncertainty regarding the future of the technology and still-evolving customer needs determines one dominant design complicated (Abernathy & Utterback, 1978).

Research direction 2: The technological complexity of disruptive innovation could be analyzed through IR networks forming for each activity

To highlight the technological aspects and the critical role of these activities, we named them Key Technological Activities (KTAs).

Bergenholtz & Waldstrøm (2011) have raised an interesting point as they argue the missing consideration of an analytical perspective of organizations' performance in networks, which seems problematic given the critical impact of IR on organizations. Also, they have discussed SNA as a very suitable network analysis methodology to provide a structural and dynamic approach to the analysis of whole networks. The literature also accepted that IR networks constitute a highly dynamic setting in which organizations are continually shaping and reshaping their ties to meet economic obligations. These dynamics are consequential to the structure of the emerging industry (Powell et al., 2005).

Consequentially, we intend to contribute to the existing theory of industry emergence by exploring whether and to what extent the dynamics at the organizational level across an emerging industry sheds light on the IR network structuring around KTAs. We thus seek to understand why and how IRs differ across networks and whether these variations are intrinsic reasons explaining the emergence of several whole IR networks around KTAs.

The absence of a network emergence framework rendered the study of such structures complicated because of methodological challenges faced by researchers.

The advantage of studying the IRs dynamics around KTAs is that it helps organizations make sure of the emerging industry by understanding the innovation content. Understanding the new technology (final value proposition) and the contingent technologies (key activities) provide insights for a potential market position concerning preexisting designs. Organizations identify what resources they have regarding the new technologies from a resource-dependence perspective and what resources they miss.

The present work intends to extend the literature on industry emergence by capturing industry emergence dynamics by providing an in-depth analysis of how disruptive innovation content categorized into identified groupings of technologies that form the final value proposition can describe industry emergence.

Although the study of KTAs seems to be relevant to bring newness to the theory of disruption, existing studies, even though they focus on the importance of categorization processes in the evolution of emerging industries, seem to overemphasize the role of the most successful categories (Navis & Glynn, 2010) despite less successful categories (Grodal et al., 2014). Categories are composed of two critical elements; first, they gather products or services defined by the same rules, architecture, and boundaries; second, they reflect the characteristics of the products or services gathered in the same category.

Consequently, we contribute to the industry emergence literature by considering disruptive innovation as both a driver and a trigger of industry emergence. It triggers the emergence of a new industry in that it creates a technological gulf between the existing technology, which has its set of required resources, capabilities, and a specific customer need to fulfill, and the new technology, which requires a new set of resources and capabilities and meet a still-changing customer need.

Disruptive innovations can also be considered as drivers of industry emergence as the study of their content in terms of categories (Grodal et al., 2014), key activities (Adner, 2017) provide organization with clear directions in regards to the still-emerging industry while helping them to make sense of the emerging industry. However, what seemed to lack is a way to identify these Key Technological Activities.

In that regard, the literature unfolded a principal amount of studies dealing with IR formation, and what outstanding is the fundamental role of innovation, the related resources, and the necessity to manage the risk inherent to the new technologies, making it possible to consider IRs as main strategies of disruptive innovation management.

Moving from a linear vision of innovation towards a categorical analysis is a deterministic perspective on how innovation and industry evolution is correlated. It has a recursive perspective that focuses on different temporal dimensions closely linked to the innovation content. The more crucial is that these studies argue that reflection regarding the categorical analysis of innovation starts way before the industry emerges. By considering industry emergence as a processual result of innovation, we argue that this may bring several key elements to our thinking.

First, this perspective accepts the crucial role of a temporal dimension in the analysis of industry emergence. It considers temporal dynamics as constantly modifying, evolving, and collectively constructed by organizations that base their actions on the past and plan their path through their understanding of the future. Secondly, it accepts that the categories may influence how the industry emerges. Finally, the willingness to capture industry emergence dynamics is fulfilled through categorical analysis that identifies the power of categories to change the competitive dynamics within an emerging industry.

Besides, categories bring clarity to the *ex-post* issue of the theory of disruption. They offer the possibility to carry out an *ex-ante* analysis of industry emergence by capturing organizational dynamics around technological activities. In that terms, Schumpeter (1934) stated that the R&D process starts long before the emergence of the first-ever technological design, and so, *ex-ante* industry emergence analysis is possible. Nevertheless, a limited amount of research is dedicated to studying the effects of such categorization actions on industry emergence.

The present work suggests that the capture of the global industry emergence picture requires identifying and analyzing categories that succeed the most and succeed the least.

2. Considering networks as wholes

In the line of under-researched concepts, Provan et al. (2007: 482) have identified whole networks that they qualify as a regrouping of “organizations connected in a way that facilitates achievement of a common goal”. They underline the necessity to study networks as whole systems and emphasized the importance of interorganizational dynamics to understand the emergence of IR networks.

Besides the longitudinal study of networks, academics argued a relatively limited amount of research regarding network outcomes that include a time dimension (Burt, 2002).

Borgatti and Foster (2003) discussed the intrinsic link between different network phases and the systematic change related to innovation advances and defended the necessity of a multilevel analysis of networks. Other studies pointed out the limited insights that the literature provides regarding network emergence dynamics over time; and calls for an analytical approach on network studies (Burt, 2002; Powell et al., 2005). Nevertheless, it is

argued that the collection of network data and applying relevant measures to even a particular type of node at one point in time for a comprehensive network is one enormous task to carry out.

The longitudinal analysis of networks is underemphasized yet, provides critical evidence regarding the structure of a given network that will facilitate accomplishing the final goal that Adner (2017) perceived as the ‘final value proposition.’ For the final value proposition to become commercialized, there is a set of ‘activities’ need to be fulfilled. Therefore, each activity has its inherent technological design and requires the interaction of different types of organizations.

In fine, each activity motivates the organization to contract IRs and is a singular purpose of IR formation. Adner (2017) named the concept of the network around activities ecosystem-as-construct, which, in contrast with ecosystem-as-affiliation that studies the network around focal organizations, is understudied. It corroborates the statement made by Provan et al. (2007) and highlights the necessity to link the concepts of the content of innovation and network emergence.

3. Drawing on the evolutionary economics theory

Nelson and Winter (1982) build the foundations of the evolutionary theory. Their work is considered the starting point and reference for a considerable body of literature that has attempted to provide a modern evolutionary research agenda (Padgett & Powell, 2012). The literature on evolutionary economics is insightful in many ways and represents the heart of the contributions and debates in economic theories that claim to be evolutionary.

We draw upon the evolutionary economics theory in several different manners. First, we adopt a comparable standpoint regarding the critical considerations regarding orthodox approaches that consider competition and growth as central points. Amongst several critiques made by Nelson and Winter (1982) against the orthodox approach, one is of significant importance to us. Indeed, they argue that economic analysis should not exclusively focus on “hypothetical states of industry equilibrium” (*ibid*: 4). Instead, dynamic processes are sources of irreversible economic changes sensitive to the followed trajectory. Accordingly, amongst

economic change studies, “none is more worthy of attention than that of understanding the great complex of cumulative change in technology and economic organization” (*ibid*: 3).

Besides by combining Darwinian competition and Lamarckian inheritance approaches, Nelson and Winter (1982) cover the major parts of the organization's industrial application at inter and intra organizational levels.

In addition, evolutionary economists consider that innovation should centrally understand the underlying dynamics of industries and organizations. Therefore, evolutionary economics considers industry emergence as a macro-level phenomenon based on dynamics created at the organizational level. We assume that the bridge between the macro level and the organizational level creates significant possibilities for research. Nevertheless, our study is centered on analyzing the dynamics of industry emergence and industry structuration patterns through our inductive approach, which provides a panorama of the underlying interorganizational dynamics of industry emergence at the macro level.

In line with evolutionary economics, we argue that disruptive innovation is a critical economic growth mechanism, which triggers the dynamics created at the organizational level.

To capture the dynamics at the organizational level, we have opted to look at the interorganizational relationships as we assume they are a central variable of organizational strategies as they reflate “the movement of something over time” and “explain why that something is what it is at the moment in terms of how it got there” (Dosi & Nelson, 1994: 154).

Therefore, we refine our scope to understand how reality appears and structures rather than identifying the reasons that lead to industry equilibrium, representing the essence of the evolutionary theory.

To complement the emergence process, it is quite natural to dwell on the structuration processes of the industry. Indeed, when they have seized that disruption is happening, organizations need to understand how the industry is going to structure, how activities will organize to identify industry stakeholders and competitors in line with the emerging technology. When disruptive innovation seems to be very complicated, several key

technological activities may be necessary to fulfill its development towards its commercialization. We adopt a non-linear approach to innovation and considers the innovation content as the primary variable of industry structuration. It leads us to the second fundamental research question:

How do interorganizational relationship networks dynamics assess the structuration patterns of industry emergence caused by disruptive innovation?

Besides, network development considerations argued that there is a lack of knowledge about network dynamics (Bell & Zaheer, 2007). The potential to learn more on networks will be limited when focusing on their static properties (Provan et al., 2007). This question raised discussions at the network level. It enabled us to build on our industry emergence analysis funnel approach intending to shed light on the emergence and structuration pattern assessment.

The final interlock occurs at the organizational level, where we supposedly argue that organizations provide information regarding influential variables in given networks as aggregates of IR networks.

Section III. A cross-level network analysis through organizational attributes

Studies on network compositions focused on many aspects of networks. The accumulation of knowledge regarding networks over the years and the review of the network literature enabled us to identify several analysis patterns of such an abstract concept. A stream of researchers has focused on exogenous motives of IR network formation through the resource dependency theory (Pfeffer & Salancik, 1978; Hillman et al., 2009), the industrial economics (Porter, 1979), the stakeholder's theory (Freeman, 1984; Hamel & Prahalad, 1990; Kogut & Zander, 1992) and the institutional theory (DiMaggio & Powell, 1983). Therefore, the literature on networks is vast and diverse and is anchored in several different fields at different levels of analysis and analyzed through different methodological approaches to understand when, where, why, and how IR network form (Ebers, 1997).

The review of the network literature enabled us to depict several lines of research.

On the first hand, even though none network theory has been identified, we depicted an actual amount of studies focusing on the IR formation drivers and the willingness to understand the advantages and benefits for organizations involved in IRs and networking activities organizational level. Mainly, at the organizational level, researchers have spent time and effort to depict the significant motivations of IR formation and the structuration of networks. However, Nohria & Eccles (1992: 4) argued that less is known about “what kinds of ties matter under what kind of circumstances,” making us think that IR networks need an in-depth analysis of IR types in lights with a set of related circumstances.

On the other hand, we have also identified the tendency of network studies to highlight the several levels of analysis to distinguish the nature and outcomes of studies. It is discussed that different levels of analysis provide the understanding of “a set of phenomena that is inherently multilevel” (Zaheer et al., 2010: 63). Authors (*ibid*) also argue that understanding distinct levels of analysis can ease identifying connections between these levels of analysis and stated that the network literature has far neglected the study of dynamics across the levels.

This section will also discuss the theoretical gaps in the network composition and the impact on network width based on an identified innovation content. Network width is the study of network outcome predictions of successful network strategies and discusses the impact of exogenous elements on network strategies (Hannan & Freeman, 1977).

1. Alternative strategies for unsuccessful incumbents

Amongst various critical dimensions of industry emergence, the composition of industry represents a critical one. Many studies have been published in these terms dealing with the success of incumbents, new entrants, early entrants, or late followers (Van de Ven & Garud, 1993). Academics and practitioners widely accept the question of the order of entry. In that regard, Hannan and Freeman (1977) discussed the fundamental dimension of understanding how populations grow by identifying the process they follow.

Academics and practitioners have widely accepted that new and early entrants will benefit from the first-mover advantage and acquire a lasting competitive advantage compared to later entrants. Many studies have shown the advantages of new entrants and their fundamental role in disruption (Christensen, 1997). However, in recent years, studies have recognized that order of entry is not systematically synonymous with success because early entry does not provide privileged access to technological clarification, and early entrance is not a warrant for organizations' capacity to exploit new market opportunities (Lambkin, 1988). Sometimes, waiting the additional time can provide later entrants the benefit of learning to later leapfrog the industry by displacing new and early entrants with superior resources and capabilities.

When early studies have discussed incumbents' condemnation to fail when facing disruption of their traditional industries because they are not fast and flexible enough, these studies have been criticized for their singular dimension that focused on niche activities or given industries. The lack of applicability of the theory of disruption to large-scale studies, providing ex-ante analysis elements, has been overlooked (Danneels, 2004).

Research direction 1: There is a lack of studies intertwining cross-level comparative analysis of networks with specific innovation content

Also, the flexibility of new entrants has been equated to success (Christensen 1997). Nevertheless, the organization's simplistic vision as a flexible whole seems to ignore the specificities of innovation while also ignoring macroeconomic dimensions of industries such as barriers to entry, access to customers, and the complexity of the innovation itself (Porter, 1979).

The questions around industry emergence almost always come with an argument about the order of entry. Van de Ven and Garud (1987) highlighted that the standard order of entry theories argue that it is not as automatic and self-consequent as it used to be. Being the early adopter does not provide automatic success because organizations are different, making them more or less proactive in seizing new opportunities.

Also, late entrants have the capabilities to leapfrog the industry and displace the competitive position by bringing in new capabilities and skills that early adopters may be missing.

While the order of entry has been studied as a determinant of organizations' success in networks, another stream of studies has focused on each organization's attribute in determining the formation of IRs and organizational performance outcomes.

2. Focusing on network width

The review of network composition highlighted paramount studies regarding understanding the similarities and dissimilarities across network members. What seemed to outstand it is the concept of homophily that is most of the time summarized as “similarity breeds connection” (McPherson et al., 2001: 415).

However, Zaheer et al. (2010: 73) mentioned that the literature is “rather silent on possible complementarities and redundancies across multiple networks in influencing organizational behavior and outcomes,” and suggest that future research on network composition consider the analysis of organizational patterns of the organization embedded in several networks simultaneously. By complementarities, some works have mentioned the technological complementarity (Adner, 2017)

The correlation between the propinquity and the singularity between two nodes within a network was one of the first dimensions observed by network analysts. These studies have started from an attitudinal perspective and were enlarged to large-scale network studies (Burt, 1995; Marsden, 1981), even though the generalization at the large-scale level still is overlooked (McPherson et al., 2001). Most of the time, these studies are anchored in sociological studies and discuss the impacts of homophily on societies, such as segregation or inequality.

Studies on network homophily have considered networks with an extensive range of different IRs between network members. Amongst these studies, few of them discussed that homophily tends to get stronger within a network when multiple relationships are contracted between two nodes and witness the cumulative effects of homophily through multiplex rather than simplex ties. McPherson et al. (2001) discuss the principle of multiplex ties to explain the propinquity of two nodes to collaborate. Social structuralist spotlighted the role of social embeddedness to explain the patterns of collaboration amongst two similar nodes (Ahuja & Katila, 2001). What caught the attention is the reference to the principle of isomorphism mentioned by Zaheer et al. (2010). Isomorphism refers to organizations' tendency to act similarly in parallel to strong differentiation efforts, and the degree to which constituent elements of a process and the relationships between the elements are identical through analytical levels (House et al., 1995).

Ebers (1997) argued that the study of similarity and dissimilarity among organizations within a network is a determinant of network formation. Only the purpose of the IR is not sufficient to explain the occurrence of a given IR. Therefore, network formation relies on the study of organizational-level analysis. This argument is even more relevant networks vary from one network to another (Gibbons, 2007). In that sense, Oliver (1990) called for a multi-level analysis based on different types of network data calling on different methodologies to compare network formation composed of different IRs across different settings. To summarize, Ebers (1997: 9) stated that:

“Much of the research stems from a single institutional setting related to organizations from one or a few industries and/or focuses on one or two forms of networking only. Comparative research that could allow us to systematically detect and explain similarities and differences in the antecedents and outcomes of formation of network is still rather rare”.

He (*ibid*: 9) added that:

“We still have a long way to go before we claim that we sufficiently understand when, where, why and how organizations form which kinds of interorganizational relationships and to what effect”.

Research direction 2: There is a lack of understanding of why organizations tend to contract IRs, and the effects of organizational attributes on strategic path choices are not well identified

Other studies (Carley & Kaufer, 1993) argued that homophily is tributary to geographical dimensions linking two nodes to each other. In other words, the geographical closeness goads organizations to collaboration because distance needs additional efforts to manage the relationship. Blau (1977: 30) discussed the importance of structural parameters that he defined as “the axes in the multidimensional space of social positions amongst which the population is distributed.” However, in recent years, with the rise of the internet and connectivity, working remotely becomes more accessible and acceptable for organizations.

Besides reiterated relationships and geographical closeness, studies on network homophily discuss, among all, the social closeness of the nodes. Blau (1977: 41) states that “social associations are more prevalent among persons in proximate than those in distant social positions” and generalizes the use of the definition to any contexts presenting social associations. He adds that relationships among nodes are either tributary or result from opportunities that entities may encounter.

Finally, homophily respects two natural mechanisms leading similar organizations to breed together either due to their preferences or as a result of opportunistic behaviors.

The conceptualization of networks as structures that include homophily or heterophily reckons a consensus that there are differences in social positions and IRs between homophile organizations, assuming that organizations’ position and role influence their IRs.

As a result, most social network studies are looking for explanations about the patterns of relationships between organizations, making network composition a fundamental constituent of network studies (Blau, 1977). However, it is argued that recent network composition studies have focused on organizational levels rather than the network level (McPherson et al.,

2001). In the present work, we intend to discuss the role of innovation content in the network structuration patterns.

Moreover, as mentioned by Bisgin et al. (2010), studies on homophily are positively related to sociology, and the applicability to other fields, is, therefore, limited. They discuss that most of the studies dealing with homophily are commonly carried out over a set of sociodemographic dimensions. The application of social influence variables jeopardizes the generalization of the results to other fields. Oliver (1990) discussed the need for a clear distinction between generalizable and IR-specific motivations for formation.

Considering the very source of IR network formation, Oliver (1990) and many other studies have discussed the positive impacts of collaborative behaviors on innovation capacity. Muller and Peres (2019: 3) stated that “the growth of an innovation in a social network is shaped by the network’s structure” and that “network structural characteristics should be incorporated into research on new market product growth as well as into managerial marketing decisions such as targeting and new product seeding”. It comes back to how the innovation content can influence the performance of a network and have impacts on the network structure.

More precisely, if we zoom further into the attributes at the node level, it is possible to see that not all nodes are equal; therefore, the impact on network structuration will be equal either. By social attributes, Muller and Peres (2019: 11) have identified three main questions regarding each node: “who one is, what one knows, whom one knows?”. However, although the main questions regarding network composition, meaning the analysis of attributes, seems to be clear in social network studies, they also underemphasize the singular characteristics of the research context. They tend to focus on single networks at one time.

Finally, Oliver (1990: 265) has discussed the future research directions implying the measure of market potential “in the context of the underlying social network is crucial to properly managing innovation growth.” Ansari et al. (2011) corroborated since researchers and practitioners are increasingly focusing on understanding and foreseeing the connectivity and interdependent patterns of such structures. Therefore, it is argued that future research on IR networks should shed light on the conditions that motivate or facilitate IR formation, and we intend to explain IR formation through the identification of attribute patterns at the organizational level. In addition to that, Zaheer et al. (2010) discuss the necessity to study

networks through a cross-level lens to shed light on the isomorphic effects across whole networks.

To summarize, what misses, is the analysis of organizational level analysis of network members, the depiction of similarities and dissimilarities amongst them at the node and tie level, the cross-level analysis considering the organizational level antecedent of IR network.

Finally, the literature suggests that understanding the network composition to identify similarities and dissimilarities in collaborative organizational behaviors requires a comparative analysis of IR patterns across several networks.

Based on the argument that industry emergence assessment is possible through IR network analysis, we intended to look at the lower level of analysis at the organizational level, if the network composition may also inherently explain structuration patterns in various networks.

Therefore, we propose the following research question to study network composition through a cross-level comparative analysis based on innovation content, organizational attributes, and determine whether organizational attribute may influence the strategic decisions of network members:

How could the innovation content explain industry emergence patterns in terms of IR types and choice of partners?

Consequently, we end up having three complementary research questions, which, when analyzed together, gave a comprehensive and dynamic understanding of industry emergence and structuration at different analysis levels.

Conclusion of Chapter 3

Consequently, we conjugate several key concepts to highlight the complexity of industry emergence and structuration mechanisms caused by disruptive innovation. We link the potential of scientific ideas with the pertinence of complex issues related to industry emergence arising from operational and academic experience.

We summarize the main theoretical gaps and the related research questions in Table 4.

We eventually identified research questions for the different analysis levels and intended to discuss the methodological and epistemological anchorage for multi-level network analysis in **Part II**.

Table 4. Summary of research directions and questions

Level of analysis	Research directions	Research questions
Macro level	<p>Research direction 1: The problem of the origin of an industry is not solved; there is a necessity to study emergence and structuration independently yet as part of a common process.</p>	<p>How could interorganizational relationship dynamics allow assessing <i>ex-ante</i> the patterns of industry emergence in a disruptive innovation context?</p>
	<p>Research direction 2: Industries are complex social systems composed of interorganizational relationship networks.</p>	
	<p>Research direction 3: Network analysis needs a multi-level analysis process assessing the macro and the meso levels equally.</p>	
Network level	<p>Research direction 1: Disruptive innovation should not be considered as a fatality, preferably as a variable to depict industry emergence</p>	<p>How do interorganizational relationship networks dynamics assess the structuration patterns of industry emergence caused by disruptive innovation?</p>
	<p>Research direction 2: The technological complexity of disruptive innovation could be analyzed through IR networks forming for each activity</p>	
Organizational level	<p>Research direction 1: There is a lack of studies intertwining cross-level comparative analysis of networks</p>	<p>How could the innovation content explain industry emergence patterns in terms of IR types and choice of partners?</p>
	<p>Research direction 2: There is a lack of understanding of why organizations tend to contract IRs, and the effects of organizational attributes on strategic path choices are not well identified</p>	

PART II: METHODOLOGY

The methodological issue logically imposes itself on management researchers since scientific research aims to produce objective knowledge. Moriceau and Soparnot (2019) argue that there is a recurrent debate opposing qualitative and quantitative methods. Nevertheless, the methodological choices gather a multitude of folders that we intend to present in **Part 2**.

Chapter 4 is dedicated to the research context as we describe the critical characteristics of the automotive industry. Chapter 4 aims to present the chronological evolution of the traditional automotive industry and the various changes this industry has faced and translated into a paradigmatic shift.

The historical retracement is purposeful to anchor our research in the autonomous vehicle, which is disruptive by comparing the traditional auto industry. It leads us to discuss the autonomous vehicle industry in greater detail in a dedicated section. In summary, we address the history and principles of autonomous driving, the necessary interaction between humans and machines, and finally present the potential for change of such a disruptive innovation. Then, we present the intrinsic motivations to choose the autonomous vehicles industry as a research field. The research context is essential as it prepares the field available to the researcher's' analysis and helps to identify the adequate methodological and epistemological anchorage necessary to mete out justice for the research field and research questions.

Chapter 5 aims to bring solidarity in the presentation of the research process. None research can be conducted without an epistemological anchorage that sustains the origin of knowledge and veracity of the produced information. On the first hand, we discuss the different epistemological paradigms that exist before scoping out our anchorage in the positivist paradigm. The positivist paradigm believes that general laws and rules can be discovered through the study of events and enable predictability for future events; therefore, it will enable us to analyze our quantitative data to depict major industry emergence patterns through the analysis of interorganizational relationships. Also, this paradigm fosters the possibility to effectuate multi-level analysis.

On the other hand, this chapter also builds the foundation of our methodological anchorage. Before presenting the anchorage of the present work in a quantitative methodology, we discuss various research methodologies and present why they are not suitable for this particular work. Finally, the assessment of different quantitative methods enabled us to select a more precise methodology to identify network patterns: the Social Network Analysis (SNA) methodology discussed in detail.

While **Chapter 5** gave the means to apply an SNA methodology successfully, **Chapter 6** discusses how we collected our empirical material. As a result, we have collected two types of data named sociometric data: the structural and attribute data. Therefore, Chapter 6 telegraphs the meticulous process of database construction, which is composed of several phases for each type of data indexed in two complementary yet different databases. We discuss the codification and pre-analysis of our raw data to understand the research findings transparent and meaningful.

Chapter 4. Research context

Part II represents a critical section of the present thesis in that it translates the intellectual and methodological path that has been followed to carry out the research. Beforehand, the presentation of the research field is necessary and is the purpose of **Chapter 4**. The present chapter is organized into three different sections.

In **Section I**, we discuss the automotive industry and the changes that this industry has encountered from its emergence until nowadays. The study of the historical evolution of the automotive industry allowed us to depict several significant waves of changes from its emergence to changes of consumption and production patterns with the globalization of the world, leading to environmental constraints weighing on automotive industry stakeholders, to finally, the raise of safety and security requirements to reduce pollution and road accidents.

The global overview discussed in Section I serves as a foundation to understand how and when the autonomous vehicles started to show growth. Indeed the rise of safety needs eventually announced the arrival of disruptive transportation means: autonomous vehicles, which are discussed in **Section II**. The study of the autonomous vehicle (AV hereafter) evolution showed that such vehicles are not entirely new, yet, their commercialization was hampered by technological and societal readiness. The in-depth presentation of the autonomous driving technology, the requirements of interaction between humans and machines, and the potential for change hold by AVs enabled us to describe autonomous vehicles as profoundly disruptive for the automotive industry and leads us to the following section where we discuss the motivations for choosing this particular research setting.

Finally, in **Section III**, we present the inherent characteristics making AVs an exciting disruptive innovation case, whether it be regarding technological, ethical, and social impacts, the effects of such a disruption on the vehicle concept, the growth opportunities for organizations, and finally, the privileged access to empirical data also served as a lever.

Section I. The genesis of the traditional automotive industry

In **Section I**, we intend to describe the evolution path of the traditional automotive industry towards a technology-intensive industry with electric and then autonomous vehicles. To do this, we will start by drawing upon the very beginning of the automotive industry and discuss the development due to globalized patterns of production and consumption. We will then present the effects of growing environmental constraints on automotive manufacturers and auto component suppliers and introduce an increasing need for safety features in vehicles leading to disruptive innovations that caused the emergence of a new industry.

1. Emergence of vehicles

1.1. Chronological emergence

The automotive industry emerged in the 1900s, and most historians confer that this period witnessed several milestones that shaped the automotive that we know today (Clark et al., 1987; Pong, 2009). The patented “Motorwagen” arrived on the market in 1885-1886 (Daimler, n.d) as the first internal combustion engine and was petrol-propelled. At the origin of this disruptive innovation shines Mercedes-Benz, which still plays a central role in the automotive industry. The “Motorwagen” is a three-wheeled cart equipped with an internal combustion engine and an electric ignition. It happened to be disruptive as compared to external combustion engines used before (Figure 13)¹

Figure 13. The Motorwagen (Daimler, n.d)



¹ Retrieved from <https://www.daimler.com/konzern/tradition/geschichte/1885-1886.html>

The success of this striking innovation provoked the creation of the world-renown automotive company Daimler in 1888. Nonetheless, the creation of the first automobile was not enough to create the automotive industry. Back then, automobiles were considered luxury products that not everyone could afford, thus constraining the automobile industry to a restricted audience and low sales as they were costly to make.

A few years later, things started to move on the other side of the Pacific Ocean, where Henry Ford introduced the Model T accompanied by an aggressive strategy during the launch. The Model T was mass-produced thanks to the invention of the first assembly line. Consequently, production costs started to drop, making vehicles more accessible assets for the mass population.

From 1908 to 1927, around 15 million Model T was produced, and it was the most extended production run for a car at that time until Volkswagen outperformed it with the Beetle model in 1972. Byrant University reported that by 1918 half of American car consumers were car owners.

In 1908, General Motors took its turn and made its appearance on the automotive market podium with the launch of the first Dodge Model 30 in 1914. The following years happened to be prosperous for the industry with the arrival of many small car companies, which did not produce a lot in volume.

When 1929 arrived, and the stock market crash hit, the bells of the Great Depression rang through the industry, eventually causing decreasing sales and the failure of up to half of all car organizations. However, this enabled the emergence of more consolidated, more extensive, and influential manufacturers than small and specialized ones. At this period, the ‘‘Big Three’’, composed of General Motors, Ford, and Chrysler, has seen the light.

After World War II, the way of seeing automobiles changed, and more and more people started to own one. During the war, car manufacturers have seen their production requisitioned and started to make vehicles for the armed forces, which enabled them to roll out significant technological innovations. These advancements notably served as a springboard for Japan and Germany by significantly increasing their growth and production.

In 1960, the automotive industry started to raise new problems, the first one being safety. Indeed, cars are made for transporting human lives, so the question of keeping lives safe quickly found its way to the automotive makers. Studebaker-Packard, a car manufacturer, introduced the seat belt on all its vehicles as standard equipment in 1964. The following years marked the contextual changes that we explain in the next paragraph.

1.2. Traditional automotive value chain

Between 1990-1991 the automotive industry bore the burdens of a global recession, where sales plummeted and opened a critical battle for market share.

The automotive industry refers to all the companies involved in the design, development, manufacturing, and marketing of motor propelled vehicles. It is composed of automotive original equipment manufacturers (OEM), tier suppliers ranging from 1 to 3 in most cases, automotive part manufacturers sequenced on the automotive value chain below (Figure 14).

Figure 14. Automotive Value Chain (Paunov & Planes-Satorra, 2019: 41)²

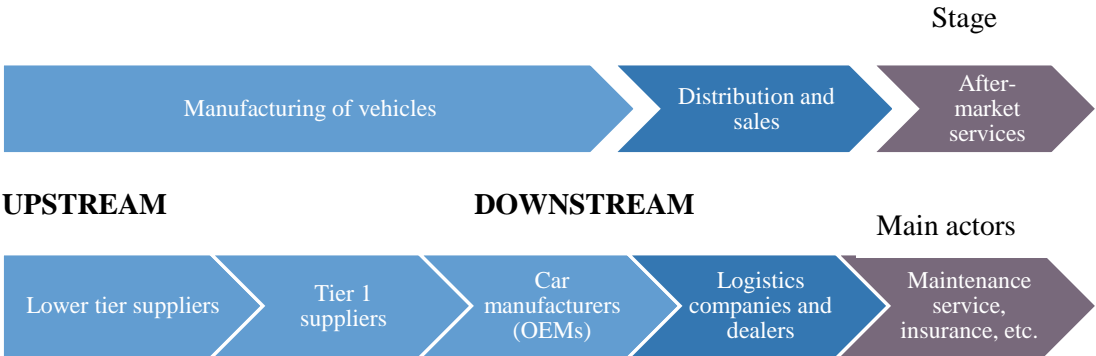

The value chain refines the interactions between upstream and downstream levels. Lower-tier suppliers (tier one suppliers), tier-one suppliers (direct suppliers of components and parts to OEMs), and original equipment manufacturers all concur to the manufacturing of vehicles.

Then, vehicles are dispatched to distributors and sold through logistic companies and vehicle dealers. The vehicle may require maintenance services, insurance, and reparations after being

² Paunov, C., & Planes-Satorra, S. (2019). How are Digital Technologies Changing Innovation?: Evidence from Agriculture, the Automotive Industry and Retail. *OECD Science, Technology and Industry Policy Papers*, 74, 2–53.

sold, which compound the after-sale service step. Each actor is a holder of a given specialized activity, and organizations interact vertically along the value chain.

Nevertheless, vehicles dating back to way earlier than the ones we know nowadays, and transportation started before the emergence of vehicles in the modern sense. We discuss the emergence of transportation and ICE vehicles in the following parts.

2. Globalization and its effects on the automotive industry

During the ensuing years, with the globalization of activities, car manufacturers reached high-efficiency levels due to the high demand for vehicles and decreasing costs due to low wages in Asian emerging countries. Vehicles that are produced for less were then exported across the world. The globalization enabled to widen the boundaries of the automotive industry. In term, globalization enabled the automotive industry to take another step forward by intensifying interorganizational competitiveness worldwide.

Automakers' willingness to get closer to their clients forced them to modify the way of working with suppliers and resulted in the modification of interactions between market players. (Lung, 2004)³ discussed that this new strategic turn influenced organizations' internal routines while driving them to focus on interorganizational relationships to get along with the coordination of activities within the industry. Along with managing the competition, automakers had to stress more on their core activities to preserve their competitive advantage. As discussed by Downing (2018)⁴, the non-cooperation between competitors forces companies to fight for resources and talent while addressing the competitive context.

The activity split enabled us to draw on a typology of the prominent trends that shape the traditional automotive industry structure. To summarize them, we will count on Lung's article from 2004⁵:

³ Lung, Y. (2004). The Changing Geography of the European Automobile System. *International Journal of Automotive Technology and Management*, 4(2–3), 137–165.

⁴ Downing, J. A. (2018). Dimensions of Competitive Advantage. *Journal of New Business Ideas and Trends*, 16(2), 1–9.

- OEMs are specializing in their core activities while peripheral activities are lent to tier-one suppliers or spin-off companies,
- Consequently, the outsourcing of peripheral activities created a crowded landscape of auto tiers, yet OEMs tended to keep their portfolio of tiers relatively small. It gave auto tiers greater responsibilities and a critical role in the value chain;
- Speaking of more significant responsibilities, tier-one suppliers became more and more involved in critical stages of design and definition of subsystems and components;
- Globally, the auto industry was synchronized to share production platforms enabled by the harmonized utilization of main components;
- Finally, tier-one suppliers localize, for the most part, close to the leading OEM customers. They agglomerate in industrial assembly sites and specialize in their plant for specific modules.

Highlighted by Clark et al. (1987)⁶, automakers entered a phase where reaching high economic performances and excellent innovation management competencies became the primary goal. This reveals that the automotive industry seized significant advantages from globalization due to the implementation of offshore facilities and the cooperation between consequent automakers and tier-one suppliers. The relationship between OEMs and tier-one suppliers lies at the heart of the automotive industry structuration. However, recent economic, environmental, and technological climate changes brought out new issues to be observed at that time; the consumer expectations' were limited to comfort, spaciousness, and safety more than fuel effectiveness, until the 1970s, when the world was confronted to the oil crisis that constrained automobile makers to improve their competencies in fuel economy. One can assume that the oil crisis predicted the future of the environmental conditions of the planet.

3. Emergence of electric vehicles

After nearly a century with internal combustion engine (ICE) vehicles leading the transportation industry, it seems now that the personal transportation sector is on the verge of

⁶ Clark, K., Chew, B., & Fujimoto, T. (1987). Product Development in the World Auto Industry. *Brookings Papers on Economic Activity*, 18(3), 729–782.

rapid growth in developing and commercializing electric vehicles (Brown et al., 2010, Lepoutre et al., 2019).

The stake that transportation plays in the rise of pollution worldwide has motivated governments and policymakers to impose Carbon dioxide reduction norms (Figure 15).

Figure 15. CO2 emissions by transportation modes in Europe (IEA, 2019)⁷

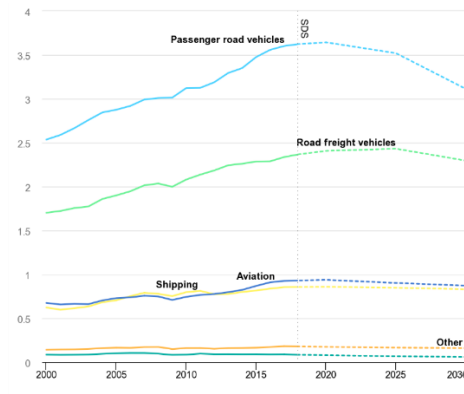

Figure 15 is a situational analysis of carbon emissions by modes of vehicles in Europe. It shows that passenger cars have emitted an increasing amount of carbon from 2000 to 2018, respectively, from 2.5 to 3.6 gigatons per year (1Gt = 1 billion metric tons). Second, come road and freight vehicles, such as trucks and other commercial vehicles with 2.4 Gt in 2018, followed by aviation (0.9 Gt) and shipping (0.9 Gt), others (0.2 Gt) such as pipelines and non-specified transports, and rail (0.1 Gt). The automobile industry has an essential role in the reduction of emissions caused by vehicles.

In 2019, over 97.000.000 vehicles were produced in the world. According to the United States Environmental Protection Agency (EPA), a typical passenger vehicle emits approximately 4.6 metric tons of Carbon dioxide every year. According to the World Health Organization, each year, 4.2 million persons died due to air pollution.

Therefore, the problems caused by transport pollution have been at the center of governments' concerns. Thus, many countries have released laws forcing consumers and automakers to make turning point decisions in the way they see vehicles.

⁷ Retrieved from <https://www.iea.org/articles/global-co2-emissions-in-2019>

More and more governments started to subsidize and grant consumers who wanted to buy an electric-propelled vehicle while also constraining automakers to make green vehicles through the implementations of laws.

India announced that the sale of ICE vehicles would be prohibited from 2030, while China aimed in 2040.

Along with the problems raised by public authorities, the structure and the composition of the automotive industry have drastically evolved. For instance, the Big Three's shining star has shut down with decreasing sales of General Motors, Chrysler's acquisition by Fiat, and the emergence of Asian brands such as Nissan, Toyota, and Honda. The American automotive market is no longer the pioneer region, letting room for European and Asian brands to glare.

Just as there are various technologies available for traditional ICE cars, electric vehicles also exist in different types. There are four types of electric vehicles (CAA National, n.d)⁸:

- Battery Electric Vehicles (BEV), which run entirely on a rechargeable battery and electric motor;
- Plug-in Electric Vehicles (PHEV), which run on a rechargeable battery in low speed, and ICE at higher speed;
- Hybrid Electric Vehicles (HEV), which have both an electric drive train with a battery pack, and ICE simultaneously turn the transmission and power the wheels. HEV is not recharged from the power grid; they recharge through the regenerative braking system;
- Fuel Cell Electric Vehicles (FCEV) rely on a fuel cell that creates electricity with hydrogen and oxygen.

After entering the industry in the first half of the decade, the sale of electric vehicles has rocketed. In 2017, the worldwide sales of electric vehicles reached 1.1 million units, making a 54% progress compared to 2016. China, a significant player in the modern automotive market, accounts for almost half of the total sales of electric vehicles. In Figure 16, we present the evolution of BEV and PHEV sales in China, Europe, and the United States.

⁸ Retrieved from <https://www.caa.ca/electric-vehicles/types-of-electric-vehicles/>

Figure 16. Passenger cars sales and market share in the largest electric vehicle markets (IEA, 2020)⁹

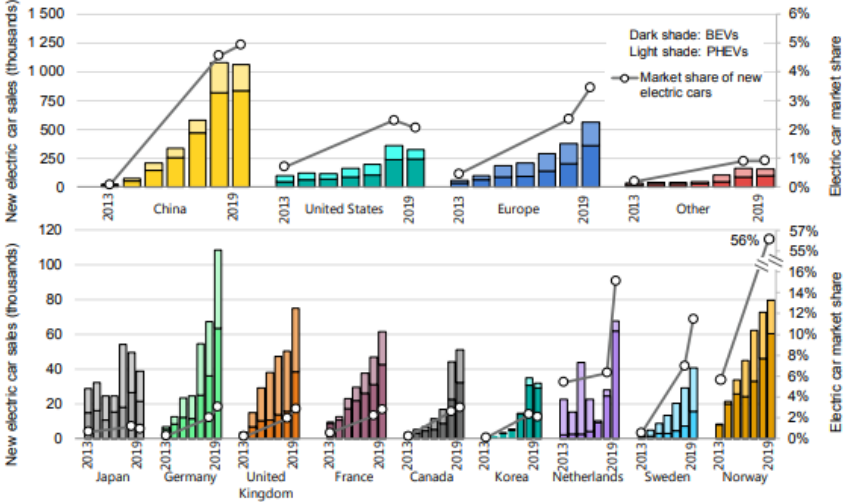

Figure 16 illustrates the increasing market share of electric vehicles for almost all major markets: Japan, Germany, United Kingdom, France, Canada, Korea, Netherlands, Sweden, and Norway. In parallel, there is a noticeable increase in EVs sales in China, which increased from almost nothing in 2013 to 1,000,000 in 2018.

It goes to Europe and the US to a lesser extent. EVs sold between 2013 and 2019 follow a slight increase curve, yet give the information about a growing industry.

In terms of industry structuration, vehicles' electrification also brought new industry players into the competitive landscape. Byton and Tesla are pioneering the electric vehicle segment for high-end cars, while the French automaker Renault propelled its name into the EV industry with the success of the Renault Zoe, a 100% electric vehicle propelled with a lithium-ion battery and an electric engine. The modern global automotive industry refers to the traditional industry players such as GM, Ford, Honda, Daimler, and BMW.

Van den Hoed and Vergragt (2005)¹⁰, in their paper, studied how fuel cell vehicles (FCV) gain popularity. Back to 30 years before, battery electric vehicles (BEVs) or “zero-emission

⁹ Retrieved from <https://www.iea.org/reports/global-ev-outlook-2020>

vehicles” were seen as the rare pearl to reach a “battery society”. Back then, several automakers thought that fuel cell technology was unrealistic (ibid), while today, every respectable automotive manufacturer works on its own FCV program. It is an indisputable fact that there is a willingness to make things move within the auto industry as it faces many challenges. Population moving in urban areas and demand for mobility following an upward trend led to new needs.

On another note, the European Economic and Social Committee published an article in 2017¹¹, where four central challenges of the auto industry were listed. Among them, electromobility and ‘de-carbonization’ of transport, the digitalization of the production processes through the development of Industry 4.0, will enable to cut costs, save energy and support sustainable strategies, last but not autonomous and connected vehicles are in sight.

The following section focuses on autonomous vehicles, as they are the innovation that disrupted the automotive industry. However, their emergence is owed to the increasing pressure weighed on automotive companies to reduce road accidents by administrating vehicles an increasing amount of driver’s assistance modules. We discuss the growing requirements to increase road safety and the premonitory signals they represented for the future autonomous vehicle industry.

4. Premonitory needs for safety and the emergence of autonomous vehicles

In 2020, Litman¹² mentioned the positive impacts of autonomous vehicles on the economy and environments. He highlights the user-friendliness of autonomous vehicles and their effects on the decreasing congestions in urban areas. Indeed, over the years, studies suggested

¹⁰ van den Hoed, R., & Vergragt, P. (2005). Technological Shifts and Industry Reaction: Shifts in Fuel Preference for the Fuel Cell Vehicle in the Automotive Industry. In P. Dewick, M. Miozzo, G. Kenneth (Eds.), *Technology, Knowledge and the Firm: Implications for Strategy and Industrial Change* (pp. 126–151). Edward Elgar Publishing.

¹¹ Retrieved from <https://www.europarl.europa.eu/cmsdata/141562/GEAR%202030%20Final%20Report.pdf>

¹² Litman, T. (2020). *Autonomous Vehicle Implementation Predictions, Implementations for Transport Planning* (pp. 3–39). Victoria Transport Policy Institute.

that human error causes 93% of traffic accidents and that AVs by overtaking human's responsibilities will drastically reduce the stake of humans' in accidents.

Amongst fatal errors, Fagnant and Kockelman (2015)¹³ quoted alcohol, distraction, drugs, and fatigue. They also suggest that AVs will reduce at least 40% of accidents attributable to these fatal human errors. In 2015, the World Health Organization suggested that AVs could reduce 1.25 million annual road accidents while also assisting those that cannot drive, such as the elderly, younger populations, and disabled persons.

Yang and Coughlin (2014)¹⁴ discuss the advantages of AVs in cases where driver aging causes the loss of critical faculties for driving, such as sight and hearing. According to Yang and Coughlin (2014: 335), "all visual functions deteriorate, including static and dynamic visual acuities, contrast sensitivity, night vision, peripheral vision, visual scan, and glare resistance" due to aging.

Besides, research suggested the critical role of hearing that tend to decline with age. Through the ordinary course of aging, humans tend to show less sensitivity to high frequencies and present risks of not to hear urgent appeals from the outside.

In terms of traffic decongestion, it is considered by anticipating congested roads and the braking of lead vehicles. Fagnant and Kockelman (2015) discuss how by foreseeing the braking action of the lead vehicle, AVs can adjust speed and brake smoothly when necessary. This will lead to fuel savings, smoother traffic, and more efficient brakes and driving equipment. They also indicate that AVs could reduce traffic congestion by 8 to 13% and increase fuel efficiency by 23 to 39%.

Considering the technological disruption and the advantages, organizations have all vested interest in autonomous vehicles. Nevertheless, as discussed, the complexity of the technology makes it a tight right party for organizations wanting to take part in this industry. However, growth opportunities are there, and organizations are willing to take the opportunity.

¹³ Fagnant, D. J., & Kockelman, K. (2015). Preparing a Nation for Autonomous Vehicles: Opportunities, Barriers and Policy Recommendations. *Transportation Research Part A, Policy and Practice*, 77, 167–181.

¹⁴ Yang, J., & Coughlin, J. F. (2014). In-vehicle Technology for Self-driving Sars: Advantages and Challenges for Aging Drivers. *The Korean Society of Automotive Engineers*, 15(2), 333–340

Conclusion of Section I

Section I is a way of getting into the discussions around the research field and legitimizing our choice for this particular research field.

In conclusion, we argue that we have reached the intended purpose of Section I by providing a historical presentation of different waves of changes that the automotive industry has witnessed.

This section traced back the historical background of the automotive industry until its disruption with autonomous vehicles. To attribute a proper review of the automotive industry history, we start with the very origins of cars and the emergence of internal combustion engines (ICE) vehicles, fed with fossil fuels such as gasoline, diesel fuel, or fuel oil. Until then, automakers' success was owned by automakers such as Ford, General Motors, Fiat, and Chrysler, and the value chain was customer-supplier, like between OEMs and auto tiers.

Then we have looked at the effects of globalization and the impacts of automobile production. At that time, governments were soon to acknowledge environmental constraints, yet the tendency strengthened in the 2000s. Increasing CO₂ emissions imparted by the WHO showed the growing role of transportation in the global pollution figures. As a result, many governments have announced the ban of ICE vehicles in their most significant cities shortly. Adding to environmental constraints, auto companies are nowadays confronted with the increasing safety level imposed by governments. All of these points enable us to attain the final element of the automotive industry, which is the disruption administered by the emergence of autonomous vehicles (AVs).

Understanding the organization and structuration of the traditional automotive industry will reveal the very changing patterns of the automotive industry after the disruption. Therefore, the pursuing section discusses the inherent characteristics of autonomous vehicles and the intrinsic difficulties imposed by autonomous driving

Section II. The autonomous vehicle industry

In the previous section, we conferred the historical background of the automotive industry, and our discussions highlighted the significant changes this industry has encountered over the years. In recent years, the automotive industry is facing some drastic changes that alter the very basics of visioning a vehicle.

Section II aims at giving a synoptic view on autonomous driving, the history, critical characteristics, the implication of a robust human-machine interaction, and the potential for change that such a disruptive innovation implies.

In terms of historical background, we first define what an autonomous vehicle is and how and when it started to appear in studies. We highlight several significant works on machine visions (Dickmanns, 1998, 2002)¹⁵, which decades ago predicted the challenges of such vehicles. We present significant projects imparted by several institutions to identify the very premises of such technology and follow by describing the current state of the technology by addressing the main principles of autonomous: the human and machine interaction. Therefore, we discuss the levels of autonomy developed by the SAE (2014)¹⁶, which describe the sequential transfer of driver's responsibilities to the autonomous driving system.

Finally, this section is closed with the discussions concerning the challenges we have identified for a global implementation of AVs, whether social, ethical, and political.

1. History of autonomous driving

1.1. Technological emergence

Nowadays, people drive their cars to do almost every daily task. In the same way, world economies largely depend on good deliveries by cars and trucks. There is a consensus that

¹⁵ Dickmanns, E. D. (1998). Vehicles Capable of Dynamic Vision: A New Breed of Technical Beings? *Artificial Intelligence*, 103(1), 49–76.

Dickmanns, E. D. (2002). The Development of Machine Vision for Road Vehicles in the Last Decade. *Intelligent Vehicle Symposium*. Versailles

¹⁶ SAE International. (2014). J3016: Taxonomy and Definitions for Terms Related to On-Road Motor Vehicle Automated Driving Systems. Retrieved from https://www.sae.org/standards/content/j3016_201401/

transportation is taken-for-granted, yet the effects of road injuries and Carbon dioxide emissions have not lessened in the past decades (Forrest & Konca, 2007)¹⁷. As urban populations grow, cities face saturation in traffic, which has many adverse effects. Research on autonomous driving used to be driven and still is motivated by the host of reasons discussed in the previous paragraph. Even though the number of accidents deaths decreases nearly in most European countries every year, the number of the worldwide number of road injuries is enough to push for a further secure mass transportation mode.

Owczarzak and Żak (2015: 473)¹⁸ define autonomous vehicles as “unmanned (driverless) vehicles that move without human intervention and use for this purpose several high-tech sub-systems and devices”; so an AV incorporates the capability to “drive partly or fully by itself, with limited or no human intervention” (European Commission, 2017)¹⁹. They are also called “autopilot, driverless car, auto-drive car, or automates guided vehicle (AGV)” (Forrest & Konca, 2007:4).

The first autonomous vehicle development occurred in 1977 with an automatically operated car developed by the Tsukuba Mechanical Engineering Lab in Japan. It was the first pioneer automatic driverless car to achieve up to 20 miles per hour. The automatically operated car achieve autonomous transportation by tracking the white street markets with a machine vision system.

The following year, Ernst Dickmanns, together with his team at the Bundeswehr Universität München, sourced significant autonomous driving development advances. The prototype that they proposed reached 60 miles per hour on the roads. Dickmanns (1998, 2002) focused on developing autonomous driving, the feature of extraction in dynamics scenes, and dynamic vision for AVs. His work led to identifying the 4-D approach, which pictures the four image processing stages to achieve image evaluation efficiency. He predicted the potential of testing

¹⁷ Forrest, A., & Konca, M. (2007). *Autonomous Cars & Society* (pp. 3–46) [Interactive Qualifying Projects]. Worcester Polytechnic Institute.

¹⁸ Owczarzak, Ł., & Żak, J. (2015). Design of Passenger Public Transportation Solutions Based on Autonomous Vehicles and Their Multiple Criteria Comparison with Traditional Forms of Passenger Transportation. *Transportation Research Procedia*, 10, 472–482.

¹⁹ Corallo, A., & Protopapa, S. (2007). Business Networks and Ecosystems: Rethinking the Biological Metaphor. In *Digital Business Ecosystems: The Results and the Perspectives of the Digital Business Ecosystem Research and Development Activities in FP6* (pp. 60–64). European Commission.

and simulation systems to understand what will happen on larger scales. At that time, Dickmanns listed the principles of autonomous driving, as illustrated in Figure 17.

Figure 17. 4-D Approach to dynamic machine (Dickmanns, 1998: 60)

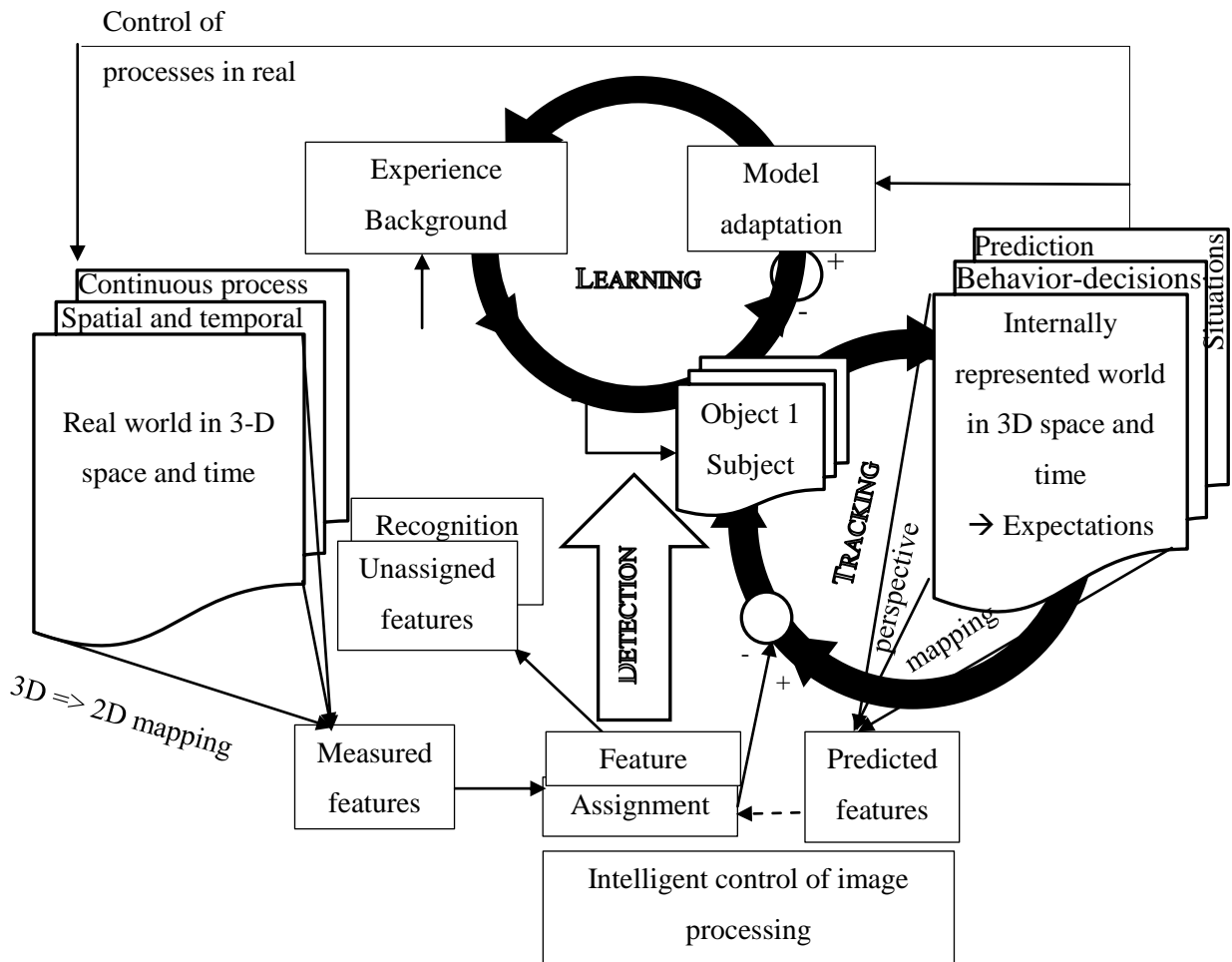

The 4-D approach to machine vision shows that the primary interest of autonomous driving systems is in temporal processes composed of objects and subjects. The approach illustrates three critical activities that run simultaneously in autonomous vehicles: the detection of objects (1), tracking of objects and state estimation (2), and learning from observation (3).

On the first hand, the model schematizes the detection of typical features not yet categorized in already tracked objects. When new features are collected, and the collection becomes stable, these objects are recognized and categorized into a new object. The new object is subjected to an object hypothesis and is added to regularly faced objects.

Simultaneously, the model pictures the tracking of objects and state estimation in the lower right of Figure 17. The objects list serves as the output through a single step prediction of the internal representation of the world in 3D space and time. Space implies the “where”; therefore, the signal path focusing on motion in both translational and rotational degrees.

Learning from observation is carried out with the same data as for tracking; yet, learning from observation implies a low-frequency estimation that measures constant parameters and batch processing of the stored data. It will open opportunities for algorithm and new architecture development to make vehicles more autonomous.

At that time, autonomous vehicles were already considered multi-technological innovations, where the need for multi-dimensional data collection, analysis, and learning from observation was crucial.

1.2. Critical autonomous vehicle development projects

Another milestone in the emergence of autonomous driving technology occurred in 1997 with the AHS’ autonomous vehicle demonstration in 1997. The US National Highway System Consortium presented a proof of technical feasibility of autonomous vehicles requested by the US Congress (Thorpe et al., 1991)²⁰. The motivation of the project was, most importantly, anchored in the necessity to build automated vehicles to improve safety on roads and reduce congestions in urban areas. Already, technologies such as vision-based road following, currently known as lane-keeping assist system, lane departure warning, radar reflective strip following, and radar-based headway maintenance, were under the demonstration.

During the 1990s, the first efforts to automated vehicles were made in Europe, Japan, and the US. Many significant projects succeeded in one another, which Forrest and Konca (2007: 10) listed in their work (Table 5).

²⁰ Thorpe, R., & Holt, R. (2007). *The SAGE Dictionary of Qualitative Management Research*. Sage Publications.

Table 5. A chronological listing of main AV projects (Forrest & Konca, 2007: 10)

Date	Event	Information
1977	Tsukuba Mechanical engineering lab developed the first AV	It attained speeds of up to 20 miles per hour by detecting white street markings of up to 50 meters.
1980's	Dickmann's work	Vision-guided Mercedes-Benz robot van could approach 60 miles per hour on the streets without traffic.
1987-1995	PROMETHEUS Project (the largest autonomous vehicle project ever)	The prototype car achieved speeds of more than 110 miles per hour on the German motorway. Unlike most early robot vehicles, it drove in traffic, carrying out maneuvers to pass other vehicles.
1995	CMU Navlab "No Hands Across America Project"	The car made almost 3,000 miles 98.2% autonomously. Throttle and brakes needed human control.
1997	AHS Demo'97	More than 20 fully automated vehicles operated on a highway in San Diego, California
2000-2002	CARSENSE	The project focuses on slow-speed driving in more challenging conditions, such as traffic jams.
2000	AHSRA Demo 2000	Thirty-eight vehicles, busses, and trucks have demonstrated the optimal method for minimizing road injuries utilizing driver knowledge and control assistance systems. The automation system used magnetic sensors on the street.
2000-2003	CHAMELEON	The system consisted of an obstacle detection sensor module (vision system, medium-range radar, laser, short-range radar) and a crash prediction processing module (control unit). Application vehicles are built to be used onboard with an advanced passive protection system.
2001	DARPA Demo III	The project demonstrates unmanned ground vehicles potential to cross miles of rough off-road terrain, avoiding obstacles like rocks and trees.
2001-2004	ARCOS (Research Action for Secure Driving)	The goal of this project was to reduce accidents by 30%. The key roles were as follows:

		<ul style="list-style-type: none"> -regulation of inter-vehicle distances; - avoid accidents with fixed or slow-moving objects; -avoiding the departure of the lane; -alerting other cars of accidents.
2001-2004	CarTALK 2000	This European project worked on new driver assistance systems based on inter-vehicle connectivity.
2001-2005	INVENT (Intelligent traffic and user-oriented technology)	The main goal of this project was to optimize traffic flow and safety using intelligent and user-friendly systems. The prototypes were evaluated in Magdeburg, Germany, in April 2005.
2004-2008	PREVENT	This project aims to create and review safety-related applications using existing devices incorporated into onboard driver assistance systems. PREVENT will alert the driver of emergencies and take action if the driver does not respond.
2005	DARPA (The Defense Advanced Research Projects Agency) Grand Challenge II	It was planned to be a race in the desert environment with no traffic. The GPS points predefined the course, and the obstacle forms were identified beforehand. Stanford University has won the race.

All these projects agreed on three critical points: safety, connectivity, and autonomous driving capabilities, based on the principles of human and machine interactions. We discuss these critical concepts in the next paragraph.

2. Interaction between human and machine

“Humans represent knowledge and learning experiences in the form of mental models” (Wolf, 2016: 103)²¹. This cognitive interpretation of psychology and information is a fundamental model for understanding and designing human-machine relationships. The cognitive perceptive of humans enables us to identify how humans process information, i.e., how fast is the information received, how it is stored, which kind of information the human brain

²¹ Wolf, I. (2016). The Interaction Between Humans and Autonomous Agents. In M. Maurer et al. (Eds.), *Autonomous Driving: Technical, Legal and Social Aspects* (pp. 103–124). Springer.

perceives as critical or trivial. Besides, understanding the mental models of humans is a way to conceptualize the representations of knowledge and foresee the interactions between humans and machines.

In that sense, vehicle autonomization changes the demands on the driver's cognitive system, and as the degree of autonomy of vehicles increases, drivers' function is replaced by automated driver systems (ADAS). Several organizations have focused on autonomy classifications, such as the Society of Automotive Engineers (SAE), the International Association of Manufacturers of Motor Vehicles (OICA), and the National Highway Traffic Safety Administration (NHTSA).

Amongst the various classification, the SAE J3016-201401 issued in 2014 (SAE International, 2014) is the most used ones as they have been defined together with the National Highway Traffic Safety Administration (NHTSA) and adopted by the Department of Transportation (DOT) in the United States.

The SAE is a non-profit organization operating in educational and scientific fields. The 90,000 engineers focus their research around mobility technology to better move humans with automobiles, trucks, and busses for road transport.

Despite being disruptive, AV development will be evolutionary. As such, five levels of automation were developed by the SAE (2014): no driving task automation, active driver assistance, partial automation, conditional automation, high automation, and full automation. The SAE classification is the most used as it proposes a harmonized system to describe autonomy levels with the respective technological applications for each level.

The J3016-201401 issued in 2014 is a taxonomy defining the terms related to autonomous vehicles. Ratified several times, the last version was issued in 2019 and is compounded with five autonomy levels, which distribute the driving responsibilities between the driver and the Automated Driver-Assistance Systems (ADAS). Each level is singular thanks to the driver supports systems with which it is equipped. From levels 0 to 2, the SAE refers to automation levels, whereas levels 3 to 5 are automation levels.

ADAS can “take over the control from the human on assessing any threat; perform easy tasks (like cruise control) or difficult maneuvers (like overtaking and parking). The greatest

advantage of using the assistance systems is that they enable communication between different vehicles, vehicle infrastructure systems, and transportation management centers” (Kala, 2016: 59). Each level is equipped with different ADAS (Figure 18).

Figure 18. SAE Levels of autonomy (SAE, 2019)²²

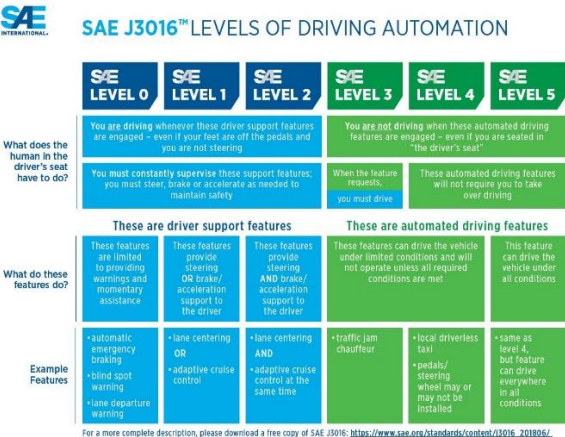

In levels 0, 1, and 2 in blue, the driver is asked to do essential driving tasks such as steering the wheel, braking, and accelerating. The driver maintains the driving tasks but is supported by light ADAS. Hence, at level zero, alerts and temporary assistance are issued to the driver, such as automatic emergency braking (AEB), blind-spot warning, and lane departure warning (LDW).

In level 1, the driver benefits from functions such as lane centering or adaptive cruise control (ACC) for steering or braking or acceleration.

At level 2, he profits from individual assistance with simultaneous lane centering and adaptive cruise control for steering, braking, and acceleration.

In contrast, in levels 3 to 5, the drivers are not asked to drive when the autonomous driving systems are engaged. At level 3, AVs reach conditional automation; the highway chauffeur or the traffic jam chauffeur will replace the driver in given situations (i.e., on the highway,

²² SAE Standards News: J3016 Automated-driving Graphic Update (2019). Retrieved from <https://www.sae.org/news/2019/01/sae-updates-j3016-automated-driving-graphic>

during traffic jams). Indeed, in level 3, even though the driver is not required to drive when the system is activated, he must take over driving tasks when the autonomous driving systems require him to do so.

In level 4, the driving tasks are entirely undertaken by the vehicle, which does not require the driver to take over. At this level, the vehicle corresponds to high automation as the vehicle is equipped with autopilot systems that mimic a driver's behavior and do not need the driver's action to drive autonomously.

Ultimately, AVs will reach level 5 of full automation, and the vehicles will serve as robots to transport people where no drivers' seat is available. From levels 0 to 3, the vehicle requires a licensed driver, whereas it is not needed in levels 4 and 5 (SAE, 2014).

These levels of autonomy testify that AVs are complex technologies far from being similar to the traditional vehicle. ADAS systems are sophisticated technologies that require new components and architectures. Altogether, software and hardware of new types constitute the autonomous vehicle and render the development and commercialization tough due to limited knowledge of incumbents on such technologies.

Since any disruption is a move from habits and what is already known, they come with a set of challenges to overcome. Even more so, when the innovation is far from being familiar to every stakeholder, whether governments, companies, and users. We discuss the main challenges of autonomous driving in the next paragraph. We address the political, legal, and ethical challenges raised by AVs.

3. Challenges for large-scale implementation

According to the most used definition, an autonomous vehicle is such a vehicle that can drive by itself. From a technological standpoint, 'autonomy' refers to a technical concept in which the human input is balanced out with an automated driving system. Therefore, the automated driving system is a technical element that performs tasks without being dependent on the driver. As describe in previous paragraphs, several autonomy levels dictate the level of responsibilities given to the vehicle, yet this poses several issues at the political, legal, social, and ethical aspects. All these challenges, however, represent impressive drivers for change.

3.1. Political, legal, and social aspects

Autonomous vehicles are one of the most apprehended technological development of the last decades. However, the emergence of the AV industry both influenced, yet also is, regardant on the development of regulatory policies to frame such a risky technology. When neither governments nor OEMs want to tackle the regulatory battle imposed by AVs, the technology faces challenge the need to prove technological reliability and safety. In the study of the political and legal aspects of AVs, we came across a regulatory patchwork, where some governments or states take actions, others categorically refute the possibility of autonomous driving in the future. It is the case in India, where the government is against any technological innovation that would be harmful to existing jobs (i.e., taxi drivers).

From a political and legal standpoint, the regulatory patchwork translates into less attention from the European Commission, which links the questions concerning autonomous driving to a more macro concept of innovativeness and performance, rather than a particular case to study independently. Several documents have been published on this matter but focus instead on the challenges of such technology rather than a precise action plan.

On the contrary, when looking up to the USA, the regulatory landscape is more dynamic. It bears the USA at the rank of the most advanced region for AV technology due to Google's regulatory and technological lobbying in the 2010s. Several states registered regulation passes such as California, Michigan, Nevada, Florida, and the District of Columbia, while some encountered failure such as Arizona, Colorada, New Hampshire, and Texas.

On the Asian continent, the tendency is closer to the American dynamics than to the European Union's lethargic actions on this matter. Japan and China, which are well-known for their robotics and electronics expertise, have followed the USA, and Japan, in collaboration with Nissan, had tested the first AV in 2013.

Several other countries, such as Germany and Sweden, have been considering legislative action on sections of the highway or cities to facilitate AV testing.

The regulatory aspects of AV pass beyond cars and bring questions regarding the insurance of vehicles, the liabilities in case of accidents, vehicle manufacturing regulations and norms, the

infrastructure of cities, and all other the peripheral aspects touching directly or indirectly the concept of transportation.

In terms of social implementation and acceptance of AVs, several majors questions are raised by scholars and practitioners. For instance, Strömberg et al. (2018: 2)²³ consider that AV will become “social entities in traffic” that OEMs will need to consider to transform them into entertainment pods (Bissell et al., 2020)²⁴. While studies on AVs have considered that the commute time is wasted, it does overlook the tendency of users to carry out additional tasks while driving in congestions; for instance, it has been proven that many business people start conference calls while driving.

Other questions concerning autonomous driving highlighted that if transportation becomes autonomous and accessible to all, countries and cities will experience decreasing general country and state funds with a decreasing amount of driving license registrations, loss in revenues generated by meter and parking fees, infraction violation, and suppression of jobs.

3.2. Importance of ethics

Based on the fundamental definition of AVs, they are such vehicles that ought to be able to navigate autonomously without putting lives in danger. Replacing the human decision-making process with machines raises several challenges that need to be overcome. Arguably, some decision-making processes are not reducible to artificial intelligence algorithms that replicate traffic rules, plotted pathways, and predicted possible situations, yet they ask for a sense of ethics (Lin, 2016). In the shadow of what precedes, autonomous vehicles, therefore, raise questions regarding their ethical validity. To illustrate the argument, let us propose a crash scenario that an AV can encounter, as rare as it might be.

Let us imagine a scenario where an autonomous vehicle drives in the city and encounters a critical situation where it turns left and strikes an older adult or turns right and strikes a young kid. Given mechanical explanations and the vehicle’s velocity, both humans have no chance

²³ Strömberg, H., Pettersson, I., Andersson, J., Rydström, A., Dey, D., Klingegård, M., & Forlizzi, J. (2018). Designing for Social Experiences with and within Autonomous Vehicles – Exploring Methodological Directions. *Design Science*, 4(13), 1–29.

²⁴ Bissell, D., Birtchnell, T., Elliott, A., & Hsu, E. L. (2020). Autonomous Automobilities: The Social Impacts of Driverless Vehicles. *Current Sociology*, 68(1), 116–134.

to survive to the potential impact. If the vehicle does not have indications to decide, both humans would be killed on impact. Consequently, the vehicle ought to decide: swerving right will kill the older adult, and swerving left will kill the kid. For some people, it is more acceptable to strike older adults. The argument is that the older adult has already lived a full life, experienced things in life, had a family of his own, while the kid still has a long way to go, a life to live, meet people, work and have a family. It might seem more natural to choose the kid's life over the older adult's one. However, this causes several issues at the ethical level. First, one might argue that the older adult's life is valuable, and it might be random to compare the value of life according to the age attribute. Reciprocally, the kid also has the right to live, and accidental situations should not force the vehicle to perform erratically.

The behavior of algorithms based on the personal traits of people involved in the atypical situations seems to cause critical issues since the Institute of Electrical and Electronics Engineers (IEEE)²⁵ stated the importance “to treat fairly all persons and to not engage in acts of discrimination based on race, religion, gender, disability, age, national origin, sexual orientation, gender identity, or gender expression.” As a result, the suppression of personal traits of people involved in situations encountered by AVs pushed towards the implementation of new standards.

From a different perspective, the vehicle may choose the target so that it protects its occupants. In that case, the vehicle would strike the lightest obstacle, which happens to be the kid in the present case. The choice to target the lightest obstacle is explained by the willingness to reduce the harmful impact of the potential collision.

As much as AV optimists would argue that the dilemma presented above should not happen with the help of autonomous vehicles operating at a large scale, it may be argued that such vehicles would eventually be confronted with radical decisions implying ethical dimensions. In the lower levels of autonomy, the vehicle may decide to stop or give the driving responsibilities back to the driver, yet in higher levels of autonomy (levels 4 and 5) where no driver is required on the drivers' seat; the vehicles are confronted to situations where braking and stopping the car are not the safest things to do. Indeed in given situations, braking may

²⁵ Retrieved from <https://i2mtc2020.ieee-ims.org/ieee-code-ethics>

cause more harm than good in cases of wet roads and close vehicles driving in the back, for instance.

Independent of what anyone may say, programming a vehicle to choose a target over another seems to respect a “targeting algorithm” (Lin, 2016: 72). Indeed, the decision to preserve human lives depend on subjective attributes to decide which one of two distinct elements should survive or die.

As far as ethical questions are far from our research questions, they remain critical questions closely related to the success of autonomous vehicles. The implementation of ethical codes from autonomous driving should be monitored by industry experts, together with institutions.

Whether from a technological, legal, ethical, or social standpoint, autonomous vehicles have a great potential for change and provide very interesting analysis elements. As much as the previous paragraphs witness the disruptive side of AVs, we aim to discuss in more detail the choice of this particular research context in the next paragraph.

Conclusion of Section II

Section II had the purpose of giving a synoptic view of the autonomous vehicle industry. The general purpose was to present the historical background of such a futuristic-like technological based on seminal works published in the 1970s. The historical analysis showed that AVs are considered a fundamental technology to reduce road accidents, congestion in urban areas, and pollution often deplored by the World Health Organization.

The AV industry's chronological consideration showed a consensus about a sophisticated technology requiring many paths of expertise for the final value proposition to become a reality. The discussion around the different levels of autonomy and the increasing amount of technology (software and hardware) underlines the move from very mechanical ICE vehicles towards highly connected autonomous vehicles. That alone shows that AVs are highly disruptive for automotive companies and raise several questions about the future of mobility.

The growing amount of technology incorporated into AVs, accompanied by the paradigmatic change in the way of transporting people, such vehicles come with a set of challenges to overcome to sustain a large-scale implementation. Amongst them, we have addressed political challenges with governments' difficulties in implementing the right amount of resources and times to emerging technology. In terms of social challenges, we highlighted the turbulences caused by an ever-changing society and the lack of trust of users in the still-emerging and structuring autonomous driving technology. Finally, we present the major ethical challenge that AV raises in algorithm determination and implied objectivity.

Section III. Justification of the research setting

The detailed presentation of the autonomous vehicle industry led us to discuss further the choice of this particular emerging industry and the elements that render its study insightful.

This paragraph discusses the concrete motivations and expectations from a fascinating case that the autonomous vehicle industry represents. First, we argue that AVs represent an exciting disruptive innovation case and relate to our literature anchorage. Secondly, we present the growth perspective of this industry, making the study of its emergence all the more interesting. The analysis of companies' perception of this emerging technology enables us to identify AVs as promising technologies that disrupt a robust traditional automotive industry. Our third argument addresses the effects of AVs on the concept of vehicles. It adds to the necessity to seize and capture the emergence of such an industry for incumbents and new entrants. Lastly, we will discuss our privileged access to a large number of specialized materials about AVs.

1. A disruptive innovation case

In 1969, John McCarthy, one of the founding fathers of Artificial Intelligence (AI), discussed the future of vehicles in his essays entitled *Computer-Controlled Car*. He predicted that vehicles will be equipped with an 'automatic chauffeur' and hinted a future where cars will not need a driver to progress.

Whatever one might say, autonomous vehicles have gone from being in science fiction movies to real life. Autonomous vehicles, also called 'self-driving cars' or 'robotics,' refers to vehicles, which carry out driving tasks in an automated way and which, at some point, do not need drivers to run smoothly.

Indeed as the final goal is to replace the driver, vehicles have to exercise the same capabilities as humans, such a seeing, predicting, and acting when needed. At a technological level, this implies that the car is equipped with sensors and captors, navigation data processing systems, and system software, for instance. Even if the driver's seat is empty, the car should locate, move, stop, start, and carry numerous actions autonomously yet safely.

In that sense, the SAE levels of autonomy presented in the previous paragraph integrate responsibilities for the driver and the autonomous driving systems. However, the takeover of the autonomous driving system and the driver's disempowerment require a high level of hardware and software equipment. These autonomous features gradually act as the vehicles' eyes to monitor the environment, brain to process the collected data, hands to steer the wheel, and feet to brake and accelerate. Therefore, AVs are disruptive by definition as they change transporting people from point A to point B. In that sense, the automotive industry faces disruption at several levels.

First, in terms of embedded technologies, AVs are utterly different from traditional vehicles as their components and modules are based on autonomous driving systems that are highly artificial-intelligence-dependent.

Second, which is a consequence of the first disruption, invalidity of paradigms in the automotive industry landscape invaded with new entrants that may or may not be from the automotive industry in the first place. AVs follow a 'sense-plan-act' design of which every robot system is composed. Transforming the vehicle from transportation to a robot destined to drive itself disrupts the traditional automotive industry and in mindsets.

Consequently, the AV industry is a schism between the automotive industry, telecommunications, and information technologies (Heineke et al., 2017)²⁶. One company might not have all the knowledge necessary to bring autonomous vehicles on the market alone. Indeed, AVs, by definition, represent a highly complicated technology at which incumbents may not be experts. To make vehicles drive autonomously, i.e., drive without a driver, companies have to equip vehicles with a cohort of sensors and cameras (i.e., long-range radar, LIDAR, Camera, short/medium-range, ultrasound) to feed the ADAS (Figure 19), such as Lane Keep Assist, Valet Parking and Emergency Braking Systems.

²⁶ Heineke, K., Kampshoff, P., Mkrtychyan, A., & Shao, E. (2017). Self-Driving Car Technology: When Will the Robots Hit the Road? *McKinsey & Company*, 1–11.

Figure 19. AV equipment (OECD, 2015: 11)²⁷

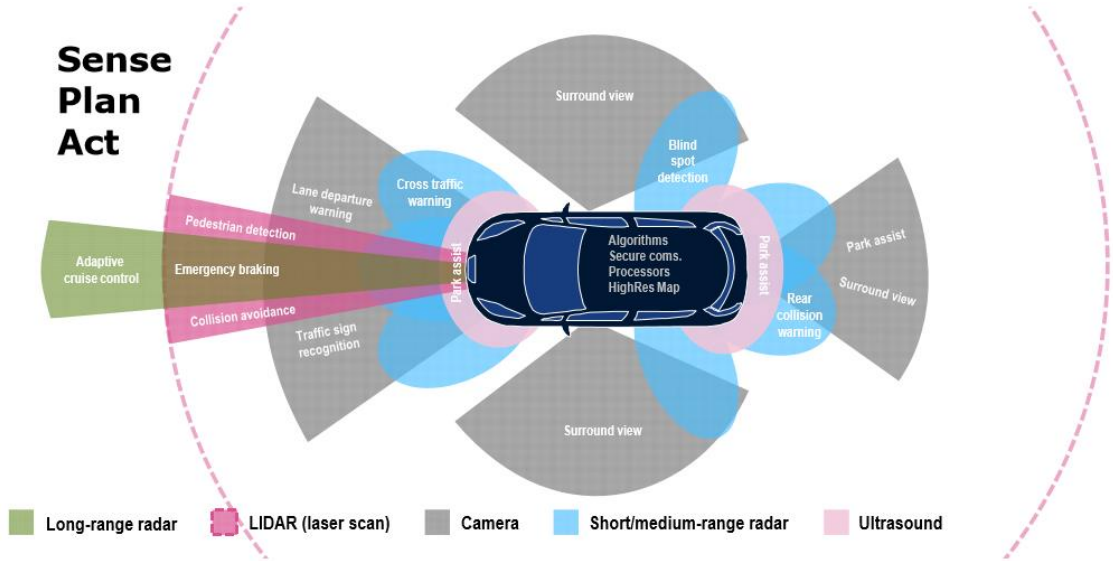

Figure 19 compiles a comprehensive list of ADAS together with the equipment required for the systems to progress. ADAS such as park assist require the embedment of ultrasound sensors, whereas cross-traffic warning, blind-spot detection, and rear collision warning systems necessitate the support of short and medium-range radars.

To monitor further distances, equipment such as long-term radars, LIDARs, and cameras are leading alternatives as they provide with higher technological features (distance, heat sensing, light sensing, etc.).

Therefore, a long-range radar backs up adaptive cruise control and emergency braking systems, whereas LIDARs serve as pedestrian detection and collision avoidance supports. Lastly, cameras and sensors are the most commonly used in AVs and are required for lane departure warning, traffic sign recognition, surround view, and medium-range Park assist.

All these new technologies have a critical impact on the vehicle concept. We discuss this subject in the next paragraph.

²⁷Retrieved from https://www.itf-oecd.org/sites/default/files/docs/15cpb_autonomousdriving.pdf

2. Effects of autonomous vehicles on the traditional vehicle concept

Since the emergence of the first vehicle, many evolutions have been observed in the automotive industry. Nevertheless, the fact remains that these contextual and technological breakthroughs have had an impact on vehicles' architecture, which went from horse carriage, motorized vehicles, internal combustion engines, and lately, electric and autonomous vehicles.

Primarily, higher levels of autonomous driving infringe the first section of Article 8 of the European Convention of Road Traffic done in Vienna in 1968, which states that “every moving vehicle or combination of a vehicle shall have a driver” (European Commission, 1968)²⁸. The different automation level, by sequentially giving the driver's responsibilities to the autonomous driving system, is a dislocation from the traditional conception of driving. Indeed, the paradigmatic change brought by AVs witnesses the possibility of transportation without drivers.

As the final purpose changes, the research and development around the autonomous driving focus on several areas (Winner & Wachenfeld, 2016)²⁹ in Figure 20.

Figure 20. Areas with requirements to consider (Winner & Wachenfeld, 2016, 257)

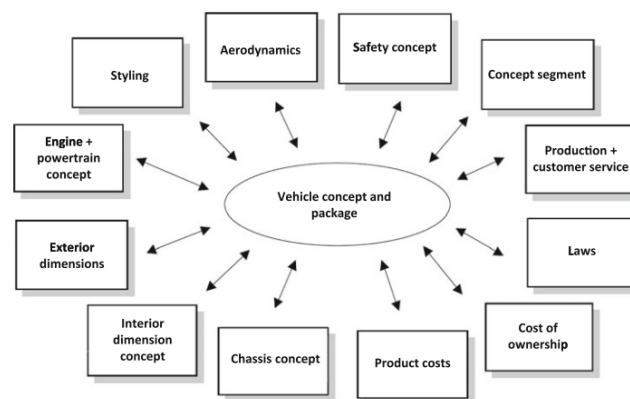

²⁸ Retrieved from https://treaties.un.org/pages/ViewDetailsIII.aspx?src=TREATY&mtdsg_no=XI-B-19&chapter=11

²⁹ Winner, H., & Wachenfeld, W. (2016). Effects of Autonomous Driving on the Vehicle Concept. In M. Maurer et al (Eds.), *Autonomous Driving* (pp. 255–275). Springer.

Since automation radically modifies the way to utilize vehicles, it requires modifying many modules within the vehicle. The automation of driving imposed the incorporation of telematics and a plethora of sensors and cameras to monitor the external and internal environments while keeping the vehicle free from cluttered designs.

Also, at higher levels of automation, vehicles are dedicated to shared usage. As users differ in their needs and willingness, auto manufacturers and service providers need to align with flexible interior designs, such as movable seats, change of atmospheres, need for coffee tables, and plugs, for instance. The BMW concept car showcased at the CES Las Vegas 2017, presented in Figure 21, telegraphs the path towards futuristic designs and cutting-edge technology incorporated into AVs.

Figure 21. BMW autonomous concept car (Muioio, 2017)³⁰



As modern as they may look, autonomous vehicles are sophisticated vehicles incorporated with many different technological modules that radically differ from those currently embedded in traditional vehicles. Therefore, they change the concept of transportation by providing users with the possibility to use their transportation/commuting times differently, by either working or using infotainment modules to entertain themselves (Figure 22).

³⁰ Retrieved from <https://www.businessinsider.fr/us/bmw-to-launch-self-driving-car-test-in-2017-to-take-on-tesla-google-2017-1>

Figure 22. Interior of the Next-gen autonomous vehicle³¹



As illustrated in Figure 22, occupants of an AV can work, hold meetings, relax, or use entertainment platforms in the same comfort as a business-class airline cabin. The sophisticated architecture of AVs incorporates a series of new components and opens new opportunities for auto stakeholders. As the new components radically differ from those of traditional vehicles, the auto companies face the turbulence of a changing competitive environment, which owes the arrival of new entrants to the need for new cutting edge technological components. We discuss the growth opportunities for the organization in the following paragraph.

3. Growth opportunities for organizations

Innovations are a source of organization performance and increasing revenues. Consequently, organizations are willing to capture the growing stakes of emerging industries.

3.1. Statistical evidence of autonomous vehicle component production

The emerging technology of autonomous driving has far-reaching applications and implications that go beyond current expectations. A recent report published by IHS automotive in 2019 (IHS Automotive, 2019) forecasts the growth potential of the main ADAS totaled at twenty-one. We have indexed the twenty-one ADAS together with their respective Compound Annual Growth Rates (CAGR) between 2018 and 2025 in Table 6.

³¹ Retrieved from <https://www.nytimes.com/2017/06/15/automobiles/wheels/driverless-cars-interior.html>

Table 6. Summary of global ADAS applications (IHS Automotive, 2019)³²

ADAS System	CAGR 2018 - 2025
Forward Collision Warning Systems	10.5%
Automatic Emergency Braking Systems - Inter-Urban	12.0%
Automatic Emergency Braking Systems - Pedestrian	13.0%
Automated Driving Systems	21.7%
Adaptive Cruise Control Systems	12.8%
Lane Departure Warning Systems	11.4%
Lane Keep Assist Systems	19.4%
Blind Spot Information Systems	12.5%
Cross-Traffic Alert Systems	16.1%
Driver Behavioral Monitoring Systems	13.1%
Driver Facial Monitoring Systems	70.1%
Rear Park Assist Systems	5.0%
Front Park Assist Systems	12.3%
Semi-Automated Park Assist Systems	15.3%
Surround View Park Assist Systems	15.4%
Side Mirror Camera Systems	12.0%
Rearview Mirror Camera Systems	21.6%
Night Vision Systems	17.6%
Automatic High Beam Systems	13.8%
Traffic Sign Recognition Systems	17.0%

As an emerging industry accommodates new technologies, so does the autonomous vehicle industry, in which these technologies are forecasted to have growing market shares over the years. Between 2018 and 2025, all ADAS indexed in the IHS database expose an upward going trend with CAGRs exceeding 10% for most of them, except rear park assist systems, which explains Figure 23.

³² IHS Automotive. (2019). *Advanced Driver Assistance Systems—Production Forecast Database 2019*. IHS Automotive.

Figure 23. Summary of ADAS applications production in units (IHS, 2019)

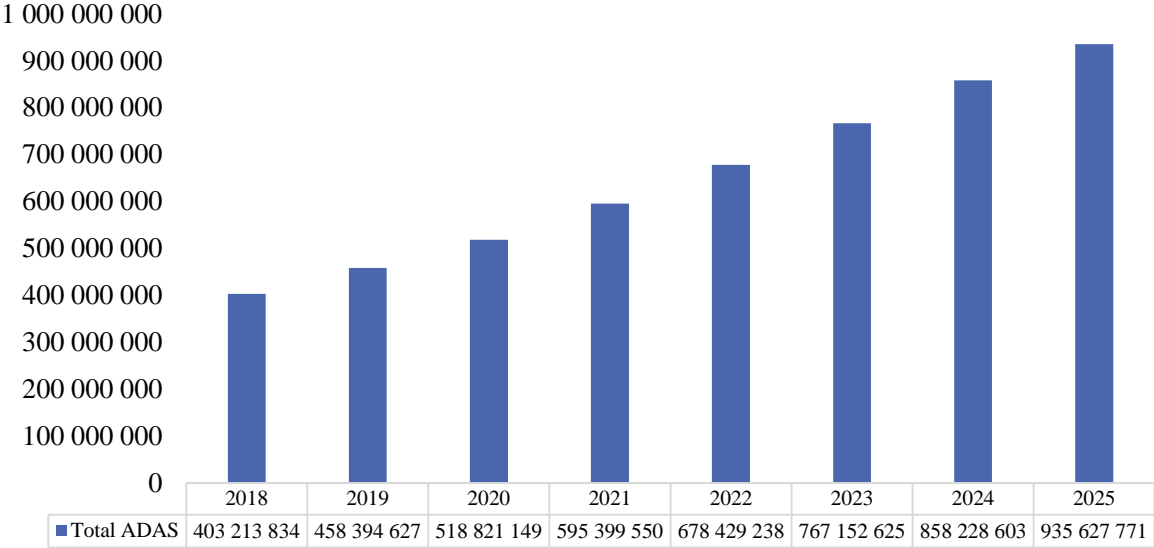

In the reviewed period (2018-2025), the amount of global ADAS systems unit rockets by two times, passing from 403,213,834 units produced in 2018 to 935,627,771 in 2025. The increase is steady, and the CAGR between 2018 and 2025 is 12.8%. ADAS systems are sophisticated, and the revenue of the ADAS market is expected to reach USD 67.43 billion by 2025.

Consistent with what is mentioned in previous paragraphs, ADAS systems require ADAS sensors, and their market share is correlated yet non-assimilative to ADAS forecasts. A unique ADAS system can sometimes require several units of the same sensors, whether it is cameras, radars, ultrasound cameras, and LIDARs (Figure 24). Similarly, some sensors are not used in some ADAS systems, as depicted previously in Figure 23.

Figure 24. ADAS sensors (IHS Automotive, 2019)

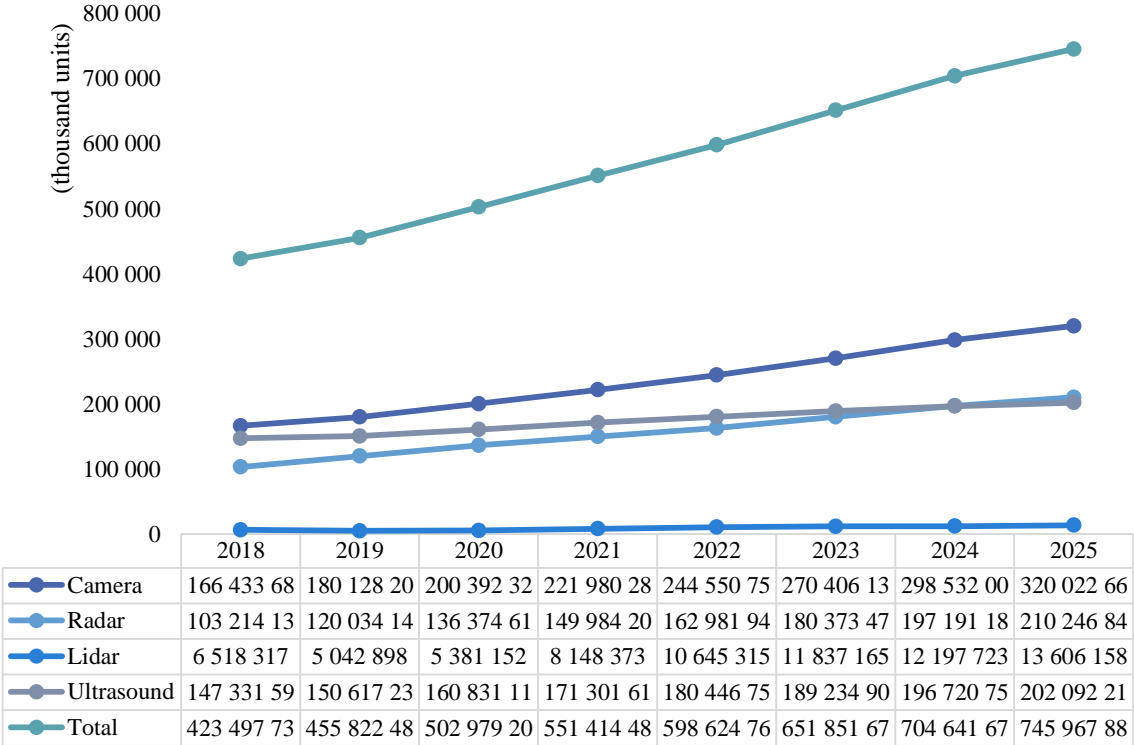

Figure 24 indexes all ADAS sensors being the cameras, radar, LIDAR, and ultrasound cameras. The figure shows an increasing trend over the years, led by LIDAR with 11.1% CAGR, cameras with 9.8%, radars with 10.7%, and ultrasound cameras with 4.6%. In general, in Figure 24, statistics appended show the growth potential of ADAS sensors in the forthcoming years.

In addition to statistical evidences showing the growth perspective of autonomous vehicle components, the AV industry, in general, perceived positive impacts of AV technologies for the future. We discuss companies’ perception of the potential growth of the AV industry by quoting executives’ statements.

3.2. Well-perceived opportunities by companies

Parallel to figures and forecasts, automobile companies perceive growth opportunities brought by autonomous driving technologies. Autonomous vehicles are highly dense in technologies, which makes the autonomous vehicle industry a broader whole. Therefore, although the risk for incumbents is to miss their stake through the overflow of new entrants, it also means that

the cake is getting bigger, and the challenge is to capture the most significant slice of this cake. Automotive stakeholders need to be thorough in their positioning choices based on unsure predictions of the emerging industry. Nevertheless, incumbents and new entrants are aware that autonomous vehicles are a business with long-term growth prospects.

Table 7 collected company executives' statements regarding opportunities that the full range of technologies needed to make vehicles autonomous bring into the automotive industry. Executives agree upon the necessity to gather to translate autonomous driving technologies from concepts to reality.

Table 7. Company statement of growth opportunities brought by autonomous driving

Company	Role	Statement	Source
Ford	Chairman, Bill Ford	“We are seeing some of the most exciting consumer products and services on the market today coming from innovative start-up companies. It will be great to be part of bringing that type of new thinking to Detroit and the automotive industry.”	(Media Ford, 2014) ³³
Continental	Vice-president engineering, Dr. Thomas Brohm	“The ADAS market is growing rapidly and there is demand for a next-generation radar platform with integrated functional safety compliant with the ISO 26262 standard.”	(Automotive World, 2015) ³⁴
Mercedes-Benz	Board member, R&D, Thomas Weber, Daimler	“Innovations in this area are coming thick and fast. While we don't want to feed wrong expectations such as sleeping in the car, autonomous driving is set to become a reality much more quickly than the public thinks.”	(Automotive-iq, 2015) ³⁵

³³ *Ford Drives Mobility Innovation With Launch Of Startup Business Incubator In Detroit* (2014). Retrieved from <https://media.ford.com/content/fordmedia/fna/us/en/news/2014/12/11/ford-drives-innovation-with-launch-of-startup-business-incubator.html>

³⁴ *Freescale Semiconductor helps Increase Passenger Safety with Advanced Automotive Radar Technology* (2015). Retrieved from <https://www.automotiveworld.com/news-releases/freescale-semiconductor-helps-increase-passenger-safety-advanced-automotive-radar-technology/>

³⁵ *Mercedes and Audi Reveal New Autonomous Driving Features* (2015). Retrieved from <https://www.automotive-iq.com/powertrain/columns/mercedes-and-audi-reveal-new-autonomous-driving-fe>

Qualcomm	CEO, Steve Mollenkopf, Qualcomm	“As we strive to connect billions more devices, automobiles and people within the Internet of Everything, we are enthusiastic about the growth that this combination will foster.”	(Qualcomm, 2015) ³⁶
WeRide	Tony Han, CEO	“Both autonomous driving technologies and commercialization are equally important to us. In the future, WeRide will continue to apply for more licenses of road test and apply them onto different autonomous vehicle models aiming at providing safer and better smart mobility experience for citizens in the future”	(TaaS, 2019) ³⁷
XMOS	CTO	“The development of intelligent transportation and advances like autonomous vehicles will have far-reaching implications.”	(Macnica, 2014) ³⁸

Table 7 gathered some company executives' statements conferring the potential growth of the emerging industry. Some of the organizations are new entrants such as Freescale, Qualcomm, Rightware, and XMOS, and others are incumbents such as Aisin Seiki, Ford, Mercedes, ZF, Renesas, and Lear. Incumbents are either OEMs or tier-one suppliers. The statements highlight that the potential growth of the autonomous vehicle industry cannot be captured by the independent initiative of organizations, as the technology happens to be very complex and dense.

Besides, several major automotive OEMs have made their AV launch strategies very clear (Table 8).

³⁶ *Qualcomm Completes \$2.4 Billion Acquisition of CSR* (2015). Retrieved from <https://www.qualcomm.com/news/releases/2015/08/13/qualcomm-completes-24-billion-acquisition-csr>

³⁷ *WeRide Receives License to Test Intelligent Connected Vehicles in Guangzhou, China* (2019). Retrieved from <https://taas.news/article/107763/article>

³⁸ *XMOS Targets \$8bn Automotive Microcontroller Market* (2014). Retrieved from <https://www.macnica.eu/news-archive/2014-03-21-xmos-nimmt-8-milliarden-dollar-automotive-mikrocontroller-markt-ins-visier>

Table 8. AV launches by levels from 2019 to 2023

OEMs	2019	2020	2021	2022	2023	Models L2+	Models L3
BMW	L2		L3			-	iNext
Daimler	L2		L3			-	S-Class EQS
FCA	L2					Wagoner	-
Ford	L2					F-150 Mustang Mach-E	-
Geely	L2			L3		-	Polestar 3 Volvo XC90
General Motors	L2					All Cadillac models	-
Honda	L2		L3			-	Honda Legend
Hyundai	L2					Genesis GV80	-
Mazda	L2					-	-
PSA	L2				L3	-	Peugeot 508
Renault Nissan Alliance	L2			L3		Nissan Skyline	Infiniti Q50
Suzuki	L2					-	-
Tesla	L2					Model 3 or Y	-
Toyota	L2		L3			-	Lexus LS
Volkswagen	L2				L3	-	Audi A8

The launch perspectives attest that OEMs perceive AVs as a long-term business while also giving an overview of OEMs strategies. From what we can perceive, most of them will focus on L2 AVs at least until 2021, and some of them will strictly focus on L2 (Hyundai, Tesla, Mazda, GM, Ford, and FCA at least until 2023).

3.3. Privileged access to empirical material

Alongside with many technological and contextual reasons that make the study of the autonomous vehicle very interesting, we justify our choice by privileged access to empirical data.

The current research project has been carried as a CIFRE project in collaboration between the University of Lorraine and the ARaymond Network.

ARaymond is an international automotive part manufacturer with more than 6,000 employees spread in 27 different countries. The company specializes in fastening solutions such as clips, quick connectors, and bonding solutions. Since fastening components into vehicles are ARaymond's core activity, the analysis of future vehicle designs and architecture and the changing competitive landscape became a critical topic.

Before creating the CIFRE position, an internship as a Market Analyst Trainee enabled me to build strong knowledge regarding the auto industry from April to September 2017. The internship was led to an internship report based on the evolution of the auto industry towards a green and sustainable industry. The internship conferred us a robust knowledge regarding the traditional industry's processes and happened when significant changes were occurring.

During the thesis, the occupation of the Market Analyst position in the Marketing team of ARaymond enabled us to access empirical data regarding the auto industry directly.

The work position conferred access to several market intelligence tools such as IHS Markit, for instance. The willingness to respect the CIFRE referent's privacy will not disclose the strategic tool used for market intelligence activities. Nevertheless, we will argue that this tool enables us to collect, store, and analyze many qualitative data about the auto industry. These tools were of great utility in the preliminary analysis of the autonomous vehicle industry and the data collection phase. Moreover, the company's involvement opened opportunities to participate in specialized conferences regarding the auto industry and several ones about AVs.

These conferences were fundamental in many ways. First, they enabled us to depict primary technological paths and design architectures in different geographical areas. As a tier supplier, ARaymond must identify where the industry is going, how, and future clients and competitors. Secondly, the networking possibilities were meaningful as they allowed to discuss the industry with industry experts, meet people from different sectors, yet be highly involved in the AV industry, and learn about the latest technological developments.

We have collected qualitative material from these conferences that helped us contextualize our quantitative data, as we will develop hereafter.

Finally, the half-time presence in the company's offices allowed us to contact colleagues and discuss the thriving technology that AV is. Participation and presentation during team meetings enabled access to explicit knowledge from customer and supplier visitations. Most importantly, it enabled us to witness how an organization undertakes major strategical choices and the urge for mobilization toward progressive yet transformative change that challenges the limitations of the company itself.

Conclusion of Section III

Section III intended to justify the choice of the AV industry as a research field as it holds the intrinsic characteristics of being disruptive and emerging.

First, the detailed presentation of the autonomous driving technology with historical background, the different levels of autonomy, disruptive amount of sensors and cameras, and incorporation of robot-like processes of artificial intelligence networks are sufficient enough to prove the disruptive characteristics of AVs, which makes it a perfect case for the study of industry emergence.

In light of **Section I**, where we describe a very traditional industry with OEMs and tier-one suppliers, Section III draws the portrait of a very complex technology implying several organizations' participation to meet the need for multiplying expertise imposed by autonomous driving.

We also considered that AVs have a significant impact on the overall vehicle concept. These changing patterns translate into changing vehicle architecture and design and causes the appearance of vehicles with futuristic features and designs. The densification of innovation types necessary for AVs to become commercialized was considered a fundamental criterion to study innovation content.

To maintain a subjective perspective on the research field and its evolution, we also looked at the statistical forecasts about the growth potential of the industry and the key enabling technologies for autonomous driving.

Finally, the choice of the AV industry as a research field is justified by privileged access to empirical data regarding the auto industry conferred by the CIFRE anchorage of the research project.

Conclusion of Chapter 4

The overall objective of **Chapter 4** is explained in several aspects:

- Retrace the evolution of the auto industry;
- Refine and focus on the AV industry because of intrinsic disruptiveness;
- Justify the choice of the research field.

In **Section I**, we presented the emergence of automobiles from the very first car invented in 1885-1886 by Mercedes Benz to nowadays. We discussed how vehicles had changed radically due to contextual attributes such as globalization, environmental constraints, and growing needs for safety on roads. The automotive industry is a tributary of many government regulations, and growing environmental lobbies chop up the threshold of acceptance of diesel vehicles.

Also, we identified the tipping point of increasing safety needs with the Toyota Fiasco, which followed with stricter regulations imposed on OEMs regarding active and passive safety features, which eventually triggered the interest in driver assistance system to reduce car injuries and collisions.

In **Section II**, the scope out on the AV industry through a historical presentation of the technology and major projects initiated in the US in the 2000s. The overall objective of the section was to propose an initiation on autonomous driving, the main principles, and finally, to present the main challenges raised by such disruptive innovations.

Finally, in **Section III**, we telegraphed the relevancy of the autonomous vehicle industry as an adequate research field due to the disruptiveness of the automotive industry that we traced back from the emergence of the first car. The path towards autonomous driving did not shape overnight. Before even autonomous driving becomes a reality, the automotive industry has witnessed significant changes that seemed to be premonitory of what would happen. Therefore, we discussed to which extent autonomous vehicles are disruptive, and this passed by an in-depth presentation of the five-level of automation developed by the Society of Automotive Engineers (SAE) and the content of autonomous driving technology. The discussions showed that autonomous vehicles are equipped with many new technologies

based on AI systems that nourish an automated driving system (ADAS) embedded with sensors, cameras, lidars, and radars.

The growing number of components and a complicated autonomous driving technology made AVs disruptive for incumbent auto players. The resources required for the new technologies did not fully match their own set of skills, resources, and capabilities. As a second consequence of changing technology architecture, the ADAS and sensors industry has known a vast increase and shows positive evolution for the next coming years.

As a natural response to increasing revenue perspectives, organizations have shown great interest in collaborative actions and positive press announcements.

Finally, privileged access to the research field and empirical data justified the choice of the research context. The access to a large amount of empirical data led to us determine a meticulous research design to exploit the data and retrieve major patterns through statistical treatments. We discuss the elaboration of the research design in **Chapter 5**.

Chapter 5. Research design

After having devoted **Chapter 4** to the presentation of the research context, its most important technical characteristics, and the motivation to study this particular industry, **Chapter 5** is devoted to the different stages of the progress of our empirical study.

In this research work, we focus on interorganizational relationship dynamics to study the AV industry emergence. In the view of responding to both theoretical (lack of metrics to assess industry emergence) and empirical (IRs are tangible strategies as opposed to industry emergence) challenges, we propose to combine several levels of analysis to assess industry emergence through IRs networks of Key Technological Activities. Focusing on IRs network and Key Technological Activities (KTAs hereafter) in a transitional phase of industry emergence, de facto questions our methodological choices to assess and capture patterns of emergence.

We set forth our epistemological anchorage and the knowledge creation process we followed in the present thesis in **Section I**. We referred to Allard-Poesi and Perret (2014), which questioned the knowledge and the nature of reality that can be apprehended through this knowledge or, in other words, the knowable reality. In the same perspective, we ask the same question as Le Moigne (1999), who presents epistemology through knowledge in three fundamental questions:

- What is knowledge (the gnoseological question)?
- How is it constituted or generated (the methodological question)?
- How to assess its value or its validity (the ethical question)?

In line with what has been introduced above, positivist positioning describes the rightest our intellectual path. Since we intend to understand the industry emergence via the dynamics of interorganizational innovation networks, it requires us to seek empirical pieces of evidence to observe at a macro level how the uncertainty caused by disruptive innovation influences organizational behaviors and the correlation with the emergence of the industry.

Correlated with inductive reasoning, it implies the observation of minor premises to come up with generalizations. Through a bottom-up process, we aim to make a general conclusion of industry emergence based on the evolution of interorganizational relationships. We aim at

understanding how minor premises (IRs) affect the significant premise (industry emergence) in a disrupted context.

In **Section II**, we intend to clarify the methodological choice and allow replicability for future research. We portray the different methodological approaches in research: quantitative, qualitative, and mixed methodologies before presenting the anchorage in a quantitative methodology. Then, we presented the Social Network Analysis (SNA) methodology that we have used for the statistical and visual treatment of our data. The choice of SNA has been made by scanning different quantitative methodologies and identifying several key factors that indicated the suitable characteristics of such a methodology for our research object. The focus on an SNA method implied the description of the principles of such a method, the need to collect and analyze sociometric data.

Section I. Epistemological paradigm

Thietart et al. (2014) argued that the researcher's choices ought to be related to his vision of reality. Indeed, every epistemological paradigm refuted that knowledge is of the same nature as reality and endorses the dichotomy that Kant proposed between the noumenon and the thing-in-itself. The noumenon exists or may exist; however, it is unknowable through human senses. Researchers, however, can apprehend and understand the thing-in-itself.

In **Section I**, we explain our intellectual journey towards the choice and implementation of an epistemological paradigm. The research ascribes to a positivist paradigm that tends to produce knowledge in the most objective way. Therefore, we defend our epistemological positioning and its benefits to our research. Then we discuss our inductive approach and highlight its advantages for the present research.

1. Epistemological anchorage

The anchorage in an epistemological paradigm represents a crucial stage and is an integral part of any research project (Gavard-Perret et al., 2018). Epistemology refers to the study of knowledge, and by adopting a given epistemological position, researchers expose their vision of the path they have followed to access that knowledge. Moreover, the epistemological paradigm clarifies the concept of knowledge on which the research is based while also justifying how he has adopted to produce the knowledge.

Piaget (1987: 6) described epistemology as “the study of the creation of valid knowledge.” Many scholars have considered this definition widely relevant since then (Gavard-Perret et al., 2018). Subsequently, Le Moigne (1995) argues that epistemology engages the answer to three questions: what is knowledge? (gnosiology approach or knowledge theory) How is knowledge created? (methodological approach), Furthermore, how to justify the validity of the knowledge?

The research process should respond to these critical questions. Therefore, researchers benefit from three epistemological paradigms that shape research in management sciences: the positivist, the interpretative, and the constructivist paradigms (Dumez, 2011).

Based on these paradigms, the researcher subscribes his research to a referential framework, highlighting the scientificity of his presuppositions and achieving legitimacy in terms of

methodology and generated results. Nevertheless, each epistemological paradigm has a different relationship with reality and the way to approach it. Allard-Poesi and Perret (2014) proposed a continuum that defines how knowledge is conceptualized by each paradigm (Figure 25).

Figure 25. Conceptualization of knowledge in epistemological paradigms (Thietart et al., 2014: 29)

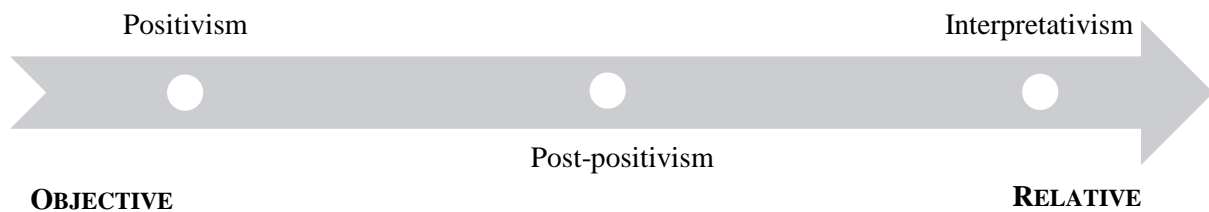

Therefore, epistemology is a reflexive activity inherent to the research and holds the purpose of demonstrating how the knowledge is obtained and justifies it. The knowledge theory “questions the nature, the means, and the value of the knowledge” (Soler, 2000: 27). The knowledge theory, also known to a lesser degree as gnosiology, accepts a natural dissociation between the research subject and the researcher himself. Consequently, we aim to demonstrate the epistemological choices that we consider as the spine of this research work. We take the opportunity of the following sub-sections to define each of them before presenting our positivist positioning.

1.1. Constructivist and interpretativist paradigms

Constructivism and interpretativism often are regarded as the rival of positivism. They differ in so that they consider knowledge based on a different edge of the conception continuum (cf. Figure 25); these two paradigms consider that reality is dependent on the mind of the one who is observing it (relativism). Interpretations and actors’ purposes establish the vision of reality (Le Moigne, 1994).

The constructivist and interpretativist paradigms argue that facts are studied and constructed by the researcher and the actors' interpretation. Therefore, other researchers and actors could have constructed these facts differently (Dumez, 2011). In this sense, they recall on subjectivity (Le Moigne, 1994) and are contextually influenced.

Interpretativism considers that reality is dependent on singular historical events (Passeron, 1991) and is based on a relativistic vision of knowledge as it ignores the existence of causal patterns. Bonneuil and Joly (2013) argue that interpretativism calls into question the neutrality of science, as it seeks to understand reality based on how actors in the studied context consider reality. This paradigm considers the intentions, motivations, expectations, reasons, and beliefs of actors that relate less to facts than practices (Pourtois & Desmet, 2007). In conclusion, the researcher is an observer who models a cognitive and constructed reality (Le Moigne, 1994). Constructivism (Piaget, 1987) branches out between radical constructivism and constructivism according to Guba & Lincoln (1989).

These two paradigms have, in common, only one primary hypothesis, which argues for the inseparability between the observing systems (the researcher) and the observed system (research object) (von Foerster, 1981). The founding assumption they share also makes inadequate the notion of absolute truth in which knowledge is supposed to correspond precisely to the reality.

However, they diverge in how they deal with the question of truth. Guba and Lincoln (1989) define what they call 'truth' as the most informed and sophisticated representation of consensus. Von Glasersfeld (1988, 2001) proposes the criteria of functional adaptation and viability of knowledge and goes back to the pragmatic definition of truth based on the verum/factum principle, according to which truth (verum) is the same as fact (factum). Guba and Lincoln (1989) argue that objective reality does not exist; instead, multiple social realities construct a reality independent of natural or causal laws.

To summarize, constructivism and interpretativism suggest that the reality is based on interpretation; these epistemological paradigms imply relativism and subjectivity regarding reality.

1.2. Choice of the positivist paradigm

Comte (1844) originally introduced the 'positivism' paradigm and believed that general laws and rules could be discovered by studying events and enabling predictability for future events. However, positivism only sticks to the relationships between the phenomena ('how'). It does not seek to understand their intrinsic nature ('why'): there is an emphasis on scientific laws and rejection of the nature of the cause. As Figure 25 shows, positivism seeks objectivity and

remains away from metaphysical speculations and theological approaches to exercise scientific rationality.

Comte's positivism (1844) finds its anchorage in the science of nature that he considers a homogeneous referential for all sciences (Thiétart et al., 2014), which will be criticized from the Vienna Circle later.

In the XXe, the Vienna Circle, composed of philosophers and scientists, which initially gathered to work on the philosophy of science and epistemology, developed the 'logical positivism' (or logical empiricism). It seeks to create boundaries between scientific knowledge and other forms of knowledge, such as the metaphysical of natural sciences (Thietart et al., 2014). This model was then enriched and amended by many researchers such as Carnap (2010) and Popper (2002) and gave rise to post-positivism. This approach grants a preponderant place to methodological approaches through quantification, experimentation, and the empirical verification of the knowledge (Thiétart et al., 2014).

In general, positivism examines the facts to identify patterns based on an objectivist epistemic vision and essentialist ontology. Essentialism guides the researcher towards the discovery of universal laws, which govern reality.

Our research project ascribes its epistemological position to the context in which it has been completed with extensive access to the field and autonomy of research given by the company. However, challenging can it be to "keeping the epistemological course in a Cifre thesis" (Foli & Dulaurans, 2013: 7), especially since "the epistemology of a CIFRE thesis can range from positivism to constructivism, including interpretativism" (Rasolofo-Distler & Zawadzki, 2013: 3).

We believe that positivist positioning describes the rightest of our intellectual path. Our research object, which aims to understand the industry emergence via the dynamics of interorganizational innovation networks, requires us to seek empirical pieces of evidence to observe at a macro level how the uncertainty caused by disruptive innovation influences organizational behaviors and the correlation with the emergence of the industry.

We believe that social phenomena exist in not only the minds but also the real world and that we can discover between them some reasonably stable legitimate relationships. "There is no

doubt that these phenomena exist objectively in the world partly because people make a common representation of it which is recognized by all; these perceptions are therefore crucial when it comes to an understanding why social behavior takes one form or another” (Miles & Huberman, 2003: 31). Therefore, we believe that a positivist positioning will enable us to benefit from the dualistic objectivism that composes our research object by nature as it is mainly at a macro-level: a level that we cannot influence or be influenced by.

We present our positioning more precisely as follows:

- We believe that understanding the complex link between uncertain environment, dynamics of interorganizational relationships, and the effect on industry emergence demands to create objective knowledge, independent from a given context;
- Our theoretical background focuses on the difficulties encountered by organizations and industries when facing uncertain phases. It is based on a dichotomy of failing or succeeding in the face of uncertainty. Identifying this gap motivated us to look further when uncertainty happens and how interorganizational dynamics create a new industry (adaptation).

However, a CIFRE thesis is often assimilated with eroded neutrality (Rasolofo-Distler & Zawadzki, 2013), and that positivism is, therefore, not best suited for those research projects. By being immersed in the social environment, the researcher sees his vision of the reality being influenced; by breaking the dualist objectivism approach, it does not meet the requisites of positivism. However, “perfect reality” does not exist (Durkheim, 2005: 108). Besides, Weber (1949) refers to ‘axiological neutrality’ to justify a researcher's vision free from partisan passions. From a contextual perspective, the macro-level positioning we have adopted to understand the link between interorganizational relationships and industry emergence eliminates the influences that the CIFRE company could have had. We neither carry out a case study nor subscribe to a research-intervention positioning.

In general, the epistemological positioning provides the researcher with guidance regarding the research approach that he could use. Management studies are influenced by three different approaches: abductive, deductive and hypothetico-deductive, and inductive. In the next part, we present each of these approaches and explain the inductive approach of our research.

2. Research approach

As much as the epistemological positioning and in line with it, the research approach adopted plays an essential role in the research process. The Cambridge dictionary (Cambridge Dictionary, n.d.) defines reasoning as “the process of thinking about something to make a decision”. In the following subparts, we will present the different research approaches in management studies before explaining the inductive reasoning of our research.

However, before explaining our research approach, we need to highlight two research modes that dominate management studies as research approaches depend on the anchorage in one or the other. Durieux and Charreire-Petit (2014) present two research modes possible in management studies: exploration and tests.

On the one hand, exploration implies the research of newness to discuss and add to existing theories. Understanding and seeking for explanations lead the research process through inductive or abductive reasoning. On the other hand, the researcher who opts for testing will interrogate the reality, the methodologies, or knowledge. Therefore, this kind of reasoning does not create knowledge; instead, care about the relevance of what already exists. Consequently, the researcher makes hypotheses that will be tested during its research work (hypothetico-deductive reasoning).

Exploration is the guiding line of our research. We aim at exploring new possibilities to catch critical patterns of industry emergence in a disruptive context and understand the potential links with interorganizational relationships.

Therefore, we discuss the literature on disruptive innovation and interorganizational relationships to create knowledge on industry emergence around key activities. This is why we adopted inductive reasoning to enhance the exploration of minor premises to highlight a general conclusion. Before that, we present the abductive and the deductive and hypothetico-deductive and conclude by explaining our inductive reasoning.

2.1. Abductive approach

Abduction is a syllogism whose major premise is inevitable, yet, minor premises are only probable. Therefore, by testing minor premises and the links amongst them, abduction moves away from seeking logic to test the hypothetical relationships among minor premises. Abduction consists of drawing from the observation of conjectures, which then have to be tested and discussed. The researcher seeks similarities and groups of premises that can explain and foster an understanding of the major premise. The reasoning flow starts from general conclusions towards bottom layers to find explanations and validate the conclusion, which was certain in the first place. This reasoning can be compared to an inverted equation where the result is known (major premise). Yet, the right link between the minor premises is necessary to understand the sense of the global equation. To summarize, abductive reasoning illustrates the evolution of facts obtained by observing the construction of theories, models, and hypotheses (Thietart et al., 2014). In management studies, researchers tend to use analogical (Delattre & Thellier, 1979) and metaphorical (Morgan, 2007) reasoning to decode general conclusions.

However, research approaches vary from one researcher to another. When the abductive approach is not suited to the research journey, the deductive and hypothetico-deductive approaches also provide exciting research directions.

2.2. Deductive and hypothetico-deductive approaches

The deductive approach probes the logical demonstration of hypotheses; when hypotheses are validated (true), the conclusion is systematically validated. The minor premises are used to obtain a logical conclusion (major premise). It is generally considered that deductive reasoning enables one to go from the general perspective towards a more particular one and apply a general law on a few cases (Bergadaà & Nyeck, 1992). The deductive reasoning lies the ground for hypothetico-deductive studies: the hypothesis is formulated. It must be confronted with the reality to judge the relevance of the hypothesis formulated initially by testing them. The hypothetico-deductive approach complements the first one, while the latter is an intrinsic part of it. This approach is suitable when the research objective is exclusively to confront formulated hypotheses based on the literature with empirical data. Besides, this approach is exclusively used for quantitative research.

The ambition is to refine our observation of interorganizational relationships at a meso level to conclude at a general, macro-level through empirical observation of reality. Therefore, we think that the deductive approach is not suitable for our research, and explain our choice in the following part.

2.3. Choice of inductive approach

Pellegrino & Glaser (1984: 278) stated that “all inductive reasoning tasks have the same basic form or generic property requiring that the individual induce a rule governing a set of elements.” We chose inductive reasoning due to several reasons that we explain as follows:

- Inductive reasoning implies particular observations to come up with generalizations and is known as a bottom-up process. We aim to make a general conclusion of industry emergence based on the evolution of interorganizational relationships. We aim at understanding how minor premises (IRs) affect the major premise (industry emergence) in a disrupted context;
- We use sociometric data coded in square matrices to observe the impacts of IRs at the industry level. Tasks such as classifications, analogies, incomplete series, and matrices entail inductive reasoning and are commonly recognized as typical inductive reasoning tasks (Büchel & Scharnhorst, 1993).
- Reporting regularities, irregularities, and diversities (Klauer & Phye, 2008), as shown in Table 9, is needed.

Table 9. Definition of inductive reasoning (adapted by Klauer & Phye, 2008: 87)

FACET A		FACET B		FACET C	
1	Similarity	1	Attributes	1	Verbal
				2	Pictorial
2	Difference	of	Relations	3	Geometrical
3	Similarity			4	Numerical
	&			5	other
	difference	2			material

The authors determine three facets: A, B, and C. Facet A is the comparison facet, highlighting similarities, differences, or similarities and differences simultaneously. Facet B narrows the comparison to refer either to attributes of the studies object or relations between them. Finally, facet C refers to the inductive reasoning materials (verbal, pictorial, geometrical, numerical, and other).

In our case, we position our study as a combination of facets A3, B2, and C4 based on matrices. Therefore, it complements our willingness to depict similarities or differences in interorganizational relationships through a longitudinal study of the industry emergence. The phenomenon of industry emergence reflects the macro-level dynamics of interorganizational relationships. The analysis of such a complex phenomenon implies combining several levels of analysis at the organizational and interorganizational to depict patterns of emergence at the macro level, and therefore, calls for an inductive positioning to emphasize main patterns of large datasets to draw conclusions.

Conclusion of Section I

The purpose of **Section I** was to present the epistemological choices made for the present research. We precisely justified the choice of a positivist paradigm through the need to study sophisticated link formation in uncertain environments and the possibility to study the dynamics of interorganizational relationships and their effects on industry emergence. The study of IRs as metrics of industry emergence through statistical treatment allows the creation of objective knowledge, which is independent of a given context, yet, translates the patterns of emergence of a given industry.

We then presented the inductive mode of reasoning adopted in the present research. The research questions that focus on the study of industry emergence through IRs. The inductive mode of reasoning also sustains the choice of a quantitative methodology that we discuss and justify in **Section II**.

Section II. Methodological anchorage

Section II reviews the different methodological methods available to researchers and stake out our choice of a quantitative method. We start by presenting the qualitative approach, explain our quantitative approach, and conclude by presenting the mixed-method approach. Then, examining the different quantitative methods available enabled us to choose the adequate one for this research, i.e., a Social Network Analysis.

1. Anchorage in quantitative methods

Over the years, it became quite usual in research to consider quantitative methods as a tool used by positivists (Zaborek, 2009). We argue that the selection of the research method should not be exclusively based on the epistemological paradigm; instead, the nature of the research and the research objects should construct the research architecture and enable its evolution. In the next subsections, we define quantitative, qualitative, and mixed methods, the advantages and disadvantages of each before explaining our anchorage in a quantitative methodology.

1.1. Qualitative methods

Qualitative methods play an essential role in management studies (Giordano, 2003). “Qualitative research is multimethod in focus, involving an interpretive, naturalistic approach to its subject matter. It means that qualitative researchers study things in their natural settings, attempting to make sense of, or interpret, phenomena in terms of the meanings people bring to them” (Denzin & Lincoln, 2005: 5). Although the qualitative methodology is primarily said to demonstrate the relevance of the hypothesis, scholars also consider the possibility of developing new theories and seek causal relationships through correlations (Davis et al., 2009).

Complex relationships amongst the studied objects are highlighted by qualitative data, which implies shared assumptions with the interpretative paradigm. The reality is perceived from the studied objects' perspective in their natural settings (Denzin & Lincoln, 1971). Qualitative methods primarily enable to develop and enrich theories, and therefore, are more descriptive.

Ethnographies (Maanen, 2011) and case studies (Yin, 2014) yield from this method alongside with analysis of artifacts, documents, and visual materials (Denzin & Lincoln, 2005). The studied objects are demanded to speak for themselves and provide several realities, which create bias and subjectivity, which are amongst the disadvantages listed in Table 10.

Table 10. Advantages and disadvantages of qualitative methodology (Matveev, 2002: 60)

Advantages	Disadvantages
Obtaining a more objective feeling which can not be reflected in the numerical data and statistical analysis used in quantitative research	Departing from the original study ambitions in response to the changing context
Flexible ways to access, ultimately analyze and interpret the produced data	Arriving at various results premised along with the same facts, dependent on the researcher's personality traits
Bring a comprehensive picture of the phenomena being studied	Complexity in illustrating the disparity in the quality and amount of knowledge derived from respondents and contributing to various, conflicting findings
Ability to converse in their language and on their terms with the study subjects	Demanding a significant level of research expertise to get the desired information from the respondent
A descriptive mechanism based on unstructured and straightforward data	Consistency and reliability are lacking because the researcher can use various testing methods, and the respondent can choose to say those unique stories and dismiss others
Permitting longitudinal assessments of subsequent research subject output	

Both qualitative and quantitative methodologies provide impressive empirical materials. Each methodology comes with its advantages and brings inertia in the research process. There is a usual dichotomy accepted in the methodological approach that when the research is not based on a qualitative methodology, it might be quantitative. We present this method in the following part.

1.2. Quantitative methods

Zaborek (2009: 6) defines quantitative methods as “numerous samples which are supposed to allow arriving at conclusions about the general population with statistical treatments.” Quantitative methods are frequently used in managerial studies; and aim to quantify, measure, and highlight causal relationships between objects and depict the frequency of occurrence of a pattern (Grawitz, 1993). Quantitative methods through rigid data collection and statistically controlled data analysis enable avoidance of bias and thus provide objective and rational results (Bergadaà & Nyeck, 1992; Carr, 1994). The numerical properties (Miles & Huberman, 2003) of the data give access to any while avoiding ambiguities of meanings that the positivist paradigm strives for (Cassell & Symon, 1994).

Usually, experiments yield this method, as they entail measures and statistics. Nevertheless, analyses and questionnaires are also a way of gathering quantitative analytical materials. Table 11 summarizes the benefits and drawbacks of the quantitative method we used during data collection and analysis.

Table 11. Advantages and disadvantages of the quantitative method (Matveev, 2002: 60)

Advantages	Disadvantages
Designating the research questions in unequivocal terms	Inability to provide the researcher with knowledge regarding the context in which the studied phenomenon occurs
Specifying explicitly and expressly all the variables under review	Inability to monitor the setting wherein the respondents provide the answers to the questionnaires
Following the initial collection of research objectives near, arriving at more rational conclusions, investigating hypothesis, evaluating the causality issues	Results limited to those set out in the original research proposal due to closed style questions and the defined format
Obtaining high levels of data collection reliability due to monitored observations, laboratory experiments, mass surveys, or other kinds of research manipulation	Not enabling a research phenomenon to grow and thoroughly investigation
Removing or eliminating judgmental subjectivity	
Enabling longitudinal analyses of subsequent research object output	

However, some researchers combine both methods to benefit from their advantages and customize their research objects; we describe the mixed methodology in the next part.

1.3. Mixed methodology

Management studies witness a natural opposition between quantitative and qualitative research methods. The variances between both methods are twofold: on the one hand, they differ on how to collect the empirical material, while on the other hand, using different methods to analyze the collected data. The mixed methodology is defined as “the type of research in which a researcher or team of researchers combines elements of qualitative and quantitative research approaches (e.g., the use of qualitative and quantitative viewpoints, data collection, analysis, inference, techniques) for breadth and depth of understanding and corroboration” (Johnson et al., 2007: 123). This definition corroborates many scholars’ interpretations (Thorpe & Holt, 2007).

Therefore, mixed-method, simultaneously or sequentially, uses the available data in different manners. Bazeley (2009: 134) explains the reasons to opt for mixed methods as follows:

- Complementary data are obtained, either to strengthen the interpretation of quantitative results or to help generalize the results or test qualitative insights;
- Different methods are optimal for various project elements, and each contributes to the overall picture;
- Data are derived from various authoritative sources to offset or mitigate the bias of each method, to verify, validate or substantiate the study's findings and assertions;
- The evaluative research focuses on understanding both mechanism and result;
- One method gives data, which is essential in guiding the other.

As mentioned, the methodology guides the researcher on collecting empirical material and then analyzing them. However, it is needed to dissociate the nature of the data from the methodology. For instance, using qualitative data is not necessarily equal to quantitative methodology.

Our methodology choice meets a need for efficiency *vis-à-vis* the research object, while the data allow by their processing respond to the research object. Our research object imposed the utilization of social network analysis, which is a quantitative methodology build upon qualitative data. We take advantage of the following paragraph to discuss the social network analysis methodology by laying the foundations, origins, and principles, making this particular methodology a receptacle of interorganizational networks studies' interests.

1.4. Choice of quantitative methodology

The research ascribes to the quantitative methodology for different reasons. Firstly, the use of a quantitative methodology is preconized in cases of different sources of information as it renders the numerical translation of a principal amount of data possible. Secondly, adopting a quantitative methodology gives more objective and precise conclusions based on the analysis of minor premises, which aligns with the inductive mode of reasoning adopted with this research. Also, we consider the meticulous procedures employed to obtain quantitative data to warrant the validity and credibility of the data. Moreover, the standard requirements during the data collection and analysis phases make the used methodology replicable from others.

Besides, the quantitative methodology is suited for collecting and analyzing both qualitative and quantitative data. It can be used to make predictions, causal test relationships, and propose to generalize conclusions to broader populations. They suit the inductive reasoning of the present thesis adequately because it implies the study of minor premises to depict significant conclusions. Also, it is relevant to our research paradigm that looks for the creation of objective knowledge. As in any methodology, there are several quantitative methods listed below:

- Research survey;
- Investigation through correlations;
- Comparative-cause research;
- Experimental study.

Survey research is one of the most used methods in quantitative research. A survey enables one to collect data from a pool of people and analyze it by producing numerical results. They can be conducted face-to-face, via phone calls, online surveys such as emails, or social media.

Correlational research aims at studying the link between two variables; the impact of one on the other, and vice versa. *In fine*, correlational research intends to find the relationship between two-closely connected elements of studies through statistical analysis of the data. It is argued that correlational research generalizes conclusions to a larger population irrelevant because identifying a relationship between two or more variables does not ensure that they are interrelated.

Causal-comparative research is mainly based on comparisons amongst a set of variables. This method is used to obtain the cause-effect relationship between two or more variables that are critical for a given matter. The outcome is obtained using the statistical treatment of the data. Finally, experimental research relies on an identified theory that needs to be proven. In other words, the research is looking to verify or refute a theoretical supposition. This method implies establishing a statement and suppositions, which are then tested to understand whether they are valid or invalid.

We have adopted causal-comparative research to give ourselves the greatest chance to depict major industry emergence patterns. This study aims to find the causal effect relationship

between IRs and their effects on industry emergence and the possibility to consider them as an assessment metrics of industry emergence. The literature review on IR networks preconized the use of social network analysis to study complex networks of IRs and depict major structural and attribute patterns inherent to such networks (Borgatti et al., 2009). We, therefore, discuss this matter in the next paragraph.

2. Social network analysis

2.1. Principles of social network analysis

The analysis of networks was introduced by Moreno (1934) in his work *We shall survive*, which laid the foundations of sociometry. Nodes and ties conceptualize actors and their relationships, respectively, within the network. The visual representation of a network is called a sociogram (Wasserman & Faust, 1994). Following Moreno's (1934) seminal work, Moreno and Jenning (1938) developed the modern social network analysis by devoting such methodology to the study of interpersonal relationships and the visualization of interpersonal connections. Since then, SNA has been utilized in many research fields (Aydin, 2019).

SNA mainly aims at investigating the social structures of networks and is strongly endorsed by Tichy et al. (1979) to apply in management fields. Also, the versatility of this statistic and descriptive method has shown growing use in management studies (Borgatti et al., 2009) since they are governed by a set of data collection and analysis methods (Tichy et al., 1979). Network analysis calls upon the social network framework to capture emergence processes and is widely accepted in social sciences (Freeman, 1984). Besides, in the SNA literature, many researchers highlighted the structural elements such as the size of the network and the structural holes (Burt, 1995, 2002) are significant variables of knowledge and resource access (Morrison, 2002).

Although similarities and differences between network members determine network diversity, the characteristics of network organizations have been mainly overlooked by SNA studies (Burt, 1997; Demirkan & Demirkan, 2011). Network analysts argue that networks are often studied at the organizational level, yet, we propose to use organizational level patterns to determine broad conclusions applicable to wider populations.

From a management standpoint, the relevance of network analysis counts on the fact that organizations have limited capability to gather and process all the relevant resources and knowledge by themselves. Thus, the literature suggests the formation of IRs (Powell et al., 1996). Reciprocally, IRs also transmit signals of change in organizations' strategies that potentially try to adapt to innovation.

Consequently, SNA is adopted (Freeman, 2004) as an essential technique in modern research to visualize and conceptualize social structures and relations and applied to many levels, interorganizational level being one of them (Borgatti & Foster, 2003). More generally, it allows the researcher to analyze a complex reality with statistics and sociograms as it is "a method of inductive description and visualization of the relational structure [of the network]" (Lazega, 1994: 293). The adopted methodology witnesses interactive movements of going back and forth between quantitative and qualitative data. The quantitative method sought to understand complex relationships that composed the general picture of industry emergence at a macro level.

Therefore, we derived qualitative information from conferences, informal discussions with industry experts, and the collection of specialized press articles. On the one hand, the quantitative methodology enabled us to seek causal and effect relationships. We complemented our statistical treatments with additional qualitative material to contextualize complex relationships amongst the studied elements.

Consequently, this particular methodology allows us to frame our data collection and analysis process by providing guidelines on data types to collect, index, and codify. The use of UCINET and Netdraw allowed us to use multiple algorithms to assess the main patterns of our IR networks and draw conclusions in regards to the emergence and structuration process of the AV industry. We utilized IR as aggregates units to study meta-organizational structures of a network around key technological activities.

Networks are concerned with structures and patterns of structuration; therefore, they open the opportunities for multilevel analysis and conceptualization of static and dynamic patterns of organizational behaviors by analyzing the network over a period. Finally, this method refers to the collection of qualitative data: the sociometric data. Sociometric data is composed of individuals, groups, or organizations joined by various relationships (Loosemore, 1998) (Figure 26).

Figure 26. Sociometric data types

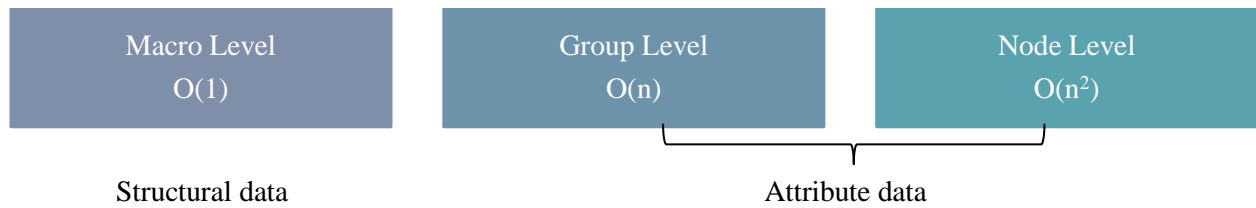

However, sociometric data by themselves hardly provide relevant conclusions by themselves. Therefore, network analysis often only makes sense insofar as a qualitative analysis allows a real knowledge of the context, an understanding, and an interpretation of the results (Thiéart et al., 2014). We present each type of data in the following paragraph.

2.2. Sociometric data collection

In SNA, attribute data and structural data characterize nodes and ties, respectively (Wasserman & Faust, 1994). Structural data represent the ties and connections that exist among nodes, whereas attribute data are the analysis variables of the nodes themselves. It is essential to analyze both attribute data and structural data to identify network patterns, such as clusters.

2.2.1. Structural data

Structural elements of the networks characterize the patterns of relationships that exist between the nodes. Tichy et al. (1979) develop four main structural characteristics categories central to network analysis: external network, comprehensive internal network, clusters, and individuals as particular nodes. We argue that these categories correspond to several levels of network analysis.

The external network focuses on the external connections that the primary network may have with external networks and how nodes are linked between the main and external networks. The whole internal network seeks to understand what forms of relationship link the ego node with alters. It is appropriate for a network-level analysis to monitor some fundamental properties of social networks that are the size, density, and degree (Jamali & Abolhassani, 2006). Therefore, the lens of analysis is placed at a group or network level ($O^{(1)}$) (Borgatti & Foster, 2003) of analysis as the network is considered from being part of a more comprehensive system.

At a lower level of analysis, studying the clusters within networks proceeds to identify denser parts within a given network. Indeed, in some areas, nodes are more closely linked.

Finally, at the node level, or in other words, at the organizational level, the study focuses on key attributes and the identification of focal nodes, network heterogeneity, similarities, and dissimilarities amongst network members. These attributes are gathered in an attribute matrix, incorporated into the square matrix, and serve as input for a dyad level analysis ($O(n^2)$) (*ibid*). We describe the attribute data collection in the following paragraph.

2.2.2. Attribute data

As mentioned by Tichy et al. (1979), networks can be analyzed at three different levels: the macro, the network, and the organizational level. Social network analysis prescribes the implementation of attribute data at the organizational level, which is different from square matrices described in previous paragraphs. Attribute data are indexed in rectangular matrices.

Unlike structural datasets, the attribute dataset is ‘rectangular’ rather than ‘square’ The matrices are composed of rows that are the actors and columns that are the attributes of each actor. These attributes are called variables in statistical language and are selected according to the nature of the research. These attributes are essential to identify clusters (Fortunato, 2010) that are a group vertices that share the same variables. Attribute data can record variables regarding nodes collected from other sources (e.g., type, the industry). As a result, attribute data focus on actors and their attributes and enables one to identify to which extent actors are similar or dissimilar to each other across attributes.

Conclusion of Section II

In the logical sequence of our intellectual journey presentation, the presentation of our methodological anchorage was the purpose of **Section II**. Indeed, epistemological positioning goes hand in hand with the methodology. However, they should not be considered as purely correlated (Thiertart et al., 2014).

We took advantage of the first paragraph to discuss the relevancy of a quantitative methodology after discussing the different methodologies available to us. To summarize, we have identified the causal-effect method as the most suitable methodology for the present research. A more in-depth analysis of the literature on interorganizational relationships and industry emergence preconized a widely accepted and used methodology to study complex networks of organizations: social network analysis.

In summary, network analysis represents an adequate method to answer our research question because we intend to analyze network structuring through the dynamics of network aggregates: the IRs and depict major industry emergence patterns.

As we have touched on the main lines for SNA principles, the inputs and outputs of such a methodology, we have identified the critical aspects of the type of data to collect. As a result, the SNA literature describes two data types to collect to carry out network analysis: the structural data and the attribute data.

Conclusion of Chapter 5

Chapter 5 intends to shed light on the overall research design by discussing the epistemological and methodological matters.

Section I addresses the anchorage in the positivist paradigm and justifies our choice through the relevancy of such a positioning on the analysis of aggregates to deduce the conclusions about a wider population. In the present work, the aggregates are IRs, and the more comprehensive variable is the emerging industry. To deduce the causal-effect relationship between the minor and major premises, we adopted an inductive approach to objectively depict industry emergence patterns and dynamics over the years by studying node and organizational level attributes. The research purpose requirement was demanding for a meticulous methodological framework based on the statistical, therefore, objective and precise analysis of material from different sources that we have discussed in **Section II**.

The scanning of various research and quantitative methods available to us allowed us to ascribe the research in a purely quantitative methodology based on the study of causal-effect relationships between organizational attribute data, structural data, and relatedness to industry emergence. The IR literature review preconized using social network analysis methodology to study complex and sophisticated IR networks and defends the suitable characteristics of such a methodology to depict similarities and dissimilarities in patterns that we have discussed in detail.

Finally, we have identified the types of data needed for applying the SNA methodology: the structural and attribute data. Therefore, SNA required us to construct two independent yet complementary databases: the structural and attribute databases. The process followed to build these two unique databases is discussed in detail in **Chapter 6**.

Chapter 6. Construction of the databases

The data collection phase represents a crucial step in any research. Gathering empirical material is a prerequisite for the creation of knowledge. Indeed, the empirical materials are both receivers and sources of theorization (Thiétart et al., 2014). The right data asserts the researchers' proposition and relegates upstage the ontological question. Collecting the right empirical material will demonstrate the validity of the research. The following part aims at presenting our data collection phase in the context of social network analysis.

As previously mentioned, there are several levels of network analysis, the macro-level ($O(1)$), the group level ($O(n)$), and the node level ($O(n^2)$) (Borgati, 2016; Tichy et al., 1979) as illustrated in Figure 27.

Figure 27. Network analysis levels



In line with network analysis levels, structural and attribute data need to be collected. In the following section, we demonstrate the rigorous data collection process based on these three analysis levels. To amplify the results that the final dataset could give us, we eventually followed the recommendations of network analysts who argue that structural data is more relevant and exciting when compiled with attribute data.

In **Section I**, we discuss the structural and attribute data collection processes. We start by describing our four-step meticulous structural data collection process (Figure 28):

- Step 1: Collection of empirical data
- Step 2: Extraction of structural data

- Step 3: Identification of Key Technological Activities (KTAs)
- Step 4: Indexation and Validation phase of Key Technological Activities (KTAs)

Figure 28. Structural data collection

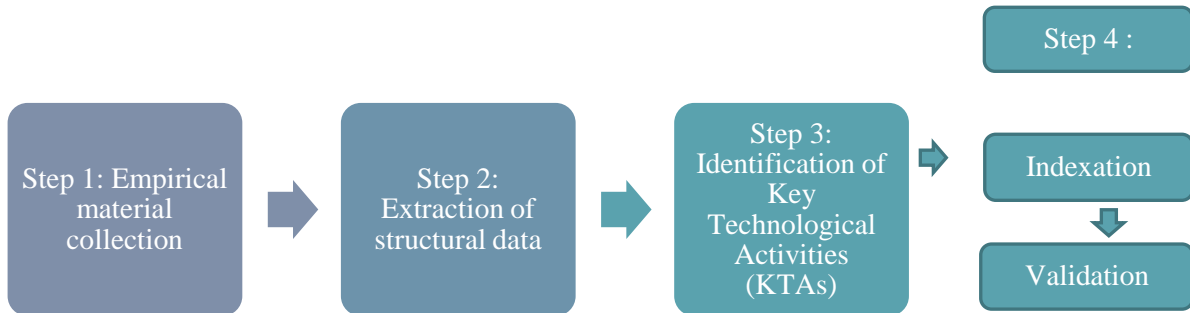

In parallel to the structural database construction, we have completed the construction of the attribute database following a three-step process, as illustrated in Figure 29:

- Step 1: Process of variable attribute identification;
- Step 2: Indexation of attribute data in the database;
- Step 3: Retreatment of the attribute data for pre-analysis.

Figure 29. Attribute data collection process

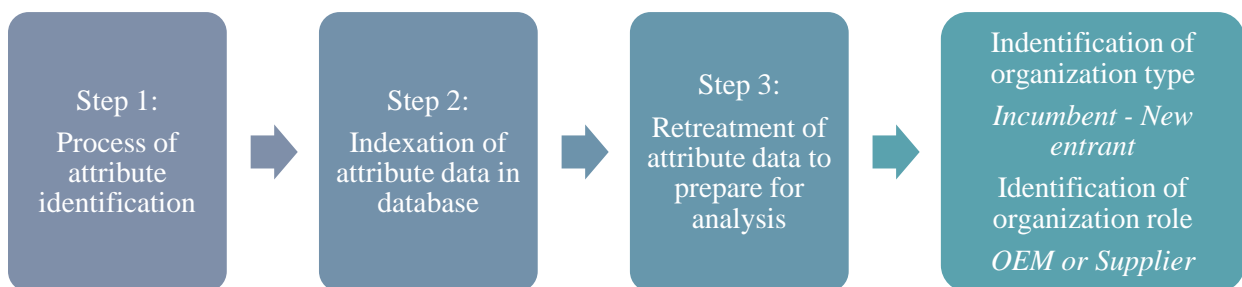

Once the data collection processes are discussed, we then begin **Section II**, where we present the data codification process required for sociometric data to be analyzed with the social network analysis software, UCINET (Borgatti et al., 2009).

Section I. Sociometric data collection

The requirement of our research questions to understand to which extent industry emergence is tributary of interorganizational relationships, we had to follow a strict and rigorous data collection and analysis process. The complexity of our case is explained in several ways.

First, we collected enormous empirical data regarding structural and attributed data regarding IRs and organizations involved in IRs. The data collection phase was time-consuming, yet eventually ended up as a unique database comprising 465 organizations involved in 510 IRs from 2011 to 2019. Secondly, the AV industry has not quite fully emerged, and this makes our analysis tributary of live changes that occur during the emergence and structuration phases. The dominant designs for AVs are not settled yet, and new IRs are contracted amongst organizations every day. Therefore, our research represents a solution to an *ex-ante* analysis of industry emergence while the industry emerges and structures.

The application of SNA seemed appropriate to catch changing patterns in IR between the organization while putting attribute data in parallel to understand the cause-effect relationship that might exist between the macro-level data and the attribute data. To depict patterns in SNA, many centrality degrees can be used that telegraphs how important a node is within a given network.

1. Collection of structural data

In the following paragraph, we discuss the four-step process that we have followed to collect the structural data meticulously. In **Step 1**, we present the empirical data collection from various sources of information being IHS Markit and conference material. We follow with **Step 2**, where we describe how we have extracted the structural data from the empirical material. Once the structural was extracted and indexed in an excel file, we have gone to **Step 3**; which intends to depict major technological activities that drive the AV industry's development. To do so, we have done a technological segmentation and indexation of each technological reason for contracting the IR and eventually came up with five different Key Technological Activities. **Step 4** presents how these technological reasons/drivers have led to a classification into five general KTA categories and the proving process to which the classification was subjected

1.1. Step 1: Collection of empirical material

The primary data source is taken from IHS Markit, the automotive market intelligence platform that provides auto companies with industry scanning reports, articles, and forecasts. IHS Automotive is well known in the automotive industry.

Originally, Markit was a UK company specialized in financial forecasting. IHS acquired Markit in 2016 and made it a leader in information, analytics solutions for major industries such as the automobile industry. IHS Markit is a stock company listed in NASDAQ that works with organizations to collect quantitative and qualitative information regarding changes, trends, and announcements. Its strength lies in its capability to provide automotive stakeholders and shareholders (OEMs and Tiers) with information regarding OEM brand strength, market shares, technology adoption pace, growth, and segment trend monitoring. The platform is a comprehensive market intelligence tool used by automotive companies to monitor their industry and shape their strategies according to the trends (Figure 30).

Figure 30. The IHS AutoTech platform

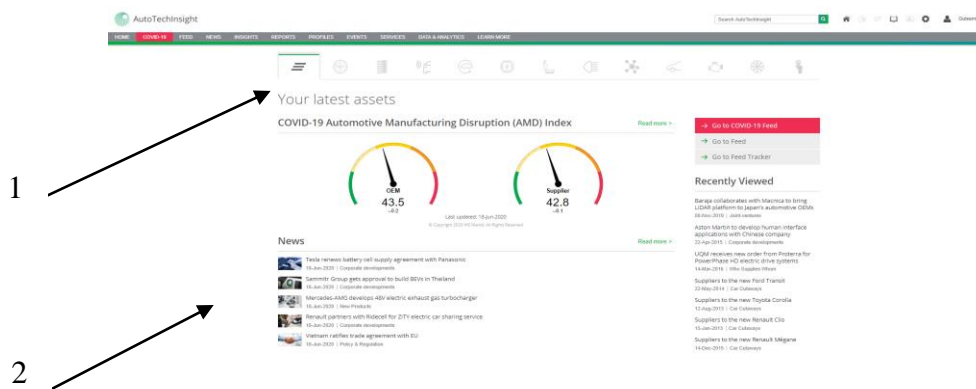

IHS Automotive scans every trend that may impact the automotive industry, and the autonomous vehicle is one of them, as shown by element number 1 in Figure 30.

IHS Automotive is widely used in ARaymond Network as it serves as a market intelligence tool to make strategical decisions, scan the market evolutions and market trends. Moreover, IHS is widely used by auto companies such as OEMs and tier-one suppliers and is a referential tool to assess the auto industry.

Once the significant filter is selected on the top bar menu (1), all the sections below (2) update and gather information about the selected technology. This is the first filter we applied to the research material. We obtained an enormous amount of articles dealing with autonomous driving and autonomous vehicles in general. Amongst the collected material, we selected ‘Topical categories’ provided by IHS in the research options to make our empirical material collection more precise and straightforward.

To obtain articles dealing with our research question, we proceeded to apply filters in the view of obtaining articles containing the following keywords: investments, joint ventures, mergers and acquisitions, and OEM purchasing. None periodicity filter was applied, the same for the involved actors. As a result, we obtained a research dashboard with many filters applied to the global news selection (Figure 31).

Figure 31. Empirical material collection filters

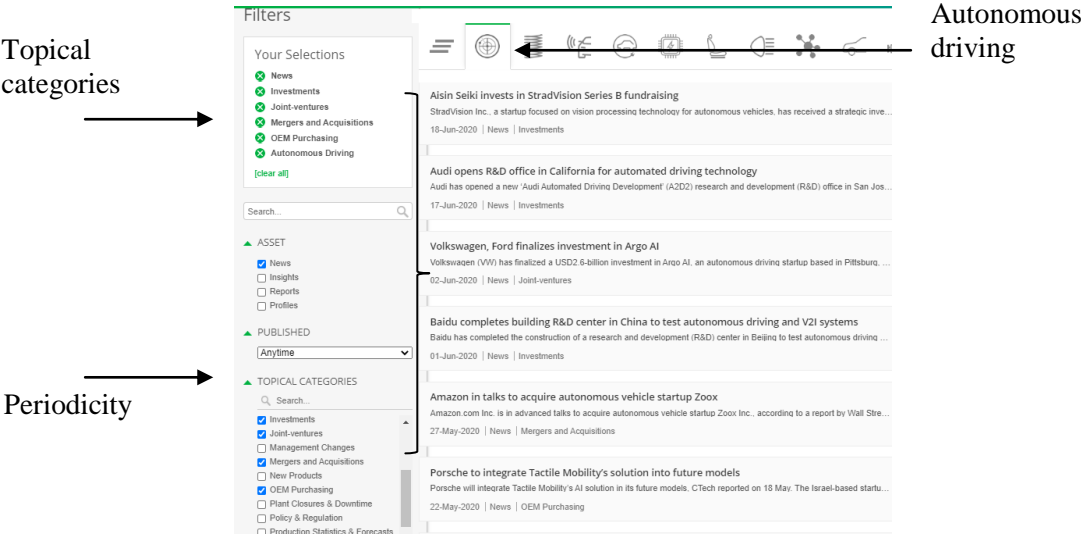

The data collection process started in September 2017, as the research project started at this period, and lasted seven months for the first collection. The database was then updated every month to add the latest IRs until December 2019. We were constrained to stamp out the data collection in December 2019 to reserve the data analysis process to entire years to provide ground for data comparability and follow up on the evolution of the AV industry emergence.

The year 2020 was marked by the global COVID-19 pandemic and rendered the auto industry very sensitive and turbulent with the decreasing amount of car sales and production. We

reckon that 2020 will not provide the right contextual variables to replicate in other circumstances and introduce bias to the conclusions.

As a result, from September 2017 and Mars 2018, we have collected 585 articles that best matched the selected keywords. The data collection started in September 2017. The first collected article dated back to 2011, before when none occurrences were to be found.

The empirical material collection phase represents a phenomenal amount of work as it has been carried out manually and has a unique architecture.

To obtain a clean database, duplicated articles have been removed through a screening process.

Finally, we were left with 510 articles referring to binary IRs. Each article refers to a singular interorganizational relationship.

From these articles, we extracted the structural data that is the objective of **Step 2**.

1.2. Step 2: Extraction of structural data from the empirical material

The structural data in a network refers to the patterns of connection between the nodes. We intended to collect structural data on a chronological basis to provide longitudinal results of AV industry emergence through IRs. As mentioned, we have collected 510 articles referring to binary IRs.

We intended to collect structural information manually from the collected materials to gather in a unique IR Database. In the view of drawing the matrix containing all the IRs between organizations intending to develop autonomous driving technologies, we have set a series of questions to apply to each collected article. To determine the nature of structural data to collect at the macro level, we ought to remind our research questions to create a relevant research flow. Having in mind the necessity to assess industry emergence patterns, we have identified several key elements in each article.

First, we have tried to understand how organizations adapted to complex and technology-intensive innovations. The main results showed a tendency for organizations to call on IRs. Each article, therefore, contained the names of the collaborating organizations and the types of IR that linked them.

We consider the names and the type of IR as two critical elements to collect in our IR Database.

So we questioned each article with two fundamental questions: Who are the partners? What is the type of IR linking them? Our indexation of IR types was based on Contractor and Lorange's typology (2002) of IRs. As a result, we obtained a roster of organizations involved in developing the AV industry through four types of IRs: Partnerships, joint ventures, equity investments, and mergers and acquisitions.

Second, to analyze the evolution of the number of IRs and the patterns of evolution of the autonomous vehicle IR networks, we indexed the year and the month when each IR has been signed between the partners. It let us with an additional question asking when the IR occurs.

Lastly and as widely mentioned in our literature review, IRs happen for many reasons. Yet, the major one is the lack of resources and competencies regarding complex and technology-intensive innovations. Understanding the technological drivers of IRs would let us understand the complex structure of the AV industry and help us to draw the technological landscape required to be formed for AVs to be commercial realities. Indeed, in each article, we asked ourselves the following question: What are the motivations behind interorganizational relationships? We came up with a roster of 38 technological drivers that we have retreated and indexed in broader Key Technological Activities (KTAs) categories.

In the technological driver column, we indexed the technological application for which organizations collaborate. In total, we have collected 45 different technologies, which vary, from the development of sensors, LIDAR, radars, computer vision software, machine learning to the testing, and commercialization of technologies and AVs. In **Step 3**, we explain the indexation of the technological drivers into five KTA categories in detail. To illustrate with an example of Figure 32, organization 1 is 'Baraja'; organization 2 is 'Macnica'. The partnership (type) occurred in 2019 and intended to develop 'LIDAR' technologies.

Figure 32. Example of collected articles

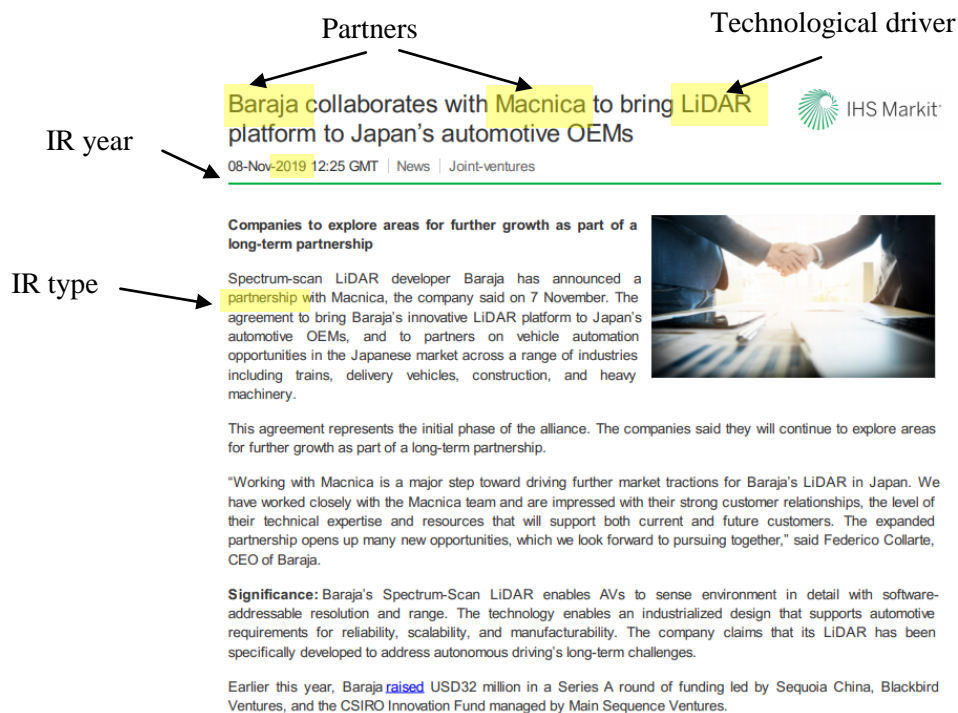

We repeated the process for all the collected articles and obtained a unique database, in which one row equals an IR and obtained a complete structural database. The summary of our unique IR Database is presented in Figure 33.

Figure 33. The output of the IR Database

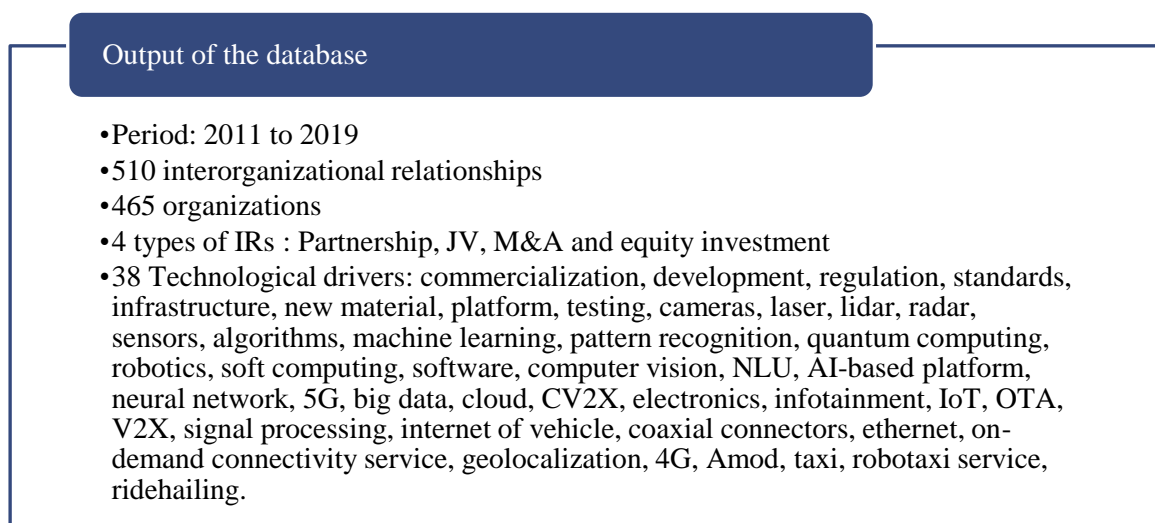

To depict major technologies necessary to AVs, we carried out a segmentation work to classify the 38 technological drivers into broader categories of Key Technological Activities (KTAs). To do so, we proceeded in two complementary steps that we describe in the next subsections:

- Step 3: Indexation of technological into KTA categories;
- Step 4: Validation of the unique KTA categorization.

1.3. Step 3: Indexation of technological drivers in Key Technology Activities (KTAs)

The technological drivers' indexation followed a two-step segmentation process, first categorizing the 38 technological drivers in broader categories; second, the validation phase of the categories.

First, we participated in specialized conferences about autonomous driving on several continents to deepen our understanding of each of them. We argued that given the technological complexity of AVs, it is crucial to meet industry specialists, keep up with AV industry trends and learn more about the current research about such vehicles. We, therefore, participated in three specialized AV conferences.

In the first year of this research project and during the segmentation process, we took part in the '2018 AV Conference Silicon Valley' held in the United States, California, from 26 to 28 February 2018. This yearly conference brings together more than 500 experts from the automotive industry, such as OEMs and Tiers, and autonomous driving specialists from all around the world. It hosts academics and practitioners' presentations regarding autonomous driving advancements and is the favorite conference of AV gurus. In terms of positions, the conference enables to network, for instance, with CEOs, chief engineers, R&D directors, innovation analysts, product and project managers, directors of AI for autonomous driving, and directors of autonomous driving systems. This conference enabled us to reach continuous improvement and carry out professional renewal.

We networked with worldwide industry experts, who are valuable resources for referrals in complex technologies. Various discussions enhanced new ways of thinking about the AV industry, fostered blended learning from leading industry experts and visionaries (Uber, Lyft).

The various discussions with industry experts during networking sessions and the participation in the conference sessions allow us to keep a journal with all the shared information regarding AV technologies.

From the participation of this conference, we gathered presentation material from OEMs such as General Motors, Jaguar Land Rover, Ford working with the MIT and Stanford University, Toyota, Hyundai Group, Volvo, Uber, Lyft, and participated in rounding tables to discuss the advanced stages of AVs, the current state of technology segmentation and the critical technologies for AVs.

At this conference, we noted the prevalence of several critical elements for AV developers and researchers that kept coming back during discussions. First, academics and practitioners mentioned the necessity of connecting AVs to their external and internal environments. Similar to humans, AVs were required to see through sensors, think with AI software, and be tested and commercialized as any technology would be. We also discussed the predominance of new mobility business models with the emergence of autonomous mobility of demand. From that conference, we identified five Key Technological Activities (KTAs) of AV technologies: connectivity, sensors, artificial intelligence, test and commercialization, and Mobility as a Service, which has been verified with industry experts.

Participation in other conferences in the next years was a lever to assess the current state of the technology, identify the advances in autonomous driving, and identify the relevancy of our KTA categorization compared to AVs' technological state in **Step 4**.

The second phase of our segmentation has been carried out in working sessions with Pr. Paul Millier in the view of categorizing our 38 technological drivers into our five KTAs in the context of the CIFRE characteristics of the research. The segmentation work has been carried out during the summer of 2019.

Paul Millier is a Professor of Marketing and management of innovation at EM Lyon Business School. Amongst many successful works, he particularly attracted attention with his studies of industries that do not exist and his propositions on how to segment these industries.

To proceed to the indexation of technological drivers into KTAs, we have identified several criteria for each technological drivers. First, we have identified the ultimate purpose of the

technological drivers: to sense, perform algorithms, connect the vehicle to internet networks, test a technology, or provide a new mobility service? Second, we have identified whether technology is software or hardware to classify a current technology according to its tangibility or intangibility. The choice of the technological attributes has been made by identifying critical elements of focus mentioned in the empirical material and translating the significant organizational challenges that auto companies face. For instance, for ADAS, there is the possibility of having the ADAS sensors and the ADAS software. So, for ADAS software, we have categorized them into AI (Artificial Intelligence), while ADAS sensors were categorized in Sensing. The categorization of technological drivers regarding their final purpose enabled us to index together with the sub-activities that serve a global innovation (KTA).

As a result, we obtained an accurate classification of our 38 technological drivers into five KTAs, as illustrated in Figure 34.

Figure 34. Indexation of technological drivers into five Key Technological Activities

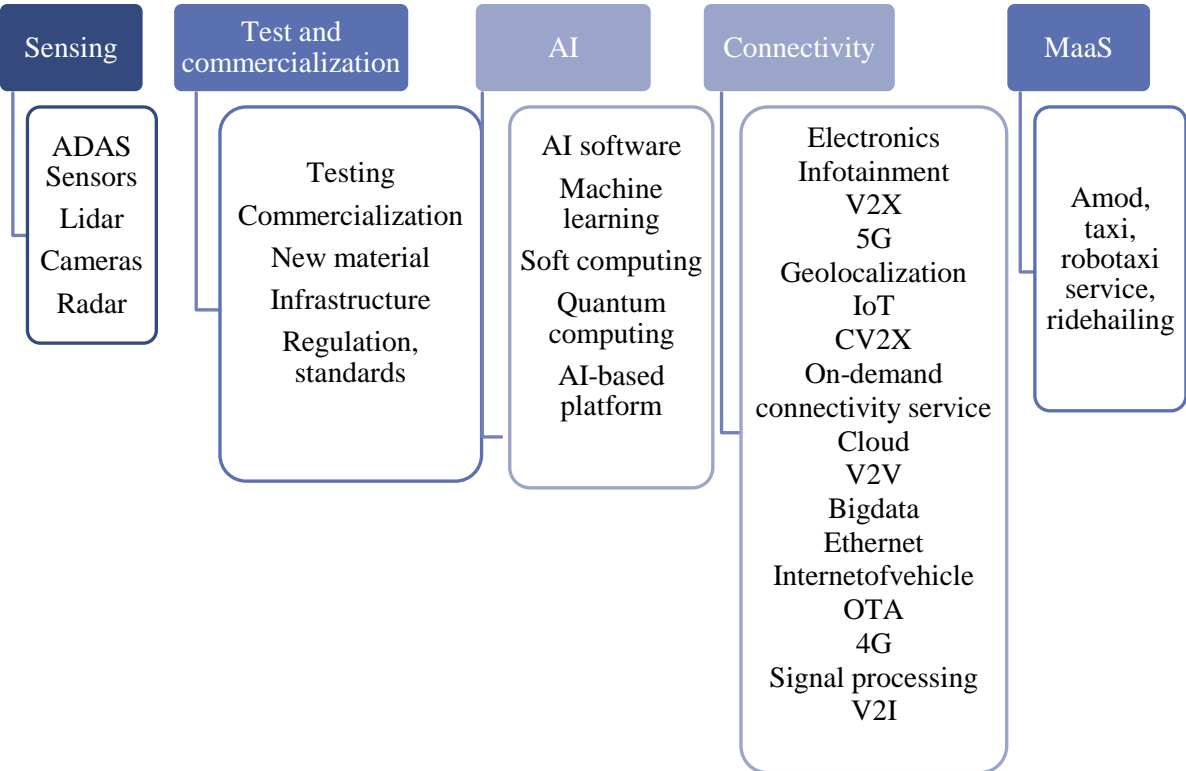

To describe each KTA, we have developed a definition to give information about what kind of technologies are compounded in each of them (Table 12).

Table 12. Definition of the five Key Technological Activities

KTA	Definition
Connectivity	Connectivity enables the vehicles to know where it needs to go through navigation systems based on HD maps, connectivity to the infrastructure (V2I), a pedestrian (V2P), other vehicles (V2V) through electronics (Electronic control systems (ECUs), systems-on-chip (SoC), semiconductors) and telecommunication systems (4G/5G, big data, cloud systems)
Artificial intelligence (AI)	AI enables ADAS to navigate traffic safely and manage complex situations as humans do through complex algorithms that compose the car’s brain. The related AI activities are, for example, machine learning, quantum computing, computer vision, or pattern recognition.
Test and commercialization	This KA refers to the development of AV fleet (shuttle, taxis, robot-taxis), testing activities as AV need to travel for technology validation purposes (e.g., testing AV level 4 in Shanghai, testing V2X applications.), but also the development of new material geared towards futuristic and refined designs for AV (e.g., new materials, new paints, new seats)
Sensing	Autonomous vehicles are equipped with three types of sensing components: cameras, sensors, and LIDAR-based system
Mobility-as-a-Service (MaaS)	This KA is highly critical for AV levels 4 and 5 as it will serve as autonomous vehicle service providers. MaaS service refers to companies collaborating for Autonomous Mobility on demand (AMod), taxi-hailing services, and ride-hailing services

As the last step, we created a data validation list in our IR Database to link each technological driver to its KTA. We obtained the final IR Database version illustrated in Figure 35.

Figure 35. Sample of the IR Database

Year	Organization 1	Organization 2	IR Type	KTA	Technological Drivers
2019	SAIC	GAC	Partnership	Testandcomm	Platform
2019	FAW	Desay	Joint venture	Testandcomm	Newmaterial
2019	Oculii	Infineon	Partnership	Sensing	Radar
2019	Oxbotica	ZF	Partnership	ArtificialIntelligence	Softcomputing
2019	Waymo	Latentlogic	Acquisition	ArtificialIntelligence	Machinelearning
2019	Geely	Quanergy	Partnership	Sensing	Lidar
2019	Daimler	Bosch	Partnership	Testandcomm	Testing
2019	Cognata	IT Access	Partnership	Connectivity	Electronics
2019	Cognata	Hirain	Partnership	Connectivity	Electronics
2019	GAC	Bosch	Partnership	Sensing	ADAS
2019	Velodyne	Hyundai	Partnership	Sensing	Lidar
2019	Onsemiconductor	Almotive	Partnership	Sensing	Sensors
2019	Continental	3M	Partnership	Connectivity	V2V
2019	HERE	Hyundai	Partnership	Connectivity	Geolocalization
2019	Almotive	Nextchip	Partnership	Connectivity	Electronics
2019	Trimble	Qualcomm	Partnership	Connectivity	Geolocalization
2019	Renesas	Stradvision	Partnership	ArtificialIntelligence	Machinelearning
2019	Lgelectronics	Unitytech	Partnership	ArtificialIntelligence	Software
2019	Windriver	Xilinx	Partnership	ArtificialIntelligence	Computer vision
2019	Baraja	Maonica	Partnership	Sensing	Lidar
2019	ZF	Cognata	Partnership	Sensing	ADAS
2019	Hyundai	Aptiv	Joint venture	Testandcomm	Commercialization
2019	Introtechnology	Windriver	Partnership	Connectivity	Electronics
2019	Dongfeng	Tencent	Partnership	Connectivity	_5G
2019	Multicore	Ultrader	Partnership	Sensing	Radar
2019	Ouster	Nvidia	Partnership	Sensing	Sensors
2019	Foresight	WuhanguideInfrared	Partnership	Sensing	Sensors
2019	Yanfeng	lee	Partnership	Testandcomm	Newmaterial
2019	Continental	Carticaai	Equity investment	ArtificialIntelligence	Machinelearning
2019	Tomtom	HellaAglaia	Partnership	Connectivity	Geolocalization
2019	Doordash	Scottylabs	Acquisition	Testandcomm	Testing
2019	Porsche	Tryeie	Acquisition	Sensing	ADAS

As a result, we obtained a unique database encompassing 510 IRs composed of two organizations linked with an IR type to work for a KTA. To assess our indexation of technological drivers, we have participated, as mentioned above, in other conferences to present, test our arguments, and discuss with peers.

1.4. Step 4: Validation of unique Key Technology Activities (KTAs) categorization

The validation process encompasses two aspects. We carried out external presentations of our KTA index and ARaymond internal presentations in AV working groups and team meetings.

In 2019, we participated in the Asian version of the Autonomous Vehicle Conference in California the year before. The *third Annual Autonomous Vehicles Asia 2019 conference*, which took place in Singapore from 12 to 13 March 2019, gathered approximately 500 autonomous and automotive industry experts. This conference was important to us as we had experienced fruitful exchanges in the United States and looked for similar exchanges on the Asian continent to apprehend the vision of AVs in this continent as well. The key themes discussed were the 2025 vision of what will cars look like, the OEM insights and the future AV business models, the government's updates, the technology advancement and project showcases by tech giants and OEMs, and the industry implications and opportunities. To

summarize, this conference provided fascinating information regarding the emerging and structuring processes of the AV industry.

The conference gathered OEMs, regulators, public transport and ride-sharing companies, AV technology providers and startups, legal and insurance companies, research institutes, and telcos. We participated in this conference as part of our ARaymond internal AV working groups to depict significant AV ecosystem changes. We participated in several key presentations, such as the OEM Panel, where Mark Crowford and Mahesh Shinde, respectively, Chief Engineer, Autonomous driving systems at Great Wall Motors, and General manager of Tata Motors, discussed the future of cars.

The conference material presented describes the evolution from traditional cars and industry to the AV ecosystem populated by connected technologies, artificial intelligence applications, the paramount sensors needed for AVs, and the necessity to test AV before their commercialization to clients and mobility service providers. The conference also presented the evolving value chain of the AV industry and indirectly validated our take on KTA as the presenters covered all our categories.

During the several network sessions, we presented our KTA segmentation, which particularly attracted the attention of software companies and OEMs. We were asked to present our segmentation from Intel's R&D director to his team; we had great feedback.

Lastly, to keep up with the AV industry trend evolution, we participated in one last conference in Berlin called AUTO.AI, from 26 to 27 September 2019. The willingness to participate in this conference finds its explanation in the fact that it is the last year of Ph.D. Thus we were analyzing our results and needed to have the latest trends and verify the relevancy of our KTA index. The conference themes mirrored our 5 KTA categorization: connectivity, simulation and testing, AI, sensors, and Maas features.

Lastly, the CIFRE anchorage of this research work allowed us to benefit from managers' and directors' feedback regarding our KTA categorization and IRs as metrics of emergence. We submitted our research methodology and presented the IR database to two AV working groups within ARaymond from September 2018 to March 2019. These working groups are composed of two innovation product managers, a global product manager, an innovation

manager, four business development managers, two senior product development managers, a project manager, and a business unit manager

The presentation of the database opened exciting questions and enabled us to pinpoint our methodological explanations. The global idea was positively received and welcomed as very innovative by the managers. Parallel to the structural database construction, we have completed the attribute database construction, which is fundamental for the final analysis of the structural data.

2. Collection of attribute data

The attribute data collection is independent of the structural data collection phase. We started to collect attribute data in May 2018, and the completion of the attribute dataset occurred during summer 2018. In line with our theoretical anchorage, we have selected a roster of variables discussed in the next paragraph.

2.1 Step 1: Identification of attribute data

Framed by our theoretical anchorage and the social network analysis guidelines on IR networks, we have collected several attributes for each organization involved in the network. In total, our IR database enabled us to extract 465 distinct organizations involved. We defined each organization's type: incumbent or new entrant to depict significant demographical changes in networks and line with the theory of disruption. Besides, we identified several other attributes that we found interesting for our multi-level network analysis. Indeed, to depict cross-sectoral dynamics and geographical distance amongst network members, we defined the industry of provenance for each organization, the year of creation, and indexed the headquarter.

As a result, we have chosen the following criteria:

- The country: This data informs about where the organization is headquartered and is interesting as it highlights geographical dynamics;
- The year: This information is useful for interpretation matters during the identification of the organization type;
- The industry of provenance: This data determines the industry of provenance of each organization and enabled to depict cross-sectoral dynamic patterns;

- The type of organization: This data informs about an organizations' types, i.e., incumbent or new entrant, and is linked to the provenance of organizations. Amongst incumbents, we find traditional automotive manufacturers and auto component suppliers. As long as new entrant was concerned, we systematically classified an organization as a new entrant when its industry of origin differed from the automotive and auto component manufacturing industry.

In the following paragraph, we discuss the identification process of each organization with its industry, creation year, type, and country attributes. We mainly used secondary data available on Bloomberg, which uses the Global Industry Classification System to create company profiles. To clarify the purpose and advantages of using Bloomberg and the GICS classification, we present both tools in the following paragraphs.

2.1.1. Global Industry Classification System

The Morgan Stanley Capital International, now called MSCI, has developed the Global Industry Classification System (GICS hereafter) in 1999. The GICS is a financial tool to help investors capture the breadth, depth, and evolution of industry sectors before moving on with investments. To provide useful information about organizations and industries, the GICS provides a four-tiered hierarchical industry classification system according to which organizations are classified quantitatively and qualitatively. Therefore, the GICS classifies each private organization into a single GICS classification level. The norm provides a four-level classification system ranging from the most general sector to the most specialized sub-industry (Figure 36).

Figure 36. The GICS hierarchy



As a result, each organization is assigned to a sub-industry according to its core business activity (level 4), which corresponds to an industry (level 3), and industry group (level 2), and a sector (level 1). The GICS is ideal for industrial classification of organizations as thousands of industry participants such as managers, custodians, consultants, research teams, and stock exchanges use it. Moreover, it provides a standardized definition of industries that are applied to organizations on a global scale.

In total, in the database, there are eight sectors encompassing materials (15), industrials (20), consumer discretionary (25), consumer staples (30), health care (35), financials (40), information technology (45), and communication services (50).

The 14 industry groups (level 2) indexed the following ones:

- Materials (1510);
- Capital goods (2010), Commercial and professional services (2020), Transportation (2030);
- Automobiles and Components (2510), Consumer Services (2530)
- Household and Personal Products (3030);
- Health Care Equipment and Services (3510)
- Diversified Financials (4020), Insurance (4030);
- Software and Services (4510), Technology Hardware and Equipment (4520), Semiconductors and Semiconductor Equipment (4530)
- Telecommunication Services (5010), Media and Entertainment (5020).

Again this level of classification aggregates into the industry categories, which respectively contain sub-industries. For the sake of our research, we exclusively collected information regarding the industry and the sub-industries because it allowed us to obtain macro-level

industry information with a sufficient level of information regarding the role of each organization. Indeed, the industry level informs about the macro-level classification of organizations without being too general compared to the sector, which seems to encompass a wide range of organizations that might differ from each other compared to the sub-industry basis. We selected the sub-industries so that it allows us to determine whether an organization is a supplier or an OEM.

In the view of identifying industry and subindustry for the 465 organizations, we have retrieved information from Bloomberg.com, which uses the GICS to make organization profiles.

2.1.2. Use of Bloomberg

The indexation of organization attributes required the identification of a detailed organization profile based on secondary data. To obtain the identical information for each organization indexed in our IR Database, we have chosen to recourse to Bloomberg, which uses the GICS to classify organizations. Bloomberg provides organizations business and financial data regarding other organizations in a given industry. It categorizes organizations following the GICS, which helps organizations and investors to figure out the competitive landscape of a given industry.

For each of our listed organizations, we have researched the company profile on Bloomberg. Figure 37 illustrates the company profile of the company Clarion.

Figure 37. Industry profile snapshot



During the first step, we have familiarized ourselves with the company and its activities. We have identified the main attributes on the Bloomberg website. Figure 37 shows the company profiles details regarding the industry (level 3), the subindustry (level 4), the year of creation, and the headquarters. Information provided by Bloomberg is useful in many ways. First, the generalization of the data for each organization provided by the website provides solid ground for data comparability amongst organizations. Second, the reliability of the website makes the collected information useful for large-scale conclusions and neutralizes the possibility of arbitrary decisions regarding the industry, the country, and the type attributes.

Therefore, we have followed a precise and meticulous protocol for each organization to gather attribute data. The protocol is two-phased: in the first phase, we carry out basic research on Bloomberg's organizations' profile. We have identified the industry and the subindustry, the country, and use the year of creation to determine whether we can deduce the incumbency or new entrant status when combined with the industry of origin. We will discuss this point in later paragraphs. In the second phase, we have indexed the identified data in our org-attribute dataset.

We will now present the attribute identification and indexation protocol starting with phase one, which identifies Bloomberg organizations' profiles.

2.2. Step 2: Indexation of data

Once we had identified the industry and country information, we have created the dataset to accommodate our data.

First, we have listed all of the organization names (465) involved in the IR Database (510). Then we have identified their industry of provenance on Bloomberg. To obtain the level 2 information regarding the industry group, we had recourse to the GICS classification accessible online and identified the given industry's industry group. Second, we have used the country information to qualify each organization as well. Third, we have identified the year of creation of each organization. As a result, we obtained the following dataset (Figure 38).

Figure 38. Sample of the attribute dataset

	A	B	C	D	E	F	G
1	Organization	Country - Headquarter	Year of creation	Industry	Industry code	Sub-industry	Sub-industry code
2	Zgetthere	Netherlands	2015	Automobiles	251020	Automobile manufacturers	25102010
3	3m	United States	1968	Industrials conglomerates	201050	Industrials Conglomerates	20105010
4	Abasensing	Norway	2008	Communication equipment	452010	Communication equipment	45201020
5	Abdynamics	United Kingdom	2013	Auto components	251010	Auto parts & Equipment	25101010
6	Accenture	Ireland	2009	IT services	451020	IT Consulting and Other services	45102010
7	Adacore	United States	1994	Software	451030	Application software	45103010
8	Adasens	Germany	2006	Auto components	251010	Auto parts & Equipment	25101010
9	Adasky	Israel	2015	Auto components	251010	Auto parts & Equipment	25101010
10	Adient	United States	2016	Auto components	251010	Auto parts & Equipment	25101010
11	Advancedtelematics	Germany	2013	Software	451030	Application software	45103010
12	Aeva	United States	2016	Auto components	251010	Auto parts & Equipment	25101010
13	Aeye	United States	2013	Auto components	251010	Auto parts & Equipment	25101010
14	Agaufomotive	Japan	1988	Auto components	251010	Auto parts & Equipment	25101010
15	Ambiquity	United States	1997	Internet Software & Services	451010	Internet Software & Services	45101010
16	Aisinaw	Japan	1969	Auto components	251010	Auto parts & Equipment	25101010
17	Aisinseiki	Japan	1949	Auto components	251010	Auto parts & Equipment	25101010
18	Albertinc	Japan	2015	Software	451030	Application Software	45103010
19	Alibabagroup	Hong Kong	1999	Interactive Media & Services	502030	Interactive Media & Services	50203010
20	Aligoembeddedsystems	India	2004	Software	451030	Application Software	45103010
21	Allianceventures	Norway	1986	Capital markets	402030	Diversified capital markets	40203030
22	Almotive	Germany	2015	Communication Equipment	452010	Communication Equipment	45201020
23	Altia	United States	1991	Software	451030	Application software	45103010
24	Ambarrella	United States	2004	Semiconductors & Semiconductor Equipment	453010	Semiconductor equipment	45301010
25	Analogdevices	United States	1976	Semiconductors & Semiconductor Equipment	453010	Semiconductors	45301020
26	Anritsu	Japan	1931	Electronic Equipment, Instruments & Components	452030	Electronic Equipment & Instruments	45203010
27	Ansys	United States	1994	Software	451030	Application software	45103010
28	Apple	United States	1977	Technology Hardware, Storage & Peripherals	452020	Electronic Equipment & Instruments	45203010
29	Aptiv	Ireland	2011	Auto components	251010	Auto parts & Equipment	25101010
30	Aquantia	United States	2004	Semiconductors & Semiconductor Equipment	453010	Semiconductor equipment	45301010

The data analysis enabled us to identify several groups of attributes:

- 30 different industries;
- 14 different industry groups;
- 31 countries;
- Year of creation spanning from 1903 to 2018.

From that information, we determined the type and role of each organization. We describe our data analysis process in the last subparagraph of our section:

- Types of organizations: incumbent (INC) or new entrant (NE);
- Role of organizations: OEM or supplier.

The retreatment of the data to obtain additional information is described as part of **Step 3**.

2.3. Step 3: Retreatment of the attribute data for pre-analysis

To determine whether an organization is an incumbent or new entrant and its role (supplier or OEMs), we have performed data pre-analysis functions in the attribute dataset. Firstly, we started by identifying each organization's role based on the traditional organization of the OEM-supplier of the automotive industry. Secondly, the year of creation of organizations oriented us to determine their type. We combined the year of creation with the provenance industry and eventually obtained organizations' classification according to their type: new entrant or incumbent.

Based on the literature, an incumbent is an organization performing in the industry before the disruption occurs. In our case, incumbent organizations are all the automobile and automobile component manufacturers.

2.3.1. Identification of the organizations’ role

During this step, we have differentiated suppliers from OEMs. OEMs are all the automotive manufacturers indexed in the database. Suppliers are all others. To identify OEMs and suppliers’ stake in the database, we have created an if function linking the industry of each organization to a global role in the industry. Therefore, the following function is applied to every organization:

$$=IF(D2="automobile manufacturers";"Oems"; "supplier")$$

Column “d2” refers to industry information (c.f. Figure 37). Concretely, if the organization is categorized as an automobile manufacturer, then the result is OEM; if not, it is a supplier. As a result, we obtained an additional column with our results (Figure 39).

Figure 39. Identification of the role

A	B	C	D	E	F	G	H
Organization	Country - Headquarter	Year of creation	Industry	Industry code	Sub-industry	Sub-industry code	Role
2 Zgithree	Netherlands	2015	Automobiles	251020	Automobile manufacturers	25102010	Oems
3 3m	United States	1968	Industrials conglomerates	201050	Industrials Conglomerates	20105010	supplier
4 Abasensing	Norway	2008	Communication equipment	452010	Communication equipment	45201020	supplier
5 Abdynamics	United Kingdom	2013	Auto components	251010	Auto parts & Equipment	25101010	supplier
6 Accenture	Ireland	2009	IT services	451020	IT Consulting and Other services	45102010	supplier
7 Adacore	United States	1994	Software	451030	Application software	45103010	supplier
8 Adasens	Germany	2006	Auto components	251010	Auto parts & Equipment	25101010	supplier
9 Adasky	Israel	2015	Auto components	251010	Auto parts & Equipment	25101010	supplier
10 Adent	United States	2016	Auto components	251010	Auto parts & Equipment	25101010	supplier
11 Advancedtelematics	Germany	2013	Software	451030	Application software	45103010	supplier
12 Aeva	United States	2016	Auto components	251010	Auto parts & Equipment	25101010	supplier
13 Aeye	United States	2013	Auto components	251010	Auto parts & Equipment	25101010	supplier
14 Agcautomotive	Japan	1988	Auto components	251010	Auto parts & Equipment	25101010	supplier
15 Aitiquity	United States	1997	Internet Software & Services	451010	Internet Software & Services	45101010	supplier
16 Aisinaw	Japan	1969	Auto components	251010	Auto parts & Equipment	25101010	supplier
17 Aisinseiki	Japan	1949	Auto components	251010	Auto parts & Equipment	25101010	supplier
18 Albertinc	Japan	2015	Software	451030	Application Software	45103010	supplier
19 AlibabaGroup	Hong Kong	1999	Interactive Media & Services	502030	Interactive Media & Services	50203010	supplier
20 Allipembeddedsystems	India	2004	Software	451030	Application Software	45103010	supplier
21 Allianceventures	Norway	1986	Capital markets	402030	Diversified capital markets	40203030	supplier
22 Amotiv	Germany	2015	Communication Equipment	452010	Communication Equipment	45201020	supplier
23 Alta	United States	1991	Software	451030	Application software	45103010	supplier
24 Ambarilla	United States	2004	Semiconductors & Semiconductor Equipment	453010	Semiconductor equipment	45301010	supplier
25 Analogdevices	United States	1976	Semiconductors & Semiconductor Equipment	453010	Semiconductors	45301020	supplier
26 Anritsu	Japan	1931	Electronic Equipment, Instruments & Components	452030	Electronic Equipment & Instruments	45203010	supplier
27 Ansys	United States	1994	Software	451030	Application software	45103010	supplier
28 Apple	United States	1977	Technology Hardware, Storage & Peripherals	452020	Electronic Equipment & Instruments	45203010	supplier
29 Aptiv	Ireland	2011	Auto components	251010	Auto parts & Equipment	25101010	supplier

Column H indexes the results of our function. In total, we had 57 OEMs and 403 suppliers. The next step focused on determining the organization type, whether an incumbent OEM or supplier, or a new entrant OEM or supplier.

2.3.2. Identification of organizations' type

To determine the incumbency or the new entrant typology between organizations, we applied an “if” function to determine whether the organization operated in the automobile industry or not. As a result, we have applied the following function:

$$=IF(Or(F2="Automobile manufacturers";F2="Auto parts & Equipment")*(C2<=2011);"traditional";"new entrant")$$

Assuming that the provenance industry would provide solid ground for the organization type identification, we have created an excel function to determine the industry type by comparison to its industry of origin. For each row, we have compared the result with the year of creation (C2) of the organization to depict incoherence in results. We considered that the organization created after 2011 as new entrants in line with the structural data that started in 2011. For instance, a supplier, which was created in 2011 and operated as a supplier in the software subindustry, is a new entrant supplier since it was not present in the traditional value chain of the automotive industry before AV emergence. We obtained organization types in column I (Figure 40).

Figure 40. Identification of the organization type

A	B	C	D	E	F	G	H	I	
1	Organization	Country - Headquarter	Year of creation	Industry	Industry code	Sub-industry	Sub-industry code	Role	Type
2	ZigBee	Netherlands	2015	Automobiles	251020	Automobile manufacturers	25102010	OEMs	New Entrant
3	3m	United States	1968	Industrials conglomerates	201050	Industrials Conglomerates	20105010	supplier	New Entrant
4	Abansensing	Norway	2008	Communication equipment	452010	Communication equipment	45201020	supplier	New Entrant
5	Abhynamics	United Kingdom	2013	Auto components	251010	Auto parts & Equipment	25101010	supplier	Traditional
6	Accenture	Ireland	2009	IT services	451020	IT Consulting and Other services	45102010	supplier	New Entrant
7	Adacore	United States	1994	Software	451030	Application software	45103010	supplier	New Entrant
8	Adasens	Germany	2006	Auto components	251010	Auto parts & Equipment	25101010	supplier	Traditional
9	Adasly	Israel	2015	Auto components	251010	Auto parts & Equipment	25101010	supplier	Traditional
10	Adient	United States	2016	Auto components	251010	Auto parts & Equipment	25101010	supplier	Traditional
11	Advancedtelematics	Germany	2013	Software	451030	Application software	45103010	supplier	New Entrant
12	Aeva	United States	2016	Auto components	251010	Auto parts & Equipment	25101010	supplier	Traditional
13	Aeye	United States	2013	Auto components	251010	Auto parts & Equipment	25101010	supplier	Traditional
14	Agoodautomotive	Japan	1988	Auto components	251010	Auto parts & Equipment	25101010	supplier	Traditional
15	Aibiquity	United States	1997	Internet Software & Services	451010	Internet Software & Services	45101010	supplier	New Entrant
16	Aisinaw	Japan	1969	Auto components	251010	Auto parts & Equipment	25101010	supplier	Traditional
17	Aismisaki	Japan	1949	Auto components	251010	Auto parts & Equipment	25101010	supplier	Traditional
18	Albertic	Japan	2015	Software	451030	Application Software	45103010	supplier	New Entrant
19	Alibabagroup	Hong Kong	1999	Interactive Media & Services	502030	Interactive Media & Services	50203010	supplier	New Entrant
20	Aligembbededsystems	India	2004	Software	451030	Application Software	45103010	supplier	New Entrant
21	Allianceventures	Norway	1986	Capital markets	402030	Diversified capital markets	40203030	supplier	New Entrant
22	Amnove	Germany	2015	Communication Equipment	452010	Communication Equipment	45201020	supplier	New Entrant
23	Alfa	United States	1991	Software	451030	Application software	45103010	supplier	New Entrant
24	Ambarella	United States	2004	Semiconductors & Semiconductor Equipment	453010	Semiconductor equipment	45301010	supplier	New Entrant
25	Analogdevices	United States	1976	Semiconductors & Semiconductor Equipment	453010	Semiconductors	45301020	supplier	New Entrant
26	Anritsu	Japan	1931	Electronic Equipment, Instruments & Components	452030	Electronic Equipment & Instruments	45203010	supplier	New Entrant
27	Ansys	United States	1994	Software	451030	Application software	45103010	supplier	New Entrant
28	Apple	United States	1977	Technology Hardware, Storage & Peripherals	452020	Electronic Equipment & Instruments	45203010	supplier	New Entrant
29	Apiv	Ireland	2011	Auto components	251010	Auto parts & Equipment	25101010	supplier	Traditional
30	Aquantia	United States	2004	Semiconductors & Semiconductor Equipment	453010	Semiconductor equipment	45301010	supplier	New Entrant

As a result, we obtained the type of organizations that are either new entrants or incumbents and have completed the construction of our attribute database.

Conclusion of Section I

In **Paragraph 1**, we have presented in detail the data collection and analysis process of our sociometric data, which is the critical foundation of any social network analysis methodology.

The structural data were mainly collected on the IHS database and resulted in 465 organizations involved in 510 IRs from 2011 to 2019. We provided a detailed presentation of the filter selection and application process on the platform and eventually ended up with a roster of IRs, organizations, IR types, and IR drivers.

The concentration on IR technological drivers is, we believe, what makes this research work unique. We propose to understand how the process of industry emergence and structuration is palpable at the interorganizational relationship level by adding a level attribute that is the innovation content itself. We named them Key Technological Activities (KTAs) and identified five different ones: Artificial Intelligence (AI), Connectivity, Sensing, Testing and Commercialization, and Mobility-as-a-Service (MaaS).

The indexation of technological drivers in different KTAs represents a crucial and relevant step in the data collection process. We present the benefits of having participated in several specialized and international conferences on autonomous driving. The several verification processes of the KTA during discussions, team meetings, and work projects made the final classification of technological drivers in five KTAs relevant.

Therefore in **Paragraph 2**, we discussed the selection and data collection process of the attribute data. To characterize the organizations indexed in the dataset, we have chosen for many relevancy reasons to utilize the Global Industry Classification System (GICS) in parallel to the information regarding organizations' industry on Bloomberg. As a result, we came up with a second dataset compounded of organizational attributes, their industry of origin, the subindustry, headquarter country, the type (incumbents, new entrant) of the organization role (OEM, supplier).

We have summarized the output of the data collection process in Figure 41.

Figure 41. The data collection process

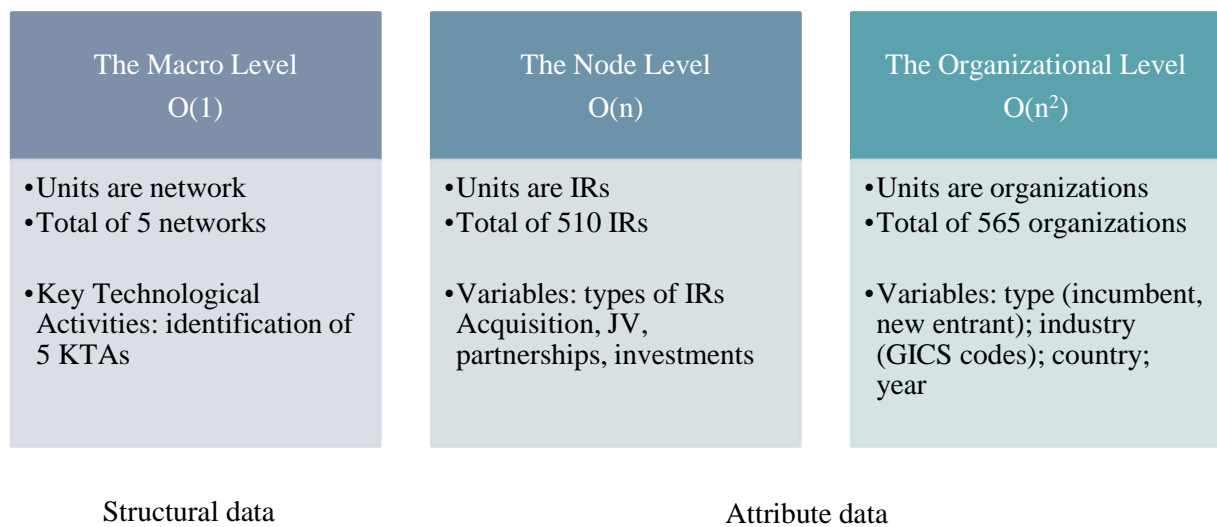

The structural data collection and analysis have represented a crucial step in our research work. The structural data collection phase was very time-consuming as we created our unique database by manually collecting our data.

Nevertheless, the construction of the two databases (structural and attribute) is not enough for carrying out SNA that requires the codification of the data in a way that suits the most widely used SNA software UCINET.

Section II. Data codification process

The data codification ascribes to the logical sequences of tasks in social network analysis methodology. Once the data collected and indexed following a clear and precise architecture, it has to be coded so that SNA data analysis is possible. Network analysts preconize the use of UCINET since it has a high level of relevancy in network studies and has seen a growing interest from network researchers (Allee, 2000; Borgatti et al., 2009).

In **Section II**, we intend to clarify the use of UCINET and the requirements that we followed for a rigorous analysis of our structural and attribute data. Therefore, we start with an introduction about the principles of UCINET and intend to familiarize ourselves with the SNA lexicon. As a result, we discuss the critical dimensions of UCINET, starting with the matrices and types of graphs, and addressing the different modes of networks. In a second time, we present the most used network analysis algorithms: degree centrality, closeness centrality, and betweenness degree. Finally, we introduce the complementary network visualization software NetDraw, which we have used to create the sociograms presented in **Part III Findings**.

1. UCINET

UCINET is general-purpose software for social network analysis developed by Borgatti, Everett, and Freeman in 2002. It is a menu-driven software that allows a vigorous analysis of network structure, content, and evolution based on algorithms (Figure 42).

Figure 42. Snapshot of the UCINET platform

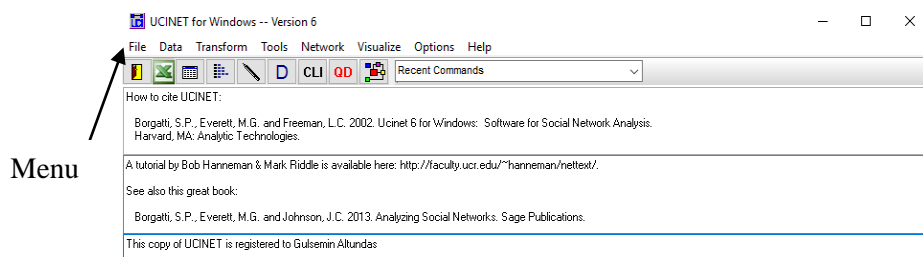

The sociometric analysis is only possible when the data is coded into matrices, either symmetrical or asymmetrical. Symmetrical matrices refer to reciprocal relationships, while

asymmetrical matrices refer to nonreciprocal relationships, which take the form of directed or undirected graphs. We discuss these fundamental dimensions of SNA in the following subparagraphs.

1.1. Matrices and graphs

The SNA, also named graph theory, is based on graphs and matrices that can vary in forms and shapes. As mentioned, networks are composed of nodes and ties. A node is compounded of a social entity (e.g., individual or organization in our case); when this node is in focus, it is called ‘ego’ and ‘alter’ are the nodes tied to that ego.

The nodes and tie data are coded in matrices, and symmetric and asymmetric are two different types of matrices that we discuss in **1.1.1**. Directed and undirected graphs are discussed in **1.1.2**.

We finish our paragraph by differentiating one-mode and two-mode graphs.

1.1.1. Symmetric and asymmetric matrices

The most common data collection method uses matrices to represent social relations (Jamali & Abolhassani, 2006). The number of rows in the dataset is equal to the number of organizations present in the network.

These matrices are called adjacency ones because the entries are adjacent, and they are qualified as ‘square matrices’ because the number of rows equates to the number of columns.

The adjacency matrices can take several forms, yet the most commonly used ones are the binary matrices. Binary matrices translate the existence or absence of a tie between nodes; if a tie exists between two nodes, a one is placed in the matrix cell. On the contrary, if no tie exists between two nodes, a zero is entered in the matrix cell.

Therefore, the relationships can be asymmetric (Table 13) or symmetric (Table 14) (Hanneman & Riddle, 2014), conferring another characteristic to the matrix by asking whether the relationships flows in both directions or only in one direction.

Table 13. Asymmetric matrix

	A	B	C
A	-	0	0
B	1	-	1
C	1	1	-

Table 14. Symmetric matrix

	A	B	C
A	0	1	1
B	1	0	1
C	1	1	0

As a result, symmetric matrices will take the form of a directed graph, while asymmetric matrices inherently shape undirected graphs.

1.1.2. Directed and undirected graphs

Undirected ties among actors compound symmetric matrices. Similarly, asymmetric matrices gather unrequited relationships among actors. In a given network, node A may be related to node B (1), whereas node B is not related to node A (0). Asymmetric matrices are represented by directed graphs where rows represent the sources of directed ties (Figure 43).

Figure 43. A simple representation of an undirected and directed graph

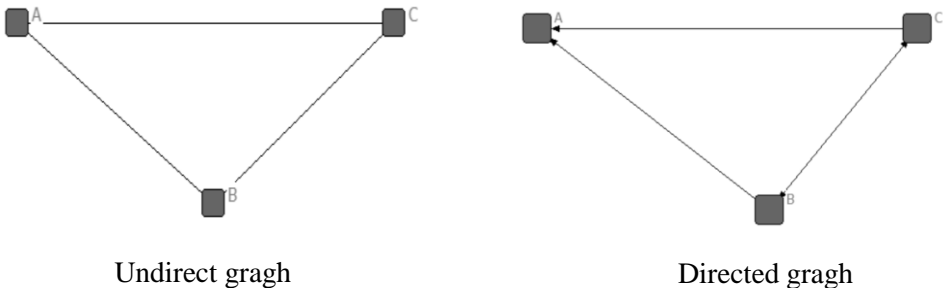

As a result, the arrows indicate that A has no relationships with B and C in the directed graph. B's ego-network is composed of A and C, and C is related to A and B. In the undirected

graph, the relationships are symmetrical; the graph explicitly informs that A is related to B and C, B is related to A, and C and C is related to A and B.

Lastly, we discuss the two different modes of networks in UCINET: one mode and two-mode networks.

1.2. One-mode vs. two-mode networks

In previous paragraphs, we described the network matrices and their conceptualization in graph forms. Nevertheless, besides being directed or undirected, networks vary in their mode as well. As a result, social network analysis can study one-mode networks or two-mode networks. One-mode networks are the most prominent, and they track networks composed of one set of similar nodes. Nodes may well be organizations, for instance. One-mode matrices are called square since the number of columns is equal to the number of rows.

Nevertheless, sometimes, SNA incorporates two-mode networks called affiliation or bipartite networks (Borgatti & Everett, 1997). These networks combine nodes from two different datasets, meaning that nodes and ties belong to different datasets. These networks mainly focus on how nodes are affiliated to particular events such as ceremonies and illnesses. Prell (2011: 115) names them “actor-by-event networks.” In this case, we speak about “rectangular matrices” as rows refer to a type of actors and columns to an event.

In our study, we use both types of matrices. We carried out square matrices of IRs networks amongst organizations that comprise symmetrical data about undirected relationships among organizations between 2011 and 2019. In parallel, we studied the affiliation of organizations in KTAs networks with one-mode entry matrices.

The final purpose of the data codification is to enable the statistical treatment of the data and the application of several centrality algorithms to depict similarities, dissimilarities, central positions in the network, and distance amongst network members. We discuss the network analysis algorithms that are mostly used in network studies.

2. Network analysis

Recent research has highlighted that most of the papers that conduct quantitative research on network structuration have focused on structural metrics provided by UCINET (Borgatti et al., 2002). As described by the founders (Borgatti et al., 2012: 12), UCINET enabled a “diverse collection of network analysis techniques, in addition to traditional statistical procedures and data management facilities”.

For presenting the rows and the columns and summarize all the value of the studied matrices, UCINET provides a wide range of univariate statistics such as the density matrix average and the standard deviation. For scaling rows and columns, UCINET performs correspondence analysis and singular value decomposition. While these statistics are not peculiar to SNA, they are often used in this context (Borgatti et al., 2002).

Alongside univariate statistics, UCINET provides a variety of algorithms to compute multiple centrality measures. Indeed, network thinking has significant contributions to social power studies, as the network perspective argues that power is most inherently relational. Therefore computing centrality degree highlights the systemic (macro) and the relational (micro) power of a node within a network.

Over the years, several centrality degrees have been developed. Hanneman and Riddle (2005) have identified degree centrality, closeness, and betweenness as critical network centrality measures.

2.1. Degree centrality

Transformations evidence the graph-theory ambitions to shed light on a network's evolving state through the generation of graphs. Connectivity in SNA focused on computing indices of proximity and cohesion between the nodes. Centrality reflects the importance of a node within its network. Several standard centrality measures exist, such as Freeman's degree, Bonacich eigenvectors, and several others. UCINET also permits the identification of subgroups, which, as mentioned previously, refers to groups of nodes with similar attributes. Positions and roles are measured through structural equivalence, automorphic equivalence, and regular equivalence. For the sake of our study, we have chosen to use centrality measures to make

comparisons between states of transformation and identify main patterns of structuration of networks.

Besides, according to Borgatti et al. (2009), at the node level, centrality is the measure that is the most looked at. It refers to “a family of node-level properties relating to the structural importance or prominence of a node in the network” (Borgatti et al., 2009: 894). Therefore, we examined two different centrality degrees to corroborate our results because they have been subjected to many tests and studies and are widely used in network studies.

First, following Rusinowska et al. (2011: 6), a degree of centrality “indicates how well a node is connected in terms of direct connections”. This formula gives the degree centrality:

$$C_d(i; g) = \frac{d_i(g)}{n - 1} = \frac{|N_i(g)|}{n - 1}$$

Where $N_i(g)$ is a set of nodes $\{1, 2, \dots, n\}$ with which a node i has a link and $d_i(g)$ the number of links between nodes i et g . The network is considered complete when $d = n - 1$.

Second, the Bonacich Eigenvector Centrality is a measure of centrality in which “a unit's centrality is its summed connections to others weighted by their centralities” (Bonacich, 1987: 1173) and considers a broader range of direct and indirect ties that influence networks. In a similar approach, the eigenvector-related centrality degree examines the idea that the importance of a node is measured by its neighborhood (Rusinowska et al., 2011). This measure is particularly important as it assumes that one node's importance and prestige are dependent on the centralities of the nodes to which it is linked to (Bonacich & Lloyd, 2001). The formula of the Bonacich Eigenvector Centrality is:

$$x_i = a_{1i}x_1 + a_{2i}x_2 + \dots + a_{ni}x_n$$

Where x is the centrality score, A et B are adjacency matrix where a_{ij} means that i influences j 's centrality (Bonacich & Lloyd, 2001).

In parallel to its centrality within the network, a node's importance is gauged through its closeness to other network nodes: this measure is called closeness centrality.

2.2. Closeness centrality

Closeness centrality is a peculiar metric, as it determines how near the ego is to alters in the network (Golbeck, 2013); thus, it is loosely linked to the concepts of node distance (Perez & Germon, 2016). Node A's length to node B is the shortest path length between A and B. As a result, closeness is a mutual fairness equal to the sum of a node's distance to all other nodes. The formula for the closeness centrality is:

$$1 / \text{sum (distance from a node to all other nodes)}$$

The lowest centrality degree is equal to one, which indicates that nodes are directly linked to all the other nodes in the network. It implies high compactness of the network, as nodes are not spread out and all connected. Conversely, the higher the closeness degree of a node, the faster it will take this node to spread information to all other nodes in the network (McKnight et al., 2011).

To conclude, the closeness degree is valuable as it measures the shortest path to access a given node in the network. Sometimes, several different paths might exist between two nodes; therefore, the betweenness centrality intends to compute the number of ties a node is on.

2.3. Betweenness

The betweenness centrality measures a tie's ability to control the flow of communication within a given network. It calculates the number of times a node is situated on the shortest path length between two other nodes. The more shortest path lengths the nodes are located on, the more power and control it has to as a large amount of information that passes through those paths will pass through the node (Parau et al., 2017). Therefore, it computes a node's capacity to create connections within the network (McKnight et al., 2011).

In a graph, a node with lower betweenness degrees is located on the outskirts while the higher betweenness degrees tend to be central to the graph. This measure is valid if we consider that most exchanges are made through the shortest path lengths.

The last step of SNA is the visualization of the data with sociograms. We used Net Draw is a graph visualization software embedded into UCINET (Borgatti, 2002).

2.4. Data visualization with NetDraw

Data visualization represents the last step to SNA as it is generated from the raw data indexed in UCINET through matrices. To generate the sociograms, UCINET comes with a mapping program called Netdraw. Netdraw uses multi-dimensional scaling (MDS) that is considered as a pivotal asset to study the “internal structure” of the network (Wasserman & Faust, 1994: 287), which enables to physically position actors based on their relational attributes and conceptualize their attributes. The NetDraw icon is located on the menu of UCINET.

To open a structural matrix that indexes the IRs, we open the square matrix. Then we proceed to the opening of attribute datasets to allow us more refined data analysis. Once the network appears on the canvas, several design options are possible. In cases of an extensive network, we zoom in and zoom out, so the entire network does fit on one screen. We format the size, color, and form of each node. We used these commands to visualize nodes by their types and their centrality degrees (Properties>Symbols>Colors or size>attributed-based) attributes.

The study of sociograms over the years telegraphs the visual transformation of the network over the studies period; therefore, it is a powerful tool to report network structuration.

Conclusion of Section II

In **Section II**, we telegraphed the fundamental dimensions of social network analysis. The presentation of the principles of UCINET alongside the algorithmic and visualization possibilities provided by the software enabled us to identify the data analysis opportunities that this methodology provides.

We intended to describe how the data has been codified, which algorithms have been selected to analyze the data, and the process to produce sociograms with NetDraw.

We have presented the two types of matrices: symmetric and asymmetric matrices, respectively, correspond to directed and undirected graphs. We also provide a presentation of different types of networks in SNA: one-mode and two-mode networks.

The codification of the data into matrices builds the foundation of SNA statistical treatment by applying algorithms.

Finally, we have briefly introduced the data visualization tool called NetDraw that we have used to retrieve graphs based on the data code matrices.

Conclusion of Chapter 6

Chapter 6 presented the data collection and pre-analysis process that we followed to construct two independent yet complementary databases: the structural and attribute database. The overall objective of this chapter was to discuss the rigorous processes leading to the two databases and, *in fine*, to bring clarity, transparency, and replicability to the methodology.

In **Section I**, we have discussed the four-step process for the structural data collection encompassing the empirical material collection, the extraction of the structural information from the empirical material, the indexation play of the technological drivers into KTA indexation, and the validation phase of the KTA indexation. The very time-consuming aspect of the data collection was mentioned in the literature, yet, makes us believe that it holds a significant impact on the data analysis and finding part.

In parallel to the structural database construction, we have followed network analysts' requirements discussing the necessity to add contextual and attribute data to analyze the structural data. It is what we have done through the construction of the attribute database. The attribute database brings information concerning the organizations indexed in the structural database and therefore required us to follow a different process composed of three steps.

On the first hand, we started by identifying the most critical attributes suite for the present research, and selected the following attributes: country, the year of creation, the industry of provenance, and derived the type and role based on the year and industry of provenance. The indexation of the attribute data occurred as part of step two, and finally, the data was subjected to some pre-analysis to identify the role and type. Once we had accomplished the construction of the two databases, we next have spent the time codifying the data to make it available for social network analysis using UCINET and NetDraw.

In **Section II**, we have presented the different possibilities offered to network analysts to depict similarities and dissimilarities in their networks using symmetric or asymmetric matrices, respectively, leading the directed and undirected graphs. We have discussed the different networks and the most used network analysis algorithms for pattern identification in networks. Finally, we have presented the data visualization module of UCINET, NetDraw, that enables us to draw the network graphs.

Conclusion of Part II

Part II traces back the methodological and epistemological reflections of the present research work. Throughout the different chapters, we aimed at telegraphing the logical continuum that we have followed to research, analyze, and identify the significant findings. The structure of **Part II** is summarized in Figure 44.

Figure 44. Research design

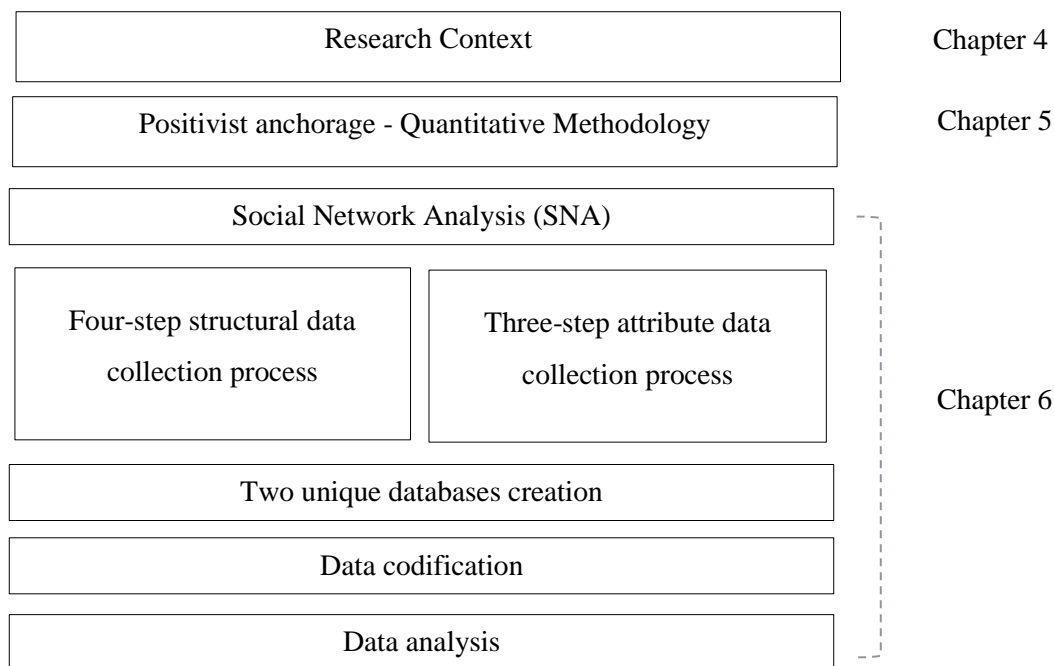

Chapter 4 introduced the automotive industry and created the link with our research context: the AV industry. We presented the disruptive characteristics of AVs and explained the various motives and intrinsic reasons, making the AV industry an interesting research context.

Then in **Chapter 5**, we have discussed the methodological anchorage. Alongside the relevancy benefits that it gives the research, the methodology and epistemological positioning also enable a particular way to respond to our research questions. The quantitative methodology scanning highlighted the suitability of SNA for the present research work.

Therefore, in **Chapter 6**, we have discussed the detailed data collection phase based on SNA requirements. Firstly, we have collected enormous empirical data regarding structural and

attributed data regarding IRs and organizations involved in IRs. Our data collection phase was time-consuming, yet eventually ended up as a unique database comprising 465 organizations involved in 510 IRs from 2011 to 2019.

Secondly, the autonomous industry has not quite fully emerged, and this makes our analysis tributary of live changes that occur during the emergence and structuration phases. The dominant designs for autonomous driving are not settled yet, and new IRs are contracted amongst organizations every day. Therefore, our research represents a solution to an *ex-ante* analysis of industry emergence while the industry emerges and structures.

The application of an SNA seemed appropriate to catch changing patterns in IR between the organization while putting attribute data in parallel to understand the cause-effect relationship that might exist between the macro-level data and the attribute data. To depict patterns in SNA, many centrality degrees can be used that telegraphs how central, important a node is within a given network.

Finally, **Part II** aimed at giving transparency and replicability of our methodology and making the understanding of the results easier. Therefore, Part II prepared the ground for **Part III**, where we discuss our main findings.

PART III: FINDINGS

In **Part III**, we present the result of this doctoral research. In concordance with the literature and methodological anchorage, we present our findings as part of a multi-level funnel approach composed of several levels of analysis: the macro level, the network level, and the organizational level (Figure 45).

Figure 45. Structure of Part III

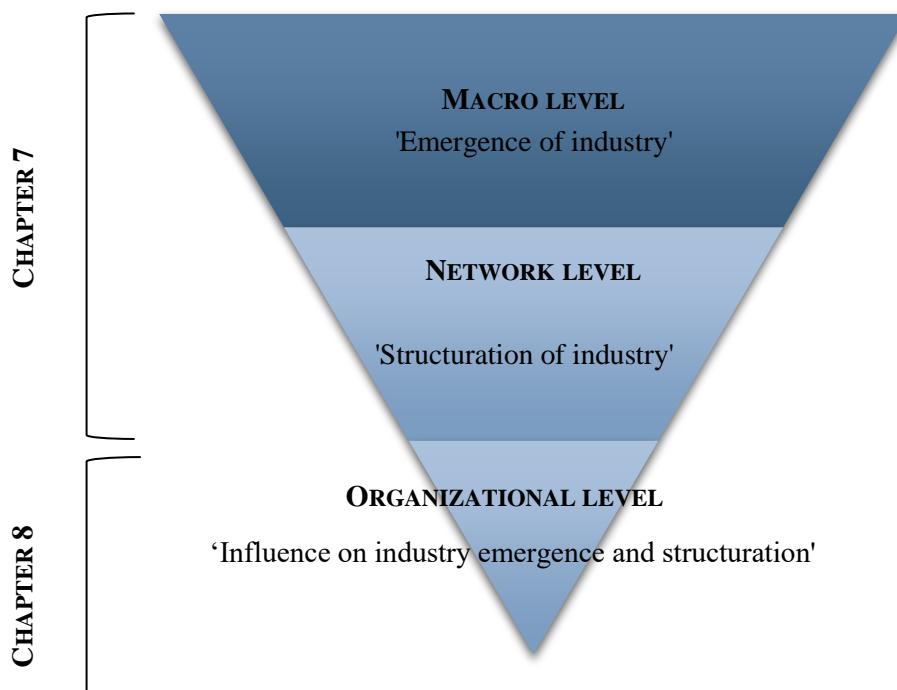

Accordingly, in **Chapter 7**, we contribute to the macro-level findings regarding industry emergence and industry structuration. The industry emergence was approached from a dynamic perspective in demonstrating that as opposed to what industry life cycle (ILC) models show, industries are more dynamic and require a longitudinal analysis of the evolution patterns. Thus, it required us to develop an adapted ILC model that would consider disruptive innovation variables and incorporate contextual variables back into the model. The parallel quantification of the number of IRs mirrored with the adapted ILC model showed critical similarities and reciprocal phases of evolution. By doing that, we aim to respond to our first research question by wondering if interorganizational relationship dynamics could allow assessing ex-ante patterns of industry emergence caused by disruptive innovation?

In **Chapter 7**, we additionally demonstrate that industries emerge and structure and these phases shall not be confused. The discussions around structuration at the network level will rotate around the main research question intending to understand how interorganizational relationship networks could assess industry emergence's structuration patterns caused by disruptive innovation. It will be the opportunity to discuss our macro-level finding of the emergence of industries composed of IR networks building around Key Technological Activities.

In **Chapter 8**, we change the analysis level and bring the lens at the organizational level to carry a cross-level analysis of IR networks around KTAs based on organizational attribute analysis. The comparative analysis of each IR network sheds light on the significant similarities observed across the five networks while highlighting the main specificities. The reason for doing that lies in the willingness to determine how the innovation content could explain industry emergence patterns in terms of IR types and partners' choice by analyzing organizational attributes and structural data combined, i.e., our third and last research questions.

Chapter 7. Interorganizational relationships as metrics to assess industry emergence and structuration

The emergence of new industries often constructs around focal organizations' networks that provide the competitive environment with favorable business conditions from the typical initial stage of industry emergence. Nevertheless, disruptive innovations have numerous challenges, such as the intense technological complexity that organizations need to overcome because the distance between existing resources and capabilities and the new industry and the related technology is considerable (Teece, 2018). Incumbents can find it risky to respond to sophisticated and emerging technologies all by themselves when new entrants break the industry from the low-end segment while already making use of the unknown required resources and capabilities. While happening in turbulent environments for numerous reasons that we developed in the literature review (c.f. **Chapter 1**), remarkable changes occur at the macro level.

Adopting an inductive approach allowed us to analyze the industry's emergence to emphasize the following points discussed in **Chapter 7**.

The first task is the development of a model for industry emergence. We propose to define a methodology to measure industry emergence through a model that compares the emergence of a network with industry life cycles, thus, showing the strengths of IRs as industry emergence metrics.

To summarize, in **Chapter 7**, we discuss:

- The applicability of IRs as industry emergence metrics;
- The cross-sectoral dynamics inherent to industry emergence informed by IRs;
- The geographical organization of industry emergence informed by IRs;

- The role played by KTAs as catalysts of industry emergence and drivers of structural patterns explication.

In **Section I**, we discuss the similarities between the concepts of network and industry and show that IRs can be robust metrics to assess the emergence point of a network. Besides, our results enabled us to consider cross-sectoral and geographical dynamics as two-market signals of industry emergence. IRs give signs of change that can be captured from different perspectives.

The result of our data analysis showed that IRs could bring fascinating insights regarding 1) any change that happens in a given industry which is related to disruptive technological innovation and 2) the dynamics that may occur across industries which both influence and corroborate the argument of technical complexity calling for collaboration.

As a consequence of all the above arguments, the results presented in **Section II** show that emerging industry caused by disruptive innovation could be seen from an innovative approach: the emergence of IR networks around Key Technological Activities. We discuss the central role of the innovation content and the importance of understanding it to manage it then.

Section I. Interorganizational relationships as industry emergence metrics

Our initial postulate questions whether: **Could interorganizational relationship dynamics allow assessing *ex-ante* patterns of industry emergence caused by disruptive innovations?** Because our main problematic deals with the lack of possibilities to assess industry emergence before it happens. We begin by exploring the parallel between an adapted industry life cycle model that we have proposed and the evolution of the IRs number in the emerging AV industry.

The parallel between the ILC and the evolution of IRs starts with creating an adapted ILC, incorporating the disruptive innovation theory's critical variables. By critical variables, we have highlighted the roles of new entrants and incumbents, the emergence of dominant designs, the paradigmatic shift, and the lack of adequate resources, for instance. All those variables simultaneously are motives of IRs formation, as discussed in previous paragraphs. Simultaneously, we discuss the evolution of the number of IRs between 2011 and 2019 and apply the quantitative results to consider the variables of ILC quantitatively. Our results show that the number of IRs grows as the industry walks through its life-cycle.

Following the discussions around IRs as metrics of industry emergence, we discuss the advantages of studying IRs to translate cross-sectoral and geographical dynamics because the number of IRs is not sufficient to translate a change on its own. Understanding from where to where these IRs are contracted holds interesting information regarding the characteristics of the emerging industry.

1. Industry life-cycle through interorganizational network patterns

Industries are dynamic groups of organizations that specialize in the same activities. Understanding the state of the emergence of a new industry requires both incumbents and new entrants, a clear understanding of how the industry is evolving, to which directions and to which technologies—understanding when and how an industry emergence will give organizations several clues to foresee an uncertain future. Especially in the auto industry,

uncertainty is relatively uncommon since the 1930s, with the emergence of dominant design that made it through actual times (Murmman & Perkins, 2018).

First, seizing and assessing the emergence of a new industry will prepare incumbents to face new entrants' arrival and the obsolescence of their resources and capabilities, or at least part of them. Second, capturing the emergence and structuration patterns of a new industry will prepare the organizations to navigate the storm, adapt to change, and make adequate investments in the related technologies.

1.1. Adaptation of the industry life-cycle model

To make industry life cycles related to disruptive innovations, we have proposed to build upon the classical ILC model by adding the critical variables of the disruptive innovation theory. As a result, we obtained the industry life cycle model presented in Figure 46.

Figure 46. The adapted industry life-cycle model

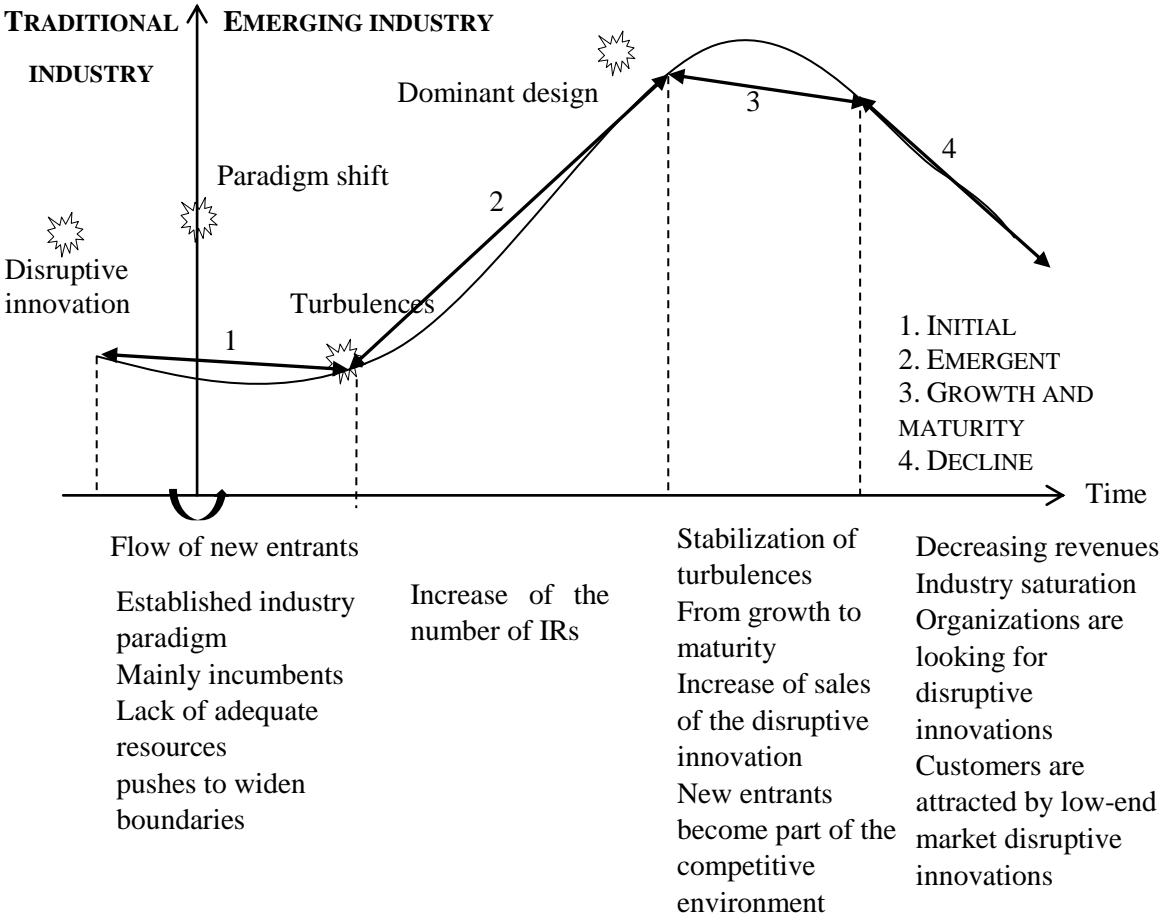

Industries are like organizations and species. They experience life cycles, which, when properly analyzed, can provide exciting outcomes for organizations' strategic planning.

In Figure 46, we determined our understanding of an industry life cycle through each phase's additional key characteristics. The different stages of the industry life cycle will vary from one industry to another; yet, the criteria apply to any emerging industry.

Phase 1 is the initial phase, which, from our perspective, starts in the traditional industry because emerging industries use some parts of the value chain of the traditional industry. Indeed, we argue that the appearance of the technology happens earlier than the related industry that will accommodate the given disruptive innovation.

As mentioned by the theory of disruptive innovation, to date, this phenomenon is quite well known. The disruptive innovation attracts the traditional industry customers, which experiences decreasing revenues and industry saturation with declining demand.

The initial phase is detectable between the traditional and the emerging industry. The passage from one sector to another depends on organizations' recognition of the new technological paradigm. Traditional industries benefit from synergies outcoming from a traditional value chain in which incumbents collaborate or compete. At some point, the equilibrium is broken; the traditional industry experiences a paradigm shift due to disruptive innovation. In the disruption, the traditional industry deteriorates as disruptive innovation slowly dislocates into the emerging industry.

Ensuing phase 1, which is an upstream phase necessary to explain the origins of disruption, phase 2 corresponds to the emergence phase. This phase, from our perspective, is the most challenging one to predict. Given the lack of visibility and foreseeability of industry emergence, we propose quantitative criteria that apply to any disrupted industry. Therefore, phase 2 is predictable through the following criteria:

- Increase of the number of IRs: a significant increase in the number of IRs is observable from phase 1. We argue that for vast industries, the number of IRs should at least multiply twofold;

- The emergence of dominant designs: technological complexities and consequential turbulences are controlled through advances in technologies. Organizations figure out the dominant architecture and the key enabling technologies;
- Cross-sectoral dynamics: different types of organizations (incumbents and new entrants) induce organizations' flow from various industrial sectors. The more complex the dominant designs, the more cross-sectoral dynamics are observed.

As would be logically expected as emerging industries have high growth potential, the emerging phase precedes the growth and maturity phases. At this stage, there is a palpable stabilization of industry turbulence. Increasing sales and demand enable to reach industry growth before its maturity. Commonly, new entrants become part of the competitive environment and switch from being new entrants to being incumbents.

Lastly, the industry will naturally experience a decline phase when sales revenues decrease. The industry reaches saturation, and customers are interested in other disruptive innovations, which will loop the life cycle back to phase one. Although phases 3 and 4 hold an essential place in the study of industries, we will focus our analysis on the first two phases because they present the most challenging phases of the emerging industry life cycle.

We have identified the main reasons explaining one phase's passage to another by incorporating these critical variables into the model. However, what emerges is surprising because no quantifiable metrics to evaluate an industry's emergence is proposed. For that, we have suggested to mirror our findings of IRs onto the adapted model and try to identify parallelity.

1.2. Quantification of interorganizational relationships

In the present paragraph, we present our results regarding the use of IRs to depict the AV industry's emergence. In the view of considering IRs as a metric of industry emergence, we carried out statistical treatment to view it in parallel to our industry life cycle model.

Our statistical treatment enabled us to depict significant evolutions in the number of IRs contracted to develop autonomous vehicles from 2011 to 2019 (Figure 47).

Figure 47. Evolution of the number of interorganizational relationships from 2011 to 2019 in the AV industry

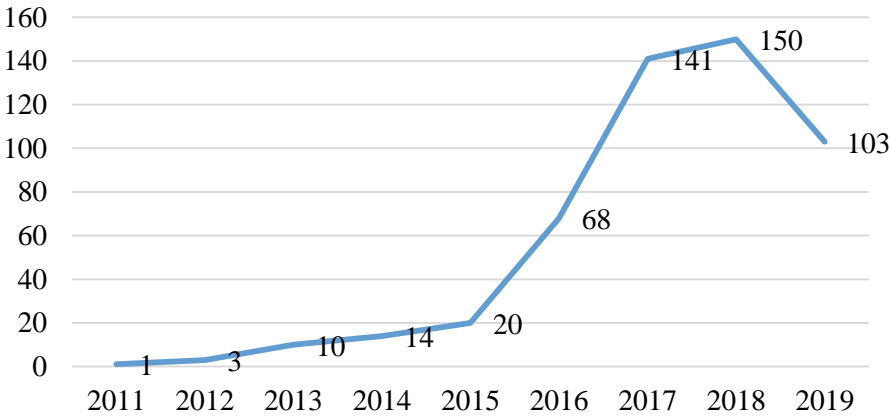

Figure 47 illustrates an increasing trend in the number of IRs contracted between 2011 and 2019. This increase warns about changing the traditional industry's changing resources, motivating organizations to palliate to internal resource obsolescence and turbulences. However, the growing number of IRs is insufficient to consider such IRs as industry emergence metrics. Therefore, we look at the AV industry's roots to understand the signals amplifying the metric-role played by IRs. For that, we compare the AV industry with the traditional automobile industry.

Although disruptive, AVs share common objectives with the internal combustion engine that blossomed until nowadays. AVs share similar appearance characteristics with traditional automobiles. Nevertheless, autonomous vehicles also have additive technological innovations, which are not present in the traditional car. AVs are equipped with artificial intelligence systems and many sensors, which disrupts the traditional auto industry.

The definition of an emerging industry implies a multi-level analysis of the emergence patterns. Therefore, the induction towards the critical role of the dynamic structural changes is demonstrated. The extensive observation of industry emergence requires a time-based analysis proposed by every industry life cycle model to identify industry emergence's critical phases. We consider that industry structuration represents a folder to a more substantial analysis spectrum of emerging industries. The static analysis of IRs number corroborate the argument of change, yet, we propose now to analyze how these IRs have densified over time, and shed light on phases of IR number evolution. To do that, we use statistical SNA network density algorithms.

1.2.1. Identification of overall network density

We performed several network statistics using UCINET and indexed the results in Table 15 to highlight the densification of IRs statistically and later identify industry emergence and structuration phases.

Table 15. Basic demographics

	2011	2012	2013	2014	2015	2016	2017	2018	2019
Density matrix average	1.000	1.000	0.0507	0.0248	0.0165	0.0120	0.0079	0.0058	0.0049
Standard deviation (σ)	0.000	0.000	0.2140	0.1556	0.1274	0.1090	0.0894	0.0773	0.0709

The density matrix average of a binary network gives information about the total number of ties divided by the total number of the possible relations. In a non-valued and undirected network, the density matrix average computes the number of ties divided by the total number of possible ties without considering if the network is valued.

The density matrix average measure performed on our data sample shows a decreasing value over the years. As the number of ties, meaning IRs, increases, so does the network's possible ties. The decreasing tendency of the measure corroborates the increasing number of connections and the potential links between network members. It mirrors the densification of the whole network from 2015 to 2019.

The standard deviation (σ) calculates the amount of variation or dispersion of a set of nodes in line with the density matrix average. The low standard deviations observed in 2011 and 2012 indicate that the nodes are closed to the mean called the set's expected value.

The low standard deviation observed in 2011 and 2012 corroborates the low-density network measure and allows us to identify a calm period regarding interorganizational relationships. However, from 2014 to 2016, the deviation increased slowly from 0.2140 in 2013 to 0.1090 in 2016.

The standard deviation then fluctuates with a slight decrease noticed from 2017 to 2019. By reaching 0.00894 in 2017 before attaining 0.0709 in 2019, the standard deviation gives the

information of consolidation around the core of the network, and existing nodes create relationships with existing network members.

As density matrix average and the standard deviation give information regarding the variances of network density and dispersion, we propose looking at the evolution of the global network’s diameter evolution. Therefore, we computed the geodesic distance measure from 2011 to 2019 to depict significant changes in the global network’s diameter.

1.2.2. Statistical identification of phases

The shortest path or the geodesic distance computed the shortest path between two nodes of a network. To obtain the whole network's evolution patterns, we applied the cohesion formula of UCINET to the matrices. As a result, we obtain the following iterations (Table 16).

Table 16. Geodesic distances

Geodesic distance	2011	2012	2013	2014	2015	2016	2017	2018	2019
Average distance (among reachable pairs)	1	1	1.263	1.289	1.901	2.805	5.808	4.923	5.056
Distance-based cohesion ('compactness')	1	1	0.06	0.029	0.024	0.024	0.102	0.114	0.119

The average distance among reachable pairs computes the mean of the matrix, excluding the diagonal. In this case, the increasing average distance is the signal for a consolidation of the network nodes.

The increase of the average shortest distance increases among reachable pairs (excluding peripheral binary IRs) means that the number of organizations between two nodes becomes more critical than before. More organizations' arrival and the fragmentation of the dataset into small networks are amplified by a decreasing compactness degree. As a result, this metric enabled us to cut out the phases of emergence and show certainty in the transition from one phase to another.

In 2011 and 2012, we have a very compact ‘network’ composed of a few IRs, encompassing one or two organizations. From 2013 to 2016, the network appears more fragmented, varying

from 0.06 to 0.024 in 2015. Finally, from 2017 to 2019, the present network shows slightly increasing compactness with 0.0102 in 2017, 0.0114 in 2018, and 0.119 in 2019.

As a result, we have identified four phases in line with the statistical characteristics defining IR evolution:

- Phase 0: Lethargic phase (2011-2012)
- Phase 1: Transitional phase (2013-2015)
- Phase 2: Progressive phase (2016-2017)
- Phase 3: Densifying phase (2018-2019)

We concatenated phase 0 and phase 1 due to the lack of clear insights for managers and practitioners in foreseeing the difference between both phases. The identification of emergence phases led us to compare the evolution of IRs and ILC as a final step of our analysis.

1.2.3. Parallel between the industry life cycle model and the number of interorganizational relationships

Based on statistical treatments, we have shown that IRs are suitable industry emergence metrics as their evolution correlates with an industry's life cycle. In the present paragraph, we relate both findings on the same picture to analyze similarities and concordance between the adapted ILC phases and the IRs evolution phases. We illustrate our postulate and the determination of steps with contextual data.

1.2.3.a. Juxtaposition of the industry life cycle and interorganizational relationship patterns

In the present paragraph, we put the IR number's evolution phases and the adapted ILC in comparison (Figure 48).

Figure 48. Parallel between the industry life cycle model and the number of interorganizational relationships

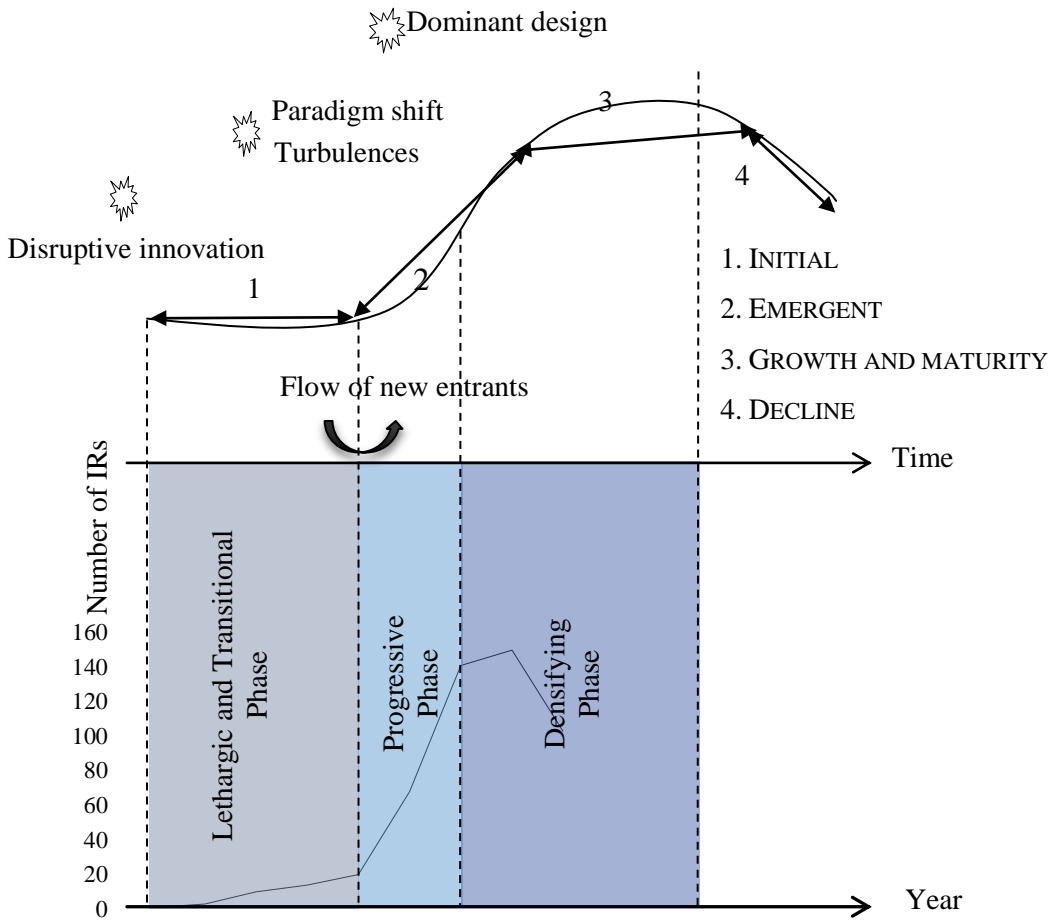

In Figure 48, we intended to show to which phases of the industry life-cycle correspond which IR evolution phases. As a result, we have observed similarities in characteristics between the initial and the lethargic and transitional phases combined.

During the initial phase, the industry brings a new product to the market for the first time. If it is a brand new technology, as the personal computer once was, the product's launch could initially pose significant risks by imposing a change in existing paradigms. While the emerging industry does not make sense to incumbents, the strategy changes remain relatively flat, is telegraphed by the lethargic and transitional phases. At this phase, some companies collapse. Some of them move on to the next phase. At this point, the market continues to be very fragmented, thus neither that profitable.

In the emergent phase, organizations gain a firmer grasp of the emerging industry. Making a lot of profits is not the primary concern of companies at this point. They are mainly investing in the research and development of their products. Besides, new products are launched for further development of the industry. As the products have made their mark in the industry, organizations may be willing to buy industry share through interorganizational relationships such as partnerships or acquisitions to sustain inorganic growth. They are predominantly engaged in studying and improving their products and translate into fuliginous efforts at the strategic level. Also, new products for further market growth are being launched. It complies with the progressive and densifying phases of IRs. The number of IRs faces a drastic increase because organizations' primary objective is investing in the new technology that continually evolves. What is also characterizing and driving those phases is the growing number of competitors in the industry and the high fragmentation of the competitive landscape. Incumbents are challenged by new entrants that managed to overhead barriers to entry thanks to the latest technology.

We considered that the AV industry is not quite in the maturity phase, even though a decreasing amount of IRs may let it appear because no dominant design has been established in terms of technological architecture. Organizations have not reached the highest performance and made the highest profits from technology. Although consumer acceptance may appear as installed, the technology's safety and robustness still have a way to go before reaching the most increased autonomy (L4 and L5). To further develop AV technology's evolution and its impacts on IR formation, we discuss some primary contextual explanations in the next paragraph.

1.2.3.b. Contextual explanations

To understand the link between the multiplication of IRs and the disruptive innovation content, we use contextual data to determine the emergence drivers. The parallel display of IRs evolution data and contextual support allows for accurate identification of the AV industry's emergence point from 2011 to 2016. Indeed, for years' road injuries have been the grey area shadowing the benefits of developing vehicles. As human error is the significant explanation of road injury, the tendency falls back into reducing human error with Automated Driver Assistance Systems (ADAS).

Thus, secondary data collection started to show results from 2011 and was derived from IHS Markit, Bloomberg, and automotive online press. The rising interest around the ADAS field strengthened in 2009 with the Toyota-fiasco when 2.2 million cars recalled by Toyota in the US over safety-related issues made the sparks brighter and constrained carmakers and tiers to focus more on these particular topics³⁹.

Consequently, regulatory authorities were awakened. For example, the National Highway Traffic Safety Administration (NHTSA) in the United States considered making fitment of brake overriding system mandatory equipment for future vehicles. However, Trump's administration recently scrapped the mandate proposed in 2009, even though such features are already installed in new cars⁴⁰.

Our second result concerns the slow emergence of IRs within this industry until 2015 and then stable growth until 2016 due notably to the role played by the technical framework developed by the Society of Automotive Engineers (SAE). From 2011 to 2015, IRs were facing quite a steady adoption pace. Organizations were quite preservative in terms of their strategic actions. However, in 2016, two years after introducing the SAE technological framework for autonomous driving, organizations raised a strong interest in AVs, with 68 IRs in 2016 against 20 the year prior.

Indeed, the SAE International issued the taxonomy and definition for terms related to driving automation systems for on-road motor vehicles in January 2014. This technical framework identifies the five automation levels described in the research setting: no driving task automation, active driver assistance, partial automation, conditional automation, high automation, and full automation. The different levels that distinguish between the driver's responsibilities and those of the other ADAS functionalities had a high impact on the recognition of AVs globally. It raised awareness about new driving technologies and gave a technological framework to which organizations could refer. It was even more critical as OEMs, tiers, and technology organizations were the players at the source of these guidelines.

³⁹Retrieved from <https://hbr.org/2011/02/toyotas-recall-crisis-full-of>

⁴⁰Retrieved from <https://www.reuters.com/article/us-toyota-recall-prius/toyota-to-recall-2-8-million-vehicles-for-steering-glitch-idUSBRE8AD09A20121114>

Besides, the US Department of Transportation and the United Nations have adopted this framework. OEMs and automotive suppliers position their product amongst the SAE levels of autonomy that they enable to reach. From that point, industry players had a technical framework to frame their product development. In consequence, the number of IRs thus increased six-fold within the two following years of that implementation.

Our third result highlights a slow decrease trend since 2018. In 2018, the number of IRs was still predominant (150) but started to face a decreasing trend and reached 103 IRs in 2019. This slowdown observed in 2019 is explained by many significant facts. First, the traditional automotive industry faces a tumultuous year with production levels that start to hit bottoms. IHS Automotive registered a 6.3% year-to-year decrease between 2018 and 2019, i.e., 94,204,155 vehicles produced in 2018 against 88,775,550 produced in 2019⁴¹.

As their traditional industry is quaking and many industry players are forced to shut down plants, part of them wants to play it safe and not be absorbed by the high level of investment required for AVs, which represents the second significant fact that explains the slowdown observed in IR adoption. Although there are no general estimations on how essential investments in AVs are, PwC (2016)⁴² published a report in which it estimated that the top five OEMs spent \$46 billion in research and development in 2015.

In conclusion, we discussed how IRs could assess a traditional industry's changing patterns with a transitional phase bridging the disrupted to the emerging industry. The lethargic and transitional phases let enough time for organizations to try making sense of the emerging industry before it reaches the stage of emergence by assessing the changes in the traditional industry and the growing amount of IRs during these phases, even though limited they enable to predict the ex-ante emergence of the new industry.

The journey to disruption is complicated, and organizations demonstrate a boldly innovative approach to take a ride on the bridge to competitiveness. The highlight of organizations' strategic actions showed that industry experts and researchers could look at the emergence and progressive structuration of the AV industry at the macro level. The previous results

⁴¹Retrieved from <https://connect.ihsmarket.com/autoinsight-data-browser/editQuery/LightVehicleProduction/LightVehicleProductionForecast>

⁴²Retrieved from <https://www.strategyand.pwc.com/gx/en/insights/2016/connected-car-2016-study.html>

enable us to discuss another dimension of industry emergence: the macro-level dynamics between organizations from different industries and countries. Despite being valuable industry emergence metrics, IRs are also vectors of industry emergence dynamics at the macro level.

Therefore, in the next paragraph, we present the results in terms of what the analysis of IRs brings at the macro level regarding identifying industry emergence dynamics. Primarily, what resulted and discussed is the value of IRs in bringing light to cross-sectoral dynamics, which seems to be an intrinsic characteristic of emerging industries due to technological complexity and geographical expertise. It highlighted two industries' existence: the disrupted and the emerging industry through interactions between auto incumbents and new entrants from various other industries. We also discuss our results concerning the geographical repartition that IR analysis enables us to identify at the macro level.

2. Interorganizational relationships as two-industry emergence signals

Our second attribute data of organization enabled us to depict cross-sectorial dynamics between organizations involved in IRs. As a result, we argue that industry emergence is also assessed by cross-sectoral dynamics, which warns about the cohabitation of two-industries: the traditional industry and the emerging industry. Therefore, the signal occurs when incumbents from the traditional industry start to contract collaborative interrelations with companies from another industry. The IR between diverging-industry organizations mirrors the need to call on external resources to adapt to the emerging industry.

In parallel, collaborating organizations can be located in different countries, making the emerging industry not central to one geographical region. In that term, the data showed that organizations involved in IRs were mostly located in two major regions, which enabled us to identify the locus and source of disruption at a geographical level too.

In the following paragraphs, we present in the first hand, the results from the cross-sectorial data analysis and follow, in a second hand, with the findings in regards to cross-regional dynamics as two-industry emergence signals.

2.1. Four dominant industries of provenance

The indexation of 465 organizations in the dataset implies that not all organizations belong to the same industry. We argue that cross-sectoral interactions are also a way to catch two-industry signals. The entry of organizations from different industries translates a change in the traditional industry and gives clues to apprehend the emerging industry.

The statistical treatment highlighted that four industries are dominant amongst the 465 listed organizations involved in 510 IRs. Amongst incumbents, we find auto and components, and new entrants are mainly software and services, semiconductors, and technology hardware organizations (Figure 49).

Figure 49. IRs segmentation by top industries

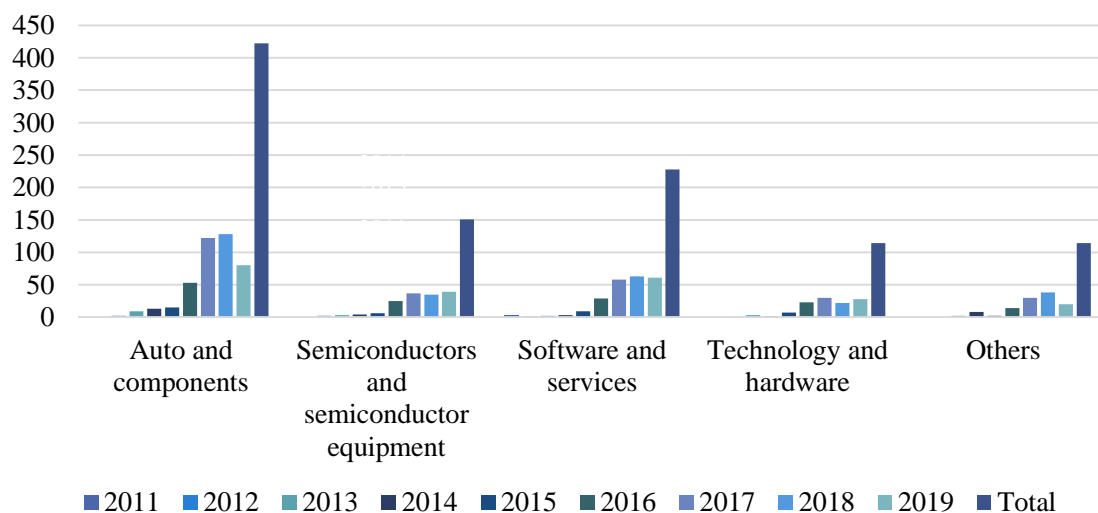

The segmentation of the organization industry attribute derived the dominance of four critical industries affiliation, and the dynamic analysis of the data from 2011 to 2019 enabled to verify the tendency. In 2011, IRs were contracted between organizations from the software and services industry. In 2012, organizations started to show variation in affiliation with one company from software and service, two from semiconductors and semiconductor equipment, two from the auto and components industry, and one from others.

In 2013, the tendency seemed to be verified; however, three companies from the technology and hardware industry participated in the contracted IRs. In 2014, the significant value was observed with the introduction of 13 companies from the auto and components industry, followed by nine companies from various industries, four semiconductor companies, three software companies, and finally one technology hardware company.

In 2015, the number of organizations from top industries showed quicker arrivals from the semiconductors and software industries. Nevertheless, auto and auto components companies seem to hold dominance in terms of presence with 15 different organizations from the related industry.

In 2016, the pace of auto, software, and semiconductor companies' entry verified the dominance of these three industries in the emergence of the AV industry, respectively, 53, 29, and 25 companies contracted IRs, closely followed by 23 technology hardware companies. Together companies from other industries represented 11% of the total companies.

From 2017 to 2019, the significant entries were made in order from auto and components companies, software companies, semiconductors companies, tech hardware companies. Finally, organizations from other industries account for less than 10% each year.

In conclusion, based on our results, industry emergence assessment derives its main variables from the analysis of IRs. Resulting from that consideration, we have found in the first place that IRs are signals of change, and their quantifiability provides solid ground for industry emergence assessment. When mirrored with the adapted industry life-cycle model, we have correlated the phases of industry emergence with the evolution of IRs. The results were very conclusive, as they have shown a positive correlative presenting an increasing number of IRs that telegraphed the structuration of an emerging industry.

Secondly, structural data's attribute characteristics enabled the detection of the prominent macro phenomenon that also brings significant knowledge regarding industry emergence and identifying such as complex phenomenon. Therefore, we have discussed how cross-sectoral dynamics are translating a very dynamic context of change and have enabled us to determine the four dominant industries composing the AV industry. Finally, to complement our macro analysis, we present the findings regarding the AV industry's geographical emergence, thanks to IRs in the following paragraph.

2.2. Geographical emergence

Complex technologies require the intervention of organizations from different industries, as discussed in previous paragraphs. However, in a globalized world, IRs have often contracted in international settings. The literature on networks has discussed that distances are not as determinant as they used to be in interactions nowadays, partly due to the internet and other telecommunication solutions enabling companies to work together remotely.

Therefore, to validate the argument and consider geographical variables as critical elements of industry emergence, we have aggregated attribute characteristics of the structural data in the sort that we obtain the geographical dispersion of organizations involved in the IR database (Figure 50).

Figure 50. Geographical dispersion of organizations involved in IRs

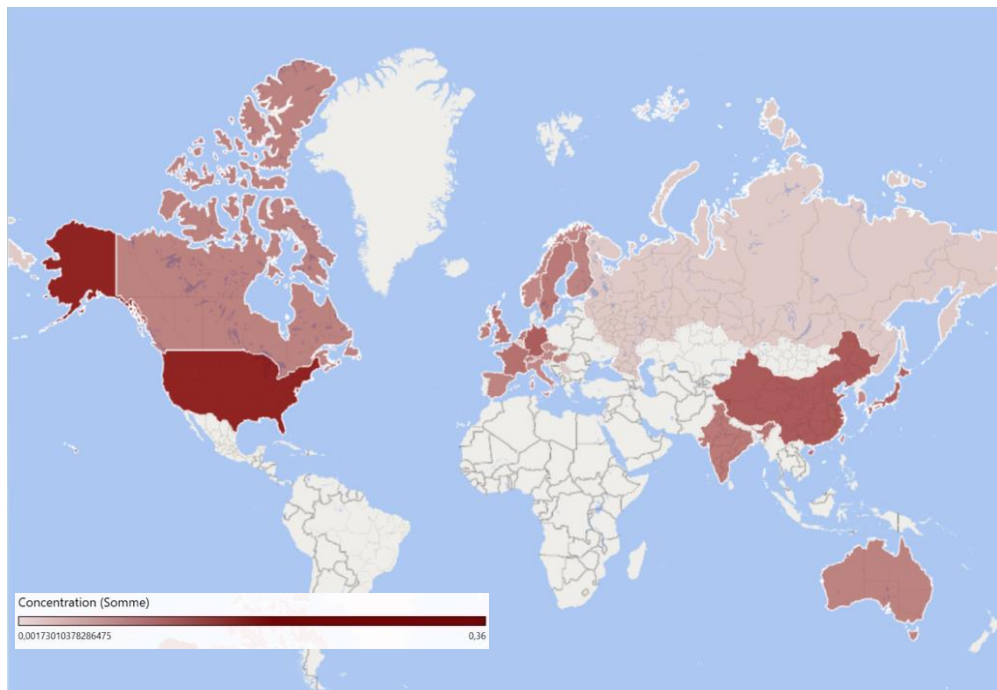

Figure 50 presents a comparative map by categorizing the number of companies according to their country of provenance. For each country, we have calculated the number of organizations involved in IRs from 2011 to 2019 and computed organizations' concentration in each state by dividing the number of organizations in one country by the total of organizations involved in the IR database (465).

As a result, we have obtained a concentration rate of scaling from 0.0017 to 0.36. The higher the concentration rate, the more companies are indexed in the related country. Besides, the higher the concentration rate, the deeper the color on the map. Respectively a less concentrated state is transparently colored. We have summarized the concentration rate of each country in Table 17.

Table 17. Concentration rate by country

Country	% of organization
United States	35,81%
China	12,46%
Germany	11,42%
Japan	10,55%
France	4,33%
United Kingdom	3,81%
South Korea	2,94%
Israel	2,77%
Sweden	2,25%
India	1,90%
Netherlands	1,73%
Singapore	1,04%
Ireland	0,87%
Israël	0,87%
Switzerland	0,87%
Australia	0,69%
Canada	0,69%
Taiwan	0,69%
Finland	0,52%
Hungary	0,52%
Spain	0,52%
Austria	0,35%
Hong Kong	0,35%
Italy	0,35%
Korea	0,35%
Norway	0,35%
Belgium	0,17%
Czech Republic	0,17%
Luxembourg	0,17%
Russia	0,17%
Serbia	0,17%
Slovenia	0,17%

As a result, organizations originated from five countries are at the initiative of the AV industry emergence: the United States, China, Germany, Japan, and France. Altogether, organizations from these five countries account for 74.57% of IRs. In total, 207 out of the 465 organizations indexed in the database are from the US, 72 from China, 66 from Germany, 61 from Japan, and 25 from France. In the second portion, there are less than 20 organizations indexed in each country. Together with the top five countries, they represent 91% of all organizations indexed in the IR dataset. These countries encompass from 20 to 6 organizations.

Finally, all the other countries comprise between 5 and 1 organizations, which does not enable us to consider these countries as the critical locus of disruptive innovation.

The results suggest that some countries are more accustomed to developing sophisticated innovation because, on the one hand, the number of adequate organizations for related innovation is high. On the other hand, the countries have dissimilarities in their efforts of innovation. The variation in effort and innovation means that exist among countries may partly explain why organizations are more willing to participate in the innovation effort, invest and develop new technologies than companies in other less developed or less technology-ready countries.

Conclusion of Section I.

In **Section I**, we have discussed the complexity of assessing the emergence of industry and identifying industry emergence at the early stages of the phenomenon. We proposed that IRs, besides being robust strategic metrics to assess industry emergence, are also new tools to carry out *ex-ante* analysis of such an unpredictable phenomenon. Our empirical structural data study showed an intensification of the number of IRs contracted over the years. Compared to the industry life cycle (ILC) model, it telegraphed detectable similarities in the evolution trend as the industry lives through its life cycle phases. As a result, the phase of the introduction in the ILC model equals the initial phase of the IR network called the transitional phase, the equivalent of the growth phase was the Progressing phase of IR networks, and the densification phase of our IR network corresponded to the shakeout phase of any ILC. The data thus reinforced the use of IRs as metrics to assess industry emergence.

Also, our findings enabled us to identify a new pattern of emergence at the macro level. Indeed, IRs are powerful tools to identify cross-sectoral dynamics by analyzing organizations and their provenance industry to depict significant industry dynamics. Therefore, we have identified the four primary industries that are fundamentally and dynamically participating in the AV industry emergence: Auto and components, Software and services, Technology and hardware, and Semiconductors and semiconductor equipment.

Finally, we have identified the primary countries and the role of identifying international dynamics of interorganizational collaborative behaviors, as shown that disruptive innovation requires many organizations' effort. These organizations may not be neighbors, which suggests that countries are more or less advanced in disruptive innovation, which can explain why some companies fail or succeed in the face of disruption.

However, the main conclusion here brings light on the metric side of IRs, which assess industry emergence by analyzing cross-sectoral IRs dynamics. In the same vein, the analysis of IRs as metrics give signals of geographical localization of the emerging industry. Altogether these variables measured through IRs provide essential information regarding industry emergence, yet we argue that structuration is another point to discuss in **Section II**.

Section II. Key Technological Activities as industry structuration metrics

In **Section I**, we have discussed the potential of IRs as metrics to assess industry emergence at the macro level. Nevertheless, assessing the emergence is not sufficient on its own, as it does not provide dimensions on the competitive landscape and strategic paths that companies can adopt. To continue the in-depth data analysis to understand the dynamics of industry emergence, we follow with the study of the emergence and structuration patterns in each KTAs from 2011 and 2019 and raise the following research question:

How could inteorganizational relationship networks reveal the structuration patterns of industry emergence caused by disruptive innovation?

Therefore, we discuss four main phases of emergence based on the Key Technological Activities (KTAs) that we have identified through the indexation of 38 technological drivers serving as motivations of IR formation:

- Phase 0: Lethargic Phase
- Phase 1: Transitional Phase (2013-2015)
- Phase 2: Progressive Phase (2016-2017)
- Phase 3: Densifying Phase (2018-2019)

We amplify our results by doing centrality degree measures to assess the particular importance of each KTA. To answer our research question, we will carry out a longitudinal analysis of the AV industry emergence by scanning the evolution of IR from 2011 to 2019. The longitudinal study enabled us to identify dynamic patterns of structuration through the IRs metric.

1. Chronological emergence of the autonomous vehicle industry

The study of industry emergence induces the analysis of dynamic industry structuration patterns. These patterns provide network analysts with essential information regarding the emerging industry's structuration mechanisms by amassing over the years. With the

introduction of Key Technological Activities, in combination with timelines, we will go deeper into analyzing the AV industry's structuration patterns. To answer our research question rigorously, in first-hand, we make a situational analysis of the repartition of IRs according to the KTAs. Then we present the SNA data processing through the chronological network graphs to reveal the spatial structuring of the AV industry and the urban sprawling.

The structural data analysis enabled us to carry out a chronological examination of the number of IRs contracted between 2011 and 2019. To obtain Figure 51, we have concatenated each IR with the year it has occurred.

Figure 51. Number of IRs by KTA

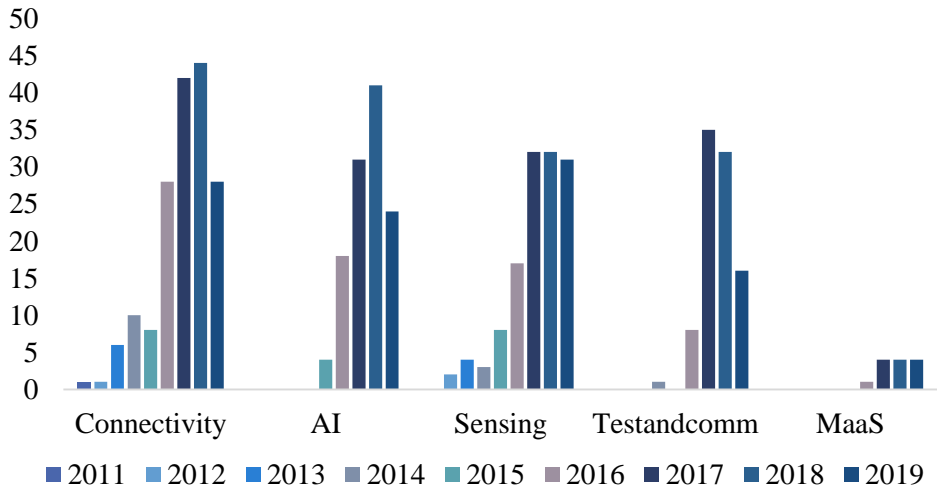
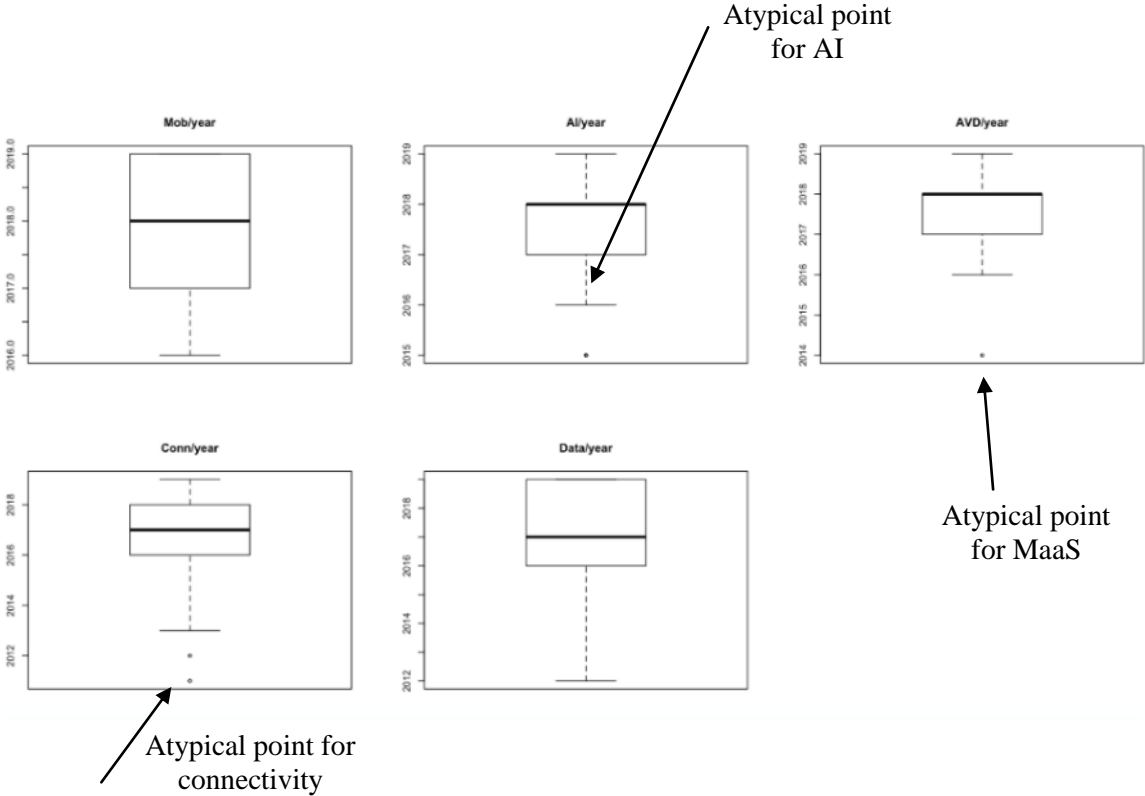

Figure 51 shows the number of IRs per KTA. The chronological visualization of IRs per KTA enables identifying the evolution of each KTA network over the years.

The depiction of intricate patterns of evolution brought us to do a box-plot analysis to spot the differences in terms of IRs and identify the atypical data that would have to create bias in our results (Figure 52).

Figure 52. Box-plot of IRs from 2011 to 2019



The box-plot analysis that we have done enabled us to identify the main atypical points of the dataset. We found that for AI, Connectivity, and Maas, the first IR contracted does not allow us to generalize a starting year regarding the emergence of the overall KTA because it does not statically represent a pattern. We have shadowed the atypical points in Table 18.

Table 18. The occurrence of IRs in each KTA, from 2011 to 2019

	Phases								
	Lethargic and Transitional				Progressive		Densifying		
	2011	2012	2013	2014	2015	2016	2017	2018	2019
Connectivity	X	X	X	X	X	X	X	X	X
AI					X	X	X	X	X
Sensing		X	X	X	X	X	X	X	X
Test and comm				X		X	X	X	X
MaaS						X	X	X	X

Connectivity is the historical KTA, meaning that the first IRs happened in that KTA in 2011. However, Table 18 shows that for 2011 and 2012, atypical points represent the IRs contracted in the connectivity KTA. The same observation is made for AI, for which the atypical point was in 2014, and for testing and commercialization, for which the atypical point started in

2015. Therefore we can consider that the KTA connectivity starts adequately in 2013, testing and commercialization in 2015, and AI in 2016.

Beyond the digital distribution by year and by KTA, it could be interesting to conceptualize the networks forming around these KTAs thanks to UCINET. The following section is a phased tier-down of IR network emergence around the KTAs. We present our results for each phase: Phase 0 + Phase 1: Lethargic and transitional phases (2011-2014), Phase 2: Progressive phase (2016-2017), and Phase 3: Densifying phase (2018-2019), as they all present singular characteristics.

1.1. Lethargic and transitional phases: Emergence of the two first KTAs, Connectivity and Sensing (2011-2014)

The first phase of the AV industry emergence started in 2011 and lasted until 2014 with the lethargic and transitional phases. A steady expansion of IR characterizes this period, around two KTAs that emerge. Connectivity and sensing start to take shape, but as mentioned, data appear as atypical points, and at this stage, one cannot state the idea of the network until 2013. Based on our statistical results, we can assess that the first IRs happened around the two KTAs, Connectivity, and Sensing (Table 19).

Table 19. Lethargic and transitional phases: The emergence of two KTAs, Connectivity and Sensing (2011-2014)

Year	Graph	Observation
<p>(Number of IRs)</p> <p>2011</p> <p>Nb of IR: 1</p> <p>Cumulative: 1</p>		<p>The apparition of the first IR network around the KTA, connectivity.</p> <p>Identification of atypical points for the first IRs around the KTA connectivity.</p>
<p>From 2011 to 2012</p> <p>Nb of IRs: 3</p> <p>Cumulative: 4</p>		<p>The apparition of a second IR network around the KTA, sensing</p>
<p>From 2011 to 2013</p> <p>Nb of IRs: 10</p> <p>Cumulative: 14</p>		<p>Progressive densification of IR networks around those two KTAs properly: connectivity and sensing</p>
<p>From 2011 to 2014</p> <p>Nb of IRs: 15</p> <p>Cumulative: 29</p>		<p>Intense densification of the IR network, especially around the KTA connectivity</p>

From 2011 to 2014, the emergence happens slowly with the lethargic and transitional phases. We identify the first KTAs necessary to AVs, which are connectivity and sensing. As mentioned previously, connectivity aims at making the vehicle aware of its internal (driver, entertainment, maintenance) and external (pedestrians, vehicles, traffic conditions based on navigation data) environments. Sensing concerns the equipment of vehicles with different sorts of sensors and cameras. What makes sense is that the willingness to make the car more predictive and automated comes with giving it the means to do so; sensors and cameras (eyes) and connectivity (communication skills).

In 2014, the tentacles of sensing and connectivity point to each other; both IR networks started to plug into each other. We seize a slight development of cooperation amongst organizations from distinct networks. This phase is quite informative regarding the latent characteristic of disruption. Indeed, disruption does not happen overnight, and some scrub-removal work is useful in cases of a daunting disruption.

However, during the next year, and the release of the SAE taxonomy of autonomous driving in 2014, organizations focused their attention even more on autonomous driving technologies.

1.2. Progressive phase: Cohabitation of all the Key Technological Activities (2015-2016)

Following the latent phases described in the previous paragraph, phase 2 represents a subsequent phase called the progressive phase.

If IR networks were first building around the two KTAs (connectivity and sensing), we observed another KTA around Artificial Intelligence (AI) in 2015. The industry starts to structure and is composed of more robust IR networks around connectivity and sensing. It moderated IR networks around AI and then the two last KTAs, MaaS and testing and commercialization in 2016 (Table 20).

Table 20. Progressive phase: Cohabitation of all the Key Technologic Activities (2015-2016)

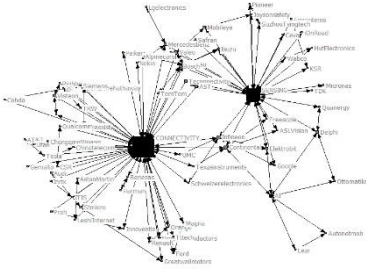
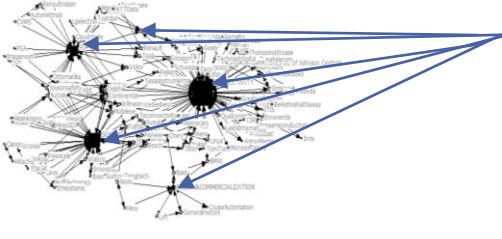
Year	Graph	Observation
<p>From 2011 to 2015</p> <p>Nb of IRs: 21</p> <p>Cumulative: 50</p>		<p>More robust IR networks around the KTAs connectivity and sensing</p> <p>Identification of atypical points for IR network around the KTA, AI</p>
<p>From 2011 to 2016</p> <p>Nb of IRs: 69</p> <p>Cumulative: 119</p>		<p>The cohabitation of IR networks around the five identified KTAs: connectivity, sensing, AI, MaaS, testing, and commercialization</p>

In 2015 (2011-2015), the introduction of an IR network around the KTA of Artificial Intelligence (AI) can be explained by a significant acquisition done by Delphi, a traditional automotive part manufacturer. This automotive giant acquired Ottomatika to develop its software competencies for autonomous driving (IHS Automotive, 2015) and attracted interest in such essential activity. Ottomatika is an American self-driving vehicle technology developer, providing software stacks, sensor calibration, and support services.

The snapshot of the industry made in 2016 (2011-2016) brings out the appearance of another new KTA: the testing and commercialization one. This year is marked by the acquisition of Cruise automation by General Motors in March 2016. Cruise Automation is a California-based startup that develops systems for autonomous vehicles and a way for General Motors to communicate indirectly about its strategy of becoming a key player in autonomous driving. The same year, Delphi and Mobileye, two leading automotive parts suppliers, announced their partnership to develop an autonomous driving system for 2019 while BMW, Delphi, and Intel entered a partnership to develop autonomous driving systems for BMW vehicles.

Regarding MaaS, the IR network around this KTA seems to be more pervasive as it appeared in 2016. The analysis of the following years shows a tendency of a slower emergence compared to the other four KTAs.

1.3. Densifying phase: A plethora of interorganizational relationships in each Key Technological Activity network (2017-2019)

Preceded by years of embryonic development from 2011 to 2014, followed by progressive structuration of the KTA networks, the structuration of the autonomous vehicle industry kept a rapid pace with the third phase, which significantly impacted industry consolidation. Indeed, the typology of the IR networks, the number of organizations connected, and the constellation around the KTAs ascertain the emergence of complex networks concurring to the AV industry's development. If we look closer to each IR network in detail, we see that from 2017 to 2019, the industry structure becomes more visible with aggregated IR networks around the five KTAs. In Table 21, we present the third and last phase, called the densifying phase, composed of three network graphs.

Table 21. Densifying phase: a plethora of IRs in each KTA networks (2017-2019)

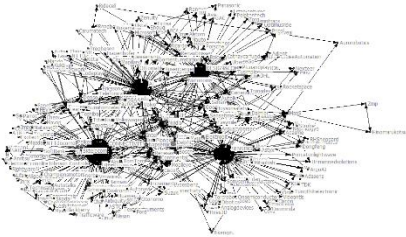
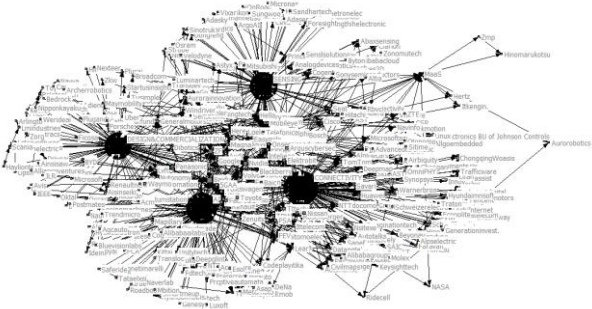
Year	Graph	Observation
<p>From 2011 to 2017</p> <p>Nb of IRs: 143</p> <p>Cumulative: 262</p>		<p>Consolidation of IR networks around each KTA, except MaaS, which remains more pervasive</p>
<p>From 2011 to 2018</p> <p>Nb of IRs: 142</p> <p>Cumulative: 404</p>		<p>Increase the consolidation of IR networks around each KTA, with lesser importance for the testing and commercialization</p>

We present the final network graph composed of 510 IRs (cumulative) in Figure 53 to ease the readability and comprehensibility of the figure.

Figure 53. The final state of the AV networked-industry (2011-2019)

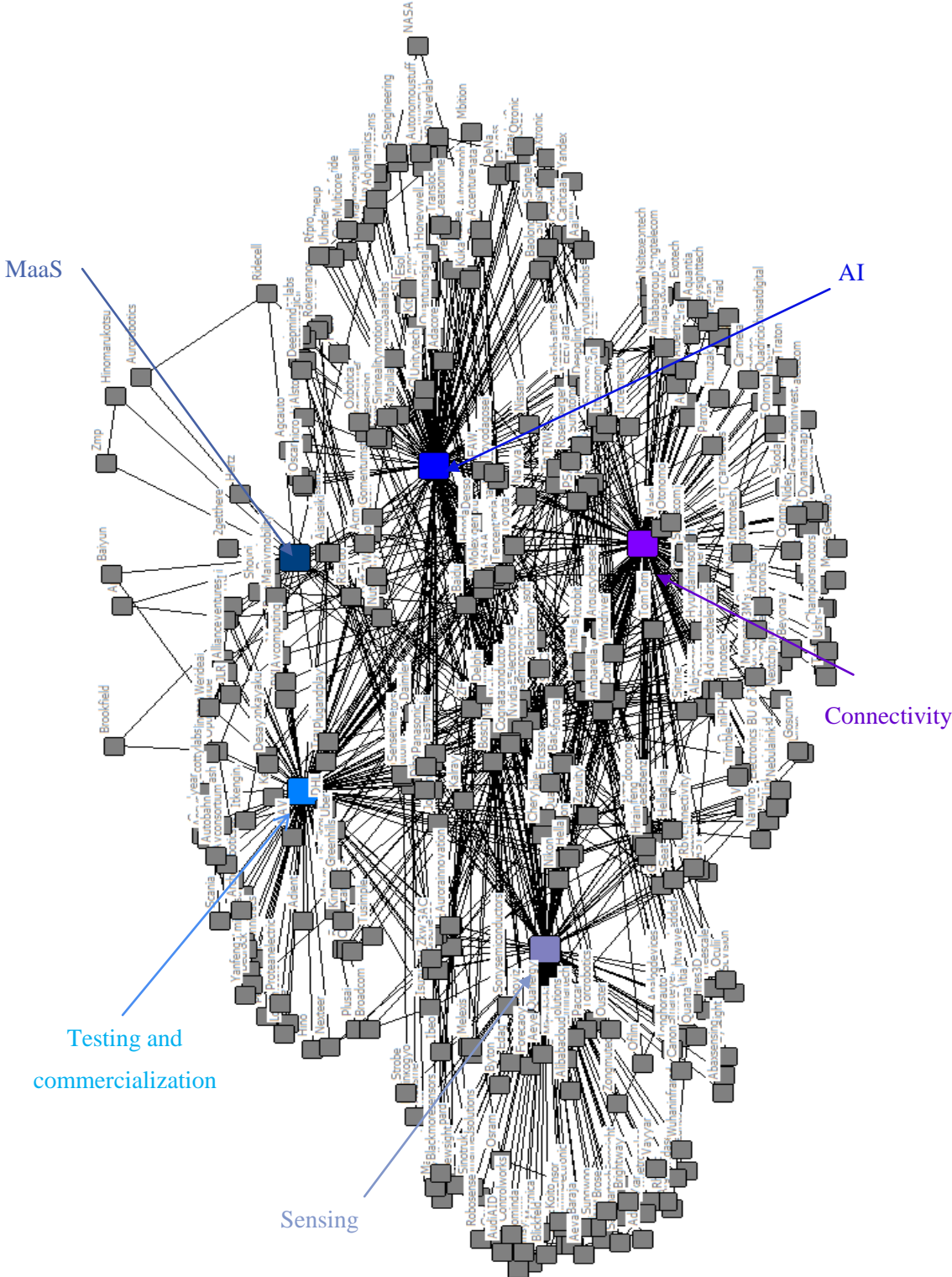

In Figure 53, we have noticed the consolidation of each IR network, notably around the KTAs testing and commercialization, partially explained by the fact that these KTAs contain testing activities for products developed before.

The network topology in 2017 (2011-2017), in contrast with the prior year (2011-2016), telegraphs massive densification of the networks around all the KTAs, except MaaS. Networks' ties seem to interleave, creating clique structure amongst organizations themselves. We discuss the structuration patterns within each KTA network in other sections.

The densification continues at a rapid pace the year after. The observation of the network in 2018 (2011-2018) conveys the appearance of similar networks around each KTA, except MaaS, which seems to progress at a relatively slower pace.

Finally, we have the final state of the AV industry in 2019 (2011-2019). This stage mirrors the consolidated state of IR networks around KTAs.

The third phase lets us see the image of more extensive, highly populated IR networks around KTAs. Indeed, the number of organizations involved in these IR networks increased from 2 (2011) to 439 (2011-2019).

The preceding paragraph exposed the findings that consider IRs as valuable industry emergence metrics through IR networks around KTAs. The following section aims at understanding what the size of the nodes hides at a statistical level, thus, validating the seminal findings regarding the fundamental role of KTAs in assessing industry emergence.

2. Predominance of the Key Technological Activities

Our first findings state that the metric of interorganizational relationships (IRs) can telegraph the emergence patterns of a new industry around IRs networks. Although seizing the emergence of the industry holds paramount importance, it is all the more important to understand the patterns of emergence of a given industry.

To shed light on the predominance of KTAs statistically, we have carried out a two-mode entry in UCINET to put the binary relationships between organizations parallel to the reason

they choose to collaborate. As a result, we obtained the predominant role played by the five identified KTAs. We then compute centrality degrees to determine the power of each KTA within the global AV industry and related the five highest degrees.

We enter the database of IRs in the software; as a reminder, the data is undirected, and the distance between organizations not defined. We selected two significant measures: the degree centrality and the closeness centrality, to depict and validate each node's importance with several calculations.

In total, we obtained centrality measures for all the 465 organizations present in the AV industry. The parallel between the IR database and the database with all the five KTAs related to each IR allowed us to identify the centrality of KTAs in IR networks.

We obtained a table composed of 496 lines and retained the highest values to get results indexed in Table 22.

Table 22. Centrality measures for each KTA

	Degree centrality	Closeness	Eigenvector
Connectivity	183,000	826,000	1,000
Sensing	143,000	918,000	0.691
Test and commercialization	129,000	917,000	0.673
AI	154,000	871,000	0.818
MaaS	24,000	1217,000	0.104

2.1. Degree centrality

In the present case, the various algorithms that we applied to the structural data permitted us to identify the predominant rank of KTAs. By running the dataset in UCINET and using the degree centrality measure, we obtain the list of degree centralities ranging between 2 and 184.

$$\text{Degree centrality} = [2; 184]$$

The purpose of computing the degree and normalized degree centrality of each tie allows identifying the overall network degree centralization. Therefore, the degree of centrality of the five main KTAs shows that organizations see great value in capturing value through adequate resource and information exchanges within the networks.

In terms of the number of incident nodes, connectivity holds the monopoly with 183 ties connected to it. Then follows artificial intelligence with 154 links, Sensing with 143, and Test and Commercialization with 123 come last. We identified MaaS as a KTA; yet, we consider that the degree centrality (24) is comparatively less important than the four other KTAs. The centrality degree of each node served as a node size variable illustrated in Figure 54.

Figure 54. Nodes size by centrality degree

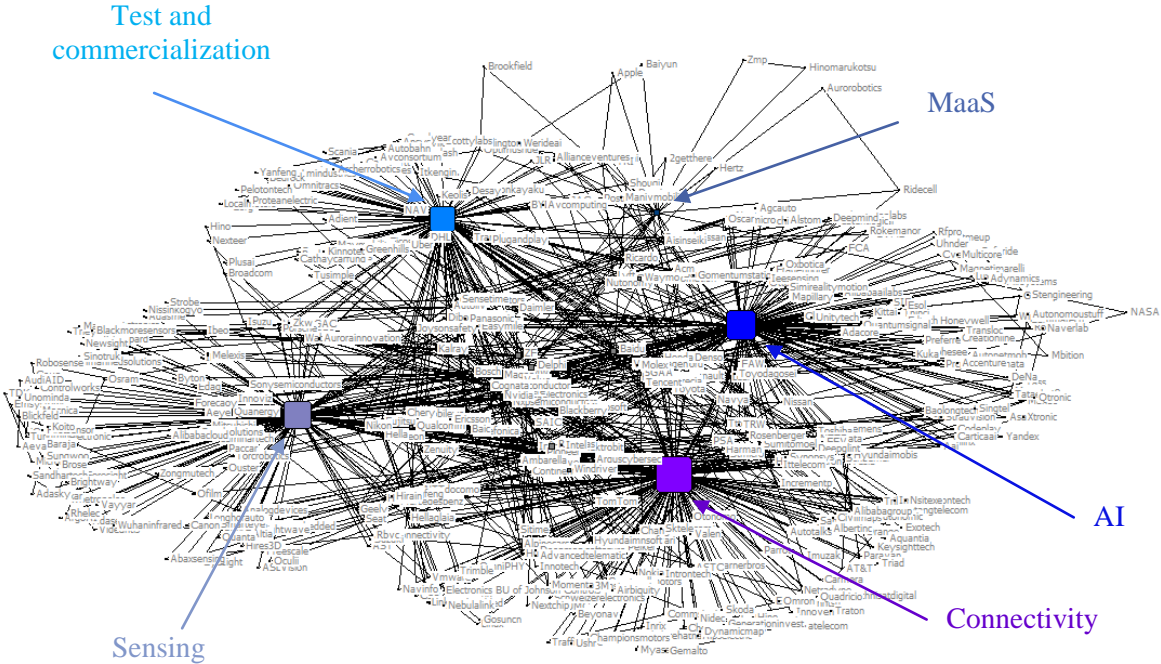

Figure 54 sheds light on the centrality degree of each node. The colored nodes represent the KTA, which rank from the central to the less central one, respectively connectivity, AI, Sensing, Testing and commercialization, and MaaS. All other nodes represent the organizations, and the ties are the IRs around the five KTAs.

To complement the degree centrality measure, we have computed the closeness degree to determine the shortest path within the KTA networks and determine the consolidation of each KTAs while also analyzing each of them's importance.

2.2. Closeness centrality

Unlike the degree centrality, which calculates the number of ties incident to a given node, the closeness centrality computes the sum of a node's distances to all other network nodes based on measuring the shortest paths between all pairs of nodes (geodesic path). The closeness degree is the reciprocal of the sum of the shortest paths between all the pairs of nodes.

The closeness centrality is suitable for this case; it measures the importance of innovation content (KTAs) in the overall AV industry. In our case, the network graphs are connected. We avoid the bias of obtaining infinite closeness centralities when we sum up all the distances of a node. Besides, the closeness centrality supports undirected and unweighted graph types. We brought the list of closeness ranging between 286 and 1.659.

$$\text{Closeness centrality} = [286; 1.659]$$

When a node has a high closeness value, meaning far from zero, it is central to the network. Conversely, the lower the closeness value, the less prominent the node is. Table 23 identified the highest values indexed for closeness degree calculations and presents the corresponding node label.

Table 23. Extract from closeness degree of network nodes

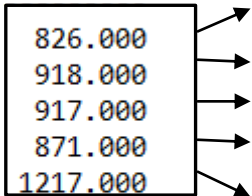
Closeness	
826.000	
918.000	
917.000	
871.000	
1217.000	
1268.000	
1268.000	
1360.000	
1360.000	

<i>Connectivity</i>
<i>Sensing</i>
<i>Test and comm</i>
<i>AI</i>
<i>MaaS</i>

Reciprocally, as connectivity has the shortest path lengths to other nodes, it translates and corroborates the previous findings stating that the KTA connectivity has many ties. It makes connectivity an accessible KTA for members of the network.

The closeness centrality measure benefits because it corresponds to a visual centrality when we draw the graph. The nodes that appear in the center of Figure 55 have the lowest closeness centrality. Conversely, the nodes with a bigger size in the network periphery are less central to the network.

Figure 55. Network visualization by node closeness degree

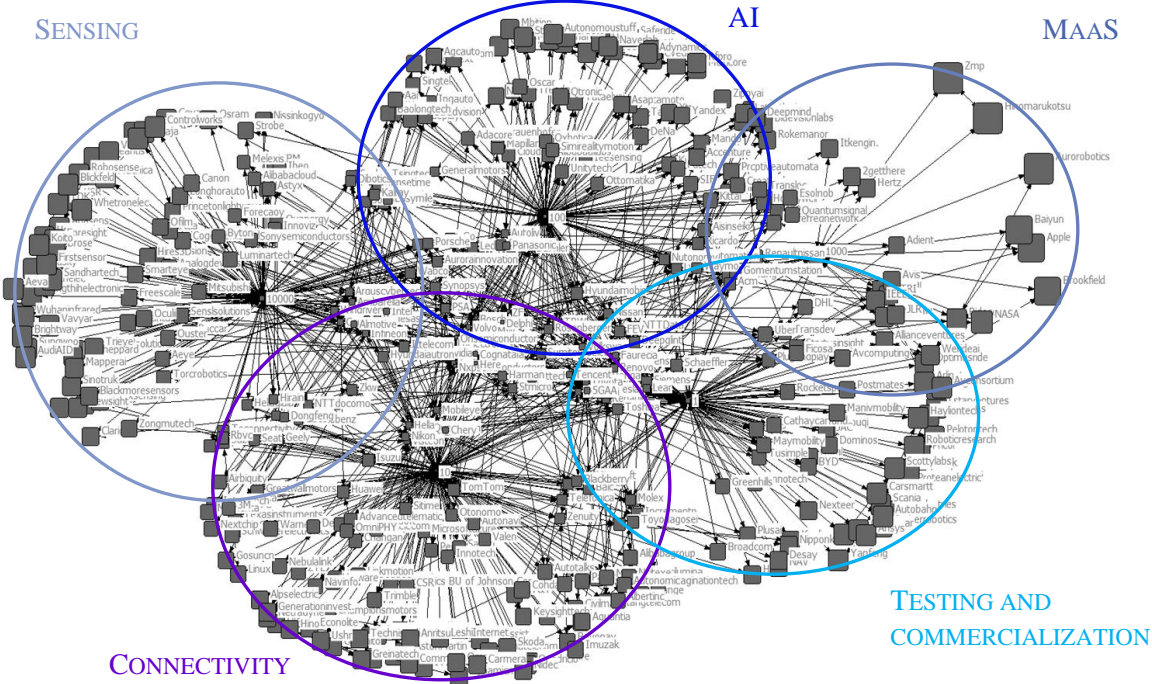

As a result, we identified the five KTAs right in the middle of the graph through the software's automatic layout. The closeness measure gives us much insight regarding the structuration of the network. We have identified the KTAs as the center of their respective networks. We have highlighted each network's central core, which are the key technologies that enable the advancements in the autonomous driving technologies, and therefore, the emergence itself.

Conclusion of Section II

In **Section II**, we intended to answer the following research question: **How could inteorganizational relationship networks assess the structuration patterns of industry emergence caused by disruptive innovation?**

The answer to the research question is related to identifying industry structuration through the quantification of IRs around Key Technological Activities. The main findings retrieved the technological driver of each IR. It enabled us to identify the main technological activities that have motivated organizations to collaborate, which in this case are: connectivity, artificial intelligence, sensing, testing and commercialization, and mobility-as-a-service. Then, we have done a longitudinal analysis of the structuration patterns of IRs over the years. The time variable highlighted several critical phases of AV industry emergence.

First, we discussed the lethargic and transitional phases from 2011 to 2014. The number of IRs is relatively low, and this period is characterized mainly by the emergence of two KTAs that are connectivity and sensing. We combined these two phases due to the slow patterns of evolution observed in the number of IRs. The transitional stage is primordial to identify the disruption point: the passage from the traditional industry to the emerging industry.

Second, we presented the progressive phase from 2015 to 2016 with the multiplying number of IRs. We noticed that this period characterizes the cohabitation of all the five KTAs.

Finally, the densifying phase occurring between 2017 and 2019 enabled us to depict the significant IR network consolidation that happened around each KTA except MaaS, which seems to have slower growth than connectivity, AI, sensing, and testing and commercialization KTAs. To corroborate the central role played by each IRs network around KTAs, we have, in parallel, carried out statistical analysis of centrality and closeness degree to determine the centrality of each node. The results both statistically and visually corroborated the centrality of KTAs, AI, sensing, testing and commercialization, and Maas in order of importance.

Conclusion of Chapter 7

In **Chapter 7**, we intended to respond to two dependent research questions.

In **Section I**, the research activities were oriented to understand whether interorganizational relationship dynamics could assess *ex-ante* patterns of industry emergence caused by disruptive innovations. To answer our first research question, we have performed a longitudinal analysis of the number of IRs between 2011 and 2019 and compared it to the adapted industry life cycle model that we have presented. The comparison between the adapted industry life cycle model and the evolution phases of the number of IRs showed a positive co-evolution link. The critical quantitative analysis enabled us to determine that IRs are valuable metrics to identify industry emergence because they translate the paradigmatic change at organizations' strategic levels.

To corroborate our results, we have carried out statistical calculations to determine the overall network densification and geodesic distances network to determine the growing diameter of the IR networks. Indeed, we discussed the fundamental role of cross-sectoral dynamics in understanding and depicting the two-industry signals and presented the AV industry's locus.

Then we argued that determining the industry's only emergence is not sufficient to reveal or assess its structuration. Consequently, in **Section II**, we asked how interorganizational relationship networks could reveal the structuration patterns of industry emergence caused by disruptive innovation. Therefore, to what extent does the disruption innovation content determine the industry emergence dynamics?

To answer our second research question, we have focused on the IR formation motives that are the technological drivers, which led us to identify five KTAs. The longitudinal analysis of IRs based on those key technological drivers enabled us to remember three phases of industry emergence: the lethargic and transitional phase, the progressive phase, and the densifying phase. We discussed the intrinsic IRs evolution characteristics for each phase.

Finally, we have identified the centrality and closeness degree for each KTA and demonstrated the central role of each KTA that all together form the disruptive innovation content.

In conclusion, **Chapter 7** enabled us to determine the critical information that IRs can provide at the macro level. The results showed that IRs are valuable metrics to depict and assess industry emergence and identify significant technological variables (KTAs) according to which emerging industries will structure. From the macro-level perspective, our study gave insights on the origins of industries yet, did not provide insight into which strategies work the best in the face of disruptive innovation.

Nevertheless, it informed about how the industry emerges and structures over the years. We argue that, and as recommended by the network literature, it is primordial to study the network at the organizational level to depict strategic orientations' main organizational pattern. This research identifies the main strategic and attributes patterns in IRs networks constellating around five KTAs. The entry of attribute data brings several contributions to the network analysis and organizational isomorphism in networks that we discuss in **Chapter 8**.

Chapter 8. Multi-network analysis based on organizational attributes

Following the multi-level funnel approach, we now look at the organizational attribute inside of each IR network around the five identified KTAs to determine **how the innovation content could explain industry emergence patterns in terms of IR types and choice of partners.**

Supported by the discussions in **Chapter 3**, we considered the need for a non-linear perspective on innovation, implying that each innovation is different and has intrinsic characteristics that define the complexity level and the efforts required to perform a given innovation. To do that and respond to our research question, we argue that the identification of the overall IR networks composition similarities to highlight if any dissimilarity patterns are observed when considering the innovation content; thus, identify whether the innovation content affects network patterns in terms of IR types and choice of partners. We have summarized the interdependence of the analysis levels and the logic we have followed in Figure 56.

Figure 56. Summary of Chapter 8

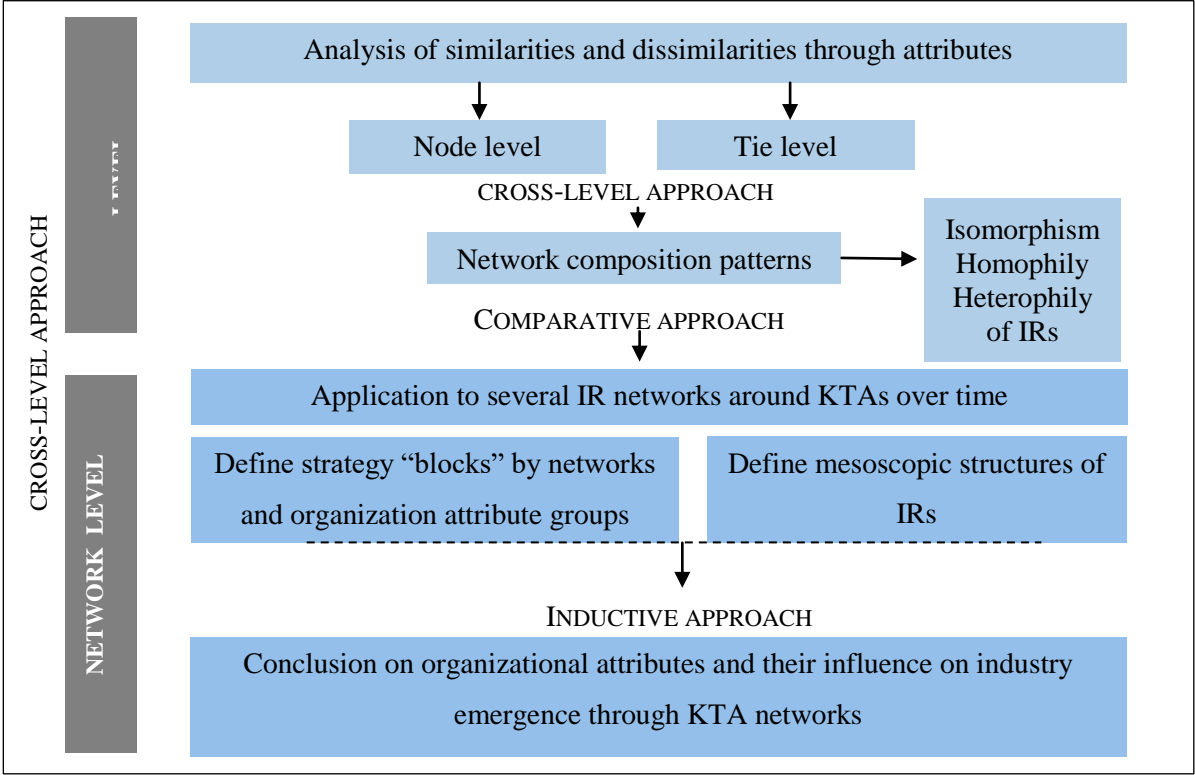

To respond to our main research question, which wonders **how the innovation content could explain industry emergence patterns in terms of IR types and choice of partners**, in **Section I**, we present that all networks share similarities and dissimilarities by assessing five IR networks at the organizational level. We have concentrated the pattern depiction efforts at the node and tie levels, as recommended by the SNA methodology. We have analyzed each of the five IR networks through a cross-level approach and presented the network composition patterns through isomorphic, homophilic, or heterophilic processes.

In **Section II**, the organizational level findings enabled us to carry out a comparative analysis of each IR network at the network level. In this particular step, we have attempted to bring light on ‘strategic boxes’ namely the preferred IRs by types of organization and the select types of partners according to organizational attributes (mesoscopic structures of IRs), and validate or refute the importance of the innovation content in shaping IRs and partner choices. This level is impressive because it enabled us to propose a multi-level approach and discuss each network’s idiosyncratic characteristics, which we believe induces the understanding of innovation content.

Section I. Identification of shared characteristics of interorganizational networks at the organizational level

In **Chapter 7**, we discussed how influential IRs are in assessing the emergence of industry dynamics. In so doing, we expanded our findings beyond the use of IRs as industry emergence metrics by proposing that IRs take the form of IR networks by accumulating over some time. The in-depth analysis helped us to find out how these IR networks configured around five KTAs. The inductive approach adopted in **Chapter 7** prepared the ground for **Chapter 8**, for a cross-level analysis between the network level and the organizational level and across IR networks around each KTA.

We aim to get comparative information regarding the IR networks of each KTA and understand **how the innovation content could explain industry emergence patterns in terms of IR types and the choice of partners**. What is interesting is to know how, based on the complexity of the innovation content of each KTA, patterns may differ or, on the contrary, be very similar (isomorphism) in each KTA and how it varies over time.

To do that, in **Section I**, we intend to present the similarities that IR networks can share, to then demonstrate that those IR networks have intrinsic characteristics that can influence the choice of a type of interorganizational relationship. We start by giving an overview of the significant organizational attribute patterns and continue with a funnel approach to:

- Carry out homophily and heterophily pattern identification by analyzing the mesoscopic patterns, e.g., the combination of organization type in IRs. Parallel to identifying the mesoscopic structure of IRs (incumbents vs. new entrants), we have looked at whether organizations are suppliers or OEMs. We intend to differentiate these two types of organization involved in IRs;
- Identify the most contracted IR types by mesoscopic structure;
- Identify the mesoscopic patterns of IR form adoption through combined data analysis;

- Crossbreed mesoscopic structure patterns with KTAs information and identify whether the innovation content could explain IR types' choice.

We start by discussing general network characteristics observed over the five IR networks.

1. General network characteristics

“Similarity breeds connection”, so is resumed the principle of homophily in networks (McPherson et al., 2001: 415), while heterophily refers to the “common relational behaviors between different groups” (Lozares et al., 2014: 2658). Some studies consider the duality of heterophily and homophily in networks (Lazarsfeld & Merton, 1954), while others discuss both concepts as dependent (Barranco et al., 2019).

SNA studies accepted that homophilic patterns combined with complementary heterophilic processes show the “attributes of a group and relate them to relational behaviors and their consequences” (Lozares et al., 2014: 2658). If reversed, this argument could explain how similar IR behaviors can explain homophilic IR networks' formation.

First, we intend to identify the AV industry's general population, whether incumbents or new entrants, suppliers, or OEMs. Furthermore, we expect to include a synoptic view of network composition and IR behavioral patterns by type of organization types in the following paragraph: incumbents (INC) or new entrants (NE). We have defined three types of IR combination based on the type of organization involved. For consistency, we will refer to the type of organization engaged in IR as the **mesoscopic structure** of IRs.

- First mesoscopic structure: IR types by NE-NE;
- Second mesoscopic structure: IR types by NE-INC or INC-NE;
- Third mesoscopic structure: IR types by INC-INC.

Second, we are going to be presenting several levels of IR composition analysis. First, we analyze the results of the composition of the IR by the types of organizations involved. We can combine findings on mesoscopic structure patterns with IR forms and gather information by mesoscopic structure over the most contracted forms of IRs.

The first analysis based on organizations' role highlighted the dominant role of suppliers in the AV industry.

1.1. Supplier-dominant industry

As a seminal finding, we have extracted statistical data regarding the yearly distribution of organizations types ('INC' and 'NE') present in the IR database. As a result, we obtained Table 24 indexing the different types of organizations of the database.

Table 24. Proportion of incumbents and new entrants in mesoscopic structure (2011-2019)

Organization type	2011	2012	2013	2014	2015	2016	2017	2018	2019	Total/IR
NE	2	3	7	9	14	73	136	158	118	520
INC	0	3	13	19	26	63	146	142	88	500
Total	2	6	20	28	40	136	282	300	206	1020

Table 24 shows the yearly distribution of incumbents and new entrants involved in the 510 IRs indexed in the IR Database. The absolute value equals to 1020 and reflates binary IRs. The database shows an almost balanced repartition between incumbents and new entrants' involvement in IRs between 2011 and 2019, with 520 occurrences of new entrants and 500 for incumbents.

From 2011 to 2015, incumbents were more involved in IRs than were new entrants. From 2016 to 2017, the proportion between incumbents and new entrants in IRs varies slightly, respectively, with 73 new entrants and 63 incumbents in 2016, and then 136 new entrants and 146 incumbents in 2017. Finally, from 2018 to 2019, new entrants are more involved in IRs than are incumbents. From the beginning to the end of the studied period, the occurrence pattern among new entrants and incumbents reverses.

Beyond the typological repartition and identifying the main typological involvement patterns between 2011 and 2019, we have looked closer to the industry of provenance and the role of each organization (OEM or supplier), and have obtained Table 25.

Table 25. Repartition based on the role-type dichotomy

	Absolute value	%
New entrants	520	
– OEMs	31	51
– Suppliers	489	
Incumbents	500	
– OEMs	145	49
– Suppliers	355	

While the typological repartition findings shed light on a balanced presence of incumbents and new entrants, representing 49% and 51%. The conclusion here adds additional information; it qualifies the role of organizations, possibly OEM or supplier. OEMs are all automotive manufacturers, and supplier refers to all organizations that carry out auto parts and components activities. In this case, it refers, for instance, to software developers, LIDAR manufacturers, and tire manufacturers. The purpose of adding the additional role identification step is valuable in several ways. Firstly, it enables tempering the first finding by identifying leading IR contracting organizations’ type and role. Secondly, it helped us to build a two-variable typology about IR-contracting organizations. *In fine*, it gives a clear overview of the network composition.

The repartition of organizations based on their role (OEM vs. supplier) concatenated with the type highlighted a key finding; the dominance of suppliers in the AV industry. Identifying a balanced repartition between new entrants and incumbents scalloped by the role variable resulted in a highly supplier dominant AV industry, with 63% of suppliers regardless of the type.

However, the second observation highlights that most suppliers are new entrants (48%) compared to incumbent suppliers (35%); incumbents suppliers are more represented in the dataset than incumbent OEMs, though. The straightforward observation about OEMs is the prevalence of incumbents one (14%) in comparison to new entrants (3%). Overall, we underline that incumbent and new entrant suppliers positively drive the AV industry. As a

result, many suppliers (63%) telegraphs a very fragmented sector where many organizations try to find their path.

1.2. Incumbent suppliers as top interorganizational relationships contractors

According to the organization's role-type dichotomy, the statistical computing of database repartition mirrored that 30 organizations account for 70% of the total IRs contracted from 2011 to 2019 (Table 26). We have analyzed these organizations' organizational attributes and identified the most IR active organizations.

Table 26. Top 30 organizations by the percentage of IRs contracted between 2011 and 2019

Organization	Type	Role	% IR
Baidu	New entrant	Supplier	5%
Renesas	Incumbent	Supplier	4%
ZF	Incumbent	Supplier	4%
Hyundai	Incumbent	OEM	3%
Bosch	Incumbent	Supplier	3%
Qualcomm	New entrant	Supplier	3%
Nxp Semiconductor	Incumbent	Supplier	3%
Continental	Incumbent	Supplier	3%
Nvidia	New entrant	Supplier	3%
Denso	Incumbent	Supplier	3%
Mobileye	New entrant	Supplier	3%
Delphi	Incumbent	Supplier	2%
Here	New entrant	Supplier	2%
Infineon	Incumbent	Supplier	2%
Daimler	Incumbent	OEM	2%
TomTom	Incumbent	Supplier	2%
Valeo	Incumbent	Supplier	2%
Audi	Incumbent	OEM	2%
Ford	Incumbent	OEM	2%
BMW	Incumbent	OEM	2%
LG Electronics	Incumbent	Supplier	2%
Wabco	Incumbent	Supplier	2%
Volkswagen	Incumbent	OEM	2%
Intel	New entrant	Supplier	2%
Toyota	Incumbent	OEM	1%
Ambarella	Incumbent	Supplier	1%
TTTech	New entrant	Supplier	1%
Lyft	New entrant	Supplier	1%
Velodyne	New entrant	Supplier	1%
Volvo Cars	Incumbent	OEM	1%

The purpose of Table 26 is to give an overview of the predominant role played by organizations indexed in the database. From an innovation emergence perspective, the AV industry's highly fragmented state is discussed in paragraph 1.1. with many suppliers, let us consider that the lack of dominant design might make competition strong and attract many suppliers' attention to keep stacking new technology versions to cannibalize market shares.

Here, the number of IRs contracted by an organization served as a variable of classification; the higher the IR number employed by a company, the more influential the company. As a result, the top 30 organizations have contracted 70% of the dataset's IRs indexed. Amongst the top 30, there are more incumbents than new entrants. The number of suppliers is more important than the number of OEMs regardless of the type, even though this tendency is reversed in the rest of the database.

Resulting from that, we identified three organizational attributes characterizing the top 30 organization:

- Incumbent OEMs such as Hyundai, Volkswagen, Audi, and Daimler, accounting for 19%;
- Incumbent suppliers such as ZF, Renesas, NXP Semiconductor, and Bosch, accounting for 31%;
- New entrant suppliers such as Baidu, Nvidia, Qualcomm, and Mobileye, accounting for 20%.

Finally, this teaches us that the type of organization (INC vs. NE) is not the only critical attribute of organizations. The cross-referring data from the type and the role shed light on the dominance of incumbents suppliers in IRs (31%), followed by new entrant suppliers (20%) and incumbent OEMs (19%) and the passiveness of new entrant OEMs in the top 30 of IR contracting organizations which represent 3% of the overall database.

In summary, the discussions enable us to draw two conclusions. First, the overall network composition patterns gave critical information regarding a balanced repartition of organization between new entrants and suppliers combined with their type attribute (incumbents vs. new entrant). Secondly, when looking statistically at the repartition of IRs according to these two attributes, we noticed that the pattern was different: suppliers are

dominant, incumbent, and new entrant combined. The identification of the 30 organizations sample showed that the dominance of new entrant suppliers is nuanced. Among the top IR contracting organizations, 20% are new entrant against 31% incumbents. The type and role attributes' cross-breeding highlighted different patterns at the general and more detailed analysis levels (Table 27).

Table 27. Synthesis of findings

Phase	Network composition characteristics
Lethargic and Transitional phases (2011-2015)	Incumbents are more present during the lethargic and transitional phases
Progressive phase (2016-2017)	Incumbents and new entrants are almost equally present during the progressive phase: the industry starts to combine two populations of organization
Densifying phase (2018-2019)	New entrants outperform the number of incumbents: the industry takes the disruptive innovation's characteristics with new entrants' arrival.

In fine, this paragraph showed the proportion of IRs by the role-type dichotomy; however, it relates to neither the choice of partners nor the type of IR.

Therefore, we carried out a teardown of the number of IRs by combining organization types between 2011 and 2019 to identify the most contracted IR types in each mesoscopic structure and found that regardless of the mesoscopic structure, partnerships are the most contracted types of IR. We discuss our findings in the next paragraph.

2. Multi-level analysis of network composition

This paragraph presents the results regarding mesoscopic structure patterns within the AV industry, combining mesoscopic structures with IR types, and cross-breed the mesoscopic structure data with KTA variables. Said otherwise, it confers a level of detail that determines which kinds of organization collaborate and how in each KTA.

2.1. Identification of mesoscopic structure patterns

Overall, we study three mesoscopic structures retrieved from the database:

- First mesoscopic structure: IR types by NE / NE
- Second mesoscopic structure: IR types by NE / INC or INC / NE
- Third mesoscopic structure: IR types by INC / INC

To set the context, we present in Figure 57, the number of IRs contracted by each mesoscopic structure from 2011 to 2019.

Figure 57. Number of IRs by mesoscopic structure

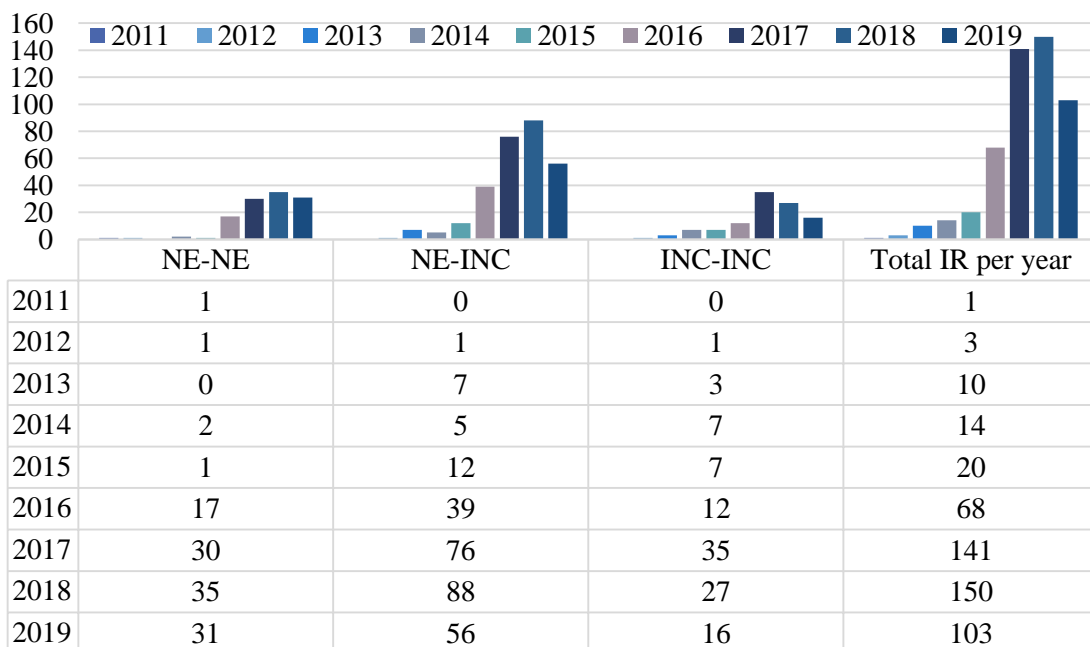

The repartition of IRs by mesoscopic structure is summarized as follows; 23% of IRs is contracted amongst new entrants (homophilic IRs), 56% amongst new entrant and incumbents (heterophilic IRs), and 21% between incumbents (homophilic IRs).

From 2011 to 2015 (lethargic and transition phases), the number of IRs is relatively low regardless of the mesoscopic structure of IRs. From 2011 to 2015, 25 IRs have been contracted in the NE-INC category, five amongst new entrants, and 18 in the INC-INC category. Then, the trend fits into a bell curve for all types. The number of IRs plummets

between 2016 and 2017 (progressive phase), intensifies between 2017 and 2018 for NE-NE and NE-INC (densifying phase) and faces a decrease in 2019. As a result, the INC-NE structure registered the highest number of IRs in 2018, with 88 IRs contracted between incumbents and new entrants.

Regarding the NE-NE structure, the number of IRs contracted between two new entrants peaked in 2018 with 35 IRs and decreased in 2019 with 31 IRs. In 2017, 30 IRs were contracted, and 17 in 2016. Finally, 2017 was the year with the most IRs contracted between two incumbents with 35 IRs indexed. We then found 27 IRs in 2018, 16 in 2019, and 12 in 2016.

The general tendency observed here is that organizations tend to be cautious in their collaborative behaviors at the stages of industry emergence (lethargic and transitional phases) regardless of the mesoscopic structure. With the effect of social embeddedness and social capital requirements, organizations seem to identify the need for collaborative behaviors to gain awareness about technological complexities translated in later stages (progressive and densifying phases). We synthesized our findings in Table 28 and showed the dynamic evolution of mesoscopic ranking over the years.

Table 28. Mesoscopic structure proportion by phases

	Phases											
	Lethargic and Transitional				Progressive			Densifying				
	Number of IR	% total IR	in Rank	Rank	Number of IR	% total IR	in Rank	Rank	Number of IR	% total IR	in Rank	Rank
NE-NE	5	10%	3	47	22%	2	66	26%	2			
NE-INC	25	52%	1	115	55%	1	144	57%	1			
INC-INC	18	38%	2	47	22%	2	43	17%	3			
Total	48	100%	-	209	100%	-	253	100%	-			
IR/phase												

Among these complexities, organizations face many barriers to overcome, such as the wide range of AV applications spanning from the personal transportation segment to last-mile deliveries, goods trucks, and driverless ride-hailing (robotaxis), implying that there will not be

a standard AV available to all, yet, several segments to develop with different needs, requirements, costs, regulation, and public acceptance challenges.

Parallel to that, the technological requirements for each of the AV modules are a proven reality. In terms of cameras, on average, 8 to 12+ are embedded in AVs in which the transmission of gigabits per second represents the main challenge. In terms of LIDARs, companies need to prove the equipment's reliability, whereas, for radars, the choice is made between the multiple ranges and the needs that they allow covering (short, mid, and long-range). In terms of software complexity for driver replacement, the complexity varies by use-cases, e.g., people density, speed, light, traffic, and is highly dependent on unpredictable human behaviors according to which the software needs to act.

Given the multitude of challenges raised by AVs, companies naturally have invested in such a growth-promising innovation. While some organizations are well-advanced and have already opened an AV platform, others choose to collaborate with the more advanced ones (Figure 58).

Figure 58. AV software platforms and collaboration⁴³

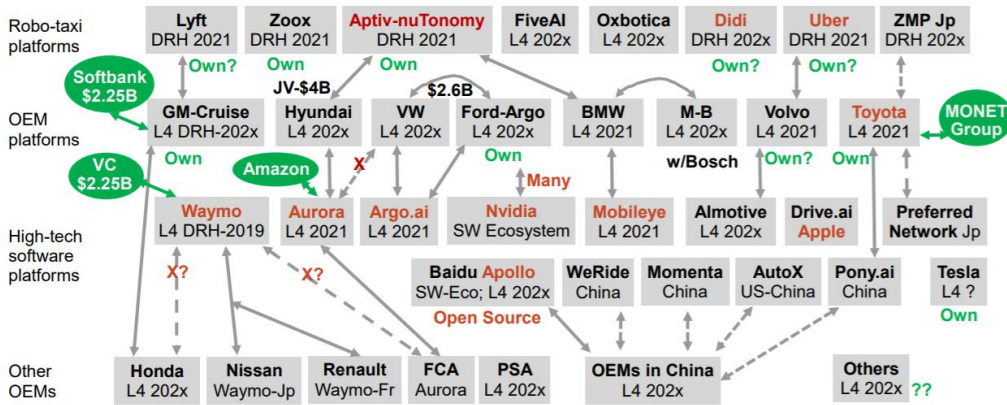

The questions regarding why organizations need to collaborate are identified mainly in the resource gaps inherent to emerging industries. When organizations like Google, Uber, and Apple investigate autonomous vehicles, the traditional players are shaken up and hurry to

43 Retrieved from https://on24static.akamaized.net/event/22/55/56/6/rt/1/documents/resourceList1586879547851/ihsmarketautotec_hinsightwebinarseriesavstateofthemarket1586879545863.pdf

dismiss the lack of resources that may cause them to fail to attract this lucrative industry's promises. According to the autonomy level, the technology balkanization raises questions around the standard and optional equipment in each AV model. Today, we observe a relatively competitive ADAS portfolio between standard, optional, and automated driving options proposed independently by OEMs based on their strategies. Car manufacturers respond to competitive pressures, complexities in manufacturing, and upcoming regulations, mostly by the standardization of ADAS features across vehicles and segments. There is still potential for differentiation and profits, with safety-centered features such as ACC and L2 autonomy level, which still offers differentiation opportunities and revenues. Many L2 + and L3 systems need new development strategies and underlying architectures that are the new differentiation area for increasingly standard ADAS companies.

Although the order of entry in the emerging industry is of little importance, the first to establish a dominant design will benefit from owning a substantial part of the cake. In this sense, a technological racing climate has established among new entrants and incumbents, which took in the turmoil of disruption and embarked on collaborative strategies in abundance.

Finally, what drives collaborative strategies is the argument that AVs are a combination of two technologies. One, traditional, relates to the manufacture of vehicles. The other, more recent and disruptive, involves connectivity, mapping, GPS, and artificial intelligence. No wonder, then, that 'driverless' vehicles appeal to both historic car manufacturers - Volkswagen presented a prototype at the Geneva Motor Show - and companies in the digital economy.

2.2. Choice of interorganizational relationship forms

In line with the previous paragraph, we incorporate the IR type variable to analyze how these mesoscopic structures collaborate because IRs can take different forms. The database results revealed four types of IRs in line with Contractor and Lorange's (2002) typology: partnership, acquisition, equity investment, and joint venture. To depict major patterns of IR type by mesoscopic structure, we have summarized the main findings in Table 29.

Table 29. Evolution of type of IR by mesoscopic structure from 2011 to 2019

			Acquisition	Equity investment	Joint-venture	Partnership	Total IR per year
Lethargic Phase	2011	NE-NE	1				1
	2012	NE-NE				1	3
		NE-INC				1	
	2013	INC-INC				1	
		NE-INC	2			5	10
Transition Phase	2014	INC-INC				3	
		NE-NE	1			1	14
	2015	NE-INC	1			4	
		INC-INC	3			4	
	2016	NE-NE				1	20
		NE-INC	5	1		6	
INC-INC		3			4		
Progressive Phase	2017	NE-NE	7			10	68
		NE-INC	6	2		31	
		INC-INC	2		2	8	
	2018	NE-NE	4	2		24	141
		NE-INC	5	9	3	59	
		INC-INC	6		3	26	
Densifying Phase	2019	NE-NE	7	6		22	150
		NE-INC	6	5	1	76	
		INC-INC	3	2	4	18	
	2019	NE-NE	6	1	1	23	103
		NE-INC	7	6	1	42	
		INC-INC	2		2	12	
Total by types	IR	77	34	17	382		

The dynamic analysis of IR adoption patterns by mesoscopic structure revealed several results for each emergence and structuration phases: lethargic, transition, progressive, and densifying.

2.2.1. Lethargic and transition phases

During the lethargic and transitional phases, we registered a total of 48 IRs, imparted into partnerships (65%), acquisitions (33%), and equity investments (2%). In terms of mesoscopic structure, 52% of IRs are contracted between new entrants and incumbents, 38% amongst incumbents, and 10% between new entrants. During the lethargic and transition phases (2011-2015), we cannot perceive any significant pattern given the low number of IRs contracted in 2011 (1) and 2012 (3). However, the appearance of the three mesoscopic structures in 2012, which opted for partnerships as a form of IR, is noticeable.

During the transition phase (2012-2015), the tendency to either contract acquisitions or partnerships is observed. From 2012 to 2015, 16 acquisitions have been made, out of which 50% occurred between new entrants and incumbents and 38% between incumbents. It appears that acquisitions were not the go-to IR for new entrants (6%). In terms of partnerships, it seems that they are the preferred IR types firstly in heterophilic IRs (54%), then between incumbents (39%), and finally amongst new entrants (7%).

The amount of IRs is limited from 2011 to 2015 (48), and the retrieved data enabled to identify incumbents as primary drivers of IRs. 52% of partnerships are contracted by incumbents and new entrants, 39% amongst incumbents, and 10% amongst new entrants. The same pattern of IR type by mesoscopic structure is observed for acquisitions. It led us to conclude that at the early stage, organizations tend to adopt mostly less risky IR forms such as partnerships in the view of making sense of the emerging industry and the related disruptive innovation content.

Yet, as contradictory as it may sound, acquisitions, considered as most risky yet advantageous in the long-term, are also highly contracted by incumbents. Said otherwise, acquisitions are more costly and resource-demanding strategies, and the results showing they happen in cases where incumbents are involved self-explanatory (88%) because of their financial robustness and stability, they may have more capabilities to carry out long-term IR such as acquisition in

comparison to new entrants (12%). Except for one equity investment in 2015 in the NE-INC mesoscopic structure, none other IR type has been observed during these phases.

2.2.2. Progressive phase

From the lethargic and transitional phases (phases 0 and 1) to the progressive phase (phase 2), the number of IRs have multiplied threefold.

Between 2016 and 2017, a total of 209 IRs occurred indexed into four types of IRs: acquisitions (14%), partnerships (76%), equity investments (6%), and joint-ventures (4%). In terms of mesoscopic structure repartition, heterophilic IRs account for 55%, homophilic NE-NE for 22%, and homophilic INC-INC for 22%.

Each mesoscopic proportion seems observable with 90 heterophilic partnerships, 34 homophilic IRs between new entrants, and 34 IRs between incumbents. The number of heterophilic IRs has rocketed from phase 0+1 (16) to phase 2 (90). Similarly, there is a relatively significant increase in partnerships between new entrants, which remained at 3 in the preceding phases, yet reached 34 in phase 2.

In terms of acquisition strategies, the number doubled from phase 0 and 1 (16) to phase 2 (30); they are adopted by the NE-NE (36%) and NE-INC (36%).

Globally, equity investments and joint-ventures are chosen from incumbent companies that commit to long-term relationships (equity investments and JVs) either with similar organizations (67%) or new entrants (39%).

The global patterns observed in Phase 2 are summarized as follows. First, partnerships are the preferred IR types for homophilic collaboration, acquisitions are chosen in INC-INC combination, and equity investments are mostly made in heterophilic IRs. Secondly, compared to Phase 0 and 1, in Phase 2, equity investments are effectuated amongst new entrants (15%), too, while also facing a significant increase from 2015 (48) to 2017 (13). Finally, what substantially differs from preceding phases is the formation of joint ventures in the second phase of emergence, probably because organizations tend to make better sense of the emerging industry, identify trustworthy partners, or the advantages of joining forces with similar companies or even competitors (63%).

2.2.3. Densifying phase

During the densifying phase, 253 IRs are observed, representing 50% of total IRs (510). Among these IRs, 76% are partnerships, 12% acquisitions, 8% equity investments, and 6% joint-ventures. NE-INC IRs account for 57%, NE-NE IRs for 26%, and INC-INC IRs for 17% in mesoscopic structure repartition.

In terms of heterophilic IRs, the choice of IRs is made towards partnerships, which is the only type of IRs facing a noticeable increase compared to Phase 2, increasing from 90 to 118.

For the other types of IRs, the tendency per mesoscopic structure seems to perdure from the progressive phase, with a large majority of partnerships contracted between new entrant and incumbents (46% vs. 43% in Phase 2). However, the tendency is reversed in terms of hemophilic IRs. The amount of IRs amongst new entrants (45) exceeded the number of IRs between incumbents (35), showing the increasing degree of a settlement of new entrants in the emerging industry. Regarding acquisitions, the patterns are similar to Phase 2, and the prevalence of hemophilic NE-NE and heterophilic IRs, representing 42% each, is also identified. Finally, equity investments and joint ventures are still a mostly incumbent IR form as 65% of equity investments and 89% of joint-ventures are initiated between incumbents and new entrants or strictly amongst incumbents.

The discussions around IR type choices by mesoscopic structure showed a general tendency towards the growing number of long-term relationships such as acquisitions, equity investments, and joint-ventures in parallel to shorter-term IR, such as partnerships from the new entrant perspective. The tendency is verified for hemophilic IRs, and since Phases 0 and 1, incumbents tend to prefer partnerships yet also acquisitions and equity investments, slowly incorporating joint ventures among similar companies.

Conclusion of Section I

In **Section I**, we presented our results regarding the overall network composition of the AV industry. The results showed that, on a global note, there is a balanced repartition between new entrants and incumbents involved in IRs in the context of AV industry emergence. Nevertheless, the additional attribute analysis by crossbreeding each organization's type and role enabled us to depict that the AV industry is highly fragmented with a plethora of incumbent and new entrant suppliers. The ranking of the Top 30 organizations based on the amount of IRs contracted between 2011 and 2019 mirrored that incumbent OEMs and auto part suppliers are also well-represented.

Secondly, the multi-level analysis combining both the interorganizational and the organizational levels showed several patterns. At the organizational level, we firstly determined the repartition of IRs by mesoscopic structure, and the result showed that:

- 56% of IRs are contracted between one incumbent and a new entrant, with a peak in 2018;
- 23% of IRs is contracted between two new entrants, with a rise in 2018;
- 21% of IRs is contracted between two incumbents, with a peak in 2017.

The dynamic pattern identification lets us conclude that overall in all three phases of industry emergence, the tendency is to collaborate with heterophile companies to identify the pattern in phases 2 and 3. In terms of homophile IRs, the tendency changes over the period. During Phase 1 and 2, the pattern illustrates that the second dominant mesoscopic structure is INC-INC IRs, even though during the progressive phase NE-NE IRs share the second rank. In Phase 3, though, the ranking changes, with INC-INC IRs coming first, followed by NE-NE IRs, mostly ahead of INC-INC IRs.

In conclusion, depicting significant mesoscopic structure patterns and the tendency to adopt similar IR forms showed that organizational isomorphism is principally helping understand the AV industry emergence. Even though willing to differ in their performance, companies tend to adopt similar behaviors and replicate mesoscopic structures. Over the year, the patterns of IR types and choice of partners have maintained the same tendency.

In **Section I**, we, therefore, remained at the superficial level of analysis of IR and organizational attributes because we intended to identify the significant shared characteristics of organizations and IRs in the database and depict which mesoscopic structure dominates the AV industry emergence. To further detail our analysis, we propose to discuss the dissimilarities and specificities that we may observe across networks in **Section II** based on the innovation content inherent to each KTA to understand whether the innovation content could influence the collaborative patterns within a given network.

Section II. Identification of specific characteristics of interorganizational networks at the network level

Section I presented the general characteristics of networks; namely, we have looked at heterophilic and homophilic IRs patterns and the choice of IR forms based on the mesoscopic structures. However, our research question intends to **understand how could the innovation content explain industry emergence patterns in terms of IR types and partner choice?** After having laid the shared characteristics of the overall IR network (the combination of IRs regardless of the KTA), we now propose to look at the patterns within each KTA to identify the impact of each KTA’s innovation content on the patterns of collaboration and profile of organizations. Considering that networks have a collusive manner to develop and anchor in intrinsic patterns, we produced a general overview of IR network composition by analyzing IR and partner choice based on the innovation content.

For each KTA, we discuss the dominant IR forms adopted by mesoscopic structures from 2011 to 2019, according to the IRs typology proposed in Figure 59 below (Contractor & Lorange, 2002).

Figure 59. Typology of interorganizational relationships

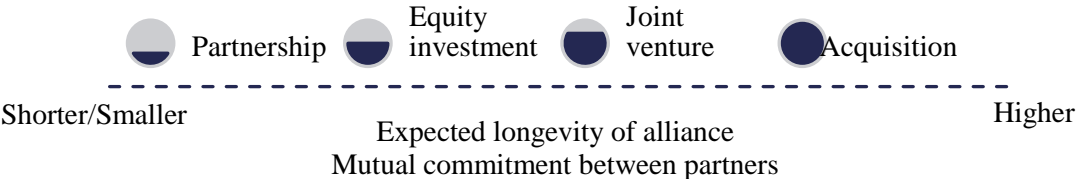

We will present the statistical treatment findings for each IR network building around the five KTAs. We start with connectivity, artificial intelligence, sensing, test and commercialization, and finally, MaaS.

Incorporating the innovation content as a variable of study will permit us to discuss whether the critical technological rationale impacts how organizations collaborate and with whom, by comparing if there is any significant alteration in comparison to the shared network patterns networks. To get a specific typology of the type of IR mesoscopic structure, we split our analysis of IR types into three categories of combination that we have identified earlier. The process was applied to each of the five KTAs. To simplify the understanding and justify our percentage calculations, we summarize IRs categorized by IRs and combination of organization types in Table 30.

Table 30. Summary of IRs categorization by KTA

	IR Types				Total IR
	Partnership	Equity investment	Joint venture	Acquisition	
	NE-NE				
T&C	22	2		2	26
Sensing	18	2		5	25
AI	17	1		8	26
Connectivity	23	4		9	36
Maas	2		1	2	5
Total IR NE-NE	82	9	1	26	118
	NE-INC				
T&C	40	2		1	47
Sensing	51	5	4	8	64
AI	46	11		16	73
Connectivity	83	5		6	95
Maas	4		1	1	5
Total IR NE-INC	224	23	5	32	284
	INC-INC				
T&C	12		1	2	15
Sensing	28	1	3	6	38
AI	11		1	5	17
Connectivity	24	1	5	5	35
Maas	1		1	1	3
Total IR INC-INC	76	2	11	19	108
Total by type of IR	382	34	17	77	510

To explain how organizations motivate their collaborative strategies and their partners' choice, we first provide an overview of the technological content of the KTA under consideration and discuss the pattern of collaboration according to essential sub-activities.

1. Connectivity KTA

This paragraph discusses the technological content of connectivity, the continuous pattern of heterophile IRs, and organizations' tendency to adopt the same IRs based on their types (isomorphism). As a result, the analysis of patterns focused on the study of heterophile partnerships and acquisitions, and acquisitions as preferred types of IRs between new entrants. Finally, an in-depth analysis of mesoscopic structures in connectivity KTA sheds light on three industries' dominance: IT, automotive, and telecommunications.

1.1. Technological content pushing towards IR formation

Connectivity is the art of connecting systems or applications without making many changes to the systems and applications themselves. These interfaces need to interact with each other to complete transactions, tasks or to allocate resources within an interface efficiently. However, application programs are written in different programming languages, and processors may use diverse operating systems, or they may be in various locations. Application programs must share standard rules to allow communication, and a physical link must be formed between the processors on which the programs operate. The complexity also arises when the number of software and applications to connect increases, requiring even more connectivity flows within the same operating system (increasing hardware and software required to communicate).

When General Motors developed the first connectivity-embedded cars (connected car) in 1996 through a collaboration with OnStar, they would not have imagined what the technology would have become 25 years later. At that time, cellular voice connections were not safe; and GM needed a trustworthy and secure system. Introducing telematics enabled at that time to carry out safe voice calls to contact the GM emergence center when an airbag was deployed during accidents. Following that advance, over the years, the amount of safety system features incorporated in connected cars has drastically increased. Even though the definition of connectivity changes as more and more products are launched, it generally includes GPS locations and HD maps, infotainment such as music and audio, smartphone interfaces, Bluetooth connections, 4G Wifi hotspots, road service assistance, traffic warnings based on

the GPS, and other vehicle assistance features such as maintenance reminders, diagnostics, parking apps, real-time weather, and gas payment apps for instance.

However, there is currently no dominant design for connected cars' operating system for the head unit computers or other iPhone or Android connected devices. Nevertheless, key players such as Airbiquity, QNX, Weblink, and Qualcomm have the most market share. To downplay the lack of dominant design and simultaneously increasing features added to connected vehicles, Google formed in 2014 the Open Automotive Alliance based on an Android operating system. Similarly, Apple launched Apple CarPlay in March 2014 and was deployed by Hyundai, Ferrari, Mercedes-Benz, Volvo Cars, Honda, and GM as soon as 2017. It was the beginning of AVs.

Based on technological content and complexity, a large panel of organizations has recognized that making connectivity possible for vehicles requires a genuinely diverse ecosystem and considers that car connectivity depends on collaborative efforts. In that vein, Ericsson and Microsoft jointly develop a connected car solution to scale global vehicle services such as telematics, fleet management, and OTA software updates. The partnership shortlisted for the title of 'collaborative partnership of the year' at the TU-Automotive Awards in 2020. Speaking of collaborative strategies, we discuss how these assumptions are concretely put into actions in the real competitive world. We looked at the sub-activities that served for the global KTA indexation mentioned in **Part II** to understand what kind of technology prevails in the connectivity KTA and if it is in line with the general overview (Table 31).

Table 31. Repartition of IRs in Connectivity KTA *per* sub-activities

Sub-activities	Number of IRs
Electronics	45
Infotainment	42
V2X	22
5G	12
Geolocalization	10
IoT	9
CV2X	5
On-demand connectivity service	4
Cloud	3
V2V	3
Bigdata	2
Ethernet	2
Internetofvehicle	2
OTA	2
4G	1
Signal processing	1
V2I	1
Total IRs	166

The general analysis of IR repartition by sub-activities in the connectivity KTA shows a consensus on electronics (27%), infotainment systems (25%), and V2-X communication, which includes CV2-X, V2I, and V2V communication (19%). Since the leading GM Onstar in 1996 telematics systems, the electronic segment for connected vehicles has achieved a long way.

Table 31 considers two critical segments of auto connectivity activities: the multiple car electronics systems or ECUs (electronic control units) and the related autonomous driver's actions. The ECUs produce most of the car's data, which an increasing number of customers use. As OTA software updates are introduced to many new car models, ECUs are also the chosen and growing destination for content heading to the vehicle.

As a useful data source for multiple industries (signal processing, big data, cloud), an interface of music and other content (infotainment, ethernet), and an e-commerce enabler in the vehicle, connectivity is growing in importance. Connected passengers are also crucial as they can attach their mobile devices to the interconnected car system (Ethernet, 5G, 4G).

The present paragraph opened discussions around various and still-evolving connectivity technologies. The segmented technological landscape (highly based on 5G nowadays) and an increasing amount of connectivity features create opportunities for organizations. Yet, industry players consider that connectivity requires a complex and varied ecosystem that telegraphs at the organization attribute level. We propose to analyze the main collaboration patterns within the connectivity KTA to identify who collaborates with whom and how.

1.2. Interorganizational relationships patterns in Connectivity KTA

The main findings discussed here present the significant partnership pattern as the preferred IR form over the studied period, regardless of the mesoscopic structure. The analysis of each mesoscopic structure showed that partnerships are more contracted between new entrants and incumbents, same for acquisitions, even though a minor acquisition pattern is observed between new entrants.

1.2.1. Partnerships as the primary form of collaboration

Preliminary observations showed that partnerships are the preferred IR types in the connectivity KTA; therefore, we propose to see if this observation is corroborated over the studied period. In terms of dynamic evolution, we ranked the IR choices per year in Table 32.

Table 32. Yearly repartition of IR types and evolution (Connectivity)

	Phases						
	Lethargic and Transitional			Progressive		Densifying	
	2013	2014	2015	2016	2017	2018	2019
Partnership	80%	100%	50%	91%	92%	88%	83%
Equity investment				5%	8%		17%
Joint venture						4%	
Acquisition	20%		50%	5%		8%	

As a result, partnerships have been the preferred IR types over the studied period, showing an isomorphic collaboration pattern in the connectivity KTA where organizations tend to opt for partnerships. Rank number 2 is shared between acquisitions that start initially and occur

sporadically during the studied period. Equity investments started in 2016 yet represent a small proportion of total IR of the given years, e.g., 5% in 2016, 8% in 2017, and 17% in 2019, where only 12 IRs were contracted in total. Joint ventures are not the first-class choice in terms of IRs in the connectivity KTA.

1.2.2. Heterophile collaboration as a leading strategic path

In the connectivity KTA, partnerships represent 78% of the overall IRs. In terms of IR repartition by mesoscopic structure based on a static perspective, the findings show that partnerships seem to be prevalent for each mesoscopic structure with a more pronounced aspect in the NE-INC mesoscopic structure (Figure 60). In terms of other IR types, the tendency is less pronounced, with 20 acquisitions in total accounting for 12%, ten equity investments (6%), and six joint-ventures (4%). Most acquisitions are indexed between new entrants. Generally speaking, there is a lower tendency to contract high-commitment IR in all the mesoscopic structures.

Figure 60. Repartition of IRs by mesoscopic structure in Connectivity KTA

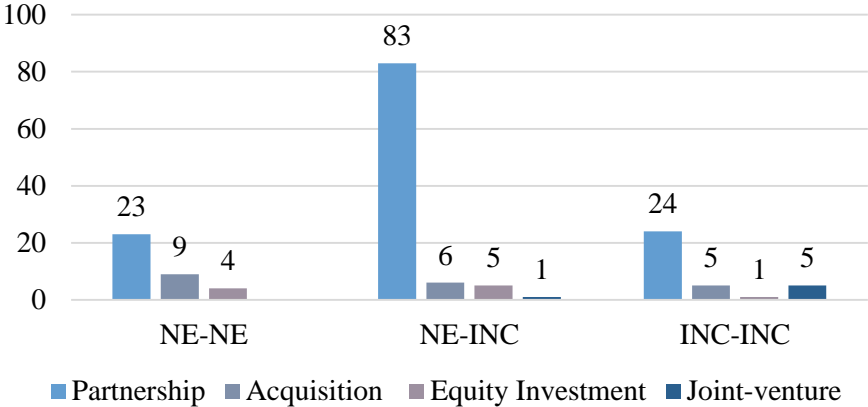

The substantial proportion of partnerships is followed by acquisitions, equity investments, and joint ventures. In terms of mesoscopic structure, 56% of IRs occurred between heterophile organizations between 2012 and 2019, 22% among new entrants from 2011 to 2019, and 21% between incumbents from 2012 to 2019.

In conclusion, regardless of the mesoscopic structure, organizations tend to opt for partnerships in priority, where the expected longevity of the IR is shorter. Each organization's mutual commitment is preferably smaller than other IRs, such as acquisition that accounts for between 6% and 14% of IR choices, JVs either 1 or 14%, and equity investments that seem to

be relatively rare in each case. The first observation leads us to the following paragraph. We make a dynamic analysis of our first static observation: the prevalence of heterophilic partnerships in the connectivity KTA after discussing the isomorphic tendency to contract partnerships. We propose looking at how this tendency is structured in the INC-NE mesoscopic structure as it is also the most represented one (Figure 61).

Figure 61. IR types for INC-NE mesoscopic structure for connectivity KTA, from 2013 to 2019

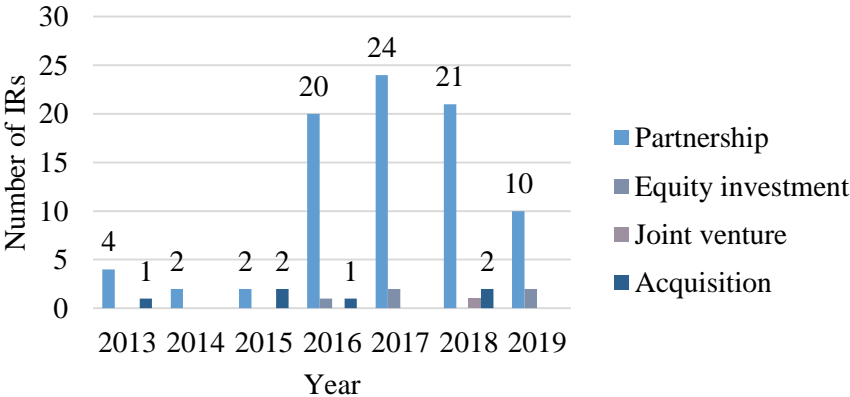

Figure 61 presents the yearly indexation of IRs by type. The main observation is the prevalence of partnerships, that we discuss first, followed by acquisitions.

1.2.2.a. Heterophile partnerships

Figure 61 presents the evolution of heterophile IRs by types over the years. The data retrieved showed that partnerships started in 2013 and evolved at a steady pace until 2015 (lethargic and transitional phases). In 2016, the industry saw the first cars that can speak via V2X communication systems back to the cloud and soon to each other, and those were planned to be commonplace by the mid-2020s⁴⁴.

⁴⁴ Retrieved from <https://www.usine-digitale.fr/article/le-vehicule-intelligent-os-car-rx5-d-alibaba-carbure-a-la-data.N402632>

The ‘Internet-car’ launched in 2016

In 2016 Alibaba, a telecom company and SAIC, a traditional auto manufacturer launched in collaboration the first connected car called ‘the Internet-car’. What we learn from that partnership and its outcome is the relatively uncommon nature of partners and the final products as well. Alibaba does not have anything to do with a actual car manufacturing, in fact SAIC planned and produced it. It is branded under the Roewe brand of SAIC and distributed through the established distributor network of Roewe. Yet, the operating system for the vehicle's infotainment system is provided by Alibaba. The name of the operating system is YunOS for Car. It is based on the operating system of the YunOS smartphone. To build their Internet of things network, Alibaba wants to use different new YunOS variants to power a wide range of devices.

Following the abrupt increase of partnership number until 2017, the following years witnessed a slight decline. However, the decline in the number of partnerships from 2018 to 2019 might suggest significant connectivity advances made the years prior. Besides, 2019 was the year for reality checks for automotive companies as congestion and public-transportation problems hit new heights for cities worldwide, deployment timelines for technologies such as AVs were deferred, and some new mobility business models struggled to win over investors. Economically, with many inflationary pressures, large automakers had a stricter period in 2018 and 2019 due to higher costs, compliance with tighter emission regulations, global trade tensions, and sluggish sales in key end segments, e.g., Dieselgate. As describing all the 86 partnerships will not be very beneficial in terms of results, we propose to look at a few of them to illustrate our findings and identify some critical organizations at the same time. We discuss one major player in the connectivity partnership category regarding the number of IR indexed in the database: Qualcomm⁴⁵.

⁴⁵ Retrieved from <https://www.qualcomm.com/news/onq/2019/02/25/how-our-2nd-generation-qualcomm-connected-car-reference-design-could-support>

Close-up on Qualcomm

Although the automotive industry was a well-established one, with entrenched industry players and supply chains, the introduction of connectivity in the product mix provided substantial opportunities to organizations like Qualcomm. But why? Qualcomm is a leading developer of Code Division Multiple Access (CDMA) and other advanced wireless technologies. The example of Qualcomm is particularly interesting because, for AVs, the demand goes beyond modem and electronic components, and place the incumbents at a position where they do not have the IP to be successful. Qualcomm turned that situation in its favor by leveraging its R&D and its pre-existing product portfolio. In terms of telematics, Qualcomm for instance, carried out cross-market utilization of its portfolio through the derivation of its 'Modern-RF' system for telematics offerings for AVs. The company also plans to retrieve \$4 Billion in revenue from the AV connectivity segment by 2022. Amongst Qualcomm's main incumbents partners, we have indexed several major ones :

- **Groupe PSA** and Qualcomm step up on communication between vehicles in 2018;
- Qualcomm and **TomTom** partner on crowdsourcing high-definition mapping data for autonomous driving in 2017;
- Qualcomm and **Geely** look to 5G-enabled C-V2X in 2019;
- Qualcomm partners with **Savari** to showcase interoperability of LTE-V2X direct communication in 2018.

Regarding other types of IRs, there is no significant pattern to underline except that in the lethargic and transitional phases (2011-2015), not many longer-term IRs such as equity investments and joint-ventures are observed. However, what seems more paradoxical is the occurrence of acquisitions, which seem to represent the second preferred IR between incumbents and new entrants.

1.2.2.b. Heterophile acquisitions

As illustrated in Figure 61, we observe six acquisitions. In the INC-NE setting, some of the busiest buyers have been big automotive players in the past years. Ford acquired two transportation technology startups, Autonomic for an undisclosed sum and TransLoc for \$60 million, through its Smart Mobility subsidiary, to expand its transportation and connected car services.

In 2013, Preh, a traditional automotive components manufacturer, acquired Innoventis to strengthen its automotive electronics competencies. The year after, Lifan, an OEM, acquired Woasis of Chongqing to strengthen its web-connected connectivity services. Qualcomm acquired the CSR Plc to widen its services in regards to Internet-of-Everything (IoE) in AVs. Three years after the acquisition of Innoventis, Preh bought Technisat Automotive in 2016 to follow its willingness to become a global player in AV infotainment and telematics.

Finally, yet notably, in 2018, NXP Semiconductors, a traditional automotive semiconductor provider, acquired OmniPhy, an Ethernet subsystem manufacturer, to deepen its knowledge regarding the rapid data transfer required by connectivity systems. In 2018, the French automotive supplier, Faurecia, acquired Clarion Electronics and Parrot Automotive and merged them with a previous acquisition at the beginning of 2019 to create a business unit that makes dashboard electronics low-speed adaptive driver assistance (ADAS) systems.

Parallel to the significant trend highlighting the role of heterophile IRs in the connectivity KTA, we have also observed many acquisitions in the NE-NE configuration (25% of total NE-NE IRs).

1.2.3. Homophile acquisitions

Another main collaborative pattern we have observed in the connectivity KTA is a notable amount of acquisitions made amongst new entrants, representing 25% of the total IRs. We propose to observe how these acquisitions structure over the years (Figure 62) and then identify the key acquiring companies.

Figure 62. Dynamic observation of NE-NE acquisitions

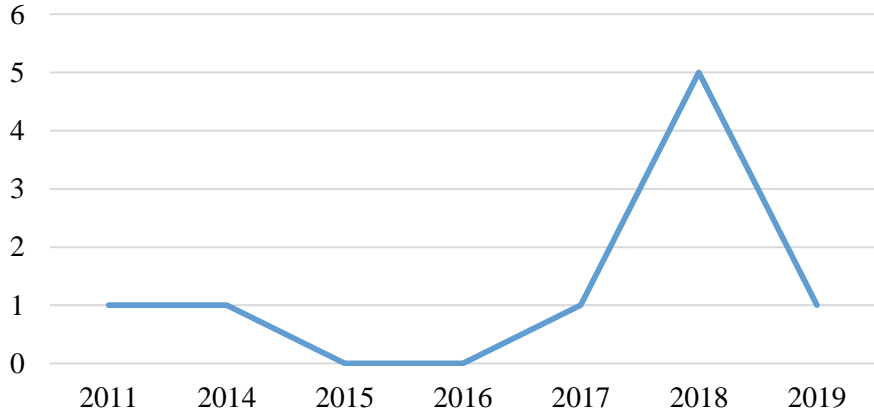

Figure 62 showcases the dynamic evolution of the number of acquisitions between new entrants. According to Figure 62, the first acquisition occurred in 2011 and followed a sporadically evolving pattern from 2011 to 2017 with either 1 or 0 acquisition indexed in the database. In 2018, there is a sharp increase, though with five acquisitions followed by the plunge in 2019.

In Figure 60, we have observed that this pattern is the same in the two other mesoscopic structures. In general, what we deduce in the limited amount of acquisitions in the first years of industry emergence, which tends to intensify, relatively, in later phases (phases 2 and 3). When looking closer to each acquisition in this period, we came across one significant acquisition in 2017: the acquisition of Mobileye by Intel⁴⁶.

⁴⁶ Retrieved from <https://intelandmobileye.transactionannouncement.com/>

Intel acquired Mobileye in \$15.3 billion deal

Mobileye is a new entrant company based in Jerusalem. The company has successfully developed a nerve center for AVs highly based on sensors and camera technologies. This begs the following question: What does this acquisition tell us about the Intel's role in connectivity and the impact on the global industry? The acquisition makes Intel a pioneer of driverless vehicle development that is forecasts to account for \$71billion by 2030. It shows that the most important acquisitions are made when two organizations come together to resolve an issue neither can solve on their own. Intel lacks the inherent expertise of software to deliver end-to-end connectivity solutions, and this acquisition propelled the company at the top ranks of an emerging yet growing AV industry. Moreover, the acquisition gave Intel access to the close relationships between Mobileye and traditional OEMs such as Audi and BMW.

In terms of what happened in 2018, the sharp increase in NE-NE IRs can be explained by contextual information. The Internet's growing role as a channel for automotive sales has translated into new strategies incorporating e-commerce and internet content as main technological drivers for connectivity. Amongst the notable NE-NE acquisitions in 2018, we indexed Motors.co.uk by the technology giant eBay in October 2019 for an undisclosed amount and Nexus's acquisition by Phoenix for \$186million on 31st July 2018, for instance. In conclusion, the emerging pattern seems to be the shorter-term IRs intended to attain a specific technological goal, which is to be considered before entering new strategic partnerships. Given the complexity of managing joint-ventures because of operation complexities and conflicting partner expectations, organizations are willing to limit risks that are already high due to varied technology content in the connectivity KTA.

Additionally, given the technological content, we observed that the connectivity KTA is a confluence between the technology, automobile, and telecom companies. We discuss this argument in the following paragraph.

1.3. The convergence of information technology, automobile, and telecom companies

When Forbes mentioned that “car companies must collaborate, or tech giants will take over”⁴⁷ in 2019, the tone was already set for future strategic moves. The close-up look at the industry of provenance of organizations involved in IRs within the connectivity KTA enabled to empirically corroborated the recent statement made by Forbes (Figure 63).

Figure 63. The industry of provenance of companies involved in IRs

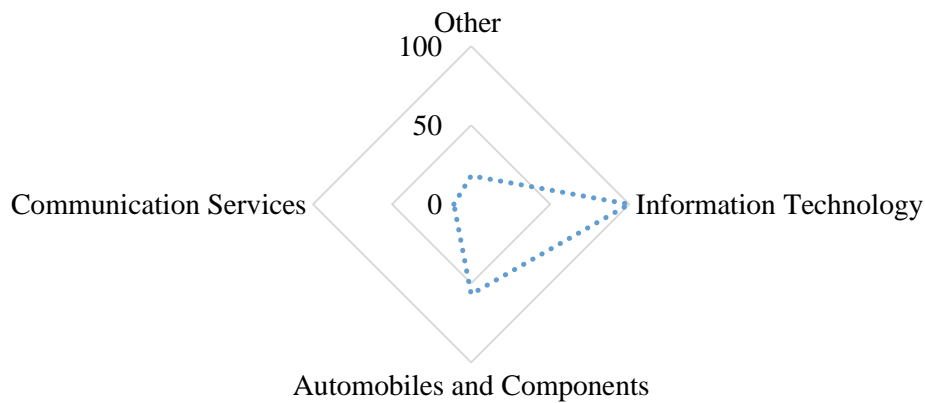

Amongst the 332 organizations (absolute number) involved in the 166 IRs in the connectivity KTA, the largest proportion of companies appeared to belong to three primary industries: Information technology (4510), Auto, and components (2510), and Telecommunication services (5010). We summarized the findings related to the number of organizations by industry. We refined the data according to each organization's type, i.e., incumbent vs. new entrant, to identify the main patterns of industry provenance for each organization and identify what kind of organization is the ‘best’ partner in the connectivity KTA (Table 33).

⁴⁷ Retrieved from <https://www.forbes.com/sites/katecooper/2019/08/04/car-companies-must-collaborate-or-tech-giants-will-take-over/>

Table 33. Organization number by industry by type in connectivity KTA

Industry groups	Industries	New Entrant	Incumbent	Total organization
Information technology (4510) 57%	Semiconductors & semiconductor equipment <i>% of the total organization</i>	44 63%	26 37%	70 21%
	Software <i>% of the total organization</i>	51 91%	5 9%	56 17%
	Communication equipment <i>% of the total organization</i>	12 52%	11 48%	23 7%
	Electronic equipment, instruments & components <i>% of the total organization</i>	7 50%	7 50%	14 4%
	IT services <i>% of the total organization</i>	11 85%	2 15%	13 4%
	Internet software & services <i>% of the total organization</i>	6 75%	2 25%	8 2%
	Technology hardware, storage & peripherals <i>% of the total organization</i>	4 100%	-	4 1%
	Auto and components (2510) 31%	Automobiles <i>% of the total organization</i>	2 4%	54 96%
Auto components <i>% of the total organization</i>		2 4%	44 96%	46 14%
Communication services (5010) 6%	Wireless telecommunication services <i>% of the total organization</i>	8 100%	-	8 2%
	Interactive media & services <i>% of total organization</i>	6 100%	-	6 2%
	Diversified telecommunication services <i>% of the total organization</i>	5 100%	-	5 2%
	Entertainment <i>% of total organization</i>	1 100%	-	1 0%
Others 6%	Electrical equipment	9	14	23
	Household durables			
	Health care equipment & supplies			
	Capital markets			
	Industrials conglomerates			
	Insurance			
	Professional services			
	Transportation infrastructure			
	Aerospace & Defense <i>% of the total organization</i>	39%	61%	7%
Total <i>% of the total organization</i>	167 50.3%	165 49.7%	332 100%	

The data shows a balance between the proportion of new entrants and incumbents within the connectivity KTA, respectively, 50.3% and 49.7%.

In terms of industry dominance, almost half of organizations involved in IRs in the connectivity KTA are from the IT industry, out of which 72% are new entrants against 28% incumbents. In total, 57% of organizations belong to the IT industry with a 37% Semiconductors & Semiconductor Equipment companies, 30% Software, and 13% of Communication Equipment companies; these three industries account for 80% of the IT industry group.

The dominance of new entrants in the IT industry group is almost verified in all IT industries, except for communication equipment with a balanced-like repartition (52% new entrant vs. 48% incumbents). The tendency is quite the opposite for the automobile industry, with 96% of incumbents OEMs and auto components suppliers.

For the communication services industry group, there are no incumbent companies indexed. Most companies are from the Wireless telecommunication services, Interactive Media & Services, and Diversified telecommunication. There is no significant tendency in other industries because the repartition is quite disparate given the several industries composing this category.

To conclude our analysis of the connectivity KTA, we summarize findings with the strategic box related to the technological content discussed in the first place.

Summary of findings regarding the connectivity KTA

In light of the preceding paragraphs, we propose summarizing our findings regarding the connectivity KTA in Table 34.

Table 34. Strategic box for connectivity KTA

	Typology 1	Typology 2	Typology 3
Who	Incumbent + New entrant	New entrant + New entrant	Incumbent + Incumbent
Industry	Auto and components organizations (INC) + IT Organization (NE) + Telecom Organizations (NE)		
Account for	57%	22%	21%
How (based on empirical observations)	1. Mostly partnerships (78%); 2. Acquisitions (12%); 3. Equity Investments (6%); 4. Joint Ventures (4%).		
Technological drivers	Electronics Infotainment V2X		

The analysis of the connectivity KTA enabled us to identify the strategic box in terms of who the prominent partnering organizations are, how they partner, and for which technological driver. For the connectivity KTA, we can conclude that the dynamic analysis of IR types over the studied period showed the continuous dominance of partnerships in all emergence phases. In parallel, we observed that heterophile partnerships also represent the most considerable portion of connectivity patterns. Heterophile partnerships are ranked as the first choice over the studied period, with a peak from 2016 to 2018. We also found that acquisitions are sporadically occurring in heterophile and NE-NE homophile IRs settings with a peak in 2018, while from 2013 to 2017, it remains sporadic.

Following our cross-network comparative analysis, we now propose to analyze the sensing KTA.

2. Sensing KTA

Sensing represents one of the most pivotal expertise required for AVs to be commercialized because it allows the vehicles to see. The technological complexity of sensing is hampered by existing knowledge of sensor technologies by automotive companies that may be familiar with such technologies to a limited extent. However, in this paragraph, we also discuss some new-to-incumbent technologies: LIDAR, Radars, and ADAS sensors, making the sensing KTA a combination of already known and very new technologies for incumbents. In line with the technological content, we discuss organizations' balanced tendency to contract partnerships with peers or different organizations (IT companies).

2.1. Technological content pushing towards IR formation

AVs follow the **sense-plan-act** paradigm of robotics. Naturally, to replicate human behavior on roads, AVs need to see better than humans, however, developing reliable and real-time vision systems has been a significant hurdle for organizations in the AV industry. Nevertheless, complexity is inherent to innovation, and organizations, by combining many sensors, have created a vision system for AVs that closely compete, if not surpass human sight. One thing is sure; it is all about sensors because AVs will be impossible without them.

What makes sensing a critical aspect of AVs is safety. To downplay safety issues, systems have been built upon various sensors and redundancy, i.e., the implementation of overlapping sensors that can double-check if what the vehicle perceives is real before undertaking any

mechanical action. The data collected by the multitude of sensors, cameras, and other sensing components are then stored and dispatched through sensor fusion platforms that distribute the data to relevant connectivity features. In Table 35, we have indexed IRs that occurred in the sensing KTA by sub-activities.

Table 35. Repartition of IRs in Sensing KTA *per* sub-activities

Sub-activities	Number of IRs
ADAS Sensors	75
Lidar	29
Cameras	16
Radar	7
Total IRs	127

Most apparent is the role of ADAS sensors, LIDAR, and cameras in giving AVs superhuman vision. The results highlight the predominance of **ADAS sensors**. Given the critical transfer of human responsibilities over to the ADAS, the higher the automation level, the more sensors are embedded in the vehicle to support the absence of human interaction in driving tasks. Consequently, sensor systems to support ADAS are becoming more and more ubiquitous in AVs and imply developing more advanced and sophisticated assistance systems (ADAS) with sensors, processors, and central sensor fusion units to interpret a large amount of sensor data.

LIDAR delivers the best of both worlds: it can collect with a superior resolution and efficient 3D map of the areas surrounding a vehicle. The resolution angle is 0.1° for a LIDAR system, and the accuracy of the range is higher than RADARs, around 5 cm or less. Solid-state LIDAR technology, flash LIDAR sensors, and pulse timed-flight LIDAR sensors using micro-electro-mechanical systems (MEMS) are two common concepts used in AVs.

The only sensors that really ‘see’ are **cameras** because they can identify the texture and inexpensively detect traffic signals. They enable the AV to continuously have a 360° view of its surroundings and are mostly equipped in the vehicle’s angle, front, or the rear. What makes RADAR useful for AVs is their robustness in any weather and light condition. Most of the time, they have an excellent range yet do not have angular and high resolution. We deduced that the sensing activity is enabled by four types of data collection sensors, which transmit the

collected data to sensor fusion systems (electronics) that use the data for various connectivity features (HD Maps, weather, V2X) (Figure 64).

Figure 64. Sensing as a critical pillar of autonomous driving

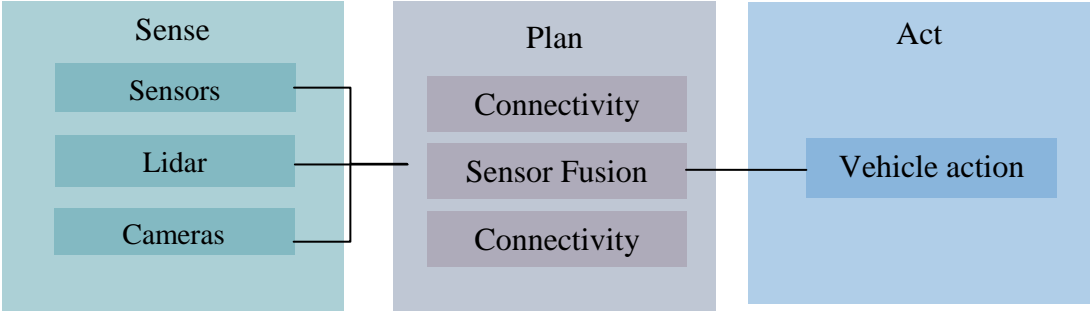

Given the plethora of sensors needed to support ADAS and the critical aspect of LIDAR for AVs to develop robust and safe computer vision systems, organizations involved in AV development have found it obvious to make joint efforts to build such complex and abundant systems.

2.2. Interorganizational relationships patterns in Sensing KTA

As the main IR pattern, we discuss the prevailing proportion of partnerships; and the equity between homophile and heterophile IRs.

2.2.1. Partnerships as the primary form of collaboration

To identify the main IR type contracted in the sensing KTA, we carried out a longitudinal statistical analysis of IR type reparation over the studied period (Table 36)

Table 36. Yearly repartition of IR types and evolution (Sensing)

	Phases								
	Lethargic and transitional				Progressive		Densifying		
	2011	2012	2013	2014	2015	2016	2017	2018	2019
Partnership		100%	83%	60%	63%	89%	90%	75%	88%
Equity investment						4%	5%	3%	
Joint venture							5%	5%	4%
Acquisition	100%		17%	40%	38%	7%		18%	8%

Table 36 shows the tendency to recourse to partnerships regardless of the mesoscopic structure from 2012 to 2019, with no occurrence in 2011. In total, partnerships account for 76% of total IR in sensing KTA. Although partnerships are preferred forms of IRs, we see the relatively important pattern for acquisitions from 2014 to 2019. The weak number of joint ventures and equity investments also concentrates on the progressive and densifying phases. To check if the tendency is replicated in each mesoscopic structure, we provide segmentation of IR types by mesoscopic structure (Figure 65).

Figure 65. Segmentation of IRs by mesoscopic structure for Sensing KTA

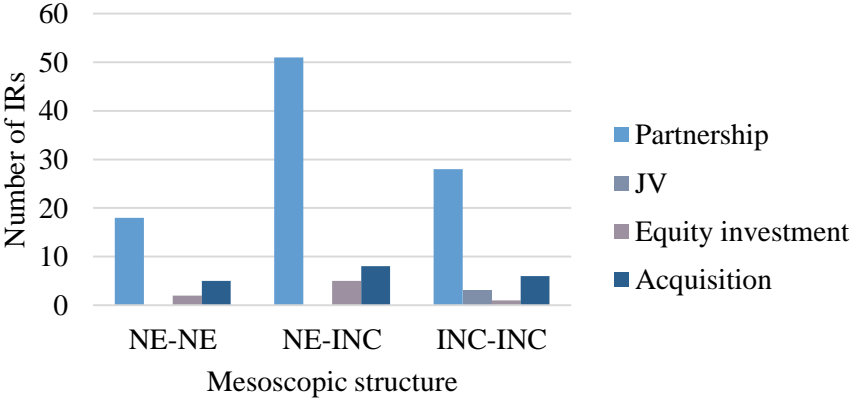

Our preliminary findings highlighted that partnerships are the most frequently contracted type of IR regardless of the mesoscopic structure. Figure 65 shows that these partnerships are mostly contracted between new entrants and incumbents as more than half of partnerships are heterophile (53%), followed by INC-INC partnerships (29%) and NE-NE partnerships (19%); it shows a close competition between heterophile and homophile IRs. The second most contracted IR form appears to be acquisitions (15%), out of which 42% are heterophile and 58% homophile. Joint ventures only occur between incumbents yet represent only 2% of total

IRs. Equity investments are indexed for each mesoscopic structure, yet they also represent a tiny portion of the total IR (6%).

We discuss the equity between heterophile and homophile IRs in the next paragraph.

2.2.2. Equity between heterophile and homophile IRs

The general observation brings light on the similar tendency to collaborate with a different company or choose similar companies as partners.

Figure 65 corroborates the potency of partnerships in all mesoscopic structures, followed by acquisitions, and the minor patterns observed for equity investments and joint ventures. However, in comparison to the connectivity KTA, in sensing, the mesoscopic structure patterns seem more balanced between heterophile (50.4%) and homophile (49.6%) IRs composed of 40% NE-NE IRs and 60% INC-INC IRs.

The global analysis of IR by organization types led to identifying an equal proportion of IRs between heterophile and homophile combinations. The dispatch of IR by mesoscopic structure highlighted that 63 IRs (49.6%) were contracted as part of the INC-INC and NE-NE categories against 64 IRs (50.3%) contracted between new entrants and incumbents.

It shows that many incumbents enter strategic IRs with a less critical pool of new entrants. The large presence of incumbents in the sensing KTA emphasizes that incumbents' reactions are crucial for technological advance. They do not perform defensive behaviors that would hamper the pace of industry emergence and extend the Schumpeterian endogenous growth model by providing ground for incumbents to carry out disruptive innovation. It proves that incumbents, in large resource gaps situations and turbulent environments, can adapt their business strategies and undertake innovation activities even if these activities are as far as sensors and cameras for automotive incumbents.

2.3. Convergence of automobile and information technology companies

Information regarding IRs in the sensing KTA revealed a high amount of partnerships regardless of the mesoscopic structure. When looking at the industry of provenance of the 254 organizations involved in IRs, we have identified that two industry groups were mostly

represented: the Auto & and components (46%) and Information technology (44%) companies (Figure 66).

Figure 66. The industry of provenance of companies involved in IRs

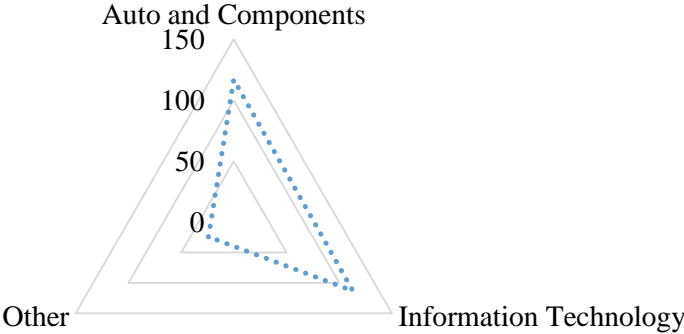

However, what differs between the sensing KTA and the connectivity KTA is the proportion of new entrants and incumbents in the total IRs. Whist almost a perfect balance is reached in the connectivity KTA. The sensing KTA incumbent represents a relatively more critical proportion (55% vs. 45% new entrants) that are more or less present in each industry.

The remarkable pattern in the sensing KTA is the relatively high proportion of incumbent automotive component suppliers, which represent 53% of total incumbents companies in the sensing KTA, followed by incumbents OEMs (16%). New entrant auto component suppliers represent only 4% of total new entrants, while new entrant OEMs are quite predominant (15%).

In terms of new entrants, the most represented industries are Software (22%), Electronic equipment (16%), and Semiconductors and semiconductor equipment (6%), yet incumbent semiconductor organizations are more represented within the total of organizations (9%).

In the sensing KTA, Telecommunication companies' dominance is not registered and enters the 'Others' category, given the low entry-level compared to connectivity.

In the new entrant suppliers category, we identified the dynamism of several key LIDAR suppliers such as tuSimple, AEye, Velodyne, Netradyne, Luminar, Blickfeld, Aptiv, Innoviz, Cepton Technologies, Vaya Vision, LeddarTech, Ouster, and Baraja. In that sense, General Motors, Ford, and BMW have invested in Velodyne and Innoviz. Information reported on incumbent vs. new entrant IRs highlighted a few organizations' dominance and highlighted

their new entrant status. Technological enlightenment allows the understanding of why such uncommon new entrants have invaded the traditional automotive industry. The meticulous analysis of sub-activities underlined the supremacy of cameras, LIDARs, and sensors.

Also, announcements made by organizations' officers showed the critical importance of IR to acquire resources rapidly and make rapid advances in the technology to enable innovation. In that sense, in 2014, when IBM and Bosch announced their collaboration on the development of a platform for safer automotive components, Dirk Hoheisel, Board Member at Robert Bosch GmbH, stated: "our [IBM and Bosch] aim is greater agility, accelerating product innovation and delivery."⁴⁸ Somewhat surprising, the partnership between the IT giant and the leading automotive part manufacturer Bosch incrementally became the model for other industry players during the following years.

The analysis of partnerships data between incumbents and new entrants led to several conclusions. We thus mapped the partnership network between incumbents and new entrants in Figure 67. A square symbolizes incumbents, and circles represent new entrants. The color legend bar explains the color scheme used for each node's industry group.

⁴⁸ Retrieved from <https://newsroom.ibm.com/2020-05-05-IBM-Evolves-PartnerWorld-to-Enable-Greater-Agility-and-Innovation-with-IBM-Cloud>

Figure 67. IRs between incumbents and new entrants for Sensing KTA

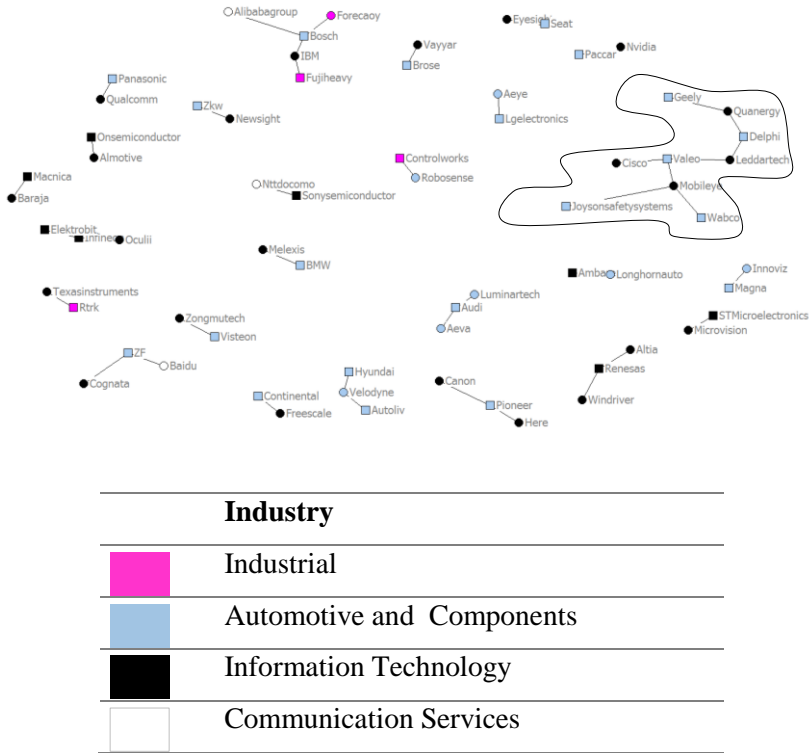

The first result highlights the dominance of two sectors: Automotive (25) and Information technology (45), representing 90% of the organizations involved in 68 partnerships for Sensing KTA. We identified that at least one of the collaborating organizations belong to one of these two sectors. The network graph illustrates the network around Bosch and Mobileye, which seem to have collaborated exclusively with new entrants.

As for connectivity KTA, we conclude with a synthesis of main findings for the sensing KTA.

Summary of findings regarding the Sensing KTA

The detailed analysis of sensing partnerships enabled us to identify significant capabilities necessary for AV sensing. Over the years, partnerships for sensing technologies have increased, and the sub-activities enabled us to depict significant capabilities critical for AVs to become computers on the road. Organizational attributes analysis sheds light on several strategic boxes and partner types to consider for Sensing (Table 37).

Table 37. Strategic box for sensing KTA

	Typology 1	Typology 2	Typology 3
Who	Incumbent + New entrant	New entrant + New entrant	Incumbent + Incumbent
Industry	Auto and components organizations (INC) + IT Organization (NE)		
Account for	50%	20%	30%
Organizational attributes	Mostly incumbent auto and auto part manufacturers	New entrant electronic and software developers	Mostly auto OEMs and suppliers
How	1. Mostly partnerships (76%); 2. Acquisitions (15%); 3. Equity Investments (6%); 4. Joint-ventures (3%).		
Technological drivers	Lidar Cameras Sensors		

In conclusion, Table 37 regroups all the observations made for the sensing KTA, which seems to offer relatively less pattern observation content. We argue that the straightforward observations making the sensing KTA is 1) the already existing auto incumbents providing sensors and cameras for the traditional auto industry corroborated by a large number of auto companies, 2) the high specificity of LIDARs making less room for a multitude of possible partners reduced to IT companies, and 3) the relatively explicit innovation content regarding the critical role of a few products: LIDAR, cameras, and sensors.

As the technological goal seems more straightforward with harsh repartition of IRs among subactivities, the pattern of collaboration is constrained mostly to heterophile IRs between auto incumbents and IT new entrants, followed either by INC-INC IRs (30%) or NE-NE IRs (20%), which mostly take the form of partnerships (76%) and acquisitions (15%).

Since the analysis of organizational attributes within connectivity and sensing KTAs revealed significant similarities and enabled us to retrieve irregular patterns inherent to each KTA, we continue analyzing the third KTA: artificial intelligence.

3. Artificial Intelligence KTA

Artificial Intelligence (AI) is undoubtedly one of the most groundbreaking innovations incorporated into vehicles. This section discusses IR patterns for such complex innovation contents and shows the impact on IR choices and partnerships. From what we deduced, the more complex the innovation content, the higher long-term the IRs.

3.1. Technological content pushing towards IR formation

Artificial intelligence (AI) is a wide-ranging branch of computer science concerned with building smart machines capable of performing tasks that typically require human intelligence. AI is an interdisciplinary science with multiple approaches. Still, advancements in machine learning and deep learning create a paradigm shift in virtually every tech industry sector, and the AV industry is becoming one of them. What makes AI valuable in AVs is that it is continually learning and changing the rules used to navigate the roads. Each AV makes the information it learns available to other AVs, making smooth communication possible amongst cars. AVs lean against neural networks that enable them to learn as they go. The repetitive loop, called the Perception-Action Cycle, is generated when AVs produce information from its internal and external environments and feed it to an intelligent agent that decides that the AV can perform a mechanical action in a given environment. According to Dr. Pink, senior expert for vehicle architecture automated driving at Bosch GmbH, “artificial intelligence is the key to automated driving. Equipping cars with it is a bit like teaching students.”⁴⁹

In the present paragraph, we scrutinized the IRs and attribute data to depict major attribute patterns and the related IR choices. We started by discussing the sub-activities for which the 116 IRs in AI KTA have been contracted (Table 38).

Table 38. Repartition of IRs in AI KTA *per* sub-activities

Sub-activities	Number of IRs
AI software	76
Machine learning	30
Soft computing	6
Quantum computing	2
AI-based platform	2
Total IRs	116

The static analysis of sub-activities shows that mainly, IRs in the AI KTA has been contracted to develop AI algorithm software, such as environment recognition based on camera image

⁴⁹ Retrieved from <https://www.bosch.com/stories/artificial-intelligence-in-cars/>

(traffic lane recognition, semantic image segmentation, environmental mapping), environment recognition based on sensors (sensor data based on environment mapping (SLAM)), moving object recognition, and decision-making algorithms (route planning, vehicle control, decision-making mechanisms).

There is also a rise in machine learning in image analysis and vehicle control, which opened new opportunities in building AV systems. Significant organizations have started developing their AV systems such as Google in 2009 with the Waymo Project (composed of the Stanley team who won the DARPA Challenge in 2005). Machine learning is the future of AVs, and it is based on the semantic segmentation of images to obtain a detailed representation of the given image.

However, the enormous computational costs that machine learning requires, combined with the numerous artifacts developed over the years, made machine learning technologies not utterly flawless in practice. The increasing efforts in algorithm software may push dedicated systems to sustain a faster method for semantic segmentation. Machine learning is driven by three main categories: general algorithms, artificial neural networks, and deep machine learning.

With the assistance of classical computing, AI software and Machine learning have reached respectable heights, but they will do much more with quantum computing. Quantum computing has a higher processing rate, i.e., these machines will operate across large data sets, which would take classical computers to process for a much longer time. When quantum computing is applied to it, AI-based complex decisions may be much more finely tuned.

The vehicle thinks with the AI-based systems, which learn from past experiences to store information in databases for future cases. However, AI has taken over the AV industry by storm to enable the development of L4 and L5 AVs, and industry players have yet come to terms that AI has become popular now than ever because of the immense amount of data available and required for AVs. The collection of vast amounts of data discussed in the sensing KTA is a fueling element of the AI revolution.

Very differently from the connectivity and sensing KTAs, incumbents' role is limited in the AI KTA. In total, incumbents organizations account for 29% of IRs against 71% for new entrants.

3.2. Interorganizational relationships patterns in AI KTA

As main IR patterns, we discuss first the role of partnerships, acquisitions, and equity investments in a concentrated time (2016-2019); and then continue with the pattern inherent to heterophile in AI IRs.

3.2.1. Partnerships, acquisitions, and equity investments as the primary form of collaboration

Overall in AI KTA, partnerships represent 61% of total IRs, acquisitions account for 27%, equity investments for 11%, and joint ventures only 1% (Table 39).

Table 39. Yearly repartition of IR types and evolution (AI)

	Phases				
	Lethargic and Transitional	Progressive		Densifying	
	2015	2016	2017	2018	2019
Partnership		50%	61%	74%	58%
Acquisition	100%	39%	21%	16%	32%
Equity Investment		6%	18%	11%	11%
Joint venture		6%			

Table 39 summarizes the tendency to recourse to partnerships regardless of the mesoscopic structure from 2015 to 2019, with no occurrence from 2011 to 2014. Even though partnerships are preferred forms of IRs, we see the relatively important pattern for acquisitions from 2015 to 2017, a slight decrease in 2017 to represent one-third of IRs in 2019.

Thirdly, equity investments are relatively significant in the AI KTA compared to other KTAs due to the fact of a submerged AV industry by AI startups such as Argo AI, Cruise Automotive (acquired by General Motors in 2015), Waymo, TuSimple, and Pony.ai. In the AI KTA, the number of equity investments also represents a growing proportion from 2016 to 2019, which seems to find explanations in the presence of many AI startups that challenge

auto companies. We can also conclude from that preliminary result that the innovation content seems very complicated and far from traditional auto technologies as opposed to connectivity and sensing to a lesser extent. The very sophisticated innovation content and the growth promises seem to push organizations to adopt higher-term IRs. Now, we propose looking at which companies tend to contract most of these types of IRs.

3.2.2. Heterophile collaboration as a leading strategic path

This paragraph discusses the patterns of collaboration amongst organizations according to their types and IR choices in the AI KTA (Figure 68).

Figure 68. Segmentation of IRs by mesoscopic structure for AI KTA

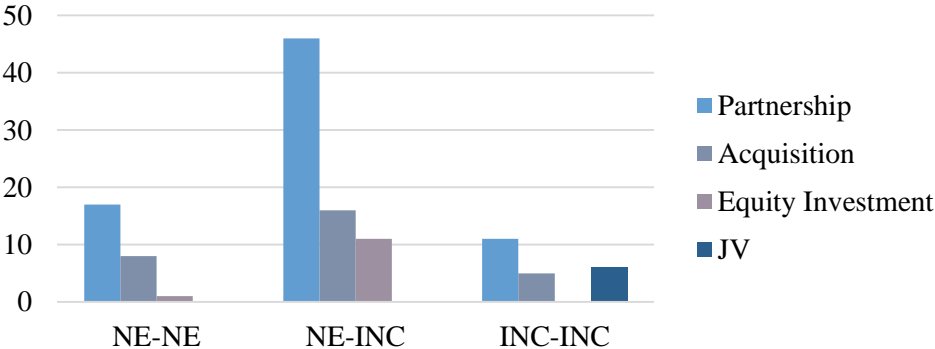

Amongst 116 IRs contracted in the AI KTA, most of them are contracted by the INC-NE structure (62%), then amongst new entrants (23%), and finally between incumbents (15%).

Figure 68 reveals that in the AI KTA, preferred IR types are partnerships and acquisitions. In terms of NE-NE IRs (26), the graph shows that partnerships and acquisitions represent 96% of total IRs, and are registered from 2016 to 2019. For the NE-INC IRs (74), partnerships and acquisitions accounted for 85% of total IRs and occurred between 2015 and 2019. The INC-INC IRs (12) partnerships are preferred IR types with 11 IRs recorded on the total period. There is an atypical point registered in terms of joint ventures.

In conclusion, in the IR network around the AI KTA, the tendency to call upon partnerships seems very similar regardless of the mesoscopic structure, with approximately 65% of partnerships contracted. Then, acquisitions seem to be more preferred in the AI network than in connectivity, with a proportion ranging from 22 to 31% depending on the mesoscopic

structure. Finally, equity investments are the third type of IR indexed in that network, yet when they seem to be a viable option for heterophile IRs, they seem not to suit homophile partners' needs. Only one joint-venture was registered in the AI KTA from 2011 to 2019 between two large-sized incumbents. The final agreement to set up a new joint venture called Zenuity to build applications for autonomous driving and driver assistance systems was signed by Volvo Cars, the luxury car OEMs, and Autoliv, the global automotive supplier safety (6%).

The evolution patterns show that the first partnerships occurred in 2016 and followed an up-going trend to peak at 19 in 2018 and slightly decrease in 2019 to remain at 10.

In 2016, PSA, a French OEM, collaborates with Safran Identity and Security to work on electronic signature platforms to warrant the authenticity and integrity of AV software. A few months later, Renault and Prophasee (formerly Chronocam) announced their strategic partnership to develop AV computer vision solutions. At the same time, Tesla and Mando teamed up to work on autonomous driving systems for future Tesla models.

During the following year, we have registered 12 partnerships. For instance, Bosch and Nvidia have joined their forces to work on self-driving car computers enabled through machine learning. Similarly, Volkswagen collaborated with Nvidia to develop system software for AVs and Kuka for robotics advancements.

Continuing with traditional auto players, Honda joined SenseTime to work on deep learning. At the same time, Renesas and Codeplay collaborated for machine learning as well, PSA and Almotive, to develop and test computer hardware and autonomous software installed on Citroen C4 Picasso concept car. Among the registered partnerships, there is a tendency to work on machine learning and computer vision applications.

As mentioned in 2018, we observed a peak in terms of partnerships with 19. Some major incumbents have collaborated with new entrants during 2018. Indeed, Hyundai Mobis chose Tata Elxsi for the development of Synthetic Scene Generator. Hyundai Autron signed a collaboration with Wind River to develop a next-generation autonomous driving software platform. Finally, Aisin Seiki joined Idein to work on machine learning, deep learning, while Daimler and Google joined hands to work on quantum computing.

Finally, in 2019, although to a lesser extent, significant incumbents and new entrants contracted some meaningful partnerships. For instance, Renesas teamed up with StradVision to work on machine learning and dive deeper into deep understanding; LG Electronics and Unity Tech joined forces to develop simulation software. At the same time, Ambarella and NXP Semiconductors co-developed deep learning algorithms for autonomous driving.

3.3. Convergence of automotive and software industries

The analysis of partnerships between incumbents and new entrants showed a verified tendency of partnerships between influential organizations, whether incumbents or new entrants. Technology giants and automotive incumbents seem to team up to make automotive AI a real solution and accelerate AV development (Figure 69).

Figure 69. The industry of provenance of companies involved in IRs

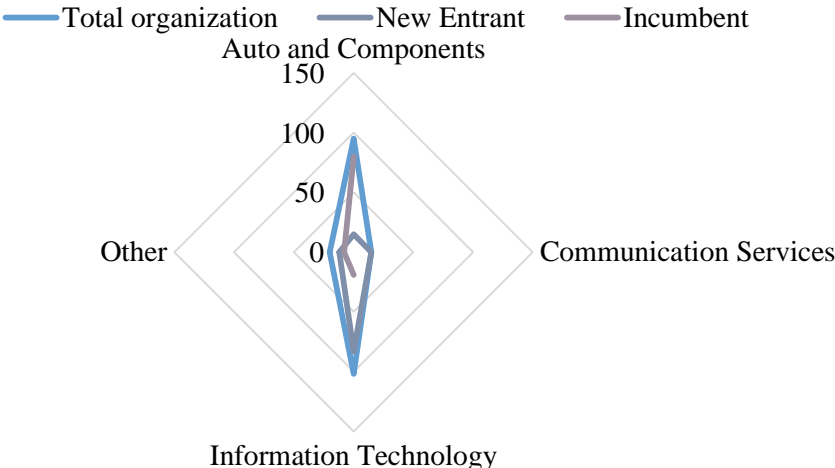

The analysis of industry provenance of organizations involved in IRs in the AI KTA showed that parallel to the first finding on the prominent role of new entrant and incumbents in IRs, in Figure 69, we see the direct affiliation of incumbents companies in the automotive and components industry. Most of the new entrants are from the IT industry. If we look even closer to the industry, we can identify that 75% of incumbent organizations are from the auto industry. New entrant companies are composed of 67% of IT companies: these two main poles are highlighted in Figure 70.

Figure 70. The industry of provenance of incumbents and new entrants in AI KTA

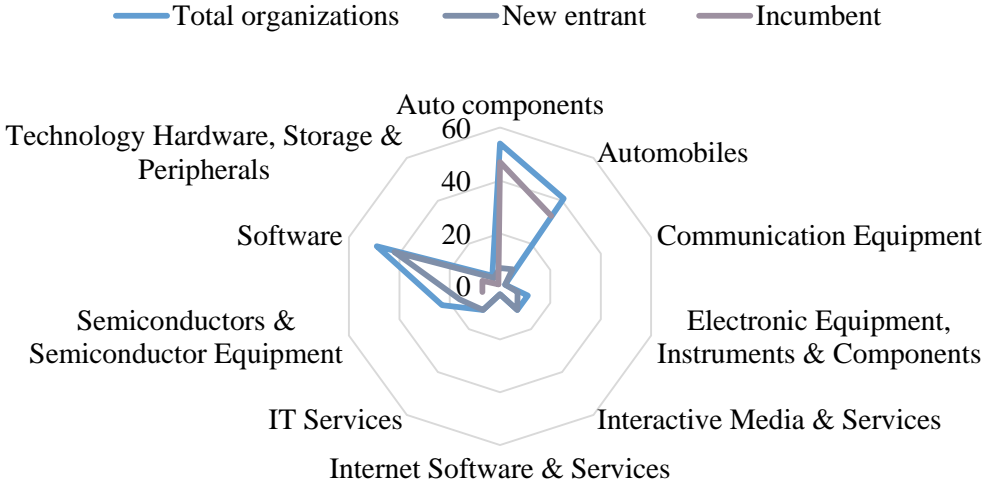

The significant trends show the dominance of incumbents auto and new entrant software suppliers. The graph presents that new entrants mostly represent all other industries because incumbents are from the auto and components industry and limited extend software representing only 7% of total incumbents. What is interesting here is identifying which kind of industries are essential for AI and towards which type of organizations should an organization rotate to acquire the right resource and capabilities for AI.

To illustrate the tendency of incumbent OEMs or auto part manufacturers with new entrant software organizations, we have looked in the database to identify these NE-INC IRs. What emerged was the general observation arguing that most incumbent auto OEMs and suppliers tend to collaborate with high-technology giants (Figure 71).

Figure 71. IRs for AI between large OEMs and Software companies (2017-2019)

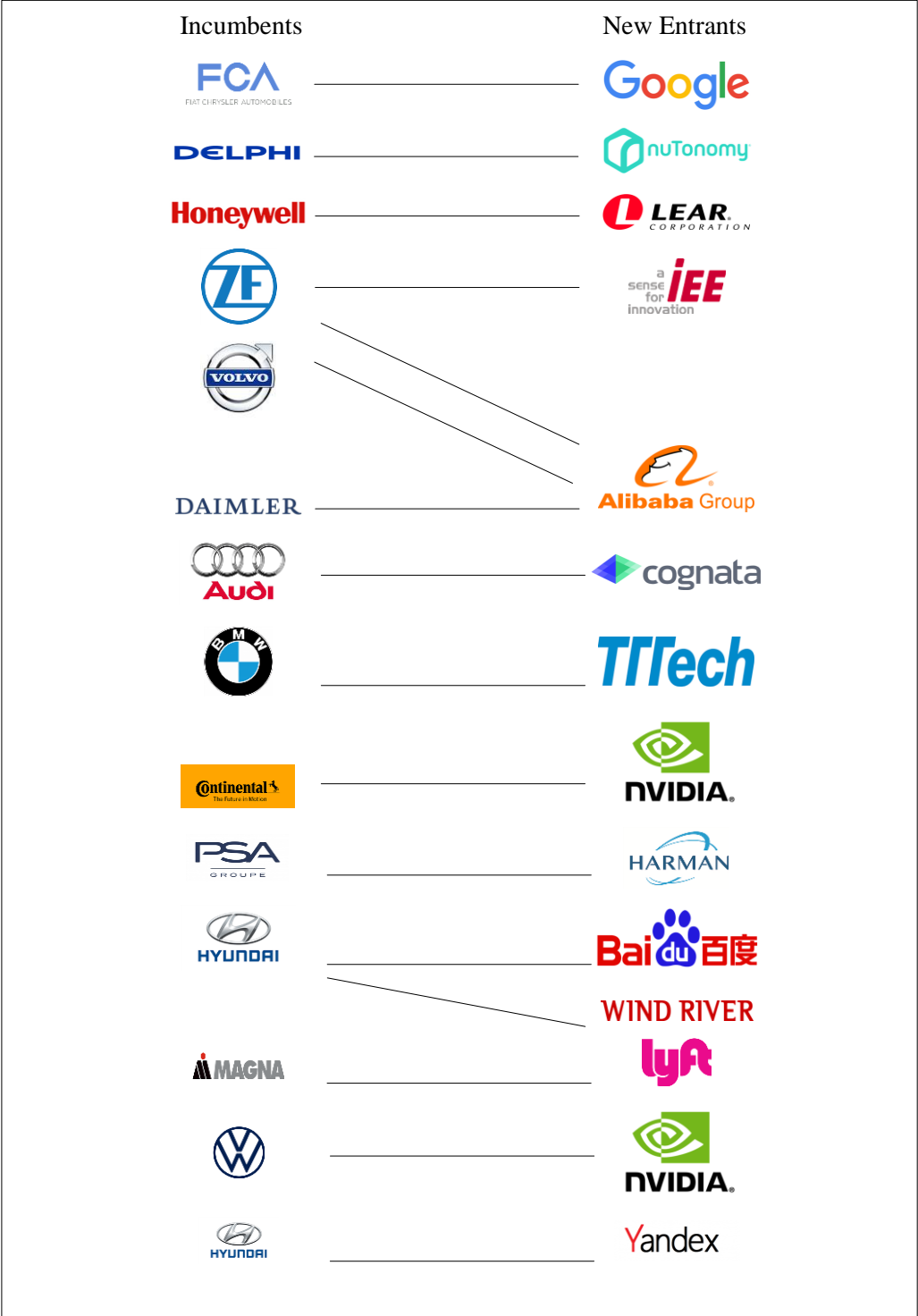

Summary of findings regarding the AI KTA

To conclude this paragraph, we build the strategic box regarding the AI KTA with the leading organization attributes and IR choices and rationale derived from the data (Table 40).

Table 40. Strategic box for AI KTA

	Typology 1	Typology 2	Typology 3
Who	Incumbent + New entrant	New entrant + New entrant	Incumbent + Incumbent
Industry	Auto incumbents + software new entrants		
Account for	63%	22%	15%
How	1. Mostly partnerships (64%); 2. Acquisitions (25%); 3. Equity Investments (10%); 4. Joint-Ventures (1%).		
Technological drivers	Algorithm software Machine learning		

Artificial Intelligence plays a crucial role in a new future of mobility. Complementary to connectivity and sensing, AI, though, seems to provide the largest gap in terms of existing and required resources due to a very sophisticated technological content, which seems to be very far from incumbents’ expertise, i.e., algorithm software and machine learning. We can assume that the number of automotive companies knowing how to deploy AI at scale represents a marginal proportion of the traditional auto industry, simply because it was not necessary until now.

To downplay such complexity and a higher level of disruptiveness, organizations showed the tendency to contract shorter-term IRs (partnerships, 64%). Long-term IRs demanding more commitment amongst organizations also seem to prevail here (acquisition, 25%, and equity investment, 10%). It is also perceived as a reduced yet more concentrated collaboration period in the AI KTA concentrated in the progressive and densifying phases of emergence, with less sporadic observations than other KTAs.

The analysis of connectivity, sensing, and AI KTAs enabled us to draw a relatively complete technological content landscape and draw attention to each innovation content's complexity. However, the discussed technologies need to be tested to be approved, legitimating the test and commercialization KTA.

4. Test and Commercialization KTA

In this paragraph, we firstly describe the contextual data explaining the slow evolution of test and commercialization KTA until 2017, together with the technological rationale behind IRs. We present our results regarding the dynamic development of T&C KTA in recent years and

the related organizational attributes linked to our conclusions. Finally, we present a major organizational consortium identified through the SNA and visualization of the T&C IR dynamics: the Apollo platform.

4.1. Technological content pushing towards IR formation

We identified that T&C KTA is driven by two primary technological rationales; safety and increasing data to manage.

4.1.1. Safety by verification and validation

Discussed mainly in the present thesis, the technological breakthrough and the positive perspectives for the future make autonomous vehicles a subject matter for automotive stakeholders. However, the advances in the new technology and the next generation automobiles need to prove their relevancy and trustfulness in public. Until consumers can trust the vehicles' automated chauffeur, e.g., all the technologies embedded in the autonomous cars, these next-generation computer-on roads need to be tested to show that they are ready to drive roads and keep the people inside and outside the vehicle safe.

As we can envision, replacing the human driver with a computer embedded with ADAS and many sensors governed by AI software requires high-level safety and security at the technological level. The three prior KTAs serve as proof of the technical complexity and gave an overview of what technologies need to be tested

Although advocates of AVs argue that replacing humans over to AI governed systems could prevent the horrific toll of 1.3 million people killed in road injuries, AVs can also cause people's death. For instance, in March 2018, the news reported the death of a pedestrian struck by an Uber self-driving car caused by a failure in the car's safety driver. Many other examples can be quoted, which will render autonomous vehicles dangerous technologies to drive on roads.

However, parallel to simulation software to simulate real-life situations in endless testing loops, companies test their technologies in real-life conditions, on roads with governmental authorizations (Figure 72) to collect real-life information and test the reaction to the current state of the technology.

Figure 72. Software simulated testing⁵⁰



The necessity of testing AVs implements technology and safety standards critical for the development of such vehicles. Organizations involved in AVs development have realized that no one can ensure that AVs are safe without validation and verification and have worked in that sense. In 2019, representative of 11 organizations, including Aptiv, Audi, Baidu, BMW, Continental, Daimler, FCA, Here, Infineon, Intel, and Volkswagen, had worked on AV safety standards and released the *Safety First for Automated Driving* report (2019)⁵¹. The report is based on several road vehicle standards, such as the road vehicles – cybersecurity engineering (ISO/SAE CD 21434), the road vehicles – functional safety (ISO 26262: 2018), and the road vehicles – the safety of the intended functionality (ISO/PAS 21448:2019). Alongside vehicle standards, norms on geographic information such as the data quality (ICO 19151: 2013) and the quality assurance of data supply (ISO/TS 19158: 2012) are included.

Finally, yet importantly, ISO/IEC 2382-1/2009 enables the understanding of absolute terms of IT vocabulary while systems and software norms provide solid ground regarding system life cycle processes. According to the report, there are twelve critical principles of autonomous driving. The report provides a necessary allocation of capabilities to these functions to enable safety-critical testing (Figure 73).

⁵⁰ Retrieved from <https://www.forbes.com/sites/davidsilver/2018/11/01/simulation-becomes-increasingly-important-for-self-driving-cars/#1357bb7a5583>

⁵¹ Retrieved from <https://newsroom.intel.com/wp-content/uploads/sites/11/2019/07/Intel-Safety-First-for-Automated-Driving.pdf>

Figure 73. Nominal and degraded capabilities⁵²

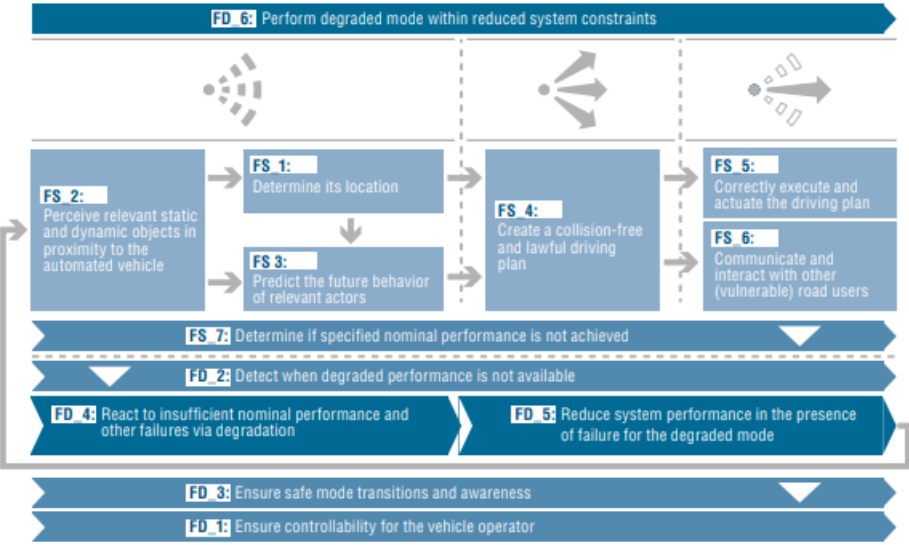

Nominal functions are the ones the system needs to perform in ‘normal situations.’ Suppose the vehicle is confronted with an unwanted factor, a deviation of required functionality, and non-responses of the technology. In that case, the system may operate in a degraded mode where it continues to run despite all underlying elements’ unavailability in a limited yet safe way.

As a result, AVs need to determine their location and identify necessary information, such as outside or inside. The system must distinguish static objects from the dynamic ones. Dynamic objects are positively associated with collision risks; thus, vulnerability, as they might have unpredictable behaviors. Dynamics objects can be pedestrians, other vehicles, and bicycles. On the other hand, static objects are more easily recognizable by ADAS, such as road boundaries, traffic signs, and other traffic obstacles that may exist.

The data collected on the static and dynamic objects should be material for future behavior prediction and fuel machine learning processes at the same time. When low risk is associated with fixed objects, dynamic objects impose an environment model that will predict future situations. The prediction should facilitate future driving motions. Moving to the acting

⁵² Ibid

process, the vehicle must act relative to the driving plan and communicate with other road users with active driving and safety features.

In some cases, the nominal performance of ADS can be disturbed by unwanted aspects such as a misplaced manipulation of the user's driving tasks or systematic failure modes. In these cases, where the nominal performance of the ADAS fails, it first requires the ADAS to recognize the non-achievement of its nominal performance and secondly to relate to FD4 and FD5.

The need to foresee, plan, act, and correct when necessary are inherent complexities of AVs. Alongside the technological excitement that AVs procure to organizations and customers, they also present critical safety and security concerns. Many ways are opted for to validate and verify the technology before its commercialization. In our database, we have indexed IR related to the testing and final commercialization of AVs; amongst testing activities, we identified real-life condition tests and simulated tests. Organizations also test embarked systems, components, and new materials.

4.1.2. Data-driven development

The new mobility era imposed mobility operators to tackle many challenges starting with the standardization and generalization of interoperability and data exchange. For years, personal data exchange has been considered s a danger to the liberty of human rights.

In those terms, regulators have made efforts to protect data the primary concerns; because users want to maintain greater control over their personal information. For instance, in Europe, the General Data Protection Regulation (GDPR) intends to provide European citizens the possibility to choose what data can be shared, in contrast to those that need to stay private. These data protection rules can have detrimental effects on organizations, which business is based on personal customer information, for instance. Although an E.U. regulation, the GDPR also impacts organizations that interfere with the union forcing them to maintain compliance with data regulation.

Data management and protection naturally occur in the mobility network, where vehicles are computers running on live data collection and analysis systems. The risks, like any computer, is that the system could be hacked.

Over the years, ride-hailing companies such as Uber, Lyft, and 2Getthere have revolutionized the way people are transported. However, ride-hailing companies are often associated with invasion of privacy at several levels. Uber first launched its black car-hailing in San Francisco; after some time, the ride-hailing service widespread and opened a robust competition based on costs to traditional drivers. To provide customers with the ride-hailing service they need, mobility providers have to adopt non-orthodox practices against data privacy principles. For instance, the drivers would be tracked down to understand each trip's patterns to improve the services. Although the collected data is anonymized, it is accepted to shadow customers' natural course of choice-making process.

Collecting the data, storing the data, protecting it, incorporating it into AI software, basing assumptions on data, planning vehicle control through data are so many reasons that make the reliability of related technology a significant factor of success for AV implementation. Despite technological complexity, organizations also need to overcome the perplexity of final users through learning by doing processes: they test the technology to prove its efficiency and readiness. We argued that if it is such as KTA, we assumed that sub-activities related to it should show what critical activities are performed and are the rationale of IRs in the T&C KTA.

In terms of what we have discussed in previous paragraphs, we now intend to verify if the technological rationale is corroborated amongst IRs of the database (Table 41).

Table 41. Repartition of IRs in Sensing KTA per sub-activities

Sub-activities	Number of IRs
Testing	38
Commercialization	36
New material	10
Infrastructure	3
Regulation, standards	1
Total IRs	88

Table 41 shows that out of 88 T&C IRs, most of them are related to the commercialization of the final technology (41%) and the testing of the final products (43%). The development of new materials such as seating and AV-specific coatings, for instance, represents a relatively

important rationale for T&C IRs compared to other subactivities such as infrastructure development and regulation and standards that are more dependent on governments and other higher institutions. Despite the limited growth of this subactivity, it lets appear that organizations are aware that AVs, despite being substantial technological innovations, require the back-up of politics and economics to prepare the ground for when technological readiness will be set.

4.2. Dynamic evolution of IRs

The dynamic analysis carried out on T&C IRs retrieved information regarding a concentrated evolution pattern around two particular years: 2017 and 2018. The dominant role of heterophilic partnerships contracted to test and commercialize AVs and AV related technologies.

4.2.1. Concentration of IRs in 2017 and 2018

If we look at IRs for testing and commercialization of AV and AV related technologies, the dataset show an impressive constellation of organizations in the T&C KTA from 2014 to 2017 regardless of the combination of organization type (Figure 74).

Figure 74. Evolution of IR for testing and commercialization of KTA

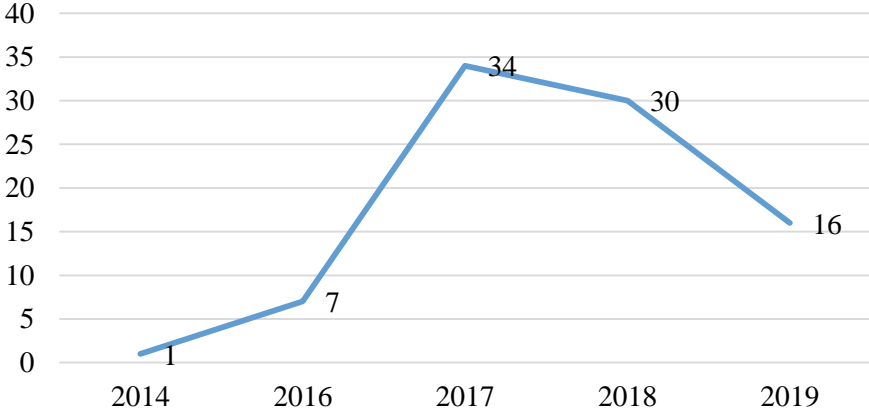

The data reveals that unlike connectivity, AI, and sensing, IRs did not occur sooner than 2014, which we have considered as an atypical starting point as only one IR was contracted that year. It is not surprising that there is an increasing number of IR for T&C because, in June 2019, the US DoT Secretary Elaine Chap announced that 1,400 AVs were under testing in the US by more than 80 organizations. If one believes industry experts, full-scale AV fleets

are just around the corner. As well understood by auto companies; however, there is a difference between building vehicles embedded with safety features destined to operate in benign conditions and to develop fleets of millions of AVs operating in uncertain environments. This assumption is quite valid if we consider the number of IRs for T&C in the early phases of emergence.

As discussed in previous KTA discussions, IRs for connectivity, sensing, and AI concretely happened in late 2016 until 2019, which induce a non-readiness of the technologies to be tested.

Eventually, the number of IRs started to show relatively significant results from 2016, and more prevalently in 2017 with 34 IRs.

In 2016, the number of IRs reached seven by representing 8% of the total IRs contracted in the T&C KTA. The following year, the number of IRs was multiplied approximately fivefold with 34, which slightly decreased in 2018 to attain 30 IRs. In 2019, the number of IRs registered a sharp decrease since the number IRs slashed by half. This preliminary result highlights organizations’ readiness to test technologies in 2017 and 2018: we propose to look closer at this observation.

We have focused on the analysis of organizational attributes for the IRs contracted in 2017 and 2018. We started to analyze the mesoscopic structure of IRs contracted in 2017 and 2018 (Figure 75), which accounted for 39% of total IRs contracted for testing and commercialization KTA.

Figure 75. Repartition of IRs in testing and commercialization KTA (2014-2019)

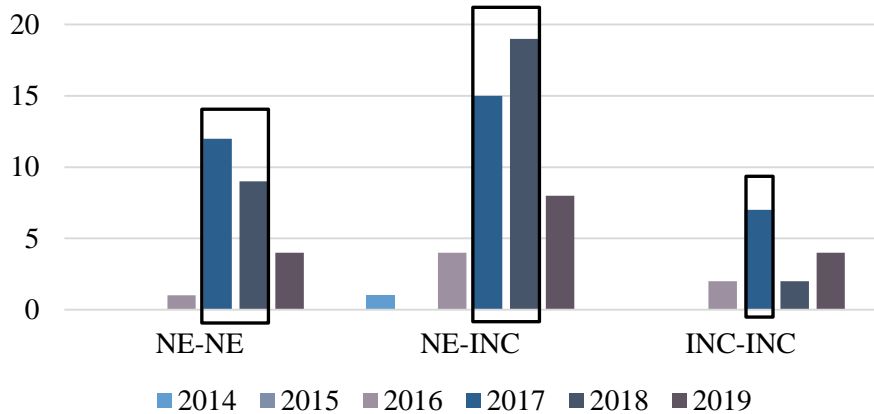

Figure 75 illustrates the repartition of IRs for T&C KTA; consequently, we have identified that IRs between incumbents and new entrants account for 44% of T&C IRs in 2017, closely followed by homophile - new entrants IRs (35%) and homophile – incumbents IRs (21%). We repeated the verification process for 2018 (34% of T&C IRs). Heterophile IRs accounting for 63%, followed by homophile – new entrant IRs (10%) and homophile – incumbent IRs (7%).

In conclusion, 72% of T&C IRs occurred between 2017 and 2018. They were mostly contracted in forms of heterophile IRs, representing 39% of IRs contracted in total.

In the next paragraph, we present the results concerning the mesoscopic structure of IRs for T&C.

4.2.2. Heterophile partnerships as the primary form of collaboration

The previous result discussed the concentration of IRs for T&C between 2017 and 2018. This paragraph discusses the findings related to the composition of IRs contracted for T&C from 2014 to 2019. We present an overview of the repartition of IRs by types and phases of emergence (Table 42).

Table 42. Yearly repartition of IR types and evolution (T&C)

	Phases				
	Lethargic and Transitional	Progressive		Densifying	
	2014	2016	2017	2018	2019
Partnership	100%	60%	79%	93%	75%
Acquisition		40%	6%	3%	6%
Equity Investment			6%	3%	6%
Joint venture			9%		13%

Table 42 shows that on a global note, partnerships are the dominating type of IR in T&C KTA. It corroborates IR number's densification in 2017 and 2018, yet also informs that these IRs are mostly partnerships: 79% in 2017 and 93% in 2018. Even though there is a substantial proportion of acquisition indexed in 2016 (40%), the results need to be hampered due to a limited amount of IRs that year.

When combined, our two preliminary observations show a concentration of partnerships from 2017 to 2018 in test and commercialization KTA. We propose looking at the mesoscopic structure patterns to identify which companies contract the most partnerships (Figure 76).

Figure 76. IR types by mesoscopic structure for testing and commercialization KTA (2014-2019)

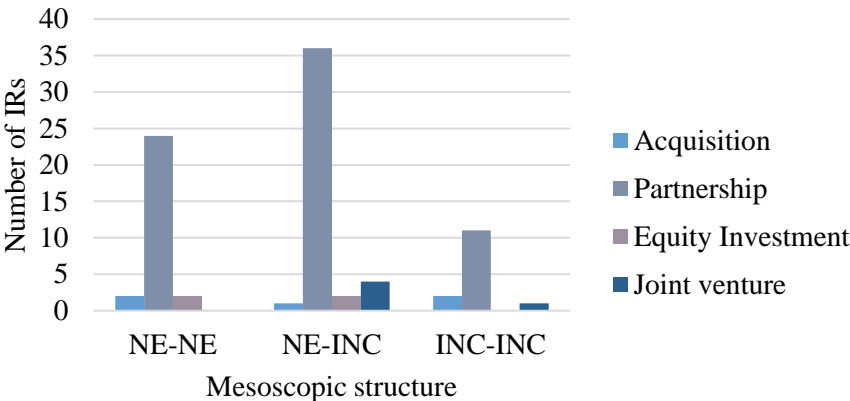

Figure 76 illustrates the predominance of partnerships regardless of the mesoscopic structure. However, we noticed that partnerships between new entrants and incumbents are more prevalent, followed by partnerships amongst new entrants and finally between incumbents. Acquisitions, equity investments, and joint ventures account for 15% of IRs contracted for testing and commercialization.

Regarding IRs for the NE-NE mesoscopic structure, amongst the 26 indexed IRs, the predominant proportion is won by partnerships with a peak of 6 contracted in 2017; it is the highest number of IRs get for the total period. There is a continuous indexation of cooperation from 2016 to 2019 in contrast to joint venture only registered in 2019, and two acquisitions listed in 2017 and 2018.

The results are quite similar for the INC-INC structure, yet span between 2014 and 2019 instead. The number of partnerships is significantly more dominant in contrast to equity investments, joint ventures, and acquisitions. Joint ventures are the second preferred type of IRs by incumbents and new entrants, followed by equity investments and acquisitions.

Finally, the similarities in the NE-NE structure are quite relevant to previous findings. Homophile – new entrant IRs are mostly partnerships, followed by acquisitions and joint

ventures. The last equity investment occurred in 2018, and acquisitions were carried out in 2017 and 2019.

As a consequence of the significant pattern of heterophilic IRs and the in-depth analysis of such IRs, we have identified one significant new entrant: Baidu and its Apollo consortium.

4.3. Identification of the Apollo Consortium

The data codification process sheds light on the emergence of an internal consortium network within the T&C KTA network as it is the only one that emerged from our database. Given the number of nodes in the Chinese telecommunication giant, Baidu, we carried out contextual data research in our secondary material. The multitude of ties adjacent to Baidu enabled us to identify the participation of a large-scale automotive and IT consortium called Apollo already in **Section I**.

4.3.1. Baidu as the most central player of T&C KTA

In 2019, TechCrunch.com announced that Baidu holds the record of miles driven by AVs in Beijing, China. Beijing's transportation department released the first report on the city's licensed AVs, and not surprisingly, several names topped the list, including the tech giant Baidu. Indeed, the company sourced the testing of AVs on 140,000 kilometers in Beijing during 2018, representing 91% of the total kilometers traveled by licensed AVs in the city at that time.

However, that success is not achieved alone. Indeed, the operation of the open platform called Apollo, which is considered as the Android system of AVs, relies on a vast ecosystem of a multitude of partners, including the largest OEMs such as Daimler, BMW, Ford, Toyota, and Volvo, and the largest automotive suppliers such as Bosch, and Hella, and new entrants such as Uber, and Microsoft.

Not all partners are presented here; each partnership bonding an organization to Baidu has a varying KTA. Nevertheless, our results showed that Baidu attracts the most nodes in the T&C KTA. Amongst the 25 IRs contracted by Baidu, 14 are in the Test & Commercialization KTA, 6 in AI, 4 in Connectivity, 1 in Sensing, and 0 in MaaS (Figure 77).

Figure 77. Baidu's T&C network

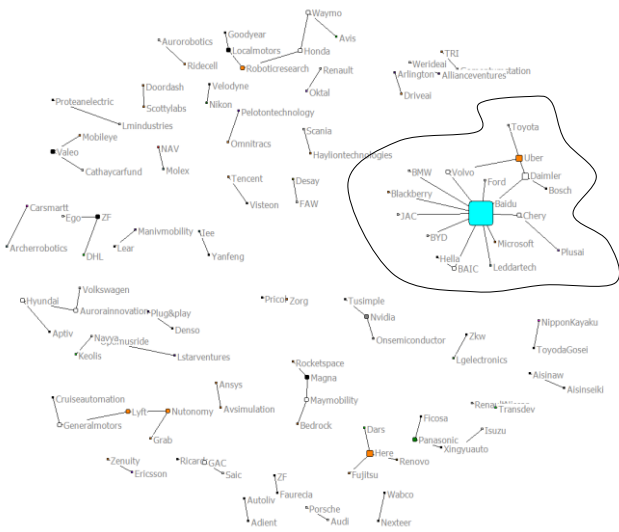

On NetDraw, we applied the Degree centrality attribute to make central nodes detectable in the naked eye. As a result, Baidu, with a centrality degree of 11, showed a high centrality compared to nodes with single ties ($n=1$). The visualization also includes industry attributes to shed light on the dominance of two primary industries in T&C KTA. While Baidu is a telecommunication giant, its ecosystem is preferably composed of incumbent organizations from the automotive industry (black and white squares). The extensive ecosystem also gives the advantage of structural embeddedness, making organizations such as Toyota, Bosch, and Uber accessible for Baidu through its connection to Daimler.

Nevertheless, to understand the constellation of organizations around Baidu, we looked at our secondary material and traced back the Apollo Platform's emergence, structuration, and mission. We discuss the Apollo platform in the next subsection.

4.3.2. The Apollo Platform

In 2017, Baidu announced the launch of its new project named ‘Apollo’. Apollo is an open software platform for Baidu’s partners to develop and test their autonomous driving systems with reference vehicles and hardware. Providing an open platform mirrors Baidu’s willingness to build a collaborative network of partners. Potential partners can rely on Baidu’s AI expertise to mix with other experts to promote and popularize AVs. Although quite cliché, Apollo's name was chosen for its reference to the US lunar program, which eventually benefited the society. Baidu argues that AVs bear the same benefits for the transformation of society. To do so, Baidu believes in the power of partnerships with organizations providing

the best and most reliable vehicles, sensors, and other automotive components necessary for autonomous driving.

Following the open innovation paradigm, Baidu aims to reduce the barriers to entry, R&D costs and accelerate innovative development. A multitude of tests in Beijing and substantial R&D investments since 2015 compose Baidu’s Palmaris. The Apollo open platform is a very comprehensive platform that gathers both software and hardware dimensions of AV.

4.4. Convergence of automotive and IT companies

From what we have discussed in the previous paragraphs, the development of the T&C KTA is highly dependent on organizations from the IT and auto industries because testing software and hardware is part of the technology validation process.

According to their provenance industry, the organization's segmentation highlighted the dominant role of OEMs and automotive suppliers, representing 49.8% of the total. The proportion of IT organizations is not entirely different, as 30.6% of the organizations are IT specialists (Figure 78).

Figure 78. The industry of provenance of companies involved in IRs

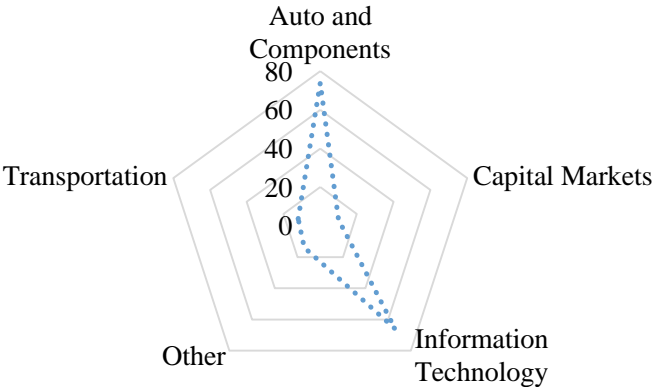

We can potentially advance the idea that IT and auto organizations need to perform co-testing and commercialize the technologies as AVs are a mixture of hardware (the vehicle itself) and software (ADAS, cameras, sensors). Organizations’ mission statements highlight the predominant role organizations have adopted for themselves and appear like AVs' future is inseparable from information technologies. In that term, 2Getthere, a company of ZF, a major

automotive component supplier, states that “our (2Getthere) mission is to continue delivering market-leading fully automated transit solutions”⁵³ while being based on collaborative values. The same goes for Waymo, a former AV project of Google, which believes that Waymo’s mission is to “make it safe and easy for people and things to get where they are going. The Waymo driver can improve the world’s access to mobility while saving thousands of lives now lost in traffic crashes.”⁵⁴

To corroborate our results, we have depicted many significant OEMs' announcements claiming that vehicles' future is a ‘tech business.’ As a result, many OEMs and suppliers have developed their automated driving pilot, also called autonomous chauffeurs, illustrated in Figure 79.

Figure 79. Examples of automated driving pilots

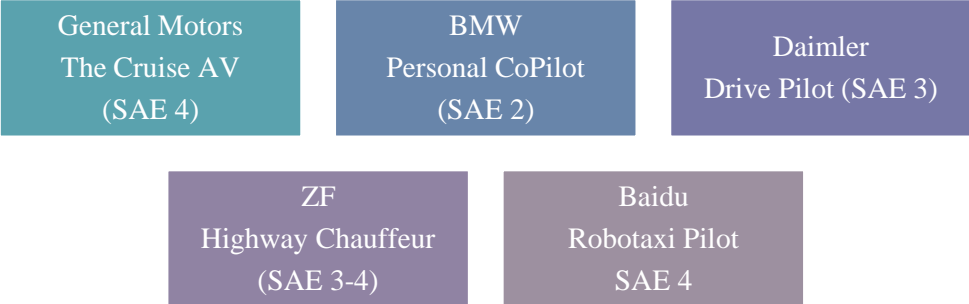

For instance, the Highway Chauffeur developed by ZF enables the driver to let the driving commands to the vehicle while on the highway. As a result, the car performs lane-keeping assist motions, adapts the speed according to the contextual traffic information, brakes when needed, and ensures that the critical safety distances are respected. Alongside essential safety features covered by the automated chauffeur such as the systematic lateral controls, increased safety for the vehicle users, or collision mitigation, the pilot also relieves the driver from monotonous driving tasks on highways and rural roads.

We conclude this section by providing a summary of the findings for the T&C KTA.

⁵³ Retrieved from <https://www.2getthere.eu/vision-and-mission/>
⁵⁴ Retrieved from <https://waymo.com/>

Summary of findings regarding the T&C KTA

In general, the predominant mesoscopic structure is the heterophile IRs (53%), followed by homophile – new entrants (30%) and finally, homophile – incumbents (17%) (Table 43).

Table 43. Strategic box for testing and communication KTA

	Typology 1	Typology 2	Typology 3
Who	Incumbent + New entrant	New entrant + New entrant	Incumbent + Incumbent
Account for	53%	30%	17%
Organizational attributes	Mostly incumbent auto and auto part manufacturers, IT companies, mobility providers (Uber, Google)	New entrant software developers, mobility providers, and telecom companies	New entrant electronic, software companies, and infrastructure organizations
How	5. Mostly partnerships (84%); 6. Acquisitions (6%); 7. Joint Ventures (6%); 8. Equity Investments (5%).		
Technological drivers	Commercialization Testing New material development (lesser extent)		

In terms of conclusion, the analysis of the test and commercialization KTA provides several insights. First, it showed that each KTA has a concentration-time (here 2017-2018), which seems to mirror the technological content. In that case, AV technologies' test and commercialization are reliant on the three leading technologies identified before: connectivity, sensing, and artificial intelligence. Second, the activities are more straightforward (commercialization and testing) and require fewer complexities to manage in terms of innovation content, which may be why short-term IRs such as partnerships represent a higher proportion (84%). Parallel to testing and commercialization, we gathered information and results regarding the network developing around Mobility-as-a-Service (MaaS), probably the most singular KTA. We discuss our results in the last paragraph of **Section II**.

5. Mobility-as-a-Service, an emerging KTA

The data collected showed that the MaaS KTA is experiencing an impending change and the establishment's process has yet to be determined. It is quite often argued that MaaS englobes the global auto industry disruption. Regardless if a vehicle is electrified, autonomous, or fuel-propelled, the final value proposition aims to provide any type of mobility in a shared manner, as a service. In consequence, the MaaS KTA holds great importance for the commercialization phase in the future years.

5.1. Technological content pushing towards IR formation

The previous section enabled us to realize that both incumbents and new entrants have taken significant moves to enact the future of mobility - autonomous. Nevertheless, alongside the collaborative patterns that we have observed, which translates adaptation to innovation (thus technological complexities), our dataset results with industry experts' assumptions and forecasts? Mobility is already embracing a radical change with the appearance of a multitude of on-demand mobility modes such as car-sharing and ride-sharing.

The Maas Alliance defined mobility as a service as “integrating various forms of transport services into a single mobility service accessible in demand.”⁵⁵ Consequently, MaaS is the final step to provide customers with autonomous shared mobility. Indeed, parallel to new technologies for autonomous driving, a new mobility ecosystem is emerging too. An emerging shared mobility model will transform the personal mobility model for the better.

New on-demand mobility modes have been around for a couple of years now. The extension to large-scale and real-time operation in large settings has become a current trend inherent to mobility changes. In March 2020, Fortune Business Insights published ‘The global mobility-as-a-Service market’ report. They anticipate that the MaaS market will reach USD 210.440 billion by 2026. Mobility-as-a-service, therefore, becomes a reality proposed by mobility providers to reduce the complexities of mobility services. The mobility service is offered to users by a mobile phone application, including all the elements linked to the use. As a result, the user can book a trip, pay, get information, and leave comments on a single app before,

⁵⁵ Retrieved from <https://maas-alliance.eu/homepage/what-is-maas/>

during, and after the trip. MaaS becomes synonymous with public transportation and induces users to reduce personal car usage in city centers. Like any disruptive technology, shared mobility has several key drivers, which suit cities' and governments' contextual concerns.

In dense urban settings, MaaS will provide more flexibility to users, who will be able to use shared vehicles to carry out first or last mile trips making the increasing need for parking spaces in cities irrelevant and reducing road congestions as autonomous MaaS is based on a robust geolocalization system that detects congested roads to avoid them. Therefore, MaaS provides more sustainable modes of transportation. In 2019, Deloitte⁵⁶ published a report called 'Toward a mobility operating system for urban areas,' highlighting the growing proportion of the urban population from 1950 to 2050. When 30% of the population was living in urban areas in 1950, by 2050, that proportion will represent 66%.

Then autonomous MaaS potentially dethrones the classic personal car ownership model by pushing towards a model based on shared mobility with fewer cars on roads. However, if vehicles are neither driven nor owned by humans, one can question the future of mobility? Who will be the future customers of OEMs if personal cars are no longer relevant?

These questions seem to remain impending as not that many actions are observed at the macro level. We present the IRs analysis for MaaS in the following paragraph.

5.2. Sporadic patterns of interorganizational relationship networks

The data retrieved from the database showed the contraction of 13 IRs for the MaaS KTA. Regardless of the mesoscopic structure of IRs indexed from 2016 to 2019, one cannot deduce any strategic box by the mesoscopic structure as this KTA seems to be in its lethargic phase (Figure 80).

⁵⁶ Retrieved from <https://www2.deloitte.com/us/en/insights/focus/future-of-mobility/urban-transport-mobility-platforms.html>

Figure 80. Segmentation of IRs by mesoscopic structure for MaaS KTA

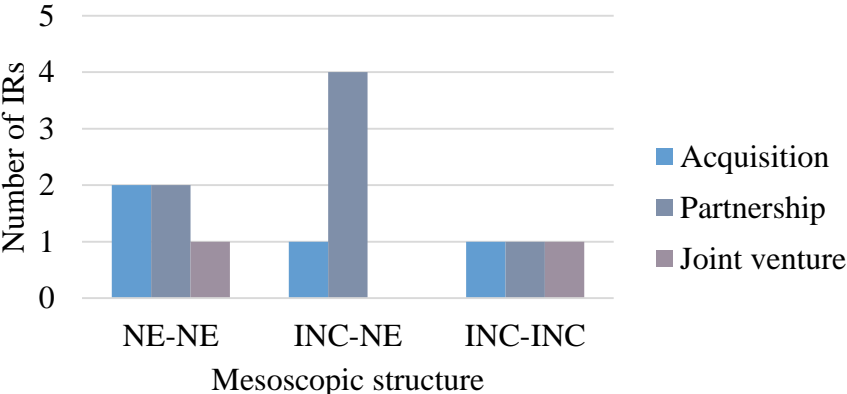

Given the relatively limited amount of IRs in the Maas KTA, we have gathered the results of IR types by mesoscopic structure together. The analysis of the empirical evolution of the number of IRs in the Maas KTA network resulted in the identification of partnerships, joint ventures, and acquisitions as preferred IR types.

IRs among incumbents and heterophile IRs represent the same portion in the global dataset. Indeed, six IRs were contracted among incumbents; the same goes for IRs between incumbents and new entrants. Only three IRs occurred among new entrants during the same period. Organizations involved in MaaS KTA are mainly from the automobile and components (50%), software and services (23%), and (17%) transportation industries. Regarding IRs between new entrants, our results show that either acquisition (2) or partnerships (2) are chosen.

Similarly, heterophile IRs take the form of partnerships (4) and acquisitions (2). Finally, IRs between new entrants represent a relatively small portion as only two are identified in the dataset: one partnership, an acquisition, and a joint venture.

We illustrate our paragraph with one major joint-venture between two German OEMs, BMW and Daimler, combining their car-sharing services DriveNow and Car2Go⁵⁷.

⁵⁷ Retrieved from <https://media.daimler.com/marsMediaSite/en/instance/ko/BMW-Group-and-Daimler-AG-agree-to-combine-mobility-services.xhtml?oid=34636751>

BMW and Daimler to create car sharing JV ShareNow (2018)

BMW and Daimler are working together under one roof to provide their customers with sustainable urban mobility services. There has been no mention of financial details on the activity. The goal is to become one of the major suppliers of future mobility services, and to operate in the face of Uber. The JV specifies that the two parties will each own 50 % of the shares, AND has a variety of components:

- The two manufacturers have a fleet (DriveNow + Car2Go) of 20,000 cars in 31 cities. Together, that's no less than four million users.
- Not only would this joint venture include car sharing, but also multiple mobile taxi ordering sites (mytaxi, Private Driver, Clever Taxi). They will get 140,000 drivers and 13 million users together.
- Also in the joint venture, there will be platforms for locating and paying for parking spaces online, as well as electric car charging stations.

DAIMLER



Conclusion of Section II.

In Section II, we intended to understand how could the innovation content explain industry emergence patterns in IR types and partner choice. We discussed each KTA's critical sub-activities that serve as a technological driver for IR formation and partner choice. In turn, the technological content's consideration as straightforward or more varied led us to identify the impact on the collaborative patterns. As a result, we argued that the more varied the technological content, the more short-termed (partnerships) are IRs between new entrants and incumbents.

The analysis of each KTA in terms of who partners the most and how enabled us to retrieve insightful information that, even though very specific to each of the five KTA, shows that organizations can rely on collaboration patterns already existing in a network to determine what works the best and with whom.

The crossbreeding data highlighted that overall, what works the best in terms of partner combination in all the KTA is heterophile partnerships. The power of collaborating with different organizations has all the more been proven in empirical studies. According to the content of innovation and the unknown level for organizations, they tend to influence a different partner's choice. We have summarized our main findings in Table 44.

Table 44. Collaborative patterns based on innovation content

KTA	Innovation content	Partners	IR type	Industry
Connectivity	Various	Heterophile	Partnerships	Automotive, IT and Telecoms
Sensing	Straightforward but similarities possible with traditional auto components	Heterophile Homophile	Partnerships Acquisitions	Automotive and IT
AI	Straightforward but very far from traditional auto components	Heterophile	Partnerships Acquisitions Joint ventures	Automotive and IT
Test and Commercialization	Various	Heterophile	Partnerships	Automotive and IT
MaaS	Impending and still-evolving content	Sporadic	Sporadic	Not identified

Various technological content will lead to more spontaneous and numerous IRs as it is the case in the connectivity KTA; partnerships are mostly heterophile because several industries (automotive, IT, and telecommunication) need to involve for the final value proposition.

When technological content is straightforward, organizations have identified the main challenges. The technological content finds similarities with what already exists; IRs are more diverse with short term partnerships and long-term acquisitions.

When the technological content is straightforward- organizations have identified the main challenges and requirements of the technological content and no similarities exist with what already is on the market, then here organizations seem to take time to make IRs (2015-2019) which are as long-term than short-term oriented and mostly between heterophile organizations.

In cases where the technological content is diverse since many technologies are tested and commercialized, the strategies are more straightforward, restricted to heterophile partnerships.

Finally, in cases where the technological content is not well-defined and still evolving, patterns of collaboration are sporadic. Yet, the change is impeding, and more monitoring is required for this KTA. In fact, in the case of AV, MaaS KTA represents the final step of the process that will enable AVs to reach several applications such as ride-hailing and robotaxis, corresponding to evolving transportation business models.

As a result, we found that each KTA network has different topological characteristics, linked to each KTA's innovation content's technological complexity.

Conclusion of Chapter 8

We introduced Chapter 8 to study **how the innovation content could explain industry emergence patterns in terms of IR types and partners' choice** by analyzing interorganizational network composition and the influence that network composition may have on the overall network structuration. The analysis of organizational attributes in distinct networks draws several key conclusions.

In **Section I**, networks are similar in their overall structure and tend to share common characteristics regarding who populate them, how, and at which frequency. The cross-level comparative analysis employed to scrutinized IR networks around each KTA showed a great tendency to collaborate with alters from the opposite type. We analyzed patterns of collaboration in each KTA and showed IR choices' relatedness with the technological content.

The more complex and far from the traditional industry, the longer terms IRs are selected between new entrants and incumbents in progressive and densifying phases of industry emergence. Contrary to the more straightforward the technological content, the shorter term is IRs between heterophile and homophile organizations. In terms of significant patterns, we have observed that when the technological content is still evolving, organizations tend to be cautious in their IR formation; it shows that for each KTA, the densifying phase is not evolving at the same pace (all the KTAs compared to MaaS).

Identifying main IR types in each KTA allowed room to choose partner analysis, where similarities were identified among the five KTAs. First, heterophile partnerships' dominance has been demonstrated in connectivity, sensing, artificial intelligence, and test and communication KTAs. In some KTAs, homophile IRs were also observed, such as in connectivity and sensing. Showing that the similarities existing between the new technological content and incumbents organizations' existing knowledge served as a lever for INC-INC IRs.

However, we have identified that regardless of the KTA, organizations tend to select IRs with lesser commitment, such as partnerships. The detection of similarities amongst networks has been corroborated through our results by comparing the results among each other.

Also, the incorporation of the time variable highlighted that some KTAs such as connectivity, artificial intelligence, and sensing had made a long way since the very beginning, when sensing has experienced a more recent development with a peak in 2017-2018 and finally, MaaS that can be considered as a latent KTA which will develop even more in the forthcoming years.

Globally, our results have shown that the technological content of a distinct network can influence network members to act similarly, making the apprehension of industry emergence more transparent.

Conclusion of Part III.

Part III is organized in two chapters, where we discuss our results at different levels of analysis according to our funnel approach.

Chapter 7 presents our contribution to the industry emergence and IR literature by mapping networks and comparing it with an industry-life cycle model. Grounded on our quantitative material analysis and following an inductive approach, our mapping highlighted five IR networks around KTAs that formed the AV industry. In this chapter, the relevancy of IRs to assess the emergence and structuration of industry and reflect the effects of disruptive innovations at the macro level is corroborated. Beyond network identification and assessment with IR as industry emergence metrics, we looked further at the aggregation of each IR according to the Key Technological Activities (KTAs) that are the key enabling technologies for autonomous vehicles to become a reality.

Interorganizational relationships and cross-sectorial dynamics have been accepted as signals and metrics of industry emergence. Nevertheless, the question of how emerging industry structures remained unanswered. To downplay the lack of insights regarding the structuration patterns of technology-intensive industries, we focused on the innovation content identified as the KTAs. We believed that the classification of IRs by technological drivers would help us deduce the technological paths adopted by managers and practitioners. Therefore, our second main finding relies on the different phases of industry emergence and structuration compared to the industry life-cycle model that we have adapted to our literature framework.

As a result of statistical treatments, we identified three phases of industry emergence based on density degrees that will change and show less fragmented networks. The chronological structuration of the AV industry implies three distinct phases: the emergence of connectivity and sensing from 2011 to 2015, that we called the Lethargic and Transitional phases, the phase of cohabitation of all the KTAs from 2016 to 2017 that we named the Progressive phase, and finally the multiplication and the resultant in a plethora of IRs in all KTAs that we called the Densifying phase (2018-2019).

Following the SNA methodology, we computed the most used degree centrality degrees to highlighted the central role played by KTAs by characterizing each IR by the technological driver behind it. As a result, this chapter enabled us to prove that IRs can translate the changes

in disrupted industries, causing a new one. We provided a model of the industry life-cycle put in parallel with the evolution of KTA network emergence.

To complement the macro-level findings of **Chapter 7**, we then focused on the interorganizational and organizational levels in **Chapter 8** to depict major patterns of mesoscopic structure and IR types by KTA to identify the influence of organizational attributes on network structuration based on each KTAs' innovation content. This chapter intended to understand if the innovation content could explain collaborative patterns within a given network setting.

For that, we provided a general overview of the network composition, arguing that to be able to measure if the innovation content has an influential effect on collaborative patterns, we first needed to identify the general network composition, to then verify in each KTA if the tendency if verified, and when it was not, understand why.

First, our results demonstrated the general pattern of close cooperation between new entrants and incumbents. In the first place, we have identified shared characteristics in all the KTAs, such as the dominance of suppliers' roles in each KTA due to their vast presence in indexed IRs. In the second place, we have focused on the preferred type of IRs contracted and found that heterophile partnerships are the select collaborative strategies between incumbents and new entrants.

Secondly, the network composition analysis for each KTA was determinant in several terms. Identifying each network's innovation content enabled the contextualization of the IRs then aggregated into the mesoscopic structure and IR type analysis. The patterns varied in each KTA in terms of 1) timing, 2) IR types. In some KTA partnerships were indisputably at the preferred rank (connectivity). In others, the patterns seem more blurry with partnerships, acquisitions, and equity investments as consequential IR types in several mesoscopic structures. In general, these patterns showed the relatedness of each network's composition with the advances and development state of the innovation content. For instance, when the innovation content is composed of various sub-activities, the results have shown that organizations tend to adopt more short-termed IR in heterophile processes because they have to specialize in many different yet equally essential sub-activities (e.g., connectivity).

Regarding the sensing KTA, which plays a central role in giving AVs the technologies they need to see the external and internal environment, the tendency implied a collaborative pattern between auto incumbents and new entrants from the IT industry.

In regards to AI, we have identified several key concerns that pushed the network to develop broader. Activities around computer vision and cybersecurity are, therefore, critical concerns of new entrants. The analysis of INC heterophile IRs pointed out that most often, IRs were contracted amongst direct competitors rather than the buyer-supplier type of cooperative strategies.

In terms of test and commercialization, technological content impacts the IR patterns in two manners. First, the nature of dominant technological activities (testing and commercialization) explains the concentration of IRs in 2017 and 2018. The three previously discussed KTAs reached a confident technological readiness to test and commercialize. Secondly, we also highlighted the major trend of heterophile partnerships that replicated in this KTA too.

Finally, the MaaS KTA is probably the less insightful source of information due to its still-evolving status. It could be interesting to come back to this KTA to study its evolution in the future.

On a global note, the organizational level analysis sheds light on the dominance of three primary industries in the AV industry: Automotive, IT, and Telecommunication industries.

In conclusion, our multi-level analysis showed that assessing industry emergence and depicting structuration patterns is not an easy task to predict.

Chapter 9. Discussion

The present doctoral work began by observing that assessing industry emergence is a complex task for organizations because industries' origins have not been solved (Padgett & Powell, 2012). The complexity of industry emergence represented itself as an intriguing subject to analyze and highlighted an amalgam between industry structuration and emergence, considered a differentiation variable in this thesis. We propose a macro level approach where both concepts were considered as different yet interdependent. Our passage to the macro level analysis of industry emergence enabled us to discuss the findings with several critical literature streams in **Chapter 9**.

Section I provides a research synthesis by reminding the research questions and discussing the main theoretical background that we have called on in this thesis. In **Section II**, we discuss our theoretical contributions following our funnel approach, and in **Section III**, we present the methodological and managerial contributions. We conclude **Chapter 9** with the limits of the research and future research directions.

Section I. Research synthesis

The research problem gradually took shape during field observations, exploration of the literature, and managerial issues observed within the host company. Gradually, it led to three related research questions, where each represents a different level of analysis to assess industry emergence through IR networks (Table 45).

Table 45. Levels of analysis and related research questions

Level of analysis	Related research question
Macro level	How could interorganizational relationship dynamics allow assessing ex-ante the patterns of industry emergence in a disruptive innovation context?
Network level	How do interorganizational relationship networks dynamics assess the structuration patterns of industry emergence caused by disruptive innovation?
Organizational level	How could the innovation content explain industry emergence patterns in terms of interorganizational relationship' types and choice of partners?

The research ascribes to the AV industry emergence setting from 2011 to 2019. We try to figure out how the traditional industry dislocates slowly and merges into a new one with new players, new attributes, and is characterized by IRs to meet sophisticated disruptive innovation requirements. Our empirical study reveals two main contributions: the potency of IRs to assess industry emergence and structuration around Key Technological Activities (KTAs). These two concepts fall within two fields of organization studies that we synthesized as follows.

On the one hand, industry emergence literature provides a relatively static view based on industry life cycles and assesses a given industry structuration rather than its emergence. We contribute to the dynamic analysis of industry emergence; it represents our first macro level contribution (Davis et al., 2009; Eisenhardt & Santos, 2009; Klepper & Graddy, 1990).

On the other hand, industry emergence processes do not include clear variables related to disruptive innovation, even though they cause its emergence. This perspective limits disruptive innovation considerations to contextual data that are linear, the consequences of which are taken for granted in the theory of disruptive innovation (Christensen, 1997).

Regarding disruption, we considered it not as an end in itself; rather, it is the triggering element of a dynamic industry emergence process. We also considered disruptive innovation a critical factor that needs to be looked at because what makes it disruptive is its actual content rather than the theory. Therefore, we have discussed the importance of studying disruptive innovation challenges and understanding the intrinsic characteristics and implications for organizations.

This second postulate leads us to our second main finding at the network level: industries like human species evolve and structure through interorganizational relationships and linked our work to evolutionary economics by adopting a comparable standpoint regarding orthodox approaches' critical considerations. We considered competition and growth as central points. Amongst several critiques made by Nelson and Winter (1982) against the conventional approach, one is of significant importance to us. Indeed, they argue that economic analysis should not exclusively focus on “hypothetical states of industry equilibrium” (*ibid*: 4). Instead, dynamic processes are sources of irreversible economic changes sensitive to the followed trajectory.

Besides, the consideration of innovation content as a variable of industry emergence gave us directions regarding the best thing to do to make macro level patterns visible. In that perspective, the literature on social network analysis (SNA) combined with a non-linear view on innovation-led us to identify that what motivates organizations the most is technology. From there, the possibilities were straightforward in what type of data to analyze when considering IRs as research variables: who collaborates and for what. Therefore we proposed to study IRs and the related variables that could make sense in industry emergence settings (Grodal et al., 2014). We considered that understanding how organizations collaborate, to which frequency, and above all, for what could give uncommon insights on 1) the way organizations adapt with IRs when an industry emerges caused by disruption; 2) the fact that IRs could give directions in terms of where is the industry going technologically, thus, highlight patterns of structuration.

This dynamic approach to industry emergence and structuration gave information on how industries structure around Key Technological Activities. What we highlight here is the crucial role played by the actual content of disruptive innovation in studying the structuration patterns of the industry.

Before detailing the different contributions of this thesis, let us summarize below the definitions of industry emergence and industry structuration concerning our empirical findings:

- Industry emergence implies an alteration of an economic system (Malerba, 2007) and is nearly always driven by technology (Schumpeter, 1934; Marshall, 1920). We argue technologies that cause industry emergence are disruptive innovations due to their intrinsic characteristics (Christensen, 1997). As a result, industry emergence induces the study of something new that did not exist before and requires identifying key research variables.
- Industry structuration implies the study of patterns, meaning the depiction of regularity in a given environment. The study of patterns provides a standard or intelligible form to the studied elements: industry emergence. As such, it is a “leading depiction of the evolution of new industries” (Klepper, 1997: 145).

Our approach created a perspective on three closely linked strategic management concepts that were mainly studied autonomically: disruptive innovation, industry emergence, and interorganizational relationships.

We consider disruptive innovation 1) as the trigger of the whole industry emergence process, 2) the driver of industry structuration patterns through the emergence of IR networks around KTA. We have argued that IRs are valuable metrics for assessing industry emergence and monitoring structuration patterns. We link the concept of disruptive innovation through the close relatedness between disruption and organizations’ strategic changes, which are either a consequence of disruption or an *ex-ante* adaptation of organizations before disruption happens. In either case, the most important is to be successful in the face of disruption (i.e., not to fail).

Section II. Theoretical contributions

In the present thesis, we have discussed how to assess an industry's emergence triggered by disruptive innovation. We have agreed with the evolutionary theory focusing on the industry's dynamic aspects rather than the overly studied static state to understand how industries emerge and evolve and discuss disruptive innovation as a critical economic growth mechanism, which triggers organizational dynamics. To capture the dynamics at the organizational level, we have opted to look at the interorganizational relationships as we assume they are a central variable of organizational strategies as they reflate “the movement of something over time” and “explain why that something is what it is at the moment in terms of how it got there” (Dosi & Nelson, 1994: 154).

This section describes how our thinking process led us to contribute and interlink several theoretical concepts to study industry emergence. We first begin with our contributions to the disruptive innovation theory, then we follow with our macro and network-level contributions and finish with our contribution at the organizational level.

1. Disruptive innovation: beginning or end?

1.1. Evaluating the implications of disruptive innovation

Since its publication in the Harvard Business Review in 1995, the theory of disruptive innovation has proven to be a powerful way of thinking about growth generated by disruptive innovation (Christensen, 1997). It refers to a process where smaller organizations can cause incumbents companies' coercive failure. However, the broad adoption and use of the theory did not warrant the right application and understanding of the fundamental tenets and led to its misapplication. According to us, the additional concern is the severe cacophony around the term itself (Danneels, 2004). The present thesis agreed that disruption is not a one-time event that occurs in languishing industries. Preferably, the process side of it was pushed through.

The blurriness around such theory provokes delamination in linking such theory to other studies. Generally speaking, disruptive innovation literature has focused on the organizational level and served as a theory to explain why organizations succeed or fail when facing disruption. Rarely disruptive innovations have been discussed in tandem with a macro level

perspective, even though theorists considered disruption a critical driver of industry emergence (Abernathy & Clark, 1985; Charitou & Markides, 2003). We agreed that integrating a disruptive innovation in an industry would shift the competitive patterns, yet implied that competitive patterns should be assessed instead of remaining a non-proven argument. The change in competitive patterns, e.g., in the industry, telegraphs different organizations needing distinct strategic approaches. The lessons we have retrieved from the theory were based on how to handle disruptive regarding if you are an incumbent or new entrant, but what missed was the deep understanding of why disruption is a threat. We argued that disruption is not automatically unfortunate news; for those organizations that can turn it to their benefit, there are incredible opportunities, and revenues can rise in all sectors. Whether it is the launch of new software or a futuristic product, technology companies push traditional industries' limits and shake up other organizations. So, the question is, what happens when these organizations make sense of an emerging industry? Are they ready to tackle the turbulences stemming from disruption?

In response, the effects of disruption on organizations can be multi-faced as highly admitted by scholars considering economic explanations (Gilbert & Newberry, 1982; O'Reilly & Tushman, 2016; Reinganum, 1983) such as rigid and sustainable innovation-oriented resource allocation (Bower, 1972); organization theory explanations deploring the lack of foreseeability of change and the rigidity of organizational processes (Chandy & Tellis, 2000; Nelson & Winter, 1982) that cause inertia (Pfeffer, 1992); and strategic choices explaining how organizations by systematically focusing on sustainable innovations to pursue high margins objectives can overlook change by failing at the parallel play.

But given the speed of change, it will be difficult for most industrial sectors to adapt quickly enough, and not all of the leading players of today will hold their position. Given its potential for transforming the business model and driving to a competitive edge, disruptive innovation is, surprisingly, often considered as the IT sector domains and less applied to the industry at the macro level as the present work proposed.

It is why, by following a thinking process that considers disruption as a process rather than an end, we assumed the role of disruptive innovation in industry emergence literature. It revealed that industry emergence happens because of technological newness that creates a resource gap between organizations' existing resources and the new resources required for disruptive

innovation. Yet at that point, the link between disruptive innovation's complexities is considered a straightforward conceptual variable that would cause low-end or new market disruption (Christensen, 1997; Christensen & Raynor, 2003), rather than a driver.

The incorporation of disruptive innovation as a contextual variable makes the necessity to assess industry emergence mandatory because the argument defending the failure of organizations facing disruptive innovation is well littered (Chandy & Tellis, 2000), yet restraining in terms of strategic insights (Danneels, 2004). Failure is a consequence of disruption (Hill et al., 2003), yet, it should not be the only one.

We agreed with the main reasons making disruptive innovation complex. Consequently, the complexity of industry emergence inheres to high uncertainty and risks that threaten organizational survival: the resources (Penrose, 1959; Santos & Eisenhardt, 2009).

Finally, the consideration of disruptive innovation as a variable of industry emergence raised questions around foreseeability because organizations are valuable and performant when they master predictability and reliability (Hannan & Freeman, 1984). From that perspective, we argued that, finally, if industry emergence caused by disruptive innovation is foreseeable at the macro level, organizations may have enough insight to routinize their processes to gain efficiency in regards to the new technology, manage inertia because they are aware of disruption (Pfeffer, 1992) and successfully take advantage of the Pandora's box that is a disruption (Hill & Rothaermel, 2003).

In light of the above discussions, we allocated disruptive innovation to a novel position in strategic studies since disruption is the first postulate that needs to be observed. Accordingly, organizations tend to change their strategical behaviors rather than a consequential variable of *post-mortem* analysis. In that sense, Bower and Christensen (1995) proposed an *ex-ante* assessment of disruption by graphing its trajectory. Still, before it is too late or the disruptive innovation has reached a certain growth level, it is almost impossible to make such predictions.

As a consequence, the introduction of disruptive innovation thus begets the emergence of a new industry and generates the most questions related to the assessment of industry emergence and the differences between emergence and structuration (Phaal et al., 2011), because emergence and structuration are not equal (Padgett & Powell, 2012).

1.2. Disruptive innovation driver of industry emergence

Before studying industry emergence as a macro level phenomenon, we have argued a relatedness between disruption and industry emergence. Despite the fact the literature has recognized, such as link, the paucity of empirical evidence motivated us to discuss both concepts as part of the same thinking process.

1.2.1. Disruptive innovation and industry emergence: taken-for-granted link?

Emergence refers to the origin of industries and implies identifying the passage from the disrupted to the emerging industry. To date, the disruptive innovation theory only proposed an *ex-post* analysis of disruption, which served as a *post-mortem* review of how things went good or bad in given industrial contexts (Danneels, 2004; Markides, 2006). The present study showed that disruption is analyzable while it is happening because industry change induces an organizational change in the short-medium term. Structuration, however, is the study of patterns over time to understand the emerging industry and make sense of how an organization strategically adapts to disruption. Herein, proposing a model to assess industry emergence before and when it occurs seemed to be a significant contribution to this literature. Studies have argued that depending on the type of organizations, whether incumbents or new entrants, their responses to industry emergence will be different and dictated by internal characteristics and inertia. We position our research as a way for organizations to assess industry emergence before the harm is done.

For that, we draw upon major works on industry emergence (Padgett & Powell, 2012) and industry life cycles (Phaal et al., 2011) by proposing a combined approach to industry emergence and showing our close affiliation to the evolutionary theories. By combined approach, we mean that we have considered the significant works done on industry life cycles by adding a twist to them and incorporating the main variables of the disruptive innovation theory: incumbents, new entrants, turbulences, paradigmatic changes, dominant designs, and the increase of interorganizational relationships (IRs) (Christensen, 1997).

The introduction of these new variables into industry life-cycle models is valuable because it allocates a fine-grained view of the industry emergence constraints while also attributing conceptual explanations to each phase of emergence.

As mentioned, we discussed the concept of disruption, not as an end in itself, instead of as the triggering elements of a dynamic industry emergence process. Then, we considered disruptive innovation a critical element that needs to be looked at because what makes it disruptive is its actual content rather than the theory statements. Therefore, we underlined the importance of studying disruptive innovation challenges to understand organizations' intrinsic characteristics and implications.

In terms of the concept of disruption, as mentioned, we extricated the challenges to the straightforward resource ditch between the traditional and disruptive industry, which we named the emerging industry, and agreed with the theory of disruption discussing new market disruptions (Christensen & Raynor, 2003). Regarding the intrinsic characteristics, we agreed with the technological content studies (Anderson & Tushman, 1990) and considered that disruption is challenging because of non-adapted organizational strategies.

Finally, we contributed to the two preceding points by arguing that the IR networks literature proposed both disruptive innovation content and adapted organizational strategies to respond to turbulence and lack of resources.

1.2.2. Understanding the organizational impact of disruptive innovation on industry emergence

Disruptive innovations are coming at a rapid pace in constantly evolving environments. The literature argued that disruptive innovation is extremely complex to foresee, methodically plan, assess, manage, and deploy from past discussions. From what we perceived, at the macro level, is that technology organizations are mostly dominant in emerging industries because disruptive innovation brings technological newness that is unknown or barely known by incumbents. On the other side, even if new entrants know where to go because they eventually have the new technology, it does not secure technological success. That particular postulate induced discussions around how these organizations can benefit from complementary synergies to remove the bottlenecks that constrain disruptive innovation's growth in the emerging industry.

In that sense, on one side, some organizations aspire to become pioneers in implementing the disruption innovation, where some others prefer to be fast followers or passively active. On the other side of the competitive game, incumbents do not even know that there are disrupted.

Ultimately recognizing industry emergence caused by disruptive innovation implies embracing new ways of doing business by finding the right balanced relationship between internal structural elements and contextual dynamism (Davis et al., 2009). Yet, the issue is how to assess it.

Amongst many studies discussing the incumbent curse (Chandy & Tellis, 2000), scholars have admitted ways for organizations to remain successful when disruption hits, such as strategies to attack back and disrupt the disruptors (Abernathy & Clark, 1985; Anderson & Tushman, 1990; Ansari et al., 2016; Bergek et al., 2013; Christensen, 1997; Christensen & Raynor, 2003; Henderson & Clark, 1990; Hill & Rothaermel, 2003); adopt the innovation and adapt the organizational strategy to compete with new competitors, or apply ambidextrous innovation processes (Charitous & Markides, 2003). However, these responses do not imply any assessment directions that organizations may use to determine how to do it. Therefore, the downplay of theoretical approaches in terms of disruptive innovation strategies was discussed as part of the industry emergence process regarding how organizations adapt internal and external operations to perform disruptive innovation.

One primary indicator is how organizations prioritize their investments and their goals. Companies want to use innovative technologies to develop their goods and services, decrease costs, and conquer the competition. Similarly, many studies have accepted that organizations owe their failures to adapt quickly to new trends that have cost them dearly. The literature has explained that what causes organizations the most prejudice is the lack of people and capabilities to retrieve the most out of disruption, which again affects the pace of change and trailing new entrants. This argument was determinant because of the non-linear approach that we have on disruptive innovation and the ensuing consequences at the macro level. It enabled us to connect with what we considered empirical responses to manage turbulences (Pfeffer and Salancik, 1978): interorganizational relationships (IRs).

2. Assessing industry emergence with interorganizational relationships

The present thesis main contribution brings light on the concept of industry emergence, which seems to be quite blurry in the literature (Krafft et al., 1994). Initially, the definition of an industry seems not to provide a thorough background for research (Gustafsson et al., 2011); it is difficult to apprehend at the first stages due to industry and organizational boundaries; in fact, to which extent is it an industry? Recent studies consider industries as networks of IRs and “the emerging form of society” (Baker & Faulkner, 2017: 520). The current focus of industries as networks has opened interesting directions for research on industry emergence because networks are bounded systems characterized as dynamic (Ahuja et al., 2012) and ever-evolving (Padgett & Powell, 2012). Therefore, the present thesis corroborated the fracture of the market and hierarchy dichotomy proposed by the transaction theorists, which seems not to provide sufficient insight into when the strategy is internal and external.

As a result, the imbrication of various bounded networks forming a given industry implied the study of IRs to analyze the patterns within networks themselves (Phelps, 2010), and a new perception of industries. Finally, we brought some answers to how to assess an industry emergence process. The literature (Grodal et al., 2014; Gustafsson et al., 2016) showed that most studies focus on industry structuration rather than assessing its origins through a heavy concentration on industry life cycle models. Herein, we extend the comprehension of industry emergence by noting that industry life-cycle does not fully assess industry emergence, focusing on industries that have already emerged.

Beyond contextual explanations such as characterizing the emerging industry with organization types (incumbents and new entrants), turbulences, paradigmatic change, and dominant designs, we proposed a quantitative metric to assess these changes in real-time. As organizations face complex technologies, they are driven by endogenous strategies to reach safer spaces; we argued that this opens a broader perspective on industry emergence. Our crossed-level approach to an old problem, the one of industry emergence, allows us to shed light on a variable that has hardly been seen in this context: interorganizational relationships as a metric of a three-level funnel approach. The incorporation of disruptive innovation

variables opened opportunities to measure industry emergence by assessing structural and organizational attributes.

2.1. Implications of interorganizational relationships at the macro level analysis of emerging industries

At the macro level, identifying an increasing amount of IRs translates that a given industry is experiencing a latent change, and disruption is not far from happening. The present thesis findings have corroborated that argument by exposing an increasing amount of IRs contracted for the AV industry.

2.1.1. Interorganizational relationships: Archetypal strategies in industry emergence settings

We have focused on literature's awareness of organizations' tendency to contract interorganizational relationships (IRs) when the industry is shaken up. Disruptive innovation is eventually recognized to have this extraordinary power on industries, thus impacting organizations' strategic behaviors. Growing from there, we have considered that interorganizational relationships, besides being straight responses of organizations to change, greatly telegraph the change in a given industry. For that, we discussed the IR literature that focused on understanding why organizations must collaborate. Because networks focus on organizations and their relationships, it has been accepted that network analysis is the most suitable way of analyzing (Van de Ven et al., 1976).

From the transaction cost theory's perspective, disruptive innovation disturbs the optimal resource organization that enables companies to reduce their costs either through transaction costs leveling (Kumar & Jyotishi, 2013) in the emerging industry. The cost adaption induced strategic questionings to solve the problem internally or externally. The data retrieved in the present thesis presented that higher is the tendency for exogenous strategies in those settings.

The observation of the multiplying number of exogenous strategies in turbulent times as it is during industry emergence is well littered (Agarwal & Bayus, 2003; Klepper & Graddy, 1990). We built upon that argument to assume that if more IRs are contracted during turbulent times, reciprocally, these turbulent times may be foreseeable by assessing the amount of IRs.

The adoption of an inductive approach assumed that IRs served as aggregates to study a macro phenomenon: industry emergence. As such, the concatenation of several key literature concepts as part of a continuum led us to identify the deep mechanisms that explain industry emergence: disruption innovation creates a turbulent environment, to which organizations need to adapt. Most frequently, they do it through IRs.

The pattern analysis carried out in this research telegraphed similarities with an industry life cycle model. In the first phase of industry emergence - the initial phase - the amount of IRs observed corresponds to the lethargic and transitional phases. The number of IRs is relatively low. Then, when the number of IR progresses, the industry life cycle moves to the emergent phase. Finally, we argued that the growth phase of an emerging industry resonates as a densifying number of IRs at the network level and is triggered by the emergence of a dominant technological design.

The positive correlation between the adapted Industry Life Cycle (ILC) model and the evolution of IRs showed that IRs are great metrics to identify emergence when it occurs rather than waiting for disruption to dismantle the industry. Even though the emergence of a new industry can impact organizational performance, it also has a triggering effect on organizational behavior. In terms of strategic organizational change, the literature discusses organizations' high tendency to contract collaborative relationships to access complementary resources due to innovation's competence-destroying effects. Accordingly, the motivational elements driving the formation of IRs are mainly access to resources, knowledge, and skills demanded from an innovation.

So, considering them as metric of change seemed to be introduced by the literature and initially proven in the present thesis, it corroborated the significant dimension of evolutionary economic questioning about the concept of industry emergence and the dynamics by which emerging industries are formed and developed over time (Krafft et al., 2011).

2.1.2. Opportunities for dynamic pattern analysis in industry emergence settings

Industry emergence implies the necessity to study a phenomenon over an extended time. The consideration of industries aggregated into IR networks is frequently discussed in the literature (Van de Ven & Garud, 1987). We believe in having brought evidence on the correlation between industries and networks. The adaptation of the ILC model by

incorporating the key variables of disruptive innovation has made it possible to contextualize and implement a processual take on a static industry life model.

Speaking about the static state, the literature on industry emergence also deplored the lack of dynamic analysis of a process that inherently has nothing static (Gnyawali & Madhavan, 2001). Indeed, industries are often compared to species (Padgett & Powell, 2012), which continuously observe, adapt, change, and evolve to survive. Furthermore, it showed that there is only so much that we could reveal about industry emergence by analyzing their static state. The present work agreed with studies arguing that industries need to be studied dynamically since disruptive innovation equals industry pattern alterations. To seize the alteration of industry patterns, we focused on a longitudinal analysis of the IRs.

As a result, we have contributed to the evolutionary economic literature by bringing shreds of evidence regarding the industry's origin by identifying the emergence through an increasing level of IRs observed in a given time. The passage from one phase to another has been carried out based on statistical treatment of evolution patterns and enables predictability, discussed by Padgett and Powell (2012). The problem of emergence is partly answered if organizations assess the number of IRs in their industry. The quantitative assessment of industry emergence showed that it is not a linear phenomenon and focused on how technologies evolve.

Finally, the consideration of IRs from a different level of analysis is, according to us, contributing to our contributions at the macro level analysis of emerging industries through a longitudinal perspective. Studies on IR networks already have considered the effects of IR networks on organizational performances (Bergenholtz & Waldstrøm, 2011) and the exogenous (Pfeffer & Salancik, 1978) and internal motives (Coase, 1937; Williamson, 1973) of collaborative behaviors. However, these studies mainly remained at the organizational level of IR networks. Thus, we converged on the organizational level studies to build on the whole network level and considered that IR networks are aggregates of complex emerging industries.

In addition, emergence and structuration are two distinct concepts that raise different questions even though part of the same approach. We believe that bringing an answer to the emergence problem only prepared the field to understand how emerging industries then structure. The understanding of industry structuration patterns opened further discussions. Eventually, we adopted a network analysis level to study how the multitude of IRs contracted

over time tend to organize; the response was found in the technological content explanations (Adner, 2017; Grodal et al., 2014).

2.2. The potency of Key Technological Activities in industry emergence studies

The second contribution relegated the level of analysis from a macro lens to an IR network level. It enabled us to present our second main theoretical contribution to study industry emergence through IR networks building around Key Technological Activities. By doing so, we manifest, once again, the contribution to the evolutionary economic theories calling for dynamic analysis of industry emergence patterns. Here, the discussions about emergence and structuration made sense since the emergence point of industry, once identified, raises additional questions: how do organizations can apprehend emerging industries caused by disruptive innovation?

For that, we converged the discussions around disruptive innovation together with networks similar to Adner's (2017) perception of ecosystems. We corroborate Adner's approach by leaning against the wide range of works on disruptive innovations' technological complexity (Abernathy & Utterback, 1978). Beyond accepting complexity as an inherent characteristic of disruptive innovations, we proposed considering complexity as the primary variable of studying industry emergence. Most studies argued that complexity inheres to the different components required in the new product architecture (Anderson & Tushman, 1990). Supposedly, we assume that organizations are willing to participate in the emerging industry. In that case, they must identify which technology best suits the strategy and hold the greatest growth perspectives: therefore, understand disruptive innovation's content. The assessment of industry emergence highlights the types of IRs adopted between organizations and foremost sheds light on IR formation's technological rationale. The depiction of patterns in collaboration motives brings information in regards to where the industry is going technologically.

These questions have most often found answers in the disruptive innovation theory, yet have remained at the organizational level (Provan et al., 2007). By reverse reasoning, we have argued that organizations face disruptive innovation in one way, yet they may also be key influencers of the structuration patterns. The problem is that organizations can find it

challenging to understand the patterns of an industry that is still emerging, thus, not structured in any shape or form. Nevertheless, how does that inform us about the overall industry structuration patterns? We argue that this analysis level does not bring so much information on how organizations could apprehend the emerging industry's structuration by being limited at the organizational level.

However, it is not necessarily a question of foreseeability; we argue that organizations need to understand what hides behind the word disruption. In that sense, we merged with studies that focused on the innovation content itself (Abernathy & Utterback, 1978; Anderson & Tushman, 1990; Chandy & Tellis, 1998). These studies discuss how disruptive innovation settle in the industry through analogical studies based on phases of preparadigmatic and paradigmatic changes (Teece, 1986), the importance of dominant designs (Anderson & Tushman, 1990; Hargadon & Douglas, 2001), and the role of identifying main technological categories (Grodal et al., 2014).

In those terms, and in line with our first contribution, we have found a systematic linkage between the content of disruptive innovation and the IR network formation motives, and related to Adner's (2017) work on ecosystem formation. The identification of paramount studies focusing on the innovation content itself opened the way for fascinating research directions to consider disruptive innovation and IR networks as critical variables of industry emergence (Forbes & Kirsch, 2011; Navis & Glynn, 2010).

By doing that, we have agreed with Adner's paper (2017), stating the need for more studies about ecosystem emergence around key activities required a final value proposition to become commercialized (Figure 81).

Figure 81. Conceptualization of emerging industries (inspired by Adner, 2017)

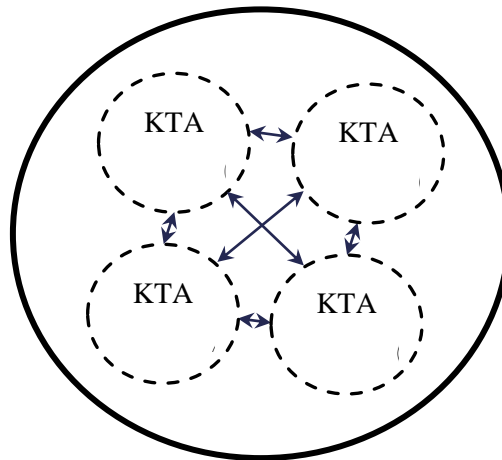

This argument is in line with the category studies (Grodal et al., 2014) and highlighted a prominent gap in the IR literature: the need for a replicable construct of emergence around innovation content categories rather than focal companies (Adner, 2017). Consequently, we build upon the detachment from a company-centric approach towards an activity-centric approach that showed that in a technologically intensive context, meta structures inhabitants, e.g., organizations, are driven by technological activities they need to acquire resources and capabilities. Besides, applying an activity-centric perspective on industry emergence seemed to provide solid ground for macro level analysis because it retrieved information from a large pool of collaborating organizations. Additionally, we dedicated a fair amount of time discussing disruptive innovation's propensity to create unstable environments due to the lack of resources caused by the disruptive innovations technological complexity.

The disruptive innovation concept's consideration lies the foundation of our second contribution to the evolutionary theory since structuration is assessed through IR networks around technological drivers (KTAs) rather than focal organizations. It also concurred with recent studies referring to industries as networks (Ritter & Gemuenden, 2003).

Altogether, the KTAs concur with the commercialization of the disruptive innovation, also called the final value proposition (Adner, 2017). We contribute to the literature on disruptive innovation by proposing to assess the concept of disruptive innovation from a different perspective. We consider that disruptive innovation is a set of KTAs that all together enable the final proposition to exist (*ibid*). As a result, our research work aligned with Adner's

(2017) argument by adding a statistical identification of five KTAs: connectivity, artificial intelligence, sensing, test, and commercialization, and Mobility-as-a-Service.

This second network-level contribution first builds upon the categorical literature and Adner's article (2017), calling for the measurability of meta-structure emergence by proposing a construct of ecosystem emergence around technological activities rather than focal organizations. Furthermore, the emergence of IR networks around KTAs responded to several theoretical gaps at a macro-level. We proposed a precise methodology to identify KTAs through the indexation of IRs over a long period, even though it required much time and data collection processes to amass, in fine, it allowed us to identify that IRs, when studied at the macro-level, are information-rich and strategical tools to identify the patterns of industry emergence.

Following our funnel approach, we discussed the organizational level findings in the last part of this thesis.

2.3. Contributions at the organizational level

The only formation of IRs is not sufficient to explain why they occur, between whom and when; understanding how populations grow and identifying the processes they follow implies analyzing such IR networks at the organizational level.

Anchored in a multi-level setting, industry emergence is a set of phenomena in IR networks composed of organizations with their inherent characteristics and behaviors. The study at the organizational level induced a fine-grained analysis of organizational attributes and collaborative patterns. Considering that each network had a technological backbone (KTAs composed of sub-activities), we have discussed the kinds of ties that matter in each KTA and the circumstances under which they matter: the technological content. We argue that it is our main contribution to network analysis at the organizational level because network composition studies are limited to why these IRs are contracted and nurture the network formation studies (Oliver, 1990).

Combining the idea that industries emerge through KTAs and the longitudinal analysis of structuration patterns, the present thesis provided information regarding how innovation content and organizational attributes may influence the structuration patterns within each KTA. This was interesting because it enabled to widen the lens of organizational level studies

to several networks simultaneously to discuss what kind of tie matters and under which circumstances (Nohria & Eccles, 1992). In so doing, we brought contributions regarding the relatedness of each level of analysis to wholly explain industry emergence and structuration (Zaheer et al., 2010). We empirically showed that exogenous elements are key variables to understand network composition patterns and IR types (Hannan & Freeman, 1977) simultaneously for multiple networks (Zaheer et al., 2010).

The sub-activities inherent to each IR showed that the innovation content is a driver for specific collaborative patterns. In general, we discussed that the more disruptive and far-from the traditional the innovation, the more concentrated the collaboration (AI KTA in our findings) with heterophile companies. Following the same idea, we have shown that the less clear and straightforward the innovation content, the more extended the collaboration and restricted to more short-term IRs (connectivity and sensing KTAs in our case). As it is the case for the innovation content here, the understanding of exogenous criteria enables discussion of disruptive innovation foreseeability if properly categorized into sub-activities. We discussed that understanding homophily and heterophily in network composition does not bring much to the understanding of how population grows and evolves, yet is a statement of how the network looks. Linking elements regarding the motives of IR formation, though brings light on key elements for analysis, the drivers signaled by network ties (Zaheer et al., 2010).

By kind of ties, we discussed the IR types adopted by incumbents and new entrants. The innovation content in each KTA defined the circumstances.

Consequently, our research mainly leans against significant work existing on organizational level discussions, yet argued that these studies mainly focused on a particular organization without considering the collaboration patterns by studying the strategical choices and analyzing organizational attributes as industry emergence variables (McPherson et al., 2001). We have considered that network composition represents an essential element in understanding collaboration patterns within a network. What we have discussed in that terms in the high tendency to collaborate as part of the heterophilic process when the innovation content is highly far from an organization's initial expertise. The dominant role played by technology and telecommunication companies in the connectivity and AI KTA illustrate our argument.

To conclude the discussions revolving around the theoretical contributions, we argue that our three-level funnel approach represents the first take on quantitative assessment of industry emergence while emergence occurs. Before we discuss the managerial and methodological contributions of our research, let us summarize the theoretical contributions hereafter.

To clarify the next paragraph on theoretical contributions, we propose to synthesize the theoretical contributions first.

Synthesis of theoretical contributions

The work carried out in this doctoral thesis leaves several contributions on its path by looking for answers regarding how industries emerge and structure to give insights regarding a relatively organizational perspective on disruptive innovation. By seeking to answer questions revolving around industry emergence and the challenges of organizations to renew innovativeness, we proposed to reflect on the problem of emergence itself by extricating ourselves from the binary finalities available to organizations when industries emerge after disruption: either succeed or fail. We identified disruptive innovation as a trigger of industry emergence; therefore, we have chosen to approach the theory of disruptive innovation (Christensen, 1997) differently by enrolling disruption and the related variables in a theorization process that seeks to understand what causes disruption, how does disruption become an emerging industry, and how to assess an emerging industry (Padgett & Powell, 2012) through the evolutionary economics (Dosi et al., 1988; Nelson & Winter, 1982; O'Reilly & Tushman, 1996).

At the macro level, the consideration of IRs as industry emergence metrics shed light on a dynamic perspective of industry emergence rather than observing an industry emergence through ILC models. However, the parallel between the static ILC structuration model showed a correlation between industry life stages and IR networks emergence and structuration phases (lethargic, transitional, progressive, and densifying). It corroborated our initial postulate arguing that if disruptive innovation causes turbulences, understanding why and how organizations adapt to it could bear significant signals regarding industry emergence processes.

We differentiated industry emergence and industry structuration at the network level because each concept has inherent challenges that need to be considered independently. Industry emergence implied considering how to predict and assess industry emergence. In contrast, industry structuration induced the analysis of how the industry structures over time and led to the analysis of innovation content: KTAs. In these discussions, we have shown the importance of considering disruptive innovation as an aggregated whole of innovation content categories.

In fine, we have adopted a highly innovation content dependent on industry emergence and build upon literature clear arguments about IR formation: the need to acquire critical resources when disruption creates turbulences.

At the organizational level, we have agreed with the network literature discussing the need to understand why some kind of ties occur and under which circumstances; by doing that, we have outperformed the straightforward consideration of homophilic and heterophilic observation and linked them to a variable: the innovation content.

Section III. Managerial and methodological contributions

Besides theoretical contributions, the present thesis also leaves methodological and managerial contributions on its way. We start by exposing our methodological contributions and follow with the managerial contributions.

1. Methodological contributions

The principal methodological contribution is the propensity of our findings to move from an interorganizational level to a whole level network and the impacts on industry emergence analysis. However, an awareness of the full methodological gaps eventually allowed us to bring valuable contributions. Based on an inductive approach, we retrieved organizational and interorganizational information and looked at the effects on industry emergence; we believe that this thesis's main contribution at the methodological level is due to the ability to combine several analysis levels as part of unique research work.

We argue that we positively contribute to the social network methodology, which mainly focuses on the organizational level by analyzing organizational attributes rather than macro level networking patterns. Besides, we explored several networks through a cross-level analysis combining organizational and network levels and interorganizational and whole network levels of analysis.

We also proposed a longitudinal cross-level analysis to provide insight into the dynamic study of networks. Our approach enabled us to depict several critical patterns regarding networks and merges with Burt's (1998) discussion around the limited amount of evidence that the literature holds regarding network dynamics over time. It corroborated the argument that the static network study only brings a limited amount of evidence to predict networks (Proven et al., 2010). Indeed, the literature on SNA discussed the difficulty of carrying out cross-level analysis between networks because analyzing networks require much data. What makes the SNA methodology more complex, besides the access to the data, is the difficulty of gathering data over an extended period (Bell & Zaheer, 2007). It is even more crucial as the evolutionary and IR network literature pointed out the crucially important role of longitudinal

analysis of such concepts. Even though we agreed with the complexity of gathering network data over an extended period, we nevertheless persisted in bringing empirical evidence regarding what we can learn about networks when adopting a dynamic approach.

We carried out a meticulous data collection phase, where we have built two independent yet positively related databases composed of the structural and attribute data.

By doing that, we agreed with the complexity and time-consuming aspect of network analysis methodologies highlighted by researchers (Kurt & Kurt, 2020). However, we also corroborate the main argument defending the necessity to study network dynamics.

Therefore, we applied an SNA methodology to determine the patterns of emergence of a new industry. Mostly, SNA methodologies are used in social and cognitive sciences (Wasserman, 1994), yet the statistical data treatment opportunities and the growing role of SNA in management studies enabled us to propose an application of such methodology at the macro level. We proposed to analyze IR as variables of industry emergence rather than the matter of study itself due to a macro level positioning. Statistically, we analyzed their evolution and structuration over a period.

Not only have we studied networks through the structural collected following the detailed requirements of SNA, but we also proposed a multi-level analysis through the organizational attributes. Therefore, the organizational and interorganizational data enabled us to depict patterns at two levels:

- At the macro level, we have statistically identified phases of industry emergence based on the mathematical evolution of IRs mirrored with the adapted industry life cycle model and brought evidence that industry emergence can be studied beyond static industry life cycle models.
- At the organizational level, we have statistically identified how the main organizational attributes represent critical antecedents exposing organizations to adopt predictable collaborative strategic paths. We argued that network composition holds a tremendous interest in strategic decision-making processes.

As a result, we agreed with Palotti et al. (2013) about the linkage between different levels of analysis and the impacts of cross-level variables on the global structure of IR networks. We

offered insights by combining different analysis levels and inductively identified similarities and dissimilarities in network composition and the implications at the IR level.

Besides the macro level positioning and the empirical evidence discussed in the preceding paragraphs, the present thesis also contributes to the SNA methodology by introducing technological drivers' role to the network emergence. Therefore, instead of computing the centrality degrees of focal organizations, we firstly focused on the motives of the formation of IRs. Later, we focused on the attribute information to determine how organizations, according to their attributes, can follow one strategic path or another and discuss that network composition analysis should not exclusively occur in organizational contexts.

Finally, this showed that SNA is an exciting methodology to conclude attribute variables to large-scale network studies.

2. Managerial contributions

Finally, the CIFRE anchorage of the present thesis called for valuable managerial contributions for companies. The project was established to inform managers and practitioners about the network dynamics that reveal industry emergence.

2.1. Monitoring external environments to seize industry emergence

We provided a model of the industry life-cycle put in parallel with the evolution of KTA network emergence. The correlation showed that managers and practitioners could use IRs as *ex-ante* metrics to seize industry emergence, and understand the structuration, thus the competitive landscape, by focusing on the innovation content through KTA identification.

Complementing the emergence of the industry around KTAs, we provide a deeper understanding of geographical specialization that may have an important outcome for policymakers, managers, and investors. The ambition of this study was to lead to the formulation of some managerial recommendations.

As such, our study should be useful to both organizations experiencing disruption of their traditional industry and organizations influencing the disruption of a given industry. Given the literature review presented in the first part of this thesis, we observed that works on industry

emergence are specifically interested in helping organizations envision and appreciate the thorough and in-depth industrial growth dynamics applicable to their particular context. Learning from this provides the basis for better processes for directing and handling future innovations. Rapid iteration is useful and allows areas of specific interest to be defined for further development and investment, and make the decision-making process smoother.

The study of industry emergence naturally ascribes to contextual variables that organizations need to consider in strategic decisions. The present research work suggested that disruptive innovations are not linear and require a comprehensive understanding of the technologies' architecture, drivers, and challenges. The assessment of an industry beforehand and its structuration may give insights to understand if this industry is attractive for organizations.

At the very macro level, the *ex-ante* identification of industry emergence may provide organizations several critical strategic directions.

First, identifying disruption before it happens may prepare the organization to give out on its potential rigid operational structure and focus on parallel games through ambidextrous activities. In line with the main critiques made to the disruptive innovation theory and in all modesty, we believe that the main contribution of this research is that it contributes to consider disruptive innovation as a variable of industry emergence rather than a failure explanation.

Second, the assessment of industry emergence through the study of IRs can help organizations make sense of the emerging industry by identifying IR formation drivers, e.g., the KTAs, and drive their collaborative strategies.

2.2. New entrants: triggers for industry emergence

From the new entrant's perspective, the *ex-ante* industry emergence assessment relays several key benefits. The intrinsic characteristics of disruptive innovation open new entrants' opportunities because they can deflect entry barriers, impeding the traditional industry. By disrupting the traditional industry or participating in the early phase of the emerging industry may provide new entrants with the benefit of an early bird by proposing its positioning and presence in the new industry while competing with incumbents, which used to use the barrier to entry as an act of competitive deterrent. In general, what we learned from this thesis can be summarized in three points.

New entrant companies are expected to target specific innovation content segments: the emerging industry will provide new entrants with new opportunities by focusing on selected activities of the value chain by targeting specific and highly intricate activities. Consequently, many more new entrants are suspected of entering future emergent industries because the disruptions appear more and more radical than the traditional industries that thrived until nowadays. In that perspective, incumbents need to be aware that new entrants exert a more significant impact on customers and regulators because they know the best way to attract interest in future mobility. Even though new entrants seem to be very dominant in emerging industries, automotive OEMs with impressive sales growth (notably Chinese OEMs) could exploit the ongoing disruptive innovations.

2.3. Incumbents: pivotal players of industry emergence

The conclusions are more nuanced for incumbents because their survival will depend on more elements than positioning underpinnings. Although the AV technology is there, automotive incumbents will have to consider their strategies by implementing a dynamic approach. We believe that the role of new entrant organizations is more considerable than only restricted to the ‘disruptor’ yet through a flexible operational process and financial structure, these organizations, regardless of their size, are the ones to carry industry emergence in the early stages (lethargic phase in our case).

We learned here that even though industry emergence is foreseeable and the structure of emerging industries positively related to the innovation content, our conclusion revealed that automotive incumbents would need to prepare for turbulence at least until 2025 because most OEMs predict to launch their first AV in that horizon (c.f. **Part II**). It will demand continuous improvement in strategic decisions to explore technological alternatives and complement their existing business with the emerging ones. In that perspective, we have discussed that organizations need to collaborate in heterophilic processes anchored in more sophisticated and long-term scenarios through leveraged partnerships.

We have observed that the AV industry is shifting from competition among incumbent organizations towards a new competitive landscape. Our conclusions in each KTA showed that incumbent OEMs and suppliers need to form partnerships with technology and service providers for artificial intelligence for AVs to succeed.

In the same vein, incumbent OEMs will need to show transformative change by aligning their skills and processes to address the emerging industry. Our study showed a great tendency to open to exogenous sources of information. What is specific to an emerging industry is the emerging challenges: these challenges have to be addressed in terms of partner choice (who will help me reach my goals the best?) and the partnership type (how can I reach my goal?). In that sense, the best response to a challenge will consider the innovation content too.

We recommended that disruptive innovation brings a plethora of interorganizational relationship opportunities needed by both types of organizations. If we stick to new entrants, the findings showed that regardless of the interconnected network, new entrants are key drivers of industry emergence, and their high presence in emerging industries translate and corroborate both the technological complexity of disruptive innovations and the necessity to combine dynamic capabilities to make the final value proposition bankable.

The allocation of resources dedicated to industry scanning and information interpretation has been proven to be a solid strategical awareness for organizations because new entrants will tend to collaborate with incumbents to benefit from their financial stability, experience, and reputation (Markman & Waldron, 2013).

Finally, these strategic directions will help automotive incumbents to reshape their value proposition through the right understanding of the new one (KTA). Different partners in different segments of the emerging industry will help organizations distinguish their products and services and move from value proposition to integrated mobility service providers. The accumulation of IR retrieved information and experience will guide incumbents to build new business models, implying cross-fertilization of opportunities from the traditional industry with the new business activity.

The emergence of an industry caused by the disruption of the existing industry reveals that it is necessary to be cautious and reflective about what technologies to focus on strategic adaption.

From the incumbents' perspective, the contributions are even more interesting as the literature often discusses them as the 'losers' in the face of industry emergence caused by disruptive innovation. Although we agree with the various explanatory factors hidden behind the

incumbent's failure, we believed that these conclusions were made too early because they only applied to given organizations and domains in specific settings.

Nowadays, organizations implement many market intelligence tools to capture changes in their traditional industry because scanning the environment is key. The embedded strategic activities created a sieve-like platform of organizations making the drainage of new types of information easily detectable. Therefore, identifying a multiplying number of IRs could quickly become an automatized process within an organization's market intelligence department.

Eventually, the argument that makes incumbents insensitive to innovation is more or less linked to internal inertia that the not foreseeability of disruption.

We suggested that incumbent organizations implement their industry to depict many new entrants' arrival and detect these new entrants' strategic moves. Identifying critical changes in a monitored industry should make sense for any organization that wants to keep up with its industry.

To conclude the present chapter, we discuss the limits and future research directions of the present thesis.

Section IV. Limits and future research directions

This doctoral research presents some limitations that indeed open the way for future research. The principal limit relies on the contextualization of our findings; thus, the external validity of the research (internal replication) (McMillan, 2000).

Despite the great efforts to decontextualize our findings and contributions, they remained mainly anchored in a real industry with determined boundaries and characteristics. Based on a limited number of variables, we proposed to explain the ties between these variables (e.g., innovation content and IR patterns) to deduce plausible conclusions based on premises on a particular context. Indeed, the study presents the emergence and structuration of the AV industry and constraints the use of industry-related variables as part of the general conclusions.

The AV industry is particular. Despite being very modern and accurate in the current world, it represents an extreme case (Eisenhardt, 1989) of disruptive innovation with different disruptive innovation levels and different kinds of related technologies that are more (or less) complex than disruptive innovations in other sectors. Identifying Key Technological Activities remains very specific to the AV industry and emblematic technologies whose transferability needs to be applied to high technology-intensive industries. However, the transcription of real-world information into statistical data offered possibilities from an inductive perspective to identify the main emergence process by studying IRs as aggregates of networked industries. It would be interesting to see in other emerging industries that if organizations' strategic change takes the same forms, they have the same drivers and react to the same constraints.

It could be interesting to continue the work on industry emergence by testing the valuable power of IRs as a metric of industry emergence in other highly-technology intensive industries to see if the patterns of collaboration seem to be the same, or if new patterns other than homophily and heterophily could be assessed, and identify KTAs in other settings than AV industry. Even though it would bring empirical evidence to the present doctoral research and partially remove external validity questionings, we believe that the process of KTA identification through the densification of IRs over a period represents critical information on

industry emergence. Also, the identification of KTAs in other industry emergence settings may highlight new variables of emergence, such as a relativized approach on each phase of emergence in terms of the number of IRs by year and number of involved organizations.

Even though external validity limits apply to this study, we argue that the strict data collection and statistical treatment of the data reported in Part II can support the delineation of instrumentation threats that usually show any studies' internal validity.

In parallel to the study's intrinsic anchorage characteristics, this study was carried out during acute industry turbulence caused by many contextual factors such as a decline in production volumes forecasted for 2019 and 2020 with already declining volumes in 2018. In fact, in 2018, the industry endured a solid downturn in production, and the forecasts were deemed to persist in the following years, without mentioning the pandemic that happened in 2019. Automotive organizations were already suffering from significant pressures on their margins, pushing them to cut costs because of (e.g., Ford closed several plants in the US) weighing regulations (e.g., European Regulation for CO2 emissions constraining OEMs to restrict CO2 emissions to less than 95 grams per kilometer for new cars) and other trade tensions (e.g., Trump's threat to put tariffs on European cars).

The already turbulent context that organizations were facing may have driven some conclusions that could have been different in certain times (e.g., more long-termed IRs, different phases of emergence, different time segmentation for each phase). We, therefore, are interested to see how emerging industries react in terms of IR formation when constrained by global elements when turbulence is only sourced by disruptive innovation.

Despite the contextual anchorage, the study ascribes to the emergence of the industry caused by disruptive innovation, representing a great link amongst theoretical axes, yet restrains the interpretation of disruptive innovations' variables. However, disruptive innovations' common characteristics let us believe that these variables may prove future research applicability.

In doing so, we may have overlooked the roles of different data sources by sticking to the social network analysis methodology. The methodology adopted in this thesis made it possible to consider and understand the interrelatedness of IRs and industry emergence in the automotive industry in which announces of partnerships have become the new strategic fashion. We may question the availability of such information in other cases.

Finally, the consideration of IRs as metrics of industry emergence also collides a particular limit that did not take the longevity of each IR into account rather focused on the date of creation. Similarly, the consideration of IRs as metrics of industry emergence overlooked the actual output of each IR.

To conclude, working on industry emergence has been a very interesting project that unfolded theoretical crossbreeding. Today, innovations are the backbone in organizational settings but also in customers' minds. Keeping track of the next disruptive innovation and how it will occur is an exciting research matter about which we are excited to read and continue working.

REFERENCES

- Abernathy, W. J., & Clark, K. B. (1985). Innovation: Mapping the Winds of Creative Destruction. *Research Policy*, 14(1), 3–22.
- Abernathy, W. J., & Utterback, J. M. (1978). Patterns of Industrial Innovation. *Technology Review*, 80(7), 2–9.
- Abrutyn, S. (2012). Toward A Theory of Institutional Ecology: The Dynamics of Macro Structural Space. *Review of European Studies*, 4(5), 167–180.
- Adner, R. (2017). Ecosystem as Structure: An Actionable Construct for Strategy. *Journal of Management*, 43(1), 39–58.
- Adner, R., & Kapoor, R. (2016). Innovation Ecosystems and the Pace of Substitution: Re-examining Technology S-curves. *Strategic Management Journal*, 37(4), 625–648.
- Agarwal, R., & Bayus, B. L. (2003). Creating and Surviving in New Industries. *Advances in Strategic Management*, 21, 107–130.
- Agarwal, R., & Sarkar, R. (2002). The Condition Effect on Time on Firm Survival: An Industry Life Cycle Approach. *Academy of Management Journal*, 45(2), 971–994.
- Aghion, P., & Howitt, P. (1992). A Model of Growth Through Creative Destruction. *Econometrica*, 60(2), 323–351.
- Ahrweiler, P., & Keane, M. T. (2013). Innovation Networks. *Mind & Society*, 12(1), 73–90.
- Ahuja, G., Soda, G., & Zaheer, A. (2012). The Genesis and Dynamics of Organizational Networks. *Organization Science*, 23(2), 434–448.
- Ahuja, G. (2000). The Duality of Collaboration: Inducements and Opportunities in the Formation of Interfirm Linkages. *Strategic Management Journal*, 21(3), 317–343.
- Ahuja, G., & Katila, R. (2001). Technological Acquisitions and the Innovation Performance of Acquiring Firms: A Longitudinal Study. *Strategic Management Journal*, 22(3), 197–220.
- Ahuja, G., & Lampert, C. M. (2001). Entrepreneurship in the Large Corporation: A Longitudinal Study of How Established Firms Create Breakthrough Inventions. *Strategic Management Journal*, 22(6–7), 521–543.
- Akerlof, G. A. (1970). The Market for ‘Lemons’: Quality Uncertainty and the Market Mechanism. *The Quarterly Journal of Economics*, 84(3), 488–500.
- Alchian, A. A., & Demsetz, H. (1972). Production, Information Costs, and Economic Organization. *The American Economic Review*, 62(5), 777–795.
- Aldrich, H. E., & Fiol, C. M. (1994). Fools Rush in? The institutional Context of Industry Creation. *Academy of Management Review*, 19(4), 645–670.
- Aldrich, H., & Ruef, M. (2006). *Organizations Evolving*. SAGE Publications.
- Allard-Poesi, F., & Perret, V. (2014). Fondements Epistémologiques de la Recherche. In R. A. Thiétart et al. (Eds.), *Méthodes de Recherche en Management* (pp. 14–47). Dunod.
- Allee, V. (2000). Reconfiguring the Value Network. *Journal of Business Strategy*, 21(4), 36–39.

- Allen, P. T., & Stephenson, G. M. (1983). Inter-Group Understanding and Size of Organisation. *British Journal of Industrial Relations*, 21(3), 312–329.
- Almeida, P., & Kogut, B. (1999). Localization of Knowledge and the Mobility of Engineers in Regional Networks. *Management Science*, 45(7), 905–917.
- Amans, P., & Loup, S. (2004). *Le Rôle-clé des Artisans d'Art dans la Conservation du Patrimoine: Des Compétences Organisationnelles au Réseau Clignotant*. 7ème Congrès International Francophone en Entrepreneuriat et PME (CIFPME), Montpellier.
- Anderson, P., & Tushman, M. L. (1990). Technological Discontinuities and Dominant Designs: A Cyclical Model of Technological Change. *Administrative Science Quarterly*, 35(4), 604–633.
- Anggraeni, E., Hartigh, E., & Zegveld, M. (2007). Business Ecosystem as a Perspective for Studying the Relations Between Firms and their Business Networks. *Phase Transitions in Organizations*. ECCON 2007 Annual Meeting, Veldhoven.
- Angué, K. (2006). *Les Partenaires de Coopération en Recherche et Développement dans les Sciences du Vivant* [PhD Thesis]. Nice.
- Ansari, A. M., Koenigsberg, O., & Stahl, F. (2011). Modeling Multiple Relationships in Social Networks. *Journal of Marketing Management*, 48(4), 713–728.
- Ansari, S., Garud, R., & Kumaraswamy, A. (2016). The Disruptor's Dilemma: TiVo and the U.S Television Ecosystem. *Strategic Management Journal*, 37, 1829–1853.
- Ansari, S., & Krop, P. (2012). Incumbent Performance in the Face of a Radical Innovation: Towards a Framework for Incumbent Challenger Dynamics. *Research Policy*, 41(8), 1357–1374.
- Aren, S., & Alpkhan, L. (2009). *Ambidexterity: The Combinations of Seemingly Conflicting Priorities*. 5th International Strategic Management Conference, South Africa.
- Argote, L., McEvily, B., & Reagans, R. (2003). Managing Knowledge in Organizations: An Integrative Framework and Review of Emerging Themes. *Management Science*, 49(4), 571–582.
- Ariño, A., & Ring, P. S. (2010). The Role of Fairness in Alliance Formation. *Strategic Management Journal*, 31(10), 1054–1087.
- Arrow, K. J. (1971). *Essays in the Theory of Risk-Bearing*. Marham Publishing Co.
- Arthur, W. B. (1989). Competing Technologies, Increasing Returns, and Lock-In by Historical Events. *Economic Journal*, 99(394), 116–131.
- Assens, C. (2013). *Le Management des Réseaux*. de Boeck.
- Assink, M. (2006). Inhibitors of Disruptive Innovation Capability: A Conceptual Model. *European Journal of Innovation Management*, 9(2), 215–233.
- Astley, W. G. (1985). Administrative Science as Socially Constructed Truth. *Administrative Science Quarterly*, 30(4), 497–513.
- Attour, A., & Lazaric, N. (2020). From Knowledge to Business Ecosystems: Emergence of an Entrepreneurial Activity During Knowledge Replication. *Small Business Economics*, 54(2), 575–587.

- Audretsch, D. B. (1995). Innovation, Growth and Survival. *International Journal of Industrial Organization*, 13(4), 441–457
- Auster, E. (1992). The Relationship of Industry Evolution to Patterns of Technological Linkages, Joint Ventures, and Direct Investment Between U.S. and Japan. *Management Science*, 38(6), 778–792.
- Aydin, N. (2019). Social Network Analysis: Literature Review. *Academic Journal of Information Technology*, 9(34), 73–80.
- Bain, J. S. (1959). *Industrial Organization*. John Wiley and Sons.
- Baker, W. E., & Faulkner, R. R. (2017). Interorganizational Networks. In J. A. C. Baum (Ed.), *The Blackwell Companion to Organizations* (pp. 520–540). John Wiley & Sons.
- Baraldi, E., Gressetvold, E., & Harrison, D. (2012). Resource Interaction in Inter-organizational Networks: Foundations, Comparison, and a Research Agenda. *Journal of Business Research*, 65(2), 266–276.
- Barney, J. (1991). Firm Resources and Sustained Competitive Advantage. *Journal of Management*, 17(1), 99–120.
- Barranco, O., Lozares, C., & Muntanyola-Saura, D. (2019). Heterophily in Social Groups Formation: A Social Network Analysis. *Quality & Quantity*, 53(2), 599–619.
- Basalla, G. (1988). *The Evolution of Technology*. Cambridge University Press.
- Basole, R. (2009). Visualization of Interfirm Relations in a Converging Mobile Ecosystem. *Journal of Information Technology*, 24(2), 144–159.
- Bazeley, P. (2009). Integrating Data Analyses in Mixed Methods Research. *Journal of Mixed Methods Research*, 3(3), 203–207.
- Bell, G. G., & Zaheer, A. (2007). Geography, Networks, and Knowledge Flow. *Organization Science*, 18(6), 955–972.
- Bengtsson, M., & Kock, S. (2000). Coopetition in Business Networks—To Cooperate and Compete Simultaneously. *Industrial Marketing Management*, 29(5), 411–426.
- Bengtsson, M., & Kock, S. (2014). Coopetition—Quo vadis? Past Accomplishments and Future Challenges. *Industrial Marketing Management*, 43(2), 180–188.
- Bengtsson, M., & Sölvell, Ö. (2004). Climate of Competition, Clusters and Innovative Performance. *Scandinavian Journal of Management*, 20(3), 225–244.
- Benner, M. J., & Tripsas, M. (2012). The Influence of Prior Industry Affiliation on Framing in Nascent Industries: The Evolution of Digital Cameras. *Strategic Management Journal*, 33(3), 277–302.
- Bensaou, M., & Venkatraman, N. (1995). Configurations of Interorganizational Relationships: A Comparison Between U.S. and Japanese Automakers. *Management Science*, 41(9), 1471–1492.
- Bergadaà, M., & Nyeck, S. (1992). Recherche en Marketing: Un Etat des Controverses. *Recherche et Applications En Marketing*, 47(3), 23–44.
- Bergek, A., Berggren, C., Magnusson, T., & Hobday, M. (2013). Technological Discontinuities and the Challenge for Incumbent Firms: Destruction, Disruption or Creative accumulation? *Research Policy*, 42(6), 1210–1224.

- Bergenholtz, C., & Waldstrøm, C. (2011). Inter-Organizational Network Studies—A Literature Review. *Industry and Innovation*, 18(6), 539–562.
- Birkinshaw, S. R., Julian. (2008). Organizational Ambidexterity: Antecedents, Outcomes, and Moderators. *Journal of Management*, 34(3), 375–409.
- Bisgin, H., Agarwal, N., & Xu, X. (2010). *Investigating Homophily in Online Social Networks*. IEEE/WIC/ACM International Conference on Web Intelligence and Intelligent Agent Technology, Toronto.
- Bissell, D., Birtchnell, T., Elliott, A., & Hsu, E. L. (2020). Autonomous Automobilities: The Social Impacts of Driverless Vehicles. *Current Sociology*, 68(1), 116–134.
- Blau, P. M. (1977). A Macrosociological Theory of Social Structure. *American Journal of Sociology*, 83(1), 26–54.
- Bocquet, R., Cattellin, M., Thevenard-Puthod, C., Scaraffiotti, J., & Gentet, W. (2006). *The Inter-Firm Networks in the Mountain Tourism Industry: Between Transactions and Competence*. DRUID Summer conference 2006, June 18-20.
- Bloom, N., Jones, C. I., Van Reenen, J., & Webb, M. (2020). Are Ideas Getting Harder to Find? *American Economic Review*, 110(4), 1104–1144.
- Bonacich, P. (1987). Power and Centrality: A Family of Measures. *American Journal of Sociology*, 92(5), 1170–1182.
- Bonacich, P., & Lloyd, P. (2001). Eigenvector-Like Measures of Centrality for Asymmetric Relations. *Social Networks*, 23(3), 191–201.
- Bonel, E., & Rocco, E. (2007). Coopeting to Survive, Surviving Coopetition. *International Studies of Management and Organization*, 37(2), 70–96.
- Bonneuil, C., & Joly, P.-B. (2013). *Sciences, Techniques et Société*. La Découverte.
- Borgatti, S. P., & Everett, M. G. (1997). Network Analysis of 2-mode Data. *Social Networks*, 19(3), 243–269.
- Borgatti, S. P., & Foster, P. C. (2003). The Network Paradigm in Organizational Research: A Review and Typology. *Journal of Management*, 29(6), 991–1013.
- Borgatti, S. P., Mehra, A., Brass, D. J., & Labianca, G. (2009). Network Analysis in the Social Sciences. *Science*, 323(5916), 892–895.
- Borgatti, S. P., Everett, M. G., & Freeman, L. C. (2002). *Ucinet for Windows: Software for Social Network Analysis*. Analytic Technologies.
- Boschma, R. A., & Lambooy, J. G. (1999). Evolutionary Economics and Economic Geography. *Journal of Evolutionary Economics*, 9(4), 411–429.
- Bouncken, R. B., & Kraus, S. (2013). Innovation in Knowledge-intensive Industries: The Double-edged Sword of Coopetition. *Journal of Business Research*, 66(10), 2060–2070.
- Bower, G. H. (1972). Mental imagery and associative learning. Paper presented at the Fifth Annual Symposium on Cognition at Carnegie Mellon University, 1969. In L. Gregg (Ed.), *Cognition in learning and memory* (pp. 51-88). John Wiley & Sons.
- Bower, J. L., & Christensen, C. M. (1995). Disruptive Technologies: Catching the Wave. *Harvard Business Review*, 73(1), 43–53.

- Brandenburger, A., & Nalebuff, B. (1996). *La Co-opétition, une Révolution dans la Manière de Jouer Concurrence et Coopération*. Village Mondial.
- Brown, S., Pyke, D., & Steenhof, P. (2010). Electric Vehicles: The Role and Importance of Standards in an Emerging Market. *Energy Policy*, 38(7), 3797–3806.
- Büchel, F. P., & Scharnhorst, U. (1993). The Learning Potential Assessment Device: Discussion of Theoretical and Methodological Problems. In J. H. M. Hamers, K. Sijtsma, & A. J. J. M. Ruijsenaars (Eds.), *Learning potential assessment. Theoretical, methodological, and practical issues* (pp. 83–111). Swets & Zeitlinger.
- Burger-Helmchen, T., Hussler, C., & Pénin, J. (2011). General Presentation. Rethinking Boundaries for Innovation: Exploring the Shapes and Stakes of the Open Innovation Phenomenon. *Journal of Innovation Economics Management*, 7(1), 3–10
- Burt, R. S. (1995). *Structural Holes – The Social Structure of Competition*. Harvard University Press.
- Burt, R. S. (1997). The Contingent Value of Social Capital. *Administrative Science Quarterly*, 42(2), 339–365.
- Burt, R. S. (2002). The Social Capital of Structural Holes. In F. Mauro, C. Collins, P. England, M. Marshall (Eds.), *The New Economic Sociology* (pp. 148–192). Russel Sage Foundation.
- Cantwell, J., & Hayashi, T. (2019). *Paradigm Shift in Technologies and Innovation Systems*. Springer.
- Carley, K. M., & Kaufer, D. S. (1993). Semantic Connectivity: An Approach for Analyzing Symbols in Semantic Networks. *Communication Theory*, 3(3), 183–213.
- Carnap, R. (2010). Le Dépassement de la Métaphysique par l'Analyse Logique du Langage. In H. Carnap et al. (Eds), *Manifeste du Cercle de Vienne et Autres Ecrits* (pp. 149–171). PUF.
- Carr, L. T. (1994). The Strengths and Weaknesses of Quantitative and Qualitative Research: What Method for Nursing? *Journal of Advanced Nursing*, 20(4), 716–721.
- Cassell, C., & Symon, G. (1994). *Qualitative Methods in Organizational Research: A Practical Guide*. Sage Publications.
- Cassiman, B., Guardo, M., & Valentini, G. (2009). Organising R&D Projects to Profit From Innovation: Insights From Co-opetition. *Long Range Planning*, 42(2), 216–233.
- Chandy, R. K., & Tellis, G. J. (1998). Organizing for Radical Product Innovation: The Overlooked Role of Willingness to Cannibalize. *Journal of Marketing Research*, 35(4), 474–487.
- Chandy, R. K., & Tellis, G. J. (2000). The Incumbent's Curse? Incumbency, Size, and Radical Product Innovation. *Journal of Marketing*, 64(3), 1–17.
- Charitou, C. D., & Markides, C. (2003). Responses to Disruptive Strategic Innovation. *MIT Sloan Management Review*, 44, 55–63.
- Chen, M. J., Su, K. H., & Tsai, W. (2007). Competitive tension: The awareness-motivation-capability Perspective. *Academy of Management Journal*, 50(1), 101–118.
- Chen, M.-J., & MacMillan, I. C. (1992). Nonresponse and Delayed Response to Competitive Moves: The Roles of Competitor Dependence and Action Irreversibility. *The Academy of Management Journal*, 35(3), 539–570

- Chesbrough, H. (2004). Managing Open Innovation. *Research-Technology Management*, 47(1), 23–26.
- Chesbrough, H. (2012). Open Innovation: Where We've Been and Where We're Going. *Research-Technology Management*, 55(4), 20–27.
- Chesbrough, H., & Appleyard, M. (2007). Open Innovation and Strategy. *California Management Review*, 50(1), 50–76.
- Chesbrough, H., & Bogers, M. (2014). Explicating Open Innovation: Clarifying an Emerging Paradigm for Understanding Innovation. *New Frontiers in Open Innovation*, 3–28.
- Chesbrough, H. W. (2003). *Open Innovation: The New Imperative for Creating and Profiting from Technology*. Harvard Business School Press.
- Chesbrough, H. W. (2006). *Open Business Models: How to Thrive in the New Innovation Landscape*. Harvard Business School Press.
- Chiambaretto, P., & Rigaud, E. (2013). Coopétition, Hétérogénéité des Consommateurs et Stratégies de Ciblage. *Journal of Social Management/Revue Européenne des Sciences sociales et du management*. 11(2):98–1&31.
- Chou, H., & Zolkiewski, J. (2017). Coopetition and Value Creation and Appropriation: The Role of Interdependencies, Tensions and Harmony. *Industrial Marketing Management*, 70, 25–33.
- Christensen, C. M. (1997). *The Innovator's Dilemma When New technologies Cause Great Firms to Fail*. Harvard Business School Press.
- Christensen, C. M. (2003). *The Innovator's Solution: Creating and Sustaining Successful Growth*. Harvard Business School Press.
- Christensen, C. M., & Kaufman, S. P. (2006). Assessing Your Organization's Capabilities: Resources, Processes and Priorities. *Harvard Business School Module Note, 607-014*.
- Christensen, C. M., McDonald, R., Altman, E. J., & Palmer, J. E. (2018). Disruptive Innovation: An Intellectual History and Directions for Future Research. *Journal of Management Studies*, 55(7), 1043–1078.
- Christensen, C. M., & Overdorf, M. (2000). Meeting the Challenge of Disruptive Change. *Harvard Business Review*, 78(2), 67–76.
- Christensen, C. M., & Raynor, M. E. (2003). *The Innovator's Solution: Creating and Sustaining Successful Growth*. Harvard Business School Press.
- Christensen, C. M., Raynor, M. E., & McDonald, R. (2015). What Is Disruptive Innovation? *Harvard Business Review*, 93, 44–53.
- Christensen, C. M., & Rosenbloom, R. S. (1995). Explaining the Attacker's Advantage: Technological Paradigms, Organizational Dynamics, and the Value Network. *Research Policy*, 24(2), 233–257.
- Christensen, C. M., & Tedlow, R. S. (2000). Patterns of Disruption in Retailing. *Harvard Business Review*, 78(1), 42–45.
- Čiutienė, R., & Thattakath, E. W. (2014). Influence of Dynamic Capabilities in Creating Disruptive Innovation. *Economics and Business*, 26, 15–26.

- Clark, K. B., Chew, W. B., Fujimoto, T., Meyer, J., & Scherer, F. M. (1987). Product Development in the World Auto Industry. *Brookings Papers on Economic Activity*, 1987(3), 729–781.
- Clark, K., Chew, B., & Fujimoto, T. (1987). Product Development in the World Auto Industry. *Brookings Papers on Economic Activity*, 18(3), 729–782.
- Coase, R. H. (1937). The Nature of the Firm. *Economica*, 4(16), 386–405.
- Coccia, M. (2006). Classifications of Innovations Survey and Future Directions. *SSRN Electronic Journal*, 8(2), 7–19.
- Cohen, W. M., & Levinthal, D. A. (1990). Absorptive Capacity: A New Perspective on Learning and Innovation. *Administrative Science Quarterly*, 35(1), 128–152.
- Coleman, J. S. (1973). *Power and the Structure of Society*. Norton.
- Coleman, J. S. (1990). *Foundations of Social Theory*. Harvard University Press.
- Comte, A. (1844). *Discours sur l'Esprit Positif*. Carilian-Goeury.
- Conner, K. R. (1991). A Historical Comparison of Resource-Based Theory and Five Schools of Thought Within Industrial Organization Economics: Do We Have a New Theory of the Firm? *Journal of Management*, 17(1), 121–154.
- Contractor, F. J., & Lorange, P. (2002). The Growth of Alliances in the Knowledge-based Economy. *International Business Review*, 11(4), 485–502.
- Cooper, R. (1979). The Dimensions of New Product Success And Failure. *Journal of Marketing*, 43(3), 93–103.
- Corallo, A., & Protopapa, S. (2007). Business Networks and Ecosystems: Rethinking the Biological Metaphor. In F. Nachira et al. (Eds.), *Digital Business Ecosystems: The Results and the Perspectives of the Digital Business Ecosystem Research and Development Activities in FP6* (pp. 60–64). European Commission.
- Cordeiro, M., Sarmiento, R. P., Brazdil, P., & Gama, J. (2018). Evolving Networks and Social Network Analysis Methods and Techniques. In M. Cordeiro et al. (Eds.), *Social Media and Journalism - Trends, Connections, Implications* (pp. 102-134). Intech Open.
- Cygler, J., Sroka, W., Solesvik, M., & Dębowska, K. (2018). Benefits and Drawbacks of Coopetition: The Roles of Scope and Durability in Coopetitive Relationships. *Sustainability*, 10(8), 2-24.
- Dahlman, C. J. (1979). The Problem of Externality. *Journal of Law and Economics*, 22(1), 141–162.
- Danneels, E. (2004). Disruptive Technology Reconsidered: A Critique and Research Agenda. *Journal of Product Innovation Management*, 21(4), 246–258.
- David, R. J., Sine, W. D., & Haveman, H. A. (2013). Seizing Opportunity in Emerging Fields: How Institutional Entrepreneurs Legitimated the Professional Form of Management Consulting. *Organization Science*, 24(2), 356–377.
- Davis, J. P., Eisenhardt, K. M., & Bingham, C. B. (2009). Optimal Structure, Market Dynamism, and the Strategy of Simple Rules. *Administrative Science Quarterly*, 54(3), 413–452.
- Day, G., & Schoemaker, P. (2000). Avoiding the Pitfalls of Emerging Technologies. *California Management Review*, 42(2), 8–33.

- Delattre, P., & Thellier, M. (1979). *Elaboration et Justifications des Modèles*. Actes du colloque, Paris. Commissariat à l'énergie atomique, [l'] École normale supérieure.
- Demirkan, I., & Demirkan, S. (2011). Network Characteristics and Patenting in Biotechnology, 1990-2006. *Journal of Management*, 38(6), 1892–1927.
- Denzin, N. K., & Lincoln, Y. S. (2005). *The SAGE Handbook of Qualitative Research*. Sage Publications.
- Dietrich, M. (1994). *Transaction Cost Economics and Beyond: Towards a New Economics of the Firm*. Routledge.
- DiMaggio, P. J., & Powell, W. W. (1983). The Iron Cage Revisited: Institutional Isomorphism and Collective Rationality in Organizational Fields. *American Sociological Review*, 48(2), 147–160.
- Donada, C., & Lepoutre, J. (2016). How can Startups create the Conditions for a Dominant Position in the Nascent Industry of Electromobility 2.0? *International Journal of Automotive Technology and Management*, 16(1), 11–29.
- Dorn, S., Schweiger, B., & Albers, S. (2016). Levels, Phases and Themes of Coopetition: A Systematic Literature Review and Research Agenda. *European Management Journal*, 34(5), 484–500.
- Dosi, G. (1988). The Nature of the Innovation Process. In G. Dosi, C. Freeman, R. Nelson, G. Silverberg, & L. Soete (Eds) *Technical Change and Economic Theory* (pp. 221–238). Pinter.
- Dosi, G., Freeman, C. R., Nelson, R. R., & Soete, L. (1988). *Technical Change and Economic Theory*. Pinter.
- Dosi, G., & Nelson, R. (1994). An Introduction to Evolutionary Theories in Economics. *Journal of Evolutionary Economics*, 4(3), 153–172.
- Douard, J., & Heitz, M. (2003). Une Lecture des Réseaux d'Entreprises: Prise en Compte des Formes et des Evolutions. *Revue Francaise de Gestion*, 146(5), 23–41.
- Downing, J. A. (2018). Dimensions of Competitive Advantage. *Journal of New Business Ideas and Trends*, 16(2), 1–9.
- Droege, S., & Johnson, N. (2010). Limitations of Low-end Disruptive Innovation Strategies. *The International Journal of Human Resource Management*, 21(2), 242–259.
- Druckman, D., Singer, J. E., & Van Cott, H. (1997). Interorganizational Relationships. In D. Druckman, J. E. Singer, & H. Van Cott (Eds.), *Enhancing organizational performance*. (pp. 120–149). National Academy Press.
- Dumez, H. (2011). Eléments pour une Epistémologie de la Recherche Qualitative en Gestion. *Le Libellio d' AEGIS*, 7(1), 1–62.
- Duncan, B. L. (1976). Differential Social Perception and Attribution of Intergroup Violence: Testing the Lower Limits of Stereotyping of Blacks. *Journal of Personality and Social Psychology*, 34(4), 590–598.
- Durieux, F., & Charreire-Petit, S. (2014). Explorer et Tester: Les Deux Voies de la Recherche. In R.A. Thiétart et al. (Eds), *Méthodes de Recherche en Management* (pp. 77–104). Dunod.
- Durkheim, E. (2005). The Dualism of Human Nature and its Social Conditions. *Durkheimian Studies*, 11, 35–45.

- Dwyer, F. R., Schurr, P. H., & Oh, S. (1987). Developing Buyer-Seller Relationships. *Journal of Marketing*, 51(2), 11–27.
- Ebers, M. (1997). Explaining Inter-Organizational Network Formation. In M. Ebers (Ed.), *The Formation of Inter-organizational Networks* (pp. 265–286). Oxford University Press.
- Eisenhardt, K. M. (1989). Building Theories from Case Study Research. *The Academy of Management Review*, 14(4), 532–550.
- Eisenhardt, K. M., & Martin, J. A. (2000). Dynamic Capabilities: What Are They? *Strategic Management Journal*, 21(10–11), 1105–1121.
- Eisenhardt, K. M., & Santos, F. M. (2009). Constructing Markets and Shaping Boundaries: Entrepreneurial Power in Nascent Fields. *Academy of Management Journal*, 52(4), 643–671.
- Eisenhardt, K. M., & Schoonhoven, C. B. (1996). Resource-Based View of Strategic Alliance Formation: Strategic and Social Effects in Entrepreneurial Firms. *Organization Science*, 7(2), 136–150.
- Fagnant, D. J., & Kockelman, K. (2015). Preparing a Nation for Autonomous Vehicles: Opportunities, Barriers and Policy Recommendations. *Transportation Research Part A: Policy and Practice*, 77, 167–181.
- Fernandez, A.-S., & Le Roy, F. (2013). Comment Coopérer avec ses Concurrents ? L'Avènement de l'Equipe-Projet Coopétitive. *Revue Française de Gestion*, 232(3), 61–80.
- Fernandez, A.-S., Marquès, P., Le Roy, F., & Robert, F. (2010). Mesurer la Coopétition: Mission Impossible ? *Revue Sciences de Gestion*, 73, 19–38.
- Fiol, C. M., & Lyles, M. A. (1985). Organizational Learning. *The Academy of Management Review*, 10(4), 803–813.
- Foli, O., & Dulaurans, M. (2013). Tenir le Cap Epistémologique en Thèse Cifre. Ajustements Nécessaires et Connaissances Produites en Contexte. *Etudes de Communication*, 40(1), 59–76.
- Forbes, D. P., & Kirsch, D. A. (2011). The study of Emerging Industries: Recognizing and Responding to Some Central Problems. *Journal of Business Venturing*, 26(5), 589–602.
- Forgues, B., Fréchet, M., & Josserand, E. (2006). Relations Interorganisationnelles. *Revue Française de Gestion*, 164(5), 17–31.
- Forrest, A., & Konca, M. (2007). *Autonomous Cars & Society* [Interactive Qualifying Projects]. Worcester Polytechnic Institute.
- Fortunato, S. (2010). Community detection in Graphs. *Physics Reports*, 486(3–5), 75–174.
- Freeman, L. (2004). *The Development of Social Network Analysis*. Empirical Press.
- Freeman, R. E. (1984). *Strategic Management: A Stakeholder Approach*. Pitman.
- Garcia, R., & Calantone, R. (2002). A Critical Look at Technological Innovation Typology and Innovativeness Terminology: A Literature Review. *Journal of Product Innovation Management*, 19(2), 110–132.
- Gavard-Perret, Gotteland, D., Haon, C., & Jolibert, A. (2018). *Méthodologie de la Recherche en Sciences de Gestion: Réussir son Mémoire ou sa Thèse*. Pearson.

- Gemici, E., & Alpan, L. (2015). An Application of Disruptive Innovation Theory to Create a Competitive Strategy in Turkish Air Transportation Industry. *Procedia - Social and Behavioral Sciences*, 207(20), 797–806.
- Ghosh, A., Kato, T., & Morita, H. (2017). Incremental Innovation and Competitive Pressure in the Presence of Discrete Innovation. *Journal of Economic Behavior & Organization*, 135, 1–14.
- Gibbons, D. E. (2007). Interorganizational Network Structures and Diffusion of Information through a Health System. *American Journal of Public Health*, 97(9), 1684–1692.
- Gilbert, R., & Newbery, D. M. (1982). Preemptive Patenting and the Persistence of Monopoly. *American Economic Review*, 72(3), 514–526.
- Giordano, Y. (2003). *Conduire un Projet de Recherche. Une Perspective Qualitative*. Editions Management et Société.
- Glenn, C. R., & Hannan, M. T. (2015). Organizational Ecology. *International Encyclopedia of Social and Behavioral Sciences*, 17, 358–363.
- Gnyawali, D., He, J., & Madhavan, R. (2006). Impact of Coopetition on Firm Competitive Behavior: An Empirical Examination. *Journal of Management*, 32(4), 507–530.
- Gnyawali, D., & Madhavan, R. (2001). Cooperative Networks and Competitive Dynamics: A Structural Embeddedness Perspective. *Academy of Management Review*, 26(3), 431–445.
- Gnyawali, D. R., & Park, B.-J. (Robert). (2009). Co-opetition and Technological Innovation in Small and Medium-Sized Enterprises: A Multilevel Conceptual Model. *Journal of Small Business Management*, 47(3), 308–330.
- Golbeck, J. (2013). *Analyzing the Social Web*. Morgan Kaufmann.
- Grawitz, M. (1993). *Méthodes des Sciences Sociales*. Dalloz.
- Grodal, S., Gotsopoulos, A., & Suarez, F. F. (2014). The Coevolution of Technologies and Categories During Industry Emergence. *Academy of Management Review*, 40(3), 423–445.
- Guba, E. G., & Lincoln, Y. S. (1989). *Fourth Generation Evaluation*. Sage Publications.
- Gueguen, G. (2009). Coopetition and Business Ecosystems in the Information Technology Sector: The example of Intelligent Mobile Terminals. *International Journal of Entrepreneurship and Small Business*, 8(1), 1135–1150
- Gulati, R. (1995). Social Structure and Alliance Formation Patterns: A Longitudinal Analysis. *Administrative Science Quarterly*, 40(4), 619–652.
- Gulati, R. (1998). Alliances and Networks. *Strategic Management Journal*, 19, 293–317.
- Gustafsson, R., Jääskeläinen, M., Maula, M., & Uotila, J. (2016). Emergence of Industries: A Review and Future Directions. *International Journal of Management Reviews*, 18(1), 28–50.
- Hagedoorn, J. (1990). Organizational Modes of Inter-Firm Co-operation and Technology Transfer. *Technovation*, 10(1), 17–30.
- Hagedoorn, J. (1993). Understanding the Rationale of Strategic Technology Partnering: Interorganizational Modes of Cooperation and Sectoral Differences. *Strategic Management Journal*, 14(5), 371–385.

- Hagedoorn, J., & Duysters, G. (2002). External Sources of Innovative Capabilities: The Preferences for Strategic Alliances or Mergers and Acquisitions. *Journal of Management Studies*, 39(2), 167–188.
- Hagedoorn, J., & Schakenraad, J. (1992). Leading Companies and Networks of Strategic Alliances in Information Technologies. *Research Policy*, 21(2), 163–190.
- Håkansson, H., & Ford, D. (2002). How Should Companies Interact in Business Networks? *Journal of Business Research*, 55(2), 133–139.
- Håkansson, H., & Snehota, I. (1989). No Business is an Island: The Network Concept of Business Strategy. *Scandinavian Journal of Management*, 5(3), 187–200.
- Hannan, M. T., & Freeman, J. (1977). The Population Ecology of Public Organizations. *American Journal of Sociology*, 82(5), 929–964.
- Hannan, M. T., & Freeman, J. (1984). Structural Inertia and Organizational Change. *American Sociological Review*, 49(2), 149–164.
- Hannan, M. T., & Freeman, J. (1989). *Organizational Ecology*. Harvard University Press.
- Hanneman, R. A., & Riddle, M. (2014). A Brief Introduction to Analyzing Social Networks. In S. John, P.G. Carrington (Eds), *The SAGE Handbook of Social Network Analysis* (pp. 323–339). Sage Publications.
- Hargadon, A. B., & Douglas, Y. (2001). When Innovations Meet Institutions: Edison and the Design of the Electric Light. *Administrative Science Quarterly*, 46(3), 476–501.
- Harrigan, K. R. (1985). An Application of Clustering for Strategic Group Analysis. *Strategic Management Journal*, 6(1), 55–73.
- Haunschild, P. R. (1994). How Much is That Company Worth?: Interorganizational Relationships, Uncertainty, and Acquisition Premiums. *Administrative Science Quarterly*, 39(3), 391–411.
- Hawley, A. H. (1944). Ecology and Human Ecology. *Social Forces*, 22(4), 398–405.
- He, Z.-L., & Wong, P.-K. (2004). Exploration vs. Exploitation: An Empirical Test of the Ambidexterity Hypothesis. *Organization Science*, 15(4), 481–494.
- Heineke, K., Kampshoff, P., Mkrtychyan, A., & Shao, E. (2017). Self-Driving Car Technology: When Will the Robots Hit the Road? *McKinsey & Company*, 1–11.
- Henderson, J. C., & Venkatraman, H. (1993). Strategic Alignment: Leveraging Information Technology for Transforming Organizations. *IBM Systems Journal*, 32(1), 472–484.
- Henderson, R., & Clark, K. (1990). Architectural Innovation: The Reconfiguration of Existing Product Technologies and the Failure of Established Firms. *Administrative Science Quarterly*, 35(1), 9–30.
- Hill, C. W. L., & Rothaermel, F. T. (2003). The Performance of Incumbent Firms in the Face of Radical Technological Innovation. *Academy of Management Review*, 28(2), 257–274.
- Hillman, A., Withers, M., & Collins, B. (2009). Resource Dependence Theory: A Review. *Journal of Management*, 35(6), 1404–1427.
- Holmstrom, B. (1989). Agency Costs and Innovation. *Journal of Economic Behavior & Organization*, 12(3), 305–327.

- House, R. J., Rousseau, D. M., & Thomas-Hunt, M. C. (1995). The Meso Paradigm: A Framework for the Integration of Micro and Macro Organizational Behavior. *Journal of Organizational Behavior*, 17(71), 71–114.
- Hurmelinna-Laukkanen, P., Sainio, L.-M., & Jauhiainen, T. (2008). Appropriability Regime for Radical and Incremental Innovations. *R&D Management*, 38(3), 278–289.
- Iansiti, M., & Levien, R. (2004). Strategy as Ecology. *Harvard Business Review*, 82(3), 68–78.
- Jamali, M., & Abolhassani, H. (2006). *Different Aspects of Social Network Analysis*. 2006 IEEE/WIC/ACM International Conference on Web Intelligence. Hong-Kong.
- Jarillo, J. C. (1988). On Strategic Networks. *Strategic Management Journal*, 9(1), 31–41.
- Jensen, M. C., & Meckling, W. H. (1976). Theory of the Firm: Managerial behavior, Agency Costs and Ownership Structure. *Journal of Financial Economics*, 3(4), 305–360.
- Johannessen, J., Olsen, B., & Lumpkin, G. T. (2001). Innovation as Newness: What is New, How New, and New to Whom? *European Journal of Innovation Management*, 4(1), 20–31.
- Johnson, B. R., Onwuegbuzie, A., & Turner, L. (2007). Toward a Definition of Mixed Methods Research. *Journal of Mixed Methods Research*. *Journal of Mixed Methods Research*, 1(2), 112–133.
- Kale, P., & Singh, H. (2009). Managing Strategic Alliances: What Do We Know Now, and Where Do We Go From Here? *Academy of Management Perspectives*, 23(3), 45–62.
- Kallio, A., Harmaakorpi, V., & Pihkala, T. (2010). Absorptive Capacity and Social Capital in Regional Innovation Systems: The Case of the Lahti Region in Finland. *Urban Studies*, 47, 303–319.
- Kamien, M. I., & Schwartz, N. L. (1975). Market Structure and Innovation: A Survey. *Journal of Economic Literature*, 13(1), 1–37.
- Kaplan, R. S., & Tripsas, M. (2008). Thinking about Technology: Applying a Cognitive Lens to Technical Change. *Research Policy*, 37(5), 790–805.
- Kavadias, S., & Chao, R. O. (2007). Resources Allocation and New Product Development Portfolio Management. In S. Kavadias (Ed.), *Handbook of New Product Development Research* (pp. 136–163). Elsevier/Butterworth.
- Khanna, T., Gulati, R., & Nohria, N. (1998). The Dynamics of Learning Alliances: Competition, Cooperation, and Relative Scope. *Strategic Management Journal*, 19(3), 193–210.
- Kilduff, M., & Tsai, W. (2003). *Social Networks and Organizations*. Sage Publications.
- King, A., & Baatartogtokh, B. (2015). How Useful is the Theory of Disruptive Innovation? *MIT Sloan Management Review*, 57(1), 77–90.
- Klauer, K., & Phye, G. (2008). Inductive Reasoning: A Training Approach. *Review of Educational Research*, 78(1), 85–123.
- Klepper, S. (1997). Industry Life Cycles. *Industrial and Corporate Change*, 6(1), 145–182.
- Klepper, S., & Graddy, E. (1990). The Evolution of New Industries and the Determinants of Market Structure. *Journal of Economics*, 21(1), 27–44.
- Knight, F. H. (1921). *Risk, Uncertainty and Profit*. Houghton Mifflin.

- Koenig, G. (2012). Le Concept d'Ecosystème d'Affaires Revisit . *M@n@gement*, 15(2), 209–224.
- Kogut, B., & Zander, U. (1992). Knowledge of the Firm, Combinative Capabilities, and the Replication of Technology. *Organization Science*, 3(3), 383–397.
- Krafft, J., Lechevalier, S., Quatraro, F., & Storz, C. (2014). Emergence and Evolution of New Industries: The Path-Dependent Dynamics of Knowledge Creation. An Introduction to the Special Section. *Research Policy*, 43(10), 1663–1665.
- Krafft, J., Quatraro, F., & Saviotti, P.-P. (2011). Knowledge Characteristics and the Dynamics of Technological Alliances in Pharmaceuticals: Empirical Evidence from Europe, US and Japan. *Journal of Evolutionary Economics*, 24, 587–622.
- Kumar, K. G., & Jyotishi, A. (2013). Transaction Cost Levelling to Reduce Incumbent's Difficulty in Innovation: A Heuristic Approach through Critical Review. *International Journal of Knowledge, Innovation and Entrepreneurship*, 1, 1–2.
- Kurt, Y., & Kurt, M. (2020). Social Network Analysis in International Business Research: An Assessment of the Current State of Play and Future Research Directions. *International Business Review*, 29(2), 1–42.
- Lambkin, M. (1988). Order of Entry and Performance in New Markets. *Strategic Management Journal*, 9(S1), 127–140.
- Lammers, J., & Barbour, J. (2006). An Institutional Theory of Organizational Communication. *Communication Theory*, 16(3), 356–377.
- Lavie, D. (2006). The Competitive Advantage of Interconnected Firms: An Extension of the Resource-Based View. *Academy of Management Review*, 31(1), 638–658.
- Lawson, B., & Samson, D. (2001). Developing Innovation Capability in Organisations: A Dynamic Capabilities Approach. *International Journal of Innovation Management*, 5(3), 377–400.
- Lazarsfeld P.F., Merton R.K., (1954). Friendship as a Social Process: A Substantive and Methodological Analysis. In M. Berger (Ed.), *Freedom and Control in Modern Society* (pp. 18–66). Van Nostrand
- Lazega, E. (1994). Analyse de R seaux et Sociologie des Organisations. *Revue Fran aise de Sociologie*, 35(2), 293–320.
- Le Moigne, J.-L. (1994). *Le Constructivisme (Tome I- Des Fondements)*. ESF.
- Le Moigne, J.-L. (1999). *La Mod lisation des Syst mes Complexes*. Dunod.
- Le Roy, F. (2008). The Rise and Fall of Collective Strategies. *International Journal of Entrepreneurship & Small Business*, 5(2), 127–142.
- Leblebici, H., Salancik, G. R., Copay, A., & King, T. (1991). Institutional Change and the Transformation of Interorganizational Fields: An Organizational History of the U.S. Radio Broadcasting Industry. *Administrative Science Quarterly*, 36(3), 333–363.
- Lee, M., & Na, D. (1994). Determinants of Technical Success in Product Development: When Innovative Radicalness is Considered. *Journal of Product Innovation Management*, 11(1), 62–68.
- Leifer, R., McDermott, C. M., O'Connor, G. C., Peters, L. S., Rice, M. P., & Veyrizer Jr, R. W. (2000). *Radical Innovation: How Mature Companies Can Outsmart Upstarts*. Harvard Business Press.

- Leiponen, A. (2005). Skills and Innovation. *International Journal of Industrial Organization*, 23(5–6), 303–323.
- Leonard-Barton, D. (1992). Core Capabilities and Core Rigidities: A Paradox in Managing New Product Development. *Strategic Management Journal*, 13(S1), 111–125.
- Lepoutre J., & Perez Y., Petit M. (2019) Energy Transition and Electromobility: A Review. In: Gawel E., Strunz S., Lehmann P., Purkus A. (Eds). *The European Dimension of Germany's Energy Transition*. Springer.
- Li, C.-R., Li, C.-X., Lin, C.-J., & Liu, J. (2018). The Influence of Team Reflexivity and Shared Meta-knowledge on the Curvilinear Relationship between Team Diversity and Team Ambidexterity. *Management Decision*, 56(5), 1033–1050.
- Liang, B. (2013). *Managing and Leading for Science Professionals*. Elsevier.
- Lin, C., Zhang, Z.-G., & Yu, C.-P. (2015). Measurement and Empirical Research on Low-end and New market Disruptive Innovation. *Journal of Interdisciplinary Mathematics*, 18(6), 827–839.
- Loasby, B. J. (1994). Organisational Capabilities and Interfirm Relations. *Metroeconomica*, 45(3), 248–265.
- Loosemore, M. (1998). Social Network Analysis: Using a Quantitative Tool within an Interpretative Context to Explore the Management of Construction Crises. *Engineering Construction and Architectural Management*, 5(4), 315–326.
- Low, M. B., & Abrahamson, E. (1997). Movements, Bandwagons, and Clones: Industry Evolution and the Entrepreneurial Process. *Journal of Business Venturing*, 12(6), 435–457
- Lozares, C., Verd, J. M., Cruz, I., & Barranco, O. (2014). Homophily and Heterophily in Personal Networks. From Mutual Acquaintance to Relationship Intensity. *Quality & Quantity*, 48(5), 2657–2670.
- Lung, Y. (2004). The Changing Geography of the European Automobile System. *International Journal of Automotive Technology and Management*, 4(2–3), 137–165.
- Luo, Y. (2005). Do Insiders Learn from Outsiders? Evidence from Mergers and Acquisitions. *The Journal of Finance*, 60(4), 1951–1982.
- Maanen, J. V. (2011). Ethnography as Work: Some Rules of Engagement. *Journal of Management Studies*, 48(1), 218–234.
- MacDuffie, J. P. (2018). Response to Perkins and Murmann: Pay Attention to What Is and Isn't Unique about Tesla. *Management and Organization Review*, 14(3), 481–489.
- Macmillan, I. C., & Katz, J. A. (1992). Idiosyncratic Milieus of Entrepreneurial Research: The Need for Comprehensive Theories. *Journal of Business Venturing*, 7(1), 1–8.
- Madhok, A. (1998). The Nature of Multinational Firm Boundaries: Transaction Costs, Firm Capabilities and Foreign Market Entry Mode. *International Business Review*, 7(3), 259–290.
- Madhok, A., & Tallman, S. B. (1998). Resources, Transactions and Rents: Managing Value Through Interfirm Collaborative Relationships. *Organization Science*, 9(3), 326–339.
- Maignant, A. (2017). *La Construction des Réseaux d'Entreprises, une Contribution par les Oppositions Paradoxales: Le Cas d'un Réseau d'Entreprises Horticoles de la Région Angevine* [Phd thesis, Université d'Angers].

- Malerba, F. (2002). Sectoral Systems of Innovation and Production. *Research Policy*, 31, 247–264.
- Malerba, F. (2007). Innovation and the Dynamics and Evolution of Industries: Progress and Challenges. *International Journal of Industrial Organization*, 25(4), 675–699.
- Mandard, M. (2015). *Les Réseaux Inter-Organisationnels*. La Découverte.
- March, J. G. (1991). Exploration and Exploitation in Organizational Learning. *Organization Science*, 2(1), 71–87.
- Markides, C. D. (2006). Disruptive Innovation: In Need of Better Theory. *The Journal of Product Innovation Management*, 23(1), 19–25.
- Markman, G. D., & Waldron, T. L. (2013). Small Entrants and Large Incumbents: A Framework of Micro Entry. *Academy of Management Perspectives*, 28(2), 179–197.
- Marsden, P. V. (1981). Introducing Influence Processes into a System of Collective Decisions. *American Journal of Sociology*, 86(6), 1203–1235.
- Marshall, A. (1920). *Principles of Economics*. Macmillan.
- Mattsson, L.-G. (1997). “Relationship Marketing” and the “Markets-as-Networks Approach”—A Comparative Analysis of Two Evolving Streams of Research. *Journal of Marketing Management*, 13(5), 447–461.
- Matveev, A. (2002). The Advantages of Employing Quantitative and Qualitative Methods in Intercultural Research: Practical Implications from the Study of the Perceptions of Intercultural Communication Competence by American and Russian Managers. *Business and Law Publishing*, 1, 59–67.
- Mayrhofer, U. (2007). Les Rapprochements d’Entreprises: Perspectives Théoriques et Managériales. *Management & Avenir*, 14(4), 81–89.
- Mayrhofer, W. (2001). Organizational International Career Logics (OICLs): A Conceptual Tool for Analyzing Organizational Expatriation Patterns and their Consequences for the Management of Organizations. *Thunderbird International Business Review*, 43(1), 121–144.
- McDonald, R. M., & Eisenhardt, K. M. (2020). Parallel Play: Startups, Nascent Markets, and Effective Business-model Design. *Administrative Science Quarterly*, 65(2), 483–523.
- McGahan, A., Argyres, N., & Baum, J. (2004). Context, Technology and Strategy: Forging New Perspectives on the Industry Life Cycle. *Advances in Strategic Management*, 21, 1–21
- McKnight, D. H., Lankton, N., & Tripp, J. (2011). *Social Networking Information Disclosure and Continuance Intention: A Disconnect*. 44th Hawaii International Conference on System Sciences. Hawaii.
- McPherson, M., Smith-Lovin, L., & Cook, J. M. (2001). Birds of a Feather: Homophily in Social Networks. *Annual Review of Sociology*, 27(1), 415–444.
- Meyer, J. W., & Rowan, B. (1977). Institutionalized Organizations: Formal Structure as Myth and Ceremony. *American Journal of Sociology*, 83(2), 340–363.
- Mikes, A., & Kaplan, R. S. (2012). Managing Risks: A New Framework. *Harvard Business Review*, 90(6), 1–20.
- Miles, M. B., & Huberman, A. M. (2003). *Analyse des Données Qualitatives*. de Boeck.

- Mitchell, R. K., Agle, B. R., & Wood, D. J. (1997). Toward a Theory of Stakeholder Identification and Salience: Defining the Principle of Who and What Really Counts. *Academy of Management Review*, 22(4), 853–886.
- Moalla, E., & Triki, D. (2011). Comment les Firmes Multinationales Peuvent-elles Réussir leurs Partenariats ? In U. Mayrhofer (Ed.), *Management des Firmes Multinationales* (pp. 183–198). Vuibert.
- Mohr, J., & Spekman, R. (1994). Characteristics of Partnership Success: Partnership Attributes, Communication Behavior, and Conflict Resolution Techniques. *Strategic Management Journal*, 15(2), 135–152.
- Möller, K., & Halinen, A. (1999). Business Relationships and Networks: Managerial Challenge of Network Era. *Industrial Marketing Management*, 28(5), 413–427.
- Moore, J. (1993). Predators and Prey: A New Ecology of Competition. *Harvard Business Review*, 71(3), 75–86.
- Moore, J. (2006). Business Ecosystems and the View of the Firm. *The Antitrust Bulletin*, 51(1), 31–75.
- Moore, J. F. (1996). *The Death of Competition: Leadership and Strategy in the Age of Business Ecosystems*. Wiley & Sons.
- Moreno, J. L. (1934). *Who Shall Survive? A New Approach to the Problem of Human Interrelations*. Nervous and Mental Disease Publishing Co.
- Moreno, J. L., & Jennings, H. H. (1938). Statistics of Social Configurations. *Sociometry*, 1(3/4), 342–374.
- Morgan, G. (2007). *Images of Organization* (Updated edition). Sage Publications.
- Moriceau, J.-L., & Soparnot, R. (2019). *Recherche Qualitative en Science Sociale. S'exposer, Cheminer, Réfléchir ou l'Art de Composer sa Méthode*. Editions Management et Société.
- Morrison, E. (2002). Newcomers' Relationships: The Role of Social Network Ties during Socialization. *Academy of Management Journal*, 45(6), 1149–1160.
- Muller, E., & Peres, R. (2019). The Effect of Social Networks Structure on Innovation Performance: A Review and Directions for Research. *International Journal of Research in Marketing*, 36(1), 3–19.
- Najafian, M., & Colabi, A. M. (2014). Inter-Organizational Relationship and Innovation: A Review of Literature. *Global Business and Management Research: An International Journal*, 6(1), 52–70.
- Narula, R., & Dunning, J. (1998). Explaining International R&D Alliances and the Role of Governments. *International Business Review*, 7(4), 377–397.
- Narula, R., & Hagedoorn, J. (1999). Innovating Through Strategic Alliances: Moving Towards International Partnerships and Contractual Agreements. *Technovation*, 19(5), 283–294.
- Navis, C., & Glynn, M. A. (2010). How New Market Categories Emerge: Temporal Dynamics of Legitimacy, Identity, and Entrepreneurship in Satellite Radio, 1990–2005. *Administrative Science Quarterly*, 55(3), 439–471.
- Nelson, E. G. (1992). Enterprise Education and Training: Dimensions of Course Design. *Education + Training*, 34(7), 12–18.

- Nelson, R. R., & Winter, S. G. (1982). *An Evolutionary Theory of Economic Change*. The Belknap Press of Harvard University Press.
- Nieto, M., & Santamaría, L. (2007). The Importance of Diverse Collaborative Networks for the Novelty of Product Innovation. *Technovation*, 27(6–7), 367–377.
- Nohria, N., & Eccles, R. G. (1992). *Networks and Organizations: Structure, Form, and Action*. Harvard Business School Press.
- Nordin, F., Raval, A., Möller, K., & Mohr, J. (2018). Network Management in Emergent High-Tech Business Contexts: Critical Capabilities and Activities. *Industrial Marketing Management*, 74, 89–101.
- Oliver, A., & Ebers, M. (1998). Networking Network Studies: An Analysis of Conceptual Configurations in the Study of Inter-Organizational Relationships. *Organization Studies*, 19(4), 549–583.
- Oliver, C. (1990). Determinants of Interorganizational Relationships: Integration and Future Directions. *The Academy of Management Review*, 15(2), 241–265.
- O'Reilly, C. A., & Tushman, M. L. (2016). *Lead and Disrupt: How to Solve the Innovator's Dilemma*. Stanford University Press.
- O'Reilly, M. L., & Tushman, C. A. (1996). Ambidextrous Organizations: Managing Evolutionary and Revolutionary Change. *California Management Review*, 38(4), 7–30.
- Owczarzak, Ł., & Żak, J. (2015). Design of Passenger Public Transportation Solutions Based on Autonomous Vehicles and Their Multiple Criteria Comparison with Traditional Forms of Passenger Transportation. *Transportation Research Procedia*, 10, 472–482.
- Padgett, J., & Powell, W. (2012). The Problem of Emergence. In J.F. Padgett & W.W. Powell (Eds.), *The Emergence of Organizations and Markets* (pp. 2–29). Princeton University Press.
- Padula, G., & Dagnino, G. B. (2007). Untangling the Rise of Coopetition: The Intrusion of Competition in a Cooperative Game Structure. *International Studies of Management and Organization*, 37(2), 32–52.
- Parau, P., Lemnaru, C., Dinsoreanu, M., & Potolea, R. (2017). Opinion Leader Detection. In F. A. Pozzi, E. Fersini, E. Messina, & B. Liu (Eds.), *Sentiment Analysis in Social Networks* (pp. 157–170). Morgan Kaufmann.
- Parkhe, A., Wasserman, S., & Ralston, D. A. (2006). New Frontiers in Network Theory Development. *Academy of Management Review*, 31(3), 560–568.
- Parmigiani, A., & Rivera-Santos, M. (2011). Clearing a Path Through the Forest: A Meta-Review of Interorganizational Relationships. *Journal of Management*, 37(4), 1108–1136.
- Passeron, J.-C. (1991). *Le Raisonnement Sociologique: Un Espace Non-poppérien de l'Argumentation*. Nathan.
- Pattison, P., & Robins, G. (2002). Neighborhood-Based Models For Social Networks. *Sociological Methodology*, 32(1), 301–337.
- Paunov, C., & Planes-Satorra, S. (2019). How are Digital Technologies Changing Innovation?: Evidence from Agriculture, the Automotive Industry and Retail. *OECD Science, Technology and Industry Policy Papers*, 74, 2–53.

- Pellegrino, J. W., & Glaser, R. (1984). *Analyzing Aptitudes for Learning: Inductive Reasoning* (Report - Research/Technical No. 143). National Institute of Education.
- Pénin, J., Hussler, C., & Burger-Helmchen, T. (2011). New Shapes and New Stakes: A Portrait of Open Innovation as a Promising Phenomenon. *Journal of Innovation Economics Management*, 7(1), 11–29.
- Penrose, E. (1959). *The Theory of the Growth of the Firm*. John Wiley.
- Perkins, G., & Murmann, J. P. (2018). What Does the Success of Tesla Mean for the Future Dynamics in the Global Automobile Sector? *Management and Organization Review*, 14(3), 471–480.
- Pfeffer, J. (1992). Understanding Power in Organizations. *California Management Review*, 34(2), 29–50.
- Pfeffer, J., & Nowak, P. (1976). Joint Ventures and Interorganizational Interdependence. *Administrative Science Quarterly*, 21(3), 398–418.
- Pfeffer, J., & Salancik, G. R. (1978). *The External Control of Organizations: A Resource Dependence Perspective*. Harper & Row.
- Phaal, R., O’Sullivan, E., Routley, M., Ford, S., & Probert, D. (2011). A Framework for Mapping Industrial Emergence. *Technological Forecasting and Social Change*, 78(2), 217–230.
- Phelps, C. C. (2010). A Longitudinal Study on the Influence of Alliance Network Structure and Composition on Firm Exploratory Innovation. *Academy of Management Journal*, 53(4), 890–913.
- Piaget, J. (1987). *Possibility and Necessity*. University of Minnesota Press.
- Pong, D. (2009). Automobile Industry. *Encyclopedia of Modern China*, 74, 2–53.
- Popper, K. (2002). *Conjectures and Refutations*. Routledge.
- Porac, J., Ventresca, M., & Mishina, Y. (2002). Interorganizational Cognition and Interpretation. In *The Blackwell Companion to Organizations* (J. Baum, pp. 579–598). Blackwell. <https://doi.org/10.1002/9781405164061.ch25>
- Porter, M. E. (1979). How Competitive Forces Shape Strategy: Awareness of these Forces Can Help a Company Stake Out a Position in its Industry That is Less Vulnerable to Attack. *Harvard Business Review*, 57, 137–145.
- Pourtois, J.-P., & Desmet, H. (2007). *Epistémologie et Instrumentation en Sciences Humaines*. Mardaga.
- Powell, W., Koput, K., & Smith-Doerr, L. (1996). Interorganizational Collaboration and the Locus of Innovation: Networks of Learning in Biotechnology. *Administrative Science Quarterly*, 41, 116–145.
- Powell, W. W., White, D. R., Koput, K. W., & Owen-Smith, J. (2005). Network Dynamics and Field Evolution: The Growth of Interorganizational Collaboration in the Life Sciences. *American Journal of Sociology*, 110(4), 1132–1205.
- Prahalad, C. K., & Hamel, G. (1990). The Core Competence of the Corporation. *Harvard Business Review*, 68(3), 79–91.
- Prell, C. (2011). *Social Network Analysis*. Sage Publications.

- Provan, K., Fish, A., & Sydow, J. (2007). Interorganizational Networks at the Network Level: A Review of the Empirical Literature on Whole Networks. *Journal of Management*, 33(3), 479–516.
- Rasolofodistler, F., & Zawadzki, C. (2013). Epistémologie et Méthodologie des CIFRE: Illustration par des Thèses Soutenues en Finance Contrôle Stratégie. *Finance Contrôle Stratégie*, 16(4), 1–15.
- Reinganum, J. (1983). Uncertain Innovation and the Persistence of Monopoly. *American Economic Review*, 73(4), 741–748.
- Rice, J., & Galvin, P. (2006). Alliance Patterns during Industry Life Cycle Emergence: The Case of Ericsson and Nokia. *Technovation*, 26(3), 384–395.
- Ritala, P. (2012). Coopetition Strategy – When is it Successful? Empirical Evidence on Innovation and Market Performance. *British Journal of Management*, 23(3), 307–324.
- Ritala, P., & Sainio, L.-M. (2014). Coopetition for Radical Innovation: Technology, Market and Business-model Perspectives. *Technology Analysis and Strategic Management*, 26(2), 155–169.
- Ritala, P., & Tidström, A. (2014). Untangling the Value-Creation and Value-Appropriation Elements of Coopetition Strategy: A Longitudinal Analysis on the Firm and Relational Levels. *Scandinavian Journal of Management*, 30(4), 498–515.
- Ritter, T., & Gemuenden, H. (2003). Network Competence: Its Impact on Innovation Success and Its Antecedents. *Journal of Business Research*, 56(9), 745–755.
- Rogers, M. (1998). The Definition and Measurement of Innovation. Working Paper n°10/98. *The University of Melbourne*.
- Rong, K., Hu, G., Lin, Y., Shi, Y., & Guo, L. (2015). Understanding Business Ecosystem using a 6C Framework in Internet-of-Things-based Sectors. *International Journal of Production Economics*, 159, 41–55.
- Rosenbloom, R. S. (2000). Leadership, Capabilities, and Technological Change: The Transformation of NCR in the Electronic Era. *Strategic Management Journal*, 21(10–11), 1083–1103.
- Rosenkopf, L., & Tushman, M. (1998). The Coevolution of Community Networks and Technology: Lessons From the Flight Simulation Industry. *Industrial and Corporate Change*, 7(2), 311–346.
- Ross, S. (1973). The Economic Theory of Agency: The Principal's Problem. *American Economic Review*, 63(2), 134–139.
- Rothaermel, F. T. (2001). Incumbent's Advantage Through Exploiting Complementary Assets via Interfirm Cooperation. *Strategic Management Journal*, 22(6–7), 687–699.
- Rothaermel, F. T., & Deeds, D. L. (2004). Exploration and Exploitation Alliances in Biotechnology: A System of New Product Development. *Strategic Management Journal*, 25(3), 201–221.
- Rumelt, R. P., Schendel, D., & Teece, D. J. (1995). *Fundamental Issues in Strategy: A Research Agenda*. Harvard Business School Press.
- Rusinowska, A., Berghammer, R., de Swart, H., & Grabisch, M. (2011). *Social Networks: Prestige, Centrality, and Influence*. In R. de Swart (Ed.), *International Conference on Relational and Algebraic Methods in Computer Science* (pp. 22–39). Springer, Berlin.

- Rusko, R. (2011). Exploring the Concept of Coopetition: A Typology for the Strategic Moves of the Finnish Forest Industry. *Industrial Marketing Management*, 40(2), 311–320.
- Schilke, O. (2014). On the Contingent Value of Dynamic Capabilities for Competitive Advantage: The Nonlinear Moderating Effect of Environmental Dynamism. *Strategic Management Journal*, 35(2), 179–203.
- Schilling, M. A., & Phelps, C. C. (2007). Interfirm Collaboration Networks: The Impact of Large-Scale Network Structure on Firm Innovation. *Management Science*, 53(7), 1113–1126.
- Schmidt, G. M., & Druehl, C. T. (2008). When Is a Disruptive Innovation Disruptive? *Journal of Product Innovation Management*, 25(4), 347–369.
- Schumpeter, J. A. (1934). *The Theory of Economic Development*. Harvard Business School Press.
- Schumpeter, J. A. (1942). *Capitalism, Socialism, and Democracy*. Harper & Brothers.
- Shan, W., Walker, G., & Kogut, B. (1994). Interfirm Cooperation and Startup Innovation in the Biotechnology Industry. *Strategic Management Journal*, 15(5), 387–394.
- Sherwani, H., & Tee, R. (2018). Innovation and Value Creation in Business Ecosystems. In M. Magnusson et al. (Eds.), *Learning and Innovation in Hybrid Organizations: Strategic and Organizational Insights* (pp. 13–32). Springer.
- Shipilov, A., & Gawer, A. (2019). Integrating Research on Interorganizational Networks and Ecosystems. *Academy of Management Annals*, 14(1), 92–121.
- Simon, F., & Tellier, A. (2008). Créativité et Réseaux Sociaux dans l'Organisation Ambidextre. *Revue Française de Gestion*, 187(7), 145–159.
- Singh, J. V., & Lumsden, C. J. (1990). Theory and Research in Organizational Ecology. *Annual Review of Sociology*, 16(1), 161–195.
- Soler, L. (2000). *Introduction à l'Épistémologie*. Ellipses.
- Sood, A., & Tellis, G. J. (2010). Demystifying Disruption: A New Model for Understanding and Predicting Disruptive Technologies. *Marketing Science*, 30(2), 339–354.
- Strömberg, H., Pettersson, I., Andersson, J., Rydström, A., Dey, D., Klingegård, M., & Forlizzi, J. (2018). Designing for Social Experiences with and within Autonomous Vehicles – Exploring Methodological Directions. *Design Science*, 4(13), 1–29.
- Stuart, T. (2000). Interorganizational Alliances and the Performance of Firms: A Study of Growth and Innovation Rates in a High-technology Industry. *Strategic Management Journal*, 21(8), 791–811.
- Stuart, T. E., Hoang, H., & Hybels, R. C. (1999). Interorganizational Endorsements and the Performance of Entrepreneurial Ventures. *Administrative Science Quarterly*, 44(2), 315–349.
- Stubbart, C. I., & Knight, M. B. (2006). The case of Disappearing Firms: Empirical Evidence and Implications. *Journal of Organizational Behavior*, 27(1), 79–100.
- Suarez, D., & Bromley, P. (2018). Institutional Theories and Levels of Analysis: History, Diffusion, and Translation. In J. Schriewer (Ed.), *World Culture Recontextualized* (pp. 139–159). Routledge.

- Sydow, G., Schreyögg, G., & Koch, J. (2008). Organizational Path Dependence: Opening the Black Box. *Academy of Management Review*, 34(4), 689–709.
- Tatarynowicz, A., Sytch, M., & Gulati, R. (2016). Environmental Demands and the Emergence of Social Structure: Technological Dynamism and Interorganizational Network Forms. *Administrative Science Quarterly*, 61(1), 52–86.
- Teece, D. J. (1986). Profiting from Technological Innovation: Implications for Integration, Collaboration, Licensing and Public Policy. *Research Policy*, 15(6), 285–305.
- Teece, D. J., Pisano, G., & Shuen, A. (1997). Dynamic Capabilities and Strategic Management. *Strategic Management Journal*, 18(7), 509–533.
- Ter Wal, A. L. J., & Boschma, R. (2011). Co-evolution of Firms, Industries and Networks in Space. *Regional Studies*, 45, 1–45.
- Thietart, R.-A., Allard-Poesi, F., Angot, J., Blanc, A., Cartier, M., Charreire-Petit, S., Chollet, B., Donada, C., Drucker-Godard, C., Durieux, F., & Ehlinger, S. (2014). *Méthodes de Recherche en Management*. Dunod.
- Thomas, L. D., & Autio, E. (2014). The processes of ecosystem emergence. *Working Paper, Imperial College Business School, University of London*.
- Thorpe, R., & Holt, R. (2007). *The SAGE Dictionary of Qualitative Management Research*. Sage Publications.
- Tichy, N. M., Tushman, M. L., & Fombrun, C. J. (1979). Social Network Analysis For Organizations. *Academy of Management*, 4(4), 507–519.
- Tidd, J. (2006). *A Review of Innovation Models*. Imperial College London. Tanaka Business School.
- Trott, P., & Hartmann, D. (2009). Why ‘Open Innovation’ is Old Wine in New Bottles. *International Journal of Innovation Management*, 13(4), 715–736.
- Turnbull, P., Ford, D., & Cunningham, M. (1996). Interaction, Relationships and Networks in Business Markets: An Evolving Perspective. *Journal of Business & Industrial Marketing*, 11(3/4), 44–62.
- Tyler, K. A., & Melander, L. A. (2011). A Qualitative Study of the Formation and Composition of Social Networks Among Homeless Youth. *Journal of Research on Adolescence*, 21(4), 802–817.
- Ulrich, D., & Barney, J. B. (1984). Perspectives in Organizations: Resource Dependence, Efficiency, and Population. *Academy of Management Review*, 9(3), 471–481.
- Utterback, J. M. (1994). *Mastering the Dynamics of Innovation: How Companies Can Seize Opportunities in the Face of Technological Change*. Harvard Business School Press.
- van Bracht, R., & Kortmann, S. (2014). On the Importance of Mediating Dynamic Capabilities for Ambidextrous Organizations. *Procedia CIRP*, 20, 85–92.
- Van de Ven, D., & Garud, R. (1993). Innovation and Industry Development: The Case of Cochlear Implants. *Research on Technological Innovation Management and Policy*, 5, 1–46.
- Van de Ven, A. H., & Garud, R. (1987). A Framework for Understanding the Emergence of New Industries. In R. S. Rosenbloom (Ed.), *Research on Technological Innovation, Management and Policy* (pp. 195–225). JAI Press.

- Van De Ven, H. (1993). The Development of an Infrastructure for Entrepreneurship. *Journal of Business Venturing*, 8(3), 211–230.
- Van De Ven, H., Delbecq, A., & Koenig, J. (1976). Determinants of Coordination Modes within Organizations. *American Sociological Review*, 41, 322–338.
- van den Hoed, R., & Vergragt, P. (2005). Technological Shifts and Industry Reaction: Shifts in Fuel Preference for the Fuel Cell Vehicle in the Automotive Industry. In P. Dewick, M. Miozzo, G. Kenneth (Eds.), *Technology, Knowledge and the Firm: Implications for Strategy and Industrial Change* (pp. 126–151). Edward Elgar Publishing.
- van Mossel, A., van Rijnsoever, F. J., & Hekkert, M. P. (2018). Navigators through the Storm: A Review of Organization Theories and the Behavior of Incumbent Firms during Transitions. *Environmental Innovation and Societal Transitions*, 26, 44–63.
- Volschenk, J., Ungerer, M., & Smit, E. (2016). Creation and Appropriation of Socio-environmental Value in Coopetition. *Industrial Marketing Management*, 57, 109–118.
- von Burg, U., & Kenney, M. (2000). Venture Capital and the Birth of the Local Area Networking Industry. *Research Policy*, 29(9), 1135–1155.
- von Foerster, H. (1981). *Observing Systems*. Intersystems Publications.
- von Glasersfeld, E. (1988). Introduction à un Constructivisme Radical. In P. Watzlawick (Ed.), *L'invention de la Réalité* (pp. 45–69). Edition du Seuil.
- von Glasersfeld, E. (2001). The Radical Constructivist View of Science. *Foundations of Science*, 6(1–3), 31–43.
- Wasserman, S., & Faust, K. (1994). *Social Network Analysis: Methods and Applications*. Cambridge University Press.
- Weber, M. (1949). *The Methodology Of The Social Sciences*. Free Press.
- Wernerfelt, B. (1984). A Resource-based View of the Firm. *Strategic Management Journal*, 5(2), 171–180.
- Williamson O.E., (1973). Markets and Hierarchies: Some Elementary Considerations. *American Economic Review*, 63, (316-325).
- Winter, S. G. (2003). Understanding Dynamic Capabilities. *Strategic Management Journal*, 24(10), 991–995.
- Wulf, K., Odekerken, G., & Iacobucci, D. (2001). Investments in Consumer Relationships: A Cross-Country and Cross-Industry Exploration. *Journal of Marketing*, 65(4), 33–50.
- Yami, S., & Nemeh, A. (2014). Organizing Coopetition for Innovation: The Case of Wireless Telecommunication Sector in Europe. *Industrial Marketing Management*, 43(2), 250–260.
- Yang, J., & Coughlin, J. F. (2014). In-vehicle Technology for Self-driving Sars: Advantages and Challenges for Aging Drivers. *The Korean Society of Automotive Engineers*, 15(2), 333–340.
- Yin, R. K. (2014). *Case Study Research*. Sage Publications.
- Zaborek, P. (2009). Qualitative and Quantitative Research Methods in Management Science. In M. Strzyżewska (Ed.), *Selected Methodological Issues For Doctoral Students* (pp. 41–50). Warsaw School of Economics Publishing.

- Zaheer, A., Gözübüyük, R., & Milanov, H. (2010). It's the Connections: The Network Perspective in Interorganizational Research. *Academy of Management Perspectives*, 24(1), 62–77.
- Zaheer, A., & Usai, A. (2004). The Social Network Approach in Strategy Research: Theoretical Challenges and Methodological Issues. *Research Methodology in Strategy and Management*, 1, 67–86.
- Zajac, E. J., & Olsen, C. P. (1993). From Transaction Cost to Transactional Value Analysis: Implications for the Study of Interorganizational Strategies. *Journal of Management Studies*, 30(1), 131–145.

LIST OF TABLES

TABLE 1. SUMMARY OF RESEARCH QUESTIONS BY ANALYSIS LEVEL	30
TABLE 2. PRINCIPLES OF CLOSED AND OPEN INNOVATION (ADAPTED FROM CHESBROUGH, 2003).....	71
TABLE 3. TYPOLOGY OF INTERORGANIZATIONAL RELATIONSHIPS (MOALLA & TRIKI, 2001: 284).....	113
TABLE 4. SUMMARY OF RESEARCH DIRECTIONS AND QUESTIONS	154
TABLE 5. A CHRONOLOGICAL LISTING OF MAIN AV PROJECTS (FORREST & KONCA, 2007: 10)	173
TABLE 6. SUMMARY OF GLOBAL ADAS APPLICATIONS (IHS AUTOMOTIVE, 2019).....	189
TABLE 7. COMPANY STATEMENT OF GROWTH OPPORTUNITIES BROUGHT BY AUTONOMOUS DRIVING	192
TABLE 8. AV LAUNCHES BY LEVELS FROM 2019 TO 2023.....	194
TABLE 9. DEFINITION OF INDUCTIVE REASONING (ADAPTED BY KLAUER & PHYE, 2008: 87).....	209
TABLE 10. ADVANTAGES AND DISADVANTAGES OF QUALITATIVE METHODOLOGY (MATVEEV, 2002: 60).....	213
TABLE 11. ADVANTAGES AND DISADVANTAGES OF THE QUANTITATIVE METHOD (MATVEEV, 2002: 60).....	215
TABLE 12. DEFINITION OF THE FIVE KEY TECHNOLOGICAL ACTIVITIES	235
TABLE 13. ASYMMETRIC MATRIX	250
TABLE 14. SYMMETRIC MATRIX	250
TABLE 15. BASIC DEMOGRAPHICS	270
TABLE 16. GEODESIC DISTANCES.....	271
TABLE 17. CONCENTRATION RATE BY COUNTRY	281
TABLE 18. THE OCCURRENCE OF IRS IN EACH KTA, FROM 2011 TO 2019	286
TABLE 19. LETHARGIC AND TRANSITIONAL PHASES: THE EMERGENCE OF TWO KTAs, CONNECTIVITY AND SENSING (2011-2014).....	288
TABLE 20. PROGRESSIVE PHASE: COHABITATION OF ALL THE KEY TECHNOLOGIC ACTIVITIES (2015-2016)	290
TABLE 21. DENSIFYING PHASE: A PLETHORA OF IRS IN EACH KTA NETWORKS (2017-2019)	291
TABLE 22. CENTRALITY MEASURES FOR EACH KTA.....	294
TABLE 23. EXTRACT FROM CLOSENESS DEGREE OF NETWORK NODES	296
TABLE 24. PROPORTION OF INCUMBENTS AND NEW ENTRANTS IN MESOSCOPIC STRUCTURE (2011-2019).....	305
TABLE 25. REPARTITION BASED ON THE ROLE-TYPE DICHOTOMY.....	306

TABLE 26. TOP 30 ORGANIZATIONS BY THE PERCENTAGE OF IRS CONTRACTED BETWEEN 2011 AND 2019	307
TABLE 27. SYNTHESIS OF FINDINGS	309
TABLE 28. MESOSCOPIC STRUCTURE PROPORTION BY PHASES.....	311
TABLE 29. EVOLUTION OF TYPE OF IR BY MESOSCOPIC STRUCTURE FROM 2011 TO 2019.....	314
TABLE 30. SUMMARY OF IRS CATEGORIZATION BY KTA	321
TABLE 31. REPARTITION OF IRS IN CONNECTIVITY KTA <i>PER</i> SUB-ACTIVITIES	324
TABLE 32. YEARLY REPARTITION OF IR TYPES AND EVOLUTION (CONNECTIVITY).....	325
TABLE 33. ORGANIZATION NUMBER BY INDUSTRY BY TYPE IN CONNECTIVITY KTA.....	334
TABLE 34. STRATEGIC BOX FOR CONNECTIVITY KTA	335
TABLE 35. REPARTITION OF IRS IN SENSING KTA <i>PER</i> SUB-ACTIVITIES	337
TABLE 36. YEARLY REPARTITION OF IR TYPES AND EVOLUTION (SENSING).....	339
TABLE 37. STRATEGIC BOX FOR SENSING KTA.....	344
TABLE 38. REPARTITION OF IRS IN AI KTA <i>PER</i> SUB-ACTIVITIES	345
TABLE 39. YEARLY REPARTITION OF IR TYPES AND EVOLUTION (AI).....	347
TABLE 40. STRATEGIC BOX FOR AI KTA.....	353
TABLE 41. REPARTITION OF IRS IN SENSING KTA <i>PER</i> SUB-ACTIVITIES	358
TABLE 42. YEARLY REPARTITION OF IR TYPES AND EVOLUTION (T&C).....	361
TABLE 43. STRATEGIC BOX FOR TESTING AND COMMUNICATION KTA.....	367
TABLE 44. COLLABORATIVE PATTERNS BASED ON INNOVATION CONTENT	372
TABLE 45. LEVELS OF ANALYSIS AND RELATED RESEARCH QUESTIONS	380

LIST OF FIGURES

FIGURE 1. THESIS STRUCTURE	28
FIGURE 2. CONCEPTUALIZATION OF THE DISRUPTIVE INNOVATION THEORY (CHRISTENSEN & RAYNOR, 2003: 310)	41
FIGURE 3. LOW-END VS. NEW MARKET DISRUPTIONS (CHRISTENSEN & RAYNOR, 2003: 44)	43
FIGURE 4. SEGMENTATION OF DISRUPTIVE INNOVATION (LIN ET AL., 2015: 830)	44
FIGURE 5. PHASES OF INNOVATION (TEECE, 1986: 289).....	47
FIGURE 6. THE CLOSED INNOVATION PARADIGM (CHESBROUGH, 2012: 22)	53
FIGURE 7. THE OPEN INNOVATION MODEL (CHESBROUGH, 2012: 23)	70
FIGURE 8. TYPES OF INTERORGANIZATIONAL RELATIONSHIPS (CONTRACTOR & LORANGE, 2002: 487).....	114
FIGURE 9. THE EXPLORATIVE-EXPLOITATIVE DICHOTOMY OF PRODUCT DEVELOPMENT PATH (ROTHAERMEL & DEEDS, 2004: 202)	115
FIGURE 10. THE INTEGRATION APPROACH (DOUARD & HEITZ, 2003: 26).....	119
FIGURE 11. THE ADDITIVE APPROACH TO NETWORK ORGANIZATION (DOUARD & HEITZ, 2003: 25)	120
FIGURE 12. NETWORK DYNAMICS	132
FIGURE 13. THE MOTORWAGEN (DAIMLER, N.D).....	158
FIGURE 14. AUTOMOTIVE VALUE CHAIN (PAUNOV & PLANES-SATORRA, 2019: 41)	160
FIGURE 15. CO2 EMISSIONS BY TRANSPORTATION MODES IN EUROPE (IEA, 2019)	163
FIGURE 16. PASSENGER CARS SALES AND MARKET SHARE IN THE LARGEST ELECTRIC VEHICLE MARKETS (IEA, 2020).....	165
FIGURE 17. 4-D APPROACH TO DYNAMIC MACHINE (DICKMANN, 1998: 60)	171
FIGURE 18. SAE LEVELS OF AUTONOMY (SAE, 2019)	176
FIGURE 19. AV EQUIPMENT (OECD, 2015: 11)	185
FIGURE 20. AREAS WITH REQUIREMENTS TO CONSIDER (WINNER & WACHENFELD, 2016, 257)	186
FIGURE 21. BMW AUTONOMOUS CONCEPT CAR (MUOIO, 2017)	187
FIGURE 22. INTERIOR OF THE NEXT-GEN AUTONOMOUS VEHICLE.....	188
FIGURE 23. SUMMARY OF ADAS APPLICATIONS PRODUCTION IN UNITS (IHS, 2019)	190
FIGURE 24. ADAS SENSORS (IHS AUTOMOTIVE, 2019)	191
FIGURE 25. CONCEPTUALIZATION OF KNOWLEDGE IN EPISTEMOLOGICAL PARADIGMS (THIETART ET AL., 2014: 29)	203

FIGURE 26. SOCIOMETRIC DATA TYPES	220
FIGURE 27. NETWORK ANALYSIS LEVELS	224
FIGURE 28. STRUCTURAL DATA COLLECTION	225
FIGURE 29. ATTRIBUTE DATA COLLECTION PROCESS	225
FIGURE 30. THE IHS AUTO TECH PLATFORM	227
FIGURE 31. EMPIRICAL MATERIAL COLLECTION FILTERS	228
FIGURE 32. EXAMPLE OF COLLECTED ARTICLES	231
FIGURE 33. THE OUTPUT OF THE IR DATABASE	231
FIGURE 34. INDEXATION OF TECHNOLOGICAL DRIVERS INTO FIVE KEY TECHNOLOGICAL ACTIVITIES	234
FIGURE 35. SAMPLE OF THE IR DATABASE	236
FIGURE 36. THE GICS HIERARCHY	240
FIGURE 37. INDUSTRY PROFILE SNAPSHOT	241
FIGURE 38. SAMPLE OF THE ATTRIBUTE DATASET	243
FIGURE 39. IDENTIFICATION OF THE ROLE	244
FIGURE 40. IDENTIFICATION OF THE ORGANIZATION TYPE	245
FIGURE 41. THE DATA COLLECTION PROCESS	247
FIGURE 42. SNAPSHOT OF THE UCINET PLATFORM	248
FIGURE 43. A SIMPLE REPRESENTATION OF AN UNDIRECTED AND DIRECTED GRAPH	250
FIGURE 44. RESEARCH DESIGN	258
FIGURE 45. STRUCTURE OF PART III	261
FIGURE 46. THE ADAPTED INDUSTRY LIFE-CYCLE MODEL	266
FIGURE 47. EVOLUTION OF THE NUMBER OF INTERORGANIZATIONAL RELATIONSHIPS FROM 2011 TO 2019 IN THE AV INDUSTRY	269
FIGURE 48. PARALLEL BETWEEN THE INDUSTRY LIFE CYCLE MODEL AND THE NUMBER OF INTERORGANIZATIONAL RELATIONSHIPS	273
FIGURE 49. IRS SEGMENTATION BY TOP INDUSTRIES	278
FIGURE 50. GEOGRAPHICAL DISPERSION OF ORGANIZATIONS INVOLVED IN IRS	280
FIGURE 51. NUMBER OF IRS BY KTA	285
FIGURE 52. BOX-PLOT OF IRS FROM 2011 TO 2019	286
FIGURE 53. THE FINAL STATE OF THE AV NETWORKED-INDUSTRY (2011-2019)	292

FIGURE 54. NODES SIZE BY CENTRALITY DEGREE	295
FIGURE 55. NETWORK VISUALIZATION BY NODE CLOSENESS DEGREE	297
FIGURE 56. SUMMARY OF CHAPTER 8.....	302
FIGURE 57. NUMBER OF IRs BY MESOSCOPIC STRUCTURE	310
FIGURE 58. AV SOFTWARE PLATFORMS AND COLLABORATION	312
FIGURE 59. TYPOLOGY OF INTERORGANIZATIONAL RELATIONSHIPS.....	320
FIGURE 60. REPARTITION OF IRs BY MESOSCOPIC STRUCTURE IN CONNECTIVITY KTA.....	326
FIGURE 61. IR TYPES FOR INC-NE MESOSCOPIC STRUCTURE FOR CONNECTIVITY KTA, FROM 2013 TO 2019.....	327
FIGURE 62. DYNAMIC OBSERVATION OF NE-NE ACQUISITIONS	331
FIGURE 63. THE INDUSTRY OF PROVENANCE OF COMPANIES INVOLVED IN IRs.....	333
FIGURE 64. SENSING AS A CRITICAL PILLAR OF AUTONOMOUS DRIVING	338
FIGURE 65. SEGMENTATION OF IRs BY MESOSCOPIC STRUCTURE FOR SENSING KTA	339
FIGURE 66. THE INDUSTRY OF PROVENANCE OF COMPANIES INVOLVED IN IRs.....	341
FIGURE 67. IRs BETWEEN INCUMBENTS AND NEW ENTRANTS FOR SENSING KTA	343
FIGURE 68. SEGMENTATION OF IRs BY MESOSCOPIC STRUCTURE FOR AI KTA	348
FIGURE 69. THE INDUSTRY OF PROVENANCE OF COMPANIES INVOLVED IN IRs.....	350
FIGURE 70. THE INDUSTRY OF PROVENANCE OF INCUMBENTS AND NEW ENTRANTS IN AI KTA.....	351
FIGURE 71. IRs FOR AI BETWEEN LARGE OEMs AND SOFTWARE COMPANIES (2017-2019).....	352
FIGURE 72. SOFTWARE SIMULATED TESTING	355
FIGURE 73. NOMINAL AND DEGRADED CAPABILITIES	356
FIGURE 74. EVOLUTION OF IR FOR TESTING AND COMMERCIALIZATION OF KTA.....	359
FIGURE 75. REPARTITION OF IRs IN TESTING AND COMMERCIALIZATION KTA (2014-2019).....	360
FIGURE 76. IR TYPES BY MESOSCOPIC STRUCTURE FOR TESTING AND COMMERCIALIZATION KTA (2014-2019). 362	
FIGURE 77. Baidu's T&C NETWORK.....	364
FIGURE 78. THE INDUSTRY OF PROVENANCE OF COMPANIES INVOLVED IN IRs.....	365
FIGURE 79. EXAMPLES OF AUTOMATED DRIVING PILOTS	366
FIGURE 80. SEGMENTATION OF IRs BY MESOSCOPIC STRUCTURE FOR MAAS KTA.....	370
FIGURE 81. CONCEPTUALIZATION OF EMERGING INDUSTRIES (INSPIRED BY ADNER, 2017).....	395

TABLE OF CONTENT

SUMMARY	7
ACKNOWLEDGMENT	9
LIST OF ABBREVIATIONS	11
GENERAL INTRODUCTION	13
1. The issue of emerging industries.....	16
1.1. The difference between industry emergence and structuration.....	17
1.2. The role of disruptive innovation in industry emergence	19
1.3. Problematization: Interorganizational relationship networks as metrics	23
2. Focus on the autonomous vehicle industry	26
3. Structure of the thesis.....	27
PART I: LITERATURE REVIEW	35
Chapter 1. Disruptive innovation: Theory, challenges, and evolution	38
Section I. The disruptive innovation theory	40
1. Core concepts	41
2. Low-end vs. new-market disruptive innovations	44
2.1. Low-end disruptive innovation	44
2.2. New market disruptive innovation	45
2.3. Preparagigmatic and paradigmatic phases.....	46
3. Incumbent vs. new entrant' dispute.....	49
3.1. Explaining incumbents' failure in the face of disruptive innovation	49
3.2. Explaining incumbents' success in the face of disruptive innovation	54
Section II. The proclivity of disruptive innovation to create turbulent environments	60
1. Reliance on capabilities and resources.....	60
1.1. Competence-destroying technological discontinuities.....	61
1.2. Cavity between capabilities and opportunities.....	62

2. Assessment of organizational resources and capabilities.....	64
2.1. The Resource-Process-Priority framework	64
2.2. The Resource-Process-Value framework.....	65
3. Risks linked to disruptive innovations	66
3.1. Strategy risks	67
3.2. External risks.....	68
4. Evolution of innovation strategies.....	68
4.1. Closed innovation vs. open innovation paradigm	69
4.2. Ambidextrous innovation strategies.....	73
5. Critiques of the disruptive innovation theory and opening to interorganizational relationships	74
Conclusion of Chapter 1.....	79

Chapter 2. Interorganizational relationships networks as a response to disruptive innovation.....

innovation.....	81
Section I. Apprehending the emergence of an industry	83
1. The theoretical approaches of industry emergence	84
1.1. Institutional approach.....	84
1.2. Evolutionary economics approach	85
1.3. Organizational ecology approach.....	87
1.4. Cognitive considerations	89
1.5. Drawing on the evolutionary economics approach	91
2. The prevalence of industry life cycles.....	92
2.1. Initial stage	92
2.2. Co-evolutionary stage	93
2.3. Growth stage	94
Section II. Considering industry emergence from a network approach.....	97
1. Emergence of networks	98
1.1. Drivers of interorganizational relationships formation	100
1.2. Levels of analysis for interorganizational relationships.....	106
1.3. Typology of organizations engaging in interorganizational relationships	107
2. Structuration of networks	111
2.1. Typology of interorganizational relationships	112
2. 2. Network architecture	118

Conclusion of Chapter 2.....	122
Chapter 3. Theoretical gaps and research questions	123
Section I. A critical review of macro level industry emergence dynamics.....	125
1. A summary of literature evidence	125
2. The limits of the industry life cycle	128
3. A dynamic network approach to industry emergence.....	129
Section II. A multi-level analysis.....	136
1. Allocating a non-linear innovation perspective to industry emergence.....	136
1.1. Building on the theory of disruptive innovation	137
1.2. Assessing industry emergence through Key Technological Activities.....	138
2. Considering networks as wholes	142
3. Drawing on the evolutionary economics theory	143
Section III. A cross-level network analysis through organizational attributes	146
1. Alternative strategies for unsuccessful incumbents	147
2. Focusing on network width.....	148
Conclusion of Chapter 3.....	153
PART II: METHODOLOGY	155
Chapter 4. Research context	157
Section I. The genesis of the traditional automotive industry.....	158
1. Emergence of vehicles	158
1.1. Chronological emergence.....	158
1.2. Traditional automotive value chain.....	160
2. Globalization and its effects on the automotive industry.....	161
3. Emergence of electric vehicles.....	162
4. Premonitory needs for safety and the emergence of autonomous vehicles.....	166
Section II. The autonomous vehicle industry.....	169
1. History of autonomous driving	169
1.1. Technological emergence.....	169
1.2. Critical autonomous vehicle development projects	172
2. Interaction between human and machine	174
3. Challenges for large-scale implementation	177

3.1. Political, legal, and social aspects	178
3.2. Importance of ethics	179
Section III. Justification of the research setting	183
1. A disruptive innovation case	183
2. Effects of autonomous vehicles on the traditional vehicle concept	186
3. Growth opportunities for organizations	188
3.1. Statistical evidence of autonomous vehicle component production	188
3.2. Well-perceived opportunities by companies	191
3.3. Privileged access to empirical material	194
Conclusion of Chapter 4.....	198
Chapter 5. Research design	200
Section I. Epistemological paradigm	202
1. Epistemological anchorage	202
1.1. Constructivist and interpretativist paradigms.....	203
1.2. Choice of the positivist paradigm.....	204
2. Research approach.....	207
2.1. Abductive approach.....	208
2.2. Deductive and hypothetico-deductive approaches	208
2.3. Choice of inductive approach.....	209
Section II. Methodological anchorage	212
1. Anchorage in quantitative methods.....	212
1.1. Qualitative methods.....	212
1.2. Quantitative methods.....	214
1.3. Mixed methodology	215
1.4. Choice of quantitative methodology	216
2. Social network analysis.....	218
2.1. Principles of social network analysis	218
2.2. Sociometric data collection	220
Conclusion of Chapter 5.....	223
Chapter 6. Construction of the databases.....	224
Section I. Sociometric data collection.....	226
1. Collection of structural data	226

1.1. Step 1: Collection of empirical material	227
1.2. Step 2: Extraction of structural data from the empirical material	229
1.3. Step 3: Indexation of technological drivers in Key Technology Activities (KTAs)	232
1.4. Step 4: Validation of unique Key Technology Activities (KTAs) categorization ..	236
2. Collection of attribute data	238
2.1 Step 1: Identification of attribute data	238
2.2. Step 2: Indexation of data.....	242
2.3. Step 3: Retreatment of the attribute data for pre-analysis	243
Section II. Data codification process.....	248
1. UCINET	248
1.1. Matrices and graphs	249
1.2. One-mode vs. two-mode networks.....	251
2. Network analysis	252
2.1. Degree centrality	252
2.2. Closeness centrality.....	254
2.3. Betweenness	254
2.4. Data visualization with NetDraw	255
Conclusion of Chapter 6.....	257
PART III: FINDINGS	261
Chapter 7. Interorganizational relationships as metrics to assess industry emergence and structuration.....	263
Section I. Interorganizational relationships as industry emergence metrics	265
1. Industry life-cycle through interorganizational network patterns	265
1.1. Adaptation of the industry life-cycle model.....	266
1.2. Quantification of interorganizational relationships.....	268
2. Interorganizational relationships as two-industry emergence signals.....	277
2.1. Four dominant industries of provenance	278
2.2. Geographical emergence	280
Section II. Key Technological Activities as industry structuration metrics.....	284
1. Chronological emergence of the autonomous vehicle industry	284

1.1. Lethargic and transitional phases: Emergence of the two first KTAs, Connectivity and Sensing (2011-2014)	287
1.2. Progressive phase: Cohabitation of all the Key Technological Activities (2015-2016)	289
1.3. Densifying phase: A plethora of interorganizational relationships in each Key Technological Activity network (2017-2019).....	291
2. Predominance of the Key Technological Activities.....	293
2.1. Degree centrality	294
2.2. Closeness centrality.....	296
Conclusion of Chapter 7.....	299
Chapter 8. Multi-network analysis based on organizational attributes.....	301
Section I. Identification of shared characteristics of interorganizational networks at the organizational level	303
1. General network characteristics	304
1.1. Supplier-dominant industry	305
1.2. Incumbent suppliers as top interorganizational relationships contractors	307
2. Multi-level analysis of network composition.....	309
2.1. Identification of mesoscopic structure patterns.....	310
2.2. Choice of interorganizational relationship forms.....	313
Section II. Identification of specific characteristics of interorganizational networks at the network level.....	320
1. Connectivity KTA.....	322
1.1. Technological content pushing towards IR formation	322
1.2. Interorganizational relationships patterns in Connectivity KTA	325
1.3. The convergence of information technology, automobile, and telecom companies.....	333
2. Sensing KTA.....	336
2.1. Technological content pushing towards IR formation	336
2.2. Interorganizational relationships patterns in Sensing KTA	338
2.3. Convergence of automobile and information technology companies.....	340
3. Artificial Intelligence KTA.....	344
3.1. Technological content pushing towards IR formation	345
3.2. Interorganizational relationships patterns in AI KTA.....	347
3.3. Convergence of automotive and software industries	350

4. Test and Commercialization KTA	353
4.1. Technological content pushing towards IR formation	354
4.2. Dynamic evolution of IRs	359
4.3. Identification of the Apollo Consortium	363
4.4. Convergence of automotive and IT companies	365
5. Mobility-as-a-Service, an emerging KTA.....	368
5.1. Technological content pushing towards IR formation	368
5.2. Sporadic patterns of interorganizational relationship networks	369
Conclusion of Chapter 8.....	374
Chapter 9. Discussion.....	379
Section I. Research synthesis	380
Section II. Theoretical contributions	383
1. Disruptive innovation: beginning or end?	383
1.1. Evaluating the implications of disruptive innovation	383
1.2. Disruptive innovation driver of industry emergence.....	386
2. Assessing industry emergence with interorganizational relationships.....	389
2.1. Implications of interorganizational relationships at the macro level analysis of emerging industries	390
2.2. The potency of Key Technological Activities in industry emergence studies	393
2.3. Contributions at the organizational level	396
Section III. Managerial and methodological contributions	401
1. Methodological contributions	401
2. Managerial contributions.....	403
2.1. Monitoring external environments to seize industry emergence	403
2.2. New entrants: triggers for industry emergence	404
2.3. Incumbents: pivotal players of industry emergence.....	405
Section IV. Limits and future research directions	408
REFERENCES	411
LIST OF TABLES	435
LIST OF FIGURES	437

Assessing industry emergence and structuration: An approach through interorganizational relationship networks around Key Technological Activities

The present doctoral thesis aims to examine industry emergence caused by disruptive innovation. We adopted a dynamic approach to industry emergence to nourish debates around its assessment through a three-level funnel approach adopted: macro, network, and organizational levels. Based on a social network analysis of the Autonomous vehicles industry from 2011 to 2019, our findings allow us to assess the *ex-ante* emergence of an industry. The present thesis notably suggests an interesting way to measure industry emergence through interorganizational relationship networks building around Key Technological Activities required for the Autonomous vehicles industry to become a reality and to distinguish the emergence from the structuration of an industry.

Keywords: Industry emergence, disruptive innovation, interorganizational relationship network, paradigm change, autonomous vehicle.

Methodology: Quantitative methodology, Social Network Analysis.

Mesurer l'émergence et la structuration d'une industrie: une approche par les réseaux de relations interorganisationnelles autour d'Activités Technologiques Clés.

Cette recherche propose d'étudier l'émergence d'une industrie suite à une innovation de rupture. Afin de participer aux débats actuels autour de sa mesure, nous avons adopté une approche dynamique en retenant trois niveaux d'analyse, c'est-à-dire niveau macro, puis réseau et enfin, niveau organisationnel. A partir d'une analyse de réseaux de l'industrie du véhicule autonome de 2011 à 2019, nos résultats mettent en évidence le rôle des réseaux de relations interorganisationnelles autour d'activités technologiques clés permettant la réalisation de véhicules autonomes, comme mesure de l'émergence et de la structuration d'une industrie. L'intensité de ces relations permettent également de distinguer ces deux phases souvent confondues, d'émergence et de structuration d'une industrie et de proposer une analyse dynamique et non a posteriori de l'émergence.

Mots clés : Emergence d'industrie, innovation disruptive, relations interorganisationnelles, réseaux, changement paradigmatique, voiture autonome

Méthodologie : Méthodologie quantitative, Analyse de Réseaux