



HAL
open science

Integrated operation and maintenance policies for the economic, social and environmental optimization of interconnected urban transport systems

Ronald Martinod

► **To cite this version:**

Ronald Martinod. Integrated operation and maintenance policies for the economic, social and environmental optimization of interconnected urban transport systems. Modeling and Simulation. Université de Lorraine; Universidad EAFIT (Medellín, Colombie), 2021. English. NNT : 2021LORR0069 . tel-03354203

HAL Id: tel-03354203

<https://hal.univ-lorraine.fr/tel-03354203v1>

Submitted on 24 Sep 2021

HAL is a multi-disciplinary open access archive for the deposit and dissemination of scientific research documents, whether they are published or not. The documents may come from teaching and research institutions in France or abroad, or from public or private research centers.

L'archive ouverte pluridisciplinaire **HAL**, est destinée au dépôt et à la diffusion de documents scientifiques de niveau recherche, publiés ou non, émanant des établissements d'enseignement et de recherche français ou étrangers, des laboratoires publics ou privés.



AVERTISSEMENT

Ce document est le fruit d'un long travail approuvé par le jury de soutenance et mis à disposition de l'ensemble de la communauté universitaire élargie.

Il est soumis à la propriété intellectuelle de l'auteur. Ceci implique une obligation de citation et de référencement lors de l'utilisation de ce document.

D'autre part, toute contrefaçon, plagiat, reproduction illicite encourt une poursuite pénale.

Contact : ddoc-theses-contact@univ-lorraine.fr

LIENS

Code de la Propriété Intellectuelle. articles L 122. 4

Code de la Propriété Intellectuelle. articles L 335.2- L 335.10

http://www.cfcopies.com/V2/leg/leg_droi.php

<http://www.culture.gouv.fr/culture/infos-pratiques/droits/protection.htm>

Politiques d'exploitation et de maintenance intégrées pour
l'optimisation économique, sociétale et environnementale
des systèmes de transports urbains interconnectés

THÈSE

Présentée et soutenue publiquement en mars 2021

Pour l'obtention du

Doctorat de l'Université de Lorraine

(mention automatique)

par

Ronald M. MARTINOD R.

Composition du jury

<i>Président :</i>	Prof. Benoit IUNG
<i>Rapporteurs :</i>	Prof. Alexandre DOLGUI Prof. Anis CHELBI
<i>Examineurs :</i>	Prof. Yasmina HANI Prof. Olga L. QUINTERO Prof. Benoit IUNG
<i>Directeurs de thèse :</i>	Prof. Nidhal REZG Prof. Leonel F. CASTAÑEDA
<i>Co-Directeur de thèse :</i>	Dr. Olivier BISTORIN

Cette page a été intentionnellement laissée en blanche

Acknowledgements

This thesis was the result of an inter-institutional agreement between *l'Université Lorraine* and *Universidad EAFIT*, which was prepared within the LGIPM laboratory (*Laboratoire de Génie Informatique, de Production et de Maintenance*) and the GEMI research group (*Grupo de Estudios en Mantenimiento Industrial*).

I would like to express my sincere gratitude to my thesis director in France, Prof. Nidhal REZG, and my co-director, Dr. Olivier BISTORIN, for their great quality supervision and for providing guidance and feedback throughout this project. Further, I would like to thank my director in Colombia, Prof. Leonel F. CASTAÑEDA, for his continuous support, and without whom I would not have been able to complete this research. They all taught me invaluable concepts, shared me their large experience, handed me their precious advice, and countless hours spent on our collaborative work. The meetings and conversations were vital to think with multiple perspectives to form comprehensive and objective criteria.

I owe my deepest gratitude to the engineers of the metropolitan transport company of Medellín city who provided us with valuable information and data to carry out this work.

I would like to extend my thanks to the report members of the jury, Prof. Alexandre DOLGUI and Prof. Anis CHELBI. I also thank the examining board of the thesis, Prof. Yasmina HANI, Prof. Olga L. QUINTERO, and Prof. Benoit IUNG.

Finally, I especially thank to my wife, Laura, and my daughter, Angélica, for their patience, for putting up with me being far away ones in a while, and for providing support and encouragement throughout way.

Cette page a été intentionnellement laissée en blanche

Content

French abstract of the thesis	iii
Introduction	9
1. Chapter 1: Integrated optimisation for operation and maintenance policies	15
1.1. Introduction	15
1.2. Literature Review	19
1.3. Problem description.....	20
1.3.1. Urban transport service policy	20
1.3.2. Maintenance policy of ropeway systems	23
1.4. Proposed Model.....	25
1.4.1. Development formulation of the service problem	26
1.4.2. Development formulation of the maintenance problem	27
1.5. Case study: urban aerial ropeway system.....	31
1.5.1. Service parameters behaviour	32
1.5.2. Maintenance parameters behaviour	34
1.5.3. Cost of service and maintenance policies	37
1.6. Conclusions and discussion.....	37
2. Chapter 2: Combined optimisation methodology for operation planning and service policies	39
2.1. Introduction	39
2.2. Literature review	42
2.3. Problem formulation.....	43
2.4. Operation plan for urban public transport systems.....	43
2.4.1. Working-time periods.....	43
2.4.2. Stop-time periods.....	44
2.4.3. Downtime periods due to preventive maintenance.....	44
2.4.4. Breakdown time due to faults	45
2.5. Service level management.....	46
2.5.1. Passenger travel time model	46
2.5.2. Passenger waiting time model	47
2.6. Optimisation process	48
2.7. Study Object: an urban aerial ropeway system	49
2.8. Results and discussion.....	51
2.8.1. Operation time costs	51
2.8.2. Passenger time costs	52
2.8.3. Optimisation results.....	54
2.9. Conclusions and perspectives.....	55

3. Chapter 3: Maintenance policy optimisation for multi-component systems considering degradation of components and imperfect maintenance actions	57
3.1. Introduction	57
3.2. Problem formulation.....	60
3.2.1. Preventive maintenance policies.....	60
3.2.2. Corrective maintenance policy	64
3.3. Proposed methodology framework.....	65
3.4. Optimisation process	66
3.4.1. Optimisation of maintenance actions cost to each component	66
3.4.2. Optimal cost by clustering preventive maintenance actions.....	67
3.5. Numerical study	68
3.5.1. Background - urban ropeway transport	68
3.5.2. Optimisation of maintenance actions cost to the set of critical elements	70
3.5.3. The optimal long-term cost maintenance by clustering.....	71
3.5.4. Discussion of results from the proposed strategy compared with the current	72
3.6. Conclusions	73
4. Chapter 4: Service policy optimisation based on demand interdependencies	75
4.1. Introduction	75
4.2. Problem definition and methodology	78
4.2.1. Service policy model for metro transport systems.....	79
4.2.2. Service model for MCPTSs	84
4.2.3. Queuing model for MCPTSs	85
4.3. Optimisation process	86
4.4. Case study	88
4.4.1. Background of the metro system	89
4.4.2. Background of the UACSS	90
4.4.3. Validation process of the model	91
4.5. Results and discussion.....	92
4.6. Conclusion.....	94
5. Chapter 5: Service policy optimisation during health emergency of pandemic cycles	95
5.1. Introduction	95
5.2. Problem formulation.....	97
5.3. Optimisation process	98
5.4. Case study	98
5.4.1. Metro lines	99
5.4.2. Tramway line	100
5.4.3. Ropeway (télécabine) lines.....	100
5.4.4. Mobility constraints on health emergency.....	100
5.5. Results	101
5.6. Conclusions	102
Conclusions	103
Appendix A. General features of the ropeway transport models	107
Appendix B. Results of validations for the models.	109

Appendix C. Results of numerical models	113
Appendix D. General diagrams of the systems	114
Appendix E. BDP algorithms	116
References	118

Cette page a été intentionnellement laissée en blanche

French abstract of the thesis

I provide a French abstract of the thesis to comply with the regulation of Université de Lorraine. The remain of the document is wrote in English language.

Politiques d'exploitation et de maintenance intégrées pour l'optimisation économique, sociétale et environnementale des systèmes de transports urbains interconnectés

Résumé

Les systèmes de transport public urbain influencent l'infrastructure des agglomérations et la vie de leurs habitants tout en stimulant directement l'économie. Les systèmes de transport public urbain intelligents contribuent à améliorer la qualité de vie et l'environnement dans les villes, ce qui contribue à une augmentation de la démographie urbaine. Ces mêmes populations souhaitent préserver une grande souplesse dans leurs déplacements et exigent donc une offre de transport urbain riche et adaptable. Toutefois, Les niveaux élevés de développement urbain (densification) et les exigences croissantes de mobilité des résidents ont tendance à dégrader les environnements urbains. Le développement rapide des solutions de transport urbain a conduit de très nombreux opérateurs à se porter sur ce marché empêchant ainsi une logique globale de l'offre pour une même agglomération. Chaque opérateur de transport a donc tenté des optimisations des stratégies d'achat, d'entretien et de recyclage de ses matériels et des personnels en charge de réaliser les dites opérations. Ces optimisations discrètes, privées de toutes concertations entre opérateurs de transport intervenant sur un même périmètre, interdit l'identification d'un optimum global au profit de minimas locaux. En conséquence, le fonctionnement inefficace des systèmes de transport public urbain ne réduit pas nécessairement la charge environnementale, et les opérateurs de transport urbain peuvent ne pas être en mesure de la gérer de manière durable. Les problèmes de longue date des systèmes de transport public urbain (par exemple, faible efficacité opérationnelle, manque de ponctualité du service de transport, etc.) ont des conséquences négatives et génèrent en particulier un manque d'attrait pour les passagers. Par ailleurs, les mauvaises performances des systèmes de transport public urbain, les temps d'arrêt et une planification inefficace augmentent les coûts et réduisent les profits des opérateurs de transport urbain. Ainsi, la maximisation du taux de service des usagers est un objectif à allier à une viabilité économique, condition sine qua none de survie pour les exploitants des réseaux de transport urbain. L'optimisation conjointe de l'exploitation et de la maintenance des installations est alors source de performance, tant du point de vue de l'exploitant que des usagers.

Pour répondre à ces défis, ces travaux de thèse proposent une méthodologie associée à des modèles mathématiques qui sont développés à travers des approches d'optimisation pour une gestion systémique des réseaux de transport public multimodal, et ce afin d'assurer le meilleur taux de service aux usagers tout en minimisant les coûts et les externalités sociétales afin de satisfaire au principe de durabilité, fréquemment exprimé dans les plans de développement urbains. Par conséquent, la principale question de recherche attachée à ces travaux peut être exprimée comme suit :

Quels sont et comment réunir les modèles mathématiques pour augmenter le service aux usagers lie au profit des passagers tout en minimisant les coûts de maintenance lie à des politiques d'exploitation des réseaux de transports publics urbains ?

La thèse a été possible grâce à la recherche conjointe entre le laboratoire LGIPM et le groupe de recherche GEMI. D'un côté, la thèse a été soutenue par des travaux de recherche précédents du laboratoire LGIPM portant sur la conjonction entre la maintenance et des différentes domines industrielles :

- (i) La maintenance intégrée aux systèmes de production, dans laquelle Hajej et al. (Hajej, Rezg, & Gharbi, Joint optimization of production and maintenance planning with an environmental impact study, 2017) ont établi le taux de production économique et la stratégie de maintenance optimale pour minimiser le coût total de production, d'inventaire, de maintenance et d'émission, sur la base d'une relation entre le taux de défaillance et l'émission ; plus tard, Bouslikhane et al. (Bouslikhane, Hajej, & Rezg, 2018) avancent sur la formulation pour déterminer un optimum considérant la maintenance et la production avec émission de carbone pour les systèmes en boucle fermée ; en outre, Hajej et al. (Hajej, Rezg, & Gharbi, Quality issue in forecasting problem of production and maintenance policy for production unit, 2018) ont développé une politique de contrôle commune basée sur une planification stochastique de la production et de la maintenance pour évaluer le plan économique de production et la stratégie optimale de maintenance.
- (ii) Maintenance intégrée aux processus de fabrication/réfabrication, dans laquelle Ameknassi et al. (Ameknassi, Ait-Kadi, & Rezg, 2017) ont analysé un système de fabrication-réfabrication-transport-stockage dans une chaîne d'approvisionnement en boucle fermée ; plus tard, Guiras et al. (Guiras, Turki, Rezg, & Dolgui, 2018) ont défini une optimisation du système de désassemblage/remise à neuf/assemblage à deux niveaux avec une stratégie de maintenance intégrée ; en outre, Turki et Rezg (Turki & Rezg, 2018) a proposé une optimisation conjointe de la maintenance à l'émission intégrée pour un système de fabrication et de remise à neuf.
- (iii) Maintenance intégrée à la logistique industrielle, dans laquelle Askri et al. (Askri, Hajej, & Rezg, 2016) ont structuré le cadre d'une stratégie de maintenance intégrée pour des machines louées en parallèle avec des périodes de garantie ; de plus, Ndhaief et al. (Ndhaief, Bistorin, & Rezg, 2017) ont créé un modèle de localisation des plates-formes logistiques en ville basé sur des flux avant et arrière combinés ; ensuite, Turki et Rezg (Turki & Rezg, Study of the E-Maintenance Service in E-Logistic Supply Chain, 2017) a établi une étude des services de maintenance électronique dans la chaîne d'approvisionnement logistique électronique.

D'autre part, le groupe de recherche GEMI a fourni le contexte des transports publics urbains pour différents systèmes :

- (i) Systèmes ferroviaires, dans lesquels Martinez et al. (Martinez, Martinod, Jensen, Palacio, & Castañeda, 2010) ont fait des recherches sur la conception de pièces de rechange optimisées pour la charge des châssis de train ; de plus, Castañeda et al. (Castañeda, Martinod, & Betancur, 2012) ont déterminé l'état technique des éléments de trains en conditions opérationnelles ; et Bernal et al. (Bernal, Martinod, Becancur, & Castañeda, 2016) ont étudié les paramètres de maintien des véhicules de métro en condition dynamique.
- (ii) Systèmes de téléphériques, dans lesquels Martinod et al. (Martinod, et al., Journey safety assessment to urban aerial ropeways transport systems based on continuous inspection during operation, 2015) ont proposé une méthode d'inspection continue pour évaluer la sécurité des trajets appliquée aux véhicules de téléphériques ; de plus, Martinod et al. (Martinod, et al., Operating conditions effect over the coupling strength for urban aerial ropeways, 2014) ont étudié l'effet causé par les conditions externes dues aux charges de vent jointes à d'autres effets externes.

La thèse est structurée comme un recueil de la production scientifique découlant de ces travaux. Il s'agit en l'occurrence de cinq articles ou communications publiés dans des revues à comité de lecture ou des conférences internationales avec comité de lecture. Chaque chapitre est ainsi associé à une publication et s'attache à résoudre un problème de transport public urbain donné en traitant des politiques intégrées d'exploitation et de maintenance pour l'optimisation économique et sociale. Bien sûr, chaque chapitre a un objectif et des contributions spécifiques, avec sa propre revue de littérature, sa description et sa formulation du problème, ses résultats et ses discussions, ses conclusions et ses perspectives. De plus, chaque chapitre développe un cadre

mathématique avec une notation et des expressions spécifiques pour fournir une méthodologie claire. Pour autant, nous avons cherché à maintenir, tout au long de ces travaux, une cohérence et une logique de progression scientifique levant progressivement les différents verrous identifiés. Enfin, nous précisons que les cas applicatifs traités font référence à un véritable réseau de transport métropolitain composé de lignes de métro, de tramway et de téléphérique.

Les chapitres 1 et 2 du manuscrit proposeront un modèle stochastique de politiques communes de service et de maintenance pour optimiser les stratégies d'exploitation, cet travail a été publié en les journaux « *International Journal of Quality & Reliability Management*, DOI: [10.1108/IJORM-10-2018-0292](https://doi.org/10.1108/IJORM-10-2018-0292) » et « *International Journal of Transport Economics*, DOI: [10.19272/202006703006](https://doi.org/10.19272/202006703006) ». Une seconde partie approfondira l'optimisation de la politique de maintenance pour les systèmes à composants multiples en tenant compte de la dégradation des composants et des actions de maintenance imparfaite, qui est développée dans le chapitre 3, lequel a été publié en le journal « *Computers & Industrial Engineering*, DOI: [10.1016/j.cie.2018.07.019](https://doi.org/10.1016/j.cie.2018.07.019) » et il a été présenté dans une conférence internationale « *5th International Conference on Project Logistics – PROLOG 2019*, <https://factuel.univ-lorraine.fr/sites/factuel.univ-lorraine.fr/files/field/files/2019/06/programme-prolog-2019-web.pdf> ». La dernière étape de la thèse se concentrera quant à elle sur l'optimisation de la politique de service pour un réseau de transport urbain multimodal, développée dans les chapitres 4 et 5, en proposant une ouverture en cas de fonctionnement perturbé par un phénomène hexogène, ici une crise sanitaire, cet travail a été présenté dans une conférence internationale « *13th International Conference on Modeling, Optimization and Simulation - MOSIM'20*, http://mosim2020.ma/wp-content/uploads/2020/11/PROGRAMME-MOSIM-2020-F-An_v4.pdf » et il est en processus de révision dans le journal « *Journal of Traffic and Transportation Engineering (English Edition)* ». Enfin, en point d'orgue, une conclusion générale présentera une synthèse des travaux menés et établira des perspectives pour de futurs travaux. Enfin, tous les modèles décrits tout au long de la thèse sont intégrés pour proposer une méthodologie de résolution des problèmes liés aux politiques de service et de maintenance dans le chapitre Conclusions.

Positionnement des travaux

L'un des thèmes centraux de la thèse est l'optimisation de la politique de maintenance, dont les caractéristiques essentielles du problème de planification de la maintenance ont été analysées par Kralj et Petrović (Kralj & Petrović, 1988) où sont incluses des contraintes imposées en utilisant des méthodes de recherche opérationnelle. Bretthauer et al. (Bretthauer, Gamaleja, Jacobs, & Wilfert, 1990) ont proposé des modèles numériques utilisant des langages de calcul robustes (implémentés sur des processeurs 16 bits sous MS-DOS avec le code Turbo-Prolog) pour évaluer les programmes de maintenance afin d'améliorer la fiabilité des systèmes. Plus tard, l'amélioration des techniques d'analyse et la disponibilité d'ordinateurs rapides ont permis de proposer des modèles plus complexes, Cho et Parlar (Cho & Parlar, 1991) ont développé des modèles numériques de maintenance multi-composants, y compris des modèles de réparation des interférences des machines, des modèles de remplacement de groupe, des modèles de pièces détachées et des modèles d'inspection ; en outre, Dekker et Wildeman (Dekker & Wildeman, 1997) ont structuré les modèles numériques de maintenance multi-composants avec une dépendance économique. Anily et al. (Anily, Glass, & Hassin, 1998) ont proposé un ensemble d'algorithmes finis pour la programmation du service de maintenance. Yang, Djurdjanovic et Ni (Yang, Djurdjanovic, & Ni, 2008) ont quant à eux utilisé un modèle basé sur la dépendance pour développer un calendrier de maintenance basé sur la dégradation attendue de la machine en considérant l'interaction complexe entre les composants, le processus de production et les opérations de maintenance.

Une politique de maintenance basée sur un modèle de risque proportionnel pour les systèmes à composants multiples a été proposée par Tian et Liao (Tian & Liao, 2011). Par la suite, Liu et al. (Liu, Xu, Xie, & Kuo, 2014) ont formulé une politique de maintenance préventive pour les

systèmes à composants multiples concernant les composants en dégradation continue. En outre, Zhou et al. (Zhou, Huang, Xi, & Lee, 2015) ont proposé un modèle de maintenance préventive basé sur une fenêtre temporelle pour les systèmes à composants multiples présentant des défaillances stochastiques et la séquence de démontage impliquée. Néanmoins, il convient de constater que la littérature n'a pas fait état de modèles basés sur la dépendance sans une classification préétablie, qui combine l'analyse de fiabilité des systèmes complexes et l'état de fonctionnement de chaque composant. D'autres modèles (Do, Vu, Barros, & Bérenguer, 2015; Lung, Do, Levrat, & Voisin, 2016) ont supposé que tous les membres d'un groupe ont un comportement identique ; par conséquent, ces modèles sont basés sur des hypothèses avec des simplifications.

Dans le cadre d'un autre thème central de la thèse, qui porte sur la politique de service afin de résoudre le problème des files d'attente dans le domaine des transports, la première approximation était un modèle simplifié au moyen de modèles de demande déterministes et prévisibles (May & Keller, 1967) ; mais plus tard, le modèle mathématique a été amélioré par Newell (Newell, 1977), qui a établi que les passagers arrivent aux arrêts selon une distribution de Poisson et le retard des véhicules selon Fokker-Planck. Les applications de la théorie des files d'attente dans les transports ont conduit un certain nombre d'auteurs à développer des systèmes de files d'attente. Ceder (Ceder, 2007) a utilisé une formulation du temps d'attente moyen des passagers en supposant que les passagers arrivent de manière aléatoire. Caris et al. (Caris, Macharis, & Janssens, 2013) ont introduit la théorie du processus de Poisson composé comme modèle principal pour traiter le problème des files d'attente dans les transports publics urbains. En outre, Lee et ses collègues (Parbo, Nielsen, & Prato, 2014) ont caractérisé les modèles de files d'attente dans les transports comme des systèmes non stationnaires (à variation temporelle). Enfin, Nesheli et al. (Nesheli, Ceder, & Liu, 2015) ont introduit des horaires synchronisés pour réduire le temps d'attente causé par l'arrivée des lots.

Enfin, certains auteurs concentrent leurs études sur une maintenance et une optimisation du fonctionnement conjointes. Xiao et al. (Xiao, Song, Chen, & Coit, 2016) ont associé une optimisation de la planification de la production à la maintenance préventive des groupes de machines. Récemment, Hajej et al. (Hajej, Rezg, & Askri, Joint optimization of capacity, production and maintenance planning of leased machines, 2018; Hajej, Dellagi, & Rezg, Joint optimisation of maintenance and production policies with subcontracting and product returns, 2014) traitent du problème de l'optimisation conjointe des coûts de maintenance, de production et de stocks. Les recherches précédentes proposent des études qui combinent une optimisation entre la production industrielle et la maintenance dans le contexte des chaînes de montage pour la production de masse de produits, mais la complexité des conditions dans le service du transport public urbain modifient particulièrement les approches et sont à l'origine de ces travaux de thèse.

Contributions apports de la thèse

Ces travaux de thèse constituent une contribution originale en développant un cadre mathématique pour intégrer les politiques de service et de maintenance dans un réseau de transport public multimodal (composé d'un ensemble de lignes de métro, de tramway et de téléphérique) basé sur des processus d'optimisation stochastique afin de résoudre conjointement le problème des files d'attente et celui du coût des actions de maintenance. À cette fin, nous avons proposé : (i) un modèle stochastique à événements discrets composé d'un ensemble de files d'attente interdépendantes pour la formulation du problème de service en utilisant une expression mathématique basée sur le coût ; et (ii) une maintenance préventive imparfaite basée sur deux politiques de maintenance différentes (maintenance périodique de type bloc et maintenance basée sur l'âge). A la suite, un modèle mathématique de la politique de service a été proposé pour déterminer les valeurs des paramètres opérationnels dans lesquels le système de transport offre différents niveaux de qualité de service (les utilisateurs obtiennent le service dont ils ont besoin sans attendre dans une file d'attente, et un temps d'attente acceptable pour les passagers. Le volet

maintenance est intégré par le biais d'un modèle stochastique qui considère la dégradation pour un système multi-composant avec une relation de dépendance entre les composants. Grâce à cette analyse, le modèle de coût de maintenance (qui comprend des actions de maintenance corrective et préventive) complète l'optimisation de la fonction de coût. Il en résulte que le modèle d'optimisation est développé pour soutenir une planification efficace de l'exploitation afin d'atteindre un profit maximum pour les opérateurs de transport urbain et un impact minimum pour les passagers en cas de service dégradé (retardé par exemple).

L'intermodalité est elle aussi constituante de l'originalité de ces travaux puisqu' une approche particulière a été développée pour considérer les différents opérateurs de transport urbain avec des lignes de métro, de tramway et de téléphérique urbain interconnectées. Le modèle générique proposé est à-même d'intégrer d'autres modes de transport, avec des paramètres spécifiques. Il apparaît ainsi que la durabilité à long terme de l'exploitation des systèmes de transport public urbain ne peut être fondé que sur une méthodologie d'optimisation combinée des politiques de maintenance et d'exploitation pour servir une politique de service.

Enfin, tirant avantage du contexte particulier lié à la pandémie mondiale COVID-19, la thèse propose une optimisation des politiques de maintenance et d'exploitation en intégrant des restrictions de service et des contraintes liées à demande des passagers, générées par l'urgence sanitaire des cycles pandémiques (par exemple, SRAS en 2003, MERS en 2015, Covid-19 en 2020), et qui bouleversent les modèles d'optimisation pour parvenir à maintenir un caractère durable dans un contexte perturbé, au-delà de micro phénomènes éphémères.

Cette page a été intentionnellement laissée en blanche

Introduction

The ongoing diffusion of technological capacity, information and connectivity is opening up a wide range of possibilities, and one of the most remarkable applications is associated with smart cities. World wide cities started a process of strong innovation in different fields (such as mobility and transportation). City managements integrate the information and data to address the exponential growth of urbanization and population; thus, intelligent urban public transport systems contribute to improve the quality of life and the environment in cities. Smart public transport systems influence the infrastructure of urban areas and the economy, while improving the lives of their populations, changing citizens' habits (Ivaldi & Ciacci, 2020). People want high flexibility in their journeys, and demand a wide and adaptable urban transport offer. However, high levels of urban development (densification) and the increasing mobility requirements of residents tend to degrade urban environments. The quickly development of urban transport solutions has led to a large number of independent transport operators; thus, avoiding a global logic regarding the transport service in a given urban area. Therefore, each transport operator has tried to optimise its profit-making strategies by managing the equipment and staff to carry out the operations. These independent (discrete) optimisations, deprived of any dialogue between transport operators providing service within an area, prevent the identification of a global optimum for the benefit of local minima. Therefore, the inefficient operation of urban public transport systems does not necessarily reduce the environmental burden, and urban transport operators may not be able to manage the service in sustainable conditions. Long-standing problems of urban public transport systems (e.g., low operational efficiency, lack of punctuality of the transport service, etc.) have negative consequences such as lack of attractiveness for passengers. Malfunctioning urban public transport systems, downtime and inefficient planning lead to loss of service, increased costs and reduced benefits for urban transport operators and passengers as well. On the other hand, urban public transport system that are able to carry out their operations effectively will save time, money and other resources by addressing issues of reliability, availability, maintenance and performance. Rational operational planning of urban public transport systems improves global operational efficiency and service level management.

Smart cities are also deeply connected to sustainability aspects and contributes to higher life quality. Smart cities improve their sustainability level, reducing transport costs and waste of resources as well as helps transport operators to manage the transport network (Bibri, 2018); moreover, smart urban transport systems increase the sustainability of the urban area, the optimized management of energy resources, and the design of innovative services and solution for citizens (Belli, et al., 2020). Sustainability concept employs three interconnected goals (Basiago, 1999) encompassing economic, social, and environmental. This tripartite description is used for balancing of trade-offs between the desirable goals. The social goal concerns to satisfy basic human needs (e.g., mobility), the ecological goal focuses on the productivity and functioning of the environment and ecosystems, and the economic goal entails resolving limitations that a sustainable society must place on financial growth (Brown, Hanson, Liverman, & Merideth, 1987).

The smart cities challenge is a main topic for different global knowledge agendas: Science Foundation (NSF), International Development Research Centre (*Centre de recherches pour le développement international* - CRDI), Inter-American Development Bank (Banco Interamericano de Desarrollo - BID), United Nations Educational, Scientific and Cultural Organization (Unesco), and specially, Sustainable Development Goals (SDGs). The 2030 Agenda for Sustainable Development, sustainable transport is mainstreamed across several SDGs and targets, especially those related to economic growth, infrastructure, health, energy, and cities settlements. The importance of transport for climate action is further recognized under the United Nations Framework Convention on Climate Change (UNFCCC), the transport sector will be playing a particularly important role in the achievement of the Paris Agreement, given the fact close to a

quarter of energy-related global greenhouse gas emissions come from transport and that these emissions are projected to grow substantially in the years to come. Furthermore, the urban mobility is a not-stop sector because is a social and economic motor, which support the competitiveness and is linked to other basic sectors of the cities (e.g., during the health emergency of pandemic cycles for Covid-19 on 2020, the urban public transport continued running, despite others sectors such as the airline transport, factories or educative centres were closed).

To respond to these challenges, the objective of this thesis is to develop a methodology and its mathematical framework with optimisation approaches to solve operation and maintenance policies problems by operators in multimodal public transport networks, in order to ensure the best rate of service to users while minimising costs and improving societal externalities to comply the principle of sustainability, frequently expressed in urban development plans. Therefore, the thesis is strong focused on two of the sustainability goals: (i) economic goal, which impact city managers (governmental agencies) and transport operators by means of improve the maintenance policy; and (ii) social goal, which impact the citizens according to rising the public service policy. The thesis assumes that improving the maintenance and service policies positively impacts the ecological goal because improve the use of resources (e.g., reduce the energy consumption of vehicles, decrease the replacement of spare parts for maintenance actions), but the direct and explicit assessments for the ecological goal remains on the fringes of this thesis, due to they are outside of the aims of this work. Thus, the main research question is expressed as follow:

What and how to bring together the mathematical models to increase the service to the users linked to the profit while minimizing the maintenance costs linked to the operational policy of the urban public transport networks?

The thesis has been possible because of the jointed research between the LGIPM laboratory belonging to *l'Université de Lorraine* (Fr.) and the GEMI research group belonging to *Univeridad EAFIT* (Co.). On one hand, the thesis has been supported by previous researches from LGIPM laboratory focused on the conjunction between maintenance to different industrial areas:

- (i) Integrated maintenance to production systems, in which Hajej et al. (Hajej, Rezg, & Gharbi, Joint optimization of production and maintenance planning with an environmental impact study, 2017) established the economical production rate and the optimal maintenance strategy for minimizing the total cost of production, inventory, maintenance and emission, based on a failure rate and emission relationship; later, Bouslikhane et al. (Bouslikhane, Hajej, & Rezg, 2018) advance on the formulation to determine an optimal considering the maintenance and the production with carbon emission for closed-loop systems; besides, Hajej et al. (Hajej, Rezg, & Gharbi, Quality issue in forecasting problem of production and maintenance policy for production unit, 2018) developed a joint control policy based on stochastic production and maintenance planning to assess the economic plan of production and the optimal maintenance strategy.
- (ii) Integrated maintenance to manufacturing/remanufacturing processes, in which Ameknassi et al. (Ameknassi, Ait-Kadi, & Rezg, 2017) analysed a manufacturing-remanufacturing-transport-warehousing system within a closed-loop supply chain; later, Guiras et al. (Guiras, Turki, Rezg, & Dolgui, 2018) defined an optimisation of two-level disassembly/remanufacturing/assembly system with an integrated maintenance strategy; furthermore, Turki and Rezg (Turki & Rezg, 2018) proposed a jointly integrated maintenance to emission optimisation for a manufacturing and remanufacturing system.
- (iii) Integrated maintenance to industrial logistic, in which Askri et al. (Askri, Hajej, & Rezg, 2016) structured a framework of an integrated maintenance strategy for parallel leased machines with warranty periods; moreover, Ndhiaief et al. (Ndhiaief, Bistorin, & Rezg, 2017) has create a model for city locating logistic platforms based on combined forward and reverse flows; then, Turki and Rezg (Turki & Rezg, Study of the E-Maintenance Service in E-Logistic Supply Chain, 2017) established a study of e-maintenance services in e-logistic Supply Chain.

On another hand, the GEMI research group has provide the background of urban public transportation for different transport systems:

- (i) Railway systems, in which Martinez et al. (Martinez, Martinod, Jensen, Palacio, & Castañeda, 2010) researched on design of load-optimized spare parts of train chassis; moreover, Castañeda et al. (Castañeda, Martinod, & Betancur, 2012) determined the technical state of trains elements in operational conditions; and Bernal et al. (Bernal, Martinod, Becancur, & Castañeda, 2016) studied the parameters maintenance of metro vehicles in dynamic condition.
- (ii) Ropeway systems, in which Martinod et al. (Martinod, et al., Journey safety assessment to urban aerial ropeways transport systems based on continuous inspection during operation, 2015) proposed a continuous inspection method to assess the journey safety applied to aerial cable vehicles; moreover, Martinod et al. (Martinod, et al., Operating conditions effect over the coupling strength for urban aerial ropeways, 2014) studied the effect caused by external conditions due to the wind loads joined up with other external effects.

The thesis is structured as a compendium of scientific production based on a set of published articles in peer-reviewed scientific journals and a refereed international conference. The peer-reviewed journals were selected based on the list of reviews of Section 37 (Categorization of Journals in Economics and Management) of the National Committee of the Scientific Research law from France (*Comité National de la Recherche Scientifique - CNRS*), which is a reference tool that is incontestable and widely recognized by international scientific agencies (CNRS, 2020). In addition, the impact factor of each Journal had been taken into account to reach the best research dissemination. Each chapter of this thesis belongs to a published work; thus, each chapter solves a given urban public transport problem dealing with the integrated operation and maintenance policies for the economic and social goals optimisation. Then, each chapter has a specific aim and contributions, with its own literature review, problem description and formulation, results and discussions, and conclusions and perspectives. Moreover, each chapter develops a mathematical framework with a specific notation and expressions for providing a clearly methodology.

As a first stage of the thesis, a stochastic model is proposed that integrates the service and maintenance policies to optimise operating strategies, which is developed in Chapter 1 and Chapter 2, this work was published by “International Journal of Quality & Reliability Management” and “International Journal of Transport Economics”. The second stage of the thesis goes in depth in the optimisation of maintenance policy for multi-component systems considering the degradation of components and imperfect maintenance actions, which is developed in Chapter 3, it was published by “Computers & Industrial Engineering” journal and was presented in “5th International Conference on Project Logistics – PROLOG 2019”. The last stage of the thesis is focused on the service policy optimisation for a multimodal urban transport network, which is developed in Chapter 4 and Chapter 5, this work was presented in “13th International Conference on Modeling, Optimization and Simulation - MOSIM’20” and it is been reviewing by “Journal of Traffic and Transportation Engineering (English Edition)”. Finally, all models described throughout the thesis are combined (or integrated) to propose a methodology for solving service and maintenance policies problems in Chapter 6.

A real metropolitan transport network composed of metro, tramway and ropeway lines are used as case study to prove the developed mathematical frameworks throughout the thesis. This metropolitan transport network is located in Medellín Colombia, which the construction and commissioning of the Metro lines in 1995 was not only one of the greatest milestones in the city's history of mobility, but also a key moment in the transformation of urban dynamics and in the integration of all the region that make up the metropolitan area. Metro lines are similar to suburban trains. The first equipment manufacturers of rolling stock were *Maschinenfabrik Augsburg-Nürnberg* (MAN) for mechanical components and Siemens for electrical components. MAN has since become Adtranz company and subsequently Bombardier Transportation. The vehicles are similar in geometry and design to the ET420 train sets formerly operated by Deutsche Bahn in commuter service (e.g., the Munich S-Bahn); then, a second generation of vehicles has been provided by the company CAF (Es.) since 2009 to increase the vehicle fleet due to the growing mobility needs. Moreover, the urban ropeway lines are a set of gondola-type aerial cable on a continuous cycle, mono-cable (simple ring) with a detachable release clamp device. The transport

system is similar in design and construction to the ones used for passenger transportation in winter tourist areas (e.g. Daemyung-Korea, La Clusaz-France, Donovaly-Slovakia). All the ropeway lines have been manufactured by the company Poma (Fr.) and inaugurated on the year 2004, providing continuous service 360 day a year, 7 days a week, 20 hours a day.

Study of Art

Within one core topic of the thesis is focused on the maintenance policy optimisation, which the essential features of the maintenance scheduling problem were analysed by Kralj and Petrović (Kralj & Petrović, 1988), where included imposed constraints and various objectives using operational research methods. Bretthauer et al. (Bretthauer, Gamaleja, Jacobs, & Wilfert, 1990) proposed numerical models using robust computing languages (implemented on 16-bit processors under MS-DOS with Turbo-Prolog code) to assess maintenance schedules for improving the system reliability. Later, improvements in analytical techniques and the availability of fast computers allowed propose more complex systems, Cho and Parlar (Cho & Parlar, 1991) developed numeric models of multi-component maintenance, including machine interference-repair models, group replacement models, spare parts models, and inspection models; besides, Dekker and Wildeman (Dekker & Wildeman, 1997) structured the multi-component maintenance numeric models with economic dependence. Anily et al. (Anily, Glass, & Hassin, 1998) proposed a set of finite algorithms for scheduling of maintenance service. Yang, Djurdjanovic and Ni (Yang, Djurdjanovic, & Ni, 2008) used a dependence-based model to develop a maintenance schedule based on the expected degradation of the machine by considering the complex interaction between the components, the production process, and the maintenance operations.

A maintenance policy based on a proportional hazard model for multi-component systems was proposed by Tian and Liao (Tian & Liao, 2011). Subsequently, Liu et al. (Liu, Xu, Xie, & Kuo, 2014) formulated a preventive maintenance policy for multi-component systems concerning continuously degrading components. In addition, Zhou et al. (Zhou, Huang, Xi, & Lee, 2015) proposed a time window based preventive maintenance model for multi-component systems with stochastic failures and the disassembly sequence involved. Nevertheless, it is possible to identify that the literature has not reported dependence-based models without a pre-established classification, which combines the reliability analysis of the complex systems and the working-life condition of each component. Other models (Do, Vu, Barros, & Bérenguer, 2015; Iung, Do, Levrat, & Voisin, 2016) have assumed that all members of a group have identical behaviour; therefore, these models are based on hypotheses with simplifications.

Within other core topic of the thesis, which is focused on the service policy in order to solve the queuing problem in the transport field, the first approximation was a simplified model by means deterministic and predictable demand patterns (May & Keller, 1967); but later, the mathematical model was improved by Newell (Newell, 1977), who established that the passengers arrive at stops according to a Poisson distribution and the delay of vehicles according to Fokker-Planck. Queueing theory applications in transport has led to a number of authors to develop queueing systems. Ceder (Ceder, 2007) used a formulation for mean passenger waiting time under the assumption of random passenger arrivals. Caris et al. (Caris, Macharis, & Janssens, 2013) introduced the theory of compound Poisson process as the main model to deal with the queueing problem on urban public transport. Moreover, Lee et al. (Parbo, Nielsen, & Prato, 2014) characterised transport queueing models as non-stationary (time varying) systems. Finally, Nesheli et al. (Nesheli, Ceder, & Liu, 2015) introduced synchronised timetables to reduce the waiting time caused by batch arrivals.

Afterward, Ivaldi (Ivaldi & Ciacci, 2020) studied smart mobility managements to cope with actual user expectations in terms of efficiency, quality and fast access to information. Recently, some authors are focused their studies on a jointed maintenance and operation optimisation. Xiao et al. (Xiao, Song, Chen, & Coit, 2016) jointed an optimisation of production scheduling with machine group preventive maintenance. Hajej et al. (Hajej, Rezg, & Askri, Joint optimization of

capacity, production and maintenance planning of leased machines, 2018; Hajej, Dellagi, & Rezg, Joint optimisation of maintenance and production policies with subcontracting and product returns, 2014) deal with the problem of jointly optimizing maintenance, production and inventory costs. Previous research proposes studies which combine optimisation between industrial production and maintenance in the context of the conditions of assembly lines for mass production of products, but the complexity of conditions in the service of urban public transport is a topic which becomes important.

Contributions of the thesis

This is the first research to develop a mathematical framework to integrate the service policy and the maintenance policy in multimodal public transport network (comprised by a set of metro, tramway, and ropeway lines) based on stochastic optimisation processes in order to solve the queueing problem and the cost of maintenance actions. For this purpose, I have proposed: (i) a stochastic discrete-event model composed of a set of interrelated queues for the formulation of the service problem using a cost-based mathematical expression; and (ii) an imperfect preventive maintenance based on two different maintenance policies (periodic block-type maintenance and age-based maintenance). In one edge of the thesis, a mathematical model of the service policy was proposed to determine the values of the operational parameters in which the transport system offers different levels of service quality (users get the service they need without waiting in a queue, and an *acceptable* waiting time for passengers) defined on the basis of the service policy. In another edge of the thesis, this research developed a stochastic model of maintenance that considers the degradation for a multi-component system with a dependence relationship between the components. Through this analysis, the model cost of maintenance (which includes the corrective and preventive maintenance actions) completes the cost function optimisation. Thus, optimisation model is developed to support efficient operation planning to reach the maximum profit for the urban transport operators and the minimum cost to the passengers for delayed service.

The thesis presents a decision-making methodology for operation planning centred on urban transport system services. The approach has been developed specifically for considering the urban transport operators in urban ropeway systems. Then, the thesis provides strong support to the concept that the long-term sustainability for operation of urban public transport systems must be a combined optimisation methodology for the operation planning and service policy.

Moreover, this research simultaneously considers both, service restrictions and passenger demand constraints, generated by the health emergency of pandemic cycles (e.g., SARS in 2003, MERS in 2015, Covid-19 in 2020), which a set of regulatory policies to control the outbreaks was integrated to solve the service problem via cost-based expressions for obtaining a queue process and exploitation optimisation.

Cette page a été intentionnellement laissée en blanche

Chapter 1:

Integrated optimisation for operation and maintenance policies

Authors: R.M. Martinod, O. Bistorin, L.F. Castañeda, N. Rezg
Original title: Joint optimisation of operation and maintenance policies in an urban ropeway transport systems context
Journal: International Journal of Quality & Reliability Management, 36(7), 1106-1136
Publication date: October 2019
DOI: <https://doi.org/10.1108/IJQRM-10-2018-0292>

Classification according to SCImago Journal Rank (SJR)

Sub-category: General Business, Management and Accounting (Q1)

H-index (2018): 75

SJR(2018): 0,584

CS (CiteScore): 3,40

SNIP: 1,413

Abstract

The purpose of this chapter is to propose a stochastic optimisation model for integrating service and maintenance policies in order to solve the queuing problem and the cost of maintenance activities for public transport services, with a particular focus on urban ropeway system. The following approaches was adopted: a discrete-event model that uses a set of interrelated queues for the formulation of the service problem using a cost-based expression; and a maintenance model consisting of preventive and corrective maintenance actions, which considers two different maintenance policies (periodic block-type and age-based). The chapter shows that neither periodic block-type maintenance nor an age-based maintenance is necessarily the best maintenance strategy over a long system lifecycle; the optimal strategy must consider both policies. The maintenance policies are then evaluated for their impact on the service and operation of the transport system. We conclude by applying the proposed optimisation model using an example concerning ropeway systems. This is the first study to simultaneously consider maintenance policy and operational policy in an urban aerial ropeway system, taking up the problem of queuing with particular attention to the unique requirements public transport services.

1.1. Introduction

The effective integration of maintenance and service policies with engineering in the organisation can help to save huge amounts of time, money and other resources in dealing with reliability, availability, maintainability and performance issues (Moubray, 2003). Reliability and maintenance are crucial to the success and long-term future of an organisation (Fraser, Hvolby, & Tseng, Maintenance management models: A study of the published literature to identify empirical evidence. A greater practical focus is needed., 2015). For most organisations it is now imperative they take opportunities via maintenance management programmes to optimise their productivity, while maximising the overall equipment effectiveness (Fraser, Hvolby, & Watanabe, A review of the three most popular maintenance systems: How well is the energy sector represented?, 2011). Poor systems performance, downtime, and ineffective planning

maintenance lead to the loss of service, increased costs and decreasing profit (Cholasuke, Bhardwa, & Antong, 2004); on the other hand, companies who can effectively infuse the maintenance function into its primary activities will save time, money, and other resources in dealing with reliability, availability, maintainability, and performance issues (Fraser, Hvolby, & Tseng, Maintenance management models: A study of the published literature to identify empirical evidence. A greater practical focus is needed., 2015).

For some critical sectors such as energy, water, health and transport maintenance take on an even greater importance (Fraser, Hvolby, & Watanabe, A review of the three most popular maintenance systems: How well is the energy sector represented?, 2011). An important problem in these sectors is the long-term maintenance scheduling of systems and equipment. Maintenance scheduling outages have a great effect on the system availability and service cost. There are some studies that consider the integration of maintenance and service policies for the critical sectors. Henceforward, we present some works focused to energy and productive sectors. Alardhi *et al.* (Alardhi, Hannam, & Labib, 2007) describes a method developed to schedule the preventive maintenance tasks in separate and linked cogeneration plants while satisfying the maintenance and production constraints, which finds the maximum number of available power and desalting units. Souheil *et al.* (Souheil, Dellagi, & Rezg, 2012) proposed an optimal plan with a preventive maintenance policy aiming at reducing the machine degradation while minimising the total cost (production, inventory and maintenance costs). Later, Hajej *et al.* (Hajej, Dellagi, & Rezg, Joint optimisation of maintenance and production policies with subcontracting and product returns, 2014) deals with the problem of jointly optimizing maintenance, production and inventory costs considering subcontracting and product returns. A detailed study of the literature of maintenance management applied to energy and productive sectors is provided by Fraser *et al.* (Fraser, Hvolby, & Tseng, Maintenance management models: A study of the published literature to identify empirical evidence. A greater practical focus is needed., 2015).

An effective scheduling can save considerable operational costs that help electric, water and transport utilities to be more competitive in terms of availability of resources while increasing system reliability (Alardhi, Hannam, & Labib, 2007). The reliabilities of critical sectors, specifically the urban transport, have become increasing important issue in large cities. A deficient public transport system due to unexpected failure is the cause of increasing customer and society dissatisfaction in cities around the world (Fraser, Hvolby, & Watanabe, A review of the three most popular maintenance systems: How well is the energy sector represented?, 2011).

The conventional urban transport systems (e.g. traditional bus, streetcar, subways, bus rapid transit -BRT-, light rail transit -LRT-) serve travel patterns in urban areas with strongly focused travel patterns and available space (whether underground or level-ground); however, different urban contexts with wide range of geographical and topographical conditions (e.g. mountains, valleys, bodies of water) do not permit the implementation of conventional public transportation. The urban ropeway systems are a technology that grow significantly to serve the travel patterns of geographically constrained areas in which conventional transit service was deemed very difficult or infeasible to implement (Alshalalfah, Shalaby, & Dale, Experiences with aerial ropeway transportation systems in the urban environment, 2014) Ropeways play an irreplaceable role in many areas as a special mean transport for a long time. As a subsystem of a transport system, ropeway transports hold a specific place because it makes accessible those places that are interesting from the aspect of tourism as well as urban areas that are difficult to access via other transport subsystems (Sever, 2002).

The urban ropeways are geographically located in urban areas and that serve public transport needs. The urban ropeway transport systems are specific in the sense that the integration into the urban landscape as well as the operating conditions of public transport (transport volumes, operating hours) constitute specific challenges. These installations have greatly increased the accessibility of existing settlements, which had not been served by public transport before, or build a more efficient alternative to former queues of busses stuck in traffic (Reichenbach & Puhe, 2018).

In cities with hills, the ropeways offer an attractive, straightforward and reasonably-priced system for mainstream urban public transport. Ropeway systems provide not only a convenient transportation in hilly terrains, over rivers, harbours and motorways, but also an alternative to connect people over densely populated residential areas (Alshalalfah, Shalaby, Dale, & Othman, Aerial ropeway transportation systems in the urban environment: state of the art, 2012). Currently, ropeway systems are becoming a popular transport mode and a logical choice for their ability to efficiently move passengers from the tops of hilly metropolitan areas to lower-lying areas. In this way, the ropeways are often the critical initial piece of the system, bringing passengers down to valley areas where they can access other transport modes in the wider integrated urban transport network. The use of ropeways in urban contexts, fit into public transport networks and tariff schemes just like any other means of public transport, is a phenomenon of accessibility, which becomes a central driver in the development and analysis of transport policies (Preston & Rajé, 2007). A growing number of urban ropeway installations in worldwide has been used as parts of the public transport network in larger cities, including for example (Bocarejo, et al., 2014; Heinrichs & Bernet, 2014; Težak, Sever, & Lep, 2016): (i) North America in New York (US), Portland (US), Roosevelt Island (US), Mexico D.F. (Mx); (ii) Latin America in Rio de Janeiro (Br), Medellin (Co), Cali (Co), Manizales (Co), Caracas (Ve), La Paz (Bo); (iii) Europe in Nizhny Novgorod Bor (Ru); (iv) Asia in Taipei Maokong (Tw), Hong Kong, Ankara (Tr); and (v) Africa in Constantine (Dz).

The proposed work analyses the demand for transport, for an optimal service-oriented maintenance plan; thus, the maintenance policy represents a set of parameters to qualitatively evaluate the proposed solution. Other work (Martinod, Bistorin, Castañeda, & Rezg, 2018) proposes a stochastic optimisation model in order to reduce the long-term total maintenance cost of complex systems considering several maintenance policies, but does not consider the service-operational policy. The lack of studies evaluating service performance, as impacted by maintenance requirements provided a motivation for the research. In particular, the authors found few studies dealing with the simultaneous optimisation of maintenance and service policies in urban ropeway transport systems. An efficient service should consider the waiting time of users, but on the operational side, decreasing the waiting time increases the cost of service in terms of maintenance actions. The contributions of this chapter are as follows:

- (iii) to the best of our knowledge, this is the first study to simultaneously consider maintenance policy and operational policy in an urban aerial ropeway system, taking up the problem of queuing with particular attention to the unique requirements public transport services;
- (iv) this chapter analyses ropeway system maintenance and operational policies based on the international regulations, evaluating how fluctuating demand influences the operating conditions; and
- (v) this chapter proposes a method to establish passenger waiting time of in relation to the optimal maintenance policy for an optimal urban transport service. The approach has been developed specifically for considering the passenger demand in urban public ropeway systems.

Chapter 1 is organised as follows. Section 1.2 summarises the relevant literature concerning to urban transport studies based on the service policy. Section 1.3 sets out the mathematical expressions of service and maintenance policies applied to ropeway system operation. In Section 1.4, a stochastic optimisation model is developed to obtain the optimal service and maintenance actions. The model is applied in Section 1.5 using an example focused on an urban ropeway system. Table 1.1 shows the coefficients, parameters and variables to be used throughout the chapter.

Table 1.1. Indices and parameters used throughout Chapter 2.

$i = \{1, 2, \dots, I\}$	indices of the platforms on the ropeway systems;
$j = \{1, 2, \dots, J\}$	indices of the components on the ropeway systems;
$k = \{1, 2, \dots, K\}$	indices of the vehicles (gondolas) on the ropeway systems;
$m = \{1, 2, \dots\}$	indices of the user demand conditions from rush hour to off-peak periods;
$n = \{1, 2, \dots, N\}$	indices of discretised time;

a, b	instants of time;
N	typical (representative) period of working time;
η	horizon of time, long time window of working-life;
Δt	discret-time.
Operational parameters:	
cv	vehicles capacity [pax];
fv_n	passing vehicles frequency in service over the n th discretised time [s^{-1}];
$g_{k,i,n}$	available places of the k th vehicle on the i th platform over the n th discretised time [pax];
h_i	quantity of discretised time period Δt that a vehicle spends to transit between stations [--];
lv_n	distance between vehicles [m];
$[qv_{inf}, qv_{sup}]$	lower and upper limit of density of vehicles in service [m^{-1}], respectively;
$[sv_{inf}, sv_{sup}]$	lower and upper limit of vehicles speed [$m/\Delta t$], respectively.
Service policy parameters:	
Cw	cost associated with the waiting time spend by passengers in the queue [$mu/\Delta t$];
l_i	proportional coefficient of $\lambda_{i,n}$ at the i th platform [--];
$Lq_{i,n}$	number of users in the queue on the i th platform over the n th discretised time [pax/ Δt];
$Pa_{i,n}$	probability function of passengers' arrival at the i th platform [pax/ Δt];
$Pe_{i,n}$	probability function of effected services at the i th platform [pax/ Δt];
Wg_n	global mean waiting time in the queue over the n th discretised time [Δt];
Wg_{sup}	upper limit of the mean waiting time of the users in the queue [Δt];
$\lambda_{i,n}$	users that arrive on the i th platform over the n th discretised time [pax/ Δt];
$\sigma_{k,n}$	effected services (disembarking passengers) the k th vehicle over the n th discretised time [pax/ Δt];
$\mu_{i,n}$	passengers boarding the vehicle form the i th platform over the n th discretised time [pax/ Δt].
Maintenance policy parameters:	
Cc_j	cost of a repair activity (corrective maintenance) due to the failure of the j th component, which is quantified on monetary unit over failure [$mu/failure$];
Ci_j	cost of an imperfect maintenance by the preventive maintenance actions for the j th component [mu/maint.];
$Cmax_j$	cost of a perfect maintenance (AGAN) for the j th component [mu/maint.];
f_j, F_j	probability and cumulative fault distributions, respectively [cycles/fault];
p	relationship between the quantity of minor maintenance actions per major maintenance action [--];
$r_{j,n}$	ratio of cycles by the j th component over the n th discretised time [cycles// Δt];
R_j, Rg	reliability of the j th component and global reliability of the system [cycles], respectively;
Rg_{inf}	lower limit of the global reliability of the system [cycles];
α	age reduction coefficient after a maintenance action. To this work: the corrective maintenance policy is a minimal repair action to a failed component, thus $\alpha = 1$; and the preventive maintenance policy is an imperfect action, $\alpha = \{\alpha_{p1}, \alpha_{p2}\}$, whit $\alpha_{p1}, \alpha_{p2} \in (0, \dots, 1]$, where α_{p1}, α_{p2} are the age reduction coefficient of a major maintenance and a minor maintenance;
φ_j	probability of failure of the j th component over the finite period of time [failure];
ω_j	current working cycles of the j th component [cycles];
ω_o, ω_A	working cycles of the last and the next preventive maintenance action [cycles], respectively.
Optimisation parameters:	
Γwg	global penalty cost due to the waiting time spend by passengers in queues [mu];
Γc	cost of the corrective maintenance [mu];
Γa	cost of the periodic block-type preventive maintenance policy [mu];
Γp	cost of the periodic age-based preventive maintenance policy [mu].
Decision variables:	
qv_n	Density of vehicles in the n th discretised time [m^{-1}];
sv_n	vehicles speed [m/s];
T_j	periodicity of periodic block-type maintenance, quantity of maintenances over a full cycle of preventive maintenance [maint./year];
A_j	range of working between the scheduled preventive maintenances [cycles/maint.].

1.2. Literature Review

Studies of passenger transport demand in urban public transport systems have increased with a renewed recognition of their role in the economic development of cities. In recent years, transport planning has evolved to place greater emphasis on urban transport to increase the mobility of commuters (Ibarra-Rojas, Delgado, Giesen, & Muñoz, 2015; Shang, Li, & Yang, 2016; Li & Sheng, 2016).

Previous works have had different approaches for analysing passenger demand in urban transport systems. Using a dynamic systems approach, Horn (Horn, 2002) showed a demand-responsive passenger transport system based on a model to analyse the performance of urban passenger transport. By means of an economic theory-based approach, Ison and Sagaris (Ison & Sagaris, 2016) examined the social, political, regulatory, and operational challenges in providing urban transport. Using a scheduling-based approach, Wang *et al.* (Wang, Tang, Ning, van den Boomb, & de Schutterb, 2015) proposed an event-driven model involving different types of events to obtain a nonlinear nonconvex optimisation problem. There are also studies (Barrena, Canca, Coelho, & Laporte, Exact formulations and algorithm for the train scheduling problem with dynamic demand, 2014) focusing on a non-periodic timetable that explicitly considers time-dependent passenger demand to reduce waiting time and travel time. Other works (Niu & Zhou, 2013; Barrena, Canca, Coelho, & Laporte, Single-line rail transit timetabling under dynamic passenger demand, 2014) reduced the waiting time of passengers looking into the arrival process of passengers in stations with a uniform process or a Poisson process. A detailed review of these approaches is provided by Caris *et al.* and Yin *et al.* (Caris, Macharis, & Janssens, 2013; Yin, Yang, Tang, Gao, & Ran, 2017).

There has also been a research focus on waiting and queueing phenomena associated with urban transport services, with studies showing that urban transport users are negatively inclined if it involves uncertain waiting time (Ceder, Chowdhury, Taghipouran, & Olsen, 2013). Nesheli *et al.* (Nesheli, Ceder, & Liu, 2015) introduced synchronised timetables to reduce the waiting time caused by batch arrivals. Queues with batch arrivals and bulk service are commonly observed in the field of behaviour in transport systems, and such queues are found with urban buses, trains, trams, railways or ropeways. The queueing process follows the following features (Wang, Guo, Ceder, Currie, & Yuan, 2014): (i) passenger demand at urban transport terminals consists of people gradually arriving in batches, with demand increasing progressively until rush hour, and then declining in the off-rush hour; and (ii) the service has a bulk-like pattern, given that it is a mass-transport service. Passengers arrive in batches to a terminal where they can be served *en masse* for the transport system. This chapter therefore assumes an urban transport system characterised by batch arrivals and bulk service patterns.

Queueing theory applications in transport has led to a number of authors to develop queueing systems (Ceder, Chowdhury, Taghipouran, & Olsen, 2013): (i) arrival patterns of passengers – e.g. Poisson, Erlang, Gaussian and others–; (ii) service patterns; (iii) queue discipline –e.g. first-come-first served, priority-based–; (iv) number of servers provided; (v) maximum queue length allowed; (vi) configuration of the transport operators –e.g., in series, in parallel, or mixed. In this chapter, the theory of compound Poisson processes is used to establish a stochastic model of passenger demand in the stations. The distribution of arrival passengers is obtained with the classes defined by the quantity of users per time unit on the frequency domain (e.g. passengers/minute). Thus, the density distribution function of passenger arrivals follows a Poisson distribution (Dalla-Chiara, 2010); in consequence, it is possible to apply the queueing theory, which allows to evaluate the quality of requested service.

Some authors (May & Keller, 1967; Hall, 2003) have argued that queues in the transport field often tend to be deterministic and predictable because of: (i) the passengers journey generates demands for repetitive patterns; and (ii) queues by random variations in arrivals and service are often deemed to be secondary relative to queues caused by predictable demand patterns. In response, another line of research (Lee & Vuchic, 2005; Nesheli, Ceder, & Liu, 2015) has defined urban transport attributes as stochastic (e.g. travel time, dwell time, passenger demand, etc.).

Ceder (Ceder, Public transit planning and operation: theory, modeling and practice, 2007) used a formulation for mean passenger waiting time under the assumption of random passenger arrivals, and Newell (Newell, 1977) assumed that the passengers arrive at stops according to a Poisson distribution and the delay of vehicles according to Fokker-Planck. The hybrid queue-based model of Wu and Mengersen (Wu & Mengersen, 2014) reflected a Bayesian Network model and stochastic queuing theory, using the properties of the Poisson and exponential distributions. The theory of compound Poisson process is introduced as the main model to deal with the queueing problem on urban public transport (Caris, Macharis, & Janssens, 2013). Moreover, transport queueing models have been characterised as non-stationary (time varying) systems (Lee & Vuchic, 2005; Parbo, Nielsen, & Prato, 2014).

Following similar lines, several optimisation models have been developed. Lee and Vuchic (Lee & Vuchic, 2005) proposed an optimal transit system as a compromise among the minimal travel time, the transit operator profit, and minimisation of social costs. Parbo *et al.* (Parbo, Nielsen, & Prato, 2014) dealt with timetable optimisation from the perspective of minimising the waiting time experienced by bus passengers; the researchers obtained a bi-level minimisation problem via a non-linear non-convex mixed integer problem. Yin *et al.* (Yin, Yang, Tang, Gao, & Ran, 2017) studied a dynamic passenger demand in the context of railway scheduling with the goal of minimising the operational costs and passenger waiting time, resulting in a mixed-integer linear programming problem.

Pitsiava-Latinopoulou and Iordanopoulos (Pitsiava-Latinopoulou & Iordanopoulos, 2012) is noteworthy for introducing a categorization of urban transport terminals based on journey features. *Intercity terminals* are transit points for passengers traveling relatively long distances between cities or countries, where the chief characteristic is long waiting times and a lack of significant traffic fluctuations. *At commuter transit centres*, the passengers are regular travellers who need advanced accessibility and minimum travel time (Sun, Guo, Schonfeld, & Li, 2017); the main feature is the large variation in hourly demand during the day and the need for a quick and convenient transfer between transport modes (Jones, Cassady, & Bowden, 2000). *Interchanges* are intermodal facilities established at connection points for different transport modes forming a co-operative urban transport network. *Park-and-ride terminals* function as stations designed to provide adequate parking, primarily at urban transport terminals (Spillar, 1997). Finally, there are *on-street facilities*, public transport stops that serve different routes or transfers between different modes. The present chapter is focused on park-and-ride terminals and on-street facilities, as they are the more typical terminals for the integration of passengers into an urban transport network via ropeway.

1.3. Problem description

This section describes the problem by analysing the characteristics of each policy separately: (i) urban transport service policy, and (ii) ropeway system maintenance policy; as follows:

1.3.1. Urban transport service policy

The distribution of passengers that arrive at a ropeway station is obtained by the quantity of users per time unit in the frequency domain (e.g. pax/min), the probability distribution of arrivals on the i th platform over the n th instant of time belongs a Poisson distribution, $Pa_{i,n}$ [pax/ Δt] (Gillen & Hasheminia, 2013), the empirical distribution of the passenger arrivals has been verified using a *goodness of fit* test (Dalla-Chiara, 2010). According to the queuing behaviour of ropeways, the best model for evaluating waiting time is expressed as M/M/1/ ∞ /FIFO (Jenelius, 2018). This work assumes the following conditions about service policy and context:

Assumption 1.1. Passengers arrive at the upper ropeway station in order to reach the downtown or connect to another transport mode by means of a transfer station at the bottom of the hill (e.g., railway, light-train, bus).

Assumption 1.2. The stations are characterised by having on-street facilities.

Assumption 1.3. Passengers do not use another transport mode before their arrival at the upper ropeway station.

Assumption 1.4. If the number of waiting users exceeds the capacity of the ropeway system, the operator leaves behind some passengers – just as in any other transportation mode (Kahraman & Gosavi, 2011). The system has therefore a finite capacity to serve users. The demand rate may exceed the capacity of the system in some periods.

Assumption 1.5. The urban transport service policy must correspond to the demand placed upon the system. There must, in other words, be flexibility in the service, allowing it to adapt to variations in demand (Amirgholy & Gonzales, 2016).

Given a Poisson process as probability function of discrete-time and linearly spaced, the sequence $n = \{1, 2, \dots, N\}$ with $n \in t$ is used to represent the time sequence between successive events. The discrete-time stochastic distributions make it possible quantify the number users over a finite set of events. The events depend on the arrival of vehicles on the platform. Using an operative characteristic of the ropeway system (all vehicles are synchronised by the pulling cable, and the vehicles speed, sv_n , has a constant value over the periods of operation) the discrete-time period can be written as

$$[n, n + 1] = \Delta t = \frac{lv_n}{sv_n} \quad (1.1)$$

where lv_n is distance between vehicles (see Figure 1.1(a)).

The weighted mean of arriving passengers on the i th platform over the n th event is represented by $\lambda_{i,n}$ [pax/ Δt], with $i = \{1, 2, \dots, I\}$. It can be expressed as a probability function at the i th platform, $Pa_{i,n}$, over a period of time $[a, b]$ by means of $\lambda_{i,n} = (b - a)^{-1} \sum_{n=a}^b Pa_{i,n}$, with $a < b$. Using an analogous definition, the average of effected services during the same period of time is given by $\sigma_{i,n} = (b - a)^{-1} \sum_{n=a}^b Pe_{i,n}$, where $Pe_{i,n}$ is the probability function of disembarking passengers. If the period of time is $[a, b] = N$, and N is defined as a typical service period of time (e.g. full working day), the service capacity of the platform must not overflow in order to ensure the complete outflow of the passengers from the system; i.e., a stability condition of the service must be guaranteed, where $\sum_n \lambda_{i,n} (\sum_n \sigma_{i,n})^{-1} \leq 1$.

Remark 1.1. Note that, $\sigma_{i,n}$ relies on the capacity of the transport system. This means $\sigma_{i,n}$ [pax/ Δt] is directly related to both variables: the frequency of passing vehicles in service fv_n [s^{-1}] (in the case of ropeway systems, all vehicles have the equivalent of fv_n value in each instant n , because pulling cable synchronises the separation –distance– between vehicles), and the quantity of available places in the k th vehicle $g_{k,i,n}$ [pax], with $k = \{1, 2, \dots, K\}$; thus, $\sigma_{i,n} = fv_n g_{k,i,n}$. Moreover, fv_n can be expressed according to the density of vehicles qv_n , and the vehicles speed sv_n , i.e.

$$fv_n = sv_n qv_n. \quad (1.2)$$

Two different boarding/disembarking models are considered for the queuing model to describe the service behaviour of a typical ropeway system:

The first model describes the boarding/disembarking process on the single platforms (see Figure 1.1(b)) belonging to stations between the loops of the line. The model is based on a stochastic service. The service on a platform directly depends on the service behaviour of the previous platform; i.e., $\mu_{i,n}$ depends on $g_{k,i,n}$. From the point of view of users in the queue, the vehicles in service have different (random) sizes because of user is interested in the available places in the vehicle.

The second model describes the process for boarding/disembarking at terminal stations, located at the ends of the line. This model is based on constant service time (see Figure 1.1(c));

i.e., the service is constant and established by the operational characteristics. This service behaviour takes place according to two different operating conditions: (i) cases in which the ropeway system starts operating, and each vehicle is empty in order to pick up passengers; and (ii) cases in which the k th vehicle is located in one of the system's terminal stations (passengers have finished their journey and just disembarked).

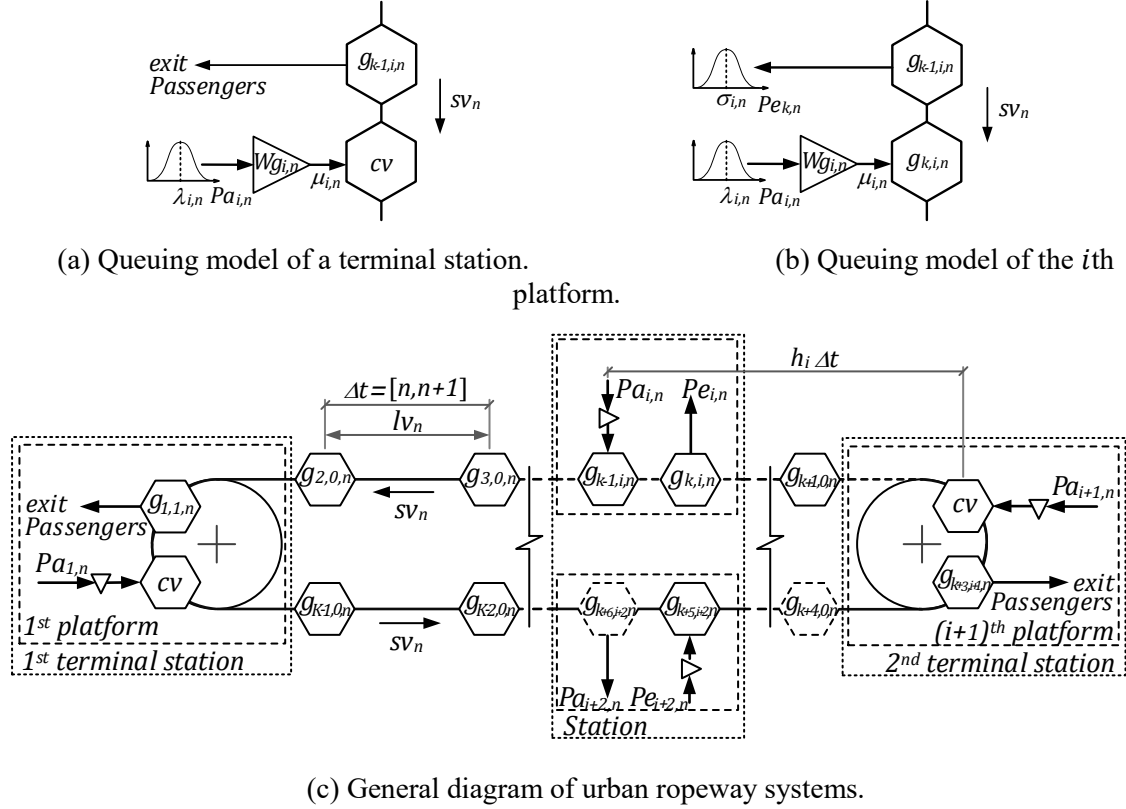

(c) General diagram of urban ropeway systems.

Figure 1.1. Service model of ropeway systems.

According to the both boarding/disembarking models, the quantity of users in the queue on the i th platform is

$$Lq_{i,n} = \begin{cases} Lq_{i,n-1} + \lambda_{i,n} - \mu_{k,i,n} ; & \text{if first queuing model} \\ Lq_{i,n-1} + \lambda_{i,n} - cv ; & \text{if second queuing model} \end{cases} \quad (1.3)$$

and $\mu_{k,i,n} = g_{k,i,n-h} + \mu_{k,i-1,n-h} - \sigma_{k,i-1,n-h}$, with $\mu_{k,i-1,n-h}$ representing the quantity of passengers that board the k th vehicle at the platform before (the vehicle spend h_i times of discrete-time period Δt to transit between stations), and $\sigma_{k,i-1,n-h}$ representing the quantity of passengers that disembarked from the k th vehicle on the preceding platform.

Proposition 1.1. The general formulation to the mean waiting time is expressed as

$$Wg_n = \frac{1}{sv_n qv_n} \sum_i \frac{Lq_{i,n}}{\mu_{i,n}} \quad (1.4)$$

Proof 1.1. By definition, the average waiting time for each platform depends on the ratio between the quantity of users in the queue, $Lq_{i,n}$, and the users leaving the queue to board the vehicle, $\mu_{i,n}$, adjusted for time they spend waiting in the queue, i.e.

$$Wg_n = [n, n + 1] \frac{Lq_{i,n}}{\mu_{i,n}} ; \quad \forall i = \{1, 2, \dots, I\} ; \quad (1.5)$$

therefore, the total weighted waiting time in the railway system is the sum of the values on all platforms,

$$Wg_n = [n, n + 1] \sum_i \frac{Lq_{i,n}}{\mu_{i,n}}, \quad (1.6)$$

then, taking Eq. (1.1) and considering that Δt is equivalent to the inverse of the passing vehicles frequency fv_n^{-1}

$$Wg_n = \frac{1}{fv_n} \sum_i \frac{Lq_{i,n}}{\mu_{i,n}}, \quad (1.7)$$

considering Eq. (1.2) the proposition is proved. \square

The discrete-event model deals with the analysis of the waiting lines with the objective of determining Wg_n value, which changes only when the passengers board the vehicle, $\mu_{i,n}$ —and simultaneously other passengers disembark from the previous vehicle, $\sigma_{k-1,n}$. In other words, the proposed model is a composite of queues from a set of stochastic distributions $\{Pa_{i,n}, Pe_{i,n}\}$. Therefore, only n is required to examine the transitory behaviour of the system, and other time points do not affect the data relating to system operation. In Section 1.4.1., we will develop the formulation of the service problem regarding to the service parameters behaviour (sv_n, qv_n).

1.3.2. Maintenance policy of ropeway systems

Technical regulations govern the requirements for passenger installations by cable drives. Directive 2000/9/EC (Council of European Union, 2000) standardises ropeway installations designed to carry persons (e.g., funicular railways, cable-cars, gondolas, chairlifts and drag lifts) and which are designed, manufactured, put into service, and operated for the purpose of transporting passengers safely. The international standard BS/EN-1709 (British Standard, 2004) establishes general guidelines in relation to the inspection and maintenance required on the component systems: (i) vehicles; (ii) carrier cables and pulling cables; (iii) electro-mechanical devices; (iv) traction and brake equipment; (v) rescue, monitoring and signalling devices; and (vi) installation and infrastructure. Moreover, there are two types of components associated with any ropeway system: (i) a set of mobile components which are driven by the pulling cable—such as the vehicle and its parts—that are influenced directly by sv_n ; and (ii) a set of structural components, such as supports, installation and infrastructure, that are influenced directly by both: sv_n and qv_n .

Remark 1.2. As part of the safety systems governing installations like ropeway systems, periodic preventive maintenance has been introduced as a technical specification on an industry-wide basis. The maintenance managers of ropeways have adopted a periodic preventive maintenance based on a periodic block-type maintenance policy, which provides for maintenance actions to be carried out according a fixed schedule based on linearly-spaced periods of chronological time.

The number of working cycles, ω_j , produces wear-out of the j th component; thus, the ratio of cycles, denoted as $r_{j,n}$ [cycles/s], defines the rate of deterioration for the j th component.

Proposition 1.2. *The ratio of cycles is expressed as*

$$r_{j,n} = \begin{cases} \frac{2I sv_n qv_n}{\sum_i h_i}; & \forall j \text{ if } u = 0 \\ \frac{lv_n sv_n qv_n^2}{\sum_i h_i}; & \forall j \text{ if } u = 1 \end{cases}; \text{ with } u = \{0,1\}, \quad (1.8)$$

where $u = 0$ in the case which the j th component be a mobile component, $u = 1$ in the case which the j th component be a structural component, and the value I is the quantity of platforms.

Proof 1.2. Consider the j th component as a moving component by the pulling cable; then, the component undergoes two cycles each time a platform is crossed (a first cycle entering the platform, and a second cycle leaving the platform), i.e. the quantity of cycles that are applied to a component during a loop journey is $2I$ [cycles]; moreover, the spent time by a vehicle for whole loop journey is $\Delta t \sum_i h_i$ [s]; therefore,

$$r_{j,n} = \frac{2I}{\Delta t \sum_i h_i}; \quad \forall j \text{ if } u = 0; \quad (1.9)$$

then, taking Eqs. (1.1) and (1.2) into Eq. (1.9), the first part of the proposition is proved. Now, consider the j th component as a structural component belonging to the ropeway system. The component undergoes a single cycle each time that a vehicle crosses the component; i.e., the quantity of cycles that are applied to a component during a loop journey is $qv_n lv_n$ [cycles]; therefore,

$$r_{j,n} = \frac{qv_n lv_n}{\Delta t \sum_i h_i}; \quad \forall j \text{ if } u = 1; \quad (1.10)$$

again, taking Eqs. (1.1) and (1.2) into Eq. (1.10), the second part of the proposition is proved. \square

Remark 1.3. Note that the operational parameters, qv_n and sv_n , define the quality level of service Wg_n , and the degree of deterioration in the ropeway components as well, $r_{j,n}$.

Figure 1.2(a) shows the relationship between $r_{j,n}$ and the two types of components (mobile and structural) over a typical service time N , which is classified by periods of user demand, $m = \{1, 2, \dots\}$, where $m = 1$ represents the users demand of full rush hour, and $\forall m \neq 1$ represents the users demand of a partial rush hour. Considering the periods of users demand for the ropeway system, the performed working cycle by the j th component can be expressed as $\omega_j = \Delta t \sum_n r_{j,n}$.

Let f_j be defined as the fault probability distribution of the j th component – working cycles per fault [ω /faults]– (see Figure 1.2(b)) and F_j as the cumulative distribution function corresponding to f_j on a determined working cycle ω_j , $F_j(\omega_j \leq \omega)$, see Figure 1.2(c). The reliability probability of each j th component in the transport system is $R_j = 1 - F_j$ with $j = \{1, 2, \dots, J\}$ (see Figure 1.2(d)). The global reliability of the system, Rg , is directly relied on the behaviour of R_j as follows

$$Rg = \begin{cases} \prod_j R_j; & \forall j \text{ if } u' = 0 \\ 1 - \prod_j (1 - R_j); & \forall j \text{ if } u' = 1 \end{cases}; \text{ with } u' = \{0,1\} \quad (1.11)$$

where $u' = 0$ in the case which the j th component be in a series relationship configuration over the system, i.e. a failure of the any j th component will result in a failed function in the whole system; and $u' = 1$ in the case where the j th component is in a parallel relationship configuration over the system, i.e. the system performs as long as a single j th component remains operational.

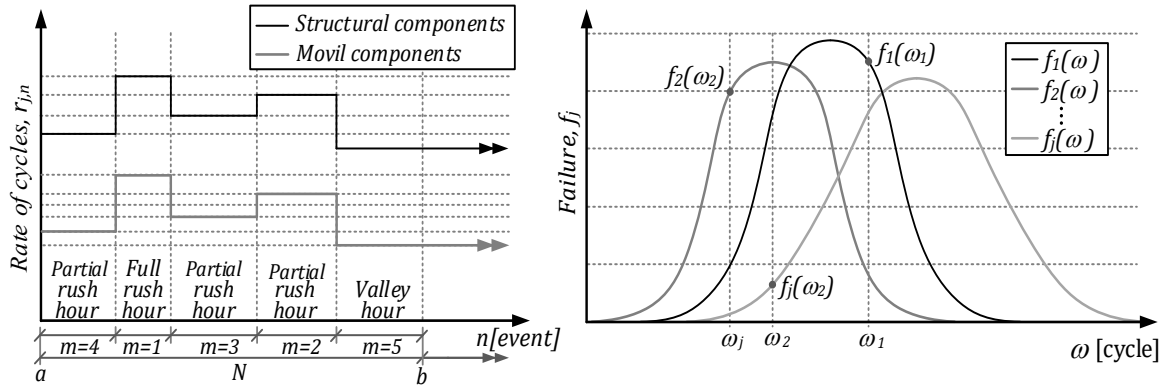

(a) Rate of cycles to different type of components.

(b) Fault probability functions.

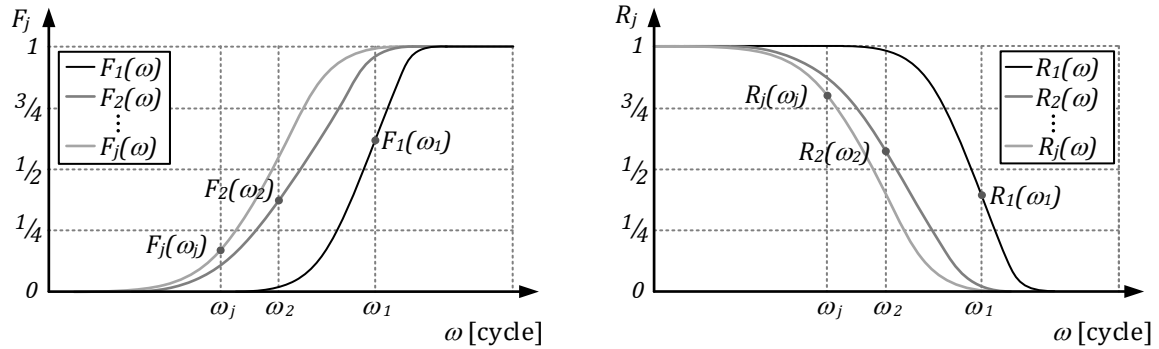

(c) Cumulative fault probability functions.

(d) Reliability probability functions.

Figure 1.2. Maintenance model of ropeway systems.

Ropeway maintenance managers may adopt different maintenance policies regarding the repair actions on a failed component ahead of the next scheduled preventive maintenance. The repairing actions affect the technical state of the repaired component in terms of its working life (Khatib, Ait-Kadi, & Rezg, 2013), i.e. $\alpha \omega_j$, with $0 \leq \alpha \leq 1$, where α is the age reduction coefficient after the maintenance action. In case of the maintenance manager adopts a maintenance policy with a value $\alpha = 0$, the reliability level of the component takes the nominal value $R_j = 1$, and the working cycles is restored to $\omega_j = 0$. This means that the corrective actions are focused on a *perfect* repair bringing the component to As-Good-As-New (AGAN) condition. AGAN involves repairing the component using the required resources to obtain the highest repair quality of the component. But, in a case where maintenance management adopts a maintenance policy with a value $\alpha = 1$, the reliability level of the component remains the value before the fault $R_j(\omega_j)$, meaning that the corrective actions are focused on a minimal intervention to the component, entitled As-Bad-As-Old (ABAO), which consists in repairing the component using the minimum possible resources to obtain the working component again (Hajej, Bistorin, & Rezg, Maintenance/production plan optimization taking into account the availability and degradation of manufacturing system, 2012; Martinod, Bistorin, Castañeda, & Rezg, 2018). In Section 1.4.2, we will develop the formulation of the maintenance policy problem regarding to the imperfect preventive maintenance.

1.4. Proposed Model

There are two different methodologies available to address the problem: (i) an aspiration-level model, which works directly with the measure of the queuing performance with the goal of determining an acceptable range for the service level, $\mu_{i,n}$, by specifying reasonable limits on the queuing performance (the limits represent the aspiration level); and (ii) a cost-based model, which attempts to balance two conflicting costs: (a) the cost of offering an efficient service, and (b) the

cost of delaying the service offer (passengers waiting time) . The two types of cost are in conflict because any increase to one automatically affects the other. Both approaches recognise that higher service levels reduce the waiting time in the system, and both models aim to strike a balance between service level and waiting time (Taha, 2011). The proposed work is focused on the cause-effect relationship between the joint service-operational policy and the maintenance policy, a relationship developed in the context of the cost-based model optimisation analysis: (i) penalty cost for passengers waiting time, and (ii) maintenance activities cost.

Chapter 1 tackles the problem by developing the formulation in three stages: (i) formulation of the service; (ii) formulation of the maintenance, which is analysed by two different strategies: (a) corrective and (b) preventive; and (iii) formulation of the combined service-maintenance policies.

1.4.1. Development formulation of the service problem

A discrete-time model is used to describe the queuing situations, in which the passengers: (i) demand the system, $\lambda_{i,n}$; (ii) wait in a queue, if necessary, Wg_n ; (iii) receive the service, $\mu_{i,n}$; and (iv) arrive at their destination, $\sigma_{i,n}$. The discrete-time model is composed of a set of interrelated queues with the objective of determining Wg_n value.

Remark 1.4. Note that the Wg_n value constitutes a penalty cost. The methodologies to quantify the penalty cost are directly defined by the operation managers of the ropeway systems. Each can use different criteria to quantify the penalty cost according to its service policy.

In this chapter, the relationship used to describe the penalty cost for waiting time is expressed as $Cw [\mu/\Delta t]$ (see Figure 1.3(a)); thus, the penalty cost for the global waiting time is defined as

$$\Gamma wg = Cw \sum_n Wg_n . \quad (1.12)$$

Remark 1.5. This work assumes that Γwg is described as a linear function, where the Cw value is a constant linear rate. The linear function is adopted because it is efficient and appropriately describe the cost for passengers waiting time. The task of building on these assumptions will be part of future works, according to the correlations highlighted in the literature review.

Section 1.5.1 will develop an application example of the service parameters behaviour regarding to the penalty cost by Γwg .

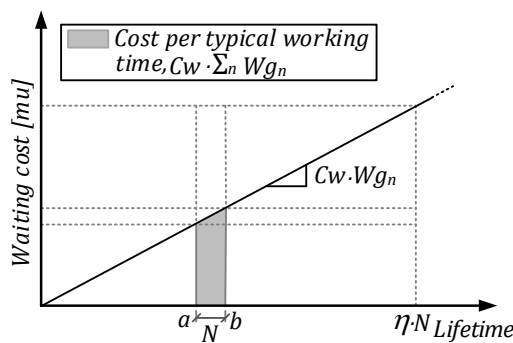

(a) Waiting cost relationship.

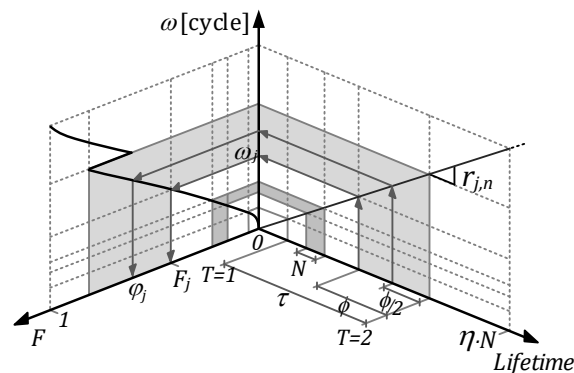

(b) Corrective maintenance parametrization.

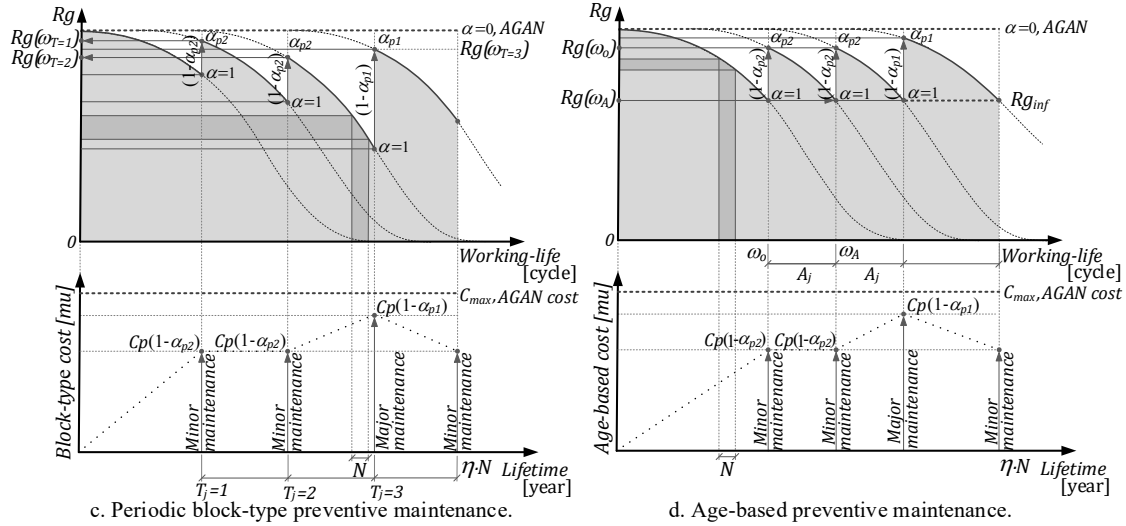

(c) Periodic block-type preventive maintenance. (d) Age-based preventive maintenance.

Figure 1.3. Relationship of maintenance policy parameters.

1.4.2. Development formulation of the maintenance problem

The maintenance actions and their associated cost are a well-known topic for ropeways maintenance managers, who must assess the relative merits of preventive versus corrective maintenance policies.

1.4.2.1. Formulation of corrective maintenance

The repairing actions on a failed component are executed between the scheduled preventive maintenances, i.e. between the working cycles range $A_j = \omega_A - \omega_o$ (see Figure 1.3(b)); in addition, the repairing actions have a cost associated for the fault of the j th component, which is expressed as a cost value on monetary unit, Cc_j [mu].

Remark 1.6. The corrective maintenance policy (commonly used by the maintenance managers) corresponds to ABAO (Pham & Wang, 1996; Khatab, Ait-Kadi, & Rezg, 2013). This work adopts an ABAO corrective maintenance policy, which is defined by the age reduction coefficient $\alpha = 1$, i.e. the R_j value, before the fault, remains (Martinod, Bistorin, Castañeda, & Rezg, 2018).

Proposition 1.3. The cost of the corrective maintenance, Γc , are expressed as the sum of the cost for the fault of the components affected by their probability of fault, φ_j ,

$$\Gamma c = \sum_j Cc_j \varphi_j \quad (1.13)$$

where φ_j is the average failure probability for the j th component, from the current lifetime, ω_j , to the next preventive maintenance action, ω_A .

Proof 1.3. The fault probability of the j th component is quantified by the mean area value from the probability function of fault distribution

$$\begin{aligned} \varphi_j &= P\left(\frac{\omega_j + \omega_A}{2} \leq \omega \leq \omega_A\right) \\ &= (\omega_A - \omega_j)^{-1} \int_{\omega_j}^{\omega_A} f_j(\omega) d\omega, \end{aligned} \quad (1.14)$$

with $\omega_j < \omega_A$. In addition, the probability average value of the function of fault distribution can be expressed by the mean value of the cumulative fault distribution

$$(\omega_A - \omega_j)^{-1} \int_{\omega_j}^{\omega_A} f_j(\omega) d\omega = F_j\left(\frac{\omega_A - \omega_j}{2} + \omega_A\right). \quad (1.15)$$

If the relationship $\omega_j + (\omega_A - \omega_j)/2$ is denoted as ϕ_j , it is possible to express $F_j(\phi_j) = \varphi_j$; then, the probability of fault, which affects Cc_j to get the corrective maintenance cost actions, has been proved. \square

1.4.2.2. Formulation of preventive maintenance

The preventive maintenance actions are adjusted to improve the Rg value. The imperfect preventive maintenance is well-established the field of engineering (Hajej, S., & Rezg, A jointly optimization of production, delivery and maintenance planning for multi-warehouse/multi-delivery problem, 2014; Hajej, S., & Rezg, Modelling and analysis for sequentially optimizing production, maintenance and delivery activities taking into account product returns, 2015) and has been the preferred approach of the maintenance managers of ropeways (Martinod, Bistorin, Castañeda, & Rezg, 2018); therefore, the imperfect preventive maintenance is considered in this study, which is defined by the age reduction coefficient, $0 < \alpha \leq 1$. After each preventive maintenance action, the equipment is restored on a lower level than the nominal state of its components, i.e. over the lifetime of the system its components undergo wear and degradation.

Let us define the highest quality maintenance cost as $Cmax_j$ [mu], which is the cost of the required resources to carry out AGAN maintenance. In other word $Cmax_j$ represents the cost of the required resources to get the highest quality maintenance and to restore the reliability function of the component to its nominal value, $R_j = 1$. As a consequence, when the budget of a maintenance action for the j th component is equivalent to $Cmax_j$, the executed maintenance action consists of replacing the component with a new one; hence, the value of the age reduction is restored, $\alpha = 0$ (Martinod, Bistorin, Castañeda, & Rezg, 2018).

The cost of the imperfect maintenance action is a fraction of $Cmax_j$, which is directly related to the age reduction coefficient of the component; thus, the cost of a preventive maintenance action can be expressed as $Cmax_j (1 - \alpha)$. The preventive actions are classified according to two types: major maintenance and minor maintenance. The age reduction coefficient associated with the preventive maintenance action is $\alpha = \{\alpha_{p1}, \alpha_{p2}\}$, whit α_{p1} and $\alpha_{p2} \in (0 < \alpha \leq 1)$, where α_{p1} is the age reduction after major maintenance action, and α_{p2} is the age reduction coefficient after minor maintenance.

Remark 1.7. The cost of the major maintenance action is higher than the cost of the minor maintenance action, $Cmax_j (1 - \alpha_{p1}) \gg Cmax_j (1 - \alpha_{p2})$, therefore $\alpha_{p1} \ll \alpha_{p2}$.

Proposition 1.4. *The cost of an imperfect maintenance action by the preventive maintenance policy is expressed as*

$$Ci_j = Cmax_j \left(1 - \frac{\alpha_{p1} + p \alpha_{p2}}{1+p}\right), \quad (1.16)$$

Proof 1.4. By definition, the cost of the imperfect maintenance relies on the sum of the costs of maintenance actions executed over the period of operating service time; i.e., the cost of the major maintenance and all the minor maintenances over a full cycle of preventive maintenance is

$$Ci_j = Cmax_j (1 - \alpha_{p1}) + Cmax_j \sum_p (1 - \alpha_{p2}); \quad (1.17)$$

thus, the relationship between the major and the minor preventive maintenances is defined by means of the parameter p , which describes the quantity of minor maintenance actions per each major maintenance action, where $1 + p$ is a full cycle of preventive maintenance over the long-term horizon of time η ; therefore, the expression is write as

$$C_{ij} = C \max_j ((1 - \alpha_{p1}) + p (1 - \alpha_{p2})), \quad (1.18)$$

and after some algebraic manipulations the proposition is proved. \square

This work considers two preventive maintenance policies:

- (i) The periodic block-type is the preventive maintenance policy adopted by the ropeways maintenance managers. Given a horizon of time expressed as η with a piecewise linear distribution of time T_j (see Figure 1.3(c)) the distribution of time over a full cycle of preventive maintenance is defined as $T_j \eta = 1 + p$. The cost of the periodic block-type maintenance policy is expressed as

$$\Gamma p = \sum_j T_j C_{ij}, \quad (1.19)$$

- (ii) The age-based maintenance policy is executed as the reliability indices of the components reach a predetermined level (Wang, 2002), i.e. the system undergoes a preventive maintenance whenever its reliability Rg reaches a given threshold level, Rg_{inf} (Martinod et al., 2018). Let the working cycles range be expressed as $A_j = \omega_A - \omega_o$ such that $Rg(\omega_o)$ is the reliability level of the last preventive maintenance denoted as Rg_o , and $\exists \omega_A \in \omega : Rg(\omega_A) = Rg_{inf}$. ω_A represents the quantity of working cycles in which the system reaches the reliability threshold level Rg_{inf} (see Figure 1.3(d)). Therefore, A covers the working cycles executed by the system in response to deterioration between preventive maintenances, and the period between maintenances can be expressed as $A_j = Rg^{-1}(Rg_{inf}) - Rg^{-1}(Rg_o)$, where $Rg^{-1}(\cdot)$ expresses the inverse function of the global reliability. The cost of the age-based maintenance policy is expressed as

$$\Gamma a = \sum_j A_j^{-1} C_{ij}, \quad (1.20)$$

Section 1.5.2 will develop an application example of the maintenance parameters behaviour regarding types of preventive maintenance policies: periodic block-type and age-based.

1.4.2.3. Formulation of the joint service-maintenance problem

This work introduces a stochastic optimisation model in order to simultaneously prove a cost-efficient service and maintenance plan. The decision variables are the service rate, qv_n and sv_n (adopted for each period) and the periodicity of the maintenance actions, T_j and A_j (corrective and preventive). The optimal service plan is obtained by minimising the expected penalty cost for passengers waiting time and the cost of maintenance activities. From that point, the proposed model merges the service policy and the maintenance policy. The maintenance cost increases as a service level increases (i.e. decreasing the cost of waiting time). Formally, the problem is solved through a cost-based model made up of waiting cost, $\Gamma w g$ (Eq. 1.12), corrective maintenance cost, Γc (Eq. 1.13), and preventive maintenance cost, Γp (Eq. 1.19) and Γa (Eq. 1.20), as follows

$$\min_{\omega_j} C : \begin{cases} Cw \sum_n Wg_n + \sum_j Cc_j \varphi_j + \sum_j T_j C_{ij} & ; \text{ if periodic block maintenance} \\ Cw \sum_n Wg_n + \sum_j Cc_j \varphi_j + \sum_j A_j^{-1} C_{ij} & ; \text{ if age-based maintenance} \end{cases} \quad (1.21)$$

Subject to the following constraints

$$0 \leq g_{k,i,n} \leq cv, \quad \forall k, i, n \quad (1.21.a)$$

$$0 \leq \mu_{i,n} \leq \min(Lq_{i,n}, g_{k,i,n}), \quad \forall i, n \quad (1.21.b)$$

$$0 \leq \sigma_{k,n} \leq cv - g_{k,i,n}, \quad \forall k, n \quad (1.21.c)$$

$$sv_{inf} \leq sv_n \leq sv_{sup}, \quad \forall n \quad (1.21.d)$$

$$qv_{inf} \leq qv_n \leq qv_{sup}, \quad \forall n \quad (1.21.e)$$

$$Rg_{inf} \leq Rg \leq 1, \quad (1.21.f)$$

$$0 \leq Wg_n \leq Wg_{sup}, \quad (1.21.g)$$

$$0 \leq \sum_{i,n} \lambda_{i,n} \leq cv \sum_n sv_n qv_n, \quad (1.21.h)$$

$$\sum_{i,n} \lambda_{i,n} = \sum_{k,n} \sigma_{k,n}, \quad (1.21.i)$$

where:

- Eq. (1.21.a) highlights that the available places of a vehicle, $g_{k,i,n}$, must be less or equal to the vehicle's capacity, cv ;
- Eq. (1.21.b) means the quantity of passengers boarding the vehicle, $\mu_{i,n}$, must be less or equal that the quantity of passengers waiting in the queue, Lq ; but besides, $\mu_{i,n}$ must be less or equal that the available places of the vehicle, $g_{k,i,n}$;
- Eq. (1.21.c) expresses that the quantity of passengers disembarking from the vehicle, $\sigma_{k,n}$, must be less or equal than the quantity of the passengers traveling inside the vehicle, $cv - g_{k,i,n}$;
- Eq. (1.21.d) is related to an operating condition; namely, the speed of the vehicles sv_n which is limited by a range $[sv_{inf}, sv_{sup}]$;
- Eq. (1.21.e) refers to another operating condition; namely, that the system must have a range of vehicles in active service (density of vehicles) $[qv_{inf}, qv_{sup}]$;
- Eq. (1.21.f) is related to the maintenance policy, where Rg_{inf} is the lower limit of global reliability of the system;
- Eq. (1.21.g) is related to other service policy, where Wg_{sup} is the upper limit of global waiting time in the queue;
- Eq. (1.21.h) implies that the capacity of the transport system, $cv \sum_n sv_n qv_n$, must be greater than the total passenger demand for a given time horizon in the transport system, $\sum_{i,n} \lambda_{i,n}$; otherwise, the system is overloaded;
- Eq. (1.21.i) indicates that the quantity of passengers disembarking from all vehicles on the time horizon $\sum_{k,n} \sigma_{k,n}$, must be equal to the quantity of users that arrive on the platforms, $\sum_{i,n} \lambda_{i,n}$. It means that with the close of a period of service time at the end of a full working day, all passengers are served and no one remains in the system. In other words, when the system is closed after a working day, the system is empty.

A model of the ropeway transport has been developed in a virtual environment using a programming language, which allows investigating the effects of a wide range of possible conditions and parameters variation. The results obtained from the model provides accurate predictions of the behaviour of the system and its interaction with the decision variables. A ropeway transport system has been defined (see Appendix A, Table A.1). A sensitivity model analysis is executed by mean of 50 sets of tests, every test covers 500 events. The input data are $\lambda_{i,n}$ (a set to each platform) which are defined as a set of variables with stochastic Poisson distribution (see Figure 1.4).

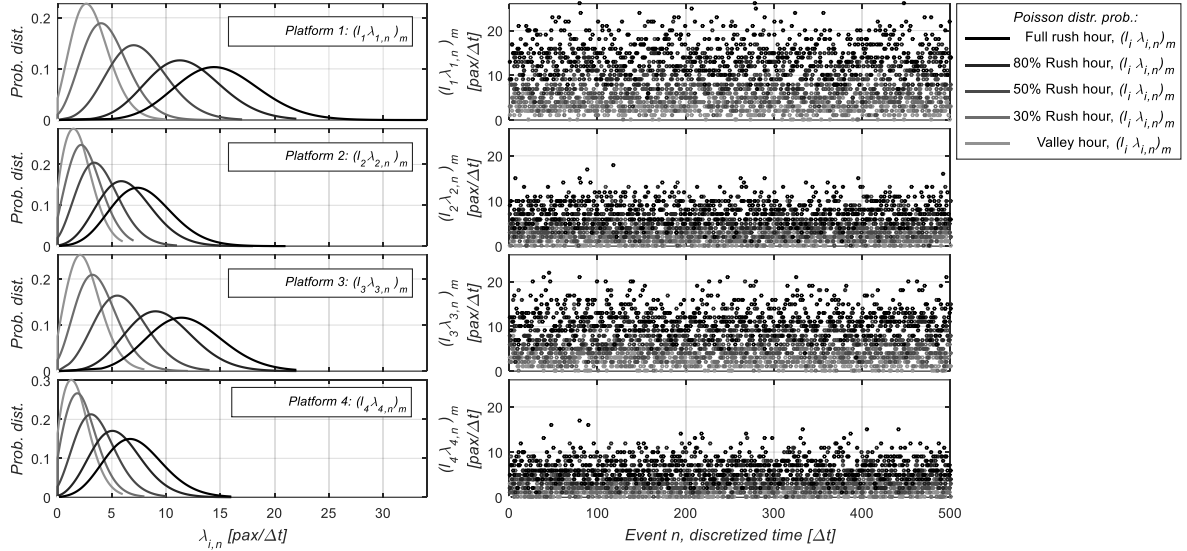

Figure 1.4. Poisson distribution of arriving users to the platforms, $\lambda_{i,n}$ [pax/ Δt].

Appendix B (Figure B.1) shows every single mean waiting time Wg_n , which represents the estimator used to describe the system behaviour over the discret-time; therefore, a relationship can be established between a measure of central tendency such as the average values, $mean(Wg_n)$, and the measure of dispersion such as the deviation standard, $std(Wg_n)$, to quantify the sensitivity of the model regarding the events. The ratio between $mean(Wg_n)$ and $std(Wg_n)$ to each platform is {0.007, 0.065, 0.011, 0.098}%, which represent an acceptable deviation level for the scope of this work.

The model is subjected to a convergence analysis to reach a stable value, Appendix B (Figure B.2) shows the results of the mean waiting time in the queue to each platform, a lower value of 3% variation represents an acceptable level of deviation from this study. Therefore, in order to fulfil the requirement a total of 18 simulations are necessary.

1.5. Case study: urban aerial ropeway system

This section provides an application example to expose the obtained numerical results. According to the general operational characteristics of ropeway transport systems, two types of aerial ropeways are identified (Mizuma, 2004; Alshalalfah, Shalaby, Dale, & Othman, Improvements and Innovations in Aerial Ropeway Transportation Technologies: Observations from Recent Implementations., 2013):

- (i) aerial tramway –*téléphérique*– in this system, two large vehicles (cabins) are permanently attached to each leg of the pulling cable which alternatively turns in one direction. The vehicles stop when they reach the station (see Figure 1.5(a)). This feature allows vehicle speed and cable velocity to remain the same throughout the journey. In addition, two operational aerial tramway designs are available: (a) an aerial tramway –reversible ropeway system consists of two vehicles suspended from cables, situated at opposite ends of the cable loops – when one is ascending, the other is descending, and they pass each other midway on the cable span–; (b) in a dual-haul aerial tramway system, there are two reversible vehicles that run on parallel tracks. There are two guide ropes and a haul rope loop per vehicle, which allows for single-vehicle operation when demand warrants.
- (ii) gondola –*télécabine*– this system has a pulling cable revolving constantly in one direction; the vehicles (gondolas) are attached and detached when entering and travelling through a platform (see Figure 1.5(b)). This feature allows the vehicles to be set at regularly spaced close intervals with the cable continuously circulating with the vehicles. The vehicles detach from the hauling rope at the platforms, decelerated, and carried at a very low speed through an embarking/disembarking area, and finally accelerating upon reattachment to the haulage

rope for high speed travel on the line between stations. There are three gondola designs: (a) the mono-cable detachable gondola, with vehicles that are suspended from a moving loop of steel cable, (b) the bi-cable detachable gondola, which uses reversible ropeway technology, but the system is detachable, which allows the system to have a high capacity and a detachable circulating system, and (c) tri-cable detachable gondola –3S– combines features of both gondola and reversible ropeway systems and detachable gondolas.

Our case study is concerned with a fleet supporting an urban mass-transport system; in particular, a gondola-type aerial cable system running on a continuous cycle, see Figure 1.5(b), mono-cable (simple ring) with a detachable release clamp device (Martinod, et al., Journey safety assessment to urban aerial ropeways transport systems based on continuous inspection during operation, 2015). The urban transport system in our case study is similar in design and construction to those used for tourist passenger transports in winter regions (e.g. Daemyung, Korea; La Clusaz, France; Donovaly, Slovakia) (Estepa, et al., 2014), but it does not share the tourist purpose of these other examples (Mizuma, 2004). Therefore, the transport system in question is required at high levels of service demand that have not been supported by similar systems, causing highly elevated wear rates (Hoffmann, 2006); it will be hence the aerial cable transportation system with highest level of demand, in terms of wear hours of components and service (Martinod, et al., Journey safety assessment to urban aerial ropeways transport systems based on continuous inspection during operation, 2015). The general features of the application example are illustrated in Appendix A (Table A.1).

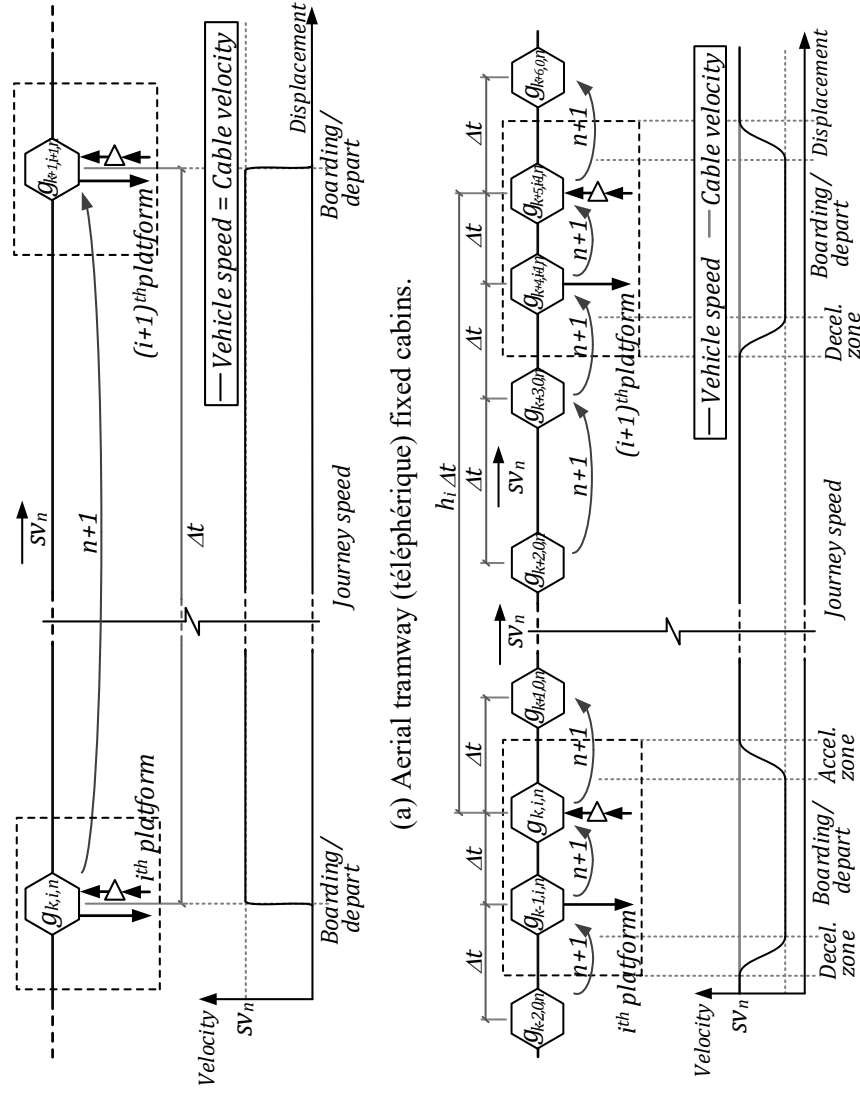

(a) Aerial tramway (téléphérique) fixed cabins.

(b) Gondola (télécabine) with a detachable release clamp.

Figure 1.5. General operational characteristics of ropeway transport systems.

1.5.1. Service parameters behaviour

A set of tests has been developed in which the decision variables (sv_n , qv_n) were considered; thus, a set of combinatory tests was performed based on the ranges de operation of the ropeway

system, $qv_n = \{50, \dots, 66\}$ [veh] and $sv_n = \{1.5, \dots, 5.5\}$ [m/s]. With each combination run, the quantity of simulations was defined by the convergence analysis to check the stability of results (Section 3.3).

The weighted mean of users that arrive on terminal platforms ($\lambda_{1,n}$, $\lambda_{3,n}$) and the halfway-platforms ($\lambda_{2,n}$, $\lambda_{4,n}$) reflects the different levels of demand at these locations (e.g. the typical demand service of the terminal platforms are higher than the halfway-platforms). The relationship between the different levels of the passenger demand can be expressed as $l_i \lambda_{i,n}$ where l_i is the proportional coefficient between platforms; as such, $l_1 \lambda_{1,n} = l_2 \lambda_{2,n} = l_3 \lambda_{3,n} = l_4 \lambda_{4,n}$. In the proposed example, the relationship between the passenger demand at each platform can be written as $\lambda_{1,n} = 1.87 \lambda_{2,n} = 1.25 \lambda_{3,n} = 2.13 \lambda_{4,n}$. In addition, the tests are structured by the conditions of user demand from rush hour to off-peak periods; see Figure 1.2(a). A set of five demand conditions are established $(l_i \lambda_{i,n})_m$ with $m = \{1, \dots, 5\}$ where $(l_i \lambda_{i,n})_1$ represents the demand conditions of full rush hour, and $(l_i \lambda_{i,n})_5$ represents the demand conditions of off-peak periods; thus, a total of 8.917 tests were executed. Table 1.2 shows the m th Poisson parameter of $(l_i \lambda_{i,n})_m$ to the i th platform (see Figure 1.6).

Table 1.2. Poisson parameters of the users demand to each platform, $(l_i \lambda_{i,n})_m$ [pax/ Δt].

		Rush hour				Off-peak
		Full	80%	50%	30%	periods
		$m = 1$	$m = 2$	$m = 3$	$m = 4$	$m = 5$
Platform 1	$(l_1 \lambda_{1,n})_m$	15.0	12.0	7.5	4.5	3.0
Platform 2	$(l_2 \lambda_{2,n})_m$	8.0	6.4	4.0	2.4	1.6
Platform 3	$(l_3 \lambda_{3,n})_m$	12.0	9.6	6.0	3.6	2.4
Platform 4	$(l_4 \lambda_{4,n})_m$	7.0	5.6	3.5	2.1	1.4

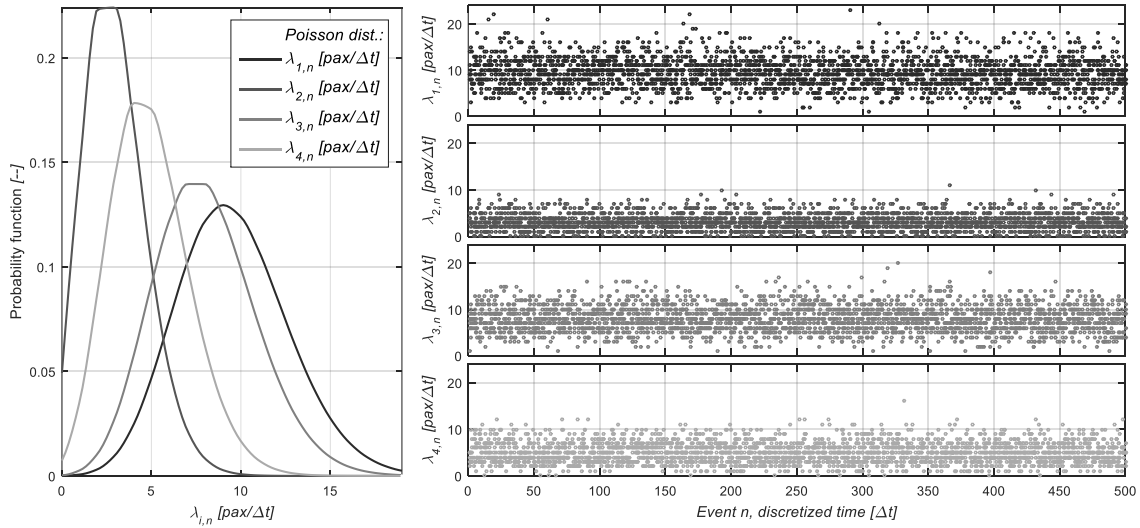

(a) Probability functions of user arrival.

(b) Dataset of user arrival.

Figure 1.6. Poisson distribution of user arrival to the platforms, $\lambda_{i,n}$.

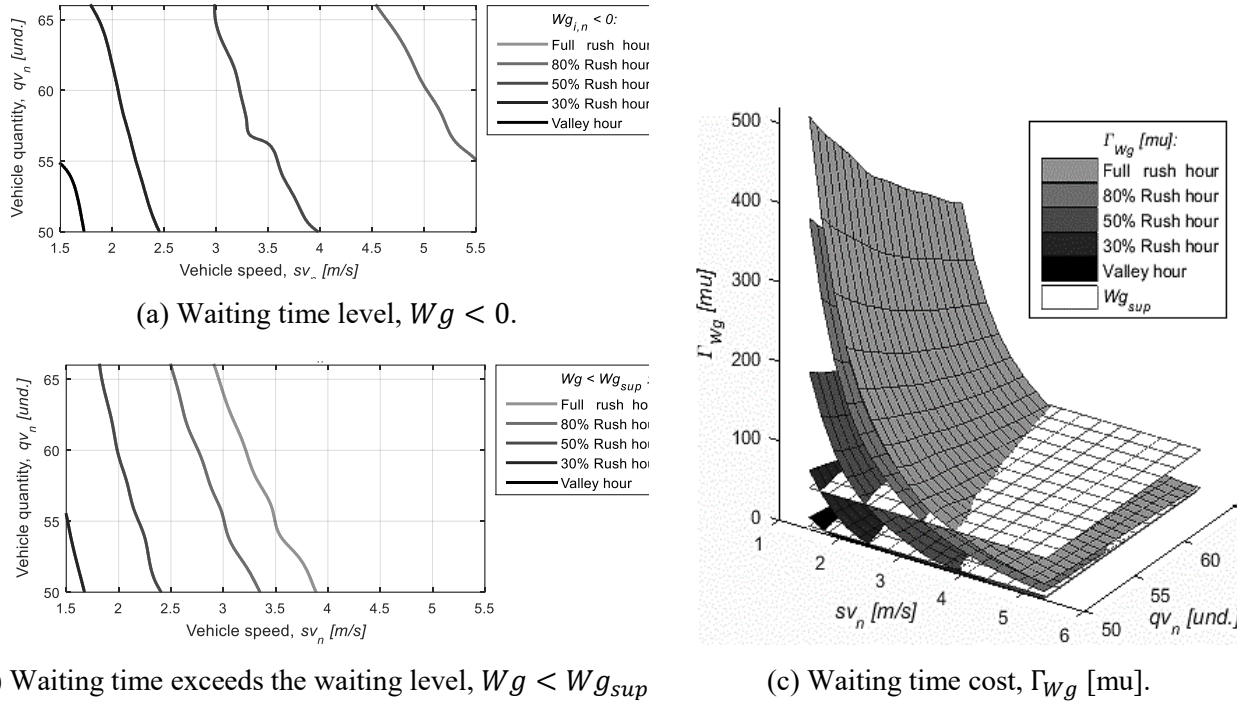

Figure 1.7. Service parameters behaviour, Wg [Δt] and Γ_{Wg} [mu].

The results of these tests are synthesised on Figure 1.7. An initial analysis was carried out to identify the combination of the values sv_n and qv_n , that must be provided by the transport system to reach a service policy without incurring passenger waiting time; i.e., $Wg_n = 0$. Figure 1.7(a) shows the boundary values of sv_n and qv_n in each demand condition. If the manager chooses a set of values equal to or higher than to the boundary, the users can board the vehicle without waiting in a queue. A second analysis is focused on assessing the values of sv_n and qv_n at which the transport system can offer a service with an acceptable waiting time of passengers defined by the service policy, i.e. $Wg_n \leq Wg_{sup}$. Figure 1.7(b) shows these boundary values. If the manager chooses a set of values sv_n and qv_n equal to or higher than the boundary, the users face a shorter waiting time that the waiting limit, Wg_{sup} . A third analysis is the quantification of Γ_{Wg} according each user demand conditions $(\lambda_{i,n})_m$, see Figure 1.7(c).

1.5.2. Maintenance parameters behaviour

The example is focused on the maintenance conditions of two sets of critical components for the exploitation of ropeway transport: (i) the conveyor-track system, and (ii) traction system.

The conveyor-track system has of the ability to decelerate/accelerate the vehicles around each platform; there is one independent system per platform. The conveyor-track system is considered one of the structural components (according to the section 2.2). The ropeway system requires that very conveyor-track works, or else the system must stop until the failure is fixed, this affecting the service policy; thus, the sets of conveyor-track systems have a series configuration on the ropeway transport, with a set of reliability functions expressed as $\{R_1, R_2, R_3, R_4\}$.

The traction system is composed by three independent and redundant systems $\{R_5, R_6, R_7\}$ (see Figure 1.8). There are two sets of electric motors, with each motor joined to a different gearbox. The ropeway system requires just one working motor-gearbox, and the second, standby motor-gearbox is available for maintenance actions. The third redundant traction system is a set of engine-gearbox; this traction system works in the case of the electrical network undergoes a cut off. Thus, the sets of traction systems have a parallel configuration on the ropeway transport.

Following the example, the set of reliability function is $\{R_1, \dots, R_J\}$ with $J = 7$, and the global reliability expression is $R_g = \prod_{j=1}^{J-3} R_j \cdot (1 - \prod_{j=5}^J (1 - R_j))$. A previous study (Trujillo, 2013), 2013) developed an evaluation and analysis focused on components of a ropeway system based on reliability, maintainability, and availability (RMA). That study measured the fault probability distribution of the detachable grips, and its reliability probability. The author made a Kosmogorov-Smirnov test and found the distribution of the faults belong to Weibull distributions.

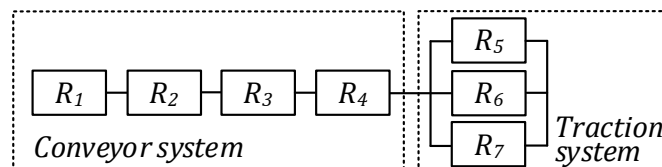
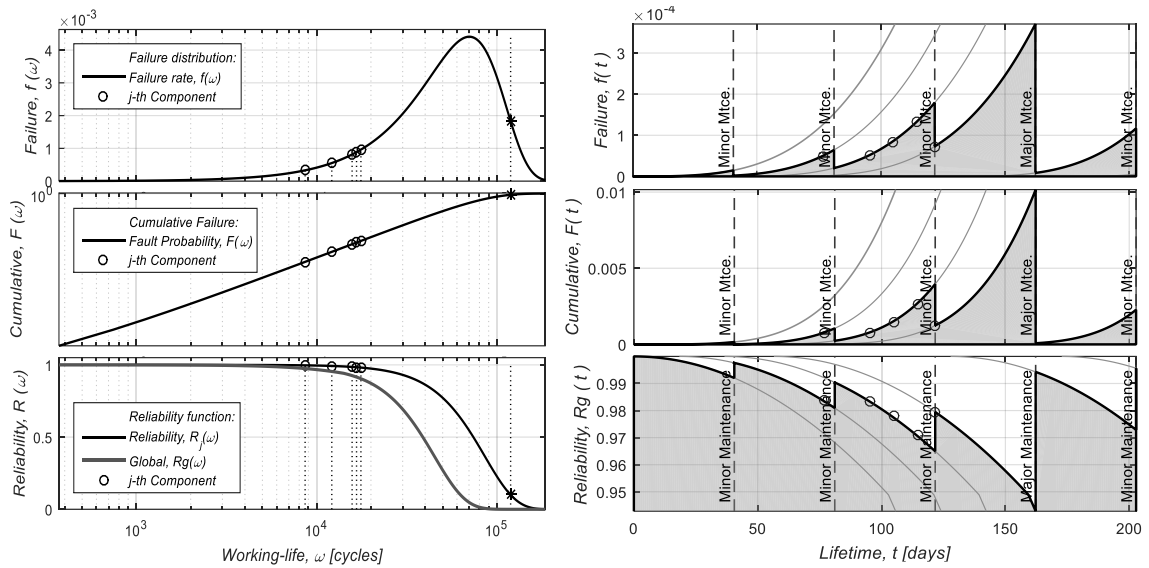

Figure 1.8. Components configuration on the ropeway system.

The example considers all analysed components, $j = \{1, \dots, J\}$, belong to the same type of components (in this case, the components belong to the structural elements in the system), the same maintenance policy is applied to the same type of the components. An analysis of the failure probability progress on the transport system is made. Deterioration of the system is computed in three stages: (i) the functions f_j , F_j and R_g are calculated to obtain the progressive degradation of the system according to typical operation conditions. Considering just the corrective maintenance actions, it means a reactive maintenance policy is applied, without preventive maintenance actions, see Figure 1.9(a); (ii) the effect of the preventive imperfect maintenance action to each period of time is calculated; and (iii) the degradation system is found by the superposition principle, to get the mixed effect due to the corrective and preventive maintenance actions on the system (see Figure 1.9(b)). Two scenarios are considered for application example:

- (i) maintenance cost calculated according to periodic block-type preventive maintenance. This is the current maintenance policy applied by the maintenance managers of ropeways systems and it is the traditional maintenance policy established by the international regulation. The decision variables (T_j, sv_n, qv_n) have been considered as a combinatorial tests based on the range $T_j = \{3, \dots, 12\}$ [maint./year] and the working cycles $\omega(sv_n, qv_n) = \{1.18E4, \dots, 4.56E4\}$ [cycles]. Each combination was run and the quantity of simulations was governed by the convergence analysis to check the stability of results. Figure 1.10(a) shows a synthesis of the results. The cost of the periodic block-type preventive maintenance does not rely on the degradation of the components, but it is directly proportional to its periodicity, T_j . The cost of the corrective maintenance increase with the degradation of the components, but decrease with the periodicity of the periodic block-type preventive maintenance.
- (ii) age-based preventive maintenance. This scenario can be used to quantify the effectiveness of the applied current maintenance policy used by the maintenance management. Figure 1.10(b) shows a synthesis of the results. The cost of the age-based preventive maintenance depends on the degradation of the components. As such, quantity of maintenance actions is in function of R_g . Note that the quantity of preventative maintenances corresponds to 7 maintenance actions per year, the cost of the corrective maintenance changes of tendency; i.e., the cost behaviour of the corrective maintenance for the age-based preventive maintenance can be classified in two performances: (a) the value of the corrective maintenance cost decreases until a defined quantity of preventive maintenances, and (b) after the defined quantity of preventive maintenances, the value of the corrective maintenance cost remain almost constant.



(a) Failure probability at frequency domain. (b) Effects of preventive maintenance actions.

Figure 1.9. Failure probability progress of the system.

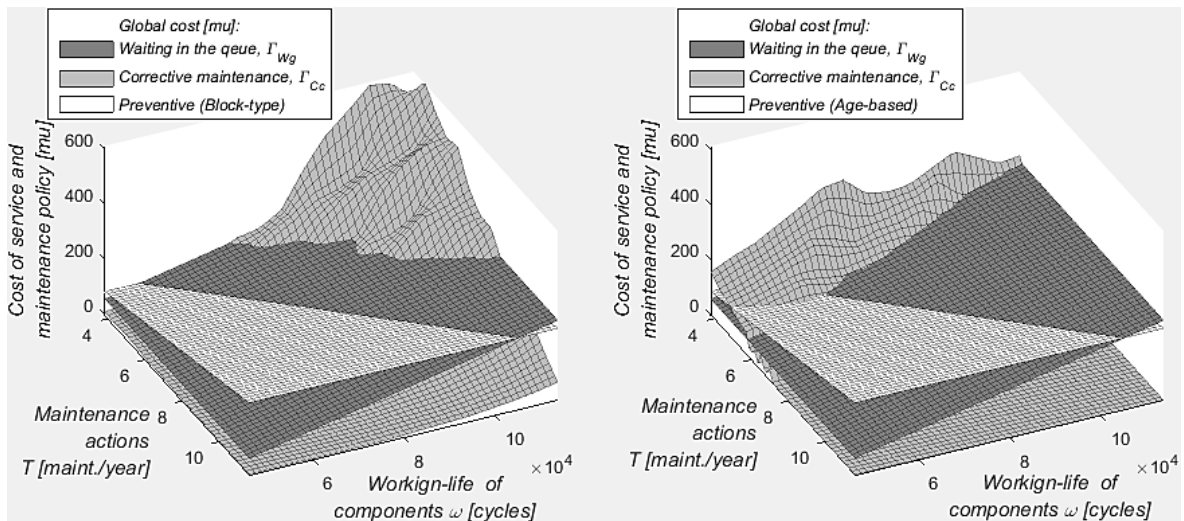

(a) Cost of service and periodic block-type maint. (b) Cost of service and age-based maint. policy

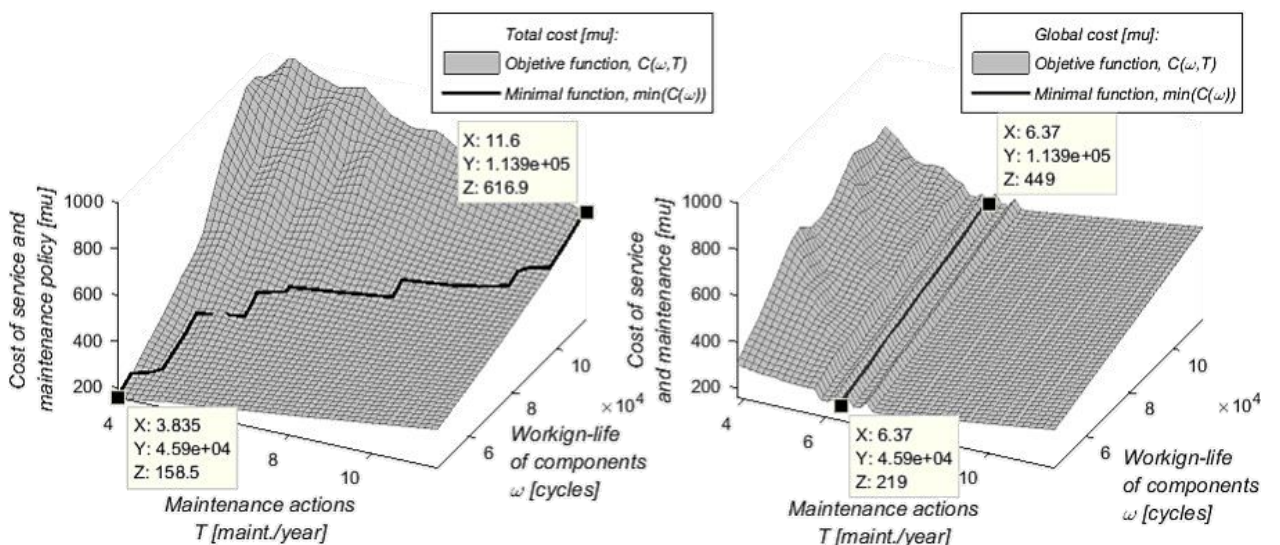

(c) Objective fn. with a periodic block-type maint. (d) Objective fn. with an age-based maint. policy.

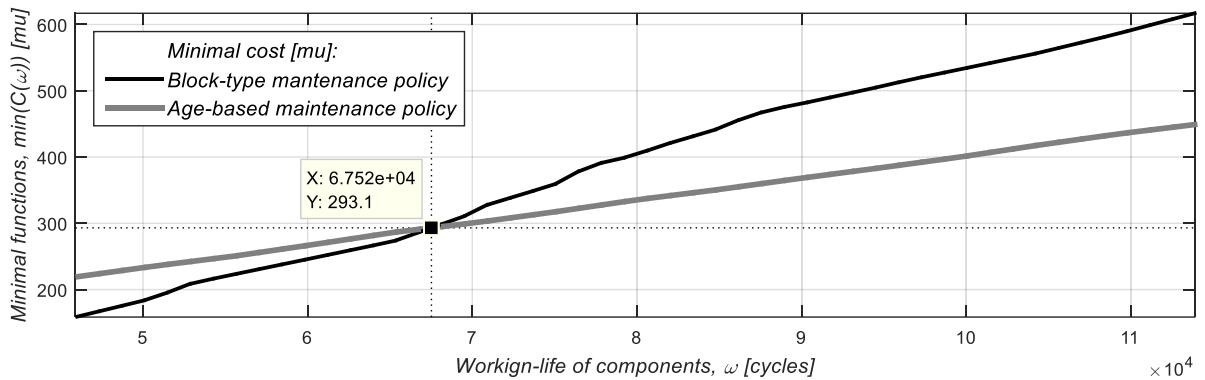

(e) Minimal functions of different maintenance policies.

Figure 1.10. Cost of service and maintenance policies.

1.5.3. Cost of service and maintenance policies

By using Eq. 1.21, which relates the cost of the service and maintenance policies, it is possible to get two independent objective functions $C(T_j, \omega)$: (i) an objective function regarding to the periodic block-type maintenance policy (see Figure 1.10(c)), and (ii) an objective function regarding to the age-based maintenance policy (see Figure 1.10(d)).

An analysis of $\min(C(T_j, \omega))$ belonging to the periodic block-type maintenance policy shows the lowest cost is obtained through quarterly preventive maintenance actions for a working-life of $4.59E4$ [cycles]. Once the working-life reaches a value of $1.139E5$ [cycles], however, the lowest cost is achieved with a monthly preventive maintenance action. The function $\min(C(T_j, \omega))$ belongs to the age-based maintenance policy. It indicates that the periodicity of the preventive actions has a constant value over the working-life of the system. The lowest cost is gotten with a two-monthly preventive maintenance action.

Figure 1.10(e) shows the relationship between the functions $\min(C(T_j, \omega))$ in each of the maintenance policies. Note that if the components of the system have a low working-life value, the appropriate policy is the periodic block-type maintenance (the cost of the periodic block-type maintenance is 27.62% lower than the age-based maintenance). However, if the components of the system undergo wear and a decline in performance, due to the high demand on the system, the appropriate policy is the age-based maintenance (the cost of the periodic block-type maintenance is 37.40% higher than the age-based maintenance). Therefore, there is an optimal working-life value for a change in the maintenance policy. This value ensures minimal cost (considering the operational service and the maintenance actions) during the service life of the transport system. The optimal working-life value is calculated as $6.75E4$ [cycles].

1.6. Conclusions and discussion

In this study, a mathematical framework is developed to integrate service and maintenance policies in order to solve the queueing problem and the cost of maintenance actions in public transport services. For this purpose, the authors have proposed: (i) a stochastic discrete-event model composed of a set of interrelated queues for the formulation of the service problem using a cost-based mathematical expression; and (ii) an imperfect preventive maintenance based on two different maintenance policies (periodic block-type maintenance and age-based maintenance).

In the first stage of the analysis, a mathematical model of the service policy was proposed to determine the values of the operational parameters (sv_n, qv_n) in which the transport system offers

different levels of service quality: (i) users get the service they need without waiting in a queue; and (ii) an *acceptable* waiting time for passengers, defined on the basis of the service policy. Further on in our analysis, the penalty cost in terms of global waiting time, Γwg , was considered as a term of the optimisation model based on cost, $C(T_j, \omega)$. In a later stage of the research, this work developed a stochastic model of maintenance that considers the degradation for a multi-component system with a dependence relationship between the components. Through our analysis, the model cost of maintenance (which includes the corrective and preventive maintenance action) completes $C(T_j, \omega)$. An optimisation model $C(T_j, \omega)$ has been formulated to bring together the service and maintenance policies, making it possible to determine the optimal cost function $\min(C(\omega))$ such that the cost over a long-time window of working-life was minimised.

This chapter developed an optimisation model that integrates the service and operations policies with the maintenance policy of a transport system. We show that neither periodic block-type maintenance nor an age-based maintenance is necessarily the best maintenance strategy over a long system lifecycle. The optimal strategy must consider both policies; at the beginning of the working-life, applying a periodic block-type is likely the most advantageous, but as the components of the system undergo age and deteriorate, an age-based maintenance policy is likely the preferable option.

Currently, maintenance managers of transport systems apply a single maintenance policy during the working-life cycle. This chapter provides strong support to the idea that an optimal maintenance policy is a mixed policy. Therefore, current maintenance strategies should be reconsidered in order to improve service and the maintenance activities.

Future research will focus on the four major aspects. From the perspective of passenger demand, transport systems are not independent, they are interconnected and inter-modal. Further analysis of service delivery and the passengers' facilitation process can be undertaken with regard to a ropeway system's connection to an intermodal transport network. This calls for a more robust algorithm to speed up the data processing for solving larger-scale problems. Secondly, it is possible to propose other study, in which broaden different relationships of the penalty cost for the global waiting time –polynomial functions, hyperbolic functions, exponential function, etc.– where an analysis of the system characteristics and its implications is considered. The present work has only considered a linear function for this relationship and for the implications for the service policy. Third, it is perceived that urban transport undergo a remarkable intensity of passenger flow in one direction over defined periods –people go to work, students go to schools, etc.– generating a strong asymmetric demand of passengers over the ropeway system. This urban transport characteristic can be further embedded into the formulated model. Fourth, this work provides an analysis which considers the user requirements and the company profit. Building on that, it possible to propose a further analysis that includes the social cost and the environmental cost; thus, an approximation of sustainability model can be proposed. Finally, this work assumed that all analysed components belong to the same type of elements, and therefore the same maintenance policy is applied to the components, and in addition the preventive maintenance actions are performed on all components at the same time. As such, it would be possible in future to develop a maintenance model which considers components affected by multiple types of independent degradation processes.

Chapter 2:

Combined optimisation methodology for operation planning and service policies

Authors: R.M. Martinod, O. Bistorin, L.F. Castañeda, N. Rezg
Original title: Combined optimisation methodology for operation planning and service policies: a case study of urban ropeway transport
Journal: International Journal of Transport Economics, 47 (3), 337-363
Publication date: December 2020
DOI: <https://doi.org/10.19272/202006703006>

Classification according to SCImago Journal Rank (SJR)

Sub-category: Transportation (Q3)
H-index(2019): 22
JIF(2019): 0.509
SJR(2019): 0.298
CS (CiteScore): 1,4
SNIP: 0,280

Abstract

The long-term efficiency of transport operator profit and the benefits for passengers conduce to opposite results. Actually, intervention by previous decision-makers to pursue one of the two goals generate opposite results on the other, forcing decision-makers to a difficult trade-off. The aim of this chapter is to provide a model that analyses, in an integrated perspective, operation and Service Policies (SPs), making an appropriate synthesis on both policies. This chapter proposes a cost-model formulation to optimize the merged operation and SPs to improve the current exploitation strategies according the service and maintenance activities. The proposed work is based on the following approaches: (i) a numerical model for the operation policy to determine the profit value of different working periods; (ii) a stochastic process for the passenger flow that considers the uncertainty of passenger travel to compute the benefits according to their travel time; and (iii) a cost-based optimisation to bring together the operation and SPs. Finally, the proposed optimisation model is applied to a massive urban ropeway operation of a public transportation system, in which the current SPs has been evaluated, considering the established transportation operation.

2.1. Introduction

Urban Public Transport Systems (UPTSs) influence the infrastructure of cities and the lives of their residents while directly stimulating the economy. High levels of urban development (densification) and increasing mobility requirements of residents tend to degrade urban environments. Smart UPTSs contributes to improve pact on the quality of life and the environment in cities, thus, increasing upright habits among the citizens (Belli, et al., 2020). In general, UPTSs reduces the environmental burden resulting from traffic congestion and gas emissions. However, the inefficient operation of UPTSs do not necessarily reduce the environmental burden, and Urban Transport Operators (UTOs) may not be able to manage it sustainably (Campbell & Van Woensel, 2019; Tamaki, Nakamura, Fujii, & Managi, 2019). Long-standing problems for UPTSs (e.g., low

operational efficiency, a lack of punctuality of transport service, etc.) have negative consequences such as passengers are not attracted (Tang, Yang, & Qi, 2018; Steiner & Irnich, 2018). Poor performance of UPTSs, downtime and inefficient planning lead to a loss of service, increase costs and reduce profits for UTOs, and passengers as well (Cholasuke, Bhardwa, & Antong, 2004). On the other hand, UPTS companies that can effectively implement their operation will save time, money and other resources in dealing with reliability, availability, maintainability and performance issues (Fraser, Hvolby, & Tseng, Maintenance management models: A study of the published literature to identify empirical evidence. A greater practical focus is needed., 2015) . The rational planning of UPTS operations improves the overall operational efficiency and service level management. Optimizing UPTS operations is fundamental to achieving intelligent mobility. Smart UPTSs improve their sustainability level, reducing transport costs and waste of resources as well as helps UTOs to manage the transport network (Bibri, 2018). Smart urban mobility managements are aiming at reconsidering the public transport network to cope with actual user expectations in terms of efficiency, quality and fast access to information (Ivaldi & Ciacci, 2020).

Rational operation planning has a significant effect on reducing the cost of transport operations, enhancing the operational efficiency and improving the service capacity. The motivation for the research is caused by a lack of studies concerning: (i) the assessment of operation performance (as impacted by the cost of in-service periods, dead-time, stop periods and maintenance) combined with the management of the service level (as impacted by the travel time) and (ii) the assessment of operator efficiency and passenger benefits, considering the deterioration of the system. In particular, the authors found few studies dealing with the simultaneous optimisation of transport operation and Service Policies (SPs) in urban ropeway systems. An efficient SP (i.e., parameters which affect the passenger perception such as vehicles frequency, speed, capacity, waiting time) transport should consider the total travel time of the users, but on the operation side, decreasing the travel time increases the operational cost in terms of the intensity of the operation periods, system wear, faults, and maintenance (i.e., the progressive deterioration of the system).

Chapter 2 develops an optimisation model for the operation plan and SPs for a UPTS over its working life applied to a typical urban ropeway system (called aerial cable-car or cableway as well). The research question is formulated as how maximize the long-term efficiency of the combined transport operation profit and the benefits for passengers concurrently; thus, the research question is addressed to a stochastic simulation model of ropeway transport was developed in a virtual environment (where the typical passenger demand is defined as a set of variables with a stochastic Poisson distribution) for investigating the effects of a wide range of possible conditions and parameter variations associated to operation and SPs. The main novelty of the chapter can be summarized as follows:

- (i) a cost-based optimisation model for transport operation and SPs is developed to solve the problem of long-term sustainability considering the progressive deterioration of the system;
- (ii) a stochastic optimisation model is developed to support efficient operation planning to reach the maximum profit for the UTO and the minimum cost to the passengers for delayed service;
- (iii) this chapter presents a decision-making tool for operation planning centred on UPTS services. The approach has been developed specifically for considering the UTOs in urban ropeway systems.

The remainder of this chapter is organized as follows. Section 2.2 introduces the literature review. Section 2.3 describes the problem. The cost-based models for the operation plan and service level management are developed in Section 2.4 and Section 2.5, respectively. The mathematical expression of the optimisation process is presented in Section 2.6. The model is applied in Section 2.7 using an example focused on an urban ropeway system. Section 2.8 presents an analysis and discussion of the results and the research work. Finally, Section 2.9 concludes the work and discusses future research. Table 2.1 presents the coefficients, parameters and variables that will be used throughout this chapter.

Table 2.1. Abbreviations, Indices and parameters used throughout Chapter 2.*Abbreviations:*

CM	Corrective Maintenance;
MP	Maintenance Policy;
PD	Passengers' Demand;
PM	Preventive Maintenance;
PWT	Passenger Waiting Time;
SP	Service Policy;
UPTS	Urban Public Transport System;
UTO	Urban Transport Operator.

Indices:

$i = \{0,1, \dots, I\}$	Indices for the platforms in the system;
$j = \{1,2, \dots, J\}$	indices for the passengers;
$k = \{1,2, \dots, K\}$	indices for the PM over a long-time horizon;
t	working day time [hours];
η	long-time horizon [years].

Operation parameters:

A_k	k th working cycle range between two age-based PM actions [cycles/maint.];
$f(\eta), F(\eta)$	fault distribution and cumulative probability function [faults/maint.], respectively;
N_k	k th PM action for a periodic block-type [maint./year];
$R(\eta), R_{TS}$	reliability probability function and reliability threshold level, respectively;
S^*	total long-term operation of the system [hours/year];
TS_1, TS_2	working-time periods of system operation and stop-time periods of the system over a long-time horizon [hours/year], respectively;
TS_3, TS_4	downtime periods for maintenance actions over a long-time horizon and failure-time by faults [hours/year], respectively;
w_c, w_s	system operation profit for the in-service periods system operation costs for stop-time periods over a long-time horizon [mu/hour], respectively; which are quantified in terms of a monetary unit (mu);
w_f, w_m	system operation costs per maintenance action for CM [mu/maint.] and PM [mu/hour], respectively;
α_k	working rate of the system [cycles/year];
δ_k	spent to carry out the k th PM action [hours/maint.]
ϕ_η, ϕ_k	current working-life and mean working-time from the current working-life to the k th PM action, respectively;
φ_k	average probability of a fault occurring from the current working life to the k th PM action [faults/maint.];
τ_k	time spent repairing faults for the k th PM action [hours/fault.];
$\Gamma S_1, \Gamma S_2$	financial profit to the UTO for the in-service periods, and cost covered by the UTO for the stop-time periods [mu/year], respectively;
$\Gamma S_3, \Gamma S_4$	cost covered by the UTO over a long-time horizon [mu/year], for downtime and failure periods, respectively.

SP parameters:

le_i	Equivalent distance for a vehicle which would travel if the vehicle were to travel at a constant speed [m];
v_i	speed of vehicles during the in-service periods [km/h];
$p_{i,j}$	j th passenger travelling from the $(i-1)$ th platform to the i th station;
P^*	total time spent by the passengers receiving service [hours/year];
c	number of vehicles on a transport line [veh/line];
ts_i	required time for a vehicle to travel from the $(i-1)$ th station to the i th station [hours];
TP_1, TP_2	time spent by passengers on the journey and global PWT mean in a queue over a long-time horizon [hours/year], respectively;
w_p, w_t	PWT cost and time benefit for passengers during the journey [mu/hour], respectively;
Lq_i	quantity of users in the queue on the i th platform, over a long-time horizon [pax];
μ_i	number of passengers boarding a vehicle from the i th platform [pax];
$\psi_{i,t}$	instantaneous PWT average at the i th platform;
f_i	frequency of the arriving vehicles at the i th platform [hour ⁻¹];

Tv_i	the demanded time to travel to the i th station from the $(i-1)$ th station [hours];
$\Gamma p_1, \Gamma p_2$	financial benefit for the passengers and PWT cost for passengers during the journeys [mu/year], respectively.
<i>Optimisation parameters:</i>	
α, β	Significance coefficients which are defined by the operation and SPs;
Δp	outcome obtained by the passengers over a long-time horizon [mu/year];
Δs	outcome for the UTO over a long-term operation period [mu/year];
Y_1	operation efficiency ratio over a long-time horizon [--];
Y_2	long-term service efficiency ratio experienced by the passengers [--];
$\chi_{i,j}^*$	combined (operation-service) optimisation function.

2.2. Literature review

There are studies that have considered the time schedule planning to improve the level of service management; thus, we present works focused on UPTS sector. Previous studies (Niu & Zhou, 2013; Barrena, Canca, Coelho, & Laporte, Exact formulations and algorithm for the train scheduling problem with dynamic demand, 2014) minimized the Passenger Waiting Time (PWT) based on the arrival process at stations, which were modeled as uniform and Poisson process. Lee and Vuchic (Lee & Vuchic, 2005) proposed an optimal transit system as a compromise between the minimal travel time and UTO profits, and the minimization of social costs. Parbo et al. (Parbo, Nielsen, & Prato, 2014) dealt with timetable optimisation from the perspective of minimizing the PWT, and they obtained a minimization formulation through a nonconvex nonlinear mixed integer problem. Barrena et al. (Barrena, Canca, Coelho, & Laporte, Single-line rail transit timetabling under dynamic passenger demand, 2014) have focused on a non-periodic timetable that explicitly considers the time-dependent Passenger Demand (PD) to reduce the PWT and traveling times.

Significant researches have been carried out on the efficient management of UTOs and on increasing the level of service as well. Hadas and Shnaiderman (Hadas & Shnaiderman, 2012) presented optimal frequency settings based on supply chain models that integrate costs, stochastic demand, and travel time. Herbon and Hadas (Herbon & Hadas, 2015) attempted to determine the departure frequency and vehicle capacity using the newsvendor model, in which both the passenger and operator costs were considered in the objective function for a given fixed route and under stochastic demand. Afterward, Yin et al. (Yin, Yang, Tang, Gao, & Ran, 2017) proposed a dynamic scheduling of metro trains oriented to PD through an integrated approach to the train the scheduling problem to minimize the operational costs and PWT, obtaining a mixed-integer linear programming problem. Later, Tang et al. (Tang, Yang, & Qi, 2018) proposed an algorithm to optimize the transit schedules of bus lines, with the aim of improving the customer satisfaction in terms of reducing the PWT and the operating costs of buses.

There are some works that have focused on the interaction between maintenance and transport schedules using different levels of integration. Souheil et al. (Souheil, Dellagi, & Rezg, 2012) proposed an optimal plan for a Preventive Maintenance (PM) policy aimed at reducing the machine deterioration while minimizing the total cost (production, inventory and maintenance costs). Giacco et al. (Giacco, D'Ariano, & Pacciarelli, 2014) and Lai et al. (Lai, Fan, & Huang, 2015) worked to improve the integration between railway traffic and maintenance planning. Dollevoet et al. (Dollevoet, Corman, D'Ariano, & Huisman, 2014) and Corman et al. (Corman, D'Ariano, Pacciarelli, & Pranzo, 2012) integrated railways and passenger schedules. Recently, D'Ariano et al. (D'Ariano, Meng, Centulio, & Corman, 2019) dealt with the integration of railway scheduling and maintenance activities using optimisation techniques for some tactical operation issues, and Martinod et al. (Martinod, Bistorin, L., & Rezg, 2019) studied the combined optimisation of operation and Maintenance Policies (MPs) in urban ropeway systems.

All the previous work is addressed to solve to improve just the level of service management or just the operator profit. Our work proposes an integrated solution, which merges the optimisation of operation and the service policy applied to urban ropeway systems.

2.3. Problem formulation

An efficient service should consider the PWT cost, but from the operational point of view, decreasing the PWT cost increases the operating cost over a long-time horizon. UTOs try to maximize their profits, by attempting to increase their revenues and decrease their operation cost, leading to conflicts of interest between the UTO and passengers. These two types of costs are in conflict, any increase to one automatically affects the other. The proposed methodology for addressing the problem is a cost-based model that attempts to balance: the UTO profit and the PWT cost.

We focus on the time criterion to quantify the cost-model, as reducing the travel time can result in other improvements (e.g., widened access to the job market, health care, and education, increased opportunities for leisure activities and political, and civic participation) (Garsous, Suárez-Alemán, & Serebrisky, 2019). The approach recognizes that higher service levels reduce the PWT in the system, and the methodology strikes a balance between the profit from transport operation and the PWT. Chapter 2 focuses on the cause-effect relationship between the service level and operational policies, which is developed in the context of the time cost for the combined efficiency of: (i) the operation of the system by UTOs and (ii) the service from the point of view of the passengers.

Section 2.4 and section 2.5 describe the problem by analyzing the characteristics of each policy separately: the operation plan of the UPTS and quality level of the service, as follows.

2.4. Operation plan for urban public transport systems

The operation of the system can be quantified by the classification of the different working periods (Ortega, Pozo, & Puerto, 2018): (i) a period of time in which the system is in-service to the passengers, it is defined as the working-time, TS_1 , and produces the UTO profit; and (ii) the dead time periods of system operation in which the system is out-of-service to the passengers and costs are being generated for the UTO: (a) stop-time, when the system is closed because the time is outside of the service period, TS_2 ; (b) downtime due to maintenance actions, TS_3 ; and, (c) downtime due to faults in the system, TS_4 ; and, (d) the total long-term operation of the system can be expressed as $S^* = \sum_n TS_n - \sum_{n,m}(TS_n \cap TS_m)$, $\forall n \in \{1, \dots, 4\}$ and $\forall m \in \{(n+1), \dots, 4\}$ (see Figure 2.1). In this section, the operation plan of a UPTS is developed by analyzing the working periods separately as follows.

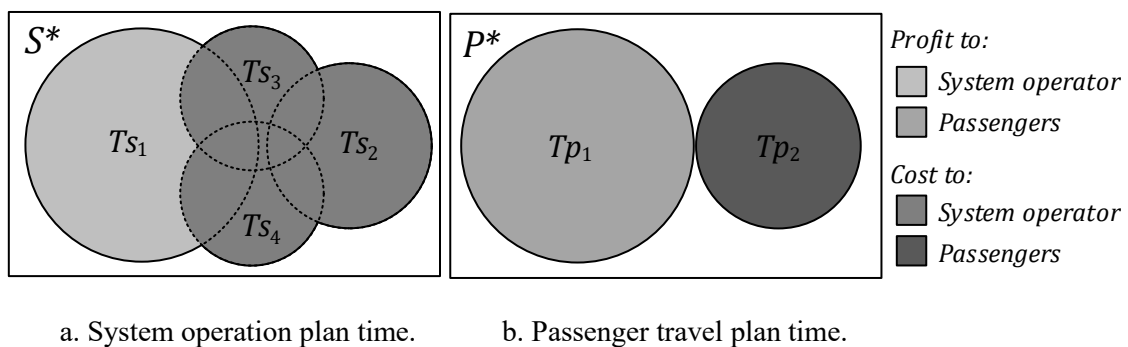

Figure 2.1. Time relationship for UTOs and passengers.

2.4.1. Working-time periods

The real time periods that the transport service is available to the passengers, TS_1 , indicates the periods in which the system produces a profit for the UTO and provides a social benefit for the community as well. TS_1 is defined by the authorities and specified by formal contracts that commit the UTOs. These contracts define the operational, financial and technical requirements to be fulfilled by the UTOs and sanctions in case of noncompliance. The UTO profit, w_c , is also

specified in these contracts, which is expressed as a cost value in the monetary unit (mu) over a working time [mu/hour].

The w_c value can be defined using different payment mechanisms to the UTO (Canitez, Alpkokin, J.A., & Black, 2019): (i) the gross-cost is used in contracts that specify the payment of a lump sum amount to the UTO, where the payments are made in terms of passengers per kilometer, occupied places per vehicle, service hour per transport line or a combination of these; (ii) net-cost contracts require the payment of a flat-rate sum subsidy plus the receipts from ticket revenues, and (iii) performance-based contracts require the calculation of the payments to UTOs according to quality incentives, such as punctuality, customer satisfaction or patronage. The cost-based model to quantify the financial outcome for the in-service periods is expressed as follows:

$$\Gamma s_1 = T s_1 w_c. \quad (2.1)$$

2.4.2. Stop-time periods

The period of time in which the system is closed because it is out-hour of service is denoted by $T s_2$. The cost-based model to quantify the stop-time cost is expressed as

$$\Gamma s_2 = T s_2 w_s \quad (2.2)$$

where w_s [mu/hour] represents the cost covered for the UTO per time unit during the stop-time.

2.4.3. Downtime periods due to preventive maintenance

PM has been introduced to minimize the effect of unscheduled breakdown time and is implemented in a planned manner to improve the reliability level, R . Imperfect PM is widely applied in the engineering field and has been adopted mainly by UTOs (Liu et al., 2017; Qiu et al., 2017). Our work focuses on imperfect PM because it is the most worldwide used by UTOs. After each PM action, the system is restored to a lower level than the nominal state of its components, i.e., over a long-time horizon, η , the components will wear out.

UTOs can adopt different MPs regarding the repair actions, but considering a long-time horizon, a series of repair actions does not avoid the effects of the wearing out of the components in the system (Martinod et al., 2018). This work considers two PM policies:

- (i) Periodic block-type maintenance is carried out periodically using maintenance actions over the long-term for the life of the system (e.g., maintenance/year). This policy accounts for a long-time horizon with a piecewise linear time distribution and an even frequency of maintenance actions, N_k (Khatab, et al., 2013; Martinod et al., 2018), see Figure 2.2(a).
- (ii) Age-based maintenance is carried out as the reliability indices of the components reach a predetermined level, i.e., the system undergoes PM whenever the $R(\eta)$ value reaches a given threshold level, R_{TS} , and the period of time between the PM actions are defined by the working cycle range, A_k (Alaswad et al., 2017; Martinod et al., 2019); see Figure 2.2(b).

Proposition 2.1. *The cost-based model to quantify the downtime cost is expressed as*

$$\Gamma s_3 = T s_3 w_m \quad (2.3)$$

where w_m [mu/hour] represents the cost covered by the UTO per time unit during the downtime.

Proof 2.1. Consider a periodic block-type MP, the downtime periods for maintenance actions over a long-time horizon are

$$\sum_k N_k \delta_k \quad (2.4)$$

where δ_k [hour/maint.] quantifies the spent time to carry out the k th PM. Again, if the age-based MP is considered, the downtime periods are

$$\sum_k A_k^{-1} \alpha_k \delta_k . \quad (2.5)$$

where α_k [cycles/year] is the working rate of the system. Taking Eqs. (2.4) and (2.5), it is possible to express

$$Ts_3 = \begin{cases} \sum_k N_k \delta_k & ; \text{ for periodic block type MP} \\ \sum_k A_k^{-1} \alpha_k \delta_k & ; \text{ for age based MP} \end{cases} \quad (2.6)$$

thus, the cost covered by the UTO over a long-time horizon, η , for the downtime due to PM actions has been proved. ■

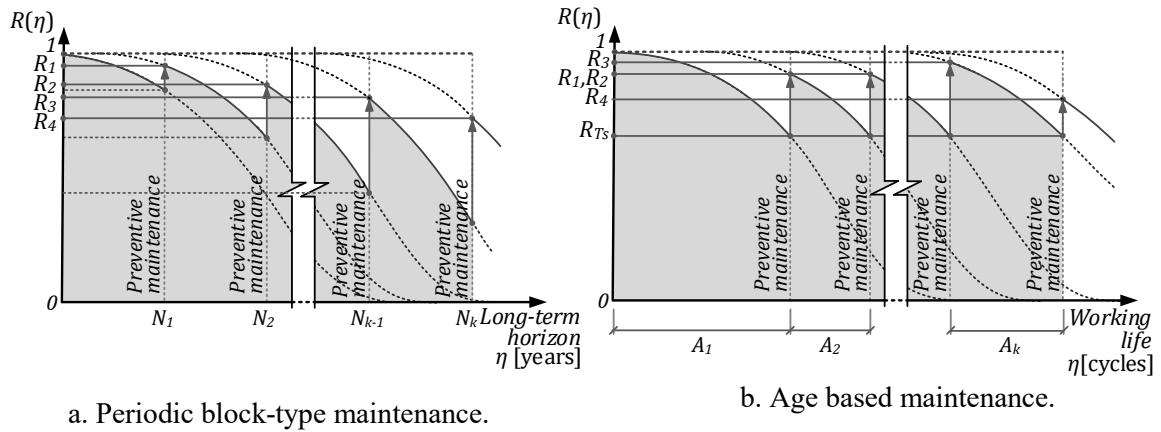

Figure 2.2. Preventive MP.

Assertion 2.1. The type-block MP is most suitable for UPTSs in the early stages of life for urban aerial ropeway systems (Martinod, Bistorin, L., & Rezg, 2019); thus, our work uses this maintenance type for next analyzes.

2.4.4. Breakdown time due to faults

The repair actions for a failed component are carried out between the scheduled PM actions (Yin, Yang, Tang, Gao, & Ran, 2017); i.e., within the working cycle range, A_k (see Figure 2.3). In addition, the repair actions have a cost associated with the system failure, w_f [mu/hour]. The breakdown cost for Corrective Maintenance (CM) is covered by the UTO.

Proposition 2.2. The cost-based model to quantify the breakdown time is expressed as

$$\Gamma s_4 = Ts_4 w_f . \quad (2.7)$$

Proof 2.2. By definition, the fault probability in the working life range A_k is $P(\phi_\eta \leq \eta \leq N_k)$, which is quantified from the area of the fault distribution, $\int_{\phi_\eta}^{N_k} f(\eta)$; thus, the cumulative probability function is defined as

$$P(\phi_\eta \leq \eta \leq N_n) = \int_{\phi_\eta}^{N_k} f(\eta) = F(\eta) ; \quad (2.8)$$

moreover, the mean value of the cumulative fault function, $F(\phi_k)$, can be expressed by the average probability value of fault within PM actions, φ_k [faults/maint.] (Martinod, Bistorin, L., & Rezg, 2019)

$$F(\phi_k) = \varphi_k, \quad (2.9)$$

with $\phi_k = (\phi_\eta + N_n)/2$. In addition, the probability of breakdown time caused by faults, TS_4 , over a long-time horizon relies on the sum of the PM actions and its average probability of fault, as following

$$TS_4 = \sum_k N_k \varphi_k \tau_k, \quad (2.10)$$

where τ_k [hours/fault.] represents the time spent repairing faults; thus, the formulation for TS_4 , the breakdown time, has been proven. ■

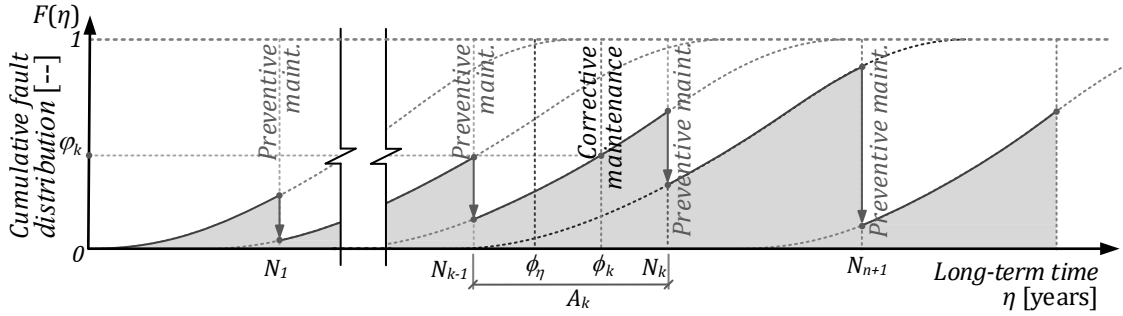

Figure 2.3. Corrective MP.

2.5. Service level management

The travel time of passengers is an effective factor for measuring transport performance in terms of the efficiency of the service quality management. The travel time varies according to the operating conditions and is influenced by a number of factors that contribute to congestion (Song & Wei, 2018). The service quality can be assessed by classifying the time spent by the passengers during the travel time, i.e., Tp_1 and Tp_2 . The total time spent by the passengers over a long-time horizon can be expressed as $P^* = \sum_i Tp_i$ (see Figure 2.1(b)). In this section, we develop the formulation for the service management quality as follows.

2.5.1. Passenger travel time model

The travel time is defined as the real time in displacement and has been increasingly recognized as an important measure for assessing the operational efficiency of transport facilities (Rojo, Gonzalo-Orden, Dell'Olio, & Ibeas, 2012). Accordingly, when the travel time is affected, travelers spend more time on their trips to reduce the possibility of arriving late at their destination. An adequate travel time means that this extra time could be reduced or avoided altogether, which is a clear benefit for the passengers (Torrise, Ignaccolo, & Inturri, 2017).

Proposition 2.3. *The cost-based model to quantify the travel time is*

$$\Gamma p_1 = Tp_1 w_t, \quad (2.11)$$

where w_t [mu/hour] represents the time benefit for the displacement of passengers.

Proof 2.3. Consider an equivalent distance, le_i , that the vehicle would travel if the vehicle was traveling at a constant speed, v_i , through the i th station; and consider the required time for a vehicle, ts_i , to travel from the $(i-1)$ th station to the i th station. Therefore, the total required time to travel between the i th station and the $(i-1)$ th station is expressed as

$$Tv_i = le_i v_i^{-1} + ts_i. \quad (2.12)$$

The time spent by the passengers during the travel can be expressed as

$$Tp_1 = \sum_{i,j} p_{i,j} Tv_i, \quad (2.13)$$

with $p_{i,j} = \{0,1\}$, where $p_{i,j} = 1$ with $j \in i$, i.e., if the j th passenger travels from the $(i-1)$ th station to the i th station; but, if that is not the case, $p_{i,j} = 0$ with $j \notin i$. The value Tp_1 equals to the total time of the passengers who travel between the i th and $(i-1)$ th stations to arrive at their destination; thus, the proposition is proved. ■

Assertion 2.3. The w_t value constitutes a penalty cost to the UTO. The methodologies to quantify the penalty costs are directly defined by the operation managers of the UPTS. Each operation manager uses different criteria to quantify the penalty cost according to their SP.

2.5.2. Passenger waiting time model

A characteristic of transportation mainlines (e.g., long-distance trains, high-speed railways, airlines) is that passengers make their trip plans according to the given transport timetable, and the passenger is attentive to the vehicle schedule (Yin, Yang, Tang, Gao, & Ran, 2017). However, the assessment of the PWT in an urban transport mode (e.g., bus, metro, ropeway systems) is directly subject to the complex passenger flow characteristics over a day-long planning horizon. Passengers in an UPTS do not usually consider the transport timetable before their trips, leading to the evident dynamic (or time-variant) features of PD (Freys, Giesen, & Munoz, 2013; Yang, Li, Gao, & Gao, 2015; Gu, Cassidy, & Li, 2015). The SP for urban transport must correspond to the PD of the system, which must naturally take account of the variations for PD (Amirgholy & Gonzales, 2016).

The theory of the compound Poisson process is introduced as the principal model to address the targeted queueing problem in UPTSs (Niu & Zhou, 2013; Barrena, Canca, Coelho, & Laporte, Exact formulations and algorithm for the train scheduling problem with dynamic demand, 2014; Xu, Liu, H.Y., & Hu, 2014; Wang, Tang, Ning, van den Boomb, & de Schutterb, 2015; Nesheli, Ceder, & Liu, 2015). In this work, the theory of the compound Poisson process is used to establish the stochastic process of the PD on platforms. To formulate the mathematical models for the cost of an urban transport service, this work is supported by the following context and assumptions:

Assumption 2.1. The UPTS is characterized by nondeterministic batch arrivals and bulk service patterns.

Assumption 2.2. If the capacity of an urban transport mode is less than the number of passengers queuing, the UTO will leave behind some passengers (Kahraman & Gosavi, 2011). The system has a limited capacity to serve users, and the PD rate may exceed the capacity of an urban transport mode in some time periods, which leads to the undesirable consequences of a PD rate that is higher than the capacity of the system.

Proposition 2.4. *The cost-based model to quantify the penalty cost for the PWT global is*

$$\Gamma p_2 = Tp_2 w_p, \quad (2.14)$$

where w_p [mu/hour] represents the PWT cost.

Proof 2.4. Given an instantaneous PWT mean at the i th platform, $\psi_{i,t}$, which is defined by the boarding rate, and it is described as the ratio of the number of users in the queue, $Lq_{i,t}$, with the number of passengers boarding the vehicle, $\mu_{i,t}$, and are both affected by the frequency of the vehicles in service over time t (Martinod, Bistorin, L., & Rezg, 2019); i.e.,

$$\psi_{i,t} = \frac{1}{f_i} \frac{Lq_{i,t}}{\mu_{i,t}}. \quad (2.15)$$

By definition, the frequency of vehicles, f_i , relies on the speed of vehicles, v_i , and the number of vehicles in service, q , i.e.,

$$f_i = v_i q, \quad (2.16)$$

then, taking Eqs. (2.15) and (2.16) and summing the instantaneous PWT mean (sum the values at every instant time for every platform), we obtain the general formulation for the mean PWT, which is expressed as

$$Tp_2 = q^{-1} \sum_i (v_i^{-1} \sum_t \psi_{i,t}). \quad (2.17)$$

The value Tp_2 equals to the global PWT ; thus, the proposition is proved. ■

Assertion 2.5. The w_p value represents another penalty cost for the UTO, and the methodology to quantify it is defined by the transport operation manager.

2.6. Optimisation process

The outcome obtained by the UTO over a long time period of system operation is expressed as $\Delta s = \Gamma s_1 - \sum_m \Gamma s_m, \forall m \in \{2,3,4\}$. It is possible to define the ratio value to assess the operation efficiency over a long-term horizon as

$$Y_1 = \Gamma s_1 (\sum_m \Gamma s_m)^{-1}, \forall m \in \{2,3,4\}. \quad (2.18)$$

Likewise, the outcome obtained by the passengers over a long time period of travel is expressed as $\Delta p = \Gamma p_1 - \Gamma p_2$, and the ratio to assess the long-term efficiency of the level of service quality is expressed as

$$Y_2 = \Gamma p_1 \Gamma p_2^{-1}, \quad (2.19)$$

This work introduces a stochastic optimisation model to simultaneously develop a cost-efficient service and operation plan. The decision variables are: (i) the service rate expressed in terms of the vehicle speeds v_i ; and (ii) the periodicity of the PM actions, N_k and A_k , for periodic block-type and age-based MP, respectively. The optimal operation plan is obtained by minimizing the expected penalty cost for the PWT and the cost of maintenance activities. From that point, the proposed model merges the operation and SPs. The maintenance cost increases as the service level increases (i.e., decreasing the PWT cost). Formally, the problem of long-term sustainability (i.e., considering the progressive deterioration of the UPTS) is solved through a cost-based optimisation, $\chi_{i,j}^*$, which is based on a merged model for transport operation and service management. $\chi_{i,j}^*$ is made up of the maintenance cost ratio, $Y_1 = f(\Gamma s_m)$, and the PWT cost ratio, $Y_2 = f(\Gamma p_m)$, as follows:

$$\chi_{i,j}^* = \max_{\omega} (\alpha Y_1 + \beta Y_2), \quad (2.20)$$

where $\alpha, \beta \in [0, \dots, 1]$ represent the significance coefficients that are defined by the operation and SPs, with $\alpha = 1 - \beta$. The optimisation model is subject to the following constraints

$$0 \leq \psi_{i,t}, \quad \forall i, t \quad (2.20.a)$$

$$0 \leq \mu_{i,t} \leq Lq_i, \quad \forall i, t \quad (2.20.b)$$

$$s_{inf} \leq v_i \leq s_{sup}, \quad (2.20.c)$$

$$q_{inf} \leq q_i \leq q_{sup}, \quad (2.20.d)$$

$$R_{Ts} \leq R(\eta) \leq 1, \quad (2.20.e)$$

$$0 < \tau, N_k, A_k; \quad (2.20.f)$$

where:

- Eq. (2.20.a) is related to the SP, where $\psi_{i,t}$ is the upper limit of the PWT global in the queue;
- Eq. (2.20.b) indicates that the number of passengers boarding the vehicle, $\mu_{i,t}$, which must be less than or equal to the number of passengers queuing, Lq_i .
- Eq. (2.20.c) is related to an operating condition; namely, the speed of the vehicles, v_i , is limited by a range $[s_{inf}, s_{sup}]$;
- Eq. (2.20.d) refers to other operating condition, namely, that the system must have a range of vehicles in active service (density of vehicles) $[q_{inf}, q_{sup}]$;
- Eq. (2.20.e) is related to MPs, where R_{Ts} is the lower limit of the global reliability of the system;
- Eq. (2.20.f) expresses that a period of time must exist between PM actions.

Remark 2.1. If the values of the significance coefficients are $\alpha = 1$ and $\beta = 0$, then the operation policy has all of the focus, and the SP is not considered; thus, all the benefit will be directed to the UTO. Otherwise, if $\alpha = 0$ and $\beta = 1$, the SP is extremely relevant and the operation policy is not considered; thus, the all the benefit will be in favor of the passengers.

2.7. Study Object: an urban aerial ropeway system

To respond to the challenges of growth and mobility, UTOs have considered alternatives to conventional modes of urban transport, including aerial ropeway systems, which led to improvements in (Heinrichs & Bernet, 2014; Bocarejo, et al., 2014): (i) urban integration and neighborhood upgrading; (ii) accessibility and safety, (iii) quality of life; (iv) employment opportunities, and (v) perceived pollution. Garsous et al. (Garsous, Suárez-Alemán, & Serebrisky, 2019) estimates that travel by ropeway systems cuts commuting times over other transport modes, which translates into a daily reduction in travel time and an average net benefit per commute. The effect holds across the commuting time distribution.

Currently, ropeway systems are becoming a popular transport mode and a logical choice for their ability to efficiently move passengers from the tops of hilly metropolitan areas to lower-lying areas. A significant number of urban ropeway installations worldwide have been used as parts of the UPTS in larger cities (Bocarejo, et al., 2014; Heinrichs & Bernet, 2014; Težak, Sever, & Lep, 2016), including, for example: in North America, New York (USA), Portland (USA), Roosevelt Island (USA) and Mexico D.F. (Mx); in South America, Rio de Janeiro (Br), Medellín (Co), Cali (Co), Manizales (Co), Caracas (Ve) and La Paz (Bo); in Europe, Nizhny Novgorod Bor (Ru); in Asia, Taipei Maokong (Tw), Hong Kong and Ankara (Tr); and in Africa, Constantine (Dz).

The study object comprises a fleet of aerial ropeway vehicles guided by gondola-type aerial cable on a continuous cycle (Estepa, et al., 2014), operating in the city of Medellín (Co) since 2004 as a UPTS facility, see Fig. 4. The ropeway operates for 20 hours a day, 7 days a week and 360 days a year (Martinod, et al., Journey safety assessment to urban aerial ropeways transport systems based on continuous inspection during operation, 2015); therefore, the system has extremely high operation levels and requires a highly elevated SP (Hoffmann, 2006; Martinod, Bistorin, Castañeda, & Rezg, 2018). Appendix A (Table A.2) shows the overall technical characteristics of the study object.

A set of field measurements were taken to establish the flow of passengers using the system during a typical working day. The set of measures was supported by the UTO, which were a part of an analysis to quantify the PD for the system transport. The analysis covered a wide range of different days from 4a.m. to 11p.m. to define the PD behavior. Therefore, the typical PD for the system transport service was characterized in terms of passengers per hour. Over a typical working day, the PD has large fluctuations, and it is possible to distinguish that the morning rush

hour is from 5 a.m. to 9 a.m., while the evening rush hour is from 5 p.m. to 8 p.m. (see Appendix B, Figure B.3).

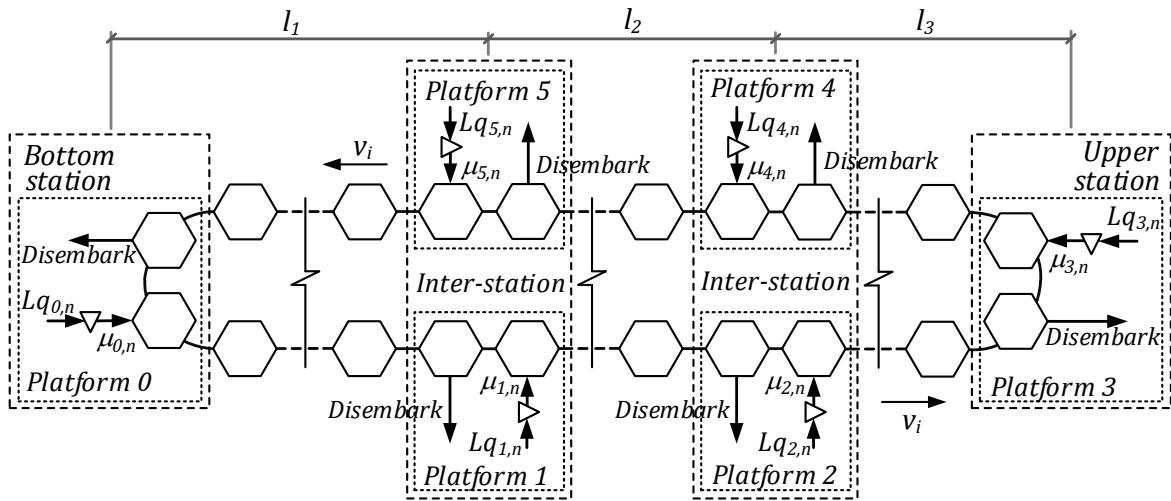

Figure 2.4. General diagram of an urban ropeway (*télécabine*) system.

Remark 2.2. This field measurements are regularly performed by the UTO to quantify the PD of the system, since the urban ropeway provides commercial service; thus, UTOs have identified a stable PD profile because of the population of this zone in the city is quite constant, and moreover, there is not a direct UPTS competition in the influence area with respect to others transport modes.

The stochastic simulation was developed in a virtual environment using a programming language. The PD values are the input data for the simulation, which are defined as a set of variables with a stochastic Poisson distribution (see the Appendix B, Figure B.3). The simulation outputs the number of disembarking passengers from the vehicles, which is compared to the measured number of disembarking passengers (see Appendix B, Figure B.4); then, the stochastic simulations are validated according to two criteria: (i) the data correlation values, R_i^2 , between the measured data from the UPTS and the output data from the simulations, the values of which are $R_i^2 = \{0.991, 0.969, 0.966, 0.981, 0.970, 0.991\}$, where each value corresponds to the i th platform; and (ii) the deviation error, E_i , which has values of $E_i = \{3.614, 5.755, 5.065, 4.955, 4.740, 2.551\}\%$, where each value also corresponds to the i th platform.

In addition, the stochastic simulations are subjected to a convergence analysis to achieve more precise and stable results. A minimal correlation threshold is defined ($R_i^2 \geq 0.995$) as an acceptable level of accuracy for this study, and a set of correlation calculations is performed based on the increasing iterations over the stochastic simulations; thus, we find that at least 5 iterations are required to reach the correlation threshold (see Figure 2.5). Using the same approach, a maximal error threshold is defined ($E_i \leq 1\%$) as an acceptable level of deviation, and we find that at least 31 iterations are required to reach the error threshold. Therefore, to fulfil the convergence requirement, a total of 31 simulation iterations are required for each analysis.

Remark 2.3. Note that the $R_i^2 \geq 0.995$ and $E_i \leq 1.0\%$ results represent an acceptable level for the scope of this work.

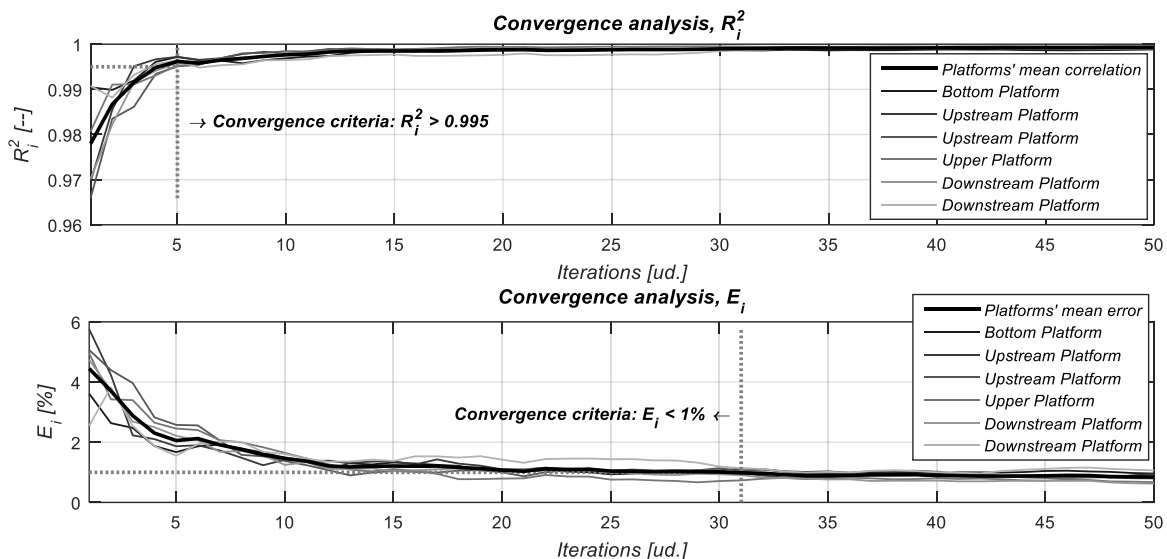

Figure 2.5. Convergence test results.

2.8. Results and discussion

We show the results and analysis by discussing each stage of the optimisation process:

2.8.1. Operation time costs

The maintenance actions is computed in three steps: (i) the functions $f(\eta)$, $F(\eta)$, and $R(\eta)$, are calculated to obtain the progressive deterioration of the components when working under the operation conditions, which considers just the CM actions, which means that a reactive MP is applied, without PM actions; (ii) the effect of the imperfect maintenance action is calculated, varying N_k ; and (iii) the deterioration of each component is found by the superposition principle, to get the merged maintenance cost due to CM and PM actions. Ropeway transport operators use to carry out a fixed schedule following the linearly spaced periods (i.e., a periodic block-type MP), then, we are focused on the results of this maintenance policy.

Figure 2.6 shows the performance of $F(\eta)$ and $R(\eta)$, based on analyzing the periodic block-type maintenance over a long time period that is equivalent to $\eta = [0, \dots, 5][\text{years}]$. If increases the frequency of the PM action, the reliability function of the ropeway system increases and the corrective actions decrease; but the PM cost increase as well.

The cost-based model for the operation policy was estimated considering the CM and PM actions (see Figure 2.7(a)). The CM cost increases substantially as the number of PM actions decreases. see Figure 2.7(b) shows the non-linear behavior of the operation efficiency ratio, Y_1 , which is clearly non-linear, but has a creased tendency regarding the frequency of maintenance actions.

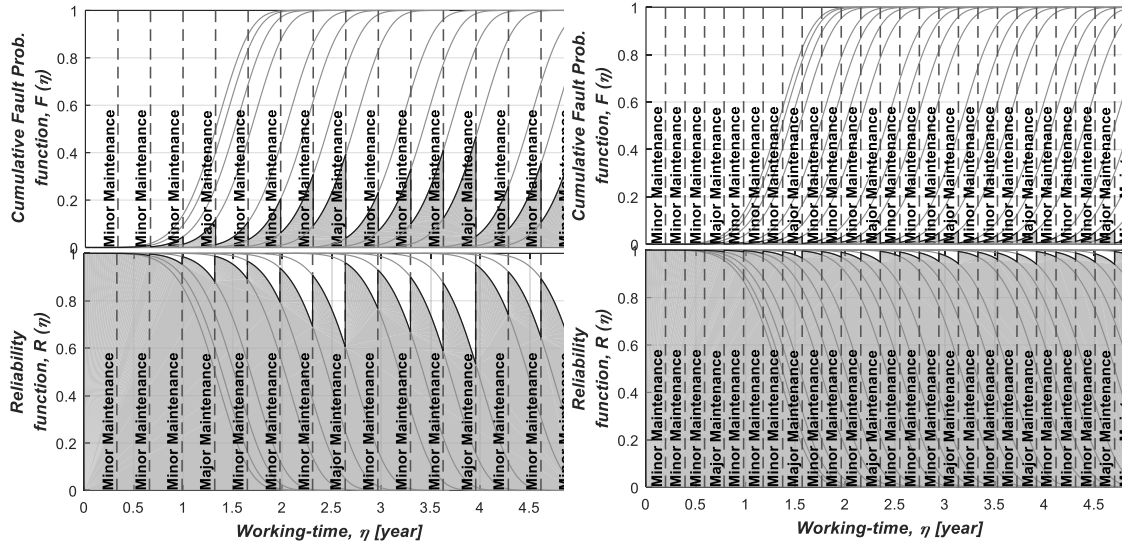

a. Three maintenances actions per year.

b. Five maintenances actions per year

Figure 2.6. Reliability functions for periodic block-type MP.

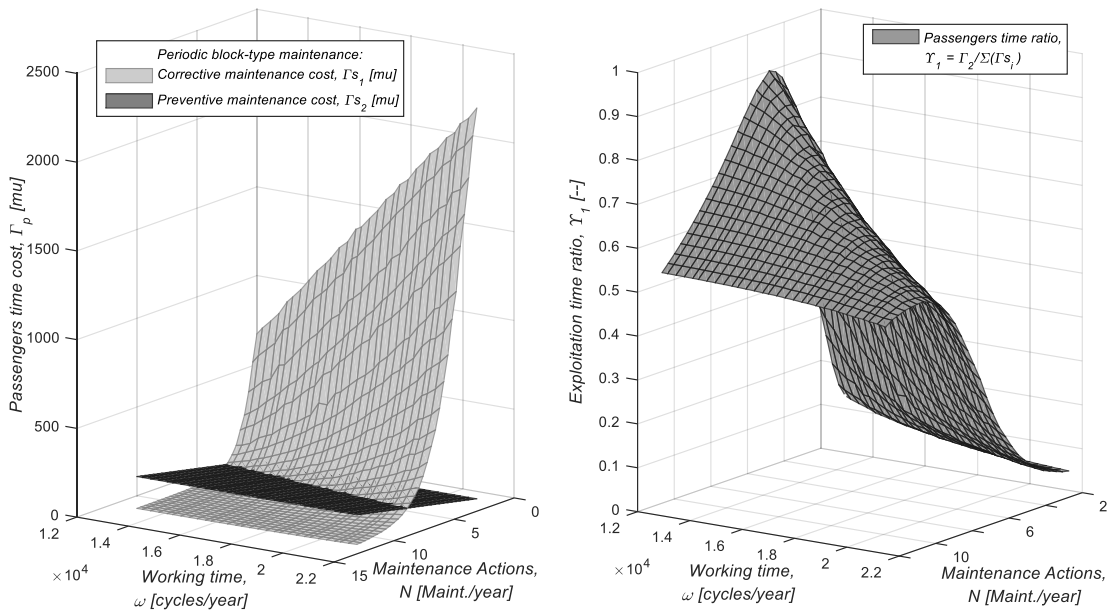

a. PM and CM actions based on periodic block-type MP.

b. Operation efficiency ratio, τ_1 .

Figure 2.7. Cost-based model for the operation policy.

2.8.2. Passenger time costs

UTOs periodically perform a set of measurements for the PD behavior to assess the passenger flow through the UPTS. Based on a set of metrics (see Appendix B, Figure B.4), it is possible to estimate the typical service demand during a working day. Figure 2.8(a) shows the queuing behavior of passengers on the platforms for three different operational vehicles speeds, $v_i = \{3,4,5\}$ [m/s], which represents the lowest, average and highest permissible speeds for the operation of the ropeway system. Figure 2.8(b) shows the global PWT mean. The PWT value substantially increases if the operational vehicle speed decreases, e.g., when the vehicle speed

decreases by a factor equivalent to 0.4, the PWT value increases by an incremental factor of 140. Therefore, the PWT variation is highly dependent on the vehicle speed parameter.

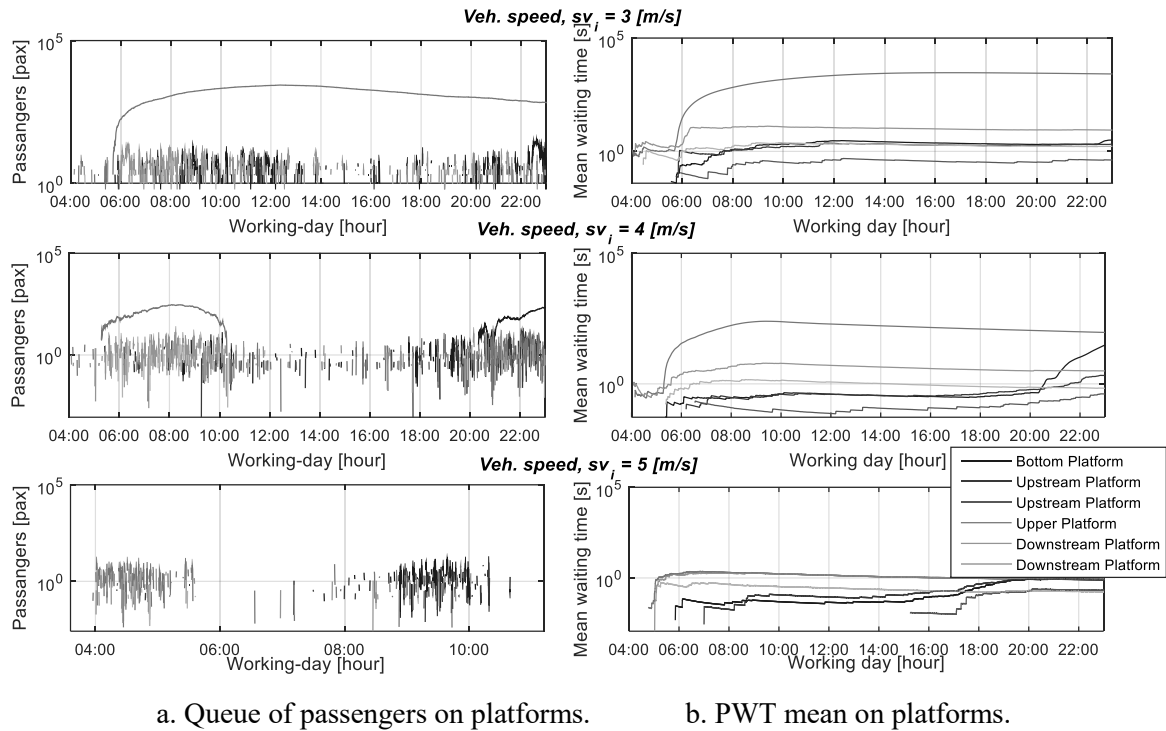

Figure 2.8. Queuing behavior on the platforms at different transport service speeds.

Figure 2.9 shows the typical PWT mean for different operational vehicle speeds and shows that when the vehicle speed is lower than 4[m/s], PWT tends to be zero, but when the speed of the vehicles is greater than 4[m/s], PWT tends to increase considerably. Figure 2.10(a) shows the passenger time costs, which depend on the working time. In this case study, the passenger travel time is not affected by the maintenance actions since the travel time between stations is a fixed parameter set by the ropeway operator because it is the stabilized value given by its SP. Figure 2.10(b) shows the non-linear behavior of Y_2 , which indicates that if the working life of the system is lower than $\omega = 1.8E4$ [cycles/year], the service level ratio increases dramatically.

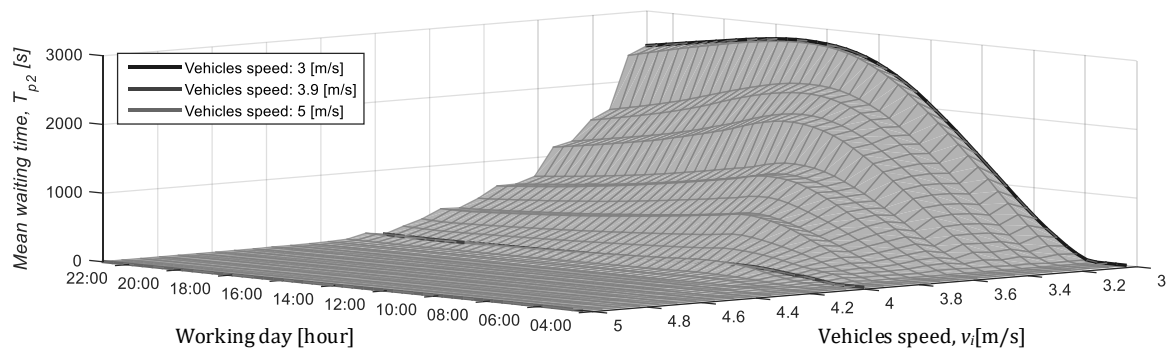

Figure 2.9. PWT global mean, T_{p2} , at different transport service speeds.

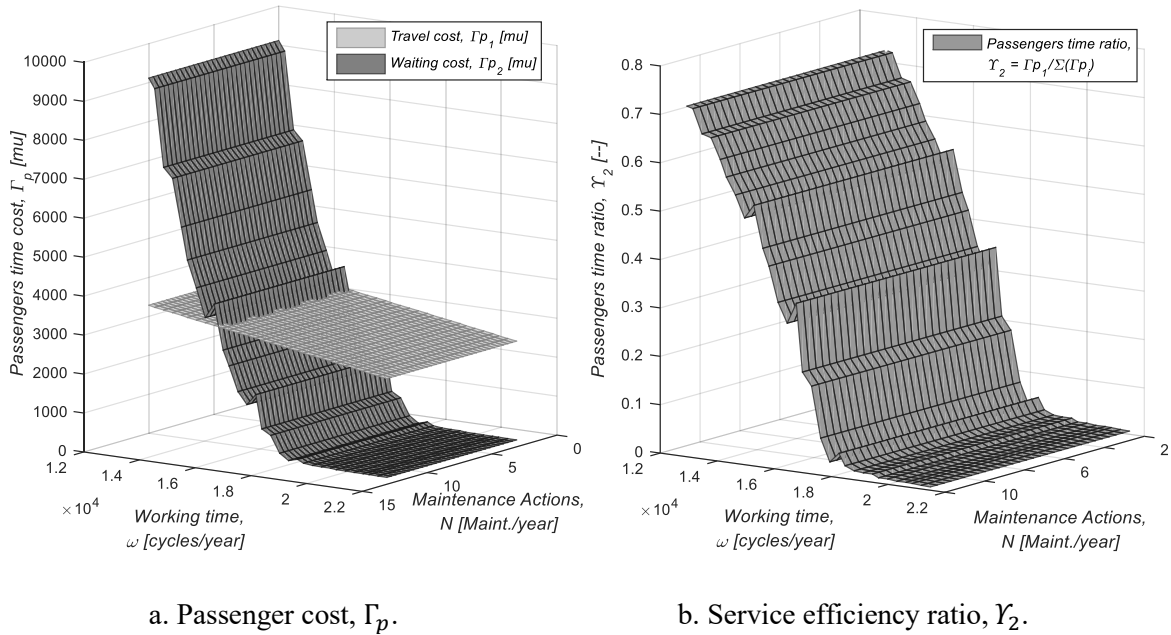

Figure 2.10. Cost-based model for the SP.

2.8.3. Optimisation results

The objective function value, $\chi_{i,n}$, is evaluated with a set of combinatorial values for the significance coefficients, i.e., $(\alpha, \beta) = \{(0, 1), (0.2, 0.8), (0.4, 0.6), (0.6, 0.4), (0.8, 0.2), (1, 0)\}$ (see Figure 2.11) to assess the different possible configurations between the operation and SPs. Each surface is a combinatorial value for the significance coefficients in function of the lifetime of the ropeway system and the frequency of maintenance actions.

Figure 2.12 shows the functions for $\chi_{i,j}^*$, i.e., the optimum values over the working cycles during a long time period (5 years) indicate an increase in the maintenance frequency according to the deterioration of the system. Moreover, Figure 2.12 shows that the proposed study object has a particular behavior because the $\chi_{i,j}^*$ functions are strongly stable relative to the α and β values, which means that the periodic block-type maintenance is not affected by the different focuses for UTOs to establish the operation and SPs. UTOs may consider implementing a service-oriented operation for the benefits of passengers ($\alpha < \beta$) or a financial/profit-oriented operation ($\alpha > \beta$), but the maintenance policy must be established as a function of the system deterioration. Only in the event that the UTO establishes an operation policy in which only the economic profit is considered and the service issue is disregarded ($\alpha = 1, \beta = 0$) will the MP vary.

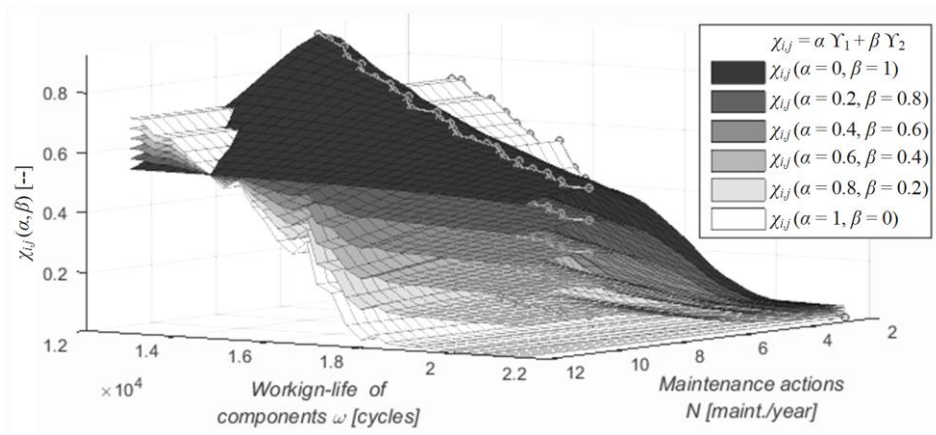

Figure 2.11. Behavior of χ_{ij} for different significance coefficients, α and β .

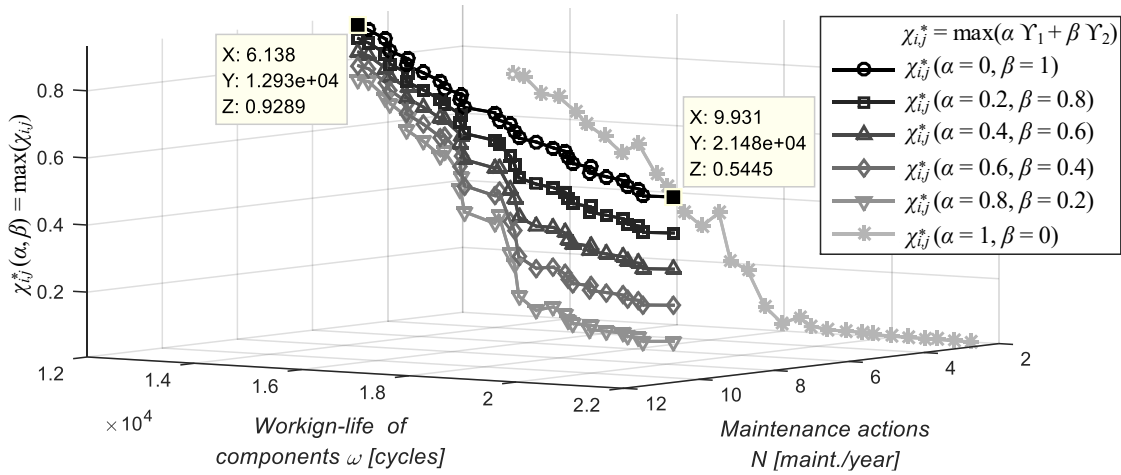

Figure 2.12. Behavior of $\max(\chi_{i,j})$ for different significance coefficients, α and β .

2.9. Conclusions and perspectives

This chapter optimizes the operations and service policies, applied to urban ropeway systems by means a stochastic model that synthesises in an integrated perspective to improve the operation management cost for UPTSSs.

This chapter provides strong support to the concept that the long-term sustainability for operation of UPTSSs must be a combined optimisation methodology for the operation planning and SPs. Therefore, the current operation strategies should be reconsidered to improve the service and maintenance activities.

This chapter developed a mathematical framework for cost-model formulation to rise the exploitation strategy levels according the service and maintenance activities. In the first stage of our work, a mathematical cost-model of the operation policy was proposed to determine the profit values from the different working periods: (i) working-time, Ts_1 ; (ii) stop-time, Ts_2 (iii) downtime, Ts_3 , and (iv) breakdown time, Ts_4 . Furthermore, in our research, the operation efficiency ratio over the long-term horizon, Y_1 , was considered as a term in the optimisation model for cost, $\chi_{i,j}$. In a later stage of our research, this work developed stochastic processes that consider the uncertainty of the passenger arrival times at platforms to assess the time spent according to the passengers' travel plans, Tp_1 and Tp_2 . Through our analysis, the SP model completes the cost-based optimisation function, $\chi_{i,j}$, to bring together the operation and SPs, thus making it possible to determine the optimal cost function, $\chi_{i,j}^*$, which maximizes the outcome over the working-life of the system.

This chapter shows that considering the early stages of the study object (a fleet of aerial ropeway vehicles operating in Medellin city), the appropriated maintenance action frequency is $N_k = 6$ [maint./year], and this frequency gradually increases to $N_k = 10$ [maint./year] over working 5 years, obtaining a win-win compromise between the UTO income and the passenger benefit.

Future research will focus on two major aspects. The first aspect is related to the perspective of urban mobility. Changes in mobility using different transport modes increase the requirements of transport integration because in many urban contexts, the geographical and topographical barriers, such as mountains, valleys and bodies of water, and the very large infrastructure costs associated with overcoming these barriers may not allow for the implementation of a single transport mode for such areas. In such cases, transport managers may offer different modes of travel to serve the needs of residents in geographically constrained areas. Further analysis of the intermodal urban transport can be undertaken to tackle the requirements of transport network integration. This calls for a stochastic process to consider the interdependencies of the PD in intermodal UPTSSs. The second aspect is focused on a study which would broaden different SPs

according to the annual seasons. The present work has only considered a single SP because the study object is a fleet of aerial ropeway vehicles operating in the city of Medellin (Co); therefore, the seasonal impacts on the operation of this UPTS is not significant because this region has only two non-intense seasons (rainy season and dry season).

This chapter has been focused on a fleet of aerial ropeway vehicles operating in Medellin city, which has fitted with Poisson distribution, further research can enhance the model for other distributions for others urban transport modes.

UPTSs have strong PD asymmetries (e.g., on morning, people go from residential areas to working and educative areas, generating congestion at one transport line direction while the other one is almost empty), this work optimize the PWT, i.e., reduces the undesirable consequence. But, this chapter does not tackle the causes. Such a case is relevant for solving queues.

Chapter 3:

Maintenance policy optimisation for multi-component systems considering degradation of components and imperfect maintenance actions

Authors: R.M. Martinod, O. Bistorin, L.F. Castañeda, N. Rezg
Original title: Maintenance policy optimisation for multi-component systems considering degradation of components and imperfect maintenance actions
Journal: Computers & Industrial Engineering, 124, 100–112
Publication date: October 2018
DOI: <https://doi.org/10.1016/j.cie.2018.07.019>

Classification according to SCImago Journal Rank (SJR)

Sub-categories: Engineering (Q1) – Computer Science (Q1)

H-index(2018): 103

JIF(2018): 3.518

SJR(2018): 1,463

CS (CiteScore): 6,6

SNIP: 0,280

Abstract

This chapter proposes a stochastic optimisation model in order to reduce the long-term total maintenance cost of complex systems. The proposed work is based on the following approaches: (i) optimisation of a cost model for complex multi-component systems consisting of preventive and corrective maintenance using reliability analysis, which faces two different maintenance policies (periodic block-type and age-based) and (ii) a clustering method for maintenance actions to decrease the total maintenance cost of the complex system. This work evaluates each maintenance policy and measures the effects on imperfect maintenance actions. Finally, the proposed optimisation model is applied to a numerical example which focuses on passenger urban aerial ropeway transport systems, in which the current maintenance policy has been evaluated, considering the established by the international regulation of passenger aerial cable cars.

3.1. Introduction

Traditional optimisation models based on maintenance of complex systems have been considered as a collection of independent components (Cho & Parlar, 1991; Chelbi & Aït-Kadi, 2001; Yang, Ma, Peng, Zhai, & Zhao, 2017); nevertheless, taking account the complexities involved in engineering systems and the need to improve the maintenance activities, it is no longer sensible to treat each component in such systems as an individual component (Cheng, Zhou, & Li, 2017). The maintenance resources of an engineering system –production and service as well– can be reduced if a set of components are repaired using only one type of maintenance action (Peng & Zhu, 2017).

There are models (Gustavsson, Patriksson, Strömberg, Wojciechowski, & Önnheim, 2014; Briš & Byczanski, Effective computing algorithm for maintenance optimization of highly reliable system, 2013) based on dependencies between the components in a complex system; these

dependencies lead to further problems to understand the behaviour of the system (Briš, Byczanski, Goño, & Rusek, 2017). The dependence-based models have assumed that all components in the system belong to a certain group according to an *a-priori* classification based on a deterministic criterion –e.g. the components are grouped by similarities of the shape, functionality, assembly or location within the system–. Some studies of dependence-based models have been focused on the optimal maintenance policies for a multi-component system (Nicolai & Dekker, 2008; Ahmad & Kamaruddin, 2012; Van Horenbeek & Pintelon, 2013; Yang, Zhao, Peng, & Ma, 2018), the set of the main dependencies are the following: (i) stochastic dependency, which considers the effect of the component deterioration regarding the lifetime distribution of others components, the studies in this area (Liu, Xu, Xie, & Kuo, 2014) focus on the trigger effect by failure of a component –i.e. failure interactions–; (ii) structural dependency (Iung, Do, Levrat, & Voisin, 2016; Peng & Zhu, 2017), which focuses on the assembly relationship condition of a component in a subsystem; and (iii) economic dependency (Van Horenbeek & Pintelon, 2013; Do, Vu, Barros, & Bérenguer, 2015; Zhou, Huang, Xi, & Lee, 2015; Qiu, Cui, Shen, & Yang, 2017), which assumes that a maintenance action cost of a grouped component does not equal to the sum of the maintenance cost of all individual components.

The effect of the clustering techniques on maintenance costs have been considered for a reduced set of systems with specific configurations (Wang, Tsai, & Li, 2011). Yang, Djurdjanovic and Ni (Yang, Djurdjanovic, & Ni, 2008) used a dependence-based model to develop a maintenance schedule based on the expected degradation of the machine by considering the complex interaction between the components, the production process, and the maintenance operations. Later, Tian and Liao (Tian & Liao, 2011) proposed a maintenance policy based on a proportional hazard model for multi-component systems, and a policy was established for preventive replacements of spare parts. Subsequently, Liu et al. (Liu, Xu, Xie, & Kuo, 2014) formulated a preventive maintenance policy for multi-component systems concerning continuously degrading components. In addition, Zhou et al. (Zhou, Huang, Xi, & Lee, 2015) proposed a time window based preventive maintenance model for multi-component systems with stochastic failures and the disassembly sequence involved. Nevertheless, it is possible to identify that the literature has not reported dependence-based models without a pre-established classification (shape, functionality, assembly, etc.), which combines the reliability analysis of the complex systems and the working-life condition of each component. Other models (Do, Vu, Barros, & Bérenguer, 2015; Iung, Do, Levrat, & Voisin, 2016) have assumed that all members of a group have identical behaviour (i.e. identical working rate, wear ratio, degradation, etc.); therefore, these models are based on hypotheses with simplifications; thus, these models are limited because they do not consider that the same type of components in the system could: (i) come from different suppliers with different quality; (ii) come from different production batches; (iii) have a material quality variation; (iv) have a metrological variation; (v) have different working stress; and (vi) have different working environment. This work shows that it is possible to develop a maintenance policy model which considers a multi-component system affected by multiple types of independent degradation processes. Economic dependencies are common in most continuous operating systems, such as aircrafts, powerplants, or chemical processing facilities. This work focuses on economic dependencies, it means a conjoined maintenance action can yield a lower total cost than maintaining each component separately.

An efficient maintenance policy should consider a long-time period between preventive maintenance actions. Nevertheless, under operational conditions, increasing the period between preventive maintenance actions decreases the reliability function of each component; thus, increasing the maintenance cost by increasing the corrective maintenance actions (Yang, Ma, Peng, Zhai, & Zhao, 2017; Qiu, Cui, Shen, & Yang, 2017). If non-identical components are considered in a complex multi-component system, each single component will have different reliability function and a different period between preventive maintenance as well. In this chapter, an optimisation of maintenance policy process is developed for multi-component systems, where a reliability relationship is considered among different components subjected to each single condition during their working-life. Given a multi-component system comprised of sets with the same type of components, wherein the components are not necessarily identical, and these

components may even have: (i) variation of properties, e.g. material quality or metrological variation; (ii) working rate variation due to different operation conditions of the system; and (iii) independent degradation processes. The objective is to minimise the long-term maintenance action cost of complex systems. Main contributions of the chapter can be summarised as follows:

- (i) a dependence-based optimisation model and different maintenance policies (periodic block-type and age-based) are merged to solve the problem of maintenance in complex systems considering the imperfect maintenance actions;
- (ii) a stochastic optimisation is developed in order to provide a maintenance plan accounting for the degradation process of each element in a multi-component system; and
- (iii) a method to cluster the maintenance actions is proposed in order to reduce the long-term total maintenance cost of complex systems, evaluating how imperfect maintenance actions influence the system.

The concept that maintenance actions reduce the age of the system is based on Kijima's virtual age models (1989), in which the reduction of age model has a failure intensity that is a function of its virtual age. Usually, studies on repairable systems (Doyen & Gaudoin, 2004; Ahmadi, Soleimanmeigouni, Block, & Letot, 2016) mainly focus on reliability models with a single component under different maintenance actions defined by conditional distributions of successive inter-failures in terms of time. Nonetheless, this study will consider multi-component systems with non-identical components, which follow fault probability distributions within their frequency domain. This chapter is organised as follows: Section 2 exposes the mathematical expressions of the problem description. Section 3 develops an optimisation model for complex multi-component systems that consider the degradation of components for obtaining the optimal maintenance actions. The model is applied in Section 4 by means of a numerical example that focuses on an urban public ropeway system and this section also proposes analyses of the results and a discussion of the work. Finally, section 5 offers a conclusion and draws some perspectives of this work. Table 3.1 presents the coefficients, parameters, and variables which will be used throughout this chapter.

Table 3.1. Indices and parameters used throughout this chapter.

i	Instant of lifetime;
$j = \{1, 2, \dots, J\}$	indices of the components on the system;
$k = \{1, 2, \dots, K\}$	indices of clustered preventive maintenance actions;
η	horizon of time, long-term window of lifetime;
B_k	Bernstein polynomial;
\mathcal{F}_h	parametric curve proposed by De Casterljeau;
g	piecewise-defined parametric curve;
u	parameter of the parametric curve \mathcal{F}_h ;
$P(\cdot)$	probability function.
<i>Maintenance policy parameters:</i>	
$\alpha_{j,\eta}$	age reduction coefficient after a maintenance action of the j th component, over the η period of lifetime, $\alpha_{j,\eta} = \{\alpha_{p1}, \alpha_{p2}\}$;
α_{p1}, α_{p2}	age reduction after a major and minor preventive maintenance action, respectively;
$\beta_{j,\eta}$	stochastic hazard rate of the j th component and over the η period of lifetime, related to a human and technical uncertainty of a maintenance action;
p	relationship between the quantity of minor maintenance actions per each major maintenance action;
f_j, F_j	probability and cumulative fault distribution of the j th component [cycles], respectively;
$R_j, \Delta R_{j,\eta}$	reliability probability function and reliability gain of the j th component [cycles], respectively;
R_{inf}	lower threshold of the reliability function [cycles];
$\omega_j, \omega_o, \omega_A$	current working cycles, working cycles of the last maintenance action and working cycles of the next maintenance action of the j th component [cycles], respectively;
$\varphi_{j,\eta}$	failure probability average of the j th component over the finite period of time τ ;
τ	period of time between preventive maintenance actions [year/maint.];
<i>Optimisation parameters:</i>	

Cp_j	cost of a perfect maintenance action (AGAN) to the j th component, which is quantified on monetary unit (mu) per maintenance action [mu/maint.];
Cc_j	cost of a corrective maintenance action to the j th component, which is related to the cost of the time-dead of the system, the cost of logistic actions, labour cost, cost of devices and equipment [mu/maint.];
C_1, C_2	cost of the major and minor preventive maintenance action [mu/maint.], respectively;
$C_{j,\eta}$	optimisation function of maintenance cost to the j th component [mu/year];
$C_{j,\eta}^*$	optimal maintenance cost value of $C_{j,\eta}$ [mu/year];
C_k^{**}	opportunistic cost of the optimal period $C_{j,\eta}^*$ by clustering [mu/year];
e_k	k th cluster centre of a set of maintenance actions;
E	objective function by k-means algorithm;
$\Gamma c_{j,\eta}, \Gamma p_{j,\eta}$	cost of a corrective and a preventive maintenance of the j th component [mu/year], respectively;
<i>Decision variables:</i>	
A_j	range of working cycles over the j th component based on age-based preventive maintenances;
T_j	periodicity over preventive maintenance actions [maint./year];
\mathbb{T}_k	periodicity of the preventive maintenance actions of the k th optimal period cluster [maint./year].

3.2. Problem formulation

This work considers the following assumptions regarding the multi-component systems under discussion: (i) a system with j non-identical components, with $j = \{1, 2, \dots, J\}$; (ii) a failure process $f_j(\omega)$ for the j th component, i.e. a fault probability distribution at frequency domain ω , where $\omega > 0$ –e.g. faults per working cycle; and (iii) a failure of the j th component affecting the performance of the system. Let F_j be the cumulative fault probability distribution function from $f_j(\omega)$, the reliability function of the j th component in a system is $R_j(\omega) = 1 - F_j(\omega)$, where the nominal value is $R_j(0) = 1$ (Yang, Djurdjanovic, & Ni, 2008).

Maintenance managements can adopt a different maintenance policy regarding the repairing actions. The repairing actions affect the technical state of the repaired component, i.e. considering a long-term horizon of lifetime, η , a series of repairing actions produce a reduction on the degradation level of the j th component by a $(1 - \alpha_{j,\eta})$ factor, with $0 \leq \alpha_{j,\eta} \leq 1$ (Khatab, Ait-Kadi, & Rezg, 2013); these maintenance policies are usually executed from three cases (Van Horenbeek & Pintelon, 2013; Schutz & Rezg, 2013; Yang, Zhao, Peng, & Ma, 2018):

- (i) In the case that a maintenance management executes a maintenance action with a value $\alpha_{j,\eta} = 0$, the reliability level takes the nominal value $R_j(\omega_j) = 1$. This means that a perfect maintenance action –defined as-good-as-new (AGAN)– is performed, which consists in repairing the component using the required resources to get the highest quality reparation.
- (ii) In the case that a maintenance management executes a maintenance action with a value $\alpha_{j,\eta} = 1$, the reliability level remains as the value before the fault $R_j(\omega_j)$. This means that a minimal-maintenance action –defined as-bad-as-old (ABAO)– is performed.
- (iii) In the case that a maintenance management executes a maintenance action with a value within the range $0 < \alpha_{j,\eta} < 1$, this means that an imperfect maintenance action is performed.

3.2.1. Preventive maintenance policies

Preventive maintenance has been introduced to minimise the effect of unscheduled breakdowns; it interferes in a planned manner by means of improving the R_j level of the j th component. Imperfect preventive maintenance is widely spread in the field of engineering and has been mainly adopted by the maintenance managements (Pham & Wang, 1996; Liu, Yeh, & Cai, 2017; Qiu, Cui, Shen, & Yang, 2017). Therefore, this work will focus on the imperfect preventive maintenance ($0 < \alpha_{j,\eta} < 1$). After each preventive maintenance action, the equipment

is restored to a lower level than the nominal state of its components, i.e. over the lifetime of the system its components undergo wear and degradation.

Let's define Cp_j as the cost of a perfect maintenance action, which is given in monetary units (mu), it will represent the cost of the required resources to get the highest quality maintenance and to restore the reliability function of the component to its nominal value, i.e. AGAN maintenance. As a consequence, when the budget of a maintenance action for the j th component is equivalent to its Cp_j , the executed maintenance action is AGAN; hence, the value of the age reduction is $\alpha_{j,\eta} = 0$, and it means that the j th component has been replaced by new j th spare part.

The proposed model assumes imperfect maintenance actions; thus, the maintenance action cost is a fraction of Cp_j , which is directly related to the age reduction coefficient after a maintenance action; then, the preventive maintenance action can be expressed as $Cp_j(1 - \alpha_{j,\eta})$. The preventive maintenance actions are classified in two types: a major maintenance and a minor maintenance. The age reduction coefficient before a preventive maintenance action is $\alpha_{j,\eta} = \{\alpha_{p1}, \alpha_{p2}\}$, where α_{p1} and $\alpha_{p2} \in (0 < \alpha_{j,\eta} \leq 1)$, with α_{p1} being the age reduction after the major maintenance action, and α_{p2} being the age reduction coefficient after the minor maintenance. The relationship between the major and the minor preventive maintenance is defined by means of the parameter p , which describes the quantity of minor maintenance actions per each major maintenance action.

Remark 3.1. Note that, the cost of the major maintenance action,

$$C_1 = Cp_j(1 - \alpha_{p1}), \quad (3.1)$$

is higher than the cost of the minor maintenance action,

$$C_2 = Cp_j(1 - \alpha_{p2}); \quad (3.2)$$

thus, $C_1 > C_2$ and $\alpha_{p1} < \alpha_{p2}$.

The imperfect preventive maintenance actions produce the reliability gain, $\Delta R_{j,\eta}$, that is related to the inverted resource in the maintenance action by improving the coefficient $(1 - \alpha_{j,\eta})$ (e.g. an annual maintenance action demands a higher cost than a quarterly maintenance action, in consequence, an annual maintenance action must increase the reliability gain more than a quarterly maintenance action).

In fact, $\Delta R_{j,\eta}$ is affected by two factors:

- (i) a tactical factor: factor related to the general conditions of the maintenance action –e.g. the type of preventive maintenance– that relies on $\alpha_{j,\eta}$, which quantifies the fraction of Cp_j that the maintenance manager has available for the preventive maintenance action; and
- (ii) an operational factor: which quantifies the quality of the operative action applied on the maintenance –e.g. the repairman's expertise, the technic, the technical support, and the quality and state of the used devices and tools–. The value of the operational factor is defined through a hazard rate model $\beta_{j,\eta}$, where $0 \leq \beta_{j,\eta} \leq 1$, then $\beta_{j,\eta}$ is a stochastic index of the j th component and carries throughout η , which is related to a human and technical uncertainty over the maintenance action.

Then, $\Delta R_{j,\eta}$ can be expressed in terms of the reliability function, the tactical factor, and the operational factor

$$\Delta R_{j,\eta} = \beta_{j,\eta}(1 - R_j)(1 - \alpha_{j,\eta}), \quad (3.3)$$

with $\alpha_{j,\eta} = \{\alpha_{p1}, \alpha_{p2}\}$.

Remark 3.2. In the case that $\beta_{j,\eta} = 1$, the preventive maintenance model becomes a single age reduction model, i.e. the imperfect maintenance cost is affected only by the tactical factor, and it means that the maintenance action was executed with an extreme quality procedure; therefore, the maintenance action was executed without the uncertainty factor; thus, Eq. (3.3) can be rewritten as $\Delta R_{j,\eta} = \alpha_{j,\eta} R_j - R_j - \alpha_{j,\eta} + 1$.

Remark 3.3. This work assumes that the relationship between the preventive maintenance action cost (major and minor as well) and the efficiency of its maintenance action are described as a linear function, i.e. the $\Delta R_{j,\eta}$ value is lineally relied on the values of C_1 and C_2 . The lineal function is adopted because it appropriately describes the cost-efficiency of maintenance actions for some technical systems. An evolution of this strong assumption will be part of future works, according to the correlations pointed by the literature review.

This work considers a model for both different preventive maintenance policies (periodic block-type and age-based), they are discussed in the following lines.

3.2.1.1. Periodic block-type policy

The periodic block-type maintenance is performed periodically using maintenance actions during a long-term period over the lifetime, e.g. maintenance/year (Khatab, Ait-Kadi, & Rezg, 2013). This policy accounts for a horizon of time expressed as η , with a piecewise linear distribution of time T , and an equally frequency of maintenance actions τ (see Figure 3.1). Therefore, the periodicity condition of the periodic block-type policy is defined as

$$\eta = \tau(1 + p) . \quad (3.4)$$

Proposition 3.1. *The weighted average cost for the j th component in the periodic block-type actions is expressed as*

$$\Gamma p_{j,\eta} = C p_j T_j \left(1 - \frac{\alpha_{p1} + p \alpha_{p2}}{1+p} \right), \quad (3.5)$$

where $1 + p$ is a full cycle of preventive maintenance over the long-term horizon of time η .

Proof 3.1. By definition, the weighted average cost of the maintenance relies on the sum of the maintenance actions cost over the period of time that is performed

$$\Gamma p_{j,\eta} = \left(\frac{1}{\tau} \right) (C_1 + \sum_p C_2) ; \quad (3.6)$$

then, taking Eq. (3.1) and Eq. (3.2) into Eq. (3.6) with some algebraic manipulations

$$\Gamma p_{j,\eta} = \left(\frac{1}{\tau} \right) C p_j (1 + p - \alpha_{j,\eta} - p \alpha_{p2}) . \quad (3.7)$$

Using the periodicity condition of the periodic block-type policy expressed in Eq. (3.4) and taking it into Eq. (3.7), it can be expressed as

$$\Gamma p_{j,\eta} = \left(\frac{1+p}{\eta} \right) C p_j \left(1 - \frac{\alpha_{p1} + p \alpha_{p2}}{1+p} \right) . \quad (3.8)$$

From the periodically maintenance actions over the long-term time, it is possible to say that $T_j \eta = 1 + p$, and considering this relationship into Eq. (3.8) the proposition is proved. \square

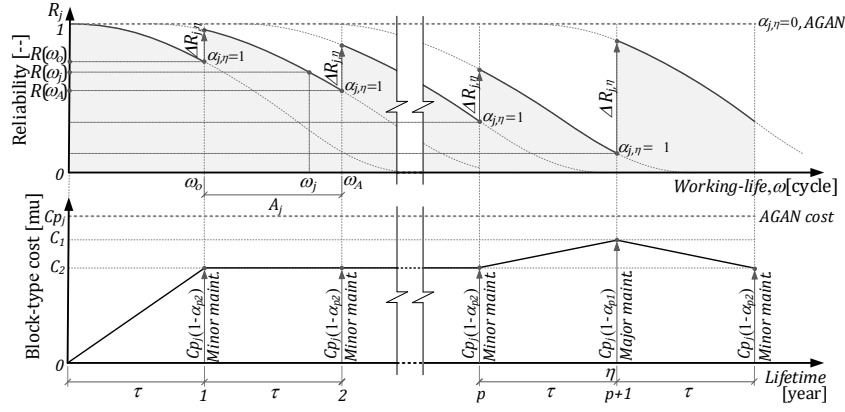

Figure 3.1. Periodic block-type preventive maintenance of the j th component.

3.2.1.2. Age-based policy

The age-based policy is executed according to the value of the reliability function to each component (Wang H. , 2002; Yang, Zhao, Peng, & Ma, 2018), i.e. the system undergoes a preventive maintenance whenever its R_j value reaches a given threshold level, R_{inf} . The quantity of the working cycles is considering according to the behaviour of each component in the operation of the system (see Figure 3.2).

Proposition 3.2. *The weighted average cost for the j th component in the age-based policy actions are the following*

$$\Gamma p_{j,\eta} = \frac{Cp_j}{A_j} \left(1 - \frac{\alpha_{p1} + p\alpha_{p2}}{p+1} \right), \quad (3.9)$$

where the A_j value covers the working cycles executed by the system under working degradation between preventive maintenance actions.

Proof 3.2. By definition, the weighted average cost of the maintenance relies on the sum of the maintenance action cost under the working cycles that are performed

$$\Gamma p_{j,\eta} = \left(\frac{1}{R_{j,\eta}^{-1}(R_{inf}) - R_{j,\eta}^{-1}(R_{\omega_0})} \right) (C_1 + \sum_p C_2), \quad (3.10)$$

where $R_{j,\eta}^{-1}(\cdot)$ expresses the inverse reliability function of the j th component, and R_{ω_0} is the reliability function level of the last preventive maintenance action.

Taking Eq. (3.1) and Eq. (3.2) into Eq. (3.10), and after some algebraic manipulations

$$\Gamma p_{j,\eta} = \left(\frac{1}{R_{j,\eta}^{-1}(R_{inf}) - R_{j,\eta}^{-1}(R_{\omega_0})} \right) Cp_j (1 + p - \alpha_{j,\eta} - p\alpha_{p2}). \quad (3.11)$$

The R_{inf} value can be expressed as $R_{inf} = R_{j,\eta}(\omega_A)$, $\exists \omega_A \in \omega$; thus, $\omega_A = R_{j,\eta}^{-1}(R_{inf})$, where ω_A is the quantity of working cycles in which the system reaches R_{inf} . Besides, $R_{\omega_0} = R_{j,\eta}(\omega_0)$ and $\omega_0 = R_{j,\eta}^{-1}(R_{\omega_0})$. It follows Eq. (3.11) that

$$\Gamma p_{j,\eta} = \left(\frac{1}{\omega_A - \omega_0} \right) Cp_j \left(1 - \frac{\alpha_{p1} + p\alpha_{p2}}{1+p} \right); \quad (3.12)$$

then, for a given working cycles range $A_j = \omega_A - \omega_0$, considering this relationship into Eq. (3.12) the proposition is proved. \square

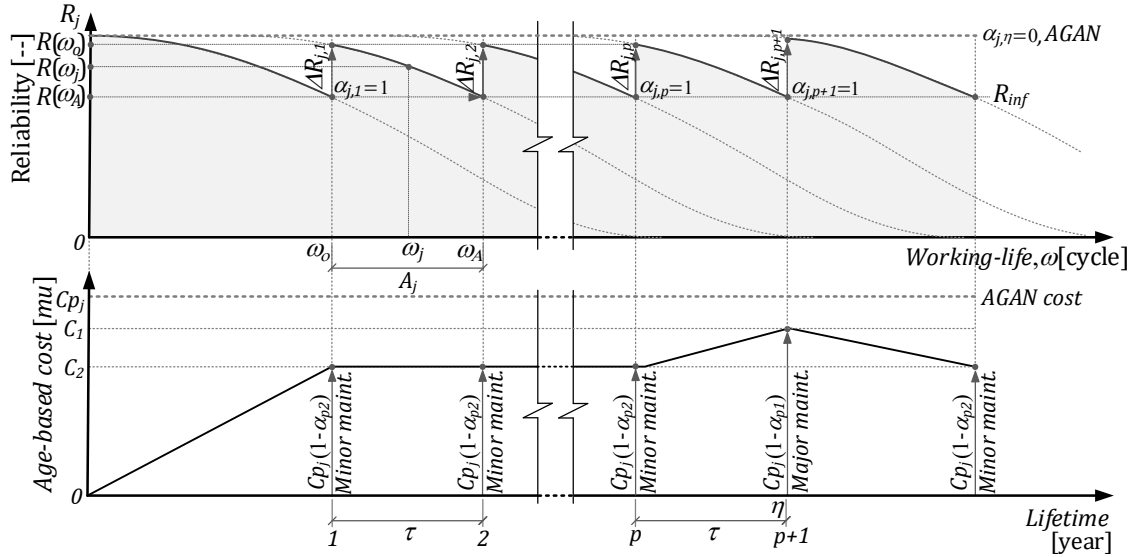

Figure 3.2. Age-based preventive maintenance of the j th component.

3.2.2. Corrective maintenance policy

The repairing action cost associated with the fault of the j th component is expressed as a unit cost value, Cc_j , and the repairing actions of a failed component are executed between the scheduled preventive maintenances (Yang, Ma, Peng, Zhai, & Zhao, 2017), i.e. between the working cycles range, A_j (see Figure 3.3).

Remark 3.4. The corrective maintenance policy, commonly used by the maintenance management, corresponds to the minimal-repair (Pham & Wang, 1996; Khatab, Ait-Kadi, & Rezg, 2013). The minimal-repair action consists in restoring the system to the working state immediately before the failure. The minimal-repair action to a failed component is adopted by this work; thus, the proposed model adopts the ABAO corrective maintenance policy, which is defined by $\alpha_{j,\eta} = 1$, i.e. R_j remains unchanged to its value before the fault.

The corrective maintenance cost action, $\Gamma c_{j,\eta}$, is expressed as Cc_j and it is affected by the failure probability average, $\varphi_{j,\eta}$,

$$\Gamma c_{j,\eta} = Cc_j \varphi_{j,\eta} \quad (3.13)$$

where $\varphi_{j,\eta}$ is the failure probability average for the j th component over a finite period of time, considered from the current lifetime, ω_j , to the next preventive maintenance action, ω_A , with $\omega_j < \omega_A$.

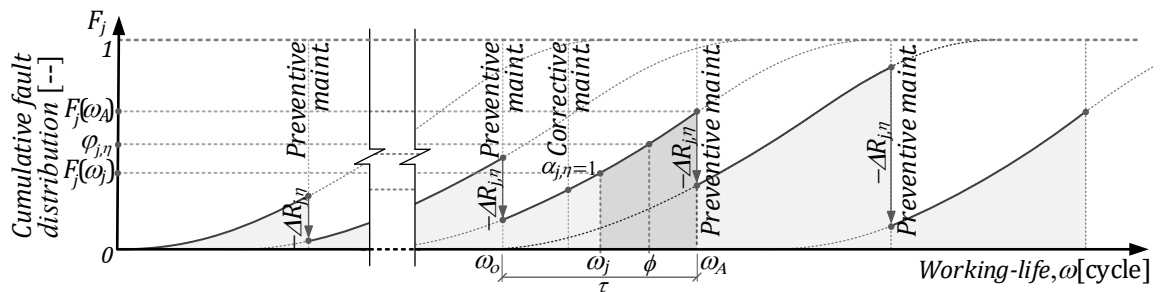

Figure 3.3. Corrective maintenance policy parameters.

3.3. Proposed methodology framework

For corrective maintenance, the repairmen action should be taken immediately after the failure of the component; the proposed methodology adopts an ABAO corrective maintenance policy. For preventive maintenance, the best periodicity of the maintenance action should be adopted to avoid a failure event, and avoid any corrective maintenance actions as well.

The proposed methodology is based on a system-dependent model for a long-term total maintenance cost, $C_{j,\eta}$; i.e., an economic dependence regarding to maintenance actions over the components of a technical system. The proposed methodology considers preventive and corrective maintenance actions which have a cost-based component, $\Gamma p_{j,\eta}$ and $\Gamma c_{j,\eta}$, respectively.

Remark 3.5. If τ increases, then $\Gamma p_{j,\eta}$ decreases, and as a result, the quantity of preventive actions decreases as well; but if τ increases, then $(\Gamma c_{j,\eta})$ increases because the $R_{j,\eta}$ level decreases.

An optimisation process has been developed in the proposed methodology, the process of optimisation is structured in two stages (see Figure 3.4): (i) a maintenance optimisation, based on the long-term total cost of corrective and preventive maintenance (the optimal value of each component establishes the periodicity of preventive maintenance actions, based on $R_{j,\eta}$); and (ii) a maintenance optimal cost of a multi-component system is determined by clustering the preventive maintenance actions of the multi-component system. This process of optimisation is further discussed in detail in Section 3.4.

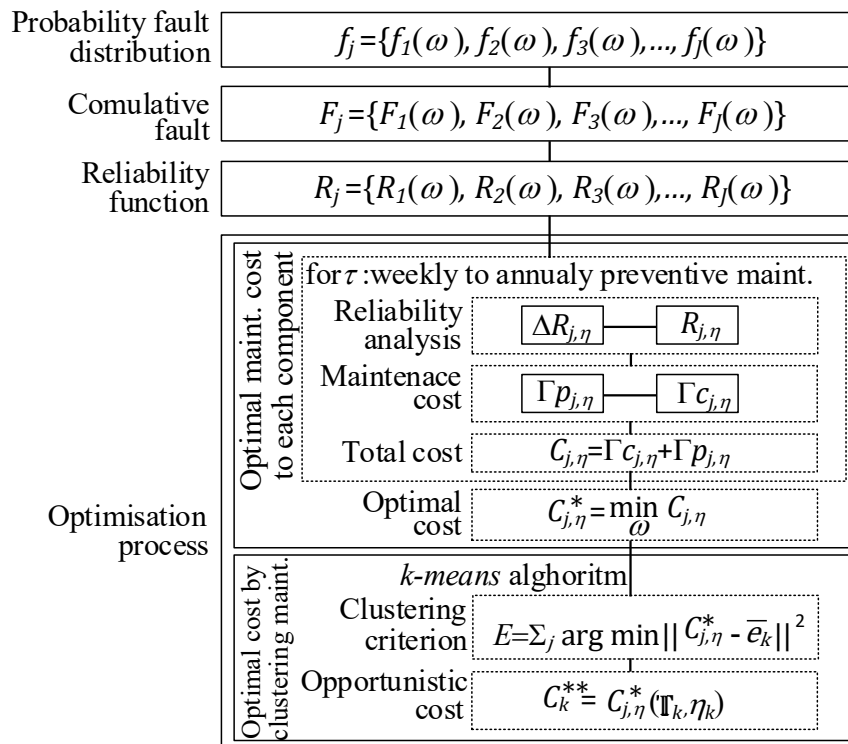

Figure 3.4. Flow diagram of the proposed methodology.

A model has been developed in a virtual environment using a programming language that allows researching the effects of a wider range of condition and parameter variations. The model is defined by $F_j(\omega)$, which has been affected by the preventive and corrective maintenance actions. Therefore, the model has considered the effects of $\alpha_{j,\eta}$ and $\beta_{j,\eta}$, where $\beta_{j,\eta}$ has a uniform distribution. This model has been subjected to a sensitivity analysis by means of 500 test sets, and each test covered 240E3 [cycles] of the components working-life, which comprises a three years period.

Appendix B (Figure B.5) shows the sensitivity analysis performance of every $F_j(\omega)$. The set of functions $F_j(\omega)$ is used to describe the system's behaviour data during a working-life; therefore, a relationship can be established between a measure of central tendency –such as the average values, $mean(F_j(\omega))$ – and a measure of dispersion –such as the deviation standard, $std(F_j(\omega))$ – to quantify the sensitivity of the model regarding the lifetime. The value of $std(F_j(\omega))$ to each maintenance action had an acceptable deviation level for the scope of this work ($< 0.85\%$).

The model is subjected to a convergence analysis to quantify the required simulations in order to reach a stable value, Appendix B (Figure B.6) shows the results of $F_j(\omega)$ at three years of lifetime; therefore, a total of 73 simulations are necessary to fulfil the requirements, wherein a value lesser than 3% of variation represents an acceptable deviation level for this study.

3.4. Optimisation process

This work introduces a stochastic optimisation model in order to prove a multi-component maintenance plan. The optimal service plan is obtained by minimising the expected long-term cost for the maintenance activities. A cost-based model is proposed to quantify the involved resources in the maintenance policies. The optimisation process is structured in two stages:

3.4.1. Optimisation of maintenance actions cost to each component

The j th component requires a maintenance protocol for its working lifetime in the technical system, which is executed by means of a set of maintenance actions (Yang, Djurdjanovic, & Ni, 2008); thus, incurring in long-term maintenance costs, $\Gamma p_{j,\eta}$ and $\Gamma c_{j,\eta}$. Note that $\Gamma c_{j,\eta}$ increases as the level of τ increases, and on the other hand, $\Gamma p_{j,\eta}$ increases while decreasing τ . Formally, the maintenance total cost is defined as follows

$$C_{j,\eta} = Cc_j \varphi_{j,\eta} + Cp_j \mathbb{M} \left(1 - \frac{\alpha_{p1} + p \alpha_{p2}}{p+1} \right), \quad (3.14)$$

where $\mathbb{M} = \{T_j, A_j^{-1}\}$ represents the decision variables, with $\mathbb{M} = T_j$ if the periodic block-type maintenance policy is considered, and $\mathbb{M} = A_j^{-1}$ if the age-based maintenance policy is considered. Therefore, the objective function related to the maintenance policy cost can be expressed as

$$C_{j,\eta}^* = \min_{\omega} C_{j,\eta}, \quad (3.15)$$

subject to the following constraints

$$0 \leq R_j(\omega) + \Delta R_{j,\eta} \leq 1, \quad \forall j, \eta \quad (3.15.a)$$

$$0 \leq F_j(\omega) - \Delta R_{j,\eta} \leq 1, \quad \forall j, \eta \quad (3.15.b)$$

$$Rg_{inf} \leq R_j(\omega) \leq 1, \quad \forall j \quad (3.15.c)$$

$$0 < \tau, p; \quad (3.15.d)$$

where,

- Eq. (3.15.a) expresses the wear and degradation of the j th component over its lifetime;
- Eq. (3.15.b) represents how the imperfect maintenance action causes a cumulative fault distribution level;
- Eq. (3.15.c) is related to the maintenance policy, where Rg_{inf} is the lower reliability threshold of the system;
- Eq. (3.15.d) expresses that a period of time must exist between preventive maintenance actions.

Remark 3.6. Note that each $C_{j,\eta}^*$ requires different T_j value. Moreover, if the multi-component system has non-identical components, the system will potentially have a preventive maintenance action periodicity for each component (e.g. one component of the system can require 20 weeks between preventive maintenances, but another can require 21 weeks, and a third one can require 22 weeks, and so on; nonetheless, it does not make sense to intervene the system each week). Therefore, a next stage of the optimisation process should be the minimisation of the maintenance cost by clustering preventive maintenance actions, which is developed for obtaining the appropriate maintenance plan.

3.4.2. Optimal cost by clustering preventive maintenance actions

The function $C_{j,i}$ describes the maintenance cost for each j th component at an instant i of its lifetime, i.e. $\eta = i$; afterwards, the optimal maintenance cost $C_{j,i}^*$ can be calculated, as a result, a noisy point cloud with locally non-uniform distributions $\{C_{j,i}^*\}$ is generated for every time an instant of the lifetime is analysed for a set of components (see Figure 3.5(a)). Combining the maintenance actions over different components is also known as clustering or opportunistic maintenance. There is a potential cost-saving by implementing an opportunistic maintenance policy for multi-component systems (Wang H. , 2002). The objective is to group maintenance activities to reduce the maintenance cost. Moreover, grouping of maintenance actions should be considered to find an optimal maintenance policy in order to consider the economic interdependencies between components in a multi-component system. Consequently, the predictive maintenance policy must be based on grouping maintenance activities (Nicolai & Dekker, 2008; Chalabi, Dahane,, Beldjilali, & Neki, 2016). This has been achieved by implementing cluster analysis, which is discussed in the following lines.

Cluster analysis is the formal study of methods and algorithms for grouping. Clustering is made according to intrinsic characteristics, such as similarity state-rate degradation. Where, given a finite set $\{C_{j,i}^*\}$, there are K groups based on the measurement of similarity, in which similarities between optimal costs in the same group are high while similarities between objects in different groups are low, for $K \ll J$ (Jain, 2010). The clusters of preventive actions provide the possibility of grouping maintenance activities in a subset from $\{C_{j,i}^*\}$ to reduce the maintenance cost over $\eta = i$. Each subset is a collection of mutually exclusive groups, the set of groups is expressed as $E = \{e_k\}$, $\forall e_k = [\mathbb{T}_k, C_k^{**}]$ with $k = \{1, 2, \dots, K\}$, which covers the periodicity of all preventive maintenance actions. Finally, a grouping structure k is defined as a subset wherein all activities are jointly executed at cost $\{C_k^{**}\}$, which is defined as the optimal maintenance for the group $\{\mathbb{T}_k\}$ (see Figure 3.5(b)). Further on, each optimal cost $\{C_{j,i}^*\}$ is evaluated against its nearest cluster centre to get the optimal periods $C_k^{**} = C_{j,i}^*(\mathbb{T}_k)$, $\forall C_{j,i}^* \in e_k$ (see Figure 3.5(c)).

There are different clustering methods (Kaufman & Rousseeaw, 2009; Han, Kamber, & Pei, 2011): (i) partitioning; (ii) hierarchical, (iii) density-based, (iv) grid-based; and (v) their combinations. Partition-based clustering algorithms include the *k-means* method, which is widely used and well-studied in the literature. This work will use *k-means* to group the dataset from optimal costs $\{C_{j,\eta}^*\}$ into k disjoint clusters $\{\mathbb{T}_k\}$. From a finite set $\{C_{j,\eta}^*\}$ to be clustered into a set of K clusters, *k-means* algorithm finds a subset such that the square error between the centre of the cluster and the optimal costs in the cluster is minimised (Jain, 2010; Mahesh-Kumar & Rama-Mohan-Reddy, 2017). Let \bar{e}_k be the Euclidean distance between $\{C_{j,i}^*\}$ and the centre of the subset $\{e_k\}$, the clustering maintenance cost is defined as the squared error distortion in the following objective function

$$E = \sum_j \arg \min \|C_{j,\eta}^* - \bar{e}_k\|^2, \text{ with } e_k = [\mathbb{T}_k, \eta_k, C_k^{**}] \quad (3.16)$$

k-means algorithm has two stages: (i) initialisation, wherein the starting set $\{e_k\}$ is defined and (ii) an iterative stage, called Lloyd's algorithm, which consists of two steps: (a) each instance is

assigned to its closest $\{e_k\}$ –assignment step–, then the set of $\{e_k\}$ is updated –updating step–; and (b) a stopping criterion is verified, the most common criterion implies the computation of the error function, Eq. 3.16, i.e. if the error does not decrease significantly with respect to the previous iteration, the algorithm stops (Capó, Pérez, & Lozano, 2017). Thus, the finite set $\{C_{j,\eta}^*\}$ is evaluated on the nearest $\{e_k\}$ to get $\{C_k^{**}\}$ as follow

$$C_k^{**} = C_{j,\eta}^* (T_k, \eta_k) ; \quad \forall C_{j,\eta}^* \in e_k . \quad (3.17)$$

The dataset $\{C_k^{**}\}$ represents the optimal maintenance action cost of the components with a cost-saving by implementing an opportunistic maintenance policy for multi-component systems with economic dependency; $\{C_k^{**}\}$ varies as the components wear, so the clustering method (Eq. 3.16 and Eq. 3.17) can be directly expanded to the lifetime of the system (see Figure 3.5(d)).

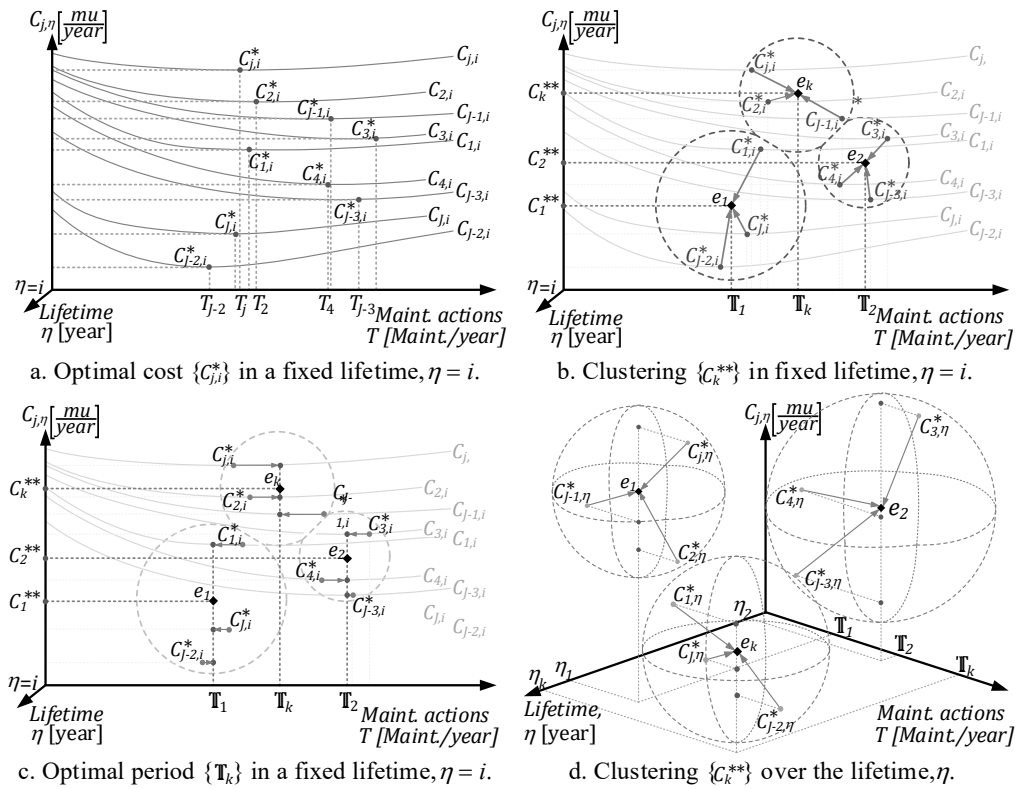

Figure 3.5. Clustering process of preventive maintenance actions.

3.5. Numerical study

This section presents an application for passenger-aerial-cable-cars to validate the numerical results. The transport system is similar in design and construction to those used for tourist passenger transport during the winter for winter sports (e.g., Daemyung, Korea; La Clusaz, France; Donovaly, Slovakia), but in this case it is used for massive urban transport, which is different from touristic systems (Mizuma, 2004); therefore, the transport system is subjected to extreme wear-off levels that similar systems do not endure, causing high wear-off ratio (Hoffmann, 2006).

3.5.1. Background - urban ropeway transport

This numerical application considers the fleet of a massive urban transport system with the following characteristics (Martinod, et al., Journey safety assessment to urban aerial ropeways transport systems based on continuous inspection during operation, 2015): (i) gondola-type aerial

cable, (ii) a continuous cycle, (iii) mono-cable (simple ring), and (iv) detachable release-clamp device (see Table 3.2). The aerial ropeway system is a *télécabine*-type system, with a pulling cable constantly revolving in one direction. Vehicles are attached and detached when they are entering and travelling through a platform. This feature allows for the vehicles to be set at a regular space interval, and the cable to be continuously circulating along the vehicles (Estepa, et al., 2014). The vehicles that are detached from the hauling rope at the platform are decelerated and carried through a boarding and departing area for passengers at a very slow speed, afterwards they are accelerated to reattach to the hauling rope while moving in between stations. This application example focuses on the maintenance actions for two sets of critical components:

- (i) a set of safety components are the detachable grips, these components have the function of clamping (during inter-station trips) and releasing (during transit inside the stations) the vehicle when to and from the track rope, by providing the clamping force needed to attach the vehicle to the track rope during the journey (Martinod, et al., Journey safety assessment to urban aerial ropeways transport systems based on continuous inspection during operation, 2015). The detachable grips are a part of the vehicles (there is one of them per gondola). Under normal exploitation conditions, the ropeway operates with all vehicles working, but the system can support up to two missing vehicles, i.e. the system remains in operational conditions with a maximum of two failed detachable grips (parallel configuration), if the system undergoes three or more failed detachable grips, the system must stop –series configuration– (Peng, Mo, Xie, & Levitin, 2013), affecting the service policy. Following the application example, the set of detachable grips reliability is $\{R_{d1}, R_{d2}, \dots, R_{dJ}\}$, with $dJ = 60$, because the quantity of sets of detachable grip components is equal to the quantity of vehicles.
- (ii) another set of components is the tyre conveyors, this device has got the function of the deceleration and acceleration of the vehicles through each platform. The ropeway system requires that every single tyre works; otherwise, the system must stop to fix the tyre, then the tyre conveyor has a series configuration in the system, the set of tyre conveyor reliability, considering the four platforms, is $\{R_{c1}, R_{c2}, \dots, R_{cJ}\}$ with $cJ = 366$.

Ropeway maintenance managements have adopted a periodic preventive maintenance based on a periodic block-type maintenance policy. These maintenance actions are executed according to a fixed schedule following linearly-spaced periods. Thus, in safety requirements for cableway installations, such as ropeways transport, a periodic preventive maintenance has already been widely introduced as a technical specification within the industry. Directive 2000/9/EC (Council of European Union, 2000) provides the technical regulations for passenger ropeway systems (e.g. funicular railways, cable cars, gondolas, chairlifts, and drag lifts). This directive covers the international standard BS/EN-1709 (British Standard, 2004) that establishes the guidelines for inspections and maintenance.

Table 3.2. General features of the transport ropeway system.

Operational parameters	Value
Quantity of service days [day/year]	365,00
Time under rush hour service [hour/day]	4,00
Time under valley rush hour service [hour/day]	16,00
Commercial speed rush hour [m/s]	5,00
Commercial speed valley hour [m/s]	3,00
Length of journey (round trip) [km]	6,00
Nominal quantity of vehicles in service [veh]	60,00
Quantity of detachable grips in series configuration [unit]	3,00
Distance between vehicles [m/veh]	61,67
Quantity of platforms per journey [platform /journey]	4,00
Wear-off ratio of detachable grips [cycle/platform]	2,00
Wear-off ratio of tyre conveyors [cycle/veh]	1,00
Maintenance policy parameters	Value
Cost of preventive maintenance action, C_p [mu]	20,00
Cost of corrective maintenance action, C_c [mu]	10 C_p

Age reduction coefficient (major maintenance), α_1 [--]	0,10
Age reduction coefficient (minor maintenance), α_2 [--]	0,30
Quantity of minor maintenance per major maintenance, p [--]	3,00
Lower threshold of the reliability function, R_{inf} [cycles]	0,98
Stochastic index due the quality of maintenance, β [--] (uniform distribution)	[0, ..., 1]
Quantity of preventive maintenance actions per year, T [--]	[1, ..., 10]

3.5.2. Optimisation of maintenance actions cost to the set of critical elements

A previous study (Trujillo, 2013) developed an evaluation and analysis focused on components of an urban ropeway transport system. This study was based on Reliability, Maintainability, and Availability (RMA) methodology. The fault probability distribution and the reliability probability functions for the detachable grips and the tyres conveyors were also measured. This study found the parameters that describe the fault probability distributions, which can be fitted by means of Weibull distributions. The application example assumed that all analysed components ($j = \{d1, \dots, dJ\}, \{c1, \dots, cJ\}$) were non-identical components and they had different failure processes f_j , then the set of reliability function was $\{R_1, \dots, R_J\}$ with $J = dJ + cJ$. All the dataset is available from the authors of this chapter; as an example, a sample of the components reliability behaviour is shown in Appendix C Figure C.2(a), where each component has different: (i) cumulative fault probability function; (ii) current cumulative fault level; and (iii) fault level.

The maintenance policy seeks to minimise the cost of the associated activities (Ahmadi, Soleimanmeigouni, Block, & Letot, 2016; Qiu, Cui, Shen, & Yang, 2017); then, the degradation during the lifetime of the components are computed by means of five stages: (i) the functions f_j , F_j and R_j are calculated to get the progressive degradation of the components when working under operation conditions, which considers just the corrective maintenance actions, it means a reactive maintenance policy is applied, without preventive maintenance actions; (ii) the effect of the imperfect maintenance action is calculated, varying T_j , see Appendix C, Figure C.2(b); (iii) the degradation of each component is found by the superposition principle, to get the mixed maintenance cost due to the corrective and preventive maintenance actions (see Figure 3.6); (iv) the set of minimal maintenance costs $\{C_{j,\eta}^*\} = \min(\{C_{j,\eta}\})$ is calculated, varying η ; and (v) the dataset of minimal maintenance cost $\{C_{j,\eta}^*\}$ is grouped into K sets by k-means.

The maintenance actions and their associated cost are a well-known topic by ropeway maintenance managements. To show the performance of the proposed model a set of simulations are applied to different scenarios, which are being considered in the following two application examples:

- (i) maintenance cost by using a periodic block-type preventive maintenance, which is the traditional maintenance policy established by the international regulation. The variables of decision (T, \mathbb{T}_k) have been considered, and combinatory tests were executed based on the lifetime $\eta = \{0, \dots, 3\}$ [year] and the range $T = \{2, \dots, 10\}$ [maint. actions/year]. Figure 3.7(a) shows a synthesis of the results, where the cost of the periodic block-type preventive maintenance is clustered through $\mathbb{T}_k = \{1, \dots, K\}$, with $K = 5$.
- (ii) maintenance cost using an age-based preventive maintenance, which can be used to quantify the effectiveness of the applied current maintenance policy. Figure 3.7(b) shows a synthesis of the results, where the cost of the age-based preventive maintenance is clustered through $\mathbb{T}_k = \{1, \dots, K\}$, with $K = 5$.

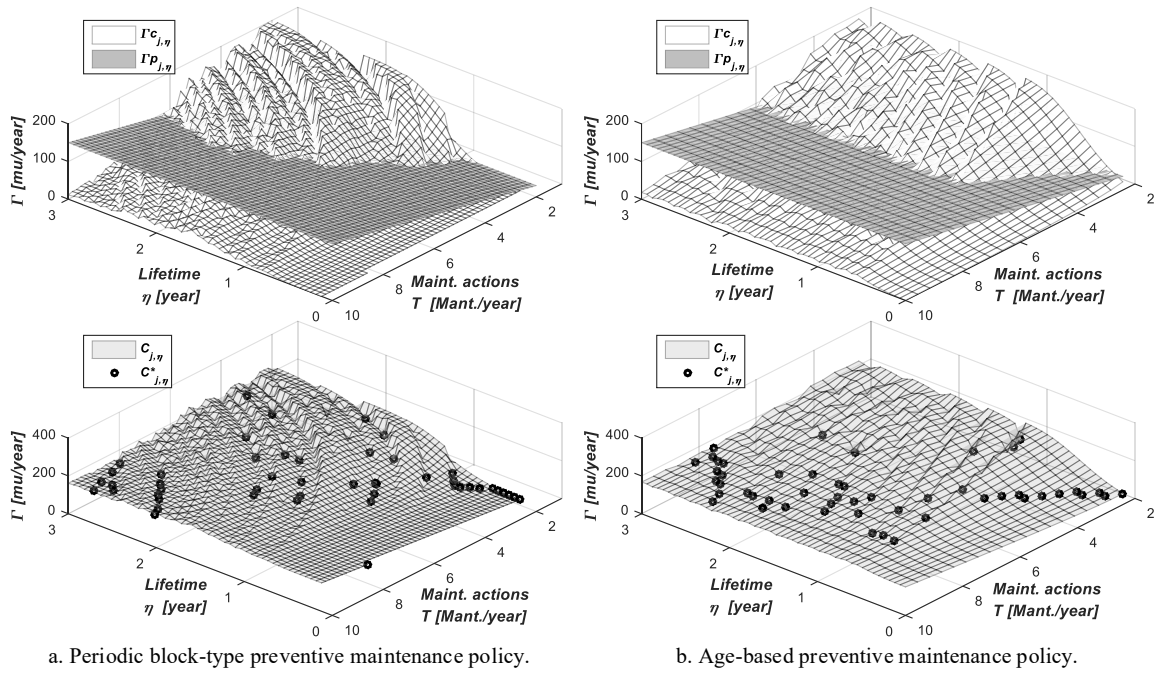

Figure 3.6. Objective function of the maintenance cost over η of the j -th component.

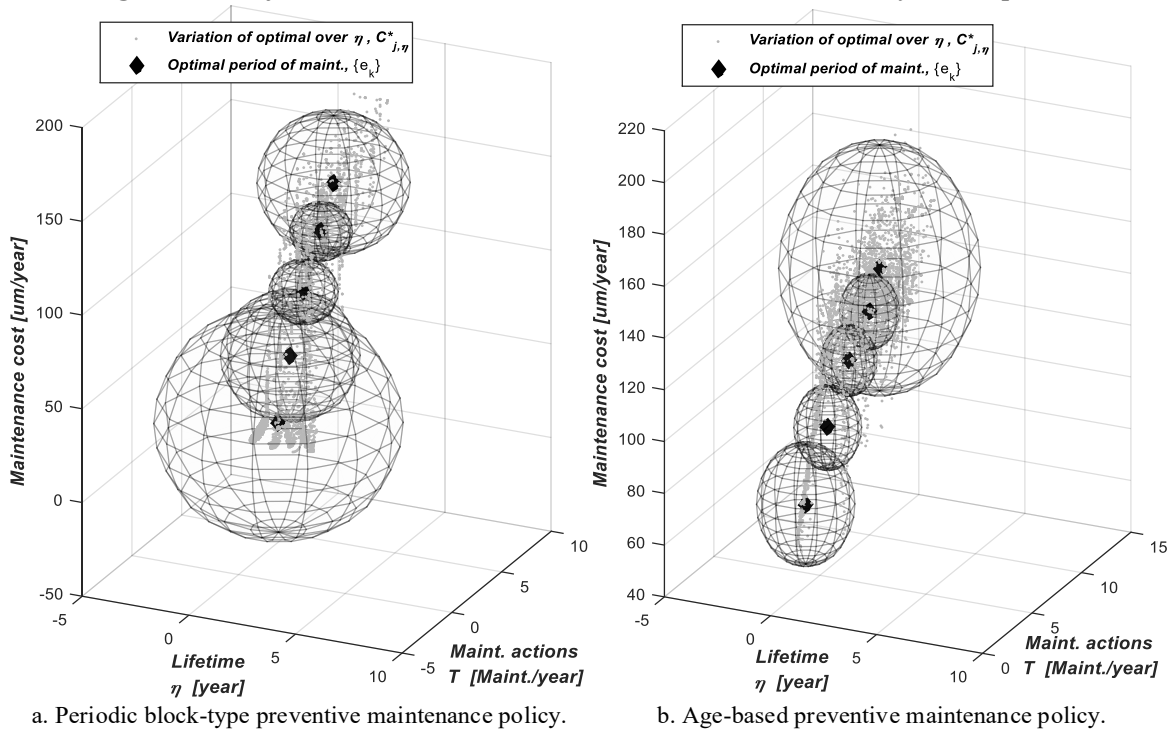

Figure 3.7. Clustering the optimal cost $\{C_k^{**}\}$ over the lifetime, η .

3.5.3. The optimal long-term cost maintenance by clustering

Given a finite set of sampled points from the curve $\{e_k\}$, that represents the opportunistic cost value of the clustered optimal period $\{C_k^{**}\}$, a parametric method can be applied to find a mathematical expression $g = \mathcal{F}_h(u)$, which describes the behaviour of the maintenance cost in relation to the lifetime of the system, i.e. g represents the function cost of the maintenance actions (preventive and corrective as well). The stochastic points $\{e_k\}$ are sampled by following systematically-ordered-patterns, i.e. the data $e_k = [T_k, \eta_k, C_k^{**}]$ has connectivity with e_{k+1} (see Figure 3.8(a)). The mathematical expression $g = \mathcal{F}_h(u)$ is a piecewise-defined parametric curve with $\mathcal{F}_h(u) = [T_k(u), \eta_k(u), C_k^{**}(u)]$ where the parameter u is one of the many possible ways to

parameterise the h th curve \mathcal{F}_h . The parametric curve \mathcal{F}_h was proposed by Bézier, De Casterljeau, and others, and it is expressed as (Ruiz, 2002)

$$\mathcal{F}_h(u) = \sum_k B_k(u)e_k, \quad (3.18)$$

with $0 \leq u \leq 1$ and $\sum_k B_k(u) = 1$; $B_k(u)$ is known as Bernstein polynomial. The k th weight coefficient for the k th point belongs to a subset $\{e_{k-l}, e_k, e_{k+l}\}$ where $1 \leq l \leq K$. One of the Bernstein polynomial is the spline interpolation, which is a piecewise-defined numeric function. The piecewise spline interpolation is appropriate because it yields similar results while interpolating higher degree polynomials and avoids instability caused by the Runge's phenomenon.

From the clustered dataset $\{e_k\}$, it is possible to show the existing relationship between the optimal cost $\{C_k^{**}\}$ and the periodicity of preventive maintenance actions $\{T_k\}$ which are being applied to the periodic block-type maintenance policy as well as the age-based maintenance policy (see Figure 3.8(b)). A polynomial regression model is obtained, with a correlation coefficient $\sqrt{R^2} > 0.97$

$$g = \begin{bmatrix} -3.64 & 48.97 & -22.23 \\ -3.87 & 57.88 & -63.22 \end{bmatrix} [T^2 \quad T \quad 1]^T, \quad (3.19)$$

The regression model is considered valid given that the $\sqrt{R^2}$ value represents the association with the obtained data, which have an acceptable level for the scope of this work.

Remark 3.7. Note that the maintenance cost of the system relies on the lifetime of the components; therefore, there is an optimal working-life value to switch the maintenance policy which allows the minimal cost (considering the preventive and corrective maintenance actions).

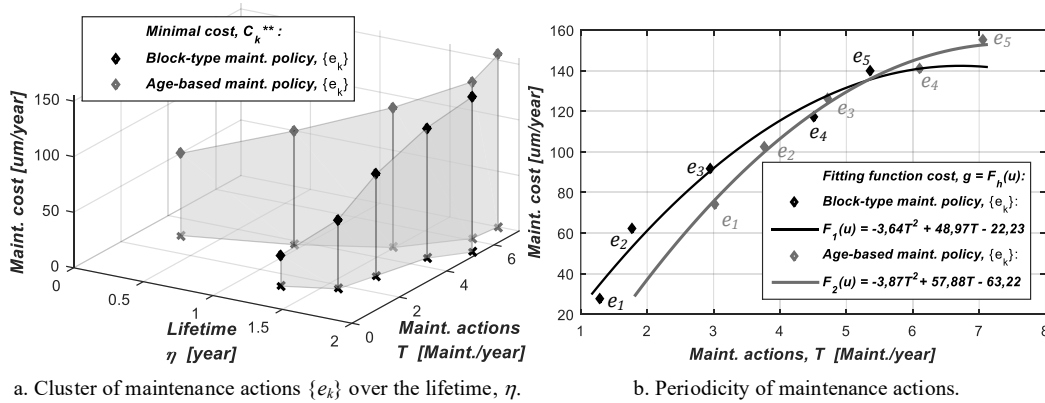

Figure 3.8. Results of clustering the optimal cost $\{C_k^{**}\}$.

3.5.4. Discussion of results from the proposed strategy compared with the current

Ropeways maintenance management have adopted a periodic preventive maintenance based on a periodic block-type maintenance policy, which the maintenance actions are executed according to a fixed schedule based on linearly-spaced periods; therefore, the function cost of the maintenance actions is expressed as $\mathcal{F}_1(u) = -3,64T^2 + 48,97T - 22,23$ (see Figure 3.8(b)).

This work shows that neither periodic block-type maintenance nor an age-based maintenance is necessarily the optimal strategy of maintenance policy over a long time of working-life. The optimal strategy must consider both policies; at the beginning of the working-life, the applied maintenance policy ought to be the age-based, whereas the components of the system undergo wear and degradation, the maintenance policy ought to switch to the periodic block-type; therefore, the function cost of the maintenance actions is $\min\{\mathcal{F}_h(u)\}$, i.e.

$$g = \min_{\eta} \mathcal{F}_h(u) = \begin{cases} -3,87T^2 + 57,88T - 63,22; & \text{with } T \leq 5 \\ -3,64T^2 + 48,97T - 22,23; & \text{with } T > 5 \end{cases} \quad (3.20)$$

Summarising, the proposed maintenance strategy minimises the function cost of the maintenance actions, thus it is an improvement regarding the current strategy used by the ropeway transport systems.

3.6. Conclusions

This chapter develops a mathematical framework to integrate the optimisation of a dependence-based model with different maintenance policies (periodic block-type policy and age-based policy) using reliability analysis to solve the problem in multi-component systems through minimising the preventive and corrective maintenance costs.

This study has also obtained the optimal maintenance cost by means of cost saving through implementing an opportunistic maintenance policy in multi-component systems with a relationship of stochastic economic dependency. For this purpose, this work was based on two stages: (i) an imperfect preventive maintenance model based on two different maintenance policies (periodic block-type maintenance and age-based maintenance); and (ii) a clustering method for maintenance actions in order to decrease the total maintenance cost in complex systems.

This work assumes that a system is composed by multiple sets of components, each set can include the same type of components, but the components are non-identical (e.g. the set of detachable grips are composed by sixty components, but each component has its own working rate variation due to different operating conditions within the system). Furthermore, this chapter develops a maintenance model, which considers the effects under multiple types of independent degradation processes to each grouped component.

Maintenance managers of transport systems follow the maintenance policy established by the international regulation of passenger aerial cable cars, which considers a single maintenance policy (periodic block-type maintenance) during the whole working-life cycle. This work proves that the appropriate strategy is to consider both policies and to apply the correct one according to the lifetime of the system in order to reach the optimal maintenance cost, i.e. to consider a strategy with an isolated maintenance policy is not the most sensible strategy.

The proposed optimisation model has been performed on a passenger urban aerial ropeway transport system, which consist of a set of 426 components, wherein the problem was solved and the results were obtained using an acceptable time computing resource (1 h and 30 min. approx.). Note that the optimisation model was numerically solved using affordable resources: (i) the algorithms was developed in a high-level programming language –MATLAB–; and (ii) the data was run on a processor Intel Core i7 CPU @ 2.93 GHz 3.07 GHz, 64 bits, 16 GB RAM.

Future research will focus on the following two major aspects: (i) it is possible to propose other study, in which broaden different relationships of the cost-efficiency function for maintenance actions –polynomial functions, hyperbolic functions, exponential function, etc.–, where an analysis of the system characteristic and its implications is considered; this work only has considered a linear function for the relationship of maintenance costs (C_1 and C_2) and the efficiency of its maintenance action; (ii) $\beta_{j,\eta}$ could be estimated through artificial intelligence methods (e.g. fuzzy logic) considering the maintenance manager could quantify these operative actions according to the planning and scheduling because in this work $\beta_{j,\eta}$ was defined as uncertainty factor given its stochastic hazard rate relation to human and technical uncertainty; and (iii) it is possible to propose a further analysis that includes the social and environmental costs, so an approximation to a sustainability model is established; this work only provides an analysis from the company profit perspective.

Cette page a été intentionnellement laissée en blanche

Chapter 4:

Service policy optimisation based on demand interdependencies

Authors: R.M. Martinod, O. Bistorin, L.F. Castañeda, N. Rezg
Original title: Multi-modal urban transport network: Service policy optimisation based on passenger demand interdependencies
Journal: Journal of Traffic and Transportation Engineering (English Edition) / under reviewing
Submission date: December 2020 [1st review]

Classification according to SCImago Journal Rank (SJR)

Sub-categories: Transportation (Q2) – Civil and structural engineering (Q2)

H-index(2019): 20

SJR(2019): 0,593

CS (CiteScore): 4,3

SNIP: 1,834

Abstract

This work introduces a stochastic optimisation method for public multi-modal urban transport networks focused on passenger demand analysis to solve the problem of passengers waiting costs involved in transport operation. This work is based on (i) a service policy model for metro and urban cableways, (ii) a numeric model of a multi-modal network considering interdependencies and asymmetries of passengers, and (iii) a process for optimizing the passengers waiting time cost. This work is applied to an actual multi-modal network, which is changing the service configuration following integration of new transport line.

4.1. Introduction

Transport planning has seen a heightened interest in multi-modal urban transport to increase the mobility of commuters (Lee & Miller, 2017). Urban Transport Modes (UTMs) are connected to each other at specific points via transfer stations, providing a multi-modal service for users. Using different UTMs for a single trip can reduce the total cost of a journey compared to the one produced by a single mode journey (Gebhardt, et al., 2016).

From literature review three types of relationships between different UTMs were identified (Hong, Yan, Ouyang, Tian, & He, 2017; Cleophas, Cottrill, Ehmke, & Tierney, 2019): (i) competition, e.g., the railway network of France (SNCF) and the France airline routes; (ii) complementary, which is a service between two independent and autonomous transport modes, e.g., shuttle service between a city centre and a quayside; and (iii) collaborative, e.g., a coalition of freight transport carriers. Almost all the previous works have referred the competition and complementary relationships (Van der Weijde, Erik, Verhoef, & Van den Berg, 2013). However, complementary relationships have received far less academic attention; one exception are studies on decision support in Multi-modal Transport Networks (MTNs) (Sørensen, Vanovermeire, & Busschaert, 2012). Analysis of the collaborative relationship makes it necessary to simultaneously consider multiple UTMs, with each UTM belongs to by an MTN (Hong, Yan, Ouyang, Tian, & He, 2017).

The collaborative relationship is considered in this work because this study focuses on the optimisation of service policy from different UTMs in single journey. Taking a Multi-modal Collaborative Public Transport System (MCPTS) perspective assumes that any transport network is more than the sum of its UTMs (Paulsson, et al., 2018). UTMs within the network need to agree upon the required means to provide public transport. But each individual transport mode might still have different operational conditions and constraints, resources, and capacity, which can lead to conflicting interests. Collaborative transport involves a linked-work transportation network, in which the different operational and service policies of each UTM are integrated; as example, (i) a synchronisation between arrival and departure times becomes important in a multi-modal transfer station, research studies (Ceder, Public transit planning and operation: theory, modeling and practice, 2007) have shown evidence that users of UTM are negatively inclined to transfer if it involves uncertain waiting time, (ii) the flow of users for a UTM is accommodated by another one, and (iii) the service quality of a UTM not being affected by the service of another one.

The connection between UTMs has been analysed to identify the MTN. Urban multi-modal stations adhere to the following accessibility characteristics (Lei & Church, 2010): (i) distance-based accessibility, which is related to the passengers walking distance, and as such, defined by the longest walking distance that passengers accept to transfer from one UTM to another; (ii) topology-based accessibility, which focuses on the physical connectivity between the stations of UTMs, the stations connectivity is broken in the case that elements block the flow of passengers between the stations, such a river, cliff, highway, building, etc.; and (iii) time-based accessibility, which is related to the time passengers spend transferring between the UTMs. The methods to quantify the accessibility characteristics of UTMs have been discussed in research works (Adjetej-Bahun, Birregah, & Planchet, 2016).

UTMs are characterized by a service with batch boarding and bulk queueing. For this reason, the queueing process of MTNs has two elements: (i) passengers go from an UTM to another by batches, i.e., the users arrive in groups, not individually, and (ii) the service has a bulking pattern because the provided service is a mass transport. MCPTSs undergo a high passengers flow in one direction over rush hours (i.e., people going to work, students going to schools, etc.), which generates an asymmetric passengers' demand for each UTM. Moreover, the asymmetric demand is considered into this work due to the layout of cities and commuting. We give special attention to this urban transport characteristic in this study given the connection between living areas and work zones (industrial, academic, business and financial) that is typical of cities.

An efficient service must consider the total passengers waiting time (including entrance into the installation area and the service time as well), but in the overall operation, decreasing the Passenger Waiting Time (PWT) increases the service cost due to increase the service capacity of the transport mode. Efficient passenger flow is a key goal for urban transport operators. PWT should be considered for an efficient transport service; but, if PWT decreases, the cost of operational actions increases. In this work, an optimisation of service policy is developed for MCPTSs based on the interdependencies of passenger demand. For the remainder of this work, the term service policy refers to the set of operational parameters which affect the passenger service such as number of service vehicles, nominal vehicles' speed, load capacity of the vehicles, distance between the vehicles, opened door time period of the vehicle at the platforms.

The objective is to minimise the waiting costs for passengers and the long-term cost of operational actions. Main contributions of this work can be summarised as follows:

- (i) this is the first work that focuses on urban aerial cableway systems connected to an MTN to solve the problem of queueing with special orientation to mass transport service;
- (ii) this work presents a stochastic model for considering interdependencies and asymmetries of passenger demand on MCPTSs; and
- (iii) this work proposes an optimisation method for passenger waiting cost, which is formulated based on the demand analysis.

The remainder of this chapter is organised as follows: Section 4.2 exposes the queuing theory for MTN framework applied to the operation of two different UTMs –metro and cableway–. A

stochastic optimisation model of MCPTSs in order to obtain the optimal service is developed in Section 4.3. Section 4.4 presents an application of the model using a numeric example focused on a passenger facilitation process that was performed at an MTN, which consists of a collaborative relationship between metro and cableway lines. Finally, Section 4.5 discusses the results of the research. Abbreviations, indices and parameters used in this work are detailed in Table 4.1.

Table 4.1. Abbreviations, indices and parameters used throughout this work.

Abbreviations and indices:

BDP:	Boarding and Disembarking Process;
MCPTS:	Multi-modal Collaborative Public Transport System;
MTN:	Multi-modal Transport Network;
ODA:	Origin and Destination Analysis;
PTT:	Passenger Travel Time;
PWT:	Passenger Waiting Time;
UACS:	Urban Aerial Cableway System;
UTM:	Urban Transport Mode;
$i = \{1, 2, \dots, I\}$	set of UTM's belong to a MCPTS;
$j = \{1, 2, \dots, 2J\}$	set of platforms in an UTM;
$k = \{1, 2, \dots, K\}$	set of in-service vehicles belonging to an UTM;
$m = \{1, 2, \dots\}$	indices of the user demand conditions from rush hour to valley hour;
$n = \{1, 2, \dots, N\}$	indices of discretised time by events;
$q = \{1, 2, 3, 4\}$	comfort level in a vehicle, where: $q = 1$, best quality ride; $q = 2$, good comfort level; $q = 3$, acceptable comfort level; and, $q = 4$, low comfort level;

Operational parameters:

$f_{j,i,n}$	Real frequency of vehicle arrival at the j th platform belonging to the i th UTM [min^{-1}];
$fs_{j,i,n}$	stochastic frequency variation of $f_{j,i,n}$ due to the operational effect at the j th platform, belonging to the i th UTM [min^{-1}];
$g_{k,i,n}$	occupied places of the k th vehicle belonging to the i th UTM [pax];
$Lq_{j,i,n}$	number of queued users on the j th platform belonging to the i th UTM [pax];
$Pa_{j,i,n}$	probability function (compound Poisson distribution) of passenger arrival on the j th platform belonging to the i th UTM;
$Pe_{j,i,n}$	probability function (compound Poisson distribution) of passengers that leave the vehicle on the j th platform belonging to the i th UTM;
$\alpha_{j,i,n}$	stochastic time variation of vehicle arrival at the j th platform, with respect to the frequency policy of the i th UTM [min];
$\beta_{j,i,n}$	stochastic index (compound Poisson distribution) for defining the subset of passengers that could disembark from the set of passengers that wish to disembark onto the j th platform with respect to the frequency policy of the i th UTM.
$\delta_{j,i,n}$	stochastic index (compound Poisson distribution) for defining the subset of boarding passengers onto a UTM from the set of disembarking passengers of another UTM (i.e., it represents the fraction of passengers who are transferring between two different UTM's using a transfer station);
$\varphi_{j,i,n}$	flow rate capacity of passengers crossing the doors onto and out of a vehicle at the j th platform, belonging to the i th UTM [pax/min];
$\tau_{i,n}$	time of vehicle arrival at the platforms belonging to the i th UTM [min].

Service policy parameters:

$cv_{k,i,q}$	Load capacity of the k th vehicle belonging to the i th UTM with a q th comfort level [pax];
$dv_{i,n}$	vehicle density of the i th UTM [veh/m];
$fv_{i,n}$	service policy of the vehicle frequency belonging to the i th UTM [min^{-1}];
$lv_{k,i,n}$	distance between the k th vehicle belonging to the i th UTM [m];
$ts_{j,i,n}$	opened door time period of the vehicle at the j th platform belonging to the i th UTM [min];
$\lambda_{j,i,n}$	passenger arrival on the j th platform belonging to the i th UTM [pax];
$\mu_{j,i,n}$	passengers boarding at the j th platform belonging to the i th UTM [pax];
$\sigma_{j,i,n}$	passengers disembarking (i.e. performed services) onto the j th platform UTM [pax];
$\sigma'_{j,i,n}$	passengers wanting to disembark onto the j th platform belonging to the i th UTM [pax];

$\kappa_{j,i,n}$ passengers queueing up from another UTM [pax].

Optimisation parameters:

$[dl_i, du_i]$ Lower and upper limits of vehicle density belonging the i th UTM [veh/m], respectively;

$[fl_i, fu_i]$ lower and upper limits of vehicle frequency belonging to the i th UTM [min^{-1}], respectively;

C_i penalty cost for waiting time (i.e., monetary unit per minute) [mu/min];

Wg_i global mean passenger waiting time belonging to the i th UTM [min];

Wu_i upper limit of waiting time for passengers [min];

Γ_i cost function for waiting time belonging to the i th UTM [mu].

Decision variable:

$sv_{k,i,n}$ Nominal commercial speed of the k th vehicle belonging to the i th UTM [km/h].

4.2. Problem definition and methodology

Queueing models in transportation have traditionally been characterised as non-stationary systems (i.e., time varying systems). Some authors (Csikós, Charalambous, Farhadi, Kulcsár, & Wymeersch, 2017) have claimed that queues in transportation can be modelled by deterministic approaches because: (i) commuting generates demands of repetitive patterns and (ii) queues due to stochastic variations in inter-arrivals are assume as low order compared to queues formed by predictable demand patterns. However, nowadays, different authors (Nesheli, Ceder, & Liu, 2015) have demonstrated that the attributes of UTMs are stochastic (e.g., travel time, dwell time, passenger demand).

Queueing models on UTMs have been based on the theory of compound Poisson process. Previous studies (Barrena, Canca, Coelho, & Laporte, Exact formulations and algorithm for the train scheduling problem with dynamic demand, 2014) have focused on reducing PWT based on the passenger arrival process at stations with a compound Poisson process, this work is supported on the following context and assumptions:

Assumption 4.1. Each UTM belongs to a MCPTS network.

Assumption 4.2. Each transfer station of the MTN fulfils the requirements of the multi-modal urban terminals (the distance-based, the topology and the time accessibilities).

Assumption 4.3. The network of a MCPTS is characterised by batch arrivals and bulk service patterns relying on the compound Poisson distributions.

Assumption 4.4. If the vehicle capacity of belongs to a line of an UTM is lesser than the quantity of users who are waiting on platform, the transport operator will leave behind the extra passengers. The transport system has a limited and fixed capacity.

Remark 4.1. For clarity to the reader, we present the following definitions, which will be used throughout this work. Transfer station refers to a station or terminal where two UTMs are integrated within an MTN. Moreover, for the remainder of this chapter, a person being inside a vehicle will be referred to as passenger; all other actors will be referred to as users (e.g., a person in a queue or arriving into a station).

A characteristic of mainline railways or high-speed trains concerns to the trip planning for passengers according to the given timetable; thus, passengers are attentive to vehicle schedules. However, the assessing PWT in an UTM is directly influenced by the complex passenger flow characteristics through a day-long planning horizon. Passengers in an UTM usually do not care about vehicle timetables before their trips; this leads to the evident dynamic (or time-variant) features of passenger demands (Freyss, Giesen, & Munoz, 2013).

For establishing the operational management of UTMs, this work analyses the transport demand to evaluate the proper service oriented to users, based on the fact that the queuing theory allows to evaluate the quality of service concerning the requested services. The probability function of passenger arrivals on the j th platform belonging to the i th UTM behaves as a probability function based on Poisson compound distribution $Pa_{j,i,n}$. Moreover, these discrete-

type stochastic distributions take values from a finite set of events, this attribute is useful because it allows to analyse the quantity of users in a time period. Given $Pa_{j,i,n}$ as a probability function of discrete-time, the sequence $n = \{1, 2, \dots, N\}$, $\forall n \in t$, is defined as the time sequence between successive events.

An appropriate service policy for UTMs includes a passenger-centric timetable to reduce the PWT (Niu & Zhou, 2013). Some researches of passenger-oriented timetables (Cordone & Redaelli, 2011) focus on the design of a periodic schedule throughout the planning horizon, by which the vehicles schedules are repeated in every time interval (e.g., *3h*, *2days*, *1week*). The periodic timetable model is formulated based on a periodic event scheduling problem, and it can yield the minimum PWT in case of constant demands (Barrena, Canca, Coelho, & Laporte, Single-line rail transit timetabling under dynamic passenger demand, 2014).

Given an i th UTM consisting of a bi-directional line with J stations and platforms designated as $j = \{1, 2, \dots, 2J\}$, where the start terminal and return terminal are indexed as station 1 and station J , respectively (see Appendix D, Figure D.1(a)); the group of service trains is denoted as $k = \{1, 2, \dots, K\}$, which begin the journey at their platform 1 in counter-clockwise direction until reaching platform J ; then, after a given turn-around time at the turnaround terminal, the vehicles return to the origin terminal and finish their journey at the platform $2J$. Hereafter, they begin the next journey cycle. Our analysis considers the general operational characteristics of MTNs, and in particular two types of service policies for UTMs:

4.2.1. Service policy model for metro transport systems

Using the intrinsic characteristic of the services in metro systems that states that the vehicles will arrive at the j th platform close to the boarding time, which is established by the frequency of the service policy, $fv_{i,n}$; the general service policy of a metro system defines a frequency of service on platforms. This relies on the passenger demand. From the point of view of a user in the queue on a platform of metro system, the frequency of trains is almost constant (e.g., every 3 minutes), i.e., the time of train arrivals at the j th platform is $\tau_{i,n} - \tau_{i,n-1} \approx fv_{i,n}^{-1}$; therefore, the discrete-events n are considered as non-linearly spaced.

Remark 4.3. If the service of metro system is provided during the rush hour period, $fv_{i,n}$ will have a high value; but if the service of metro system is provided during the off-rush hour period, $fv_{i,n}$ will have a low value.

Remark 4.4. In the context of operations management, the real frequency of arrival vehicles, $f_{j,i,n}$, should be equivalent to $fv_{i,n}$ from the point of view of an operation manager, but there are operational effects (e.g., technical conditions of the track and the vehicle, driver experience, weather, etc.) that produce a stochastic time variation, $\alpha_{j,i,n}$, in relation to the established service policy frequency.

Proposition 4.1. *The frequency of vehicle arrival at the j th platform over the n th discretised time are expressed as*

$$f_{j,i,n} = fv_{i,n}(\alpha_{j,i,n} fv_{i,n} + 1)^{-1}. \quad (4.1)$$

Proof 4.1. By definition, the reciprocal of $f_{j,i,n}$ is equivalent to the reciprocal of $fv_{i,n}$ added the reciprocal of the stochastic frequency variation by the operational effects, $fs_{j,i,n}$; then

$$f_{j,i,n}^{-1} = fv_{i,n}^{-1} + fs_{j,i,n}^{-1}. \quad (4.2)$$

The stochastic time variation of a vehicle arrival at the j th platform can be expressed as $\alpha_{j,i,n} = fs_{j,i,n}^{-1}$, and after some algebraic manipulations this proposition is proven. \square

The service policy proposed here is related to the discrete-event model based on a boarding and disembarking processes (BDPs) for a single-platform station (see Figure 4.1). In these processes, the vehicle arrives at the platform and stops a period of time with opened doors, $ts_{j,i,n}$, and the opened doors have a flow rate capacity of passengers moving through the doors $\varphi_{j,i,n}$ (into and out of the vehicle). Therefore, there is a quantity of passengers that want to leave the vehicle, $\sigma'_{j,i,n}$; however, these could be a fraction of passengers that want to leave and are able to disembark, $\sigma_{j,i,n}$, i.e. $\sigma'_{j,i,n} \geq \sigma_{j,i,n}$, due to the relation of passenger flow $\varphi_{j,i,n}$ $ts_{j,i,n}$.

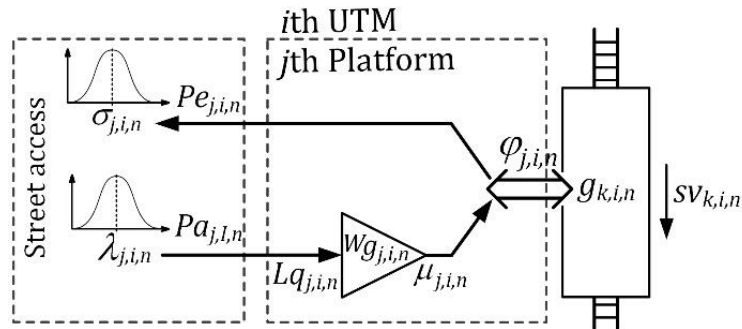

Figure 4.1. Metro queuing model of a single platform.

Remark 4.5. The $ts_{j,i,n}$ value is an adaptable operational parameter that relies on the demand of passengers. The passenger demand increases progressively until rush hour; and then, declines during the off-rush hour. Therefore, passenger flow through the vehicle doors varies according to the user demand.

This work identifies two different service policies for BDPs:

4.2.1.1. Disciplined BDP

This is a well-organised process (e.g., Tokyo railway system) which relies on two stages and is executed at each single event n (see Appendix E, Algorithm E.1, lines 19-35):

In the first stage, passengers that arrive at their destination want to pass from the vehicle to the platform, $\sigma'_{j,i,n}$. This stage is defined as a probability function $P e_{j,i,n}(\sigma'_{j-1,i,n-1} - \sigma_{j-1,i,n-1} \leq \sigma'_{j,i,n} \leq g_{k,i,n-1})$ (see Appendix E, Algorithm E.1, line 17), where the expression $\sigma'_{j-1,i,n-1} - \sigma_{j-1,i,n-1}$ represents the quantity of passengers who wish to disembark from the vehicle at the previous platform but could not and $g_{k,i,n-1}$ is the quantity of occupied places inside the vehicle. The quantity of passengers that is able to disembark is (see Figure 4.2(a))

$$\sigma_{j,i,n} = \min(\varphi_{j,i,n} ts_{j,i,n}, \sigma'_{j,i,n}) \quad (4.3)$$

In the second stage, some users in queue board the vehicle, $\mu_{j,i,n}$, during the remaining time of the boarding process (see Figure 4.2(b-d)). Therefore, the users in queue must wait for the passengers leaving the vehicle. The number of users in queue boarding the vehicle is expressed as (see Appendix E, Algorithm E.1, lines 24, 29 and 34)

$$\mu_{j,i,n} = \begin{cases} 0 & ; \text{if } \sigma_{j,i,n} \geq \varphi_{j,i,n} ts_{j,i,n} \\ \min(\varphi_{j,i,n} ts_{j,i,n} - \sigma_{j,i,n}, Lq_{j,i,n-1}, cv_{k,i,q} - g_{k,i,n-1} - \sigma_{j,i,n}) & ; \text{if } \sigma_{j,i,n} < \varphi_{j,i,n} ts_{j,i,n} \end{cases} \quad (4.4)$$

where $cv_{k,i,p}$ is the load capacity of the vehicle (i.e., $cv_{k,i,q} - g_{k,i,n-1}$ represents the quantity of available places remaining in the vehicle). The $cv_{k,i,q}$ value is established by the transport manager through the service policy, where $q = \{1,2,3,4\}$ represents the comfort level inside the vehicle: (i) $cv_{k,i,q=1}$ is the best quality ride regarding the comfort level, which only seating places are available inside the vehicle (e.g., Venice Simplon-Orient-Express, Trans-Siberian railway,

and Bernina Express); (ii) $cv_{k,i,q=2}$ is the quality ride with good comfort level, which the seating places and standing up places on the corridor of the vehicle are allowed, e.g., the railway of high speed of France (TGV); (iii) $cv_{k,i,q=3}$ is an acceptable comfort level, which in addition to the seating and stand-room only places in the corridor, standing up places between vehicles are allowed (e.g., Singapore metro system); and (iv) $cv_{k,i,q=4}$ is a low comfort level, which is defined by the physical space capacity inside the vehicle to carry passengers, e.g., New York or Tokyo metro systems (during rush hours).

Remark 4.6. In this stage, we can analyse three cases: (i) the open-doors time is shorter in relation to the number of users in the queue to board (see Figure 4.2(b)), then, some users in the queue must wait for the next vehicle to board, i.e., $\sigma_{j,i,n} < \varphi_{j,i,n} ts_{j,i,n}$ and $\mu_{j,i,n} = \varphi_{j,i,n} ts_{j,i,n} - \sigma_{j,i,n}$ (see Appendix E, Algorithm E.1, lines 25-29); (ii) there is enough open-doors time for all users in the queue to board (see Figure 4.2 (c)), i.e., $\sigma_{j,i,n} < \varphi_{j,i,n} ts_{j,i,n}$ and $\mu_{j,i,n} = Lq_{j,i,n}$; and (iii) there is enough open-doors time for all users in the queue to board, but there are fewer available places in the vehicle than users in the queue (see Figure 4.2(d)), then, some users in the queue must wait the next vehicle to board, i.e., $\sigma_{j,i,n} < \varphi_{j,i,n} ts_{j,i,n}$ and $\mu_{j,i,n} = cv_{k,i,q} - g_{k,i,n-1} - \sigma_{j,i,n}$ (see Appendix E, Algorithm E.1, lines 31-34).

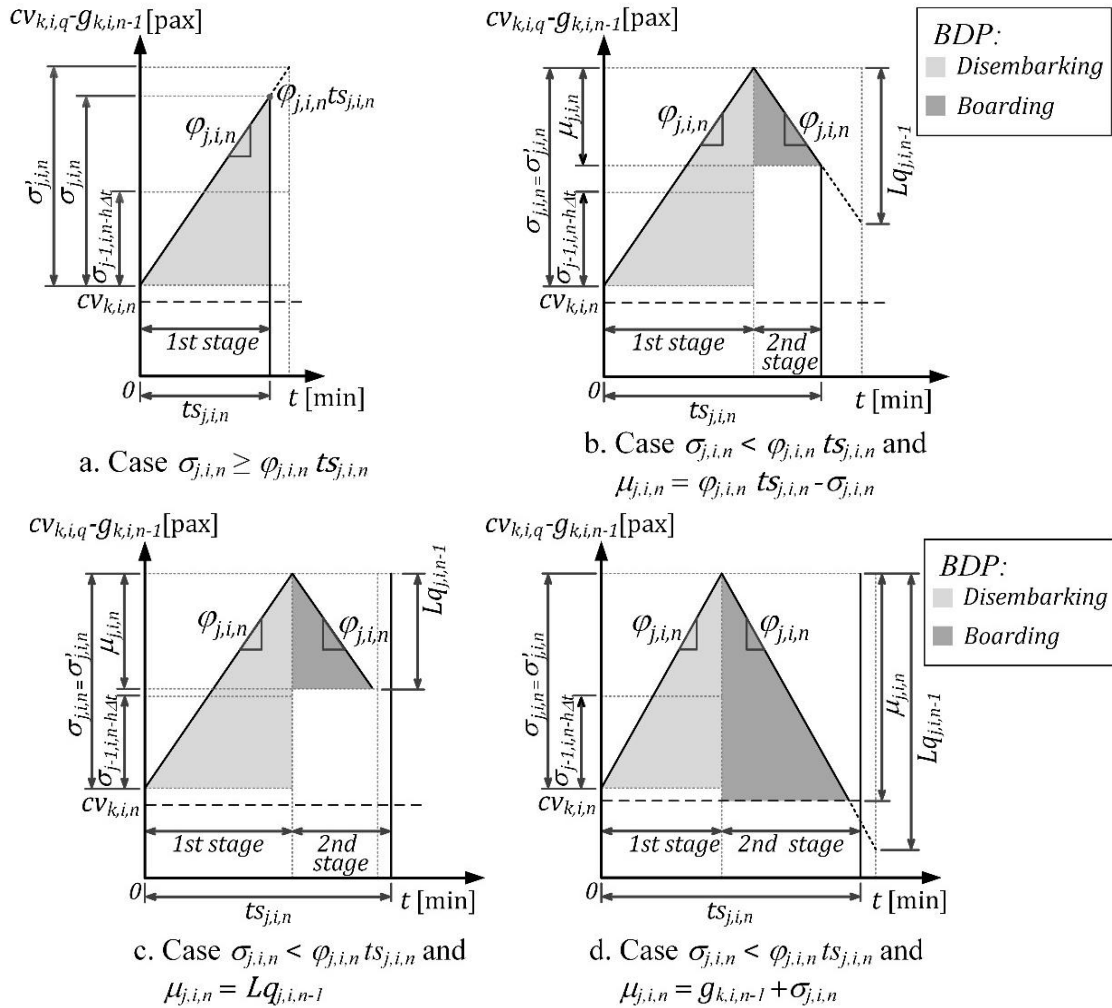

Figure 4.2. Behaviour diagram of available places in the vehicle for disciplined BDP.

4.2.1.2. Informal BDP

This is a disorganised process (e.g., Paris metro system), in which both flows of passengers ($\sigma_{j,i,n}$, $\mu_{j,i,n}$) try to cross the doors simultaneously. Let $Pe_{j,i,n}(\sigma'_{j-1,i,n-1} - \sigma_{j-1,i,n-1} \leq \sigma'_{j,i,n} \leq$

$g_{k,i,n-1}$) be the probability function of passengers that want to leave the vehicle, but due to the cross-flow of passengers (i.e., onto and out of the vehicle) some of them can disembark but others cannot (see Appendix E, Algorithm E.1, line 17); thus, $\sigma_{j,i,n}$ is defined through a hazard rate model. This means that on the previous platform ($j-1$) and over the event ($n-1$). This is expressed as $\sigma_{j-1,i,n-1} = \beta_{j-1,i,n-1} \sigma'_{j-1,i,n-1}$, where $\beta_{j-1,i,n-1}$ is a stochastic index, which is a compound Poisson distribution with the range of $0 \leq \beta_{j-1,i,n-1} \leq 1$; therefore, $\sigma_{j,i,n}$ is expressed as (see Appendix E, Algorithm E.1, lines 40 and 46)

$$\sigma_{j,i,n} = \beta_{j,i,n} (\sigma'_{j,i,n} + (1 - \beta_{j-1,i,n-1}) \sigma'_{j-1,i,n-1}), \quad (4.5)$$

where $0 \leq \beta_{j,i,n} < 1$ if $\sigma'_{j,i,n} + Lq_{j,i,n-1} \geq \varphi_{j,i,n} ts_{j,i,n}$, in the case that the pen-doors time is short in relation to the quantity of passengers wishing to disembark and users in queue for board (see Figure 4.3a; Appendix E, Algorithm E.1, lines 38-42); and $\beta_{j,i,n} = 1$ in the following two cases: (i) the open-doors time is long enough for all passengers to embark and disembark (see Figure 4.3.b), i.e., $\sigma'_{j,i,n} + Lq_{j,i,n-1} \leq \varphi_{j,i,n} ts_{j,i,n}$ and $\mu_{j,i,n} = Lq_{j,i,n-1}$; and (ii) the open-doors time is long enough as well, but there are fewer available places in the vehicle than users in queue (see Figure 4.3.c), i.e., $\sigma'_{j,i,n} + Lq_{j,i,n-1} \leq \varphi_{j,i,n} ts_{j,i,n}$ and $\mu_{j,i,n} = g_{k,i,n-1} + \sigma_{j,i,n}$ (see Appendix E, Algorithm E.1, lines 45-48). The term $(1 - \beta_{j-1,i,n-1}) \sigma'_{j-1,i,n-1}$ represents the number of passengers that have not been able to disembark from the vehicle on the previous platform, which increases the $\sigma_{j,i,n}$ value; as a result, the number of passengers that want to leave the vehicle over the event n is increased by the passengers that have not been able to disembark from the vehicle during the event ($n-1$) at the previous platform. The users in queue, who are boarding the vehicle in an informal BDP are expressed as (see Appendix E, Algorithm E.1, lines 48 and 48)

$$\mu_{j,i,n} = \begin{cases} \varphi_{j,i,n} ts_{j,i,n} - \sigma_{j,i,n} & ; \text{if } \sigma'_{j,i,n} + Lq_{j,i,n-1} \geq \varphi_{j,i,n} ts_{j,i,n} \\ \min(Lq_{j,i,n-1}, cv_{k,i,q} - g_{k,i,n-1} - \sigma_{j,i,n}) & ; \text{if } \sigma'_{j,i,n} + Lq_{j,i,n-1} < \varphi_{j,i,n} ts_{j,i,n} \end{cases} \quad (4.6)$$

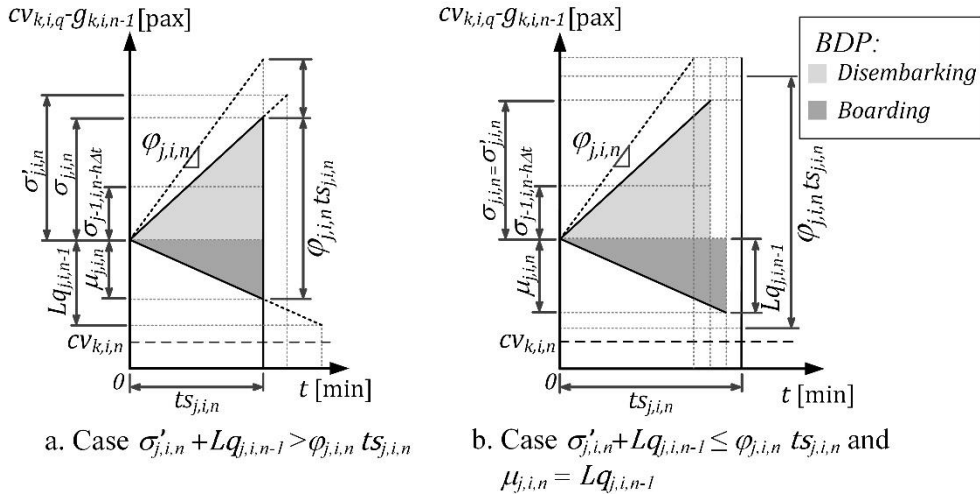

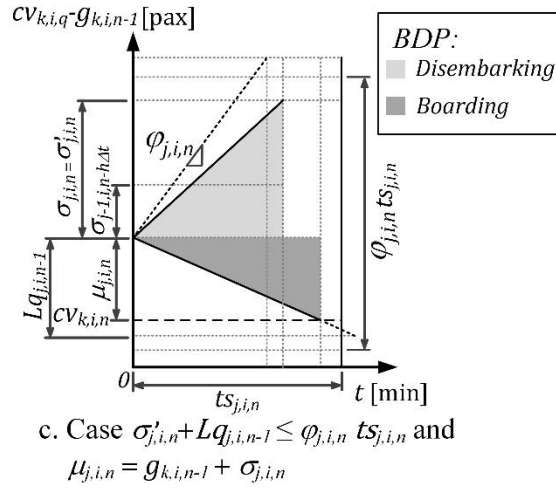

Figure 4.3. Behaviour diagram of available places in the vehicle for Informal BDP.

2.2. Service policy model for urban aerial cableway systems

Let us consider the i th UTM consisting of an Urban Aerial Cableway System (UACS) with a pulling cable revolving constantly in one direction (see Appendix D, Fig. D.1(b)), to which the vehicles are attached when they are travelling, there are a set of features that need to be considered. These features allow for the vehicles to be set at regularly spaced close intervals and a frequency of arrival vehicles fixed. According to the general characteristics of UACSs, their service policy is based on the following particularities: (i) in cities with hilly urban environment, where residential areas are located on the top of the hills; (ii) passengers arriving at the cableway station to descend to downtown or connect to other UTM by means of a transfer station on the bottom of the hill; (iii) the upper stations is characterised by having easy on-street access; (iv) passengers who do not use other UTM before arriving at the upper UACS; and (v) a system in which the operator may behind some passengers whenever the capacity of the transport mode is less than the number of users waiting.

For UACSs model, the event relies on the arriving of vehicles at the platforms, using an operative characteristic of UACS (the pulling cable synchronises the vehicles; then, the value $sv_{k,i,n}$ is constant for each different operation periods), the service policy of the vehicle frequency also has a constant value, $fv_{i,n}^{-1} = \tau_{i,n} - \tau_{i,n-1} = lv_{k,i,n} sv_{k,i,n}^{-1}$, and the stochastic time variation of vehicle arrivals is null, $\alpha_{j,i,n} \cong 0$. Consequently, the real frequency of vehicle arrivals at the platforms is equivalent to the service policy of the vehicle frequency, $f_{j,i,n} = fv_{i,n}$.

Let $Pe_{j,i,n}(\sigma_{j-1,i,n-1} \leq \sigma'_{j,i,n} \leq g_{k,i,n-1})$ be the probability function of passengers that wish to disembark; thus, the generalised BDP policy for UACSs is executed in two different discrete-events (see Figure 4.4): in the event $(n-1)$, passengers leave the vehicle, and at next event (n) , queued users at the platform board onto the vehicle. According to the queuing model, $\mu_{j,i,n}$ is defined as (see Appendix E, Algorithm E.2)

$$\mu_{j,i,n} = \min(Lq_{j,i,n-1}, cv_{k,i,q} - g_{k,i,n-1}); \quad \forall i \in UARS \quad (4.7)$$

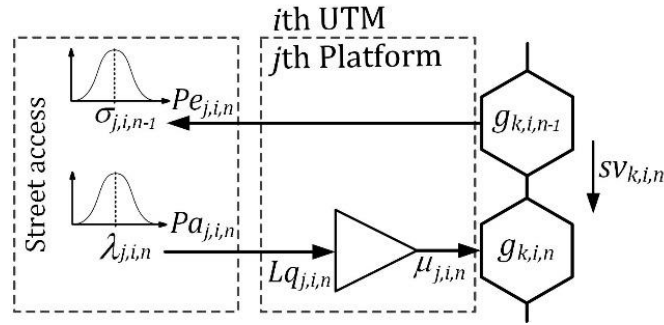

Figure 4.4. UACS queuing model for a single platform.

4.2.2. Service model for MCPTSs

The discrete service model used for MCPTSs is comprised of a set of interrelated queues, where $\kappa_{j,i,n}$ defines the relationship between the queuing users and the different UTM's (see Figure 4.5). This work analyses two types of interrelated queues that could arise in MCPTSs:

- (i) Some passengers disembarking from the UACS at a transfer terminal to transfer to the metro system, i.e., $\delta_{j,i+1,n} \sigma_{j,i+1,n}$, where $\delta_{j,i+1,n}$ is a stochastic index $0 \leq \delta_{j,i+1,n} \leq 1$, which represents the fraction of $\sigma_{j,i+1,n}$ disembarking from the UACS to board the metro system. Later, a subset of $(\delta_{j,i+1,n} \sigma_{j,i+1,n})$ chooses to board at j th platform of the metro system, i.e., $\delta_{j,i,n} (\delta_{j,i+1,n} \sigma_{j,i+1,n})$, where $0 \leq \delta_{j,i,n} \leq 1$. Therefore, the expression of $\kappa_{j,i,n}$ at the j th platform of the metro system is expressed as

$$\kappa_{j,i,n} = \begin{cases} 0 & ; \forall j \text{ if } u = 0 \\ \delta_{j,i,n} \delta_{j,i+1,n} \sigma_{j,i+1,n} & ; \forall j \text{ if } u = 1 \end{cases} \quad (4.8)$$

where i represents the metro system and $(i + 1)$ represents the UACS, with $u = 0$ in the case that j be a single station (see Figure 4.1 and Figure 4.4), and $u = 1$ in the case that j be a platform belonging to a transfer station.

On the other hand, the remaining subset of users chooses the opposite platform traveling in the $(2J - j)$ direction; then, the expression is

$$\kappa_{2J-j,i,n} = \begin{cases} 0 & ; \forall j \text{ if } u = 0 \\ ((1 - \delta_{j,i,n}) \delta_{j,i+1,n} \sigma_{j,i+1,n}) & ; \forall j \text{ if } u = 1 \end{cases} \quad (4.9)$$

- (ii) Some passengers disembarking from both platforms of the metro system at a transfer station to transfer to the UACS; then

$$\kappa_{j,i+1,n} = \begin{cases} 0 & ; \forall j \text{ if } u = 0 \\ \delta_{j,i,n} \sigma_{j,i,n} + \delta_{2J-j,i,n} \sigma_{2J-j,i,n} & ; \forall j \text{ if } u = 1 \end{cases} \quad (4.10)$$

where i represents the metro system and $(i + 1)$ represents the UACS, with $u = 0$ if j is a single station and $u = 1$ if j is a transfer station.

Remark 4.7. Note that some passengers can disembark from a metro vehicle onto a platform (e.g. j th platform) to change the direction of their journey (e.g. $2J - j$ th platform). However, this model assumes that the passengers leave the platform (e.g. j th platform) and, later, they arrive at another platform (e.g. $2J - j$ th platform) via a street access for the simplicity of the model.

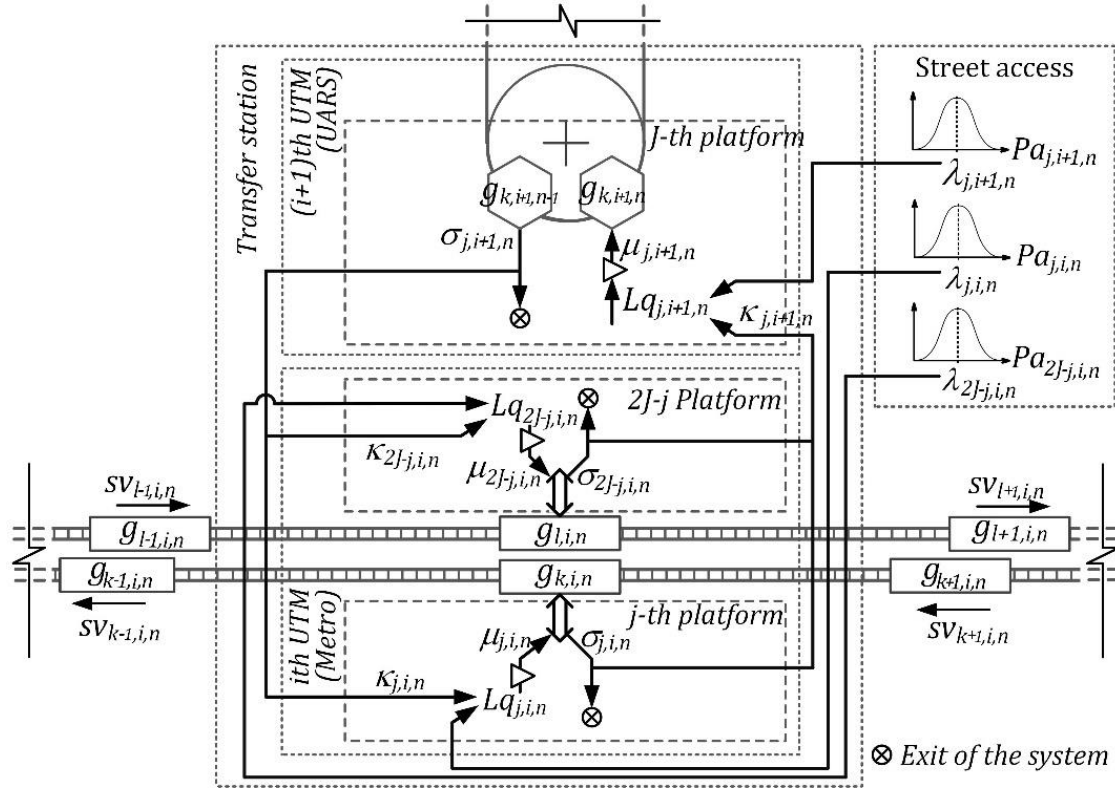

Figure 4.5. Transfer station of MCPTS (metro-UACS).

4.2.3. Queuing model for MCPTSs

The queuing model is based on a set of interdependent stochastic processes. Arriving users at the j th platform belonging to the i th UTM, over the n th instant of discretised time is denoted as $\lambda_{j,i,n}$, which merges with the number of users already queuing, $Lq_{j,i,n}$. According to the queuing model, the number of users queuing up at the j th platform is expressed as

$$Lq_{j,i,n} = Lq_{j,i,n-1} + \lambda_{j,i,n} + \kappa_{j,i,n} - \mu_{j,i,n}, \quad (4.11)$$

where $\kappa_{j,i,n}$ represents a set of users arriving from another UTM into the queue using a transfer station and $\mu_{j,i,n}$ is the users leaving from the queue.

Remark 4.8. From the point of view of a user in the queue, $Lq_{j,i,n}$, the vehicles in service have different and random sizes because the user is only interested in the available passenger spots inside the vehicle, $g_{k,i,n}$; therefore, the number of passengers that can board the vehicle depends directly on the service policy, which affects the amount of vacant spots on the arriving vehicle and the number of passengers disembarking from the vehicle, i.e. $\mu_{j,i,n}$ relies on $g_{k,i,n-1}$ and $\sigma_{j,i,n}$, respectively.

The discrete-event model tackles the passenger waiting time problem determining the global mean PWT, Wg_i . Therefore, this chapter introduced the inputs ($\lambda_{j,i,n}$, $\kappa_{j,i,n}$) and output ($\mu_{j,i,n}$) for developing the Wg_n value. The proposed model describes the queuing behaviour of a MCPTS comprised of a metro system and UACS (see Appendix A) by means of $Lq_{j,i,n}$, which is defined by the BDP service policy, $\mu_{j,i,n}$, $\kappa_{j,i,n}$, and $\sigma_{j,i,n}$. The formulation of the mean PWT for each UTM is expressed as

$$Wg_i = \sum_n \left(\mathcal{F}_i \sum_j \frac{Lq_{j,i,n}}{\mu_{j,i,n}} \right) \quad (4.12)$$

where $\mathcal{F}_i = f_{j,i,n}^{-1} \forall i \in (\text{metro})$ and $\mathcal{F}_i = (sv_{k,i,n} dv_{i,n})^{-1} \forall i \in (\text{UACS})$.

4.3. Optimisation process

A discrete-event formulation is built to obtain the queuing behaviour, in which the passengers: (i) request a service, $\lambda_{j,i,n}$; (ii) wait on platform, Wg_i ; (iii) board the vehicle; (iv) make the journey, $\mu_{j,i,n}$; and (v) disembark their last stop, $\sigma_{j,i,n}$. The discrete-event model aims to determinate the Wg_i value considering a set of interrelated queues. We propose a stochastic optimisation formulation for improving the service behaviour of MTN by means of the cause-effect relationship between the different service/operational policies for the MCPTs. There are two different approaches to quantify the service efficiency (Taha, 2011):

- (i) aspirational-level: the aim is obtaining an acceptable range for operational performance by specifying reasonable limits on the service policy. The limits represent the aspirational level. For instance, an operation manager may define an acceptable range for operational performance according to the level of occupied places in the vehicle during the commercial operation behaviour (e.g. $0,8 cv_{k,i,q} \leq g_{k,i,n} \leq cv_{k,i,q}$); and
- (ii) cost-based: cost-based: the aim is balancing the service costs and the PWT cost for UTM. These costs are in conflict because any change to service automatically affects PWT for the other interconnected modes.

This work proposes a cost-based approach to quantify the performance of the service policy for each UTM because this approach has an impact on the passengers' perceptions related to travel comfort (quality on the trip) and economic savings (PWT) as well; therefore, the cost-based approach represents a comprehensive study through a quantitative analysis, which focuses on user experience during the trip. The service policy is optimized by means of Wg_i cost minimisation, which represents the basis to assess the set of penalty costs for PWT to the i th UTM. The general relationship to describe the cost function for PWT is expressed as (see Figure 4.6)

$$\Gamma_i = f(Wg_i). \quad (4.13)$$

Methodologies to obtain Γ_i are fixed by UTM's operation managers. Each operation manager can set up different criteria to assess the penalty cost regarding to the service policy.

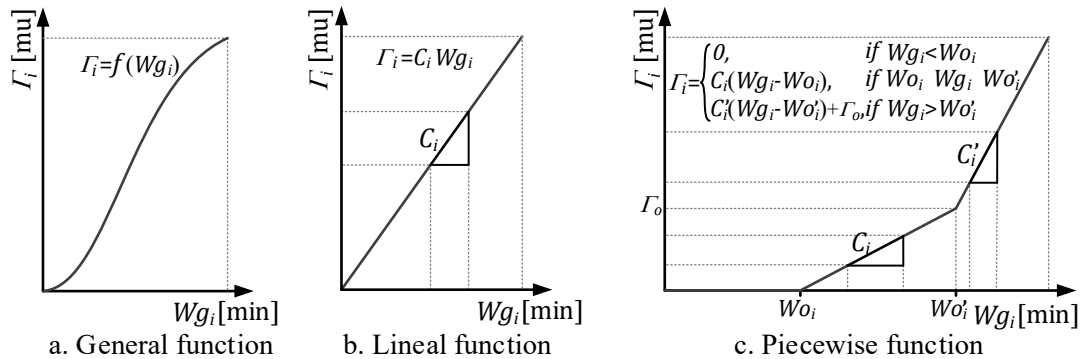

Figure 4.6. Definitions of cost functions for PWT.

Remark 4.9. If an operation manager defines a linear cost function, the relationship can be expressed as $\Gamma_i = C_i Wg_i$ (see Figure 4.6(b)), where the penalty cost for PWT is denoted as C_i [mu/min], and C_i has a different value according to the UTM (e.g., the penalty cost for waiting 15 minutes to get a five-days travel on Toronto-Prince Rupert train is different from the penalty cost for waiting the same period of time to get a 7 minutes journey on the New York subway). However, the operation manager can define a piecewise function (see Figure 4.6(c)), in which there is a minimum time where no penalty cost is produced (given a predictable PWT for this UTM). Nevertheless, if this initial time is overtaken, the penalty cost increases due to the PWT.

Therefore, the objective function related to the service policy cost can be expressed as

$$C^* = \min_n \sum_i \Gamma_i, \quad (4.14)$$

subject to the following constraints

$$0 \leq g_{k,i,n} \leq cv_{k,i,q}, \quad \forall k, i, n \quad (14.a)$$

$$0 \leq \mu_{j,i,n} \leq Lq_{j,i,n}, \quad \forall j, i, n \quad (14.b)$$

$$0 \leq \sigma_{j,i,n} \leq g_{k,i,n}, \quad \forall j, i, n \quad (14.c)$$

$$0 \leq \sigma'_{j,i,n} \leq \sigma_{j,i,n}, \quad \forall j, i, n \quad (14.d)$$

$$fl_i \leq f_{j,i,n} \leq fu_i, \quad \forall j, i, n \quad (14.e)$$

$$dl_i \leq dv_{i,n} \leq du_i, \quad \forall i, n \quad (14.f)$$

$$0 \leq Wg_i \leq Wu_i, \quad \forall i \quad (14.g)$$

$$\sum_{j,i,n} \lambda_{j,i,n} = \sum_{j,i,n} \sigma_{j,i,n}, \quad (14.h)$$

$$0 < k, j, i, n, \quad (14.i)$$

where:

- Eq. (14.a) expresses that the occupied places in the k th vehicle must be lesser than or equal to its capacity;
- Eq. (14.b) highlights that the number of passengers boarding the vehicle must be lesser than or equal to the number of users queuing up on the j th platform;
- Eq. (14.c) means that the number of passengers disembarking on the j th platform must be lesser than or equal to the number of passengers in the k th vehicle;
- Eq. (14.d) expresses that the number of arriving passengers at their last stop and wish to disembark, $\sigma'_{j,i,n}$, must be lesser than or equal to the number of the passengers actually disembark on the j th platform, $\sigma_{j,i,n}$;
- Eq. (14.e) the frequency of arrival vehicles at the j th platform is limited by an operational range $[fl_{i,n}, fu_{i,n}]$, i.e., it concerns to the operational condition;
- Eq. (14.f) the i th UTM have a range of vehicles in-service $[dl_i, du_i]$, i.e., it concerns to the operational condition;
- Eq. (14.g) Wu_i is the upper limit of the global PWT, i.e., it concerns to the service policy;
- Eq. (14.h) No one stays on any platform once the service is over.

An efficient service policy considers the different service time periods according to the demand condition of the users over the whole operational service time, $n = \{1, 2, \dots, N\}$ (e.g., a full working day). Therefore, the operational service time is classified by the demand condition during a subset of periods, $m = \{1, 2, \dots\}$. A high intensity of user demand occurs during peak hours if $m = 1$, and a low intensity of user demand occurs during out-rush hour if $\forall m \neq 1$ (see Figure 4.7).

The PWT cost problem is solved by means a two stages formulation: (i) an analysis focused on identifying the combination of the values $sv_{k,i,n}$, $dv_{i,n}$, and $cv_{k,i,q}$ that must be provided by the UTM to obtain $Wg_i = 0$, i.e., ensuring a service policy with null PWT cost, and (ii) an analysis focused on assessing the values of $sv_{k,i,n}$, $dv_{i,n}$, and $cv_{k,i,q}$ at which $Wg_i \leq Wu_i$, i.e., providing acceptable PWT cost according its service policy.

The stochastic model was developed using the Monte-Carlo method, which is used to tackle a range of problems referred to multiple probability simulations; thus, the resolution of the algorithm relies on a set of repeated probabilistic sampling to obtain numerical results. A set of combinatory simulation tests was developed to assess the projected commercial day, in which considered the following decision variables $\{sv_{k,i,n}\}$. The relationship between the different commercial speed levels of the MTN was expressed as $l_i sv_{k,i,n}$, where l_i is a proportional coefficient, with $l_i = \{0,5, \dots, 1,0\}$. The tests were performed based on the operation ranges of a

metro system $l_1 sv_{k,1,n} = \{76,5, \dots, 99\}$ [km/h], $l_2 sv_{k,2,n} = \{4,25, \dots, 5,5\}$ [m/s] for a first UACS, and $l_3 sv_{k,3,n} = \{4,67, \dots, 6,05\}$ [km/s] for a second UACS (i.e., $i = 1$ with a metro system—called *Línea A*—, and $i = \{2, 3\}$, with UACSs—called *Línea K* and *Línea P*— respectively). Thus, the quantity of combinatory simulation tests was 500 (5 different commercial speed conditions for *Línea A*, and 10 different speed conditions for both *Línea K* and *Línea P*). A convergence analysis was used to establish the quantity of simulations for each combination of the decision variables in the numeric model; therefore, a total of 21.000 simulations were running to achieve the stochastic model solution.

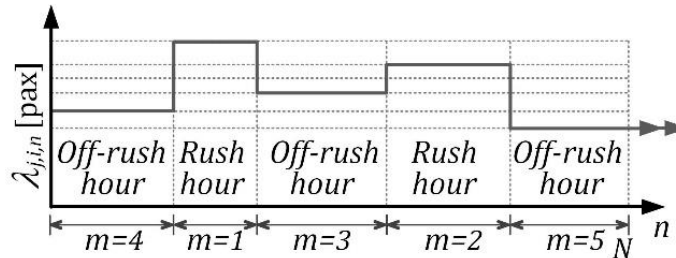

Figure 4.7. Commercial service time classified by demand conditions during a subset of periods.

4.4. Case study

Modern transport installations are integrated into a MCPTS at the metropolitan scale (Bergerhoff & Perschon J., 2012). UTM projects are linked to the MTNs by means of integrated transport lines (e.g. subway, bus, light rail, railway, cableway, etc.). UACS projects are usually connected to metro systems as a MCPTS. Two types of MCPTSs can be observed: (i) projects focused on large cities, wherein metro systems have been operating for decades and the UACS are introduced for complementing the existing metropolitan MTN, e.g., London (UK), Rio de Janeiro (Br), Medellín (Co), and (ii) projects focused on smaller cities such as Constantine (Dz) or Oran (Dz), wherein the UACS was introduced before tramway implementation. This application example focuses on a MCPTS, comprised of two AURS lines (*Línea K*, and *Línea P*) joined to a metro station belonging to the main metro line (*Línea A*) through a multi-modal transfer station, which is classified as large city project.

This case study is applied to passenger vehicles belonging to the MTN of Medellín city (Co) comprised of interconnected an AURS/metro system (see Figure 4.8), which have a transfer station for the multi-modal connection (called Acevedo station), see Figure 4.9. The collaborative relationship between the metro system and UACSs is a consequence of both systems belonging to the same transport operator (*Metro de Medellín Ltda.*).

Remark 4.10. If the walking distance between the metro platforms and the UACS platforms is no longer than the longest distance that passengers would be willing to walk, then these UTMs are defined as a MCPTS. In this case study, the transfer station is comprised of metro and UACS platforms directly integrated through civil infrastructure; thus, the MCPTS is established. The characteristics of each UTM are discussed hereafter.

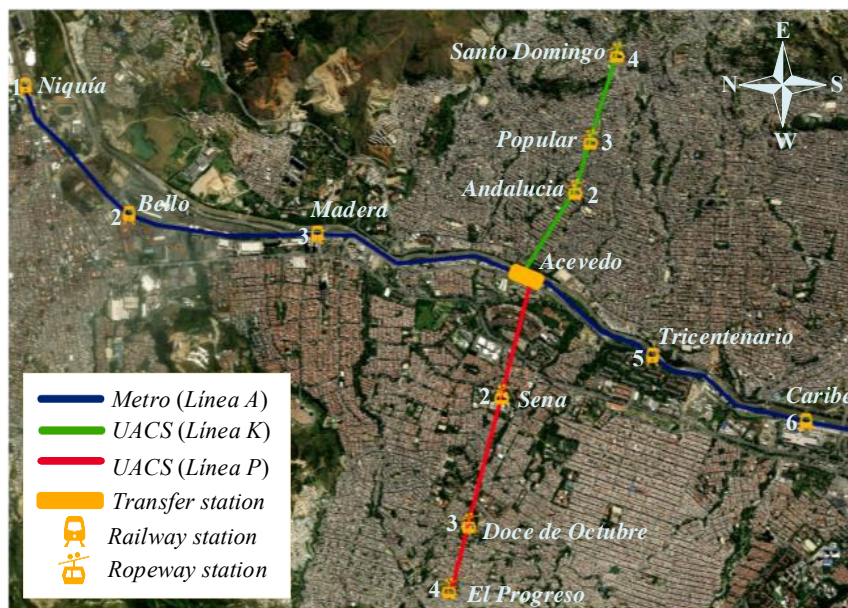

Figure 4.8. AUACS mode (Línea K, and Línea P) connected to the metro system (Línea A).



Figure 4.9. Multi-mode transfer station (Acevedo).

4.4.1. Background of the metro system

The metro line similar to suburban ET420 trains (Castañeda, Martinod, & Betancur, 2012), its vehicles in half-load conditions have $5,5\text{pax}/\text{m}^2$ and in full-load condition have $8\text{pax}/\text{m}^2$ (Bernal, Martinod, Becancur, & Castañeda, 2016; Martinod, Betancur, Castañeda, & Restrepo, Structural analysis of railways bolster-beam under commercial operation conditions: over-traction and over-braking, 2016). This case study focuses on the behaviour of an ITM station and its influence on near stations; therefore, the model considers a 6-station section belonging to the main metro line (Línea A) and a terminal station that consolidates the numerical information from the MCPTS, in which the transfer station (Acevedo) is located in the middle of this section. Table 4.2 (column 1) presents the overall technical characteristics of the metro line.

Table 4.2. General features of the UACS and metro system.

Parameter	Metro	UACS	UACS
Transport line	Línea A	Línea K	Línea P
Nominal number of vehicles in service [veh]	12,00	90,0	130,00
Vehicle capacity, $cv_{k,i,q}$ [pax]	905,00	10,00	12,00
ush hour	0,33	4,89	5,56

Vehicle frequency, $fv_{i,n}$ [veh/min]	off-rush hour	0,17	2,94	5,56							
Nominal speed, $sv_{k,i,n}$ [m/s]	ush hour	25,00	5,00	5,50							
	off-rush hour	25,00	3,00	5,50							
Nominal headway [m]		1.400,00	61,26	59,40							
Line length (round trip) [km]		15,23	3,91	5,27							
Flow rate of pass. crossing the doors, $\varphi_{j,i,n}$ [pax/s]		120,00	2,00	2,00							
Number of stations [unit]		{1, 2, 3, 4, 5, 6}	{1, 2, 3, 4}	{1, 2, 3, 4}							
Inter-stations (start-end)	1-2	2-3	3-4	4-5	5-6	1-2	2-3	3-4	1-2	2-3	3-4
Inter-station length [m]	1377	1616	1866	1284	1471	810	407	738	968	973	694
Inter-station number vehicles [veh]	1	1	1	1	1	17	12	16	10	25	10
Opened door time period, $ts_{j,i,n}$ [s]	60	21	21	32	23	5	5	5	6	6	6

A set of field measurements, called Origin and Destination Analysis (ODA), were conducted for establishing the passenger demand profile during a typical working-day on 16 August 2018. This date was selected because it was a part of a large-scale measurement protocol for the Medellín metropolitan area, when there were no disturbances (no holidays, no collective vacations, no festivals and no religious ceremonies) during a long time period. The ODA took place between 4a.m. and 11p.m. (i.e., full commercial day to record the complete passengers demand profile). During this typical working day, the passenger demand profile has significant fluctuations; thus, it is possible to distinguish that the morning rush hour starts at 5a.m. and ends at 7a.m., while the evening rush hour starts at 5p.m. and ends at 8p.m.

The ODA is performed regularly by the transport operator to quantify passenger demand profile of the system. The transport operator has identified a stable passenger demand profile and there have been no significant differences in recent years as the population of this area in the city is quite constant; thus, it is possible to define the passenger demand profile for 2020 using the measured ODA.

4.4.2. Background of the UACSS

The UACS lines belong to a fleet of passenger cable cars comprised of a gondola-type aerial cable on a continuous cycle (Martinod, et al., Operating conditions effect over the coupling strength for urban aerial ropeways, 2014). The lines have the same design and construction regarding the cableway tourist transport, but serve completely different functions than those for tourists (Martinod, Bistorin, L., & Rezg, 2019). This case study models two UACS lines (*Línea K* and *Línea P*), which consist of 4-station line each, where the lower stations are connected to the multi-modal transfer station to the metro line. Table 4.2 (columns 2 and 3) presents the overall technical features of the UACS lines. For further understanding, here is a global description of each line:

- (i) *Línea K* provides mobility to the northeaster district of the city since 2004 (see Figure 4.10.a). This line operates for 20 hours a day, 7 days a week and 360 days in year. Its nominal speed is 18[km/h] and the system capacity is 3000[pax/hour] per direction (spread over 90 vehicles). This line was the first UACS used for massive transport (Martinod, Bistorin, Castañeda, & Rezg, 2018). Analogous to *Línea A*, the passenger demand profile of *Línea K* is also defined by the ODA from 16 August 2018. The transport operator has stated that the residential densification in the northeastern district of the city has been stable in the last years; therefore, it is possible to set the passenger demand profile for *Línea K* at 2020 using the measured ODA results.
- (ii) *Línea P* was started to construction in March 2018 with an expected time to *completion* of 24 months (see Figure 4.10.b). This line will provide mobility to the northwestern district of the city. *Línea P* will feature some upgrades from *Línea K*; the nominal speed has been raised to 19,8[km/h] and the system capacity has been increased to 4.000[pax/hour] per direction (spread over 130 vehicles). With an expected travel time of 11 minutes, the line will decrease 75% of current commute time and will benefit 420.000 residents who live in some of the most disconnected areas of the city. Once *Línea P* opens to the public in July 2020, Medellín will have the second largest UACS in the world after Mi Teleférico network in La Paz/El

Alto (Bo). The methodology for setting the demand for *Linea P* is based on a correlation analysis of the passenger demand profile of two different UACS, which have a commercial service in the city (*Linea K* and *Linea J*). The passenger demand profile is adjusted by a factor from a metropolitan study on the future mobility habits of residents in the northwestern of the district in 2020. This metropolitan study was conducted by the Regional Administration of Territorial Planning for establishing the land uses and their control policies.



a. AUCCS (*Linea K*)

Figure 4.10. UACS lines.

b. AUCCS (*Linea P*)

4.4.3. Validation process of the model

A numerical model of the metro-UACS MTN been developed using a programming language. The graphic computing representation is shown in Appendix D (see Fig. D.2), the model allows running a set of stochastic simulations, each one covers all the commercial day (from 4a.m. to 11p.m.) in which are evaluated the whole parameter combinations. The transport operator uses a method widely implemented by the UTM's to quantify the flow of passengers throughout different transport lines within the MCPTS. In order to acknowledge the quality of the obtained results, a validation is conducted through a direct comparison between a set of field measurements made by the transport operator and the results from the set of simulation model.

In this case study, the measuring head consists on recording the dataset, $\chi_i^* = \{\lambda_{j,in}^*, \mu_{j,in}^*\}$ with $i = \{1, 2, 3\}$, which represent the reference values of the interconnected metro line and UACS lines. Thus, the transport operator quantifies the users that arrive at each platform, $\lambda_{j,in}^*$, while quantifying the users that leave the platform $\sigma_{j,in}^*$. This methodology is useful to define the rate of users within the stations but it is not possible to infer the flow of passengers throughout the MCPTS because the operator cannot know the direction nor the destination of each passenger. As such, the methodology is limited in that it cannot quantify the length of the queues on the platforms ($Lq_{j,in}$), the PWT (Wq_j), nor the occupied places on the vehicles ($Lq_{j,in}$).

The simulation results from the numeric model accurately assess the behaviour of the system and its interactions with the decision variables. The input dataset, $\lambda_{j,i,n}$, is defined as a set of variables with stochastic Poisson distribution, $Pa_{j,i,n}$ (see Appendix B, Figure B.7), to obtain the behaviour of $\mu_{j,i,n}$, $g_{k,i,n}$, $Lq_{j,i,n}$, $\sigma_{j,i,n}$ and Wg_i . The validation process of the numerical model is structured in three stages, as follows:

The first stage of the validation process is a convergence analysis to improve the simulation accuracy through a correlation analysis from the behaviour of the users that arrive at the platforms, $R_i^2(\lambda_{j,i,n}, \lambda_{j,i,n}^*)$. A deviation threshold is defined ($R_i^2 \geq 0,97$) as an acceptable level of variation between $\lambda_{j,i,n}$ and $\lambda_{j,i,n}^*$. From these convergence analyses, we find that at least 11 iterations are required to reach the deviation threshold (see Appendix B, Figure B.8).

In the second stage of the validation process, a minimal error threshold is defined ($\varepsilon_{j,i} \leq 0,5\%$) as an acceptable level of deviation from the numerical simulations regarding the reference values (see Appendix B, Figure B.9). A new convergence analysis is conducted for achieving precise results via error values, $\varepsilon_{j,i} = \|\lambda_{j,i,n}^* - \lambda_{j,i,n}\| \lambda_{j,i,n}^{*-1}$; likewise, and we find that at least 42 iterations are required to reach the error threshold.

The third stage of the validation process is obtained by analysing the sensitivity of the numerical model. In this stage, we run a set of 30 simulations focused on the number of disembarking passengers from the vehicles $\sigma_{j,i,n}$. $\sigma_{j,i,n}$ is an estimator to describe the ITN behaviour during the simulation, where $mean(\sigma_{j,i,n})$ is the central tendency measurement and $std(\sigma_{j,i,n})$ is the model sensitivity measure for the stochastic variables over the discretized time by events. Then, the ratio values, $r(\sigma_{j,i,n}) = mean(\sigma_{j,i,n})/std(\sigma_{j,i,n})$, are in the range $r(\sigma_{j,i,n}) = [0,0, \dots, 7,1]$ (see Appendix B, Figure B.10), which represents an acceptable estimator range.

A set of tests was carried out for establishing the flow of passengers during a commercial day (*Línea A* and *Línea K*) as reference values for a projected commercial day (*Línea A*, *Línea K* and *Línea P*) after *Línea P* be integrated to the commercial operation into the MCPTS. From the validation process, $R_i^2 \geq 0,97$, $\varepsilon_{j,i} \leq 0,5\%$, and $r(\sigma_{j,i,n}) = [0,0, \dots, 7,1]$ represent an acceptable level for the scope of this chapter; therefore, for fulfilling these requirements 42 set of tests simulations are necessary and every test covers 11.082 events.

4.5. Results and discussion

The results are condensed in Fig. 11 which shows the behaviour of users arriving on the platforms at the transfer station (*Acevedo*); moreover, Figure 4.11 also show the projected effect after *Línea P* opens for commercial service. Therefore, the increment of passengers in the transfer station (*Acevedo*) has a direct effect on the queue at the platforms of the other lines (*Línea A* and *Línea K*); finally, increasing the PWT function, Γ_i .

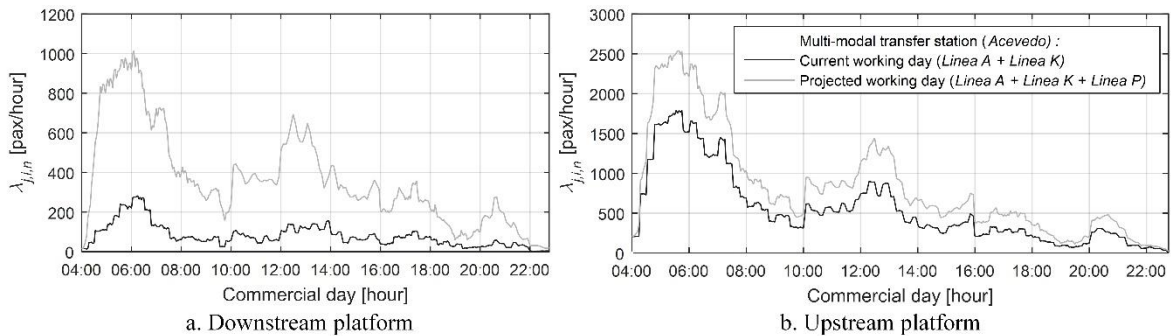

Figure 4.11. Flow of passengers into the transfer station (*Acevedo*).

Figure 4.12, Figure 4.13, and Figure 4.14 describe the PWT cost function for Γ_1 , Γ_2 , and Γ_3 (i.e., *Línea A*, *Línea K*, *Línea P*, respectively), which describes the effect of the projected

operation policy for *Línea P* over the PWT cost against the other lines (*Línea A* and *Línea K*). These figures show the Γ_i behaviour changing the speed parameter for *Línea K* ($\{4,25, \dots, 5,5\}$ [km/h]) vs. *Línea P* ($\{4,67, \dots, 6,05\}$ [km/h]). Figure 4.12(a), Figure 4.13(a), and Figure 4.14(a) show the scenario with a metro speed at 76,5[km/h]; Figure 4.12(b), Figure 4.13(b), and Figure 4.14(b) show the scenario with a metro speed at 87,75[km/h]; and Figure 4.12(c), Figure 4.13(c), and Figure 4.14(c) show the scenario with a metro speed at 90,0[km/h]; moreover, Figure 4.12, Figure 4.13, and Figure 4.14 describe a complete map of the service policy from the point of view of passengers. The stood-out points represent the PWT cost for each UTM under the current configuration parameters (i.e., using the nominal commercial speed for each line, $sv_{k,i,n}$).

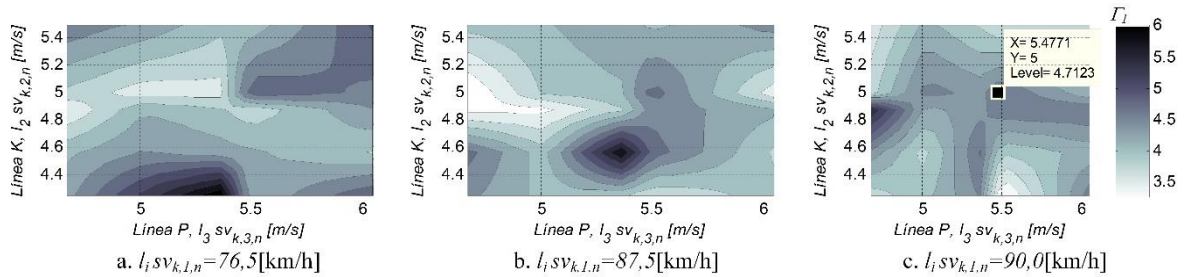

Figure 4.12. PWT function for metro line (*Línea A*), Γ_1 .

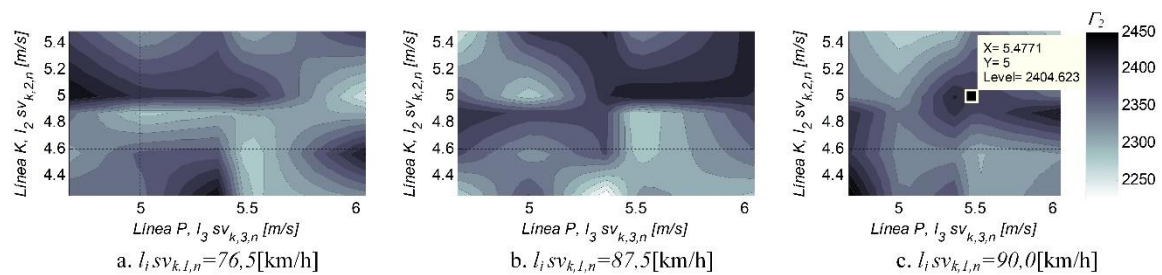

Figure 4.13. PWT function for UACS line (*Línea K*), Γ_2 .

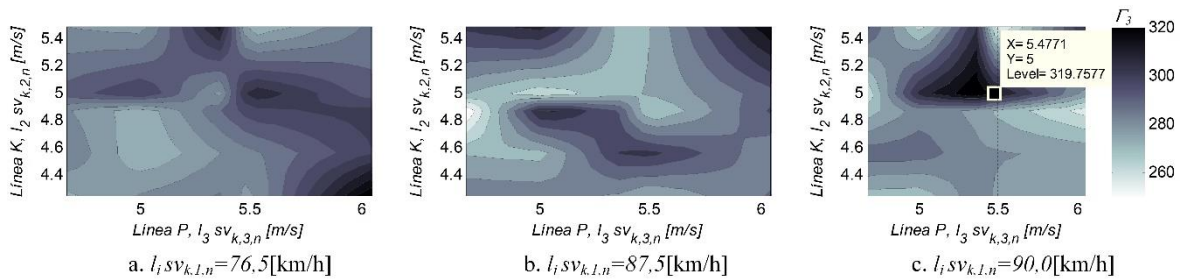

Figure 4.14. PWT function for UACS line (*Línea P*), Γ_3 .

Remark 4.11. Notice that the range values for the PWT cost for *Línea A* is $\Gamma_1 = [3,4, \dots, 6,0]$, the range values for *Línea K* is $\Gamma_2 = [2.200, \dots, 2.450]$, and the range values for *Línea P* is $\Gamma_3 = [250, \dots, 320]$; therefore, the PWT cost of *Línea K* is substantially sensitive to the service policy (e.g., if the vehicle speed of the metro go by 14[km/h], the PWT for *Línea K* will vary 250[mu], see Figure 4.13). Therefore, the PWT variation is highly dependent on the vehicle speed parameter.

Then, it is possible to evaluate the optimisation process of the PWT function, $C^*(\sum \Gamma_i)$, for obtaining the general value configuration for the operation policies belonging to the different UTMs line. Fig. 15 shows how the proposed case study has a particular behaviour because the metro speed parameter must be fixed, otherwise its variation will affect the other transport lines that were not considered in this chapter (e.g., *Línea B*, *Línea TA*, etc.). The operator could consider

implementing $sv_{k,2,n} = 5,5[\text{m/s}]$ and $sv_{k,3,n} = 5,0[\text{m/s}]$, in the case that just if the operator establishes an operation policy in which the PWT cost is optimal as pointed out in Figure 4.15.

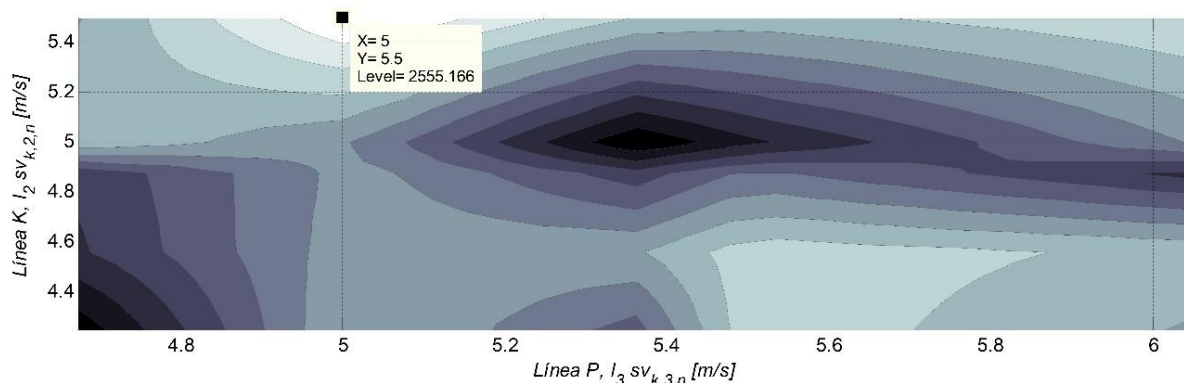

Figure 4.15. Optimisation process for the PWT function, $C^*(\sum F_i)$.

4.6. Conclusion

A mathematical framework was developed for integrating the service policy of different UTMs into a MCPTS to solve the problem of PWT costs involved in MTN commercial operation.

The proposed method provides a stochastic optimisation based on the passenger demand analysis, which is applied to an existing MTN to be used as a cost of study. The results show that under the proposed optimisation method, the PWT cost is significantly reduced and service levels is improved.

In the first stage of the work, a service policy model for metro transport systems was proposed, which identifies two different policies for BDPs: (i) a disciplined BDP; and (ii) an informal BDP. In the second stage, a service policy model for UACS was formulated. In the final stage of our research, a MCPTS model (two urban UACS lines connected to a metro line) was developed for obtaining a queue process of optimisation based on numeric simulations, one that considers the interdependencies and asymmetries of passenger demand.

As another conclusion, this chapter shows that, considering future configuration of commercial operation of the case study (a fleet of two UACS lines –*Línea K* and *Línea P*– connected to a metro line –*Línea A*–, operating in Medellín city), the appropriate service policy is $sv_{k,2,n} = 5,5[\text{m/s}]$ and $sv_{k,3,n} = 5,0[\text{m/s}]$. The latter would appear to deliver the best service compromise between the different transport lines feeding into MTN regarding the PWT cost. This result represents an appropriate criterion considering a reasonable service policy regarding to a real case study.

As a final remark, future research should focus on three major aspects. The first relates to the prospect of future population density for the northwestern district of the city. Because improved transport and new facilities provided by the future UACS line (*Línea P*) will increase the demand for transport. Further analysis of the MTN can be undertaken to address the future MCPTS conditions with the new passenger requirements in the upcoming years. The second aspect focuses on expanding the study to the entire metro line (*Línea A*) connecting to others metro and UACS lines as this chapter only considers a portion of a metro line (6 stations) to analyse the local effect of passenger demand requirements in designing multi-modal configuration service. The third aspect would be to broaden the chapter to include others UTMs (tramway lines, urban bus lines, shuttle bus lines, electric scooters paths, etc.), which would allow to obtain the behaviour of a city's MCPTS as a whole, aiming to apply the optimisation method based on passenger demand analysis developed here.

Chapter 5:

Service policy optimisation during health emergency of pandemic cycles

- Authors:** R.M. Martinod, O. Bistorin, L.F. Castañeda, N. Rezg
- Original title:** Service policy optimisation for urban public transport networks: mobility constraints during health emergency of pandemic cycles
- Conference:** 13th International Conference on Modeling, Optimization and Simulation - MOSIM'20
- Web site:** http://mosim2020.ma/wp-content/uploads/2020/11/PROGRAMME-MOSIM-2020-F-An_v4.pdf
- Publication date:** November 12-14, 2020
- Main theme:** New advances and challenges for sustainable and smart industries
- Partner:** Université Internationale d'Agadir
Arts et Métiers PARISTECH
Université de Lorraine
- Frequency:** Biennale

Abstract

This chapter presents an approach to model the behaviour of urban public transport networks for optimizing the service policy, which includes the effect of mobility constraints on health emergency for pandemic cycles. During health emergencies, local governments strongly use two regulatory policies for contain a disease spreading: (i) social distancing and (ii) restriction of social interaction; these regulatory policies thoroughly affect the urban mobility. We propose the optimisation of a stochastic discrete-event model based on a passenger demand analysis by means: (i) a numeric model of a multimodal network considering interdependencies and asymmetries of passengers; (ii) an integration of the regulatory policies for health emergency; and (iii) a process for optimizing the passengers waiting time cost. This work is applied to an actual metropolitan transport network comprised of metro, tramway, and ropeway lines.

5.1. Introduction

Health emergencies on pandemic cycles have massively affected the lives of people all over the world. Countries must take drastic measures to contain outbreaks (De Haas, Faber, & Hamersma, 2020) and they have put in place restrictive measures in order to confine the pandemic and contain the number of casualties. Among the restrictive measures, Urban Public Transport (UPT) constraints are certainly quite effective in reducing the mobility on the local scale in the short term but it also has high social impact on the long and short term (Iacus, Natale, Santamaria, Spyrtos, & Vespe, 2020). The trend of UPT has been rising over the last decade at a pace that is faster than the population growth (Recchi, Deutschmann, & Vespe, 2019). Nevertheless, mobility flows have been shaped at regional scale by shocks due to operational and service policies (Gabielli, Natale, Recchi, & Vespe, 2019). In addition, UPT has shown strong dependency on pandemic outbreaks in the past such as SARS in 2003, MERS in 2015 (IATA, 2020), and Covid-19 in 2020 (Bucsky, 2020), with effects that had repercussions at local and regional scale.

The circumstances result in situations in which people have had to change their daily life radically. People's activity patterns, the way they work and how they travel are three facets of daily life that have changed drastically. From both a research and social point of view, it is important to assess the mobility to these externally induced changes (De Haas, Faber, & Hamersma, 2020). Researches show that not only travel patterns, but also activity patterns are less stable during pandemic cycles (Hilgert, von Behren, Eisenmann, & Vortisch, 2018). Daily travel behaviour particularly depends on habit and routine (Schönfelder & Axhausen, 2010). However, several studies have shown that there are certain events in people's life course that trigger change in travel behaviour (Müggenburg, Busch-Geertsema, & Lanzendorf, 2015).

Social distancing measures (the social isolation and the passenger transport restriction) have important effects on the service transport, i.e., the Passenger Waiting Time (PWT). Previous studies (Niu & Zhou, 2013; Barrena, Canca, Coelho, & Laporte, Single-line rail transit timetabling under dynamic passenger demand, 2014) have focused on reducing PWT based on the passenger arrival process at stations with either a uniform process or a Poisson process. Other study (Martinod, Bistorin, L., & Rezg, 2019) proposes a stochastic optimisation model for integrating service and maintenance policies in order to solve the queueing problem and the cost of maintenance activities for UPT, with a particular focus on urban ropeway systems. But, these previous works have considered only single transport line without a Public Transport Network (PTN) context. Our work analyses the intermodality effects integrating a study focused on the mobility constraints on health emergency of pandemic cycles, in which the UPT lines undergoes a remarkable intensity of passengers' flow in one direction over defined periods –people go to work, students go to schools, etc.– generating a strong asymmetric demand of passengers over the PTN. Besides, the merit of our work in is develop a mathematical framework for integrating the service policy of different UPT line modes minimising the PWT cost and considering interdependencies of the passenger demand on intermodal PTNs

During pandemic cycles, local governments strongly use two constraint policies for contain the virus spreading: (i) social distancing and (ii) restriction of social interaction. Nevertheless, under operational conditions, increasing the social distancing decreases the transport capacity, and as a result increases the PWT; however, increasing the restriction of social interaction decreases the transport demand, and as a result decreases the PWT. The aim is to optimise the PWT for long-term cost of operational service considering regulatory policies. Main contributions of this chapter can be summarised as follows:

- (i) this is the first work that develops a mathematical framework to model multimodal PTNs (comprised by a set of metro, tramway, and ropeway lines) based on stochastic optimisation processes that integrate both service restrictions and passenger demand constraints generated by the health emergency, with the aim of solving the travel time; and
- (ii) this chapter proposes a dynamic discrete event model that use interrelated queuing processes to formulate the service problem using a cost-based expression.

Governments and transport operators do not know for certain how long these measures will last and whether or not subsequent waves can be expected. In this viewpoint we offer a service policy optimisation for PTNs considering constraints for pandemic health emergencies. The remainder of this chapter is organised as follows: in Section 5.2 we expose the detailed problem formulation for different UPT line modes. A stochastic optimisation model for obtaining the optimal service is developed in Section 5.3. Section 5.4 presents a case study focused on a passenger demand that was performed at a mass transport system, which consists of a collaborative relationship between metro, tramway and ropeway lines. Finally, Section 5.5 discusses the results of the research.

Transport operators should consider the service policy. For the remainder of this chapter, the term service policy refers to the set of operational parameters which affect the passenger service such as vehicle capacity (number of available seating places and standing up places), vehicle

density (number of service vehicles on a line), nominal vehicles' speed, distance between the vehicles, and vehicle frequency, which all of these affect the PWT.

5.2. Problem formulation

Taking an Intermodal Collaborative Transport Network (ICTN) perspective assumes that any transport network is more than the sum of its UPT lines (Paulsson, et al., 2018). Collaborative transport involves a linked-work PTN, in which the different services policies of each UPT lines are integrated (Ceder, Public transit planning and operation: theory, modeling and practice, 2007), e.g., (i) a synchronisation between arrival and departure times becomes important in an intermodal transfer station, i.e., users of UPT lines are negatively inclined to transfer if it involves uncertain waiting time, (ii) the flow of users for a UPT line is accommodated by another one, and (iii) the service quality of a UPT line not being affected by the service of another one. From this perspective, the facilitation of intermodal transfers is a key component in achieving full integration of PTNs (Nesheli, Ceder, & Liu, 2015).

An efficient service of ICTNs should consider the PWT cost. We propose a cost-based approach to quantify the performance of the service policy for each UPT line. This approach has an impact on the passengers' perceptions related to travel comfort (quality on the trip) and economic savings (PWT) as well. Therefore, the cost-based approach represents a comprehensive study through a quantitative analysis, which focuses on user experience during the trip. We analyse the transport demand to evaluate the proper service oriented to users, based on the fact that the queuing theory allows to evaluate the quality of service concerning the requested services. The probability function of passenger arrivals on the j th platform belonging to the i th UPT line behaves as a compound Poisson process $Pa_{j,i,n}$ (Gillen & Hashemini, 2013) and take values from a finite set of events; thus, given $Pa_{j,i,n}$ as a probability function of discrete-time, the sequence $n = \{1, 2, \dots, N\} \forall n \in t$ is defined as the time sequence between successive events, over each i th UPT bi-directional line, with J stations and platforms designated as $j = \{1, 2, \dots, 2J\}$, where the start terminal and return terminal are indexed as station 1 and station J , respectively (see Appendix D, Figure D.1(a)).

The discrete-event model deals with the analysis of the PWT aiming to determining its global mean, Wg_i . The proposed model describes the queuing behaviour by means of the ratio between the number of users in the queue, $Lq_{j,i,n}$, and the passengers boarding, $\mu_{j,i,n}$, at the j th platform belonging to the i th UPT line over the n th discretised time

$$Wg_i = \sum_n \left(\mathcal{F}_i \sum_j \frac{Lq_{j,i,n}}{\mu_{j,i,n}} \right) \quad (5.1)$$

where $\mathcal{F}_i = f_{j,i,n}^{-1} \forall i \in (\text{metro or tramway lines})$ and $\mathcal{F}_i = (sv_{k,i,n} dv_{i,n})^{-1} \forall i \in (\text{ropeway lines})$, with $f_{j,i,n}$ as the frequency of vehicle arrival at the platforms, $sv_{k,i,n}$ as the commercial vehicle speed, and $dv_{i,n}$ as the number of vehicles giving commercial service in the i th UPT line.

The discrete-event model is comprised of a set of interrelated queues between UPT lines at the transfer stations (see Figure 4.5), where κ defines the relationship between the queuing users and the different UPT lines for the ICTN

$$Lq_{j,i,n} = Pa_{j,i,n} + \kappa \sum \sigma_{j',i',n} \quad \forall j' \neq j \quad (5.2)$$

The optimal service plan is obtained by minimising the expected Wg_i cost, which represents the basis to assess the set of penalty costs for PWT to the i th UPT line. Formally, the problem is solved through a cost-based model made up of passenger waiting cost, F_i . The general relationship to describe the cost function for PWT is expressed as

$$\Gamma_i = f(Wg_i). \quad (5.3)$$

Methodologies to obtain Γ_i are directly defined by the operation managers of each UPT line, which is quantified in monetary units [mu]. Each UPT line can use different criteria to quantify the penalty cost according to its service policy.

5.3. Optimisation process

A discrete-event formulation is used to describe the queuing, in which the passengers: (i) request a service, $\lambda_{j,i,n}$; (ii) wait in a queue, if necessary, Wg_i ; (iii) are serviced, $\mu_{j,i,n}$; and (iv) arrive at their destination, $\sigma_{j,i,n}$. The discrete-event model aims to determinate the Wg_i value considering a set of interrelated queues. This chapter introduces a stochastic optimisation model for improving the service behaviour of ICTNs by means of the cause-effect relationship between the different service/operational policies for its UPT lines. The objective function related to the service policy cost can be expressed as

$$C^* = \min_n \sum_i \Gamma_i, \quad (5.4)$$

subject to the following constraints

$$0 \leq g_{k,i,n} \leq cv_{k,i,q}, \quad \forall k, i \quad (5.4.a)$$

$$0 \leq \mu_{j,i,n} \leq Lq_{j,i,n}, \quad \forall j, i, n \quad (5.4.b)$$

$$0 \leq \sigma_{j,i,n} \leq g_{k,i,n}, \quad \forall j, i, n \quad (5.4.c)$$

$$fl_i \leq f_{j,i,n} \leq fu_i, \quad \forall j, i, n \quad (5.4.d)$$

$$dl_i \leq dv_{i,n} \leq du_i, \quad \forall i, n \quad (5.4.e)$$

$$0 \leq Wg_i \leq Wu_i, \quad \forall i \quad (5.4.f)$$

$$\sum_{j,i,n} \lambda_{j,i,n} = \sum_{j,i,n} \sigma_{j,i,n}, \quad (5.4.g)$$

$$0 < k, j, i, n, \quad (5.4.h)$$

where: Eq. (5.4.a) highlights that the occupied places in a vehicle, $g_{k,i,n}$, must be lesser than or equal to the vehicle's capacity, $cv_{k,i,q}$; Eq. (5.4.b) means that $\mu_{j,i,n}$ must be lesser than or equal to $Lq_{j,i,n}$; Eq. (5.4.c) expresses that the number of passengers disembarking from the vehicle, $\sigma_{j,i,n}$, must be lesser than or equal to $g_{k,i,n}$; Eq. (5.4.d) is related to an operational condition, which $f_{j,i,n}$ is limited by the range $[fl_i, fu_i]$; Eq. (5.4.e) refers to another operational condition, which is the system must have a range of vehicles in commercial service $[dl_i, du_i]$; Eq. (5.4.f) is related to a service policy, where Wu_i is the upper limit of the global PWT; Eq. (5.4.g) indicates that at the end of a full working day, all passengers are served and no one remains within the system.

5.4. Case study

This case study is applied to urban public transport network belonging to the ICTN of Medellín city (Co). This ICTN is a rapid transit system mainly comprised of two metro lines, a tramway line and four ropeway (*télécabine*) lines, which are interconnected by means transfer stations for the intermodal connections (see Figure 5.1). This ICTN has 27 Metro stations, 15 ropeway stations, and 9 tramway stations/stops for a total of 79 stations (+14 stops). All lines operate for 20 hours a day, 7 days a week and 360 days in year.

A set of field measurements, called Origin and Destination Analysis (ODA), were conducted for establishing the passenger demand profile during a typical working-day on 16 August 2018. This date was selected because it was a part of a large-scale measurement protocol for the Medellín metropolitan area, when there were no disturbances (no holidays, no collective vacations, no festivals and no religious ceremonies) during a long time period. During this typical

working day, the passenger demand profile has significant fluctuations; thus, it is possible to distinguish that the morning rush hour starts at 5a.m. and ends at 7a.m., while the evening rush hour starts at 5p.m. and ends at 8p.m. The characteristics of each line are discussed hereafter.

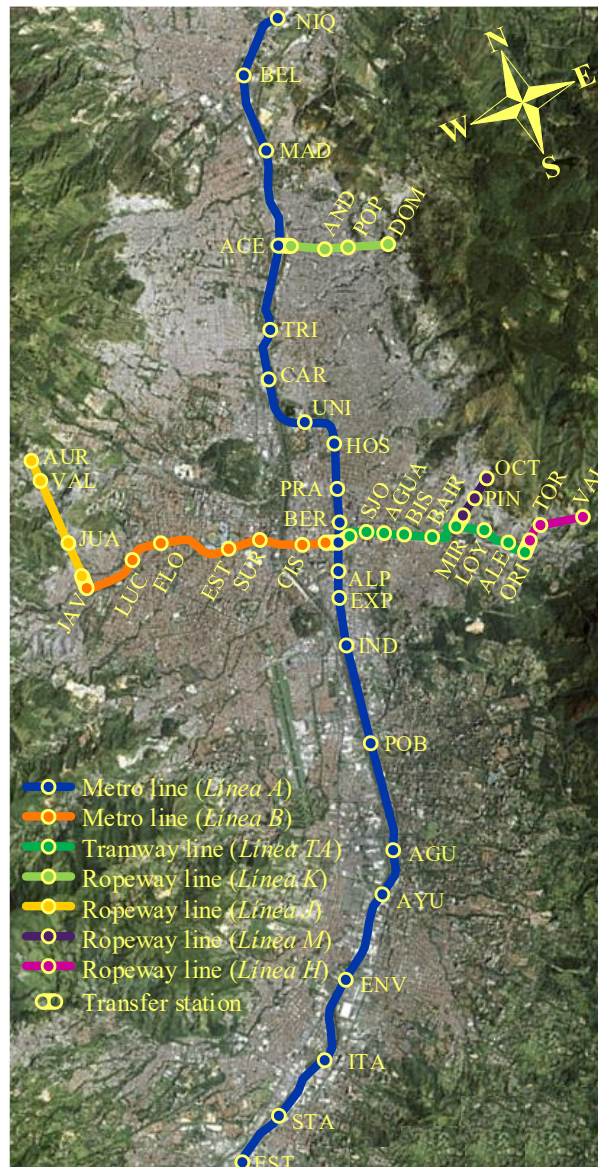

Figure 5.1. ICTN main lines of Medellín city.

5.4.1. Metro lines

The metro lines are similar to suburban ET420 trains, it first opened for service in 1995 (Castañeda, Martinod, & Betancur, 2012; Martinod, Betancur, & Castañeda, Evaluation of the damping elements for two stage suspension vehicles, 2012). The vehicle traction in half-load conditions ($5,5 \text{ pax}/\text{m}^2$) is $0,95 \text{ m}/\text{s}^2$ and in full-load condition ($8 \text{ pax}/\text{m}^2$) is reduced to $0,85 \text{ m}/\text{s}^2$. The vehicle braking in service is in a range $[1,6 - 1,7] \text{ m}/\text{s}^2$ (Bernal, Martinod, Becancur, & Castañeda, 2016; Martinod, Betancur, Castañeda, & Restrepo, Structural analysis of railways bolster-beam under commercial operation conditions: over-traction and over-braking, 2016). They are comprised by two lines:

- (i) *Línea A* crosses the metropolitan area from North to South, which is $25,8 \text{ km}$ long and serves 21 stations; and
- (ii) *Línea B* crosses the metropolitan area from downtown to the western district, which is $5,5 \text{ km}$ long and serves 6 stations (+1 transfer station with *Línea A*).

5.4.2. Tramway line

The tramway line (*Línea TA*) is a Translohr rubber-tyred tram system. It started trial operations in 2015 and serves as a feeder line built to connect two ropeways lines (*Línea M* and *Línea H*) from eastern district of the city to a metro line (*Línea A*) at downtown. *Línea TA* runs 4,3km with 3 tramway stations (+6 stops).

5.4.3. Ropeway (télécabine) lines

The ropeway lines belong to a fleet of passenger cable cars comprised of a gondola-type aerial cable on a continuous cycle (Martinod et al., 2014). All lines are similar in design and construction to those used for passenger tourist transports in winter regions, but serve completely different functions than those for tourists (Martinod et al. 2015). They are comprised by four lines:

- (i) *Línea K* provides mobility to the northeaster district of the city since 2004. Its commercial max. speed is 18km/h and the system capacity is 3000pax/hour per direction, spread over 90 cable cars;
- (ii) *Línea J* has been operating since 2008. It crosses the central-western district over south-north direction, with a total length of 2,7km. It has a maximum capacity of 3000 pax/hour per direction with 119 cable cars, a travel time of 12min., with a max. frequency of 12sec. between cable cars and a commercial speed of 18 km/h;
- (iii) *Línea M* crosses an area of the central-eastern zone of the city from south-north direction, in a total length of 1,05 km. It has a max. capacity of 2500 pax/hour per direction, 51 cable cars, a travel time of 4min., with a maximum frequency of 9 seconds between cable cars and a commercial speed of 18 km/h; and
- (iv) *Línea H* was inaugurated in 2016. It crosses an area of the central-eastern zone parallel to *Línea M*, in a total length of 1,4km. It has a max. capacity of 1800 pax/hour per direction, 44 cable cars, a travel time of 5min., with a maximum frequency of 13sec. between cabins and a commercial speed of 18 km/h.

5.4.4. Mobility constraints on health emergency

In March 2020, the World Health Organization (WHO) declared the Covid-19 virus outbreak as a pandemic. The spread of the virus has resulted in a set of variable measures, which have become the new norms:

- (i) social distancing that involves urban transport capacity constraints, T_c , i.e., the transport system capacity (stations, stops, and vehicles) has been limited; and
- (ii) restriction of social interaction, P_d , a lot of people have been temporarily unemployed or work from home, and most out-of-home (leisure) activities have been cancelled; thus, passenger demand decreases.

The proposed method provides a stochastic model optimisation based on passenger demand analysis, which is applied to a commercial ICTN subject to two regulatory policies for pandemic social isolation: (i) a social distancing that implies urban transport capacity constraints, and (ii) restriction of activity participation in cities affecting passenger demand. Therefore, the mobility constraints are temporal situations and we can expect that out-of-home activity participation (i.e. travel demand) and the transport system capacity will progressively rise (see Table 5.1).

Table 5.1. Regulatory policies for isolation levels.

Social isolation level	Transport capacity constraint, T_c [%]	Passenger demand restriction, P_d [%]
Hard confinement	85	90
Mandatory confinement	80	80
Flexible isolation	70	60
Smart isolation	65	50

5.5. Results

A numeric model of the ICTN main lines of Medellín city was developed in a virtual environment, which allows to assess the effects of the social isolation levels for a wide range of possible conditions and parameter variations, i.e., predicting the behavior of the occupancy rate for the different transport modes of the UPT lines on each discrete-time. As an example of results, Figure 5.2 shows (using a color code) the occupancy rate for the UPT lines by means: (i) the number of passengers traveling in the vehicles, $g_{k,i,n}$, and (ii) the number of passengers waiting in the queue on the platforms, $Lq_{j,i,n}$.

Figure 5.3 shows the projected PWT cost for each i th UPT line after the governmental regulatory policy orders with the different isolation levels; moreover, Figure 5.3 also shows that the regulatory policy denoted as flexible isolation has the highest PWT cost to the transport system due to the combination of the transport capacity constraint, Tc , and passenger demand restriction, Pd . The metro lines (*Línea A* and *Línea B*) have the lowest service impact during the regulatory policies; indeed, *Línea B* has a null PWT cost in the different social isolation levels, i.e., *Línea B* is enough robust to provide the highest transport service regardless of the regulatory policies. On the other hand, the tramway line has a stable behaviour relative to the regulatory policies; but, the ropeway lines are sensible to different social isolation levels.

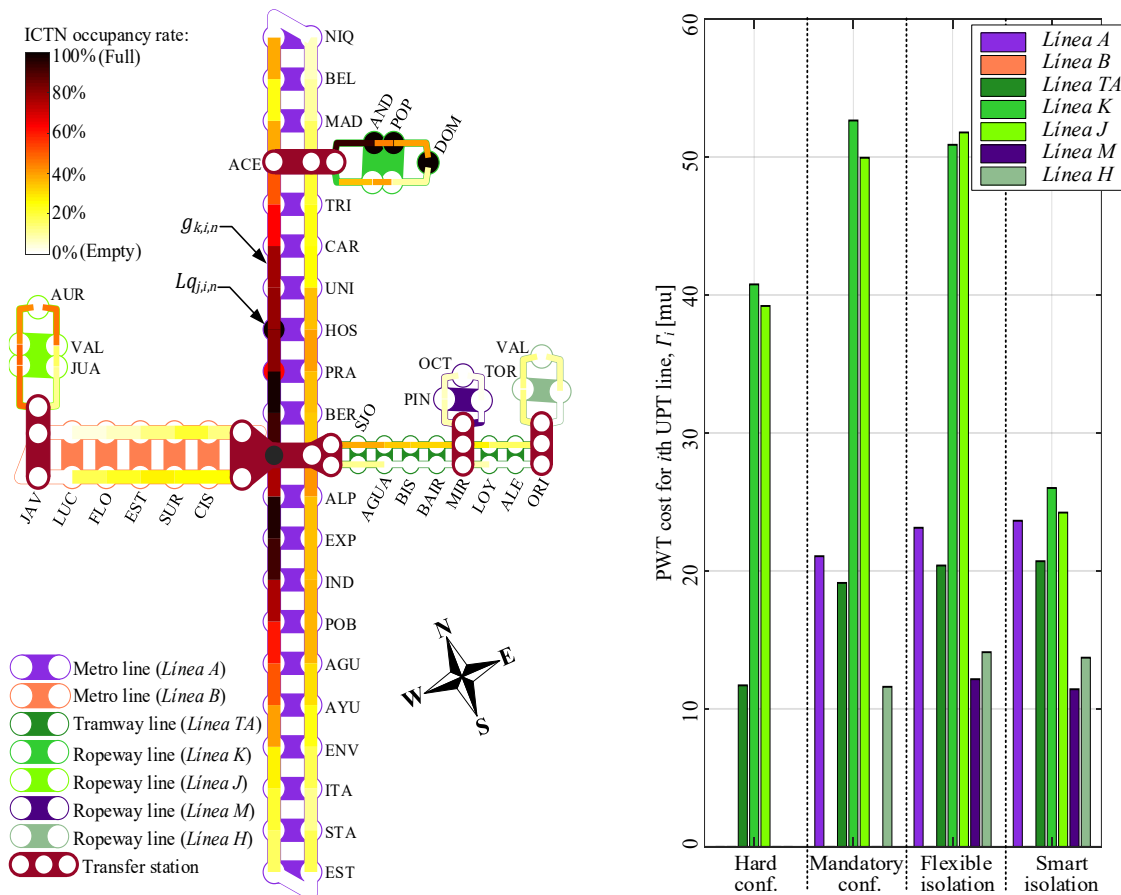

Figure 5.2. Numerical model for the ICTN. Figure 5.3. PWT cost for the i th UPT line, Γ_i [mu].

A set of tests was carried out for establishing the flow of passengers during a commercial service by means the PWT. Figure 5.4 presents as an example a set of numerical tests for the flexible isolation policy, in which the rush-hours (i.e. 7h00 and 16h00) has significant peaks due to the passenger demand behavior. Moreover, Figure 6 also shows two different behavior of PWT for flexible isolation policy: (i) a group with low PWT value comprised of metro and

tramway lines (*Línea A*, *Línea B*, *Línea TA*), and a group with high PWT value comprised of ropeway lines (*Línea K*, *Línea J*, *Línea M*, and *Línea H*).

The results of the tests are condensed in Figure 5.5, in which the decision variables (Tc , Pd) were considered to obtain the general PWT cost, $\sum_i \Gamma_i$, considering social isolation level; thus, a set of combinatory tests was performed based on the ranges of operation for the ICTN, $Tc = \{62, \dots, 88\}[\%]$ and $Pd = \{57, \dots, 93\}[\%]$. A final analysis was carried out to identify the combination of the values Tc and Pd that must be provided by the ICTN to reach a service policy with minimum PWT cost, C^* , it is obtained by means the local optimums to improve the transport service. Decreasing the transport capacity constraint and increasing the passenger demand restriction is the approach to obtain the local optimum. Thus, the hard confinement policy should be modified to $C^* = \langle Tc, Pd \rangle^* = \langle 84, 91 \rangle \%$, and the mandatory confinement policy should be modified to $C^* = \langle Tc, Pd \rangle^* = \langle 78, 81 \rangle \%$.

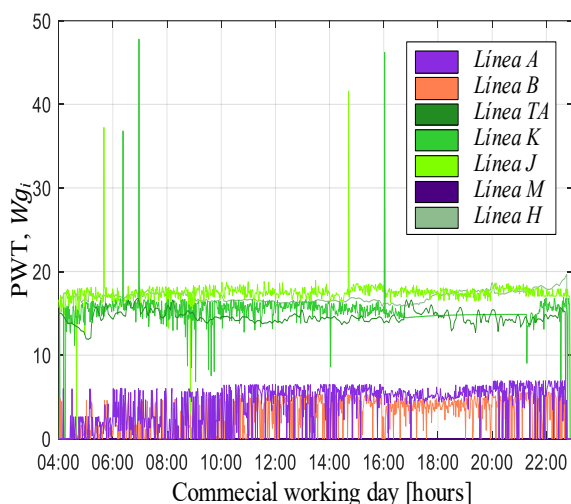

Figure 5.4. PWT for flexible isolation policy.

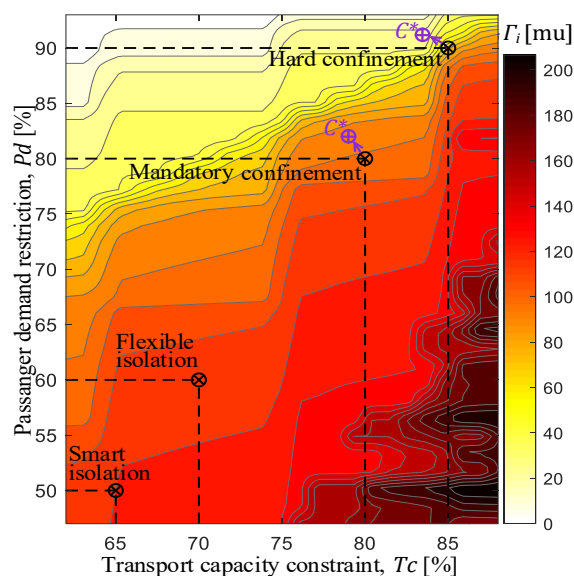

Figure 5.5. General PWT cost of the ICTN for social isolation level, $\sum_i \Gamma_i$ [mu].

5.6. Conclusions

A making decision tool was developed for considering the mobility constraints on health emergency of pandemic cycles to solve the problem of PWT costs involved in different UPT line into ICTNs.

The proposed method provides a stochastic discrete-event model optimisation based on passenger demand analysis, which is applied to a commercial ICTN subject to two regulatory policies for pandemic social isolation: (i) social distancing that implies urban transport capacity constraints, and (ii) restriction of social interactions affecting passenger demand.

In the first stage of the chapter, an ICTN model (two metro, a tramway and four ropeways lines) was developed for obtaining a queue process based on numeric simulations, one that considers the interdependencies and asymmetries of passenger demand. In the second stage, a set of regulatory policies for health emergency of pandemic cycles was integrated to the numeric model. In the final stage of our research, we solve the service problem via a cost-based expression for obtaining a queue process of optimisation.

Conclusions

A methodology with its mathematical framework (see Figure 0.1) was developed to integrate service and maintenance policies in order to solve the queueing problem and the cost of maintenance actions in multi-modal public transport networks. Note that Figure 0.1.a and Figure 0.1.b are assembled by means Γw_g , which is computed at the urban transport network service model (step A.7), and integrated at the preventive maintenance model (steps B.4-2 and B.7-1); thus, the proposed methodology synthetize the numerical models for improving the follow sustainability goals: (i) social goal, which solves the transport network service, and (ii) economic goal, which optimize the maintenance policy. For this purpose, the two-stage methodology is comprised by:

- (i) urban transport network service stage: a stochastic discrete-event model (see Figure 0.1.a) composed of a set of interrelated queues for the formulation of the service problem using a cost-based mathematical expressions form metro, tramway and ropeway lines; and
- (ii) imperfect preventive maintenance stage: a cost-based reliability model for simple systems and multi component systems which considers two different maintenance policies (periodic block-type and age-based).

$i = \{1, 2, 3, \dots, I\}$: Set of transport modes belong to a multi-modal public transport system
 $j = \{1, 2, 3, \dots, J\}$: Set of platforms in an transport mode
 $n = \{1, 2, 3, \dots, N\}$: Indices of discretised time by events

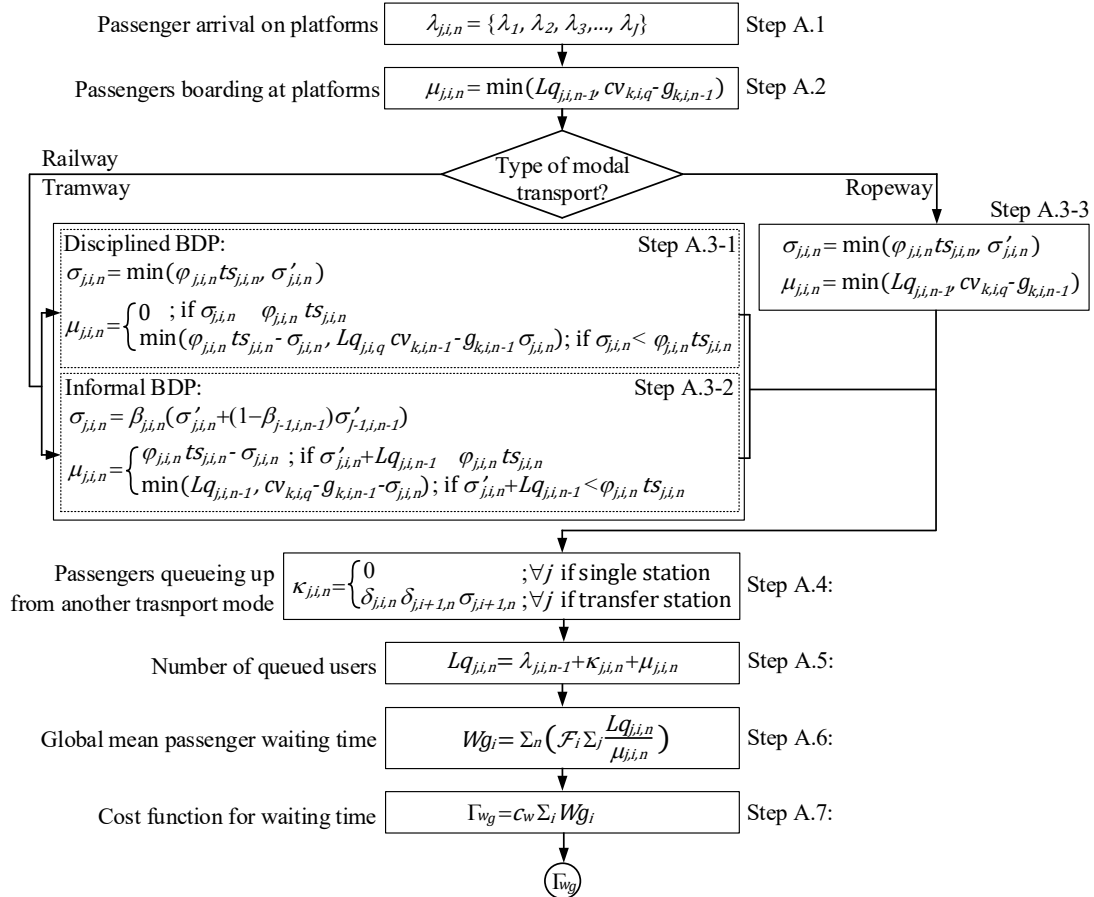

a. Urban transport network service stage.

$i = \{1, 2, 3, \dots, I\}$: Instant of lifetime
 $j = \{1, 2, 3, \dots, J\}$: Indices of the components on the system
 $k = \{1, 2, 3, \dots, K\}$: Indices of clustered preventive maintenance actions
 η : Horizon of time, long-term window of lifetime

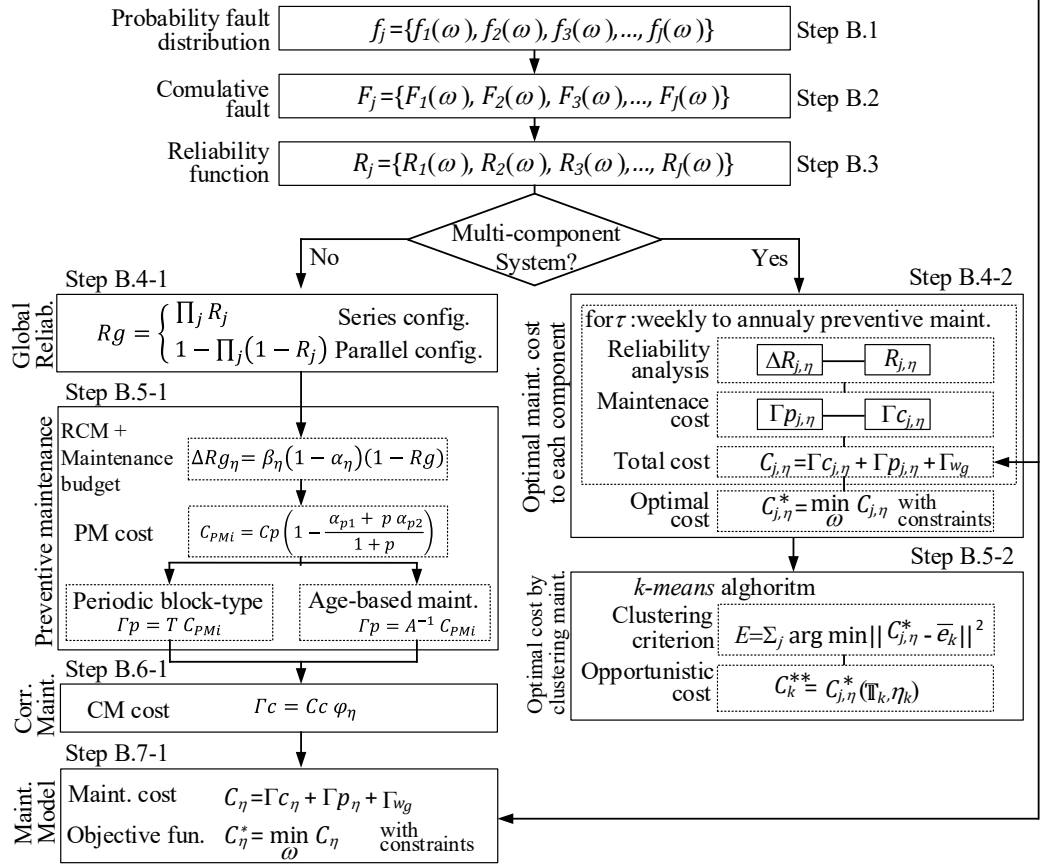

b. Imperfect preventive maintenance stage.

Figure 0.1. Integrated service-maintenance policies methodology for the public transport network.

The urban transport network service stage (steps A.1–A.7, Figure 0.1a) has been developed as a numeric tool for transport operators to service decision making oriented to the passengers. The thesis has proposed a method to determine the values of the operational parameters in which the transport system offers different levels of service quality considering the uncertainty of the passenger arrival times at platforms to assess the time spent according to the historic data of passengers’ travel plans.

As it was proved throughout the chapters of this thesis, the proposed work is an adaptable methodology to solve different objective functions. The methodology can be used interchanging the variables and the parameters according to the objective function (e.g., the passenger waiting time cost is a parameter for Chapter 1, Chapter 4, and Chapter 5; but, the costs of the preventive and the corrective maintenances are parameters for Chapter 1 and Chapter 3; and the combined (operation-service) optimisation function is a parameter for Chapter 2. Moreover, the methodology can be used in different phases of an engineering project as a decision making tool in a design phase, start-up phase, already running system, or refurbishing system to optimize the performance of transport systems (e.g., already running systems was used as the case studies for the Chapter 1, Chapter 2, and Chapter 3; but, refurbishing system was studied for the Chapter 4; and a start-up system for Chapter 5).

Throughout the thesis, the versatility of the proposed methodology was proved because it was used to solve different transport problems, e.g.: (i) integrated service and maintenance policies to

optimise operating strategies, in Chapter 1 and Chapter 2, in which Chapter 2 optimizes the service policy for a transfer station comprised a metro line and a ropeway lines, where the service configuration following an integration for new transport line; (ii) an optimisation of maintenance policy for multi-component systems considering the degradation of components and imperfect maintenance actions, in Chapter 3; and (iii) service policy optimisation for a multimodal urban transport network which includes the effect of mobility constraints on health emergency for pandemic cycles subject to two regulatory policies for pandemic social isolation, in Chapter 5.

The imperfect preventive maintenance stage (steps B.1–B.7-1, Figure 0.1.b) provides a strategy for maintenance managers to cost-based decision making. The thesis develops a maintenance model, which considers the effects under multiple types of independent degradation processes to each grouped component where each are non-identical (e.g., each component has its own working rate variation due to different operating conditions within the system). Furthermore, the thesis has considered both maintenance policies to apply the correct one according to the lifetime of the system in order to achieve the optimal maintenance cost. The thesis shows that neither periodic block-type maintenance nor an age-based maintenance is necessarily the best maintenance strategy over a long system lifecycle. The optimal strategy must consider both policies. Thus, the thesis provides strong support to the idea that an optimal maintenance policy is a mixed policy.

The thesis claims that the concept that the long-term sustainability for operation of urban public transport networks must be a combined optimisation methodology for the operation planning and service policies; thus, making it possible to determine the optimal cost function, which maximizes the outcome over the working-life of the system.

Finally, a significant scientific production was provided by the frame of this thesis through three articles in peer-reviewed scientific international journals: (i) *Computers & Industrial Engineering*, (ii) *International Journal of Quality & Reliability Management*, and (iii) *International Journal of Transport Economics*; and two refereed international conferences: (i) *13th International Conference on Modeling, Optimization and Simulation - MOSIM'20*, and (ii) *5th International Conference on Project Logistics – PROLOG 2019*.

Prospective

Future research will focus on four major aspects. The first aspect is related to the perspective of big data. Actually, the transport operators carry out each year an expensive and hard-logistic set of field measurements for establishing the passenger demand profile during a typical working-day, but the large development of the sensors, data acquisition, and telemetry promotes the data analytic for transport operators for establishing the passenger demand to improve the service. This calls for developing algorithms that can access data and use it to improve the assessment of passengers' travel plans; thus, in this context, it is possible to apply Artificial Intelligence, specially, Machine Learning.

The second aspect relates to the perspective of the maintenance RAMS assessment (Reliability, Availability, Maintainability, and Safety). The thesis has only considered the reliability analysis (steps B.1–B.4-1 and B.4-2, Figure 0.1.b). Further maintenance analysis of RAMS (steps C.1–C.2, Figure 0.2.a) as a flexible tool to identify risks (business, environment, safety) and classify them based on their failure consequences can be undertaken with regard to a holistic view over the performance and improvement options of the assets.

Third aspect, it is possible to propose an alternative analysis for the maintenance (steps C.3-2, Figure 0.2.a), which uses the condition monitoring maintenance rather than the budget-based maintenance developed in this thesis (steps C.3-1, Figure 0.2.a). The integrated RAMS to condition monitoring maintenance calls for a more robust algorithm attached to data acquisition from sensor in the system, which would obtain an efficient process for maintenance optimisation.

Fourth aspect, this thesis provides a methodology which considers two of the sustainability goals (social and economic goals). Building on that, it is possible to propose a further analysis that includes a deeper ecological goal model with direct and explicit assessments; thus, a more robust methodology related to the sustainability criteria can be proposed.

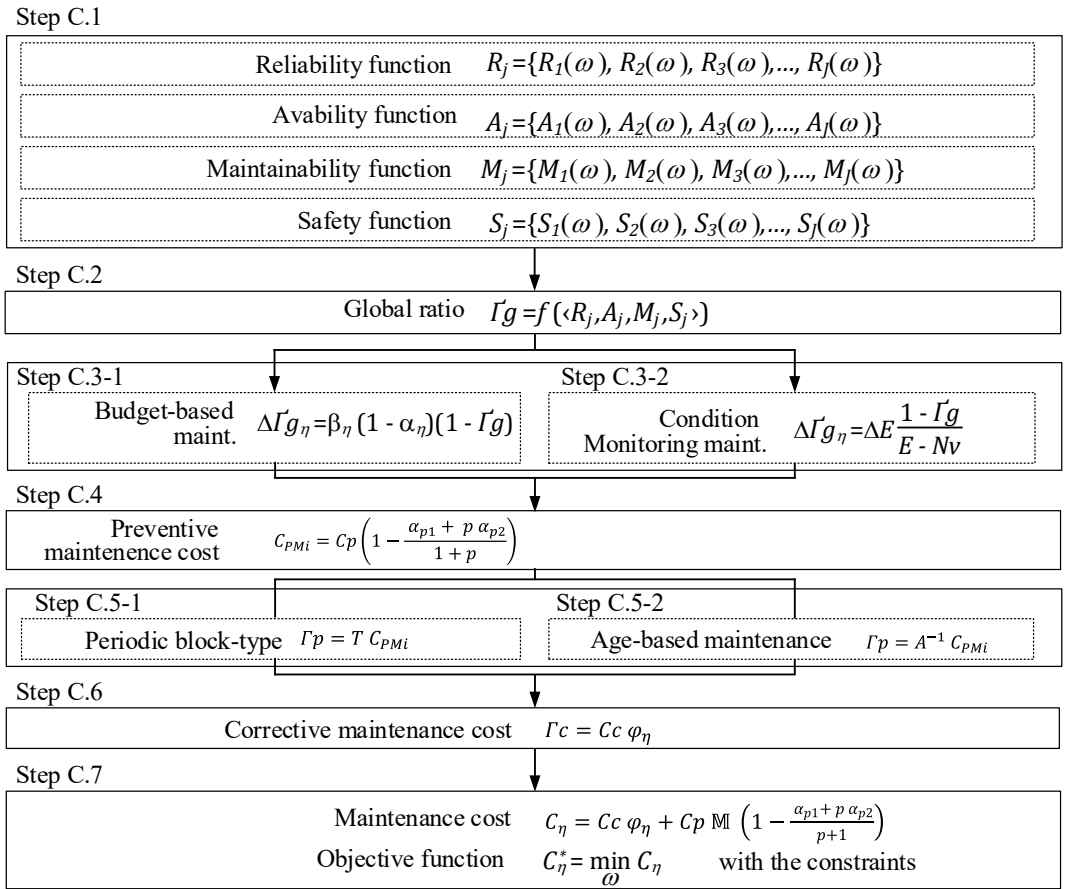

a. Preventive maintenance stage based on RAMS assessment.

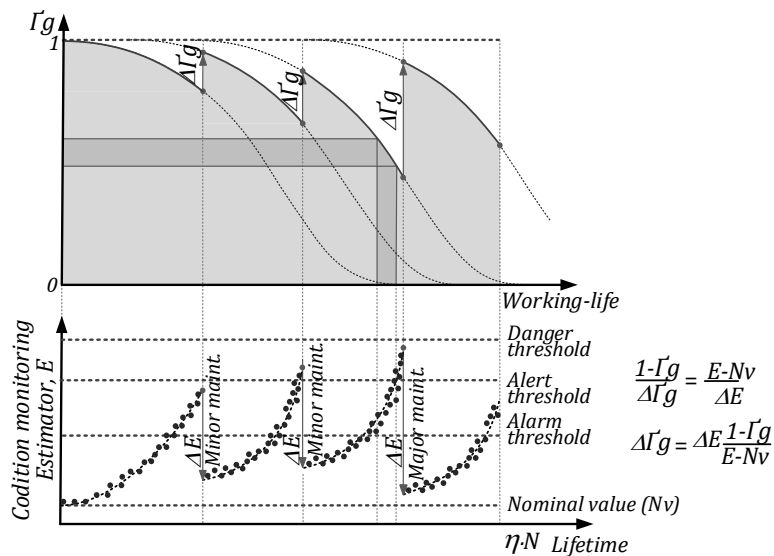

b. Preventive maintenance stage based on RAMS assessment.

Figure 0.2. Alternative processes for methodology for integrated service-maintenance policies methodology.

Appendix A. General features of the ropeway transport models

Table A.1. Parameters of the transport ropeway system.

Operational parameters		Value			
Vehicle (gondola) capacity, cv [pax/veh]		10			
Quantity of vehicles, qv_n [unit]		60			
Commercial speed, sv_n [m/s]		5,00			
Distance between vehicles, lv_n [m]		61,67			
Frequency of vehicles, fv_n [s]		12,33			
Quantity of stations [unit]		{1, 2, 3}			
Quantity of platforms, i [unit]		{1, 2, 3, 4}			
Discretized time, n		{1, 2, ... 500}			
Travel between platforms (start-end)		1-2	2-3	3-4	4-1
Inter-platform length [m]		750	900	900	750
Inter-platform vehicles [veh]		14	16	16	14
Inter-platform travel time [s]		170	200	200	170
Service policy parameters		Value			
Travel between platforms (start-end)		1-2	2-3	3-4	4-1
Users arrival to platform (Poisson distribution), $\lambda_{i,n}$ [pax/ Δt]		9,0	3,0	8,0	5,0
Effected services, $\sigma_{i,n}$ [pax/ Δt] (uniform distribution)		--	--	--	--
Maintenance policy parameters		Value			
Cost of preventive maintenance action, Cp [mu]		60			
Cost of corrective maintenance action, Cc [mu]		10 Cp			
Age reduction coefficient (major maintenance), α_1 [--]		0,1			
Age reduction coefficient (minor maintenance), α_2 [--]		0,3			
Quantity of minor maintenance per major maintenance, p [--]		3			
Stochastic index due the quality of maintenance, β [--] (uniform distribution)		[0, ...,1]			

Table A.2. General features of the ropeway transport system.

Service parameters		Value
Number of service days [day/year]		360
Time for rush hour service [hour/day]		7
Time for valley rush hour service [hour/day]		13
Commercial speed during rush hours, v_i [m/s]		5
Commercial speed during valley hours, v_i [m/s]		3
Nominal number of vehicles in service, q_i [veh]		64
Vehicle (gondola) capacity [pax]		10
Frequency of the SP, f_i [min]		12,33
Length of trip (round trip) [km]		6,00
Operation parameters		Value
Capacity [pax/h]		3000
Length of the plot [m]		2072
Height difference [m]		399
Medium slope [%]		20
Maximum slope [%]		49
Distance between vehicles [m]		61,67
Lower threshold of the reliability function, R_{TS} [cycles]		0,98
Number of PM actions per year, N [--]		{2, ...,12}
Number of platforms [ud.]		{0, ...,5}

Number of stations [ud.]							{1, ..., 4}
Travel between stations {start – end}	{1 – 2}	{2 – 3}	{3 – 4}	{4 – 3}	{3 – 2}	{2 – 1}	
Interstation length [m]	840,67	443,41	768,98	768,98	443,41	840,67	
Interstation time travel [s]	219,38	137,06	215,17	215,17	137,06	219,38	
Interstation vehicles [veh]	17	11	17	17	11	17	

Appendix B. Results of validations for the models.

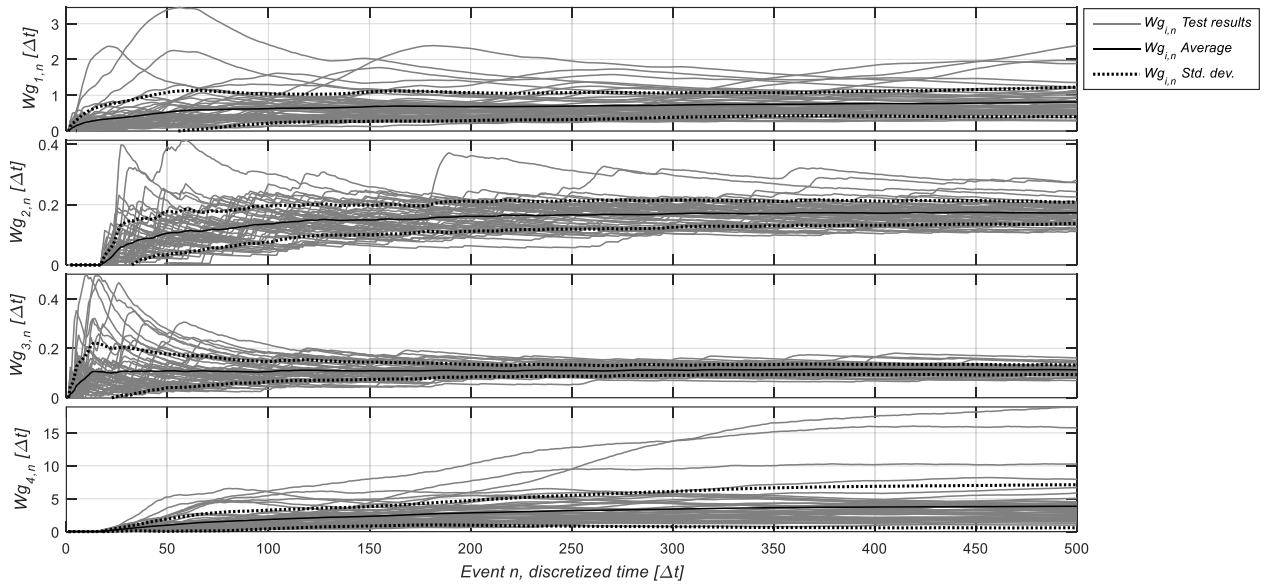

Figure B.1. Mean waiting time in the queue, $Wg_{i,n} [\Delta t]$.

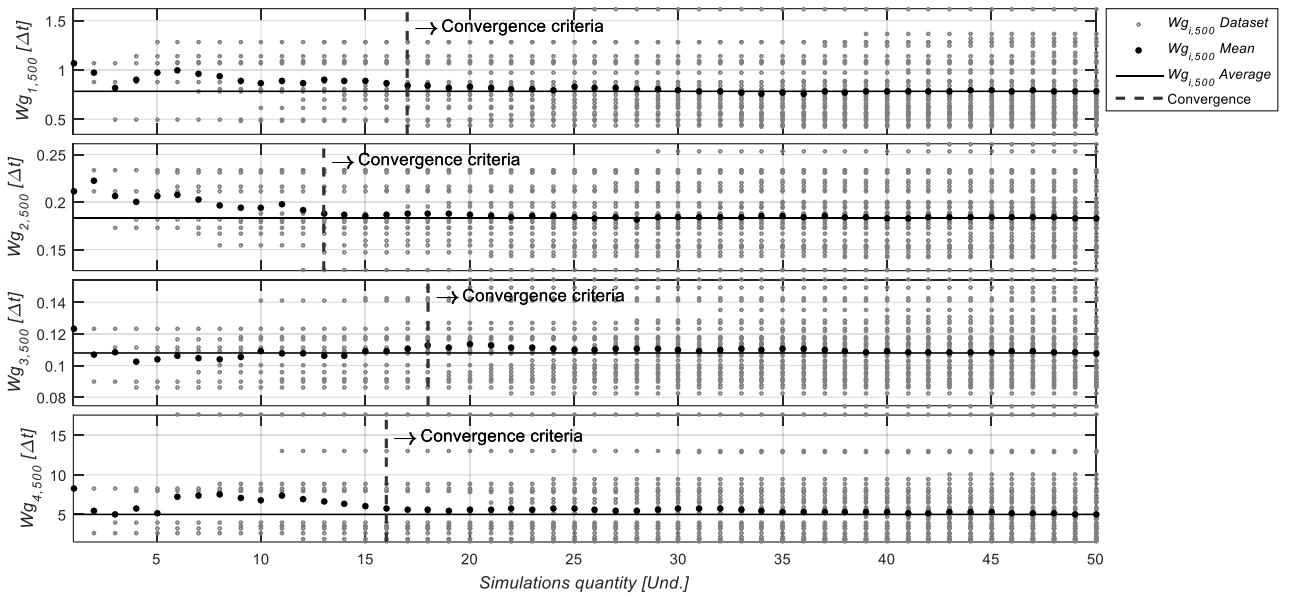

Figure B.2. Convergence analysis result of the numerical model.

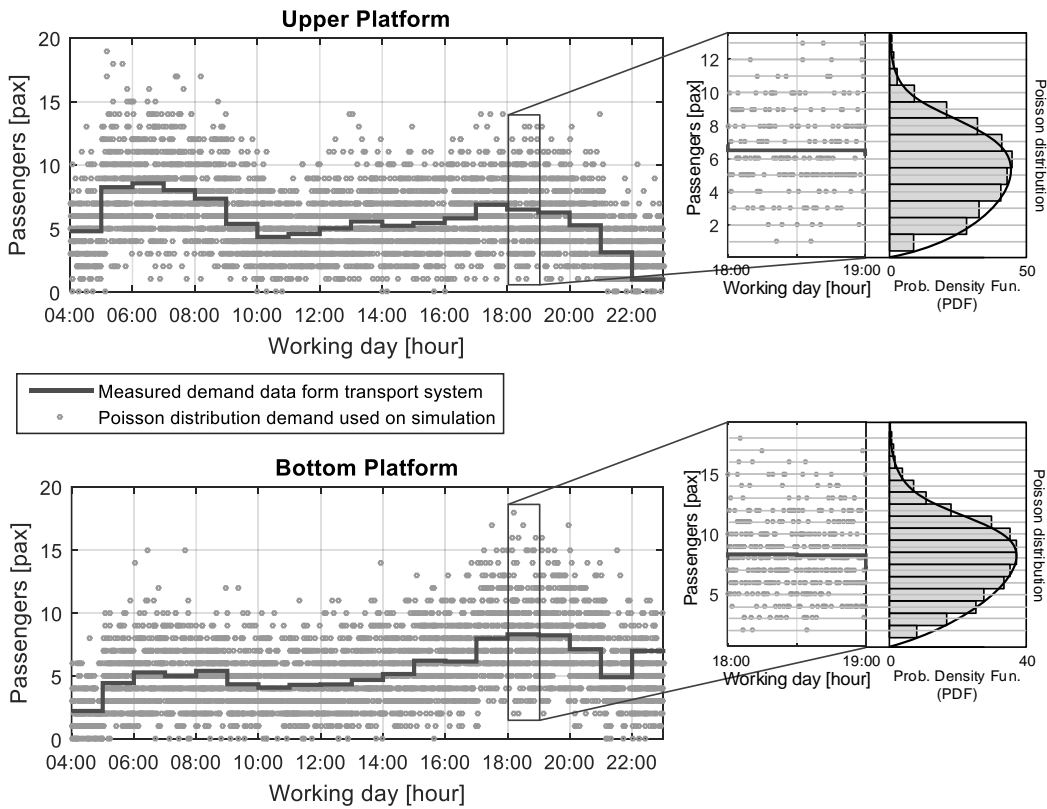

Figure B.3. Typical input of passengers to the system, i.e., distribution of arriving passengers at platforms during a working day.

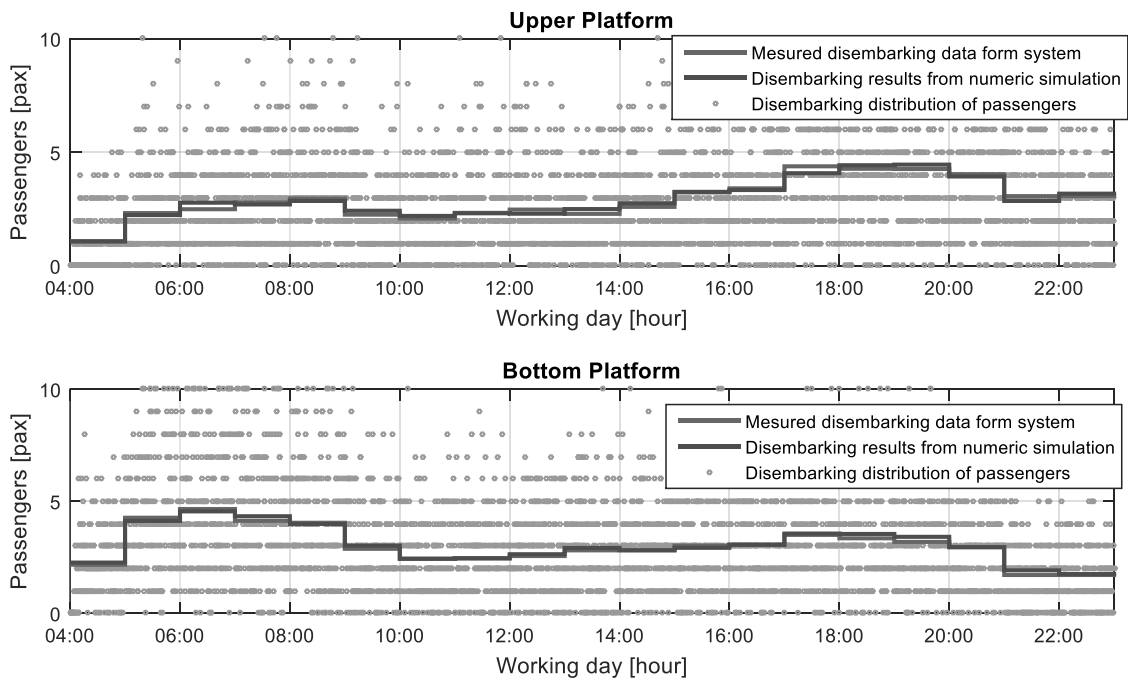

Figure B.4. Output of passengers from the system, i.e., distribution of passengers disembarking during a working day.

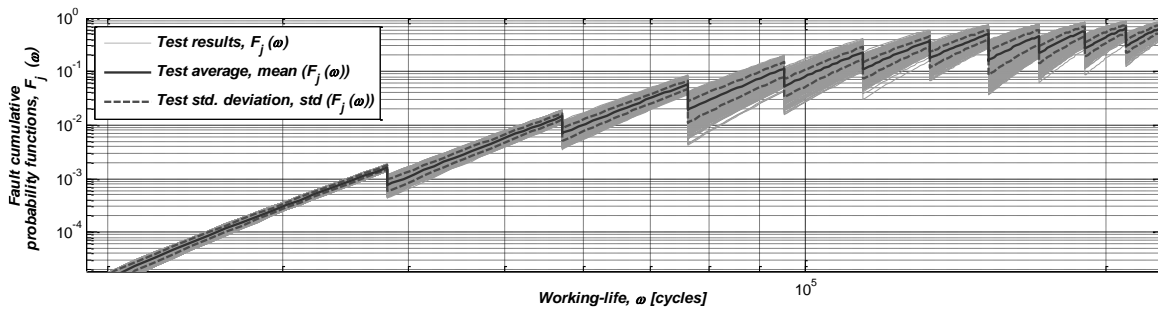

Figure B.5. Sensitivity tests results

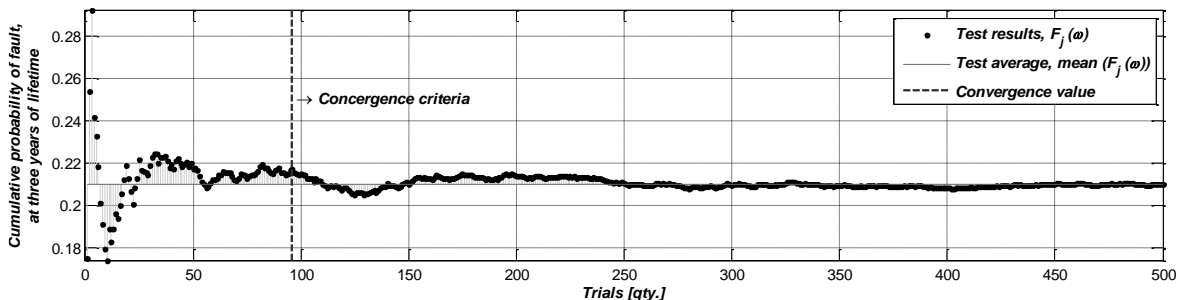

Figure B.6. Convergence tests result.

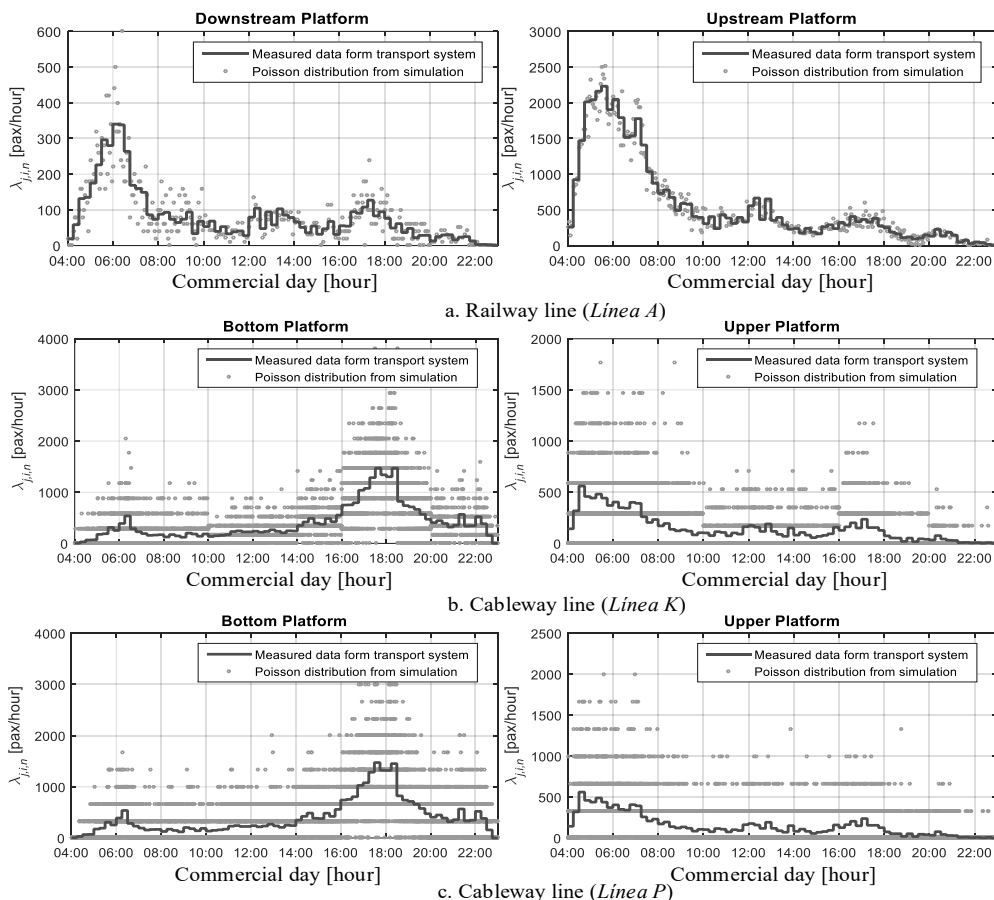

Figure B.7. Input dataset, stochastic Poisson distributions $\lambda_{j,i,n}$.

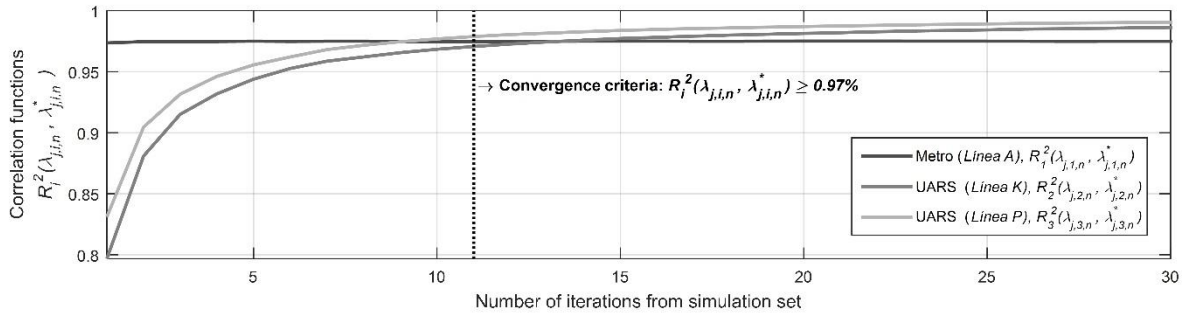

Figure B.8. Convergence analysis via correlation threshold, R_i^2 .

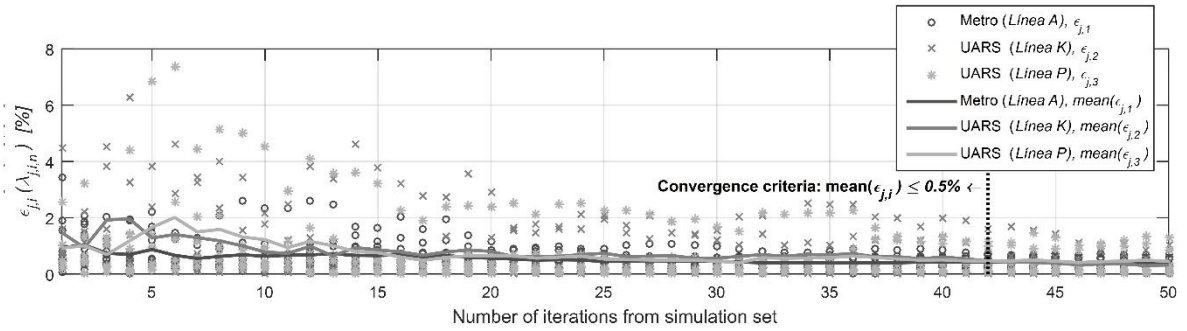

Figure B.9. Convergence analysis via error threshold, $\epsilon_{j,i}$.

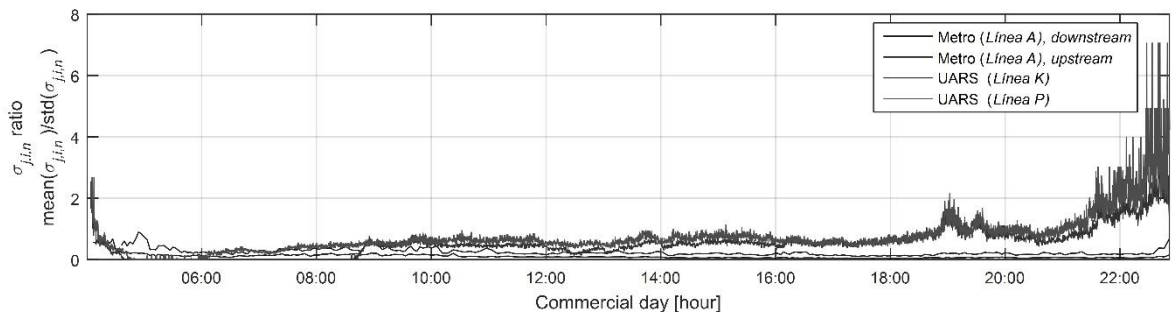

Figure B.10. Sensitivity analysis using the estimator, $r(\sigma_{j,i,n})$.

Appendix C. Results of numerical models

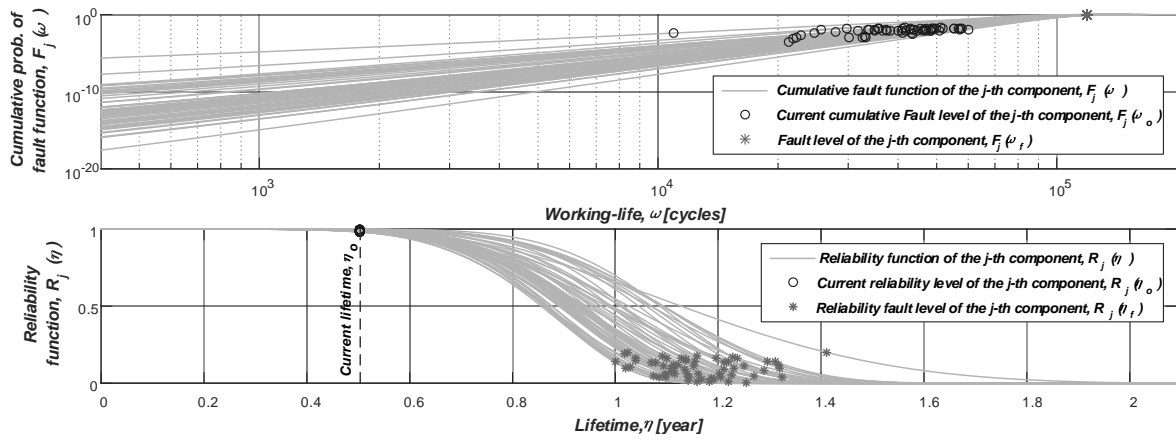
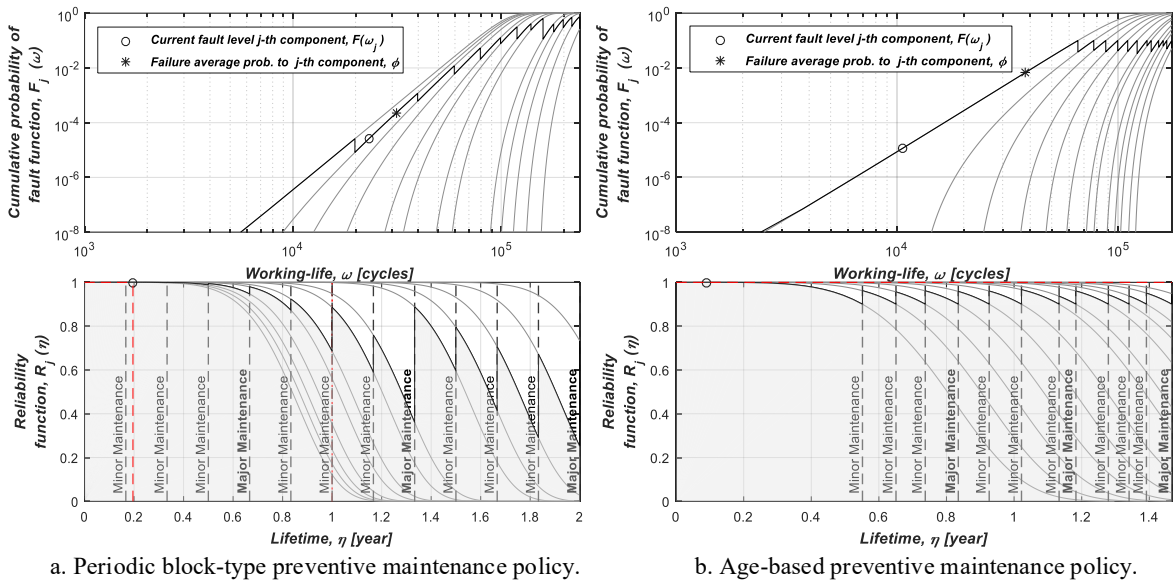

Figure C.1. Sample of the component's reliability behaviour.



a. Periodic block-type preventive maintenance policy.

b. Age-based preventive maintenance policy.

Figure C.2. Preventive imperfect maintenance policies.

Appendix D. General diagrams of the systems

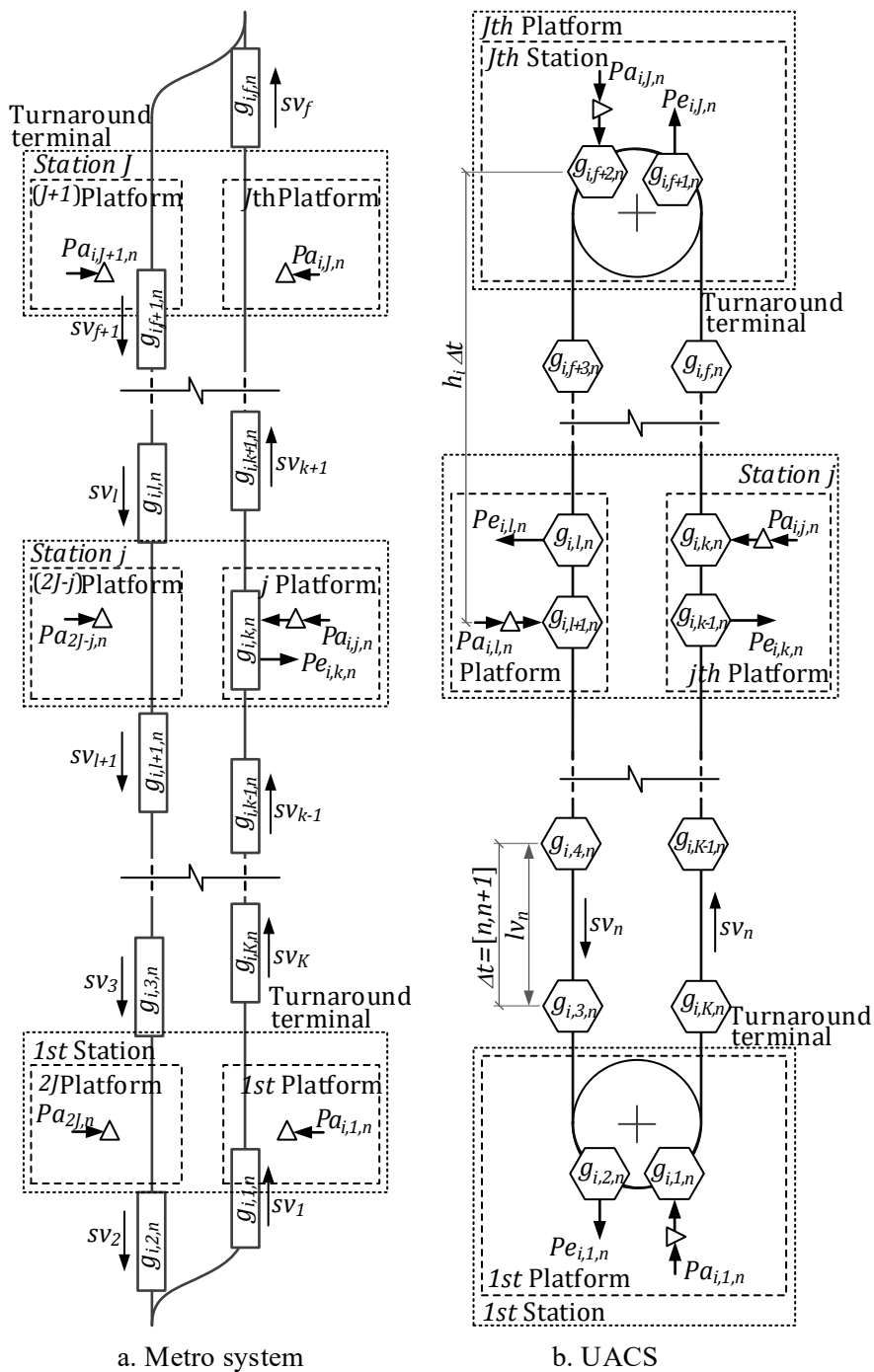

Figure D.1. General diagram of UTMs.

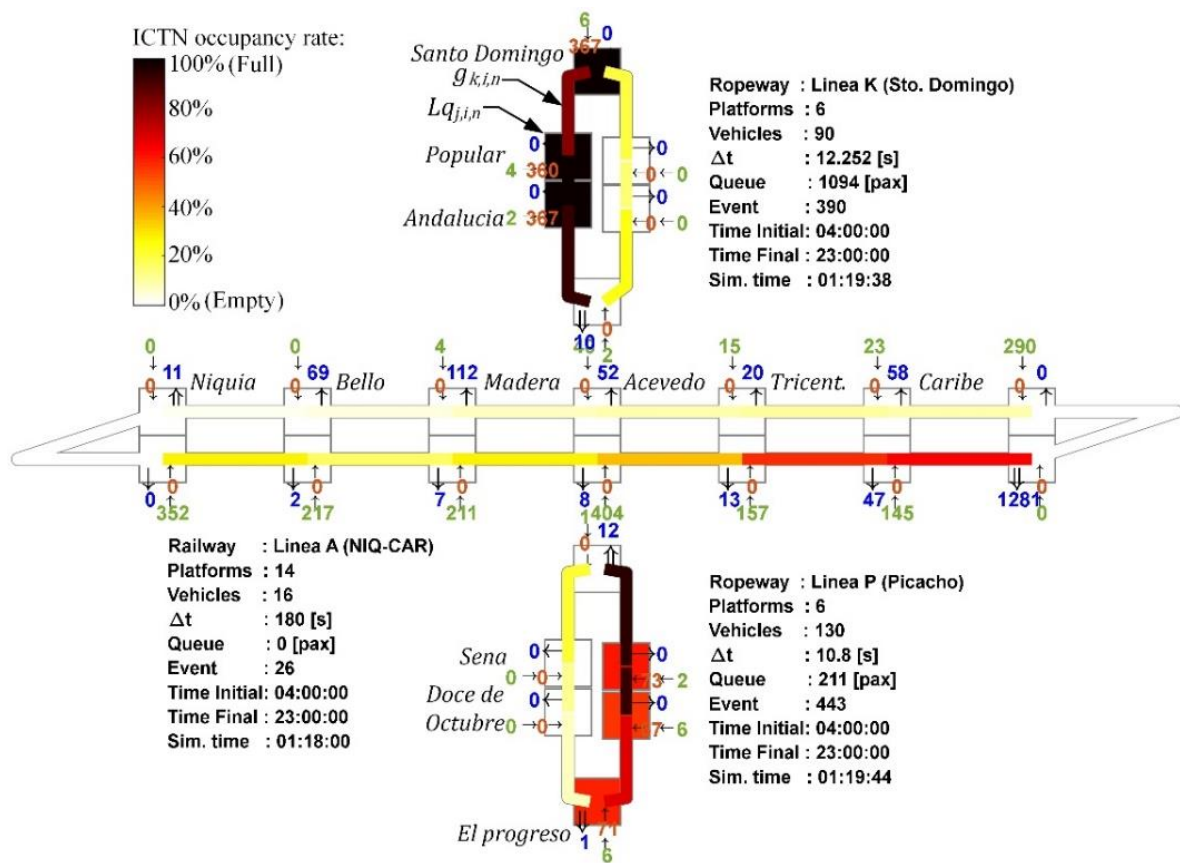

Figure D.2. Graphical computing representation of the numeric model.

Appendix E. BDP algorithms

Algorithm E.1. BDP algorithm for metro system.

```

1: Input :  $g_{k,i,n}, Lq_{j,i,n}, cv_{k,i,q}, \varphi_{j,i,n}, ts_{j,i,n}, N, I, J, BDP$ 
2: Output :  $\sigma_{j,i,n}, \sigma'_{j,i,n+1}, \mu_{j,i,n}$ 
3: for  $n = 1 : N$  do // repeat all discretised time by events
4:   for  $i = 1 : I$  do // repeat to set of UTMs belong to a MCPTS
5:     for  $j = 1 : J$  do // repeat all platforms
6:       if  $(g_{k,i,n} \in j) = 0$  then // if the k-th vehicle on the j-th platform is empty
7:          $\sigma_{j,i,n} \leftarrow 0$  // nobody disembarks
8:          $\sigma'_{j,i,n} \leftarrow 0$  // nobody remains in the vehicle
9:          $\mu_{j,i,n} \leftarrow \min(Lq_{j,i,n}, cv_{k,i,q} - g_{k,i,n})$  // boarding passengers
10:      else // if there are passengers into the k-th vehicle
11:        if  $(j = 1) \vee (j = J)$  then // if the j-th platform is inside a turnaround terminal
12:           $\sigma_{j,i,n} \leftarrow g_{k,i,n}$  // all passengers in the k-th vehicle disembark
13:           $\sigma'_{j,i,n} \leftarrow 0$  // nobody remains in the vehicle
14:           $\mu_{j,i,n} \leftarrow 0$  // nobody boards the vehicle
15:        else // if the j-th platform is inside a single station
16:          // passengers that arrive at their destination and wish to pass from the vehicle to the platform
17:           $\sigma'_{j,i,n} \leftarrow Pe_{j,i,n}(\sigma'_{j-1,i,n-1} - \sigma_{j-1,i,n-1} \leq g_{k,i,n-1})$ 
18:           $\varphi_{j,i,n} \leftarrow Lq_{j,i,n} + \sigma'_{j,i,n}$  // total passengers who wish to cross the doors (boarding & disembarking)
19:          if  $BDP = 0$  then // disciplined boarding and disembarking processes
20:            // case a: passengers who wish to disembark is longer that the door flow capacity:
21:            if  $\sigma_{j,i,n} \geq \varphi_{j,i,n} ts_{j,i,n}$  then
22:               $\sigma_{j,i,n} \leftarrow \varphi_{j,i,n} ts_{j,i,n}$  // passengers actually disembark
23:               $\sigma'_{j,i,n+1} \leftarrow \sigma'_{j,i,n} - \varphi_{j,i,n} ts_{j,i,n}$  // passengers who wish to disembark but remain into the vehicle
24:               $\mu_{j,i,n} \leftarrow 0$  // nobody boards the vehicle
25:            // case b: passengers who wish to disembark do so, but just some users in queue can board:
26:            elseif  $(\sigma'_{j,i,n} < \varphi_{j,i,n} ts_{j,i,n}) \wedge (\sigma'_{j,i,n} + Lq_{j,i,n} \geq \varphi_{j,i,n} ts_{j,i,n})$  then
27:               $\sigma_{j,i,n} \leftarrow \sigma'_{j,i,n}$  // passengers actually disembark
28:               $\sigma'_{j,i,n+1} \leftarrow 0$  // no one who wish to disembark remains in the vehicle
29:               $\mu_{j,i,n} \leftarrow \varphi_{j,i,n} ts_{j,i,n} - \sigma_{j,i,n}$  // boarding passengers
30:            // case c & d: all passengers who wish to disembark do so, and all some users in queue can board:
31:            else
32:               $\sigma_{j,i,n} \leftarrow \sigma'_{j,i,n}$  // passengers actually disembark
33:               $\sigma'_{j,i,n+1} \leftarrow 0$  // no one who wish to disembark remains in the vehicle
34:               $\mu_{j,i,n} \leftarrow \min(Lq_{j,i,n}, cv_{k,i,q} - g_{k,i,n-1} - \sigma_{j,i,n})$  // boarding passengers
35:            end
36:          else // informal boarding and disembarking processes
37:            // case a: the total of pass. who wish to disembark and the queue are longer that the doors' flow cap.
38:            if  $(\sigma'_{j,i,n} + Lq_{j,i,n} \geq \varphi_{j,i,n} ts_{j,i,n})$  then
39:               $\beta_{j,i,n} \leftarrow Pe_{j,i,n}(0 \leq 1)$  // stochastic index
40:               $\sigma_{j,i,n} \leftarrow \beta_{j,i,n}(\sigma'_{j,i,n} + (1 - \beta_{j-1,i,n-1})\sigma'_{j-1,i,n-1})$  // passengers actually disembark
41:               $\sigma'_{j,i,n+1} \leftarrow \sigma'_{j,i,n} - \sigma_{j,i,n}$  // passengers who wish to disembark but remain into the vehicle
42:               $\mu_{j,i,n} \leftarrow \varphi_{j,i,n} ts_{j,i,n} - \sigma_{j,i,n}$  // boarding passengers
43:            // case b & c: the total of pass. who wish to disembark and the queue are less that the doors' flow cap.
44:            else
45:               $\beta_{j,i,n} \leftarrow 1$  // index
46:               $\sigma_{j,i,n} \leftarrow \beta_{j,i,n}(\sigma'_{j,i,n} + (1 - \beta_{j-1,i,n-1})\sigma'_{j-1,i,n-1})$  // passengers actually disembark
47:               $\sigma'_{j,i,n+1} \leftarrow \sigma'_{j,i,n} - \sigma_{j,i,n}$  // passengers who wish to disembark but remain into the vehicle
48:               $\mu_{j,i,n} \leftarrow \min(Lq_{j,i,n-1}, cv_{k,i,q} - g_{k,i,n-1} - \sigma_{j,i,n})$  // boarding passengers
49:            end
50:          end
51:        end
52:      end
53:    end
54:  end
55: end

```

Algorithm E.2. BDP algorithm for UACS.

```

1: Input :  $g_{k,i,n}, Lq_{j,i,n}, cv_{k,i,q}, N, I, J$ 
2: Output :  $\sigma_{j,i,n}, \sigma'_{j,i,n+1}, \mu_{j,i,n}$ 
3: for  $n = 1 : N$  do // repeat all discretised time by events
4:   for  $i = 1 : I$  do // repeat to set of UTMs belong to a MCPTS
5:     for  $j = 1 : J$  do // repeat all platforms
6:       if  $(g_{k,i,n} \in j) = 0$  then // if the k-th vehicle on the j-th platform is empty
7:          $\sigma_{j,i,n} \leftarrow 0$  // nobody disembarks
8:          $\sigma'_{j,i,n} \leftarrow 0$  // nobody remains in the vehicle
9:          $\mu_{j,i,n} \leftarrow \min(Lq_{j,i,n}, cv_{k,i,q} - g_{k,i,n})$  // boarding passengers
10:      else // if there are passengers into the k-th vehicle
11:        if  $(j = 1) \vee (j = J)$  then // if the j-th platform is inside a turnaround terminal
12:           $\sigma_{j,i,n} \leftarrow g_{k,i,n}$  // all passengers in the k-th vehicle disembark
13:           $\sigma'_{j,i,n} \leftarrow 0$  // nobody remains in the vehicle
14:           $\mu_{j,i,n} \leftarrow 0$  // nobody boards the vehicle
15:        else // if the j-th platform is inside a single station
16:          // passengers that arrive at their destination and wish to pass from the vehicle to the platform
17:           $\sigma'_{j,i,n} \leftarrow Pe_{j,i,n}(\sigma_{j-1,i,n-1} \leq g_{k,i,n-1})$ 
18:           $\sigma_{j,i,n} \leftarrow \sigma'_{j,i,n}$  // all passengers who wish disembark actually do so
19:           $\sigma'_{j,i,n+1} \leftarrow 0$  // no one who wish to disembark remains into the vehicle
20:           $\mu_{j,i,n} \leftarrow \min(Lq_{j,i,n-1}, cv_{k,i,q} - g_{k,i,n-1})$  // boarding passengers
21:        end
22:      end
23:    end
24:  end
25: end

```

References

- Adjetej-Bahun, K., Birregah, B., & Planchet, J. (2016). A model to quantify the resilience of mass railway transportation systems. *Reliab. Eng. Syst. Safe.*, *153*, 1–14.
- Ahmad, R., & Kamaruddin, S. (2012). An overview of time-based and condition-based maintenance in industrial application. *Computers & Industrial Engineering*, *63* (1), 135–149.
- Ahmadi, A., Soleimanmeigouni, I., Block, J., & Letot, C. (2016). Optimum failure management strategy for periodically inspected units with imperfect maintenance. *IFAC*, *49*(12), 799–804.
- Alardhi, M., Hannam, R., & Labib, A. (2007). Preventive maintenance scheduling for multi-cogeneration plants with production constraints. *J. of Quality in Maint. Eng.*, *13*(3), 276–292.
- Alshalalfah, B., Shalaby, A., & Dale, S. (2014). Experiences with aerial ropeway transportation systems in the urban environment. *J. Urban Plann. Dev.*, *140*(1), 1–12.
- Alshalalfah, B., Shalaby, A., Dale, S., & Othman, F. (2012). Aerial ropeway transportation systems in the urban environment: state of the art. *J. Transp. Eng.*, *138*, 253–262.
- Alshalalfah, B., Shalaby, A., Dale, S., & Othman, F. (2013). Improvements and Innovations in Aerial Ropeway Transportation Technologies: Observations from Recent Implementations. *J. Transp. Eng.*, *139*(8), 814–821.
- Ameknassi, L., Ait-Kadi, D., & Rezg, N. (2017). Optimisation and analysis of a manufacturing-remanufacturing-transport-warehousing system within a closed-loop supply chain. *International Journal of Production Economics*, *186*, 132.
- Amirgholy, M., & Gonzales, E. (2016). Demand responsive transit systems with time-dependent demand: User equilibrium, system optimum, and management strategy. *Transp. Res. Part B*, *92*, 234–252.
- Anily, S., Glass, C., & Hassin, R. (1998). The scheduling of maintenance service. *Discrete Applied Mathematics*, *82*, 27–42.
- Askri, T., Hajej, Z., & Rezg, N. (2016). Optimal integrated maintenance strategy for parallel leased machines with warranty periods. *Conference on Control and Fault-Tolerant Systems (SysTol)*, 208–213.
- Barrena, E., Canca, D., Coelho, L., & Laporte, G. (2014). Exact formulations and algorithm for the train scheduling problem with dynamic demand. *Comp. Oper. Res.*, *44*, 44, 66–74.
- Barrena, E., Canca, D., Coelho, L., & Laporte, G. (2014). Single-line rail transit timetabling under dynamic passenger demand. *Transp. Res. Part B*, *70*, 134–150.
- Belli, L., Cilfone, A., Davoli, L., Ferrari, G., Adorni, P., Di Nocera, F., . . . Bertolotti, E. (2020). IoT-Enabled Smart Sustainable Cities: Challenges and Approaches. *Smart Cities*, *3*, 1039–1071.
- Bergerhoff, J., & Perschon J. (2012). Urban ropeway as part of sustainable urban transport networks in developing countries. *Conference on the role of urban mobility in (re)shaping cities (CODATU XV)*, (pp. 2–13). Addis Ababa, Ethiopia.
- Bernal, E., Martinod, R., Becancur, G., & Castañeda, L. (2016). Partial-profilegram reconstruction method to measure the geometric parameters of wheels in dynamic condition. *Veh. Sys. Dyn.*, *54*, 606–616.

- Bibri, S. (2018). The IoT for smart sustainable cities of the future: An analytical framework for sensor-based big data applications for environmental sustainability. *Sustainable Cities and Society*, 38, 230-253.
- Bocarejo, J., Portilla, I., Velásquez, J., Cruz, M., Peña, A., & Oviedo, D. (2014). An innovative transit system and its impact on low income users: the case of the metrocable in Medellín. *J. Transp. Geogr.*, 39, 49–61.
- Bouslikhane, S., Hajej, Z., & Rezg, N. (2018). An optimal integrated maintenance to production with carbon emission for a closed-loop system. *5th International Conference on Control, Decision and Information Technologies (CoDIT)*, 177-182.
- Bretthauer, G., Gamaleja, T., Jacobs, A., & Wilfert, H. (1990). Determination of favourable maintenance schedules for improving the power system reliability. *IFAC Proceedings*, 23(8), 109-114.
- Briš, R., & Byczanski, P. (2013). Effective computing algorithm for maintenance optimisation of highly reliable system. *Reliability Engineering & System Safety*, 109, 77–85.
- Briš, R., Byczanski, P., Goño, R., & Rusek, S. (2017). Discrete maintenance optimisation of complex multi-component systems. *Reliability Engineering & System Safety*, 168, 80–89.
- British Standard. (2004). Safety requirements for cableways for cableway installations designed to carry persons. Precommissioning inspection, maintenance and operational inspection and checks. In C. MCE/20, *BS/EN-1709* (p. 24). Londres.
- Bucsky, P. (2020). Modal share changes due to COVID-19: The case of Budapest. *Transp. Res. Interdisc. Perspectives*, 100141.
- Campbell, A., & Van Woensel, T. (2019). Special Issue on Recent Advances in Urban Transport and Logistics Through Optimisation and Analytics. *Transp. Sc.*, 53(1), 1–5.
- Canitez, F., Alpkokin, P., J.A., & Black. (2019). Agency costs in public transport systems: Net-cost contracting between the transport authority and private operators - impact on passengers. *Cities*, 86, 154-166.
- Capó, M., Pérez, A., & Lozano, J. (2017). An efficient approximation to the K-means clustering for massive data. *Knowledge-Based Systems*, 117, 56–69.
- Caris, A., Macharis, C., & Janssens, G. (2013). Decision support in intermodal transport: a new research agenda. *Comp. in Ind.*, 64, 105–112.
- Castañeda, L., Martinod, R., & Betancur, G. (2012). Determination of the technical state of suspension elements based on the OMA-LSCE method. *Ingeniería Ferroviaria*, 67(1), 41–54.
- Ceder, A. (2007). *Public transit planning and operation: theory, modeling and practice*. UK: Elsevier.
- Ceder, A., Chowdhury, S., Taghipouran, N., & Olsen, J. (2013). Modelling public-transport users' behaviour at connection point. *Transp. Policy*, 27, 112–122.
- Chalabi, N., D. M., Beldjilali, B., & Neki, A. (2016). Optimisation of preventive maintenance grouping strategy for multi-component series systems: Particle swarm based approach. *Computers & Industrial Engineering*, 102, 440–451.
- Chelbi, A., & Aït-Kadi, D. (2001). Spare provisioning strategy for preventively replaced systems subjected to random failure. *International Journal of Production Economics*, 74, 183–189.
- Cheng, G., Zhou, B., & Li, L. (2017). Joint optimisation of lot sizing and condition-based maintenance for multi-component production systems. *Computers & Industrial Engineering*, 110, 538–554.

- Cho, D., & Parlar, M. (1991). A survey of maintenance models for multi-unit systems. *European Journal of Operational Research*, 51, 1–23.
- Cho, D., & Parlar, M. (1991). A survey of maintenance models for multi-unit systems. *Eur. J. of Oper. Res.*, 51, 1-23.
- Cholasuke, C., Bhardwa, R., & Antong, J. (2004). The status of maintenance management in UK manufacturing organisations: results from a pilot survey. *J. of Quality in Maint. Eng.*, 10(1), 5–15.
- Cleophas, C., Cottrill, C., Ehmke, J., & Tierney, K. (2019). Collaborative urban transportation: Recent advances in theory and practice. *European J. of Oper. Res.*, 273(3), 801–816.
- CNRS. (2020). Section 37 (Économie/Gestion) du Comité National de la Recherche Scientifique. *Catégorisation des revues en Économie et en Gestion, Version 5.07*.
- Cordone, R., & Redaelli, F. (2011). Optimizing the demand captured by a railway system with a regular timetable. *Transp. Res. Part B*, 45, 430–446.
- Corman, F., D’Ariano, A., Pacciarelli, D., & Pranzo, M. (2012). Bi-objective conflict detection and resolution in railway traffic management. *Transp. Res. Part C*, 20(1), 79–94.
- Council of European Union. (2000). Relating to cableway installations designed to carry persons. In T. E. Parliament, *Directive 2000/9/EC* (pp. 21–48). U.E.: Official J. of the European Communities.
- Csikós, A., Charalambous, T., Farhadi, H., Kulcsár, B., & Wymeersch, H. (2017). Network traffic flow optimisation under performance constraints. *Transp. Res. Part C*, 83, 120–133.
- D’Ariano, A., Meng, L., Centulio, G., & Corman, F. (2019). Integrated stochastic optimisation approaches for tactical scheduling of trains and railway infrastructure maintenance. *Comp. & Ind. Eng.*, 127, 1315–1335.
- Dalla-Chiara, B. (2010). *Guidelines for the engineering and design of rope transport systems*. Torino: Politecnico di Torino, Dep. of Transp. Eng.
- De Haas, M., Faber, R., & Hamersma, M. (2020). How COVID-19 and the Dutch ‘intelligent lockdown’ change activities, work and travel behaviour: Evidence from longitudinal data in the Netherlands. *Transp. Res. Interdisc. Perspectives*, 6, 100150.
- Dekker, R., & Wildeman, R. (1997). A review of multi-component maintenance models with economic dependence. *Mathematical Methods of Operations Research*, 45, 411-435.
- Do, P., Vu, H. C., Barros, A., & Bérenguer, C. (2015). Maintenance grouping for multi-component systems with availability constraints and limited maintenance teams. *Reliability Engineering & System Safety*, 142, 56–67.
- Dollevoet, T., Corman, F., D’Ariano, A., & Huisman, D. (2014). An iterative optimisation framework for delay management and train scheduling. *J. of Flexible Serv. and Manuf.*, 26(4), 490–515.
- Doyen, L., & Gaudoin, O. (2004). Classes of imperfect repair models based on reduction of failure intensity or virtual age. *Reliability Engineering & System Safety*, 84(1), 45–56.
- Estepa, D., Martinod, R., Paris, C., Pineda, F., Restrepo, J., Castañeda, L., & Mejía, G. (2014). Operating conditions effect over the coupling strength for urban aerial ropeways. *Transp. Problems*, 9(3), 5–14.
- Fraser, K., Hvolby, H., & Tseng, B. (2015). Maintenance management models: A study of the published literature to identify empirical evidence. A greater practical focus is needed. *Int. J. of Quality & Reliab. Manag.*, 32(6), 635–664.

- Fraser, K., Hvolby, H., & Watanabe, C. (2011). A review of the three most popular maintenance systems: How well is the energy sector represented? *Int. J. of Global Energy Issues*, 35(4), 287–309.
- Freyss, M., Giesen, R., & Munoz, J. (2013). Continuous approximation for skip-stop operation in rail transit. *Transp. Res. Part C*, 36, 419–433.
- Gabrielli, L. D., Natale, F., Recchi, E., & Vespe, M. (2019). Dissecting global air traffic data to discern different types and trends of transnational human mobility. *EPJ Data Sci.*, 8(1), 1–24.
- Garsous, G., Suárez-Alemán, A., & Serebrisky, T. (2019). Cable cars in urban transport: Travel time savings from La Paz-El Alto (Bolivia). *Transp. Policy*, 75, 171–182.
- Gebhardt, L., Krajzewicz, D., Oostendorp, R., Goletz, M., Greger, K., Klötzke, M., . . . Heinrichs, D. (2016). Intermodal urban mobility: users, uses, and use cases. *Transp. Res. Procedia*, 14, 1183–1192.
- Giacco, G., D’Ariano, A., & Pacciarelli, D. (2014). Rolling stock rostering optimisation under maintenance constraints. *J. of Intell. Transp. Syst.: Tech., Plann., and Oper.*, 18(1), 95–105.
- Gillen, D., & Hasheminia, H. (2013). Estimating the demand responses for different sizes of air passenger groups. *Transp. Res. Part B*, 49, 24–38.
- Gu, W., Cassidy, M., & Li, Y. (2015). Models of bus queueing at curbside stops. *Transp. Science*, 49(2), 204–212.
- Guiras, Z., Turki, S., Rezg, N., & Dolgui, A. (2018). Optimisation of two-level disassembly/remanufacturing/assembly system with an integrated maintenance strategy. *Applied Sciences (Switzerland)*, 85(5), 666.
- Gustavsson, E., Patriksson, M., Strömberg, A., Wojciechowski, A., & Önnheim, M. (2014). Preventive maintenance scheduling of multi-component systems with interval costs. *Computers & Industrial Engineering*, 76, 390–400.
- Hadas, Y., & Shnaiderman, M. (2012). Public-transit frequency setting using minimum-cost approach with stochastic demand and travel time. *Transp. Res. Part B*, 46(8), 1068–1084.
- Hajej, Z., Bistorin, O., & Rezg, N. (2012). Maintenance/production plan optimisation taking into account the availability and degradation of manufacturing system. (pp. 963–967). Bucharest, Romania: Proc. of the 14th IFAC Symp.
- Hajej, Z., Dellagi, S., & Rezg, N. (2014). Joint optimisation of maintenance and production policies with subcontracting and product returns. *J. Intell. Manuf.*, 25, 589–602.
- Hajej, Z., Rezg, N., & Askri, T. (2018). Joint optimisation of capacity, production and maintenance planning of leased machines. *J. of Intell. Manuf.*, 31, 351–374.
- Hajej, Z., Rezg, N., & Gharbi, A. (2017). Joint optimisation of production and maintenance planning with an environmental impact study. *International Journal of Advanced Manufacturing Technology*, 93(1-4), 1269-1282.
- Hajej, Z., Rezg, N., & Gharbi, A. (2018). Quality issue in forecasting problem of production and maintenance policy for production unit. *International Journal of Production Research*, 56(18), 6147-6163.
- Hajej, Z., S., T., & Rezg, N. (2014). A jointly optimisation of production, delivery and maintenance planning for multi-warehouse/multi-delivery problem. Honolulu, Hawaii: Prob. Saf. Asses. and Manag (PSAM 12).
- Hajej, Z., S., T., & Rezg, N. (2015). Modelling and analysis for sequentially optimizing production, maintenance and delivery activities taking into account product returns. *Int. J. of Prod. Res.*, 53(15), 4693–4719.

- Hall, R. (2003). *Transportation queueing*. In: *Handbook of transportation science* (Second ed.). USA: Kluwer Academic Publisher.
- Han, J., Kamber, M., & Pei, J. (2011). *Data Mining: Concepts and Techniques*. Morgan Kaufmann.
- Heinrichs, D., & Bernet, J. (2014). Public transport and accessibility in informal settlements: aerial cable cars in Medellín, Colombia. *Transp. Res. Proc.*, 4, 55–67.
- Herbon, A., & Hadas, Y. (2015). Determining optimal frequency and vehicle capacity for public transit routes: A generalized newsvendor model. *Trans. Res. Part B*, 71, 85–99.
- Hilgert, T., von Behren, S., Eisenmann, C., & Vortisch, P. (2018). Are activity patterns stable or variable? Analysis of three-year panel data. *Transp. Res. Rec.*, 2672 (47), 46–56.
- Hoffmann, K. (2006). Recent developments in cable-drawn urban transport systems. *FME Transactions*, 34(4), 205–212.
- Hong, L., Yan, Y., Ouyang, M., Tian, H., & He, X. (2017). Vulnerability effects of passengers' intermodal transfer distance preference and subway expansion on complementary urban public transportation Systems. *Reliab. Eng. Syst. Safe*, 158, 58–72.
- Horn, M. (2002). Multi-modal and demand-responsive passenger transport systems: A modelling framework with embedded control systems. *Transp. Res. Part A*, 36(2), 167–188.
- Iacus, S., Natale, F., Santamaria, C., Spyratos, S., & Vespe, M. (2020). Estimating and projecting air passenger traffic during the COVID-19 coronavirus outbreak and its socio-economic impact. *Safety Sci.*, 129, 104791.
- IATA. (2020). *What can we learn from past pandemic episodes?* Retrieved from <https://www.iata.org/en/iata-repository/publications/economic-reports/what-can-we-learn-from-pastpandemic-episodes/>.
- Ibarra-Rojas, O. J., Delgado, F., Giesen, R., & Muñoz, J. (2015). Planning, operation, and control of bus transport systems: A literature review. *Transp. Res. Part B*, 77, 38–75.
- Ison, S., & Sagaris, L. (2016). Workshop 4 report: Developing inter-modal transport systems. *Res. in Transp. Econ.*, 59, 175–178.
- Lung, B., Do, P., Levrat, E., & Voisin, A. (2016). Opportunistic maintenance based on multi-dependent components of manufacturing system. *CIRP Annals*, 65(1), 401–404.
- Ivaldi, E., & Ciacci, A. (2020). Measuring Level of Technological Infrastructure in Smart Cities: A Non-compensatory Approach. In D. H., & Y. S., *Strategic Outlook for Innovative Work Behaviours*. Springer.
- Jain, A. (2010). Data clustering: 50 years beyond K-means. *Pattern Recognition Letters*, 31, 651–666.
- Jenelius, E. (2018). Public transport experienced service reliability: Integrating travel time and travel conditions. *Transp. Res. Part A*, 117, 275–291.
- Jones, W., Cassady, C., & Bowden, R. (2000). Developing a standard definition of intermodal transportation. *Trans. Law J.*, 27, 345–352.
- Kahraman, A., & Gosavi, A. (2011). On the distribution of the number stranded in bulk-arrival, bulk-service queues of the M/G/1 form. *Eur. J. Oper. Res.*, 212(2), 352–360.
- Kaufman, L., & Rousseeaw, P. (2009). *Finding groups in data: An introduction to cluster analysis*. John Wiley & Sons.
- Khatab, A., Ait-Kadi, D., & Rezg, N. (2013). Availability optimisation for stochastic degrading systems under imperfect preventive maintenance. *Int. J. of Prod. Res.*, 52(14), 4132–4141.

- Kralj, B., & Petrović, R. (1988). Optimal preventive maintenance scheduling of thermal generating units in power systems - A survey of problem formulations and solution methods. *Eur. J. of Oper. Res.*, 35(1), 1-15.
- Lai, Y., Fan, D., & Huang, K. (2015). Optimizing rolling stock assignment and maintenance plan for passenger railway operations. *Comp. and Ind. Eng.*, 85, 284–295.
- Lee, C., & Miller, J. (2017). A probability-based indicator for measuring the degree of multimodality in transportation investments. *Transp. Res. Part A: Policy and Practice*, 203, 377–390.
- Lee, Y., & Vuchic, V. (2005). Transit network design with variable demand. *J. Transp. Eng.*, 131(1), 1–10.
- Lei, T., & Church, R. (2010). Mapping transit-based access: integrating GIS, routes and schedules. *Int. J. Geogr. Inf. Sci.*, 24 (2), 283–304.
- Li, Z., & Sheng, D. (2016). Forecasting passenger travel demand for air and high-speed rail integration service: A case study of Beijing-Guangzhou corridor, China. *Transp. Res. Part A*, 94, 397–410.
- Liu, B., Xu, Z., Xie, M., & Kuo, W. (2014). A value-based preventive maintenance policy for multi-component system with continuously degrading components. *Reliability Engineering & System Safety*, 132, 83–89.
- Liu, H., Yeh, R., & Cai, B. (2017). Reliability modeling for dependent competing failure processes of damage self-healing systems. *Computers & Industrial Engineering*, 105, 55–62.
- Mahesh-Kumar, K., & Rama-Mohan-Reddy, A. (2017). An efficient k-Means clustering filtering algorithm using density based initial cluster centers. *Information Sciences*, 418, 286–301.
- Martinez, A., Martinod, R., Jensen, J., Palacio, M., & Castañeda, L. (2010). Gestaltung von Lastoptimierten Ersatzteilen am Beispiel eines Eisenbahnwaggon-Fahrgestells. *Konstruktion*, 67–70.
- Martinod, R., Betancur, G., & Castañeda, L. (2012). Evaluation of the damping elements for two stage suspension vehicles. *Ingeniería e Investigación*, 32(1), 11–17.
- Martinod, R., Betancur, G., Castañeda, L., & Restrepo, J. (2016). Structural analysis of railways bolster-beam under commercial operation conditions: over-traction and over-braking. *Transp. Problems*, 11(2), 67–77.
- Martinod, R., Bistorin, O., Castañeda, L., & Rezg, N. (2018). Maintenance policy optimisation for multi-component systems considering degradation of components and imperfect maintenance actions. *Comp. & Ind. Eng.*, 124, 100–112.
- Martinod, R., Bistorin, O., L., C., & Rezg, N. (2019). Joint optimisation of operation and maintenance policies in an urban ropeway transport systems context. *Int. J. of Quality & Reliab. Manag.*, 36, 1106–11136.
- Martinod, R., Estepa, D., Paris, C., Pineda, F., Restrepo, J., Castaneda, L., & Mejia, G. (2014). Operating conditions effect over the coupling strength for urban aerial ropeways. *Transp. Problems*, 9(3), 5–14.
- Martinod, R., Estepa, D., Paris, C., Trujillo, A., Pineda, F., Castañeda, L., & Restrepo, J. (2015). Journey safety assessment to urban aerial ropeways transport systems based on continuous inspection during operation. *J. Transp. Safety & Security*, 7, 279–290.
- May, A., & Keller, H. (1967). A deterministic queueing model. *Transp. Res.*, 1(2), 117–128.
- Mizuma, T. (2004). Recent urban transport technologies and assessments. *Jap. Rail. Eng.*, 44(1), 5–10.

- Moubray, J. (2003). *Twenty-first century maintenance organization: Part 1 – the asset management model*. Barrington, IL.: Maintenance Technology, Applied Technology Publications.
- Müggenburg, H., Busch-Geertsema, A., & Lanzendorf, M. (2015). Mobility biographies: A review of achievements and challenges of the mobility biographies approach and a framework for further research. *J. of Transp. Geography*, *46*, 151–163.
- Ndhaief, N., Bistorin, O., & Rezg, N. (2017). A modelling approach for city locating logistic platforms based on combined forward and reverse flows. *IFAC-PapersOnLine*, *50*(1), 11701-11706.
- Nesheli, M., Ceder, A., & Liu, T. (2015). A Robust, tactic-based, real-time framework for public-transport transfer synchronization. *Transp. Res. Proc.*, *9*, 246–268.
- Newell, G. (1977). *Unstable Brownian motion of a bus trip*. In: *Statistical mechanics and statistical methods in theory and applications*. USA: Plenum Press.
- Nicolai, R., & Dekker, R. (2008). Optimal maintenance of multi-component systems: a review. In K. Kobbacy, & D. Prabhakar, *Complex system maintenance handbook* (pp. 263–286). London: Springer.
- Niu, H., & Zhou, X. (2013). Optimizing urban rail timetable under time-dependent demand and oversaturated conditions. *Transp. Res. Part C*, *36*, 212–230.
- Ortega, F., Pozo, M., & Puerto, J. (2018). On-Line Timetable Rescheduling in a Transit Line. *Transport Science*, *55*(5), 1106–1121.
- Parbo, J., Nielsen, O., & Prato, C. (2014). User perspectives in public transport timetable optimisation. *Transp. Res. Part C*, *48*, 269–284.
- Paulsson, A., Isaksson, k., Sørensen, C., Hrelja, R., Rye, T., & Scholten, C. (2018). Collaboration in public transport planning – Why, how and what? *Res. in Transp. Econ.*, *69*, 377–385.
- Peng, H., & Zhu, Q. (2017). Approximate evaluation of average downtime under an integrated approach of opportunistic maintenance for multi-component systems. *Computers & Industrial Engineering*, *109*, 335–346.
- Peng, R., Mo, H., Xie, M., & Levitin, G. (2013). Optimal structure of multi-state systems with multi-fault coverage. *Reliability Engineering & System Safety*, *119*, 18–25.
- Pham, H., & Wang, W. (1996). Imperfect Maintenance. *Eur. J. of Oper. Res.*, *94*, 425–438.
- Pitsiava-Latinopoulou, M., & Iordanopoulos, P. (2012). Intermodal passengers terminals: design standards for better level of service. *Proc. Social and Behavioral Sci.*, *48*, 3297–3306.
- Preston, J., & Rajé, F. (2007). Accessibility, mobility and transport-related social exclusion. *J. of Transp. Geog.*, *15*(3), 151-160.
- Qiu, Q., Cui, L., Shen, J., & Yang, L. (2017). Optimal maintenance policy considering maintenance errors for systems operating under performance-based contracts. *Computers & Industrial Engineering*, *112*, 147–155.
- Recchi, E., Deutschmann, E., & Vespe, M. (2019). Estimating transnational human mobility on a global scale. *Robert Schuman Centre for Advanced Studies*, *30*, 1–10.
- Reichenbach, M., & Puhe, M. (2018). Flying high in urban ropeways? A socio-technical analysis of drivers and obstacles for urban ropeway systems in Germany. *Transp. Res. Part D*, *61*, 339–355.
- Rajo, M., Gonzalo-Orden, M., Dell’Olio, L., & Ibeas, A. (2012). Relationship between service quality and demand for inter-urban buses. *Transp. Res. Part A*, *46*, 1716–1729.
- Ruiz, O. (2002). *Understanding CAD/CAM/CG*. ASME Code GT-006.

- Schönfelder, S., & Axhausen, K. (2010). *Urban rhythms and travel behaviour: spatial and temporal phenomena of daily travel*. Ashgate publishing.
- Schutz, J., & Rezg, N. (2013). Maintenance strategy for leased equipment. *Computers & Industrial Engineering*, 66, 593–600.
- Sever, D. (2002). Some new methods to assure harmonisation of sustainable development of mountain resorts ropeway. *Promet*, 14(5), 213–220.
- Shang, P., Li, R., & Yang, L. (2016). Optimisation of Urban Single-Line Metro Timetable for Total Passenger Travel Time under Dynamic Passenger Demand. *Proc. Eng.*, 137, 151–160.
- Song, C., & Wei, C. (2018). Travel time use over five decades. *Transp. Res. Part A*, 116, 73–96.
- Sörensen, K., Vanovermeire, C., & Busschaert, S. (2012). Efficient metaheuristics to solve the intermodal terminal location problem. *Comput. Operat. Res.*, 39, 2079–2090.
- Souheil, A., Dellagi, S., & Rezg, N. (2012). Joint optimisation of maintenance and production policies considering random demand and variable production rate. *Int. J. of Prod. Res.*, 50(23), 6870–6885.
- Spillar, R. (1997). *Park & Ride planning and design guidelines*. USA: Parsons Brinckerhoff Inc.
- Steiner, K., & Irnich, S. (2018). Schedule-based integrated intercity bus line planning via branch-and-cut. *Transp. Sc.*, 52(4), 882–897.
- Sun, L., Jin, J., Lee, D., Axhausen, K., & Erath, A. (2014). Demand-driven timetable design for metro services. *Transp. Res. Part C*, 46, 284–299.
- Sun, Y., Guo, Q., Schonfeld, P., & Li, Z. (2017). Evolution of public transit modes in a commuter corridor. *Trans. Res. Part C*, 75, 84–102.
- Taha, H. (2011). *Operations research: an introduction*. USA: Pearson Prentice Hall.
- Tamaki, T., Nakamura, H., Fujii, H., & Managi, S. (2019). Efficiency and emissions from urban transport: Application to world city-level public transportation. *Economic Analysis and Policy*, 61, 55–63.
- Tang, J., Yang, Y., & Qi, Y. (2018). A hybrid algorithm for Urban transit schedule optimisation. *Physica A: Statistical Mechanics and its Applications*, 512, 745–755.
- Težak, S., Sever, D., & Lep, M. (2016). Increasing the capacities of cable cars for use in public transport. *J. of Public Transp.*, 19(1), 1–16.
- Tian, Z., & Liao, H. (2011). Condition based maintenance optimisation for multi-component systems using proportional hazards model. *Reliability Engineering & System Safety*, 96, 581–589.
- Torrise, V., Ignaccolo, M., & Inturri, G. (2017). Estimating travel time reliability in urban areas through a dynamic simulation model. *Transp. Res Procedia*, 27, 857–864.
- Trujillo, A. (2013). *Impacto esperado en indicadores de desempeño con la implementación del SPD-Cable en la Línea J del Metro de Medellín* (Vol. Mater thesis). Medellín: Universidad EAFIT.
- Turki, S., & Rezg, N. (2017). Study of the E-Maintenance Service in E-Logistic Supply Chain. *Proceedings - 11th IEEE International Symposium on Service-Oriented System Engineering (SOSE)*, 132-137.
- Turki, S., & Rezg, N. (2018). A jointly integrated maintenance and emission optimisation for a manufacturing and remanufacturing system. *International Journal of Systems Science: Operations and Logistics*, 5(1), 25-44.

- Van der Weijde, A., Erik, T., Verhoef, E., & Van den Berg, V. (2013). Competition in multi-modal transport networks: a dynamic approach. *Transp. Res. Part B: Methodol.*, *53*, 31–44.
- Van Horenbeek, A., & Pintelon, L. (2013). A dynamic predictive maintenance policy for complex multi-component systems. *Reliability Engineering & System Safety*, *120*, 39–50.
- Wang, H. (2002). A survey of maintenance policies of deteriorating systems. *European Journal of Operational Research*, *139*(3), 469–489.
- Wang, I., Tsai, Y., & Li, F. (2011). A network flow model for clustering segments and minimizing total maintenance and rehabilitation cost. *Computers & Industrial Engineering*, *60*, 593–601.
- Wang, Y., Guo, J., Ceder, A., Currie, G. D., & Yuan, H. (2014). Waiting for public transport services: Queueing analysis with balking and renegeing behaviors of impatient passengers. *Transp. Res. Part B*, *63*, 53–76.
- Wang, Y., Tang, T., Ning, B., van den Boomb, T., & de Schutter, B. (2015). Passenger-demands-oriented train scheduling for an urban rail transit network. *Transp. Res. Part C*, *60*, 1–23.
- Wu, P.-Y., & Mengersen, K. (2014). A Hybrid Queue-based Bayesian network framework for passenger facilitation modelling. *Transp. Res. Part C*, *46*, 247–260.
- Xiao, L., Song, S., Chen, X., & Coit, D. (2016). Joint optimisation of production scheduling and machine group preventive maintenance. *Reliability Engineering & System Safety*, *146*, 68–78.
- Xu, X., Liu, J., H.Y., L., & Hu, J. (2014). Analysis of subway station capacity with the use of queueing theory, . *Transp. Res. Part C*, *38*, 28–43.
- Yang, L., Li, S., Gao, Y., & Gao, Z. (2015). A coordinated routing model with optimized velocity for train scheduling on a single-track railway line. *Int. J. Intell. Syst.*, *30*, 3–22.
- Yang, L., Ma, X., Peng, R., Zhai, Q., & Zhao, Y. (2017). A preventive maintenance model based on dependent two-stage deterioration and external shocks. *Reliability Engineering & System Safety*, *160*, 201–211.
- Yang, L., Zhao, Y., Peng, R., & Ma, X. (2018). Hybrid preventive maintenance of competing failures under random environment. *Reliability Engineering & System Safety*, *174*, 130–140.
- Yang, Z., Djurdjanovic, D., & Ni, J. (2008). Maintenance scheduling in manufacturing systems based on predicted machine degradation. *Journal of Intelligent Manufacturing*, *19*, 87–98.
- Yin, J., Yang, L., Tang, T., Gao, Z., & Ran, B. (2017). Dynamic passenger demand oriented metro train scheduling with energy-efficiency and waiting time minimization: mixed-integer linear programming approaches. *Transp. Res. Part B*, *97*, 182–213.
- Zhou, X., Huang, K., Xi, L., & Lee, J. (2015). Preventive maintenance modeling for multi-component systems with considering stochastic failures and disassembly sequence. *Reliability Engineering & System Safety*(142), 231–237.