



HAL
open science

Personalisation in Cyber-Physical-Social Systems (CPSS)

Bereket Abera Yilma

► **To cite this version:**

Bereket Abera Yilma. Personalisation in Cyber-Physical-Social Systems (CPSS). Computer Science [cs]. Université de Lorraine; Luxembourg Institute of Science and Technology, 2021. English. NNT : 2021LORR0130 . tel-03367875

HAL Id: tel-03367875

<https://hal.univ-lorraine.fr/tel-03367875v1>

Submitted on 6 Oct 2021

HAL is a multi-disciplinary open access archive for the deposit and dissemination of scientific research documents, whether they are published or not. The documents may come from teaching and research institutions in France or abroad, or from public or private research centers.

L'archive ouverte pluridisciplinaire **HAL**, est destinée au dépôt et à la diffusion de documents scientifiques de niveau recherche, publiés ou non, émanant des établissements d'enseignement et de recherche français ou étrangers, des laboratoires publics ou privés.



AVERTISSEMENT

Ce document est le fruit d'un long travail approuvé par le jury de soutenance et mis à disposition de l'ensemble de la communauté universitaire élargie.

Il est soumis à la propriété intellectuelle de l'auteur. Ceci implique une obligation de citation et de référencement lors de l'utilisation de ce document.

D'autre part, toute contrefaçon, plagiat, reproduction illicite encourt une poursuite pénale.

Contact : ddoc-theses-contact@univ-lorraine.fr

LIENS

Code de la Propriété Intellectuelle. articles L 122. 4

Code de la Propriété Intellectuelle. articles L 335.2- L 335.10

http://www.cfcopies.com/V2/leg/leg_droi.php

<http://www.culture.gouv.fr/culture/infos-pratiques/droits/protection.htm>



Personalisation in Cyber-Physical-Social Systems (CPSS)

THÈSE

soutenue le 28 juillet 2021

pour l'obtention du titre de

Doctorat de l'Université de Lorraine

(mention Automatique, Traitement du signal et des Images, et Génie Informatique)

par

Bereket Abera YILMA

Composition du jury

Président : • Prof. Néjib Moalla, Professeur des Universités à Université Lumière Lyon II, France

Rapporteurs :

- Prof. Vassilakis Costas, Professeur à Université du Péloponnèse, Grèce
- Dr. Hedi Karray, Maître de Conférences HDR à ENIT, INP Toulouse, France

Examineurs :

- Dr. Wided Guédria, Chef de Projet, chercheure associée au CRAN, France
- Prof. Hervé Panetto, Professeur à l'Université de Lorraine, France (*Directeur de thèse*)
- Dr. Yannick Naudet, Chef de groupe au Luxembourg Institute of Science and Technology, Luxembourg (*Co-directeur de thèse*)

Acknowledgements

First of all , I would like to thank my supervisors Dr. Yannick Naudet and Prof. Hervé Panetto for their continuous support, guidance and encouragement throughout my Ph.D. I would also like to thank Prof. Vassilakis Costas and Dr. Hedi Karray, who agreed to be the official reviewers of this thesis, and the other members of the jury, Prof. Néjib Moalla and Dr. Wided Guédria for examining my work.

I thank my fellow lab mates in CRAN and my colleagues at LIST, especially members of DSA unit: Louis DELADIENNEE, Uzma IFFAT, Dr. Patrick Gratz, Dr. Alexandru TANTAR and Dr. Riad AGGOUNE for stimulating discussions, their support and collaboration.

In addition, I would like to thank my friends: Gabriel, Marcello, Elisabeth, Surafel, Milen, Zack, Yonas, Wael, Najib, Alex, Liyu and many others for the good moments that we spent together as well as their support during my Ph.D journey.

Finally, I would like to express my sincere gratitude and appreciation to my beloved family; my brave mother (Mershaye Beyene), my kind, loving and caring sisters (Kidist and Hiwot YILMA) and all my extended family for their prayers, continuous support and encouragement. A special thank you to my beloved brother Captain Seneshaw YILMA, this is for you all, Psalm 91!

Dedication

Dedicated to my family – for their love, support, and vision.

ይህ አንብሮ መታሰቢያነቱ ለቤተሰቦቼ ፍቅር፣ ድጋፍ እና ህልም ይሁንልኝ።



Contents

List of figures	vii
List of tables	ix
General Introduction	xi
1 Research Context and motivation	xii
2 Research Questions and the contribution of this thesis	xiv
3 Structure of this manuscript	xv

Chapter 1	
Literature Survey	1

1.1 Introduction	1
1.2 Cyber-Physical-Social System (CPSS): State of the art	1
1.2.1 Systematic literature review	2
1.2.1.1 Paper Selection Procedure	2
1.2.1.2 Descriptive Analysis of Papers	4
1.2.2 State of the art perspectives of CPSS	8
1.2.2.1 Alternative Terminologies	8
1.2.2.2 Definitions of CPSS	11
1.2.2.3 The role of human in CPSS	13
1.3 Conceptualising the Social aspect in CPSS	14
1.3.1 Social interaction and CPSS	14
1.3.2 Emotion, Cognition and Behaviour	15
1.3.3 Discussion	17
1.4 Contribution positioning	19

Chapter 2	
Personalisation in Cyber-Physical-Social Systems (CPSS)	21

2.1 Introduction	21
----------------------------	----

2.2	Systemic formalisation of Cyber-Physical-Social System (CPSS)	21
2.2.1	Definition of CPSS	22
2.2.2	Systemic model for CPSS	24
2.2.3	A meta-model of CPSS	26
2.3	Personalisation in Cyber-Physical-Social System (CPSS)	30
2.3.1	Background on Personalisation	30
2.3.1.1	Recommendation	31
2.3.1.2	Adaptation	31
2.3.2	From Personalisation in Physical Space to CPSS	31
2.3.3	CPSS personalisation formalisation	33
2.3.4	Discussion	34
2.4	Conclusion	35

Chapter 3	
Case studies	37

3.1	Introduction	37
3.2	Personalisation in Exhibition Areas	37
3.2.1	Introduction	37
3.2.2	Problem formulation	38
3.2.3	Implementation	42
3.2.3.1	POI Recommendation	42
3.2.3.2	Path Recommendation	49
3.2.4	Experiments and Results	51
3.2.4.1	Experimental setup and Dataset	51
3.2.4.2	LDA Model Evaluation	52
3.2.4.3	Recommendation Quality Evaluation	54
3.2.5	Discussion	56
3.3	Personalisation in Cobotics	57
3.3.1	Introduction	57
3.3.2	Problem formulation	57
3.3.3	Implementation	60
3.3.3.1	Personalised Adaptation as a Reinforcement Learning task	60
3.3.3.2	Personalised Adaptation with Deep Reinforcement Learning	62
3.3.4	Experiments and Results	63
3.3.4.1	Experimental setup	63
3.3.4.2	Single-state Single-action Adaptation	63
3.3.4.3	Multi-state Multi-action Adaptation	65

3.3.5 Discussion	67
3.4 Conclusion	67
Chapter 4	
Conclusion and Future Directions	71
4.1 Conclusion	71
4.1.1 Summary of the thesis	71
4.1.2 Perspectives and Future Directions	75
Bibliography	77
Appendix A	
System Theory	99
Appendix B	
Latent Dirichlet Allocation (LDA)	101
Appendix C	
Types of Recommender System	103
C.1 Content-Based Recommender Systems	103
C.2 Collaborative Filtering Recommender Systems	103
C.3 Hybrid Recommender Systems	104
C.4 Evolution of Recommender systems	104
Appendix D	
Multi-Objective Optimisation	107
D.1 Pareto method	107
D.2 Scalarization method	108
Appendix E	
Explainability of recommendations by the painting LDA model	109
Appendix F	
Reinforcement Learning	111
F.1 Q-learning	113
F.2 Deep Q-Learning (DQN)	113

Acronyms

Acronyms	Definition
CPS	Cyber-Physical System
CPSS	Cyber-Physical-Social System
SLR	Systematic Literature Review
CPHS	Cyber-Physical-Human System
HiLCPS	Human-in-the-Loop Cyber-Physical System
SIoT	Social Internet of Things
SCPS	Social Cyber-Physical System
CPST	Cyber-Physical-Social Thinking
HCPPS	Human Cyber-Physical Production System
CIoT	Cognitive Internet of Things
HitM	Human in the Mesh (HitM)
CPHMS	Cyber-Physical Human–Machine System
PCSC	Physical-Cyber-Social Computing
SoS	System-of-Systems
GST	General Systems Theory
LCSs	Loosely Coupled Systems
RS	Recommender System
POI	Points of Interest
LDA	Latent Dirichlet Allocation
NLP	Natural Language Processing
DNN	Deep Neural Network
TSP	Travelling Salesman Problem
MIP	Mixed Integer Programming
RL	Reinforcement Learning
DQN	Deep Q-Network
DDPG	Deep Deterministic Policy-Gradient
MOOP	Multi-Objective Optimisation Problem

List of figures

1.1	Overview of the Paper selection Procedure.	5
1.2	The type of publications selected in this study.	5
1.3	Number of papers published per year.	6
1.4	Number of papers published per Country.	6
1.5	The development of CPSS research worldwide.	7
1.6	Co-authorship network of the top 20 authors.	7
1.7	Application areas of CPSS.	8
1.8	Distribution of terminologies over sample papers	11
1.9	Correlations of social facets in a situation	16
1.10	Personality and Social facets	17
2.1	CPSS Evolution.	23
2.2	The Systemic model.(<i>Yilma et al. [275]</i>)	25
2.3	The CPSS Meta-Model Part I: systemic core.	26
2.4	Part II: relations among components.	29
3.1	Partial instantiation of the CPSS meta-model in the context of smart exhibition area	39
3.2	The intuition behind the Painting LDA model	44
3.3	Topic modelling with LDA	44
3.4	Painting Scoring Strategy	45
3.5	Recommendation procedure with LDA	45
3.6	Recommendation procedure with CPSS	48
3.7	Path recommendation procedure	51
3.8	Comparative topic coherence analysis of the two data sets	52
3.9	Inter-topic Distance Map in a 2-dimensional space of 10 topics	53
3.10	Comparison of LDA Vs ResNet-50.	54
3.11	Comparison of ResNet-50, LDA and CPSS.	55
3.12	Partial instantiation of the CPSS meta-model in the context of smart workshop	58
3.13	Personalisation in Cobotics as an RL task	61
3.14	Single-state Single-action learning curve.	65
3.15	Single-state Single-action model performance.	66
3.16	Multi-state Multi-action learning curve.	66
B.1	Latent Dirichlet Allocation plate diagram	102
C.1	Content based filtering vs Collaborative filtering	104

List of figures

E.1	Explainability of recommendations by LDA	109
E.2	Example of interest word cloud	110
F.1	Reinforcement Learning(Sutton et al. [230])	112
F.2	Reinforcement Learning taxonomy	112
F.3	Q-table update	113
F.4	An example of Q-table	113
F.5	Deep reinforcement learning	114

List of tables

1.1	Number of papers retrieved from each database, per search string.	3
1.2	Inclusion and exclusion criteria used to select the papers.	4
1.4	The details of paper selection process.	5
1.6	Alternative terminologies to CPSS and their corresponding definitions.	10
1.7	Definition categories of the CPSS acronym in literature.	12
3.1	Notations and Description	42
3.3	Curated Stories	46
3.4	Attributes & descriptions of the Paintings dataset	52
E.1	Description of three topics	110

General Introduction

1 Research Context and motivation

The notion of Cyber-Physical System (CPS) was originally derived from an engineering perspective with the support of the US National Science Foundation (NSF) [124, 94]. The objective of a CPS was mainly controlling and monitoring physical environments and phenomena via the integration of sensing, computing, and actuating devices. In parallel the notion of Internet of Things (IoT) which originates in the late 1990's¹ took off with the support of the European Commission, as a paradigm in the Computer Science perspective [92]. The emergence of IoT played an indispensable role for the orchestration of the physical and cyber systems with the goal of connecting tools and electronic equipment to the Internet and developing a network of computers and objects. Despite their initial philosophical difference, IoT and CPS share many similarities hence they have been used sometimes interchangeably without a clearly defined demarcation [112]. There is however a fundamental difference that should be highlighted: the fact that a CPS refers to a particular type of systems explicitly, while IoT refers at the same time to the concept, the system formed by all the connected devices and a particular system of interconnected objects. As a system, a CPS typically collects and controls information about phenomena from the physical world through networks of interconnected devices, in order to achieve its objective [126]. In the development of both paradigms, humans were originally assumed as external entities interacting with these systems.

Over the years, the increasing popularity of smart devices and their significant role in the daily life of their users has led CPS based systems to consider humans as a multifaceted sources of information (i.e. human sensors)[253, 229]. Subsequent research studies have then started to incorporate humans in CPS research. This trend in particular, has uncovered the importance of humans' centrality for the development of CPS which was then recognised by the Human-in-the-Loop (HitL) CPS paradigm [177, 224, 161], where humans are intrinsic actors of the system. Following this, different researchers advocated the addition of a social component as a logical proposition to formally integrate human aspects in the domain of CPS. Over the past decade, different researchers used different terminologies to refer to the integration of the human aspect in to CPS projecting different conceptualisations in various domains. Furthermore, the need to understand the impact of CPS on humans and vice versa gradually paved a way for the foundation of a new paradigm: Cyber-Physical-Social System(CPSS)[246, 81]. Although the notion of CPSS has been adopted by many researchers, there is no unified definition and common understanding of the concept. Furthermore, the exact meaning and scope of the social part differs among current works and application domains.

Particularly the rationale behind the paradigm shift from CPS to CPSS can be seen as a means to make interactions with CPS devices more anthropomorphic through the addition of a social component. Hence, the "*Social*" part carries a broader meaning relating to complex emotional, cognitive and behavioural aspects. These are deemed as the three layers of human interaction responses [174, 175, 189, 83]. Although our focus is on human-CPS interaction, it is worth noting that CPS interactions can also be with non-human entities. For instance CPS for animal care [185], CPS for crop cultivation and gardening[227], etc. Generally, capturing the full spectrum of the social aspect in CPSS essentially means to amend the design of machines inspired by social traits which allows CPS to detect, reason and adapt to the various needs of the interacting entities.

Nevertheless, today the commonly adopted conceptualisations of CPSS fail to capture such

¹The earliest quote about Internet of Things is a presentation from Kevin Ashton, 1999, MIT Auto ID Center, reported in Forbes in 2002 (see <https://www.forbes.com/global/2002/0318/092.html/?sh=6d0c6c4b3462>)

characteristics of the social dimension. In literature the social part is merely associated with the presence of human at the vicinity of CPS. For instance, in the work of *Ganti et al.* [81] the social part only encapsulates the fact that humans were considered as sources of information. On the other hand the prominent works in [212, 37, 152] characterised the social aspect by the activities of users linked on social networks using CPS. It is also evident that the evolution towards a more and more pervasiveness of technology is gradually increasing the complexity of CPSS environments [281, 53]. In a CPSS people interact with each other as well as with different kinds of devices and robots that offer a variety of services. Especially since the ultimate goal of the CPSS paradigm in such a context is to bring humans at the centre of the interaction, system designs should carefully address various aspects of social dynamics including emotional, cognitive and behavioural [266, 268, 270]. Nevertheless, ensuring a seamless interaction in such a context is not a trivial task. Particularly because it is often a subjective experience which is largely influenced by individual preferences, interests, needs and capabilities varying from one person to another [104, 178]. This plays a crucial role in determining users' quality of experience [171, 233, 104, 178]. Additionally the actions and behaviours of people within a CPSS are also the reflections of their unique personalities which are shaped over time through personal experiences, knowledge and different environmental factors which are not yet fully understood [117, 105, 171, 166]. Therefore, recognising personal preferences, interests as well as limitations and opportunities such as disability, knowledge and skills of individuals becomes one of the necessities to ensure a seamless experience within a CPSS. This positions the notion of personalisation at the heart of the CPSS paradigm, if we consider that interactions, especially between CPS and human entities, should be adapted to each human individual and thus personalised. In the framework of this thesis we argue and eventually demonstrate that the introduction of personalisation in CPSS opens opportunities to better integrate the less recognised social aspects and enhance the experience of users.

Personalisation by itself is a relatively older research field dating back to the late 1990s. The notion of personalisation, which is broadly known as customisation, refers to tailoring a service or a product in a way that fits to specific individuals' preferences, cognition, needs or capabilities under a given context [116]. Over the years technological advances in web applications, online marketing and a tight link between humans and smart devices has revolutionised the need for personalised services. Virtual assistants on devices such as Alexa, Siri and Cortana, Chatbots, online recommendations for e-commerce and entertainment are among the popular areas where virtual personalisation has gained momentum. Unlike the case of virtual personalisation, in a CPSS context people evolve in a physical space together with other people and smart devices, each having their own objective. This adds more properties and dynamic variables to be considered [270]. The physical space by itself has a given purpose, calling for expected specific behaviours of the people inside. However, people are not always tolerant to following rules if they are not aligned to their preferences. Hence, the complexity of human behaviour together with the multiple objectives of the co-existing entities and environmental factors make the task of personalisation in CPSS rather complex. We also observed that there are still no reliable approaches to harmoniously model the full complexity of the social part together with cyber and physical [274, 275]. Therefore, in order to benefit CPSS through personalisation and in terms of realising social aspects there is a need for efficient approaches tackling the full complexity of the problem.

In this context the thesis firstly aims at providing an up-to-date picture of the state-of-the-art perspectives of CPSS. To answer the questions on how a CPSS is defined? How the Social dimension (i.e. human aspect) is conceptualised in current CPSS research? What are the application areas of CPSS? What are the main issues and challenges in the current CPSS research?

(mainly due to the active involvement of humans). The thesis first addresses these questions positioning its scientific basis on information and principles derived from a Systematic Literature Review (SLR). Subsequently the thesis seeks to formalise the concept of Cyber-Physical-Social System based on the findings of the SLR. This is primarily aimed at establishing a generic and domain independent understanding of CPSS. Secondly the formalisation aims to reflect a more complete characterisation of social aspects in the design of CPSS.

Relying on the established basis through the formalisation of CPSS the thesis then pursues personalisation as one feasible direction to realise social aspects in the design and implementation of CPSS environments. Consequently it proposes an approach for personalisation in CPSS that jointly tackles the challenges of personalisation and complexities arising from CPSS environments. The practicality of the proposed approach is illustrated on two independent case studies. The first one showcases a personalised recommendation and guidance in the context of smart exhibition areas where as the second showcases adaptation of collaborative robots (Cobots) in the context of smart workshop setting. Inherently the personalisation task in CPSS context is of a multi-objective optimisation nature as it tries to achieve different goals in parallel and makes the best possible compromise. **Particularly, we hypothesise that the proposed approach to introduce personalisation in CPSS opens new perspectives and contributes both to the fields of CPSS, and Personalisation/User Modelling/ Recommender Systems where applications to the physical world have gained momentum.**

2 Research Questions and the contribution of this thesis

Taking into account the identified research challenges, the thesis defines the following key research questions:

RQ 1. *How to formally present the notion of Cyber-Physical-Social System (CPSS)?*

One of the first steps in our research is to investigate and to define the notion of CPSS by exploring the state of the art perspective, its evolution from Cyber-Physical System (CPS) and the different conceptualisations of the social aspect in literature. In order to present a fair evaluation of the state of the art on CPSS we conducted a systematic literature review according to the guidelines proposed by Kitchenham [120] following a rigorous and auditable methodology. The analysis of the SLR reveals that there is a lack of common understanding regarding the definition of CPSS. The conceptualisations of the social part linking it with the existing notion of CPS are also diverse and they often reflect partial characterisations of social aspects. As a result, system design methodologies are found to be inconsistent in different application areas.

Hence, we set out to formalise the notion of CPSS integrating a comprehensive characterisation of social aspects as a central unifying criterion. To achieve this goal the proposed formalisation is designed constituting two main parts. The first one is a domain independent formal definition of CPSS which reflects current conceptualisation as well as components that can be utilised in the future with the development of the CPSS paradigm. The second part of the formalisation is the proposal of a meta-model which illustrates the formal definition and can be used as a basis to design CPSS environments with a more comprehensive representation of social aspects. After establishing a common ground on CPSS, the thesis then tackles the problem of personalisation in CPSS as one of the feasible approaches to realise social aspects and ensure a better user experience in CPSS.

RQ 2. *How to make human-CPS interaction more anthropomorphic in CPSS? Can personalisation bring a first step towards this?*

Ensuring a seamless human-machine interaction being the core of the CPSS paradigm, the conceptual formalisation establishes a common ground for anthropomorphising machines. However, this can not be realised by simply attributing superficial human characteristics and hence, it calls for progressive steps to characterise and implement relevant social cues in CPS. As discussed above such social aspects are often subjective and are influenced by individuals' personal experiences, knowledge, preferences and interests. Therefore, we hypothesised that introducing the concept personalisation in such a context opens opportunities for the realisation of social aspects in the CPSS paradigm.

Hence, to answer to the second research question we proposed a novel formalisation to the task of personalisation in CPSS taking into account its specificities from an overall (systemic) perspective, which is not the case of current approaches. This is done in such a way that it can be adopted in different domains of CPSS to design and implement personalised services. We then illustrate the usability of the formalisation in two selected case studies.

3 Structure of this manuscript

This thesis is organised in five chapters:

Chapter 1 presents a comprehensive literature survey to give an overview of the research context and position the contribution of the thesis. It starts by exploring the state of the art on Cyber-Physical-Social System through a systematic literature review. Following the analysis of the SLR, identified limitations, open challenges and opportunities are discussed. The thesis contribution is then proposed based on these findings.

Chapter 2 presents the main contributions of the thesis. Firstly, we propose a systemic formalisation of Cyber-Physical-Social System. We start by summarising the notion of CPSS and establish a link with theory of system and System-of-Systems(SoS) principles. Then, we propose a systemic definition of CPSS and a meta-model. Subsequently, we introduces the notion of Personalisation in Cyber-Physical-Social System. We discuss the foreseen benefits of personalisation in CPSS as well as the challenges that arise with the mergence of the two fields. Then, we propose a novel problem formulation to personalisation in CPSS that takes into account the overall complexity from the established systemic point of view.

Chapter 3 presents two independent case studies on personalisation in CPSS to illustrate the adaptability of the proposed approach across different domains.

Chapter 4 concludes by summarising the contributions of the thesis, outlining the remaining open challenges and potential direction for future work.

Annex A presents a brief background on theory of systems, **Annex B** introduces Latent Dirichlet Allocation (LDA); a concept utilised in the implementation of the first case study, **Annex C** presents a summary on types recommender systems, **Annex D** presents a supporting introduction on Multi-objective optimisation for the case studies, **Annex E** presents results

on explainability of recommendations using our painting LDA model from the first case study conducted as a side work. **Annex F** provides a supplementary background on Reinforcement learning, Q-learning and Deep Q-learning utilised for the implementation of the second case study.

Chapter 1

Literature Survey

1.1 Introduction

In this chapter, we begin with a detailed overview of Cyber-Physical-Social System (CPSS) through a Systematic Literature Review (SLR). The SLR explores the different definitions of CPSS, its application areas and how the social aspect is conceptualised in literature. This will lead us to discuss the open challenges and opportunities in the CPSS paradigm, particularly in terms of integrating the social aspect with the existing notion of Cyber-Physical System (CPS). Following this, we justify the need for a systemic formalisation of the CPSS paradigm as a central unifying criterion. Subsequently, we discuss the role of *personality* as one of the social dimensions and its enormous impact on the interaction experience of users in a CPSS. Hence, we position the contribution of the thesis based on these findings.

1.2 Cyber-Physical-Social System (CPSS): State of the art

As explained in the general introduction Cyber-Physical-Social System (CPSS) is an emerging research topic resulting from the addition of a Social dimension to the existing Cyber-Physical System (CPS) research[81]. This paradigm shift from CPS to CPSS was mainly attributed to the increasing use of sensor enabled smart devices and their tight link with users. The concept of CPSS has been around for over a decade now and it has gained an increasing attention over the past few years. Nevertheless, its conceptualisation has always been use-case dependent and there is no generic view as most works often focus on specific domains of application. We also understand from literature reviews such as [275, 94, 177] that the common understanding shared among the majority of researchers is that CPSS corresponds to the so called *smart environments* that are cohabited by humans and smart devices. However, looking at the definitions in literature, the emphasis given and the meaning associated to the social aspects are often diverse. Furthermore, researchers have also been using different terminologies to refer to the integration of social aspects (*i.e.* humans) with CPS projecting different conceptualisations.

For instance in [225, 222, 125, 192, 219, 262, 205, 280, 237, 97] the term Cyber-Physical-Human systems (CPHS) was used, being defined as “*a system of interconnected systems (computers, cyber-physical devices, and people) "talking" to each other across space and time, and allowing other systems, devices, and data streams to connect and disconnect.*” Alternatively Human-cyber-physical system(HCPS) was also used in some works perceiving human elements as physical entities interconnected with CPS, being controlled and coordinated (rather passively) by cyber systems in the whole system [141]. In [292] the concept of Cyber-Physical-Social-

Thinking hyperspace (CPST) was introduced for geological information service system. These works define CPSS as “*a system deployed with emphasis on humans, knowledge, society, and culture, in addition to Cyber space and Physical space. Hence, it can connect nature, cyber-space, and society with certain rules.*” where as CPST is established through the mergence of a new dimension of thinking space into the CPS space. The thinking space is *a high-level thought or idea raised during the intellectual activities of people*. These works visualize the *intellect* of humans separately from the Social aspect of CPSS as Thinking space. On the other hand the term Social-Cyber-Physical-Systems (SCPS) was also used in [115, 265, 80, 103] defined as “*a complex socio-technical systems, in which human and technical aspects (CPS) are massively intertwined.*” as defined by [103]. According to this definition the awareness of SCPS extends to the intangibles of social context, which includes social culture and norms, personal beliefs and attitudes, and informal institutions of social interactions. The term Cyber-Physical Human-Machine system was also used in [45].

Nowadays the acronym CPSS is being widely used in various application areas. Smart Cities, Smart Homes, Schools, Offices, Museums, and medium to large scale industries are among the main sectors, where applications of the CPSS notion has gained momentum [271, 273, 276, 107, 287, 250, 211, 187, 266, 188, 284, 294, 140, 50, 257, 134, 72, 252, 98, 40, 53, 15]. Despite the advances made to integrate human aspects in CPS, we observed that the development of CPSS research is still in its infancy. In this section we provide a detailed overview on what a CPSS is and how it has evolved through a systematic literature review, and we reflect on the perspectives.

1.2.1 Systematic literature review

The study formed by the systematic literature review, conducted according to Kitchenham’s guidelines [120], explores the broad spectrum of CPSS from its evolution to state-of-the-art perspectives. In particular the SLR tries to answer the following research questions:

- How is a CPSS defined?
- How is the Social dimension (i.e. human aspect) conceptualised in current CPSS research?
- What are the application areas of CPSS?
- What are the main issues and challenges in the current CPSS research? (mainly due to the active involvement of humans).
- What can be made to address these challenges?

1.2.1.1 Paper Selection Procedure

Here, we present the details of our paper selection procedures: database selection, keyword and search strings definition, and paper filtering steps.

1.2.1.1.1 Database Selection In order to cover all relevant studies that could potentially answer the above mentioned key research questions we searched for papers by querying the following digital libraries: ACM, Scopus, IEEE_Xplore, Taylor & Francis Online, Wiley and Springer. We selected six databases taking into account that a minimum of four is deemed sufficient to perform a robust literature search [121]. It is worth mentioning that among the six queried databases Scopus is known to be an extensive abstract and citation database that gathers

papers from several peer-reviewed journals. The papers retrieved from this database come from diverse publishers such as Elsevier, Springer, Taylor & Francis Online, and IEEE. It is expected that this will provide more robustness to the search. Normally, duplicated papers are expected to appear from this search and they are removed. Each database has its own syntax to write queries. Hence, the search strings described in Section 1.2.1.1.2 are slightly modified for each database to obtain the expected output.

1.2.1.1.2 Keywords and search strings definition The keywords used in this study were defined based on an iterative process, which is described as follows. First we queried the digital libraries with the search string *Cyber Physical Social System* denoted by S_1 . A total of 431 papers were retrieved. From these papers, we extract the most used keywords (i.e. repeated more than five times) and the most repeated terms (i.e. repeated more than fifteen times) in their titles and abstract. This was done by downloading paper’s metadata (i.e. title, year of publication, authors, abstract and keywords). Next, we perform a data mining on the extracted metadata in order to identify the relevant keywords using VOSviewer software [240]. VOSviewer is used to construct and visualise co-occurrence networks of important terms extracted from the metadata. Additionally a manual analysis of the metadata was carried out in order to identify relevant keywords. Combining the two we identified twelve additional keywords and redefined the search string S_1 to S_2 .

- S_1 : *{Cyber Physical Social System}*
- S_2 : *{Cyber Physical Social system}, {Human Cyber Physical System}, {Socio Cyber Physical System}, {Social IoT}, {Cyber physical Human System}, {Social Cyber Physical System}, {Human in the Loop CPS}, {Cyber Physical Social Thinking}, {Cognitive IOT}, {Human Centered IoT}, {Human Centered CPS}, {Human in the Mesh}*.

Querying the databases with S_2 we retrieved a total of 705 papers. Table 1.1 summarises the total number of papers obtained from each database per search string.

Publisher Databases	Search string S_1	Search string S_2
ACM	9	114
Scopus	248	260
IEEE_Xplore	67	189
Taylor & Francis	4	4
SpringerLink	99	101
Wiley	4	37
Total	431	705

Table 1.1: Number of papers retrieved from each database, per search string.

1.2.1.1.3 Papers Filtering After retrieving 705 papers from the the database search, we included 34 additional papers using the "*snowball sampling*" technique [261]. In the "*snowball sampling*" we considered the referrals of CPSS approaches made by experts, as well as the most

cited papers in the existing surveys and reviews. We did not restrict our search with publication year and citation impact in order not to miss out those papers with relevant definitions but not cited enough as they were published recently or due to the narrow domain of interest of the papers. Therefore we considered all papers offering definitions of CPSS regardless of publication time and citation impact. A total of 739 publications were identified at the end of this sampling phase. Subsequently the selection of papers to be analysed and included in the study was done in a two step filtering mechanism. In the first filtering step represented by F_1 the metadata of each paper was screened through a set of inclusion and exclusion criteria. The second filtering step involves reading the full text of the remaining papers. To select which papers are to be considered in this study an additional set of inclusion and exclusion criteria were applied represented by F_2 which is based on analysing the full text of the papers.. The two step filtering mechanism is described in table 1.2, and the overall paper selection process is depicted in Figure 1.1 through a Business Process Model and Notation (BPMN) diagram [179].

Filter	Inclusion Criteria	Exclusion Criteria
F_1	Papers written in English Paper with full text access Primary studies	Papers not written in English Paper without full text access Literature reviews
F_2	Papers establishing a link between CPS/IoT and social dimensions/ human aspects Papers containing definitions Papers with implicit definitions Papers discussing open challenges in CPSS Papers proposing solutions for social dynamics in CPSS	Papers without link between CPS/IoT and social dimensions/ human aspects Papers that are only about CPS/IoT

Table 1.2: Inclusion and exclusion criteria used to select the papers.

1.2.1.2 Descriptive Analysis of Papers

The initial search revealed 705 references from the digital libraries, and 34 papers based on the snowball sampling. We then applied filtering on the total of 739 papers guided by a series of inclusion and exclusion criteria as described in table 1.2. First we excluded those papers that are not accessible , not written in English and papers that are reviews and surveys. Consequently the number of considered papers dropped to 589. Moving forward, we analysed the rest of the papers, considering their title, abstract and keywords. Thus, the number of considered papers dropped to 427. Moreover, after reading and analysing the full text of the remaining papers according to inclusion and exclusion criteria, we selected 122 of them. Once the papers are selected, we classify them by the type of publication (e.g. journal article, conference proceedings, etc.), year of publication and country. Table 1.4 shows the details of the selection process.

The analysis shows that the selected publications are composed of journal articles amounting to 53% and conference proceedings amounting to 42%. The remaining 5% were identified as

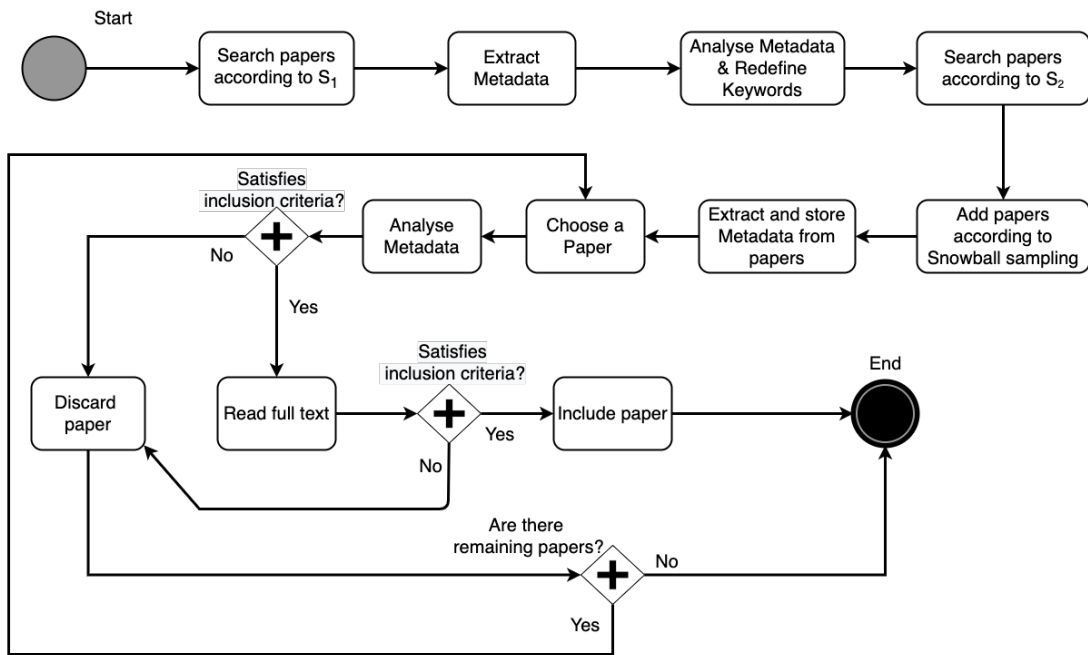

Figure 1.1: Overview of the Paper selection Procedure.

Phase	Total
Total number of paper from digital libraries	705
N° of papers after snowballing sampling	739
N° of papers after exclusion based on the paper access, language and type of research	589
N° of papers after exclusion based on title, abstract and keywords	427
N° of papers after exclusion based on full text = N° of included papers	122

Table 1.4: The details of paper selection process.

technical reports. Figure 1.2 summarises the type of publications selected in this study.

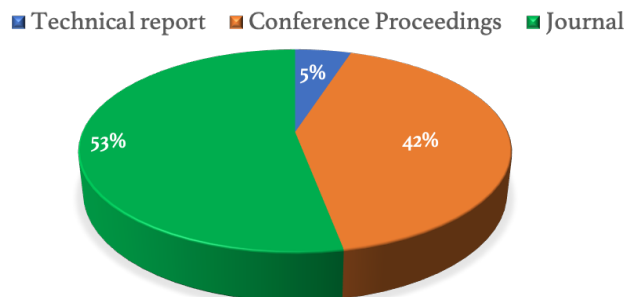

Figure 1.2: The type of publications selected in this study.

The overall sample considered in this study constitutes papers published up to May 2020.

The time distribution of the papers published is shown in Figure 1.3. A small fluctuation can be seen between the years 2007 and 2014 in the number of papers. In 2015 a steady growth appeared followed by a sharp increase in 2016 with gradual changes in 2017 and 2018. In the year 2020, the rate of publication only within the first few months has almost doubled the previous year. This evolution rationalises the the increasing attention the CPSS research gained over the years.

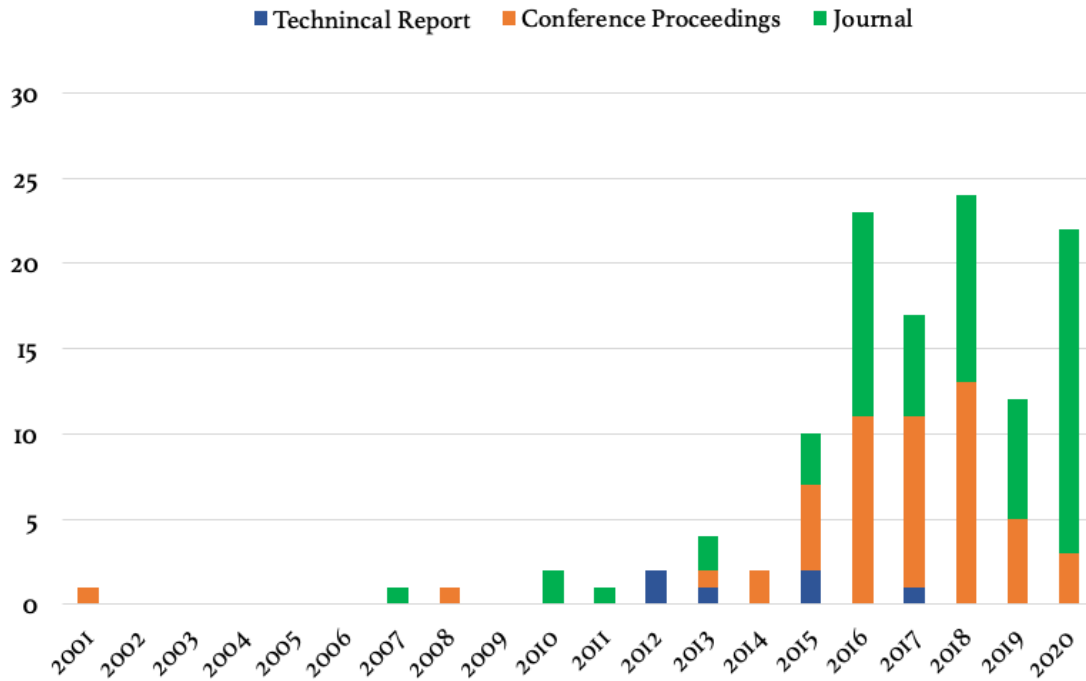

Figure 1.3: Number of papers published per year.

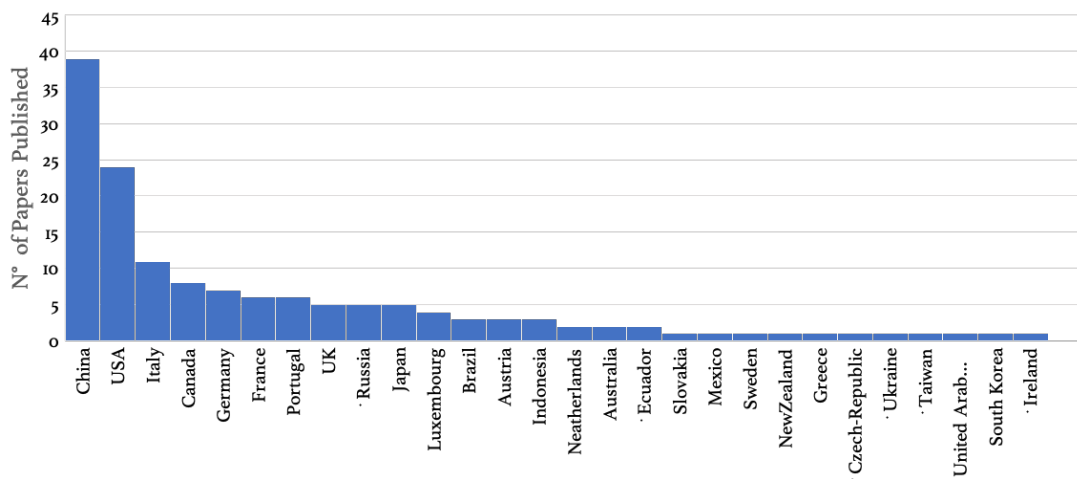

Figure 1.4: Number of papers published per Country.

Our analysis also revealed the development of CPSS research across nations worldwide. As it can

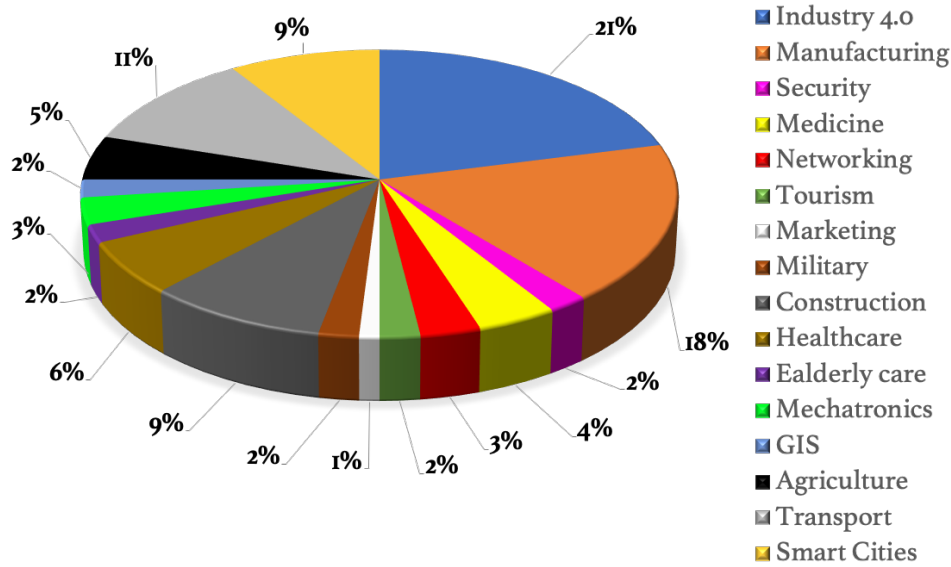

Figure 1.7: Application areas of CPSS.

small community rather an emerging area of interest among many researchers from more than 30 countries across 5 continents.

Since the goal of this SLR is also to identify the application areas of CPSS we did not restrict the search to specific domains. Consequently, the analysis revealed that the selected papers referring to CPSS, address different issues in various application domains. In Figure 1.7 we summarised a list of application areas where the concept of CPSS has been adopted according to the selected papers for this study.

1.2.2 State of the art perspectives of CPSS

In the following we present the state-of-the-art perspectives on CPSS by first exploring alternative terminologies used by different researchers and their corresponding definitions followed by a discussion on the CPSS paradigm with an exclusive analysis on works that used the CPSS acronym.

1.2.2.1 Alternative Terminologies

While studying the selected papers we observed that a number of alternative terminologies to CPSS has been used by different researchers. Thus, we identified eleven terminologies for which a seemingly coherent definitions could be extracted. A summary of the terminologies and their extracted definitions is presented in Table 1.6. Figure 1.8 illustrates the distribution of identified

terminologies over the sample references used in this study.

Term	Definition	Reference
CPHS/ HCPS	Cyber-Physical-Human System (CPHS) or Human-Cyber-Physical System(HCPS) is a system of interconnected systems (i.e. computers, devices and people) that interact in real-time working together to achieve the goals of the system –which ultimately are the humans’ goals.	[141, 225, 222, 125, 219, 205, 280, 210, 182, 123, 73, 289, 290]
HiLCPS	Human-in-the-Loop Cyber-Physical System ((HiL)CPS) is a system consisting of a loop that involves humans, an embedded system (cyber component), and the physical environment where the embedded system augments a human interaction with the physical world making humans’ intents, psychological states, emotions, and actions an intrinsic part of any computational system. Thus, establishing a feedback control loop. In (HiL)CPS there are three types of feedback control, (i) <i>applications where humans directly control the system</i> , (ii) <i>applications where the system passively monitors humans and takes appropriate actions</i> , and (iii) <i>a hybrid of (i) and (ii)</i> .	[161, 206, 61, 75, 122, 256, 226, 114, 176, 22, 46]
SIoT	Social Internet of Things (SIoT) is a kind of Social network where every node is an object capable of establishing social relationships with other things in an autonomous way according to rules set by the owner. SIoT is created by integrating social networking (SN) principles into the native IoT model.	[52, 154, 193, 21, 86, 218, 127]
SCPS	Social Cyber-Physical System (SCPS) is Cyber-physical system (CPS) that strongly interacts with the human domain and the embedding environment, working according to the expectations of humans, communities and society, under the constraints and conditions imposed by the embedding environment.	[103, 268, 115, 288, 169, 80]
CPST	Cyber-Physical-Social Thinking (CPST) is a concept emerged through the fusion of CPS and IoT on the basis of cloud computing technology, as a broader vision of the IoT. Precisely CPST is a hyperspace established by merging a new dimension of thinking space with the CPS.	[293, 172, 292]
HCPPS	Human Cyber-Physical Production System (HCPPS) is a generic architecture with the control loop, adaptive automation control systems, and human-machine interaction to support humans, machines, and software to interface in the virtual and physical worlds so as to create a human-centric production system.	[295, 199]

continues on next page

CIoT	Cognitive Internet of Things (CIoT) is a paradigm aimed at improving performance and to achieve intelligence of IoT through cooperative mechanisms with Cognitive Computing technologies that try to mimic human-like Cognitive capabilities, such as Understanding, reasoning and Learning.	[69, 282]
HitM	Human in the Mesh (HitM) refers to human activities in Cyber-Physical production system in which the worker is participating to the process of production planning and its loop of control, and it is usually enacted by the role of the Manager.	[72]
CPHMS	Cyber-Physical Human–Machine Systems (CPHMS) is a CPS that includes problems of cognition (planning and decision making), navigation, action, human-robot interaction (perception, environment sensing, and interfacing with the end-user), and architecture development and middleware.	[192]
PCSC	Physical-Cyber-Social Computing is a paradigm that encompasses a holistic treatment of data, information, and knowledge from the Physical, Cyber and Social worlds to integrate, correlate, interpret, and provide contextually relevant abstractions to humans.	[212]
Smart-CPS	is a CPS that combines various data sources (both from physical objects and virtual components), and applying intelligence techniques to efficiently manage real-world processes.	[59]

Table 1.6: Alternative terminologies to CPSS and their corresponding definitions.

Although there is a fundamental variation in nomenclature and design among these systems, many commonalities can be observed. For instance in terms of their components, all contain Human, Computers and Smart devices as component systems. Furthermore, they all share a similar global objective, which is common to works adopting the CPSS acronym: despite relying on different techniques all systems aim to ensure a better human-machine synergy across various application areas.

In the following, we present our analysis from exploration of the rest of the works adopting the CPSS acronym. In particular, we present the core definitions given for CPSS, we then discuss the CPSS paradigm and take a closer look at how the social dimension (human aspect) is conceptualised in literature.

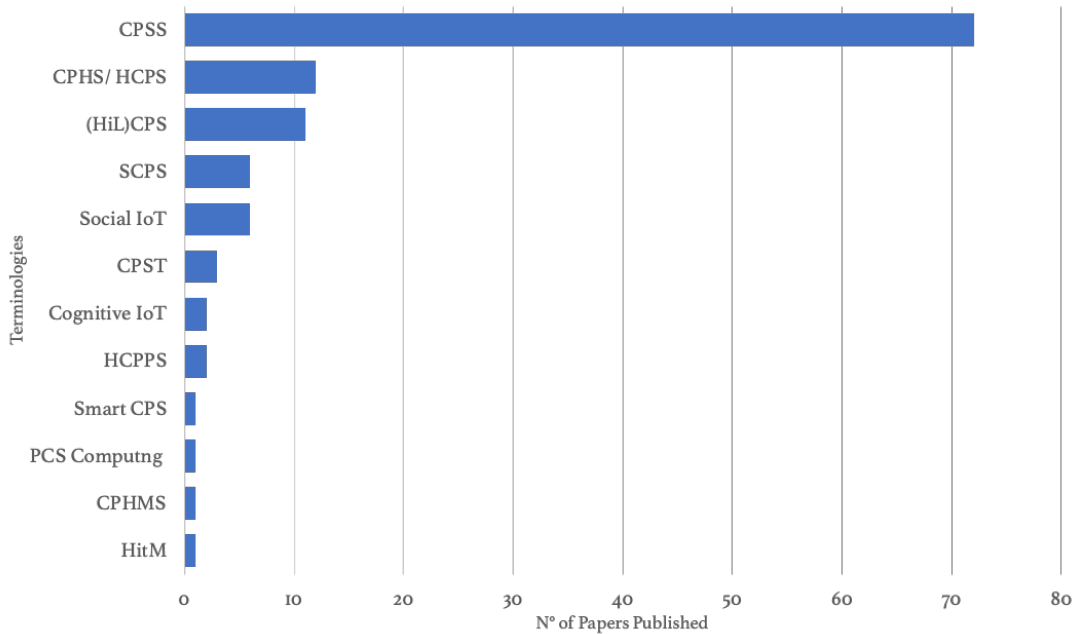

Figure 1.8: Distribution of terminologies over sample papers

1.2.2.2 Definitions of CPSS

Our analysis revealed that the ways of defining CPSS is also different from one research work to another. Particularly, we identified five major categories of definitions that can summarise the understanding of the CPSS notion in literature presented in Table 1.7. The definitions are categorised under the following themes inspired by the emphasis given by majority of the works: *Command and Control*, *Social Sensing*, *Self-organisation*, *Big Data and Networking*).

Theme	Definition	Reference
Command & Control	CPSS is a system consisting of a computer system, a controlled object and interacting social components (e.g., humans). This allows the control of physical object using computation and social data to ultimately achieve moral goals and online cloud management of social processes.	[81, 49, 84, 194, 162, 216, 287, 98, 166, 82, 263, 140, 223, 129, 251, 28, 142]
Social Sensing	CPSS is a system consisting of not only cyberspace and physical space, but also human knowledge, mental capabilities, and socio-cultural elements. Information from cyberspace interacts with physical and mental spaces in the real world, as well as the artificial space mapping different facets of the real world.	[267, 106, 273, 272, 291, 62, 144, 16, 248]

Self-organisation	CPSS is a system comprising three intertwining subsystems <i>(i) The human-based system</i> which refers to the social system containing human actors and their interconnected devices/agents and/or social platforms providing human-based services, <i>(ii) The software-based system</i> that refers to the cyber world providing software-based services including the underlying infrastructures and platforms, either on-premise or in the Cloud and <i>(iii) The thing-based systems</i> referring to the physical world that includes sensors, actuators, gateways and the underlying infrastructures. CPSS tightly integrate physical, cyber, and social worlds to provide proactive and personalized services for humans.	[221, 95, 220, 278, 155, 36, 253, 228, 35, 50, 107, 254, 281, 271, 257, 78, 266, 139, 239]
Big Data	CPSS is an extension of CPS/IoT formed by introducing human's social behaviour fostering a synergetic interaction between computing and human experience. Thus, integrating Big Data Collectors (BDCs), Service Organizers (SOs) and users to build a unified data-centric computing framework.	[264, 1, 48, 40, 47, 247, 32, 51, 281, 134, 108, 252, 211, 294, 188, 187, 250, 249, 113, 284, 132, 74, 255]
Networking	CPSS is a paradigm originates from the technology development of the cyber-physical systems (CPS) and cyber-social systems (CSS) to enable smart interaction between cyber, physical and social spaces, where CPS includes communicators, multimedia entertainment and business processing devices, etc. and CSS refers to social networks such as Facebook, Twitter, Youtube, etc.	[212, 85, 37, 152, 133, 217]

Table 1.7: Definition categories of the CPSS acronym in literature.

Despite the alternative terminologies used and their different conceptualisations discussed in Section 1.2.2.1 a common understanding of CPSS shared among all works can be summarised by the following definition.

*A **CPSS** is an environment cohabited by humans and smart devices that are involved in a virtual and physical interaction.*

Inherently, CPSS is tightly linked to the presence of humans at the vicinity of CPS devices. The next section takes a closer look at how human aspects, i.e., the social dimension, has been conceptualised in the CPSS literature.

1.2.2.3 The role of human in CPSS

Exploring the state-of-the-art we discovered that there are two main schools of thoughts regarding the role of human in CPSS, and research works systematically adopt one of the two views detailed below:

1. ***Human as a sensor:***

This is relatively the earliest view in the evolution from CPS to CPSS which originates with the increasing use of sensor-enabled smart devices by humans. In this view the social aspect was brought by considering humans as sources of information for Cyber-Physical systems (*i.e.* sensors). This conceptualisation primarily focuses on fusing various information originating from the social space (humans and their observations) with cyber-systems and physical-systems in order to accommodate various application needs[81, 49, 84, 194, 162, 216, 287, 98, 166, 82, 263, 140, 223, 129, 251, 28, 267, 37, 133, 217].

2. ***Human as a system component:***

On the other hand most of the recent works tend to conceptualise the social aspect of CPSS not only by considering human as a source of information (*i.e.* a sensor) but also as co-creators being an integral part of the system. It is also known as the human-centric way of conceptualizing CPSS [212]. This approach considers humans as members of the CPSS, involving observations, experiences, background knowledge, society, culture and perceptions (*i.e.* human intelligence and social organizations (*e.g.* Communities)) in order to co-create products and services together with the CPS. Here humans play the role of resources in that they provide information, knowledge, services, etc., which at the same time they consume, thus becoming users of the CPSS [142, 255, 273, 291, 62, 144, 16, 248, 221, 95, 220, 278, 155, 36, 253, 228, 35, 50, 107, 254, 281, 271, 257, 78, 266, 139, 239, 212, 152, 264, 48, 40, 106, 47, 247, 32, 51, 281, 134, 108, 252, 211, 294, 188, 187, 250, 249, 113, 284, 132, 74].

Adapting the second view in recent years, a considerable advance has been made in CPSS research. Particularly, research works had successful results in designing smart environments and objects/machines to perform complicated tasks. These results are becoming more and more evident in various fields. According to [29], putting humans and machines to work closely by promoting collaboration, learning and supervision can potentially deliver better outcomes than isolated operations. The pursuit of smartness in machines has allowed achieving high quality in task execution, in some cases even surpassing a human potential. However, achieving high quality in task execution by machines is not enough to ensure a seamless human-machine interaction as it fundamentally lacks social aspects[273, 82, 263, 140]. This is because social aspects captures not only task related engagements of a human but also behavioural, emotional and cognitive characteristics which are deemed as the three layers of human response in any kind of interaction [174].

1.3 Conceptualising the Social aspect in CPSS

1.3.1 Social interaction and CPSS

In Social science, Turner [238] defined a Social interaction as follows:

- **Social interaction:** *"is a situation where the behaviours of one actor are consciously reorganised by, and influence the behaviours of, another actor, and vice versa."*

This can be extended to *the process whereby there is a mutual influence between behaviours of multiple individuals*. There are also other close interpretations all driven from most influential works of Goffman [87] and Weber [260]. Most commonly recognised types of social interactions are: Exchange, Competition, Collaboration and Conflict. Overall, what qualifies an interaction as *social* is complex, but is inherently associated to specific characteristics of humans: consciousness and understanding. According to Weber's social action theory, [260], a social interaction implies taking the actions of the other into account, which in turn means having a *sympathetic understanding*. Here, the adjective sympathetic resonates more of human behaviour in an interaction context because it relates to sentiments, compassion, and empathy.

Considering an interaction among humans, one can understand or at least interpret the other person's emotional, cognitive and behavioural responses because they are equipped with similar sets of sensors and information processing units. Today, CPS start only to have those capacities, especially driven by the work in social robotics, or emotion recognition. However they are far from being equivalents to human ones, and allow only weakly Human-CPS interaction at a social level. Hence, human-machine interaction in a truly collaborative manner demands efficient means to understand and reason such dynamic responses of a human. Cognition and understanding is a first prerequisite, which will allow the machine to adapt its behaviour to the presence of humans (situation identification), and to individuals (personalisation). Then, having sentiments, compassion or empathy (i.e. emotional responses) leads us to another level in the evolution of machines, which is related to anthropomorphism, a research topic in social robotics and Human Computer Interaction (HCI) [68].

- **Anthropomorphism:** *comes from the Greek words **anthropos** for man, and **morphe**, form/structure and it is characterised as the tendency to attribute human characteristics to inanimate objects, animals and others with a view to helping us rationalise their actions [68].*

In the domain of HCI the concept of anthropomorphism has been argued by many researchers. In its early ages only few scientists considered it worthy of investigation [38, 70, 231] while others vouched for its removal from science [119, 213, 164]. This argument came from the assumption that employing anthropomorphism compromise in the designs, leading to issues of unpredictability and vagueness. Furthermore, it may also invoke attitudinal and behavioural consequences. Kennedy [119] even said *"is a drag on the scientific study of the causal mechanisms"*. In contrast, Caporael [38] proposed that "if we are therefore unable to remove anthropomorphism from science, we should at least set traps for it". Most of these early arguments in HCI overlooked the fact that designing a human-centric machine effectively, requires recognising human-like traits, at least a metaphorical attribution of human-like qualities to non-human entities.

Although, safety, ethical issues and balance are valid reasons to question the concept, researchers like Caporael took a progressive stand point rather than being dismissive. Consequently, progressive works especially in the area of social robotics opened a new perspective for anthropomorphism [68]. In this perspective anthropomorphism is more of a metaphor to facilitate human-machine interaction rather than a constraint. This essentially requires a deeper understanding of human and social facets in interactions.

From a broader perspective, in developments including artificial intelligence, HCI, cognitive science and behavioural studies we find two school of thoughts regarding a human [183]. The first school of thought views a human as a relatively stable and fully autonomous entity that can be fully understood. Strong AI is a main proponent of this view which believes that duplicating human intelligence in artificial systems is feasible and argue that a human brain as a kind of biological machine that can be replicated and hence, understanding the computational process of the brain reveals how people think and feel [76, 68]. In contrast the second school of thought views a human as a complex entity with aspects that can only be progressively simulated by machine. A main proponent of this view is Weak AI which believes artificial system could only give the illusion of intelligence. A large body of current research in AI, machine consciousness and social robotics also take the stance of this view which leaves open ended possibilities to discover human dynamics and thus, anthropomorphise machines [68, 76].

In this regard the CPSS paradigm ultimately aims at empowering smart systems of today with the tools necessary to have an anthropomorphic relationship with their users. However, the complexity of the social aspects deeply ingrained in emotional, cognitive and behavioural facets makes achieving this goal far from trivial. Furthermore, the uniqueness of users' personality shaped over time through personal experience, knowledge and several other factors is inextricably entangled with these social facets; thus it delineates the actions and behaviours of people during interaction. In the following we take a closer look at these three social facets (*i.e. Emotion, cognition and behaviour*), their relationships and influence on human interactions.

1.3.2 Emotion, Cognition and Behaviour

Cognition was defined as "*the mental action or process of acquiring knowledge and understanding through thought, experience, and the senses*"². Cognitive neuroscience studies consider cognition as the way a human perceives and conceptually structure the world, hence, it leads to emotions and behaviours [195]. Although, there is no consensus on definitions of emotion Panksepp [186] characterised it as "a psychological state brought on by neurophysiological changes, variously associated with thoughts, feelings and a degree of pleasure or displeasure". Emotion is indispensable part of human interaction and experience caused by a complex mixture of hormones and the unconscious mind, signalling needs, preference and attitudes of humans that can affect and regulate how humans perceive, judge and react [279].

The 19th-century psychologist, *William James* [110] questioned the ultimate relevance of viewing the brain as an information processing system; a highly influential metaphor in cognitive neuroscience during his time. In his work he highlighted emotions as psychological experiences which have unique qualities. He summarised his view as "*if we fancy some strong emotion, and then try to abstract from our consciousness of it all the feelings of its bodily symptoms, we find we have nothing left behind, no mind-stuff out of which the emotion can be constituted, and that*

²<https://www.cambridgecognition.com/blog/entry/what-is-cognition>

a cold and neutral state of intellectual perception is all that remains” . This quotation of James as later elaborated by Dolan [65] reflects three unique qualities of emotion. Primarily, emotions are embodied and manifest in uniquely recognisable, and stereotyped, behavioural patterns of facial expression, comportment, and autonomic arousal. Secondly, emotion is less susceptible to the intent of a human compared to other psychological states since they are often triggered, in the words of James, "in advance of, and often in direct opposition of our deliberate reason concerning them", The third and most important is that emotions are less encapsulated. This is evident in their global effects on virtually all aspects of human cognition. For example when we are sad the world seems less bright and it becomes harder to concentrate. Hence, although emotions are triggered by different situations they exert a powerful force on human experience. We can also understand that cognition plays a central role in human experience as situations that trigger emotion are processed and interpreted through cognition (thought) invoking a range of feelings such as joy, sorrow, pleasure, pain, etc. which influence behaviour [65]. We summarise the correlation of these social facets in Figure1.9 adapted from³.

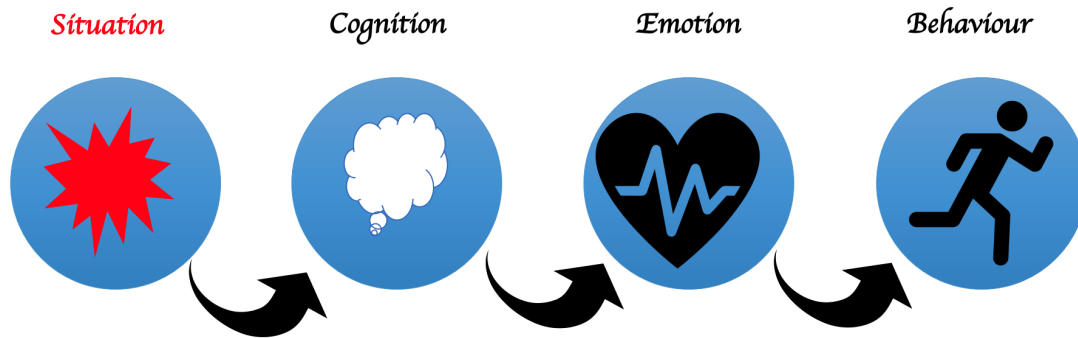

Figure 1.9: Correlations of social facets in a situation

According to Dolan [65] emotional, cognitive, and behavioural dimensions are in constant interaction and are cyclical. They can be understood as both antecedents and consequences of actions. In recent years, with the support of AI a considerable advance has been made in cognitive neuroscience and affective computing to understand and detect these facets [20, 279]. However, little is known and much is yet to be discovered regarding the innate mechanisms that intertwine them.

Furthermore, a coherent patterning and integration of these components leads to the formation of Personality [180]. In that personality represents the integration over time of feelings, actions, thoughts and desires resulted from experiences making people distinctive from one another. Ortony [180] argued that a glimpse into this complexity can be seen by answering the questions of why some people become angry, while others become frightened or depressed in response to similar threats, and why some become elated while others seem unaffected when given the same rewards. Figure 1.10 shows the cyclical relationship of these social facets and the formation of personality overtime.

Hence, a deeper understanding of social facets and their influence on personality underpins anthropomorphic paradigms in HCI and machine intelligence. This offers a path forward towards

³<http://qualiacounselling.com/the-cognitive-model-free-cbt/>

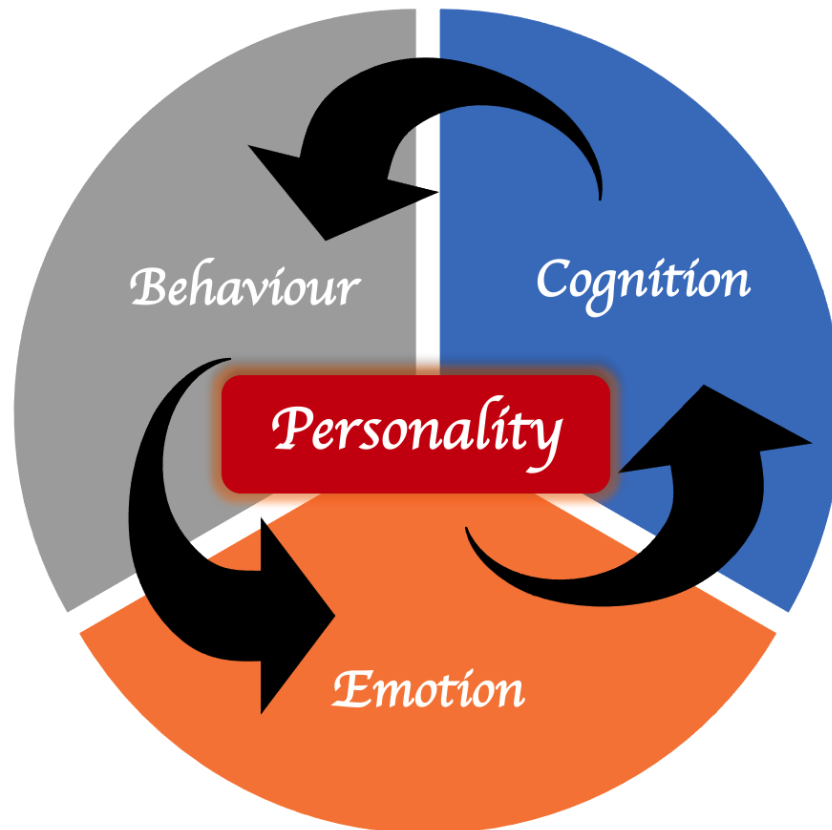

Figure 1.10: Personality and Social facets

to enhance human machine interactions. Although, the issues of safety, ethics and balance remain vital, the questions like is there a notion of “optimal anthropomorphism”? What is the ideal set of human features that could supplement and augment a social functionality? When does anthropomorphism go too far? remain open *Duffy* [68].

1.3.3 Discussion

When considering human-to-human social interaction, it is apparent that the quality of the interaction is subject to how well the individuals know each other. Indeed, if one knows the other person’s preferences, behaviour, likes and dislikes it is more convenient to respond appropriately in a social context. The same is true in human-machine interaction [273]. This is because each person is unique and his/her actions and behaviours are guided by individual knowledge, preferences, interests, culture and beliefs. Hence, in the context of *CPSS* the need to ensure a true seamless interaction experience positions the concept of *personalisation* or adaptation of the systems to users at the heart of the paradigm. As this is unexplored direction among others, particularly from the CPSS perspective, it poses a number of opportunities to support the integration of social aspects in CPSS. Personalisation is a well evolved field of research mostly in virtual applications. There are also some recent works of personalisation in physical spaces that can be framed as CPSS environments [13, 235, 173, 12, 58, 276]. For instance enhancing user experience resorting game theory and optimisation methods[234], augmented reality [138], inferring art preferences from gaze [41], path recommendation in museum [181, 236], etc. While

most of these approaches focus on matching user preferences and interests, while considering only a few contextual elements like location, time or activity [130, 34, 2]. However, from the CPSS perspective contextual information that can affect the way users interact with systems and the way a system responds to user's behaviour are diverse and their joint impact can also be distinctive. Furthermore, coexisting users/systems, their objectives and the environmental factors bring new challenges for personalisation in CPSS.

Thus, making the long-standing problem of personalisation newly salient in the context of CPSS. This calls for a novel approach to personalisation in CPSS that takes into account the overall systemic complexities.

Ongoing efforts in the CPSS paradigm are ultimately aimed at ensuring a human-machine synergy. Although this is the rationale behind many of the existing works and a seemingly common understanding may have been reached, without a common definition of the concept and underlining principles to guide the integration of social aspects, this ultimate goal will not be reached. Hence, the exploration of social aspects in the CPSS paradigm to ensure a seamless user experience remains an open challenge.

1.4 Contribution positioning

Based on the research context of CPSS and the discussed challenges, the thesis sets out to provide a contribution to the following specific limitations.

Limitation 1. *The lack of a uniform understanding and a proper formalisation of the CPSS concept.*

The state of the art analysis reveals that the definitions of CPSS has always been inconsistent and often use-case dependent. Indeed, due to the lack of a proper formalisation of the CPSS concept, researchers often adopt their own definitions and design methodologies fitting to their particular use-cases. This hinders the re-usability and domain adaptability of research works. Therefore, to support the development of CPSS and adaptability of successful works across different application areas, there is a need for a domain independent formalisation of CPSS.

Limitation 2. *The lack of a comprehensive representation of social aspects in CPSS.*

One of the notable outcomes of the SLR is the conceptualisation of the social aspect over the various definitions of CPSS. In literature the social aspect is tightly coined with the presence of human at the vicinity of the so-called smart devices either serving as a source of information or consuming a service. We also understand that the prominent aim of the paradigm shift from CPS to CPSS is to ultimately ensure a seamless human-machine interaction. Hence, the newly introduced social part largely resides on how machines perceive and respond to humans' interaction responses. This constitutes emotional, cognitive and behavioural facets [174, 175, 189]. However, none of the existing works provide a comprehensive representation of such aspects.

Limitation 3. *The lack of efficient approaches to tackle the problem of personalisation in CPSS by taking into account the overall systemic complexity.*

Together with complex natural and environmental factors one part of the social aspect which drives the subjective experience of users is the uniqueness of personalities [171, 233, 104, 178]. This makes personalising services and human-things interaction in CPSS an indispensable component of the paradigm to ensure a seamless user experience. In CPSS users co-exist with different stakeholders influencing each other while being influenced by different environmental factors. Additionally, these environments often have their own desired goals and corresponding set of rules in place expecting people to behave in certain ways. Hence, in such settings classical approaches to personalisation which solely optimise for user satisfaction are often encumbered by competing objectives and environmental constraints which are yet to be addressed jointly. Particularly there are no current approaches that tackle the problem of personalisation in CPSS considering the overall systemic complexity.

Hence, in the framework of this thesis we set the following objectives for realising our contribution:

- Investigate and formalise the notion of Cyber-Physical-Social System. In particular, we propose a definition and a meta-model designed in such a way that it fully integrates the less represented social aspects and be generic enough to be adopted in different domains.)

- Investigate and formalise the general problem of personalisation in CPSS taking into account the overall systemic complexity.
- Extend the general formalisation on selected case-studies to illustrate the usability of the proposed approach across different domains of CPSS.

Chapter 2

Personalisation in Cyber-Physical-Social Systems (CPSS)

2.1 Introduction

In this chapter, we present the main contributions of this thesis. Primarily, we propose a formalisation to the notion of CPSS which captures the existing conceptualisation in literature and projects a view for the future developments of the paradigm. The formalisation mainly constitutes a generic definition of CPSS and a meta-model proposal. This offers a domain independent understanding of the concept. Secondly, we introduce the concept of personalisation to the domain of CPSS as one feasible solution to support the integration of social aspects in the CPSS paradigm. Particularly, we proposed a novel problem formulation strategy that can be used to implement personalisation in different domains of CPSS.

2.2 Systemic formalisation of Cyber-Physical-Social System (CPSS)

A CPSS is composed of many interacting systems that have their own operational and managerial independence. Thus, according to *Maier* [147], it is not only a system but can also be a System-of-Systems (SoS). Nevertheless, the SLR analysis in section 1.2.2 reveals that the conceptualisations of CPSS in literature are inconsistent and have little to no foundation on theory of systems and SoS principles. In this section we discuss how we can contribute to establish a systemic foundation and a common understanding of the CPSS paradigm as a central unifying criterion over its various application domains. To this end, we propose a systemic formalisation to the notion of CPSS, by being grounded in the theory of systems and SoS principles. The formalisation offers a domain-independent definition of CPSS that tries to capture a comprehensive representation of social aspects. This is supported by a two-parts meta-model, which illustrates the proposed definition and serves as a basis to design CPSS environments of the future.

2.2.1 Definition of CPSS

From the multiple theories related to systems, our work takes as groundings the seminal work of *Von Bertalanffy*, one of the founders of the General Systems Theory (GST) [245] and the SoS principles from the widely accepted works of *Maier*[147]. From these theories, we extract the general concepts and their relationships, which can be exploited as an ontological basis to describe CPSS as a system. (A brief summary on the background of main system theories is presented in Annex A.)

In the GST, a system is defined very generically as "*a complex set of interacting elements, with properties richer than the sum of its parts*" [245]. In a more recent work on systems interoperability, defining an ontology also grounded in GST, but also on the work of others like Le Moigne [18]; Naudet et al. [165] proposed a definition of system fitting more our context, which we reused for defining and modelling CPSS:

- "*A **System** is a bounded set of interconnected elements forming a whole that functions for a specific finality (objective) in an environment, from which it is dissociable and with which it exchanges through interfaces*" [165].

In this work the authors characterised a system by its components and the interactions between them, where each component can itself be a system. In this latter case, we can talk about a System-of-Systems (SoS), which is a concept that came into common usage in the late 90's to characterise large systems often formed from a variety of component systems which developmentally and operationally exhibit the behaviour of complex adaptive systems (CAS) [184, 88]. The SoS notion fundamentally captured the non-monolithic nature of complex modern systems. The earliest and most accepted definition of SoS is given by Maier et al. [147] and is formalised as follows:

- "*A **System-of-Systems (SoS)** is an assemblage of components which individually may be regarded as systems, and which possesses two additional properties: operational and managerial independence of the components*" [147].

Operational independence means that if the system-of-systems is disassembled into its component systems the component systems must be able to usefully operate independently, while managerial independence means the component systems not only can operate independently, but do operate independently: the component systems are separately acquired and integrated but maintain a continuing operational existence independent of the system-of-systems [147]. From a systems engineering perspective, the notion of SoS was best described as an emergent system from at least 2 *loosely coupled systems* that are collaborating [158]. The SoS principle dictates that the relationship between component systems is recursive as any system is produced by another higher system, answering specific requirements. For a dedicated project, the target system (CPSS in our case) is the final produced system, in this recursive loop.

Reflecting back on the state-of-the-art (section 1.2.2), majority of the works perceive CPSS as a system formed through the interaction of humans and various kinds of CPS devices. Here,

each of the interacting entities are independent systems with operational and managerial independence. Thus, the newly formed system as a result of their interaction is in fact an SoS (according to the SoS definition above). Typical examples of CPSS are the so-called *Smart systems* [200] such as *smart enterprises, smart buildings, smart homes, smart cities, etc.* Although current literature often considers such SoS as CPSS, the human and social aspects remain not clearly expressed nor formalised. In fact, they remain partially implemented in the smart devices that make the smartness possible in these systems. Hence, our postulate is that a true CPSS should be the evolution of CPS devices as an independent system with the addition of a social component. Thus, making it possible for a new kind of CPSS to emerge as SoS from the interaction of these socially capable CPSS devices with humans as well as other non-human entities possessing a social interaction facets. *E.g. animals, plants, social robots, etc.* Nonetheless, the scope of our research remains limited to interactions with a human. This essentially means a CPSS is primarily an independent system in the form of a smart device but can also emerge as an SoS when the smart devices are engaged in a social interaction.

Having said that, in Figure 2.1 we summarise the evolution of CPSS encapsulating our perspective. As it can be seen on the figure, the bubbles below the arrow depict the kind of SoSs formed as a result of the interactions between humans and evolving devices (from *Physical system(PS)* to *CPS* and eventually to *CPSS*). Whereas, the bubbles above the arrow detail the main components that form these devices. The current understanding of CPSS corresponds to the middle bubbles, where we have a human interacting with socially constrained *CPS devices*. However, as stated above, our postulate is to eventually arrive at a true *CPSS* where a human interacts mainly (but eventually not only) with the CPSS's social component which is materialised through the socially capable *CPSS devices* represented by the top bubble. Hence, the *CPSS* paradigm we propose in this work primarily aims at shading light in this direction to achieve social capability of machines.

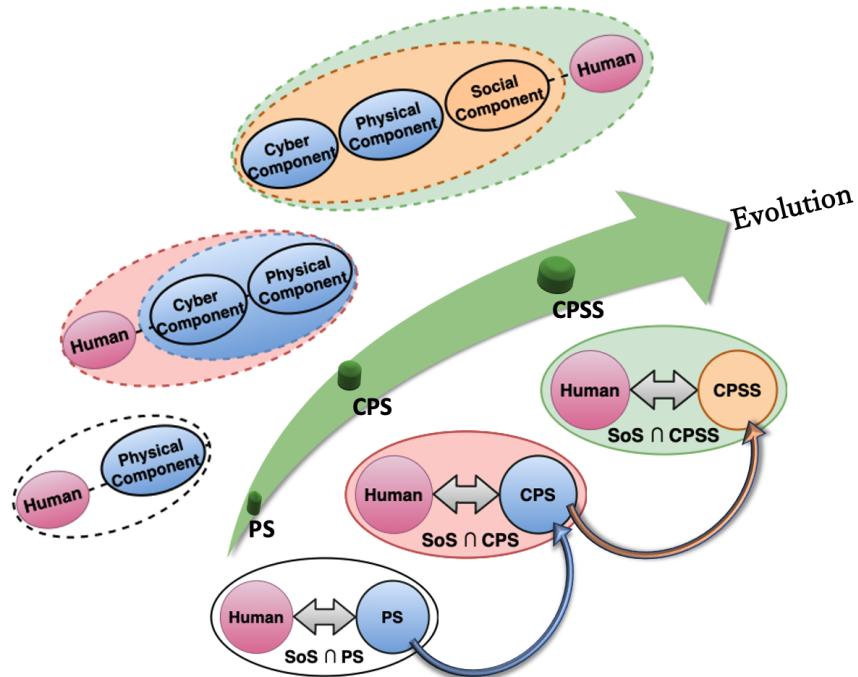

Figure 2.1: CPSS Evolution.

Following the notion of system and SoS principles we propose the following definition for CPSS, as a domain-independent basis for a common understanding:

Definition 1. A Cyber-Physical-Social System (CPSS): *is a system comprising cyber, physical and social components, which exists or emerges through the interactions between those components. A CPSS comprises at least one physical component responsible for sensing and/or actuation, one cyber component for computations and one social component for implementing social interactions.*

This definition stipulates the fundamental requirements for the emergence of a CPSS, which are the basic components (*Cyber, Physical and Social*) and a relationship between these components. CPSS can be an independent systems or, recursively, a CPSS in a *social interaction* (as defined by Turner [238] Section 1.3.1) with another system (CPSS, CSS, PSS). The later can be called, for the sake of simplicity, a CPSoS short for a $CPSS \cap SoS$.

2.2.2 Systemic model for CPSS

Having recalled the notion of system and SoS definitions suitable for characterising a CPSS; we subsequently define the key systemic concepts to be used in this work, reusing or extending definitions from [165]. Then, we present a systemic model linking these concepts with the SoS notion from [158] which will be the basis for designing the CPSS meta-model.

- **System Component:** *"is an element of a System that is a system itself composed of sub-components that are in a relation and can be decomposed until an atomic level."*
- **Relation:** *"is a link between two entities whatever the nature of the link. From a systemic point of view relation can be formalised locally or globally, i.e. between system components or between a system and its environment or other systems. We can further distinguish between structural and behavioural relation."*
- **Environment:** *"represents a space that is outside a system's boundary. An environment itself is a system. In a system context there are two types of environments to consider; a specific system's environment which acts on or is acted by the system it surrounds and global environment which is the complement of the system. The global environment starts where the system is no more influenced and influences no more."*
- **Interface:** *"is a component of a system through which a connection between a system and its environment can be established. It also represents a system's boundaries."*
- **behaviour:** *" is a change which leads to events in itself or other systems. Thus, action, reaction or response may constitute behaviour in some cases. [3]"*
- **Objective:** *"a finality or objective defines a system's goal at a given time. Every system has an objective often composed of sub-objectives. An objective can be either uniform throughout the life-cycle of a system or changing in different contexts."*

- **Function:** "is the set of actions the system can execute for the purpose of achieving its objectives. It is a property of a system that can be lent for or inherited by a super-system. A function is a means to an end (Objective)."
- **Structure:** "implies not only the position of a system's elements in space but also their movement in time, their sequence and rhythm. So structure is actually the law or set of laws that determine a system's composition and functioning, its properties and stability⁴."

The complexity of any SoS mainly depends on the nature of relations between its component systems, their individual behaviour, objectives and functionalities [147]. In a SoS, each interacting entity being a system possesses all the following key systemic properties discussed above (i.e. Relation, Behaviour, Function, Structure, Objective, interface, Environment and System Component). Framing CPSS not only as a system but also as a SoS and aligning it with the theory of systems helps to ease the design process by allowing to clearly visualise the composing systems, identify their individual objectives, relationships, inter-dependencies, and determine complementary as well as conflicting objectives. On figure 2.2 we present a systemic model to be used as a basis to design a CPSS which depicts these key systemic concepts linking System and System-of-Systems (SoS). The systemic model combines concepts from *Naudet et al.* [165] and *Morel et al.* [158]. The latter brings the SoS concept to the former through the «weak emergence» from loosely coupled systems. Semantically the «weak emergence» refers to the arising of new properties as a result of the interactions at a component level.

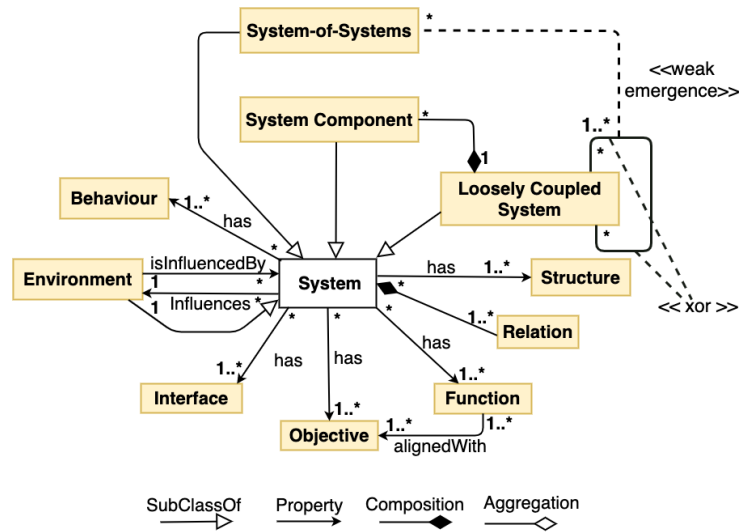

Figure 2.2: The Systemic model.(Yilma et al. [275])

The emergence of CPSS is inherently the result of *relations* among components. Thus, using the systemic notion as a basis in the following we present a meta model of CPSS illustrating the emergence of CPSS and the types of relations forming a CPSS and other kinds of SoSs in a CPSS context. This is aimed at creating a shared vision of CPSS in order to guide ongoing efforts and inspire the development of novel ones.

⁴<https://www.marxists.org/reference/archive/spirkin/works/dialectical-materialism/ch02-s07.html>

2.2.3 A meta-model of CPSS

In this subsection we propose two complementary meta-models for CPSS, formalised using UML2.0 notation. Formally, all concepts in the meta-model are *metaclasses*. They should be stereotypes with «metaclass». For the sake of simplicity and reading, we will miss the stereotype «metaclass» the the UML representation of both meta-models. The first meta-model Figure 2.3, presents the systemic core. It reuses concepts from the CPS meta-model proposed by *Lezoche and Panetto* [131] (blue parts), and introduces the social component. The CPSS meta-model part II Figure 2.4, formalises the main components of a CPSS as combinations of fundamental (C)yper, (P)hysical and (S)ocial elements, as well as the relation between them. It further allows representing the different kinds of systems that emerge when relations are instantiated: Cyber-Physical-Social System (CPSS), Cyber-Physical System (CPS), Physical-Social System (PSS), and Cyber-Social System (CSS).

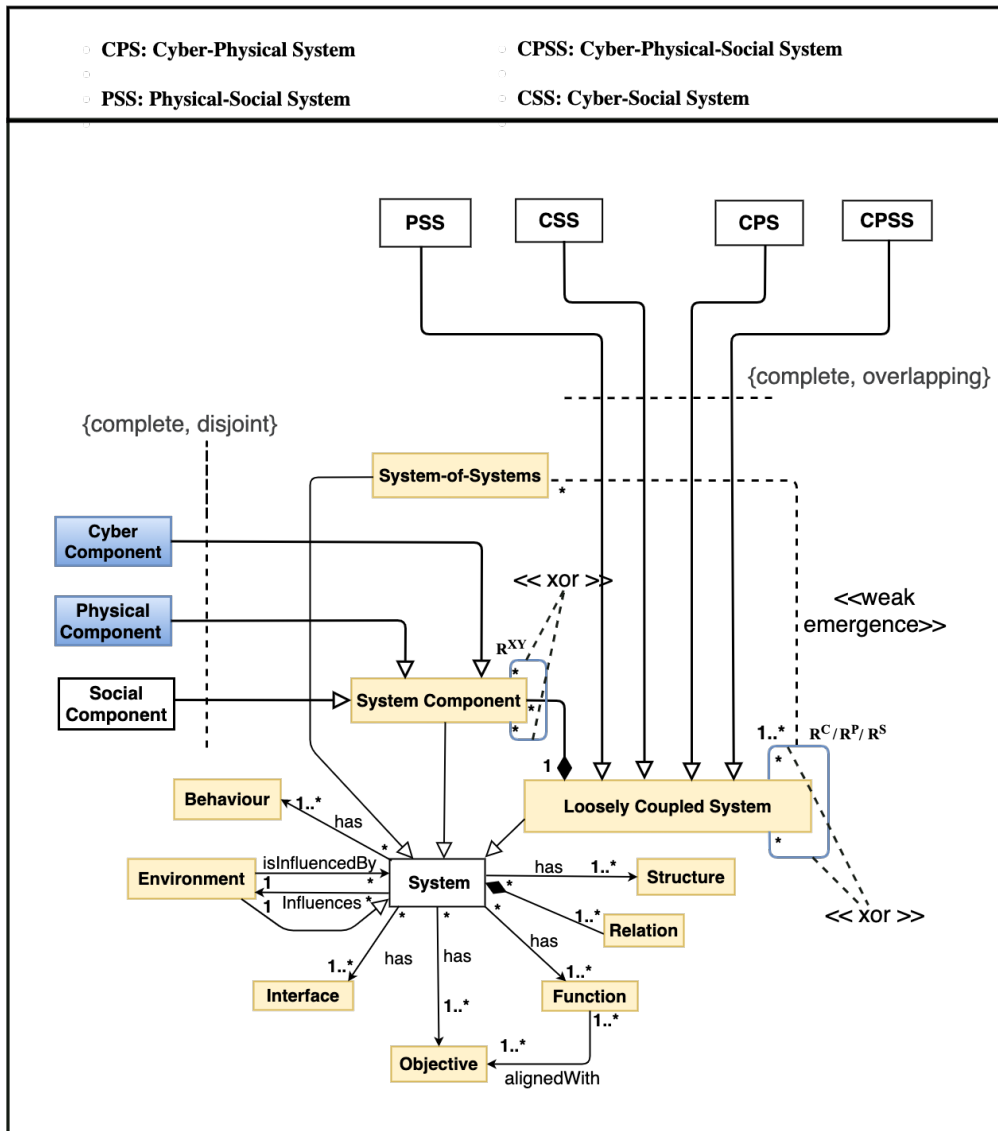

Figure 2.3: The CPSS Meta-Model Part I: systemic core.

Let C, P, S be respectively the set of Cyber, Physical, and Social components, and R be the set of existing relations, in a system of interest. We define three kinds of relations:

- $R^X: X \times X \rightarrow R$, where X is "C", "P" or "S"
- $R^{XY}: X \times Y \rightarrow R$, where X and Y are "C", "P" or "S" and $X \neq Y$
- $R^{CPS}: C \times P \times S \rightarrow R$

There are in total seven types of relations that can link components of a CPSS together, which we detail in the following: $R^C, R^P, R^S, R^{CP}, R^{PS}, R^{CS}$, and R^{CPS} .

- R^C :- refers to a connection between cyber components, existing in the virtual space, for example an information flow, a command, query, etc. It can also refer to the sharing of a computational resources. *e.g.*, two software packages sharing the same processing unit.
- R^P :- refers to a connection between physical components, existing in the physical space. An example could be the connection between mechanical parts of a machine.
- R^S :- refers to a social relationship between social components. It can materialise as an information flow or a transfer of knowledge between social components. It also reflects cognitive ties that govern human behaviour, *e.g.*, an intellectual conversation between people.
- R^{CP} :- refers to a relationship that exists between cyber components and physical components that can potentially result in the integration of computation with physical processes (sensing or actuation), *e.g.*, the relation between components of a smartphone to function. The R^{CP} relation leads to the emergence of a CPS (Cyber-Physical System):

$$\forall C, \forall P, \exists R^{CP} \Leftrightarrow \exists CPS \quad (2.1)$$

- R^{PS} :- refers to a relationship that exists between physical components and social components that can potentially result in cognitive processes and observable social behaviours. This is the property that enables a human to take actions that reflects his emotion, cognition and behaviour in a given context. The R^{PS} relation leads to the emergence of a PSS (Physical-Social System):

$$\forall P, \forall S, \exists R^{PS} \Leftrightarrow \exists PSS \quad (2.2)$$

- R^{CS} :- refers to the relationship between Cyber and Social components that can potentially result in the integration of computation and social capabilities, *e.g.*, virtual representation of people in a social network. The R^{CS} relation leads to the emergence of a CSS (Cyber-Social System):

$$\forall C, \forall S, \exists R^{CS} \Leftrightarrow \exists CSS \quad (2.3)$$

- R^{CPS} :- refers to a relationship that exists between at least one cyber, one physical and one social component, that can potentially result in the integration of sensing, actuation, computation and social processes. The R^{CPS} relation is what glues the three components together leading to the emergence of a CPSS as an independent system:

$$\forall C, \forall P, \forall S, \exists R^{CPS} \Rightarrow \exists CPSS \quad (2.4)$$

The CPSS meta-model is built on top of the systemic meta-model presented in Section 2.2.2. Formally, all component classes (*Cyber Component*, *Physical Component*, *Social Component*) are subclasses of *System Component*, and all system classes (*CPS*, *PSS*, *CPSS*, *CSS*) are subclasses of the *System* class by inheritance. As systems, the latter inherits from all the properties detailed in Section 2.2.2. While the concepts of CPS and CPSS were already known, the meta-model introduces two relatively new concepts: PSS and CSS. *PSS* is a composition of physical and social elements, where the social part is materialised through the physical part. The main representative is the *Human* system: the physical part is the physical body, while the social part is composed of the attributes that generate social responses such as cognition, behaviour and emotion, that are observed through physiological changes on the body [189]. The reader could argue that for human, the social system is indeed a part of the physical system. However, we view them separately to study and better understand social aspects which we eventually want to transpose to machines.

Although human is our topic of interest, the PSS is a concept encompassing also other non-human entities with social behaviours. *CSS* corresponds to a system where the social component is manifested through the cyber component. A typical kind of CSS is a *Social Network*, [66], where the social activities actually result from interactions in the virtual world. For a better readability in Fig. 2.4, relations are represented by a link, but all should be understood as subclasses of the systemic *Relation* class from Fig. 2.2. The constraint *{and}* is used to represent the mandatory requirement of at least one component from each part in relation in order for a new system to emerge.

The CPSS meta-model is completed by axioms 2.1, 2.2, 2.3 and 2.4, to which we add another set defining the main kinds of SoSs that can be formed as a result of interactions between the components (*Cyber*, *Physical and Social*) of independent systems. Fundamentally the postulate here is that a CPSS is also a SoS when there is a social relation R^S between a single CPSS *e.g.* *Cobot* (*Collaborative robot*) and a PSS *e.g.* *human*. Here, having a physical relation R^P instead of social R^S can form a SoS. However, it does not necessarily entail the formed SoS is a CPSS which essentially requires a social relation R^S where the single CPSS *e.g.* *Cobot* is able to detect, reason and adapt to social interaction responses of the human. Furthermore, CPSS can also emerge as a SoS whenever a CPS or a CSS initiate a social relation with a single CPSS. The first 3 new axioms 2.5, 2.6 and 2.7 describe the basic ways a CPSS can exist as a SoS. The rest of the axioms describe other kinds of SoSs that can be formed in a CPSS context.

$$\forall PSS, \forall CPSS, (\exists R^S) \Rightarrow SoS \cap CPSS \quad (2.5)$$

$$\forall CPS, \forall CPSS, (\exists R^S) \Rightarrow SoS \cap CPSS \quad (2.6)$$

$$\forall CSS, \forall CPSS, (\exists R^S) \Rightarrow SoS \cap CPSS \quad (2.7)$$

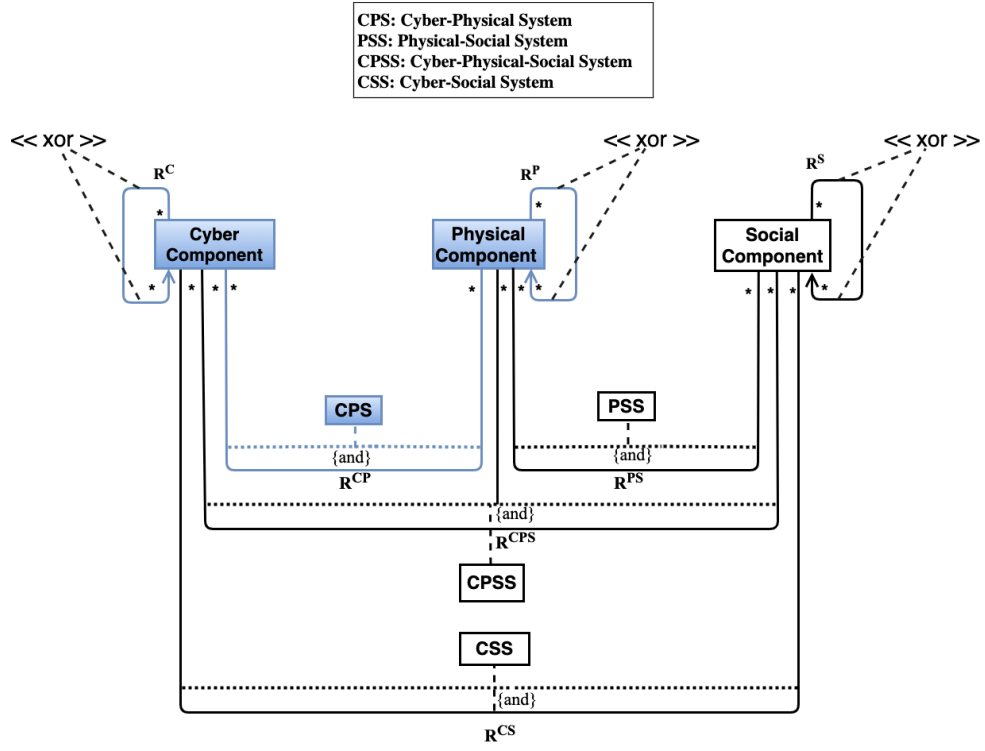

Figure 2.4: Part II: relations among components.

$$\forall PSS, \forall CPS, (\exists R^P) \Rightarrow SoS \cap CPS \quad (2.8)$$

$$\forall PSS, \forall CSS, (\exists R^S) \Rightarrow SoS \cap CSS \quad (2.9)$$

$$\forall CSS, \forall CPS, (\exists R^C) \Rightarrow SoS \cap CPS \quad (2.10)$$

$$\exists PSS, \exists PSS, (\exists R^P \vee \exists R^S) \Rightarrow SoS \cap PSS \quad (2.11)$$

$$\exists CSS, \exists CSS, (\exists R^C \vee \exists R^S) \Rightarrow SoS \cap CSS \quad (2.12)$$

The model defines PSS/CSS/CPS/CPSS as loosely coupled systems. Each of these classes of system exist on their own, as the result of the interaction between some C, P or S components (see Fig. 2.3 and related axioms). But when combined together, they form a SoS. The recursive loop on *Loosely Coupled System* refer to any of the relations discussed above.

2.3 Personalisation in Cyber-Physical-Social System (CPSS)

As we have motivated in chapter 1, one of the prominent features of the social aspect which plays a significant role in determining user experience is the distinctiveness of personalities [233, 104, 178, 145, 276]. The CPSS paradigm focuses on human-centrality and a seamless handling of the human factors. To reach this objective, the notion of personalisation stands out offering a path forward to address unique needs of users. (*i.e.* matching their preferences, interests, individual limitations and opportunities). Over the years personalisation has been used as a mean to improve user experiences especially in virtual application such as e-commerce and entertainment as well as in some physical spaces. While there were no other works on the subject, the application of personalisation to CPSS has been initiated in [166]. In this section we introduce the notion of personalisation in the domain of CPSS relying on the systemic formalisation established in the previous section. To this end, we first present a brief background on personalisation. We start by its definition and main taxonomies followed by a review of recent works of personalisation in physical spaces that can be considered as CPSS. Subsequently, we formalise the problem of personalisation in CPSS. And finally, we conclude with a discussion on the intersection of *Personalisation* and *CPSS* domains; the challenges and opportunities it brings.

2.3.1 Background on Personalisation

Jan Bloom defined the notion of personalisation as follows:

- "**Personalisation** : is a process that changes the functionality, interface, information content, or distinctiveness of a system to increase its personal relevance to an individual" [26].

As a research field the earliest formal works of personalisation date back to the the 1990s [197, 203, 96]. In the year 2000 a taxonomy of personalisation was proposed by *Jan Blom* [26] which classified personalisation into two categories: those that are motivated by facilitating work and those motivated by accommodating social requirements. In the first category it was discussed that personalisation enables access to information content, accommodates work goals, and individual differences such as disability and skill sets. Whereas in the second category it was argued that personalisation leads to elicit emotional responses such as pleasure and excitement. This claim was further supported by works in behavioural study [203]. Furthermore, under the umbrella of accommodating social requirements personalisation was mentioned to be useful in defining, maintaining and expressing the identity of users [87]. Over the past 20 years academic research in personalisation has increased significantly leading to various kinds of personalisation methods and taxonomies. The application areas, the type of users, the datasets and the technologies used, etc. have been the basis for different taxonomies of personalisation. However, what changes while applying personalisation remains largely the same; it is either the *information content* presented to users or the *distinctiveness* of the system [26]. These aspects drive the two major areas of research in personalisation namely *Recommendation* and *Adaptation* respectively. In the following we briefly introduce these two types of personalisation.

2.3.1.1 Recommendation

Recommender Systems (RSs) provide users with predictions or recommendations of items that are considered to match their preferences. This is usually done through a process of collecting information on the preferences of users for a set of items like (movies, songs, books, applications, etc.), demographic features of users like (age, nationality, gender, etc.), social media information, like (followers, followed and posts) so as to build a user model which is then used to find relevant items for recommendation. RSs were first mentioned in a technical report as a "digital bookshelf" in 1990 by *Jussi Karlgren* at Columbia University [116]. Over the years a rapid growth of web services and the need for maintaining quality of these services facilitates the development of RS research. Today RS is considered to be one of the fast paced research areas in computer science [102]. In literature traditional RSs can be classified into three big categories [198] (content-based filtering (CBF), collaborative filtering(CF) recommender systems and hybrid recommender systems. The main aspects of traditional RS approaches and a brief review on the evolution of modern RSs is presented in Annex C.

2.3.1.2 Adaptation

Contrary to recommender systems where personalisation mainly changes the presentation of information content; adaptation changes the distinctiveness of a system to match user profiles. A common definition of adaptation is "the ability to make appropriate responses to changed or changing circumstances" *Kaukoranta et al* [118]. A common application areas of personalised adaptation are games [148, 23]. In computer science, adaptation refers to a system or process, in which a system changes its behavior for individual users based on information acquired about those users and its environment⁵. Adaptation can be static behaviour (*i.e.* one time change) which is based on information about previous knowledge, interests, weaknesses or it can be dynamic behaviour where a system adapts automatically to its users according to changing conditions. In the later case which is a response to some stimuli, a system alters something in such a way that the result of the alteration corresponds to the most suitable solution in order to fulfil some specific needs. For instance in the context of this work, the specific needs are linked to the goals of a person interacting with the system; which is a CPSS.

2.3.2 From Personalisation in Physical Space to CPSS

Personalisation in physical spaces that can be considered as CPSS such as smart homes, smart workshops, museums and art galleries has been an area of investigation in recent years [13, 235, 173, 146, 12, 58]. For instance enhancing user experience resorting game theory and optimisation methods[234], augmented reality [138], inferring art preferences from gaze [41], path recommendation in museum [181, 236], etc. Unlike those personalisation services limited to virtual application such as e-commerce and entertainment, offering a personalised service in physical spaces is often encumbered by several factors from the environment in addition to human factors. Hence, it requires solutions that jointly handle environmental complexity and human dynamics. Although there are some existing works of personalisation in physical spaces, the extent to which they tackle these challenges is very limited. Context-aware recommender systems (CARS) are among the closest approaches addressing such issues [57, 196, 243, 202].

⁵[https://en.wikipedia.org/wiki/Adaptation_\(computer_science\)](https://en.wikipedia.org/wiki/Adaptation_(computer_science))

Dey and Abowd [60] have provided the most used definition for "context" defined as follows:

- A **Context**: "is any information that can be used to characterise the situation of an entity. An entity is a person, place, or object that is considered relevant to the interaction between a user and an application, including the user and application themselves."

In the domain of Recommender Systems contextual information is categorised into three groups.

- **Spatial contexts**: are those contexts that formalise the geographical situation or environment of users and/or items such as their location.
- **Static contexts**: are those contexts that do not change over time, and which affect the recommendation process such as gender, age, and identity etc.
- **Temporal Contexts**: contrary to static context, are those contexts that change over time and which are dynamic in nature like user's mood, user's current goal and social relations etc.

According to a recent survey [99] a large body of CARS research focuses on virtual applications such as *e-commerce*, *e-document* and *multimedia*. The applications of CARS in physical space are limited to tourism and travel. CARS in the tourism domain often make use of sensory information such as location, time and activity in order to define a *context* that characterises the situation of a user. However, mostly these contexts are used independently instead of jointly. *E.g. location-aware RSs [130], time-aware RSs [34], multistakeholder-Aware RSs [2], Activity-aware RSs [67]*, etc. There are also works on hybrid approach of CARS using multi-modal context information [277]. Nevertheless, these approaches are very specific to situations and hence, are not generic and flexible enough to be implemented across different domains of applications.

Additionally, most of these works ignore the context of past interactions, which in many instances are the prerequisite to the current context, and neglecting such information may result in a poor performance [99]. Generally, contextual information that can affect the way users interact with systems and the way a system responds to user's behaviour are diverse and their joint impact can also be distinctive. Hence, considering only few contextual aspects to implement personalisation in such a dynamic environment is rather daunting. This calls for efficient approaches of personalisation that jointly address environmental complexities and human dynamics.

Thus, in order to offer a path forward in tackling the discussed challenges while at the same time to make a step in integrating social aspects in CPSS; we formalise the problem of *Personalisation in CPSS* by relying on the systemic view discussed in section 2.2.

2.3.3 CPSS personalisation formalisation

Let us consider a smart system (e.g. smart building, smart city, or smart exhibition area or smart manufacturing shopfloor), in which humans, (smart) devices and other systems cohabit and interact for some time. Formally, this is a SoS, emerging from the loose coupling of all those systems. Since this is a smart system, we assume it contains systems that can be PSS (e.g. the humans), CPS, CSS and CPSS. Let env be this smart system, which we define as a CPSSoS, respecting the existence conditions defined by axioms 2.5, 2.6 and 2.7. For ease of reference in the rest of the thesis we will denote the different kinds of SoS in CPSS context as follows: **PSSoS** for $SoS \cap PSS$, **CPSoS** for $SoS \cap CPS$, **CSSoS** for $SoS \cap CSS$ and **CPSSoS** for $SoS \cap CPSS$.

We can define Personalisation as a service implemented by a *Personaliser* for a given *User*. In the CPSS paradigm, the Personaliser is a function of a social component S of a system, which targets another system with which an R^S relation is thus created. In the smart system env , any system with an S can potentially implement a personaliser for another system with an S , which then becomes a user. In the following we focus on one single R^S , involving two systems interacting in a same smart system env as defined before. The personalisation function, or personaliser pa , is defined as:

$$pa = f(u, cpss_{pa}, env), \quad (2.13)$$

where:

- $u \in env$ is the system targeted by the personalisation. It has an S component and thus can be a PSS (e.g. a human), a CSS or a CPSS.
- $cpss_{pa} \in env$ is a CPSS implementing the personalisation function pa in its S component, and generates the social relationship between the two systems: $R^S(cpss_{pa}, u)$.
- env is the smart system in which $cpss_{pa}$ and u interact together with other systems. Formally, env is a CPSSoS emerging from the loose coupling and social interactions of $cpss_{pa}$ and u and these other systems.

The $cpss_{pa}$ and the other systems within env cohabiting the same physical space, they can also initiate a physical relation R^P with a user u through their physical components. Furthermore, being independent systems each of them function for the fulfilment of their individual objectives. These objectives are not always complementary but can also be conflicting. Additionally, their relationships with the external environment, their behaviours, structures and interfaces also impose additional constraints on the user they interact with. Therefore, the personalisation function pa should also take into account the coexisting systems within env that have an impact on the user. In env , the variables that influence the personalisation can be divided further in two categories: the ones coming from direct relations and ones coming from indirect relations. We thus introduce two new variables, respectively *Crowd* (cr) and *Context elements* (cx).

- cr : represents the set of elements within the smart system, that are of any kind, with whom the user is in relation, and this relation has an impact on the personalisation (for the user).

- cx : refers to the set of elements within the smart system as well as the external environment that are not in direct relation with the user but have an indirect influence on the personalisation (for the user).

Finally, the personalisation function pa is given by:

$$pa = f(u, cpss_{pa}, cr^{uc}, cx^{uc}, env), \quad (2.14)$$

where cr^{uc} denotes use-case -specific influential variables from direct relations; and cx^{uc} is the list of use-case -specific indirect influential factors. Implementing pa means finding the best possible compromise between the objectives of the *user* and the *coexisting stakeholders* while respecting environmental constraints. Doing so allows to not only mitigate influential factors on the user but also maintain a desirable state for all stakeholders. Formally, this translates into a constrained multi-objective optimisation problem (MOOP), which we formulate in the following.

Each objective O^s of a system s involved in the personalisation can be formulated as:

$$\text{minimise/maximise } fo(s), \quad (2.15)$$

where fo is an objective function to optimise in order to fulfil O^s . By extension, it can be used for all influential variables of the personalisation. Considering the variables of pa , we define the following objectives. Let O^u be the set of objectives attached to u . $O^{cpss_{pa}}$ is the set of objectives for $cpss_{pa}$ excluding the personalisation objective, which is the overall objective to reach. We define $O^{cr^{uc}}$, $O^{cx^{uc}}$ and O^{env} as being respectively the set of objectives linked to cr^{uc} , cx^{uc} and env . Implementing pa leads to solve the following constrained multi-objective optimisation problem:

$$\begin{aligned} \min/\max \{ &fo_u, fo_{pa}, fo_{cr^{uc}}, fo_{cx^{uc}}, fo_{env} \} \\ \text{subject to } &\{co_u, co_{pa}, co_{cr^{uc}}, co_{cx^{uc}}, co_{env}\} \end{aligned} \quad (2.16)$$

where co_s denotes the set of constraints linked to a system s or influential variable of the personalisation. This provides a general perspective on a personalisation problem for smart systems that can be designed as CPSS. However, this does not necessarily mean implementations will strictly follow a classical MOOP solution method. This will be illustrated through case studies.

In the next chapter, we will apply our approach on two specific case studies. In particular, we will see the variables as well as the attached objectives and constraint differ and lead to a different implementation of the multi-objective optimisation approach, while they both follow the same model instantiating the CPSS meta-model and personalisation formalisation.

2.3.4 Discussion

The CPSS paradigm ultimately aims at empowering smart systems of today with the tools necessary to have an anthropomorphic relationship with their users. However, the complexity of the social aspects deeply ingrained in emotional, cognitive and behavioural facets makes achieving this goal far from trivial. Furthermore, the uniqueness of users' personality shaped over time through personal experience, knowledge and several other factors is inextricably entangled with these social facets; thus it delineates the actions and behaviours of users. This calls for efficient approaches to seamlessly integrate social aspects in CPSS research. In this thesis we hypothesise that personalisation can contribute to make a step in this direction.

Proposing a problem formulation strategy for personalisation in CPSS, our goal is to establish a common ground for the various domains of CPSS. This also links personalisation with the

systemic notion of CPSS discussed in section 2.2 which further supports system design to model users and their environment. Consequently, it helps to appropriately position scenarios for implementing personalised services. Although, the goal of introducing personalisation in CPSS is inherently aimed at supporting the integration of social aspects in CPSS, it also brings additional challenges that are not yet explored. Bringing personalised services to an individual somehow drives or limits her actions and behaviours. Particularly, in CPSS context personalisation has an impact on the way a user interacts with the physical space as well as other entities, modifying his normal behaviour and hence, causing perturbations in the *CPSSoS* where she exists. The potential impact of this is also more evident on other users and systems that cohabitate the same environment. On the other hand the complexity and the dynamic nature of CPSS also poses various challenges to personalisation. Nevertheless, the merging of the two domains opens possibilities for multidisciplinary efforts to jointly tackle the challenges originating from both personalisation and CPSS domains. This in particular will be accentuated by the case studies in chapter 3.

2.4 Conclusion

In this chapter, **we proposed a systemic formalisation to the notion of CPSS, which is grounded on the theory of systems and SoS principles.** The proposed formalisation of the CPSS paradigm captures the current state of the research as well as our vision of a true CPSS that integrates various social aspects with cyber and physical components. This was supported with a meta-model that can be used in initial system design. Hence, it opens opportunities in the CPSS research domain to propose solutions that can pave the way towards a seamless integration of social aspects in CPSS. This contributes to address the identified research challenges in *Limitation 1* and *Limitation 2*, while answering our first research question (*RQ1*) on how to formally represent CPSS.

In the road towards a true CPSS, human dynamics remains being one of the major challenges yet to be tackled. This calls for efficient approaches that underpin the ultimate vision of the CPSS paradigm to anthropomorphise human-CPS interaction. However, this can not be realised by simply attributing superficial human characteristics and hence, it requires progressive steps to characterise and implement relevant social cues in CPS. In particular, the uniqueness of personalities delineating the actions and behaviours of people in interaction positions the concept of personalisation in a strategic position to be leveraged in CPSS. Although, personalisation is a well evolved domain of research and has lot to offer, it faces new challenges from the dynamic environment of CPSS making the long standing problem of personalisation newly salient. To this end, **we introduced the notion of personalisation in CPSS by resorting the proposed systemic formalisation as a basis.** In particular, we proposed a problem formulation strategy to implement personalisation in a CPSS context that takes into account the overall complexity. This partially contributes to the identified research challenge in *Limitation 3* and strategically positions our research to answer the second research question (*RQ2*) on how to make human-CPS interaction more anthropomorphic in CPSS? and whether personalisation can bring a step towards this. This will be addressed in the next chapter by applying our proposed approaches on real case studies to implement personalisation.

Chapter 3

Case studies

3.1 Introduction

In this chapter, we present two independent case studies, which instantiate the CPSS meta-model and the CPSS-specific personalisation method proposed in chapter 2. These case studies illustrate the domain-independent characteristic of our approach. The first case study concerns personalised recommendation and guidance in smart exhibition areas, whereas the second one is about adaptation of collaborative robots (Cobots) in a smart workshop setting. Framing their respective scenarios on the basis of CPSS, each of the case studies resort to different implementation techniques to fulfil their personalisation objective, fitting to their specific context. After presenting the approaches we finalise each case study by discussing experimental results. Finally we close the chapter by summarising the takeaways from the two case studies.

3.2 Personalisation in Exhibition Areas

3.2.1 Introduction

Exhibition areas such as museums and galleries are the kind of environments that are usually composed of a large number of points of interest (POIs) to be explored by many visitors. In such environments visitors evolve with others, often carrying their smart devices (*i.e.* smart phones, wearables, cameras, etc.) serving individual needs. The exhibition areas themselves are also equipped with various sensors and actuating components for various purposes thereby forming a system where humans and smart devices cohabit a physical and virtual space of interaction. Hence, they can be seen as CPSS environments. In exhibition areas the physical space has rules expecting people to behave in a certain way. However, the actions and behaviours of visitors are often governed by individual preferences, motivations, cognition or other natural and environmental factors. Visitors are generally not flexible regarding following museum recommendations unless aligned to their current state of mind and preferences. Exhibition curators might also have desired goals such as making less popular items more visible, reducing congestion around popular exhibits, etc. In larger places such as the National Gallery in London or Le Louvre in Paris, visitors often tend to forget the limited time they have, they sometimes get lost, or they spend wondering around the museum following different recommendations biased by many sources without visiting POIs that could be of interest to them. Hence, offering personalisation in such systems not only improves the visitor's quality of experience but also gives meaning to the presence of people inside the museums by better managing crowds and facilitating content

exploration. Personalisation in the context of exhibition areas is commonly applied in the form of recommendation which implements two kinds of tasks: firstly selecting best POIs, and secondly finding an optimal route to visit the selected POIs. Nevertheless, due to the environmental complexity these tasks require solutions beyond just matching user preferences and interests. In particular, the co-existing entities need to be taken into account in the personalisation process and their influence on the user should be handled efficiently. Our goal in this context is to address the problem of personalisation by taking into account not only user preferences and interests but also environmental complexities. To this end, this case study focuses on a personalised recommendation and guidance approach in the National Gallery of London.

The National Gallery is an art museum housing a collection of over 2,300 paintings dating from the mid-13th century to 1900. This gallery located in Trafalgar Square in the City of Westminster, in Central London has a total floor area of 46,369 square meters⁶. In 2019 it ranked 3rd nationally with 6.2 million visitors. Due to the large size and number of exhibits the gallery has been employing different techniques in its large multi-thematic venues to assist visitors and improve their quality of experience. The complex nature of the physical space together with the gradual introduction of different technologies into the gallery highlights its CPSS nature. Hence, delivering personalised services in terms of guiding visitors, improving quality of experience, managing crowd and at the same time satisfying different goals of exhibition curators remains an open challenge. Hence, we apply the problem formulation strategy for personalisation in CPSS proposed in chapter 2 to first frame the scenario. Particularly, we identify important variables, their respective objectives and constraints as well as their relationship and inter-dependencies. Subsequently, we choose a suitable implementation method depending on the properties of the identified variables.

3.2.2 Problem formulation

According to the systemic formalisation from section 2.2.3, visitors in such smart exhibition areas are PSS , interacting with (smart) devices ($CP(S)S$) that are independent or embedded in the physical space around them. This forms a SoS , because the interacting systems (at minimum, the visitors, their devices and the exhibition area) exist on their own and are connected together only for the exhibition visit. The smart exhibition area is at least a CPS , when there are only R^P relations between the humans (PSS) and the devices (CPS). When a social feature is added to at least one of the device with which a visitor interacts, it becomes a $CPSS$ (axiom 2.4), and an R^S relation can therefore exist with a visitor. According to axiom 2.12, the smart exhibition area can then be qualified as a $CPSSoS$. We express the personalisation function for exhibition areas according to equation 2.14 as:

$$pa^{Exhib} = f(vs, mg, cr^{vis}, ex), \quad (3.1)$$

where, vs is a visitor (the target user of personalisation), mg is a mobile guide implementing the personalisation function, cr^{vis} is a crowd of other visitors and ex is the exhibition area.

⁶<https://theculturetrip.com/europe/united-kingdom/england/london/articles/history-of-the-national-gallery-london/>

Let O^{vs} be the set of objectives attached to vs . O^{mg} is the set of objectives for mg excluding the personalisation objective, which is the overall objective to reach. We define $O^{cr^{vis}}$ and O^{ex} as being respectively the set of objectives linked to cr^{vis} and ex . Hence, adopting equation 2.16 implementing pa^{Exhib} becomes a constrained multi-objective optimisation problem of the form:

$$\begin{aligned} \min/\max \quad & \{f(O^{vs}), f(O^{mg}), f(O^{cr^{vis}}), f(O^{ex})\} \\ \text{subject to} \quad & \{co_{vs}, co_{mg}, co_{cr^{vis}}, co_{ex}\} \end{aligned} \quad (3.2)$$

where f is an objective function to optimise in order to fulfil corresponding objectives of the variables and co_s denotes a set of constraints linked to a variable s . This equation illustrates the nature of the problem

Mapping the main systems of the case study with the variables of function 3.1, allows us to partially instantiate the CPSS meta-model for the case of exhibition areas in Figure 3.1 and detail the properties of the variables of the personalisation formula, which need to be considered to actually implement the personalisation.

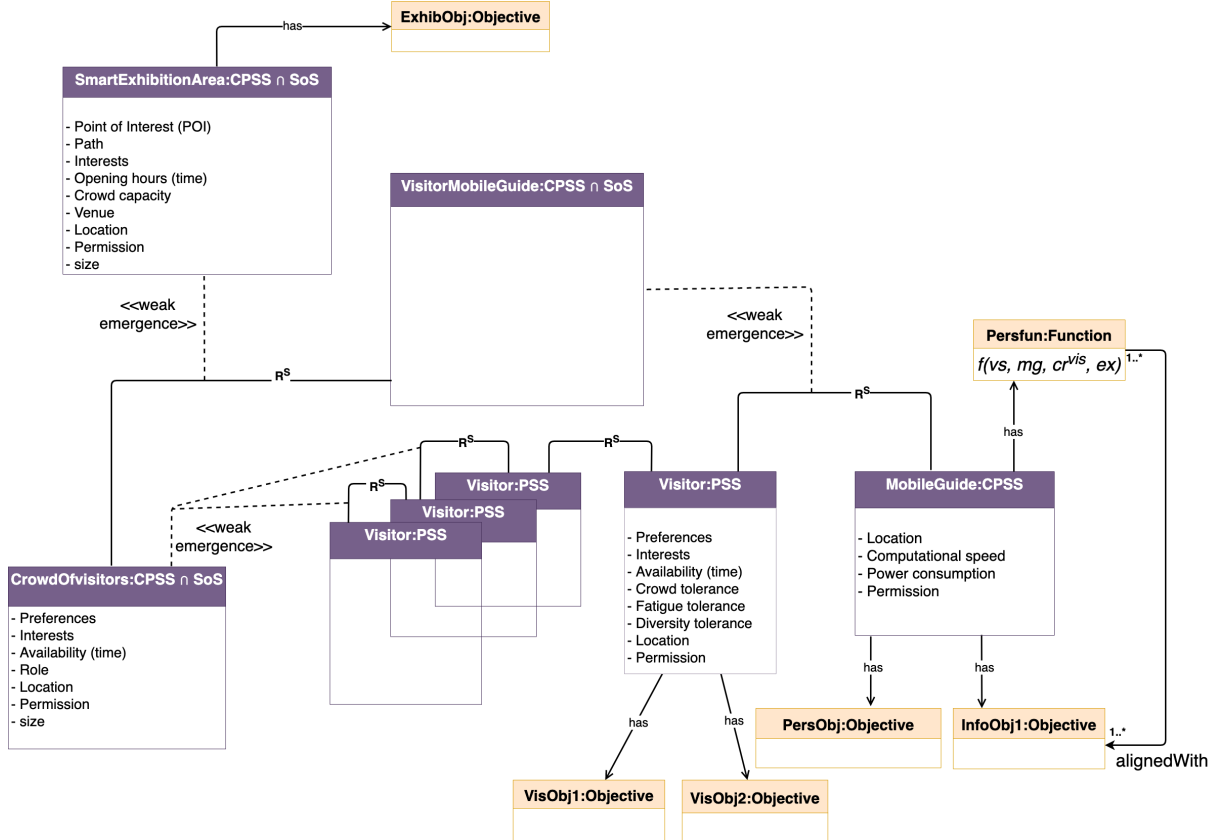

Figure 3.1: Partial instantiation of the CPSS meta-model in the context of smart exhibition area

Figure 3.1 shows classes of systems involved in the personalisation of our case study. For modelling convenience, only attributes involved in the personalisation implementation are detailed. Systemic properties represented by classes in the systemic model (Fig. 2.2) are displayed also as attributes, except for the objectives and the personalisation function. As personalisation concerns specific individuals, variables concern instances of these classes. Hence, vs is an instance of the *Visitor* class, mg is an instance of *MobileGuide*, cr^{vis} is an instance of *CrowdOfvisitors* and ex is an instance of *SmartExhibitionArea*.

The R^S between a *Visitor* and *MobileGuide* leads to the emergence of a *CPSSoS* (axiom 2.5) which we called *VisitorMobileguide*. The social relations R^S between the visitors (PSS) leads to the emergence of a *PSSoS* which we called a *CrowdOfvisitors* (axiom 2.11). Finally we have the *SmartExhibitionArea* which is a *CPSSoS* formed from those social relations. Although the attributes of *VisitorMobileguide* and *SmartExhibitionArea* are not listed in the model, both inherit a merging list of attributes through the «weak emergence». Below we detail the main objectives that we consider for the personalisation function:

- **VisObj1:** is an objective of the visitor which corresponds to visiting POIs that best match her preferences.
- **VisObj2:** is an objective of the visitor not to lose time getting lost in the museum between exhibits.
- **ExhibObj:** is an objective of the smart exhibition area to increase the diversity of POIs recommended to visitors.
- **InfoObj1:** the objective of a *MobileGuide* to provide general information to visitors.
- **PersObj:** is the personalisation objective implemented by the *MobileGuide* which is to primarily satisfy the objective of the visitor while at the same time considering the influence of the systems.

As mentioned in the introduction, this case study implements personalisation in the form of POI and Path recommendation.

- ***PersObj* for POI recommendation:**

In the case of POI recommendation *PersObj* should find POIs that best match the preference of the user. However, the exhibition curator's *ExhibObj* also wants the recommended POIs to be diverse in content which could be competing with *VisObj1* depending on visitor's tolerance to diversity. Furthermore, *PersObj* is constrained by the available time of the visitor and the exhibition areas opening hours. Thus, *PersObj* should make best possible compromise between these two competing objectives under time constraint to make a POI recommendation.

- ***PersObj* for Path recommendation:**

In the case of path recommendation *PersObj* should recommend a path that guides the visitor to her most relevant POIs and also shortest in distance. This recommended path should respect the crowd tolerance and fatigue tolerance of the visitor. This requires tracking real time changes. Furthermore, similar to the POI recommendation case, *PersObj* in path recommendation is constrained by the available time of the visitor as well as the opening hours of the exhibition area. Hence, both POI recommendation and Path recommendation problems translate *PersObj* into a constrained multi-objective optimisation problem.

In general, the successful implementation of *PersObj* entails that the social relation R^S between visitor and mobile guide is enhanced since the visitor's unique personal needs are recognised by the mobile guide. Having defined the objectives and constraints for implementing personalisation in exhibition area from a general perspective, in the next subsection we translate them into mathematical formulas and present the details of implementation.

3.2.3 Implementation

As discussed in the problem formulation, the implementation of personalisation in this case study is in the form of a POI (Paintings) and a path recommendation. In this subsection, we lay out a step by step implementation details and mathematically formulate *PersObj* as constrained multi-objective optimisation problem for both tasks. Table 1 summarises the frequently used notations in this case study.

Notations	Description
$P = \{p_1, p_2, \dots, p_y\}$	A set of all paintings in the gallery.
$D = \{d_1, d_2, \dots, d_y\}$	A set of documents with textual descriptions of paintings in P .
$P^{vs} = \{p_1^{vs}, p_2^{vs}, \dots, p_n^{vs}\}$	A set of paintings liked or rated by a visitor vs ; $P^{vs} \in P$.
$W^{vs} = \{w_1^{vs}, w_2^{vs}, \dots, w_n^{vs}\}$	Weights representing ratings of visitor vs for the paintings in P^{vs} .
$R = \{p_1, p_2, \dots, p_r\}$	A set of recommended paintings to visitor vs ; $R \in P$.
$V = \{v_1, v_2, \dots, v_v\}$	A set of all Venues in the gallery.
$V_R = \{v_1, v_2, \dots, v_q\}$	A set of Venues containing recommended Paintings; $V_R \in V$.
$PT(vs)$	Optimal path for a visitor .
$Cr_t(vs)$	Crowd tolerance of a visitor.
$Cr_s(v_i)$	The crowd size in a venue v_i at any given time; $\forall v_i \in V$
β	Visitor's tolerance to popular content.
λ	Visitor's tolerance to walking (fatigue).
ξ	Visitor's tolerance to diversity.
Δt	Elapsed time during a visit.
$Tv(p_i)$	Estimated time to visit a painting.
$Tt(v_i, v_i + 1)$	Estimated travel time between two consecutive venues.
T_{ava}	Total available time of a visitor.

Table 3.1: Notations and Description

3.2.3.1 POI Recommendation

As introduced in the problem formulation (*section 3.2.2*), the central idea of POI recommendation in *PersObj* is to suggest relevant POIs to visitors matching their preferences which satisfies *VisObj* while at the same time reflecting the exhibition curator's goals (*ExhibObj*). At this phase of POI recommendation implementing *PersObj* essentially calls for a strategy to find a set of paintings that concurrently satisfy these conditions. Hence, we first operationalise the notion of relevance for visitors and select a recommendation set of paintings if they closely resemble the visitor's profile. Subsequently we introduced crowd influence in terms of popularity bias and finally we added the *ExhibObj* (curators goal) in terms of recommendation diversity. For this task we used explicit profiling to elicit user preferences regarding paintings. Below we discuss our formulations starting from a purely user centred recommendation gradually adding the crowd influence and curators objectives leading to a constrained multi-objective optimisation problem.

Paintings are important pieces in visual art that bring together complex elements such as drawings, gestures, narration, composition, abstraction, etc [149]. These elements carry deeper semantics beyond their usual categorizations (i.e. time period, material, size, color, etc.) They are also perceived differently by people as they trigger different emotional and cognitive reflections depending on the background and personality of a visitor [149]. Personalised recommendation often suggest similar contents to those users have already seen or previously indicated that they liked. Similarities and relationships among paintings can normally be inferred based on common high level features such as colour, material, style, artist, etc. However, such features are not expressive enough as they cannot fully capture abstract concepts that are hidden in the paintings.

In order to capture non-obvious contexts by a machine, effective data representation is very crucial [24]. In general prominent works in visual art recommendation rely on ratings and manually curated metadata (i.e. color, style, mood, etc.) in order to drive recommendations. Recently works such as [101] started to use latent visual features extracted using Deep Neural Networks (DNN) and also use pre-trained models for making visual art recommendations. According to results reported by [153], DNN-based visual features perform better than manually curated metadata. However, these latent visual features do not have a direct interpretation and cannot be used to explain recommendations [241]. Hence they hinder user acceptance. To this regard, in our work we adopt a Latent Dirichlet Allocation (LDA) based representation learning approach. LDA is a topic analysis model that is known to be successful in the domain of Natural Language Processing (NLP) for uncovering hidden semantic relationships among documents. Therefore, we leveraged the textual description of paintings to train an LDA model that captures hidden semantic similarities of the paintings in National Gallery.

The intuition used in LDA is that each document can be seen as a combination of multiple topics. If we take paintings as an example, they can be described as a mixture of several concepts such as religion, nudity, portrait, etc. In LDA, each document is characterized by a predefined set of latent topics. In essence, each document is a distribution of topics and each topic is a distribution of words. This means each word in each document comes from a topic and the topic is selected from a per-document distribution over topics. Prominent words in each latent topic explain the nature of the topic and prominent latent topics related to each document explain the nature of the document (i.e. paintings). For instance, let us assume that latent topics are "religion", "still life", and "landscape". A painting may have the following distribution over the topics : 70% "religion", 10% "still life" and 20% "landscape". Moreover, each topic has a distribution over the words in the vocabulary. For topic "religion", the probability of the word "Saint" would be higher than in the topic "landscape".

Assigning the right number of topics as well as the hyperparameters however is not a trivial task. In literature the Gibbs sampling algorithm is widely used to estimate parameters of LDA [79][91][168]. In our implementation we used an optimised version of collapsed gibbs sampling from MALLET [90]. We refer the reader to the detailed discussion about LDA formulation in [25] and [111]. Figure 3.2 illustrates the intuition behind our Painting LDA model and Figure 3.3 explains topic modelling with LDA. As it is illustrated in the figures a collection of documents is used as an input to the LDA algorithm. LDA creates topics that can be seen as clusters of words. Each document of the collection is represented as a distribution of the topics which are themselves, distributions of words. Details on LDA formulation can be found in Annex B.

Once the LDA model is trained over the entire corpus we get a matrix of documents by topics

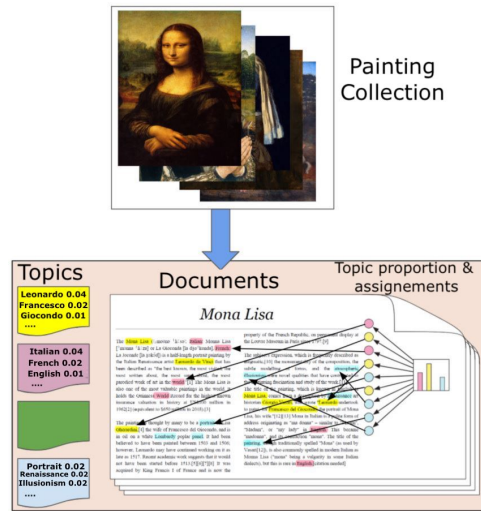

Figure 3.2: The intuition behind the Painting LDA model

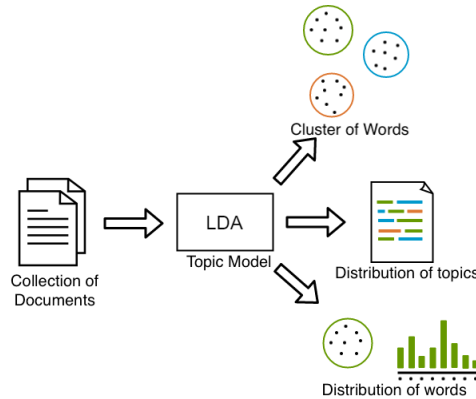

Figure 3.3: Topic modelling with LDA

which expresses latent topic distribution of each painting. From this we can generate an $M \times M$ similarity matrix for all the paintings in the dataset.

For recommending paintings to a visitor vs , the preferences of the visitor towards paintings are modelled by a normalised weight vector, transformed from a 5 point Likert scale ratings: we assign a weight $w_i^{vs} \in [0, 1]$ for every painting p_i^{vs} a visitor has rated. The recommendation task is then to recommend most similar paintings to a visitor based on the set he has rated before. This is done by expanding visitor preferences towards unseen paintings and computing a similarity score for the paintings in the dataset. The predicted score $S(p_i, vs)$ for a painting p_i in the dataset, according to the preferences of vs is calculated based on the weighted average similarity score (distance) from all other paintings that have been rated by the active visitor given by:

$$S(p_i, vs) = \frac{1}{N} \sum_{j=1}^N w_j * d(p_i, p_j) \quad (3.3)$$

where $d(p_i, p_j)$ is the similarity between painting p_i and $p_j \in P^u$ according to the LDA similarity matrix. The summation is taken over all visitor's rated paintings. This scoring strategy is

illustrated in Figure 3.4. Once the scoring procedure is complete, the paintings are sorted in a descending order and the first K paintings are selected to generate a recommendation list. Our LDA based personalised painting recommendation procedure is sketched in Algorithm 1.

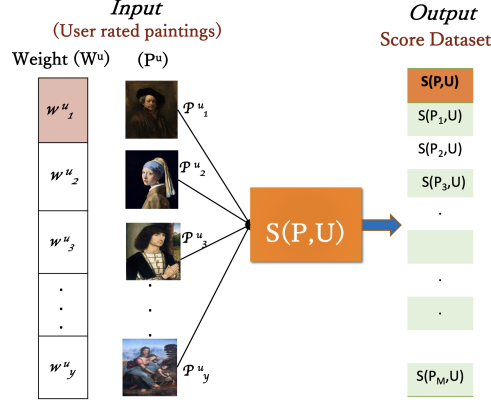

Figure 3.4: Painting Scoring Strategy

Algorithm 1 The LDA-BASED PERSONALISED PAINTING RECOMMENDER algorithm; $\mathcal{R} = \{p_1, \dots, p_k\}$ is a set of top k recommendations.

```

1: procedure LDA-BASED PERSONALISED PAINTING RECOMMENDER( $D, P, P^{vs}, W^{vs}, \mathcal{R}, S(p, vs)$ )
2:   ; Initialization
3:   ; repeat
4:   for  $d_1, \dots, d_m$  do
5:     Train LDA model
6:     for  $p_1, \dots, p_m$  do
7:       Compute Cosine distance
8:     end for
9:   end for
10:   $\mathcal{R} \leftarrow \emptyset$ 
11:  ; repeat
12:  for  $p_1, \dots, p_m$  do
13:     $S(p_i, vs) \leftarrow \text{COMPUTE}(\frac{1}{N} \sum_{j=1}^N w_j * d(p_i, p_j))$ 
14:  end for
15:  Sort  $P \leftarrow \text{DESCENDING}(S(p_i, vs))$ 
16:  return  $\{p_1, \dots, p_k\} \leftarrow \text{SELECT TOP } k(\mathcal{R})$ 
17: end procedure
    
```

Figure 3.5: Recommendation procedure with LDA

The above method implements *VisObj1* which generates a purely personalised recommendation by only taking into account the user preferences [269]. However, users also have different tendency to be interested in visiting famous POIs. Hence, we introduces a popularity score $S(p_i, Pop)$ into *VisObj1* for the paintings in the dataset which reflects the crowd influence on visitor's preferences. This score is based on a MUST-SEE list generated according to public review from National Gallery website. By taking into account the preference of the visitor and

also the influence of the crowd on the popularity of the paintings we introduce an aggregate score $S_{AG}(p_i, vs)$ for the paintings in the dataset which is given by:

$$S_{AG}(p_i, vs) = S(p_i, vs) + \beta S(p_i, Pop) \quad (3.4)$$

where β is user provided hyperparameters determining visitor’s interest to see popular items.

As discussed above, the other prevalent objective in implementing *PersObj* comes from the exhibition curator’s *ExhibObj*. Regarding PoI recommendation curators might want the personaliser to make less popular items more visible by exposing them to visitors, educate visitors about a certain topic, etc. In the case study of National Gallery we identified 9 curated stories defined by artists. Each story constitutes a certain number of paintings from the collection. The objective of the curator considered here is to increase the number of curated stories in the recommendation set. (i.e. the recommendation set contains paintings that are fairly selected from each of the curated story groups). Thus, to implement *ExhibObj*, we define a fair story selection strategy adopted from [151]. Under the current assumption a recommendation set R is fair if it contains paintings that belong to different story groups. The fairness score for a set R that contains paintings belonging to only one or few of the story groups is lower than the one that covers all or most of the story groups. To this end, we compute a fair story selection function $\psi(R)$ as:

$$\psi(R) = \sum_{i=1}^K \sqrt{\sum_{p_a \in S_i \cap R} \gamma_{p_a}} \quad (3.5)$$

where K is the total number of story groups, S_i is the i^{th} story group and γ_{p_a} is a count for every painting p_a selected from a story group i . $\psi(R)$ rewards recommendation sets that are diverse in terms of the different story groups covered. Given the nature of the function, there is more benefit to selecting a painting from a story group not yet having one of its paintings already chosen. As soon as a painting is selected from a story group, other paintings from the same story group start having diminishing gain owing to the square root function (e.g. For $K = 3$ a recommendation set that chooses 2 paintings from S_1 and 1 Painting from each of S_2 and S_3 gets a higher score of $\psi(R)$ compared to a recommendation set that chooses 4 paintings from just S_1 . i.e. $\sqrt{2} + \sqrt{1} + \sqrt{1} > \sqrt{4} + \sqrt{0} + \sqrt{0}$). Table 3.3 summarises the story groups defined in the National Gallery dataset. The 10th group contains all the paintings that are not associated with the 9 curated stories as defined by the artists.

1. Women’s Lives	6. Monsters and Demons
2. Contemporary Style and Fashion	7. Migration: Journeys and Exile
3. Water	8. Death
4. Women Artists and Famous Women	9. Battles and Commanders
5. Warfare	10. Uncategorised

Table 3.3: Curated Stories

Implementing personalisation fulfilling all the conditions discussed above yields two different Policies to investigate.

The first policy is matching visitor's preferences which corresponds to *VisObj1*. (i.e. Given a set of paintings P and a visitor vs we select the most relevant set R to recommend which maximises the following:

$$Policy1 : \left\{ \operatorname{argmax} \sum_{i=1}^R S_{AG}(p_i, vs) \right. \quad (3.6)$$

It is well known that optimizing for user preferences has a positive impact on user satisfaction [150, 128, 136]. Thus, we expect to achieve higher user satisfaction for this policy as a baseline.

The second Policy we investigate is matching the curator's goal which corresponds to the *ExhibObj*. This aims at recommending PoIs that maximally cover the story groups in the dataset given by:

$$Policy2 : \left\{ \operatorname{argmax} \psi(R) = \operatorname{argmax} \sum_{i=1}^K \sqrt{\sum_{p_a \in S_i \cap R} \gamma_{p_a}} \right. \quad (3.7)$$

Maximising over $\psi(R)$ ensures the diversity of the recommendation set in terms of the story groups covered. However, this could also be a minimisation depending on the curator's goal (i.e minimising over $\psi(R)$ maintains the consistency of the recommendation set regarding the curated stories presented.

Fulfilling *PersObj* leads to concurrently satisfy the two policies. Hence, in this approach we depart from solely optimising for a single objective unlike the classical cases instead we combine the two objectives. Furthermore, as explained in the problem formulation, *PersObj* can only be implemented in the available time frame of the visitor. Therefore, we take into account time constraint to limit the size of recommendation set. This is a soft constraint introduced by estimating visiting times per POI depending on the type of visitors. For this we adopted the analogy used in the work of *Veron and Levasseur* [242] to classify museum visitors into four visiting style metaphors (Ant, butterfly, fish and grasshopper). This is translated from explicit user feedback to the following question.

Which of the following best describes your museum visiting style?

- I spend a long time observing all exhibits and moves close to the walls and the exhibits avoiding empty space. (**The ant visitor**)
- I walk mostly through empty space making just a few stops and see most of the exhibits but for a short time. (**The fish visitor**)
- I see only exhibits I am interested in. I walk through empty space and stays for a long time only in front of selected exhibits. (**The grasshopper visitor**)
- I frequently change the direction of my tour, usually avoiding empty space. I see almost all exhibits, but times vary between exhibits. (**The butterfly visitor**)

Thus, for the ant visitor estimated visiting time was set to 60 seconds per POI, for fish 30 seconds per POI, for grasshopper 45 seconds per POI and for butterfly a random value between 45 and 60 seconds.

The personalisation function pa^{Exhib} (equation 3.1), implemented by mg for POI recommendation task suggests a recommendation set R for a visitor vs . This recommendation takes into account the preferences of vs influenced by cr^{vis} in terms of popular content (equation 3.4) as well as the objectives of ex in terms of content diversity (equation 3.5) given the available time of the visitor. Hence, the personalisation function:

$$pa^{Exhib} = f(vs, mg, cr^{vis}, ex) = PersObj$$

for POI recommendation, can be implemented by solving the following MIP problem:

$$pa^{Exhib} = argmax \left(1 - \xi \sum_{a=1}^R p_a * S_{AG}(p_a, vs) + \xi \sum_{i=1}^K \sqrt{p_a \sum_{p_a \in S_i \cap R} \gamma_{p_a}} \right) \quad (3.8)$$

$$subject\ to\ \sum_{a=1}^R Tv(p_a) \leq T_{ava},$$

where ξ is a user provided hyperparameter determining visitor's tolerance to diversity, $Tv(p_a)$ is the estimated visiting time of a painting p_a according to the visiting style of the visitor and T_{ava} is the total available time of the visitor. Our CPSS based Personalised PoI recommendation strategy is sketched in Algorithm 2.

Algorithm 2 The CPSS BASED PERSONALISED POI RECOMMENDER algorithm; $\mathcal{R} = \{p_1, \dots, p_r\}$ is an optimal set of recommendations.

```

1: procedure PERSOANLISED POI RECOMMENDER
2:   ; Initialization
3:    $P, P^{ps}, W^{vs}, S(p, vs), S(p, Pop), \beta, \xi, T_{ava}, \psi(R), \gamma_p, K$ 
4:   ; repeat
5:   for  $p_1, \dots, p_y$  do
6:      $S_{AG}(p, vs) \leftarrow COMPUTE(\beta, S(p, vs), S(p, Pop))$ 
7:   end for
8:    $\mathcal{R} \leftarrow \emptyset$ 
9:   ; repeat
10:   $\psi(R) \leftarrow COMPUTE(\gamma_p, K)$ 
11:   $R \leftarrow SOLVE(\xi, S_{AG}(p, vs), \psi(R), T_{ava})$ 
12:  return  $\{p_1, \dots, p_r\} \leftarrow OPTIMAL(\mathcal{R})$ 
13: end procedure

```

Recommendation procedure with CPSS

3.2.3.2 Path Recommendation

Exhibition in National Gallery is divided into multiple "venues", which are areas grouping paintings according to some criteria chosen by the curators (*e.g.* paintings of a certain period, or of a particular painter, or of a particular theme). Hence, the second form of personalisation in exhibition areas is that of optimal path recommendation to help the visitor traverse in these venues leading to the recommended set of paintings. Once a recommendation set R of paintings is generated, we can then map the paintings in R to their corresponding venues.

The primary goal *PersObj* here is to find a path that is of high relevance. Since a path is a combination of venues, the relevance of a path is the total sum of the relevance of each venue on a path. The relevance score $S(v_i)$ of a venue $v_i \in V$ is defined as the total sum of the relevance scores of the paintings from the recommendation set R that are found in v_i . Therefore, finding a path of high relevance means satisfying *VisObj1*. Depending on the interest of a visitor, $S(v_i)$ could be defined in two different ways as (Quality or Quantity). The deadlock here is that two venues say v_i and v_j could have the same relevance score $S(v_i) = S(v_j)$ but one might be composed of a single painting of very high score while the other is composed of many paintings with lower scores. Thus, in order to prioritise between venues containing recommendations we define a Quality relevance score $\Theta(v_i)$ and Quantity relevance score $\delta(v_i) \forall v_i \in V_R$ as:

$$\Theta(v_i) = \sum_{a=1}^h S_{AG}(p_a, vs) + \frac{x}{K}; \quad \delta(v_i) = |h_i| + \frac{x}{K} \quad (3.9)$$

where h is the total number of paintings that are in $v_i \cap R$, x is the number of story groups covered by the recommended paintings in v_i . $\frac{x}{K}$ contributes diversity. $\Theta(v_i)$ is taken as relevance for visitors interested in visiting fewer but most relevant paintings (*i.e.* paintings with high score $S_{AG}(p, vs)$). In the contrary, for those visitors that are interested in covering as many relevant paintings as possible we use $\delta(v_i)$.

The second prevalent objective in implementing *PersObj* comes from the visitor's objective of not losing time getting lost between exhibits *VisObj2*. This means *PersObj* should find a path with minimal cost that navigates the user from the current venue to all relevant venues and back. This can easily be solved as the travelling salesman (TSP) problem. However, the physical layout of the museum forces visitors to traverse more than once in some venues. Hence, we rather define the cost of a path $C(PT)$ as the total sum of the travel distance between consecutive venues.

$$C(PT) = \sum_{i=1}^M dist(v_i, v_{i+1}) \quad (3.10)$$

Following the above discussion we get two policies to investigate in order to find an optimal path.

The first one is to maximise the relevance of the venues that are found in the path which corresponds to *VisObj1* given by:

$$Policy1 : S(v_i) = \begin{cases} argmax \sum_{i=1}^M \Theta(v_i) & Quality \\ argmax \sum_{i=1}^M \delta(v_i) & Quantity \end{cases} \quad (3.11)$$

The second one to find the least expensive (shortest) path. This corresponds to *VisObj2* that minimises the cost of the recommended path given by:

$$Policy2 : \left\{ argmin \sum_{i=1}^M dist(v_i, v_{i+1}) \right. \quad (3.12)$$

Hence, fulfilling *PersObj* for path recommendation requires concurrently satisfying the two policies. Furthermore, as discussed in the problem formulation, *PersObj* can only be implemented in the available time frame of the visitor and visitors also have different tolerance to crowd size. Therefore, while solving for the two policies, *PersObj* should respect crowd tolerance and available time of the visitor.

The personalisation function pa^{Exhib} (equation 3.1), implemented by *mg* finds an optimal path $PT(vs)$ to recommend for a visitor vs . This recommendation tries to satisfy the objectives of vs while being influenced by cr^{vis} in terms of congestion in the physical space and the ex in terms of layout that forces traversal more than once in some venues. Hence, the personalisation function:

$$pa^{Exhib} = f(vs, mg, cr^{vis}, ex) = PersObj$$

for path recommendation can be implemented by solving the following MIP problem which combines the two policies and their constraints:

$$pa^{Exhib} = argmax \left(1 - \lambda \sum_{i=1}^M v_i * S(v_i) + \lambda v_i * \frac{1}{\sum_{i=1}^M dist(v_i, v_{i+1})} \right) \quad (3.13)$$

$$S.t \sum_{i=1}^R Tv(p_i) + Tt(v) \leq T_{ava}; \quad (3.14)$$

$$Tt(v) = \sum_{i=1}^{M-1} Tt(v_i, v_{i+1})$$

$$Cr_s(V_i) \leq Cr_t(vs); \quad (3.15)$$

$$\forall V_i, 1 \leq i \leq M$$

where λ is a user provided hyperparameter that entails visitor's tolerance to fatigue (i.e. walking). Constraint (3.14) entails that the total estimated time for visiting (Tv) and traveling (Tt) should not exceed the available time (T_{ava}) of the visitor. Constraint (3.15) entails that the crowd size $Cr_s(v_i)$ in every venue v_i on the optimal path should not exceed the Crowd tolerance $Cr_t(vs)$ of the visitor. Our CPSS based path recommendation strategy is roughly sketched in Algorithm 3.

Algorithm 3 The CPSS BASED PERSONALISED OPTIMAL PATH RECOMMENDATION algorithm; $PT(vs) = (v_1, \dots, v_M)$ is the Optimal path which is a sequence of M venues recommended for visitor vs .

```

1: procedure OPTIMAL PATH RECOMMENDER
2:   ; Initialization
3:    $V, \mathbf{x}, S_{AG}(p, vs), h, \lambda, T_{ava}, Cr_s(v), Cr_t(vs), C(PT)$ 
4:   ; repeat
5:   for  $v_1, \dots, v_Q$  do
6:      $S(v) \leftarrow \text{COMPUTE}(\mathbf{x}, K, h, S_{AG}(p, vs))$ 
7:   end for
8:    $PT(vs) \leftarrow \emptyset$ 
9:   ; repeat
10:   $PT(vs) \leftarrow \text{SOLVE}(\lambda, S(v), Cr_s(v), Cr_t(vs), C(PT), T_{ava})$ 
11:  return  $(v_1, \dots, v_M) \leftarrow \text{OPTIMAL}(PT(vs))$ 
12: end procedure

```

Path recommendation procedure

3.2.4 Experiments and Results

3.2.4.1 Experimental setup and Dataset

In order to evaluate the performance of our approach we conducted two kinds of experimental evaluations. The first experiment was designed to evaluate the trained painting LDA model in terms of its representation quality and explainability. Whereas the second experiment was designed to assess the performance of the overall CPSS approach in terms of recommendation quality against baselines.

In this study we used a dataset containing 2368 paintings from the National Gallery of London. Each painting is represented by a set of attributes which are summarized in Table 3.4. For training the painting LDA model we specifically focus on painting description attribute. These descriptions are provided by museum experts and carry complementary information about the paintings such as stories and narratives that can be exploited to capture the semantic of a painting. These descriptions provide concise information about each painting. For the task of topic modeling using LDA, we decided to enrich the descriptions dataset D by concatenating the paintings descriptions with keyword attributes such as the artist name, the painting title, the technique used, the publication date, the format (landscape, portrait) and the size (small, medium, etc.) and also additional information from other sources to better train the model. Hence we generated a second dataset DE enriched with additional textual descriptions and stories related to the paintings, collected from various sources such as Wikipedia and books. To avoid "garbage in, garbage out" we performed textual pre-processing on both datasets (i.e. removal of punctuation, stop words, bi-grams, Lemmatization) as they do not add any value to the topic models.

The paintings from the National Gallery of London were categorised into 9 curated story groups listed in table 3.3.

Each user provided a rating for 80 paintings from the dataset to be used for profiling. All algorithms were implemented using python leveraging Gurobi 9.0⁷ to solve the core MIP problems. All experiments were run on a 1,4 GHz Intel CPU with 5 cores and 16 GiB of RAM.

⁷<https://www.gurobi.com/>

Attributes	Description
artist_name	Artist name
painting_title	Painting title
painting_id	Painting identifier
painting_description	Description
publishing_date	Publication date
format	(Landscape, Portrait)
size	(Small, Medium, Large)
technique	(Oil, tempera, ...)

Table 3.4: Attributes & descriptions of the Paintings dataset

3.2.4.2 LDA Model Evaluation

In topic modeling, *Topic Coherence* is a commonly used technique to evaluate topic models. It is defined as the sum of pairwise similarity scores on the words w_1, \dots, w_n used to describe the topic, usually the top n words by frequency $p(w|t)$ [111, 167]:

$$Coherence = \sum_{i < j} Score(w_i, w_j) \quad (3.16)$$

Ideally, a good model should generate coherent topics. (i.e the higher the coherence score the better the topic model is [167]). In order to identify the optimal number of topics as well as which data set D or DE generates the best topic model, our implementation resorted the topic coherence pipeline from gensim library⁸ *CoherenceModel*. Figure 3.8 shows the evolution of the normalised topic coherence as a function of the number of topics for each of the two dataset. From the analysis presented in figure 3.8 we can make two observations. Firstly, the data set

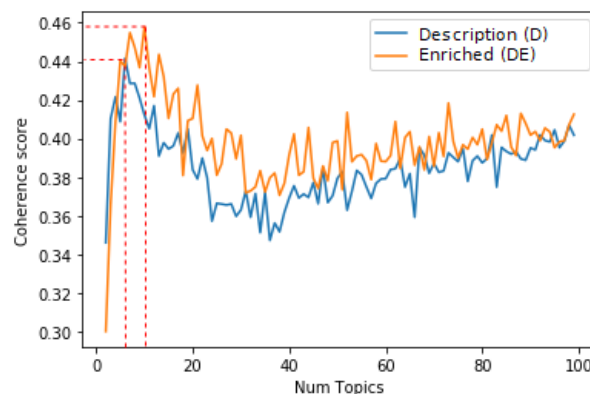

Figure 3.8: Comparative topic coherence analysis of the two data sets

DE (orange) generally gives slightly better topic coherence score and thus, a better topic model.

⁸<https://radimrehurek.com/gensim/models/ldamodel.html>

Secondly, we can observe that with 10 topics we obtained a topic coherence of approximately 0.46 for the data set *DE* which is the best score for this window. Having too many topics requires more resources as well as time for a result that is not significantly better. Thus, we decided to limit the number of topics to 10. Generally the topic coherence scores shows that enriching the original descriptions with additional information led to a better topic model. Hence, we chose to work with the dataset *DE* instead of *D*.

In addition to the evaluation of the topic coherence, we visualise the topics by using a visualisation tool called pyLDAvis⁹. In figure 3.9, we see each topic represented by a circle annotated with a digit from 0 to 9. The size of the circle represents the prevalence of a topic, i.e, the popularity of a topic among the paintings. The distance represents the similarity between topics. In fact it is an approximation to the original topic similarity because we are using a 2-dimensional scatter plot to best represent the spatial distribution of the topics. The objective here is to have topics that are overlapping as little as possible. With 10 topics, we can observe that the topics are evenly popular while being sufficiently distinct from each other which was our objective here.

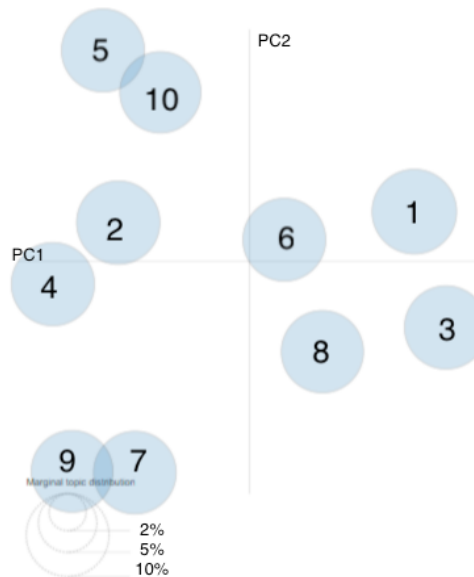

Figure 3.9: Inter-topic Distance Map in a 2-dimensional space of 10 topics

Recent studies in the domain of recommender systems have shown that there is direct relationship between explainability of recommendations and user acceptance [285]. Following this, we have studied the the explainability of recommendations oby our Painting LDA model as a side work. Details can be found in the Annex E.

⁹<https://pypi.org/project/pyLDAvis/>

3.2.4.3 Recommendation Quality Evaluation

To assess recommendation quality we conducted two independent controlled experiments with real users. The first one was conducted to evaluate the pure personalised recommendation method by LDA against the DNN based state of the art visual art recommenders [100]. Whereas the second controlled experiment was conducted to evaluate the CPSS approach against the above approaches as baselines. We adopted a user-centric evaluation framework [190]. This was done through a questionnaire, where participants had to express their opinion in a five points Likert scale to four of the following statements.

- *"The recommendations match my personal preferences and interests"* (Predictive accuracy);
- *"The recommender helped me discover paintings I did not know before"* (Novelty);
- *"The recommender helped me discover surprisingly interesting paintings I might not know otherwise."* (Serendipity);
- *"The recommended paintings are diverse"* (Diversity).

The first experiment was conducted with 15 real users. Each user provided a rating for 80 paintings from the dataset along with preference information for diversity, crowd tolerance, fatigue, etc. to be used for profiling. As a baseline recommender we used visual features extracted using Residual Networks (ResNet-50) [100]. ResNet-50 is a 50-layer deep convolutional neural network trained on more than a million images from the ImageNet database¹⁰. Thus, it has learned rich feature representations for a wide range of images. We used the pre-trained ResNet-50 to extract latent visual features from our painting dataset. The extracted features are then used to identify similar paintings to user preferred ones through similar scoring mechanism used for LDA. Figure 3.10 summarises the average values of user ratings for the two recommendation pipelines.

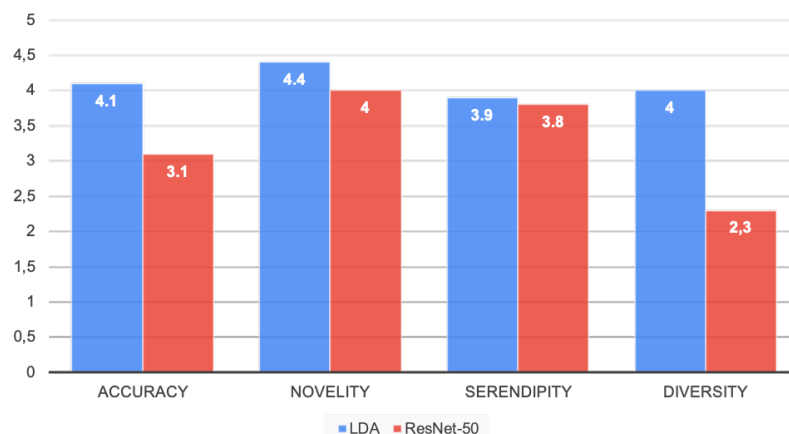

Figure 3.10: Comparison of LDA Vs ResNet-50.

¹⁰ImageNet. <http://www.image-net.org>

As reported on the figure, LDA achieved significantly higher diversity values (4/5) compared to ResNet-50 (2.3/5). This is due to the fact that the notion of similarity in LDA is directly related to semantically dominant concepts shared among paintings. i.e. LDA also uncovers relationship between paintings that do not necessarily have a resembling visual features. Hence, LDA captures semantic similarities that cannot be discovered through latent visual features. This can also justify the higher values of serendipity and Novelty since LDA based recommendation can contain visually diverse but semantically related paintings. In terms of matching user preferences, LDA also performs significantly better (4.1/5) than ResNet-50 (3.1/5). Additionally users were asked if explanations offered by LDA helped them to better understand recommendations. Interestingly all participants responded "Yes", this shows the tendency that explainable recommendations have a positive impact on user experience.

Following a similar setup, the second experiment was conducted with 40 real users to assess the performance of the CPSS approach of POI recommendation. We resorted LDA and ResNet50 as baseline recommenders to compare with the CPSS approach. The results of the second experiment are reported in Figure 3.11 in terms of average values of user ratings for the three recommendation pipelines.

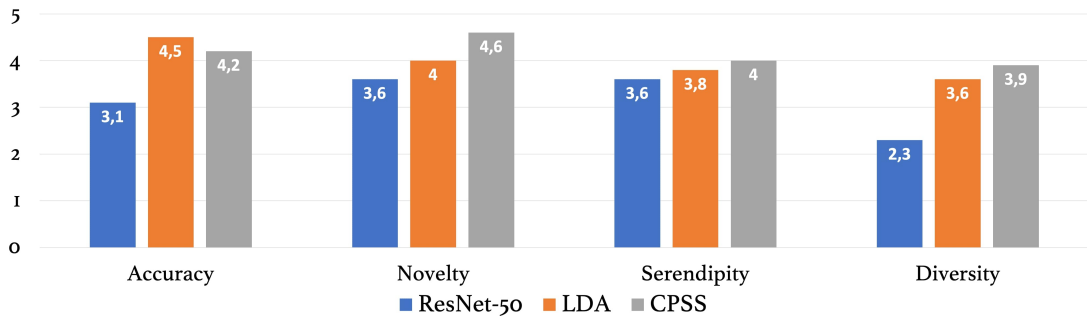

Figure 3.11: Comparison of ResNet-50, LDA and CPSS.

As reported on Figure 3.11, the CPSS approach achieved significantly higher diversity values (3.9/5) compared to LDA (3.6/5) and ResNet-50 (2.3/5). This can be attributed to the introduction of popularity bias and fair story selection strategy employed in the CPSS algorithm. LDA performs slightly lower than CPSS but shows significantly better performance compared to ResNet-50 in terms of diversity. This shows that the LDA based recommendation contains visually diverse but semantically related paintings. Since we also used LDA in the CPSS method as a first layer scoring function it also contributes to the higher diversity in the CPSS approach together with the popularity and fairness biases. This can also justify the higher values of serendipity and Novelty. In terms of prediction accuracy (i.e matching user's preferences) LDA performed better than CPSS and ResNet-50. Although in CPSS we considered the influence of the other stakeholders in the system (i.e crowd and curator), optimising for multiple objectives did not cause a significant worsening of performance accuracy (4.5/5) to (4.2/5). The slightly lower accuracy of CPSS can be attributed to the popularity and fairness bias compared to LDA and ResNet-50 whose objective solely optimises for user preferences. We also observed that this is significantly better than ResNet-50 (3.1/5). This supports our analysis from the first experiment which deduced that the exploration of textual descriptions of paintings with LDA empowers visual art recommenders to reveal hidden semantic relationships among paintings.

In all experiments computational cost was measured to an average of 2 seconds for solving

both MIP problems to generate a path with a list of recommendations. This is fast enough given the size of the search space. Furthermore, participants were asked if the CPSS recommendations were acceptable relative to LDA and ResNet-50. Interestingly 95% of the participants responded "Yes". This shows that the compromise to concurrently satisfy the goals of the curator and visitors was reasonable. In general the reported results in our experiment illustrate that the multi-stakeholder approach is a promising direction to pursue for personalisation in such CPSS settings.

3.2.5 Discussion

In this case study, **we presented a personalised recommendation and guidance method for smart exhibition areas** that implements our approach for personalisation in CPSS proposed in chapter 2. Thus, it adopts the general problem formulation (equation 2.14) to the specific case of exhibition areas (equation 3.1) and uses the CPSS meta-model to design the scenario. This in particular has given better visibility for the variables and their properties to be considered for personalisation. Utilising these, we were able to implement personalisation in exhibition areas from a multi-stakeholder perspective by solving a constrained multi-objective optimisation problem. **The case study illustrates some of the common challenges of personalisation in CPSS environments like exhibition areas such as ensuring quality of user experience, managing crowd and meeting curator goals, etc., which are often co-existing objectives but not always complementing each other.**

Unlike classical methods which solely focus on user satisfaction, our approach tries to jointly satisfy the objectives of users' as well as curators. Results obtained from a user centric evaluation in section 3.2.4.3 indicate that despite departing from solely optimising for user satisfaction recommendations made by the CPSS approach were acceptable for users. Hence, **we can deduce from these results that a multi-stakeholder approach to personalisation in CPSS is a promising direction. It not only compares favourably against baselines (ResNet-50 and LDA) but also allows to better manage the environment as it tries to make the best possible compromises between coexisting objectives of stakeholders.** Although our method offers POIs recommendations and an optimal path, the dynamic nature of the environment imposes more challenges as the visit commences. For instance variations in crowd size, closure of certain venues or the deviation of the user from the recommended path due to unknown reasons, etc. Thus, tracking real time constraints and updating recommendations accordingly could be feasible extensions of the work.

3.3 Personalisation in Cobotics

3.3.1 Introduction

Together with advances in Industry 4.0 the use of collaborative robots (Cobots) has become a common trend in various sectors. For instance in the case of smart manufacturing systems, factories are often organised as job shops. In the production line we have engineers, operators and maintenance technicians that are skilled and able to perform tasks on different machines. In this settings, Cobots are often introduced at job shops to collaborate with the workers in order to improve efficiency. Thus, forming a system where humans and smart devices cohabit a physical and virtual space of interaction; a CPSS. However, Cobots are often programmed to only execute predefined tasks. Hence, they are not able to seamlessly adapt to dynamic responses of human workers and environmental changes. This can potentially degrades collaboration quality and could also compromise the safety of human workers. By introducing personalisation in this case study, we set out to contribute mechanisms that will enable cobots to learn complex interaction responses of a human as well as to detect and adapt to dynamic environmental changes. Particularly this case study illustrates a personalised adaptation of a cobot in a smart workshop setting. To do this, we resort to the problem formulation strategy for personalisation in CPSS proposed in chapter 2. Similar to the first case study we utilised the CPSS meta-model to first frame the scenario, identify important variables, their respective objectives and influential factors as well as their relationship and inter-dependencies. Subsequently, we choose a suitable implementation method depending on the properties of the identified variables.

3.3.2 Problem formulation

In this case study, we focus on a scenario of a smart workshop comprising a set of workers, machines and a cobot working collaboratively with one of the workers. The case of personalisation we consider is the adaptation of the cobot behaviour to the human working with it. In such smart workshops, workers are *PSS*, interacting with a cobot and other (smart) devices (*CP(S)S*) that are independent or embedded in the physical space around them. This forms a *SoS*, because the interacting systems (at minimum, the worker, the cobot and the smart devices) exist on their own and are connected together only for some production task. The smart workshop is at least a CPS, when there are only R^P relations between the humans (*PSS*) and the cobot or other devices (CPS). When a social feature is added to at least the cobot or one of the device with which a worker interacts, it becomes a CPSS (axiom 2.4), and an R^S relation can therefore exist with a worker. According to axiom 2.12, the smart workshop can then be qualified as a CPSSoS.

Hence, adopting equation 2.14 the personalisation function in cobotics can be given by:

$$pa^{Cob} = f(w, cb, tw, ws) \quad (3.17)$$

where, w is a worker (the target user of personalisation), cb is the cobot implementing the personalisation function, tw is a team of coworkers forming a crowd and ws is the smart workshop.

This allows us to partially instantiate the CPSS meta-model in figure 3.12 for the case study and detail the properties of the variables that need to be considered to implement the personalisation.

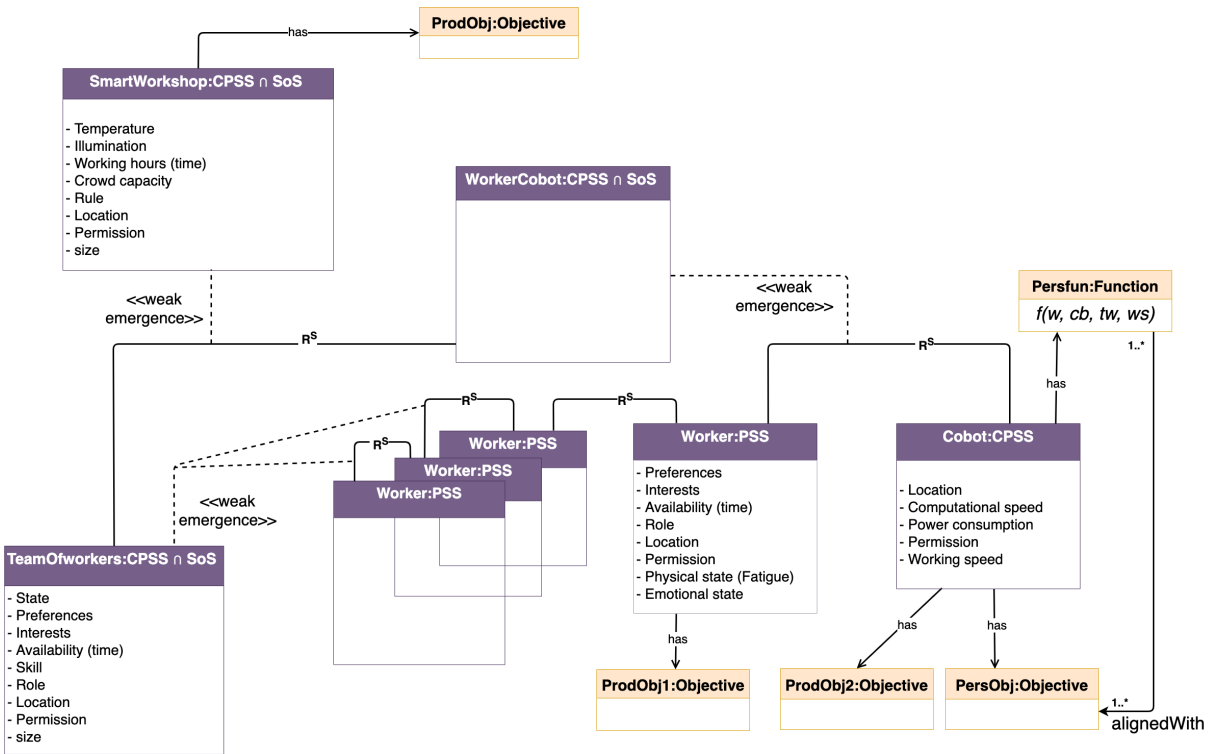

Figure 3.12: Partial instantiation of the CPSS meta-model in the context of smart workshop

Figure 3.12 shows classes of systems involved in the personalisation of our case study. For modelling convenience, only attributes involved in the personalisation implementation are detailed. Systemic properties represented by classes in the systemic model (Fig. 2.2) are displayed also as attributes, except for the objectives and the personalisation function. As personalisation concerns specific individuals, variables concern instances of these classes. Hence, w is an instance of the *Worker* class, cb is an instance of *Cobot*, tw is an instance of *TeamOfWorkers* and ws is an instance of *SmartWorkshop*.

The R^S between a *Worker* and *Cobot* leads to the emergence of a *CPSSoS* (axiom 2.5) which we called *WorkerCobot*. The social relations R^S between the coworkers (PSS) leads to the emergence of a *PSSoS* which we call a *TeamOfWorkers* (axiom 2.11). Finally we have the *SmartWorkshop* which is a *CPSSoS* formed from those social relations. Although the attributes of *WorkerCobot* and *SmartWorkshop* are not listed in the model, both inherit a merging list of attributes through the $\ll\text{weak emergence}\gg$. Below we detail the main objectives that we consider for the personalisation function:

- ProdObj**: is the global production objective of the smart workshop.
- ProdObj1**: is an objective of the worker to accomplish a production task.
- ProdObj2**: is an objective of the cobot to accomplish a production task assigned to it.
- PersObj**: is the personalisation objective implemented by the cobot. This includes regulating the temperature and brightness of the workshop to match the preference of the worker, to adapt its working speed to the fatigue level of worker as well as to track the

emotional states of the worker during collaboration and notify when detecting certain conditions that affect the worker's ability to operate such as stress, anger and anxiety.

- ***PersObj* for Cobotic adaptation:**

To implement *PersObj* the cobot should take appropriate actions corresponding to the changing states of temperature, illumination, physical and emotional state of the worker. These are four sub-objectives that the cobot need to satisfy in a synchronised manner. This is constrained by several factors within the workshop. For instance, the actions of the worker, the cobot and other coworkers performing different tasks in the workshop for the fulfilment of *ProdObj*, *ProdObj1* and *ProdObj2*, such as cutting wood, welding metal, boiling materials, etc., can potentially causes temperature and illumination to fluctuate which influences the user preferences and hence, constrain *PerfObj*. Additionally, rules and delivery deadlines of the *SmartWorkshop* or other personal issues might cause stress on the worker and hence, influencing *PersObj*. This requires *persObj* to find an optimal operational policy for the cobot that enables it to take appropriate action in order to satisfy the four objectives concurrently. Thus, implementing a personalised adaptation in this setting is essentially satisfying multiple objectives that are influenced by several factors. The successful implementation of *PersObj* entails that the social relation R^S between worker and cobot is enhanced since the worker's unique personal needs are recognised by the cobot.

Having defined the scenario for implementing personalisation in smart workshop setting from a general perspective, in the next subsection we present details on our implementation choice fitting the context and mathematical translations of the problem formulation in equation 3.17.

3.3.3 Implementation

In this particular scenario of a smart workshop *PersObj* is implemented by the cobot interacting with a worker. This essentially means enabling the cobot to understand and reason dynamic human interaction responses and adapt to changing needs accordingly. These are emotional responses such as stress, anger and anxiety as well as physical responses in terms of muscle fatigue. Implementing this however is not a trivial task as it requires relaxing the control rules and training cobots to derive efficient representations of the humans state from high-dimensional sensory inputs, and use these to generalize past experience to new situations. Such kinds of challenging tasks are remarkably solved by humans and other animals through a harmonious combination of reinforcement learning(RL) and hierarchical sensory processing systems, [208, 77]. This in particular has inspired the development of several RL algorithms over the years, [170] used for training agents to perform complicated tasks. RL allows agents to learn by exploring their environment unlike supervised methods which require collecting huge amount of data and harder to train with continuous action space. This makes RL a suitable candidate for implementing personalised adaptation of cobots. Thus, by taking this inspiration we extend the formalisation in equation 3.17 and reformulate the task of personalisation in cobotics as an RL task.

3.3.3.1 Personalised Adaptation as a Reinforcement Learning task

In RL, agents interact with their environment through a sequence of observations, actions and rewards [259]. At a given time an agent takes observation (*i.e.* information about the state of the environment) and takes an action that will maximise a long term reward. The agent then observes the consequence of the action on the state of the environment and the associated reward. It then continues to make decisions about which actions to take in a fashion that maximises the cumulative future reward. This can be done by learning an action value function given by:

$$Q^*(s, a) = \max_{\pi} \mathbb{E} \left[\sum_{t \geq 0} \gamma^t r_t | s_0 = s, a_0 = a, \pi \right], \quad (3.18)$$

which is the maximum sum of rewards r_t discounted by γ at each time step t , achievable by a policy $\pi = p(a | s)$, after making an observation of (s) and taking an action (a). This means that RL agents operate based on a policy π to approximate Q -values(state-action pairs) that maximise a future reward. The details on RL formulation and Q-learning are discussed in (*Annex F*).

Adopting this to the context of cobotics, the cobot corresponds to the agent which operates based on a policy π and the environment corresponds to the smart workshop which is a CPSS containing a worker (target user of personalisation), the cobot itself, the team of workers, other context elements (*i.e.* devices and objects). The state of the environment s_t at any time step t is a combination of the states of the main entities in the workshop (*i.e.* state of the worker s_t^w , state of the team of workers s_t^{tw} , and state of any context element that has an impact on the worker s_t^{xi}). Similarly the action a_t taken by the cobot can be one or a combination of other actions according to the states of the respective entities depending on the scenario. The reward r_t the cobot receives for taking an action a_t is the total sum of the rewards deemed appropriate for the corresponding states of the main entities ($r_t = r_t^w + r_t^{tw} + r_t^{xi} + \dots$). In RL reward values play a crucial role in guiding the exploratory behaviour of the agent (*i.e.* the Cobot in our case). Since the main objective of personalisation here is enabling the Cobot to make informed decisions and take actions adapting to needs of the worker, r_t^w should be prioritised. Doing so, the cobot should not cause significant harm on the functioning of the other entities. This will

be regulated by the rewards associated with the co-existing entities (r_t^{tw} , r_t^{xi} , etc.) . Figure 3.13 illustrates the problem of personalisation in cobotics as an RL task.

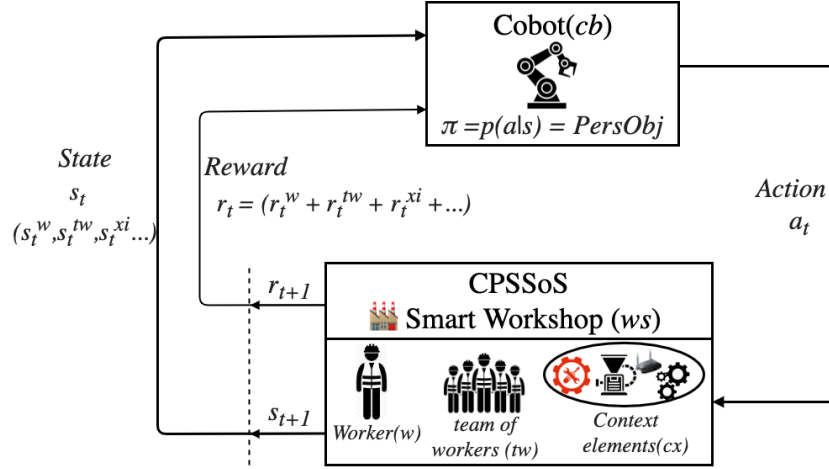

Figure 3.13: Personalisation in Cobotics as an RL task

At each step the approximation of the optimal Q-value function Q^* will be refined by enforcing the "Bellman equation" [259] given by:

$$Q^*(s, a) = \mathbb{E}_{s' \sim \mathcal{E}} \left[r + \gamma \max_{a'} Q^*(s', a') | s, a \right], \quad (3.19)$$

which states that given any state-action pair s and a the maximum cumulative reward achieved is the sum of the reward for that pair r plus the value of the next state we end up with s' . The value at state s' is going to be the maximum over actions a' at $Q^*(s', a')$. Thus the optimal policy π^* corresponds to taking the best action in any state as specified by Q^* . In this iterative process the Bellman equation is used as a value iteration algorithm which iteratively refines Q^* :

$$Q_{i+1}(s, a) = \mathbb{E} \left[r + \gamma \max_{a'} Q_i(s', a') | s, a \right], \quad (3.20)$$

Q_i converges to Q^* as i approaches to infinity.

To implement *PersObj* in Cobotics we are interested in finding an optimal policy on which the cobot operates on in order to adapt by taking the best possible action given the state of workshop (i.e. s_t^w , s_t^{tw} , s_t^{xi}).

Following this, the task of training personalised adaptation in cobots can be summarised as follows. Recalling the schematic from figure 3.13 the environment of the cobot is a *CPSSoS* which is a smart workshop. Since workers in such settings experience mental as well as physical workloads they often produce a subjective experience and respond differently depending on individual skills, characters, preferences, etc. The state of a worker here refers to the interaction responses which are fatigue level and emotional states. Thus, the personalisation objective is to adapt to the current state of the worker s_t^w as well as to his preferences regarding different states of the workshop particularly temperature and illumination which can be impacted by s_t^{tw} or any other context element s_t^{xi} . Thus, *PersObj* in this situation corresponds to an finding an optimal operational policy $\pi^* = p(a | s)$ for the cobot to take the best possible set of actions a (regulating

temperature and illumination, adapt working speed and generate notification) given any state s of the the workshop. This corresponds to satisfying multiple objectives that are under constant influence ;essentially a constrained multi-objective optimisation problem as defined in equation 2.16.

As we recall from the MOOP formulation of equation 2.16 and demonstrated in the implementation of the fist case study, the list of objectives and constraints naturally lead to a MIP equation. However, unlike the first case study the nature of the problem in this case study, especially the constraints which are partially observable consequences of different actions of the co-existing entities and the environment forces us to depart from the classical MOOP solution methods. Hence, the personalisation function pa^{cob} (equation 3.17) implemented by cb to adapt to the needs of w regulating the impact of tw and ws on the w is given by:

$$\begin{aligned} pa^{cob} &= f(w, cb, tw, ws) = PersObj \\ pa^{cob} &= \pi^* = p(a | s) \end{aligned} \tag{3.21}$$

Thus, utilising the Q-learning mechanism we can train a cobot to learn a reasonable policy of adaptation. However, when modelling a more realistic scenario where we have infinite observation and action spaces this method becomes computationally expensive. This is due to the fact that one must compute $Q(s, a)$ for every state-action pair in order to select the best action. In recent RL works this issue has been addressed by using a function approximator such as a neural network to approximate the action-value function. $Q(s, a; \theta) \approx Q^*(s, a)$ where θ is the function parameters (weights) of a neural network. Deep Q-learning is one of the most commonly used techniques to approximate optimal action-value functions using a deep neural network. Thus, in an effort to build a scalable adaptation technique we resort to neural networks as our Q function approximators. In the following we present our proposed personalised adaptation method with deep reinforcement learning.

3.3.3.2 Personalised Adaptation with Deep Reinforcement Learning

The idea of using neural networks as a function approximators for a reinforcement learning task was originally proposed by *Mnih et al. 2013* [157]. In the original paper the authors used convolutional networks labelled DQN for Deep Q-networks. DQN later evolved and proved to solve various complicated tasks with the help of different techniques such as experience replay, target networks and reward clipping [156, 214, 215, 44, 19]. Inspired by the practicality of such methods we define our Q-function approximator using a neural network. This means in the forward pass of the network we use a loss function which tries to minimise the error of the Bellman equation. (*i.e* determines how far $Q(s, a)$ is from the target $Q^*(s, a)$ given by:

$$L_i(\theta_i) = \mathbb{E}_{s, a \sim \rho(\cdot)} [(y_i - Q(s, a; \theta_i))^2] \tag{3.22}$$

$$\text{where, } y_i = \mathbb{E}_{s' \sim \varepsilon} \left[r + \gamma \max_{a'} Q(s', a'; \theta_{i-1}) | s, a \right]$$

The backward pass is then going to be a gradient update with respect to the Q-function parameters θ given by:

$$\nabla_{\theta_i} L_i(\theta_i) = \mathbb{E}_{s, a \sim \rho(\cdot); s' \sim \varepsilon} \left[(r + \gamma \max_{a'} Q(s', a'; \theta_{i-1}) - Q(s, a; \theta_i)) \nabla_{\theta_i} Q(s, a; \theta_i) \right] \tag{3.23}$$

Using this network structure a single feed forward pass is able to computes Q-values for all possible actions in the current state which is efficient. Thus, to train a cobot it iteratively tires

to make the Q-value close to the target value (y_i) it should have, if Q-fuction corresponds to optimal Q^* (and the optimal policy π^*).

The personalised adaptation task requires the cobot to take one or more actions depending on the specific circumstances. For instance a cobot can be regulating temperature and brightness while at the same time steering a wheel at an angle which requires a certain level of precision. The pure DQN method with a single neural network allows training single actions at a time with discrete values. However our adaptation task at times could require taking multiple actions with continuous values. Therefore, to solve our adaptation task we utilised a variation of DQN called Actor-Critic method which combines DQN with Deep Deterministic Policy-Gradient Algorithms (DDPG) [137]. This method uses two neural networks one for approximating a policy $p(a/s)$ which is the actor network and one for computing Q-values which is the critic Network. The two networks work together to find out how to best act in the environment. The actor network takes as an input states from the environment and computes the probability of selecting each actions. Where as the critic takes as input both the states and the predicted actions by the actor and determines how good each action is by computing the Q-values. Then the result is compared to the reward from the environment. Overtime, the critic becomes more accurate at estimating the values of states which allows the actor to select actions that lead to those states. These two networks complementing each other allow the cobot to learn optimal adaptation policy.

3.3.4 Experiments and Results

3.3.4.1 Experimental setup

In order to validate our approach, we conducted two main kinds of experimental evaluations. The first experiment was conducted to evaluate the adaptation of cobot to a single state observation *e.g.* regulating temperature, brightness. The second experiment evaluates the adaptation of cobot to multiple state observation by taking multiple actions which simulates a more realistic scenario. In our implementation we considered four parameters for our observation which are temperature, illumination, emotional and physical states of the worker. Here, temperature and illumination are environmental variables for which the worker can have a certain preference range. However, they are often subject to fluctuation as they can be impacted by the actions of other workers or the state of other entities in the workshop such as opening of doors/windows, boiling of some materials causing the workshop temperature and illumination to deviate from the user preferred range. For the physical state of the worker we considered muscle fatigue and for emotional states we used a binary categorisation of emotions as desirable and undesirable states determining if the worker is able to work or not. The cobot's personalised adaptation task is thus to simultaneously regulate temperature and illumination, adjust arm speed according to the muscle fatigue of the worker and notify a supervisor if the worker is in emotionally an unstable condition. In our implementations we used openAI gym environment¹¹, TensorFlow¹² and Keras¹³ with python. All experiments were run on a 1,4 GHz Intel CPU with 5 cores and 16GiB of RAM.

3.3.4.2 Single-state Single-action Adaptation

In this experiment we train the agent representing the cobot to find a policy that adapts to single state observations and evaluate its performance. Particularly the experiment involves learning

¹¹<https://gym.openai.com>

¹²<https://www.tensorflow.org>

¹³<https://keras.io/>

to regulate temperature and illumination independently.

■ Learning to regulate temperature

Training setting:

- Optimal temperature range: between 23°c and 26°c.
- A single work session: 60 seconds.
- Action: Increase, decrease, leave T°.
- State: Temperature of workshop.
- Reward: 1 if temperature is in optimal range -1 if temperature is outside the optimal range.
- Noise: Random
- Goal: maintain temperature in optimal range

The cobot gets a reading of current temperature of the workshop every step. (*i.e.* 60 times in a single work session). In every step it chooses to increase, to decrease or to leave the temperature as it is and it gets a reward for these actions. The random noise simulates perturbations causing the temperature to fluctuate. Learning an optimal policy here essentially means selecting those actions that maximise the cumulative long term reward. Thus, the rewards guide the cobot to take actions that lead towards the optimal temperature. If an optimal policy is eventually learned by the cobot the maximum amount of reward that can be achieved is +60 whereas the minimum amount of achievable reward is -60 in case of failure.

■ Learning to regulate illumination

Training setting:

- Optimal illumination range: between 56 and 60.
- A single work session: 60 seconds.
- Action: Increase, decrease, leave as is.
- State: Illumination of workshop.
- Reward: 1 if Illumination is in optimal range -1 if it's outside the optimal range.
- Noise: Random
- Goal: maintain illumination in optimal range

Similar to the temperature regulation training the cobot gets a reading of current illumination of the workshop every step. (*i.e.* 60 times in a single work session). In every step it chooses to increase, to decrease or to leave the brightness as it is and it gets a reward for these actions. Thus, the rewards guide the cobot to take actions that lead towards the optimal illumination in the workshop. If an optimal policy is eventually learned by the cobot the maximum amount of reward that can be achieved is +60 where as the minimum amount of achievable reward is -60 in case of failure.

Our Q-network architecture uses 2 hidden layers with 24 dense nodes each and relu activation. We used Adam optimiser to train the models. Figure 3.14a and 3.14b report the learning curves for temperature and illumination respectively plotted in terms of average reward(y-axis) against training episodes(x-axis).

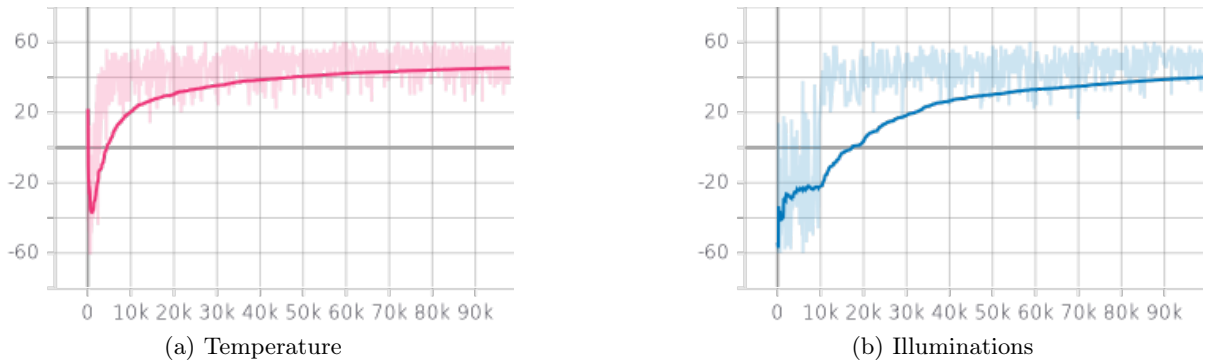

Figure 3.14: Single-state Single-action learning curve.

As we can see on the figures the cobot struggles at the very beginning of the training with negative rewards since it starts by selecting random actions. However, it eventually starts to learn the policy. Figure 3.15a and 3.15b show the performance of the two models after 10 million steps of training on 20 test work sessions. As reported the cobot managed to correctly set the temperature and illuminations in the desired ranges in almost all cases thus, it gets an average reward of 60 per episode. In few cases such as in episode 5,7,8,12,14,17 and 19 for temperature and episode 1,4,9 for illumination it failed few times as a result it gets an average episodic reward of 58. Overall it gets an average cumulative reward of 59.3 for temperature and 59.7 for illumination over the 20 test work sessions which is a reasonably good performance. Hence, these experiments show that we can successfully train a reasonable policy of adaptation for single state observations using deep reinforcement learning.

3.3.4.3 Multi-state Multi-action Adaptation

In this experiment we simulate a realistic scenario of smart workshop by training a cobot to simultaneously adapt to multiple state observations using the actor-critic method. Our observation states are temperature, illumination, muscle fatigue and emotional state. We keep similar training settings for temperature and illumination as the single-state single-action experiment. For muscle fatigue we have 3 possible states (fit, intermediate and weak) and the training goal is to adapt working speed by taking the actions (increase, decrease or leave as is) in order to maintain the speed within the desired range for the current state. Whereas for emotional states

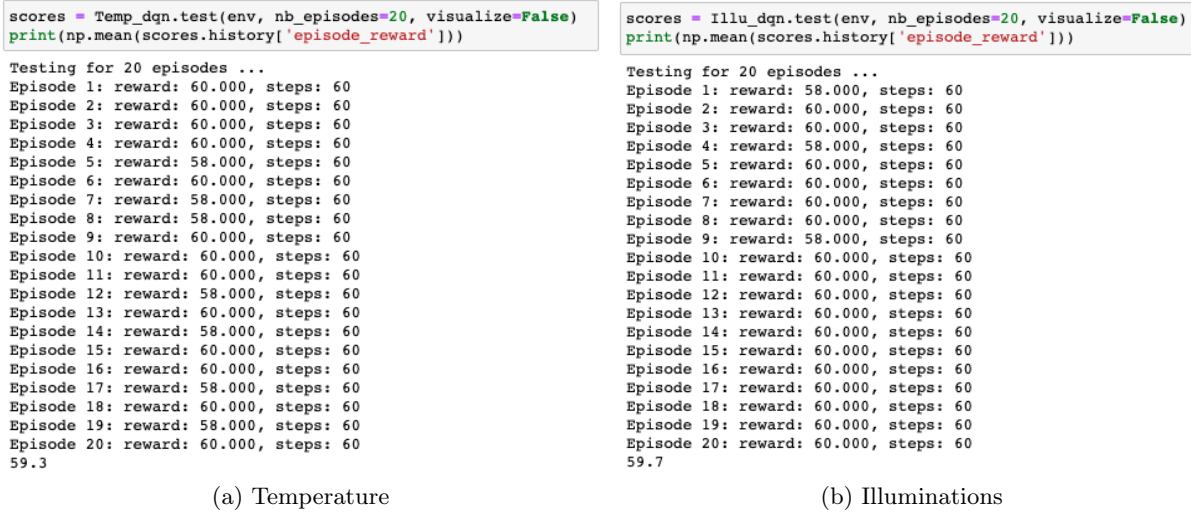

Figure 3.15: Single-state Single-action model performance.

we have two categories of emotional states, positive and negative. These are related to conditions that affect the worker's ability to operate such as stress, anger and anxiety. The goal regarding emotional states is to train the cobot to detect whenever the worker plunges into negative emotional states and notify a supervisor. Reward values were set to +1 for success and -1 for failure. Hence, in the training the cobot gets a reading of the current states for all the four parameters (*i.e.* 60 time per single work session). In every step it chooses to take four different actions simultaneously depending on the states observed. Consequently it receives a reward for each action either +1 or -1 for success and failure respectively. Learning an optimal policy here essentially means in the next step taking actions that will maximise the cumulative reward. Thus, if an optimal operational policy is eventually reached, the maximum achievable reward in a single work session is going to be +240 where as in case of failure the minimum amount of achievable reward is -240.

Our actor-critic network uses 2 hidden layers with 300 and 600 hidden units respectively. We used Adam optimiser [31] to train the models. Figure 3.16 reports the learning curve for multi-state multi-action training plotted in terms of average reward(y-axis) against training episodes(x-axis).

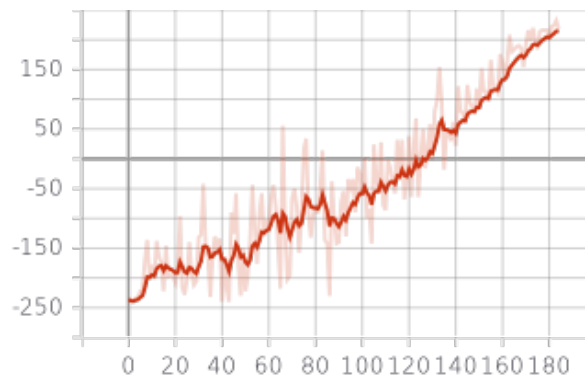

Figure 3.16: Multi-state Multi-action learning curve.

As we can see from the figure the cobot eventually picked up on learning the optimal policy for the multi-state observations. However, a common limitation is longer training time and also DQN policies are known to be brittle as we keep updating gradient descent on global optimum, thus the learning curve often fluctuates as it can be seen on the figure. Its performance can be further improved by better tuning hyperparameters and resorting different variations of the actor-critic method that have shown better performance in different application areas such as *Multi-agent Actor-critic* which uses a centralised critic [201]. Although our model is not the perfect representation of a complex cobotic workshop setting the goal of this study is to illustrate the feasibility of the approach. Hence, from these experiments we can deduce that deep reinforcement learning has the potential to empower personalisation in cobotic environments by training cobots that can adapt to changing needs of workers.

3.3.5 Discussion

In this case study, **we focused on designing a personalised adaptation technique that can be implemented on a cobot in a smart workshop setting.** We utilised the CPSS meta-model from section 2.2.3 to instantiate and frame the scenario. We translated the general formulation of personalisation in CPSS equation 2.14 to the cobotics setting in equation 3.17. This allowed us to visualise and model components that have an impact on the target user of personalisation. Unlike recommendations in the first case study, the personalisation task in this case is the adaptation of a cobot to various needs of worker in a constrained environment. This requires the cobot to derive efficient representations of the human workers and the state of different components in the environment from high-dimensional sensory inputs. And use these to generalise past experience to new situations in order to adapt. Taking inspiration from recent successes in the domain of reinforcement learning we frame the personalisation goal as a reinforcement learning task. As the experimental simulation illustrate in section 3.3.4 we were able to train optimal operational policies for cobotic adaptation by resorting deep reinforcement learning techniques. This allows training a cobot to recognise and adapt to the personal needs of a worker. Particularly, the results on multi-state multi-task adaptation indicate the potential of this approach to personalisation in cobotic environments as it allows to concurrently satisfy to multiple goals. Hence, such cobotic systems where human-machine collaborations are solely focused on predefined task executions can make use of our approach to enhance collaboration experience. Consequently, it fosters the creation of digitised collaborative working environments where individual preferences, interests limitations and opportunities are realised.

3.4 Conclusion

The introduction of a social aspect in the CPSS paradigm has unlocked a number of research challenges. This "*social*" part inspired from social interactions is rooted in the process where the behaviours of one *actor* are consciously recognised by, and influence the behaviours of, another actor, and vice versa. Here, the original *actors* being humans, what qualifies such interaction as social is rather complex. This is inherently associated to specific human characteristics deeply ingrained in emotional, cognitive and behavioural facets. Furthermore, a coherent patterning and integration of such facets overtime shapes the personality of individuals making people distinctive from one another adds another layer of complexity. As *Ortony* [180] states a glimpse into this complexity can be seen by answering the questions of *why some people become angry, while others become frightened or depressed in response to similar threats, and why some become elated while others seem unaffected when given the same rewards.* Although these questions are yet to

be answered fully, they clearly show the pivotal role of personality in determining individuals experience in social interactions. When considering human-to-human social interaction, it is apparent that the quality of the interaction is subject to how well the individuals know each other. Indeed, if one knows the other person's preferences, behaviour, likes and dislikes it is more convenient to respond appropriately in a social context. The same is true in human-machine interaction. This is because each person is unique and his/her actions and behaviours are guided by individual personality (i.e knowledge, preferences, interests, culture, beliefs, etc.) Hence, in the context of CPSS the need to ensure a seamless interaction experience positions the concept of personalisation or adaptation of the systems to users at the heart of the paradigm.

As discussed in Chapter 2, we introduced the notion of personalisation in CPSS to address these unique aspects of personality in facilitating human-CPS interaction. Thus, to enhance user experience by recognising individual preferences, interests, limitations and opportunities. Nevertheless, in CPSS users co-exist with different stakeholders influencing each other while being influenced by different environmental factors. Additionally, these environments often have their own desired goals and corresponding set of rules in place expecting people to behave in certain ways. Hence, in such settings classical approaches to personalisation which solely optimise for user satisfaction are often encumbered by competing objectives and environmental constraints making the task of personalisation rather challenging. The CPSS-specific personalisation approach proposed in chapter 2 was aimed to address this challenge highlighted in *Limitation 3*.

In this chapter, we presented two case studies of personalisation in CPSS environments by applying the proposed approach. The first case study presents personalisation as a recommendation task whereas the second showcases personalised adaptation. The case studies have demonstrated the potential of the approach to implement personalisation in CPSS. In both case-studies we showcased the multi-objective nature of the problem. Particularly, in the first case study we addressed a recommendation task by solving a constrained multi-objective optimisation problem using a MIP solver. Whereas in the second case study the adaptation task involves finding optimal operational policy for multiple actions. Here, the multi-objective optimisation problem was solved using Deep Reinforcement learning. In general the results of the two case studies illustrate that our personalisation approach utilising the systemic view of CPSS can be adopted in different domains of CPSS. The experimental results of the case-studies, especially user feedback on the recommendations indicate that the personalisation approach indeed manages to deliver personalisation while handling the CPSS complexities. This shows that, through personalisation we can empower machines to recognise and address unique aspects of personality in human-CPS interactions.

Furthermore, the proposed CPSS specific personalisation approach establishes a common ground to further investigate and integrate feasible implementation strategies from various domains to enhance user experiences in CPSS. This also opens possibilities to leverage successful results from fields that investigate human dynamics such as *Cognitive science, behavioural science, affect/emotion recognition and related sub-fields of artificial intelligence (AI)*. As mentioned in the second case study, workers experience mental as well as physical workloads for which they often produce a subjective experience and respond differently depending on individual skills, characters, preferences, etc. Such responses are often hard to directly detect and analyse. Nevertheless, thanks to the advances made in artificial intelligence emotional, cognitive and behavioural states of humans can now be inferred by physiological response monitoring with a reasonably good accuracy [63]. Thus, such algorithms can be leveraged as an underlining technique of our approach to iteratively infer states of the worker while tackling the problem of finding the best personalised action through an optimal policy given observation states.

Consequently, the CPSS-specific personalisation approach demonstrated through the case studies, answers the second research question (**RQ2**) by opening new perspectives and contributes both to the fields of CPSS, and Personalisation/User Modelling/ Recommender Systems where applications to the physical world have gained momentum.

Chapter 4

Conclusion and Future Directions

4.1 Conclusion

In this thesis, we propose a systemic formalisation of the Cyber-Physical-Social System (CPSS) paradigm and a personalisation approach to contribute to the integration of social aspects in CPSS. In this chapter we revisit the research problems, the state-of-the-art limitations as well as an overview of our contributions. Finally we conclude with a discussion on perspectives and future research directions.

4.1.1 Summary of the thesis

In chapter 1 we conducted a systematic literature review and explored the broad spectrum of CPSS from its evolution to state-of-the-art perspectives. Particularly, we explored the various definitions, application areas and the conceptualisations of the social aspect in literature. The analysis revealed that the way of defining a CPSS has always been inconsistent and often use-case dependent. As a result, researchers often adopt their own definitions and design methodologies fitting to their particular use-cases which hinders the re-usability and domain adaptability of research works.

Furthermore, the analysis on the current conceptualisations of the social aspect are tied to the presence of human at the vicinity of Cyber-Physical Systems either being a source of information or consuming a service. Nevertheless, with the ultimate goal of anthropomorphising human CPS interaction, a deeper representation of social aspects in machines remains vital for CPSS. We also understand from literature that the social aspect is something deeply ingrained in emotional, cognitive and behavioural facets of humans. Additionally the uniqueness of humans' personality plays a pivotal role in determining individual interaction experience. This is shaped over time through experience, knowledge and several other factors inextricably entangled with these social facets. Hence, positioning the notion of personalisation at the heart of the CPSS paradigm.

These findings led us to position the contribution of the thesis to particularly address the following limitations.

- **Limitation 1:** The lack of a uniform understanding and a proper formalisation of the CPSS concept.
- **Limitation 2:** The lack of a comprehensive representation of social aspects in CPSS.
- **Limitation 3:** The lack of efficient approaches to tackle the problem of personalisation in CPSS by taking into account the overall systemic complexity.

In order to address the identified limitations and develop our contribution, we formulated two research questions:

- **RQ 1:** *How to formally present the notion of Cyber-Physical-Social System (CPSS)?*
- **RQ 2:** *How to make human-CPS interaction more anthropomorphic in CPSS? Can personalisation bring a first step towards this?*

In chapter 2 we presented the main contributions of the thesis. Primarily we proposed a formalisation to the notion of CPSS which captures the existing conceptualisation in literature and projects a view for the future developments of the paradigm. The formalisation mainly constitutes a generic definition of CPSS and a meta-model proposal. This offers a domain independent understanding of the concept. Hence, it opens opportunities in the CPSS research domain to propose solutions that can pave the way towards a seamless integration of social aspects in CPSS. This contributes to address the identified research challenges in **Limitation 1** and **Limitation 2**, while answering our first research question (**RQ1**) on how to formally present the notion of CPSS.

Secondly, we introduced the notion of personalisation in CPSS by resorting the proposed systemic formalisation as a basis. In particular, we proposed a problem formulation strategy to implement personalisation in a CPSS context that takes into account the overall complexity. This partially contributes to the identified research challenge in **Limitation 3** and strategically positions our research to answer the second research question (**RQ2**).

Finally, in chapter 3 we presented two independent case studies which instantiate the CPSS meta-model and the CPSS-specific personalisation method proposed in chapter 2. In the first case study we presented a personalised recommendation and guidance approach in the context of smart exhibition areas, whereas in the second one we implemented personalisation as adaptation of collaborative robots (Cobots) in the context of a smart workshop setting. The design and implementations of the case studies illustrated the domain independent usability of the proposed formalisation of CPSS. Furthermore, they showcase the benefits, challenges and opportunities created by the proposed approach to introduce personalisation in CPSS.

The experimental results of the case-studies, especially user feedback on the recommendations indicate that the personalisation approach indeed manages to deliver personalisation while handling the CPSS complexities. Thus, it establishes a common ground to further investigate and integrate feasible implementation strategies from various domains to enhance user experiences in CPSS. Consequently, it answers the second research question (**RQ2**) by opening new

perspectives and contributes both to the fields of CPSS, and Personalisation/User Modelling/Recommender Systems where applications to the physical world have gained momentum.

The specific contributions in this thesis with referenced publications are:

- A systematic literature review and a systemic formalisation of CPSS with a meta-model.
 - **Bereket Abera Yilma**, Hervé Panetto, and Yannick Naudet. *"Systemic formalisation of Cyber-Physical-Social System (CPSS) : A systematic literature review"*. In Computers in Industry, Volume 129 :103458, April 2021.
 - **Bereket Abera Yilma**, Hervé Panetto, and Yannick Naudet. *"A Meta-Model of Cyber-Physical-Social System:The CPSS paradigm to support Human-Machine collaboration in Industry 4.0,"*. In the proceedings of the 20th Working Conference on Virtual Enterprises (*PRO-VE 2019*), Turin, Italy, September 2019.
 - **Bereket Abera Yilma**, Yannick Naudet and Hervé Panetto. *"A New Paradigm and Meta-Model for Cyber-Physical-Social Systems,"*. In the proceedings of the 21st IFAC World Congress in Berlin, Germany, July 2020.
- A novel formalisation to the general problem of personalisation in Cyber-Physical-Social Systems.
 - **Bereket Abera Yilma**, Yannick Naudet and Hervé Panetto. *"Introduction to Personalisation in Cyber-Physical-Social Systems,"*. In the proceedings of the 13th OTM/IFAC/IFIP International Workshop on Enterprise Integration, Interoperability and Networking (*EI2N 2018*) Valletta, Malta, October 2018.
- A novel personalisation approach by utilising the general formalisation on a case study of personalised Recommendation and Guidance in the context of smart exhibition areas.
 - **Bereket Abera Yilma**, Yannick Naudet and Hervé Panetto. *"Personalisation in Cyber-Physical-Social Systems: A Multi-stakeholder aware Recommendation and Guidance,"*. In the proceedings of the 29th ACM Conference on User Modeling, Adaptation and Personalization (*UMAP '21*), June 2021, Utrecht, Netherlands.
 - **Bereket Abera Yilma**, Najib Aghanda, M. Romero, Yannick Naudet and Hervé Panetto. *"Personalised Visual Art Recommendation by Learning Latent Semantic Representations,"*. In the proceedings of the 15th International Workshop on Semantic and Social Media Adaptation and Personalisation (*SMAP 2020*), Zakynthos, Greece(Virtual) October 2020.

- Yannick Naudet, **Bereket Abera Yilma** and Hervé Panetto. "*Personalisation in Cyber Physical and Social Systems: the Case of Recommendations in Cultural Heritage Spaces*". In the proceedings of the 13th International Workshop on Semantic and Social Media Adaptation and Personalisation (*SMAP 2018*) Zaragoza, Spain, September 2018.

- A novel personalisation approach by utilising the general formalisation on a case study of personalised adaptation of collaborative robots (Cobots) in the context of smart workshop setting.

- **Bereket Abera Yilma**, Yannick Naudet and Hervé Panetto. "*Towards a Personalisation Framework for Cyber-Physical-Social System (CPSS)*". In the proceedings of the 17th IFAC Symposium on Information Control Problems in Manufacturing (*INCOM 2021*), Budapest, Hungary(Virtual), June 2021.

4.1.2 Perspectives and Future Directions

In this era of digitisation, where virtual workplaces are becoming a common trend, the popular opinion, and fear is that machines will continue to take ever larger portions of human work activities eventually replacing us. Despite, the progressive changes especially in industry 4.0 seem to imply that we are on track towards full automation, there are still a wide range of opportunities to reimagine digital workplaces in the context of human-machine collaboration. As opposed to a race against one another we can redesign these systems blending human-machine participation to perform far more efficiently than either could individually. The ultimate vision of the CPSS paradigm shares this notion of fostering a seamless human-machine collaboration by instrumenting the human and socialising the machine [39]. Nowadays as more and more people are becoming users of wearables and sensory devices, the leap in the concept of "quantified self" opens opportunities to instrument humans by taking advantage of the humongous amount of collected data.

Although humans are still being instrumented for various purposes in the realm of CPSS, extrapolating true social dynamics for the socialisation of machines is yet to be explored. The work presented in thesis aims at contributing to make a step in this direction. Having established a vision for the future of CPSS, the formalisation reveals that the current conceptualisations are not where they need to be to arrive at the required level of maturity. At this point we can say that the lack of a common understanding and a comprehensive means of representing social aspects in CPSS (*Limitation 1* and *Limitation 2*) are no more issues. Thanks to the systemic formalisation, a stepping stone is established towards a collaborative and multidisciplinary research space. Going forward the formalisation and the meta-model are believed to facilitate the sharing and re-usability of successful results across various domains and application areas of CPSS. Thus, opening opportunities for multidisciplinary efforts to gradually introduce social aspects in CPSS research. Furthermore, the proposed approach to introduce personalisation in CPSS also opens new perspectives and contributes both to the fields of CPSS, and Personalisation/User Modelling/ Recommender Systems where applications to the physical world have gained momentum. Thus, alleviating (*Limitation 3*). This strategically positions CPSS to benefit from innovative and multidisciplinary solutions in tackling social dynamics. Therefore, we are optimistic that relying on the premises established in this work, a multidisciplinary approach is a worthwhile endeavour in the quest towards a true CPSS.

Bibliography

- [1] Faheem Ahmed Abbasi, Mohammed Hedi Karray, Raymond Houe, Muhammad Ali Memon, and Bernard Archimède. Towards a knowledge-driven framework of cyber-physical social system for multidimensional urban mobility. *Advances in Data Science and Adaptive Analysis*, page 2041005, 2020.
- [2] Himan Abdollahpouri, Gediminas Adomavicius, Robin Burke, Ido Guy, Dietmar Jannach, Toshihiro Kamishima, Jan Krasnodebski, and Luiz Pizzato. Multistakeholder recommendation: Survey and research directions. *User Modeling and User-Adapted Interaction*, 30(1):127–158, 2020.
- [3] Russell L Ackoff. Towards a system of systems concepts. *Management science*, 17(11):661–671, 1971.
- [4] PH Aditya, Indra Budi, and Q Munajat. A comparative analysis of memory-based and model-based collaborative filtering on the implementation of recommender system for e-commerce in indonesia: A case study pt x. In *2016 International Conference on Advanced Computer Science and Information Systems (ICACSIS)*, pages 303–308. IEEE, 2016.
- [5] Gediminas Adomavicius and Alexander Tuzhilin. Context-aware recommender systems. In *Recommender systems handbook*, pages 217–253. Springer, 2011.
- [6] Charu C Aggarwal. Attack-resistant recommender systems. In *Recommender Systems*, pages 385–410. Springer, 2016.
- [7] Charu C Aggarwal. Ensemble-based and hybrid recommender systems. In *Recommender Systems*, pages 199–224. Springer, 2016.
- [8] Charu C Aggarwal. Knowledge-based recommender systems. In *Recommender systems*, pages 167–197. Springer, 2016.
- [9] Charu C Aggarwal. Model-based collaborative filtering. In *Recommender systems*, pages 71–138. Springer, 2016.
- [10] Charu C Aggarwal. Neighborhood-based collaborative filtering. In *Recommender systems*, pages 29–70. Springer, 2016.
- [11] Charu C Aggarwal. Social and trust-centric recommender systems. In *Recommender Systems*, pages 345–384. Springer, 2016.
- [12] Lyuba Alboul, Martin Beer, and Louis Nisiotis. Robotics and virtual reality gaming for cultural heritage preservation. 2019.

- [13] Saeed Amal, Mustafa Adam, Peter Brusilovsky, Einat Minkov, Zef Segal, and Ts vi Kuflik. Demonstrating personalized multifaceted visualization of people recommendation to conference participants. In *Proceedings of the 25th International Conference on Intelligent User Interfaces Companion*, pages 49–50, 2020.
- [14] Maha Amami, Gabriella Pasi, Fabio Stella, and Rim Faiz. An lda-based approach to scientific paper recommendation. In *International conference on applications of natural language to information systems*, pages 200–210. Springer, 2016.
- [15] Farhan Amin and Gyu Sang Choi. Hotspots analysis using cyber-physical-social system for a smart city. *IEEE Access*, 8:122197–122209, 2020.
- [16] Fazel Ansari, Marjan Khobreh, Ulrich Seidenberg, and Wilfried Sihm. A problem-solving ontology for human-centered cyber physical production systems. *CIRP Journal of Manufacturing Science and Technology*, 22:91–106, AUG 2018.
- [17] Rel Guzman Apaza, Elizabeth Vera Cervantes, Laura Cruz Quispe, and José Ochoa Luna. Online courses recommendation based on lda. In *SIMBig*, pages 42–48. Citeseer, 2014.
- [18] André-Jean Arnaud. Jean-louis le moigne, la modélisation des systèmes complexes, 1990. *Droit et Société*, 19(1):424–424, 1991.
- [19] Kai Arulkumaran, Antoine Cully, and Julian Togelius. Alphastar: An evolutionary computation perspective. In *Proceedings of the Genetic and Evolutionary Computation Conference Companion*, GECCO '19, page 314–315, New York, USA, 2019. Association for Computing Machinery.
- [20] Resham Arya, Ashok Kumar, and Megha Bhushan. Affect recognition using brain signals: A survey. In *Computational Methods and Data Engineering*, pages 529–552. Springer, 2021.
- [21] E Baccarelli, M Scarpiniti, P G V Naranjo, and L Vaca-Cardenas. Fog of Social IoT: When the Fog Becomes Social. *IEEE Network*, 32(4):68–80, jul 2018.
- [22] Mateus Vinícius Bavaresco, Simona D’Oca, Enedir Ghisi, and Roberto Lamberts. Technological innovations to assess and include the human dimension in the building-performance loop: A review. *Energy and Buildings*, 202:109365, 2019.
- [23] Francesco Bellotti, Riccardo Berta, Alessandro De Gloria, and Ludovica Primavera. Adaptive experience engine for serious games. *IEEE Transactions on Computational Intelligence and AI in Games*, 1(4):264–280, 2009.
- [24] Yoshua Bengio, Aaron Courville, and Pascal Vincent. Representation learning: A review and new perspectives. *IEEE transactions on pattern analysis and machine intelligence*, 35(8):1798–1828, 2013.
- [25] David M Blei, Andrew Y Ng, and Michael I Jordan. Latent dirichlet allocation. *Journal of machine Learning research*, 3(Jan):993–1022, 2003.
- [26] Jan Blom. Personalization: a taxonomy. In *CHI’00 extended abstracts on Human factors in computing systems*, pages 313–314, 2000.
- [27] Jesús Bobadilla, Fernando Ortega, Antonio Hernando, and Abraham Gutiérrez. Recommender systems survey. *Knowledge-based systems*, 46:109–132, 2013.

-
- [28] Borja Bordel Sanchez, Ramon Alcarria, Alvaro Sanchez-Picot, and Diego Sanchez-de Rivera. A Methodology for the Design of Application-Specific Cyber-Physical Social Sensing Co-Simulators. *SENSORS*, 17(10), OCT 2017.
- [29] Fabien Bouffaron, Jean-Marc Dupont, Mayer Frédérique, and Gérard Morel. Integrative construct for model-based human-system integration: a case study. *IFAC Proceedings Volumes*, 47(3):12317 – 12324, 2014. 19th IFAC World Congress.
- [30] John S Breese, David Heckerman, and Carl Kadie. Empirical analysis of predictive algorithms for collaborative filtering. *arXiv preprint arXiv:1301.7363*, 2013.
- [31] Jason Brownlee. Gentle introduction to the adam optimization algorithm for deep learning. *Machine Learning Mastery*, 3, 2017.
- [32] Fanyu Bu. A High-Order Clustering Algorithm Based on Dropout Deep Learning for Heterogeneous Data in Cyber-Physical-Social Systems. *IEEE Access*, 6:11687–11693, 2017.
- [33] Robin Burke. Hybrid recommender systems: Survey and experiments. *User modeling and user-adapted interaction*, 12(4):331–370, 2002.
- [34] Pedro G Campos, Fernando Díez, and Iván Cantador. Time-aware recommender systems: a comprehensive survey and analysis of existing evaluation protocols. *User Modeling and User-Adapted Interaction*, 24(1):67–119, 2014.
- [35] Muhammad ZC Candra and Hong-Linh Truong. Reliable coordination patterns in cyber-physical-social systems. In *2016 International Conference on Data and Software Engineering (ICoDSE)*, pages 1–6. IEEE, 2016.
- [36] Z C M Candra, H Truong, and S Dustdar. On Monitoring Cyber-Physical-Social Systems. In *2016 IEEE World Congress on Services (SERVICES)*, pages 56–63, jun 2016.
- [37] ZC Muhammad Candra, Hong-Linh Truong, and Schahram Dustdar. On monitoring cyber-physical-social systems. In *2016 IEEE World Congress on Services (SERVICES)*, pages 56–63. IEEE, 2016.
- [38] Linnda R Caporael. Anthropomorphism and mechanomorphism: Two faces of the human machine. *Computers in human behavior*, 2(3):215–234, 1986.
- [39] Maria Chiara Carrozza. *The Socialization of Robotics*, pages 27–40. Springer International Publishing, Cham, 2019.
- [40] Christos G. Cassandras. Smart cities as cyber-physical social systems. *Engineering*, 2(2):156 – 158, 2016.
- [41] Sylvain Castagnos, Florian Marchal, Alexandre Bertrand, Morgane Colle, and Djalila Mahmoudi. Inferring art preferences from gaze exploration in a museum. In *Adjunct Publication of the 27th Conference on User Modeling, Adaptation and Personalization*, pages 425–430, 2019.
- [42] Cheng Chen, Xiangwu Meng, Zhenghua Xu, and Thomas Lukasiewicz. Location-aware personalized news recommendation with deep semantic analysis. *IEEE Access*, 5:1624–1638, 2017.

- [43] David Chen and Walter Stroup. General system theory: Toward a conceptual framework for science and technology education for all. *Journal of Science Education and Technology*, 2(3):447–459, 1993.
- [44] Jim X Chen. The evolution of computing: Alphago. *Computing in Science & Engineering*, 18(4):4–7, 2016.
- [45] Liming Chen, Diane J Cook, Bin Guo, and Wolfgang Leister. Guest editorialspecial issue on situation, activity, and goal awareness in cyber-physical human–machine systems. *IEEE Transactions on Human-Machine Systems*, 47(3):305–309, 2017.
- [46] Chiara Cimini, Fabiana Pirola, Roberto Pinto, and Sergio Cavalieri. A human-in-the-loop manufacturing control architecture for the next generation of production systems. *Journal of Manufacturing Systems*, 54:258–271, 2020.
- [47] A Costanzo, A Faro, D Giordano, and C Spampinato. Implementing Cyber Physical social Systems for smart cities: A semantic web perspective. In *2016 13th IEEE Annual Consumer Communications Networking Conference (CCNC)*, pages 274–275, jan 2016.
- [48] Alfio Costanzo, Alberto Faro, Daniela Giordano, and Concetto Spampinato. An ontological ubiquitous city information platform provided with Cyber-Physical-Social-Systems. *2016 13th IEEE Annual Consumer Communications and Networking Conference, CCNC 2016*, pages 137–144, jan 2016.
- [49] D N Crowley, E Curry, and J G Breslin. Closing the loop — From citizen sensing to citizen actuation. In *2013 7th IEEE International Conference on Digital Ecosystems and Technologies (DEST)*, pages 108–113, jul 2013.
- [50] Fei Dai, Qi Mo, Zhenping Qiang, Bi Huang, Weili Kou, and Hongji Yang. A Choreography Analysis Approach for Microservice Composition in Cyber-Physical-Social Systems. *IEEE Access*, 8:53215–53222, 2020.
- [51] Rustem Dautov, Salvatore Distefano, Dario Bruneo, Francesco Longo, Giovanni Merlino, and Antonio Puliafito. Data processing in cyber-physical-social systems through edge computing. *IEEE Access*, 6:29822–29835, 2018.
- [52] M Davoudpour, A Sadeghian, and H Rahnama. Synthesizing social context for making Internet of Things environments more immersive. In *2015 6th International Conference on the Network of the Future (NOF)*, pages 1–5, 2015.
- [53] Suparna De, Yuchao Zhou, Iker Larizgoitia Abad, and Klaus Moessner. Cyber–physical–social frameworks for urban big data systems: A survey. *Applied Sciences*, 7(10):1017, 2017.
- [54] Marco De Gemmis, Pasquale Lops, Cataldo Musto, Fedelucio Narducci, and Giovanni Semeraro. Semantics-aware content-based recommender systems. In *Recommender systems handbook*, pages 119–159. Springer, 2015.
- [55] Olivier L De Weck. Multiobjective optimization: History and promise. In *Invited Keynote Paper, GL2-2, The Third China-Japan-Korea Joint Symposium on Optimization of Structural and Mechanical Systems, Kanazawa, Japan*, volume 2, page 34, 2004.

-
- [56] Raymond Defay. Introduction à la thermodynamique des systèmes ouverts. *Bulletin de la Classe des sciences. Académie royale de Belgique*, 15(8-9):678–688, 1929.
- [57] María del Carmen Rodríguez-Hernández and Sergio Ilarri. Ai-based mobile context-aware recommender systems from an information management perspective: Progress and directions. *Knowledge-Based Systems*, 215:106740, 2021.
- [58] María del Carmen Rodríguez-Hernández, Sergio Ilarri, Ramón Hermoso, and Raque Trillo-Lado. Towards trajectory-based recommendations in museums: evaluation of strategies using mixed synthetic and real data. *Procedia computer science*, 113:234–239, 2017.
- [59] Flavia C Delicato, Adnan Al-Anbuky, and Kevin I-Kai Wang. Editorial: Smart Cyber-Physical Systems: Toward Pervasive Intelligence systems. *Future Generation Computer Systems*, 107:1134–1139, 2020.
- [60] Anind K Dey. Understanding and using context. *Personal and ubiquitous computing*, 5(1):4–7, 2001.
- [61] V Dimitrov and T Padir. A shared control architecture for human-in-the-loop robotics applications. In *The 23rd IEEE International Symposium on Robot and Human Interactive Communication*, pages 1089–1094, aug 2014.
- [62] Kai Ding and Pingyu Jiang. Incorporating social sensors, cyber-physical system nodes, and smart products for personalized production in a social manufacturing environment. *Proceedings of the institution of mechanical engineers part b-journal of engineering manufacture*, 232(13, SI):2323–2338, NOV 2018.
- [63] Toan Dinh, Thanh Nguyen, Hoang-Phuong Phan, Nam-Trung Nguyen, Dzung Viet Dao, and John Bell. Stretchable respiration sensors: Advanced designs and multifunctional platforms for wearable physiological monitoring. *Biosensors and Bioelectronics*, page 112460, 2020.
- [64] John S Dodgson, Michael Spackman, Alan Pearman, and Lawrence D Phillips. Multi-criteria analysis: a manual. 2009.
- [65] Raymond J Dolan. Emotion, cognition, and behavior. *science*, 298(5596):1191–1194, 2002.
- [66] Mohammadreza Doostmohammadian, Hamid R Rabiee, and Usman A Khan. Cyber-social systems: modeling, inference, and optimal design. *IEEE Systems Journal*, 14(1):73–83, 2019.
- [67] Afsaneh Doryab and Jakob E Bardram. Designing activity-aware recommender systems for operating rooms. In *Proceedings of the 2011 Workshop on Context-awareness in Retrieval and Recommendation*, pages 43–46, 2011.
- [68] Brian R. Duffy. Anthropomorphism and the social robot. *Robotics and Autonomous Systems*, 42(3):177 – 190, 2003. Socially Interactive Robots.
- [69] Pijush Dutta Pramanik, Saurabh Pal, and Prasenjit Choudhury. Beyond automation: The cognitive iot. *Artificial Intelligence Brings Sense to the Internet of Things. Springer International Publishing AG*, 10:978–3, 2018.

- [70] Timothy J Eddy, Gordon G Gallup Jr, and Daniel J Povinelli. Attribution of cognitive states to animals: anthropomorphism in comparative perspective. *Journal of Social issues*, 49(1):87–101, 1993.
- [71] Matthias Ehrgott. *Multicriteria optimization*, volume 491. Springer Science & Business Media, 2005.
- [72] Paola Fantini, Paulo Leitao, José Barbosa, and Marco Taisch. Symbiotic Integration of Human Activities in Cyber-Physical Systems. *IFAC-PapersOnLine*, 52(19):133–138, 2019.
- [73] Paola Fantini, Marta Pinzone, and Marco Taisch. Placing the operator at the centre of Industry 4.0 design: Modelling and assessing human activities within cyber-physical systems. *Computers and Industrial Engineering*, 139(February 2018):105058, feb 2020.
- [74] Jun Feng, Laurence T. Yang, Xingang Liu, and Ronghao Zhang. Privacy-preserving tensor analysis and processing models for wireless internet of things. *IEEE Wireless Communications*, 25(6):98–103, DEC 2018.
- [75] A Figueira, D Nunes, R Barbosa, A Reis, H Aguiar, S Sinche, A Rodrigues, V Pereira, H Dias, C Herrera, D Raposo, J S Silva, and F Boavida. WeDoCare: A humanitarian people-centric cyber-physical system for the benefit of refugees. In *2016 IEEE Global Humanitarian Technology Conference (GHTC)*, pages 213–219, oct 2016.
- [76] Johnathan Charles Flowers. Strong and weak ai: Deweyan considerations. In *AAAI Spring Symposium: Towards Conscious AI Systems*, 2019.
- [77] Kuniyiko Fukushima and Sei Miyake. Neocognitron: A self-organizing neural network model for a mechanism of visual pattern recognition. In *Competition and cooperation in neural nets*, pages 267–285. Springer, 1982.
- [78] C. Gan, Q. Feng, X. Zhang, Z. Zhang, and Q. Zhu. Dynamical Propagation Model of Malware for Cloud Computing Security. *IEEE Access*, 8:20325–20333, 2020.
- [79] Soumyajit Ganguly and Vikram Pudi. Paper2vec: Combining graph and text information for scientific paper representation. In *European Conference on Information Retrieval*, pages 383–395. Springer, 2017.
- [80] Raghu Ganti, Yu-En Tsai, and Tarek Abdelzaher. Senseworld: Towards cyber-physical social networks. pages 563–564, 04 2008.
- [81] Raghu K Ganti, Yu-En Tsai, and Tarek F Abdelzaher. Senseworld: Towards cyber-physical social networks. In *2008 International Conference on Information Processing in Sensor Networks (ipsn 2008)*, pages 563–564. IEEE, 2008.
- [82] Q. Gao, X. Shen, and W. Niu. Large-Scale Synthetic Urban Dataset for Aerial Scene Understanding. *IEEE Access*, 8:42131–42140, 2020.
- [83] Francesco Garibaldo and Emilio Rebecchi. Cyber-physical system, 2018.
- [84] Mohamad Gharib, Paolo Lollini, and Andrea Bondavalli. Towards an approach for analyzing trust in Cyber-Physical-Social Systems. *2017 12th System of Systems Engineering Conference, SoSE 2017*, pages 1–6, 2017.

-
- [85] Ikram Ghernaout, Linda Elmhadhbi, Maroua Masmoudi, Sidi Mohamed Meliani, Bernard Archimede, and Mohamed Hedi Karray. Towards a centric network-based cyber-physical social system for a digitalized mobile blood collection process. In *2020 IEEE/ACS 17th International Conference on Computer Systems and Applications (AICCSA)*, pages 1–6, 2020.
- [86] R Girau, E Ferrara, M Pintor, M Sole, and D Giusto. Be Right Beach: A Social IoT System for Sustainable Tourism Based on Beach Overcrowding Avoidance. In *2018 IEEE International Conference on Internet of Things (iThings) and IEEE Green Computing and Communications (GreenCom) and IEEE Cyber, Physical and Social Computing (CPSCom) and IEEE Smart Data (SmartData)*, pages 9–14, jul 2018.
- [87] Erving Goffman. *The Presentation of Self in Everyday Life Editorial Reviews*. Number 9780385094023. University of Edinburgh, Social Sciences Research Centre, Edinburgh, 1958.
- [88] David C. Gompert, Jeffrey A. Isaacson, Rand Corporation., and National Defense Research Institute (U.S.). *Planning a ballistic missile defense system of systems : an adaptive strategy / David C. Gompert and Jeffrey A. Isaacson*. RAND Santa Monica, Calif, 1999.
- [89] SongJie Gong, HongWu Ye, and HengSong Tan. Combining memory-based and model-based collaborative filtering in recommender system. In *2009 Pacific-Asia Conference on Circuits, Communications and Systems*, pages 690–693. IEEE, 2009.
- [90] Shawn Graham, Scott Weingart, and Ian Milligan. Getting started with topic modeling and mallet. Technical report, The Editorial Board of the Programming Historian, 2012.
- [91] Aditya Grover and Jure Leskovec. node2vec: Scalable feature learning for networks. In *Proceedings of the 22nd ACM SIGKDD international conference on Knowledge discovery and data mining*, pages 855–864, 2016.
- [92] Jayavardhana Gubbi, Rajkumar Buyya, Slaven Marusic, and Marimuthu Palaniswami. Internet of things (iot): A vision, architectural elements, and future directions. *Future generation computer systems*, 29(7):1645–1660, 2013.
- [93] Nyoman Gunantara. A review of multi-objective optimization: Methods and its applications. *Cogent Engineering*, 5(1):1502242, 2018.
- [94] Volkan Gunes, Steffen Peter, Tony Givargis, and Frank Vahid. A survey on concepts, applications, and challenges in cyber-physical systems. *KSII Transactions on Internet & Information Systems*, 8(12), 2014.
- [95] W Guo, Y Zhang, and L Li. The integration of CPS, CPSS, and ITS: A focus on data. *Tsinghua Science and Technology*, 20(4):327–335, 2015.
- [96] Robert H Guttman, Alexandros G Moukas, and Pattie Maes. Agent-mediated electronic commerce: A survey. *Knowledge engineering review*, 13(2):147–159, 1998.
- [97] Hamed Haggi, Meng Song, Wei Sun, et al. A review of smart grid restoration to enhance cyber-physical system resilience. In *2019 IEEE Innovative Smart Grid Technologies-Asia (ISGT Asia)*, pages 4008–4013. IEEE, 2019.

- [98] V Hahanov, S Chumachenko, E Litvinova, and A Hahanova. Cyber-physical social monitoring and governance for the state structures. In *2018 IEEE 9th International Conference on Dependable Systems, Services and Technologies (DESSERT)*, pages 123–129, may 2018.
- [99] Khalid Haruna, Maizatul Akmar Ismail, Suhendroyono Suhendroyono, Damiasih Damiasih, Adi Cilik Pierewan, Haruna Chiroma, and Tutut Herawan. Context-aware recommender system: A review of recent developmental process and future research direction. *Applied Sciences*, 7(12):1211, 2017.
- [100] Kaiming He, Xiangyu Zhang, Shaoqing Ren, and Jian Sun. Deep residual learning for image recognition. In *Proceedings of the IEEE conference on computer vision and pattern recognition*, pages 770–778, 2016.
- [101] Ruining He, Chen Fang, Zhaowen Wang, and Julian McAuley. Vista: a visually, socially, and temporally-aware model for artistic recommendation. In *Proceedings of the 10th ACM Conference on Recommender Systems*, pages 309–316, 2016.
- [102] Yassine Himeur, Abdullah Alsalemi, Ayman Al-Kababji, Faycal Bensaali, Abbes Amira, Christos Sardianos, George Dimitrakopoulos, and Iraklis Varlamis. A survey of recommender systems for energy efficiency in buildings: Principles, challenges and prospects. *Information Fusion*, 72:1–21, 2021.
- [103] I Horvath. Beyond advanced mechatronics: New design challenges of social-cyber-physical systems. In s.n., editor, *Proceedings of the 1" Workshop on "Mechatronic Design" Linz 2012*, pages 1–20. ACCM, 2012. geen ISBN; 1th Workshop on "Mechatronic Design", Linz, Austria ; Conference date: 30-11-2012 Through 30-11-2012.
- [104] Rong Hu and Pearl Pu. Acceptance issues of personality-based recommender systems. In *Proceedings of the Third ACM Conference on Recommender Systems, RecSys '09*, page 221–224, New York, NY, USA, 2009. Association for Computing Machinery.
- [105] Rong Hu and Pearl Pu. A study on user perception of personality-based recommender systems. In *International conference on user modeling, adaptation, and personalization*, pages 291–302. Springer, 2010.
- [106] Chao Huang, Jermaine Marshall, Dong Wang, and Mianxiong Dong. Towards Reliable Social Sensing in Cyber-Physical-Social Systems. In *2016 IEEE International Parallel and Distributed Processing Symposium Workshops (IPDPSW)*, pages 1796–1802, may 2016.
- [107] L. Huang, G. Zhang, and S. Yu. A Data Storage and Sharing Scheme for Cyber-Physical-Social Systems. *IEEE Access*, 8:31471–31480, 2020.
- [108] M Huang, W Liu, T Wang, Q Deng, A Liu, M Xie, M Ma, and G Zhang. A Game-Based Economic Model for Price Decision Making in Cyber-Physical-Social Systems. *IEEE Access*, 7:111559–111576, 2019.
- [109] Tim Hussein, Timm Linder, Werner Gaulke, and Jürgen Ziegler. Hybreed: A software framework for developing context-aware hybrid recommender systems. *User Modeling and User-Adapted Interaction*, 24(1-2):121–174, 2014.
- [110] William James, Frederick Burkhardt, Fredson Bowers, and Ignas K Skrupskelis. *The principles of psychology*, volume 1. Macmillan London, 1890.

-
- [111] Hamed Jelodar, Yongli Wang, Chi Yuan, Xia Feng, Xiahui Jiang, Yanchao Li, and Liang Zhao. Latent dirichlet allocation (lda) and topic modeling: models, applications, a survey. *Multimedia Tools and Applications*, 78(11):15169–15211, 2019.
- [112] Sabina Jeschke and T Meisen. Everything 4.0-drivers and challenges of cyber physical systems. *www.ima-zlw-ifu.rwth-aachen.de*, 2013.
- [113] L. Jiao, H. Yin, and Y. Wu. Dynamic Resource Allocation for Scalable Video Streaming in OFDMA Wireless Networks. *IEEE Access*, 8:33489–33499, 2020.
- [114] M Jirgl, Z Bradac, and P Fiedler. Human-in-the-loop issue in context of the cyber-physical systems. *IFAC-PapersOnLine*, 51(6):225–230, 2018.
- [115] Joonas Kannisto, Niko Makitalo, Timo Aaltonen, and Tommi Mikkonen. Programming model perspective on security and privacy of social cyber-physical systems. *Proceedings - 2016 IEEE International Conference on Mobile Services, MS 2016*, pages 87–94, 2016.
- [116] Jussi Karlgren. An algebra for recommendations: Using reader data as a basis for measuring document proximity, 1990.
- [117] Raghav Pavan Karumur, Tien T Nguyen, and Joseph A Konstan. Personality, user preferences and behavior in recommender systems. *Information Systems Frontiers*, 20(6):1241–1265, 2018.
- [118] Timo Kaukoranta, Jouni Smed, Harri Hakonen, and S Rabin. Understanding pattern recognition methods. *AI game programming wisdom*, 2:579–589, 2003.
- [119] John S Kennedy. *The new anthropomorphism*. Cambridge University Press, 1992.
- [120] Barbara Kitchenham. Procedures for performing systematic reviews. *Keele, UK, Keele University*, 33(2004):1–26, 2004.
- [121] Barbara Kitchenham, Rialette Pretorius, David Budgen, O. Pearl Brereton, Mark Turner, Mahmood Niazi, and Stephen Linkman. Systematic literature reviews in software engineering – a tertiary study. *Information and Software Technology*, 52(8):792 – 805, 2010.
- [122] Alexander C. Koenig and Robert Riener. The human in the loop. *Neurorehabilitation Technology, Second Edition*, pages 161–181, 2016.
- [123] C Kotronis, I Routis, A Tsadimas, M Nikolaidou, and D Anagnostopoulos. A Model-Based Approach for the Design of Cyber-Physical Human Systems Emphasizing Human Concerns. In *2019 IEEE International Congress on Internet of Things (ICIOT)*, pages 100–107, jul 2019.
- [124] Anis Koubâa and Björn Andersson. A vision of cyber-physical internet. In *8th International Workshop on Real-Time Networks*, pages –, 2009.
- [125] Sathish AP Kumar, Bharat Bhargava, Raimundo Macêdo, and Ganapathy Mani. Securing iot-based cyber-physical human systems against collaborative attacks. In *2017 IEEE International Congress on Internet of Things (ICIOT)*, pages 9–16. IEEE, 2017.
- [126] Edward A Lee. Cyber physical systems: Design challenges. In *2008 11th IEEE International Symposium on Object and Component-Oriented Real-Time Distributed Computing (ISORC)*, pages 363–369. IEEE, 2008.

- [127] H Lee and J Kwon. Survey and Analysis of Information Sharing in Social IoT. In *2015 8th International Conference on Disaster Recovery and Business Continuity (DRBC)*, pages 15–18, nov 2015.
- [128] SeoYoung Lee and Junho Choi. Enhancing user experience with conversational agent for movie recommendation: Effects of self-disclosure and reciprocity. *International Journal of Human-Computer Studies*, 103:95–105, 2017.
- [129] Jiewu Leng, Pingyu Jiang, Chao Liu, and Chuang Wang. Contextual self-organizing of manufacturing process for mass individualization: a cyber-physical-social system approach. *Enterprise Information Systems*, 0(0):1–26, 2018.
- [130] Justin J Levandoski, Mohamed Sarwat, Ahmed Eldawy, and Mohamed F Mokbel. Lars: A location-aware recommender system. In *2012 IEEE 28th international conference on data engineering*, pages 450–461. IEEE, 2012.
- [131] Mario Lezoche and Hervé Panetto. Cyber-physical systems, a new formal paradigm to model redundancy and resiliency. *Enterprise Information Systems*, pages 1–22, 2018.
- [132] Qingyong Li, Zhiping Shi, Huayan Zhang, Yunqiang Tan, Shengwei Ren, Peng Dai, and Weiyi Li. A cyber-enabled visual inspection system for rail corrugation. *Future Generation Computer Systems-The International Journal of eScience*, 79(1):374–382, FEB 2018.
- [133] Shancang Li, Shanshan Zhao, Yong Yuan, Qindong Sun, and Kewang Zhang. Dynamic Security Risk Evaluation via Hybrid Bayesian Risk Graph in Cyber-Physical Social Systems. *IEEE Transactions on Computational Social Systems*, 5(4):1133–1141, DEC 2018.
- [134] Wei Li, Zhiyun Lin, Hanyun Zhou, and Gangfeng Yan. Multi-objective optimization for cyber-physical-social systems: a case study of electric vehicles charging and discharging. *IEEE Access*, 7:76754–76767, 2019.
- [135] Xin Li, Mengyue Wang, and T-P Liang. A multi-theoretical kernel-based approach to social network-based recommendation. *Decision Support Systems*, 65:95–104, 2014.
- [136] Ting-Peng Liang, Hung-Jen Lai, and Yi-Cheng Ku. Personalized content recommendation and user satisfaction: Theoretical synthesis and empirical findings. *Journal of Management Information Systems*, 23(3):45–70, 2006.
- [137] Timothy P Lillicrap, Jonathan J Hunt, Alexander Pritzel, Nicolas Heess, Tom Erez, Yuval Tassa, David Silver, and Daan Wierstra. Continuous control with deep reinforcement learning. *arXiv preprint arXiv:1509.02971*, 2015.
- [138] Eran Litvak and Tsvi Kuflik. Enhancing cultural heritage outdoor experience with augmented-reality smart glasses. *Personal and Ubiquitous Computing*, pages 1–14, 2020.
- [139] Su Liu, Ye Chen, Hui Huang, Liang Xiao, and Xiaojun Hei. Towards smart educational recommendations with reinforcement learning in classroom. In *2018 IEEE International Conference on Teaching, Assessment, and Learning for Engineering (TALE)*, pages 1079–1084. IEEE, 2018.
- [140] Z. Liu, X. Yin, and Y. Hu. CPSS LR-DDoS Detection and Defense in Edge Computing Utilizing DCNN Q-Learning. *IEEE Access*, 8:42120–42130, 2020.

-
- [141] Zhiming Liu and Ji Wang. Human-cyber-physical systems: concepts, challenges, and research opportunities. *Frontiers of Information Technology & Electronic Engineering*, 21(11):1535–1553, 2020.
- [142] Zhong Liu, Dong-sheng Sheng Yang, Ding Wen, Wei-ming Ming Zhang, and Wenji Mao. Cyber-Physical-Social Systems for Command and Control. *IEEE Intelligent Systems*, 26(4):92–96, jul 2011.
- [143] Alfred J Lotka. *Elements of mathematical biology*. Dover Publications, 1956.
- [144] Xiong Luo, Zhijie He, Zhigang Zhao, Long Wang, Weiping Wang, Huansheng Ning, Jenq-Haur Wang, Wenbing Zhao, and Jun Zhang. Resource Allocation in the Cognitive Radio Network-Aided Internet of Things for the Cyber-Physical-Social System: An Efficient Jaya Algorithm. *SENSORS*, 18(11), NOV 2018.
- [145] Ioanna Lykourantzou, Angeliki Antoniou, Yannick Naudet, and Steven P Dow. Personality matters: Balancing for personality types leads to better outcomes for crowd teams. In *Proceedings of the 19th ACM Conference on Computer-Supported Cooperative Work & Social Computing*, pages 260–273, 2016.
- [146] Ioanna Lykourantzou, Xavier Claude, Yannick Naudet, Eric Tobias, Angeliki Antoniou, George Lepouras, and Costas Vassilakis. Improving museum visitors’ quality of experience through intelligent recommendations: A visiting style-based approach. In *Intelligent environments (workshops)*, pages 507–518, 2013.
- [147] Mark W. Maier. Architecting Principles for Systems-of-Systems. *INCOSE International Symposium*, 6(1):565–573, 1996.
- [148] Jean-Charles Marty and Thibault Carron. Observation of collaborative activities in a game-based learning platform. *IEEE Transactions on Learning Technologies*, 4(1):98–110, 2011.
- [149] Ralph Mayer. *The artist’s handbook of materials and techniques*. 1991.
- [150] Rishabh Mehrotra, James McInerney, Hugues Bouchard, Mounia Lalmas, and Fernando Diaz. Towards a fair marketplace: Counterfactual evaluation of the trade-off between relevance, fairness & satisfaction in recommendation systems. In *Proceedings of the 27th acm international conference on information and knowledge management*, pages 2243–2251, 2018.
- [151] Rishabh Mehrotra and Emine Yilmaz. Representative & informative query selection for learning to rank using submodular functions. In *Proceedings of the 38th international ACM sigir conference on research and development in information retrieval*, pages 545–554, 2015.
- [152] Subodh Mendhurwar and Rajhans Mishra. Integration of social and iot technologies: architectural framework for digital transformation and cyber security challenges. *Enterprise Information Systems*, pages 1–20, 2019.
- [153] Pablo Messina, Vicente Dominguez, Denis Parra, Christoph Trattner, and Alvaro Soto. Exploring content-based artwork recommendation with metadata and visual features. *arXiv preprint arXiv:1706.05786*, 2017.

- [154] V Miori and D Russo. Improving life quality for the elderly through the Social Internet of Things (SIoT). In *2017 Global Internet of Things Summit (GIoTS)*, pages 1–6, jun 2017.
- [155] S Misra, S Goswami, and C Taneja. Multivariate Data Fusion-Based Learning of Video Content and Service Distribution for Cyber Physical Social Systems. *IEEE Transactions on Computational Social Systems*, 3(1):1–12, mar 2016.
- [156] Volodymyr Mnih and Koray Kavukcuoglu. Methods and apparatus for reinforcement learning, June 13 2017. US Patent 9,679,258.
- [157] Volodymyr Mnih, Koray Kavukcuoglu, David Silver, Alex Graves, Ioannis Antonoglou, Daan Wierstra, and Martin Riedmiller. Playing atari with deep reinforcement learning. *arXiv preprint arXiv:1312.5602*, 2013.
- [158] Gérard Morel, Hervé Panetto, Frédérique Mayer, and Jean-Philippe Auzelle. System of enterprise-systems integration issues: an engineering perspective. *IFAC Proceedings Volumes*, 10 2007.
- [159] Ruihui Mu. A survey of recommender systems based on deep learning. *Ieee Access*, 6:69009–69022, 2018.
- [160] Debnath Mukherjee, Snehasis Banerjee, Siddharth Bhattacharya, and Prateep Misra. Method and system for context-aware recommendation, November 29 2016. US Patent 9,510,050.
- [161] Sirajum Munir, John A. Stankovic, Chieh-Jan Mike Liang, and Shan Lin. Cyber physical system challenges for human-in-the-loop control. In *8th International Workshop on Feedback Computing (Feedback Computing 13)*, pages 363–369, San Jose, CA, June 2013. USENIX Association.
- [162] KJ Murakami. Cpss (cyber-physical-social system initiative-beyond cps (cyber-physical system) for a better future-” keynote speech. *JEC-ECC 2012*, 2012.
- [163] Tadahiko Murata, Hisao Ishibuchi, and Hideo Tanaka. Multi-objective genetic algorithm and its applications to flowshop scheduling. *Computers & industrial engineering*, 30(4):957–968, 1996.
- [164] Clifford Nass and Youngme Moon. Machines and mindlessness: Social responses to computers. *Journal of social issues*, 56(1):81–103, 2000.
- [165] Yannick Naudet, Thibaud Latour, Wided Guedria, and David Chen. Towards a systemic formalisation of interoperability. *Computers in Industry*, 61(2):176–185, 2010.
- [166] Yannick Naudet, Bereket Abera Yilma, and Hervé Panetto. Personalisation in Cyber Physical and Social Systems: The Case of Recommendations in Cultural Heritage Spaces. In *Proceedings - 13th International Workshop on Semantic and Social Media Adaptation and Personalization, SMAP 2018*, pages 75–79, 2018.
- [167] David Newman, Jey Han Lau, Karl Grieser, and Timothy Baldwin. Automatic evaluation of topic coherence. In *Human language technologies: The 2010 annual conference of the North American chapter of the association for computational linguistics*, pages 100–108. Association for Computational Linguistics, 2010.

-
- [168] Patrick Ng. dna2vec: Consistent vector representations of variable-length k-mers. *arXiv preprint arXiv:1701.06279*, 2017.
- [169] T Nguyen. A modelling simulation based engineering approach for socio-cyber-physical systems. In *2017 IEEE 14th International Conference on Networking, Sensing and Control (ICNSC)*, pages 702–707, may 2017.
- [170] Thanh Thi Nguyen, Ngoc Duy Nguyen, and Saeid Nahavandi. Deep reinforcement learning for multiagent systems: A review of challenges, solutions, and applications. *IEEE transactions on cybernetics*, 2020.
- [171] Tien T Nguyen, F Maxwell Harper, Loren Terveen, and Joseph A Konstan. User personality and user satisfaction with recommender systems. *Information Systems Frontiers*, 20(6):1173–1189, 2018.
- [172] Huansheng Ning, Hong Liu, Jianhua Ma, Laurence T. Yang, and Runhe Huang. Cybermatics: Cyber–physical–social–thinking hyperspace based science and technology. *Future Generation Computer Systems*, 56:504 – 522, 2016.
- [173] Louis Nisiotis, Lyuba Alboul, and Martin Beer. A prototype that fuses virtual reality, robots, and social networks to create a new cyber–physical–social eco-society system for cultural heritage. *Sustainability*, 12(2):645, 2020.
- [174] Donald A. Norman. *The Design of Everyday Things*. Basic Books, New York, first edition, 1988.
- [175] Donald A. Norman. The design of everyday things. *Choice Reviews Online*, 51(10):51–5559–51–5559, 2014.
- [176] David Nunes, Jorge S Silva, and Fernando Boavida. *A Practical Introduction to Human-in-the-Loop Cyber-Physical Systems*. Wiley-IEEE Press, 1st edition, 2018.
- [177] David Sousa Nunes, Pei Zhang, and Jorge Sá Silva. A survey on human-in-the-loop applications towards an internet of all. *IEEE Communications Surveys & Tutorials*, 17(2):944–965, 2015.
- [178] Maria Augusta S.N. Nunes and Rong Hu. Personality-based recommender systems: An overview. In *Proceedings of the Sixth ACM Conference on Recommender Systems, RecSys ’12*, page 5–6, New York, NY, USA, 2012. Association for Computing Machinery.
- [179] OMG. Business Process Model and Notation (BPMN), Version 2.0, January 2011.
- [180] Andrew Ortony, Donald A Norman, and William Revelle. Effective functioning: A three level model of affect, motivation, cognition, and behavior. *Who needs emotions*, pages 173–202, 2005.
- [181] Pierre-Edouard Osche, Sylvain Castagnos, Amedeo Napoli, and Yannick Naudet. Walk the line: Toward an efficient user model for recommendations in museums. In *2016 11th International Workshop on Semantic and Social Media Adaptation and Personalization (SMAP)*, pages 83–88. IEEE, 2016.
- [182] A Y . Ou, Yu Jiang, P Wu, L Sha, and R B Berlin. Using human intellectual tasks as guidelines to systematically model medical cyber-physical systems. In *2016 IEEE International Conference on Systems, Man, and Cybernetics (SMC)*, pages 4394–4399, oct 2016.

- [183] Søren Overgaard and John Michael. The interactive turn in social cognition research: A critique. *Philosophical Psychology*, 28(2):160–183, 2015.
- [184] William A Owens. *The emerging US system-of-systems*. National Defense University, Institute for National Strategic Studies, 1996.
- [185] Chung-Ming Own. For the pet care appliance of location aware infrastructure on cyber physical system. *International Journal of Distributed Sensor Networks*, 8(6):421259, 2012.
- [186] Jaak Panksepp. *Affective neuroscience: The foundations of human and animal emotions*. Oxford university press, 2004.
- [187] K. Peng, X. Qian, B. Zhao, K. Zhang, and Y. Liu. A New Cloudlet Placement Method Based on Affinity Propagation for Cyber-Physical-Social Systems in Wireless Metropolitan Area Networks. *IEEE Access*, 8:34313–34325, 2020.
- [188] Y. Peng, Y. Song, W. Huang, H. Deng, Y. Wang, Q. Chen, M. Liao, and J. Hua. Self-Layer and Cross-Layer Bilinear Aggregation for Fine-Grained Recognition in Cyber-Physical-Social Systems. *IEEE Access*, 8:55826–55833, 2020.
- [189] Margherita Peruzzini, Fabio Grandi, and Marcello Pellicciari. Exploring the potential of operator 4.0 interface and monitoring. *Computers& Industrial Engineering*, page 105600, 2018.
- [190] Pearl Pu, Li Chen, and Rong Hu. A user-centric evaluation framework for recommender systems. In *Proceedings of the fifth ACM conference on Recommender systems*, pages 157–164, 2011.
- [191] Shinjee Pyo, Eunhui Kim, et al. Lda-based unified topic modeling for similar tv user grouping and tv program recommendation. *IEEE transactions on cybernetics*, 45(8):1476–1490, 2014.
- [192] Joao Quintas, Paulo Menezes, and Jorge Dias. Information model and architecture specification for context awareness interaction decision support in cyber-physical human–machine systems. *IEEE Transactions on Human-Machine Systems*, 47(3):323–331, 2016.
- [193] K Rabadiya, A Makwana, and S Jardosh. Revolution in networks of smart objects: Social Internet of Things. In *2017 International Conference on Soft Computing and its Engineering Applications (icSoftComp)*, pages 1–8, dec 2017.
- [194] H Ramadhan, D Oktaria, and I G B B Nugraha. Road traffic signal control using cyber physical social system. In *2017 International Conference on Information Technology Systems and Innovation (ICITSI)*, pages 223–227, oct 2017.
- [195] Victoriano Ramos Linares, José Antonio Piqueras Rodríguez, Agustín Ernesto Martínez González, and Luis Armando Oblitas Guadalupe. Emoción y cognición: Implicaciones para el tratamiento. *Terapia psicológica*, 27(2):227–237, 2009.
- [196] Shaina Raza and Chen Ding. Progress in context-aware recommender systems—an overview. *Computer Science Review*, 31:84–97, 2019.
- [197] Byron Reeves and Clifford Nass. *The media equation: How people treat computers, television, and new media like real people*. Cambridge university press Cambridge, UK, 1996.

-
- [198] Paul Resnick and Hal R Varian. Recommender systems. *Communications of the ACM*, 40(3):56–58, 1997.
- [199] David Romero, Johan Stahre, and Marco Taisch. The Operator 4.0: Towards socially sustainable factories of the future. *Computers & Industrial Engineering*, 139(November 2019):106128, 2020.
- [200] Marcelo Romero, Wided Guédria, Hervé Panetto, and Béatrix Barafort. Towards a characterisation of smart systems: A systematic literature review. *Computers in Industry*, 120:103224, 2020.
- [201] Heechang Ryu, Hayong Shin, and Jinkyoo Park. Multi-agent actor-critic with hierarchical graph attention network. In *Proceedings of the AAAI Conference on Artificial Intelligence*, volume 34, pages 7236–7243, 2020.
- [202] Imen Ben Sassi, Sehl Mellouli, and Sadok Ben Yahia. Context-aware recommender systems in mobile environment: On the road of future research. *Information Systems*, 72:27–61, 2017.
- [203] Susan L Scheiberg. Emotions on display: The personal decoration of work space. *American Behavioral Scientist*, 33(3):330–338, 1990.
- [204] Andrew I Schein, Alexandrin Popescul, Lyle H Ungar, and David M Pennock. Methods and metrics for cold-start recommendations. In *Proceedings of the 25th annual international ACM SIGIR conference on Research and development in information retrieval*, pages 253–260, 2002.
- [205] C Scheuermann, B Bruegge, J Folmer, and S Verclas. Incident Localization and Assistance System: A case study of a Cyber-Physical Human System. In *2015 IEEE/CIC International Conference on Communications in China - Workshops (CIC/ICCC)*, pages 57–61, nov 2015.
- [206] Gunar Schirner, Deniz Erdogmus, Kaushik Chowdhury, and Taskin Padir. The future of human-in-the-loop cyber-physical systems. *Computer*, 46(1):36–45, 2013.
- [207] Roger Schrodinger, Erwin Schrödinger, and Erwin Schr Dinger. *What is life?: With mind and matter and autobiographical sketches*. Cambridge University Press, 1944.
- [208] Thomas Serre, Lior Wolf, and Tomaso Poggio. Object recognition with features inspired by visual cortex. In *2005 IEEE Computer Society Conference on Computer Vision and Pattern Recognition (CVPR'05)*, volume 2, pages 994–1000. Ieee, 2005.
- [209] Claude Elwood Shannon. *The Mathematical Theory of Communication*. By CE Shannon and Warren Weaver. Urbana, 1949.
- [210] R Sharpe, K van Lopik, A Neal, P Goodall, P P Conway, and A A West. An industrial evaluation of an Industry 4.0 reference architecture demonstrating the need for the inclusion of security and human components. *Computers in Industry*, 108:37–44, 2019.
- [211] F. Shen, C. Xu, and J. Zhang. Statistical Behavior Guided Block Allocation in Hybrid Cache-Based Edge Computing for Cyber-Physical-Social Systems. *IEEE Access*, 8:29055–29063, 2020.

- [212] A Sheth. Physical-Cyber-Social Computing: An Early 21st Century Approach to Computing for Human Experience. *IEEE Internet Computing*, 14(1):88–91, 2010.
- [213] Ben Shneiderman. 7, 1 a nonanthropomorphic style guide: overcoming the humpty dumpty syndrome. *Sparks of innovation in human-computer interaction (1993)*, 331, 1993.
- [214] David Silver, Aja Huang, Chris J Maddison, Arthur Guez, Laurent Sifre, George Van Den Driessche, Julian Schrittwieser, Ioannis Antonoglou, Veda Panneershelvam, Marc Lanctot, et al. Mastering the game of go with deep neural networks and tree search. *nature*, 529(7587):484–489, 2016.
- [215] David Silver, Julian Schrittwieser, Karen Simonyan, Ioannis Antonoglou, Aja Huang, Arthur Guez, Thomas Hubert, Lucas Baker, Matthew Lai, Adrian Bolton, et al. Mastering the game of go without human knowledge. *nature*, 550(7676):354–359, 2017.
- [216] R E N Sisyanto, Suhardi, and N B Kurniawan. Hydroponic smart farming using cyber physical social system with telegram messenger. In *2017 International Conference on Information Technology Systems and Innovation (ICITSI)*, pages 239–245. Institute of Electrical and Electronics Engineers Inc., oct 2017.
- [217] Robert Eko Noegroho Sisyanto, Novianto Budi Kurniawan, et al. Hydroponic smart farming using cyber physical social system with telegram messenger. In *2017 International Conference on Information Technology Systems and Innovation (ICITSI)*, pages 239–245. IEEE, 2017.
- [218] Paul Smart, Aastha Madaan, and Wendy Hall. Where the smart things are: social machines and the Internet of Things. *Phenomenology and the Cognitive Sciences*, 18(3):551–575, jul 2019.
- [219] A. Smirnov, A. Kashevnik, N. Shilov, A. Makklya, and O. Gusikhin. Context-aware service composition in cyber physical human system for transportation safety. In *2013 13th International Conference on ITS Telecommunications (ITST)*, pages 139–144, Nov 2013.
- [220] Alexander Smirnov, Alexey Kashevnik, and Nikolay Shilov. Cyber-physical-social system self-organization: ontology-based multi-level approach and case study. In *2015 IEEE 9th International Conference on Self-Adaptive and Self-Organizing Systems*, pages 168–169. IEEE, 2015.
- [221] Alexander Smirnov, Tatiana Levashova, Nikolay Shilov, and Kurt Sandkuhl. Ontology for cyber-physical-social systems self-organisation. In *Conference of Open Innovation Association, FRUCT*, volume 2014-Decem, pages 101–107, 2014.
- [222] Alexander Smirnov, Nikolay Shilov, and Oleg Gusikhin. Cyber-physical-human system for connected car-based e-tourism : Approach and case study scenario. *2017 IEEE Conference on Cognitive and Computational Aspects of Situation Management, CogSIMA 2017*, pages 1–7, 2017.
- [223] Y. Song, Y. Zhu, J. Hou, S. Du, and S. Song. Astronomical data preprocessing implementation based on FPGA and data transformation strategy for the FAST telescope as a giant CPS. *IEEE Access*, 8:56837–56846, 2020.

-
- [224] Sulayman K. Sowe, Eric Simmon, Koji Zettsu, Frederic De Vault, and Irena Bojanova. Cyber-Physical-Human Systems: Putting People in the Loop. *IT Professional*, 18(1):10–13, jan 2016.
- [225] Sulayman K. Sowe, Eric Simmon, Koji Zettsu, Frederic De Vault, and Irena Bojanova. Cyber-Physical-Human Systems: Putting People in the Loop. *IT Professional*, 18(1):10–13, jan 2016.
- [226] John A. Stankovic. Research Directions for Cyber Physical Systems in Wireless and Mobile Healthcare. *ACM Transactions on Cyber-Physical Systems*, 1(1):1–12, 2016.
- [227] Susan Stepney, Ada Diaconescu, René Doursat, Jean-Louis Giavitto, Taras Kowaliw, Ottoline Leyser, Bruce MacLennan, Olivier Michel, Julian Miller, Igor Nikolic, et al. Gardening cyber-physical systems. In *Unconventionnal Computation and Natural Computation (UCNC’2012)*, pages 1–1, 2012.
- [228] Z Su, Q Qi, Q Xu, S Guo, and X Wang. Incentive Scheme for Cyber Physical Social Systems Based on User Behaviors. *IEEE Transactions on Emerging Topics in Computing*, page 1, 2017.
- [229] Zhou Su, Qifan Qi, Qichao Xu, Song Guo, and Xiaowei Wang. Incentive scheme for cyber physical social systems based on user behaviors. *IEEE Transactions on Emerging Topics in Computing*, 2017.
- [230] Richard S Sutton, Andrew G Barto, et al. *Introduction to reinforcement learning*, volume 135. MIT press Cambridge, 1998.
- [231] Pinchas Tamir and Anat Zohar. Anthropomorphism and teleology in reasoning about biological phenomena. *Science Education*, 75(1):57–67, 1991.
- [232] Huynh Thanh-Tai, Huu-Hoa Nguyen, and Nguyen Thai-Nghe. A semantic approach in recommender systems. In *International Conference on Future Data and Security Engineering*, pages 331–343. Springer, 2016.
- [233] Marko Tkalcic and Li Chen. Personality and recommender systems. In *Recommender systems handbook*, pages 715–739. Springer, 2015.
- [234] Eirini Eleni Tsiropoulou, George Kousis, Athina Thanou, Ioanna Lykourentzou, and Symeon Papavassiliou. Quality of experience in cyber-physical social systems based on reinforcement learning and game theory. *Future Internet*, 10(11):108, 2018.
- [235] Eirini Eleni Tsiropoulou, Athina Thanou, and Symeon Papavassiliou. Modelling museum visitors’ quality of experience. In *2016 11th International Workshop on Semantic and Social Media Adaptation and Personalization (SMAP)*, pages 77–82. IEEE, 2016.
- [236] Eirini Eleni Tsiropoulou, Athina Thanou, and Symeon Papavassiliou. Quality of experience-based museum touring: A human in the loop approach. *Social Network Analysis and Mining*, 7(1):33, 2017.
- [237] Kyriakos D Tsoukalas, George P Kontoudis, and Kyriakos G Vamvoudakis. Active-bayesian learning for cooperation connectivity in dynamic cyber-physical-human systems. In *2017 IEEE Symposium Series on Computational Intelligence (SSCI)*, pages 1–7. IEEE, 2017.

- [238] Jonathan H. Turner. *A theory of social interaction*. Stanford University Press, 1988.
- [239] Subroto Budhi Utomo and Bayu Hendradjaya. Usability testing and evaluation of smart culinary system based on cyber-physical-social system. In *2017 International Conference on Information Technology Systems and Innovation (ICITSI)*, pages 219–222. IEEE, 2017.
- [240] Nees Van Eck and Ludo Waltman. Software survey: Vosviewer, a computer program for bibliometric mapping. *scientometrics*, 84(2):523–538, 2010.
- [241] Katrien Verbert, Denis Parra, Peter Brusilovsky, and Erik Duval. Visualizing recommendations to support exploration, transparency and controllability. In *Proceedings of the 2013 international conference on Intelligent user interfaces*, pages 351–362, 2013.
- [242] Eliséo Véron and Martine Levasseur. *Ethnographie de l'exposition: l'espace, le corps et le sens*. Bibliothèque publique d'information du Centre Pompidou, 1989.
- [243] Norha M Villegas, Cristian Sánchez, Javier Díaz-Cely, and Gabriel Tamura. Characterizing context-aware recommender systems: A systematic literature review. *Knowledge-Based Systems*, 140:173–200, 2018.
- [244] Ludwig Von Bertalanffy. General theory of systems: Application to psychology. *Social Science Information*, 6(6):125–136, 1967.
- [245] Ludwig Von Bertalanffy. The history and status of general systems theory. *Academy of management journal*, 15(4):407–426, 1972.
- [246] F. Wang. The emergence of intelligent enterprises: From cps to cpss. *IEEE Intelligent Systems*, 25(4):85–88, July 2010.
- [247] Fei-Yue Wang. The emergence of intelligent enterprises: From cps to cpss. *IEEE Intelligent Systems*, 25(4):85–88, 2010.
- [248] Fei-Yue Wang and Jun Jason Zhang. Transportation 5.0 in cpss: Towards acp-based society-centered intelligent transportation. In *2017 IEEE 20th International Conference on Intelligent Transportation Systems (ITSC)*, pages 762–767. IEEE, 2017.
- [249] Huihui Wang and Xingguo Chen. A fast alternating direction method of multipliers algorithm for big data applications. *IEEE Access*, 8:20607–20615, 2020.
- [250] Jing Wang, Zhiyuan Yan, Kuan Ching K.-C. Kuan Ching K.-C. Li, Hongmei Xie, and Xiangyang Liu. Local Codes with Cooperative Repair in Distributed Storage of Cyber-Physical-Social Systems. *IEEE Access*, 8:38622–38632, 2020.
- [251] Puming Wang, Laurence T. Yang, and Jintao Li. An Edge Cloud-Assisted CPSS Framework for Smart Cities. *IEEE Cloud Computing*, 5(5):37–46, Sep-Oct 2018.
- [252] Puming Wang, Laurence T Yang, Jintao Li, Jinjun Chen, and Shangqing Hu. Data fusion in cyber-physical-social systems: State-of-the-art and perspectives. *Information Fusion*, 51:42–57, 2019.
- [253] S Wang, A Zhou, M Yang, L Sun, C Hsu, and F. yang. Service Composition in Cyber-Physical-Social Systems. *IEEE Transactions on Emerging Topics in Computing*, page 1, 2017.

-
- [254] Shangguang Wang, Yan Guo, Yan Li, and C.-H. Ching-Hsien Hsu. Cultural distance for service composition in cyber-physical-social systems. *Future Generation Computer Systems*, 2018.
- [255] X Wang, W Wang, L T Yang, S Liao, D Yin, and M J Deen. A Distributed HOSVD Method With Its Incremental Computation for Big Data in Cyber-Physical-Social Systems. *IEEE Transactions on Computational Social Systems*, 5(2):481–492, jun 2018.
- [256] Xiao Wang, Lingxi Li, Yong Yuan, Peijun Ye, and Fei-Yue Wang. ACP-based social computing and parallel intelligence: Societies 5.0 and beyond. *CAAI Transactions on Intelligence Technology*, 1(4):377–393, 2016.
- [257] Xiaokang Wang, Laurence T. Yang, Yihao Wang, Xingang Liu, Qingxia Zhang, and M. Jamal Deen. A Distributed Tensor-Train Decomposition Method for Cyber-Physical-Social Services. *ACM Transactions on Cyber-Physical Systems*, 3(4):1–15, 2019.
- [258] Xinxi Wang and Ye Wang. Improving content-based and hybrid music recommendation using deep learning. In *Proceedings of the 22nd ACM international conference on Multimedia*, pages 627–636, 2014.
- [259] Christopher JCH Watkins and Peter Dayan. Q-learning. *Machine learning*, 8(3-4):279–292, 1992.
- [260] Max Weber. *Economy and society an outline of interpretive sociology*. Bedminster Press, New York, 1968.
- [261] Claes Wohlin. Guidelines for snowballing in systematic literature studies and a replication in software engineering. In *Proceedings of the 18th international conference on evaluation and assessment in software engineering*, pages 1–10, 2014.
- [262] Po-Liang Wu, Dhashrath Raguraman, Lui Sha, Richard B Berlin, and Julian M Goldman. A treatment validation protocol for cyber-physical-human medical systems. In *2014 40th EUROMICRO Conference on Software Engineering and Advanced Applications*, pages 183–190. IEEE, 2014.
- [263] B. Xin and Y. Wang. Stability and Hopf Bifurcation of a Stochastic Cournot Duopoly Game in a Blockchain Cloud Services Market Driven by Brownian Motion. *IEEE Access*, 8:41432–41438, 2020.
- [264] G Xiong, F Zhu, X Liu, X Dong, W Huang, S Chen, and K Zhao. Cyber-physical-social system in intelligent transportation. *IEEE/CAA Journal of Automatica Sinica*, 2(3):320–333, 2015.
- [265] Jiachen Xu, Anfeng Liu, Naixue Xiong, Tian Wang, and Zhengbang Zuo. Integrated collaborative filtering recommendation in social cyber-physical systems. *International Journal of Distributed Sensor Networks*, 13(12), 2017.
- [266] L. Xu, J. Han, T. Wang, and L. Bai. An Efficient CNN to Realize Speckle Correlation Imaging Based on Cloud-Edge for Cyber-Physical-Social-System. *IEEE Access*, 8:54154–54163, 2020.
- [267] Yusheng Xue and Xinghuo Yu. Beyond Smart Grid-A Cyber-Physical-Social System in Energy Future. *Proceedings of the IEEE*, 105(12):2290–2292, DEC 2017.

- [268] Xifan Yao and Yingzi Lin. Emerging manufacturing paradigm shifts for the incoming industrial revolution. *International Journal of Advanced Manufacturing Technology*, 85(5-8):1665–1676, jul 2016.
- [269] Bereket Abera Yilma, Najib Aghenda, Marcelo Romero, Yannick Naudet, and Hervé Panetto. Personalised visual art recommendation by learning latent semantic representations. In *2020 15th International Workshop on Semantic and Social Media Adaptation and Personalization (SMA)*, pages 1–6, 2020.
- [270] Bereket Abera Yilma, Yannick Naudet, and Hervé Panetto. Introduction to personalisation in cyber-physical-social systems. In *OTM Confederated International Conferences "On the Move to Meaningful Internet Systems"*, pages 25–35. Springer, 2018.
- [271] Bereket Abera Yilma, Yannick Naudet, and Hervé Panetto. Introduction to personalisation in cyber-physical-social systems. In *Lecture Notes in Computer Science (including subseries Lecture Notes in Artificial Intelligence and Lecture Notes in Bioinformatics)*, volume 11231 LNCS, pages 25–35. Springer Verlag, oct 2019.
- [272] Bereket Abera Yilma, Yannick Naudet, and Hervé Panetto. A new paradigm and meta-model for cyber-physical-social systems. In *21st IFAC World Congress, IFAC 2020*. Elsevier, 2020.
- [273] Bereket Abera Yilma, Hervé Panetto, and Yannick Naudet. A Meta-Model of Cyber-Physical-Social System: The CPSS Paradigm to Support Human-Machine Collaboration in Industry 4.0. In *IFIP Advances in Information and Communication Technology*, volume 568, pages 11–20. Springer New York LLC, sep 2019.
- [274] Bereket Abera Yilma, Hervé Panetto, and Yannick Naudet. A meta-model of cyber-physical-social system: The cpss paradigm to support human-machine collaboration in industry 4.0. In *Working Conference on Virtual Enterprises*, pages 11–20. Springer, 2019.
- [275] Bereket Abera Yilma, Hervé Panetto, and Yannick Naudet. Systemic formalisation of cyber-physical-social system (cpss): A systematic literature review. *Computers in Industry*, 129:103458, 2021.
- [276] Bereket Abera Yilma, Hervé Panetto, and Yannick Naudet. Towards a personalisation framework for cyber-physical-social system (cpss). *arXiv preprint arXiv:2103.15781*, 2021.
- [277] Zhiwen Yu, Xingshe Zhou, Daqing Zhang, Chung-Yau Chin, Xiaohang Wang, and Ji Men. Supporting context-aware media recommendations for smart phones. *IEEE Pervasive Computing*, 5(3):68–75, 2006.
- [278] J Zeng, L T Yang, and J Ma. A system-level modeling and design for cyber-physical-social systems. *ACM Transactions on Embedded Computing Systems*, 15(2), 2016.
- [279] Zhihong Zeng, Maja Pantic, Glenn I Roisman, and Thomas S Huang. A survey of affect recognition methods: Audio, visual, and spontaneous expressions. *IEEE transactions on pattern analysis and machine intelligence*, 31(1):39–58, 2008.
- [280] Hongwei Zhang, Chuan Li, Yu Chen, Pengfei Ren, and Ling Wang. Predictable wireless networking for real-time cyber-physical-human systems. In *2017 IEEE/ACM Second International Conference on Internet-of-Things Design and Implementation (IoTDI)*, pages 319–320. IEEE, 2017.

-
- [281] Jun Jason Zhang, Fei-Yue Wang, Xiao Wang, Gang Xiong, Fenghua Zhu, Yisheng Lv, Jiachen Hou, Shuangshuang Han, Yong Yuan, Qingchun Lu, et al. Cyber-physical-social systems: The state of the art and perspectives. *IEEE Transactions on Computational Social Systems*, 5(3):829–840, 2018.
- [282] Mingchuan Zhang, Haixia Zhao, Ruijuan Zheng, Qingtao Wu, and Wangyang Wei. Cognitive internet of things: concepts and application example. *International Journal of Computer Science Issues (IJCSI)*, 9(6):151, 2012.
- [283] Shuai Zhang, Lina Yao, Aixin Sun, and Yi Tay. Deep learning based recommender system: A survey and new perspectives. *ACM Computing Surveys (CSUR)*, 52(1):1–38, 2019.
- [284] W. Zhang, X. Chen, Y. Liu, and Q. Xi. A Distributed Storage and Computation k-Nearest Neighbor Algorithm Based Cloud-Edge Computing for Cyber-Physical-Social Systems. *IEEE Access*, 8:50118–50130, 2020.
- [285] Yongfeng Zhang and Xu Chen. Explainable recommendation: A survey and new perspectives. *arXiv preprint arXiv:1804.11192*, 2018.
- [286] Feng Zhao, Yajun Zhu, Hai Jin, and Laurence T Yang. A personalized hashtag recommendation approach using lda-based topic model in microblog environment. *Future Generation Computer Systems*, 65:196–206, 2016.
- [287] Fangming Zhong, Guangze Wang, Zhikui Chen, Feng Xia, and Geyong Min. Cross-modal retrieval for CPSS data. *IEEE Access*, 8:16689–16701, 2020.
- [288] J Zhou, X Yao, and J Zhang. Big Data in Wisdom Manufacturing for Industry 4.0. In *2017 5th International Conference on Enterprise Systems (ES)*, pages 107–112, 2017.
- [289] Ji Zhou, Peigen Li, Yanhong Zhou, Baicun Wang, Jiyuan Zang, and Liu Meng. Toward new-generation intelligent manufacturing. *Engineering*, 4(1):11–20, 2018.
- [290] Ji Zhou, Yanhong Zhou, Baicun Wang, and Jiyuan Zang. Human–cyber–physical systems (hcpss) in the context of new-generation intelligent manufacturing. *Engineering*, 5(4):624 – 636, 2019.
- [291] Xiaokang Zhou, Guangquan Xu, Jianhua Ma, and Ivan Ruchkin. Scalable platforms and advanced algorithms for IoT and cyber-enabled applications. *Journal of parallel and distributed computing*, 118(1):1–4, AUG 2018.
- [292] Y Zhu, Y Tan, R Li, and X Luo. Cyber-Physical-Social-Thinking Modeling and Computing for Geological Information Service System. In *2015 International Conference on Identification, Information, and Knowledge in the Internet of Things (IIKI)*, pages 193–196, oct 2015.
- [293] Yueqin Zhu, Yongjie Tan, Ruixin Li, and Xiong Luo. Cyber-physical-social-thinking modeling and computing for geological information service system. *International Journal of Distributed Sensor Networks*, 12(11):1550147716666666, nov 2016.
- [294] Z. Zhu, Y. Wen, Z. Zhang, Z. Yan, S. Huang, and X. Xu. Accurate position estimation of mobile robot based on cyber-physical-social systems (CPSS). *IEEE Access*, 8:56359–56370, 2020.

- [295] Iveta Zolotová, Peter Papcun, Erik Kajáti, Martin Miškuf, and Jozef Mocnej. Smart and cognitive solutions for Operator 4.0: Laboratory H-CPPS case studies. *Computers & Industrial Engineering*, 139(October 2018):105471, 2020.

Appendix A

System Theory

System theory emerged as a result of several decades of work by scientists, philosophers and mathematicians in an effort to come up with an exact theory that unifies the many branches of the scientific enterprise [43]. These efforts were aimed at providing a powerful framework to understand both natural and human constructed world. The concept of system theory finds its origin from Aristotle's descriptive-metaphysical approach to characterise the world. He expressed the basic tenet of system theory as "*The whole is more than the sum of the parts.*" This was later replaced by Galileo's mathematical conception of the world paving the way for modern scientific methods analysing complex phenomena into elementary particles and processes [245, 43]. In the domains of engineering, natural and social sciences modern efforts to develop a unified theory competent enough to characterise complex systems can be traced to the early 1920s [143, 43]. The principles of *Lotka* in 1920 to describe complex biological phenomena, the works of *Defay* in 1929 and *Schrodinger* in 1944 utilising thermodynamics principles to explore biological systems and the seminal works of *Weaver and Shannon* in 1949 are among the prominent efforts to develop a unified system theory[143, 56, 207, 209]. In the year 1955 Ludwig Bertalanffy published a comprehensive theory based on basic ideas he developed in the 1930s which marked the foundation of General System Theory(GST) [244, 245]. Since then, GST has been advocated by many researchers for its comprehensive vision. The philosophical foundation of GST resides in the notion of "seeing things whole" and "seeing the world as an interconnected, interdependent field continuous with itself." GST constitutes three basic elements namely *Mathematical system theory, System technology and System philosophy* which served to reconcile competing traditions of system theory. and provide a fully articulated world view. Thus, it played a pivotal role to provide an intellectual framework capable of unifying the various domains of empirical understanding [245, 43]. Similar principles of GST were used to explain different kinds of complex modern systems such as organisations, business systems and various computational platforms.

Appendix B

Latent Dirichlet Allocation (LDA)

In Recommender systems, data representation techniques play a great role as they have the power to entangle, hide and reveal explanatory factors embedded within datasets. Hence, they influence the quality of recommendations. The earliest works in Information Retrieval (IR) and Natural language processing (NLP) have been using vector space models to represent documents as a vector of key words [24]. However, such representations offered very limited reduction of description length and had a limited ability to capture inter/intra-document structures. To this end further techniques have been developed to tackle the curse of dimensionality by capturing hidden semantic structures in document modeling. In 2003 an unsupervised generative probabilistic model called Latent Dirichlet Allocation (LDA) was proposed [25]. LDA demonstrated superiority over the other models used at that time. Following this Latent variable models became widely accepted strategies to make inference about hidden semantic relationship between variables. Particularly in the domain of Recommendation Systems, LDA has been applied on several tasks such as online courses recommendation [17], personalized hashtag recommendation [286], scientific paper recommendation [14], similar TV user grouping and TV program recommendation [191]. LDA has been proven to be successful over several recommendation tasks. Hence, in our work we utilised LDA to exploit hidden semantic similarities for the task of recommendation in the first case study.

In "LDA" the meaning of each word defines the concept as follows. *Latent* refers to everything that we don't know a priori and are hidden in the data. *Dirichlet* is the distribution of topics in documents and distribution of words in the topic. In other words it is a 'distribution of distributions'. *Allocation* means that once we have Dirichlet, we will allocate topics to the documents and words of the document to topics. The intuition behind LDA is that documents are represented as random mixtures over latent topics, where each topic is characterised by a distribution over words.

The LDA model is represented as a probabilistic graphical model in Figure B.1. α is the per-document topic distribution, β is the per-topic word distribution, θ is the topic distribution for a document d , φ is the word distribution for the topic K and z the topic for the n^{th} word in the document d and finally, W is a word. In LDA, each topic is a Multinomial distribution over the vocabulary in the collection of documents. To represent a topic, only the top- n words are considered based on their probability.

The procedure of building LDA model is explained as follows:

- Pre-processing: we construct a collection of documents that contain detailed textual description.

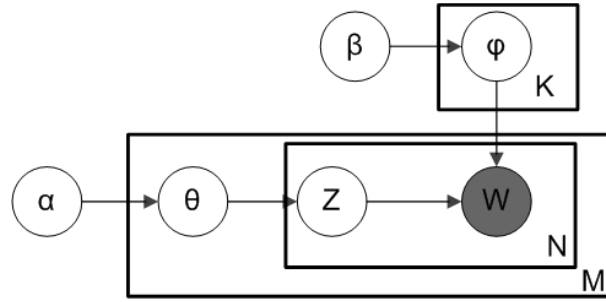

Figure B.1: Latent Dirichlet Allocation plate diagram

- Initialization:

1. We assume there is a defined number of topics k in the collection of documents
2. Attribute a topic to each word W in the collection of documents where $\theta_i \sim Dir(\alpha)$ with $i \in \{1, \dots, M\}$ and $Dir(\alpha)$ is a Dirichlet distribution. This initializes a topic model.

- Learning:

1. We assume that the topic assigned to a word W is wrong but that all the others are correct which consists in computing the conditional probabilities $p(\text{topic } t \mid \text{document } d)$ (probability that the document d is assigned to the topic t) and $p(\text{word } w \mid \text{topic } t)$ (probability that the topic t is assigned to the word w)
2. We update the topic of the document which is now the topic that has the highest probability to be assigned to this document ($p(\text{topic } t \mid \text{document } d) \cdot p(\text{word } w \mid \text{topic } t)$)

Once the LDA model is trained over the entire corpus we get a matrix of documents by topics which expresses latent topic distribution of each document. This can be leveraged to compute semantic similarities for a recommendation task.

Appendix C

Types of Recommender System

C.1 Content-Based Recommender Systems

The main idea of content based (CB) recommendation is utilising the contents of items and finding the similarities among them. These type of recommender systems try to match users to items that are similar to what they have liked in the past. This similarity is not necessarily based on rating correlations across users but on the basis of the attributes of the objects liked by the user. After analyzing sufficient numbers of items that one user has already shown favor to, the user interests profile is established. Then the RS could search the database and choose proper items according to this profile [159]. The main challenge of these type of recommender systems is identifying preference of users merely based on contents (attributes of the objects) of items.

C.2 Collaborative Filtering Recommender Systems

Collaborative filtering (CF) approaches are one of the most influential recommendation algorithms in many web services. This type of recommendation is based on the assumption that users who have rated the same items with similar ratings are likely to have similar preferences (like-minded users). Generally the underlying assumption is that if a person A has the same opinion as a person B on an issue, A is more likely to have B's opinion on a different issue than that of a randomly chosen person [30]. CF methods can be classified into two categories Memory-Based and Model-Based [89] depending on the type of implementation. Memory-based method directly assess the database to make recommendations, while model-based method uses the transaction data to create a model that can generate recommendation [27]. By accessing directly to database, memory-based method is adaptive to data changes, but requires large computational time according to the data size. As for model-based method, it has a constant computing time regardless the size of the data but not adaptive to data changes [4].

CF approaches often suffer from three problems: *cold start*, *scalability*, and *sparsity* [204].

- **Cold start:** For a new user or item, there isn't enough data to make accurate recommendations.
- **Scalability:** In many of the environments in which these systems make recommendations, there are millions of users and products. Thus, a large amount of computation power is often necessary to calculate recommendations.

- **Sparsity:** The number of items sold on major e-commerce sites is extremely large. The most active users will only have rated a small subset of the overall database. Thus, even the most popular items have very few ratings.

Figure C.1 illustrates a comparison of CB and CF recommendation strategies. [Source]¹⁴.

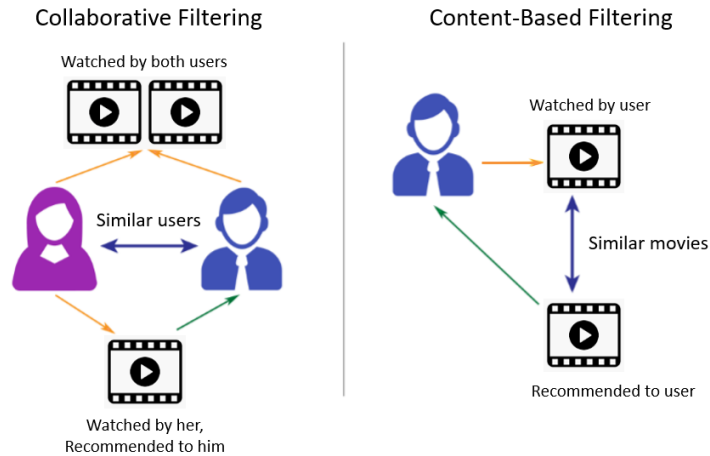

Figure C.1: Content based filtering vs Collaborative filtering

C.3 Hybrid Recommender Systems

Hybrid recommender systems are used either to leverage the power of multiple data sources or to improve the performance of existing recommender systems within a particular data modality [135]. hybrid recommender systems are divided into three categories (monolithic hybrid recommendation, parallel hybrid recommendation, and pipeline hybrid recommendation) [33]. Monolithic hybrid recommendation is a hybrid recommendation method that integrates several recommendation strategies into one algorithm [109]. The remaining two hybrid recommendations require at least two different recommendation methods and then combine them. According to the input, the parallel hybrid recommendation operates independently of each other, respectively generating a recommendation list, and then the output data is combined into the final recommendation set. The pipeline hybrid recommendation connects multiple recommender systems in pipelined architecture, with the output of the previous recommender system becoming the input portion of the latter recommender system. Of course, the latter recommendation unit can also choose to use part of the original input data. An important motivation for the construction of hybrid recommender systems is that different types of recommender systems, such as collaborative filtering-based, content-based methods, have different strengths and weaknesses. Some recommender systems work more effectively at cold start, whereas other work more effectively when sufficient data are available [160].

C.4 Evolution of Recommender systems

Although classical RSs are applied in many real systems there are several problems that need to be addressed; such as cold-start problem (when there is no information available about new users

¹⁴<https://www.kdnuggets.com/2019/11/content-based-recommender-using-natural-language-processing-nlp.html>

or new items), data sparsity problem, and especially data scarcity problem since in some cases users are not willing to provide their opinions on items. To this regard different approaches have been proposed to mitigate such challenges and boost the performance of traditional recommender systems. Semantic technologies are among the recently explored domains in this field. For instance, in [232] a semantic model was developed for recommender systems, especially to alleviate the sparsity and scarcity problems. Furthermore in recent years the revolutionary advances of Deep learning in speech recognition, image analysis, and natural language processing has become a hotspot research topics in artificial intelligence and has been applied to recommender system. Recent research works show that the application of deep learning techniques in recommender systems were able to effectively capture the non-linear and non-trivial user-item relationships and enables the codification of more complex abstractions as data representations [42, 258].

Due to the wide spectrum of application ares and the increasing diversity and complexity of services several approaches for modern RSs have been developed. we provide a list of the main ones that exist in modern RS research.

- Neighborhood-Based Collaborative Filtering [10]
- Model-Based Collaborative Filtering[9]
- Knowledge-Based Recommender Systems[8]
- Ensemble-Based and Hybrid Recommender Systems[7]
- Context-aware Recommender Systems [5]
- Social and Trust-Centric Recommender Systems[11]
- Attack-Resistant Recommender Systems[6]
- Semantic based Recommender Systems [54]
- Deeplearning based Recommender Systems[283]

Appendix D

Multi-Objective Optimisation

As discussed in the general introduction the personalisation task in CPSS context is of a multi-objective optimisation nature as it tries to satisfy multiple goals in parallel. Hence, in this section we present a brief introduction of multi-objective optimisation.

Multi-objective optimisation (MOO) refers to finding the optimal solution values of more than one desired goals. Mathematically, the equations of the MOO problem can be written as follows (*Ehrgott* [71]):

$$\min/\max \quad f_1(x), f_2(x), \dots, f_n(x); x \in U \tag{D.1}$$

where x is solution, n is the number of objective functions, U is feasible set, $f_n(x)$ is n^{th} objective function, and \min/\max is combined object operations. In the MOO, there is a multi-dimensional space of the objective function vector and the decision variable space of the solution vector. In every x solution in the decision variable space there is a point on the objective function space.

In general resolution methods for MOO methods can be broadly decomposed into two categories namely Scalarization approaches and Pareto approaches [55, 93]. In the following we explain the two resolution methods.

D.1 Pareto method

The Pareto method is used if the desired solutions and performance indicators are separate and produce a compromise solution (tradeoff) and can be displayed in the form of Pareto optimal front (POF). The Pareto method typically uses the concept of dominance to distinguish between inferior and non-inferior solutions. Mathematically, the MOO problem using the Pareto method can be written as follows:

$$\begin{aligned} f_{1,opt} &= \min f_1(x) \\ f_{2,opt} &= \min f_2(x) \\ &\cdot \\ &\cdot \\ &\cdot \\ f_{n,opt} &= \min f_n(x) \end{aligned} \tag{D.2}$$

The Pareto method keeps the elements of the solution vectors separate (independent) during optimisation and the concept of dominance is there to differentiate the dominated and non-dominated solutions. The dominance solution and optimal value in MOO are usually achieved when one objective function cannot increase without reducing the other objective function. This condition is called Pareto optimality. The set of optimal solutions in MOO is called Pareto optimal solution.

D.2 Scalarization method

In Scalarization method the multi-objective problem is solved by translating it back to a single (or a series of) single objective, scalar problems. This requires the formation of an overarching objective function which contains contributions from the sub-objectives. The formation of the aggregate objective function requires that the preferences or weights between objectives are assigned a priori, *i.e.* before the results of the optimisation process are known.

The scalarization method incorporates multi-objective functions into scalar fitness function as in the following equation (*Murata et al.* [163]):

$$F(x) = w_1f_1(x) + w_2f_2(x) + \dots w_nf_n(x) \quad (\text{D.3})$$

The weight of an objective function will determine the solution of the fitness function and show the performance priority (*Dodgson et al.* [64]). This entails that the larger the weight given to an objective the higher its priority. This approach in particular is useful for a multi-stakeholder aware personalisation task as priorities of objectives are predefined according to the context.

Appendix E

Explainability of recommendations by the painting LDA model

In figure E.1 we present two paintings¹⁵. The painting in (E.1.b) is the most similar painting to the painting (E.1.a) based on our LDA topic model. We observe in figure E.1.c and E.1.d that their topic distribution is very similar and one particular topic stands out; topic 8. The fact that this topic stands out from the others for these paintings implies that the words found in this topic are more likely to be found in the paintings descriptions than the words from the other topics.

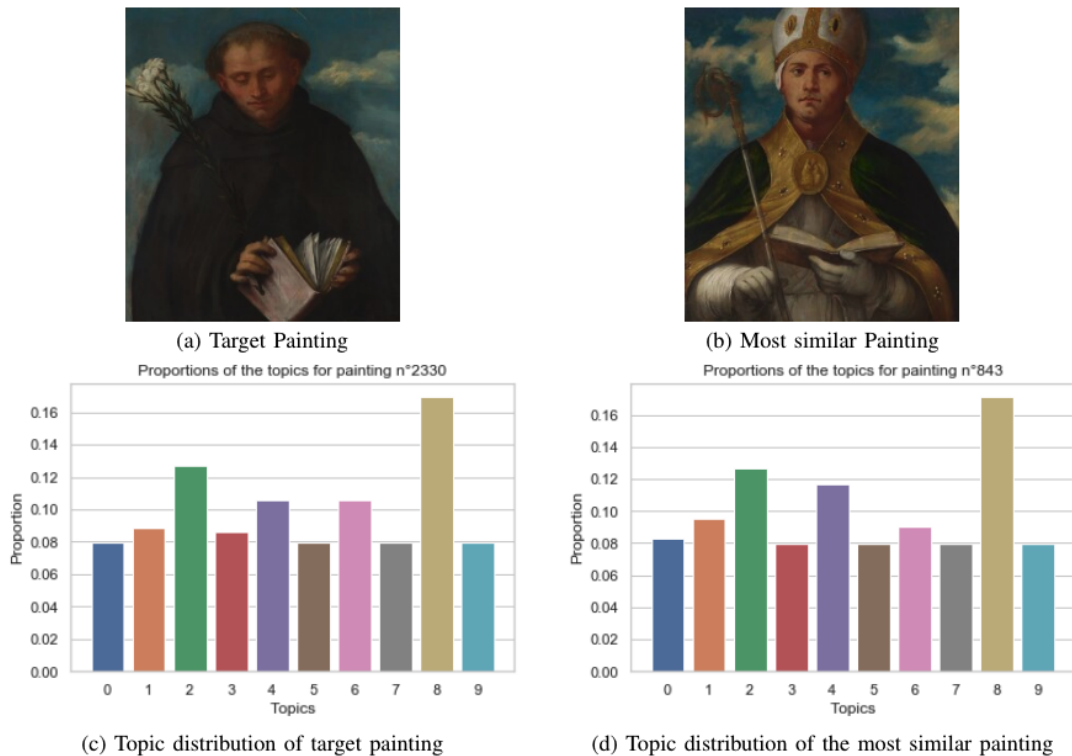

Figure E.1: Explainability of recommendations by LDA

¹⁵These paintings are available under Creative Commons License

Topic 0	Topic 5	Topic 8
LANDSCAPE	PARIS	CHRIST
SCENE	LIGHT	SAINT
VIEW	FORM	ALTARPIECE
17th C LANDSCAPE	COLOUR	PANEL
PEASANT	SKETCH	JESUS
DUTCH	STUDIO	NEW TESTAMENT
LANDSCAPE OIL	FLOWER	EVANGELIST
TREE	COMPOSITION	CROSS
TOWN	STUDY	CHURCH
RIVER	19th CENTURY LANDSCAPE	CRUCIFICATION

Table E.1: Description of three topics

When we have a closer look at the topics descriptions in Table E.1, we can see that the topic 8 is very well defined as it is obvious that there is a coherence between the words that are used. In fact, topic 8 can be described as the "*christian*" topic since many of the words in this topic are usually found in christian corpora. When we look at the paintings, it is obvious that there are many references to Christianity and therefore, we can assume that their descriptions contain vocabulary that refers to a religious context. On the other hand, when we look at the descriptions of topics 0 and 5, what is interesting is that the words found in these topics do not seem to share the same semantic at first sight. However, the underlying intuition behind LDA is that words are in the same topics because they are *frequently* found together and therefore, they are used in a same context. Thus, words "Paris" and "flower" found in the topic 5 that do not seem to have any obvious relation are nonetheless in the same topic because many paintings descriptions in our data set describe Paris and flowers together. LDA is able to find relations between words and at a broader extent, paintings that are not always obvious to us but explainable. Therefore for the task of recommendation using LDA we can easily identify prominent topics and reason out shared semantics among recommendations in order to help users better understand recommendations. In our experiment we offered explanations to users as a word cloud of prominent concepts (i.e. topics extracted with LDA) shared among the recommendations matching their personal preferences. Fig. E.2 is an example of interest word cloud.



Figure E.2: Example of interest word cloud

Appendix F

Reinforcement Learning

Reinforcement learning (RL) is a type of machine learning technique that enables an agent to learn in an interactive environment by trial and error using feedback from its own actions and experiences. It formalises the idea that rewarding or punishing an agent for its behaviour makes it more likely to repeat or forego that behaviour in the future. The main characters of RL are the agent and the environment. The environment is the world that the agent lives in and interacts with. At every step of interaction, the agent sees a (possibly partial) observation of the state of the world, and then decides on an action to take. The environment changes when the agent acts on it, but may also change on its own. The agent also perceives a reward signal from the environment, a number that tells it how good or bad the current world state is. The goal of the agent is to maximise its cumulative reward.

A basic RL problem can be formulated using the following key concepts

- **Environment:** Physical world in which the agent operates.
- **State:** Current situation of the agent.
- **Reward:** Feedback from the environment.
- **Policy:** Method to map agent's state to actions.
- **Value:** Future reward that an agent would receive by taking an action in a particular state.

Figure F.1 illustrates the schematics of the different components in classical RL.

RL is an actively evolving research field and different variations of RL algorithms are continuously being developed. Hence, It is quite hard to draw an accurate and all-encompassing taxonomy of algorithms in the modern RL space. In figure F.2 we present a non-exhaustive, but useful taxonomy of algorithms in modern RL as defined by OpenAI ¹⁶.

In general there are two major classes of RL algorithms namely model based and model free.

- **Model Based:** In Model-Based RL, the agent has access to a model of the environment. It uses transition function and the reward function in order to estimate the optimal policy.

¹⁶<https://spinningup.openai.com>

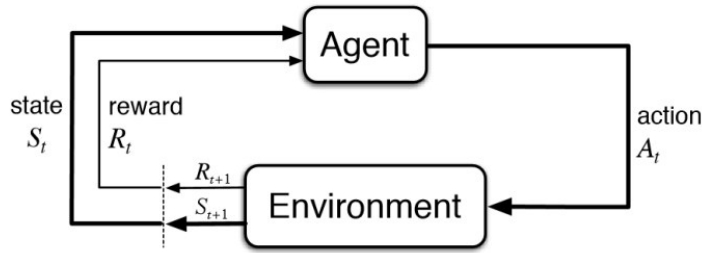

Figure F.1: Reinforcement Learning(Sutton et al. [230])

- **Model Free:** In Model-Free RL, the agent does not have access to a model of the environment. (*i.e.* a function which predicts state transition and rewards) instead it learns a policy directly using algorithms like Q-learning or policy gradient.

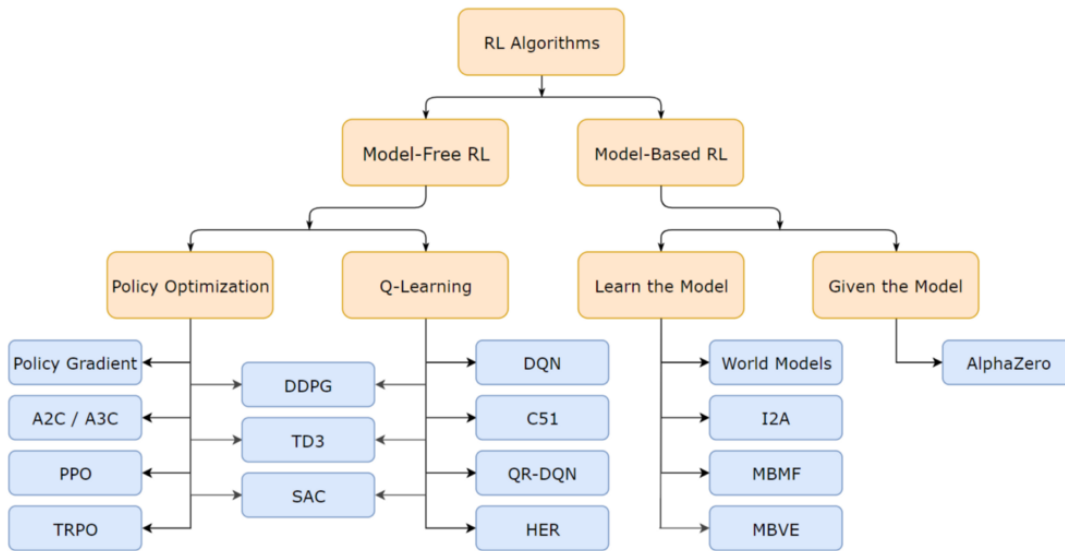

Figure F.2: Reinforcement Learning taxonomy

The advances made in the landscape of RL algorithms have recently enjoyed a wide variety of successes. Recently a novel artificial agent called deep Q-network (DQN) was proposed in the work of *Mnih et al. 2017*[156] resorting neural networks. DQN can learn successful policies directly from high-dimensional sensory inputs using end-to-end reinforcement learning. It has been tested over various complicated tasks and was able to surpass the performance of all previous algorithms [214, 215]. It has also enabled the creation of “AlphaGO”; which is to date considered as one of the greatest breakthroughs in artificial intelligence that was able to beat the world’s most diligent and deeply intelligent human brains [44]. This and other recent successes such as “AlphaStar” [19] demonstrate the potential of DQN, to build intelligent agents by giving them the freedom to learn by exploring their environment. Inspired by this works we resort DQN along with the RL formulation [259, 230] for the task of adaptation in our second case study. DQN is a branch of Q-learning which is a class of model free RL algorithms. In the following we present a brief introduction on Q-learning and Deep Q-learning.

F.1 Q-learning

Q-learning is a model-free RL algorithm to learn the value of an action in a particular state. The mind of the agent in Q-learning is a table called *Q-table* with the rows as the state or observation of the agent from the environment and the columns as the actions to take. Each of the cells of the table will be filled with a value called *Q-value* which is the value that an action brings considering the state it is in. The central idea of Q-learning is that the Q-table guides the agent to take the best action which has the highest Q-value. A Q-table is initialised to zeros. Then, at each time t the agent selects an action a_t , observes a reward r_t , enters a new state s_{t+1} (that may depend on both the previous state s_t and the selected action). Q-values are then updated using the bellman equation as a simple value iteration update.

Source: <https://en.wikipedia.org/wiki/Q-learning>

$$Q^{new}(s_t, a_t) \leftarrow (1 - \alpha) \cdot \underbrace{Q(s_t, a_t)}_{\text{old value}} + \underbrace{\alpha}_{\text{learning rate}} \cdot \left(\underbrace{r_t}_{\text{reward}} + \underbrace{\gamma}_{\text{discount factor}} \cdot \underbrace{\max_a Q(s_{t+1}, a)}_{\text{estimate of optimal future value}} \right)$$

learned value

Figure F.3: Q-table update

Q-Table		Actions				
		Action 1	Action 2	...	Action n-1	Action n
States	State 1	0.789112	0.745642	...	0.212485	0.256545
	State 2	5.123455	5.11565	...	5.156545	4.155612

	State n-1	2.156454	2.15567	...	2.144423	2.454658
	State n	6.156212	6.154556	...	6.145441	6.444444

Figure F.4: An example of Q-table

F.2 Deep Q-Learning (DQN)

Q-learning is a simple yet quite powerful algorithm. However, the amount of memory required to save and update that table would increase as the number of states increases and the amount of time required to explore each state to create the required Q-table would be unrealistic. To this end the idea of using a neural network to approximate Q-values was proposed [157] which led to Deep Q-learning (DQN). In DQN the state is given as the input and the Q-value of all possible actions is generated as the output. The only difference between Q-learning and DQN is the agent's brain. The agent's brain in Q-learning is the Q-table, but in DQN the agent's brain is a deep neural network. Figure F.5 illustrates the schematic of Deep reinforcement learning.

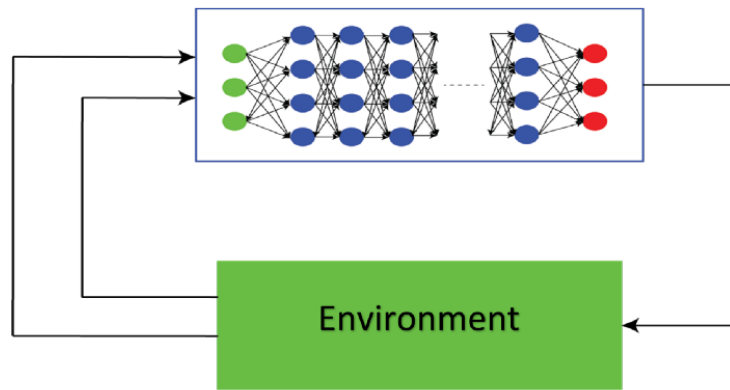

Figure F.5: Deep reinforcement learning

Abstract

The notion of Cyber-Physical-Social system (CPSS) is an emerging concept developed as a result of the need to understand the impact of Cyber-Physical Systems (CPS) on humans and vice versa. The concept of CPSS has been around for over a decade now, and it has gained increasing attention over the past few years. Nevertheless, its conceptualisation has always been use-case dependent and there is no generic view as most works focus on specific domains of application. Despite the notion that CPSS is still in its infancy, the evolution to incorporate human aspects in the CPS research has unlocked many research challenges. CPSS environments are often regarded as physical and virtual places of interaction that humans and sensor-enabled smart devices cohabit. Thus, the social aspect is tightly coined with the presence of a human in the vicinity of the so-called smart devices either serving as a source of information or consuming a service. The prominent aim of this paradigm shift is to ultimately ensure a seamless human-machine interaction experience. Hence, the newly introduced social part largely resides in how machines perceive and respond to humans' interaction responses. This constitutes complex emotional, cognitive and behavioural facets. However, none of the existing works provides a comprehensive representation of such aspects. It is also evident that the evolution towards a more and more pervasiveness of technology is gradually increasing the complexity of CPSS environments. Especially since the rationale behind the CPSS paradigm is to bring humans to the centre of the interaction experience, system designs should carefully address various aspects of social dynamics. Nevertheless, ensuring a seamless experience in such a context is not a trivial task. Particularly because it is often a subjective experience that is largely influenced by individual preferences, interests, needs and capabilities varying from one person to another. This plays a crucial role in determining users' quality of experience. Additionally, the actions and behaviours of people within a CPSS are also reflections of their unique personalities shaped over time through personal experiences, knowledge, and different environmental factors that are not yet fully understood. Therefore, recognising personal preferences, interests, limitations and opportunities of individuals become one of the necessities to ensure a seamless interaction within a CPSS. This positions the notion of personalisation at the heart of the CPSS paradigm. In this context the objective of the thesis is primary to provide a theoretical contribution in formalising the concept of CPSS, thereby establishing a domain-independent understanding of the paradigm. Subsequently, to propose a novel personalisation approach in the context of CPSS by taking into account the overall systemic complexities which is not the case of current approaches. Finally to evaluate the proposed approach in selected case studies.

Keywords: Cyber-Physical-Social System, Cyber-Physical System, Systematic Literature Review, System-of-Systems, Meta-model, Personalisation, Recommendation, Adaptation.

Personnalisation dans les systèmes Cyber-Sociaux Physiques

La notion de système cyber-physique (CPS) a été initialement dérivée d'une perspective d'ingénierie avec le soutien de la National Science Foundation (NSF) des États-Unis [124, 94]. L'objectif d'un CPS contrôlait et surveillait principalement les environnements et phénomènes physiques via le l'intégration de dispositifs de détection, de calcul et d'actionnement. Parallèlement, la notion d'Internet de Things (IoT) qui trouve son origine à la fin des années 1990 a décollé avec le soutien de l'Union européenne Commission, comme paradigme dans la perspective de l'informatique [92]. L'émergence de l'IoT a joué un rôle essentiel pour l'orchestration des systèmes physiques et cyber avec le objectif de connecter des outils et des équipements électroniques à Internet et de développer un réseau de ordinateurs et objets. Malgré leur différence philosophique initiale, l'IoT et le CPS partagent de nombreux similitudes par conséquent, ils ont été utilisés parfois de manière interchangeable sans une démarcation clairement définie [112].

Il y a cependant une différence fondamentale qu'il convient de souligner : le fait qu'un CPS se réfère explicitement à un type particulier de systèmes, tandis que l'IoT se réfère en même temps à le concept, le système formé par tous les objets connectés et un système particulier d'objets interconnectés. En tant que système, un CPS collecte et contrôle généralement des informations sur les phénomènes du monde physique à travers des réseaux de dispositifs interconnectés, afin d'atteindre son objectif [126]. Dans le développement des deux paradigmes, les humains étaient à l'origine supposés comme externes entités interagissant avec ces systèmes.

Au fil des ans, la popularité croissante des appareils intelligents et leur rôle important dans le la vie quotidienne de leurs utilisateurs a conduit les systèmes basés sur CPS à considérer les humains comme des sources à multiples facettes d'informations (c'est-à-dire des capteurs humains)[253, 229]. Des études de recherche ultérieures ont alors commencé à incorporer les humains dans la recherche CPS. Cette tendance en particulier a révélé l'importance de la centralité des humains pour le développement du CPS qui a ensuite été reconnu par le paradigme Humanin-the-Loop (HitL) CPS [177, 224, 161], où les humains sont des acteurs intrinsèques de la système. Suite à cela, différents chercheurs ont

préconisé l'ajout d'une composante sociale comme une proposition logique d'intégrer formellement les aspects humains dans le domaine des CPS. Dans la dernière décennie, différents chercheurs ont utilisé différentes terminologies pour désigner l'intégration de l'humain dans le CPS projetant différentes conceptualisations dans divers domaines. De plus, le besoin de comprendre l'impact du CPS sur les humains et vice versa a progressivement ouvert la voie à la fondation d'un nouveau paradigme : le Système Cyber-Physique-Social (CPSS)[246, 81]. Même si la notion de CPSS a été adoptée par de nombreux chercheurs, il n'existe pas de définition unifiée et compréhension commune du concept. De plus, le sens exact et la portée de la partie diffère selon les travaux actuels et les domaines d'application.

En particulier, le rationnel du changement de paradigme du CPS au CPSS peut être considéré comme un des moyens de rendre les interactions avec les appareils CPS plus anthropomorphes grâce à l'ajout de une composante sociale. Par conséquent, la partie « sociale » a un sens plus large lié à des aspects émotionnels, cognitifs et comportementaux. Ceux-ci sont considérés comme les trois couches de l'homme

réponses d'interaction [174, 175, 189, 83]. Bien que nous nous concentrons sur l'interaction homme-CPS, il est à noter que les interactions CPS peuvent également être avec des entités non humaines. Par exemple CPS pour les soins aux animaux [185], CPS pour les cultures et le jardinage[227], etc. spectre complet de l'aspect social dans CPSS signifie essentiellement modifier la conception des machines inspiré des traits sociaux qui permet à CPS de détecter, de raisonner et de s'adapter aux différents besoins de les entités en interaction.

Néanmoins, aujourd'hui, les conceptualisations communément adoptées du CPSS ne parviennent pas à saisir de telles.

caractéristiques de la dimension sociale. Dans la littérature, la partie sociale est simplement associée à la présence humaine à proximité du CPS. Par exemple, dans les travaux de Ganti et al. [81] le social une partie résume seulement le fait que les humains étaient considérés comme des sources d'information. Sur le d'autre part, les ouvrages marquants de [212, 37, 152] caractérisent l'aspect social par les activités de Utilisateurs liés sur les réseaux sociaux à l'aide de CPS. Il est également évident que l'évolution vers une l'ubiquité de la technologie augmente progressivement la complexité des environnements CPSS [281, 53]. Dans un CPSS, les personnes interagissent entre elles ainsi qu'avec différents types d'appareils et des robots qui

offrent une variété de services. D'autant plus que le but ultime du CPSS paradigme dans un tel contexte est de mettre l'humain au centre de l'interaction, les conceptions des systèmes devrait soigneusement aborder divers aspects de la dynamique sociale, y compris les aspects émotionnels, cognitifs et comportemental [266, 268, 270]. Cependant, assurer une interaction transparente dans un tel contexte n'est pas une tâche triviale. D'autant plus qu'il s'agit souvent d'une expérience subjective largement influencée par les préférences individuelles, les intérêts, les besoins et les capacités variant d'une personne à l'autre [104, 178]. Cela joue un rôle crucial dans la détermination de la qualité de l'expérience utilisateur [171, 233, 104, 178].

De plus, les actions et les comportements des personnes au sein d'un CPSS sont également le reflet de leurs personnalités uniques qui se forment au fil du temps à travers des expériences personnelles, des connaissances et divers facteurs environnementaux qui ne sont pas encore entièrement compris [117, 105, 171, 166]. Par conséquent, reconnaître les préférences personnelles, les intérêts ainsi que les limites et les opportunités à mesure que le handicap, les connaissances et les compétences des individus deviennent l'une des nécessités pour assurer expérience homogène au sein d'un CPSS. Cela place la notion de personnalisation au cœur du paradigme CPSS, si l'on considère que les interactions, notamment entre CPS et entités, doivent être adaptées à chaque individu humain et donc personnalisées. Dans le cadre de de cette thèse, nous argumentons et montrons enfin que l'introduction de la personnalisation dans Le CPSS ouvre des opportunités pour mieux intégrer des aspects sociaux moins reconnus et améliorer expérience utilisateur.

La personnalisation en elle-même est un domaine de recherche relativement plus ancien remontant à la fin des années 1990. Thé la notion de personnalisation, qui est largement connue sous le nom de personnalisation, fait référence à l'adaptation d'un service ou un produit d'une manière qui correspond aux préférences, à la cognition, aux besoins ou aux capacités d'individus spécifiques dans un contexte donné [116]. Au fil des années, les avancées technologiques dans les applications Web, en ligne marketing et un lien étroit entre les humains et les appareils intelligents a révolutionné le besoin de prestations personnalisées. Les assistants virtuels sur des appareils tels que Alexa, Siri et Cortana, les chatbots, les recommandations en ligne pour le commerce électronique et le divertissement sont parmi les domaines populaires où la personnalisation virtuelle a pris de l'ampleur. Contrairement au cas de la personnalisation

virtuelle, dans un contexte CPSS, les personnes évoluent dans un espace physique avec d'autres personnes et dispositifs, chacun ayant son propre objectif. Cela ajoute plus de propriétés et de variables dynamiques à considérer [270]. L'espace physique en lui-même a un but donné, appelant à des comportements des personnes à l'intérieur. Cependant, les gens ne sont pas toujours tolérants à suivre les règles si ils ne sont pas alignés sur leurs préférences. Par conséquent, la complexité du comportement humain ainsi avec les objectifs multiples des entités coexistantes et les facteurs environnementaux rendent la tâche de personnalisation en CPSS assez complexe. Nous avons également observé qu'il n'existe toujours pas de données fiables approches pour modéliser harmonieusement toute la complexité de la partie sociale avec le cyber et physique [274, 275]. Ainsi, afin de bénéficier au CPSS en termes de personnalisation et en termes de prendre conscience des aspects sociaux, il est nécessaire d'adopter des approches efficaces s'attaquant à toute la complexité de la problème.

Dans ce contexte, la thèse vise tout d'abord à fournir une image à jour des perspectives de l'état de l'art du CPSS. Pour répondre aux questions sur la définition d'un CPSS ? Comment le social dimension humaine (c'est-à-dire l'aspect humain) est conceptualisée dans la recherche actuelle du CPSS? Quels sont les domaines d'application du CPSS ? Quels sont les principaux enjeux et défis de la recherche actuelle du CPSS?

(principalement en raison de l'implication active de l'homme). La thèse aborde d'abord ces questions en positionnant sa base scientifique sur des informations et des principes issus d'une littérature systématique. Révision (SLR). Par la suite la thèse cherche à formaliser le concept de Cyber-Physico-Social Système basé sur les conclusions du SLR. Il s'agit principalement d'établir un modèle générique et compréhension indépendante du domaine du CPSS. Deuxièmement, la formalisation vise à refléter une approche plus caractérisation complète des aspects sociaux dans la conception du CPSS.

Sur la base des bases établies à travers la formalisation du CPSS, la thèse se poursuit ensuite la personnalisation comme une direction réalisable pour atteindre les aspects sociaux dans la conception et la mise en œuvre Environnements CPSS. Par conséquent, il offre une approche de

personnalisation dans CPSS qui aborde conjointement les défis de la personnalisation et les complexités découlant des environnements CPSS.

L'aspect pratique de l'approche proposée est illustré par deux études de cas indépendantes. Le premier on présente une recommandation et un accompagnement personnalisés dans le cadre d'une exposition intelligente domaines où comme le second présente l'adaptation de robots collaboratifs (Cobots) dans le contexte réglage d'atelier intelligent. Intrinsèquement, la tâche de personnalisation dans le contexte du CPSS est de nature d'optimisation multi-objectifs car elle tente d'atteindre différents objectifs en parallèle et rend le meilleur compromis possible. En particulier, nous émettons l'hypothèse que l'approche proposée l'introduction de la personnalisation dans le CPSS ouvre de nouvelles perspectives et contribue à la fois dans les domaines du CPSS, et des systèmes de personnalisation/modélisation/recommandation des utilisateurs où les applications au monde physique se sont développées.